

Proceedings



of the I·R·E

A Journal of Communications and Electronic Engineering
(Including the WAVES AND ELECTRONS Section)

May, 1948

Volume 36

Number 5

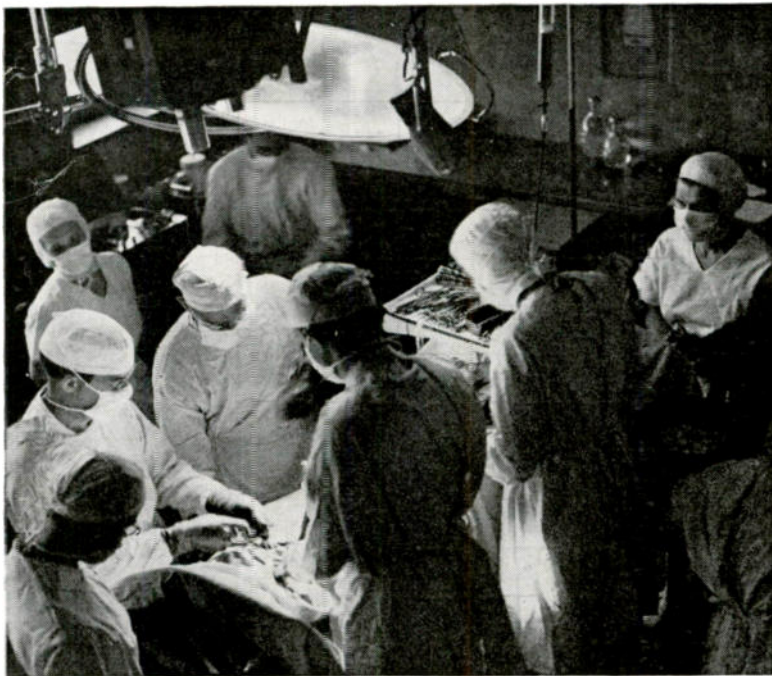

RCA Victor Division

TELEVISION ASEPSIS

An image orthicon television camera and microphone, suspended over the operating table, enable large groups in separate rooms to view clear close-ups of the operating field, and hear comments by the surgeon. Further, the possibility of infection is reduced.

PROCEEDINGS OF THE I.R.E.

Effects of Reproducing System on Tonal-Range Preferences

Experimental Studies of a Remodulating Repeater

Noise Reduction and Range in Radar and Communication

Steady-State and Transient Analysis of Feedback Video Amplifiers

500-Mc. Transmitting Tetrode Design Considerations

The Maximum Directivity of an Antenna

Multifrequency Bunching in Reflex Klystrons

Waves and Electrons Section

Men in Research

Considerations of Moon-Relay Communication

Statistical Methods in Design and Development of Electronic Systems

Microwave Propagation Experiments

A Portable Microwave Communication Set

Abstracts and References

TABLE OF CONTENTS FOLLOWS PAGE 32A

The Institute of Radio Engineers

Important Advances In Radiation Counter Tubes

... by Amperex

Unlimited Life* • Mica Seals Unaffected By Wide Temperature Ranges • Low Operating Voltages • Uniform Characteristics Rugged • Smaller • Thin Mica Windows

AMPEREX End Mica Window types of the Stainless Steel variety for Alpha, Beta, Gamma and X-Ray counting

- Vacuum seal of mica to cathode—thereby eliminating gaskets or organic wax seals, with their resulting defects and inherent limitations
- Uniform characteristics throughout the life of the tube
- Mica windows of uniform thickness

AMPEREX Gamma Ray counter tubes of the Copper Cathode variety

- Sturdy mechanical construction with chemically pure copper cathode
- Uniform characteristics throughout the life of the tube
- Pure tungsten anode held in position by unique spring suspension that prevents sag
- Standard cap anode terminals

AMPEREX

	TUBE TYPE	OVERALL DIMENSIONS (Max. Length x Max. O.D.) IN INCHES	CATHODE DIMENSIONS (Length x O.D. x Wall) IN INCHES	AVERAGE MICA WINDOW THICKNESS IN INCHES	EFFECTIVE DIAMETER OF MICA WINDOW IN INCHES	OPERATING TEMPERATURE RANGE IN DEGREES C	MINIMUM PLATEAU VOLTS	SLOPE OF PLATEAU PER 100 VOLTS	CAPACITY AT TERMINALS MMF.	BACKGROUND COUNTS PER MINUTE (Unshielded)	MINIMUM COSMIC RAY EFFICIENCY	MINIMUM LIFE EXPECTANCY IN COUNTS	OPERATING VOLTAGE D. C.	FILLING
COPPER CATHODE	1E GAMMA	4 $\frac{3}{16}$ x 3 $\frac{3}{16}$	1 $\frac{1}{16}$ x $\frac{1}{2}$ x .020	—	—	-20 to +100	300	2% to 5%	1.5	10	99%	10 ⁸	1150	ARGON PLUS QUENCHING VAPOR
	1M GAMMA	4 $\frac{3}{16}$ x 3 $\frac{3}{16}$	1 $\frac{1}{16}$ x $\frac{1}{2}$ x .020	—	—	0 to +100	500	10%	1.5	2	20%	10 ¹⁰	1400	
	4E GAMMA	7 $\frac{1}{8}$ x 1 $\frac{3}{16}$	3 x 1 x $\frac{1}{16}$	—	—	-20 to +100	300	2% to 5%	2.4	90	99%	10 ⁸	1150	
	4M GAMMA	7 $\frac{1}{8}$ x 1 $\frac{3}{16}$	3 x 1 x $\frac{1}{16}$	—	—	0 to +100	500	10%	2.4	20	20%	10 ¹⁰	1400	
	10E GAMMA	13 x 1 $\frac{3}{16}$	8 x 1 x $\frac{1}{16}$	—	—	-20 to +100	300	2% to 5%	3.6	200	99%	10 ⁸	1150	
	10M GAMMA	13 x 1 $\frac{3}{16}$	8 x 1 x $\frac{1}{16}$	—	—	0 to +100	500	10%	3.6	40	20%	10 ¹⁰	1400	
STAINLESS STEEL CATHODE (END MICA WINDOW)	100C BETA	3 $\frac{3}{4}$ x 1 $\frac{5}{16}$	1 $\frac{1}{2}$ x 1 $\frac{3}{16}$ x $\frac{3}{32}$.0005	1 $\frac{3}{32}$	-70 to +100	300	2% to 5%	1.0	50	—	*Unlimited by Use	1200	ARGON PLUS QUENCHING ADMIXTURE
	120C BETA	5 $\frac{1}{4}$ x 2 $\frac{3}{8}$	2 $\frac{1}{16}$ x 2 x $\frac{5}{64}$.0008	1 $\frac{3}{32}$	-70 to +100	300	2% to 5%	1.0	250	—	*Unlimited by Use	1200	
	150C BETA, GAMMA and X-RAY	6 $\frac{7}{8}$ x 1	4 x $\frac{7}{8}$ x .047	.0005	$\frac{3}{32}$	-70 to +100	300	5%	2.4	62	80%	*Unlimited by Use	1200	
	150M BETA, GAMMA and X-RAY	6 $\frac{7}{8}$ x 1	4 x $\frac{7}{8}$ x .047	.0005	$\frac{3}{32}$	0 to +100	500	10%	2.4	15	20%	10 ¹⁰	1400	ARGON PLUS QUENCHING ADMIXTURE
	200C ALPHA	3 $\frac{3}{4}$ x 1 $\frac{5}{16}$	1 $\frac{1}{2}$ x 1 $\frac{3}{16}$ x $\frac{3}{32}$.0002	1 $\frac{3}{32}$	-70 to +100	300	2% to 5%	1.0	50	—	*Unlimited by Use	1200	
	100N BETA	3 $\frac{3}{4}$ x 1 $\frac{5}{16}$	1 $\frac{1}{2}$ x 1 $\frac{3}{16}$ x $\frac{3}{32}$.0005	1 $\frac{3}{32}$	-70 to +100	100	5%	1.0	50	80%	*Unlimited by Use	450	
	150N BETA and GAMMA	6 $\frac{7}{8}$ x 1	4 x $\frac{7}{8}$ x .047	.0005	$\frac{3}{32}$	-70 to +100	100	5%	2.4	62	80%	*Unlimited by Use	450	

NOTE: All tubes listed have a dead time of 200 microseconds

.0002 in. = 1.4 mg/cm² = 5.08 microns .0005 in. = 3.5 mg/cm² = 12.70 microns .0008 in. = 5.6 mg/cm² = 20.32 microns

Also Available, TUBES FOR EXPERIMENTAL AND SPECIAL APPLICATIONS



- Self-quenching counters with operating voltages as low as 250 volts . . .
- Temperature-free counters that may be operated in the range from -70° C. to +120° C . . .
- Extra large volume Cosmic Ray counters, with overall lengths of 42" and larger, with I.D. to 3 $\frac{1}{4}$ " and larger . . . also extra small End Mica Window counters, $\frac{1}{4}$ " diameter by 1" long . . . and smaller

re-tube with Amperex

Write for Technical Rating and Data Sheets.

AMPEREX ELECTRONIC CORP.

25 WASHINGTON STREET, BROOKLYN 1, N. Y.
In Canada and Newfoundland: Rogers Majestic Limited
11-19 Brentcliffe Road, Leaside, Toronto, Ontario, Canada



Erie "GP" Ceramicons*

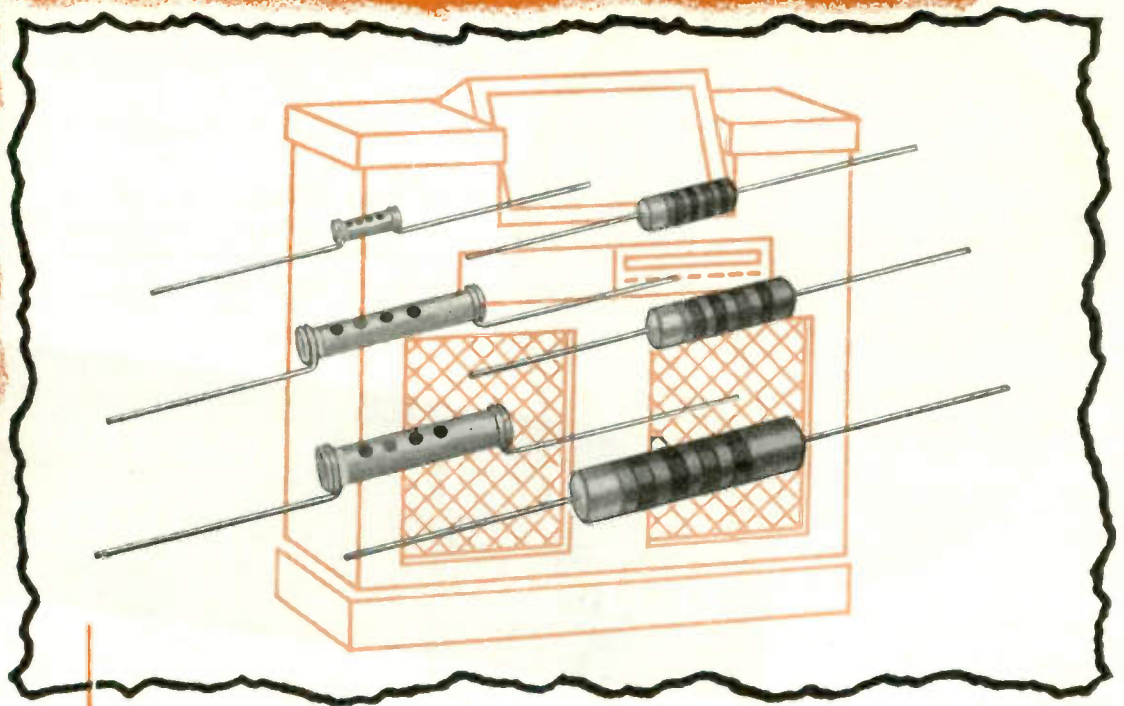

Going Places ... in FM and Television

The basic, simple construction of ERIE "GP" Ceramicons give them higher resonant frequencies, which make them the ideal condensers for FM and Television applications.

The same basic, simple construction makes possible the mass production which accounts for the surprisingly economical cost of high quality condensers. They are designed for practically all applications in which the condenser is not definitely frequency determining.

ERIE "GP" Ceramicons are not only cheaper to buy—they are cheaper to use than other types of condensers. Their wide range of adaptability reduces the number of condensers necessary to stock. Their compact tubular form and their sturdy construction make them easy to install on the assembly line.

ERIE "GP" Ceramicons are made in insulated styles in popular capacity values up to 5,000 MMF, and in non-insulated styles up to 10,000 MMF. If you are not already using them, write for detailed information.



*Ceramicon is the registered trade name of silvered ceramic condensers made by Erie Resistor Corporation.

Electronics Division

ERIE RESISTOR CORP., ERIE, PA.

LONDON, ENGLAND • TORONTO, CANADA

PROCEEDINGS OF THE I.R.E., May, 1948, Vol. 36, No. 5. Published monthly in two sections by The Institute of Radio Engineers, Inc., at 1 East 79 Street, New York 21, N.Y. Price \$1.50 per copy. Subscriptions: United States and Canada, \$12.00 a year; foreign countries \$13.00 a year. Entered as second class matter, October 26, 1927, at the post office at Menasha, Wisconsin, under the act of March 3, 1879. Acceptance for mailing at a special rate of postage is provided for in the act of February 28, 1925, embodied in Paragraph 4, Section 412, P. L. and R., authorized October 26, 1927.

Table of contents will be found following page 32A



The **TYPE E** potentiometer is rated at 7 watts. Widely used in precision instruments, resistance bridges and other circuits requiring accurate settings. Diameter 2 $\frac{3}{4}$ ".

What Do They Have That is Different... and Better?

Plenty! All Mallory wire-wound controls are designed for maximum heat dissipation. In addition, the M and E types are metal-enclosed to provide electrostatic shielding.

Then, too, they're tapered with extreme accuracy (linear taper tolerance is within 3%). Wire size is carefully controlled, too, to provide smooth, noiseless operation between tapers. What's more, control dimensions are strictly streamlined. They're kept as compact as possible, resistance value and wattage dissipation considered.

Finally, they have numerous individual features—a feature of the M and C type controls, for example, being a unique spring wedge that maintains constant pressure between silver-plated terminals and silver contacts.

What it all adds up to is *more for your money*—good engineering coupled with rugged construction that are the natural concomitants of Mallory leadership. See your Mallory distributor, or consult us, *while your designs are still in the blue print stage.*

YOU EXPECT MORE AND GET MORE FROM MALLORY

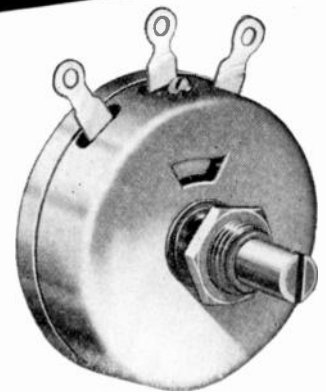

TYPE M potentiometers and rheostats have a normal rating of 4 watts, are insulated for 1,000 volt DC breakdown to ground, and are also available in a complete line of T and L Pad Attenuators. Diameter 1 $\frac{1}{2}$ ".

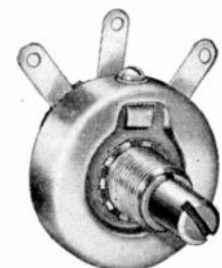

TYPE C control is the smallest 2 watt wire-wound variable resistor made. Ideal for meter compensators, miniature motor controls and light dimmers. Diameter 1 $\frac{1}{4}$ ".

P. R. MALLORY & CO. Inc.
MALLORY RESISTORS
 (FIXED AND VARIABLE)

P. R. MALLORY & CO., Inc., INDIANAPOLIS 6, INDIANA

YOU CAN CONTROL MULTI-TOWER ARRAYS THIS SIMPLE WAY

1 Use one Antenna Control Unit for two towers



The Western Electric 33C Antenna Control Unit includes a branching circuit and two phase shifters, and permits adjustment of the current ratio and phase relation between the element currents of two towers. This unit handles up to 10 kw.

2 Add a compact Phase Control Unit for each additional tower

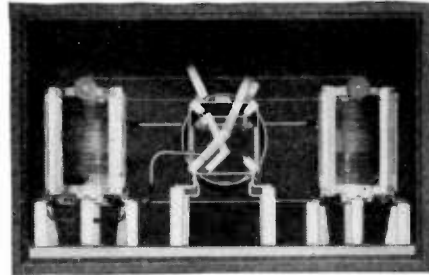

Does your pattern call for an array of 4 or even 6 towers? Then merely order the necessary number of compact 34A Antenna

Phase Control Units to be connected to taps on the branching transformer of the 33C. The 34A handles up to 10 kw.

TYPICAL CIRCUIT DIAGRAM SHOWING TWO 34A ANTENNA PHASE CONTROL UNITS CONNECTED TO BRANCHING TRANSFORMER OF 33C ANTENNA CONTROL UNIT FOR CONTROL OF 4-TOWER ARRAY. ADDITIONAL 34A'S MAY BE CONNECTED AS NEEDED FOR AS MANY AS 6 TOWERS.

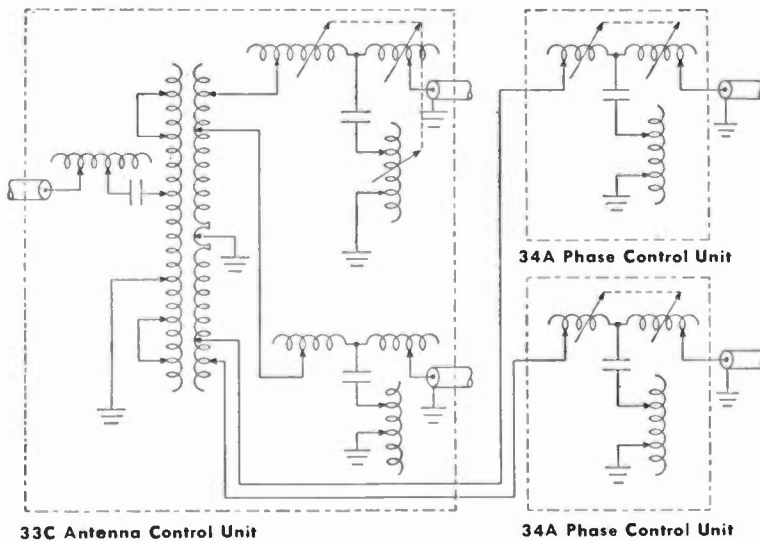

You can use Western Electric Antenna Control Equipment to good advantage in controlling current ratios and phase relationships. The master 33C Antenna Control Unit is styled to harmonize with cabinet design of Western Electric AM Transmitters. The 34A Phase Control Unit measures only 2' high, 3'7" wide, 2' deep, and requires no front-of-panel line-up space.

- QUALITY COUNTS -

For complete information on Western Electric Antenna Control Equipment, send the coupon below.

Graybar Electric Company, P-37
420 Lexington Avenue, New York 17, N. Y.

Gentlemen: Please send me Bulletin T-2513, Western Electric Antenna Control Equipment.

Name _____
Company _____
Address _____
City _____ State _____



Western Electric

DISTRIBUTORS: IN THE U. S. A. -
Graybar Electric Company, IN
CANADA AND NEWFOUNDLAND -
Northern Electric Company, Ltd.

See why Leaders in

TELEVISION

choose

MYCALEX 410

insulation

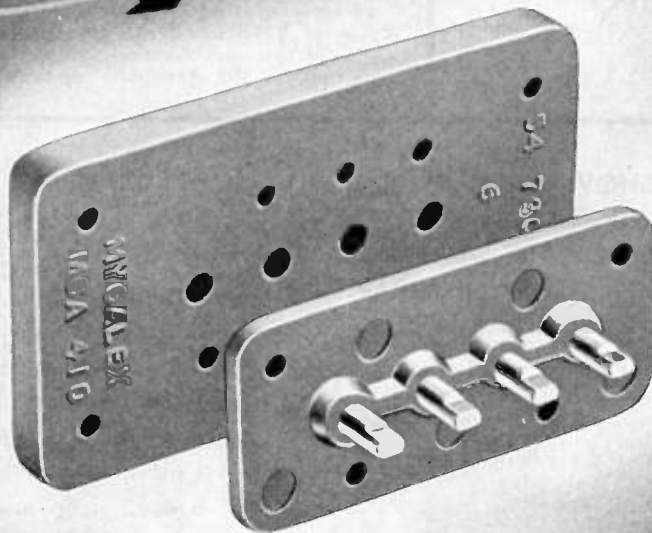

In television seeing is believing . . . and big name makers of television sets are demonstrating by superior performance that MYCALEX 410 molded insulation contributes importantly to faithful television reception.

Stability in a television circuit is an absolute essential. In the station selector switch used in receivers of a leading manufacturer, the MYCALEX 410 molded parts (shown here) are used instead of inferior insulation in order to avoid drift in the natural frequency of the tuned circuits. The extremely low losses of MYCALEX at television frequencies and the stability of its properties over extremes in temperature and humidity result in dependability of performance which would otherwise be unattainable.

Whether in television, FM or other high frequency circuits, the most difficult insulating problems are being solved by MYCALEX 410 molded insulation . . . exclusive formulation and product of MYCALEX CORPORATION OF AMERICA. Our engineering staff is at your service.

Specify MYCALEX 410 for:

1. Low dielectric loss
2. High dielectric strength
3. High arc resistance
4. Stability over wide humidity and temperature changes
5. Resistance to high temperatures
6. Mechanical precision
7. Mechanical strength
8. Metal inserts molded in place
9. Minimum service expense
10. Cooperation of MYCALEX engineering staff

MYCALEX CORP. OF AMERICA

"Owners of 'MYCALEX' Patents"

Plant and General Offices, CLIFTON, N. J.

Executive Offices, 30 ROCKEFELLER PLAZA, NEW YORK 20, N. Y.



Traffic is heavy under the street, too

Surely the busiest thoroughfare in the world is a telephone cable. But it is more than "telephone"; for these thousand or more wires, carrying sound and pictures at lightning speed, are highways for many different services.

Each one of these presents its own problems to Bell Laboratories scientists and engineers: for the telephone differs from television, and television differs from a radio program. And yet they have an essential unity: they

involve transmission of alternating currents, with frequencies from zero up to several million cycles. Each calls for new thinking, new ideas, new goals of accomplishment.

The diversity of the cable's many services speaks for the unity of Bell Laboratories' purpose. That is, to know the theory of communication so thoroughly, to practice the art so skilfully, that any transmission of sight or sound can reach its destination clearly, quickly, economically.

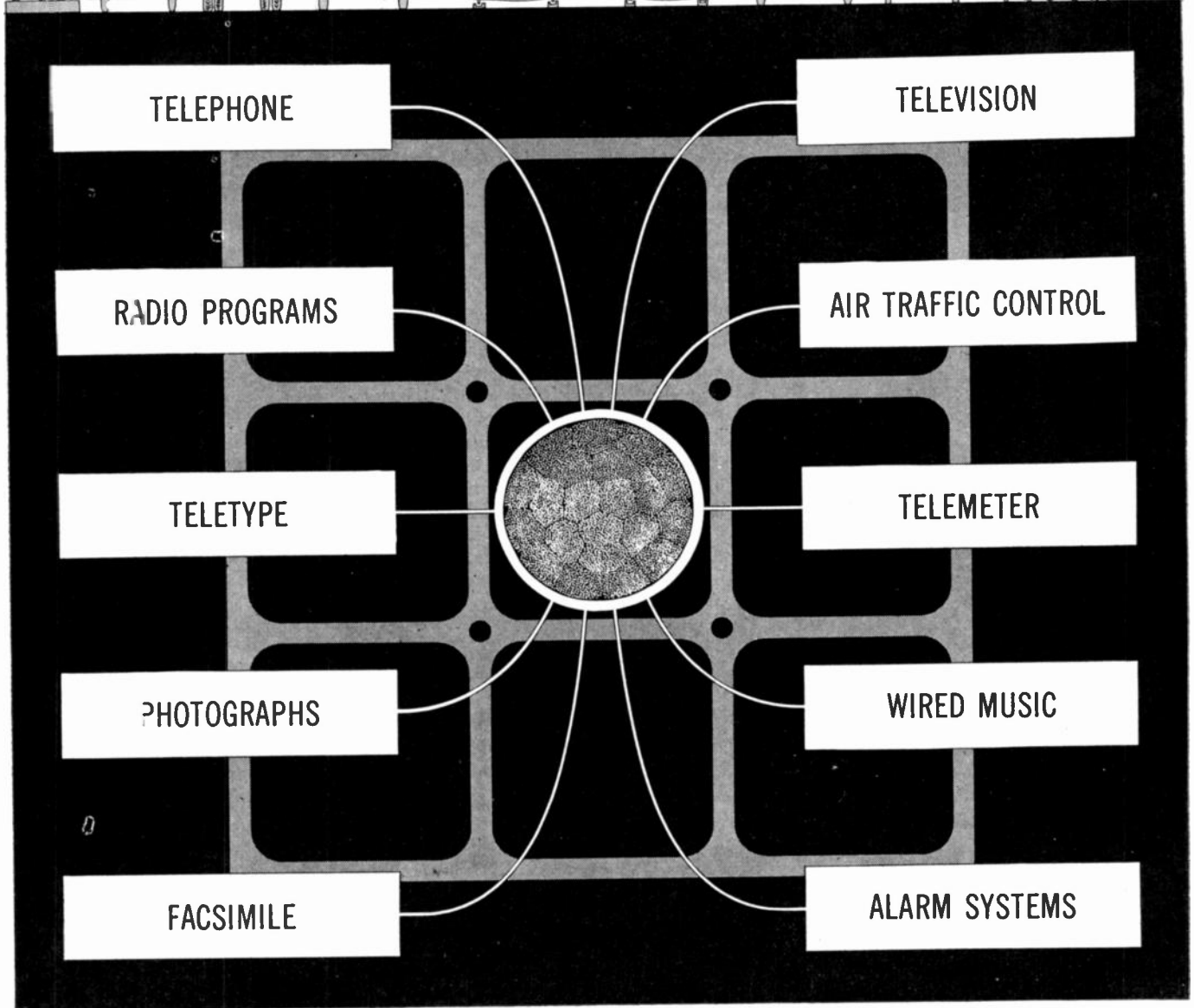
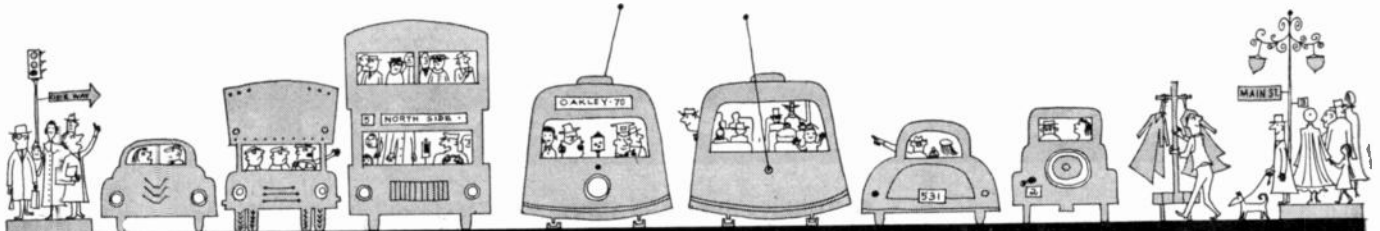

BELL TELEPHONE LABORATORIES

Exploring and inventing, devising and perfecting for continued improvements and economies in telephone service



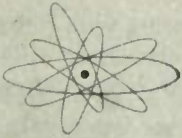

Designers

RELAYS ... for any duty, any duty cycle

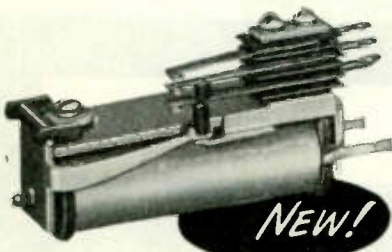

COMMUNICATIONS AND SIGNALING Designed specifically for use in industrial electronic equipment, communications and signaling equipment, this General Electric telephone-type relay has a service life measured in many millions of operations. Working from five basic contact arrangements, combinations can be stacked to satisfy intricate circuit switching requirements.

Welded-crossbar palladium contacts, new-type molded insulation and stainless steel bearings contribute to this d-c relay's longevity. Coils rated 1 to 250 volts, 0.1 to 26,000 ohms; contacts 3 amps maximum. Bulletin GEA-4859.

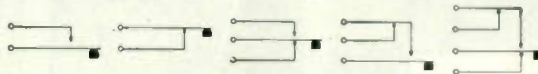

VENDING MACHINES AND DISPENSERS

Designers of coin changers, coin-operated phonographs, drink dispensers, and similar automatic devices will soon be familiar with G.E.'s new appliance relay, an inexpensive multi-contact unit. Featuring quiet operation, reliability and compactness, the CR2790G relay is available in ratings of 24 and 115 volts a-c, 24 volts d-c, 5 amps continuous. Bulletin GEA-4864.

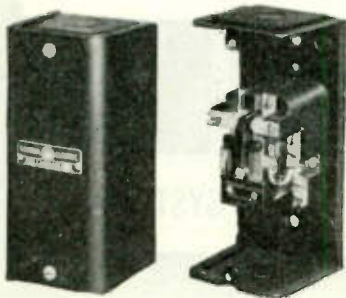
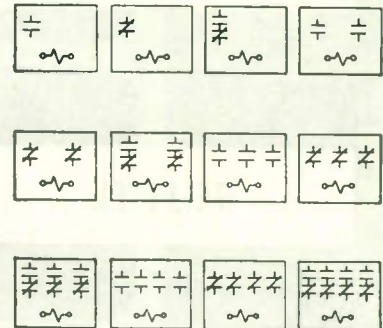

HEAVY-DUTY GENERAL-PURPOSE

Three contact arrangements—spst, dpst, and dpdt—plus four mounting arrangements give the CR2790E real versatility. Mounting arrangements available are the enclosed form shown here, open form, back-connected form for panel mounting, and a plug-in form for use in process control equipment.

Its heavy silver contacts are rated 10 amps continuous at 115/230 volts, 60 cycles; normally open contacts will make and break 45 amps, normally closed contacts 20 amps. Bulletin GEC-257 gives full details.



Digest

TIMELY HIGHLIGHTS ON G-E COMPONENTS



DYNAMOTORS FOR QUICK DELIVERY!

Shopping for fractional-hp dynamotors? General Electric can now supply you on a short-shipment basis! Production has finally caught up on these d-c

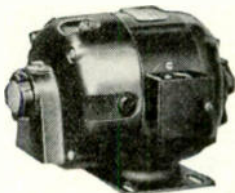

to a-c converters for communications service. Standard dynamotors are available in ratings of 200 and 500 volt-amperes, 60 cycles, continuous duty. Specials are also available, but on a slightly longer shipment. For more complete information on these fhp equipments, contact your G-E representative or write Fractional-horsepower Motor Div., General Electric Co., Fort Wayne, Indiana.

MORE PULL IN LESS SPACE

You'll find these new, small, all-welded solenoids useful in any application where a straight-line thrust is required... they're a natural for vending machines. The small unit requires only three cubic inches of space, and develops 0.26 pounds pull at 1/4-inch stroke; its "big brother" produces 3.7 pounds at 3/4-inch stroke.

Brazed-in pole shaver increases efficiency, insures quiet operation. Varnish-impregnated coil provides high resistance to shock, splashing water, oil. Check Bulletin GEA-4897.

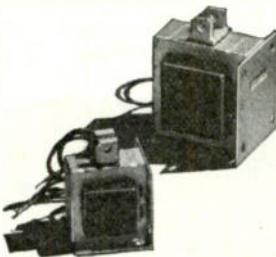

SHOW IT, THEN THEY'LL KNOW IT

If your organization has an educational program underway, or plans one, ask your G-E representative to show you the Industrial Electronics Training Course. Rated tops in visual training by the nation's industrials, schools and institutions now using it, the complete kit contains twelve half-hour slide films with records, individual lesson guides keyed to the film, and a manual for the course instructor.

Everything from fundamental electronics to up-to-the-minute electronic



production tools are forcefully described and explained in this easy-to-take visual course. Check Bulletin GES-3303.

NEED SOMETHING SPECIAL IN CAPACITORS?

Here's a new .0075-muf, 10-kv d-c capacitor for television, precipitation, and similar electronic equipment requiring filtering in high-voltage power supply. Other capacitances (.0005 to .01 muf) and voltages (3 to 30 kv) can be supplied.

Ceramic container acts as insulator, simplifies mounting, cuts size (volume) to 1/5th without lowering quality in any

way. Ingenious internal hermetic silicone seal eliminates solder. Pyranol filled. Contact your G-E representative or write Transformer Div., General Electric Co., Pittsfield, Mass., for quotation.



LOOKING FOR PERMANENT MAGNET DATA?

These two new bulletins are packed full of application and design information to help you build magnets into your electronic equipment. CDM-1 covers "Permanent Magnets"; CDM-2 describes "Cast and Sintered Alnico Magnets." Coupon below will bring this valuable information to your desk quickly. Check it now.

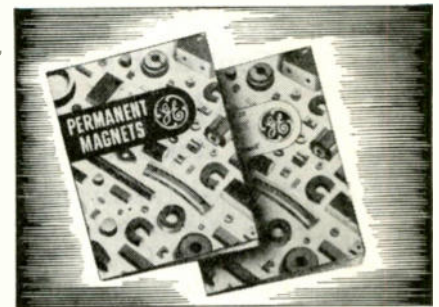

GENERAL ELECTRIC COMPANY, Section C 642-17
Apparatus Department, Schenectady, N. Y.

Please send me the following bulletins:

- | | |
|--|---|
| <input type="checkbox"/> GEA-4859 Telephone-type Relay | <input type="checkbox"/> GES-3303 Electronics Training Course |
| <input type="checkbox"/> GEA-4864 Appliance Relay | <input type="checkbox"/> CDM-1 Permanent Magnets |
| <input type="checkbox"/> GEC-257 General-purpose Relay | <input type="checkbox"/> CDM-2 Cast & Sintered Alnico Magnets |
| <input type="checkbox"/> GEA-4897 Solenoids | |

Name.....

Company.....

Address.....

City..... State.....

PROGRESS REPORT ON P.E.C.*

How Sickles engineers
put Centralab's "Filpec"
to work
to save space, save weight
on miniature
I. F. Transformers

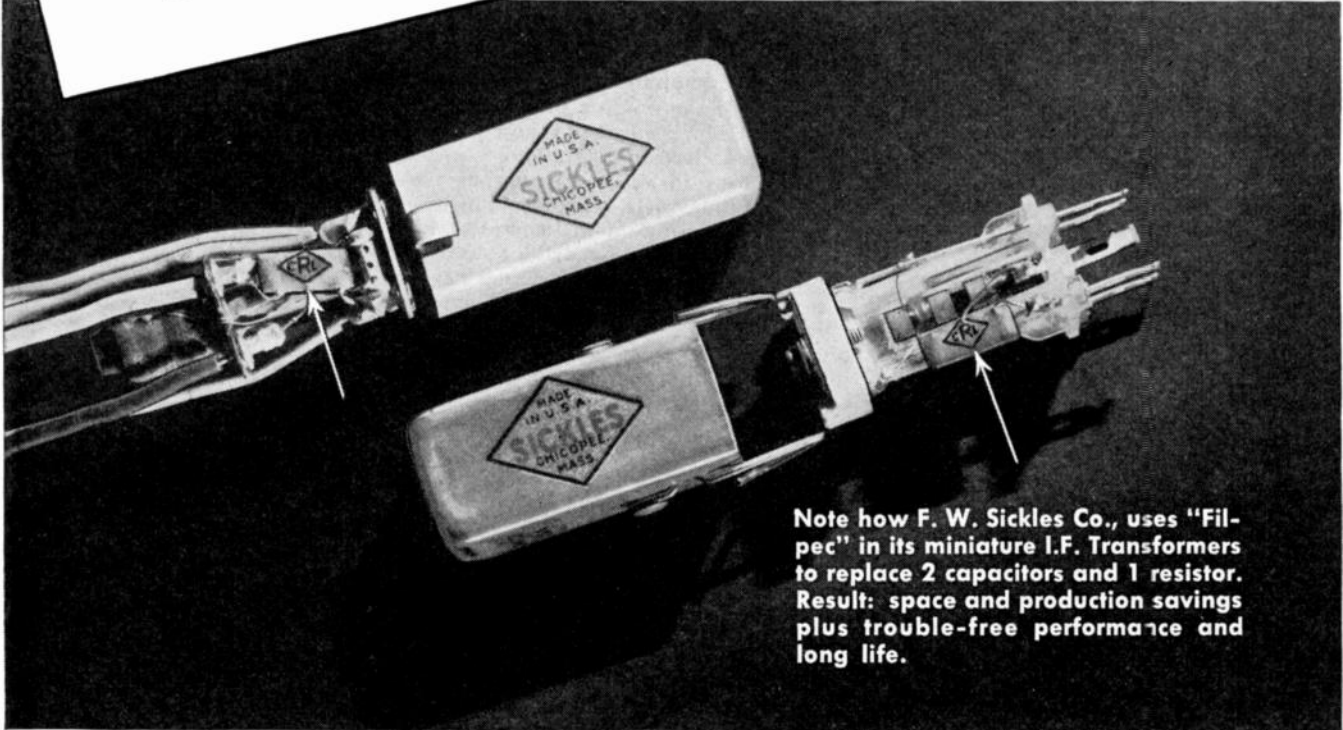

Note how F. W. Sickles Co., uses "Filpec" in its miniature I.F. Transformers to replace 2 capacitors and 1 resistor. Result: space and production savings plus trouble-free performance and long life.

Transformers courtesy of F. W. Sickles Co.

***Centralab's revolutionary Printed Electronic
Circuit — Industry's newest method
for stepping-up manufacturing efficiency!**

COMPARE THE SAVINGS in size and weight which Centralab's new printed electronic circuit filter gives you, and you'll see why F. W. Sickles Co., Chicopee, Mass. is taking advantage of it in its new miniature I.F. Transformers. And that's not all: Centralab's *Filpec* can be soldered into place easily and quickly without tricky bending or fitting, assures more dependable performance, as well as a reduction of line operations.

Secret of *Filpec's* amazing performance is its integral ceramic construction which combines two capacitors and one resistor into one tiny balanced load filter unit, saves space, cuts inventory, and is highly adaptable to a variety of circuits. Capacitor values 50 to 200 mmf. Resistor values from 5 ohms to 5 megohms. Resistance rating: 1/5 watt 100 WVDC. Flash test 200 VDC. For complete information about *Filpec* see your Centralab representative, or write for Bulletin 976.

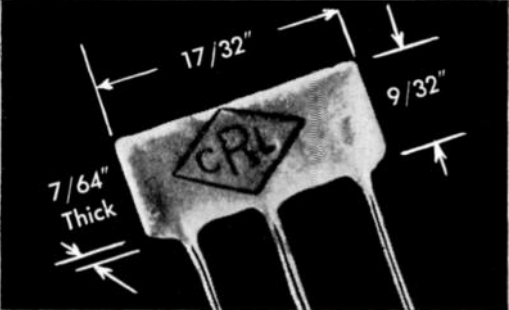

"Filpec" gives you integral construction! Made with high dielectric Ceramic-X, CRL's *Filpec* assures long life, low internal inductance, resistance to humidity and vibration. Note schematic diagram below, showing typical application.

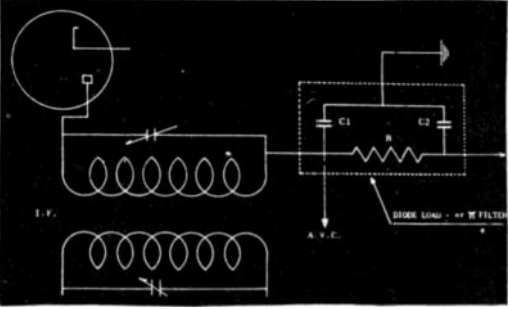

LOOK TO **Centralab** IN 1948!
Division of GLOBE-UNION INC., Milwaukee

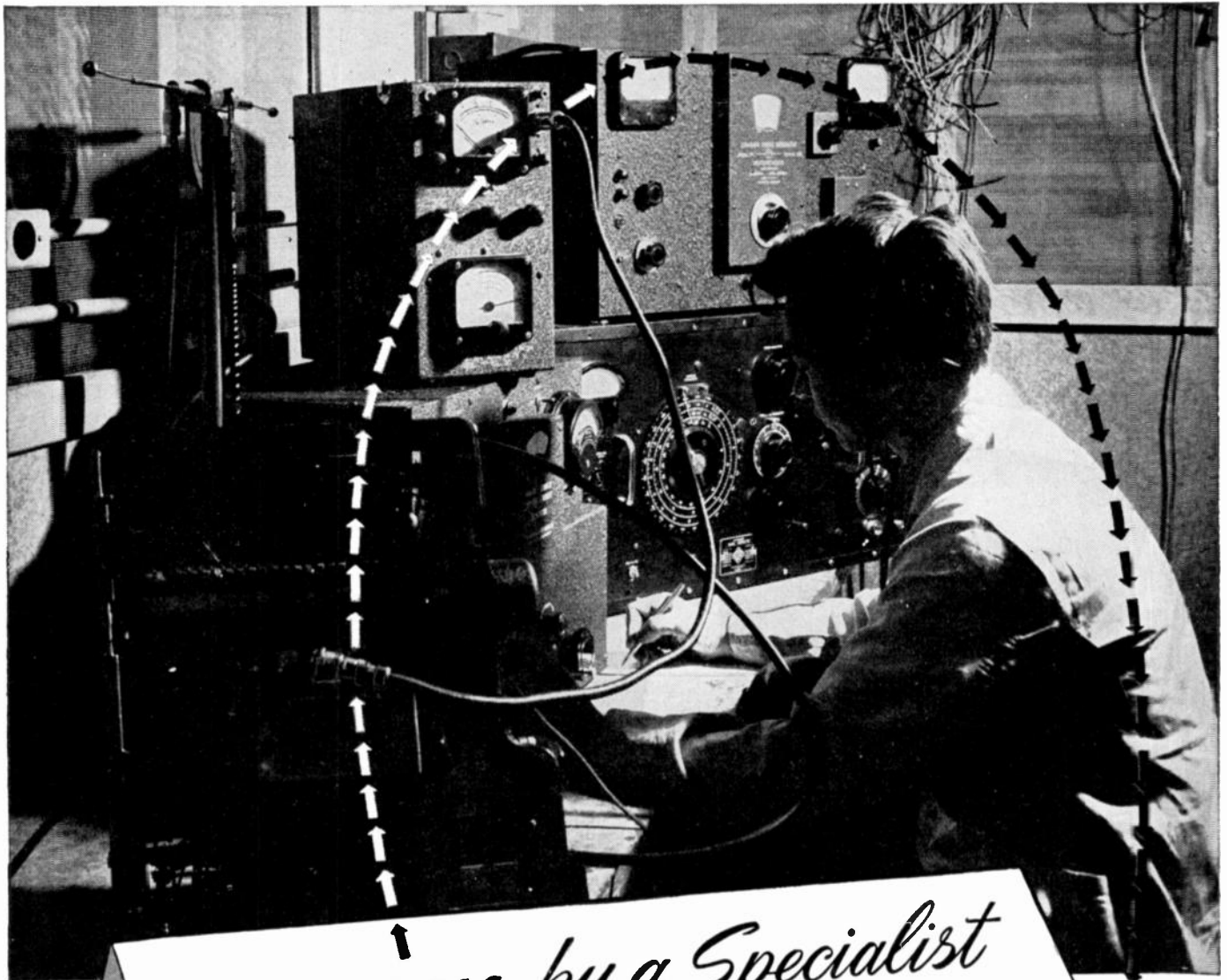

DIAGNOSIS *by a Specialist*

THE CURE OF RADIO NOISE is a highly specialized task that involves much more than simply "hooking a condenser across the line". It requires exact knowledge of the proper size and type of capacitor to use . . . of the correct place to add it to the noise-making circuit . . . of the necessary length or positioning of connecting leads . . . and of many other seemingly trivial, but actually vital, bits of information that cannot rightfully be expected of the electrical design engineer.

This exact knowledge is available to you when you must provide radio silence for electrical apparatus. Just send us the offending equipment and we will measure its radio noise output according to standard specifications, will design the most efficient Filterette to cure the noise, will specify the proper means of installing it, and, upon your adoption of our recommendations, will authorize your use of the FILTERIZED label that tells buyers your apparatus will not interfere with radio reception. This service is free to users of Tobe Filterettes . . . write for details.

TOBE DEUTSCHMANN CORPORATION NORWOOD, MASSACHUSETTS

ORIGINATORS OF FILTERETTES . . . THE ACCEPTED CURE FOR RADIO NOISE



Larvie

UHF PRECISION INSTRUMENTS



HARMONIC FREQUENCY GENERATOR

PROVIDES output voltages in 10 or 40 megacycles with CRYSTAL-CONTROLLED accuracy.

SELECTS 10 or 40 megacycle series by means of front panel switch.

IDENTIFIES any one of these harmonics by means of a Frequency Identifier* which consists of a filter providing high attenuation of all voltages except that of frequency to be identified.

USED FOR calibration of receivers, wavemeters, or (with Beat Detector built into instrument) for calibration of oscillators and signal generators

* Specify frequency.



PRECISION FREQUENCY METER

Completely portable Accuracy 0.1%
Battery or AC-Operated

Models available from 100 to 1500 megacycles with 2 to 1 frequency coverage on each model. Available only on high priority while nation is at war.

RECOMMENDED FOR:

- Production testing
- Measurement of oscillator drift
- Independent alignment of transmitters and receivers
- Precise measurements of frequencies

FULL DETAILS ON REQUEST



Larvie Laboratories

RADIO ENGINEERS AND MANUFACTURERS

MORGANVILLE, N. J.

Specialists in the Development of UHF Equipment



May, 1948

Distortion and Noise Meter

A new distortion and noise analyzer for broadcast, television, research, and development applications has been announced by the Specialty Division, General Electric Co., at Syracuse, New York. Combining four basic functions, the unit will measure percentage distortion down to 0.1%, measure the hum or noise present on an audio signal, act as a high-sensitivity vacuum-tube voltmeter, and perform as a frequency meter over the range of 50 to 15,000 c.p.s.

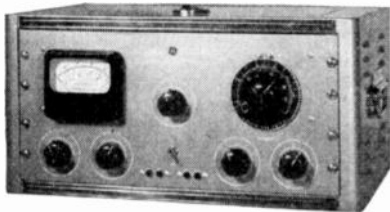

Distortion ranges of 1, 3, 10, 30, and 100% full scale are provided. The noise range is from +2 to -80 db. The noise frequency bandwidth is 30 to 30,000 c.p.s. on 600 ohms balanced input, and 30 to 75,000 c.p.s. on 100,000 ohms unbalanced input. When used as a vacuum-tube voltmeter, the same db range is used, corresponding to inputs between 1 volt and 80 microvolts, and bandwidths are the same as for noise measurements. Frequency can be measured between 50 and 15,000 c.p.s. in five ranges.

This analyzer, Type YDA-1, weighs approximately 45 pounds, and measures 21 x 10 1/2 x 15 inches. It may be mounted outside its case on any standard 19-inch rack.

D.C. Timing Motors

A new series of low-current, high-impedance timing motors has been announced by A. W. Haydon Co., Waterbury, Conn. The motors are matched to receiving tubes, and by operating over a period of time through the enclosed gearing, they will integrate the very small instantaneous energy input from the tubes and perform almost any desired amount of work. Connected in the plate circuit, the motors permit translation of a minute electrical function into a large amount of work without the use of thyatron or other power equipment.

Each motor requires less than 270 milliwatts power input, drawing approximately 6 milliamperes at 45 volts d.c. It has a totally enclosed gear train, and speeds are 3200 r.p.m. down to 4 revolutions an hour. It is only 2 1/2 x 2 1/2 x 1 1/2 inches and weighs 6 ounces. By its use, designers of electronic equipment can simplify circuit layouts for automatic radio-frequency controls, self-seeking control devices, sensitive power relays, and photoelectric controls.

These manufacturers have invited PROCEEDINGS readers to write for literature and further technical information. Please mention your I.R.E. affiliation.

D.C. Microammeter

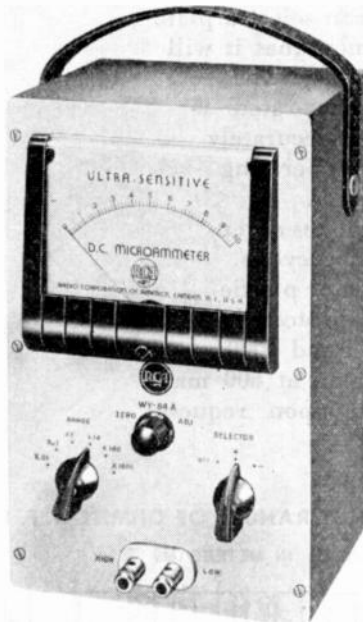

A new ultrasensitive electronic microammeter, capable of accurately measuring d.c. currents down to one-billionth of an ampere, has been designed by the Tube Department, Radio Corp. of America, Harrison, N. J. It is a portable, battery-operated, vacuum-tube meter, whose usefulness extends to all fields. Current ranging from 0.001 to 1000 microamperes can be measured with the instrument, which has six range settings permitting a choice of the most convenient range. The current sensitivity approaches that of a reflecting galvanometer. An important feature is its capability of withstanding accidental overloads of 10,000% without damage to the meter movement.

By adding suitable external multiplier resistors, the microammeter can be converted to an extremely high-resistance voltmeter. On the lowest range, this gives the instrument an input resistance of 100 megohms per volt, providing an almost perfect method for measuring voltages with unusually low current drain. The microammeter can also be used as a high-range ohmmeter when connected to a suitable power supply. For example, when used with a 45-volt battery, the instrument will measure resistances as high as 4500 megohms, and can be used to measure leakage resistance of insulation.

Cathode-ray Oscilloscope

A new oscilloscope of exceptional performance for industrial and radio applications is available from FURZEHILL LABORATORIES of England.



Equipped with high-gain amplifiers for both axes, it has a separate sync amplifier, time-base circuit, and two electronically stabilized power supplies. A 3 1/2-inch fine-focus tube is used, and all normal operating controls and connections are on the front panel. The gun, modulator and deflector plates are available at terminals at the rear of the instrument. Particularly valuable features are the instantaneous shifts, controllable expansion of the time-base sweep independent of frequency, and negligible phase-shift over the entire range from zero to 3 Mc.

The first models have recently arrived in this country and information may be obtained from AMERICAN BRITISH TECHNOLOGY INC., 57 Park Avenue, New York 16, N. Y.

Wire Shielding

Mild steel, spring steel, copper, or brass, with plain or tinned finish, provide the economy, springiness, or corrosion resistance inherent in the improved flat-wire Monocoil casing now in production by Elliott Manufacturing Co., Binghamton, N. Y.

Uses are in installations where it is necessary to shield wiring electrically and mechanically to avoid interference with radio circuits. The casing has smooth inner and outer surfaces and can accommodate single or multiple wires. A special bulletin explaining features and application, together with samples, will be supplied by the manufacturer upon request.

NOTICE

Information for our News and New Products section is warmly welcomed. News releases should be addressed to Industry Research Division, Proceedings of I.R.E., Room 707, 303 West 42nd St., New York 18, N.Y. Photographs, and electrotypes if not over 2" wide, are helpful. Stories should pertain to products of interest specifically to radio engineers.

(Continued on page 24A)

OHMITE plate chokes

“FREQUENCY-RATED” for easy selection and top performance

● Now, for the first time, you can select a plate choke for a particular frequency and know that it will give excellent performance at this frequency. The Ohmite line of plate chokes are “frequency-rated”—their frequency characteristics have been accurately predetermined. The chart below gives the operating frequency range for each of the seven sizes.

Ohmite single-layer wound, r.f. plate chokes cover the entire frequency range of 3 to 520 megacycles. These chokes are wound on low power factor plastic or steatite cores, and are insulated and protected by a moistureproof coating. All chokes are rated 1000 ma except the Z-14 and Z-28, which are rated at 600 ma. Further information will be supplied upon request.

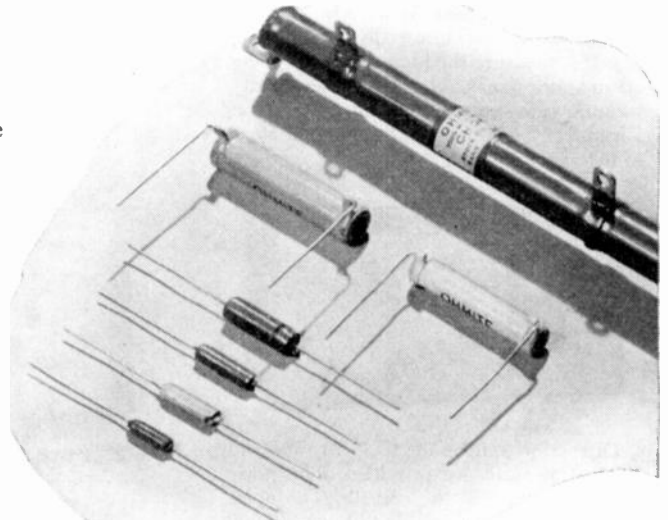

RECOMMENDED OPERATING FREQUENCY RANGES OF OHMITE R. F. PLATE CHOKES

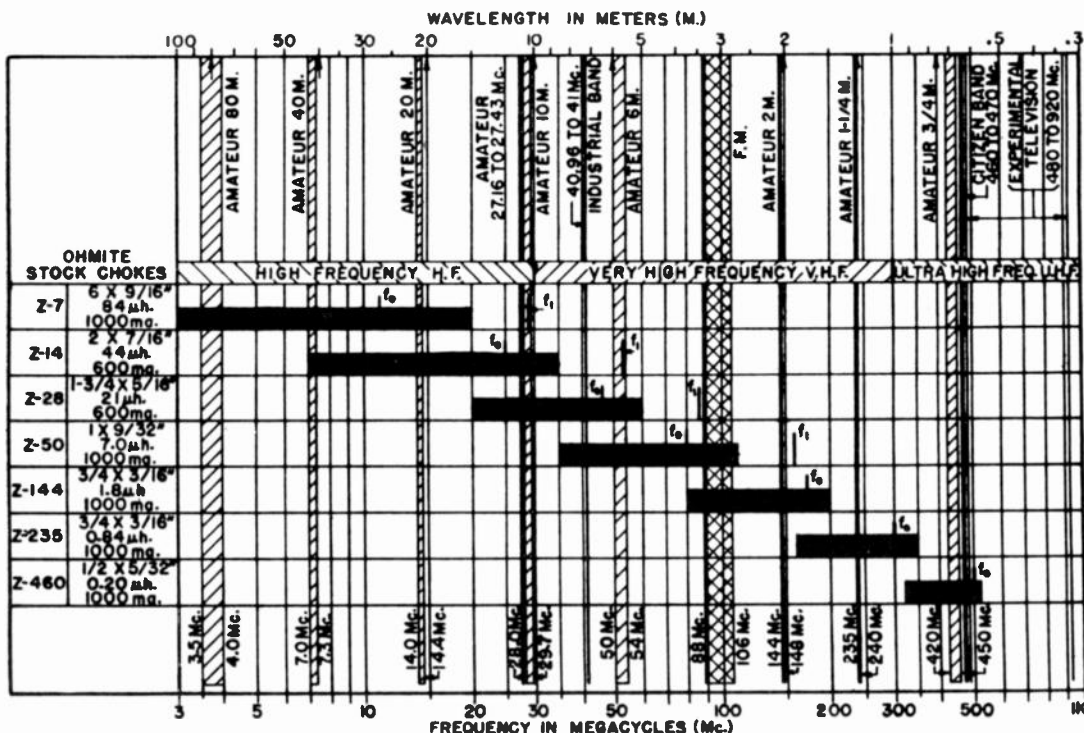

WRITE FOR
PLATE CHOKES
BULLETIN
No.
133.



OHMITE
MANUFACTURING
COMPANY

4861 Flournoy St.,
Chicago 44, Ill.



Be Right with...

OHMITE

RHEOSTATS • RESISTORS • TAP SWITCHES • CHOKES

SELECT from the

Techniquality

GROUP

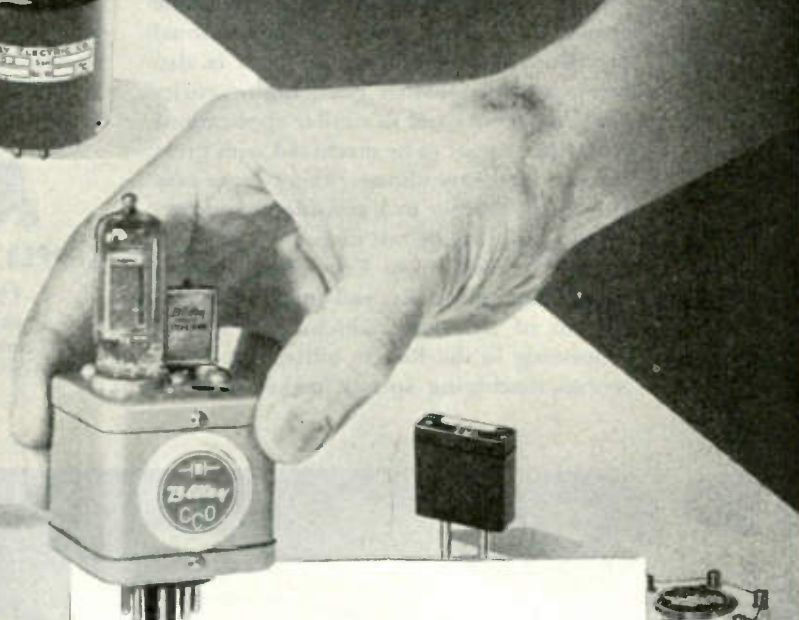

Bliley CRYSTALS

Many Bliley crystal units are first produced on a custom-built basis for special application. Quite often these designs contain outstanding features that are desirable in many applications and when this occurs the unit is included in our catalog listing. Our Bulletin 36 contains 22 standard crystal units, all widely used in commercial and governmental applications.

Bliley engineers are constantly utilizing

our many years of specialized experience to solve new frequency control problems. If you have a frequency control application, whether standard or specialized, we can probably come up with the right answer. Remember to specify Bliley TECHNICALITY crystals for greater accuracy, stability, quality, and advance design.

WRITE FOR YOUR COPY OF BULLETIN 36

BLILEY ELECTRIC COMPANY • UNION STATION BUILDING • ERIE, PENNSYLVANIA

REVERE FREE-CUTTING COPPER ROD

... INCREASES ELECTRONIC PRODUCTION

SINCE its recent introduction, Revere Free-Cutting Copper has decisively proved its great value for the precision manufacture of copper parts. Uses include certain tube elements requiring both great dimensional precision, and exceptional finish. It is also being used for switch gear, high-capacity plug connectors and in similar applications requiring copper to be machined with great accuracy and smoothness. This copper may also be cold-upset to a considerable deformation, and may be hot forged.

Revere Free-Cutting Copper is oxygen-free, high conductivity, and contains a small amount of tellurium, which, plus special processing in the Revere mills, greatly increases machining speeds, makes possible

closer tolerances and much smoother finish. Thus production is increased, costs are cut, rejects lessened. The material's one important limitation is that it does not make a vacuum-tight seal with glass. In all other electronic applications this special-quality material offers great advantages. Write Revere for details.

REVERE

COPPER AND BRASS INCORPORATED

Founded by Paul Revere in 1801

230 Park Avenue, New York 17, New York
Mills: Baltimore, Md.; Chicago, Ill.; Detroit, Mich.; New Bedford, Mass.; Rome, N. Y.—Sales Offices in Principal Cities, Distributors Everywhere.

CUSTOMERS REPORT:

"This material seems to machine much better than our previous hard copper bar: it cuts off smoothly, takes a very nice thread, and does not clog the die." (Electrical parts.)

"Increased feed from 1-1/2" to 6" per minute and do five at one time instead of two." (Switch parts.)

"Spindle speed increased from 924 to 1161 RPM and feed from .0065" to .0105" per spindle revolution. This resulted in a decrease in the time required to produce the part from .0063 hours to .0036 hours. Material was capable of faster machine speeds but machine was turning over at its maximum. Chips cleared tools freely, operator did not have to remove by hand." (Disconnect studs.)

Include El-Menco Components in Your Products...

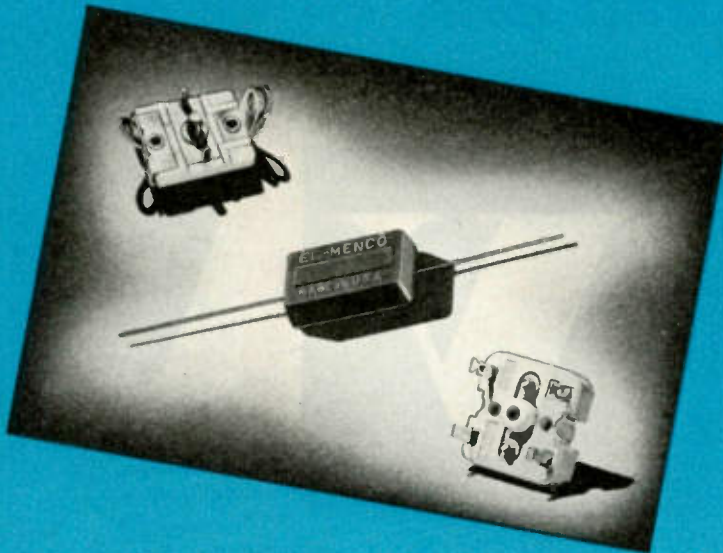

Insure "Product Performance" as Specified

The use of El-Menco Capacitors and Silvered Mica Films throughout the electronics industry is proof of El-Menco dependability. These components are worthy of your name . . . they contribute quality and reliability . . . add performance prestige to your product.

MANUFACTURERS

Our silver mica department is now producing silvered mica films for all electronic applications. Send us your specifications.

JOBBER AND DISTRIBUTORS
ARCO ELECTRONICS
135 Liberty St., New York, N. Y.
is Sole Agent for El-Menco Products
in United States and Canada.

Send for samples and complete specifications. Foreign Radio and Electronic Manufacturers communicate direct with our Export Department at Willimantic, Conn., for information.

The Electro Motive Mfg. Co., Inc.
Willimantic, Connecticut

MOLDED MICA

EL-Menco

MICA TRIMMER

CAPACITORS

AM

FM

and now

TV

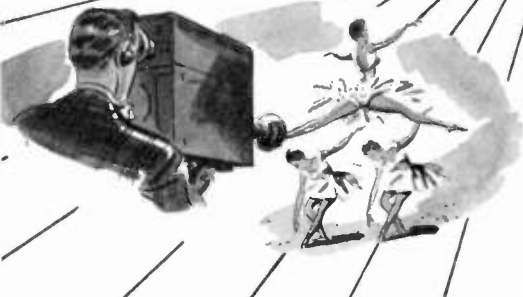

With the announcement of its *Basic System Plan* for television stations, Raytheon extends its policy of offering a *complete* equipment service to include Television as well as AM and FM stations.

Raytheon's forward-looking *Basic System Plan* permits television stations of low or high power to begin commercial operations without delay, with a minimum investment and with provision for increasing power and facilities as conditions permit.

Raytheon equipment for television stations includes: aural and visual transmitters, camera chains, film projectors, antenna equipment, speech equipment, studio equipment and microwave relays.

LOOK TO RAYTHEON FOR ALL YOUR NEEDS

RAYTHEON MANUFACTURING COMPANY
COMMERCIAL PRODUCTS DIVISION · WALTHAM 54, MASSACHUSETTS

RAYTHEON

Excellence in Electronics

Industrial and Commercial Electronic Equipment; FM, AM and TV Broadcast Equipment; Tubes and Accessories

BOSTON, MASSACHUSETTS

Chris F. Brauneck
1124 Boylston Street
KE. 6-1364

CHATTANOOGA, TENNESSEE

W. B. Taylor
Signal Mountain
8-2487

CHICAGO 6, ILLINOIS

Warren Cozzens, Ben Farmer
COZZENS & FARMER
222 West Adams Street
Ran. 7457

DALLAS 8, TEXAS

Howard D. Crissey
414 East 10th Street
Yale 2-1904

LOS ANGELES 15, California

Emile J. Rome
1255 South Flower Street
Rich. 7-2358

NEW YORK 17, NEW YORK

Henry J. Geist
60 East 42nd Street
MU. 2-7440

SEATTLE, WASHINGTON

Adrian VanSanten
135 Harvard North
Minor 3537

WASHINGTON 4, D. C.

Raytheon Manufacturing Co.
739 Munsey Building
Republic 5897

EXPORT SALES AND SERVICE IN FOREIGN COUNTRIES —

Raytheon Manufacturing Co.
International Division, 50
Broadway, New York 4, N. Y.,
WH 3-4980

See the
RAYTHEON
EXHIBIT
N. A. B.
CONVENTION
May 17-21
Biltmore Hotel
Los Angeles



for DIFFICULT COMPONENTS

FILTERS

UTC manufactures a wide range of filters for virtually every application. The unit illustrated is for supersonic service. The high Q toroid dust structure effects flat response to 100 KC with 50 DB cutoff at 108 KC.



SATURABLE REACTORS

Saturable reactors are used for phase control as well as for power control and magnetic amplifier applications. The reactor illustrated is hermetically sealed... weighs 2 oz. . . . gives 6:1 change in inductance for 1MA DC saturation.

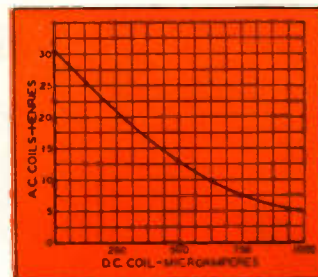
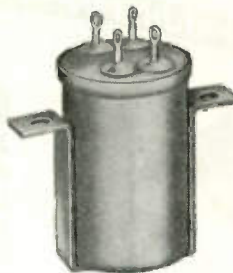

WIDE FREQUENCY RANGE

UTC Linear Standard components are ideal for high fidelity applications. The 10 watt output transformer illustrated, however, meets a frequency response requirement of plus or minus 2DB—9 cycles to 180,000 cycles.

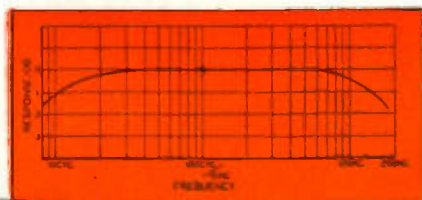

MINIATURE COMPONENTS

This miniaturized modulation transformer is $\frac{3}{4}$ inch in diameter . . . 1 inch high . . . weighs .7 oz. It handles 250 MW in the speech range.

This reactor provides 20 henrys in $\frac{1}{2}$ cubic inch . . . weighs .9 oz. For minimum hum pickup, it is wound hum balanced and shielded in a mu-metal case.



Write for our new catalog PS-408

United Transformer Corp.

150 VARICK STREET

NEW YORK 13, N. Y.

EXPORT DIVISION: 13 EAST 60th STREET, NEW YORK 16, N. Y.

CABLES: "ARLAB"

100 feet of film is a lot of film to handle . . .
 yet it's done conveniently with
DU MONT OSCILLOGRAPH-RECORD EQUIPMENT

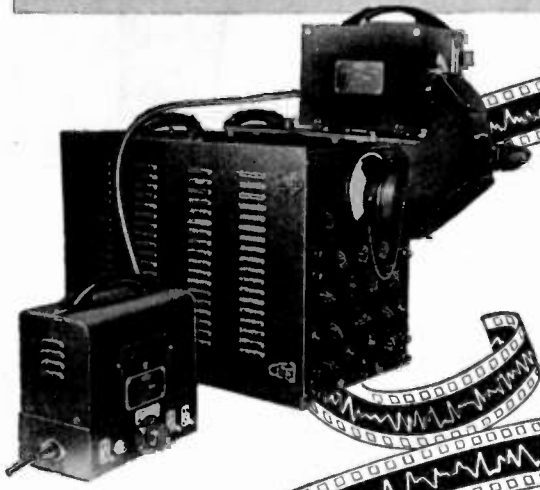

▶ Film rolled on spools is easily inserted and removed when making oscillograms with Type 314 Oscillograph-record Camera. Up to 100 feet of 35-mm. film is readily accommodated by this camera designed for both single-frame and continuous-motion recording of oscillograph patterns.

CAT. NO. 1217-E (f/2.8 coated lens) \$ 980.00
 CAT. NO. 1366-E (f/1.5 coated lens) \$1,155.00



▶ And after exposing the film, the Type 2512 Motor-driven Processing Unit is available for developing the entire 100-foot roll with minimum of bother and without danger of scratching the emulsion. Merely insert film in processing unit and start the motor. Provision is made in this unit for adding and pouring off processing solutions.

CAT. NO. 1372 (115 volts 50-60 cps) \$231.00

▶ For utmost convenience in drying processed film, the Type 2514 Portable Drying Rack accommodates up to 200 feet of film at one time, automatically unwinding and rewinding the film during the drying process. For maximum convenience, the unit is folded when not in use. A carrying case is provided.

CAT. NO. 1375 (115 volts 50-60 cps) \$232.00

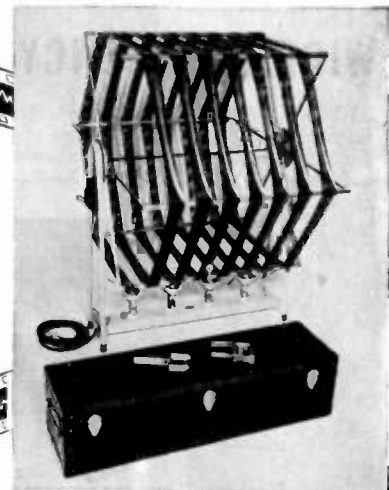

▶ **DU MONT CATALOG SENT ON REQUEST**

© ALLEN B. DU MONT LABORATORIES, INC.

DU MONT

Precision Electronics & Television

ALLEN B. DU MONT LABORATORIES, INC., PASSAIC, NEW JERSEY • CABLE ADDRESS: ALBEEDU, PASSAIC, N. J., U. S. A.

Get this practical engineering data on designing electronic equipment!

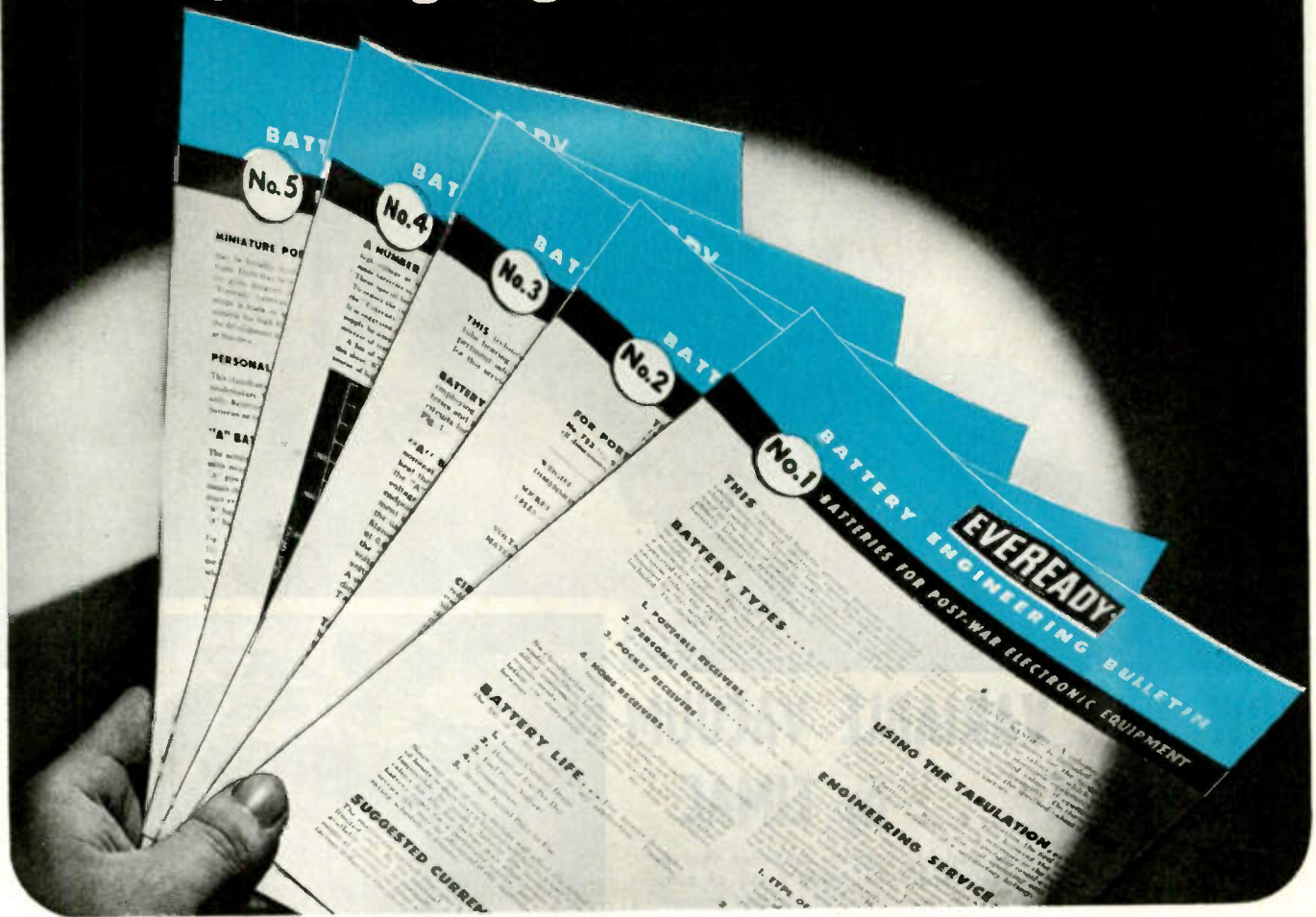

HERE, for the asking, is complete, well-organized information on battery circuits and applications for miniature radios... portable and farm-type receivers... vacuum tube hearing aids... and newly developed electronic equipment. The battery engineering department of National Carbon Company, Inc., issues bulletins like these periodically, as part of a continuing program to provide

technical information to designers of battery-operated devices. In addition, our battery engineers and our development laboratories are prepared to help you select the proper "Eveready" battery to fit your needs—or to design new batteries for specific applications. Write for the bulletins and feel free to consult us about your battery problems at any time without obligation.

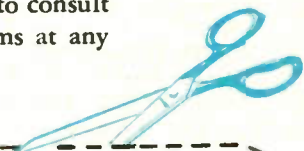

The registered trade-marks
"Eveready" and "Mini-Max" distinguish products of

NATIONAL CARBON COMPANY, INC.

Unit of Union Carbide and Carbon Corporation



30 East 42nd Street, New York 17, N. Y.

Division Sales Offices: Atlanta, Chicago, Dallas, Kansas City,
New York, Pittsburgh, San Francisco

NATIONAL CARBON COMPANY, INC.
30 East 42nd Street, New York 17, N. Y.

Please send me, free of charge, the following checked battery engineering bulletins:

- | | | | |
|--|--------------------------|--|--------------------------|
| 1. Batteries for post-war electronic equipment | <input type="checkbox"/> | 4. High voltage batteries | <input type="checkbox"/> |
| 2. "Mini-Max" "A-B" packs for 1.4 volt receivers | <input type="checkbox"/> | 5. Batteries for miniature radio receivers | <input type="checkbox"/> |
| 3. Batteries for vacuum tube hearing aids | <input type="checkbox"/> | Name..... | |
| | | Street..... | |
| | | City.....State..... | |

Eimac
REG. U. S. PAT. OFF.
 TYPE
VVC 60-20

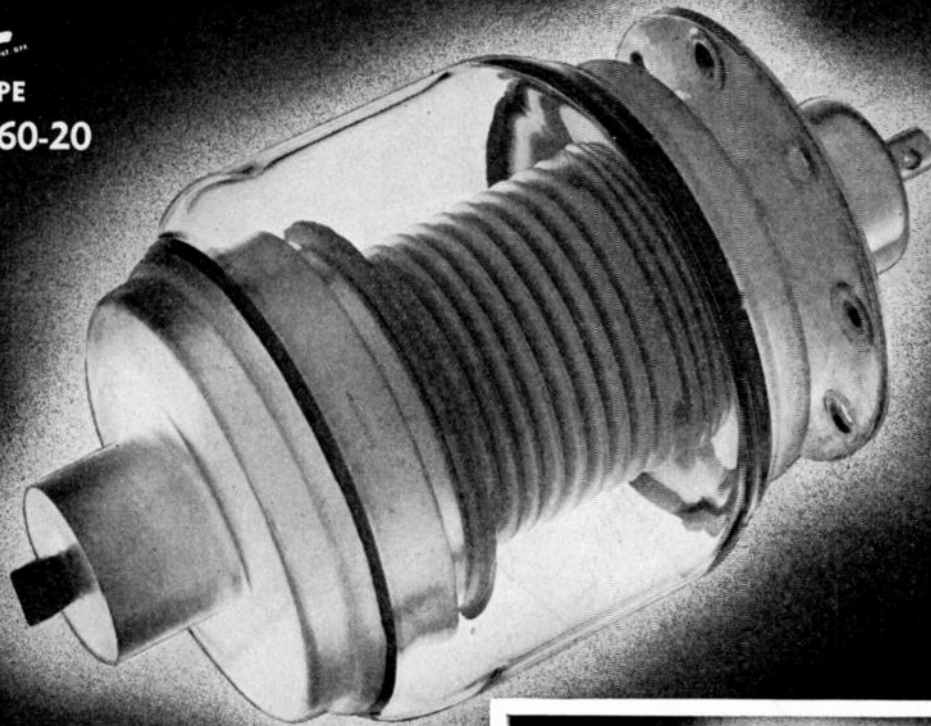

NOW . . . VARIABLE VACUUM CAPACITORS . . . by EIMAC

Here at last is a dependable variable vacuum capacitor that is physically designed for practical application. Every detail of construction makes the Eimac VVC series the standout variable vacuum capacitor component for your equipment. Here is supreme performance and dependability as only Eimac research and engineering can provide.

CHECK THESE FEATURES

PRACTICAL MOUNTING . . . designed for wide application, the base plate on the single units mounts on panel for direct control, or vertically on chassis for control from a flexible shaft or angular control. Multiple units are conveniently bracketed for chassis and panel installation

COMPACT SIZE . . . the single unit VVC-60 is but 3 inches in diameter and 5 inches in length. Multiple units are proportionally larger.

COPPER COMPONENTS . . . for increased R-F conductivity and minimum internal losses. All contact surfaces are silver plated.

MECHANICALLY RUGGED . . . bellows, bearings and adjusting mechanism designed to withstand excessive use and provide long life.

SIMPLE CONTROL . . . single and multiple units vary capacitance by rotation of a single knob. Return to previously indexed settings is positive.

For further information see your Eimac dealer or write direct.

EITEL-McCULLOUGH, INC.

194 San Mateo Avenue, San Bruno, California

EXPORT AGENTS: Frazer & Hansen—301 Clay St.—San Francisco, Calif.

Follow the Leaders to

Eimac
REG. U. S. PAT. OFF.
TUBES
 The Power for R-F

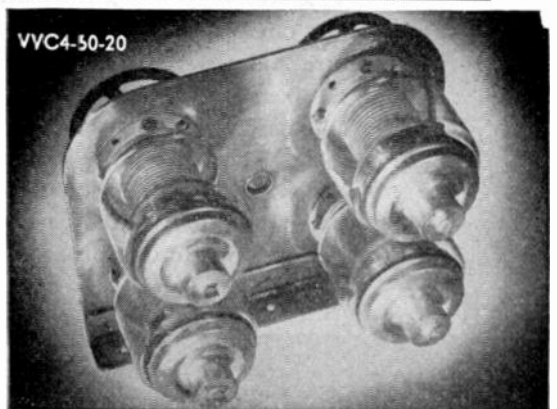
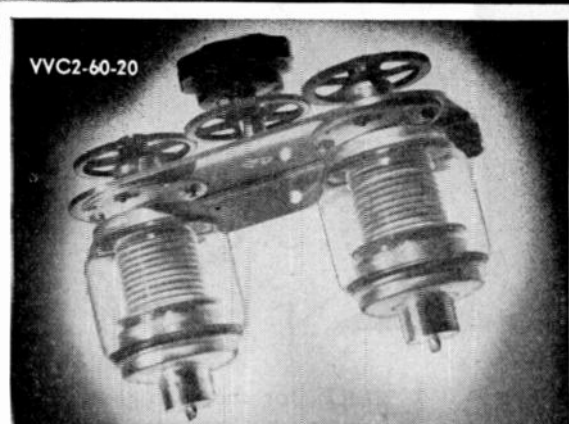

GENERAL CHARACTERISTICS

	Capacity	R-F Peak Voltage	Maximum RMS Current
VVC 60-20	10-60 mmf.	20-KV	40 amp.
VVC2-60-20 Parallel	20-120 mmf.	20-KV	80 amp.
Split-stator	5-30 mmf.	40-KV	40 amp.
VVC4-60-20 Parallel	40-240 mmf.	20-KV	160 amp.
Split-stator	10-60 mmf.	40-KV	80 amp.

ASTATIC BRINGS YOU A TRULY REVOLUTIONARY DEVELOPMENT



Here are the **OUTSTANDING FEATURES . . .**

1. No "Air Gaps."
2. Necessity for delicate handling eliminated.
3. No troublesome, costly armature balancing problems.
4. Longer-lived, troublefree performance without distortion or changes in characteristics.
5. Transcription quality reproduction.
6. Velocity response flat to 12,000 cycles.
7. Output is 100 millivolts. This is approximately 20 db. greater than most previously available, light-weight magnetic pickups.
8. Needle pressure, 1 oz.
9. Impedance, 7,500 ohms at 1,000 c.p.s.—110,000 ohms at 10,000 c.p.s.
10. Interchangeability: Physical dimensions of this cartridge are such that it can be employed with a majority of present day standard pickup and transcription arms.

Now Available

THE MAGNETO-INDUCTION PICKUP

Yes, this is it! An entirely new concept in record-reproduction engineering. A radically new pickup cartridge that opens broad new vistas of listening pleasure . . . offers unchanging faithfulness and quality of reproduction that is stable and trouble-free.

The Astatic Magneto-Induction Pickup represents the first clean break with traditional principles, employed in the manufacture of magnetic type reproducers, since the introduction of such devices in early phonographs. Discarded now by this amazing development is the need for delicately spaced "air gaps," which collect lint and dust, and thereby become a prime source of trouble in other type magnetic pickups. Their elimination in the Magneto-Induction cartridge is all the more revolutionary . . . a newly opened door to greater record enjoyment . . . to a peak fidelity of reproduction that LASTS, even under the most consistent service or adverse climatic conditions.

MODEL MI-1, Code ASAKA MODEL MI-2, Code: ASALZ
Standard Housing Mumetal Housing*

**Provides increased shielding effect for maximum reduction of hum*

Two Equalizer-Amplifier models available:

Model EA-1, compact unit designed for installation in radio sets and audio amplifiers having insufficient gain for operation of Astatic Magneto-Induction Pickup Cartridges. Provides "bass boost."

Model EA-2, self-powered, provides adjustable "bass boost," adjustable treble "roll-off," and selection of "turnover frequency."

Manufactured under Massa Laboratories License

Copyright THE ASTATIC CORP. 1948

THE
Astatic
ASTATIC CORPORATION
CONNEAUT, OHIO
IN CANADA CANADIAN ASTATIC LTD. TORONTO ONTARIO

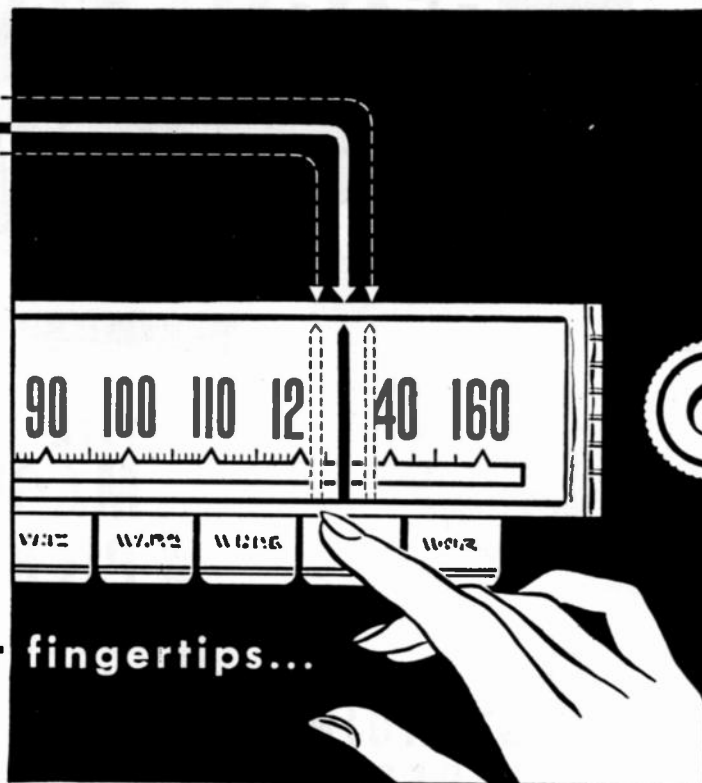

STRAIGHT LINE TRACKING at her fingertips...

A station comes in at the number it's supposed to . . . IF the tuner gives straight line tracking.

TO GET perfect tracking — straight line tracking — in your inductance tuners, the electrical characteristics of the cores have to be *uniform throughout the entire core-length*.

But a core can be no more uniform than the powder it's made of. That's why it's important to use the uniquely uniform G. A. & F. Carbonyl Iron Powder.

Made with great care — and by G. A. & F.'s exclusive, patented carbonyl process — G. A. & F. Carbonyl Iron Powders are uniform, not only within a batch, but from one batch to another. For example, the permeability of different batches over a period of years has been held *within plus or minus one percent*.

G. A. & F. Carbonyl Iron Powders for high frequency cores offer these advantages to the electronics industry:

1. When used at radio frequency, G. A. & F. Carbonyl Iron Powders are superior in coefficients of eddy current loss and residual loss. These low losses make for higher Q.
2. G. A. & F. Carbonyl Iron Powders stand alone

- in co-efficients of magnetic and temperature stability.
3. In comparison with air-cored coils, G. A. & F. Carbonyl Iron Powder-cored coils permit savings in volume, weight, and wire-length, along with great increases in inductance and Q.

➔ Ask your core manufacturer for information about G.A.&F. Carbonyl Iron Powders. Or write direct to: Antara Products, 444 Madison Avenue, New York 22, N. Y. Dept. 51.

These unique properties tell why G. A. & F. Carbonyl Iron Powders are superior:

PROPERTY	ADVANTAGE
Spherical structure	Facilitates insulation and compacting
Concentric shell structure (some types only)	Low eddy current losses
High purity	Exceptional permeability and compressibility
Absence of non-ferrous metals	Absence of corresponding disturbing influences
Relative absence of internal stress; regular crystal structure	Low hysteresis loss
Spheres of small size	Low eddy current losses; usable for high frequencies
Variations of sphere size	Extremely close packing

G. A. & F. CARBONYL IRON POWDERS

An Antara® Product of General Aniline & Film Corporation



SETS A NEW PERFORMANCE STANDARD!

YOU GET ALL THESE FEATURES
IN THIS NEW HIGH FIDELITY
SIGNAL GENERATOR



Voltage accurate within 0.2 db
Distortion less than 0.1 %
Continuously variable a-f voltage
Frequency range 20 cps to 20 kc
High stability of frequency

-hp- 206A Audio Signal Generator

For the first time all the features listed above are combined in one precision instrument, to give you signals of utmost purity and accuracy for high fidelity measuring work.

In addition, the new -hp- 206A Generator includes low-temperature coefficient frequency determining ele-

ments for high stability and unvarying accuracy over long periods of time. A precision attenuator varies output signal level in 0.1 decibel steps throughout 111 decibels.

quality audio circuits, the -hp- 206A is ideal for FM transmitter maintenance, studio amplifier and console testing, a source for bridge measurements, a-f voltage or transmission measurements; and for other applications requiring a very low distortion signal of known amplitude.

SPECIFICATIONS

FREQUENCY RANGE: 20 cps to 20 kc, 3 bands.

CALIBRATION: Direct in cps on lowest band.

STABILITY: Better than 2%. Low temperature coefficient frequency network.

OUTPUT: +15 dbm into 50, 150, 600 ohms. Approx. 10 v into open circuit.

OUTPUT IMPEDANCE: 50, 150, 600 ohms balanced. 600 ohms single ended. Matched internal impedances.

FREQUENCY RESPONSE: Within 0.2 db, 30 cps to 15 kc, beyond meter, at all levels.

DISTORTION: Less than 0.1% above 50 cps. Less than 0.25% below 50 cps.

HUM LEVEL: 70 db below output signal, or 100 db below zero level.

OUTPUT METER: Reads in dbm or volts.

ATTENUATORS: 111 db in 0.1 db steps. Accuracy approximately 0.1 db.

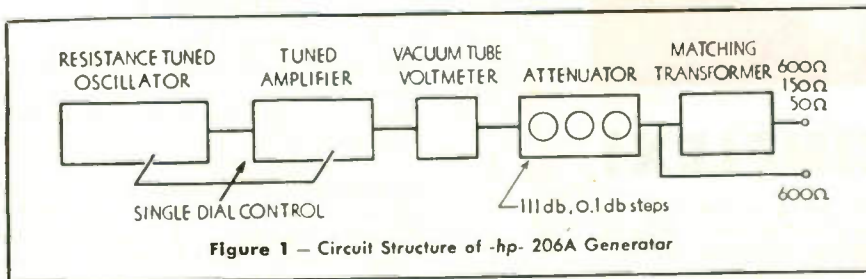

ments for high stability and unvarying accuracy over long periods of time. A precision attenuator varies output signal level in 0.1 decibel steps throughout 111 decibels.

Resistance-tuned Oscillator

The resistance-tuned oscillator is followed by an automatically tracked amplifier whose high selectivity reduces oscillator harmonics. Following the 111 db attenuator is a transformer which can be matched to loads of 50, 150 and 600 ohms. A 600 ohm single-ended output is also provided (Fig. 1).

Specially designed for testing high

Full details available on request

HEWLETT-PACKARD CO.

1640D Page Mill Road, Palo Alto, California
Export Agents: Frazor & Hansen, Ltd.
301 Clay Street • San Francisco, Calif., U. S. A.



Power Supplies Frequency Standards Amplifiers Electronic Tachometers Frequency Meters
UHF Signal Generators Square Wave Generators Audio Frequency Oscillators Attenuators
Audio Signal Generators Noise and Distortion Analyzers Wave Analyzers Vacuum Tube Voltmeters

BENDIX-SCINTILLA

the finest ELECTRICAL CONNECTORS
money can build or buy!

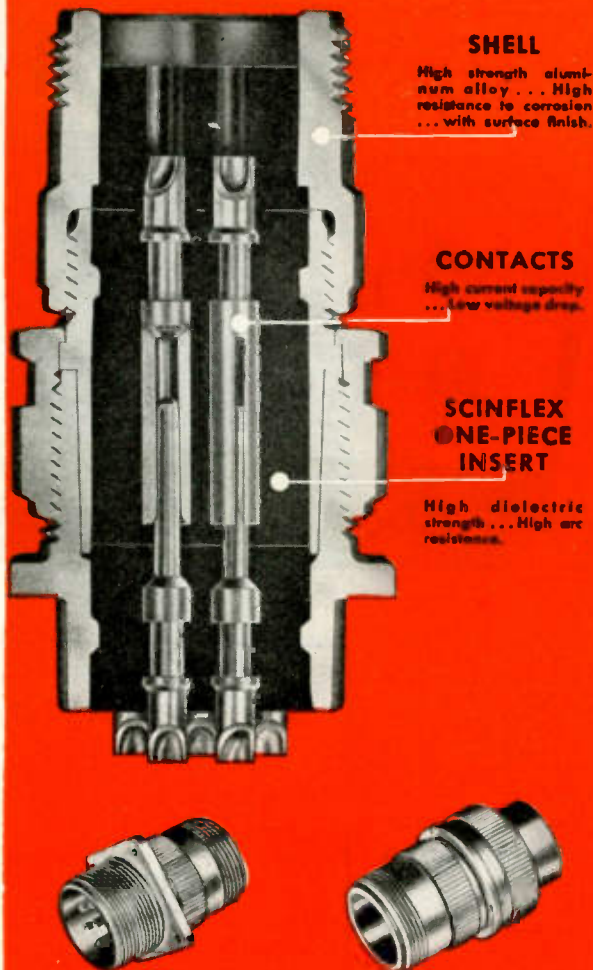

SHELL

High strength aluminum alloy... High resistance to corrosion... with surface finish.

CONTACTS

High current capacity... Low voltage drop.

SCINFLEX ONE-PIECE INSERT

High dielectric strength... High arc resistance.

AND THE SECRET IS SCINFLEX!

Bendix-Scintilla* Electrical Connectors are precision-built to render peak efficiency day-in and day-out even under difficult operating conditions. The use of "Scinflex" dielectric material, a new Bendix-Scintilla development of outstanding stability, makes them vibration-proof, moisture-proof, pressure-tight, and increases flashover and creepage distances. In temperature extremes, from -67° F. to $+300^{\circ}$ F., performance is remarkable. Dielectric strength is never less than 300 volts per mil.

The contacts, made of the finest materials, carry maximum currents with the lowest voltage drop known to the industry. Bendix-Scintilla Connectors have fewer parts than any other connector on the market—an exclusive feature that means lower maintenance cost and better performance.

*REG. U.S. PAT. OFF.

Write our Sales Department for detailed information.

- Moisture-proof, Pressure-tight • Radio Quiet • Single-piece Inserts
- Vibration-proof • Light Weight • High Arc Resistance • Easy Assembly and Disassembly • Less parts than any other Connector

Available in all Standard A.N. Contact Configurations



News—New Products

These manufacturers have invited PROCEEDINGS readers to write for literature and further technical information. Please mention your I.R.E. affiliation.

(Continued from page 11A)

Small High-Torque Motor

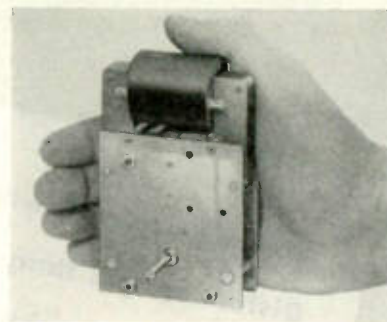

A 20-watt shaded-pole induction-type motor with high torque capacity is being marketed by the T. C. Smith Manufacturing Co., Springfield, Ill. Small enough to fit in the hand, this motor has a stalling torque of 75 inch-ounces. It has a built-in gear train with oil-impregnated powdered metal bearings. The no-load speed is 20 r.p.m. on the output shaft. Other gear ratios can be supplied.

A particular feature of this motor is its magnetic clutch. With the deenergizing of the motor, this clutch prevents any over-travel of the output shaft. The motor is particularly suited for use with directional antennas and other control applications.

Radio Relay Link Equipment

New equipment for broadcasting stations to relay programs from studios to transmitter has been developed by the Transmitter Division of General Electric Co., Electronics Park, Syracuse, N. Y. The equipment consists of a transmitter, receiver, and two antennas, which operate on frequencies between 920 and 960 mc. Characteristics measured from transmitter input to receiver output include the following: a noise level at least 65 db below 100% modulation; harmonic distortion less than 1% from 50 to 15,000 cycles; audio-frequency response plus or minus 1 db from 50 to 15,000 cycles; stability of 0.005% of carrier frequency; and operation on a standard power supply.

The transmitter weighs about 450 pounds, and has a power output of 10 watts. Its audio input level is 10 dbm plus or minus 2 db. It is designed to feed the antenna through a conventional coaxial line. The transmitter may be remotely controlled over a telephone line. The crystal-controlled receiver weighs 70 pounds and is comprised of three units. Its audio output level is plus 18 dbm. The two antennas used in the system are 40-inch parabolic types with enclosed dipoles. Each weighs about 40 pounds.

(Continued on page 58A)

Specify
for



COMPONENTS

MINIATURIZATION

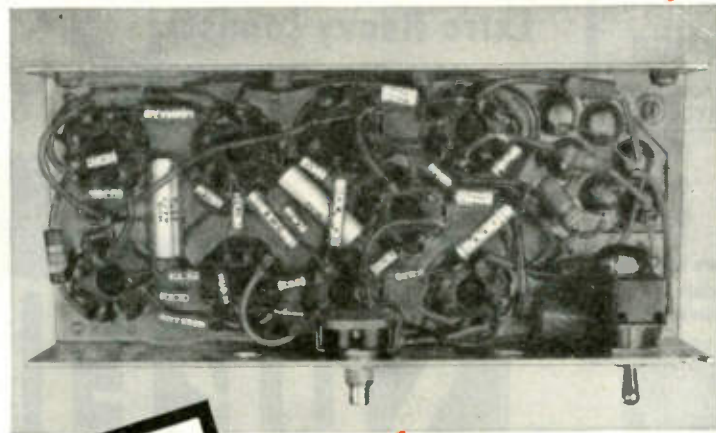

HI-Q MINIATURE G. P. TUBULARS



G. P. Miniatures providing capacities from 5 mmf to 33,000 mmf will cover the majority of your by-passing problems. By the use of our new body 41 the above extended capacity ranges are now available. These smaller units provide closer coupling of leads thus insuring the minimum of inductance and highest self resonant frequencies.
Illustration at left is actual size.

HI-Q DISK CAPACITORS

BPD Another example of accurate and dependable miniaturization is this high dielectric by-pass, blocking or coupling Hi-Q Disk Capacitor. Many applications where physical shape is more adaptable than the tubular unit. Available in two standard capacities:
Type BPD-5: .005 mfd guar. min.
Type BPD-10: .01 mfd. guar. min.
Type BPD-1.5: .0015 mfd. guar. min.
Illustration at right is actual size.

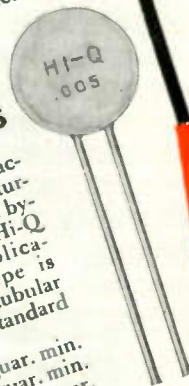

FOR superior performance in a limited space, the utilitarian compactness of **Hi-Q** components is sure to meet your enthusiastic approval. Although **Hi-Q** components are compact, there is no sacrifice of accuracy, dependability or uniformity. Each component meets or surpasses rigid standards for capacity, tolerance and performance. This compactness is accomplished through application of up-to-the-minute processing techniques, combined with use of highest quality materials and complete control of quality throughout all stages of manufacture. Specify **Hi-Q** for maximum efficiency in a minimum amount of space.

**HI-Q COMPONENTS
BETTER 4 WAYS**

- PRECISION** Tested step by step from raw material to finished product. Accuracy guaranteed to your specified tolerance.
- UNIFORMITY** Constancy of quality is maintained over entire production through continuous manufacturing controls.
- DEPENDABILITY** Interpret this factor in terms of your customers' satisfaction . . . Year after year of trouble-free performance. Our Hi-Q makes your product better.
- MINIATURIZATION** The smallest **BIG VALUE** components in the business make possible space saving factors which reduce your production costs . . . increase your profits.

Hi-Q

Electrical Reactance Corp.

FRANKLINVILLE, N. Y.

Plants: FRANKLINVILLE, N. Y.—JESSUP, PA.

Sales Offices: NEW YORK, PHILADELPHIA, DETROIT, CHICAGO, LOS ANGELES



3-Phase Regulation

MODEL	LOAD RANGE VOLT-AMPERES	*REGULATION ACCURACY
3P15,000	1500-15,000	0.5%
3P30,000	3000-30,000	0.5%
3P45,000	4500-45,000	0.5%

• Harmonic Distortion on above models 3%.
Lower capacities also available.

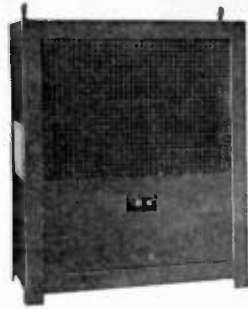

Extra Heavy Loads

MODEL	LOAD RANGE VOLT-AMPERES	*REGULATION ACCURACY
5,000*	500 - 5,000	0.5%
10,000*	1000-10,000	0.5%
15,000*	1500-15,000	0.5%

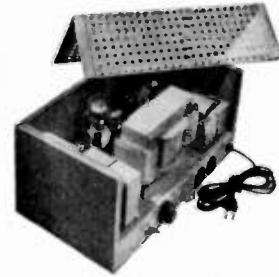

General Application

MODEL	LOAD RANGE VOLT-AMPERES	*REGULATION ACCURACY
150	25 - 150	0.5%
250	25 - 250	0.2%
500	50 - 500	0.5%
1000	100-1000	0.2%
2000	200-2000	0.2%



400-800 Cycle Line INVERTER AND GENERATOR REGULATORS FOR AIRCRAFT.

Single Phase and Three Phase

MODEL	LOAD RANGE VOLT-AMPERES	*REGULATION ACCURACY
D500	50 - 500	0.5%
D1200	120-1200	0.5%
3PD250	25 - 250	0.5%
3PD750	75 - 750	0.5%

Other capacities also available

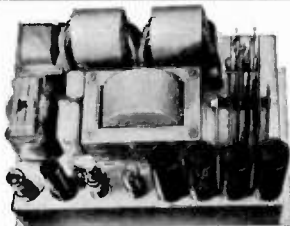

The NOBATRON Line

Output Voltage DC	Load Range Amps.
6 volts	15-40-100
12 "	15
28 "	10-30
48 "	15
125 "	5-10

• Regulation Accuracy 0.25% from 1/4 to full load.

SORENSEN

The First Line of standard electronic AC Voltage Regulators and Nobatrons

GENERAL SPECIFICATIONS:

- Harmonic distortion max. 5% basic, 2% "S" models
- Input voltage range 95-125; 220-240 volts (—2 models)
- Output adjustable bet. 110-120; 220-240 (—2 models)
- Recovery time: 6 cycles; † (9 cycles)
- Input frequency range: 50 to 65 cycles
- Power factor range: down to 0.7 P.F.
- Ambient temperature range: —50°C to +50°C

All AC Regulators & Nobatrons may be used with no load.

*Models available with increased regulation accuracy.

Special Models designed to meet your unusual applications.

Write for the new Sorensen catalog. It contains complete specifications on standard Voltage Regulators, Nobatrons, Increvolts, Transformers, DC Power Supplies, Saturable Core Reactors and Meter Calibrators.

SORENSEN & CO., INC.
STAMFORD CONNECTICUT

Represented in all principal cities.

Which Capacitor for what?

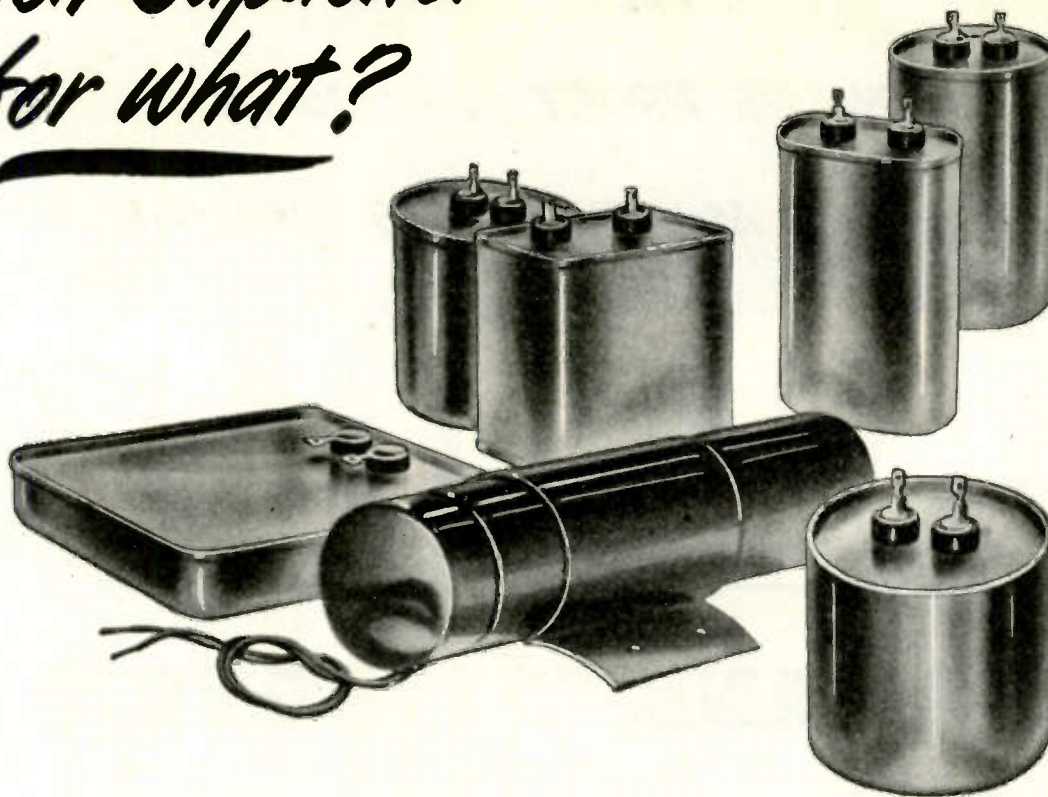

These capacitors are identical, electrically. The different case styles were, most of them, developed for specific applications. However, since the capacitors *are* electrically the same, it is perfectly practical to use them interchangeably—to use a ballast capacitor on a motor, or a motor capacitor with a sign transformer.

We have made just such proposals at times—and have frequently been

able to help manufacturers solve an unusual mounting or space problem, and cut their capacitor costs by recommending a unit not normally thought of for the application.

The capacitor that *you* should use of course depends on your own problem. For assistance in any specific case, get in touch with the nearest G-E Apparatus Office, or write *General Electric Company, Pittsfield, Massachusetts.*

GENERAL ELECTRIC

407-151

Specialty Capacitors

FOR

Motors
Luminous-tube
transformers
Fluorescent lamp
ballasts

Industrial control
Radio filters
Radar
Electronic equipment
Communication
systems
Capacitor discharge
welding

Flash photography
Stroboscopic
equipment
Television
Dust precipitators
Radio interference
suppression
Impulse generators

AND MANY OTHER APPLICATIONS

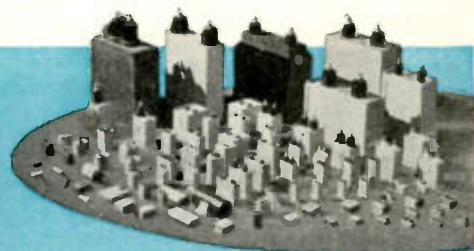

*THERE'S PROFIT FOR YOU IN
THE TIME AND MONEY-SAVING QUALITIES OF*

ARNOLD

PERMANENT MAGNETS



Several avenues of profit are open to you in Arnold Permanent Magnets. You can improve the performance and overall efficiency of equipment. You can increase production speed, and in many cases reduce both weight and size. And most important, you can maintain these advantages over any length of production run or period of time, because Arnold Permanent Magnets are completely quality-controlled through *every* step of manufacture—from the design board to final test and assembly. You'll find them unvaryingly uniform and reliable in every magnetic and physical sense.

It's our job to help you discover and then fully attain these benefits. Arnold Products are available in all Alnico grades and other types of magnetic materials—in cast or sintered forms, and in any size or shape required. Our engineers are at your command—check with our Chicago headquarters, or with any Allegheny Ludlum branch office.

W&D 1298



THE ARNOLD ENGINEERING CO.

Subsidiary of **ALLEGHENY LUDLUM STEEL CORPORATION**

147 East Ontario Street, Chicago 11, Illinois

Specialists and Leaders in the Design, Engineering and Manufacture of PERMANENT MAGNETS

VIEW OF SHERRON ELECTRO-MECHANICAL LABORATORY

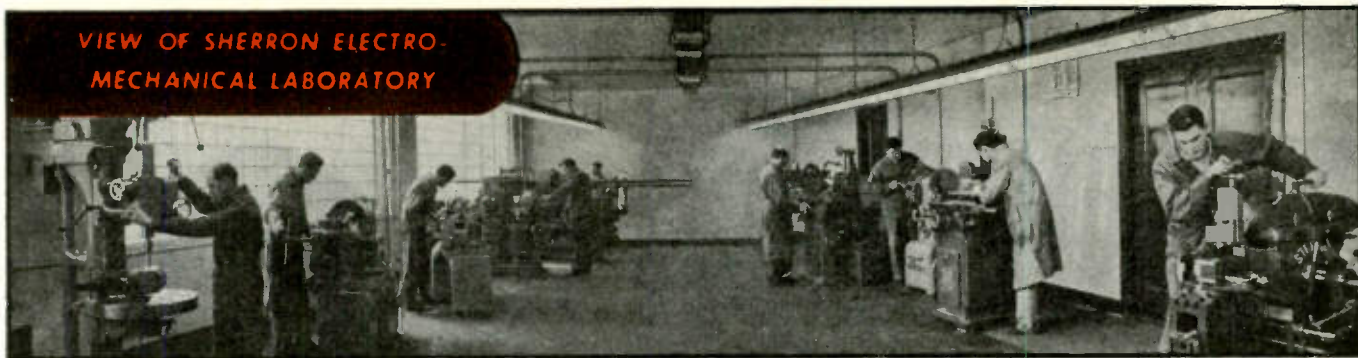

THEORY INTO REALITY

Research and development problems, involving the manufacture of prototypes, are routine Sherron Electronics projects. We offer a comprehensive service . . . design, development, consultation on and completion of research, and the manufacturing of working models.

We can assist you by working from an idea, theory, or laboratory design — or manufacturing units from your own completed designs.

In the performance of this service, we have the advantage of expertly staffed, modern electronics and electro-mechanical laboratories. All

the experience, skills and facilities, which Sherron Electronics has been applying to the broad needs of electronics, are also available for the specialized requirements of Nucleonics.

Sherron projects include: Counters, computers, servo mechanisms . . . Amplifiers, oscillators . . . Power supplies, power regulators . . . Process control, generator control . . . Parameter measurement, control and production (temperature, flow, radiation) Synchrotron, Betatron, Cyclotron controls and accessories.

Your inquiries are invited.



SHERRON ELECTRONICS CO.

Division of Sherron Metallic Corporation

1201 FLUSHING AVENUE • BROOKLYN 6, N.Y.

VIEW OF SHERRON ELECTRONICS LABORATORY

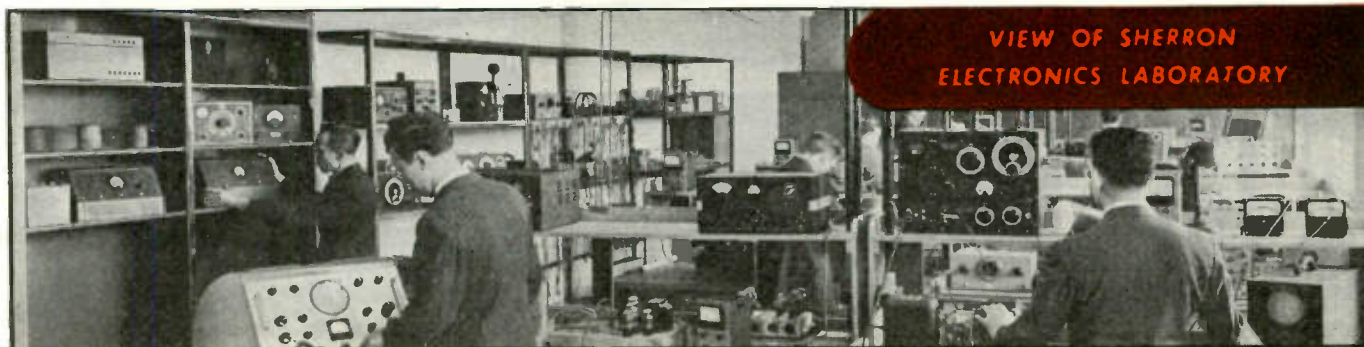

For *greater* brilliance and *greater* DEFLECTION SENSITIVITY—



CHARACTERISTICS . . .

Deflection and Focus Electrostatic
 Screen: Choice of P1, P2, P4, P7
 and P11 Screens

RATINGS:

Heater Voltage 6.3 a.c. or d.c.
 Current 0.6 ampere
 Anode #3 (Intensifier) 4400 volts max.
 Anode #2 (Accelerating) 2200 volts max.
 Anode #1 (Focusing) 1100 volts max.
 Grid (Control Voltage) Never Positive
 Peak Voltage between Accelerating
 Electrode and Any Deflecting
 Electrode 550 volts max.
 Grid Circuit Resistance 1.5 meg. max.
 Impedance of Any Deflecting
 Electrode Circuit at Heater Supply
 Frequency 1.0 meg. max.
 E_{b3}/E_{b2} Ratio 2.3 max.

MECHANICAL CHARACTERISTICS:

Overall Length 10"
 Maximum Diameter 3"
 Base Med. 12-pin diheptal

Here's the logical successor to the wartime Types 3BP and 3FP, combining the high deflection sensitivity of the 3BP with the higher operating voltage and brightness of the 3FP. Thus, it is the ideal tube for test equipment which is operated under high ambient light.

The new DuMont Type 3JP is designed for oscillographic and other applications requiring a small, short tube with very high light output and high deflection sensitivity. The focusing electrode current under operating conditions is negligible, thereby simplifying bleeder design. The 2" dia. neck and diheptal base provide adequate insulation between electrode leads for high-altitude insulation.

For applications where deflecting voltages are under suitable control, the 3JP is directly interchangeable with the 3FP. Equipment using the 3BP may be readily adapted to use the 3JP by providing for connecting the intensifier electrode of the 3JP either to the second anode potential or to a higher potential than the second anode. Due to the higher deflection sensitivity, the 3JP can be utilized with intensifier potential equal to twice the second anode potential without reduction in sensitivity, as compared with the 3BP operating with the same second anode potential.

◆ TECHNICAL DATA ON REQUEST.

© ALLEN B. DUMONT LABORATORIES, INC.

DUMONT Precision Electronics & Television

ALLEN B. DUMONT LABORATORIES, INC., PASSAIC, NEW JERSEY • CABLE ADDRESS: ALBEEDU, PASSAIC, N. J., U. S. A.

HOW MANY
db?

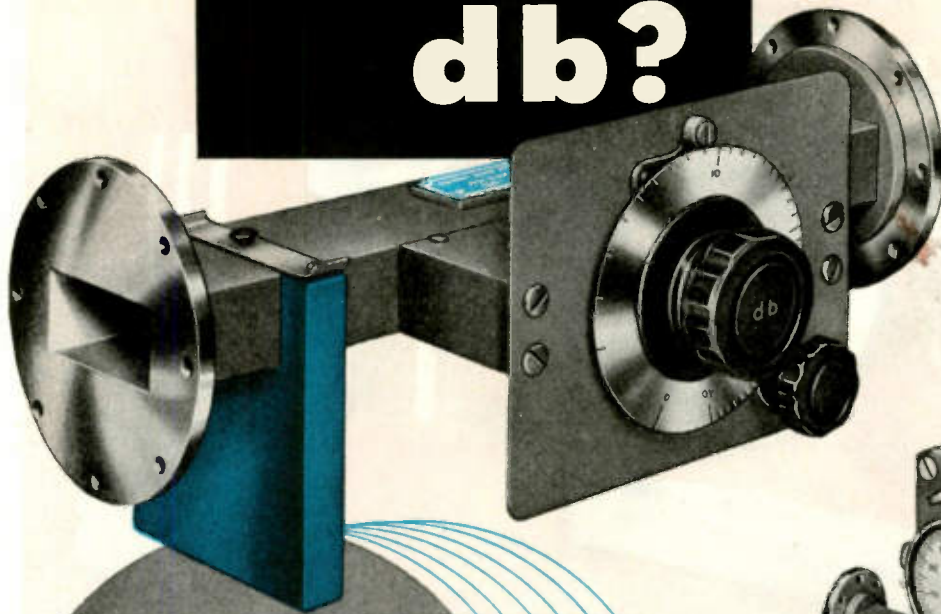

.. AT 5,000
MEGACYCLES?

.. AT 25,000
MEGACYCLES?

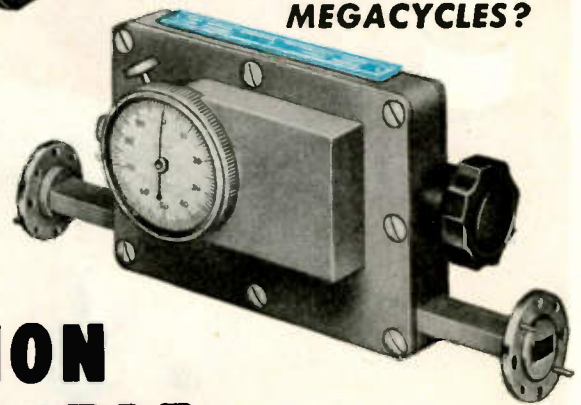

PRECISION VARIABLE ATTENUATORS

Features:

METALLIZED-GLASS
ATTENUATING ELEMENTS
PRECISE AND PERMANENT
CALIBRATION
BROADBAND
CHARACTERISTICS
NEGLIGIBLE INSERTION LOSS
BACKLASH-FREE
VERNIER DRIVE
LOW REFLECTION
WELL SHIELDED CASING

These attenuators, utilizing metallic-film-on-glass resistive elements, are of the most advanced design now available. Broadband matching, minimum frequency sensitivity, and constancy of attenuation with time, are but a few of the advantages which this technique affords. Casing designs available cover requirements from that of a simple power control attenuator to that of a precisely calibrated secondary standard.

Metallized glass attenuators are an important type of microwave measurement component in the complete PRD line. Available also are precision slotted sections and probes, impedance matching devices, frequency meters and standard cavities, and all of the other items which make up a complete measurements bench. An illustrated catalog and price list may be obtained by writing to Department R-5, on company letterhead.

66 COURT STREET
BROOKLYN 2, N. Y.

PRD *Polytechnic* **RESEARCH
& DEVELOPMENT COMPANY, Inc.**



Representative RCA types standardized for future equipment designs

Tubes for today and tomorrow

HERE ARE power tubes, phototubes, and c-r tubes to serve the major requirements of equipment manufacturers for a long time to come. The tubes listed are those you can depend on now, and for your future designs.

These RCA types are especially recommended because their wide-spread application permits production to be concentrated on fewer types. Such longer manufacturing runs reduce costs—lead to improved quality and greater uniformity. Resultant benefits are shared alike by the equipment manufacturer and his customers.

RCA Application Engineers are ready to suggest suitable tube types for your design requirements. For further information write RCA, Commercial Engineering, Section ER-42, Harrison, N. J.

THE FOUNTAINHEAD OF MODERN TUBE DEVELOPMENT IS RCA

Preferred List of RCA Non-Receiving Types				
CATHODE-RAY TUBES AND CAMERA TUBES				
Kinescopes (Projection)	Camera Types	Oscillograph Types	Monoscope	
5TP4	5527 2P23 5655 1850-A	2BP1 3KP1 5UP1	2F21	
(Directly Viewed)				
7DP4 7JP4 10BP4				
PHOTOTUBES				
Gas Types	1P41	921	927	930
Vacuum Types	922	929		
Multiplier	931-A			
GAS TUBES				
Thyratrons	2D21	3D22	884	2050
Ignitrons	5550	5551	5552	5553
Rectifiers	3B25	673	816	857-B
	800B			866-A
Voltage Regulators	0A2	0C3/VR105	0D3/VR150	869-B
POWER AMPLIFIERS AND OSCILLATORS				
(Air-Cooled)	TRIODES (Forced-Air-Cooled)		(Water-Cooled)	
811	6C24	9C21	9C21	
812	7C24	9C27	9C27	
826	9C22	889-A	889-A	
833-A	9C25	892	892	
8000	889R-A			
8005	892-R			
8025-A	5588			
	5592			
	TETRODES	BEAM TUBES	PENTODES	
(Air-Cooled)	(Water-Cooled)	(Air-Cooled)	(Air-Cooled)	
4-125A/4D21	8D21	2E24	802	
		2E26	828	
		807		
		813		
		815		
		829-B		
		832-A		

The world's most modern tube plant . . .
RCA, Lancaster, Pa.



TUBE DEPARTMENT

RADIO CORPORATION of AMERICA

HARRISON, N. J.

BOARD OF DIRECTORS, 1948

- Benjamin E. Shackelford
President
- R. L. Smith-Rose
Vice-President
- S. L. Bailey
Treasurer
- Haraden Pratt
Secretary
- Alfred N. Goldsmith
Editor
- Frederick B. Llewellyn
Senior Past President
- W. R. G. Baker
Junior Past President

1948-1949

- J. B. Coleman
Murray G. Crosby
Raymond A. Heising
T. A. Hunter
H. J. Reich
F. E. Terman

1948-1950

- J. E. Shepherd
J. A. Stratton

1948

- A. E. Cullum, Jr.
Virgil M. Graham
Raymond F. Guy
Keith Henney
J. V. L. Hogan
F. S. Howes
J. A. Hutcheson
I. J. Kaar
D. B. Sinclair

-
- Harold R. Zeamans
General Counsel

-
- George W. Bailey
Executive Secretary

- Laurence G. Cumming
Technical Secretary

- E. K. Gannett
Assistant Secretary

BOARD OF EDITORS

- Alfred N. Goldsmith
Chairman

PAPERS REVIEW COMMITTEE

- Murray G. Crosby
Chairman

PAPERS PROCUREMENT COMMITTEE

- John D. Reid
General Chairman

PROCEEDINGS OF THE I.R.E.

(Including the WAVES AND ELECTRONS Section)

Published Monthly by

The Institute of Radio Engineers, Inc.

VOLUME 36

May, 1948

NUMBER 5

PROCEEDINGS OF THE I.R.E.

The Institute on the March	570
Science and Universal Military Training	571
3050. Influence of Reproducing System on Tonal-Range Preferences	572
3051. Experimental Studies of a Remodulating Repeater	580
3052. A Negative-Current Voltage-Stabilization Circuit	583
3053. Some Fundamental Considerations Concerning Noise Reduction and Range in Radar and Communication	584
3054. The Steady-State and Transient Analysis of a Feedback Video Amplifier	595
3055. 500-Mc. Transmitting Tetrode Design Considerations	611
3056. Note on the Maximum Directivity of an Antenna	620
3057. Multifrequency Bunching in Reflex Klystrons	624
Contributors to the PROCEEDINGS OF THE I.R.E.	631
Correspondence:	
3058. "Conformal Mapping Transformations"	632
2920. "E-Plane Bend"	632
2980. "Directional Couplers"	632

INSTITUTE NEWS AND RADIO NOTES SECTION

Executive Committee	633
New England Radio Engineering Meeting	635
Petition for Amendment of Article II, Sections 1-c and 2 c, of the Constitution	636
Industrial Engineering Notes	637
Sections	641
I.R.E. People	642
Books:	
3059. "Very High Frequency Techniques," Radio Research Laboratory Staff of Harvard University	645
3060. "Techniques of Microwave Measurements" edited by Carol G. Montgomery	645
3061. "Meteorological Factors in Radio-Wave Propagation"	645
3062. "Computing Mechanisms and Linkages" by A. Svoboda	646
3063. "Ionospheric Research at College, Alaska" by S. L. Seaton, H. W. Wells and L. V. Berkner	646
3064. "Auroral Research at College, Alaska" by S. L. Seaton and C. W. Malich	646
3065. "High Frequency Measuring Techniques Using Transmission Lines" by E. N. Phillips, W. G. Stearns and N. J. Gamara	646
3066. "Understanding Vectors and Phase" by John F. Rider and Seymour D. Usland	646
3067. "The Radio Handbook, Eleventh Edition" by R. L. Dawley and Associates	647
3068. "Radio Data Charts" by R. T. Beatty, Revised by J. McG. Sowerby	647
3069. "Electrochemical and Electroacoustical Analogies" by Bent Gehlshoj	647

WAVES AND ELECTRONS SECTION

William G. Hutton and William H. Radford	648
Sylvania Research Center	649
3070. Men in Research	650
3071. Considerations of Moon-Relay Communication	652
3072. Statistical Methods in the Design and Development of Electronic Systems	664
3073. Microwave Propagation Experiments	671
3074. A Portable Microwave Communication Set	676
Contributors to Waves and Electrons Section	681
3075. Abstracts and References	683
News—New Products	38A
Section Meetings	50A
Membership	53A
Advertising Index	67A

EDITORIAL DEPARTMENT

Alfred N. Goldsmith
Editor

Clinton B. DeSoto
Technical Editor

Mary L. Potter
Assistant Editor

William C. Copp
Advertising Manager

Lillian Petranek
Assistant Advertising Manager

Responsibility for the contents of papers published in the PROCEEDINGS OF THE I.R.E. rests upon the authors. Statements made in papers are not binding on the Institute or its members.

Changes of address (with advance notice of fifteen days) and communications regarding subscriptions and payments should be mailed to the Secretary of the Institute, at 450 Ahnaip St., Menasha, Wisconsin, or 1 East 79 Street, New York 21, N. Y. All rights of republication, including translation into foreign languages, are reserved by the Institute. Abstracts of papers, with mention of their source, may be printed. Requests for republication privileges should be addressed to The Institute of Radio Engineers.





THE INSTITUTE ON THE MARCH

A NEW PROFESSIONAL GROUP SYSTEM

The Institute is taking another forward step, yea verily, a leap, in order properly to serve its members. The Board of Directors has adopted a *Professional Group System* to provide an integration of its membership in areas of special technical interest.

These Professional Groups may be organized on either a vertical or horizontal basis; i.e., a Group may consist of members interested in particular problems of operation, covering several technical fields, such as broadcasting, point-to-point communication, etc., or the Group may have specialized technical interests, such as audio engineering, wave propagation, etc.

Each Group will elect its own chairman, vice-chairman, and executive committee. It will be the duty of these officers to look after the interests of their particular Group and to make sure that they are properly served. In order to do this they may activate their own committees, special conferences, and meetings. In addition, a Group may expect to take charge of one or more programs at the sessions of National and Regional conventions to insure that papers of interest are presented for each Group. The Groups will also provide a means for insuring proper coverage of their field in the publications of the Institute. It is anticipated that Groups will also provide for a limited distribution of papers of special interest. They may develop special honors for their members and promote recognition of their leaders among the Institute membership at large.

Bylaws are being prepared by the Board for the activation of the program. These Bylaws provide that an individual Group can be instituted by petition from twenty-five or more members of the Institute. Co-ordination is provided by a Standing Committee on Professional Groups. By this means, there is a guarantee that Groups will have the active interest of members with initiative, and a healthy activity will be insured.

As the plan develops, it is anticipated that individual Groups will take the initiative in providing special services to their members which in turn may be adopted by others.

Forms for petitions and a model constitution for a Group are now being prepared. Correspondence regarding the formation of Groups should be addressed to the Technical Secretary, L. G. Cumming, 1 East 79 Street, New York City.

Members have frequently indicated the need for such a plan; the Board has now provided it; the next steps are up to the membership.



The implications of an appropriate form of universal training in an "atomic age" are far from self-evident. The writer of the following guest editorial on this subject combines an exceptional group of relevant experiences and skills. As a commander in the United States Naval Reserve, a research, development, and production engineer, an observer at the Bikini atomic-bomb tests, and a Past-President of The Institute of Radio Engineers, his views on this timely topic merit careful consideration and thoughtful analysis.—*The Editor*.

Science and Universal Military Training

ARTHUR VAN DYCK

During the past few years, realization has been growing in technical circles that scientists and engineers should take a more active part in the guidance of human affairs. The terrific impact of the sudden appearance of atomic energy with its great and immediate effect on all society has intensified that realization. But it is still difficult for the technical man to find specific ways in which he can participate. The object of this editorial is to point out one way in which members can contribute.

It concerns Universal Military Training. There is much discussion and great difference of opinion as to its necessity or desirability. Prominent educators and many other men having influence with the public are saying that UMT is not necessary or desirable because the atom bomb has made large armies and navies obsolete. Such conclusions exhibit complete ignorance of the character of modern war including the next one, if there is one—a character which resulted from rapid technological advances. The characteristics of modern war with respect to men, training, organization, and planning, are known at least to those scientists and engineers who were in the service in World War II. The knowledge needs to be spread.

It is true that battles are no longer fought with hundreds of thousands of troops rushing across fields in close order, nor even deployed in trenches hundreds of miles long. No longer are training with rifle and bayonet, and drill practice in executing battle maneuvers, the necessities for large numbers of men that they once were. Nevertheless, more men than ever are needed for modern conflict, even though most of them never see the enemy. The modern battle line extends from the shooting fronts back through bases, airfields, and ports to this country, and inside the country to factories, laboratories, and offices.

Modern war means huge organizations, functioning efficiently, well trained. Modern war is mechanized, and the mechanisms are far more difficult to operate than are rifles and bayonets. Planes, tanks, ships, radio sets, radars, guided missiles, to name a few examples, all require operation and maintenance involving trained skills, which take months or years to acquire.

Skills are useless without organizations to plan and utilize them. Huge organizations cannot be gotten into operation quickly except by the military organization method. That requires many things, of which a simple example is physical health. When it becomes necessary to deploy a hundred pilots, fifty radar technicians, or thirty stenographers, there is no time to check physical health and personal freedom to go—instantly. That is a necessity even in the office work end of military organizations. The

big value of even women branches of the armed services is in the fact that they are ready for call and can be sent wherever needed, without delay.

Universal military training is needed to overcome those time-consuming but essential basic matters which are a part of huge organization handling. Knowledge of close-order drill is no longer necessary in order that millions of soldiers may charge into an enemy's ranks, but it is necessary just to enable large numbers of men or women to maneuver efficiently from barracks to mess-hall, or to load a train or ship. If it can be taught in peacetime to those civilians who will be in uniform in the event of war, valuable time will be saved. Also, the selection of specialities for these civilian can be accomplished more efficiently in peacetime, and some of the basic training in selected specialities given, so that all of this need not be done after war begins.

If another war comes, there will be little time to train armies—there will be need the first month, the first week, or the first day, for millions of men and women to spring to arms—but the arms will not be muskets and pitchforks. They will be highly technical things and the millions will need to know how to spring, where to spring to, and what to do after they get there. That is the purpose and the need of UMT.

There is not a youth who would not benefit from a year's training of body and mind, and some inculcation of discipline and duty to society. The youth of today learns too much about what he can get from society, too little of what he can give, and nothing of what he owes.

Parenthetically, UMT should not omit basic training with the rifle, because while huge armies may not be needed any more for large-scale personal combat warfare, millions of us will find rifle skill a handy accomplishment in the guerrilla life we are headed for if world government does not take over very soon.

I think that every technical man should try to explain to laymen the technical nature of modern war, the consequent necessity for advance selection, training, and organization of millions of our youth, and that this necessity is vital to survival, continuing to that time when world law and order make such foolish waste no longer necessary.

Perhaps there is a job for the Institute to do in this matter, too. The above-mentioned benefits of UMT will result only if its operations are properly planned. It seems reasonable that the engineering and scientific societies should contribute to that planning; and since radio and electronics form so large a part of the new warfare methods, the I.R.E. might be able to contribute greatly to UMT planning for selection, training, and assignment.

Influence of Reproducing System on Tonal-Range Preferences*

HOWARD A. CHINN†, FELLOW, I.R.E., AND PHILIP EISENBERG‡

Summary—A paper has been published¹ presenting the results of study of the tonal-range preferences of radio-broadcast listeners when listening to a system whose transmission characteristics were essentially uniform at all frequencies within the transmission band. The present report covers a new series of experiments designed to ascertain the preferences when listening to a system whose transmission characteristics are such as to compensate for the change in the response of the ear with loudness level. In addition, the effect of employing a reproducing system of entirely different components than those used in the original work was determined.

The results of the study pertain to single-channel listening using present-day program pickup techniques. The main conclusions are as follows:

- (1) Most listeners do not prefer a wide range even when a fully compensated system is used.
- (2) Most listeners choose about the same bandwidth with either a compensated or an uncompensated system. If anything, most prefer a slightly narrower range with a compensated system.
- (3) Most listeners like bass and dislike an excess of high frequencies in music. In speech, they dislike sibilance.
- (4) Other changes in the reproducing system—the transcription reproducer, the amplifier channel, and the loudspeaker—did not influence tonal-range preferences.

It may be (although it seems doubtful) that such slight residual distortions as existed in the reproducing system are enough to make listeners dislike wide range. But this hypothesis can be tested only when new methods are found to reduce further both electrical and acoustical distortion. Meanwhile, the results of other studies (not reported herein) indicate that the more likely explanation lies in the nature of current program pickup techniques.

I. INTRODUCTION

THE RESULTS of a study that was made to determine the tonal-range preference of broadcast listeners¹ (as contrasted to their acuity of hearing) led to the conclusion that the majority of broadcast listeners preferred either a narrow or medium tonal range to a wide one. The investigation represented a new type of research and yielded data that astonished some people. Consequently, the conclusions and the conduct of the experiment were the subjects of some polemics.²

One of the main questions raised was: Is the conclusion that most listeners do not prefer a wide tonal range limited to the particular reproducing system used? Would listeners choose a wide range with a reproducing system employing different elements?

This question had been anticipated during the original work, and the experiments were designed to answer it. For example, the experimental procedure, the equip-

ment, and the data were presented in considerable detail, so that anyone could judge the validity of the results and reach his own conclusions. Furthermore, it was recognized that different results might be obtained with a reproduction system compensated for the particular reproduction level employed (as indicated by the Fletcher-Munson equal-loudness contours.³ In order to make a start without introducing complications in the first series of tests, it was decided to undertake them without compensation and to employ compensation in a later series.

To provide additional answers to this question, a new series of four experiments was conducted between May and July, 1946. In all, 211 listeners took part in the tests and made 3800 individual tonal-range choices.

This paper reports listeners' preferences: (1) when listening to a compensated reproducing system, and (2) when listening to a reproducing system employing entirely different elements than were employed in the 1945 experiments.

II. COMPENSATED VERSUS UNCOMPENSATED REPRODUCING SYSTEMS

The sound-reproducing system used in the 1945 experiments was an "uncompensated" one—that is, the transmission characteristic was uniform with frequency (except as deliberately modified by filters to obtain different tonal ranges) at all sound-reproduction levels. As is well known, the response of the ear is a function of loudness level.³ When listening at the ordinary listening levels, say 65 db, the low- and the high-frequency tones are not heard as well as the middle frequencies, even though all tones in the spectrum are reproduced at the same physical intensity. Consequently, when listening at a sound level that is different than the original, it would appear that the transmission characteristic should be modified to compensate for the difference in the ear's response. Unless this is done, the original "balance" between tones of various frequencies may not be maintained.

The first study indicated that most listeners preferred a peak sound level somewhere between 60 and 70 db above the acoustical reference level. On the other hand, the original performance is often balanced at a sound level as high as 95 db.⁴

Fig. 1 illustrates the manner in which the average

* Decimal classification: R550X534. Original manuscript received by the Institute, September 12, 1947; revised manuscript received, November 20, 1947.

† Columbia Broadcasting System, Inc., New York, N. Y.

¹ H. A. Chinn and P. Eisenberg, "Tonal-range and sound-intensity preferences of broadcast listeners," *Proc. I.R.E.*, vol. 33, pp. 571-581; September, 1945.

² Discussion on "Tonal-range and sound-intensity preference of broadcast listeners," *Proc. I.R.E.*, vol. 34, p. 757; October, 1946.

³ H. Fletcher and W. A. Munson, "Loudness, its definition, measurements and calculation," *Jour. Acous. Soc. Amer.*, vol. 5, p. 82; October, 1933.

⁴ H. A. Chinn and P. Eisenberg, "New CBS program transmission standards," *Proc. I.R.E.*, vol. 35, pp. 1547-1555; December, 1947.

person would hear various tones, which were initially balanced at a 100-db level, when listening at a 65-db level to a compensated and an uncompensated system. It is evident that a tone of 50 c.p.s., for instance, must be increased in level by 15 db and a tone at 10,000 c.p.s. by 6 db, to make them sound as loud as a 1000 c.p.s. tone.

It is recognized that the psychoacoustical effect of the tones contained in program material is different from that of pure test tones. However, pending the availability of precise data on the former, it is necessary to make use of the accepted data on the latter as a guide to present experimentation.

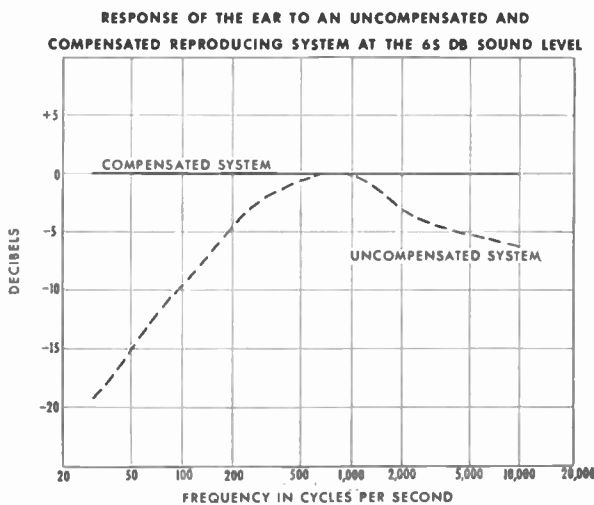

Fig. 1—As is well known, the response of the ear is a function of loudness level. Consequently, when listening at ordinary home listening levels (say 65 db), the low and the high frequencies are not heard as well as the middle frequencies, even though all tones are reproduced at the same physical intensity. The dotted curve (based upon the Fletcher-Munson data) shows the manner in which the average person hears various sounds that are initially balanced at a 100-db level (i.e., original performance levels) when listening at a 65-db level. With a reproducing system that is compensated for the normal loss in the ear's sensitivity, the original balance would be maintained as shown by the solid line.

III. INFLUENCE OF REPRODUCING SYSTEM ON TONAL RANGE PREFERENCE

What tonal range do listeners prefer with a compensated system?

The subjects in Experiment 1 of the present series were asked to listen to a test passage, one minute in duration, in which two conditions of reproduction would alternate three times. In each test passage, two tonal-range conditions were alternated (with peak sound level kept constant at 65 db): narrow versus medium, narrow versus wide, or medium versus wide. (See Appendix IV, Fig. 7.) The only identification to the participants of the conditions of the test was a pair of signal lights, numbered 1 and 2, which were synchronized with the changes in type of presentation. The listeners were not told which pair of conditions was

being tested, nor what condition corresponded to each signal light.

Upon the completion of a test passage, the listeners were asked to indicate which type of presentation they found more pleasant to listen to. They could, if they wished, indicate that they liked both about equally well, or that neither was liked.

In Experiment 1, the test passages consisted of two symphonic, two popular orchestra, and two male speech selections. Since each of the six passages were reproduced with 3 tonal range pairs, listeners reacted to eighteen passages. All passages were reproduced with a reproducing system whose response was compensated in accordance with the tenets outlined in the preceding section.

Fig. 2 shows the tonal-range preferences, the preference for all passages being combined. (Data were combined to indicate trends more reliably. Reactions to individual passages are discussed later.) Table I details the data for each passage.

TONAL RANGE PREFERENCES WHEN MATERIAL IS REPRODUCED WITH A COMPENSATED SYSTEM (Four Music and Two Speech Passages Combined)

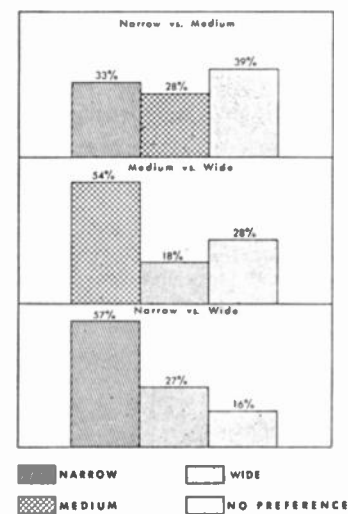

Fig. 2—The tonal-range preferences of a cross section of listeners when listening to a compensated reproducing system is shown by this chart. When the narrow tonal range was compared with the medium the choice between the two was about equal, as is shown by the fact that many evidenced "no preference" and the proportion choosing "narrow" was about the same as for "medium." However, in the comparison between "medium" and "wide" and between "narrow" and "wide," the preference was markedly for the narrower bands.

The findings support the conclusion of the 1945 study. The majority of listeners prefer a narrow or a medium range to a wide one. Their bandwidth preference falls between a narrow and medium range. At least as far as the two systems tested are concerned, the majority of listeners do not prefer a wide range. However, the questions discussed in the following paragraphs must be answered before this conclusion can be fully accepted.

TABLE I
EXPERIMENT 1—PREFERENCES WHEN A COMPENSATED SYSTEM IS USED

Tonal-Range Preference	Symphonic Music A	Symphonic Music B	Popular Orchestra C	Popular Orchestra D	Male Speech A	Male Speech B	All Passages Combined
Number of listeners: 60							
	per cent	per cent	per cent	per cent	per cent	per cent	per cent
Narrow	32	37	30	20	45	35	33
Medium	32	18	33	37	17	30	28
No preference	36	45	37	43	38	35	39
	100	100	100	100	100	100	100
Medium	57	32	62	53	60	62	54
Wide	18	23	15	27	12	15	18
No preference	25	45	23	20	28	23	28
	100	100	100	100	100	100	100
Narrow	58	53	63	32	70	63	57
Wide	25	27	25	51	18	17	27
No preference	17	20	12	17	12	20	16
	100	100	100	100	100	100	100

Do Listeners Prefer a Wider Tonal Range with a Compensated Than With an Uncompensated System?

While, in general, it was found that listeners do not prefer a wide range with a compensated system, it is essential to determine whether with a compensated system they preferred a *wider* range. The results of Experiment 1 could not be compared with the data of the 1945 studies because there were significant changes in the performances and the content of the test passages.

Therefore, it was necessary to obtain preferences with an uncompensated system, using the same passages and experimental technique as employed in Experiment 1. Accordingly, a new experiment was conducted (Experiment 2a) with a symphonic orchestra, a popular orchestra, and a male speech selection. These passages were reproduced with an uncompensated system, and for each, three tonal range pairs were alternated (making nine passages in all).

The tonal range preferences in Experiment 1 (compensated system) are compared with the preferences in Experiment 2a (uncompensated system) in Fig. 3, which shows that listeners chose about the same bandwidth in both systems. If anything, the majority preferred a slightly narrower range with a compensated than with an uncompensated system. Table II details the data for each passage of Experiment 2a.

TONAL RANGE PREFERENCES WHEN UNCOMPENSATED & COMPENSATED REPRODUCTION SYSTEMS ARE USED
(Two Music and One Speech Passage Combined)



Fig. 3—The tonal-range preferences when listening to (a) uncompensated and (b) to compensated reproduction systems are shown by this chart. The listeners chose about the same bandwidth with either system; if anything, the majority prefer a slightly narrower range with a compensated than with the uncompensated system. This is probably explained by the fact that, with a compensated system, a somewhat wider range of frequencies can be heard than with an uncompensated system.

TABLE II

EXPERIMENT 2A—PREFERENCES WHEN AN UNCOMPENSATED SYSTEM IS USED

Tonal-Range Preference	Symphonic Music A	Popular Orchestra D	Male Speech B	All Passages Combined
Number of listeners: 70				
	per cent	per cent	per cent	per cent
Narrow	25	19	33	25
Medium	31	50	36	39
No preference	44	31	31	36
	100	100	100	100
Medium	57	51	41	50
Wide	20	32	34	29
No preference	23	17	25	21
	100	100	100	100
Narrow	41	47	31	40
Wide	25	24	40	30
No preference	34	29	29	30
	100	100	100	100

In a compensated system, the ear hears a slightly wider tonal range than in an uncompensated system. Raising the sound-intensity level of the lower and higher frequencies increases the span of frequencies distinctly heard. If the original conclusions that people do not prefer a wide range are accepted, it is to be expected that listeners' preferences are slightly narrower with a compensated system than with an uncompensated system.

Is a Compensated System Preferred to an Uncompensated System?

Thus far the influence of a compensated and of an uncompensated system on tonal-range preference had been studied. It was still necessary to determine whether either system of reproduction was preferred to the other. Another experiment, Experiment 2b, was undertaken for this purpose. In this study, listeners were presented with a symphonic orchestra, a popular orchestra, and a male speech passage, in which reproduction alternated between a compensated and an uncompensated system. Each of the three pairs was tested at a narrow, a medium, or a wide tonal range, making nine passages in all. Fig. 4 shows the listeners' choices (all passages combined). Table III details the data.

TABLE III

EXPERIMENT 2B—PREFERENCE BETWEEN A COMPENSATED AN UNCOMPENSATED SYSTEM

System Preference	Symphonic Music B	Popular Orchestra C	Male Speech A	All Passages Combined
Number of listeners: 70				
At narrow range	per cent	per cent	per cent	per cent
Uncompensated	36	37	33	35
Compensated	33	34	34	34
No preference	31	29	33	31
	100	100	100	100
At medium range				
Uncompensated	44	34	36	38
Compensated	31	40	27	33
No preference	25	26	37	29
	100	100	100	100
At wide range				
Uncompensated	41	39	64	48
Compensated	30	31	19	27
No preference	29	30	17	25
	100	100	100	100

It is evident from the data that, when the two systems are compared at a narrow or medium tonal range, there is no marked preference for one method of reproduction over the other. The choices are about evenly spread among an uncompensated system and no preference. But at a wide tonal range a majority of the listeners having an opinion prefer an uncompensated to a compensated system. This result can be understood by the fact that the difference between the two systems is more apparent at a wide range than at a narrower range. Apparently, the uncompensated system is preferred be-

PREFERENCES FOR A COMPENSATED VS. AN UNCOMPENSATED SYSTEM (Two Music and One Speech Passage Combined)

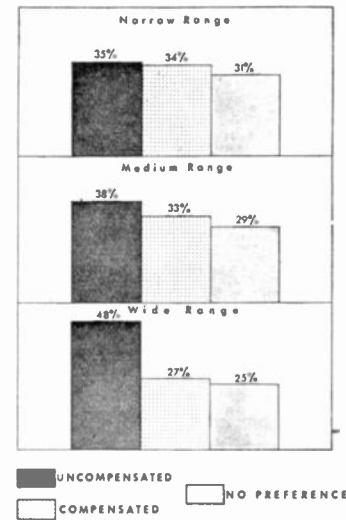

Fig. 4—The results of a *direct* comparison between a compensated and an uncompensated reproducing system are shown in this chart. When the comparison is made at either a narrow or a medium tonal range there is no predominant preference for either system. At a wide tonal range, however, a majority of the listeners having an opinion prefer the uncompensated system. Apparently the uncompensated system is preferred because, effectively, it is slightly narrower than the compensated system.

cause, effectively, it is slightly narrower than the compensated system:

Does the Use of Electrical Transcriptions Affect the Tonal Range Preference?

One more question remained to be studied. In the 1945 experiments it was demonstrated that tonal-range preferences are not influenced by the use of high-quality "master" recordings when an uncompensated system is used. What happens with a compensated system?

To answer this question, two additional experiments, Experiments 3 and 4, were conducted. Listeners were asked to make choices between tonal pairs as in Experiment 1. The reproduced material was taken from programs brought by direct wire from the originating studio, however, rather than through the medium of recordings. In Experiment 3, the participants responded to eighteen speech passages from a mystery drama, and in Experiment 4, to eighteen musical passages from "American Melody Hour." A compensated system was used in both experiments.

Fig. 5 compares the preferences (music and speech programs combined) for material obtained by wire directly from the originating studio and for recorded material. It can be seen that the tonal-range preferences are about the same whether material is brought to the listener by direct wire or by high-quality recordings. In other words, any residual degradation which may have been present in the transcriptions did not influence the choices. Table IV details the data.

TONAL RANGE PREFERENCES FOR RECORDED PASSAGES AND FOR PASSAGES BROUGHT BY DIRECT WIRE

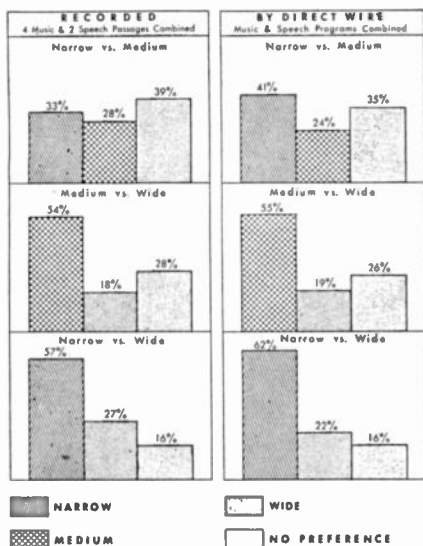

Fig. 5—This chart compares the tonal-range preferences for program material obtained by wire directly from the originating studio, and from high-quality recordings. It is seen that the preferences are essentially the same in both cases.

TABLE IV
EXPERIMENT 3 AND 4—PREFERENCES FOR SPEECH AND MUSIC BROUGHT BY DIRECT WIRE

Tonal-Range Preference	Experiment 3 Speech	Experiment 4 Music	All Passages Combined
Number of listeners: 39			
	per cent	per cent	per cent
Narrow	41	41	41
Medium	24	25	24
No preference	35	34	35
	100	100	100
Medium	44	66	55
Wide	26	13	19
No preference	30	21	26
	100	100	100
Narrow	55	68	62
Wide	23	21	22
No preference	22	11	16
	100	100	100

Do Other Changes in the Reproducing System Influence Tonal-Range Preference?

In the present series of experiments, other changes were introduced in the reproducing system besides compensation. These included changes in the transcription reproducer, the amplifier channel, and the loud-speaker, all made with the view to utilizing the latest equipment available and providing the best possible system. The preferences in Experiment 2a, in which an uncompensated system was used, can be compared¹ with the preferences obtained in the 1945 experiments to determine whether these changes in the reproducing

system influenced tonal-range preference. It is evident that the changes did not influence preference because the bandwidth preferred is essentially the same in both studies.

IV. INFLUENCE OF TONAL CONTENT ON TONAL-RANGE PREFERENCE

In the 1945 studies it was found that choice of bandwidth varies between narrow and medium range for different types of tonal content. Most listeners preferred a slightly wider band for female speech, piano, and popular orchestra than for male speech, mixed dramatic speech, and symphonic orchestra.

How Do Tonal-Range Preferences Differ with Tonal Content?

Fig. 6 shows the tonal-range preferences for the six types of content, as obtained from Experiment 1 of the present series. It is seen that most listeners' choices still vary between narrow and medium ranges.

VARIATION OF TONAL RANGE PREFERENCE WITH TONAL CONTENT

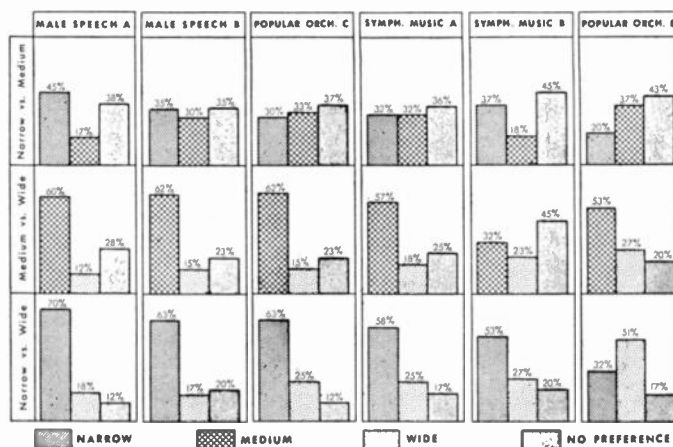

Fig. 6—The influence of tonal content of a program passage upon the tonal-range preferences of listeners is shown by this chart. It is seen that most listeners' choices still vary between narrow and medium ranges. The columns in this chart have been arranged in ascending order of preference from the narrowest to the widest band. As detailed in the text, an analysis of the actual content of the passages explains the reason for the particular order that resulted.

In both studies, listeners' preference for a medium or wide band was most pronounced for popular orchestra. But in the 1945 study, listeners preferred a wider band for male speech than for symphonic music, while in this study their preferences were reversed. Furthermore, a wider band is preferred for one symphonic music passage (Music B) than for one popular orchestra passage (Music C).

These results are seen to be consistent when the tonal content of the passages is examined. In both Music B and D the bass was fairly well accented, with relatively few high frequencies. In Music D, the strings were mostly in the background with saxophone and brass dominant. In Music B, the strings were muted, which

cut off the high-frequency harmonics. In Music A and C, the bass was also fairly well accented, but there was a considerable amount of high frequencies, mostly the high registers on strings. The speaker in Speech A was very sibilant. The speaker in Speech B was not sibilant but had a very deep voice.

Judging from the listeners' preferences under conditions of these tests, as well as their comments, it seems that most listeners like bass and dislike an excess of high frequencies in music. In speech, they dislike sibilance. It may be also that they dislike voices that are too deeply pitched.

If these generalizations are correct, it follows that, where a musical passage contains too many high frequencies, listeners prefer a narrow band which will eliminate the high registers. Where a musical passage does not contain high frequencies, listeners will tolerate a wider band. Similarly, when a speaker is very sibilant listeners prefer a narrow range which will eliminate some of the hiss of the "s's." A re-examination of the tonal content of the passages used in the 1945 experiments tends to verify these conclusions.

In short, the majority of listeners maintain a preference for a bandwidth between narrow and medium. When the content of a passage varies, they judge it according to this standard. If the content is too wide, they choose a narrower band to reduce its width. Generally, people seem to be displeased with the extension of the range at the high-frequency end, and prefer an extension at the low-frequency end.

V. CONCLUSIONS

Insofar as single-channel listening is concerned, using *present-day broadcasting pickup techniques*, it has been found from this new series of tonal range experiments that:

- (1) Most listeners do not prefer a wide range even when a fully compensated system is used.
- (2) Most listeners choose about the same bandwidth with either a compensated or an uncompensated system. If anything, most prefer a slightly narrower range with a compensated system.
- (3) Most listeners do not prefer a fully compensated to an uncompensated system at a narrow or medium tonal range; at a wide range, most prefer an uncompensated system.
- (4) Most listeners like bass but dislike an abnormal amount of high frequencies in music which can be transmitted over present-day wide-range systems. In speech, they dislike sibilance.
- (5) The use of high-quality recordings, in place of live talent, does not influence tonal-range preferences.
- (6) Changes other than response-frequency compensation, e.g., in the reproducing system, in the transcription reproducer, in the amplifier channel, and in the loudspeaker, do not influence tonal-range preferences.

In general, most listeners preferred a bandwidth between narrow and medium—no matter how the reproducing system was changed in these experiments. Of course, this conclusion is limited to the systems which were tested. It may be (although it seems doubtful) that such slight residual distortions as existed in the reproducing system are enough to make listeners dislike wide range. But this hypothesis can be tested only when new methods are found to reduce further both electrical and acoustical distortion. Meanwhile, the results of other studies (not reported herein) indicate that the more likely explanation lies in the nature of current program pickup techniques.

The evidence of this study suggests that listeners prefer to hear a fair amount of bass in music. It has even been suggested that the bass frequencies be given pre-emphasis in broadcast transmitters and in recordings. However, the amount of bass boost employed could only be right for a particular listening level. Even so, it would probably not be in accordance with the particular preference of a given listener.

A better solution is the incorporation in all reproducing systems of properly designed tone controls. Manufacturers can make radio receivers having provisions for altering the tonal-range characteristics of the reproducing system so as to please the individual listeners. Consequently, from a purely technical standpoint, the broadcast transmission system should provide as wide-range reproduction as is consistent with economic considerations, so that those listeners who prefer wide-range reproduction will be given an opportunity to enjoy it. At the same time, those preferring narrow-band reception will also be able to obtain it.

This arrangement has still another advantage. There is some indication that tonal-range preferences may be influenced by the acoustical liveness⁵ of the pickup. If such is the case, a suitable tone control will permit the listener to tailor the response versus frequency characteristic of his reproducing system to fit the psycho-acoustical nature of the pickup.

There are endless ramifications and variations to experiments of the type reported upon. It is hoped that others will soon enter this new field of research in the interest of adding to the fund of knowledge on listeners' preferences.

ACKNOWLEDGMENT

The work reported on in this paper was made possible only through the co-operation of many individuals—more than it is appropriate to name here. The contribution of all is gratefully acknowledged, nonetheless. Particular recognition is due A. G. Peck, without whose patience, keen understanding, tact, and ability the study would have been seriously handicapped.

⁵ J. P. Maxfield and W. J. Albersheim, "Acoustic constant of enclosed spaces correlatable with their apparent liveness," *Jour. Acous. Soc. Amer.*, vol. 19, p. 71; January, 1947.

APPENDIX I

EXPERIMENTAL PROCEDURE

The pattern followed in all listeners' sessions was alike. The listeners were told that, during the course of the experiment, they were to hear music and speech passages presented in several different ways. They were advised that there were no right or wrong answers, and that they were to indicate the method of presentation they found more pleasant and personally liked. In addition, the blanks upon which the listeners recorded their choices provided means for indicating if both conditions were liked about equally well or neither was liked. Furthermore, if the listeners had a strong preference they could so indicate. Upon the completion of the tests, listeners were asked to fill out a questionnaire providing personal data.

The conditions of presentation were identified for the listeners by means of a pair of signal lights, numbered 1 and 2, which were synchronized with the changes in type of presentation. The listeners were not informed, however, as to the particular type of presentation to which either light corresponded. Furthermore, a random pattern was adopted in assigning the numerals to the various test conditions. The lights were mounted vertically, one over the other. It was found that the listeners were not influenced in any way by the position of the lights in their choices.

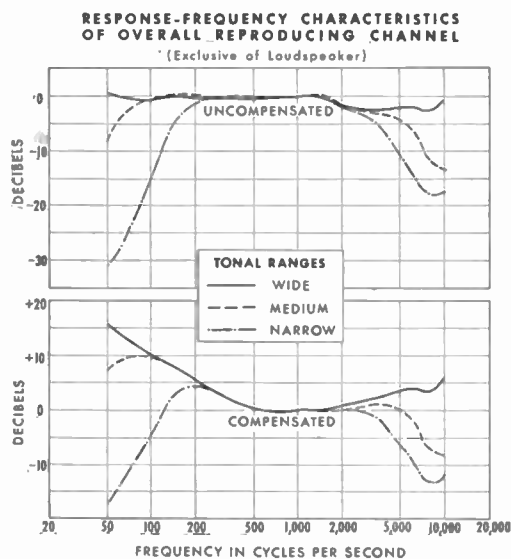

Fig. 7—The frequency limits of the three tonal ranges (wide, medium, and narrow) used for the study are shown. These characteristics are for the entire channel, including the recording and reproducing equipment, but excluding the loudspeaker. The deviation of the compensated characteristic from the "ideal" (as determined from the Fletcher-Munson contours) is less than 2 db throughout the transmission band.

Each test passage was 1 minute in length, and during this period the paired conditions were alternately presented, each time for a 10-second interval. Thus, in a 1-minute period, the listener had an opportunity to compare each type of presentation three times.

In the experiments, three tonal ranges were used in various combinations. For convenience, these are referred to as narrow, medium, and wide tonal ranges (see Fig. 7). The volume level was kept constant at a 65 db average peak level. The tonal ranges were combined in three pairs: narrow versus medium, medium versus wide, and narrow versus wide.

In each experiment, the three comparisons were repeated for each of the six types of program content (two symphonic music, two popular orchestra, and two male speech), making a total of eighteen paired comparisons for each experiment. The order of presentation was varied and the light positions were reversed, so that order and positions effects might be eliminated. For example, condition 1 for Music A, in some listener sessions, became condition 2 for Music A in other sessions.

In Experiment 2a, nine of the passages were tonal-range comparisons. In Experiment 2b, the other nine passages were uncompensated-compensated system comparisons, three of them played at a narrow range, three at a medium range, and three at a wide range. In Experiments 3 and 4, the same experimental plan was used, except that the program material was brought by direct wire from a mystery and from a light musical program. The list of experiments is given in Table V.

TABLE V
LIST OF EXPERIMENTS

Experiment	Purpose	Program Material	Number of Subjects
1	Tonal-range preference, with compensated system.	Symphonic, popular orchestra, male speech (recorded).	60
2	a. Preference with uncompensated system (9 passages). b. Compensated versus uncompensated systems (9 passages).	Symphonic, popular orchestra, male speech (recorded).	70
3	Influence of transcriptions on preference, compensated.	Mystery program (live).	39
4	Influence of transcriptions on preference, compensated.	Light classical and popular music program (live).	42
			211

APPENDIX II

SUBJECTS

The subjects, all adults, were secured by means of spot announcements over the CBS key station, WCBS, in New York City. They represented a cross section of radio listeners. The exact composition of the groups is detailed in Table VI.

APPENDIX III

ENVIRONMENT

In order to simulate living-room conditions, a small studio with a low ceiling was used for the study. It was

TABLE VI
COMPOSITION OF THE GROUPS

	Total number of subjects: 211			
	Experi- ment 1	Experi- ment 2	Experi- ment 3	Experi- ment 4
<i>Number of persons</i>	60	70	39	42
<i>Sex</i>	per cent	per cent	per cent	per cent
Male	42	49	44	38
Female	58	51	56	62
	100	100	100	100
<i>Age</i>				
Under 26	18	30	34	40
26-40	52	37	26	29
Over 40	30	33	40	31
	100	100	100	100
<i>Education</i>				
Grammar school	17	19	15	10
High school	47	46	64	52
College	36	35	21	38
	100	100	100	100
<i>Musical training</i>				
None	25	40	33	20
Less than 2 years	43	44	47	54
More than 2 years	32	16	20	26
	100	100	100	100
<i>Musical preference</i>				
Popular and dance	30	24	23	52
Semiclassical	48	47	51	36
Classical	22	29	26	12
	100	100	100	100

22 feet wide, 30 feet long, and 8½ feet high. It was provided with a rug, armchairs, and other furnishings to give it a living-room atmosphere.

The loudspeaker used to reproduce the voice and program material was located at the front of the room, behind a light scrim curtain. Measurements indicated that the sound intensity for all frequencies in all parts of the studio was essentially alike, since the loudspeaker had a wide angle of coverage. As an additional

precaution, however, all listeners were seated toward the front of the room and as near its center line as feasible.

APPENDIX IV
EQUIPMENT

Except for Experiments 3 and 4, which were made with live talent, all voice and musical selections were reproduced from especially recorded "masters" cut on cellulose-nitrate coated disks. The records were made by the Columbia Records Inc., and employed the standard electrical-transcription recording characteristic. This source of program material was used to insure absolute uniformity in the material presented at each session. Furthermore, original master recordings were used because of the low distortion and the extremely low surface-noise level that this type of recording affords. A new cut was used for each session to avoid any possibility of the quality being impaired by repeated playings.

The best available postwar loudspeaker system was used for the tests. It consisted of a duplex loudspeaker unit mounted in a small, reflex theater-type horn. The free-field response of this assembly is essentially uniform over the spectrum from 70 to 10,000 c.p.s. The loudspeaker was installed high enough above the floor so that listeners in the front row did not block the sound for listeners in succeeding rows.

The system was equipped with filters to provide three tonal ranges, nominally designated as narrow, medium, and wide. The over-all response versus frequency characteristics of the system (including the recording and reproducing equipment, but exclusive of the loudspeaker) is shown in Fig. 7. These characteristics reflect the compensation required for a 65 db acoustical level in accordance with the Fletcher-Munson contours. The deviation from the ideal characteristic is less than plus or minus 2 db throughout the transmission band.

TABLE VII
LIST OF PROGRAM MATERIAL

Selection	Title	Author	Performer	Used in Experiment
<i>Music Selections</i>				
A	Carmen	Bizet	35-piece orchestra	1, 2a
B	Preludia	Jarnefelt	35-piece orchestra	1, 2b
C	My Ideal	Whiting	17-piece orchestra	1, 2b
D	Blue Skies	Berlin	17-piece orchestra	1, 2a
E, F	There's No One But You	Evans, Croom, Johnson	Tenor, 29-piece orchestra*	4
G, H	In The Moon Mist	Lawrence	Alto, orchestra	4
I, J	Strange Love	Heymann, Rosza	Tenor, chorus, orchestra	4
K, L	Should I Tell You I Love You	Porter	Chorus, orchestra	4
M, N	They Say It's Wonderful	Berlin	Soprano, tenor, chorus, orchestra	4
O, P	I Don't Know Enough About You	Lee, Bartour	Tenor, chorus, orchestra	4
Q, R	The Gypsy	Reid	Alto, orchestra	4
S, T	Someday You'll Want Me	Hodges	Chorus, orchestra	4
U, V	Surrender	Benjamin, Weiss	Tenor, chorus, orchestra	4
<i>Speech Selections</i>				
A	Untitled	Corwin	Tenor Speech	1, 2b
B	Untitled	Corwin	Tenor Speech	1, 2a
C to T	Casey, Crime Photographer**	Cole	Various dramatic speech passages	3

* Music passages E through V were taken from the June 25, 1946, broadcast of the "American Melody Hour."

** Speech passages C to T were taken from the June 24, 1946, broadcast.

The background noise, even during the reproduction of the records, was negligible and not detectable by the majority of the listeners. The measured distortion of the electrical portion of the system was less than 0.5 per cent r.m.s. throughout the frequency range (i.e., less than $\frac{1}{2}$ of the present F.C.C. requirement for f.m. broadcasting systems). Although facilities were not available to determine, quantitatively, the nonlinear distortion introduced by the loudspeaker, trained observers, critically listening to the system, agreed that no distor-

tion of this type was detectable. This observation was consistent with the manufacturer's claims for the loudspeaker and the measured distortion of the electrical portion of the system.

APPENDIX V

PROGRAM MATERIAL

The passages, each 1 minute in duration, used in the experiment are given in Table VII.

Experimental Studies of a Remodulating Repeater*

W. M. GOODALL†, SENIOR MEMBER, I.R.E.

Summary—This paper describes tests made on an experimental broad-band microwave f.m. repeater. A superheterodyne receiving unit is used with a microwave reflex-oscillator transmitting unit to form a repeater. An experimental setup for testing this repeater in a circulating-pulse system is described. Oscillograms showing the performance of the repeater on a multilink basis are discussed.

INTRODUCTION

WHEN WORK WAS resumed in the microwave repeater field it was natural to investigate in more detail an f.m. system using microwave reflex oscillators where the frequency modulation is produced electronically by varying the repeller voltage. Such a system had been tried in a preliminary manner by S. D. Robertson of these Laboratories before the war. During the war the reflex oscillator had been improved and had become a readily available source of power. In addition, improved tubes like the 6AK5 were available for wide-band i.f. amplifiers. Accordingly, a repeater of the remodulating type was assembled using these components. By a remodulating repeater is meant one in which the original baseband¹ signal is recovered by the receiving unit and is used to remodulate the transmitting unit. The preliminary results had been promising and further tests were now indicated.

The material to be presented may be outlined as follows: After a brief description of the repeater to be tested, it is shown how the circulating-pulse technique can be used to evaluate its performance. It will be shown that it is possible to study pulse transmission of a multilink basis with a limited amount of equipment.

* Decimal classification: R480×R310. Original manuscript received by the Institute, April 10, 1947.

† Bell Telephone Laboratories, Inc., Deal, N. J.

¹ In discussing systems, it has been found desirable to use a term describing the original signal wave to be transmitted over the system. Thus we have an audio-frequency band, a carrier-frequency band, and a video-frequency band.

The term "video-frequency band" has been used by many to include any wide-band signal, even where television is not involved. The writer has proposed the general term "baseband" to include the original signal waves of all classes. Thus an audio wave would be described as an audio-baseband signal, and a pulse signal as a pulse-baseband signal. Since we are concerned with any one of several wide-band signal waves, the general term "baseband" will be used in this paper.

An experimental setup for circulating-pulse testing is described. This is followed by a brief discussion of some of the experimental results obtained.

DESCRIPTION OF REPEATER

Fig. 1 shows a block diagram of a two-link system using a remodulating repeater. This repeater consists of

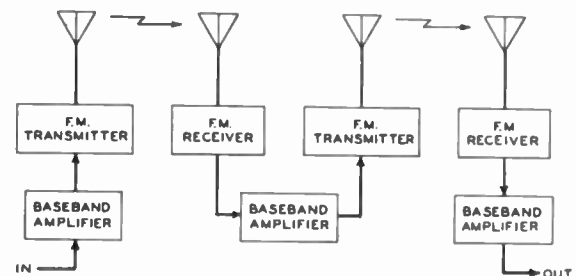

Fig. 1—Block diagram of a remodulating repeater system.

a receiver and transmitter connected together, back-to-back. An actual repeater would consist of a receiving antenna, a microwave-to-i.f. converter, i.f. amplifiers, f.m. detector, baseband amplifiers, a microwave reflex oscillator, and a transmitting antenna.

In addition to these basic units, auxiliary equipment in the form of power supplies, monitoring circuits, etc., would be required in a working repeater.

In the experimental equipment used in these studies, this auxiliary equipment was kept to a minimum consistent with the experimental objectives. In addition, only the active parts of the repeater were used. Consequently, the antenna systems and the transmission medium were not included, and the tests were made with the active parts of the repeater together with such additional equipment as was necessary for the circulating-pulse studies.

The microwave reflex oscillator available at 4000 Mc. was capable of a peak-to-peak modulation of the order of 10 Mc. The bandwidth of the microwave components was large in comparison to the i.f. system. The i.f. system had an essentially flat band (0.2 db.) of 12 Mc.

CIRCULATING-PULSE TESTING

Since the preliminary tests on the remodulating repeater were promising, it was decided to build an experimental setup to test this type of repeater on a circulating-pulse basis. As will be seen later, this technique, which passes the same pulse through a single repeater several times, can be used to study the performance of a repeater in a multilink system. The need for such a test becomes apparent when it is realized that the deterioration permitted in a single repeater of a system involving a large number of repeaters is indeed very small. This is especially true where the over-all system requirements are held to close limits. This work paralleled in time, as well as in general subject matter, the investigation already reported by Beck and Ring,² but the repeater which they used did not recover the baseband.

At this point it would be well to review briefly the general method of circulating-pulse testing, which was originally suggested by G. W. Gilman of these Laboratories (Fig. 2). Here we have, in addition to the equip-

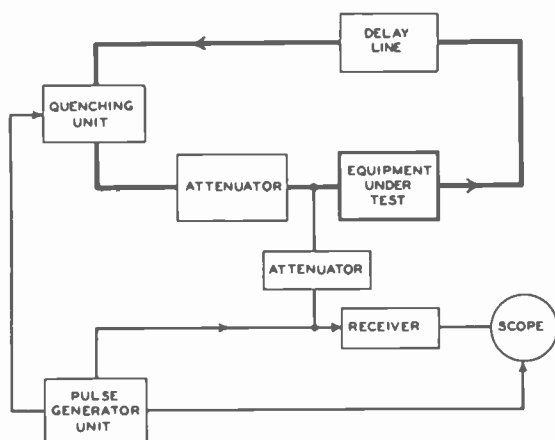

Fig. 2—Block diagram for a circulating-pulse loop test.

ment to be tested, a delay line, attenuators, a quenching unit, and input and output equipment. The delay line provides a delay greater than the length of each pulse, so that the end of the first pulse has passed completely through the equipment under test before the beginning of the pulse arrives back at the input. The attenuator is used to adjust the gain of the loop to unity. The starting pulse is produced by the pulse-generator unit. The function of the receiver and oscilloscope is to provide a means of viewing the pulses that are circulating in the loop. The heavy line indicates the path of the circulating pulses.

Unless provision is made to stop the operation, a pulse once started would circulate endlessly around the loop. The quencher is added to open the loop and stop the circulation after the pulse has made a predetermined number of trips. Even for many trips, simulating a

² A. C. Beck and D. H. Ring, "Testing repeaters with circulated pulses," *Proc. I.R.E.*, vol. 35, pp. 1226-1230; November, 1947.

system with many repeaters, the time involved is so small that the quenching operation may be repeated many times a second, so that the whole pulse pattern may be observed repetitively on a cathode-ray oscilloscope.

Because of imperfections in the equipment, a small transient results from the quenching operation. This transient circulates in the loop in the same manner as the test pulse. In order to separate this transient from the desired test pulse, a somewhat longer delay is used than would be necessary under ideal conditions. The quenching operation can be done in either the baseband or the i.f. equipment. Both methods were tried, and the arrangement using the i.f. quenching proved to be the more desirable. The results discussed in this paper utilized i.f. quenching.

The pulse-generator unit supplies signals for the test pulse, the quenching amplifier, and the sweep circuits in the viewing scope.

As pointed out by Beck and Ring,² pulse testing of this sort can be done at baseband, intermediate, or microwave frequencies, and, by including modulators in the loop, two or more frequency ranges may be included simultaneously.

In order to use the circulating-pulse technique, it is necessary to provide equipment additional to that needed for a repeater. In Fig. 3 the repeater would con-

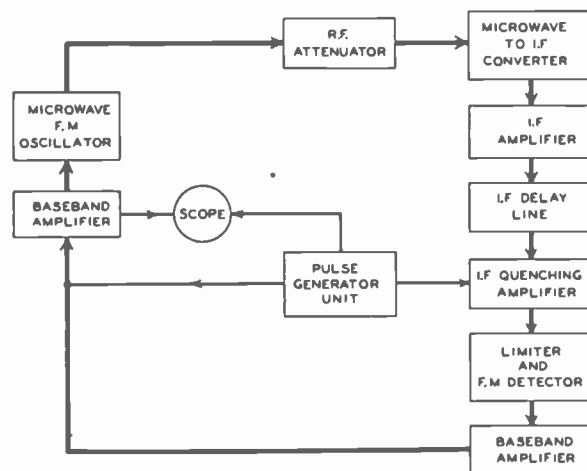

Fig. 3—Block diagram for the circulating-pulse loop test used for the f.m. remodulating repeater.

sist of the microwave to i.f. converter, the i.f. amplifier, the limiter and f.m. detector, the baseband amplifiers, and the microwave f.m. oscillator. In these tests the transmitting and receiving antenna, as well as the radio path, are replaced by the r.f. attenuator. The equipment shown in Fig. 3, but which is not needed in an actual repeater, consists of the i.f. delay line and associated i.f. amplifiers, the i.f. quenching amplifier, and some additional baseband stages needed for adjusting levels and for introducing the starting pulse. The total number of i.f. and baseband stages used in the equipment of Fig. 3 is about double that needed for a repeater. Since much of the deterioration of the signal occurs in this

part of the system, each trip through the loop would correspond to passage through more than one repeater.

The timing of the various pulses generated by the pulse-generator unit is shown in Fig. 4. In addition, the

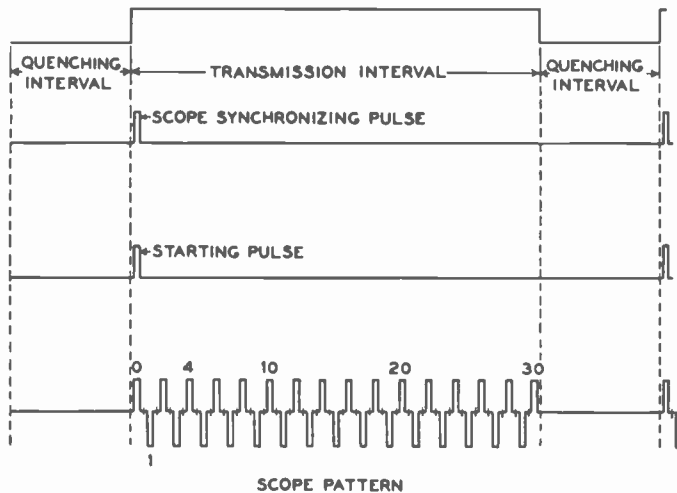

Fig. 4—Timing diagram for pulses obtained from the pulse-generator unit. The bottom line shows the pattern observed on the monitoring scope.

bottom line shows the pattern observed on the monitoring scope when the gain of the loop is adjusted to unity. The quenching transient mentioned previously is shown between the main pulses. It will be noted that alternate pulses are positive and negative, indicating a phase reversal in the baseband equipment for each trip through the loop. This method of transmission was used in these tests primarily to avoid the cumulative effect of 60-c.p.s. power noise, which, because it originates from the same source each trip, tends to add on a voltage rather than a power basis.

The pulse marked 0 is the initial or starting pulse. The scope monitors the wave form of the pulses at the input to the repeller of the reflex oscillator. The pulse marked 1 has made one trip through the loop, while the pulse marked 10 has made ten trips through the loop. Thus it can be seen that the distortion resulting from several trips can be studied by comparing the wave forms of the pulses for different numbers of trips.

DISCUSSION OF RESULTS

The system was tested by circulating 1-microsecond pulses and observing the deterioration of the pulse shape after several trips.

Since the amplitude characteristic of the over-all system is essentially flat for the significant frequencies involved in the test pulses, it would be expected that delay distortion would be the main source of deterioration. The oscillograms shown in Fig. 5 show that this is indeed the case.

In the first column, the pulses represent the transmission through the equipment with no phase equalizers added. It will be observed that transmission, satisfactory for many purposes, could be obtained through several repeaters without equalizers. Pronounced dis-

tortion begins to appear when the number of trips is very large. The second column shows the result of including phase equalizers in the i.f. portion of the loop. These equalizers were designed and built by W. J. Albersheim, to whom the author is indebted for his interest in this work. The comparison of the two sets of pulses clearly show the advantages of phase equalization in this type of system. It is seen that a signal usable for many purposes could be obtained for twenty to thirty trips.

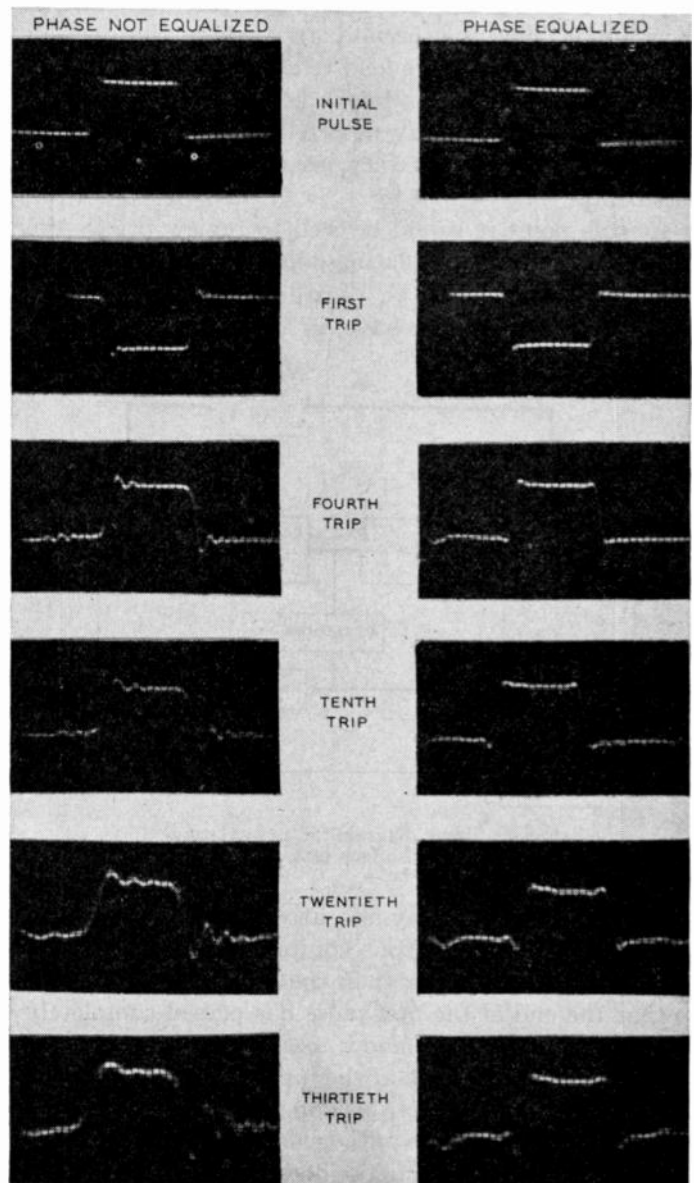

Fig. 5—Oscillograms of 1-microsecond pulses for different numbers of trips. Note improvement from phase equalization.

The results shown in Fig. 5 were obtained with a frequency deviation of +1 Mc. for the positive pulses and -1 Mc. for the negative pulses, corresponding to a peak-to-peak deviation of 2 Mc. This deviation could be increased to + and -2 Mc. for the phase-equalized case with only a slight increase in overshoot. For the unequalized case the overshoot was increased appreciably for + and -2 Mc. deviation.

For the unequalized case, Fig. 6 shows how the overshoot is changed by decreasing the deviation from a peak-to-peak value of 2 Mc. to a peak-to-peak value of

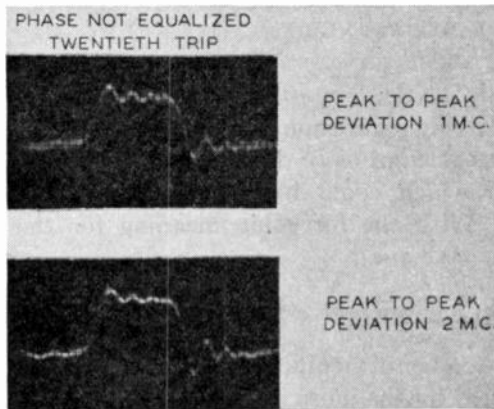

Fig. 6—Oscillograms of 1-microsecond pulses for the twentieth trip for two values of frequency deviation.

1 Mc. It will be noted that the overshoot at the top and bottom of the pulse is symmetrical and of the same shape for the smaller deviation, while for the larger deviation the overshoot at the top of the pulse is reduced and the overshoot at the end of the pulse is increased. The overshoot at the top of the pulse results from a frequency change towards the edge of the i.f. band, while the overshoot at the end of the pulse represents a frequency change towards the center of the band. Similar, but less pronounced, effects were observed for the equalized condition.

ACKNOWLEDGMENT

The author is indebted to C. F. Edwards and K. G. Jansky for the converter and preamplifier used in the receiver; to A. C. Beck and D. H. Ring for general discussion of the work as it was in progress; and to A. F. Dietrich, who built the equipment and co-operated in the tests.

A Negative-Current Voltage-Stabilization Circuit*

PEILIN LUO†

OCCASIONALLY, when a negative-current voltage stabilizer of high performance is required, the simple form of Fig. 1¹ does not yield satisfactory results. For example, the grid-bias voltage of a class-B a.f. amplifier, when stabilized by such a means, may rise by more than 5 per cent with the signal swelling from zero to full. This, together with a simultaneous fall in the plate voltage of the same order, upsets the voltage relation by more than 10 per cent. Obviously, this will cause much distortion.

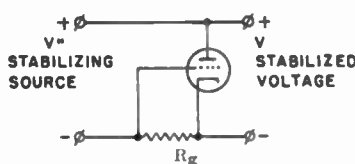

Fig. 1

A new circuit, shown in Fig. 2, operates more satisfactorily in this respect and reduces this distortion almost to zero. In this

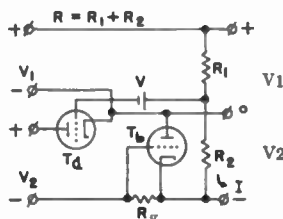

Fig. 2

circuit, the ratio arms R_1R_2 , together with the voltages V_BV_C , form a bridge arrangement. When the voltage ratio deviates from the resistance ratio, no matter what is the cause, the unbalance in voltage is applied to the grid of T_a . An amplified voltage change then occurs at the grid of T_b and changes the d.c. plate resistance of the latter. The net result is nearly complete restoration of the voltage relation.

In this way, the voltage V_2 is regulated to:

$$\frac{R_2}{R_1} \left[1 - \frac{1}{\mu_a} \frac{R_{pa} + R_g}{R_2} \frac{1}{1 + G_{mb}R_g} \right] V_1 + \frac{1}{\mu_a} \frac{R}{R_1} \left[(V_2' - \mu_a v) + \frac{R_{pa} + R_g}{1 + G_{mb}R_g} I \right] \div \left[1 + \frac{1}{\mu_a} \frac{R}{R_1} \left[1 + \frac{(R_{pa} + R_g)(R_{pb} + R)}{R(\mu_b R_g + R_{pb})} \right] \right] \quad (1)$$

and the ratio

$$\frac{V_2}{V_1} = \frac{\frac{R_2}{R_1} \left[1 - \frac{1}{\mu_a} \frac{R_{pa} + R_g}{R_2} \frac{1}{1 - G_{mb}R_g} \right] + \frac{1}{\mu_a} \frac{R}{R_1} \left[(V_2' - \mu_a v)/V_1 + \frac{R_{pa} + R_g}{4 + G_{mb}R_g} I/V_1 \right]}{1 + \frac{1}{\mu_a} \frac{R}{R_1} \left[1 + \frac{(R_{pa} + R_g)(R_{pb} + R)}{R(\mu_b R_g + R_{pb})} \right]} \quad (2)$$

As a numerical illustration, let us consider this example:

- $V_B = 2000$ volts
- $R_2 = 0.48$ megohm
- $T_a =$ type 6SF5
- $V_2' = 195$ volts
- $I = 0.1$ ampere
- $R_1 = 8$ megohms
- $T_b = 2$ type 6L6's as parallel triodes
- $v = 2$ volts
- $V_C = 118$ volts
- $R_g = 60,000$ ohms.

The calculated V_2 is $0.059 V_1 + 2.51$. With full

Several important features of this circuit may be noted, namely:

- (1) The voltage V_2 is stabilized against V_1 as standard. The stability is excellent. Thus, in such a circumstance as is exemplified, the optimum working point can be maintained under all practical conditions.
- (2) This circuit performs best with high values of V_2' , μ_a , and G_{mb} .
- (3) When V_2' is fairly constant, choosing v to be V_2'/μ_a will cause the second term of the numerator of (2) to vanish. Then the voltage ratio will be maintained even when V_1 approaches zero. This might open other possibilities for practical application.

grid current, the working point shifts only by 0.25 volts or 0.21 per cent. In the case of a simple stabilizer, with the 6SF5 omitted, the calculated change of V_2 alone amounts to 7.5 per cent.

The high stability of this device might make the bias-supply by-pass capacitor unnecessary under certain conditions. Frequency distortion is thus somewhat reduced at the low a.f. end.

These analytical conclusions were essentially verified by experiments performed in the laboratory of the N. R. C. Central Radio Manufacturing Works, Chungking Division, China.

* Decimal classification: R366.151. Abstract received by the Institute, June 30, 1947.
 † Central Radio Corporation, Tientsin Division, Tientsin, China.
 1 "The Radio Amateurs Handbook," 20th ed., American Radio Relay League, West Hartford, Conn.

Some Fundamental Considerations Concerning Noise Reduction and Range in Radar and Communication*

STANFORD GOLDMAN†, SENIOR MEMBER, I.R.E.

Summary—A general analysis based upon information theory and the mathematical theory of probability is used to investigate the fundamental principles involved in the transmission of signals through a background of random noise. Three general theorems governing the probability relations between signal and noise are proved, and one is applied to investigate the effect of pulse length and repetition rate on radar range. The concept of "generalized selectivity" is introduced, and it is shown how and why extra bandwidth can be used for noise reduction. It is pointed out that most noise-improvement systems are based upon coherent repetition of the message information either in time or in the frequency spectrum. It is also pointed out why more powerful noise-improvement systems should be possible than have so far been made.

The general mechanism of noise-improvement thresholds is discussed, and it is shown how they depend upon the establishment of a coherence standard. The reason for and the limitation of the apparent law that the maximum operating range of a communications system, for a given average power, is independent of the type of modulation used is then explained. General ways in which improvements in range of radar and communication systems may be made are also discussed. The possibility of using extra bandwidth to reduce distortion is pointed out. Finally, some possible relations of this work to biology and psychology are described.

I. INFORMATION THEORY

THE SIGNALS which are of interest in radio engineering may be represented graphically as functions of time. One such signal is shown in Fig. 1. In a transmission system having L different significant

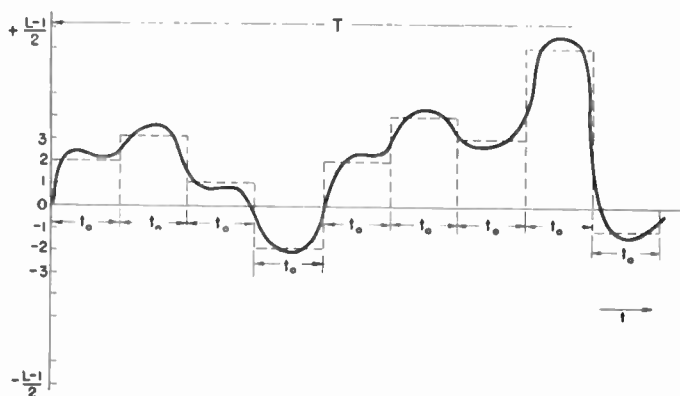

Fig. 1—Diagram of a signal, showing its significant time intervals and amplitude levels. This signal is in a system in which there are both positive and negative levels. With noise also having both positive and negative levels, the spacing between signal levels must be the peak-to-peak value of noise, namely, $2N$, so that the number of different significant amplitude levels is still $L = (S/N) + 1$. (The ideal signal is shown by the broken line. The solid line shows the same signal after passing through a transmission system of bandwidth B .)

* Decimal classification: R272.3. Original manuscript received by the Institute, October 6, 1947; revised manuscript received, January 15, 1948. Presented, National Electronics Conference, November, 1947, Chicago, Ill. This work has been supported in part by the Signal Corps, the Air Matériel Command, and the Office of Naval Research.

† Research Laboratory of Electronics, Massachusetts Institute of Technology, Cambridge, Mass.

amplitude levels, any particular signal such as that shown, having a duration of n significant time intervals, represents one out of L^n different possible signals of this duration which could have been transmitted in the system.¹ With the foregoing meaning for the various symbols, we have

$$\text{number of different possible messages} = L^n. \quad (1)^{1,2}$$

The number of significant amplitude levels is usually determined by the noise in the system. If the system is of a linear nature, and the maximum signal amplitude is S , while the noise amplitude is N , then the number of significant amplitude levels is essentially

$$L = (S/N) + 1 \quad (2)$$

where the "1" is due to the fact that the zero signal level can be used.

The duration t_0 of a significant time interval of the signal is determined by the inherent limited bandwidth of the signal. It is well known that, if a signal has passed through a transmission system having more or less uniform transmission over a frequency bandwidth B , the smallest time intervals into which we can separate the portions of the signal such that amplitudes of the individual intervals shall be separately significant will have a duration of approximately³

$$t_0 = 1/2B. \quad (3)$$

Equation (3) may, in any particular case, be in error by several per cent. However, it will not be wrong by an order of magnitude. If the total duration of the signal is T , then the number of its significant time intervals is

$$n = T/t_0 = 2TB. \quad (4)$$

Consequently, a given message of duration T represents a particular choice of one out of

$$L^n = \left(\frac{S}{N} + 1 \right)^{2TB} \quad (5)^4$$

different possible messages of the same duration which could have been sent through the system.

¹ R.V. L. Hartley, "Transmission of information," *Bell Sys. Tech. Jour.*, vol. 7, pp. 535-563; July, 1928.

² For example, if there are three amplitude levels, designated as a , b , and c , and if there are two time intervals, then the $3^2 = 9$ possible signals are aa , ab , ac , ba , bb , bc , ca , cb , and cc .

³ Stanford Goldman, "Frequency Analysis, Modulation and Noise," McGraw-Hill Book Co., New York, N. Y., 1947; chap. IV, especially Fig. 7c.

⁴ Equation (5) has been derived independently by many people, among them W. G. Tuller, from whom the writer first learned about it.

It is apparent that the amount of information in a signal increases monotonically with the amount of choice, L^n , available in choosing the signal. Hartley has given reasons for using

$$\log(L^n) = n \log L \tag{6}$$

as a measure of the quantity of information in a signal. It will not be necessary for the purposes of this paper to choose a particular relation, such as (6), for the relation between quantity of information and L^n , and thus to assign a numerical value to information. However, we will make use of the fact that, according to (5) and the monotonic relation between information and L^n , the quantity of information in a signal increases with T , B , and (S/N) . We will also use the fact that (5) shows the relative importance of these three factors.

Next, suppose that, instead of plotting the signal as a function of time, as shown in Fig. 1, we made a plot of its frequency composition, including magnitude and phase; and let us suppose that the information which it is desired to transmit is carried in this frequency plot. Using a similar method to that used in arriving at (3), it may be shown that the number of significant independently specifiable quantities in the frequency composition of the signal is equal to the number of significant components in a Fourier-series expansion of the signal using T as its fundamental period. Thus we have

$$\begin{aligned} \text{signal} &= f(t) \\ &= a_0 + a_1 \cos 2\pi \frac{t}{T} + a_2 \cos 4\pi \frac{t}{T} + \dots \\ &\quad + b_1 \sin 2\pi \frac{t}{T} + b_2 \sin 4\pi \frac{t}{T} + \dots \end{aligned} \tag{7}$$

Since the signal has no components of higher frequency than B , the coefficients in (7) become negligibly small after a_{TB} and b_{TB} . The signal, therefore, has

$$2TB + 1 = 2TB \text{ (approximately)} \tag{8}$$

independently specifiable frequency components. Comparing (8) with (4), we see that the signal has the same number of independent information components, whether it is analyzed on a time or a frequency basis. A frequency plot of a signal is shown in Fig. 2. Instead of

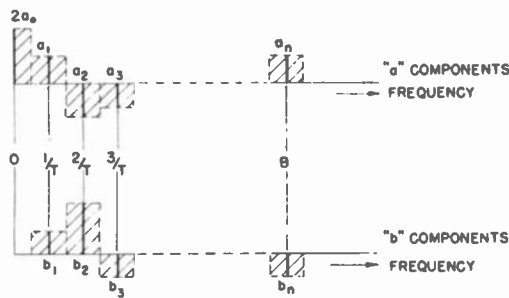

Fig. 2—Frequency plot of a signal such as that of Fig. 1.

plotting a and b components, we could just as well plot magnitude and phase.

II. MODULATION

For many purposes, it is desirable to send a signal in the form of a modulated carrier. The simplest method of doing this from an information-theory point of view is to use single-sideband transmission. In that case, the frequency components of the signal are all shifted by a constant amount C in the spectrum, as shown in Fig. 3.

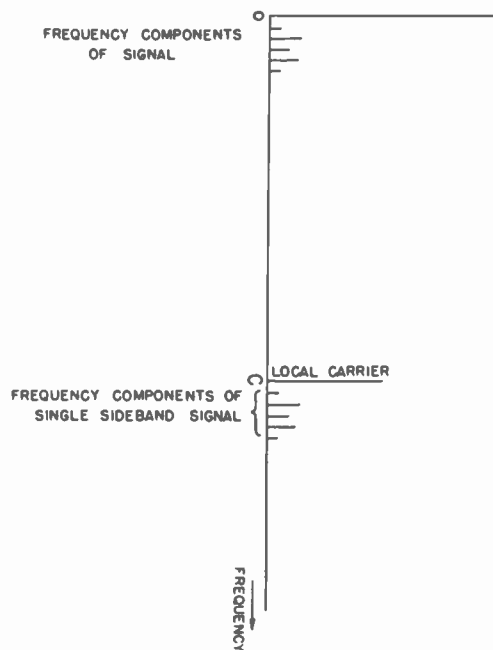

Fig. 3—Single-sideband transmission as a displacement of the information components in the frequency spectrum. (This figure shows only one set, either the a or the b components. The other set would be displaced in the same manner.)

Then, if a large carrier is added to the signal, the combination of signal plus carrier will be amplitude-modulated and its envelope will have the same shape as a function of time as did the original signal. Furthermore, the number of significant time intervals and frequency components will still be given by (4) and (8). (The combination of carrier plus sidebands will also be frequency-modulated, and if the proper frequency equalization is used, a frequency-modulation detector will also detect the original signal.)

Although single-sideband transmission with an added carrier is the simplest type of modulation from an information-theory point of view, there are many other types of modulation which are to be preferred in various applications. In Fig. 4, a group of these types is shown. In addition, Fig. 4 (d) shows a method of transmission of a message as n separate amplitude-modulated carriers. The detected signal from the n channels are superimposed in phase in the final output.

Of special interest to us is the fact that the use of these various types of modulation, for a given average transmitted power, gives rise to different ratios of signal versus random noise in the final output. The value of (S/N) for the type of transmission in question divided by the (S/N) value for double-sideband ampli-





	TIME REPRESENTATION	FREQUENCY REPRESENTATION	NOISE IMPROVEMENT RATIO
(a) PURE AMPLITUDE MODULATED SIGNAL. (DOUBLE SIDEBAND)			UNITY
(b) FREQUENCY MODULATED SIGNAL.			$\sim \frac{D}{\mu}$
(c) PULSE WIDTH MODULATED SIGNAL			$\sim \sqrt{\frac{BW}{f_p}}$
(d) n SEPARATE FREQUENCY CHANNELS WITH INDEPENDENT CARRIERS AMPLITUDE MODULATED BY THE SAME AUDIO PROGRAM			UNITY

Fig. 4— F =carrier frequency, μ =modulation frequency, D =peak frequency deviation in f.m., f_p =pulse-repetition frequency in pulse-width modulation; BW =bandwidth of pulse-modulated signal.

tude modulation is called the noise-improvement ratio of the former.⁵ The noise-improvement ratios of the various types of modulation are also shown in Fig. 4.

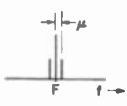
III. SOME GENERAL PROPERTIES OF SIGNALS

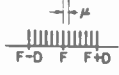
A. The Distinction Between Random Noise and Signals

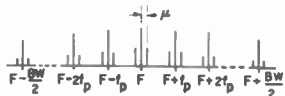
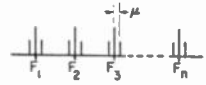
The outstanding difference between signals and random noise is that, whereas there is no specified or predictable relationship between the amplitudes in the different specific time intervals of random noise, in the case of a signal there is some specified relation between the amplitudes of the time intervals. Correspondingly, in the frequency domain, whereas there is no specified or predictable relationship between the amplitudes of the Fourier a and b components in the case of random noise, in the case of a signal there is a specified relation. In the case of random noise, the amplitude of any time or frequency interval does not depend upon the values in any preceding or succeeding interval. The only thing which is specified is the probable average value taken over a large number of intervals, and even this is subject to random fluctuations. On the other hand, in the case of a signal the relation between the time intervals is definitely specified. If the signal is simple, these relations may be specified by a simple equation such as

$$a = A(1 + n \sin \mu t) \cos \omega t, \tag{9}$$

⁵ It would be more logical to use single-sideband transmission as standard, but, since double-sideband a.m. has always been used in the past, we will retain it as the standard.

and the relation between the frequency components is thereby also definitely specified as being

$$A \cos \omega t \text{ at frequency } \omega/2\pi,$$

$$\frac{An}{2} \sin [(\omega + \mu)t] \text{ at frequency } \frac{\omega + \mu}{2\pi},$$

$$- \frac{An}{2} \sin [(\omega - \mu)t] \text{ at frequency } \frac{\omega - \mu}{2\pi},$$

and zero amplitude at all other frequencies. In case the signal is more complicated, the specification of the relations between the time intervals and between the frequency components is not so simple, but it is none the less definite.

B. Generalized Selectivity

The fact that a signal has a definitely specified relationship between its time components (and between its frequency components) allows a certain correspondence to be set up between signals and transmission systems. Thus it is well known that a tuned LRC circuit will transmit signals of the frequency $f = 1/2\pi\sqrt{LC}$ with less attenuation than any other signal, whether the latter be a pure sinusoidal signal of a different frequency or any other type of signal. As another example, an f.m. detector will give more output for signals of the form

$$a = A \cos \left[2\pi ft + \frac{D}{\mu} \sin 2\pi \mu t \right] \tag{10}$$

than for any other type of signal. However, whereas in the case of the tuned circuit the output signal is of the

same form as the input, in the case of the f.m. detector this is not true. In the case of the latter, the output just shows the modulation of the signal in (10), and not the whole signal.

As a general description of the degree to which a given transmission system will give a greater response to certain signals than to others, we will use the term *generalized selectivity*. Since random noise contains signals of all types in greater or lesser amounts, we will find it convenient to define the numerical value of the generalized selectivity of a transmission system as the ratio of the value of (Output)/(Input) for the preferred type of signal to the value of (Output)/(Input) for random noise. As already pointed out, the output need not be similar in wave shape to the input. Actually, we will use *generalized selectivity* as a descriptive term and will not need to calculate its numerical values.

Finally, we may point out that the more complicated the signal to which a given transmission system is fitted, the greater is the opportunity for a large value of the generalized selectivity. This is rather obvious, but we shall have occasions to demonstrate specific examples in which it is true.

C. Coherence

In Subsection B, we described the relation between a signal and a transmission system in terms of *generalized selectivity*. We now wish to describe the relation between one signal and another signal, or between parts of the same signal. When two identical signals are superimposed *in phase*, it is well known that the energy of the resultant is equal to four times that of either signal taken separately. On the other hand, if they are superimposed 180° out of phase, the resultant has zero energy. In general, if we have two signals $E_1(t)$ and $E_2(t)$, and the two are superimposed, the resultant energy is proportional to

$$\int [E_1(t) + E_2(t)]^2 dt \\ = \int \{ [E_1(t)]^2 + [E_2(t)]^2 \} dt + \int 2E_1(t)E_2(t) dt. \quad (11)$$

The first integral on the right of (11) represents the energy of the two signals taken separately, and the second integral represents the interaction energy. In the past, it has been customary to define two signals as incoherent if their interaction energy is zero. In accordance with this definition, two noise signals of independent origin are incoherent, and the different Fourier series components of the same signal (even the sine and cosine components of the same frequency) are incoherent. It is a general practical fact that any two signals of independent origin have a vanishingly small percentage of interaction energy when considered over a long period of time.

The definition of coherence on the basis of interaction energy, while quite useful for many purposes, is too

specialized for our present considerations. Thus the different sidebands⁶ of a modulated wave, whether amplitude-modulated, frequency-modulated, or pulse-modulated, have definite phase relationships with respect to one another and with respect to the carrier, even though they are of different frequencies. Therefore, we will call them coherent, even though their interaction energy is zero. In general, we shall call any two signals (or any two parts of the same signal) coherent when there is a specified relationship between their detailed values. Incoherent signals will then be signals, or parts of the same signal, which are independent of one another. All incoherent signals will still have vanishingly small interaction energy, but the converse will not be true. Signals, whether having zero interaction energy or not, will still be called coherent if there is a specified relationship between their detailed values; i.e., between the amplitudes of their time intervals.

IV. ULTIMATE NOISE PROBABILITIES

A. Probability Measure of Noise Level

In any observation of a signal appearing above a level of random noise, there is always a certain probability that the signal is not a signal at all, but just a fluctuation in the noise. When the signal-to-noise ratio by any definition is large, this probability will be very small indeed. However, when the signal and the noise are of comparable size, the probability becomes appreciable. In radar, when only one (or a few) significant time intervals are involved, the probability that what is believed to be signal actually may be noise is a matter of practical concern.

In the case of communication, when a large number of significant time intervals is involved, the probability that a received signal such as "The temperature at Dallas at 7 P.M. was 21 degrees" is merely a fluctuation of random noise and does not represent a transmitted signal is obviously almost infinitesimal. The reason for this is that the above signal includes a large number of significant time intervals. We know, from probability theory, that the probability that each of the amplitudes in the independent time intervals should be a noise fluctuation is equal to the product of this probability for each interval taken separately. Since the probability for each interval is considerably less than unity, the final product is extremely small.

However, it would not be necessary to change the sound amplitudes in many intervals of the above signal to change "21 degrees" to "29 degrees," and, if the noise level is high, we might have some doubt about the accuracy of the reception of the above signal. This will serve to remind us that the correctness of the information in the above signal is a matter of probability, and that there is actually an extremely small probability that the entire signal may be merely a noise fluctuation and may not represent a transmitted signal at all.

⁶ Arising from a particular modulation frequency.

Despite the extremely small magnitude of this probability in almost all practical cases, we will shortly find that it will serve as a very useful measure of some of the noise properties of a signal. Accordingly, we now propose the following universal measure of the noise level of a signal:

Definition: The noise level of a signal is hereby defined as the probability that the observed signal does not represent transmitted information, but is just a fluctuation in the background of random noise.

With the aid of this definition, we will now investigate some noise properties of signals:

B. Some Useful Theorems

Suppose that a signal is received for a time T by way of a transmission system of bandwidth B . Suppose also that the reception has a background of random noise of mean square value \bar{I}^2 (for the bandwidth B). According to random-noise theory, the probability that the noise shall have the value I , in any particular significant time interval, is then, as a first-order effect,

$$P(I)\Delta I = \frac{1}{\sqrt{2\pi\bar{I}^2}} e^{-I^2/2\bar{I}^2} \Delta I \quad (12)^7$$

where ΔI is the increment between significant amplitude levels.

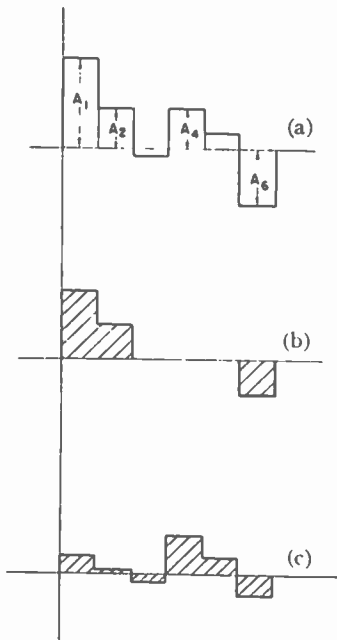

Fig. 5—Superposition of signal and noise: (a) signal plus noise; (b) signal; and (c) noise.

In Fig. 5(a) is shown the received signal plus background noise, of which the signal is shown in Fig. 5(b),

⁷ In the following discussion, we shall assume that the distance ΔI between significant amplitude levels is the same for all amplitude levels. Very likely, this is an unnecessary limitation as far as theorem B is concerned. The present section assumes that the superposition of signal and noise is a linear process. Therefore, it no longer applies after the mixed signal has gone through a nonlinear transmission system.

and the noise in Fig. 5(c). The observer is, of course, unaware of the composition of Figs. 5(b) and (c). The amplitudes in the time intervals of Fig. 5(a) will be designated A_1, A_2, A_3 , etc., respectively. Now, according to (12), the probability that the signal in the first interval, of amplitude A_1 , is random noise is

$$P(A_1)\Delta I = \frac{1}{\sqrt{2\pi\bar{I}^2}} e^{-A_1^2/2\bar{I}^2} \Delta I. \quad (13)$$

Similarly, the probability that the signal in the second interval is random noise is

$$P(A_2)\Delta I = \frac{1}{\sqrt{2\pi\bar{I}^2}} e^{-A_2^2/2\bar{I}^2} \Delta I, \quad (14)$$

and so on. According to a well-known law in probability theory, the probability that the entire signal is random noise is, then,

$$P(A_1)\Delta I \cdot P(A_2)\Delta I \cdots P(A_n)\Delta I \\ = \frac{1}{\{2\pi\bar{I}^2\}^{n/2}} e^{-[(A_1^2+A_2^2+\cdots+A_n^2)/2\bar{I}^2]} (\Delta I)^n \quad (15)$$

where

$$n = 2TB. \quad (16)$$

It should be pointed out in passing that the probability given by (15) is not the probability that the amplitudes $A_1, A_2 \cdots A_n$ just occur, but rather that they occur in the sequence $A_1, A_2 \cdots A_n$. In other words, the signal shape as well as its magnitude is taken into account.

We have already pointed out that, when a signal is superimposed upon random noise, the energy of the combination will be the sum of the energy of the signal plus the energy of the noise.⁸ Therefore, if we have a desired signal whose amplitudes in the n intervals are $a_1, a_2 \cdots a_n$, respectively, and if this is superimposed upon noise of average value \bar{I}^2 , the probability (to an observer who does not know the composition of what is being received but who only knows the average noise level of \bar{I}^2 of the transmission system and its bandwidth B) that the combination is merely a noise fluctuation is⁹

$$\frac{1}{[2\pi\bar{I}^2]^{n/2}} e^{-[(a_1^2+a_2^2+\cdots+a_n^2+n\bar{I}^2)/2\bar{I}^2]} (\Delta I)^n. \quad (17)$$

Immediately, we note the remarkable fact that this probability depends only on the total energy ($a_1^2+a_2^2+\cdots+a_n^2$) of the signal and does not depend upon the way in which this energy is distributed among the different time intervals. We have thus arrived at the following important theorem:

⁸ Strictly speaking, what we mean is that, if the number of intervals $2TB$ is large, the probability of an appreciable deviation from this addition of energies is very small. (See footnote reference 3, Chap. VII.) If $2TB$ is a small number, then in an individual trial there may be appreciable interaction energy, but averaged over a large number of trials the average interaction energy will be zero, regardless of whether $2TB$ is large or small.

⁹ More precisely, "is" should read "will on the average be."

Theorem A: *In a system of given bandwidth, a signal of given duration and a given amount of total energy, in a background of "white" noise, will have the same probability of being a noise fluctuation regardless of how its energy is distributed in time.*

A completely similar derivation based upon Fourier components instead of time intervals will give us the following alternative theorem:

Theorem A': *In a system of given bandwidth, a signal of given duration and a given amount of total energy, in a background of "white" noise, will have the same probability of being a noise fluctuation regardless of how its energy is distributed among its Fourier components.*

We can make (17) more universal by normalizing it. Thus,

$$\bar{I}^2 = M^2 B \tag{18}$$

where M^2 is a constant (called the strength of the background noise field), and

$$\frac{a_1^2 + a_2^2 + \dots + a_n^2}{2\bar{I}^2} = \frac{n \bar{a}^2}{2M^2 B} = \frac{2TB \bar{a}^2}{2M^2 B} = \frac{T \bar{a}^2}{M^2} \tag{19}$$

Consequently, we can rewrite (17) as

$$\left\{ \begin{array}{l} \text{probability that received mixed} \\ \text{signal is a noise fluctuation} \end{array} \right\} = \epsilon^{-[(a_1^2+a_2^2+\dots+a_n^2)/2\bar{I}^2]} \frac{\epsilon^{-n/2}}{[2\pi\bar{I}^2]^{n/2}} (\Delta I)^n = \epsilon^{-T\bar{a}^2/M^2} \frac{\epsilon^{-n/2}}{[2\pi\bar{I}^2]^{n/2}} (\Delta I)^n \tag{20}^{10}$$

Now,

$$\frac{\epsilon^{-n/2}}{[2\pi\bar{I}^2]^{n/2}} (\Delta I)^n = \frac{(\Delta I)^n}{[2\pi\epsilon\bar{I}^2]^{n/2}} = \left\{ \frac{(\Delta I)^2}{2\pi\epsilon\bar{I}^2} \right\}^{n/2} \tag{21}$$

is the average probability that we would find that the mixed signal were noise if we made repeated trials and if the mixed signal were pure noise. Let us now define the normalized probability that a mixed signal is a noise fluctuation as the ratio of the actual numerical probability to the corresponding average probability for noise. Then (20) becomes

$$\left\{ \begin{array}{l} \text{normalized probability that} \\ \text{mixed signal is a noise} \\ \text{fluctuation} \end{array} \right\} = \epsilon^{-T\bar{a}^2/M^2} \tag{22}^{11}$$

Equation (22) is a fundamental equation. It shows that the normalized probability that the mixed signal is a noise fluctuation depends only upon the total signal

¹⁰ The combination of desired signal plus random noise will be called the "mixed signal."

¹¹ The strength M^2 of the "white" noise field has the dimensions of energy per cycle per second = energy. Therefore, since $\bar{a}^2 T$ also has the dimensions of energy, the exponent of equation (22) is dimensionless, as it should be.

energy $\bar{a}^2 T$ and upon the strength M^2 of the background noise field. It is independent of the time distribution of the signal energy as well as of the bandwidth B and duration T of the transmission.

Instead of deriving (22) by a consideration of the amplitudes in the time intervals, we could, by exactly similar mathematical steps dealing with the amplitudes of the Fourier series components, have derived the equation:

$$\left\{ \begin{array}{l} \text{normalized probability that} \\ \text{mixed signal is a noise} \\ \text{fluctuation} \end{array} \right\} = \epsilon^{-T \sum [(a^2+b^2)/2] / M^2} \tag{23}^{12}$$

where the summation is taken over all the Fourier-series components of the signal. The quantity $T \sum (a^2+b^2)/2$ is, of course, just the expression for the signal energy in terms of the Fourier-series components. The details in the derivation of (23) will not be reproduced here.

In addition to the conclusions drawn from (22), (23) shows that the normalized probability that the mixed signal is a noise fluctuation is also independent of the frequency distribution of the signal. We can now include all these results in the following theorem:

Theorem B: *The normalized probability that a mixed signal is a noise fluctuation depends only upon the total energy of the desired signal and the strength of the background "white" noise field. It is independent of the time or frequency distribution of the desired signal energy, as well as of the bandwidth and duration of the transmission.*

Theorem B is of fundamental importance. It tells us that no type of pulse signal shape and no method of modulation can improve the normalized probability unless it increases the total signal energy or decreases the strength of the background "white" noise field.¹³ Although Theorem B is of universal applicability, it does not tell the whole story. The number of significant information components of the signal $2TB$ does not depend upon either the amount of signal energy available or the background noise level. We shall show in a later section that, when ample information is available, some of this information can be used to increase the signal-to-noise ratio and improve the noise probability despite the fact that the normalized probability is not improved. Even in radar reception, we will find that the actual range of operation is usually not pushed to the limit imposed by Theorem B, and certain types of noise reduction can be of practical value.

¹² a in (23) stands for the amplitude of a cosine component in the Fourier expansion, in accordance with the notation in Section I. It should not be confused with a in (22), and the other equations of this section where a stands for the amplitude of a time interval.

¹³ The strength of the background "white" noise field is determined in the early circuits of the receiver, and is unaffected by the noise reduction of frequency modulation or pulse modulation. However, a change of the carrier frequency, which allows the thermal noise and/or shot noise of the receiver (as usually measured by the noise figure) to be reduced will actually cause a practical reduction in the strength of the background noise field.

Finally, it is worth pointing out that Theorem B is a general mathematical theorem; i.e., a phenomenon of mathematics, and it may well have applications in the natural sciences in addition to its use in the field of communication engineering.

C. Application to Radar

The foregoing discussion will now be applied to the analysis of radar systems. In analyzing the maximum range problem, we must distinguish between two cases. In the first case, the presence of a reply echo is determined by both the excess signal at the location of the echo and by recognizing a characteristic shape of the radar pulse. This requires bandwidth in excess of that necessary to give the best signal-to-noise ratio; the excess bandwidth being required to show the pulse shape. In the second case, the bandwidth is reduced to obtain the best signal-to-noise ratio, and the presence of the echo is recognized purely on the basis of excess signal. The first case involves "perception selectivity," discussed later on in this paper. This case is not amenable to accurate quantitative calculation. The second case, however, can be handled quantitatively in terms of our earlier analysis, and will now be discussed.

The maximum range of a radar system is determined by the probability that what is believed to be a received signal is actually a noise fluctuation. Let us first suppose that a given average amount of signal power is available and that it is desired to know whether the range can be improved by changing the pulse length. This will, of course, require that the pulse height will be changed to retain the same average power; and it will cause a change in the bandwidth of operation. Now, the size of ΔI of a significant amplitude level is usually proportional to \bar{I}^2 of the noise, and furthermore, n is unchanged if the pulse-repetition rate is unchanged. Since $T\bar{a}^2$ is proportional to the average signal power, and since M is independent of bandwidth, it then follows from (20) that *radar range (in the second case) is unaffected by a change of pulse length if the same average power is used.*

The foregoing discussion applies accurately only to the ultimate noise probabilities. In the detection process, a degradation of the signal ordinarily occurs, so that the value of the expression (21) increases. This is particularly true because the value of n is usually decreased in detection. In case the detector operates below its improvement threshold, as described in Section V B, then the degradation of the signal is particularly bad. However, as far as change of pulse length, as discussed in the preceding paragraph, is concerned, the effect of the operation of the detector is exactly the same regardless of the pulse length, since the S/N ratio is independent of pulse length. The discussion of the preceding paragraph, therefore, applies to postdetection as well as predetection conditions and, consequently, applies to practical radar ranges.

Let us next consider the effect of pulse-repetition rate.

If the average power is kept constant, the energy per pulse decreases as the pulse-repetition rate increases. This results in a lower signal-to-noise ratio as the signal enters the detector. If the altered S/N ratio does not affect the detection process, and if an integrating type of observation is used so that successive pulses are combined in observation, then the range is independent of the pulse-repetition rate and depends only on the total received energy. In this case, the range can be increased by increasing the time of observation, which is the only way of increasing the total received energy when the average power is constant. It may be shown that these results are a consequence of Theorem B.

In case the value of the S/N ratio entering the detector affects the detection process, then the actual probabilities will not be proportional to the normalized probabilities, and Theorem B will not apply to the situation. Equation (20) would still be applicable, but different means must be used to compare the relative degradations of the signals in the process of detection for the various pulse-repetition rates. It can be shown that there is less degradation for the larger S/N ratios, so that range increases as the pulse-repetition rate decreases. Defects in the integration process (combination of successive pulses) also tend to be less damaging for the lower pulse-repetition rates.

D. The Question of Communication Signals

Radar has the simplest type of information of any signal, since we are interested only in whether a signal is present or not. The situation in communication is more complicated, since we are there concerned with the probable percentage of information intervals which have correct information. In the simplest communication system we will have only two levels, off and on. However, in most cases, such as voice or television communication, we have many amplitude levels. Thus we have the possibility that an interval which has signal may give the wrong information because a noise fluctuation has moved it to the wrong amplitude level. Theorem B deals only with the probability that the entire mixed signal is noise. Therefore, it is inadequate to handle the usual practical problem that arises in communication where a small percentage of intervals carrying erroneous information can be tolerated.

No attempt will be made in the present paper to handle the question of probable percentages of correct intervals in a communication signal. However, in the next section, we will discuss the problems and the mechanism involved in the improvement of signal-to-noise ratio.

V. NOISE IMPROVEMENT AND THRESHOLDS

A. Improvement Based Upon Coherence (by Means of Apparatus)

In the present section we will deal with noise theory particularly as it relates to communication signals. We will be particularly concerned with the fundamental

theory of noise improvement and the thresholds at which it begins.

The detailed wave shape of an audio signal carrying information cannot be predicted ahead of time, since it would not be carrying information if it could be predicted. There are, however, certain average characteristics of audio voice and audio music signals by means of which they can, on the average, be distinguished from random noise, and on the basis of these characteristics a certain amount of average noise reduction can be obtained. Frequency pre-emphasis and de-emphasis as used in present day f.m. broadcasting may be cited as an example. The most potent types of noise reduction, however, such as that of wideband f.m. or of pulse modulation, are based upon a method of generalized selectivity in which extra bandwidth is used outside the required audio range which carries the desired intelligence. This extra bandwidth is used to carry extra information which is used for purposes of generalized selectivity; that is, it makes a signal of the particular type of wave shape to which a prearranged detector is especially sensitive. Due to this generalized selectivity, the signal-to-noise ratio in the output of the detector is much greater than in the input.

The extra information which is put into a signal for selectivity purposes is not really true information, since its characteristics must be known ahead of time. For this reason, we may call it "wave-shaping information" or "selectivity information" to distinguish it from what we may call the "message information." The "selectivity information" could theoretically be put into a signal by using either extra bandwidth or extra duration. However, in most cases of interest, such as audio or television broadcasting, the duration cannot be varied from the duration of the original "message information." Therefore, it is necessary to put the "selectivity information" into extra bandwidth. In a general way, it is also clear that the more excess bandwidth there is available and used to carry "selectivity information," the greater will be the possible distinction between the signal and random noise, and, consequently, the greater will be the possible generalized selectivity.

The amount of noise improvement which is obtained by any particular method of "generalized selectivity" does not depend merely upon the amount of extra bandwidth used, since we found different answers for f.m. and pulse-width modulation. In particular, we found a noise-reduction factor proportional to D/F_a for f.m. and a noise-reduction factor proportional to $\sqrt{BW/f_p}$ for pulse-width modulation. Now, (D/F_a) and (BW/f_p) are, in their respective cases, each proportional to the number of complete sets of sidebands of the message modulation frequencies. Therefore, it appears that, in these cases, the number of times that the message information is repeated in the frequency spectrum is what determines the noise reduction. However, if we consider f.m. to operate on a linear basis, then pulse-width modulation operates on a square-root-law basis. On the

same basis, we would say that the case of multichannel operation with coherent audio, which we found had no noise reduction for a given amount of total power, was a case in which the exponent was zero.

A general explanation of the way in which coherent repetition acts to reduce the noise level can also be based upon probability theory. If the original signal level gives a certain probability p that a particular information unit is a noise fluctuation, coherent repetition of the information q times is the equivalent of getting the same results q times out of q tries in probability theory. This reduces the probability that the signal is a noise fluctuation to p^q . However, a considerable correction must be made in p , since the noise level rises with the extra bandwidth. Different types of transmission systems have different degrees of effectiveness in translating this decreased probability into noise reduction. We found, in the above-mentioned cases, that the noise reduction was proportional to q^m where m is a constant. The above p^q formula suggests, however, that the inherent possible noise reduction may increase exponentially with bandwidth, which is a more rapid increase than is given by raising q to any constant exponent. The same possibility is suggested by (5). Therefore, it seems reasonable to believe that systems can be devised whose noise reduction greatly exceeds that of any of the systems which have been mentioned or which have yet been built.

The systems which we have so far described as noise-reducing systems gave noise reduction with a given amount of total energy. There are, however, practical cases in which it is not the total energy which is limited, but the energy per unit time or energy per unit bandwidth. In such cases, it is fair to describe a system which uses extra time or bandwidth for noise reduction as a noise-reduction system, even though the system uses extra energy. On this basis, an integrating radar is a noise-reducing system which uses coherent repetition in time for noise-reduction purposes. On the same basis, the previously discussed cases of multichannel coherent audio transmission would be a noise-reducing system, if extra power were available in the extra frequency channels. The noise reduction would be based upon coherent repetition in the frequency spectrum in the latter case.¹⁴

B. Thresholds of Detection

All known noise-improvement systems which are based upon "selectivity information" will operate effectively only above a certain threshold value of the S/N ratio. In the case of pulse-phase modulation discussed

¹⁴ A standard double-sideband system of pure a.m. uses twice the required bandwidth to carry its information. The reason for this is that, in each significant time interval, it gives the message information as a.m., but it also gives the extra information that the f.m. in the interval is zero. This latter information results in an in-phase addition of the upper and lower frequency sidebands in their effect on the envelope, which has the effect of noise reduction. A similar situation apparently occurs in any type of double-sideband transmission. Thus, in f.m. the extra information is transmitted that the a.m. in each interval is zero.

above, the improvement threshold occurs when the signal pulses are twice as high as the peak noise fluctuations that are likely to occur during the reception of a message. At this level it is possible to use top and bottom limiters to remove all noise except that which occurs during the time of rise and fall of the pulses. If the signal falls below the improvement threshold level, the reception of noise between pulses causes a sudden greater increase in the noise output, usually so great that it will blanket the desired signal.

In the case of f.m., when the signal exceeds the noise entering the detector, the frequency modulation of the signal by the noise is relatively small. If, however, the noise exceeds the signal, then it is the noise which controls the phase of the signal plus noise combination, and the various sidebands of the desired signal are no longer coherent in phase with the effective carrier and can no longer operate effectively in unison to give large amounts of frequency modulation. The transition level between larger signal and larger noise is the improvement threshold in frequency modulation.

In the case of double-sideband amplitude modulation, there is also an improvement threshold. Above the threshold, the upper and lower sets of sidebands of the desired signal, due to their phase relation with respect to each other and with respect to the effective carrier, have double efficiency in causing amplitude modulation. Below this threshold, the noise is large enough so that the carrier is modulated more than 100 per cent most of the time by the noise sidebands. This eliminates most of the desired signal or transforms it into distortion.

To get an idea of what happens when the improvement threshold is reached, consider the case of pulse-width modulation. Above the threshold value of 2 of the S/N amplitude ratio, only signal modulation or noise which changes the location of the time of rise or fall of the pulses is effective in producing output. From the point of view of probability theory, we can say that such signal modulation or noise is given *preferred weighting* above the improvement threshold. In a general way, we can say that, below the improvement threshold, the receiving system cannot locate the signals which are to be given preferred weighting in order to obtain benefit from the "generalized selectivity."

The existence of a noise-improvement threshold is apparently a characteristic of all types of modulation systems which use "selectivity information."¹⁶ *When the noise exceeds the improvement threshold value, the signal no longer controls the standard by which coherence is determined and on the basis of which the detector is designed to give preferred weighting to the desired signal.* Under these circumstances, the detector increases the noise-to-signal ratio rather than the signal-to-noise ratio.

The maximum operating range of any communication system is determined by the location at which the

¹⁶ The only type of modulation which doesn't use "selectivity information" is single-sideband transmission.

signal falls below the improvement threshold. When this occurs, even in ordinary (double-sideband) amplitude modulation, there is a relatively sudden large rise of the noise level which effectively blankets the signal.¹⁶ (See Fig. 6.) This added noise is due to an ir-

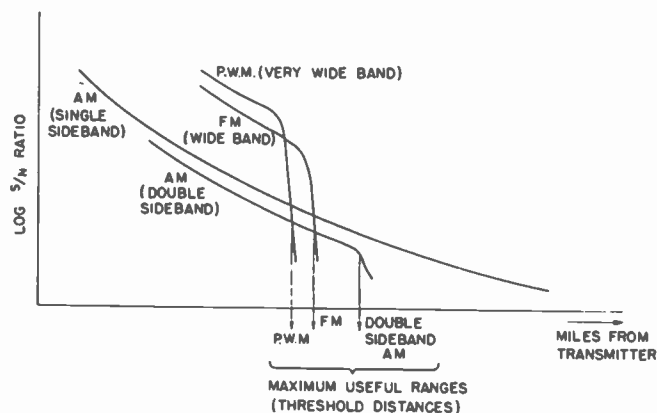

Fig. 6—Threshold versus range for a given average power, using various types of modulation.

reversible process, and it cannot be removed by frequency selectivity. A realization of this fact is important in the design of communication systems. For example, in the design of an amplitude-modulated communication or radar receiver, if the signal-to-noise ratio is much higher than the improvement threshold, the bandwidth of the receiver prior to the second detector can be increased manyfold in order not to lose the signal in case there is frequency drift of either the transmitter or the receiver oscillator. There will be no loss in signal-to-noise ratio in the final output, despite the increased predetection noise caused by the increased bandwidth, so long as the bandwidth is again narrowed to its optimum value by the audio (or video) amplifier. The situation, however, is quite different in case the signal-to-noise ratio is near the improvement threshold. In that case, widening of the predetection bandwidth to the extent that the signal-to-noise ratio falls into the range¹⁷ of the improvement threshold will cause an irreversible rise in noise which cannot be erased by narrowing the bandwidth of the audio (or video) amplifier. For this reason, if maximum range is desired, the predetection bandwidth should not be increased beyond its normal value of twice the modulation frequency range except insofar as is absolutely necessary because of frequency drift.

The existence of the noise-improvement threshold is the cause of the "law" that the maximum operating range of a communication system for a given average power, is essentially independent of the type of modulation used. The explanation depends upon the fact that,

¹⁶ Below the improvement threshold, a major part of what comes into the receiver as desired signal is transformed by the detector into distortion or noise because of the loss of the coherence standard. This is the distinguishing characteristic of the improvement threshold.

¹⁷ The improvement threshold has a narrow range of about 3 or 6 db, depending on the type of modulation. The coherence standard is gradually lost as the input signal-to-noise ratio falls to the bottom of this level.

according to the $2TB$ formula for information components, the minimum possible bandwidth required, and therefore, the minimum average noise, is fixed by the audio-frequency range¹⁸ which it is desired to transmit. The minimum noise is thus independent of the type of modulation used. It is approximately true, in the types of modulation which we have examined, that when the average noise power exceeds the average signal power, the signal no longer controls the coherence standard used by the detector. When this occurs, the signal becomes unintelligible. The maximum range, since it is thus determined by the minimum noise, is consequently likewise approximately¹⁹ independent of the type of modulation used. The above-mentioned maximum-range "law" is thus a characteristic of all types of modulation systems in which the signal no longer controls the coherence standard of the detector when the average noise exceeds the average signal. If other types of modulation systems could be devised in which the coherence standard is not so controlled, there would be no reason to expect the "law" to hold for them.

The foregoing analysis indicates that, if it were possible to supply a large local carrier in a double-sideband a.m. receiver²⁰ which is synchronized with the transmitted carrier, then the noise-reduction threshold of the receiver would be decreased and the operating range of the communication system would be extended, correspondingly. Radar synchronization is a closely related type of procedure, but for full utilization of the noise-reducing possibilities, local *carrier* would have to be added in the receiver with synchronization of the r.f. phase.

C. Perception Selectivity

In the practical reception of signals, whether audio, television, or radar, the final human observer usually adds a large and important amount of effective noise reduction. A human observer will weigh intelligible speech much higher than "gibberish" as being parts of the signal, and the human observer will even fill in the gaps where noise makes the signal unintelligible. As soon as the signal can be recognized as belonging to a customary type of communication signal, such as speech or music, the human perception mechanism gives greatly preferred weighting, on the average, to true signals as compared with noise and greatly decreases the previous probability that the signal is a noise fluctuation. This human "perception selectivity" is thus another example of generalized selectivity.

Perception selectivity, like other noise-reducing systems, has a threshold below which it will not operate. The threshold at which perception selectivity begins

may be roughly described as the S/N level at which the signal can be recognized as belonging to the transmission "language." At this level the human perception mechanism recognizes parts of the mixed signal as coming from a common origin; i.e., it recognizes them as parts of a coherent signal. This level may be described as the intelligibility threshold, and is the noise-improvement threshold of a human being as a signal detector. It is probable that perception selectivity begins at a lower S/N ratio than any nonliving type of noise improvement system so far devised.

Perception selectivity for speech does not require any extra bandwidth in addition to that normally used, because the normal audio range of, say, 10 kc. is many times more than adequate to carry the actual amount of information in a speech signal. The actual message information in speech is generated at a rate of about 5 to 25 significant time intervals per second. The audio bandwidth is thus of the order of one thousand times as much as necessary for the purposes of carrying the pure "message information" in speech. The excess bandwidth is thus available for the generation of characteristic human-speech wave shapes which can be modulated by the "message information." The human detector then gives preferred weighting to these characteristic human-speech wave shapes.²¹

We have found previously, in our study of nonhuman noise-improvement systems, that coherent repetition of the information in many different frequency channels is a common characteristic of the signals used. At least part of the noise reduction of audio perception selectivity is obviously due to the use of signals with this same characteristic.

Perception selectivity is also used in radar. For example, in the use of a radar "A" presentation, the fact that a slightly greater signal amplitude is apparently characteristic of a particular location along the horizontal axis in many repeated intervals is interpreted by the human observer as indicating an echo. It is interesting to note that repetition of the information in the time domain, rather than in the frequency domain, is here used for noise reduction.

The use of repetition in the time domain for reducing the probability that a signal is a random fluctuation is a very common practice in perception selectivity. Repeating a message in order to be sure that all the information is correctly received is an example of applying this to every information interval in a signal, so as to reduce the probability that any part of the received signal is a random noise fluctuation.

Perception selectivity is an important part of almost every communication system in which a human observer is the final receiver.

¹⁸ Systems, such as the Voder, which reduce the required bandwidth of transmitting speech, will, of course, increase range. This, however, will be true regardless of the type of modulation used.

¹⁹ We are neglecting here small constant factors in the neighborhood of unity, such as 2 or 1/2, etc.

²⁰ This might be obtained with the aid of a very narrow-band high-gain receiver tuned to receive the carrier alone.

²¹ The writer does not mean to imply that the wide audio range of human speech has noise reduction as its sole purpose. Obviously, the radiation of sound from the mouth, as just one example, could not take place efficiently at a syllabic frequency, but requires the use of higher audio frequencies.

D. The General Question of Undesired Signals

We can classify all undesired signals in the following three groups:

- (1) Random noise (which is incoherent information)
- (2) Signal interference (which is erroneous information, coherent in itself, but not coherent with the desired signal)
- (3) Distortion (which is erroneous information, coherent with the desired signal).

Extra bandwidth can be used to reduce (1) and (2) relative to the signal. Frequency-modulation systems are perhaps the best-known example of this fact. That extra bandwidth can be used to reduce distortion is not well known; but a comparison of double-sideband versus single-sideband a.m. transmission shows that it can be done. The use of large amounts of extra bandwidth to reduce distortion to a very low value presents interesting possibilities. Just as in the case of the reduction of random noise and signal interference, the reduction of distortion in the simplest cases would probably be accomplished by coherent repetition of the desired signal information in several different transmission channels, with the use of a type of modulation and detection which would give coherent addition of the desired signal but not of the distortion.

In this connection, it is interesting to note that feedback is a type of coherent repetition. It has certain drawbacks, especially instability. Perhaps some other type of coherent repetition will do the same job as feedback in some cases, without the danger of instability.

VI. SOME APPARENT RELATIONS TO PSYCHOLOGY AND BIOLOGY

The material discussed in the present paper, if properly developed, may have a fascinating field of application in the other sciences. Every indication points to the fact that the nervous system is an intricate communication network, and a good deal of the perception selectivity we have talked about probably takes place in a manner similar to the coherent repetition used in simple communication systems. The well-known phenomenon of a conditioned reflex is also closely related to coherent repetition. The proper interpretation and analogies of bandwidth, random noise level, information intervals, and thresholds in these physiological domains may lead to new and worth-while ideas in devising and interpreting new experiments.

As far as psychology is concerned, it does not seem far-fetched to say that thinking bears considerable resemblance to a noise-reduction process. Once threads of intelligibility are discernible in a mass of data (i.e., once a noise-improvement threshold is reached), the

mind begins to make order out of it; i.e., it begins to reduce the "probability of error" in it. Actual thinking, if it proceeds along these lines at all, probably consists of repeated applications of "noise reduction"; that is, the signal is sent through one noise-reduction detector after another to match coherence (with past experience or logic) until the final S/N ratio is very large. At that time, the probability that the conclusion which is reached is due to random errors, rather than fact, is small. Whether the actual physiology of the brain in the thinking process is similar to that of noise-reducing systems in communication is, of course, unknown. However, it is an interesting conjecture.

A particularly interesting biological application of the ideas in this paper is in the explanation of a reason for the division of large organisms into cells.²² According to current biological theory, the characteristics of an organism are determined by the chromosomes in its cells, and there are essentially identical sets of chromosomes in each of the cells of the organism (excepting the germ cells). Now the life history of the organism is regulated by the interactions of the various parts of the organism which is living in an environment subject to a considerable amount of random fluctuation. These interactions, whether they are secretions by glands, the sending of nerve impulses, the process of digestion or any other type of physiological action, represent perfectly good signals in the general theory of communication. The activity of the chromosomes, whatever it may be, may likewise be considered a set of signals.

In the case of a large organism, there is a large amount of structure built according to a detailed plan which must be kept running according to plan during the life cycle, in spite of the general disintegrating processes of the physical world and the random fluctuations of the environment. The large amount of characteristic detail in the organism is the communication equivalent of a large amount of signal detail. The communication-theory equivalent of retaining all this characteristic individual detail despite the presence of the fluctuating environment is the maintenance of a large signal-to-noise ratio. It is, therefore, not surprising to find that, in the case of large organisms, the fundamental information contained in the structure or activity of the chromosomes, which regulate the life history of the organism, is set up in such a way that the information is repeated coherently; i.e., according to a planned layout. Thus the division of the organism into cells, each of which has an essentially identical set of chromosomes, is a way in which nature can keep a large organism operating in a planned life cycle despite the disintegrating effects of the physical world.

²² There are, of course, also other reasons for the division of a large organism into cells besides the one suggested in these paragraphs.

The Steady-State and Transient Analysis of a Feedback Video Amplifier*

J. H. MULLIGAN, JR.†, MEMBER, I.R.E., AND L. MAUTNER‡, SENIOR MEMBER, I.R.E.

Summary—A two-stage feedback video amplifier is analyzed on the transient and steady-state bases, and a simplified design procedure is developed for each approach. Using the transient response of the amplifier to a step-voltage input as a basis, design curves have been prepared which allow determination of the necessary amplifier parameters when either the rise time (10 to 90 per cent of final amplitude) and the per cent transient overshoot, or alternatively, the per cent transient overshoot and the net gain, are specified. The effect of changes in transconductance and resistor values on the output wave form is discussed. The low-frequency distortion of the input wave as a result of the interstage-coupling network is also considered, and a relation for the increase in the effective interstage time constant is derived.

The steady-state response of the amplifier is examined in considerable detail, particular emphasis being given to provide an analysis which integrates with the transient study. It is found that an amplifier can be uniquely determined by means of design curves, provided the overshoot in the steady-state characteristic and the frequency for 3-db attenuation, or alternatively, the midband gain and the overshoot in the steady-state characteristic, are known. In addition, the improvement in steady-state low-frequency response is determined.

I. INTRODUCTION

THE AMPLIFIER to be considered is that shown in Fig. 1. Although the application in this paper is to video-frequency amplification, Beveridge¹ and co-workers at the Combined Research Group have used the same general configuration as a wideband i.f.

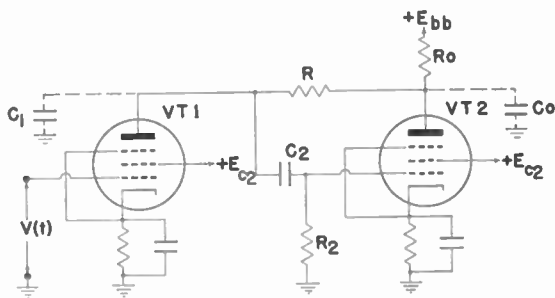

Fig. 1—Two-stage feedback amplifier showing shunt capacitances.

amplifier. Wheeler² has shown that a configuration such as the second stage of this amplifier may be considered as a filter section, and has derived relations for the image impedance and cutoff frequency of such a filter sec-

tion. It has been considered more expeditious for the purposes of this paper to analyze the equivalent circuit of the amplifier on a straightforward basis. The solution of the circuit for the steady-state response is carried out in the conventional manner; on the transient basis a step voltage of unit amplitude is considered to be the input signal. The latter analysis gives at once all the desired information concerning the transmission of pulses or square waves through the amplifier.

The transient analysis will be performed in two parts. The first part will employ the high-frequency equivalent circuit of the amplifier and will provide information concerning rise time of the leading edge and the transient overshoot. The second part will use the low-frequency equivalent circuit and will provide information concerning the distortion of the flat portion of the input step voltage. From the transient-response equations developed, design relationships will be formulated and applied.

The steady-state analysis follows the transient solution and is carried out in a similar manner; that is, the high-frequency equivalent circuit is considered first, followed by consideration of the low-frequency equivalent circuit. After the presentation of these two parts, comment is made on the correlation between the transient and steady-state analyses.

II. THE TRANSIENT RESPONSE OF THE HIGH-FREQUENCY EQUIVALENT CIRCUIT

The high-frequency equivalent circuit of the amplifier³ is that shown in Fig. 2. The parameters g_{m1} , r_{p1} and

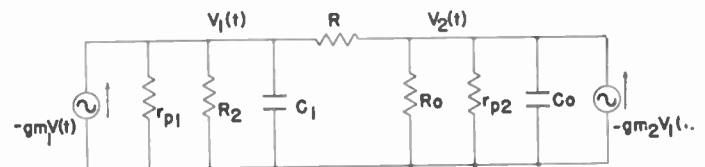

Fig. 2—High-frequency equivalent circuit of amplifier shown in Fig. 1.

g_{m2} , r_{p2} are the tube constants of tubes *VT1* and *VT2*, respectively. The capacitors C_1 and C_0 represent the total shunt capacitances to ground at the plates of *VT1* and *VT2*, respectively. $V_2(t)$, the output voltage of the amplifier, is the function which is to be determined. The

³ The stray capacitance shunting the feedback resistor R is neglected in the analysis of this paper. This is a good approximation to the actual situation for most video applications.

* Decimal classification: R363.4. Original manuscript received by the Institute, May 12, 1947; revised manuscript received, October 17, 1947.

† Formerly, Allen B. DuMont Laboratories, Inc.; now, Columbia University, New York, N. Y.

‡ Allen B. DuMont Laboratories, Inc., Passaic, N. J.

¹ H. N. Beveridge, "Information on Broad Band Feedback Intermediate Frequency Amplifiers," CRG-93 (Combined Research Group, Naval Research Laboratory, Washington, D. C.).

² H. A. Wheeler, "Wideband amplifiers for television," PROC. I.R.E., vol. 27, pp. 429-438; July, 1939.

necessary transient analysis of the circuit will be performed using the Laplace transformation.⁴

The transform equations for the circuit of Fig. 2 are

$$\begin{aligned} I(s) &= \left(\frac{1}{r_{p1}} + \frac{1}{R_2} + \frac{1}{R} + sC_1 \right) V_1(s) - \frac{1}{R} V_2(s) \\ -g_{m2}V_1(s) &= -\frac{1}{R} V_1(s) + \left(\frac{1}{r_{p2}} + \frac{1}{R_0} + \frac{1}{R} + sC_0 \right) V_2(s), \end{aligned} \quad (1)$$

where $I(s) = -g_{m1}V(s)$, and $V(s)$, $I(s)$, etc., are the Laplace transforms of $V(t)$, $I(t)$, etc. For the wide-band video amplifiers of interest in this paper, it can be assumed that $r_{p1} \gg R$, $r_{p2} \gg R$, and $R_2 \gg R$. On the basis of this assumption, (1) can be written

$$\begin{cases} I(s) = (g + sC_1)V_1(s) - gV_2(s) \\ 0 = (g_{m2} - g)V_1(s) + (g_2 + sC_0)V_2(s) \end{cases} \quad (2)$$

where

$$g = \frac{1}{R}, \quad g_0 = \frac{1}{R_0}, \quad \text{and} \quad g_2 = g + g_0 = \frac{R_0 + R}{R_0R}, \quad (3)$$

and

$$I(s) = -g_{m1}V(s). \quad (4)$$

Solving (2) for $V_2(s)$, there is obtained

$$V_2(s) = \frac{g_{m1}(g_{m2} - g)V(s)}{C_0C_1(s^2 + b_1s + b_0)} \quad (5)^6$$

where

$$b_1 = \frac{g_0 + g}{C_0} + \frac{g}{C_1} \quad \text{and} \quad b_0 = \frac{g(g_0 + g_{m2})}{C_0C_1}. \quad (6)$$

For a step voltage input of unit amplitude, $V(t) = u(t)$, and hence

$$V_2(s) = \frac{g_{m1}(g_{m2} - g)}{C_0C_1} \frac{1}{s(s^2 + b_1s + b_0)}. \quad (7)$$

In order to evaluate the time function $V_2(t)$, it is necessary to determine the nature of the roots of the characteristic equation $s^2 + b_1s + b_0 = 0$. In general, three distinct cases are possible corresponding to whether $b_1^2 - 4b_0$ is positive, negative, or zero. These possibilities are summarized in Table I with the resulting values of the roots s_1 and s_2 .

It is desired to limit the investigation to a consideration of Case III, and hence it is necessary to determine the conditions under which $b_0 > b_1^2/4$. For convenience in future manipulation, the parameters m , n , and A are introduced. By definition,

$$\left. \begin{aligned} m &= \frac{C_0}{C_1} \\ n &= \frac{R}{R_0} \\ A &= g_{m2}R_0. \end{aligned} \right\} \quad (8)$$

In terms of these parameters the condition $b_0 > b_1^2/4$ requires that

$$A > \frac{(1 + m + n)^2}{4mn} - 1. \quad (9)$$

By minimizing (9) with respect to n it is found that the absolute lower bound for A as n is varied is $1/m$, which minimum occurs at a value of n equal to $1 + m$.

Assuming that relation (9) is always satisfied, the transform equation (7) may be written as

$$V_2(s) = \frac{K}{s[(s + \alpha)^2 + \beta^2]} \quad (10)$$

where

$$K = \frac{g_{m1}(g_{m2} - g)}{C_0C_1} = \frac{mg_{m1}(nA - 1)}{nR_0C_0^2}. \quad (11)$$

The inverse transformation⁶ of (10) yields the following expression for $V_2(t)$:

$$V_2(t) = K \left[\frac{1}{\beta_0^2} + \frac{1}{\beta_0\beta} \epsilon^{-\alpha t} \sin(\beta t - \psi) \right] \quad (12)$$

where

$$\left. \begin{aligned} \beta_0^2 &= \alpha^2 + \beta^2 \\ \psi &= \tan^{-1} \frac{\beta}{-\alpha} \end{aligned} \right\} \quad (13)$$

Equation (12) may be written as

$$V_2(t) = \frac{K}{\beta_0^2} \left[1 + \frac{\beta_0}{\beta} \epsilon^{-\alpha t} \sin(\beta t - \psi) \right],$$

and since

$$\beta_0^2 = \alpha^2 + \beta^2 = \frac{b_1^2}{4} + \frac{1}{4} (4b_0 - b_1^2) = b_0 = \frac{m}{n} \frac{1 + A}{R_0^2 C_0^2},$$

one obtains

$$V_2(t) = \frac{g_{m1}R_0(nA - 1)}{(1 + A)} \left[1 + \frac{\beta_0}{\beta} \epsilon^{-\alpha t} \sin(\beta t - \psi) \right]. \quad (14)$$

The quantity

$$G = \frac{g_{m1}R_0(nA - 1)}{(1 + A)}$$

can easily be shown to be the midband gain of the amplifier, and consequently the *normalized* value of $V_2(t)$,

⁶ See transform pair No. 1.304, p. 342, of footnote reference 4.

⁴ The notation and methods of solution used in the transient analysis of this paper follow those of M. F. Gardner and J. L. Barnes, "Transients in Linear Systems," Volume I, John Wiley and Sons, Inc., New York, N. Y., 1942.

⁶ From the transform of the voltage transfer ratio given by this equation, it is a simple matter to show that a series resonant (RLC) circuit may be used as the equivalent circuit of this amplifier. Since such an equivalent circuit is not needed for the ensuing transient analysis, the equivalence is not considered until a later section.

TABLE I
POSSIBLE FORM OF THE ROOTS OF THE CHARACTERISTIC EQUATION

	Defining condition	Roots	Form of characteristic function
Case I	$b_1^2 - 4b_0 = 0; b_0 = \frac{b_1^2}{4}$	$s_1 = -\frac{b_1}{2}$ $s_2 = -\frac{b_1}{2}$	$(s + \alpha_0)^2$
Case II	$b_1^2 - 4b_0 > 0; b_0 < \frac{b_1^2}{4}$	$s_1 = -\frac{b_1}{2} + \frac{1}{2}\sqrt{b_1^2 - 4b_0}$ $s_2 = -\frac{b_1}{2} - \frac{1}{2}\sqrt{b_1^2 - 4b_0}$	$(s + \alpha_1)(s + \beta_1)$
Case III	$b_1^2 - 4b_0 < 0; b_0 > \frac{b_1^2}{4}$	$s_1 = -\frac{b_1}{2} + j\frac{1}{2}\sqrt{4b_0 - b_1^2}$ $s_2 = -\frac{b_1}{2} - j\frac{1}{2}\sqrt{4b_0 - b_1^2}$	$(s + \alpha + j\beta)(s + \alpha - j\beta) = (s + \alpha)^2 + \beta^2$

which will be denoted as $V_{2n}(t)$, can be written simply as

$$V_{2n}(t) = \frac{V_2(t)}{G} = 1 + \frac{\beta_0}{\beta} \epsilon^{-\alpha t} \sin(\beta t - \psi) \tag{15}$$

$$V_{2n}(t) = 1 + \sqrt{1 + \left(\frac{\alpha}{\beta}\right)^2} \epsilon^{-\alpha t} \sin(\beta t - \psi). \tag{16}$$

The normalized output voltage $V_{2n}(t)$ will now be examined in some detail. As a result of confining attention to Case III the response will, in general, have some transient overshoot. It is now desirable to locate the values of t at which the function $V_{2n}(t)$ has maxima, and to evaluate the first maximum value of $V_{2n}(t)$. Differentiating $V_{2n}(t)$ with respect to t , there is obtained

$$\frac{dV_{2n}(t)}{dt} = \sqrt{1 + \left(\frac{\alpha}{\beta}\right)^2} [-\alpha \epsilon^{-\alpha t} \sin(\beta t - \psi) + \beta \epsilon^{-\alpha t} \cos(\beta t - \psi)]$$

which, on setting $dV_{2n}(t)/dt = 0$, yields

$$\sqrt{\alpha^2 + \beta^2} \left[\frac{-\alpha}{\sqrt{\alpha^2 + \beta^2}} \sin(\beta t - \psi) + \frac{\beta}{\sqrt{\alpha^2 + \beta^2}} \cos(\beta t - \psi) \right] = 0$$

$$\cos \psi \sin(\beta t - \psi) + \sin \psi \cos(\beta t - \psi) = 0,$$

or, finally,

$$\sin \beta t = 0. \tag{17}$$

Equation (17) is satisfied for $\beta t = k\pi$ where $k = 0, 1, 2, \dots$, since only positive values of t are of concern. It is thus found that the time taken to reach the first maximum of $V_{2n}(t)$ is

$$t]_{\text{first max.}} = \frac{\pi}{\beta} \text{ second.} \tag{18}$$

It is also noted at this time that, if $V_{2n}(t)$ is plotted with a time scale βt , all the maxima will occur at $\beta t = k\pi$ ($k = 1, 3, 5 \dots$). Next, the value of the first maximum of $V_{2n}(t)$ will be evaluated; this is the absolute maximum reached by $V_{2n}(t)$. Setting t equal to π/β in (15), it is found that

$$V_{2n}(t)]_{\text{max.}} = V_{2n}\left(\frac{\pi}{\beta}\right) = 1 + \frac{\beta_0}{\beta} \epsilon^{-\pi\alpha/\beta} \sin(\pi - \psi) = 1 + \frac{\beta_0}{\beta} \epsilon^{-\pi\alpha/\beta} \sin \psi.$$

Since $\sin \psi = \beta/\beta_0$, evidently a simpler form of this expression is

$$V_{2n}(t)]_{\text{max.}} = 1 + \epsilon^{-\pi\alpha/\beta}. \tag{19}$$

Equation (19) is a simple, yet extremely useful, result. From this equation it is seen immediately that the fractional overshoot, or peak, which will be denoted by γ , is

$$\gamma = \epsilon^{-\pi\alpha/\beta}. \tag{20}$$

The value that α/β must assume to yield an overshoot of 100 γ per cent is, then,

$$\frac{\alpha}{\beta} = \frac{1}{\pi} \log_e \frac{1}{\gamma}. \tag{21}$$

It is evident from an examination of (16) and (21) that, if one plots $V_{2n}(t)$ as a function of βt , there will be but one curve for any particular value of overshoot γ . Thus there is a means of obtaining a family of transient characteristics for this system in a relatively simple manner. Rewriting (16) with this idea in mind, there is obtained

$$V_{2n}(t) = 1 + \sqrt{1 + \left(\frac{\alpha}{\beta}\right)^2} \epsilon^{-\alpha/\beta(\beta t)} \sin(\beta t - \psi). \tag{22}$$

As noted previously, all the maxima of these transient responses will occur at $\beta t = k\pi$ ($k = 1, 3, 5 \dots$). Curves

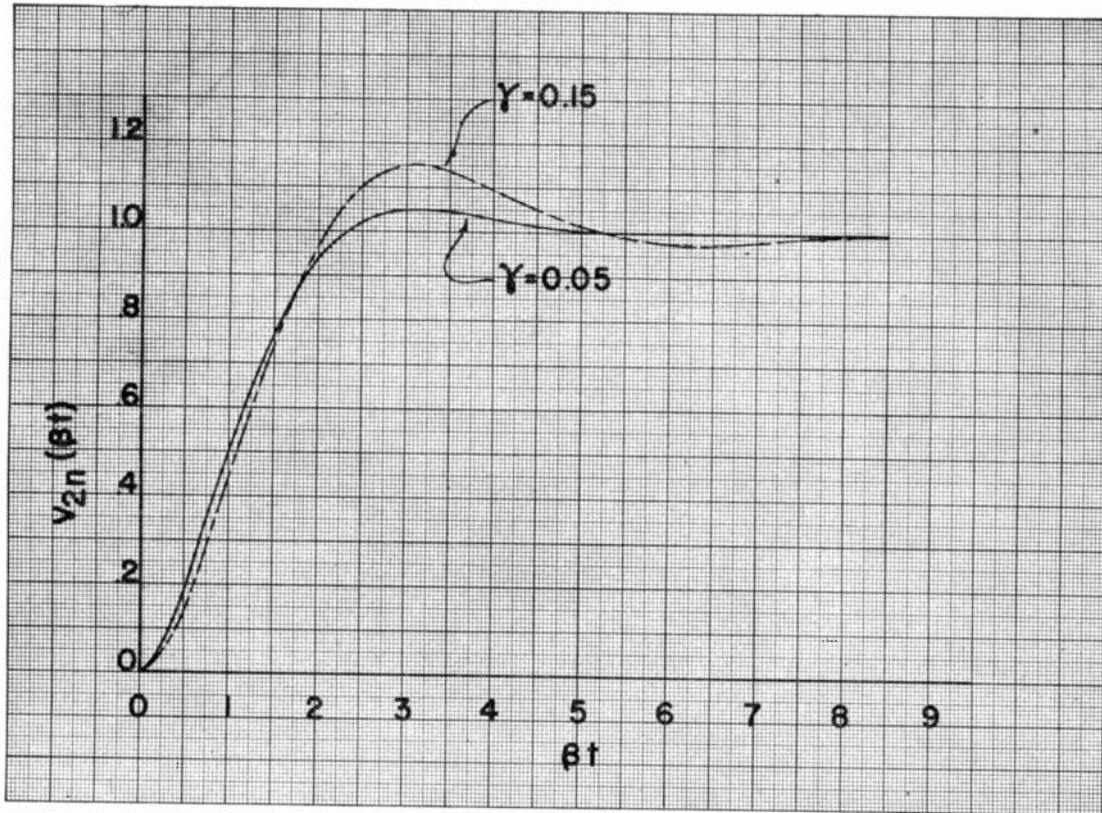

Fig. 3—Representative transient-response curves for feedback doublet.

showing the relationship between $V_{2n}(t)$ and βt are given in Fig. 3 for two values of γ , namely, 0.05 and 0.15.

Up to this point the relationships developed involving α and β are perfectly general results⁷ obtained from the properties of the transform given in (10). It now seems advisable, however, to identify α and β explicitly with the parameters for the circuit under consideration. Using (6), (8), and the relations of Case III, Table I, there results

$$\alpha = + \frac{b_1}{2} = \frac{1}{2} \frac{m+n+1}{nR_0C_0} \quad (23a)$$

$$\begin{aligned} \beta &= \frac{1}{2} \sqrt{4b_0 - b_1^2} \\ &= \frac{1}{R_0C_0} \sqrt{\frac{m(1+A)}{n} - \frac{(m+n+1)^2}{4n^2}} \end{aligned} \quad (23b)$$

Equation (23b) can also be written as

$$\frac{C_0}{g_{m_2}} \beta = \sqrt{\frac{m(1+A)}{nA^2} - \left(\frac{m+n+1}{2nA}\right)^2} \quad (24)$$

From (23a) and (23b) it is also possible to write

$$\frac{\alpha}{\beta} = \frac{1}{\pi} \log_e \frac{1}{\gamma} = \frac{1}{\sqrt{\frac{4mn(1+A)}{(m+n+1)^2} - 1}} \quad (25)$$

⁷ It should be noted that $V_2(t)$ could have been normalized using only the quantity $K/\beta\sigma^2$, in which case it would not have been necessary to introduce the factor G .

Finally, for convenience, the midband gain of the amplifier is rewritten

$$G = \frac{g_{m_1}R_0(nA-1)}{(1+A)} \quad (26)$$

If tubes $VT1$ and $VT2$ have equal transconductances, (26) may be expressed as

$$G = \frac{A(nA-1)}{1+A} \quad (27)$$

If $g_{m_1} = \sigma g_{m_2}$, then

$$G = \frac{\sigma A(nA-1)}{1+A} \quad (28)$$

Equations (23)–(28) are general relations which are applicable whenever m , n , A , R_0C_0 , and σ are given. For design purposes it is desirable to present the information given in these relations in curve or nomograph form, so that an actual design problem can be solved with a minimum of labor. Perhaps the most convenient way of accomplishing this is to assign various values to m and prepare a corresponding set of design curves involving the rest of the parameters. In the remainder of this analysis m has been assumed equal to unity; that is, C_0 is assumed equal to C_1 , which seems to be the most reasonable approximation to make. The value of σ has also been assumed unity; that is $g_{m_1} = g_{m_2}$. This provides little loss in generality, however, as will be seen when a design example is given in a later section. In a given de-

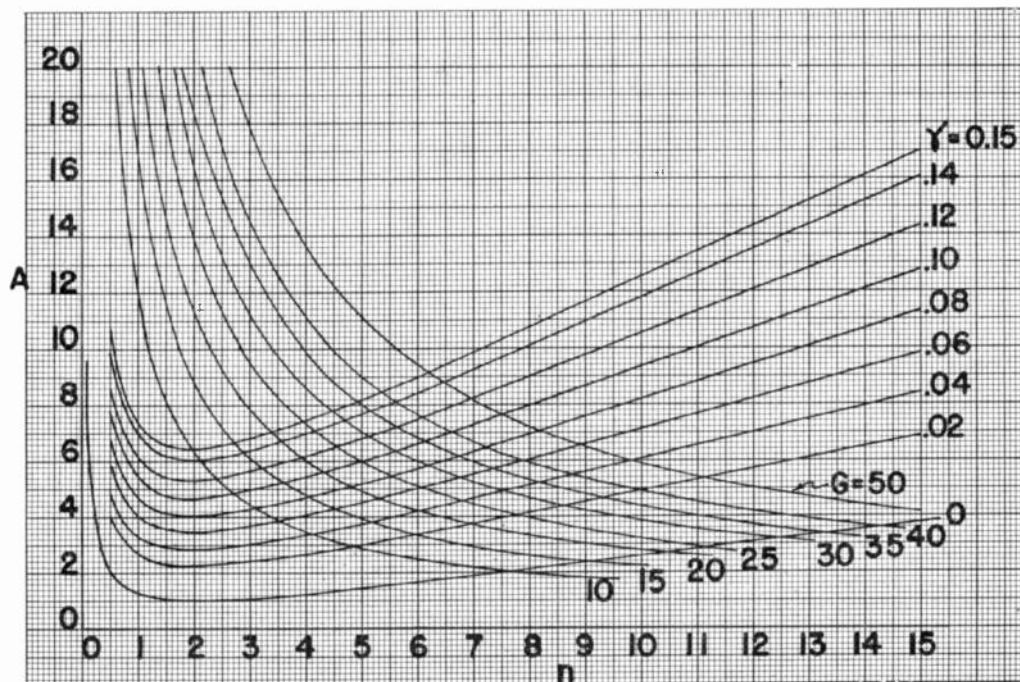

Fig. 4— G and γ curves in $A-n$ plane.

sign problem the parameters C_0 , C_1 , g_{m1} , and g_{m2} are fixed when the tube types are selected. It remains to determine R_0 and R subject to the limitations imposed by the design requirements. With the assumptions just made, the two design equations are (27), and (25) with $m = 1$; that is,

$$\frac{\alpha}{\beta} = \frac{1}{\pi} \log_c \frac{1}{\gamma} = \frac{1}{\sqrt{\frac{4n(1+A)}{(2+n)^2} - 1}} \quad (29)$$

It is evident from consideration of these two equations that R and R_0 are uniquely determined from a specification of the tube parameters and the values of G and γ . For ease in the simultaneous solution of (27) and (29), the curves of Fig. 4 have been prepared. This plot has (29) plotted for various values of the per cent overshoot which are considered useful in practical design problems, and (27) plotted for representative values of gain G . Knowing the value of the over-all amplifier gain (G) and the per cent overshoot (γ), the intersection of the two respective curves determines n and A , and hence R and R_0 .

To illustrate the solution of a possible design problem, suppose that two 6AK5 tubes are to be used with $g_{m1} = g_{m2} = 5000$ micromhos and with $C_1 = C_0 = 15 \mu\text{fd}$. A gain of 25 is desired with a maximum overshoot of 10.8 per cent.⁸ From Fig. 4 it is seen that the intersection of the curve $\gamma = 0.108$ and $G = 25$ establishes n as 4.85 and A as 6.25. Then

⁸ Two cascaded shunt-peak stages with $m = L/CR^2 = 0.50$ have approximately 10.8 per cent maximum overshoot to a unit step function input.

$$R_0 = \frac{A}{g_{m2}} = \frac{6.25}{5 \times 10^{-3}} = 1250 \text{ ohms}$$

$$R = nR_0 = (4.85)(1250) = 6058 \text{ ohms.}$$

The commercially available resistance values nearest to these figures would, of course, be used in a practical amplifier. The method of correcting for differences in g_{m1} and g_{m2} can also be noted here. It will be assumed that $g_{m2} = 5000$ micromhos and that $g_{m1} = 3000$ micromhos, and the same design problem as above is to be solved. Then $\sigma = g_{m1}/g_{m2} = 3000/5000 = 0.60$, and from (28)

$$25 = \frac{0.60A(nA - 1)}{1 + A}$$

or

$$\frac{A(nA - 1)}{1 + A} = \frac{25}{0.60} = 41.6.$$

But the quantity $A(nA - 1)/1 + A$ is the G from (27). Consequently, the curves of Fig. 4 are entered with $G = 41.6$ and $\gamma = 0.108$, and n and A are found to be approximately 6.45 and 7.25, respectively.

It will be noticed that the values of C_1 and C_0 have not been used in the computation. This is to be expected, however, since the capacitance does not directly affect the gain of the amplifier but only the high-frequency cutoff, or its counterpart, the rise time of the output voltage in response to the step-voltage input. Indeed, the above illustrative problem is somewhat different than the usual design problem encountered in practice.

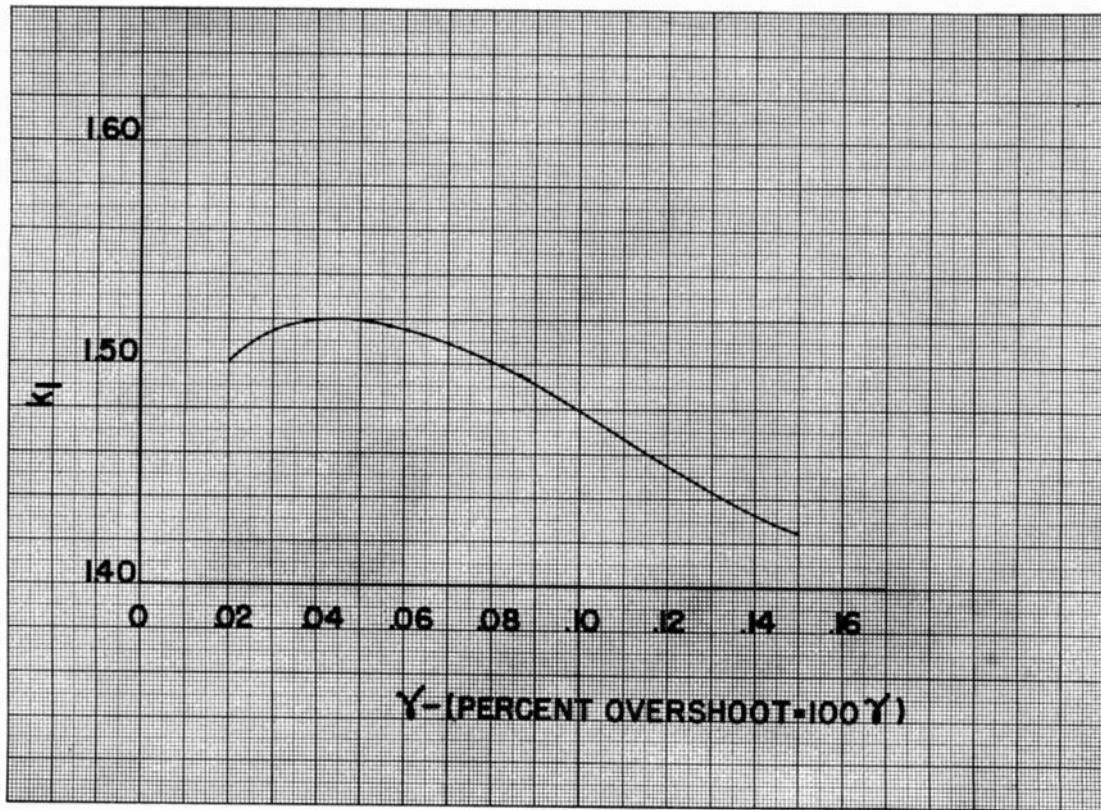

Fig. 5—The relation between k_1 and γ .

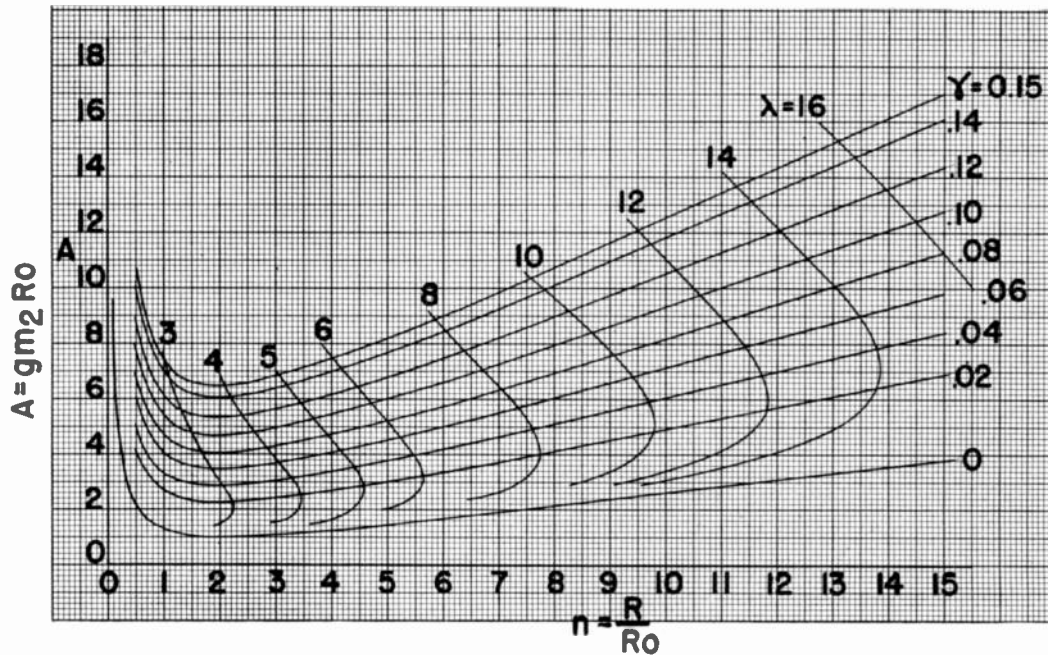

Fig. 6— λ and γ curves in $A-n$ plane.

A more nearly representative problem is that of designing the amplifier so that the output wave in response to a step input wave will have a given rise time (usually expressed as the time taken for the amplitude to change from 10 to 90 per cent of the final amplitude) and a

given transient overshoot (expressed in per cent of final amplitude), assuming that the tube transconductances and circuit capacitances are specified. Problems of this type can be solved quite rapidly using the curves given in Figs. 5 and 6.

Before describing the use of the above-mentioned curves, some comment concerning their construction is in order. From (22) it is evident that there is a single equation describing the transient characteristic $V_{2n}(\beta t)$ for a given per cent overshoot. It follows, therefore, that to each such per cent overshoot there corresponds a value of βt which represents the time necessary for the amplitude to change from 0.10 to 0.90. This value of βt will be denoted by k_1 ; that is,

$$k_1 = \beta t_0 \tag{30}$$

where t_0 is the rise time from 0.10 to 0.90. Evidently k_1 is a function of the per cent overshoot γ ; the functional relationship is found by solving (22) for several values of α/β . Fig. 5 shows the relation between k_1 and γ for values of overshoot from 2 to 15 per cent. It is now possible to substitute the value of β found from (30) in (24) to find a relation between t_0 and the other parameters. With the substitution of this value of β and the value unity for m in (24), there obtains

$$\frac{C_0 k_1}{g_{m_2} t_0} = \sqrt{\frac{(1+A)}{nA^2} - \left(\frac{2+n}{2nA}\right)^2}$$

or

$$\lambda = \frac{t_0}{k_1} \frac{g_{m_2}}{C_0} = \frac{A}{\sqrt{\frac{(1+A)}{n} - \left(\frac{2+n}{2n}\right)^2}} \tag{31}$$

Fig. 6 is a plot in the $A-n$ plane of (31) for constant values of λ , and a plot of (29) for various constant values of γ . The use of these curves will now be illustrated by a design example.

Consider the design of an amplifier using two 6AK5 tubes with $g_{m_1} = g_{m_2} = 5000$ micromhos and $C_0 = C_1 = 15 \mu\mu\text{fd.}$, required to have a rise time of 0.03 microsecond and an overshoot of 2 per cent. From Fig. 5, for $\gamma = 0.02$, $k_1 = 1.50$. Then

$$\lambda = \frac{t_0 g_{m_2}}{k_1 C_0} = \frac{(0.03 \times 10^{-6})(5.0 \times 10^{-3})}{(1.50)(15 \times 10^{-12})} = 6.67.$$

From Fig. 6, for $\lambda = 6.67$, $\gamma = 0.02$, n and A are determined as 6.32 and 3.5, respectively. It follows immediately that

$$R_0 = \frac{A}{g_{m_2}} = \frac{3.5}{5.0 \times 10^{-6}} = 700 \text{ ohms}$$

$$R = nR_0 = (6.32)700 = 4420 \text{ ohms.}$$

Entering Fig. 4 with $n = 6.32$ and $A = 3.5$, the net gain is found to be approximately 17. The time of maximum overshoot may be used as a design factor instead of the 10 to 90 per cent rise time if k_1 is set equal to π in the above procedure.

The curves of Fig. 4 may also be used to determine the effect of changes in tube transconductances on the gain

and transient overshoot. The effect of a change in g_{m_1} is to cause a change in the net gain G only. This may be computed by the method previously described when $\sigma \neq 1$. A change in the transconductance g_{m_2} produces the same percentage change in the factor A , whereas n is unchanged. Consequently, the variations in g_{m_2} produce a shift in design center along the lines of constant n in Fig. 4. For example, if, in the design illustration given on page 599, g_{m_2} should vary ± 20 per cent from the design center of 5000 micromhos, A would vary from 7.50 to 5.0 along $n = 4.85$, which yields a change in overshoot from approximately 13.8 to 7.7 per cent. It is also of interest to determine operating limits for the amplifier when changes in g_{m_2} , R_0 , and R are made simultaneously. This situation is of importance when considering variations in components on a production basis. Given the tolerances on g_{m_2} , R_0 , and R , it is a simple matter to find the corresponding maximum and minimum values of A and n . By extension of the above method, it is evident that a rectangle can be constructed in the $A-n$ plane which will at once show the limits of variation in gain and transient overshoot to be expected.

TABLE II
COLLECTION OF RELATIONSHIP USED IN
TRANSIENT ANALYSIS OF HIGH-FREQUENCY EQUIVALENT CIRCUIT

Equation	Equation No.
$\alpha = \frac{1}{2} \frac{m+n+1}{nR_0C_0}$	(23a)
$\beta = \frac{1}{R_0C_0} \sqrt{\frac{m(1+A)}{n} - \frac{(m+n+1)^2}{4n^2}}$	(23b)
$\gamma = e^{-\frac{\pi\alpha}{\beta}}$	(20)
$V_{2n}(t) = 1 + \sqrt{1 + \left(\frac{\alpha}{\beta}\right)^2} e^{-\alpha t} \sin(\beta t - \psi)$	(16)
Time of first maximum = $\frac{\pi}{\beta}$	(18)
$G = \frac{\sigma A(nA-1)}{1+A}$	(28)
$k_1 = \beta t_0$	(30)
$\lambda = \frac{t_0 g_{m_2}}{k_1 C_0}$	(31)

Where

$$m = \frac{C_0}{C_1}, \quad n = \frac{R}{R_0}, \quad A = g_{m_1} R_0$$

$$\sigma = \frac{g_{m_1}}{g_m}, \quad = \tan^{-1} \frac{\beta}{-\alpha}$$

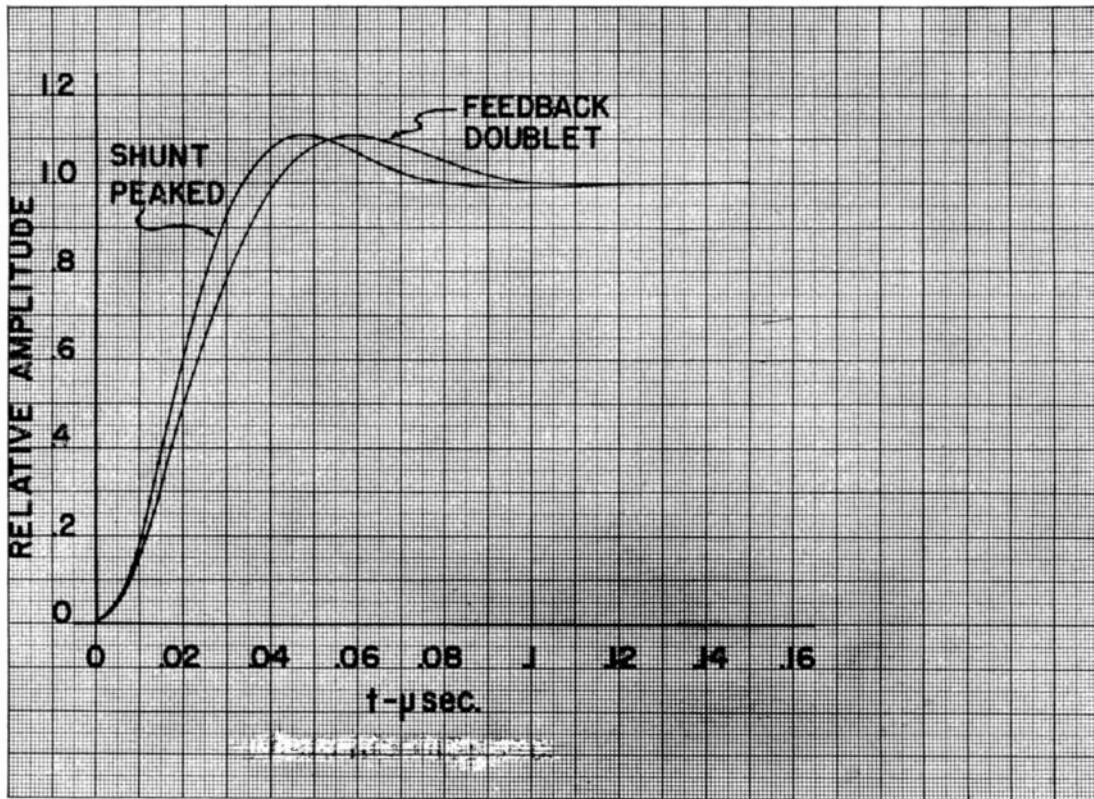

Fig. 8—Comparison of the transient response of two-stage shunt-peaked ($m=L/CR^2=0.5$) and feedback amplifiers for equal gains.

The preceding design information concerning transient overshoot and rise time is based on the assumption that $m = 1.0$. Although design curves for other values of m would be useful in certain design problems, they have not been computed for the present paper. The curves of Figs. 3 and 5 and the gain curves of Fig. 4, however, are general relationships which do not depend on the assumption $m = 1$. Thus, in situations where m differs appreciably from unity, these curves can be used as part of the design procedure, although (29) and (30) must be replaced by the following relationships:

$$\frac{\alpha}{\beta} = \frac{1}{\pi} \log \gamma = \frac{1}{\sqrt{\frac{4mn(1+A)}{(m+n+1)^2} - 1}}$$

$$\lambda = \frac{l_0 g_{m2}}{k_1 C_0} = \frac{A}{\sqrt{\frac{m(1+A)}{n} - \left(\frac{m+n+1}{2n}\right)^2}} \quad (32)$$

For reference, the more important relationships that have been derived for the analysis of the high-frequency equivalent circuit are collected in Table II.

A comparison of the transient response of a two-stage voltage-feedback structure with a two-stage shunt-peaked amplifier, for equal gain and overshoot, is given in Fig. 7. This case is also referenced in footnote 8.

III. THE TRANSIENT RESPONSE OF THE LOW-FREQUENCY EQUIVALENT CIRCUIT

The low-frequency equivalent circuit of the amplifier

is that shown in Fig. 8.⁹ Following the same assumptions and definitions as in previous derivations, the transform equations are

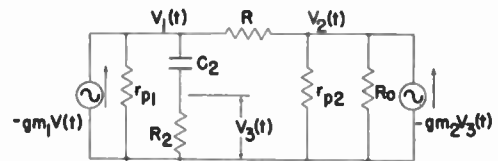

Fig. 7—Low-frequency equivalent circuit of amplifier shown in Fig. 1.

$$\left. \begin{aligned} -g_{m1}V(s) &= (g + sC_2)V_1(s) - gV_2(s) - sC_2V_3(s) \\ 0 &= -sC_2V_1(s) + (g_2 + sC_2)V_3(s) \\ -g_{m2}V_3(s) &= -gV_1(s) + (g + g_0)V_2(s) \end{aligned} \right\} \quad (33)$$

where

$$g_2 = \frac{1}{R_2}$$

Solving the system (33) for $V_2(s)$, there is obtained

$$V_2(s) = \frac{I(s)}{\Delta} \left(g - \frac{sg_{m2}}{s + \tau} \right) \quad (34)$$

⁹ It is assumed here that the time constants of the RC combinations in the cathode circuits are sufficiently large that negligible distortion occurs when a square wave is transmitted through the amplifier, assuming a sufficiently large R_2C_2 product. The following analysis studies the effect of the time constant R_2C_2 .

where

$$\Delta = g_{11}g_{22} + g_{12}g_{21}$$

and

$$\left. \begin{aligned} g_{11} &= g + sC_2 - \frac{s^2C_2}{s + \tau}; & \tau &= \frac{1}{R_2C_2}; & g_{22} &= g + g_0 \\ g_{12} &= g; & g_{21} &= -g + g_{m2} \frac{s}{s + \tau}; & I(s) &= -g_{m1}V(s) \end{aligned} \right\} \quad (35)$$

After some manipulation, Δ is expressible as

$$\Delta = \frac{1}{s + \tau} \frac{1}{R_0R} \left[\left(\frac{R_0 + R}{R_2} + g_{m2}R_0 + 1 \right) s + \tau \right],$$

and since, according to the previous assumptions, $R_0 + R/R_2 \ll 1$, thus

$$\Delta = \frac{(1 + A)}{nR_0^2} \frac{\left[s + \frac{\tau}{1 + A} \right]}{(s + \tau)}. \quad (36)$$

Substituting the result (36) in (34) and replacing $V(s)$ by $1/s$, the transform of the response to a unit step input is found to be

$$\begin{aligned} V_2(s) &= -\frac{g_{m1}R_0}{1 + A} \frac{s + \tau}{s \left(s + \frac{\tau}{1 + A} \right)} \\ &+ \frac{g_{m1}nAR_0}{(1 + A)} \frac{1}{s + \frac{\tau}{1 + A}}. \end{aligned} \quad (37)$$

Replacing

$$\frac{s + \tau}{s \left(s + \frac{\tau}{1 + A} \right)}$$

by its equivalent

$$\frac{(1 + A)}{s} - \frac{A}{s + \frac{\tau}{1 + A}},$$

there results, finally,

$$V_2(s) = -g_{m1}R_0 \frac{1}{s} + \frac{g_{m1}R_0A}{1 + A} (1 + n) \frac{1}{s + \frac{\tau}{1 + A}}. \quad (38)$$

The function $V_2(t)$ is found directly from (38) as

$$V_2(t) = -g_{m1}R_0 + \frac{g_{m1}R_0A(1 + n)}{1 + A} \epsilon^{-\tau t/(1 + A)}. \quad (39)$$

In uncompensated amplifiers designed to reproduce square waves faithfully, τt is usually made equal to or less than 0.1, where t is the duration of the flat portion

of the wave. For the analysis that follows, it can be assumed, then, that $\tau t/(1 + A) \leq 0.1$, since $A > 1$. With such an assumption it is possible to obtain a good approximation to $\epsilon^{-\tau t/(1 + A)}$ by considering only the first two terms of the series expansion for $\epsilon^{-\tau t/(1 + A)}$. Thus

$$\epsilon^{-\tau t/(1 + A)} \doteq 1 - \frac{\tau t}{1 + A},$$

and hence

$$\begin{aligned} V_2(t) &= -g_{m1}R_0 + \frac{g_{m1}R_0A(1 + n)}{1 + A} \\ &- \frac{g_{m1}R_0A(1 + n)}{1 + A} \frac{\tau t}{1 + A}. \end{aligned} \quad (40)$$

By setting $t=0$ in (39), $V_2(0)$ is found to be

$$V_2(0) = -g_{m1}R_0 + \frac{g_{m1}R_0A(1 + n)}{1 + A} = G,$$

and thus (40) may be written as

$$V_2(t) = V_2(0) \left[1 - \frac{g_{m1}R_0A(1 + n)}{G} \frac{\tau t}{(1 + A)^2} \right].$$

The percentage decrease in amplitude of the step voltage at the output in a time t is then

$$\text{per cent fall} = 100 \frac{g_{m1}R_0A(1 + n)\tau t}{G(1 + A)^2}. \quad (41)$$

For an ordinary RC interstage such that $t/RC = \tau t \leq 0.10$, the percentage decrease is

$$\text{per cent fall} = \tau t(100). \quad (42)$$

By comparison of (41) and (42), it is evident that the factor τ of the interstage used with the feedback connection has an effective value τ' of value

$$\tau' = \frac{g_{m1}R_0A(1 + n)}{G(1 + A)^2} \tau = \frac{A(1 + n)}{(nA - 1)(1 + A)} \tau,$$

and hence the effective time constant of the interstage is:

$$\text{effective } TC \text{ with feedback} = \frac{(1 + A)(nA - 1)}{A(1 + n)} R_2C_2. \quad (43)$$

The factor of improvement in time constant k_2 , due to this connection, is evidently

$$k_2 = \frac{(1 + A)(nA - 1)}{A(1 + n)}. \quad (44)$$

For the first design example considered in this paper, n and A were determined as 4.85 and 6.25, respectively. For that particular amplifier, the improvement factor is readily computed to be 5.81.

IV. THE STEADY-STATE HIGH-FREQUENCY SOLUTION

The steady-state solution is of value in the design of this feedback video amplifier in that it readily provides a

partial correlation between the design and actual performance through the use of relatively simple measuring equipment. A sweep-frequency generator and oscillograph will enable steady-state measurements of magnitude of gain versus frequency to be easily made; the companion phase measurements are often neglected because they are more difficult to make. The common assumption is then made that if the gain versus frequency characteristic has a variation which is not excessively rapid throughout the desired range, the companion phase-shift function will be such that the combination will result in a satisfactory transient response. However, since the transient response to a unit step input gives all the desired information at once, it represents the preferred method of treatment, and consequently has been discussed first in this paper.

It will be shown later that a simple correlation has been obtained relating the steady-state and transient response for this feedback video amplifier. As a result, more significance can be attached to the steady-state solution, since all the desired information can be obtained through the use of steady-state techniques. With these concepts in hand, the steady-state solution will now be described.

From (2) and (3) one can write, replacing s by $j\omega$ and $-I(s)$ by $g_{m1}V$,

$$V_2 = \frac{g_{m1}V(g_{m2} - g)}{(g_2 + j\omega C_0)(g + j\omega C_1) + g(g_{m2} - g)} \quad (45)$$

This can be written as

$$V_2 = \frac{g_{m1}V}{g} \frac{1}{1 + \frac{(g_2 + j\omega C_0)(g + j\omega C_1)}{g(g_{m2} - g)}} \quad (46)$$

For convenience the terms used will be restated, together with some new parameters required.

Let

$$\begin{aligned} n &= \frac{R}{R_0} = \frac{g_0}{g} & A &= g_{m2}R_0 \\ m &= \frac{C_0}{C_1} & g &= \frac{1}{R} \\ G &= \frac{\sigma A(nA - 1)}{A + 1} & g_0 &= \frac{1}{R_0} \\ \omega_0 &= \frac{1}{R_0 C_0} & g_2 &= g + g_0 \\ x &= \frac{\omega}{\omega_0} & \sigma &= \frac{g_{m1}}{g_{m2}} \end{aligned}$$

Whence,

$$\frac{g_{m2}}{g} = g_{m2}R = An$$

$$\frac{g_2}{g} = 1 + \frac{g_0}{g} = n + 1$$

$$R\omega C_0 = nx.$$

Introducing these parameters, the expression for V_2 becomes

$$V_2 = \frac{V}{R_0} \sigma A(nA - 1) \frac{R_0}{(A + 1) - \frac{n}{m} x^2 + jx \left(\frac{n}{m} + \frac{1}{m} + 1 \right)} \quad (47)$$

Equation (47) is of the form

$$V_2 = IZ = I \left(\frac{1}{Y} \right)$$

where

$$\left. \begin{aligned} I &= \frac{V}{R_0} \sigma A(nA - 1) \\ Z &= \frac{R_0}{(A + 1) - \frac{n}{m} x^2 + jx \left(\frac{n}{m} + \frac{1}{m} + 1 \right)} \end{aligned} \right\} \quad (48)$$

and

$$Y = \frac{(A + 1)}{R_0} - \frac{nx^2}{mR_0} + jx \frac{\left(\frac{n}{m} + \frac{1}{m} + 1 \right)}{R_0}$$

The expression for the transfer admittance Y in (48) can be shown to have the same form as that of a damped series-resonant circuit. Thus, an equivalent circuit can be derived, and this is shown in Fig. 9, with the equivalent

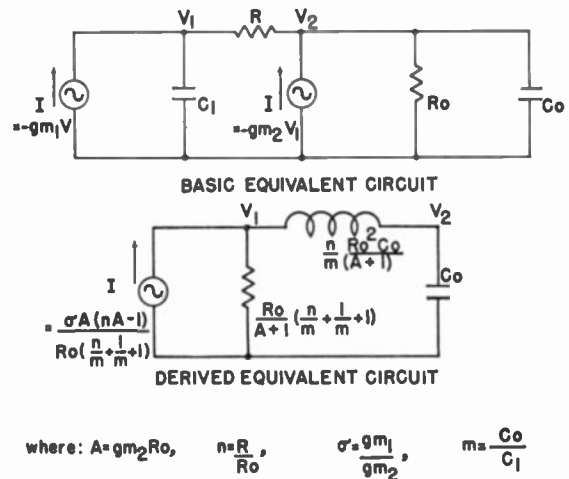

Fig. 9—Basic and derived equivalent circuits for a two-stage voltage-feedback video amplifier.

R , L , and C . Thus it may be expected that such a combination will provide a peaked response not unlike that of a shunt-peaked video amplifier.

Since the current generator of the derived equivalent circuit is not a function of frequency, it will only be necessary to deal with the transfer impedance Z , in order to study the variation of V_2 with frequency. Converting

the expression for Z given by (48) to polar form, one obtains

$$Z = \frac{R_0}{\sqrt{x^4 \left(\frac{n}{m}\right)^2 + x^2 \left[\left(\frac{n}{m} + \frac{1}{m} + 1\right)^2 - 2\frac{n}{m}(A + 1)\right] + (A + 1)^2}} / \theta \tag{49}$$

where

$$\theta = -\tan^{-1} \frac{x \left(\frac{n}{m} + \frac{1}{m} + 1\right)}{A + 1 - \frac{n}{m} x^2} \tag{49a}$$

It is of interest at this point to determine under what conditions the transfer impedance Z has a peak in its magnitude versus frequency characteristic, and if it exists, at what frequency such a peak occurs. This information is readily obtained from the derived equivalent circuit of Fig. 9. It can be shown that the voltage across the capacitor in this circuit attains its maximum value at the angular frequency

$$\omega = \frac{1}{\sqrt{LC}} \sqrt{1 - \frac{R^2C}{2L}} \tag{50}$$

and hence the condition that a maximum exists is that $R^2C/2L < 1$. Replacing R , L , and C by their equivalents in terms of the amplifier parameters from Fig. 9, the normalized frequency at which the magnitude of Z is a maximum is found directly as

$$x_m = \sqrt{\frac{(A + 1)m}{n} - \frac{(m + n + 1)^2}{2n^2}} \tag{51}$$

and the condition that must be satisfied in order that the maximum exist is

$$m(A + 1) > \frac{(m + n + 1)^2}{2n}$$

or

$$A = \frac{(m + n + 1)^2}{2nm} - 1 \quad (\text{limiting case}).$$

This equation may be solved likewise for n in terms of A ; this gives

$$n = (mA - 1) + \sqrt{m^2(A^2 - 1) - 2m(A + 1)},$$

which is also written for the limiting case. There is also the restriction that n must be real and positive; this indicates the need for the additional constraint

$$m^2(A^2 - 1) > 2m(A + 1)$$

or

$$A > \frac{2}{m} + 1.$$

It may be reasoned from this that if $m = 1$ and a maximum exists in the function Z with respect to frequency,

then for any value of n , A must equal or exceed a value of 3. This should be contrasted to the transient analysis, wherein it was shown that in the limiting condition of the oscillatory case (i.e., critically damped), for any value of n , A must equal or exceed a value of 1 for $m = 1$. These two conditions are tabulated in Table III for comparison.

TABLE III
LIMITING CONDITIONS FOR TRANSIENT AND STEADY-STATE RESPONSE

Condition	Defining Equation	For $m = 1$	
		Minimum Value of A	Corresponding Value of n
Limiting oscillatory case (Critically damped)	$A = \frac{(m+n+1)^2}{4nm} - 1$	1	2
Limiting case for a maximum to exist in expression $Z = f(x)$	$A = \frac{(m+n+1)^2}{2nm} - 1$	3	2

It may be realized from the defining equations that, if A and n take on such values as to give a maximum in the Z function, the system will exhibit a transient overshoot to a step input; however, the converse is not true. *The system may have a monotonic Z function and still show a transient overshoot to a step function of applied voltage.*

Having demonstrated the condition for the existence of a maximum in the Z function, it will be useful to determine the value of Z for $x = x_m$. Since the value of Z for the midband region (i.e., $x \ll 1$) is given by

$$Z]_{\text{midband}} = \frac{R_0}{A + 1} \tag{52}$$

the value of Z at x_m will be defined in relation to this quantity. If a peak in the steady-state response has a value of $(1 + \delta)$ times the midband value, corresponding to a steady-state deviation from midband value of 100 δ per cent, then

$$Z]_{\text{max}} = (1 + \delta)Z]_{\text{midband}},$$

or, from (49),

$$\frac{R_0}{\sqrt{x_m^4 \left(\frac{n}{m}\right)^2 + x_m^2 \left[\left(\frac{n}{m} + \frac{1}{m} + 1\right)^2 - 2\frac{n}{m}(A+1) \right] + (A+1)^2}} = (1 + \delta) \frac{R_0}{A+1}.$$

Inserting the value of x_m from (51), there obtains

$$\frac{1 + \delta}{A + 1} = \left[\left(\frac{n}{m}\right)^2 \left[\frac{m}{n}(A+1) - \frac{m^2 \left(\frac{n}{m} + \frac{1}{m} + 1\right)^2}{2n^2} \right]^2 + \left[\left(\frac{n}{m} + \frac{1}{m} + 1\right)^2 - 2\frac{n}{m}(A+1) \right] \left[\frac{(A+1)m}{n} - \frac{m^2 \left(\frac{n}{m} + \frac{1}{m} + 1\right)^2}{2n^2} \right] + (A+1)^2 \right]^{-1/2}$$

or

$$1 + \delta = \frac{(A+1)m}{(m+n+1)} \left[\frac{m(A+1)}{n} - \frac{(m+n+1)^2}{4n^2} \right]^{-1/2}. \quad (53)$$

From (53) the value of δ can be readily computed, provided A , n , and m are fixed. The corresponding value of Z_{\max} is found to be

$$Z_{\max} = \frac{R_0}{\left(\frac{n}{m} + \frac{1}{m} + 1\right) \sqrt{\frac{m(A+1)}{n} - \frac{\left(\frac{n}{m} + \frac{1}{m} + 1\right)^2}{4n^2}}}. \quad (54)$$

There are two more parameters which are of interest, and these will now be described. They are as follows:

(1) The 0-db Point

Since it has been established that the value of Z reaches a maximum at x_m , and has a steady-state "overshoot" of δ at that frequency, it follows that there must be a value of x , other than zero, for which Z is equal to its midband value. This corresponds to the point of zero attenuation, following the peak in the steady-state gain versus frequency characteristic. With reference to (49), it will be observed that, if a value of x is chosen so that

$$x^4 \left(\frac{n}{m}\right)^2 + x^2 \left[\left(\frac{n}{m} + \frac{1}{m} + 1\right)^2 - 2\frac{n}{m}(A+1) \right] = 0, \quad (55)$$

then

$$Z = \frac{R_0}{A+1},$$

the midband value. Let this value of x be denoted x_1 , or the "zero db" point. From (55), then,

$$x_1^2 \left(\frac{n}{m}\right)^2 = 2\frac{n}{m}(A+1) - \left(\frac{n}{m} + \frac{1}{m} + 1\right)^2,$$

and

$$x_1 = \left[\frac{2m}{n}(A+1) - \frac{(m+n+1)^2}{n^2} \right]^{1/2}. \quad (56)$$

(2) The -3-db Point

At a value of x greater than x_1 , there exists a frequency at which the value of Z is only 70.7 per cent of its midband value. Let this normalized frequency be x_2 , with an associated angular velocity ω_2 . The value of x_2 can be determined in a straightforward manner from (49) and (52), and it is found that

$$x_2 = \left[\frac{m}{n}(A+1) - \frac{(m+n+1)^2}{2n^2} + \sqrt{\left[\frac{(m+n+1)^2 - 2nm(A+1)}{2n^2} \right]^2 + \left[\frac{m}{n}(A+1) \right]^2} \right]^{1/2}. \quad (57)$$

Since x_2 must be real and positive, the positive roots have been chosen.

A sufficient number of design criteria have now been established so that it will be convenient to summarize them and present a design procedure. For the sake of brevity, the formulas will be tabulated, and design curves will be given, enabling a typical problem to be undertaken in a straightforward manner. Inasmuch as the number of parameters involved is large, several simplifying assumptions will be made in the design curves. In most cases, it is possible to let $\sigma = 1.0$ and $m = 1.0$. These restrictions still permit the general form of the solution to be set forth, and where they do not apply, reference may be made to the original equations. The design criteria are tabulated in Table IV.

TABLE IV
HIGH-FREQUENCY DESIGN EQUATIONS FOR STEADY-STATE SOLUTION OF A TWO-STAGE VOLTAGE-FEEDBACK VIDEO AMPLIFIER

Condition	General Equations	Equation
Gain at any frequency		$\frac{V_2}{V} = \frac{\sigma A(nA-1)}{\left[x^4 \left(\frac{n}{m}\right)^2 + x^2 \left[\left(\frac{n}{m} + \frac{1}{m} + 1\right)^2 - 2\frac{n}{m}(A+1) \right] + (A-1)^2 \right]^{1/2}}$
Steady-state overshoot in gain		$(1+\delta) = \frac{(A+1)m}{(m+n+1)} \left[\frac{m}{n}(A+1) - \frac{(m+n-1)^2}{4n^2} \right]^{-1/2}$
Frequency for 0 db		$x_1 = \left[\frac{2m}{n}(A+1) - \frac{(m+n+1)^2}{n^2} \right]^{1/2}$
Frequency for -3 db		$x_2 = \left[\frac{m}{n}(A+1) - \frac{(m+n+1)^2}{2n^2} + \sqrt{\left[\frac{(m+n+1)^2 - 2nm(A+1)}{2n^2} \right]^2 + \left[\frac{m}{n}(A+1) \right]^2} \right]^{1/2}$
Equations for $m=1.0, \sigma=1.0$		
Gain at any frequency		$\frac{V_2}{V} = \frac{A(nA-1)}{\left[x^4 n^2 + x^2 [(n+2)^2 - 2n(A+1)] + (A+1)^2 \right]^{1/2}}$
Steady-state overshoot in gain		$(1+\delta) = \frac{A+1}{(n+2)} \left[\frac{A+1}{n} - \frac{(n+2)^2}{4n^2} \right]^{-1/2}$
Frequency for 0 db		$x_1 = \left[\frac{2(A+1)}{n} - \left(\frac{n+2}{n}\right)^2 \right]^{1/2}$
Frequency for -3 db		$x_2 = \left[\frac{A+1}{n} - \frac{(n+2)^2}{2n^2} + \sqrt{\left[\frac{(n+2)^2 - 2n(A+1)}{2n^2} \right]^2 - \left[\frac{A+1}{n} \right]^2} \right]^{1/2}$

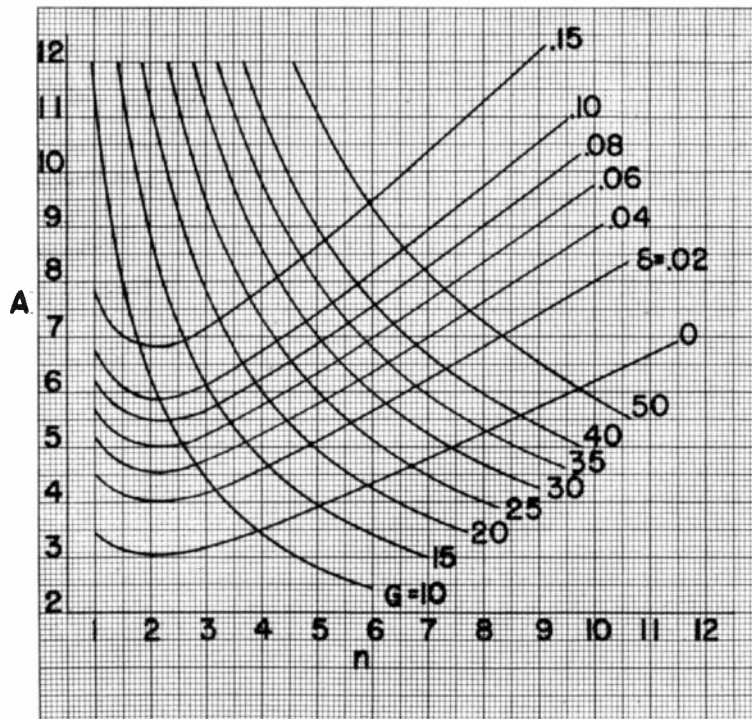

Fig. 10.— G and δ curves in $A-n$ plane.

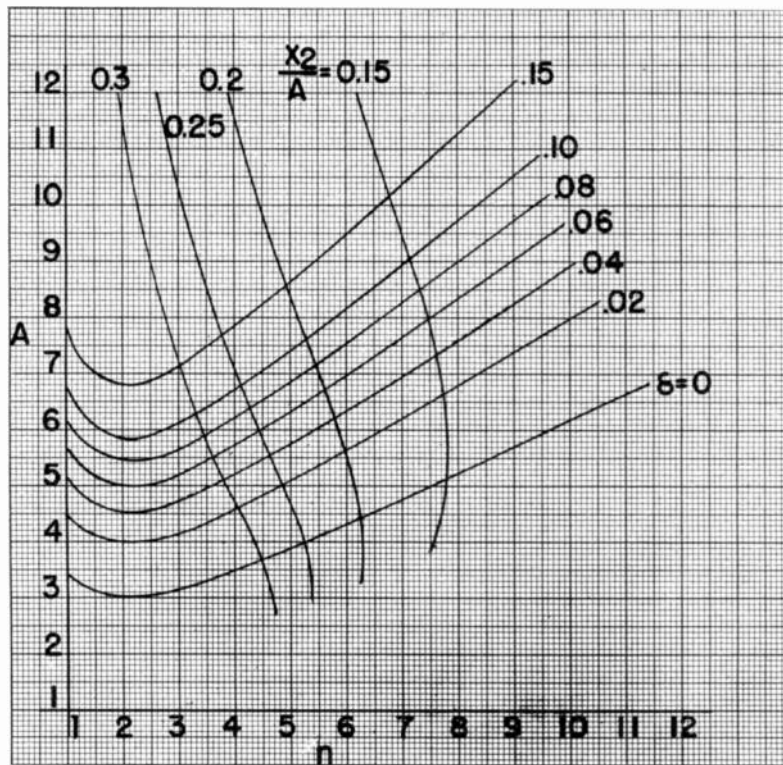

Fig. 11— x_2/A and δ curves in $A-n$ plane.

In Fig. 10 are shown a family of curves for different values of G versus A and n . Also shown are a family of curves for several values of δ versus A and n . In Fig. 11 are shown a family of curves for different values of x_2/A (x_2 as defined by (57)) versus A and n , together with the δ versus A and n curves. These curves are sufficient to uniquely determine the characteristics of the amplifier. Two typical types of problems will be given as examples.

Case I: An Original Design

In designing an amplifier on the steady-state basis, assume that one is given the midband gain and the permissible peak deviation in the steady-state gain versus frequency characteristic. From the curves of Fig. 10, the value of A and n are fixed. Also, from the curves of Fig. 11, knowing A and n , one can then fix a value of x_2/A . Now,

$$x_2 = \frac{\omega_2}{\omega_0} = \omega_2 R_0 C_0 = \omega_2 \frac{AC_0}{g_m},$$

whence

$$\omega_2 = \left(\frac{g_m}{C_0} \right) \frac{x_2}{A}.$$

Consequently, fixing the tube type for the amplifier, and the companion values of g_m and C_0 , determine the -3 -db point for the amplifier. Likewise, the 0 -db point can be readily computed from (56) or the simplified expression of Table IV, and the value of ω_1 found by reasoning similar to that above. Alternatively, one might be asked to design an amplifier for a given bandwidth and over-

shoot, being required to find the maximum midband gain. This can be solved in reverse fashion to that outlined above.

Case II: A Given Design

In an amplifier already built, by simple measurement one can determine the value of G , as well as δ and ω_2 . From these values, A , n , and x_2/A are fixed. Since a knowledge of the tube characteristics will give g_{m2} , the value of C_0 can then be computed. The amplifier is then uniquely determined (this process assumes m and σ are known).

As a final example, suppose the first design example considered in the transient analysis is studied here from the steady-state viewpoint. In that example, given that

$$\begin{aligned} g_{m1} = g_{m2} &= 5000 \times 10^{-6} \text{ mho} \\ \text{midband gain} &= 25 \\ C_1 = C_0 &= 15 \times 10^{-12} \text{ farad} \end{aligned}$$

it was found that A and n were 6.25 and 4.85, respectively, in order to satisfy the transient design conditions. It can now be seen that, from the steady-state curves, the values of δ and x_2/A are 6 per cent and 0.23, respectively. The complete response curve is then plotted in Fig. 12 with the aid of (49).

For comparison, a two-stage shunt-peaked video amplifier designed to give the same gain and transient overshoot has been considered. For this case, $m = L/CR^2 = 0.5$. This gives a transient overshoot of 10.8 per cent or a steady-state overshoot of 6 per cent. The two curves are plotted on the same graph to permit easy comparison.

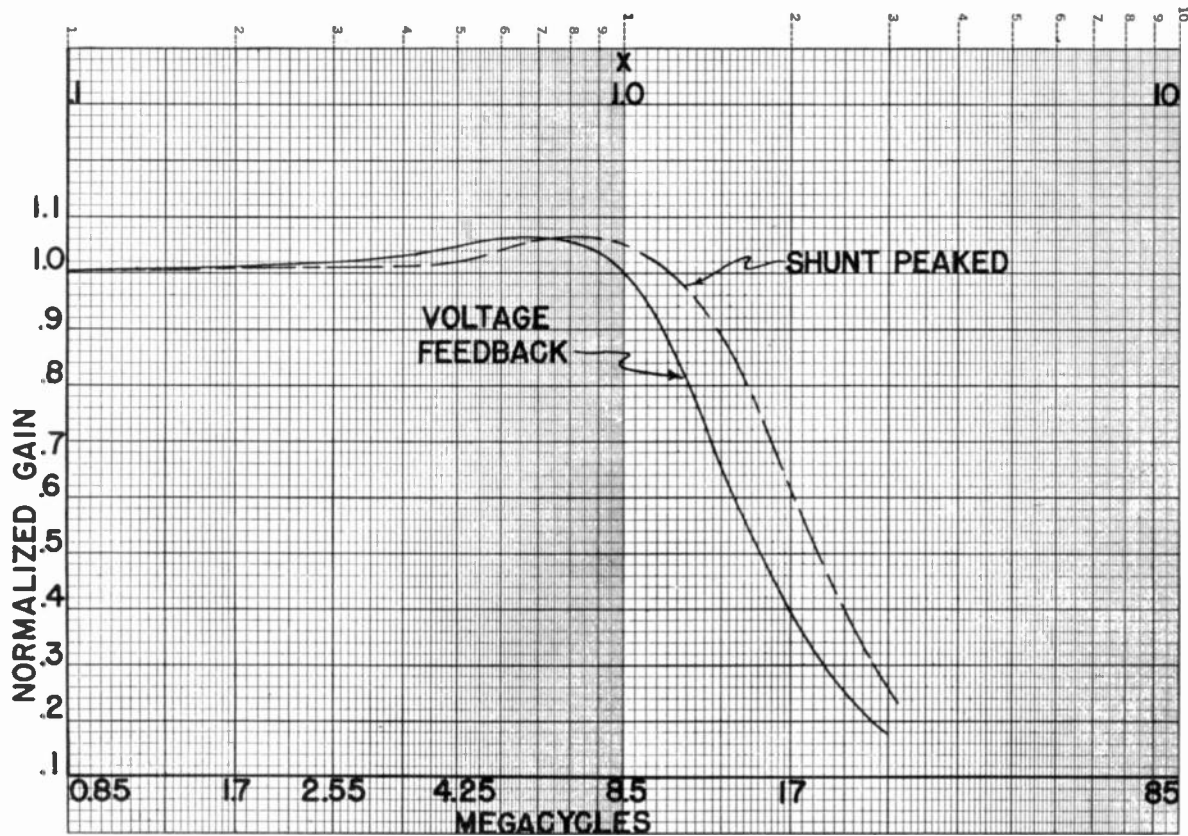

Fig. 12—Comparison of the steady-state response of two-stage shunt-peaked ($m=L/CR^2=0.5$) and feedback amplifiers for equal gains.

V. THE STEADY-STATE LOW-FREQUENCY SOLUTION

The steady-state solution will be carried forward on a similar basis to that of the transient solution. The simplified equivalent circuit is shown in Fig. 13. It can read-

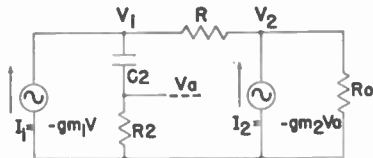

Fig. 13—Simplified equivalent circuit. Low-frequency analysis of feedback video amplifier.

ily be seen that (46) will describe V_2 in the low-frequency range if it is assumed that C_1 and C_0 can be neglected, and that the value of g_{m_1} is diminished by a factor ρ , where

$$\rho = \frac{R_2}{R_2 + \frac{1}{j\omega C_2}} \tag{58}$$

The factor ρ represents the loss in the $R_2 C_2$ coupling network at low frequencies. Thus, for low frequencies,

$$V_2 = \frac{g_{m_1}}{g} V \frac{1}{1 + \frac{g + g_0}{\rho g_{m_2} - g}} \tag{59}$$

It will be convenient to normalize the low frequencies to the product of the values of R_2 and C_2 . Thus, let

$$\omega_p = \frac{1}{R_2 C_2} \quad \text{and} \quad \frac{\omega}{\omega_p} = y,$$

whence

$$\rho = \frac{1}{1 + \frac{1}{jy}}$$

Equation (59) can then be modified to yield

$$\left| \frac{V_2}{V} \right| = \sigma A \left[\frac{(nA - 1)^2 + \frac{1}{y^2}}{(A + 1)^2 + \frac{1}{y^2}} \right]^{1/2} \tag{60}$$

The value of y at which the function $|V_2/V|$ is reduced to 70.7 per cent of its midband value can now be determined. From (60), the gain for a frequency y_1 at which $|V_2/V|$ is reduced to 70.7 of its midband value is

$$\begin{aligned} \left| \frac{V_2}{V} \right|_{y_1} &= \sigma A \sqrt{\frac{(nA - 1)^2 + \frac{1}{y_1^2}}{(A + 1)^2 + \frac{1}{y_1^2}}} \\ &= \sigma A \frac{\sqrt{2}}{2} \frac{nA - 1}{A + 1} \end{aligned} \tag{61}$$

whence

$$2(A+1)^2 \left[(nA-1)^2 + \frac{1}{y_1^2} \right] \\ = (nA-1)^2 \left[(A+1)^2 + \frac{1}{y_1^2} \right]$$

and

$$y_1 = \sqrt{\frac{\left(\frac{nA-1}{A+1}\right)^2 - 2}{(nA-1)^2}} \quad (62)$$

This equation may be written in terms of the midband gain as

$$y_1 = \frac{1}{G} \left[\left(\frac{G}{A+1} \right)^2 - 2 \left(\frac{A}{A+1} \right)^2 \right]^{1/2} \quad (63)$$

The + solution has been taken here, since y_1 cannot be a negative quantity. It should now be apparent that, if values of A and n are chosen such that y_1 is less than unity, the low-frequency response of a two-stage voltage-feedback video amplifier has been improved by the ratio of $1/y_1$ to unity. Improvement in this case is specified as the amount by which the -3-db point has been lowered in frequency over the normal uncompensated case.

In practice, an amplifier is usually designed to give a specified high-frequency response, based upon the previous analysis. The resulting A and n factors, when inserted in (62), will give the improvement in low-frequency response. A typical amplifier may have a value of $1/y_1$ in excess of 5; this improvement in low-frequency response is a significant advantage. As an example, the amplifier previously considered may be examined from the low-frequency viewpoint. Here $A=6.25$, $n=4.85$, $G=25$. Then $y_1=0.128$, or the low-frequency gain improvement factor is 7.80.

VI. CORRELATION OF THE TRANSIENT AND STEADY-STATE ANALYSES

Since the steady-state and transient solutions have been developed relatively independently, it now remains to show that there is a very simple correlation between the two. The types of problems fall naturally into two cases: (I) an original design, and (II) a given design.

In Case I, the design data already presented clearly show the desired correlation. For example, if one starts on the steady-state basis, and selects G and δ , then A and n are fixed. From the transient overshoot curves (see Fig. 4) and a knowledge of A and n , the transient overshoot γ is then known. A knowledge of g_m and C will then give both the rise time as well as the 0-db and -3-db attenuation points.

In Case II, the correlation is even more straightforward. One needs only to test the unknown amplifier on a steady-state basis, and determine values for G , δ , σ , and m through the use of simple measuring equipment. If m and σ are near unity, the design curves will then yield values for A and n , and the procedure is then as given above, γ and λ being determined. To find the value of actual rise time, an additional measurement is necessary. The determination of the -3-db point will give ω_2 ; since x_2/A is given from the design data, the value of g_m/C is then available. A simple calculation then yields the value of the rise time t_0 .

VII. CONCLUSION

Design information has been presented from which it is possible to design a feedback doublet for a given transient or steady-state response. It is believed that the data given provide a simple method of design, once the necessary initial parameters are known with sufficient accuracy. Besides the aforementioned use, the material is also of value as a guide in modifying development models of such structures. In addition, of course, the general relationships presented concerning the time function $V(t)$ expressed by (12) of the transient analysis have application to any physical system having the same transform function.

It has been demonstrated that the transient response of such a feedback doublet can be accurately predicted from certain features of the amplitude versus frequency characteristic. In addition, of course, the reverse can readily be accomplished. Whereas it has been shown that the steady-state response for an equivalent shunt-peaked two-stage video amplifier has an effective high-frequency response which is roughly 20 per cent better than the corresponding feedback doublet, this disadvantage is offset by the following three advantages of the feedback structure:

(a) No peaking coils are required, and fairly stable performance may be achieved with a reasonable tolerance on components.¹⁰

(b) Considerable increase in low-frequency response can usually be obtained. In typical cases this may be of the order of a factor of 5.

(c) The inherent feedback in such a configuration will tend to linearize the over-all transfer characteristic.

Although the amplifier has inherent limitations, as discussed above, in certain applications its use has definite advantages.

¹⁰ In this connection it may be remarked that, unless one is permitted to neglect the stray capacitance shunting the feedback resistor R in Fig. 1, the results obtained herein may not be valid. However, this assumption is usually possible with commercially available resistors in the normal video-frequency range. In addition, a prominent resistor manufacturer has developed a special low-capacitance resistor for this particular application, these special resistors being particularly useful for band-pass amplifiers in the 60-Mc. range.

500-Mc. Transmitting Tetrode Design Considerations*

WINFIELD G. WAGENER†, SENIOR MEMBER, I.R.E.

Summary—Performance characteristics for a good power amplifier in the 30- to 500-Mc. region are discussed and some tube design considerations are presented. It is shown that tetrodes inherently self-neutralize the radio-frequency feedback due to the plate-to-grid capacitance. This self-neutralization frequency may readily be shifted by simple circuit modifications. A comparison of neutralized triodes and neutralized tetrodes in the limiting frequency range is made, and tetrodes are shown to be inherently more stable as well as providing circuit advantages. Two new transmitting tetrode tubes are presented, one of which delivers 100 watts at 500 Mc.

TRIODE transmitting tubes used in radio-frequency amplifiers, with the feedback due to the high plate-to-grid capacitance neutralized by external circuit arrangements, work satisfactorily up to 30 Mc. In the v.h.f. region from 30 to 300 Mc., neutralized triodes still work, but the circuit difficulties are greatly increased, the power gain falls off, and stability is hard to achieve. When achieved, it is usually not satisfactory over an appreciable range of frequency, adjustment, or power level. In the u.h.f. region from 300 to 3000 Mc., neutralized triode power amplifiers are rarely found.

A partial solution to the problem of transmitting-tube amplifiers is found in triodes designed to operate as "grounded-grid amplifiers,"¹ that is, amplifiers with the output circuit between plate and grid, and the grid structure designed to complete the shielding between plate and cathode. These may be taken up above 300 Mc. However, the power gain is so low, on the order of 4 or 5 to 1, that they are only a partial solution to the basic problem.

Screen-grid transmitting tubes or tetrodes have held out a hope for satisfactory power amplifiers above 30 Mc., but until recently the hope was not realized due to the lack of proper solutions to the engineering problems. There are a few medium-power tetrodes, such as the 4-125A and 4-250A, that work satisfactorily up through the new f.m. bands to 110 Mc., in conventional circuits with good stability, high power gain (on the order of 100 to 1), satisfactory circuit arrangements, and good life. However, none of these successful v.h.f. tetrodes have worked up into the u.h.f. region; i.e., above 300 Mc.

An examination of the limitations responsible for the present status should be helpful. As the frequency increases, the grid-to-plate capacitance of a triode becomes an increasingly lower impedance, and in a normal amplifier circuit the feedback current runs into amperes. A triode inherently has high feedback, and the burden

of correcting this shortcoming is put upon the circuit design engineer. The high feedback current exaggerates every incidental inductance in the tube leads, circuit connections, and neutralizing capacitor leads. Some of these inductances are common to the input and output circuits and are not neutralized out in the normal neutralizing circuit.

In order to reduce the transit time of electrons, the spacing of filament, grid, and plate must be made as small as is physically possible. To operate at these frequencies, then, the very interelectrode capacitances causing the trouble must be made larger. Aside from the large tube capacitances, which make resonant-circuit design very difficult, it is necessary to add still more capacitance in the neutralizing capacitor, and the difficulties are further increased.

In addition, the leads to the neutralizing capacitors have distributed inductance and capacitance which do not add usefully to the neutralizing capacitance but only further shorten the useful resonant circuits outside the tube.

Some of the difficulties with neutralized triodes are removed by going to the grounded-grid circuit. This is not a completely satisfactory solution because of the high driving power and resultant low power gain.

Screen-grid tubes or tetrodes face, in some degree, these same limitations of transit time, high interelectrode capacitances, and lead inductances. They do not, however, have a high feedback capacitance between the plate and the control grid, if properly built. This should offer some hope of reducing the feedback problem, and, when properly handled, has been found to decrease the problem more than the simple consideration of the residual feedback capacitance would indicate. This will be discussed later. Also, properly designed screen-grid tubes permit the driving power to be greatly reduced and hence hold out possibilities for high power gain. As stated before, screen-grid tubes offer promise, but the engineering execution must be right to realize the promise. One cannot merely put a screen mesh into a triode and hope to fulfill these promises.

Let us now consider the design of good screen-grid tubes. The first step is to establish a set of performance characteristics for a good power amplifier in the region of 30 to 500 Mc. or higher.

1. High power gain, 25- to 100-fold per stage.
2. Stable over a range of frequencies, adjustments, and power levels. Adjustment must not be critical.
3. Circuits must be simple and practical.
4. Plate efficiency on the order of good class-C efficiency.
5. Tubes must have stable characteristics and performance throughout a normal life expectancy.

* Decimal classification: R399.2. Original manuscript received by the Institute, August 4, 1947; Presented, 1947 I.R.E. National Convention, New York, N. Y., March 4, 1947.

† Eitel-McCullough, Inc., San Bruno, Calif.

¹ E. E. Spitzer, "Grounded-grid power amplifiers," *Electronics*, vol. 19, pp. 138-141; April, 1946.

Some of these requirements are not peculiar to operation at v.h.f. and u.h.f., but must be achieved at low frequencies and then maintained when the frequency of operation becomes high. High power gain and high plate efficiency must first be realized at low frequencies. Neither of these are new considerations, but essentially they involve the following design principles.

Power gains on the order of 100 to 1 are not achieved by triodes when operating at high plate efficiencies, nor by simple screen-grid tubes. In a well-designed screen-grid tube, the screen also serves to draw electrons away from the cathode, and in so doing reduces the amount of positive voltage which must be applied to the control grid. With less-positive grid voltage both the grid current and grid bias are reduced. Primarily, this reduces the total required r.f. grid voltage. Secondly, it is also necessary to take full advantage of electron-optical principles to channel the flow of electrons between the control-grid and screen-grid bars.² Fig. 1 shows a cross-

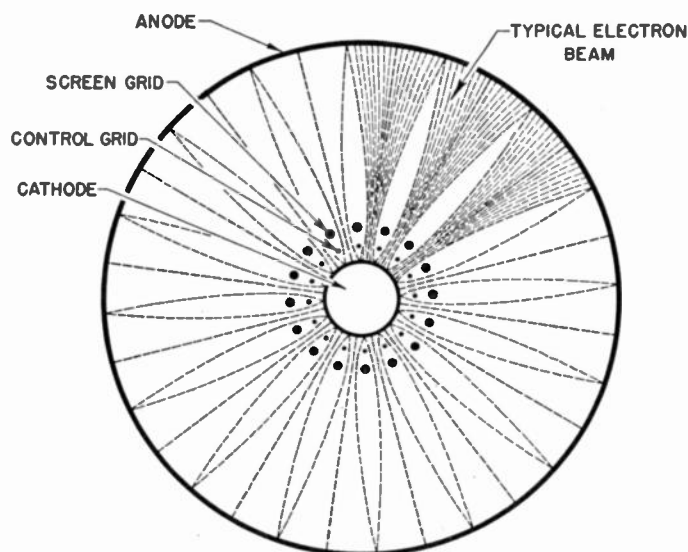

Fig. 1—Cross-section view of tetrode with cylindrical elements, and electron beams which reduce control-grid and screen-grid currents.

section view of a well-designed tetrode with cylindrical elements and well-defined electron beams. Thus, still fewer electrons flow to the control grid and screen grid, with a further reduction in the control-grid current. Only by so reducing the control-grid current and the control-grid voltage can the driving power be reduced to give power gains in high-efficiency amplifiers of several hundred to one. Not only is the screen-grid current kept low as a circuit convenience, but it is necessary to reduce the power lost on the screen in order to permit close spacing of the elements to achieve high transconductance and low electron-transit time.

In order to attain high plate conversion efficiency at

² O. H. Schade, "Beam power tubes," Proc. I.R.E., vol. 26, pp. 137-181; February, 1938.

reasonable plate voltages, it is necessary to permit a high plate current to flow at very low instantaneous plate voltages. (See Fig. 2.) To keep the knee of the plate-cur-

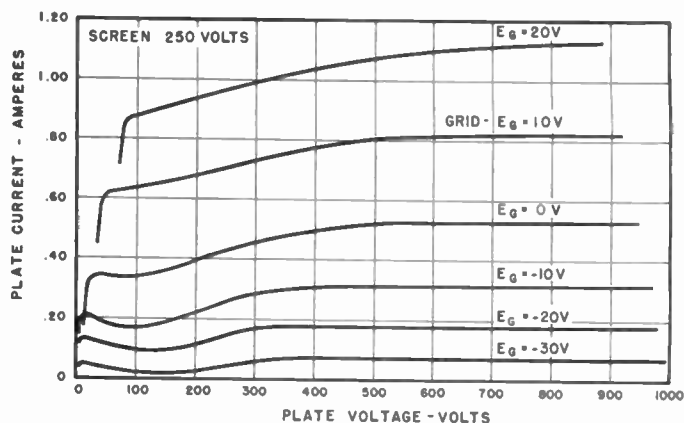

Fig. 2—Plate-current characteristics with proper amount of space-charge suppression in the screen-plate region to allow high conversion efficiencies. (Type 4X150A.)

rent curves down to low plate voltages, the formation of a virtual cathode between screen and plate must be avoided, yet enough space charge must be permitted to suppress secondary electrons emitted from the plate.³

In a closely spaced tube, the control grid and screen grid will become quite hot due to proximity to the cathode, and by electron bombardment. These grids must be treated to reduce the emission of thermal or primary electrons, or the desirable characteristics would not hold under operating conditions.⁴ Similarly, the emission of secondary electrons from the control grid must be controlled, or the region of such emission avoided during operation of the tube, in order to avoid "dynatron" oscillations or regenerative effects from the negative-resistance slope of the grid-current versus grid-voltage characteristics. Complete suppression of secondary emission, on the other hand, increases the control-grid current unnecessarily. The control of the primary- and secondary-emission characteristics of the grids, as attained by processing the grid material, must be stable throughout the life of the tube.

The preceding "static characteristics" of tetrodes are necessary at all frequencies, and the balance of the design must be such that they are made use of and not lost when operation is in the region of 30 to 500 Mc. The virtues of such static characteristics would be lost if the transit time of electrons were too great, or if the r.f. circuits permitted feed-through of driving power.

The balance of the performance characteristics deal with the very important problems of r.f.-circuit design. In a well-designed screen-grid tube, there is still a residual plate-to-grid capacitance C_{gp} on the order of 0.01 to

³ Bernard Salzberg and A. V. Haefl, "Effects of space charge in the grid-anode region of vacuum tubes," *RCA Rev.*, vol. 2, pp. 336-373; January, 1938.

⁴ Harold E. Sorg and George A. Becker, "Grid emission in vacuum tubes," *Electronics*, vol. 18, pp. 104-109; July, 1945.

0.1 $\mu\mu\text{fd}$. This amount of screening is adequate for the medium radio frequencies, but when operating above 30 Mc. the effects of feedback through this residual capacitance must be considered. In operation, the developed r.f. plate voltage E_p acts through the complexities of the r.f. circuits of the tube to introduce certain voltage components into the grid-cathode circuit. The magnitude of this voltage and its rate of change with frequency, circuit tuning, loading, etc., determine the dynamic stability of the amplifying stage.

A first consideration shows a simple potential-dividing circuit involving the impedances of the feedback capacitance and the input circuit. (See Fig. 3.) If these

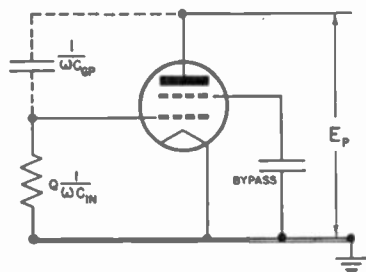

Fig. 3—Oversimplified concept of feedback in tetrodes.

impedances are on the same order of size, a large fraction of the radio-frequency plate voltage will appear between the control grid and cathode. In that event,

$$\frac{1}{\omega C_{gp}} \cong Q \frac{1}{\omega C_{in}} \quad \text{or} \quad \frac{C_{in}}{G_{gp}} \cong Q$$

where

- C_{gp} = grid-to-plate tube capacitance
- C_{in} = input capacitance of tube
- $\omega = 2\pi f$
- f = frequency in c.p.s.
- Q = ratio of reactance to series resistance of resonant circuit.

In actual tubes, the ratio of C_{in}/C_{gp} tends to be on the order of the circuit Q . At frequencies above 30 Mc., the input capacitance of the tube will be the principal capacitance present in the input circuit. Because of this, it is reasoned that the fraction of the r.f. plate voltage appearing in the grid circuit would seem to be quite large. This incomplete theoretical approach has caused many engineers to draw incorrect conclusions about the stability of well-designed tetrodes.^{5,6}

Actually, a more complete consideration of the feedback in a tetrode must also consider the plate-to-screen-grid capacitance C_{ps} , the control-grid-to-screen capacitance C_{gs} , and the inductance of the screen lead to

⁵ I. E. Mourontseff, "Tuned-grid tuned-plate oscillator," *Communications*, vol. 20, pp. 7-9; August, 1940.

⁶ B. G., "No neutralization required," *QST*, vol. 30, p. 48; June, 1946.

ground L . (See Fig. 4.) The plate voltage E_p causes a current I to flow through the plate-to-screen capacitance C_{ps} and through the screen-lead inductance L . Because the reactance of L is small compared to that of

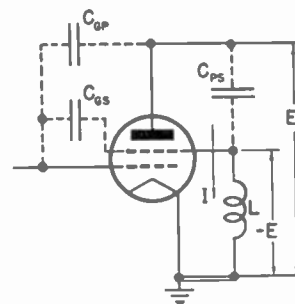

Fig. 4—More complete concept of the feedback circuit in tetrodes.

C_{ps} , a small voltage $-E$ (equal to $I\omega L$) is set up between screen and ground, or cathode. See Fig. 5, where the instantaneous values of the components of plate voltage

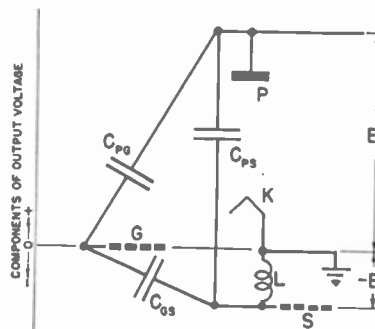

Fig. 5—Components of output voltage of a tetrode as they appear in the neutralizing circuit at the self-neutralizing frequency.

E_p are indicated graphically. The voltage $-E$ is small compared to E_p and is 180° out of phase with E_p . The total voltage $E_p - E$ is applied across a potential-dividing circuit consisting of the grid-to-plate capacitance C_{gp} and the grid-to-screen capacitance C_{gs} in series. If, now,

$$\frac{1}{\omega C_{gs}} = \frac{|E|}{|E_p|}, \quad (1)$$

the control grid will be at ground potential and *no* voltage is introduced into the input circuit by the action of the r.f. voltage E_p in the plate circuit.

It is thus seen that properly built tetrodes will self-neutralize at some particular frequency. This self-neutralizing frequency is usually in the very-high-frequency portion of the spectrum. Note that the neutralizing bridge involves only internal capacitances of the tube existing between the elements themselves, and that no grid, plate, or external lead inductances are involved in

the bridge. Only the screen-lead inductance is involved, and its voltage drop supplies the desired out-of-phase neutralizing voltage!

Once one understands the simple theory of self-neutralization of tetrodes, it is an easy matter to shift the center frequency of the neutralized band of frequencies.

At frequencies above the self-neutralizing frequency, one can see that the bridge is unbalanced because the voltage developed in the screen-to-ground inductance has become too large. This can be corrected as shown in Fig. 6 or Fig. 7. In Fig. 6, a capacitance has been

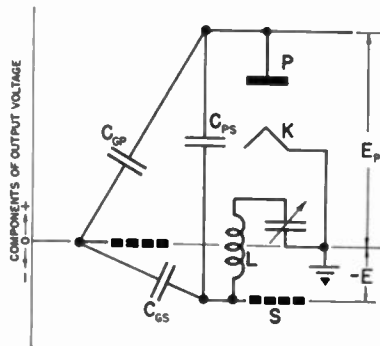

Fig. 6—Components of output voltage of a tetrode when neutralized by added series screen-lead capacitance.

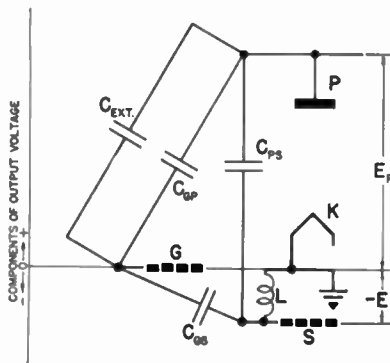

Fig. 7—Components of output voltage of a tetrode when neutralized by added external grid-to-plate capacitance.

placed in series with the screen-grid lead which reduces the total reactance to ground. In Fig. 7, the total capacitance between grid and plate has been increased to re-balance the bridge and bring the control grid back to ground potential. Equation (1) for the balance of the bridge can be rearranged:

$$\frac{C_{gp}}{C_{gs}} = \frac{|E|}{|E_p|} \quad (2)$$

It is easily apparent that C_{gp} must be made larger if the voltage E is increased.

It should be noted that the added external capacitance between grid and plate is very small and on the same order of size as the internal residual grid-to-plate capacitance C_{gp} . This capacitance can be provided by a wire extending up from the grid circuit and allowed to "look" at the plate of the tube. Because this capacitance is so small, the fact that its small current must flow

through the grid-lead inductance of the tube causes no appreciable disturbance, and the bridge is not made more "frequency sensitive."

At frequencies below the self-neutralizing frequency of the tetrode, the out-of-phase voltage E is not large enough to balance the bridge. This can be corrected either by adding external inductance between the screen-grid terminal and ground, Fig. 8, or increasing

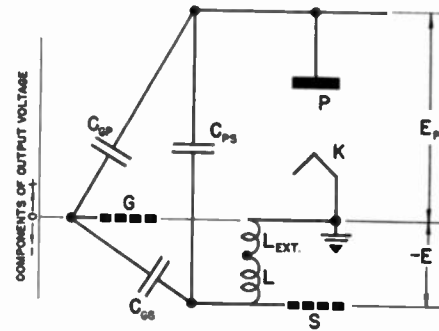

Fig. 8—Components of output voltage of a tetrode when neutralized by added external screen-lead inductance.

the out-of-phase current flowing to the grid by conventional cross neutralization, Fig. 9. The method of Fig.

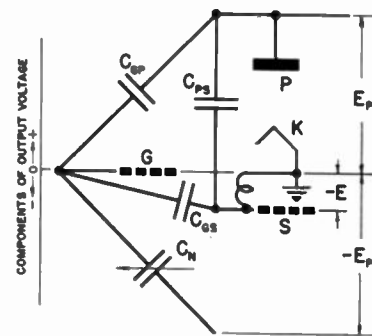

Fig. 9—Components of output voltage of a tetrode when neutralized by added conventional cross neutralization.

8, wherein the inductance in the bridge is increased, may have the disadvantage of making the bridge more "frequency sensitive." However, the ill effects of the residual grid-to-plate capacitance and lead inductance decrease with frequency also, and inherently tend to become less disturbing. The cross-neutralizing method of Fig. 9 uses added capacitance, again on the same order of value as the residual grid-to-plate capacitance, and may consist of a wire extending up from one side of the grid circuit and allowed to "look" at the plate of the tube on the opposite side of the circuit. No loss in the broad frequency response results from this method because capacitive reactances shift at the same rate with frequency changes, and there has been essentially no increase in the total inductance involved. This approaches the low-frequency concept of an all-capacitive bridge action.

It should be noted that the design of a v.h.f. and u.h.f. tetrode eliminates almost all of the feedback through

the tube from the output to the input circuit.⁷ Reduction of any residual feedback by circuit arrangements is seen to add very little capacitance, or circuit elements, that will load up or cut down the size of the resonant input and output circuits outside the tube. Thus a circuit engineer does not lose precious length of circuit, compensating for failure of the tube design to keep feedback within the tube to a minimum. The resonant circuits outside the tube are free to take on a form comparable to the simple concept of a resonant-line circuit or lumped-element circuit.

One might ask, at this point, what advantages are there to a tetrode over a triode if it must be neutralized? Without going into the point of the greatly superior power gain, the principal advantages of a well-designed tetrode are that the tetrode stage is far more stable against changes in frequency, circuit adjustments, and power level, that more length of circuit outside the tube is attained, and that this circuit is far simpler.

Let us now examine the neutralizing circuits of triodes and tetrodes with more complete theory than the simple circuits usually studied to grasp the elementary principles involved. Fig. 10 shows a neutralizing bridge for a triode including the inductances existing in the

circuit, although it is well known that cathode-lead inductance causes added losses to the input circuit and lowers the power gain of the stage.⁸ It is assumed that mutual coupling effects are small compared to self-inductive effects, and that no external coupling between output and input circuits exists.

It should be noted that, in the case of the neutralized triode, there is more than the problem of the effects of the inductances within the tube and the added capacitance and long leads of the neutralizing capacitor. In addition, once the bridge has been adjusted so that the actual grid is at ground potential as far as the feedback from the plate circuit is concerned, the grid-to-cathode voltage is seen to be the sum of the input circuit voltage and the $I_{gp}X$ voltage developed by the grid-plate charging current I_{gp} flowing in the total grid-lead reactance X (between the control grid and the juncture with the neutralizing circuit). Because the charging current flows as a result of the action of the r.f. plate voltage E_p , this $I_{gp}X$ voltage is a direct function of E_p , and in practical circuits is a large fraction of E_p . At 100 Mc., with C_{gp} of 4 $\mu\text{mfd.}$ and total grid-lead inductance of 0.08 microhenries, the $I_{gp}X$ voltage is 13 per cent of E_p . In class-C amplifiers, the grid voltage is usually in the range of 10 to 25 per cent of E_p . The $I_{gp}X$ voltage is regenerative, and even with the neutralizing bridge balanced, it is present as part of the r.f. voltage between grid and ground. Thus the grid voltage is not independent of the magnitude and phase of the developed plate voltage, even though the bridge is balanced at a given frequency.

The effect of varying the grid-lead reactance with the consequent variation in the regenerative feedback of the stage is shown in Fig. 11. In this experiment with a neutralized push-pull stage, the reactance of the grid-lead inductance of each tube was reduced by means of a series capacitor in each grid lead. At each setting of the capacitor, the circuit was neutralized. The criterion of neutralization chosen was that the minimum plate current and the maximum grid current should occur at the same plate-circuit tuning adjustment. The output circuit was unloaded, so that the plate current I_b of the final indicates the incidental circuit losses and the power feedback to the input circuit. The driver, or third doubler, plate current indicated losses in the driver plate circuit and final grid circuit, the driving power, and the net feedback power. As the series capacitance was increased, which increased the total grid-lead inductive reactance, the regenerative feedback increased as shown by the reduction in the loading on the driver, and by the increase in the loading on the final.

In the circuit of Fig. 11, assuming the input has infinite impedance, the rate of change of feed-back grid voltage with frequency is shown (see (12) in Appendix I) to be:

⁸ F. E. Terman, "Radio Engineer's Handbook," McGraw-Hill Book Co., New York, N. Y., 1943; first edition, p. 472.

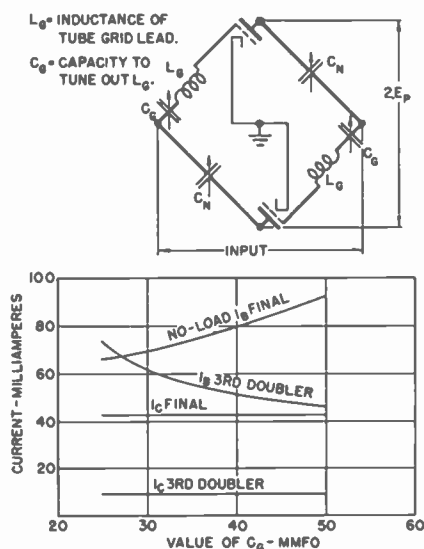

Fig. 10—Effect of varying grid-lead reactance in a push-pull neutralized triode stage at 125 Mc.

bridge, which cannot be neglected at frequencies in excess of 30 Mc. Neglected are the effects of the cathode

⁷ It should be noted that, if the circuit is so constructed that a very-high-frequency parasitic oscillation (at a frequency higher than the fundamental frequency) can occur, the feedback through the tube may not be neutralized for this parasitic frequency. This oscillation may exist in a tuned-plate tuned-grid circuit comprising the parallel tuning capacitors and their lead inductances. This same circuit exists in triode amplifiers. The cure is so to alter the arrangement of parts and leads that the circuit is eliminated, or to use parasitic suppressors. Another possibility is to return the tetrode screen lead through both an inductance and capacitance in parallel to neutralize on both the fundamental and parasitic frequencies.

$$\frac{dE_g}{df} = 8\pi^2 f E_p C_{gp} (1.5L_g + 1.5L_{ge} + 0.5L_{cn} - 0.5L_p) \quad (3)$$

where

- E_g = the component of E_p appearing between grid and ground
- L_g = inductance of grid lead of tube
- L_{ge} = inductance of external grid connection to juncture of neutralizing lead and input circuit
- L_{cn} = inductance of neutralizing circuit
- L_p = inductance of plate lead of tube and circuit.

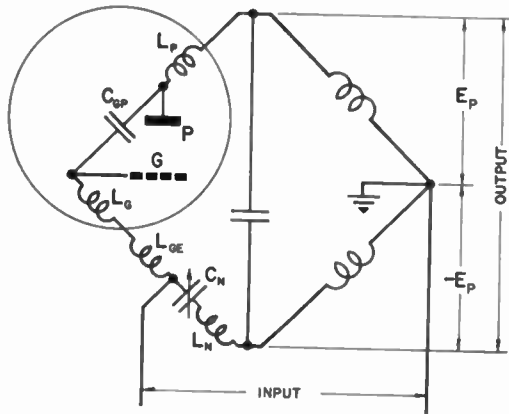

Fig. 11—Neutralizing bridge for a triode with lead inductances added.

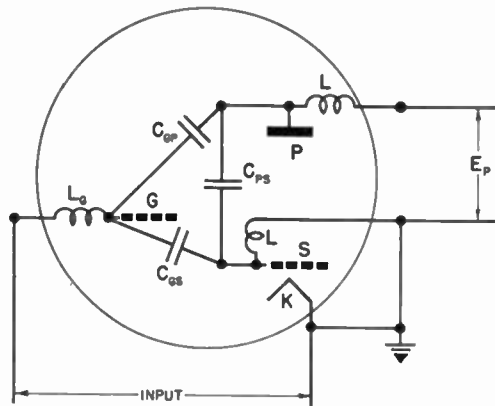

Fig. 12—Neutralizing circuit for a tetrode, showing that lead inductances do not hamper neutralization.

Fig. 12 shows a similar, more complete schematic diagram of the neutralizing action of a tetrode. It will be noted that the inductances of the plate and grid leads do not enter into the bridge circuit, and the simple within-the-tube neutralizing circuit is unchanged. No components of the r.f. plate voltage add to the grid voltage, and the grid voltage is independent of the magnitude and phase of the plate voltage. The rate of change of feed-back grid voltage with frequency is shown (see (19) in Appendix II) to be:

$$\frac{dE_g}{df} = 8\pi^2 f E_p C_{ps} L \quad (4)$$

where L is the inductance of the screen lead.

When the tetrode is neutralized for other frequencies, this equation is essentially unchanged by any of the methods indicated (except in one case where L is actually increased).

TABLE I

TRIODE		TETRODE	
C_{gp}	4 $\mu\text{fd.}$	C_{ps}	4 $\mu\text{fd.}$
L_g	0.04 $\mu\text{h.}$	L	0.04 $\mu\text{h.}$
L_{ge}	0.04 $\mu\text{h.}$		
L_p	0.04 $\mu\text{h.}$		
L_{cn}^*	0.11 $\mu\text{h.}$		

* ($\frac{1}{8}$ -inch rod, 6 inches long.)

Using similar figures for the triode and tetrode at 100 Mc. and E_p of 2000 volts, such as are shown in Table I, the rate of change of grid voltage is 10 volts per Mc. for the triode and 2.5 volts per Mc. for the tetrode. Thus the tendency of the tetrode neutralization to hold over a wide range of frequencies might be on the order of 4 to 1 in favor of the tetrode.

This is not the sole criterion of stability of the radio frequency stage. These figures are for the rate of change of grid voltage when frequency alone is changed and resonant circuits are in adjustment. In this idealized case, there is no change in the magnitude or phase of the r.f. plate voltage E_p .

In the case where the r.f. plate voltage E_p changes rapidly in magnitude and phase, as in tuning the stage, or in a tendency to self oscillate, the story is quite different. In the triode case it was shown that the total grid-cathode voltage is composed partly of input-circuit voltage and partly of $I_{gp}X$ voltage. In this case, the $I_{gp}X$ voltage may be on the same order as the driver input voltage and subject to wide variations as E_p varies. In fact, in the triode case, if the $I_{gp}X$ component of the grid voltage becomes large enough so that the input-circuit voltage required approaches zero, the neutralizing circuit can be shown to have degenerated into a Hartley oscillator circuit!

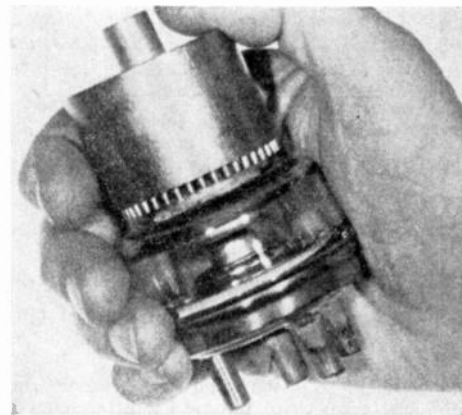

Fig. 13—4X500A tetrode with a 500-watt plate dissipation and top frequency of around 400 Mc.

It has been noted that inductance in the cathode lead is degenerative. In order to maintain the very high power gain obtained at low frequencies, it is essential

to keep the inductance of the cathode lead small both in the original design of the tetrode and in the construction of a circuit about the tube.

Use of these principles has enabled the development of several new tetrodes in addition to the 4-125A and 4-250A power tetrodes. Fig. 13 shows the 4X500A, with a forced-air-cooled anode of 500 watts dissipation, a self-neutralizing frequency on the order of 150 Mc., and a top performance frequency of around 400 Mc. Fig. 14

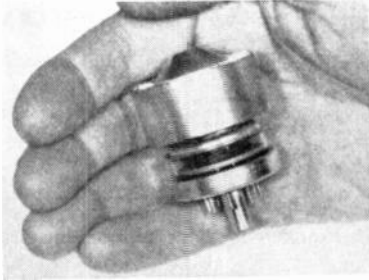

Fig. 14—4X150A tetrode with a 150-watt plate dissipation and top frequency above 500 Mc.

shows the 4X150A, with a plate dissipation of 150 watts and a top performance frequency in excess of 500 Mc. With this tube, 100 watts of useful output power can be had at 500 Mc. in a grounded-cathode amplifier.

Figs. 15 and 16 show sectional views of the 4X500A and 4X150A. The control grid and screen grid are

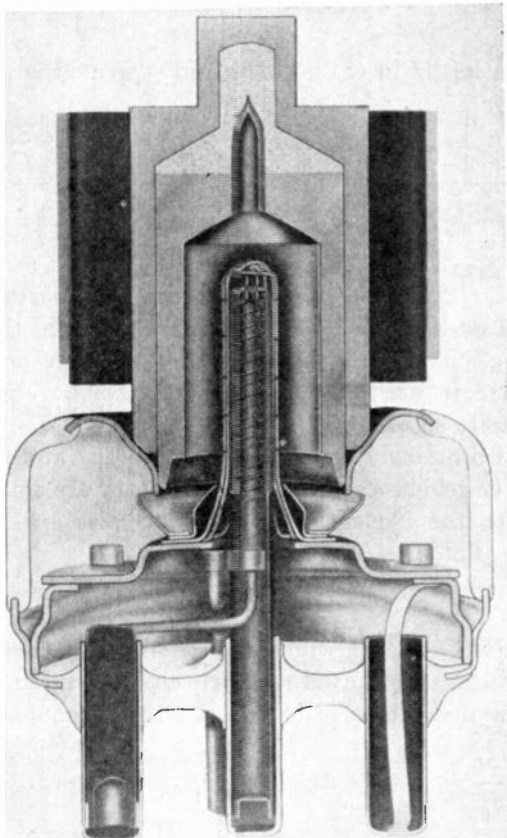

Fig. 15—Cross-sectional view of the 4X500A tetrode.

vertical-bar cylindrical grids, aligned radially about the cylindrical cathode. By electron optics, radial beaming of electrons is accomplished, channeling the electrons between the grid bars and into the screen-plate region in which space-charge suppression of plate secondaries is achieved. No inactive portions of an element or elements are required to complete the beam action.

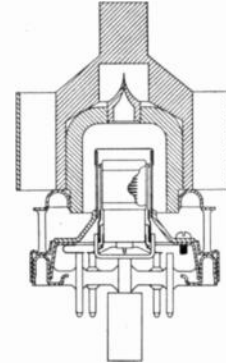

Fig. 16—Cross-sectional drawing of the 4X150A tetrode.

In both tubes, new powdered-glass techniques have permitted the construction of combined base and stem assemblies. These base-stem combinations include a peripheral ring connection and support for the screen grid. As a convenience, a second screen connection is made through a base pin. The cathode pins are on a large pin circle to minimize cathode-lead inductance and to provide a short grounding path to the surrounding chassis or shielding. The control grid is brought out through the center pin to facilitate coaxial input-line-circuit construction.

The screen grids are mounted on a completely generated circular disk and cone. This provides complete shielding between input and output circuits and reduces the screen-lead inductance to a lowest possible value.

The 4X150A fits a loctal-type socket and has an indirectly heated cathode. The cathode-to-grid spacing is 0.008 inch. The tube is designed for mobile work and withstands normal vibration tests.

Figs. 17 and 18 show typical installations. Note that the output circuit is above the metal chassis and the in-

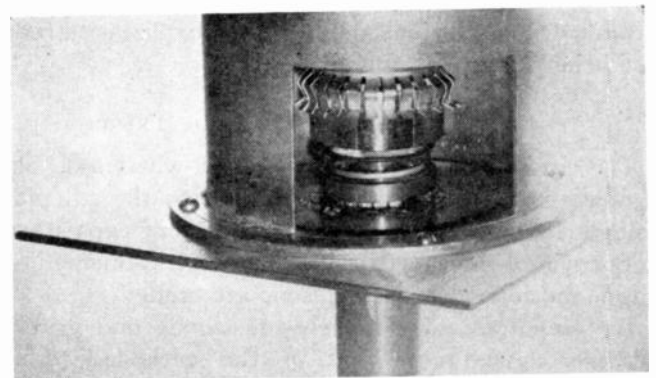

Fig. 17—Typical u.h.f. installation of a 4X150A tetrode.

put circuit is below. The shielding is completed by bypassing the screen ring connection to the chassis with mica-insulated sheet capacitors.

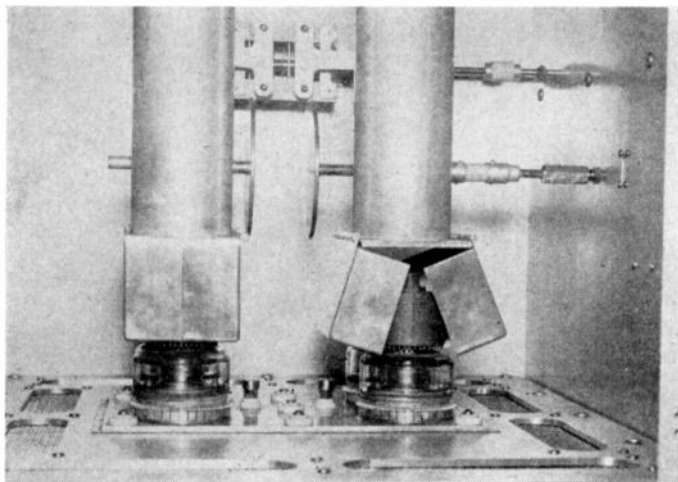

Fig. 18—Typical v.h.f. installation of a 4X500A tetrode.

At this point it should be noted that the tube engineers have done the job of reducing the feedback between output and input circuits to a small value, and to zero at the self-neutralizing frequency. It is the responsibility of the circuit engineer to design equipment in which the external feedback is reduced to zero, practically speaking. In the case of neutralized triodes with huge feedback through the tube, such external shielding is futile. Circuit engineers have long permitted incomplete shielding and poor circuit filtering to exist and be neutralized out by the same adjustment which neutralizes the high feedback through the triodes. In tetrodes there exist no such corrections for the "sins" of incomplete shielding and feedback in the external circuits.

In return for such efforts one is repaid by stable, high-gain power amplifiers which extend conventional circuit techniques up to 500 Mc.

The work of developing and designing the two new tetrode types, the 4X500A and 4X150A, was done by a group of engineers in the laboratories of Eitel-McCullough, Inc. Credit for the first experimental demonstration of these various methods of neutralizing tetrodes also belongs to this same group.

APPENDIX I. NEUTRALIZATION OF TRIODES

The circuit is that shown in Fig. 10 wherein an out-of-phase voltage, equal and opposite to the r.f. plate voltage, is connected through a neutralizing capacitance to the grid of the tube. Beside the circuit elements indicated, the following assumptions are made:

1. The effects of the plate-to-cathode and grid-to-cathode capacitances and of the cathode-lead inductance are not involved in the principal action of the neutralizing circuit.

2. Mutual-inductance effects are small compared to self-inductance effects.

3. No other coupling between output and input exists, or it can be neglected.

4. The impedance of the input circuit is high enough to be assumed to be infinite.

The equivalent circuit is shown in Fig. 19. Let us solve

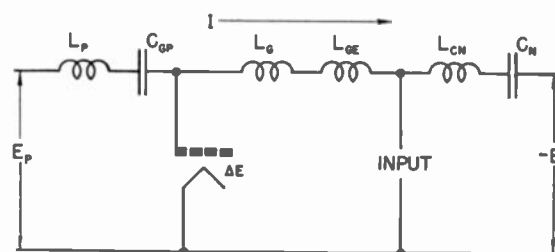

Fig. 19—Equivalent triode neutralizing circuit.

for component Δe of the plate voltage E_p which can appear from grid to cathode with misadjustment of the neutralizing circuit.

$$\Delta e = E_p - jI \left(\omega L_p - \frac{1}{\omega C_{gp}} \right) \quad (5)$$

$$0 = E_p - jI \left[\omega L_p - \frac{1}{\omega C_{gp}} + \omega(L_g + L_{gc} + L_{cn}) - \frac{1}{\omega C_n} \right] + E. \quad (6)$$

Eliminating jI in (5) and (6) and rearranging gives

$$\Delta e = \frac{E_p \left[\omega(L_g + L_{gc} + L_{cn}) - \frac{1}{\omega C_n} \right] - E \left[\omega L_p - \frac{1}{\omega C_{gp}} \right]}{\omega(L_p + L_g + L_{gc} + L_{cn}) - \frac{1}{\omega} \left(\frac{1}{C_n} + \frac{1}{C_{gp}} \right)}. \quad (7)$$

In (7) it will be noted that the two parts of the numerator comprise the feedback through the neutralizing circuit and through the tube, respectively. When neutralized, these two parts will be equal and of opposite sign.

For a practical case, assume $|E_p| = |E|$ and that the inductive reactances of the denominator are small compared to the capacitive reactances. Also to simplify, assume that $C_n = C_{gp}$. Then

$$\Delta e = -\frac{1}{2} E_p C_{gp} \omega^2 (L_g + L_{gc} + L_{cn} - L_p). \quad (8)$$

To find the rate at which this small unbalanced feedback voltage Δe may vary with changes in frequency, take the derivative with respect to the frequency f :

$$\frac{d\Delta e}{df} = -4\pi^2 E_p C_{gp} f (L_g + L_{gc} + L_{cn} - L_p). \quad (9)$$

However, the total grid-cathode voltage also has a component $jI\omega(L_g + L_{gc})$ in addition to the input volt-

age, and this also will vary with frequency. For this voltage it can be assumed that

$$I = \frac{E_p}{-j \frac{1}{\omega C_{gp}}}$$

so that the IX component

$$= -E_p \omega^2 C_{gp} (L_g + L_{ge}). \tag{10}$$

The rate of change with frequency f is

$$\frac{dIX}{df} = -8\pi^2 E_p C_{gp} f (L_g + L_{ge}). \tag{11}$$

Adding (9) and (11), the total rate of change with frequency of the component of plate voltage fed back to the grid is found to be

$$\frac{dE_g}{df} = -8\pi^2 f E_p C_{gp} \left[\frac{3}{2}(L_g + L_{ge}) - \frac{1}{2}(L_{cn} - L_p) \right]. \tag{12}$$

APPENDIX II. NEUTRALIZATION OF TETRODES

The circuit is that shown in Fig. 12, where all the tube lead inductances except the cathode are considered. The same assumptions are made as in the triode analysis given in Appendix I. The equivalent circuit is shown in Fig. 20, and the following equations

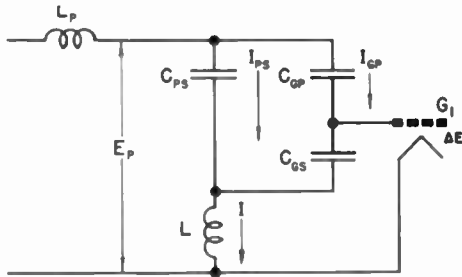

Fig. 20—Equivalent tetrode neutralizing circuit.

can be set up to determine the expression for the component Δe of plate voltage E_p which might appear between control grid and cathode.

$$I_{gp} + I_{ps} = I \tag{13}$$

$$E_p + jI_{gp} \left(\frac{1}{\omega C_{gp}} + \frac{1}{\omega C_{gs}} \right) - jI\omega L = 0 \tag{14}$$

$$E_p + jI_{ps} \frac{1}{\omega C_{ps}} - jI\omega L = 0 \tag{15}$$

$$\Delta e = E_p + jI_{gp} \frac{1}{\omega C_{gp}}. \tag{16}$$

The solution of these equations for the feedback component Δe is as follows (this solution neglects a second-order term

$$\frac{\omega^2 L^2}{\frac{1}{\omega C_{ps}} + \frac{1}{\omega C_{gs}}}$$

in the denominator which is on the order of 0.1 per cent):

$$\Delta e = E_p \frac{\left\{ \frac{1}{\omega C_{gs}} + \omega L - \frac{1}{\omega C_{gp}} \cdot \omega L \right\}}{\frac{1}{\omega C_{gp}} + \frac{1}{\omega C_{ps}} + \omega L}. \tag{17}$$

This expression is composed of three fractions, as follows:

$$\Delta e = E_p \left[\frac{\frac{1}{\omega C_{gs}}}{\frac{1}{\omega C_{gp}} + \frac{1}{\omega C_{ps}} + \omega L} + \frac{\omega L}{\frac{1}{\omega C_{gp}} + \frac{1}{\omega C_{ps}} + \omega L} - \frac{\frac{1}{\omega C_{gp}}}{\frac{1}{\omega C_{gp}} + \frac{1}{\omega C_{ps}} + \omega L} \cdot \frac{\omega L}{\frac{1}{\omega C_{ps}} + \omega L} \right].$$

Examination of the reactances involved show

$$\omega L \ll \frac{1}{\omega C_{ps}} \ll \frac{1}{\omega C_{gp}}$$

and

$$\frac{1}{\omega C_{gs}} \ll \frac{1}{\omega C_{gp}}.$$

Because of these relations, the second term is seen to be of a lower order than the other two and can be neglected. The first part of the third term is substantially equal to unity. It is also reasonable to keep only the first parts in the denominators in the first term and simplified third term. Then, the expression simplifies to

$$\Delta e = E_p \left[\frac{\frac{1}{\omega C_{gs}}}{\frac{1}{\omega C_{gp}}} - \frac{\omega L}{\frac{1}{\omega C_{ps}}} \right]$$

or

$$\Delta e = E_p \left[\frac{C_{gp}}{C_{gs}} - \omega^2 C_{ps} L \right] \tag{18}$$

and the rate of change of this feedback component with frequency becomes

$$\frac{d\Delta e}{df} = -8\pi^2 f E_p C_{ps} L. \tag{19}$$

Note on the Maximum Directivity of an Antenna*

H. J. RIBLET†, ASSOCIATE, I.R.E.

Summary—It has been shown by Bouwkamp and deBruijn that the directivity of a linear current distribution of fixed length may be made arbitrarily large. By a slight extension of their arguments, the same conclusion is demonstrated for a two-dimensional current distribution and for a distribution of current on an infinite strip.

I. INTRODUCTION

IT IS THE OBJECT of this note to emphasize an interesting discrepancy between present antenna theory and practice. On the basis of experience, it is widely recognized that the directivity of an antenna is determined by the ratio of its size to the wavelength of the energy being propagated. On the other hand, it will be demonstrated that size places no restriction on the directivity obtainable from the three types of current distributions which are of principal interest.

There has arisen among workers in the antenna field an awareness that arbitrarily large directivities are available—in theory, at least. To the best of the writer's knowledge, however, the only widely published result of this kind prior to the paper of Bouwkamp and deBruijn,¹ already referred to, is due to Schelkunoff,² although W. W. Hansen reached the same conclusion in lectures given at the Massachusetts Institute of Technology Radiation Laboratory at about the same time. Unfortunately, the published results apply only to special cases, leaving the general situation still somewhat in doubt. Not all workers in the field of antenna theory are aware of this difficulty, with the consequence that, in January, 1943, LaPaz and Miller³ proposed to solve the problem of determining the current distribution on a vertical antenna which would give the maximum possible field strength on the horizon for a given power output. In addition to showing that this problem has no solution, Bouwkamp and deBruijn¹ pointed out the errors in the proofs used by LaPaz and Miller.

The arguments used by Bouwkamp and deBruijn may be extended without difficulty to include, in addition to the case of the linear current distribution considered by them, the cases of the two-dimensional current distribution and the infinite-strip current distribution. It is hoped that this note will systematize the results on this problem.

II. THE PROBLEM

In this section, expressions will be derived which determine the patterns obtainable from the different types of antennas under consideration, as a function of their respective current distributions. It should be recalled that the directivity of an antenna is defined as the maximum power intensity radiated, presumably in the direction of interest, divided by the average power per unit solid angle radiated in all directions. For the infinite-strip antenna this definition must be altered, since the field is two-dimensional and the total power radiated will always be infinite. It suffices to define the directivity of such an antenna as the ratio of the maximum power radiated to the average power per unit angle radiated in a unit slice of the field. We see that the directivity of an antenna is determined by the shape of the pattern and is not affected by the general power level. The proof that arbitrarily high directivities are obtainable will be complete, in each case, when it is shown that arbitrarily narrow patterns may be achieved.

Case I

For the sake of completeness, the case discussed by Bouwkamp and deBruijn is included. Let the current,

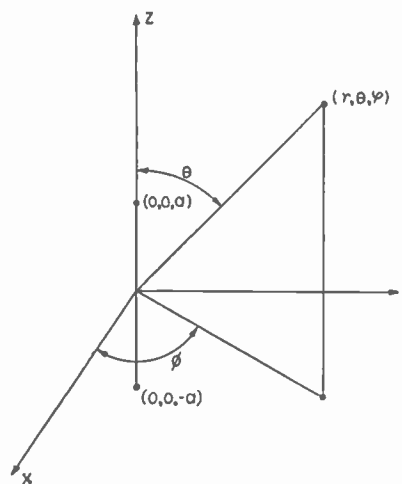

Fig. 1—Linear antenna.

distributed on the line segment $(0, 0, a)$ and $(0, 0, -a)$ as is shown in Fig. 1, be described by $f(z)e^{i\omega t}$, where $f(z)$ is complex-valued in general and ω is the angular frequency of the radiation. Then the only component of the vector potential A which does not vanish is

$$A_s = \frac{1}{4\pi} \int_{-a}^a \frac{f(z)}{\bar{r}} e^{-i(2\pi/\lambda)\bar{r}} dz. \quad (1)$$

* Decimal classification: R120. Original manuscript received by the Institute, June 17, 1947; revised manuscript received, October 14, 1947.

† Submarine Signal Company, Boston, Mass.

¹ C. J. Bouwkamp and N. G. deBruijn, "The problem of optimum antenna current distribution," *Philips Res. Rep.*, vol. 1, pp. 135-158; 1946.

² S. A. Schelkunoff, "A mathematical theory of linear arrays," *Bell Sys. Tech. Jour.*, vol. 22, pp. 80-107; January, 1943.

³ Lincoln LaPaz and Geoffrey Miller, "Optimum current distributions on vertical antennas," *Proc. I.R.E.*, vol. 31, pp. 214-232; May, 1943.

Here λ is the wavelength in free space and \bar{r} is the distance from the point of observation to the general point $(0, 0, z)$ on the antenna. At a great distance r from the center of the antenna, $\bar{r} \approx r - z \cos \theta$, and we have

$$A_z = \frac{e^{-i(2\pi/\lambda)r}}{2\pi r} \int_{-a}^a f(z) e^{i(2\pi/\lambda)z \cos \theta} dz. \quad (2)$$

Following Schelkunoff,⁴ we define the magnetic radiation vector N by

$$N_z = \int_{-a}^a f(z) e^{i(2\pi/\lambda)z \cos \theta} dz. \quad (3)$$

The magnetic radiation vector describes that portion of the pattern which depends on the current distribution $f(z)$. It is analogous to the "space factor" of an antenna array. On the basis of equations (2.1) and (3.2) of chapter IX of footnote reference 4, the power radiated per unit solid angle Φ in any direction is given by

$$\Phi = C |N_z|^2 \sin^2 \theta, \quad (4)$$

where, for reasons already given, it is convenient to lump a number of constants into a single factor of proportionality. The additional factor of $\sin \theta$, which, when multiplied by N_z , completely determines the pattern of the antenna, arises from the directivity of the current elements themselves, and is thus similar to the "form factor" of antenna array theory. For this case, the directivity will be measured in the direction given by $\theta = 90^\circ$. We notice that the pattern of (4) is thus more directive than that due to N_z by itself. This fact will allow us to simplify somewhat the arguments later on.

Case II

Fig. 2 shows the geometry to be used in discussing the case of the two-dimensional current distribution. If the current distribution is described by the complex-

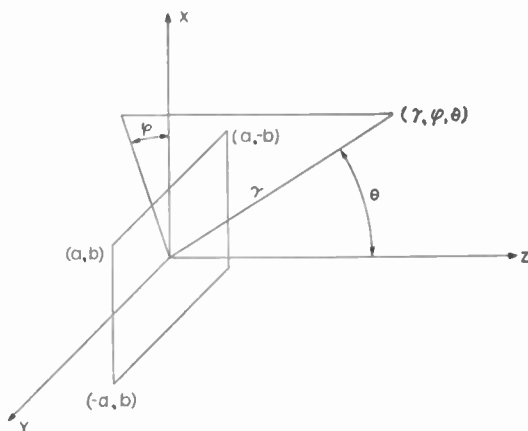

Fig. 2—Rectangular antenna.

valued function $F(x, y)$, and is entirely in the x direction, then the only component of A , the vector potential, at great distances is

$$A_x = \frac{e^{-i(2\pi/\lambda)r}}{4\pi r} \int_{-b}^{+b} \int_{-a}^a F(x, y) e^{i(2\pi/\lambda)(x \cos \phi + y \sin \phi) \sin \theta} dx dy. \quad (5)$$

This may be readily concluded by reference to Schelkunoff.⁵ It will certainly be no restriction on the validity of our conclusions to assume that the current distribution is independent of y , so that $F(x, y) = f(x)/b$. Then

$$\begin{aligned} A_x &= \frac{e^{-i(2\pi/\lambda)r}}{4\pi r b} \int_{-a}^a f(x) e^{i(2\pi/\lambda)x \cos \phi \sin \theta} dx \\ &\quad \cdot \int_{-b}^b e^{i(2\pi/\lambda)y \sin \phi \sin \theta} dy \\ &= \frac{e^{-i(2\pi/\lambda)r \sin(b(2\pi/\lambda) \sin \theta \sin \phi)}}{4\pi r \frac{b2\pi}{\lambda} \sin \theta \sin \phi} \\ &\quad \cdot \int_{-a}^a f(x) e^{i(2\pi/\lambda)x \cos \phi \sin \theta} dx. \end{aligned} \quad (6)$$

The factor of A_x which partially determines the final pattern of the antenna may be written

$$N_x = \frac{\sin\left(\frac{b2\pi}{\lambda} \sin \theta \sin \phi\right)}{\frac{b2\pi}{\lambda} \sin \theta \sin \phi} \int_{-a}^a f(x) e^{i(2\pi/\lambda)x \cos \phi \sin \theta} dx. \quad (7)$$

The energy Φ radiated per unit solid angle may be found as before, and is

$$\Phi = C |N_x|^2 (\cos^2 \theta \cos^2 \phi + \sin^2 \phi). \quad (8)$$

If we call \bar{N}_x that portion of the pattern which is determined by the current distribution, we have

$$\bar{N}_x = \int_{-a}^a f(x) e^{i(2\pi/\lambda)x \cos \phi \sin \theta} dx. \quad (9)$$

If the direction of maximum directivity is given by $\theta = 0$, we notice, just as in Case I, that the other factors of Φ_x which determine the pattern are essentially form factors due to the current element. These factors reach their maximum value of unity at $\theta = 0$. Thus the pattern of \bar{N}_x alone has, of necessity, less directivity than the pattern given by (8).

Case III

Fig. 3 shows the co-ordinate system to be used in discussing the infinite-strip antenna. The current distribution is assumed to be independent of the z co-ordinate, so that it is convenient to use polar co-ordinates. It should be emphasized that this case is of considerable

⁴ S. A. Schelkunoff, "Electromagnetic Waves," p. 332, eq. 1-7; D. Van Nostrand Co., Inc., New York, N. Y.; April, 1943.

⁵ See p. 354 of footnote reference 4.

practical interest since many microwave antennas of the so-called parallel-plate variety are slices of an infinite-strip antenna.

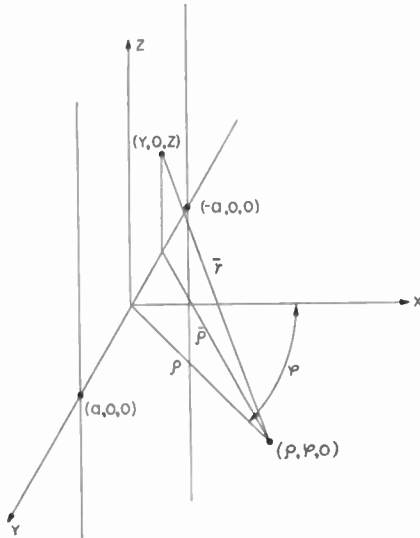

Fig. 3—Infinite-strip antenna.

If $f(y)$ is a complex-valued function which describes the current flow parallel to the z axis, then the only non-vanishing component of the vector potential A is

$$\begin{aligned} A_z &= \frac{1}{4\pi} \int_{-a}^a \int_{-\infty}^{\infty} \frac{e^{-i(2\pi/\lambda)\bar{r}}}{\bar{r}} f(y) dy dz \\ &= C \int_{-a}^a f(y) dy \int_{-\infty}^{\infty} \frac{e^{-i(2\pi/\lambda)\bar{r}}}{\bar{r}} dz. \end{aligned} \quad (10)$$

If we replace \bar{r} by $\sqrt{\bar{\rho}^2 + z^2}$, as defined in Fig. 3, we have

$$A_z = C \int_{-a}^a f(y) dy \int_{-\infty}^{\infty} \frac{e^{-i(2\pi/\lambda)\sqrt{\bar{\rho}^2 + z^2}}}{\sqrt{\bar{\rho}^2 + z^2}} dz. \quad (11)$$

The substitution $z = \bar{\rho} \sinh t$ and $dz = \bar{\rho} \cosh t dt$ leads to

$$\begin{aligned} A_z &= C \int_{-a}^a f(y) dy \int_{-\infty}^{\infty} e^{-i(2\pi/\lambda) \cosh t} dt \\ &= C_1 \int_{-a}^a f(y) H_0^{(2)}\left(\frac{2\pi}{\lambda} \bar{\rho}\right) dy. \end{aligned} \quad (12)$$

Here $H_0^{(2)}((2\pi/\lambda)\bar{\rho})$ is the Hankel function of order zero and second kind as defined by Watson.⁶ For large values of $\bar{\rho}$, $H_0^{(2)}((2\pi/\lambda)\bar{\rho})$ may be replaced by its asymptotic expansion. Thus,

$$A_z = C_2 \int_{-a}^a f(y) \frac{e^{-i(2\pi/\lambda)\bar{\rho}}}{\sqrt{\bar{\rho}}} dy; \quad (13)$$

but, for large distances from the strip, we may replace $\bar{\rho}$ by $\rho - y \sin \phi$ in the exponent and $\bar{\rho}$ by ρ under the radical sign. We then have

$$A_z = C_2 \frac{e^{-i(2\pi/\lambda)\rho}}{\sqrt{\rho}} \int_{-a}^a f(y) e^{i(2\pi/\lambda) \sin \phi y} dy. \quad (14)$$

We may put, as before,

$$N_z = \int_{-a}^a f(y) e^{i(2\pi/\lambda) \sin \phi y} dy; \quad (15)$$

and, since A_z is independent of z , it is easily shown that

$$E_z = C_3 \frac{e^{-i(2\pi/\lambda)\rho}}{\sqrt{\rho}} N_z. \quad (16)$$

The power per radian Φ radiated by the infinite-strip antenna is then given by

$$\Phi = C_4 |N_z|^2. \quad (17)$$

We have thus seen that, in each of the three cases, the pattern, as determined by the current distribution, is given by an integral of the form

$$G(t) = \int_{-a}^a f(x) e^{ixt} dx \quad (18)$$

for a suitable choice of t . Moreover, the effect of the form factors in Cases I and II is to increase the directivity, with the result that we shall have proved our point for all three cases if we can show that, by suitable choice of $f(x)$, the integral of (18) defines patterns of arbitrary sharpness. This, of course, is the result obtained by Bouwkamp and deBruijn in the paper referred to above.

In the interest of simplicity, the discussion so far has been limited to electric current distributions. The same general arguments may be extended to distributions of Huygens sources as discussed by Schelkunoff.⁴ The only effect is in the appearance of the form factors. It will be found that the space factors to which our arguments apply are unchanged.

III. THEOREM OF BOUWKAMP AND DEBRUIJN

The fundamental tool used by Bouwkamp and deBruijn in their demonstration that arbitrarily high directivities may be obtained from a linear antenna by suitable choice of the current distribution is the following theorem:

If a and b are given positive numbers and $g(t)$ is a given function which is continuous on the closed interval $(-b \leq t \leq b)$, then, for any $\epsilon > 0$, there exists a continuous function $f(x)$, so that, for all t in the specified interval,

$$\left| g(t) - \int_{-a}^a f(x) e^{ixt} dx \right| < \epsilon.$$

⁶ G. N. Watson, "Theory of Bessel Functions," The Macmillan Company, New York, N. Y., 1945; pp. 73.

For a complete proof of this theorem, the reader is referred to the paper by Bouwkamp and deBruijn. Their theorem is restricted to the case $b=1$, but this assumption plays no essential part in the argument. In brief, they have approximated $g(t)$ uniformly by a polynomial $p(t)$ of sufficiently high degree. This is always possible according to the well-known theorem of Weierstrass.⁷ Then it is shown that a typical term of $p(t)$, say t^n , may be uniformly approximated over the range from $-b$ to b by an integral of the form

$$\int_{-a}^a f_n(x)e^{itx}dx$$

where $f_n(x)$ is a suitably chosen Hermitian function. Those who may not have access to the original paper will find a hint to this part of the argument in Campbell and Foster.⁸

For the three cases under consideration, the appropriate choice of t and b is as follows:

Case I:

$$t = \frac{2\pi}{\lambda} \cos \theta; \quad b = \frac{2\pi}{\lambda} \quad (19)$$

Case II:

$$t = \frac{2\pi}{\lambda} \cos \phi \sin \theta; \quad b = \frac{2\pi}{\lambda} \quad (20)$$

Case III:

$$t = \frac{2\pi}{\lambda} \sin \phi; \quad b = \frac{2\pi}{\lambda} \quad (21)$$

For a sequence of patterns having ever-increasing directivity, we select the continuous functions shown in Fig. 4. It is clear that transformations (19), (20), and (21) determine from them arbitrarily directive patterns, as functions of θ and Φ , for the three cases, respectively.

⁷ Dunham Jackson, "The Theory of Approximation," American Mathematical Colloquium Publications, vol. 11, chap. I, 1930.

⁸ Campbell and Foster, "Fourier Integrals for Practical Applications," D. Van Nostrand and Co., Inc., New York, N. Y.; p. 43, formula 401.1.

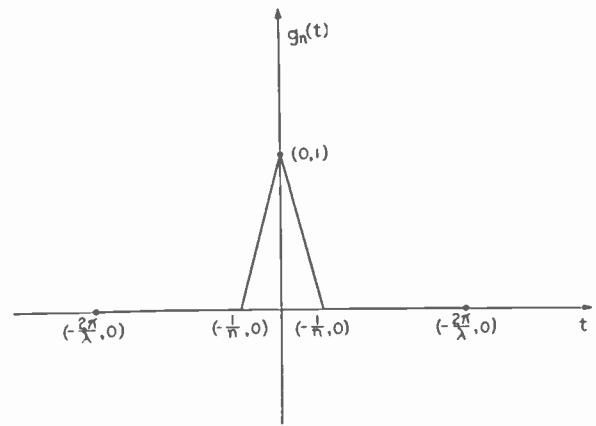

Fig. 4—Possible arbitrarily narrow patterns.

But, according to the theorem of Bouwkamp and deBruijn, these patterns may be approximated with any required accuracy by integrals of the form of (3), (9), and (15). This proves, then, that observed patterns as given for the cases under consideration by (4), (7), and (17) may be made arbitrarily directive by suitable choice of the current distributions.

IV. REMARKS

Unfortunately, the discrepancy between experiment and theory is also arbitrarily large. In spite of this, however, the writer believes that the results obtained are the logical consequence of the theory in use at present in describing antenna performance. The question then remains as to whether the theory is based on incomplete assumptions or whether the designers of antennas have been unfortunate up until now in their choice of parameters. Schelkunoff,² when faced with this situation, took the position that, although arbitrarily high directivities may be possible in theory, it will be difficult to realize them because of ohmic losses resulting from the large currents required. This will certainly limit the power gain ultimately obtainable, but does not appear to explain the fact that to date no aperture-type antenna has been built having a directivity which exceeds that calculated on the assumption of a uniform current distribution.

CORRECTION

The author has called to the attention of the editors the following errata in the paper, "Phase and Amplitude Distortion in Linear Networks," by M. J. DiToro, which appeared in the January, 1948, issue of the PROCEEDINGS OF THE I.R.E., pp. 24-36.

1. After equation (5) read: "Using the dimensionless frequency ratio $x=(\omega/\omega_0)$, (4) becomes, because of (5). . . ."

2. After equation (7) read: ". . . takes the logarithm (7) and . . ."

3. Equation (20), replace the $-$ sign preceding ω^5 by $+$

4. Equation (22) should read: " $y = \dots$ "

5. Equation (33) should read:
" $y_a = (1.t_a) \exp(-x'^2/\pi)$."

Multifrequency Bunching in Reflex Klystrons*

W. H. HUGGINS†, ASSOCIATE, I.R.E.

Summary—Webster's simple bunching theory is extended to include the simultaneous oscillation of a reflex klystron at two or more frequencies. General expressions for the power and electronic admittance are derived that show the intermodulation effects of the oscillations upon each other.

It is shown that in the presence of a vigorous low-frequency oscillation, oscillations may be obtained simultaneously at a higher frequency if the transit time is $(n+1/4)$ r.f. cycles. The "normal" oscillations obtained for $(n+3/4)$ r.f. cycles are shown to be usually unstable in the presence of the low-frequency oscillation.

An analysis is given of the power and electronic admittances obtained when the oscillation frequencies are exactly in the same ratio as two integers. The theory is found to explain the intermodulation effects previously reported by the author.¹

GLOSSARY

- ω = oscillation frequency in radians per second
 ϕ = initial phase angle of oscillation
 V_0 = d.c. accelerating voltage
 I_0 = effective beam current
 $V_e(t)$ = velocity modulation (in volts) of electrons entering repeller space at epoch t
 V = peak value of each sinusoidal r.f. voltage at interaction gap
 β = beam-coupling coefficient
 τ_0 = average reflex transit time
 $\tau(t)$ = reflex transit time for electron entering repeller space at epoch t
 $X = \omega\tau_0\beta V/2V_0$, bunching parameter
 $N = \omega\tau_0/2\pi$, transit time in r.f. cycles
 $M = \pi N\beta^2 I_0/V_0$, zero-signal admittance
 1, 2, 3 . . . = subscripts to indicate the value of a parameter for specific frequencies of oscillation. •

I. METHOD AND APPROXIMATIONS

IN ORDER TO simplify the analysis, the effects of space charge upon bunching, focusing, and the repeller field will be ignored. Furthermore, it is assumed that the repeller field is uniform, and that the effects of multiple transits may be neglected.

It will also be assumed that the resonator attached to the interaction gap of the klystron is simultaneously resonant at several frequencies $\omega_1, \omega_2, \omega_3$, etc., so that the instantaneous cavity voltage at the interaction gap is $\sum V_k \sin(\omega_k t + \phi_k)$. In general, the beam-coupling coefficient β will be different at each frequency, so the effective voltage modulation imposed upon the electron beam will be

$$V_e(t) = \sum_{k=1,2,3,\dots} \beta_k V_k \sin(\omega_k t + \phi_k). \quad (1)$$

Since the velocity is proportional to the square root of the voltage, and the reflex transit time will be proportional to the velocity with which the electrons enter the uniformly retarding repeller field, the reflex transit time for an electron entering at epoch t will be

$$\tau(t) = \tau_0 \sqrt{1 + \frac{V_e(t)}{V_0}}. \quad (2)$$

Under the assumption that multiple transits through the gap may be ignored, the charge that initially enters the repeller region during the interval dt is simply $I_0 dt$. On the return transit through the interaction gap, this differential charge will encounter a decelerating voltage $V_e(t+\tau)$ and will deliver to the resonator the energy

$$dw = V_e(t+\tau) I_0 dt. \quad (3)$$

The average power delivered by the electron stream over a long period of time is, therefore,

$$\lim_{T \rightarrow \infty} \frac{I_0}{T} \int_0^T V_e(t+\tau) dt = I_0 \overline{V_e(t+\tau)} \quad (4)$$

where a bar is used to denote the time average of a quantity.

Equation (4) together with (1) and (2) are the basic relations from which the detailed expressions for electronic admittance and power output will now be derived.

If the r.f. voltage at the gap is small compared to the accelerating voltage V_0 , (2) may be expanded by the binomial theorem

$$\tau(t) = \tau_0 \left[1 + \frac{V_e(t)}{2V_0} - \frac{1}{8} \left(\frac{V_e(t)}{V_0} \right)^2 + \dots \right]. \quad (5)$$

Since $V_e(t)$ is ordinarily much smaller than V_0 , for simplicity only the first-degree term will be retained in this analysis. However, it should be mentioned that the effect of second- and higher-degree terms in (5) is simply to produce intermodulation components of other frequencies. These may be included, if desired, with modification in the appropriate analysis.

The power delivered to the resonator by the beam is, therefore,

$$P = I_0 \sum \beta_k V_k \overline{\sin(\omega_k t + \omega_k \tau + \phi_k)} = \sum P_k \quad (6)$$

where the k 'th term represents the power P_k that is delivered to the oscillation mode having the k 'th frequency. Since these expressions will all be symmetric in their subscripts, we need consider only one in detail,

* Decimal classification: R355.912.3. Original manuscript received by the Institute, September 8, 1947.

† Electronic Research Laboratories, U. S. Air Force, Cambridge, Mass.

¹ "Very High Frequency Techniques," Radio Research Laboratory Staff, McGraw-Hill Book Co., New York, N. Y., 1947; article 31-9.

and without loss in generality, that may be the term for which $k = 1$. For this term,

$$P_1 = I_0 \beta_1 V_1 \sin \left[\omega_1 \tau_0 + \omega_1 t + \sum_k \frac{\tau_0 \omega_1 \beta_k V_k}{2V_0} \sin(\omega_k t + \phi_k) \right]. \tag{7}$$

But, by introducing the transit-time parameter X and noting that $\omega_1/\omega_2 = N_1/N_2$, (7) can be simplified considerably. If we write it in complex form (noting that $\sin \theta = \text{Re}[-j e^{j\theta}]$), there results

$$P_1 + jQ_1 = -j I_0 \beta_1 V_1 \overline{\epsilon^{j\omega_1 \tau_0 + j\omega_1 t + \sum_k (N_1/N_k) X_k \sin((N_k/N_1)\omega_1 t + \phi_k)}}, \tag{8}$$

which may be factored to give

$$P_1 + jQ_1 = -j I_0 \beta_1 V_1 \epsilon^{j\omega_1 \tau_0} \epsilon^{j\omega_1 t} \prod_{k=-\infty}^{k_1+\infty} \epsilon^{(N_1/N_k) X_k \sin((N_k/N_1)\omega_1 t + \phi_k)}. \tag{9}$$

But, by using the expansion in Bessel functions,

$$\epsilon^{z j \sin \theta} = \sum_{l=-\infty}^{l=+\infty} J_l(z) \epsilon^{j l \theta}. \tag{10}$$

The power may be written, where $\omega_1 t = \theta$, as

$$P_1 + jQ_1 = -j \frac{I_0 V_0}{\pi N_1} \epsilon^{j 2 \pi N_1 X_1 \epsilon^{j \theta}} \prod_{k=-\infty}^{k_1+\infty} \sum_{l=-\infty}^{+\infty} J_l \left(\frac{N_1}{N_k} X_k \right) \epsilon^{j l [(N_k/N_1)\theta + \phi_k]}. \tag{11}$$

Now the only terms in the expanded expression for (11) which will contribute toward an average value other than zero will be terms that are independent of θ ; in other words, we need only write down those terms in the expansion of (11) for which the coefficients of θ add up to zero. All other terms may be ignored (they represent oscillating power terms). Whereas this is rather awkward to indicate for the general case, it may be illustrated by considering only two frequencies.

II. SIMULTANEOUS OSCILLATION AT TWO INCOMMENSURATE FREQUENCIES

If there are only two oscillations, then (11) becomes

$$P_1 + jQ_1 = -j \frac{I_0 V_0}{\pi N_1} \epsilon^{j 2 \pi N_1 X_1 \epsilon^{j \theta}} \sum_{k=-\infty}^{\infty} J_k(X_1) \epsilon^{j k \theta} \sum_{l=-\infty}^{\infty} J_l \left(\frac{N_1}{N_2} X_2 \right) \epsilon^{j l [(N_2/N_1)\theta + \phi]}, \tag{12}$$

and the constant terms in the expanded expression will be those for which

$$\theta + k\theta + l \frac{N_2}{N_1} \theta = 0,$$

or

$$(1 + k) = -l \frac{N_2}{N_1}. \tag{13}$$

Now, if N_2 and N_1 are incommensurate, the only integral values of k and l that will satisfy (13) are

$$k = -1, l = 0, \tag{14}$$

and the power expression (12) becomes

$$P_1 + jQ_1 = -j \frac{I_0 V_0}{\pi N_1} \epsilon^{j 2 \pi N_1} J_{-1}(X_1) J_0 \left(\frac{N_1}{N_2} X_2 \right). \tag{15}$$

By the property that $J_{-n}(X) = (-1)^n J_n(X)$, this may be written as

$$P_1 + jQ_1 = j \frac{I_0 V_0}{\pi N_1} \epsilon^{j 2 \pi N_1} J_1(X_1) J_0 \left(\frac{N_1}{N_2} X_2 \right). \tag{16}$$

The concept of electronic admittance is useful. From the viewpoint of the resonator, the electron stream appears to have an admittance $Y_{e,1}$ such that

$$\frac{(Y_e V_1)^* V_1}{2} = \frac{Y_e^* V_1^2}{2} = -P_1 - jQ_1$$

or

$$Y_e = -\frac{2}{V_1^2} \text{conj} [P_1 + jQ_1]. \tag{17}$$

This admittance will have its maximum magnitude when the amplitudes of all the oscillations are vanishingly small. By evaluating (17) and letting X_1 and X_2

approach zero, it is found that the magnitude of the zero-signal admittance M is

$$M_1 = \frac{\pi N_1 \beta_1^2 I_0}{V_0},$$

and that the electronic admittance for large signals behaves as

$$Y_{e,1} = +j \epsilon^{-j 2 \pi N_1} M_1 J_0 \left(\frac{N_1}{N_2} X_2 \right) \cdot \frac{2J_1(X_1)}{X_1}. \tag{18}$$

By symmetry, the electronic admittance for the other oscillation is

$$Y_{e,2} = + j\epsilon^{-i2\pi N_2 M_2 J_0} \left(\frac{N_2}{N_1} X_1 \right) \frac{2J_1(X_2)}{X_2}. \quad (19)$$

The usual expression for the electronic admittance of a klystron operating at a single frequency is

$$Y_{e,1} = + j\epsilon^{-i2\pi N_1 M} \frac{2J_1(X_1)}{X_1}, \quad (20)$$

and to obtain oscillations the electronic conductance must be negative and

$$N_1 \simeq n + \frac{3}{4} \quad (n \text{ an integer}). \quad (21)$$

Now the effect of superimposing another oscillation at a higher frequency is to compress the ordinary electronic admittance (20) by the factor $J_0[(N_1/N_2)X_2]$. Hence, the mere presence of the second oscillation is undesirable in that it reduces the power that may be developed at the first frequency. It should be noted that, as X_2 increases and exceeds $2.4 N_2/N_1$, the compression factor becomes negative; the electronic conductance becomes positive; and the oscillations at the first frequency vanish. However, since $N_1 < N_2$, it is questionable that X_2 could be sufficiently great to cause this phase reversal for practical values of N_1 and N_2 .

On the other hand, we find that the compression of $Y_{e,2}$ due to oscillations at the first frequency will increase rapidly with X_1 , since N_2/N_1 is greater than unity. Hence, in the presence of a vigorous oscillation X_1 , the compression may be negative (if $N_2 X_1/N_1 > 2.40$), and to obtain a negative conductance at the second frequency the transit time must be such that

$$N_2 \simeq n + \frac{1}{4} \quad (n, \text{ any integer}). \quad (22)$$

Thus, in the presence of a vigorous low-frequency oscillation, *self-sustaining high-frequency oscillations may occur at repeller voltages that are roughly midway between the voltages that would be required to sustain the high-frequency oscillations in the absence of the low-frequency oscillation.* This phenomenon is of great significance in the design of wide-tuning-range reflex oscillators, since the problems of mode interference are complicated thereby.

III. STABILITY

Even though the electron stream may simultaneously present electronic conductances that are negative at two or more frequencies, it does not necessarily follow that stable oscillations can be obtained simultaneously at each frequency. The interaction between the various modes of oscillation may result in a *dynamically* unstable condition whereby the lower-frequency oscillation prevents the growth of an oscillation of higher frequency even though the electronic admittance expres-

sion (19) indicates the presence of a large negative conductance. It is suggested that the excessive noise sometimes found in klystrons may be due to a "fighting action" between a dominant and a recessive, unstable mode of oscillation.

The condition for stable oscillations at several frequencies will depend primarily upon the manner in which the various electronic conductances change with the amplitude of the oscillation at each frequency. The resonator behavior at each frequency may also determine certain boundaries of the problem. Since the general multifrequency formulation is awkward, we shall consider here only the stability conditions for simultaneous oscillation at two frequencies.

At each frequency of oscillation, the resonator will present to the electron stream an admittance

$$Y_k = G_k + jB_k \quad (23)$$

where the conductance G includes all resonator loss as well as the coupled external load, and the susceptance is zero for resonance.² The susceptance of the resonator will change very rapidly with a change in frequency, and the rate of change is a measure of the energy storage in the resonator. We may define the *characteristic capacitance* of the resonator by the relation

$$C_k = \frac{1}{2} \frac{dB_k}{d\omega_k}. \quad (24)$$

Since the susceptance slope is proportional to the average magnetic and electric energies T and V , stored in the resonator, we have³

$$V_k^2 \frac{dB_k}{d\omega_k} = 4(T + V) \quad (25)$$

or

$$\frac{C_k V_k^2}{2} = (T + V). \quad (26)$$

That is, *the characteristic capacitance of a resonator is that value which, for a d.c. voltage equal to the amplitude of the r.f. voltage at the resonator interaction gap, will store the same energy as in the resonator.*

For two-frequency bunching the electronic conductances are, from (18) and (19),

$$\begin{aligned} g_1(X_1, X_2) &= M_1 \sin 2\pi N_1 J_0 \left(\frac{N_1}{N_2} X_2 \right) \frac{2J_1(X_1)}{X_1} \\ g_2(X_1, X_2) &= M_2 \sin 2\pi N_2 J_0 \left(\frac{N_2}{N_1} X_1 \right) \frac{2J_1(X_2)}{X_2}. \end{aligned} \quad (27)$$

For steady oscillations, the electronic conductance will be just equal and opposite to the resonator conductance.

² See chapter 31 of footnote reference 1.

³ E. A. Guilleman, "Communication Networks," John Wiley and Sons, New York, N. Y., 1935, vol. II, p. 229.

If the negative electronic conductance exceeds the circuit conductance, the electron beam will deliver energy to the resonator more rapidly than it is dissipated therein. The excess energy must be stored in the electromagnetic field of the resonator, and the amplitude of the oscillation must increase. The differential equations describing the growth or decay of the oscillations are, therefore,

$$\begin{aligned} \frac{dX_1}{dt} &= -\frac{X_1}{2C_1} [G_1 + g_1(X_1, X_2)] \\ \frac{dX_2}{dt} &= -\frac{X_2}{2C_2} [G_2 + g_2(X_1, X_2)] \end{aligned} \tag{28}$$

where the C 's are the characteristic capacitances previously defined. Equations (28) together with (25) could be used to calculate the growth and decay of oscillations under pulsed conditions, or for large, sudden changes in load. However, the solution is a job for the differential analyzer. It is hoped that such studies can be made in the near future.

It is possible, however, to study analytically the stability of the oscillations to small disturbances about any stationary operating point. Assume that the oscillation amplitudes obtained for circuit loadings G_1 and G_2 are \bar{X}_1 and \bar{X}_2 , and that these amplitudes are changed slightly:

$$\begin{aligned} X_1 &= \bar{X}_1 + \delta_1 \\ X_2 &= \bar{X}_2 + \delta_2. \end{aligned} \tag{29}$$

Then,

$$g_1(X_1, X_2) \simeq g_1(\bar{X}_1, \bar{X}_2) + \frac{\partial g_1}{\partial X_1} \delta_1 + \frac{\partial g_2}{\partial X_2} \delta_2,$$

and, since $g_1(\bar{X}_1, \bar{X}_2) = -G_1$, (21) may be replaced by

$$\begin{aligned} \frac{d\delta_1}{dt} &= -\frac{X_1}{2C_1} \left[\frac{\partial g_1}{\partial X_1} \delta_1 + \frac{\partial g_1}{\partial X_2} \delta_2 \right] \\ \frac{d\delta_2}{dt} &= -\frac{X_2}{2C_2} \left[\frac{\partial g_2}{\partial X_1} \delta_1 + \frac{\partial g_2}{\partial X_2} \delta_2 \right]. \end{aligned} \tag{30}$$

These are ordinary simultaneous, linear differential equations with constant coefficients, and their characteristic equation is

$$\begin{aligned} p^2 + \frac{1}{2} \left[\frac{X_1}{C_1} \frac{\partial g_1}{\partial X_1} + \frac{X_2}{C_2} \frac{\partial g_2}{\partial X_2} \right] p \\ + \frac{1}{4} \frac{X_1 X_2}{C_1 C_2} \left[\frac{\partial g_1}{\partial X_1} \frac{\partial g_2}{\partial X_2} - \frac{\partial g_1}{\partial X_2} \frac{\partial g_2}{\partial X_1} \right] = 0. \end{aligned} \tag{31}$$

For stability, the real parts of the roots of the characteristic equation must be negative. This requires that

$$\frac{X_1}{C_1} \frac{\partial g_1}{\partial X_1} + \frac{X_2}{C_2} \frac{\partial g_2}{\partial X_2} > 0 \tag{32}$$

and

$$\frac{\partial g_1}{\partial X_1} \frac{\partial g_2}{\partial X_2} - \frac{\partial g_2}{\partial X_1} \frac{\partial g_1}{\partial X_2} > 0. \tag{33}$$

Since the inequality (32) includes the characteristic capacitances, the regions of stationary stability may be influenced by the properties of the resonator used with the klystron. It will be assumed, therefore, that these capacitances are equal in the following analysis. In fact, the regions of stability are determined largely by (33), and the assumption of equal characteristic capacitances which affects only (32) is, therefore, quite reasonable.

The boundaries of the regions in the (X_1, X_2) plane satisfying either condition for stability may be obtained by equating (32) or (33) to zero and solving numerically or graphically. The regions in the (X_1, X_2) plane where both conditions are satisfied simultaneously then mark off amplitudes at which stationary-stable oscillations may be obtained simultaneously.

As an example, we may show that simultaneous oscillation on the $N_1 = 2\frac{3}{4}$ and $N_2 = 4\frac{3}{4}$ repeller modes is ordinarily impossible. From (2) we can calculate contours on the (g_1, g_2) plane corresponding to constant values of X_1 or X_2 . For the $N_1 = 2\frac{3}{4}$ and $N_2 = 4\frac{3}{4}$ modes, these contours appear as shown in Fig. 1. Inspection of this

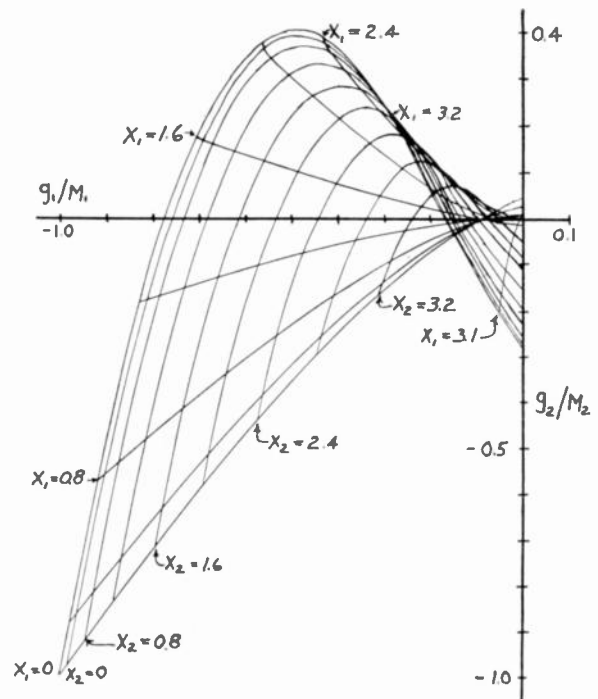

Fig. 1—Electronic conductance contours for constant-amplitude oscillations on modes $N_1 = 2\frac{3}{4}$ and $N_2 = 4\frac{3}{4}$.

figure shows that, if $X_1 < 1.39$, both g_1 and g_2 will be negative, and energy could be supplied by the electron stream simultaneously to oscillations of both frequencies. However, (33) indicates that these stationary oscillations would be intrinsically unstable, the lower-frequency oscillation dominating over the higher-fre-

frequency oscillation and reducing X_2 to zero. The situation is illustrated more clearly in Fig. 2 where there is shown, on the (X_1, X_2) plane, negative-conductance regions superimposed upon regions of intrinsic stability. Obviously, stable oscillations can be obtained only where the two regions overlap (i.e., where there is cross hatching).

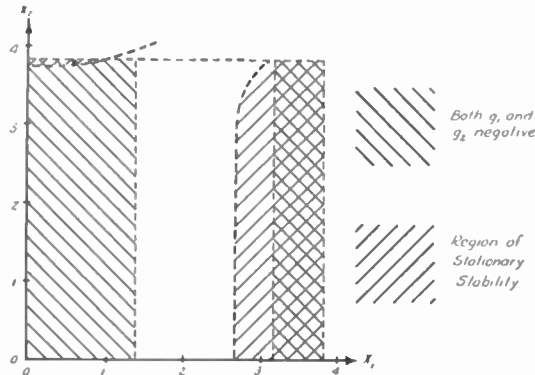

Fig. 2—Regions of stable oscillations on modes $N_1=2\frac{3}{4}$ and $N_2=4\frac{1}{4}$.

It should be noted that if the circuit loading of the first oscillation is very light, so that $X_1 > 3.18$, then stable oscillations could be obtained at the higher frequency. However, the circuit loadings would have to be smaller than roughly 1/10 the maximum values of the respective electronic conductance, and since the circuit losses in common resonators are normally in excess of this, simultaneous oscillations in this region are rarely observed and it may justifiably be stated that *in the steady state the $N=4\frac{1}{4}$ -cycle mode is recessive to the $N=2\frac{3}{4}$ -cycle mode in a reflex klystron.*

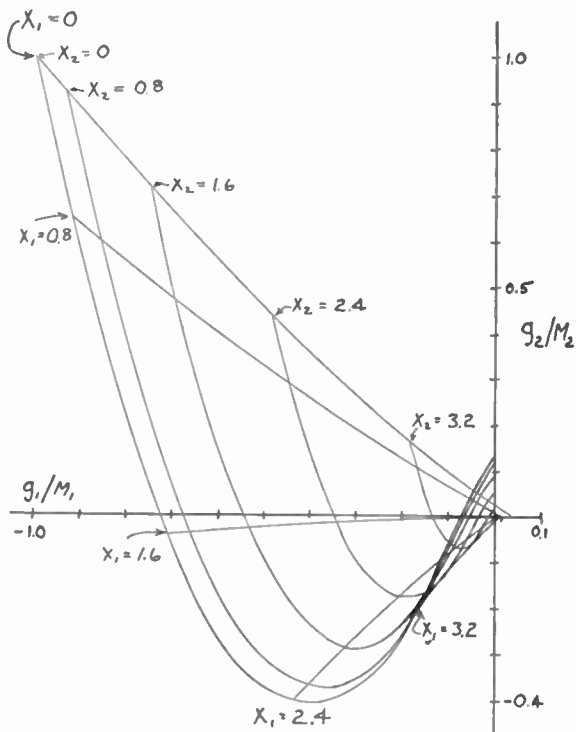

Fig. 3—Electronic conductance contours for constant-amplitude oscillations on modes $N_1=2\frac{3}{4}$ and $N_2=4\frac{1}{4}$.

We may also show that, in the presence of a vigorous oscillation in the $2\frac{3}{4}$ -cycle mode, stable, self-sustaining oscillations may be obtained when $N_2=4\frac{1}{4}$ cycles, and that in general, due to the presence of a lower-frequency oscillation, an entire new set of higher-frequency oscillation modes are produced.

Contours of constant oscillation amplitude upon the electronic-conductance plane are shown in Fig. 3 for $N_1=2\frac{3}{4}$ and $N_2=4\frac{1}{4}$. These contours are very similar to those of Fig. 1 except that the g_2 scale has been inverted; i.e., regions of g_2 that were negative are now positive, and vice versa. It is seen that, if

$$1.56 < X_1 < 3.58,$$

g_2 will be negative, and oscillation at the higher frequency may be produced. Furthermore, application of (30) shows that a major part of this region is intrinsically stable, as shown in Fig. 4. This $4\frac{1}{4}$ -cycle mode is of serious consequence since it may occur in wide-tuning-range oscillators designed to operate upon

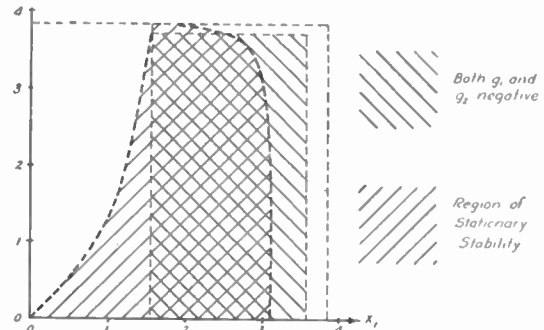

Fig. 4—Regions of stable oscillations on modes $N_1=2\frac{3}{4}$ and $N_2=4\frac{1}{4}$.

the $2\frac{3}{4}$ -cycle mode. Even though the presence of the high-frequency oscillation may be tolerated, it will result in reduced power output and increased noise on the desired $2\frac{3}{4}$ -cycle mode. It may be suppressed by increasing the loading at the higher frequency by suitable selective suppressors, but these complicate considerably the resonator design.

Although only the low-frequency $2\frac{3}{4}$ -cycle mode has been discussed thus far, it is obvious that similar effects of an even more marked nature will be present with the $1\frac{3}{4}$ -cycle repeller mode (the ratio of N_2/N_1 will be greater and the interaction between $1\frac{3}{4}$ -cycle mode and one of higher frequency therefore also greater).

IV. HARMONIC BUNCHING

By harmonic bunching, we shall mean that the frequencies of oscillation are *exactly* in the same ratio as a set of integers. Thus this definition includes not only the case where the second frequency is exactly twice the first, but also, for example, the case where the two frequencies are in the ratio of 2:3 or 3:4, etc.¹ Although the general equation (11) may be applied if more than 2 frequencies are available, we shall consider here only two oscillations and (12) is appropriate.

First, we shall investigate the case where $N_2/N_1 = 2/1$. The extraction of 2nd-harmonic energy from a lower-frequency oscillation is of practical importance because the inherent stability of the harmonic-frequency oscillation should be excellent. That is, loading at the harmonic frequency could not "kill" the harmonic oscillation.

If $N_2/N_1 = 2$, the only terms in (12) that are independent of θ will be those for which

$$1 + k + l \frac{N_2}{N_1} = 0 \tag{34}$$

or

$$\frac{k}{l} \left| \begin{array}{c|c|c|c|c} -3 & -1 & 1 & 3 & \dots \\ \hline +1 & 0 & -1 & -2 & \dots \end{array} \right. \tag{34a}$$

Hence,

$$P_1 + jQ_1 = -j\epsilon^{i2\pi N_1} \frac{I_0 V_0}{\pi N_1} X_1 [J_{-3}(X_1)J_1(\frac{1}{2}X_2)\epsilon^{i\phi} + J_{-1}(X_1)J_0(\frac{1}{2}X_2) + J_1(X_1)J_{-1}(\frac{1}{2}X_2)\epsilon^{-i\phi} + J_3(X_1)J_{-2}(\frac{1}{2}X_2)\epsilon^{-i2\phi} + \dots] \tag{35}$$

and the electronic admittance is

$$Y_{e,1} = -j\epsilon^{-i2\pi N_1} M_1 \frac{2}{X_1} \left\{ -J_1(X_1) \left[J_0\left(\frac{X_2}{2}\right) + J_1\left(\frac{X_2}{2}\right)\epsilon^{-i\phi} \right] - J_3(X_1) \left[J_1\left(\frac{X_2}{2}\right)\epsilon^{i\phi} - J_2\left(\frac{X_2}{2}\right)\epsilon^{-i2\phi} \right] \right\} \tag{36}$$

where terms involving higher-order Bessel Functions have been dropped. For the higher-frequency oscillation, interchange the subscripts 1 and 2 in (12) and obtain those terms independent of θ from

$$1 + k + l \left(\frac{N_1}{N_2}\right) = 0 \tag{37}$$

or

$$\frac{k}{l} \left| \begin{array}{c|c|c|c|c} -2 & -1 & 0 & 1 & \\ \hline 2 & 0 & -2 & -4 & \end{array} \right. \tag{37a}$$

Hence,

$$P_2 + jQ_2 = -j\epsilon^{i2\pi N_2} \frac{I_0 V_0}{\pi N_2} X_2 [J_{-2}(X_2)J_2(2X_1)\epsilon^{i2\phi} + J_{-1}(X_2)J_0(2X_1) + J_0(X_2)J_2(2X_1)\epsilon^{-i2\phi} + J_1(X_2)J_{-4}(2X_1)\epsilon^{-i4\phi} + \dots] \tag{38}$$

and

$$Y_{e,2} = -j\epsilon^{-i2\pi N_2} M_2 \frac{2}{X_2} \{ J_0(X_2)J_2(2X_1)\epsilon^{-i2\phi}$$

$$- J_1(X_2)[J_0(2X_1) + J_4(2X_1)\epsilon^{-i4\phi}] + J_2(X_2)J_2(2X_1)\epsilon^{i2\phi} + \dots \} \tag{39}$$

The first two terms in (39) are of the most interest:

$$\frac{J_0(X_2)}{X_2} J_2(2X_1)\epsilon^{-i2\phi} - \frac{J_1(X_2)}{X_2} J_0(2X_1). \tag{39a}$$

We note first that they are of opposite sign and that the phase of the first will depend upon relative phase angle ϕ between the two r.f. oscillations. Furthermore, it is noted that, as $X_2 \rightarrow 0$, the first term becomes infinitely great, but that as X_2 increases from zero the first term rapidly becomes smaller than the second. This large compression may be avoided by detuning the resonator so that ϕ has the proper value. For example, if $N_1 = 1\frac{3}{4}$ cycles, then $N_2 = 2N_1$ and the phase of the first admittance term is

$$-j\epsilon^{-i(4\pi N_1 + 2\phi)}. \tag{40}$$

If this is to represent a negative conductance,

$$4\pi N_1 + 2\phi = 2\pi(n + \frac{1}{4}) \tag{41}$$

where n is any integer. Moreover, all possible voltage phases are included in $-(\pi/2) < \phi < (\pi/2)$. The values of N_1 calculated from (38) that will result in useful output at the second-harmonic frequency are tabulated in Table I. Now oscillations may be expected on the $1\frac{3}{4}$ -

TABLE I
POSSIBLE VALUES OF N_1 FOR SECOND HARMONIC GENERATION

ϕ	n			
	1	2	3	4
$+\pi/2$	0.375	0.875	1.375	1.875
0	0.025	1.125	1.025	2.125
$-\pi/2$	0.875	1.375	1.875	2.375

cycle mode for transit-time deviations up to ± 60 degrees of the optimum value. That is, low-frequency oscillations should be obtained for

$$1.58 < N_1 < 1.92.$$

But reference to Table I indicates that harmonic oscillations may be obtained on either of two "harmonic modes," viz., with⁴

$$n = 3 \quad \text{and} \quad 0 > \phi > -\frac{\pi}{2},$$

or

$$n = 4 \quad \text{and} \quad \frac{\pi}{2} > \phi > 0.$$

This explains the experimental observation that "the harmonic frequency output is very low ... at the

⁴ These relations are further augmented by the fact that n also may deviate from an integer value by roughly $\pm 1/6$.

exact center of the $1\frac{3}{4}$ -cycle mode but is quite high . . . at either edge of the $1\frac{3}{4}$ -cycle mode.”⁵ The shorter transit-time mode would be expected to develop the greatest power and have the greatest “width” in repeller voltage.

As a final example of harmonic bunching we shall consider the interesting intermodulation effect wherein oscillations may be produced at a harmonic of some submultiple of the normal oscillating frequency. For example, it has been observed¹ that, if the klystron cavity resonates simultaneously at frequencies that are exactly in the ratio of 2:3, power output may be obtained at the higher frequency when the repeller voltage is adjusted to sustain oscillations on the lower of the two, even though the repeller voltage is not “correct” for operation at the higher frequency in any of the ordinary repeller modes.

If $N_2/N_1 = 3/2$, the terms in (12) that will contribute to the average power are found to be, from (13)

$$2(1 + k) = -3l \tag{42}$$

$$\frac{k}{l} \left\| \begin{array}{c|c|c|c} -4 & -1 & 2 & 4 \\ \hline 2 & 0 & -2 & -5 \end{array} \right. \tag{42a}$$

$$P_1 + jQ_1 = -j\epsilon^{i2\pi N_1} \frac{I_0 V_0}{\pi N_1} X_1 \left\{ J_{-4}(X_1) J_2\left(\frac{2}{3}X_2\right) \epsilon^{i2\phi} + J_{-1}(X_1) J_0\left(\frac{2}{3}X_2\right) + J_2(X_1) J_{-2}\left(\frac{2}{3}X_2\right) \epsilon^{-i2\phi} + \dots \right\} \tag{43}$$

and

$$Y_{e,1} = -j\epsilon^{-i2\pi N_1} M_1 \frac{2}{X_1} \left\{ -J_1(X_1) J_0\left(\frac{2}{3}X_2\right) + J_2(X_1) J_2\left(\frac{2}{3}X_2\right) \epsilon^{-i2\phi} + J_4(X_1) J_2\left(\frac{2}{3}X_2\right) \epsilon^{i2\phi} + \dots \right\}. \tag{44}$$

And for the second frequency,

$$3(1 + k) = -2l \tag{45}$$

$$\frac{k}{l} \left\| \begin{array}{c|c|c|c} -3 & -1 & 1 & \\ \hline 3 & 0 & -3 & \end{array} \right. \tag{45a}$$

⁵ Annual Report, “Microwave Local Oscillator Project,” Contract No. N6-or; 106 Task III, May, 1946, to June, 1947, Karl A. Spangenberg, Stanford University, Calif., p. 6.

$$P_2 + jQ_2 = -j\epsilon^{i2\pi N_2} \frac{I_0 V_0}{\pi N_2} X_2 \left\{ J_{-3}(X_2) J_3\left(\frac{3}{2}X_1\right) \epsilon^{i3\phi} + J_{-1}(X_2) J_0\left(\frac{3}{2}X_1\right) + J_1(X_2) J_{-3}\left(\frac{3}{2}X_1\right) \epsilon^{-i3\phi} \right\} \tag{46}$$

and

$$Y_{e,2} = -j\epsilon^{-i2\pi N_2} M_2 \frac{2}{X_2} \left\{ -J_1(X_2) J_0\left(\frac{3}{2}X_1\right) + J_3\left(\frac{3}{2}X_1\right) \epsilon^{-i3\phi} - J_3(X_2) J_3\left(\frac{3}{2}X_1\right) \epsilon^{i3\phi} + \dots \right\}. \tag{47}$$

Inspection of (47) indicates that the electronic conductance can always be made negative provided X_1 is sufficiently large that

$$J_3\left(\frac{3}{2}X_1\right) > J_0\left(\frac{3}{2}X_1\right),$$

and the phase angle, ϕ may then always be adjusted by slight detuning to yield the required phase.

V. CONCLUSIONS

It has been shown that, in the presence of a vigorous low-frequency oscillation, modes of oscillation at higher frequencies may be obtained that were hitherto not recognized.

The condition for stationary stability of these modes is established, and it is shown that the normal $n + \frac{3}{4}$ modes are usually unstable and recessive to a lower-frequency mode. However, in the presence of a vigorous low-frequency mode, stable higher-frequency modes may be obtained for which the reflex transit time is $n + \frac{1}{4}$. The general expressions for power and electronic admittance are derived and a detailed discussion given for several cases of practical importance.

It is shown that the general expressions may be applied when the oscillation frequencies are in the same ratio as integers, and explicit expressions are given for the power and admittance when two frequencies are in the ratio of 2:1 and in the ratio of 2:3. The theory is found to agree with observations reported by Spangenberg and others.



Contributors to the Proceedings of the I.R.E.



STANFORD GOLDMAN

Stanford Goldman (A'36-M'43-SM-'43) was born in Cincinnati, Ohio, on November 14, 1907. He received the B.A. degree from the University of Cincinnati, and the Ph.D. in physics from Harvard in 1933. From 1930 to 1931, he was a sound engineer at RCA Photophone, Inc.; and from 1935 to 1946, he was employed by General Electric Company, Inc., as a development engineer in the electronics department. He is now a research associate in electrical engineering at the Massachusetts Institute of Technology.

Dr. Goldman is a consulting physicist for the United States Army Air Corps, a member of the American Physical Society and Sigma Xi, a member of the Papers Review and of the Circuits committees of I.R.E., and the author of "Frequency Analysis, Modulation and Noise," McGraw-Hill, 1948, and of numerous technical articles.



William M. Goodall (A'29-M'37-SM'43) was born in Washington, D. C., on September 7, 1907. He received the B.S. degree from the California Institute of Technology in



WILLIAM M. GOODALL

1928, and joined the staff of the Bell Telephone Laboratories, Inc., that same year.

Mr. Goodall has worked on research problems in connection with the ionosphere, radio transmission and early radio-relay studies, radar modulators, and, more recently, microwave radio-relay systems.



For a biography and photograph of HOWARD A. CHINN, see page 1585 of the December 1947, issue of the PROCEEDINGS OF THE I.R.E.



For a biography and photograph of PHILIP EISENBERG, see page 1585 of the December, 1947, issue of the PROCEEDINGS OF THE I.R.E.



For a biography and photograph of W. H. HUGGINS, see page 935 of the September, 1947, issue of the PROCEEDINGS OF THE I.R.E.



For a biography and photograph of H. J. RIBLET, see page 497 of the May, 1947, issue, of the PROCEEDINGS OF THE I.R.E.



Leonard Mautner (M'46-SM'47) was born on October 30, 1917, in New York, N. Y. He received the degree of B.S. in electrical engineering from the Massachusetts Institute of Technology in 1939. He did graduate study at the Stevens Institute of Technology from 1940 to 1941, and at the Massachusetts Institute of Technology in 1942.

In 1939 Mr. Mautner was an illuminating engineer at the Macbeth Daylighting Corporation in New York City, later joining the Army Signal Corps as radio engineer. In 1942 he joined the television department of the National Broadcasting Company, and when broadcasting was curtailed because of the war, he became a staff member of the Radiation Laboratory at the Massachusetts Institute of Technology. Here he was a member of the indicator group, developing a variety of indicator units for radar equipment. In 1944 Mr. Mautner was asked to serve as a Radiation Laboratory member of the Combined Research Group at the Naval Research Laboratory, Washington, D. C., where he took charge of the display section. In this capacity, he supervised the development of all of the display and interconnection equipment for the Mark V IFF/UNB project. Since 1945, he has been with the Allen B. DuMont Laboratories, where he is in charge of the development of television video equipment.

Mr. Mautner is a member of Eta



LEONARD MAUTNER

Kappa Nu. He is active on several committees of the Radio Manufacturers Association, serving as chairman of the Television Studio Facilities Subcommittee of the Television Transmitter Department. He is the author of a textbook recently published by the Pitman Publishing Corporation, entitled "Mathematics for Radio Engineers."



James H. Mulligan, Jr. (S'41-A'45-M'45) was born on October 29, 1920, in Jersey City, N. J. He received the B.E.E. and the E.E. degrees from the Cooper Union School of Engineering, and the M.S. degree from Stevens Institute of Technology. He was first employed in the transmission development department of the Bell Telephone Laboratories, and later became a member of the Combined Research Group of the Naval Research Laboratory where he served as Project Engineer for one of the equipments in the Mark V IFF/UNB Project. In November, 1945, he joined the Research Divi-



JAMES H. MULLIGAN, JR.

sion of the Allen B. DuMont Laboratories as a senior development engineer, and was concerned with research and development work on portable and studio television pickup and video equipment. He left this position in August, 1947, to accept the Watson Scientific Computing Laboratory Fellowship in applied mathematics, and is now doing research work in the department of electrical engineering, Columbia University.

Mr. Mulligan is an associate member of the AIEE, and a member of Tau Beta Pi and Sigma Xi. He is a licensed professional engineer in the State of New York.



Winfield G. Wagener (A'29—SM'44) was born in San Jose, Calif., in July, 1906. He attended the University of California and



WINFIELD G. WAGENER

received the B.S. degree in electrical engineering in 1928. In that year, he was appointed John W. Mackay fellow in electrical engineering at the University of California, and received the M.S. degree. He has been active in design and development of transmitting power tubes since 1930. From 1929 to 1933, he was with the Federal Telegraph Company, and from 1933 to 1938 with the Radio Corporation of America.

In 1938, he returned to the West coast and became chief engineer of Heintz and Kaufman, Ltd. In 1944 he joined the Litton Engineering Laboratories as head of the tube engineering division, working on counter-measure tubes.

In 1946, he became sales engineer for Eitel-McCullough, Inc., continuing his close association with the engineering aspects of vacuum tubes. He is a member of Eta Kappa Nu and Tau Beta Pi.

Correspondence

Conformal Mapping Transformations*

The properties of conformal mapping in a complex plane have been used to good advantage in the solution of static electromagnetic field problems. Mapping transformations could be of inestimable value in antenna analysis if the method could be extended to high-frequency fields; however, the limitations of complex mapping transformations when applied to time-varying fields are rarely mentioned in the literature, so it is of interest to know what these limitations are.

From Maxwell's equations in differential form it can be seen that the electric and magnetic field vectors are everywhere orthogonal in a nonconducting charge-free region,

$$\nabla \times E = -\mu \frac{\partial H}{\partial t} \quad (1)$$

$$\nabla \times H = \epsilon \frac{\partial E}{\partial t} \quad (2)$$

The field equations containing E and H independently can be obtained by taking the curl of (1) and (2) and observing that

$$\nabla^2 E = \mu\epsilon \frac{\partial^2 E}{\partial t^2} = -\mu\epsilon\omega^2 E \quad (3)$$

$$\nabla^2 H = \mu\epsilon \frac{\partial^2 H}{\partial t^2} = -\mu\epsilon\omega^2 H \quad (4)$$

or

$$\nabla^2 \psi = -\mu\epsilon\omega^2 \psi \quad (5)$$

where ψ represents the scalar components of E or H . We see that the Laplacian of the scalar components of E and H depends upon the frequency at which the fields vary in time.

The properties associated with conformal mapping transformations of the form $W=f(z)=u(x, y)+iv(x, y)$ are valid only

* Received by the Institute, December 15, 1947.

when the Cauchy-Riemann conditions are satisfied:

$$\frac{\partial u}{\partial x} = \frac{\partial v}{\partial y} \quad (6a)$$

$$\frac{\partial u}{\partial y} = -\frac{\partial v}{\partial x} \quad (6b)$$

By differentiation of (6a) and (6b) and properly combining the resulting equations, it can be seen that only complex functions whose real and imaginary parts satisfy Laplace's equation

$$\frac{\partial^2 u}{\partial x^2} + \frac{\partial^2 u}{\partial y^2} = 0 \quad (7a)$$

$$\frac{\partial^2 v}{\partial x^2} + \frac{\partial^2 v}{\partial y^2} = 0, \quad (7b)$$

or

$$\nabla_{xy}^2 \phi = 0, \quad (8)$$

are analytic, and hence only such functions in the z plane can be mapped conformally on the W plane.

It can now be seen from (5) that coplanar scalar components of E and H can be mapped conformally if, and only if, the right member of (5) is negligibly small for all Ψ , which means that the fields in question must be essentially stationary. The transformation is a good approximation for slowly varying fields, but the error increases with the square of the frequency. At high frequencies the error is so great that the transformation becomes meaningless.

D. R. RHODES
Antenna Laboratory
Ohio State University
Columbus 10, Ohio

E-Plane Bend*

Since my paper on corner-bend equivalent circuits in waveguides appeared in

* Received by the Institute, January 5, 1948.

the PROCEEDINGS OF THE I.R.E.,¹ I have acquired access to a copy of the M.I.T. Radiation Laboratory "Wave Guide Handbook" (Report 43—2/7/44). On pages 29-6 and 19-7, results are given for the E -plane bend in a rectangular guide which are considerably more accurate than those which were calculated in my paper. It would appear from these results that my own results are in error about 10 per cent at $26/\lambda_0=0.8$. For a larger or smaller value of wavelength the errors are less, or more respectively.

It is believed that the calculations referred to in the "Wave Guide Handbook" were made by Julian Schwinger, presently in the Physics Department at Harvard University.

JOHN W. MILES
University of California
Los Angeles 24, Calif.

¹ John W. Miles, "The equivalent circuit of a corner bend in a rectangular waveguide," Proc. I.R.E., vol. 35, pp. 1313-1318; November, 1947.

Directional Couplers*

In the paper by Riblet and Saad¹ there is described a basic combination of slots which has already appeared in my book, "The Physical Principles of Wave Guide Transmission and Antenna Systems," published in January, 1947. The combination was also described in the *Journal of the Institution of Electrical Engineers*, vol. 93, part IIIA, no. 4, 1946, pp. 758 and 765.

While one cannot expect references to be all-inclusive, I think it is fair comment to draw to the attention of the Institute that work done outside the United States tends to be overlooked far too frequently.

W. H. WATSON, Head,
Theoretical Physics Branch,
National Research Council
Chalk River, Ont., Canada

* Received by the Institute, January 29, 1948.
¹ H. J. Riblet and T. S. Saad, "A new type of waveguide directional coupler," Proc. I.R.E., vol. 36, pp. 61-65; January, 1948.

Institute News and Radio Notes

Executive Committee

March 2, 1948

Citations for George T. Royden and Members of the Admissions Committee. As instructed by the Executive Committee at its last meeting, Dr. Sinclair, Membership Relations Co-ordinator, prepared the following citation:

"The phenomenal growth of the Institute membership and the concurrent transfer occasioned by the 1943 change in membership grades have thrown an unprecedented burden on the Admissions Committee. Over the past three years the Committee has given individual attention each month to an average of over 100 applications for admission or transfer to the grades of Member and Senior Member.

"In recognition of the excellent job done and the unselfish contribution of time, the Board of Directors wishes to acknowledge particularly its gratitude to the members of the Admissions Committee and the Chairman during this critical period, George T. Royden."

Dr. Goldsmith moved that the Committee accept Dr. Sinclair's citation, as quoted above, and asked that it be read to the Board, and at the annual meeting of the Institute on March 22, 1948, and that it be published in the PROCEEDINGS. (Unanimously approved.)

Student Branches. Dr. Goldsmith moved that the following petitions for Student Branches be approved, and the Branches established: California Institute of Technology, Case Institute of Technology, State University of Iowa, Syracuse University. (Unanimously approved.)

German and Japanese Nationals. Executive Secretary Bailey reported that, under date of February 27, 1948, the State Department established the policy that German and Japanese Nationals may establish or resume formal membership in nonprofit societies, but they may not pay dues, since no foreign exchange will be made available for payment of dues or for any other financial transactions. There is no objection to the forwarding of scientific journals to German nationals. Scientific journals may not be sent directly to Japanese members, but may be addressed to the Civil Information and Education Section, Supreme Commander for Allied Powers, APO 500, c/o Postmaster, San Francisco, Calif., with a request that the material be forwarded to the member in question.

Symposium in Applied Mathematics of the American Mathematical Society. Dr. Goldsmith moved that The Institute of Radio Engineers act as a co-sponsor of the Symposium in Applied Mathematics of the American Mathematical Society, to be held July 29-31, 1948, in accordance with an invitation dated February 9, 1948, from John L. Synge, Chairman of the Committee on

Applied Mathematics of the American Mathematical Society. (Unanimously approved.)

Education Committee Chairman. Dr. Sinclair moved that W. H. Radford be appointed Chairman of the Education Committee. (Unanimously approved.)

Armed Forces Liaison Committee. Mr. S. L. Bailey moved that President Schackelford be empowered to appoint a committee to be called the Armed Forces Liaison Committee, in accordance with a letter received from Major General A. C. McAuliffe of the General Staff, United States Army, the committee to be a standing committee to act as the official liaison agency between the Institute and the Department of the Army on all matters of mutual interest. (Unanimously approved.)

San Antonio Section. Dr. Sinclair moved that the Executive Committee recommend to the Board of Directors that the petition of the San Antonio Section be accepted, and that the boundaries of the Section be set according to the map included with the petition. (Unanimously approved.)

Constitution and Laws Committee. Mr. S. L. Bailey moved that F. B. Llewellyn be appointed a member of the Constitution and Laws Committee in the place of A. B. Chamberlain, who declined membership due to pressure of work. (Unanimously approved.)

M.K.S. Rationalized System of Measuring Units. Mr. S. L. Bailey moved that the Executive Committee recommend to the Board of Directors approval of the Standards Committee recommendation of January 8, 1948, that the I.R.E. promote the general use of the m.k.s. rationalized system of measuring units. Planned methods of promotion will include an editorial on the m.k.s. system to be prepared by Chairman Schelkunoff of the Wave Propagation Committee for publishing in the PROCEEDINGS. (Unanimously approved.)

Definition of Scope of the Electronic Computers Committee. Mr. S. L. Bailey moved that the Executive Committee approve the following definition of scope of the Electronic Computers Committee, submitted by the Committee Chairman, J. B. Weiner, with the suggestion that the Technical Secretary investigate the use of the term "continuous" in this application:

"The Technical Committee on Electronic Computers is responsible for all work relating to digital and continuous computers. Included are applications to scientific computing, fire control, and industrial control problems. A primary duty of the Committee will include the compilation of a glossary of definitions designed to correct the many current ambiguities. Additional duties of the Committee include standardization of test methods, coordination with the Papers Procurement Committee, and computer session planning." (Unanimously approved.)

Joint I.R.E.-AIEE Committee on Radio Aids to Navigation. Dr. Sinclair moved that the Executive Committee recommend to the Technical Committee on Radio Aids to Navigation, in response to its proposal re joint I.R.E.-AIEE action, that the present I.R.E. Technical Committee on Radio Aids to Navigation be enlarged by the inclusion of AIEE members. (Unanimously approved.)

Finance Committee. Mr. S. L. Bailey moved that the Executive Committee recommend to the Board of Directors that there be appointed a Finance Committee of three members to maintain continuous familiarity with the finances of the Institute, and to make recommendations thereto from time to time as may seem desirable. (Unanimously approved.)

TELEVISION TEST FILMS

In view of the wide utilization of motion-picture film in television, engineers in that field as well as broadcasters will be interested in the availability of a group of 16-mm. and 35-mm. test films. These films will enable the checking of the performance of 35-mm. and 16-mm. motion-picture projectors and sound-reproducing equipment.

The catalog of these test films, giving the nature, length, and price of each film, can be obtained upon request from the Society of Motion Picture Engineers, 342 Madison Avenue, New York 17, N. Y. The films themselves are purchasable from the Society, or from the Motion Picture Research Council, Inc., 1421 Northwestern Avenue, Hollywood 27, Calif.

RECENTLY APPROVED STANDARD

The American Standards Association recently approved a new American Standard, "Specification for Buzz-Track Test Film for 16-Millimeter Motion Picture Sound Reproducers, Z22.57-1947." The Institute of Radio Engineers participated in the formation of this Standard, which is available for the use of I.R.E. members wherever it may appropriately be employed. It is priced at 25 cents, and may be obtained by writing to the ASA at 70 East 45 Street, New York 17, N. Y.

AUTOMOTIVE REPORT

The Society of Automotive Engineers, Inc., in a recent press release, describes a report on two-way radio suitable for automotive fleet application which has been prepared by a group of radio, automotive electrical equipment, and fleet operation engineers. This report does not attempt to give information on the intricacies of radio itself, but is concerned with the difficulties involved in the application of radio to the automotive vehicle.

The original intent of the report was to inform truck and bus operators on the problems encountered in the application of two-way radio to their vehicles, and, for that reason, technical radio terms and problems were avoided. The price of this report is \$2.00, with substantial reduction for quantity.

PUBLICATIONS ON NUCLEAR PHYSICS AND RADIOISOTOPES

The United States Atomic Energy Commission has published a series of lectures in the field of nuclear physics prepared by a group of outstanding experts who assisted in the development of the atomic bomb. Published under the title, "Lecture Series in Nuclear Physics," these lectures were originally given at Los Alamos late in 1943 for the purpose of training personnel. The publication is issued in accordance with the Atomic Energy Act of 1946, which directs "that the dissemination of scientific and technical information relating to atomic energy should be permitted and encouraged so as to provide that free interchange of ideas and criticism which is essential to scientific progress."

The forty-one chapters which comprise it are divided into six sections prepared by the following authorities: E. M. McMillan, E. Segre, J. H. Williams, C. L. Critchfield, V. F. Weisskopf, and R. F. Christy. The price of the volume is 55 cents, and it is available from the Superintendent of Documents, Washington 25, D. C.

The AEC has also published a document entitled, "Background Material on Activity in First Year Distribution of Pile-Produced Radioisotopes." This is available from the Superintendent of Documents at 10 cents per copy.

NAB CONVENTION

A two-day Broadcast Engineering Conference, May 20-21, will be held in Los Angeles in connection with the 26th Annual NAB Convention. Authorities in the engineering fields of a.m. and f.m., television and facsimile, have given definite commitments to the National Association of Broadcasters' Department of Engineering, assuring presentations and demonstrations on topics in keeping with the advancement of the art.

Technical discussions will include such subjects as video relay and remote facilities, television planning, and topics related to the installation of the small television station. Magnetic-recording papers and demonstrations will present the latest developments in this field. Modern portable pickup devices for line and high-frequency services will be discussed. Studios for high-quality broadcasts in both the aural and video field will be discussed.

On Saturday, May 22, a tour up Mt. Wilson has been scheduled to provide engineers as well as management an opportunity

to examine first-hand the f.m. and television installations there. An opportunity is also presented for all to see the famous 100-inch Mt. Wilson telescope. Arrangements for this trip, via special chartered busses, are under the guidance of Lester H. Bowman, CBS Western Division chief.

NAB's Director of Engineering, Royal V. Howard, and Assistant Director Neal McNaughten, in co-operation with Orrin W. Towner, of radio station WHAS, Louisville, Ky., chairman of the Engineering Executive Committee, have met with station and network engineering executives in preparation of the Conference agenda. Taking part in these arrangements are: J. R. Poppele for WOR; Earl M. Johnson for MBS; Frank Marx and James Middlebrooks for ABC; W. B. Lodge and Howard Chinn for CBS; George M. Nixon and Robert M. Morris for NBC; Everett Dillard, F.M. Association; J.G. Lawrence, Western Electric; T. T. Goldsmith, DuMont; the Bell Telephone Laboratories, and RCA's Service Division.

The F.C.C.-Industry Roundtable will be one of the attractions of the meeting again this year.

1948 WEST COAST CONVENTION

Plans for the 1948 I.R.E. West Coast Convention are well under way. Headquarters of the Convention, which will run from September 30 through October 2, 1948, will be the Biltmore Hotel, Los Angeles.

Members of the Convention Committee are: Lloyd C. Sigman, Chairman; John J. Fiske, Jr., Vice-Chairman; C. Frederick Wolcott, Liaison between I.R.E. and West Coast Electronic Manufacturers; William U. Dent, I.R.E. Papers Chairman; Fred Ireland, I.R.E. Arrangements; Maurice Kennedy, Los Angeles Flood Control Commission; Seymour Johnson, I.R.E. Finance; Frederick G. Suffield, Chairman, I.R.E. Publicity; Vernon J. Braun, I.R.E. Publicity; Victor Martin, I.R.E. Hotels; William Parker, I.R.E. Hotels; Robert L. Sink, I.R.E. Program Printing; Cameron Pierce, Chairman, I.R.E. Membership Committee; Lou Howard, West Coast Electronic Manufacturers Association, Liaison Officer; and Allan Pollock, Chamber of Commerce Representative. Officers of the Los Angeles Section are: Walter Kenworth, Section Chairman; Bernard Walley, Vice-Chairman; and Raymond Monfort, Secretary-Treasurer.

The 4th Annual Pacific Electronic Exhibition will be held in the grand ballroom of the Biltmore Hotel on all three days, according to Lou Howard, Chairman of the Show Committee, and James L. Fouch, Chairman of the Los Angeles Council of the West Coast Electronic Manufacturers Association. The exhibition rotates annually between San Francisco and Los Angeles. George Davis was appointed general manager for the exhibition. There will be 10,000 square feet of floor space for display and demonstration.

I.R.E. ELECTRON-TUBE CONFERENCE—1948

The 1948 Electron-Tube Conference will be held at Cornell University, Ithaca, N. Y., on Monday and Tuesday, June 28 and 29. This conference is sponsored by the Electron-Tube Committee of The Institute of Radio Engineers and is held annually for active members in the field of electron-tube research.

Announcements of the conference have been mailed to those whom the committee knows to be active in the field. Those who have not received notices and feel that they can contribute to the discussions are asked to communicate with the chairman of the invitation committee, Professor A. E. Harrison, at Princeton University, Princeton, N. J.

As usual, advance registration will be required for attendance at the conference.

1948 NATIONAL ELECTRONICS CONFERENCE

The National Electronics Conference, Inc., which will hold its annual technical forum at the Edgewater Beach Hotel, Chicago, Ill., November 4, 5, and 6, has selected W. C. White (A'15-M'25-F'40) of General Electric Co., Schenectady, N. Y., as Chairman of the Board of Directors for the current year. Mr. White is the I.R.E. Representative on the conference.

A program of approximately 50 technical papers covering all phases of electronics, together with exhibits of manufacturers' new electronic equipment, is being planned. Larger space facilities than in former years will be available, both for exhibits and meetings. The entire program is under the joint sponsorship of the Illinois Institute of Technology, Northwestern University, The Institute of Radio Engineers, American Institute of Electrical Engineers, and the University of Illinois. Manufacturers interested in acquiring exhibit space at this conference should write to J. A. M. Lyon, Northwestern Technological Institute, Evanston, Ill.

Other officers who were elected for the coming year in connection with this national forum on electronic research, development, and application are as follows: President, E. O. Neubauer, Illinois Bell Telephone Co., Executive Vice-President, G. H. Fett, University of Illinois; Secretary R. R. Buss, Northwestern Technological Institute; Treasurer, O. D. Westerberg, Commonwealth Edison Co.; Vice-President in Charge of Arrangements, Karl Kramer, Jensen Manufacturing Co.; Vice-President in Charge of Program, H. A. Leedy, Armour Research Foundation; Vice-President in Charge of Publicity, L. G. Killian, Cook Research Laboratories; Vice-President in Charge of Publication, A. H. Wing, Northwestern Technological Institute; Chairman of Exhibits Committee, J. A. M. Lyon, Northwestern Technological Institute; and Chairman of Hotels Committee, R. K. Metcalf, Illinois Bell Telephone Co.

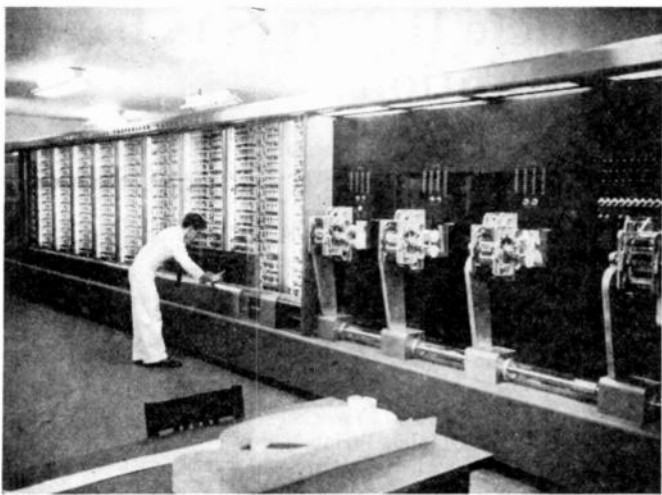

Harvard News Service

I.B.M. Automatic Sequence-Controlled Calculator. This is the fifty-foot long electrical computer in use at Harvard University.

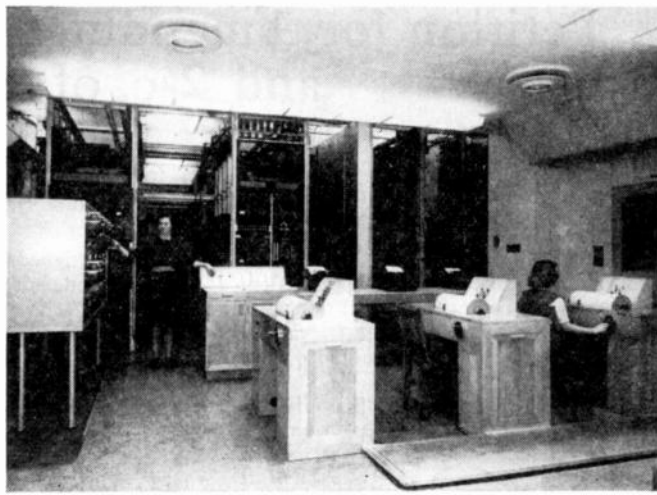

M.I.T. Service

Differential Analyzer at M.I.T. 2000 vacuum tubes, 100 tons of equipment employed in automatic solution of differential equations.

New England Radio Engineering Meeting

The second annual New England Radio Engineering Meeting under the sponsorship of the North Atlantic Region of The Institute of Radio Engineers will be held on Saturday, May 22, 1948, in Cambridge, Mass., at the Hotel Continental. The North Atlantic Region is made up of the membership of the Boston and Connecticut Valley Sections of The Institute of Radio Engineers.

The first of these regional one-day meetings held last year drew an enthusiastic attendance of 600 and firmly established the appeal of such a gathering for New England's radio and electronic engineers. Plans for this year's meeting include technical sessions, manufacturers' exhibits, trips to points of current electronic interest, a luncheon, and a banquet. The banquet will feature a speaker of national prominence. A special events committee will punctuate the day's program with special displays and demonstrations.

There will be six technical sessions, three in the morning and three in the afternoon. The papers will be presented consecutively. Six of these papers are:

A STANDARD-SIGNAL GENERATOR FOR F.M. BROADCAST SERVICE

Donald B. Sinclair

(General Radio Company)

A discussion of problems involved in design of f.m. signal generators, using the new General Radio instrument as an example.

THE BOSTON-NEW YORK MICROWAVE RADIO RELAY LINK

J. W. McRae

(Bell Telephone Laboratories, Inc.)

A discussion of the technical features of the 3700- to 4200-Mc. relay link, providing two 5-Mc. channels in each direction over a distance of 220 miles.

CERTAIN ASPECTS OF PULSE MODULATION

E. R. Kretzmer

(Research Laboratory of Electronics, M.I.T.)

A discussion of two types of pulse-time modulation; namely, pulse-duration modulation and pulse-position modulation, demodulating and modulating circuits, inherent distortion, and the interference problem. Equipment demonstrations of co-channel interference in pulse-duration modulation.

MICROWAVE GAS-DISCHARGE COUNTERS FOR THE DETECTION OF IONIZING RADIATION

Sanborn C. Brown,

(Research Laboratory of Electronics, M.I.T.)

TRAVELING-WAVE TUBES

H. Gunther Rudenberg

(Lyman Laboratory of Physics, Harvard University)

STUDIO ACOUSTICS

Leo Beranek

(Massachusetts Institute of Technology)

Shaping of studios, distribution of acoustical materials in the room, and the properties of various kinds of modern acoustical materials.

Three trips will be run during the day at times not in conflict with the technical sessions. One will be to the Boston terminal of the Bell System New York-to-Boston microwave television circuit, one to the Differential Analyzer at M. I. T., and one to the Automatic Sequence-Controlled Computer at Harvard University.

All I.R.E. members in the North Atlantic Region will receive a detailed program and registration card through the mail. Nonmembers can obtain this material and members can obtain further information regarding registration by addressing Registration Chairman, Harold Dorschug, Radio Station WEEI, 182 Tremont Street, Boston, Mass.

The registration fee for members of I.R.E. is \$1.00, and for nonmembers it is \$2.00. There is no registration fee charged for university students or for student members of I.R.E. The charge for the luncheon is \$1.75 per person and for the banquet, \$4.60 per person. This includes the Massachusetts Old Age tax and the service gratuity. The trip tickets will be 25 cents each.

Prior registration is essential in order to insure accommodation at the luncheon and banquet. Late registration can, of course, be made at the registration desk on May 22 to permit attendance at the technical sessions and to visit the exhibits.

To recapitulate: the date is May 22, 1948; the place: Hotel Continental, Cambridge, Mass. The General Chairman is Howard H. Dawes, General Radio Company, 275 Massachusetts Avenue, Cambridge, Mass.

Calendar of COMING EVENTS

I.R.E.-URSI Meeting, Washington, D. C.

May 3-5, 1948

New England Radio Engineering Meeting, Cambridge, Mass.

May 27, 1948

I.R.E. Electron-Tube Conference, Ithaca, N. Y.

June 28 and 29

1948 West Coast Convention of the I.R.E., Los Angeles, Calif.

September 30-October 2, 1948

National Electronics Conference, Chicago, Ill.

November 4-6, 1948

Petition for Amendment of Article II, Sections 1-c and 2-c, of the Constitution

TO THE MEMBERS OF I.R.E.:

As a result of the elections of August 15, 1947, the following Sections were added to the Constitution:

ARTICLE II, SECTION 1-c: "Special Members, who shall be entitled to all rights and privileges of the Institute except the right to hold the offices of President and Vice President."

ARTICLE II, SECTION 2-c: "Special Member is a grade limited to those who have shown an interest in furthering the radio or allied arts and sciences and who have attained such position or prestige that by membership they shall advance the objectives of the Institute. This grade shall be conferred only by invitation of the Board of Directors.

Upon the inclusion in the Constitution of the foregoing Sections, the following Bylaw was adopted by the Board:

SECTION 2-a: "Special Member: The grade of Special Member shall be conferred only upon a person who is at least thirty-two years of age and who meets the requirements of the grade set forth in the Constitution. Proposals for election to the grade, together with supporting information, may be presented by a member of the Board of Directors at any meeting of the Board. After full consideration at a Board meeting, the proposal, unless withdrawn, shall be placed on the agenda for action at the next Board meeting. A favorable vote of at least two-thirds of the members of the Board present shall be required for election."

The foregoing Sections, which are now part of the Constitution and Bylaws, were planned by the Board of Directors to provide a special grade of membership which could be awarded by the Board to *nonprofessional* workers in the radio field, as recognition of their outstanding contributions to the Institute, or to the profession of radio engineering. It was desired to confer favorable recognition by the Institute upon individuals deserving of such action, but not meeting certain of the professional qualifications for the other higher grades of membership.

It appears that some Institute members became concerned that a large number of such Special Members would be appointed by the Board and that, having the privilege of voting, such Special Members might eventually have a voice in the operation of the Institute that would be disproportionately large for nonprofessionals. This concern is reflected in a petition which the Board has received, for submission to the membership, which petition proposes the following new Constitutional Amendment:

"That ARTICLE II, Section 1-c be amended to read as follows:

"c. Honorary Members, who shall be entitled to all rights and privileges of the Institute except the right to hold the offices of President, Vice-President, and Director, and the right to vote.

"That ARTICLE II, Section 2-c be amended as follows:

"Substitute 'Honorary Member' for 'Special Member'."

Those who signed the petition proposing the above amendment were:

George Rodwin
W. J. Brackmann
F. A. Polkinghorn
E. W. Houghton
W. H. Tidd
H. F. Winter
E. J. Drazy
H. P. Kelly
A. E. Kerwien
O. E. DeLange
W. M. Goodall
C. F. P. Rose
Lloyd E. Hunt
J. P. Schafer
L. G. Young
A. C. Beck
W. E. Koch
W. M. Sharpless
L. R. Lowry
D. H. Ring
C. F. Edwards
Sloan D. Robertson
Archie P. King
A. Gardner Fox
A. E. Bowen
Howard A. Chinn
Robert B. Monroe
Richard S. O'Brien
Donald E. Maxwell
William B. Lodge
A. B. Chamberlain
Jay W. Wright
James D. Parker
W. Howard Moffat
Price Fish
Henry F. Shull, Jr.
Cameron B. McCulloch
Ted Denton
James B. French
Albert R. Hodges
D. S. Rau
J. L. Finch
H. Tanck
L. R. Kahn
Walter Lyons
Lynn C. Everett
A. C. Venditto
E. D. Becken
I. K. Given
K. N. Cumming
S. H. Simpson, Jr.
O. M. Dunning
O. M. Salati
C. J. Hirsch
Knox McIlwain
Charles E. Dean
Robert E. Schneider
W. C. Hahn
J. M. Lafferty
Albert W. Hull
R. A. Dehn

N. T. Lavoo
Richard B. Nelson
D. E. Chambers
E. D. McArthur
Stuart Wm. Seeley
Earl I. Anderson
Earl Schoenfeld
William Brown
Richard A. Maher
G. S. Wickizer
G. E. Hansell
J. B. Atwood
R. W. George
DeWitt R. Goddard
Kenneth G. MacLean
Harry R. Summerhayes, Jr.
Thomas M. Wilson
R. V. Pohl
C. W. Clapp
M. T. Reynolds
Harry R. Meahl
Stephen C. Clark, Jr.
Fred E. Dickey
George F. Waggoner
Ellsworth D. Cook
Franklin G. Patterson
Philip M. Garratt
Frank J. Moles
Wm. G. Broughton
S. W. Upham
Richard F. Shea
Gilbert R. Odum
Carl J. Scheiner
W. H. Hall
John L. Callahan
Joseph J. Coughlin
Lawrence A. Reilly
H. L. Krauss
C. D. Hewitt
Roger C. Curtis
Sydney E. Warner
R. M. Bowie
A. E. Martin
Paul G. Bohlke
L. H. McKee
F. C. Breeden
G. D. O'Neill
Neen Lund
Paul G. Edwards
O. D. Engstrom
C. H. Rumpel
H. A. Wenk
W. J. Albersheim
Karl G. Jansky
W. D. Lewis
R. S. Ohl
C. R. Englund
Warren A. Tyrrell
W. W. Mumford

Henry Grossman
R. Thompson
L. H. Bowman
W. A. Cobb
J. F. Novy
A. W. Aird
J. D. Cobine
D. E. Norgaard
S. Roberts
A. M. Gurewitsch
Saul Dushman
V. H. Fraenckel
Julius Weinberger
Allen A. Barco
Frank Mural
Robert F. Romero
H. M. Bach
Gordon F. Rogers
Arthur M. Braaten
Robert E. Schock
F. J. W. Schoenborn
W. A. Ford
G. E. Feiker, Jr.
Edward F. Travis
Robert W. Hodgers, Jr.
Philip H. Peters, Jr.

W. H. Teare
E. F. W. Alexander-son
E. S. Lee
Estill G. Roberts, Jr.
Bradford K. Hawes, Jr.
E. F. Carr
A. W. Sear
N. E. Schick
O. E. Dow
G. L. Usselman
Nils E. Lindenblad
Eugene R. Shenk
Henry E. Hallborg
Anthony Liguori
Philip C. Kelsey
Frederick N. Larock
John L. Bower
L. B. Grew
B. Bliss
W. Robert Dresser
Peter V. Colmar
Quentin Q. Quinn
H. S. Moncton
(Four additional signatures illegible)

The letter accompanying the petition to the Board of Directors is as follows:

To the Board of Directors,
Institute of Radio Engineers
1 East 79 Street
New York, N. Y.

Gentlemen:

Among the new amendments to the Constitution, recently approved by the Institute membership, was one creating the new grade of Special Member. Due to the form in which these amendments were presented en masse to the membership, there was no opportunity for an individual vote on the various items, and many members undoubtedly approved the whole, while dissatisfied with some individual item. In this category, I am sure, falls this creation of the Special Member grade.

The principal arguments advanced in favor of creating this new grade are that there are many outstanding members of the radio industry who have made definite contributions to the art and to the Institute, yet these members, being nontechnical people are eligible only for the Associate grade at present, which grade is not felt to confer the requisite distinction, or there are industry executives who do not belong to the Institute, do not support it, and in many cases begrudge the active participation of their engineers in Institute affairs. It is argued that conferring a special membership upon these individuals would make them active supporters of the Institute in many ways.

The arguments against this grade in its present form are that these Special Members have every right and privilege of Senior Members, except the right to the offices of President and Vice-President, that they

therefore may be Directors, may be Chairmen of sections, may serve on committees, even as chairmen, and gradually may encroach into a controlling position in Institute affairs. Another point against the inclusion of nontechnical members in the Institute is that it runs directly counter to current attempts to improve the professional position of the engineer, to set him up on a level comparable with his professional brothers.

Recognizing the desirability of enabling the Board to confer honorary recognition upon outstanding industry leaders, yet at the same time guarding against degradation of the professional caliber of the Institute, the attached Constitutional Amendment is submitted. This Amendment, in general, has two objectives:

(1) to change the name of this grade to "Honorary Member" instead of "Special Member," as being more descriptive of the intent of this grant, and to eliminate any objectionable connotations of the word "Special";

(2) to deprive these Honorary Members of the right to hold office or vote, and thereby protect the Institute against nonprofessional encroachment.

It is also respectfully suggested that this letter be published in the PROCEEDINGS, and that ample provision be made for a full and unbiased discussion of this proposed Amendment before it is put to a vote by the membership.

Respectfully,
/S/ R. F. Shea
R. F. SHEA

RFS: ab

Accordingly, at its meeting of January 7, 1948, the Board appointed the undersigned as a Special Committee to inform the membership, through the PROCEEDINGS, of the present situation and to provide the requested opportunity for full discussion. The Board and this Special Committee regard the following related matters as especially pertinent.

In relation to a first point, the informal opinion of the Board may be expressed as follows. The right of Special Members to vote is regarded by the Board as of minor practical and administrative significance or effect. Accordingly, the Board has no strong objection to the proposal that Special Members shall not have voting privileges.

However, as a second point, it should be noted that, if Special Members (however designated) are debarred from becoming Directors, not only will the general membership of the Institute become unable to select such persons as Directors at Large, but the largely autonomous Regions will similarly be prohibited from choosing such Special Members as their representatives on the Board of Directors.

As a third point, the Board emphatically recommends against the use of the term, "Honorary Member," as proposed in the new amendment, to designate members of the new *nonprofessional* grade. The Board holds no brief for the present term, "Special Member," but feels strongly that the qualifications as required by ARTICLE II, Section 2-c of the Constitution (see above) are not suf-

ficiently rigid to define an individual to whom the grade of "Honorary Member" should properly be awarded. In fact, the qualifications were drawn to define an entirely different type of membership than that customarily designated by the term "Honorary."

Information available to this Committee indicates that, either by specific provision or accepted procedure, learned and professional societies in general confer Honorary Membership only upon persons of outstanding *professional* attainments. The Committee feels that to apply the name of "Honorary Member" to individuals who need have only the nonprofessional qualifications now required for Special Members would be inappropriate, misleading, and not in accord with the dignity of the Institute.

This raises a fourth question for discussion, viz., is there a better name than "Special Member" or "Honorary Member" for individuals who meet the qualifications of ARTICLE II, Section 2-c, but who are not professionally qualified for the higher grades of Institute membership? Neither the Board of Directors nor this Committee has been able to find such a term preferable to "Special Member." Suggestions on this point will be appreciated by this Committee.

Obviously, the considerable number of letters which, it is hoped, will be received by the Committee could not be published in their entirety in the PROCEEDINGS. Accordingly, the Committee will welcome specific answers to the following questions which, it is believed, cover the salient matters under consideration:

1. Should "Special Members," however designated, who may be elected on the basis of the *nonprofessional* qualifications of Article II, 2-c, be permitted to vote?
2. Should "Special Members," however designated, who may be elected on the basis of the *nonprofessional* qualifications of Article II, 2c, be permitted to hold office as Director, but not as President or Vice-President?
3. Should the term "Honorary Member" be used to designate individuals who may be elected on the basis of the *nonprofessional* qualifications of Article II, 2-c?
4. To what other designation, if any, should the name, "Special Member," be changed?

The Committee undertakes to prepare for publication a summary of the viewpoints of those members addressing the Committee relative to the above questions. The proposed new amendment will not be submitted to the membership until such summary has been prepared and published. In the meantime, the Board of Directors has decided that it will take no action toward the consideration or election of any individual to the grade of Special Member.

Please address your communications to The Institute of Radio Engineers, 1 East 79 St., New York 21, N. Y., attention of the Executive Secretary.

A. N. GOLDSMITH
J. V. L. HOGAN
B. E. SHACKELFORD

AMERICAN MATHEMATICAL SOCIETY SYMPOSIUM

The American Mathematical Society will hold its second annual Symposium in Applied Mathematics at the Massachusetts Institute of Technology from July 29 to 31, 1948. The subject for the Symposium will be Electromagnetic Theory; this subject will be interpreted in a broad sense to include problems of a mathematical nature arising out of electron optics and quantum electrodynamics, as well as electromagnetic field problems related to diffraction, radiation, and the like. Particular attention will be given also to the rapidly developing subject of information theory as related to spectral band width and noise.

Following the invitation of Dr. John L. Synge, chairman of the Committee on Applied Mathematics of the American Mathematical Society, The Institute of Radio Engineers will act as co-sponsor of the Symposium in conjunction with the American Institute of Physics. The program is being arranged by the Society's Committee on Arrangements for the Symposium.

To avoid congestion of the program and leave ample time for discussion, the formal program will consist of invited papers of 20 or 40 minutes. Programs and information regarding accommodations will be mailed to all members of the American Mathematical Society early in July. Others who wish to receive this material are requested to write to Associate Secretary T. R. Hollcroft, American Mathematical Society, 531 West 116 Street, New York 27, N. Y.

Industrial Engineering Notes¹

GERMAN TELEVISION DEVELOPMENTS

The Office of Technical Services released a report on television development and applications in Germany. The report contains technical information on image-storage devices, antennas, amplifiers, television cameras, cathode-ray tubes, photoelectric and thermionic multipliers, projection systems and screens, and facsimile transmission.

Copies of the 81-page report (PB-75819) sell for \$2.25, and may be obtained from the Office of Technical Services, Department of Commerce, Washington 25, D. C. Orders should be accompanied by check or money order payable to the Treasurer of the United States.

GERMAN CERAMICS REPORT

Further advances in the German ceramics industry are described in a report released yesterday by the OTS. The report, the sixth OTS document on the subject, describes the composition and electrical and mechanical properties of two titanium-oxide

¹ The data on which these NOTES are based were selected, by permission, from "Industry Reports," issues of February 13, 20, and 27, and March 5 and 12, 1948, published by the Radio Manufacturers' Association, whose helpful attitude in this matter is hereby gladly acknowledged.

bodies with a high dielectric constant and low loss. Copies of the report (PB-79644; 50 cents) may be obtained from the OTS, Department of Commerce, Washington, D. C.

SYNTHETIC MICA REPORT

The specialized composition and shapes of the crucibles employed in melting synthetic mica are described in a report on sale by the OTS, Department of Commerce. The report, the OTS says, supplements six other reports previously released on German production of synthetic mica. Mimeographed copies of the report (PB-63552) may be obtained from the OTS, Department of Commerce, Washington 25, D. C., at 50 cents a copy. Orders for the document should be accompanied by check or money order payable to the Treasurer of the United States.

MILITARY POLICE RADIO

Signal Corps engineers are now working on the development of military-type v.h.f. transmitters and receivers to be used by vehicular-mounted military police for two-way voice communication. The new equipment, designed to operate on a frequency range of 30.0 to 44.0 Mc., will be used in f.m. transmission, and the receiver will be capable of receiving both a.m. and f.m. signals. Development of a h.f. vehicular a.m. receiver to provide one-way voice communication from fixed civilian police headquarters to vehicular-mounted military police patrols also is contemplated.

NEW BATTERY SPECIFICATIONS

The U. S. Bureau of Standards issued new specifications for dry cells and batteries. The new specifications, to be known as American Standard C18-1947, cover all types of batteries commonly used by the public. Included are specifications for radio battery packs combining low voltage for the A circuit and a higher voltage battery for the B circuit, a more complete standardization for hearing aid batteries, and standardized socket connections for radio A, B, and C batteries. Copies of the specification (Circular 466) may be obtained from the Superintendent of Documents, Washington 25, D. C., at ten cents each.

GERMAN INDUSTRIAL AND MEDICAL RADIOGRAPHY

A group of ten reports describing wartime developments in German industrial and medical radiography, including information on high-voltage betatrons and neutron generators, was released by the OTS, Department of Commerce. The reports are: PB-18929, German betatrons, 50 cents; PB-55, X-ray apparatus, 10 cents; PB-302, manufacture of X-ray tubes, etc., 10 cents; PB-336, German X-ray and electromedical industry, 25 cents; PB-482, X-ray industry, 25 cents; PB-17551, the industrial X-ray field in Germany, 50 cents; PB-25635, betatron development in Germany, 25 cents; PB-20464, Nondestructive testing of materials, 25 cents; PB-23651, ultrasonic re-

search and development in X-ray equipment, 25 cents; and PB-25556, the non-destructive testing of materials and X-ray protection methods, 25 cents.

Address the Office of Technical Services, Department of Commerce, Washington 25, D. C. Check or money order should be made payable to the Treasurer of the United States.

BRITISH PRINTED CIRCUITS

According to information furnished RMA by the Department of Commerce, Sargrove Electronics, Ltd., of England has developed a 70-foot machine which automatically produces printed-circuit radio receivers at the rate of one every 20 seconds. The company, according to reports, recently announced an order for 100,000 small two-tube receivers for India.

AIRCRAFT INSTRUMENT DESIGN ANALYZED

The accuracy of instrument dial reading generally increases with the dial size; but when dials exceed two inches in diameter, accuracy tends to decrease, according to one of three research reports on aircraft instrument design prepared for the Army Air Forces and now on sale by the OTS, Department of Commerce. Copies of the reports (PB-81416, microfilm \$1.50 or photostat \$3; PB-81417, microfilm \$1.25, photostat \$2; PB-81418, microfilm \$1.50, photostat \$3). Orders for the reports should be addressed to the OTS, Department of Commerce, Washington 25, D. C., and should be accompanied by check or money order made payable to the Treasurer of the United States.

HIGH-FREQUENCY HEATING USED BY GERMANS

The Germans were fully aware of the industrial possibilities of high-frequency electronic heating and were reasonably far advanced in the techniques involved, according to a report released recently by the OTS.

The Germans, according to the report (PB-75851; \$1), used high-frequency heating in wood gluing, timber drying, cigarette manufacture, plastics heating, lice killing, and food processing, among other purposes. Orders for the report should be addressed to the OTS, Department of Commerce, Washington 25, D. C., and should be accompanied by check or money order made payable to the Treasurer of the United States.

AGENCY FOR INDUSTRIAL MOBILIZATION

The National Security Resources Board, a new Government agency created to cover generally the field of the emergency agencies of World War II such as OWM, WPB, ODT, OPA, and others, stepped up its operations in March by setting up an organizational chart of 24 divisions covering the entire military, industrial, and civilian mobilization fields. Present plans of the Board call for the organization of a radio and electronics section in the Production Facilities Division.

The new agency was created under the

National Security Act of 1947 and has the responsibility under the law to "advise the President concerning the co-ordination of military, industrial and civilian mobilization." The Board is a separate Government agency responsible to the President of the United States.

The organizational chart of the Board shows 20 Mobilization Planning Staff Divisions which are broken down further into the following four groups: divisions dealing with industrial resources, which includes the Production Facilities Division under which a radio section would operate; divisions dealing with material resources; divisions dealing with human resources; divisions dealing with organization and management.

The Board is headed by Arthur M. Hill, of Charleston, W. Va., and its membership consists of the Secretaries of the Treasury, Defense, Interior, Agriculture, Commerce and Labor.

F.M. LICENSES EXTENDED TO THREE YEARS

The F.C.C. amended its Rules and Regulations to extend the normal license period of commercial and noncommercial f.m. broadcast stations to three years after a preliminary licensing period based upon a system of expiration dates to fit a staggered schedule for renewal of licenses. The new procedure became effective May 1, 1948.

This action is the result of a rule proposed on December 16, 1947 (Docket 8467), which contemplated a staggered renewal system for f.m. No objections were received to that plan. However, suggestions and comments favored the same license period for f.m. that standard broadcast stations have, the F.C.C. said. Although a.m. stations were not given three-year licenses until after 16 years of operation, the Commission recognized the rapid development of f.m. as meriting the statutory maximum license period.

RULES GOVERNING RADIO DEVICES ADOPTED BY F.C.C.

That portion of the F.C.C. rules and regulations governing the operation of medical diathermy and industrial heating equipment issued on April 30, 1948, will not also apply to the operation of miscellaneous radio-frequency devices. Copies of the F.C.C. order (Mimeograph No. 17593) may be obtained from the Secretary, Federal Communications Commission, Washington 25, D. C.

The F.C.C. stated that manufacturers proposing to produce this equipment in volume may submit their equipment to the Commission's Laboratory at Laurel, Md., upon approval of a request addressed to the F.C.C. Secretary.

ANTENNA RULE CHANGE PROPOSED

A proposal to liberalize its rules and regulations governing the use of a common antenna by one or more standard broadcast stations or by standard broadcast stations and stations of any other service was issued by the F.C.C. on March 11. The proposal (Mimeograph No. 17511) would permit operation of a single antenna by two or more stations "provided one of the licensees accepts responsibility for maintaining, painting, and illuminating the structure, thus

permitting more efficient utilization of available transmitter sites."

RULE CHANGE PROPOSAL DISMISSED BY F.C.C.

The F.C.C. abandoned its proposal to change its rules and regulations governing the emissions of transmitters in the experimental, emergency, miscellaneous, railroad, and utility radio services and dismissed the proceedings in Docket 8294, which it had instituted on April 10, 1947. The F.C.C. felt it inadvisable to lump the proceedings together as had been proposed, and the amendments will be taken up individually at a later date.

CHECK LIST OF F.C.C. RULES

The F.C.C. issued a check list of its rules and regulations (Public Notice 18383) to provide a means for individuals possessing books of the Commission's rules and regulations to check for their completeness. All rules and regulations listed are on sale by the Superintendent of Documents. Copies of this list may be obtained from the Secretary of the F.C.C., Washington, D. C.

NAVY ELECTRONIC DIVISION CHANGES

Two top officials of the Electronic Division of the Bureau of Ships, U. S. Navy Department, changed position this week, one going to private industry and the other being shifted within the service.

Captain D. R. Hull (A'36-F'47) who was chief of the Electronic Division for about a year, was retired from the Navy on February 25, and joined the Federal Telephone & Radio Corporation on March 1 in an executive capacity. In another personnel shift, Commander W. I. Bull, (S'42-A'43) chief of the Equipment Branch, Electronics Division, moves to Pearl Harbor as electronics officer. He will be succeeded by Commander E. G. Howard (S'42-A'44), who has served the division as head of the Requirements and Distribution Section.

ONE BILLION FOR AIR TRAFFIC CONTROL

A new integrated system of air traffic control, intended to meet both military and civil requirements and costing an estimated \$1,113,000 for installations and development of new equipment, has been recommended by the Radio Technical Commission for Aeronautics, for consideration of government and private aviation concerns. "The program requires some fifteen years for complete development, installation, and training of operators," the RTCA said. "Meanwhile it is essential that something be done to relieve the present congested condition of the airways in the interest of national defense." To overcome this condition, an immediate interim program is proposed to be completely installed and operating within a five-year period. This comprises installation of low-cost, lightweight v.h.f. receivers to permit use of static-free voice channels and omnidirectional range navigation on small aircraft. Additional instrument-landing-system and ground-controlled-approach installations also are proposed under the interim program.

The cost of the interim RTCA program is estimated at \$376,200,000, and all equipments, except the v.h.f. automatic direction finders, would be integrated into the final target system. It is proposed to utilize existing air navigation and traffic control facilities during the interim, completion of a radar cover of the more crowded traffic areas, and installation of airborne transponders in all aircraft capable of planned instrument flight. The full program would be financed by government and private aviation agencies jointly.

AIR NAVIGATION AIDS RECEIVE SPACE IN 960-1660-Mc. BAND

The F.C.C. issued a new table of frequency allocations, effective April 2, 1948, providing channels in the 960- to 1660-Mc. band for the aeronautical services. In the opinion of the F.C.C., "certain important air navigation functions cannot be performed within the 960 to 1215 Mc. band previously allocated but that additional frequencies up to 1660 Mc. are required." Other nongovernment services now operating between 1295 and 1425 Mc. will be permitted use of those frequencies until they are actually occupied by the aeronautical radio navigational aids.

SIGNAL CORPS ANNIVERSARY

The U. S. Signal Corps on March 3, 1948, observed its 85th anniversary without formal observance of the passage by a Civil War Congress of legislation establishing it as a separate branch of the service. The Corps grew out of the work of an Army Surgeon, Albert J. Myer, whose system of signals for communication was developed in an effort to perfect a sign language for the deaf.

CALIFORNIA HEADS LIST

California has more authorized broadcast stations than any other state, according to a tabulation released by the F.C.C. California also heads the states in the number of television authorizations, with 12. New York has 10, Ohio 9, and Pennsylvania 6.

In standard authorizations, Texas heads the list with 153, followed by California's 129, Pennsylvania's 58, New York's 89, and North Carolina's 86. In number of f.m. authorizations, California tops the list with 87, followed by Pennsylvania with 80, New York with 79, and Ohio and Texas with 66 each. Two states—New Jersey and Ohio—and the District of Columbia have more f.m. than a.m. grants. Only two states—Montana and Vermont—presently have no f.m. authorizations.

F.M. AND TELEVISION STATIONS

With 432 f.m. stations on the air on March 11, the F.C.C. issued five conditional grants for new outlets at Tuscaloosa, Ala., Bakersfield, Calif., Weiser, Idaho, San Juan, P.R., and Arlington, Va.

Since early February of this year the new f.m. stations which began operation are: Dubuque, Iowa (WDBQ); Easton, Pa. (WEEX-FM); Fort Smith, Ark. (KFSA-FM); Siloam Springs, Ark. (KUOA-FM); West Palm Beach, Fla. (WJNO-FM); Con-

nersville, Ind. (WCNB-FM); Uniontown, Pa. (WMBS-FM); Cleveland, Ohio, (WJW-FM); Dayton, Ohio (WHIO-FM); Columbia, S. C. (WIS-FM); Fresno, Calif. (KARM); Lewiston, Me. (WCOU-FM); Flint, Mich. (WAJL); Durham, N. C. (WDNC-FM); San Angelo, Tex. (KGKL-FM); Lewiston, Pa. (WLTN); Washington, Ind. (WFML); Crawfordsville, Ind. (WFMU); Chicago, Ill. (WBIK); Blytheville, Ark. (KLCN-FM); Watertown, N. Y. (WWNY-FM); Madison, Wis. (WIBA-FM); Williamsport, Pa. (WRAC-FM); Aurora, Ill. (WBNU); Quincy, Ill. (WTAD-FM); Greensboro, N. C. (WFMY); Newman, Ga. (WCOH-FM); Hartford, Conn. (WTHT-FM); Haverhill, Mass. (WHAU-FM); Boston, Mass. (WHDH-FM); St. Petersburg, Fla. (WTSP-FM); Alexandria, Va. (KALB-FM); and Clarksburg, W. Va. (WPDH-FM).

More than 900 f.m. construction permits and conditional grants were outstanding in March, and 127 f.m. applications were pending. In all, 89 television stations have received Commission approval, including 82 construction permits and 7 licenses. Applications pending before the F.C.C., as of March, were 151. There were at this time 18 commercial television broadcasting stations in operation. Two new television stations on the air are WCN-TV in Chicago, and WTVR in Richmond, Va.

W.U. PLANS TELEVISION RELAY

The Western Union Telegraph Company has asked F.C.C. for construction permits for six Class 2 stations to operate microwave relay channels for television between New York and Philadelphia. The proposed television relay system would utilize frequencies 5926 and 6425 Mc.

F.C.C. PROVIDES INTERCITY TELEVISION RELAYS

Provision for operation of intercity television relays by broadcaster was made by the F.C.C. in a report (Mimeograph No. 17266) which specified three bands to be used for that purpose. The bands, 1990-2110 Mc., 6875-7125 Mc., and 12,700-13,200 Mc., are to be used "temporarily and secondarily" for television relay purposes and primarily for television pickup and studio-to-transmitter-links purposes.

It was also ruled that requirements for theater television are still not sufficiently clear to indicate the need for a specific allocation for its exclusive use now. Copies of this report may be obtained from the Secretary of the Federal Communications Commission, Washington 25, D. C. It includes an allocation table for the frequencies 1000-13,200 Mc. for nongovernment fixed and mobile services, which became effective April 2, 1948.

TELEVISION NETWORK FACILITIES EXTENDED TO MIDWEST

Plans to construct additional television network channels this year were announced this week by the American Telephone & Telegraph Company. Included in the program, according to press announcements, are 2,000 miles of television network chan-

nels from Buffalo to St. Louis, which will be available in time for the football season this fall. Both microwave radio-relay systems and coaxial cables are to be used for the television networks, according to the announcement.

LAND TRANSPORTATION SERVICE

Authorized radio stations in the Land Transportation Service, including taxicabs, busses, trucks, transit utility, and railroad radio stations, totalled 2,616 at the end of January, according to F.C.C. tabulations. This compares with 2,447 stations of this category at the end of December, 1947. The figures do not include many mobile transmitters in the taxicab and other services which are covered by a single authorization.

Taxicab stations numbered 2,324 in January, an increase of 168 authorizations over the 2,156 reported at the end of December. Intercity bus and truck stations remained at 65, and transit utility authorizations increased by 5 to reach 70 in the one-month period. The number of railroad stations dropped from 193 in December to 189 in January. Common-carrier stations totalled 607, compared with 576 at the end of December, 1947.

F.M. STATION RANGE EXTENSION

Reliable service areas of f.m. broadcast stations using transmitters now available may be extended far beyond the horizon, according to indications obtained in experimental research conducted by K. A. Norton of the National Bureau of Standards.

According to the Bureau official's research report, "the most effective way to increase the service range of an f.m. broadcast station is to increase the transmitting antenna height rather than the power, since such a change, by lengthening the line of sight, increases the service range more rapidly than the interference range, resulting in a more efficient utilization of the channel." It seems probable "that there exists, for a particular set of conditions in the lower troposphere, an optimum frequency for propagation to large distances beyond the horizon. However, experimental data now available are not sufficient to locate these optimum frequencies in the spectrum."

A paper by Dr. Norton in the April issue of the Bureau's "The Technical News Bulletin," analyzes the time variation of intensities received during the past year from f.m. stations. This analysis shows that atmospheric "ducts" and boundary layers in the lower troposphere both have the effect of reducing the attenuation of high-frequency radio waves with distance at points beyond the line of sight. "These results," Dr. Norton said, "are expected to provide a firmer basis for the prediction of the service and interference ranges of f.m. broadcasting stations; they should also aid in the solution of problems that may occur in connection with other uses of the spectrum above 30 Mc."

Copies of Dr. Norton's article may be obtained from the Superintendent of Documents, Washington 25, D. C., at ten cents each.

TELEVISION SET OUTPUT

The January output of television receivers by RMA member-companies reached a new high of 30,001, exceeding slightly the December production of 29,345 despite the fact that December's total included five work weeks as against four in January.

F.m.-a.m. set production dropped to 136,015 from 191,974, but much of this difference was due to the extra week in December. January's f.m.-a.m. total represented an increase of about 40 per cent over the 1947 monthly average. Total set production by RMA manufacturers in January was 1,339,256—the lowest output since September, 1947—as compared with 1,705,918 in December. It was also below the January, 1947, production of 1,564,171 although the latter output covered five weeks as compared with four this year.

A preliminary tabulation of index reports from RMA parts manufacturers on January sales to manufacturers and to jobbers, showed a decline below December levels, as did radio set production.

ARGENTINE RADIO INDUSTRY DESCRIBED

A report from the U. S. Embassy in Argentina says some 3,000 concerns are engaged in the assembly of radio receivers in that country, but that 14 firms are considered leaders of the industry. However, the report indicates that 40 per cent of the country's radio output is accounted for by the smaller concerns.

Quality of sets manufactured by the large concerns, the Embassy report stated, is "equal or almost equal" to American-made receivers. RCA, Philips, Philco, and General Electric control the four principal Argentina concerns, the report said.

Radio tubes are produced in Argentina only by the Philips company, but other components are produced by some 25 manufacturers. These components include coils, capacitors, cabinets, and transformers.

The complete report is expected to be published by the OIT in the "World Trade in Commodities" service of the Department of Commerce.

OPA RECORD RETENTION ORDER ABOLISHED

Radio manufacturers no longer need preserve records required by the OPA. At the time of decontrol by the OPA these records were required to be preserved for one year, but during 1947 the order was extended for two additional years until November 9, 1949. This action limits record-keeping under the Emergency Price Control Act of 1942 to the following three groups: Parties to pending actions; recipients or claimants of subsidy, premium, or other payments from the Government; and sellers of commodities or services to the Government under adjustable price schedules.

DECLINE IN JANUARY EXCISE COLLECTIONS

The seasonal decline in the production of radios and phonographs was reflected in the January collections of the 10 per cent excise tax on radios and phonographs and certain of their components, according to the

Bureau of Internal Revenue. January collections fell more than two million dollars below the collections in December, 1947, and also dropped below the January, 1947, collections.

Television receiver production continued to climb in February to a new peak as f.m.-a.m. receivers advanced above the January figure.

Manufacture of television sets during February was 35,889, bringing their total production since the war to 250,937. The February television output, which was 5,888 more than RMA member-companies manufactured in January, represented an annual production rate of more than 430,000 and an increase of 141 per cent over the average 1947 monthly output during 1947.

F.m.-a.m. receivers reported by RMA member-companies for February totalled 140,629 or an increase of 4,614 over January, but still below the monthly average of the last quarter of 1947. About 36 per cent of these receivers were table models and converters.

Over-all set production was slightly ahead of January and about equal to the output in February, 1947. Last February RMA members turned out 1,379,605 receivers, as compared with 1,339,256 in January.

RMA MEETINGS

The following RMA meetings have been held:

- February 20—Subcommittee on Studio-Transmitter Links
- February 26—Subcommittee on Transmitting Tubes
- February 26—Subcommittee on Glass Characteristics
- February 27—Committee on F.M. Broadcast Transmitters
- March 5—Subcommittee on Tube Sockets
- March 5—Subcommittee on Crystals
- March 9—Subcommittee on Wood Containers
- March 11—Committee on Sampling Procedure
- March 23—Subcommittee on Magnetic Recorders
- March 23—Committee on Cathode-Ray Tubes
- March 23—Subcommittee on Capacitors
- March 23—Subcommittee on Loran
- March 23—Subcommittee on Transmitters
- March 23—Subcommittee on Acoustic Devices
- March 24—Committee on Acoustic Devices
- March 24—Committee on Thermoplastic Hookup Wire
- March 24—Committee on Components Standardization
- March 24 and 25—Subcommittee on Systems Standards of Good English Practice
- March 25—Committee on High-Frequency Cores
- March 25—Subcommittee on Electrolytic Capacitors
- March 26—Subcommittee on Studio Facilities
- March 26—Subcommittee on Gas-Filled Microwave Transmission Lines

Sections

Chairman		Secretary	Chairman		Secretary
W. A. Edson Georgia School of Tech. Atlanta, Ga.	ATLANTA May 21	M. S. Alexander 2289 Memorial Dr., S.E. Atlanta, Ga.	E. T. Sherwood Globe-Union Inc. Milwaukee 1, Wis.	MILWAUKEE	J. J. Kircher 2450 S. 35th St. Milwaukee 7, Wis.
F. W. Fischer 714 Beechfield Ave. Baltimore 29, Md.	BALTIMORE	E. W. Chapin 2805 Shirley Ave. Baltimore 14, Md.	R. R. Desaulniers Canadian Marconi Co. 211 St. Sacrement St. Montreal, P.Q., Canada	MONTREAL, QUEBEC May 15	R. P. Matthews Federal Electric Mfg. Co. 9600 St. Lawrence Blvd. Montreal 14, P.Q., Canada
John Petkovsek 565 Walnut Beaumont, Texas	Beaumont— Port Arthur	C. E. Laughlin 1292 Liberty Beaumont, Texas	J. E. Shepherd 111 Courtenay Rd. Hempstead, L. I., N. Y.	NEW YORK June 2	I. G. Easton General Radio Co. 90 West Street New York 6, N. Y.
W. H. Radford Massachusetts Institute of Technology Cambridge, Mass.	BOSTON	A. G. Bousquet General Radio Co. 275 Massachusetts Ave. Cambridge 39, Mass.	C. G. Brennecke Dept. of Electrical Eng. North Carolina State Col- lege Raleigh, N. C.	NORTH CAROLINA- VIRGINIA	C. M. Smith Radio Station WMIT Winston-Salem, N. C.
A. T. Consentino San Martin 379 Buenos Aires, Argentina	BUENOS AIRES	N. C. Cutler San Martin 379 Buenos Aires, Argentina	K. A. Mackinnon Box 542 Ottawa, Ont. Canada	OTTAWA, ONTARIO May 20	D. A. G. Waldock National Defense Headquarters New Army Building Ottawa, Ont., Canada
R. G. Rowe 8237 Witkop Avenue Niagara Falls, N. Y.	BUFFALO-NIAGARA May 19	R. F. Blinzler 558 Crescent Ave. Buffalo 14, N. Y.	P. M. Craig 342 Hewitt Rd. Wyncote, Pa.	PHILADELPHIA June 3	J. T. Brothers Philco Radio and Tele- vision Tloga and C Sts. Philadelphia 34, Pa.
G. P. Hixenbaugh Radio Station WMT Cedar Rapids, Iowa	CEDAR RAPIDS	W. W. Farley Collins Radio Co. Cedar Rapids, Iowa	E. M. Williams Electrical Engineering Dept. Carnegie Institute of Tech. Pittsburgh 13, Pa.	PITTSBURGH June 14	E. W. Marlowe 560 S. Trenton Ave. Wilkinburgh PO Pittsburgh 21, Pa.
Karl Kramer Jensen Radio Mfg. Co. 6601 S. Laramie St. Chicago 38, Ill.	CHICAGO May 21	D. G. Haines Hytron Radio and Elec- tronics Corp. 4000 W. North Ave. Chicago 39, Ill.	O. A. Steele 1506 S.W. Montgomery St. Portland 1, Ore.	PORTLAND	F. E. Miller 3122 S.E. 73 Ave. Portland 6, Ore.
J. F. Jordan Baldwin Piano Co. 1801 Gilbert Ave. Cincinnati, Ohio	CINCINNATI May 18	F. Wissel Crosley Corporation 1329 Arlington St. Cincinnati, Ohio	N. W. Mather Dept. of Elec. Engineering Princeton University Princeton, N. J.	PRINCETON	A. E. Harrison Dept. of Elec. Engineering Princeton University Princeton, N. J.
W. G. Hutton R.R. 3 Brecksville, Ohio	CLEVELAND May 27	H. D. Seielstad 1678 Chesterland Ave. Lakewood 7, Ohio	A. E. Newlon Stromberg-Carlson Co. Rochester 3, N. Y.	ROCHESTER May 20	J. A. Rodgers Huntington Hills Rochester, N. Y.
C. J. Emmons 158 E. Como Ave. Columbus 2, Ohio	COLUMBUS May 14	L. B. Lamp 846 Berkeley Rd. Columbus 5, Ohio	E. S. Naschke 1073-57 St. Sacramento 16, Calif.	SACRAMENTO	G. M. Cummings 7200 Delta Ave. Richmond Height 17, Mo.
L. A. Reilly 989 Roosevelt Ave. Springfield, Mass.	CONNECTICUT VALLEY May 28	H. L. Krauss Dunham Laboratory Yale University New Haven, Conn.	G. M. Cummings 7200 Delta Ave. Richmond Height 17, Mo.	ST. LOUIS	N. J. Zehr Radio Station KWK Hotel Chase St. Louis 8, Mo.
J. G. Rountree 4333 South Western Blvd. Dallas 5, Texas	DALLAS-Ft. WORTH	J. H. Homsy Box 5238 Dallas, Texas	C. N. Tirrell U. S. Navy Electronics Lab. San Diego 52, Calif.	SAN DIEGO June 1	S. H. Sessions U. S. Navy Electronics Lab. San Diego 52, Calif.
E. L. Adams Miami Valley Broadcast- ing Corp. Dayton 1, Ohio	DAYTON May 20	George Rappaport 132 E. Court Harshman Homes Dayton 3, Ohio	L. E. Reukema Elec. Eng. Department University of California Berkeley, Calif.	SAN FRANCISCO	W. R. Hewlett 395 Page Mill Rd. Palo Alto, Calif.
C. F. Quentin Radio Station KRNT Des Moines 4, Iowa	DES MOINES- AMES	F. E. Bartlett Radio Station KSO Old Colony Bldg. Des Moines 9, Iowa	W. R. Hill University of Washington Seattle 5, Wash.	SEATTLE June 10	W. R. Triplett 3840-44 Ave. S.W. Seattle 6, Wash.
A. Friedenthal 5396 Oregon Detroit 4, Mich.	DETROIT May 21	N. C. Fisk 3005 W. Chicago Ave. Detroit 6, Mich.	C. A. Priest 314 Hurlburt Rd. Syracuse, N. Y.	SYRACUSE	R. E. Moe General Electric Co. Syracuse, N. Y.
N. J. Reitz Sylvania Electric Prod- ucts, Inc. Emporium, Pa.	EMPORIUM	A. W. Peterson Sylvania Electric Prod- ucts, Inc. Emporium, Pa.	C. A. Norris J. R. Longstaffe Ltd. 11 King St., W. Toronto, Ont., Canada	TORONTO, ONTARIO	C. G. Lloyd 212 King St., W. Toronto, Ont., Canada
F. M. Austin 3103 Amherst St. Houston, Texas	HOUSTON	C. V. Clarke, Jr. Box 907 Pasadena, Texas	O. H. Schuck 4711 Dupont Ave. S. Minneapolis 9, Minn.	TWIN CITIES	B. E. Montgomery Engineering Department Northwest Airlines Saint Paul, Minn.
R. E. McCormick 3466 Carroilton Ave. Indianapolis, Ind.	INDIANAPOLIS	Eugene Pulliam 931 N. Parker Ave. Indianapolis, Ind.	G. P. Adair 1833 "M" St. N.W. Washington, D. C.	WASHINGTON June 14	H. W. Wells Dept. of Terrestrial Mag- netism Carnegie Inst. of Wash- ington Washington, D. C.
C. L. Omer Midwest Eng. Devel. Co. Inc. 3543 Broadway Kansas City 2, Mo.	KANSAS CITY	Mrs. G. L. Curtis 6003 El Monte Mission, Kansas	J. C. Starks Box 307 Sunbury, Pa.	WILLIAMSPORT June 2	R. G. Petts Sylvania Electric Prod- ucts, Inc. 1004 Cherry St. Montoursville, Pa.
R. C. Dearle Dept. of Physics University of Western Ontario London, Ont., Canada	LONDON, ONTARIO	E. H. Tull 14 Erie Ave. London, Ont., Canada			
Walter Kenworth 1427 Lafayette St. San Gabriel, Calif.	LOS ANGELES May 18	R. A. Monfort L. A. Times 202 W. First St. Los Angeles 12, Calif.			
O. W. Towner Radio Station WHAS Third & Liberty Louisville, Ky.	LOUISVILLE	D. C. Summerford Radio Station WHAS Third & Liberty Louisville, Ky.			

SUBSECTIONS

Chairman		Secretary		Chairman		Secretary	
P. C. Smith 179 Ido Avenue Akron, Ohio	Akron (Cleveland Sub- section)	J. S. Hill 51 W. State St. Akron, Ohio		J. B. Minter Box 1 Boonton, N. J.	NORTHERN N. J. (New York Subsection)	A. W. Parkes, Jr. 47 Cobb Rd. Mountain Lakes, N. J.	
J. D. Schantz Farnsworth Television and Radio Company 3700 E. Pontiac St. Fort Wayne, Ind.	FORT WAYNE (Chicago Subsection)	S. J. Harris Farnsworth Television and Radio Co. 3702 E. Pontiac Fort Wayne 1, Ind.		A. R. Kahn Electro-Voice, Inc. Buchanan, Mich.	SOUTH BEND (Chicago Subsection) May 20	A. M. Wiggins Electro-Voice, Inc. Buchanan, Mich.	
F. A. O. Banks 81 Troy St. Kitchener, Ont., Canada	HAMILTON (Toronto Subsection)	E. Ruse 195 Ferguson Ave., S. Hamilton, Ont., Canada		W. M. Stringfellow Radio Station WSPD 136 Huron Street Toledo 4, Ohio	TOLEDO (Detroit Subsection)	M. W. Keck 2231 Oak Grove Place Toledo 12, Ohio	
A. M. Glover RCA Victor Div. Lancaster, Pa.	LANCASTER (Philadelphia Subsection)	C. E. Burnett RCA Victor Div. Lancaster, Pa.		R. M. Wainwright Elec. Eng. Department University of Illinois Urbana, Illinois	URBANA (Chicago Subsection)	M. H. Crothers Elec. Eng. Department University of Illinois Urbana, Illinois	
E. J. Isbister 115 Lee Rd. Garden City, L. I., N. Y.	LONG ISLAND (New York Subsection)	F. Q. Gemmill Sperry Gyroscope Great Neck, L. I., N. Y.		W. A. Cole 323 Broadway Ave. Winnipeg, Manit., Can- ada	WINNIPEG (Toronto Subsection)	C. E. Trembley Canadian Marconi Co. Main Street Winnipeg, Manit., Can- ada	
A. D. Emurian HDQRS. Signal Corps Engineering Lab. Bradley Beach, N. J.	MONMOUTH (New York Subsection)	Ralph Cole Watson Laboratories Red Bank, N. J.					

I.R.E. People



E. F. W. ALEXANDERSON

E. F. W. ALEXANDERSON

On January 1, 1948, Ernst Frederick Werner Alexanderson (A'13-M'13-F'15) retired from the General Electric Company, with which he had been associated for over forty-five years.

Dr. Alexanderson was born on January 25, 1878, at Upsala, Sweden. He was educated at the Royal Technical Institute of Stockholm, Sweden, and at the Royal Technical Institute at Charlottenburg. In 1902 he joined the drafting department of the General Electric Company, entering the engineering department as a design engineer of alternating-current machines in 1904. In 1910 he became consulting engineer at General Electric, and in 1920 he was appointed chief engineer of the Radio Corporation of America, later becoming consulting engineer.

In addition to many developments and inventions in the rotating machinery field, Dr. Alexanderson is responsible for the design of the Alexanderson high-frequency alternator, a system of cascading radio-frequency amplifier stages, a magnetic amplifier for radiotelephone, and many other radio developments. It is estimated that he ob-

tained an average of one patent every seven weeks during his years of association with General Electric, or a total of 309 patents.

Dr. Alexanderson has published numerous papers in the PROCEEDINGS, among them: "Dielectric Hysteresis at Radio Frequencies," "Simultaneous Sending and Receiving," "Transoceanic Radio Communication," "Central Stations for Radio Communications," and "The Amplidyne System of Control." He was the recipient of The Institute of Radio Engineers' Medal of Honor in 1919. Other awards which he received through the years include the John Ericson Gold Medal from the American Society of Swedish Engineers in 1944, the Edison Medal from the American Institute of Electrical Engineers (of which he is a Fellow) in 1944, and the Odergren Gold Medal from the Royal Swedish Technical University in 1944. He was Vice-President of the I.R.E. in 1920, President in 1921, Manager from 1917 through 1919, and Director from 1920 to 1921. He has also served on various I.R.E. Committees.



CLEDO BRUNETTI



EDWARD H. GAMBLE

EDWARD H. GAMBLE

Edward H. Gamble (A'46) has joined the staff of Battelle Memorial Institute in Columbus, Ohio, where he is engaged in research in industrial physics. He was associated with the Bell Telephone Laboratories.

Dr. Gamble is a graduate of Ohio University, and holds the M.S. degree in physics from Ohio State University and a doctorate in electrical engineering from the Polytechnic Institute of Brooklyn. He is a member of the American Physical Society, Phi Beta Kappa, Sigma Xi, Sigma Pi Sigma, and Pi Mu Epsilon.



CLEDO BRUNETTI

The Materials and Methods Grand Award for 1947 was given to Cledo Brunetti (A'37-SM'46), chief of the engineering electronics section of the National Bureau of Standards, for "the most significant use of modern engineering materials and processing methods to increase production and lower the cost of products now being manufactured."



R. B. COLTON

MAJOR GENERAL R. B. COLTON

Major General Roger B. Colton (retired) (SM'46), who was recently elected vice-president of the Federal Telephone and Radio Corporation, has completed more than thirty years of service with the United States Army, and has had extensive experience in communications research and development.

He was born on December 15, 1887, at Jonesborough, N. C., and was graduated from the Sheffield Scientific School, Yale University, in 1908. In 1920 he received the M.A. degree from the Massachusetts Institute of Technology. He was commissioned as a second lieutenant, Coast Artillery Corps, in the Regular Army in 1910, and transferred to the Signal Corps in 1930 with the rank of lieutenant colonel. In August, 1932, he was placed in charge of the Plant and Traffic Division in the Office of the Chief Signal Officer at Washington, D. C., and two years later was in charge of its Research and Development Division. Upon his graduation from the Army War College in 1938, he was made director of the Signal Corps Laboratories at Fort Monmouth, N. J.

General Colton's long and distinguished military career includes service as chief of the Signal Supply Services, Office of the Chief Signal Officer, Washington, D. C., and later as Air Communications Officer of the Air Technical Service Command at Wright Field, Dayton, Ohio. In 1946 he retired from active service with the Army.



GILBERT C. LARSON

Gilbert C. Larson (S'35-A'37-VA'39-SM'45), engineer-in-charge of the Licensee Laboratory of the Hazeltine Electronics Corporation, Little Neck, L. I., was awarded a Certificate of Commendation by the United States Navy for his achievements during World War II. The certificate was accompanied by a citation reading: "This award is made for your outstanding ability and unremitting effort as a Senior Engineer of the Hazeltine Electronics Corporation, in designing wavemeters and airborne identification and radar beacon equipment. Your numerous contributions to the improvement of individual equipments constituted an important advance in the electronics art."

VIRGIL M. GRAHAM

Virgil M. Graham (A'24-M'27-F'35), director of technical relations for Sylvania Electric Products Inc., Flushing, L. I. N. Y., was recently elected chairman of the Joint Electron-Tube Engineering Council, which is sponsored by the RMA and the National Electrical Manufacturers Association. The Council was established in 1944 to standardize data and engineering practice for electron tubes. It includes two directors, one from RMA and the other from NEMA, and six members representing tube manufacturers. JETEC was organized largely through the efforts of W. R. G. Baker (A'19-F'28), A. C. Streamer, and O. W. Pike (A'26-M'28-SM'43). The council operates through several line committees concerned with various classes of electron tubes commonly used in radio and industrial electronic applications.

Mr. Graham has been active in the engineering department of the RMA since its inception, and has served as an associate director of that department for twelve years. He is a Director of The Institute of



VIRGIL M. GRAHAM

Radio Engineers and has been Chairman of the I.R.E.-RMA Rochester Fall Meeting Committee since 1929. He is also a member of the Institute of Radio Engineers of Australia, the Acoustical Society of America, the Society of Illuminating Engineers, the Société des Radioélectriciens, and the Rochester Engineering Society.



STANFORD C. HOOPER

On February 5, 1948, Rear Admiral Stanford C. Hooper (F'28-A'33-F'46), United States Navy, retired, received an honorary LL.D. degree from Drury College, Springfield, Mo. The ceremony, at which General Jonathan M. Wainwright was similarly honored, marked the first of several events planned in observance of the 75th anniversary of the founding of the college.

Stanford Caldwell Hooper was born on August 16, 1884, in Colton, Calif. His early education was received in the public schools of San Bernardino, and he worked as a re-



STANFORD C. HOOPER

lief telegraph operator during his summer vacations. He was graduated from the United States Naval Academy in 1905, and instructed in electricity, physics, and chemistry at the Naval Academy from 1910 to 1911. Later, he served for two years as the first Fleet Radio Officer, resuming that post again from 1923 to 1925, and he was in charge of the Radio Division of the Navy Department for eleven years. From 1928 to 1934 he was Director of Naval Communications. Admiral Hooper has been a leader in developing the field of wireless radio communications in the Navy by carrying out pioneer tests, establishing a chain of land stations for communication between fleet and land, and serving as technical advisor and head of numerous boards and committees dealing with communications. He suggested the office of Fleet Radio Officer as necessary to the new radio communications, and served in this post two years. In the first World War he was awarded the Navy Cross for distinguished service as commanding officer of the U.S.S. *Fairfax*.

Admiral Hooper was retired in 1945, after forty years of service, with civilian, military, and foreign awards and medals for "outstanding contributions to the radio art, particularly in building up the wireless communications system of the United States Navy from the stature of an engineering experiment to a major military arm for control, detection and communication."



JOSEPH H. GILLES

Joseph H. Gillies (M'37-SM'43) who has been vice-president in charge of radio production in the Philco Corporation since 1942, has been appointed vice-president in charge of radio division operations.

In his new capacity, he will co-ordinate engineering, purchasing, planning, material control, and production of all Philco radio, television, and other electronic products. Mr. Gillies joined this company in 1929 and was a member of the factory engineering organizations for several years. In 1939 he was named works manager. During the war, under his direction Philco produced for the Army and Navy over 500,000 complete radar equipments with a value of more than \$250,000,000. He was elected to membership on the board of directors of Philco Corporation in 1947.



JOSEPH P. MAXFIELD

JOSEPH P. MAXFIELD

Joseph P. Maxfield (SM'47), distinguished pioneer in research and the practical development of sound transmission, recording, and reproduction, recently became associated with the Altec-Lansing Corporation as a consulting engineer. This was shortly after his retirement from the Bell Telephone Laboratories.

The years of his instructorship at the Massachusetts Institute of Technology saw his start in the career of original research. In World War I he made basic contributions in the development of acoustic detection of aircraft and the sound ranging of artillery. In World War II he was director of the Division of Physical War Research at Duke University, an organization of twenty-five leading scientists and engineers, engaged in a secret war project for the development of equipment to detect and locate enemy targets by acoustic methods.

Among Mr. Maxwell's many contributions in the application of acoustical science are the design of the Kleinhaus Music Hall in Buffalo; the development of the sound system for the General Motors Futurama Exhibit at the 1939 New York World's Fair; his participation in the development of the electrical recording of phonograph records, which resulted in the Orthophonic and Vivatonal records of Victor Talking Machine and the Columbia Phonograph Company, respectively; and his contributing influences in the adaptation of sound recording to the first commercially successful talking motion pictures in 1926.



MAX J. O. STRUTT

Since taking up his duties as electronics consultant and head of commercial engineering of the Electronic Tube Division of N. V. Phillips' Gloeilampenfabrieken at Eindhoven, the Netherlands, Max J. O. Strutt (SM'46) has visited ten Western European countries in which he lectured to the respective engineering societies and academic institutes on electronic subjects connected with his personal research work over a period of twenty years. Notable among these

lectures were one delivered at the Sorbonne in Paris in 1947, and three at the International Congress in commemoration of Marconi's work, at Rome, in September, 1947. Of the latter lectures, two were on electron tube subjects, while the third was on high-frequency magnetism.

In the last months prior to the start of World War II, Dr. Strutt completed the development work on the EF50 ultra-high-frequency amplifier tube, which was subsequently used in great numbers in the electronic equipment of British bombers.

Dr. Strutt has been appointed by the Swiss government to a full professorship in the faculty of electricity at the Swiss Federal Institute of Technology at Zürich, where he took up his new duties in April, 1948. He will be head of the Institute of Theoretical Electricity, incorporating several modern research and training laboratories. He is a member of the Royal Institute of Engineers at the Hague, the Dutch Radio Society, the Dutch Physical Society, the Dutch Mathematical Society, and the Society for the Advancement of Physics and Medicine at Amsterdam. His book, "Ultra- and Extreme-Shortwave Reception," was published by the D. Van Nostrand Company in 1947.



M. J. O. STRUTT



DANA W. ATCHLEY, JR.

D. W. Atchley, Jr., (S'39-A'47-M'47), has joined Tracerlab, Inc., as sales and advertising manager. He will be in charge of sales of equipments and components used in the field of radioactivity and of processed isotopes.

Mr. Atchley was born in New York, N. Y., on October 27, 1917. He received the B.S. degree from Harvard University in 1939. From 1940 to 1941 he was employed as research engineer in the Fluorescent Lighting Division of Sylvania Electric Products Inc., in Salem, Mass. From 1941 until 1945 he was on active duty with the United States Navy as a lieutenant commander, USNR. He was on the staff of the Naval Research Laboratory, Washington, D. C., as Technical Aide to the Director for Special Electronic Research and Development. From the fall of 1945 until recently, he was



DANA W. ATCHLEY, JR.

in charge of Government Sales in the Electronic Division of Sylvania Electric Products Inc., Boston.

Mr. Atchley is a member of the Subcommittee on Counter Tubes-JTC-3.4 of the Joint Electron-Tube Engineering Council. He has been a radio amateur since 1932, and has written several articles for amateur magazines.



PHILIP J. KONKLE

Philip J. Konkle has been appointed facilities engineer for the American Broadcasting Company. Mr. Konkle has been active in radio engineering since 1925.

A graduate of Iowa State College, he was television engineer with the RCA Victor Company from 1929 to 1933, where he worked on the development of the present all-electronic television system. In 1933, he became television engineer with the Philco Corporation in Philadelphia, and from 1937 to 1948 he was manager of the Engineering Laboratory of the Crosley Broadcasting Corporation.



THOMAS E. HOWARD

Thomas E. Howard (M'47) has been appointed engineer of KSD and KSD-TV, the St. Louis *Post-Dispatch* radio and television stations, succeeding Robert L. Coe, who is now manager of the New York *Daily News* television stations. Prior to this appointment, Mr. Howard was assistant chief engineer and supervisor of all technical operations for KSD-TV.

Mr. Howard joined KSD in 1940, after completing construction of the police department radio station in St. Louis. He is a native of Connelville, Pa., and has been in radio work for twenty-two years. During the last war he was in the Air Corps, entering as a first lieutenant and being discharged with the rank of colonel. He was communications officer for the First Troop Carrier Command, and later for the Ninth Troop Carrier Command, which carried American paratroopers into the Normandy invasion. He also served as head of the Signal Branch, Air Forces Board.

Books

Very High Frequency Techniques, Compiled by the Staff of the Radio Research Laboratory of Harvard University. Volumes I and II

Published (1947) by McGraw-Hill Book Company, Inc., 330 West 42 Street, New York 18, N. Y. 1031 pages+24-page index +4-page bibliography. 923 figures. Price: \$14.00.

The two volumes comprise nearly 1100 pages, divided into 35 chapters. They have a modest index supplemented by a very well-arranged table of contents consisting of the chapter headings and sub-headings under each chapter, which should be of material assistance in locating general topics. The chapter content for both volumes is included in Volume I and the pertinent part repeated in Volume II.

The two volumes are the combined work of about 40 authors, but despite some overlap between a few chapters, the finished product is unified and well edited.

There is no pretense that these books are a comprehensive text. The authors have tried to summarize the work carried out during the war by the Radio Research Laboratory at Harvard University and the many agencies which contributed to the work of the Radar Countermeasures Group under Division 15, National Defense Research Council. For this reason, the books are in the nature of a technical report which gives in concise form a vast amount of detailed information illustrated by excellent line drawings and photographs. These are used generously and should be particularly helpful since they offer one of the best ways of illustrating complicated microwave plumbing.

Most emphasis is placed on three general fields: (1) microwave receivers; (2) microwave tubes; and (3) antennas. Within these fields, there is a great amount of practical and theoretical information about microwave measurement techniques as well as data on the performance of particular systems.

These books are definitely not for the beginner, but the design engineer and the research and development worker should find many instances where these books will serve as invaluable reference handbooks.

E. D. McARTHUR
Research Laboratory
General Electric Company
Schenectady 5, N. Y.

Techniques of Microwave Measurements, Edited by Carol G. Montgomery

Published (1947) by McGraw-Hill Book Company, Inc., 330 West 42 Street, New York 18, N. Y. 922 pages+11-page index +5-page Appendix+xix. 627 illustrations. 6×9 inches. Price \$10.00.

This is a new book describing laboratory types of measuring equipment. The volume is interesting and usable to anyone connected with testing or measuring in the microwave region of the frequency spectrum. It covers a big field thoroughly and expertly. The descriptions are lucid, with pictures or drawings of most of the equipments. There are many tables, characteristic curves, equations, and formulas pertinent to the equipment being described. Only those equations are included that are necessary to the understanding of the design and operation of the equipment being described. It is just the book that a person engaged in microwave development needs to bring him up to date about the different methods and equipments available. The paper is of good quality; the type, easy to read.

Fourteen authors, each an expert in one or more fields, have contributed to write a complete story. Although complete, it does not pretend to be exhaustive. There are numerous references, especially to other books in the Massachusetts Institute of Technology Radiation Laboratory Series of twenty-six volumes, of which this is volume II.

The microwave region is defined as extending from 1 to 30,000 Mc. The word "microwave" is to be read into all the subjects listed, which are discussed a chapter at a time as outlined below:

Power sources, power measurements, signal generators, measurement of wavelength, frequency measurements, measurement of frequency spectrum and pulse shape, measurements of standing waves, impedance bridges, measurement of dielectric constants (including a 4-page bibliography), cutoff-type attenuators, resistive-type attenuators, measurement of attenuation, directional couplers, and r.f. phase and pattern measurements.

The 9-page table of contents includes one line for each numbered paragraph in the text, making it easy to locate text material. The list of manufacturers in the appendix is of some historical interest, even though it is admittedly not complete.

ALLEN F. POMEROY
Bell Telephone Laboratories, Inc.
New York, N. Y.

Meteorological Factors in Radio-Wave Propagation

Published (1947) by the Physical Society, 1 Lowther Gardens, Prince Consort Road, London S.W.7, England. 325 pages +1-page foreword. 171 figures and 30 tables. 6½×9½ inches. Price 24s, obtainable only directly from the publisher.

The Physical Society of Great Britain has made available to nonmembers of the Society this report of a conference on radio meteorology held jointly with the Royal Meteorological Society on April 8, 1946. Much of the knowledge of meteorological effects upon radio frequencies from 30 to 20,000 Mc. is contained, either in the publi-

cation of the full text of the ten papers read during the conference, or in the eleven additional papers in this printed report.

Although much of the material in this report is on the common meeting ground between the meteorologist and the radio engineer, thus precluding some previous study of meteorology and wave propagation, the papers have been arranged in an orderly and logical sequence. Opening the conference and the report is the descriptive paper by recent Nobel Prize winner Sir Edward Appleton. Sir Edward tells much about the early discoveries of weather variations affecting radar vision. The work and organization of the Ultra-Short Wave Panel of the R.D.F. Committee, similar to the American Committee on Propagation of the National Defense Research Council is outlined.

The second paper on the radio wave tropospheric effects noted experimentally at 10 centimeters and below is co-authored by I.R.E. Vice-President R. L. Smith-Rose and Miss A. C. Stickland. Data for this paper are based on two years of continuous recordings over a land path of about 38 miles and one entirely over the sea for 57 miles. The general agreement between various frontal conditions of known gradient of refractive index and signal amplitude is shown in detail. The structure and the meteorological variables affecting the refractive index of the lower atmosphere are then discussed in detail by P. A. Sheppard. This paper as it especially applies to v.h.f. propagation is probably one of the most comprehensive published to date.

The phenomenon of superrefraction is treated in accordance with mode theory and its relation to waveguides by H. G. Booker and W. Walkinshaw. Numerous propagation curves suitable for qualitatively describing this unusual effect are presented. The great success of the mode theory is in its ability to explain transfiguration of refraction that takes place when decreasing the operating wavelength. Several methods of solving the differential equations of tropospheric refraction are then given by D. R. Hartree, J. G. Michel, and P. Nicolson. Much of this work was carried out on the differential analyzer at the University of Cambridge.

The next five papers deal largely with meteorological effects upon radar operation and vision. J. W. Ryde discusses the calculated attenuation and the intensity of radar echoes expected from fog, cloud, rain, snow, and hail. Two shorter papers illustrate the current status of radar storm detection. Of particular interest is the paper by C. S. Hurst of the Meteorological Office (British Air Ministry) on radio climatology. This is a study and mapping of those regions about the surface of the earth where abnormal radio propagation may be anticipated. Climatic conditions and radar observations are correlated for the Bay of Bengal, Arabian Sea, Gulf of Aden, etc. The use of standard meteorological information in estimating the probability of super- or subrefraction is shown.

The report also includes papers on methods of deducing the refractive-index profile

of the lower atmosphere, radar observations in New Zealand, vertical distribution of radar field strengths, and several papers on the dielectric properties of water vapor and anomalous dispersion at very-high radio frequencies.

A three-part proposal for a standard radio atmosphere is also included. Workers will find the alternative *standard atmospheres* interesting, inasmuch as they differ from the *standard American atmosphere* of 60 per cent relative humidity. It is shown that the assumed NACA k of 4/3 at all heights between sea level and 1500 meters is in error. A *standard atmosphere* of 80 per cent relative humidity is more applicable to the British Isles, while an atmosphere of linear v.p. has the facility of being usable at much greater heights—becoming completely dry at 3900 meters.

The report does not contain an index, which somewhat hinders its use as a reference volume. However, at this writing it is the most complete work in this field that is available. Engineers engaged in v.h.f. of microwave propagation problems will find it exceedingly interesting and useful.

OLIVER P. FERRELL
Radio Magazines, Inc.
342 Madison Ave.
New York 17, N. Y.

Computing Mechanisms and Linkages, by A. Svoboda (Radiation Laboratory Series)

Published (1947) by McGraw-Hill Book Company, Inc., 330 West 42 Street, New York 18, N. Y. 299 pages+52-page appendix +6-page index+xii pages. 178 figures. 6×9 inches. Price \$4.50.

This volume, which is number twenty-seven in the Radiation Laboratory Series, contains little on the subject of computing mechanisms in general, and much on the so-called bar-linkage computers. These, as the name implies, consist of a system of rigid bars connected to each other through pivots and/or slides. The types of linkages which are considered in this volume cannot perform the operations of integration and differentiation, and hence are essentially function generators.

The first seven chapters of the volume are devoted to development of methods for design of bar linkages with one degree of freedom; that is, having one input and one output terminal. The methods evolved are mainly graphical in nature and resolve ultimately to adjustment of the parameters of the linkage through a systematized process of trial and error. Extensive tables appended at the end of the volume make the task of carrying out such processes considerably simpler than usual.

The last two chapters of the volume contain much interesting material on design of bar linkages, with two degrees of freedom. Here the author introduces the notion of "grid structure" and demonstrates that all functional relationships $z=f(x, y)$ which possess "ideal grid structure" can be mechanized by using a differential and two or more transformer linkages. Also, a gauging process is described whereby the linkage con-

stants can be adjusted to yield perfect fit at a finite number of preselected points.

Many, and perhaps most of the synthetic methods for rational design of bar linkages which are described in this volume, are novel. Their use is amply illustrated with ingenious and thoroughly discussed examples. However, it is clear that the volume is not intended as a text and is written primarily for the specialist in the field. On the whole, the subject matter should be of particular interest to those who are in quest of methods for generating functions with a degree of accuracy that is unobtainable with electronic devices.

LOTFI A. ZADEH
Columbia University
New York 27, N. Y.

I. Ionospheric Research at College, Alaska, July 1941–June 1946, by S. L. Seaton, H. W. Wells, and L. V. Berkner

II. Auroral Research at College, Alaska, 1941–1944, by S. L. Seaton and C. W. Malich

Carnegie Institution of Washington Publication 175. 396 pages+vi. 24 figures. 8½×11 inches, \$1.85 in paper cover, \$2.35 in cloth cover.

Three hundred and thirty-five pages of tables present hourly values of ionospheric results, giving the measured critical frequencies of the F_2 , F_1 and E regions, the virtual heights of the F_2 and the F_1 regions, and the minimum recorded frequency. Fourteen pages of tables present the results of zenith auroral intensity measurements.

Comprehensive descriptions of the instruments and instrumental procedures are given. Results are discussed, with special reports on the subjects of Polar Radio Disturbance During Magnetic Bays, Vertical Distribution of Electrons, and Measurements of Height of Maximum Electron Density.

The material is clearly presented, and a good list of references is included. This publication is of special interest to those dealing with problems of ionospheric wave propagation.

HAROLD O. PETERSON
RCA Laboratories
Riverhead, N. Y.

High Frequency Measuring Techniques Using Transmission Lines, by E. N. Phillips, W. G. Sterns, and N. J. Gamarra

Published (1947) by John F. Rider, Publisher, Inc., 404 Fourth Avenue, New York 16, N. Y. 58 pages. 23 figures. 11×8½ inches. Price \$1.50.

Measurement techniques and design formulas for use with a slotted coaxial line are presented in this book. The measurement of velocity of propagation, attenuation, and characteristic impedance of the slotted line

itself are first taken up. Then the measurement of an impedance is considered, both when connected directly to the slotted line and when connected through a long attenuating cable. In the latter case, formulas are given which do not require a prior knowledge of the propagation constant and characteristic impedance of the long cable. These formulas are next rearranged so that the electrical constants of a cable may be calculated in terms of its input impedance when several known loads are connected to it. The use of the Smith chart is briefly covered.

Many topics which ought to be treated in a book of this type are not even mentioned. Some of the omitted topics are the design of the measuring line and detector, the effect of discontinuities, the dependence of the measured impedance on the method of connection of the slotted line to the load, waveguide measurements, and the resonance-curve method.

The authors make a number of dubious rule-of-thumb generalizations which are likely to confuse the less advanced reader. Descriptions of some of the methods are not clear, but in these cases the numerical examples show what is intended.

An elementary knowledge of transmission-line theory, hyperbolic functions, and complex number operations is assumed. Since the book does not give a complete or rigorous treatment of transmission-line measurements, it is not suitable as a textbook. To the reader who is doing the sort of work in which the authors are interested, this book may serve as a valuable guide for laboratory work. The more advanced radio engineer will, however, find the book of little value except as an incomplete collection of formulas.

SEYMOUR B. COHN
20 Prescott St.
Cambridge, Mass.

Understanding Vectors and Phase, by John F. Rider and Seymour D. Usland

Published (1947) by John F. Rider Publisher, Inc., 404 Fourth Avenue, New York 16, N. Y. 149 pages+3-page index+1-page bibliography+vi pages. 75 figures. 5×7½ inches. Price, paper bound, 99 cents; cloth bound, \$1.89.

This book was written for the man lacking technical training and serves as an introduction to the use of arrows in the pictorial representation of problems involving alternating currents. The authors confine the text to the discussion of the two-dimensional vector used in the representation of the alternating currents, voltages, and impedances. They do not attempt to discuss the subject of three-dimensional vectors, and rightly so, since it would not be wise to open the reader to confusion in so elementary a book. It might have been better, however, to point out the difference between a true vector and the vectors (or phasors, a term which might have been employed by the authors to good advantage) which are used in the representation of a.c. values.

The authors have done an excellent job of discussing a difficult subject in a simple

and clear manner which may be understood by a reader with very little mathematical background. After an introduction to vectors and the co-ordinate system employed, the multiple representation of two-dimensional vectors and their addition, subtraction, multiplication, and division are discussed. Multiplication and division are represented mathematically in the polar form, while addition and subtraction are worked out graphically. No attempt is made by the authors to introduce the complex notation, which is probably beyond the level for which the book is written.

A final chapter on applications, with particular stress on the important applications to frequency modulation, concludes the book.

Throughout the book the actual application of the two-dimensional vectors to radio circuits and their representation of phase is emphasized.

NATHAN MARCHAND
301 West 108 Street
New York 25, N.Y.

The Radio Handbook, Eleventh Edition, by R. L. Dawley and Associates

Published (1947) by Editors and Engineers, Ltd., 1300 Kenwood Road, Santa Barbara, Calif. 508 pages + 4-page index. 568 figures. $11\frac{1}{2} \times 8\frac{1}{2}$ inches. Price \$3.00.

Here, for the radio amateur, is a feast from soup to nuts. Starting with elementary instructions on the practice of code and with electrical theory for the veriest tyro, the contents cover the various types of communication circuits, both f.m. and a.m., up to and including magnetron and klystron circuits on the one hand, and to radiation theory and directional antennas on the other. As stated in the introduction, the work includes frequencies from 3.5 to 500 Mc. The treatment is aimed at the radio amateur, "particularly for the serious amateur." This portion of the book, which is quite practical but necessarily superficial in its treatment, occupies the first 200 pages.

There follow 67 pages of reference data including quite complete tables of receiving and transmitting tubes and their characteristics of interest to the amateur.

The next 163 pages contain practical instruction in the building of equipment necessary to a station, with many photographs to illustrate good mechanical practice in both chassis and wiring layout. This is followed by an interesting section of 28 pages on the conversion of surplus war equipment for amateur use. The rest of the book is a buyer's guide giving sources of components required for building the equipment described. The question-and-answer section included in some previous editions is omitted. There is considerable question whether the new and larger format is an improvement, since it is doubtful if many amateurs will carry the book around in a briefcase and the larger book is somewhat more tiring to hold.

Being in its eleventh edition, the book obviously fills a wide need broadly and well. It would be a temerarious reviewer indeed who

would make disparaging remarks, and this one is of no mind to do so. The book is well planned and clearly written. Indeed it is evident that, added to the careful instructions and detailed circuit diagrams of this book, sufficient interest is all that is required to build and operate a high-grade amateur radio station.

KNOX MCILWAIN
Hazeltine Electronics Corporation
5825 Little Neck Parkway
Little Neck, L. I., N. Y.

Radio Data Charts, by R. T. Beatty, Revised by J. McG. Sowerby, Fourth Edition, Second Impression

Published (1947) by Iliffe & Sons, Ltd., Dorset House, Stamford Street, London, S.E.1, England. 93 pages. 44 abacs. $8\frac{1}{2} \times 11$ (D4to). Price: 7/6 (Postage 5d). Obtainable from U. S. booksellers at \$2.00.

This is a collection of nomograms or "Abacs" which is a revision of the original collection first published in 1930.

The general idea of the nomogram is very useful to the engineer since it saves much time and calculation labor. The charts are most useful to a radio receiver designer, but are also commendable for student use since many of the nomograms present a physical picture of what would otherwise be a complex formula difficult to comprehend.

The nomograms are all-inclusive and cover practically all the possible features of receiver design. The charts start with such simple relations as frequency vs. wavelength, and Ohm's Law, and progress to complicated subjects such as band-pass intermediate-frequency transformer design and other problems which would normally require the use of one or more complex formulas.

The subject of radio-frequency coil design is quite thoroughly covered. It includes the change of inductance and increase of radio-frequency resistance due to the shielding cans surrounding the coil. The "Universal Selectivity Chart" is easy to use and provides a convenient short-cut method of designing tuned transformers.

The nomograms on transmission lines, giving Q , resonant impedance, and length of a capacitance-loaded quarter-wave resonant line are a convenience to the designer of receivers for the higher radio-frequency ranges.

There are a considerable number of shortcomings brought about by the difference between British and American practices. The terms "short wave," "medium wave," etc., are used inconsistently with frequency terms such as "very high," "high," etc. Outstanding in these differences is the use of meters in place of feet, such as in "micro-micro-farads per meter." The wire table given, and wire sizes used in the nomograms, are the British "Standard Wire Gauge," which is different from the American-used Brown & Sharpe gauge. Furthermore, in the case of power-transformer design, British makes of transformer core iron are used and the charts assume a power frequency of 50 cycles only.

The paper and printing are in accordance "with the authorized economy standards," and therefore leave much to be desired. The quality of paper is of an inferior grade which is bound to suffer from continued use of the charts. Furthermore, not one sheet of blank note paper was included for use by the reader in recording or mounting additional reference data.

In spite of its shortcomings, the collection is a valuable tool for the radio designer, and the benefits gained by its use considerably overshadow the slight inconveniences which are brought about by the British nomenclature.

MURRAY G. CROSBY
65 Peg's Lane
Riverhead, L. I., N. Y.

"Electromechanical and Electroacoustical Analogies," by Bent Gehlshøj

Published in English (1947) by The Academy of Technical Sciences, Oster Volgade 10, KBH,K, Copenhagen, Denmark. 141 pages + 1-page index. 81 figures, $6\frac{1}{2} \times 9\frac{1}{2}$ inches. Price 12 Crowns (Danish).

This monograph is a well-written survey of the principles and applications of the electrical circuit analogies of mechanical and acoustical systems. Electrical engineers will agree that it is convenient to analyze dynamical problems both qualitatively and quantitatively by studying an electrical circuit having analogous equations. If the step involving the sketching and scaling of the analogous circuit is made simple, the power of the method is immeasurably increased.

The author covers three main areas, mechanical analogies, acoustical analogies, and electromechanical transducers. In the case of mechanical systems, he points out the advantages of admittance and impedance diagrams, respectively. In the case of the former, the topological similarity between the mechanical system and the analogous electrical circuit is discussed. This fact makes it possible to draw an analogous circuit simply by inspection. By a process of network dualization, the impedance diagram which is generally favored for analysis of characteristics may be derived. Applications of the techniques to numerous examples with both lumped and distributed constants are given.

The second section applies the methods of analogy to acoustical systems, with examples including filters, microphones, and earphones. In the final section on electromechanical transducers, analogous networks for electromagnetic speaker drives, moving armatures, and piezoelectric transducers are discussed.

This monograph is written clearly and its illustrations are well drawn. It should be particularly useful to students in electrical engineering interested in how to generalize the scope of their circuit theory. It is also of use to engineers who are called upon to design dynamical systems.

JOHN R. RAGAZZINI
Columbia University
New York 27, N. Y.



William G. Hutton

CHAIRMAN, CLEVELAND SECTION

William G. Hutton was born on March 9, 1904, at Batavia, Iowa. He received the A.B. degree in mathematics from Parsons College, Fairfield, Iowa, in 1928, and the M.S. degree in physics from Iowa State College in 1932.

Mr. Hutton taught one year in rural school, one year in high school, two years as graduate assistant in physics at Iowa State, three years as professor of physics at William Penn College, Oskaloosa, Iowa, and a year of Signal Corps radio at Penn College, Cleveland. One year, from 1929 to 1930, he worked for Western Electric Company in Chicago as a check inspector. During the war he served for nearly three years as technical representative for Western Electric on airborne radar equipment and accompanied the United States Air Forces to New Guinea and to England. For a short time in 1939 he did field work for radio consultant Raymond M. Wilmotte of Washington, D. C., and tuned up directional antenna systems at WAVE, Louisville, and WDAY, Fargo.

In 1937 Mr. Hutton joined the staff of the WGAR Broadcasting Company, Cleveland, as a design engineer, and since the war has been on the general engineering staff for the three 50-kw. sister stations, WGAR, WJR, and KMPC. Two of these stations are using directional antennas of his design. He is the inventor of a mechanical three-element directional antenna pattern calculator (described in the PROCEEDINGS OF THE I.R.E., May, 1942), which is of immense value in predicting the shape of a directional pattern in a short time. During the summer of 1946, Mr. Hutton worked with the Clear Channel Broadcasting Service in Washington, D. C., on a proposal to the F.C.C. for the use of directional antennas with powers of 750,000 watts on clear-channel frequencies.

Mr. Hutton joined The Institute of Radio Engineers in 1938, transferred to Senior Member in 1947, and is serving as Chairman of the Cleveland Section for the year 1947-1948. He is a member of the Cleveland Technical Societies Council and is a registered Professional Engineer in the State of Ohio.



William H. Radford

CHAIRMAN, BOSTON SECTION

William H. Radford was born in Philadelphia, Pa., on May 20, 1909. In 1931 he received the B.S. degree in E.E. from the Drexel Institute of Technology. He was awarded a Tau Beta Pi National Fellowship, and in 1932 received the M.S. degree in E.E. from the Massachusetts Institute of Technology. He has been a member of the staff of the department of electrical engineering at M.I.T. since 1932, and is now an associate professor of electrical communications.

From 1932 until 1938 he was a research assistant in electrical engineering and was engaged at Round Hill in extensive studies of light penetration of natural fog and of methods for local dissipation of fog. From 1939 to 1941 he was an instructor in electrical engineering, and during this time conducted research on basic circuits for electronic computers and taught electrical communications. In 1941 he was promoted to the rank of assistant professor of electrical engineering, and in 1944 he was named associate professor of electrical communications.

In 1941 Professor Radford assisted in establishing the M.I.T. Radar School. He has been closely associated with the Radar School since its inception, and has been associate director since 1944. He is now devoting much of his time to supervision of a government-sponsored research program in the field of electrical communications. He has been a consultant on radio-communication facilities and specialized electronic applications since 1935. He served as a section member and consultant to the National Defense Research Committee from 1940 to 1943. He is a registered professional engineer in the State of Massachusetts.

Professor Radford joined The Institute of Radio Engineers as an Associate in 1941 and transferred to Senior Member in 1945. He is chairman of the I.R.E. Committee on Education, and a member of the I.R.E. Membership Committee. He was Vice-Chairman of the I.R.E. Boston Section from 1946 to 1947. He is also an associate member of the American Institute of Electrical Engineers, and a member of Sigma Xi and Tau Beta Pi.

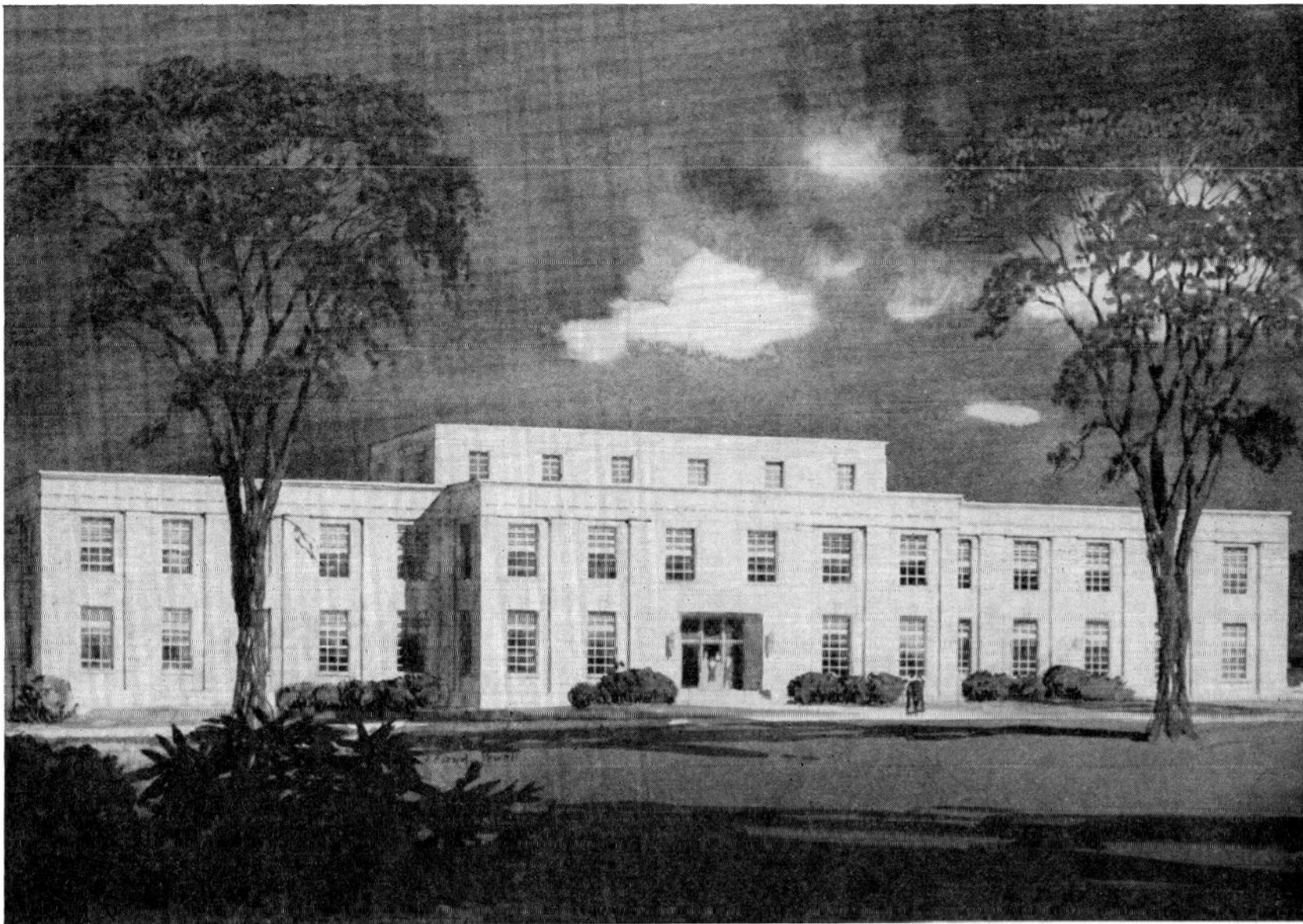

Sylvania Electric Products Inc.

SYLVANIA RESEARCH CENTER

Architect's conception of the new Sylvania Electric Physics Laboratory. The first of a series of modern research laboratories for Sylvania Center at Bayside, Long Island, N.Y., will appear like this when it is completed in the fall of this year.

Men in Research*

JESSE E. HOBSON†, MEMBER, I.R.E.

THE EFFECTIVENESS of an industrial research organization is determined to a very great extent by the scientific and technical men and women in that organization; by their training, by their experience in industrial research, by their inherent and acquired abilities, by their aggressiveness, and by their stability as independent and creative searchers for truth.

In few other types of organization is the quality of the end products so dependent upon the individual and co-ordinated skills of the staff. The word "co-ordinated" is used to emphasize that all productive staffs of industrial research are well-organized teams, with closely integrated efforts. Rapid inventive and creative development in the applied sciences during the last four decades has been largely due to the combined and co-ordinated efforts of individual scientists and engineers, of laboratories, of corporations, and, in some cases, of entire industries. The period of the individual inventor, working alone in attic, basement, or shack, has almost entirely disappeared. Inventive geniuses of the past century did their brilliant work alone—Edison, Bell, Whitney, Morse, Westinghouse, and others. During this century we have learned that organized research is much more productive and efficient, particularly when working with the application of known scientific principles to the development of products, processes, and devices for commercial application. Today we find 2500 organized industrial research laboratories in industry, employing in each laboratory from 10 to 2000 scientists, and with a total budget in excess of \$500,000,000 annually. The applied research laboratories of government, some of them employing several thousand persons, are spending annually more than \$600,000,000 (not including atomic energy expenditures).

Not only is research big business; it is also an organized business, although the pattern of organization is by no means set. However it may be organized—from a laboratory employing a staff of 10 to a laboratory employing a staff of 2000—it is the men of research who produce the remarkably effective results.

As they are seen, other assets of a laboratory of applied research, in decreasing order of importance, are:

1. *The cumulative "know-how" and experience obtained from a number of research successes and research failures in a diversified research group.* Quite often the knowledge obtained from an investigation on one project can be used directly to chart the work on another investigation, perhaps apparently quite unrelated to the preceding one. The techniques developed to produce a breakfast cereal may also produce an improved cleanser.

2. *Policies of the organization established and maintained to provide the most favorable environment for creative work by the technical staff.* The organizational pattern must assure adequate responsibility, authority, and supervision to effect the "comfort" and smooth functioning of a closely knit organization; it must also provide for the maximum of contact and co-operation between individuals and groups; but it must likewise provide for the individual freedom of thought and action so essential for creative work. An atmosphere of stimulation, providing outlets for individual expression, is certainly essential. No pattern or formula can be established to meet these paradoxical requirements; each situation and each group of researchers must be continuously analyzed by the research management. Research conferences on management held by several groups during the past year, and well-attended graduate courses on research management at New York University and the Illinois Institute of Technology, evidence the desire of many administrators to learn more about research management. Most of such conferences contain much talking and much discussion but little transmission of useful information, because there is no established pattern of research organization. The importance of adequate organization in the individual laboratory cannot be over-emphasized, but its character and structure can seldom be copied from elsewhere. The objectives of the organization, the fields in which it operates, the atmosphere of the environment, and the men of research in the organization create a management situation unique for each laboratory.

3. *Research facilities maintained to assist the research scientist or engineer, including service organizations to provide assistance on all nontechnical and routine phases of the research projects, the most efficient scientific tools and apparatus with skilled operators, and capable library assistance.* The service organization will often include reproduction facilities, pattern shop, carpentry shop, foundry, machine shop, glass blowing, store rooms, maintenance, graphic arts, and a physical and chemical analytical group staffed with capable technicians under competent supervision. It is becoming increasingly important to conserve the time and efforts of the trained research scientist and to shield him from all routine work.

4. *Intelligent, aggressive, flexible, and sympathetic management to co-ordinate the factors mentioned above.* The dogmatic and static administration sometimes found in business does not produce good results in research management.

5. *Adequate building and other physical facilities to provide comfortable, convenient, and inspirational surroundings.* How often this factor, which seems to be of least importance among the assets of an effective research organization, is considered first and of prime importance!

Industrial research as a service to in-

dustry has had a remarkable growth during this century. As late as 1915 there were only 100 laboratories employing 3000 people. At the beginning of World War II, the National Research Council reported 2350 laboratories staffed by 70,000 individuals with an annual budget of \$250,000,000. By 1946 these data had increased to 140,000 persons employed in more than 2450 laboratories, and an annual industrial research expenditure estimated at \$500,000,000. The Steelman Report estimates government expenditures for research at \$625,000,000 (excluding atomic-energy research) with at least \$570,000,000 being spent for applied research and development. Even when measured in terms of research appropriations, neglecting its role as the fountainhead of industrial progress, applied research has become an important part of our economy.

The Steelman Report, as well as many other sources, has pointed out the appalling shortage of scientific manpower to staff our laboratories. The "net" loss of scientists for research laboratories, due to curtailment of training during World War II, has been estimated at some 40,000 to 50,000 with a shortage of about 10,000 men with Ph.D. training. The significance of this shortage on our national economy is realized when we consider the data presented by John S. Crout of Battelle Memorial Institute showing that 50 per cent of the total employment of our country is based on products resulting from industrial research, and that the creative genius of each research worker has made employment for 200 men and women! In this rapidly expanding field of scientific endeavor, and in this work so essential to our economic growth and prosperity, there is now plenty of room for the young scientist, and there will be even more opportunities for him during the next several years.

With the present shortage of scientifically trained men, which will continue for several years under the most favorable conditions, it is imperative that every possible way be found to supply the research men that industry needs. It is also necessary that each research man be used efficiently—Ph.D.'s for Ph.D. work; M.S.'s for M.S. work; B.S.'s for B.S. work; and assistants wherever they can be used to supplement the time and energy of the experienced scientist and engineer and free him for more creative work.

Although great progress has been made in all fields of applied research during the past quarter century, and many new fields have been energetically explored, there yet remain many frontiers for fruitful work. The channels open to industrial research are by no means closed; in fact, they are ever widening. One needs only to consider such fields for instance, as electric illumination to realize the enormous potentialities for further exploration. Theoretically it is possible to obtain approximately 635 lumens of light energy from 1 watt of electrical energy. To

* Decimal classification: R010. Original manuscript received by the Institute, December 15, 1947.
† Armour Research Foundation, Technology Center, Chicago 16, Ill.

ward this theoretical objective we have gone only a little way. The carbon lamp gave 2 to 3 lumens per watt; the tungsten lamp 10 to 14; the neon lamp gives 10; the arc lamp gives 40 to 65 lumens per watt, but has several undesirable characteristics; the sodium-vapor lamp gives 45 to 50 lumens per watt; and the recent development of the fluorescent lamp, using an entirely different principle of converting electric energy to light energy, gives only 35 to 75 lumens per watt. We have yet much ground for exploration in finding new principles of energy conversion to reach nearer to the limit of 635 lumens per watt. A firefly (*photuris pennsylvanicus*) gives the equivalent of nearly 600 lumens per watt, but, of course, does not convert directly from electrical to light energy.

And what of the man in research: What qualities and characteristics should he evidence to be successful in his profession? No more exact and complete specifications can be written for him (or her) than for the artist, the musician, the sculptor, the political genius, or any other person in a creative profession. In many respects, scientific research, whether fundamental or applied, is an art—and its practitioners are artists, in the sense of the definition: "An artist is one who sees what others fail to see; and seeing, makes that live where all may see." We do not yet know specific tests or measurements which will select, even with reasonable accuracy, the promising man for research. Those desired tests do not exist because we do not know the formulas relating academic training, experience, attitudes, creative ability, aggressiveness, perseverance, co-operative ability, and the other factors inherent in an effective man of research.

Certain important factors can be mentioned as necessary attributes of the research man. In addition to the obvious qualifications of specialized technical and scientific training in his field, high intellectual capacity and experience in the application of formal scientific knowledge, certain less tangible attributes must also be evidenced. Without attempting to be all-inclusive, or to list the desired characteristics in order of their importance, the following attributes are included among those which should be possessed by a successful man in industrial research:

1. A creative and original approach to scientific matters, with constructive questions regarding the opinions and findings of other investigators.
2. The ability to program research, to chart the investigation, and to proceed along a definite plan without deviation from the major objectives. The "putterer" in applied research is usually inefficient and non-productive.
3. The ability to use existing knowledge to advantage, both the knowledge and experience of the man himself and also that gained by and from others. How to find quickly existing knowledge of facts, techniques, and methods is highly important.

4. The ability to co-operate well with other research workers, either in the same group and the same organization or in other laboratories. This must include the ability to understand the direction of supervisors and translate that direction into action, and should also include the ability to direct activities of subordinates.

5. The ability to use efficiently all of the research services, tools, and aids available. Quite often the research man is unnecessarily lacking in productivity because he insists on doing too much of the routine and manual work himself, without taking advantage of the assistance provided for him.

6. Alertness to recognize significant results, whether those results are positive or negative to the research objectives.

7. The ability to evaluate results obtained and to understand the full significance of all findings, particularly as a guide for subsequent work.

8. Ingenuity to translate results of the research laboratory into practical information, processes, products, and methods for the use of industry.

9. Insight to determine when research should be terminated or discontinued, and to know when the results are sufficiently positive or sufficiently negative to satisfy the practical objectives, or when they indicate that some other approach should be investigated.

10. Emotional stability to pursue a planned objective to its logical termination; and, when necessary, courage sufficient to recognize that months of hard labor may have led to entirely negative results with the necessity to start again from the beginning.

11. Ambition and loyalty to do sincere and conscientious hard work.

12. Intellectual integrity.

Although the qualities just mentioned are vital to a successful man in the fields of applied research, it is evident that those are essentially the qualities necessary for any creative individual, whether it be in literature, music, politics, public relations, business administration, or salesmanship.

The college graduate, including many with an M.S. or Ph.D. degree, is often not immediately effective in industrial research. Graduate-school experience in fundamental research usually is not adequate training for industrial research, although it is certainly beneficial and is, perhaps, a necessity for the average man entering the research field. The viewpoints, objectives, and techniques of research in the graduate school differ from those in the industrial research laboratory. Fundamental research is often uncharted; is without economic considerations; frequently proceeds at a relatively leisurely pace; may not have definite objectives; and may be done without adequate recourse to the assistance of men, apparatus, and machines to use most efficiently the ability and time of the researcher. Perhaps unimportant and even distracting in fundamental research, the aforementioned considerations

assume major importance in industrial research. Important as basic scientific research may be to industrial development, and it certainly forms the basis for all applied research, the objectives and procedures should be recognized as significantly different. For these reasons the recent college graduate may not be prepared to contribute greatly to the industrial research program without further training and further development to utilize fully his scientific knowledge and ability.

The public-service industrial research institutions must recognize that a part of their public responsibility and their obligation to industry is to supply qualified men, well trained in the techniques of industrial research, to the laboratories of industry. Their ability to release trained men for work in industry is limited, of course, by the necessity to perpetuate the accumulated experience and "know how" of their staffs. Other means must be found for training men in industrial research.

One year ago, Armour Research Foundation announced a plan of industrial research "internships." Under this plan a graduate engineer or scientist is employed in the Foundation laboratories and is given an opportunity for a three-fold training: about one-third of his time is spent in advanced graduate study at the Illinois Institute of Technology; another third is spent on fundamental research in the Graduate School of Illinois Tech; and the balance of his time, including summer vacation periods, is spent on industrially sponsored projects active in Armour Research Foundation. The latter phase of training, as an assistant on practical problems of industrial research with experience in the methods, techniques, and approach of applied research, should balance in a very constructive manner the formal and more academic training of the graduate school. It is hoped that other organizations, and particularly industrial corporations, will see the desirability and the necessity for the encouragement and the active sponsorship of such training programs in industrial research.

For the continuation of world leadership of American industry, for continued improvement of our standards of living, for the economic and political security of our country, and for the sheer fascination of exploration on the frontiers of science—both fundamental and applied research offer an appeal and a challenge to the well-trained young scientist unsurpassed by any other profession.

Psalms 144, verses 13 and 14, could well be used to state the present-day objectives of industrial research:

"That our garners may be full and plentiful with all manner of store; that our sheep may bring forth thousands and ten thousands in our streets.

"That our oxen may be strong to labour, that there be no decay; no leading into captivity, and no complaining in our streets."

Considerations of Moon-Relay Communication*

D. D. GRIEG†, SENIOR MEMBER, I.R.E., S. METZGER†, MEMBER, I.R.E.,
AND R. WAER†, ASSOCIATE MEMBER, I.R.E.

Summary—Communication between two places on the surface of the earth by reflecting radio waves off the moon is considered. Each terminal of the circuit must be in a direct line from the moon. Frequencies above about 50 Mc. should be suitable for penetrating the ionosphere at all times and at all angles of incidence to reach the moon.

If the moon has a perfectly smooth reflecting surface, signals of all types, including wide-band television, could be utilized. If the moon has a perfectly diffuse reflecting surface, transmission would be limited to telegraph or teleprinter operation and, possibly, narrow-band telephone service. Transmitting powers now available would seem to be adequate.

I. INTRODUCTION

EFFECTIVE reflection of radio waves by the ionosphere in the region of 50 Mc. per second and below permits long-distance communication on the earth. As the frequency is increased, however, critical ionospheric frequencies are approached, and, when exceeded, transmission becomes limited to line-of-sight distances as a result of penetration of the waves through the ionized layers. To utilize the higher frequencies for long-distance communication under these conditions, a system of radio repeaters becomes necessary.

Because a repeater system presents substantial technical and economic problems, simplifications or alternatives have been sought. One approach has been to accept the general limitations but to obtain system simplification through special methods of transmission.^{1,2} A second type of solution reduces the number of repeaters by increasing the effective antenna height, and thus the range of transmission, through the use of airborne repeaters.³⁻⁵

A third possible method is utilization of sky waves and reflective media outside the earth to eliminate repeaters entirely. A study has been made of this latter method, using the moon as a reflector for communication between distant locations on the surface of the earth.

* Decimal classification: R480×R115.23. Original manuscript received by the Institute, April 16, 1947; revised manuscript received, September 30, 1947. Presented, 1947 I.R.E. National Convention, March 6, 1947, New York, N. Y., and U.R.S.I.—I.R.E. Meeting, May 5, 1947, Washington, D. C.

† Federal Telecommunication Laboratories, Inc., New York, N. Y.

¹ D. D. Grieg and A. M. Levine, "Pulse-time-modulated multiplex radio relay system—terminal equipment," *Elec. Commun.* (London), vol. 23, pp. 159-178; June, 1946.

² L. E. Thompson, "Microwave relay system," *PROC. I.R.E.*, vol. 34, pp. 936-942; December, 1946.

³ "Stratosphere planes for television and frequency-modulation broadcasting," *Elec. Eng.*, vol. 64, p. 346; September, 1945.

⁴ C. E. Nobles, "Stratovision system of communication," *Proc. N.E.C.*, vol. 2, pp. 54-72; October, 1946.

⁵ W. K. Ebel, "Stratovision system of communication—aircraft requirements," *Proc. N.E.C.*, vol. 2, pp. 73-81; October, 1946.

Historically, ionospheric investigations seem first to have suggested the presence and possible utilization of radio echoes from the heavenly bodies. Echo signals with long time delays, ranging from several seconds to minutes, have been reported a number of times by various investigators. While echoes lasting for seconds have been partially explained on the basis of specialized propagation in the upper ionosphere, the longer echoes have been accounted for by a traverse of great distances in outer space.^{6,7}

The idea of specific utilization of the moon as a reflecting surface for radio waves dates back more than twenty years when it was proposed as an experiment to determine the existence of the Heaviside layer and as a means for interplanetary transmission.⁸ The possibility of radio communication with various planets has been examined by several workers.⁹ The well-known experiments of the United States Signal Corps in January, 1946, culminated the various efforts to receive echoes via the moon, and such a type of transmission was proved to be feasible for the first time.^{10,11}

For communication purposes, several phenomena and connected limitations should be considered. For example, one major shortcoming arises from the fact that the moon is visible only up to approximately twelve hours a day, a time limitation on communication. Another factor is the time required for transmission from earth to moon and return. This amounts to approximately 2.4 seconds, and the use of the moon in a telephone circuit, or similar applications where an immediate response is required, would not be permissible. Also, the moon being a reflector in depth may possibly restrict the effective bandwidths that can be transmitted. To obtain usable bandwidths with a satisfactory signal-to-noise ratio, an elaborate directional antenna system at the receiver together with an appropriate transmission system is indicated. With this complexity of equipment, direct transmission to the listener, such as in broadcasting, is obviously not feasible.

With these various limitations, the type of long-distance communication that can be accommodated to this transmission medium is restricted to simplex relaying between terminal locations.

⁶ P. O. Pedersen, "Wireless echoes of long delay," *Proc. I.R.E.*, vol. 17, pp. 1750-1785; October, 1929.

⁷ C. Breit, "Group-velocity and long retardations of radio echoes," *Proc. I.R.E.*, vol. 17, pp. 1508-1512; September, 1929.

⁸ H. Gernsback, "Can we radio the planets," *Radio News*, vol. 8, pp. 946-948; February, 1927.

⁹ E. O. Hulburt, "Ionization in the atmosphere of Mars," *Proc. I.R.E.*, vol. 17, pp. 1523-1527; September, 1929.

¹⁰ J. Mofenson, "Radar echoes from the moon," *Electronics*, vol. 19, pp. 92-98; April, 1946.

¹¹ H. D. Webb, "Project Diana—Army radar contacts the moon," *Sky and Telescope*, vol. 5, pp. 3-6; April, 1946.

II. GENERAL CONSIDERATIONS

A. Astronomical Aspects

In the general moon-relay system illustrated in Fig. 1, transmission takes place between both terminals through the intermediary of reflections from the lunar

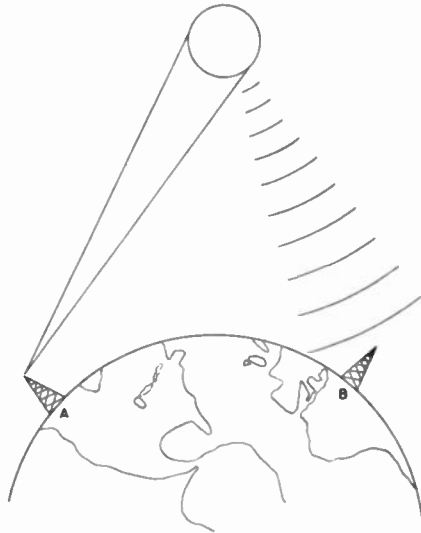

Fig. 1—Moon relay system.

surface. The various astronomical factors associated with the system are indicated in Table I. Because the orbital position of the moon changes with respect to the earth, the directional antennas at both the transmitting and receiving locations must be steerable.

TABLE I
ASTRONOMICAL DATA

Mean diameter of earth in miles	7920
Diameter of moon in miles	2160
ELLIPTICAL ORBIT OF MOON AROUND EARTH	
Semimajor axis a in miles	239,000
Distance at perigee in miles	222,000
Distance at apogee in miles	253,000
Angle subtended at perigee	33.4 minutes
Angle subtended at apogee	29.6 minutes
Eccentricity of orbit $e = (a^2 - b^2)^{1/2}/a = 1/18$.	
Period of revolution $P = 27.3$ days	
Average angular speed in orbit $= d\theta/dt = 33$ minutes per hour	
Relative speed of moon with respect to center of earth:	
$V_r = \frac{2\pi ae}{P(1 - e^2)^{1/2}} \sin \theta = 127.4 \sin \theta$ miles per hour	
$\theta = 0.53^\circ \times (\text{days elapsed since last transit at perigee})$	
Total relative velocity of New York, N. Y., with respect to the moon (neglecting parallax) $= 785 \cos \delta \sin t - 127 \sin \theta$ miles per hour.	

B. Doppler Effect

In addition to the variation in orbital position, there is a change of relative velocity between the earth and moon which introduces a doppler shift in frequency between the transmitted and received wave. For a round trip between earth and moon, a double doppler shift is experienced; one on the going and another on

the return journey. The total shift is given by the expression¹²

$$\frac{f_r - f_t}{f_t} 10^6 = -0.38 \sin(0.526t) - 1.55 \cos \delta \cos(LA_t) \sin[GHA + LO_t] - 1.55 \cos \delta \cos(LA_r) \sin[GHA + LO_r] \quad (1)$$

where

- f_r = received frequency
- f_t = transmitted frequency
- t = hours elapsed since last transit at perigee
- δ = moon declination at given instant
- GHA = moon greenwich hour angle = local hour angle + west longitude
- LA_t, LA_r = latitude of transmitter and receiver, respectively
- LO_t, LO_r = longitude of transmitter and receiver, respectively.

The magnitude of the doppler shift thus depends on the location of the transmitting and receiving terminals, frequency of operation, and on the month and hourly period. The relative frequency shift for a New York-to-Paris relay for the indicated period of time is plotted in Fig. 2. For 1000 Mc., the shift for this relay path amounts to approximately ± 1500 cycles, maximum. The percentage shift is sufficiently small so as to be generally accommodated by the receiver bandwidth at the expense of the signal-to-noise ratio. Alterna-

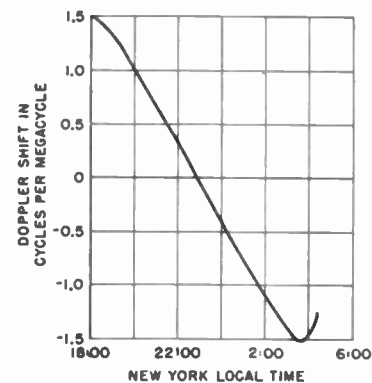

Fig. 2—Relative doppler frequency shift on New York-Moon-Paris link for November 10 and 11, 1946. Moon rises in New York at 18:00 and sets in Paris at 04:30.

tively, as the received frequency varies at a slow rate and in a predictable cyclical pattern, automatic frequency tracking of the receiver tuning may be used.

C. Cosmic Noise

Another effect peculiar to the transmission system is the presence of cosmic noise. This noise results from radiation of particles in outer space and is a function of the equivalent black-body temperature, radio frequency, time, and direction in space. In general, for

¹² H. A. Perkins, "College Physics," Prentice-Hall, Inc., New York, N. Y. 1942; p. 338.

frequencies less than approximately 120 Mc., cosmic noise is the limiting factor in detection of weak electromagnetic radiations, while at frequencies greater than this the receiver thermal resistance noise tends to mask cosmic noise.¹³ Other cosmic effects may, however, introduce detectable noise into the system. For example, the presence of comets, meteorites,¹⁴ and similar phenomena can produce ionized gas trails that introduce spurious echoes and noise. Similarly, bursts of noise have been experienced during sun-spot eruptions; they may be many times the magnitude of normal cosmic noise, and presumably arise from intense ultraviolet radiation.¹⁵

D. Refraction Effects

An effect of importance, which arises with the use of narrow beams, is the refraction variation with change in length and composition of the atmospheric path on the earth. This path length is the longest during moonrise and moonset, and changes with the zenith angle. Weather will likewise affect refraction and absorption of waves, but will be important only for frequencies higher than about 3×10^9 cycles.

Two types of refraction effects are to be expected: one a predictable bending of the beam, which varies cyclically with change of zenith angle, and second, a random bending caused by weather variation of the index of refraction. The first effect represents a known error, which can be compensated by antenna tracking, while the random variation limits the beam width. Existing data would seem to indicate that random bending for short optical paths using microwaves can be as large as 0.5° in the vertical and 0.2° in the horizontal.^{16,17} As the angle subtended by the moon is approximately 34 minutes, it would seem necessary that the beam width be made larger than 0.5° to avoid variable irradiation of the surface of the moon and corresponding random modulation of the received signal energy.

For small zenith angles, i.e., when the moon is at or near its highest elevation with respect to the earth, the effective angle at which the beam leaves the atmosphere of the earth may be computed in a simple manner, provided the refractive index of the ground location of the transmitter or receiver is known. For these conditions, the angle of refraction, which corresponds to the tilt correction that must be given to the transmitting and receiving antennas, is given by the expression

$$R \cong (n_0 - 1) \tan Z_0 \text{ radians} \quad (2)$$

¹³ "Reference Data for Radio Engineers," Second Edition, Federal Telephone and Radio Corporation, New York, N. Y., 1946; pp. 244-246.

¹⁴ A. M. Skellet, "Ionizing effects of meteors," PROC. I.R.E., vol. 23, pp. 132-149; February, 1935.

¹⁵ E. V. Appleton, "Departure of long wave solar radiation from black-body intensity," *Nature*, vol. 146, p. 534; 1945.

¹⁶ W. M. Sharpless, "Measurement of the angle of arrival of microwaves," PROC. I.R.E., vol. 34, pp. 837-845; November, 1946.

¹⁷ A. B. Crawford and W. M. Sharpless, "Further observations of the angle of arrival of microwaves," PROC. I.R.E., vol. 34, pp. 845-848, November, 1946.

where

n_0 = ground refractive index

Z_0 = antenna zenith angle with respect to earth normal.

The ground refractive index n_0 , which is a function of temperature of the air, barometric pressure, and water-vapor pressure, can be obtained by measurement or by utilizing accepted empirical formulas, which are available for microwave frequencies. For an average day, a representative value of the index can be: $(n_0 - 1) = 292 \times 10^{-6}$, from which $R = 60 \tan Z_0$ seconds of arc. Equation (2) is valid for angles up to $Z_0 \approx 45^\circ$. It should be noted that the waves are bent away from the zenith for the transmitted rays and toward the zenith for the returning reflected rays.

For zenith angles greater than 45° , the curvature of the earth's surface cannot be neglected and, in addition, the simple laws of refraction cannot be assumed to hold true. To evaluate the refractive angle R under these conditions, it is necessary to express the refractive index as a function of the altitude, which function is unknown at high altitudes. Approximations for R have been developed in the region of optical frequencies for dry air and "normal" conditions (0° C. and 760 millimeters pressure), which are valid up to about 75° zenith angles such as

$$R = \frac{(n_0 - 1)}{n_0} \tan Z_0 \text{ radians.} \quad (3)$$

If reasonable assumptions are made regarding the condition of the atmosphere, and utilizing (3) for large angles, the optical refraction angles that might be expected are given in Table II. A similar set of values can be expected to hold at microwave frequencies for the larger zenith angles.¹⁸

TABLE II
REFRACTION FOR LARGE ZENITH ANGLES

Zenith angle Z_0 in degrees	Refractive angle in minutes and seconds
80	5-30
85	10-30
90	35

At large zenith angles, such as greater than 80° , the effects of weather and anomalous propagation conditions can be expected to be exaggerated, and adversely influence transmission. On the other hand, reflection from the surface of the earth will tend to increase the effective power transmitted and received by the moon relay and thus partially compensate for spurious transmission effects. It is likely, however, that a practical compromise will be to limit the zenith angle to approximately 85° to avoid undue horizon effects at the expense of a small reduction in operational time.

¹⁸ R. Gans, "Medien mit veränderlichem Brechungsindex," *Handbuch der Experimentalphys.*, vol. 19, pp. 343-360; 1928.

E. Miscellaneous Factors

Additional factors that may effect a moon-relay system should be mentioned. Unfortunately, only a small amount of data exists regarding the ultimate magnitude of these several effects, and only an approximate estimation can be made concerning their final importance. On the basis of available data, most of these effects would seem to be of second-order importance only.

1. *Moon Perturbations:* In addition to the normal orbital motion of the moon with respect to the earth, perturbations of the orbital position exist and can affect moon-relay operation. These librations enable us to view somewhat more of the surface of the moon than otherwise and, in the case of radio transmission, act to vary the position of the reflective surfaces of the moon. As discussed later, small positional changes of the surface "jump points" can result in fading.

2. *Moon-Reflected Noise:* The noise radiated from the sun and other astral bodies and reflected from the moon may introduce additional noise in the system. An estimate of the noise can be based on an assumption of the surface temperature of the sun and the reflection coefficient of the moon. The assumption of a temperature of 10^6 °K., a receiving antenna of 1600 square feet, and a wavelength of 3 meters yields a direct sun-radiated noise approximately 9 db above the thermal noise relative to the ambient temperature of the earth. The ratio of received energy between sunlight and moonlight is approximately 60 db and, assuming this ratio holds true for radio waves, the resulting moon reflective noise would seem to be of the order of 50 db below thermal noise of the earth. However, measurements of solar activity have indicated instances in which the noise increased in the order of 60 db above normal.

3. *Moon-Radiated Noise:* The surface of the moon experiences temperature variations ranging from -150 to $+100$ °C. Thermal noise represented by this range of temperature can, therefore, be radiated by the moon. Assuming noise power is radiated at the highest moon temperature, and with the same assumptions regarding antenna size and wavelength made in the preceding paragraph, the resulting noise received on earth corresponds to 25 db below thermal noise from the earth.

4. *Ionization Effects:* Special ionization effects can be postulated both with respect to the moon as well as the earth. With the narrow beams and large concentration of radiated power that must be utilized in the system, ionization distortion phenomena such as the "Luxembourg" effect may be experienced. An additional effect, which may also be encountered, is that of ionization noise modulating the transmitted waves, thus again increasing the total system noise. No reasonable estimate of the magnitude of these effects can be given because of the paucity of available information.¹⁹

Evidence obtained on the basis of visual observations would tend to indicate that little or no atmosphere exists on the surface of the moon and, hence, the existence of an ionosphere has been questioned. However, the visual data are based on refraction effects, which require a considerably greater atmospheric pressure than that necessary to produce an ionizing layer equivalent to that surrounding the earth. In addition, the extreme high temperatures on the moon might make possible vaporization of surface material and, hence, some ionization effects. The existence of such a variable ionizing layer will cause various reflective phenomena that will be influenced by the orbital position and radiation from the sun to the moon.

III. MOON REFLECTIONS

In estimating the power to be received on earth by moon reflections and the effect of these reflections on the modulation envelope, it is necessary first to make an assumption as to the character of the surface of the moon. Fig. 3 is a reproduction of a photograph of the moon. Calculations have been made for two idealized cases: a perfectly smooth moon, and a rough moon. The distortion and bandwidth limitation resulting from the moon being a reflector in depth has been examined for both cases and for different types of modulation. For a diffuse moon, these latter effects are a function of beam width, and beam characteristics have been included in the discussion.



Fig. 3—Surface of the moon.

Courtesy Lick Observatory

¹⁹ "Accurate measurements of the Luxembourg effect," *Wireless Eng.*, vol. 15, pp. 187-188; April, 1938.

A. Smooth Moon, Power Considerations

It can be shown that a smooth, perfectly conducting sphere with a radius large compared to the wavelength of the radiation provides an effective echoing area exactly equal to its visual area.²⁰ Also, the echo received is caused mainly by reflections from the first Fresnel zone of the moon. These zones correspond to concentric slices of radial thickness equal to a quarter wavelength at the operating frequency, and it can be shown by analogy to optics that the contributions of any one zone other than the first is essentially cancelled by reflections from an adjacent zone. The net effect is to produce a field intensity of half the value to be expected from the first zone alone.

The reflection in the actual case will be reduced below that expected from a perfect moon because of the electrical properties of the surface of the moon. The ratio of reflected-to-incident intensity of a wave normal to the surface of the moon²¹ is given by

$$\frac{\sqrt{\epsilon} - 1}{\sqrt{\epsilon} + 1} \quad (4)$$

where

$$\epsilon = K - j6\sigma\lambda 10^{10}$$

K = dielectric constant of moon in electrostatic units

σ = conductivity of the moon in electromagnetic units

λ = wavelength in centimeters

$$j = \sqrt{-1}$$

The transmission frequencies are restricted to those capable of passing through the ionosphere at all times; i.e., about 50 Mc. and above, so that the maximum wavelength is 600 centimeters. For rocky ground, $\sigma = 10^{-14}$ electromagnetic units and K about 5, so that the reactive term may be neglected, and the reflection coefficient will be about 38 per cent. Therefore, the reflected power will be reduced to about 14 per cent of its incident value. A figure of 10 per cent will be used henceforth. It is interesting to note that the measured value of light energy reflected from the moon is about 7 per cent of the incident energy.

The power of an echo received from the moon²² is, then,

$$P_r = \frac{P_t G_t A_m \rho A_r}{(4\pi L^2)^2} = \frac{P_t R^2 G_t \rho A_r}{16\pi L^4} \quad (5)$$

where

P_r = received power in watts

P_t = transmitted power in watts

G_t = power gain of transmitting antenna over isotropic radiator

A_m = echoing area of moon = πR^2

ρ = reflection coefficient (power) = 10 per cent

A_r = effective area of receiving antenna

L = distance from earth to moon

A_t = effective area of transmitting antenna

λ = wavelength in same units as for above lengths

R = radius of moon.

Since

$$G_t = \frac{4\pi A_t}{\lambda^2},$$

then

$$\frac{P_r}{P_t} = \frac{\rho R^2 A_t A_r}{4\lambda^2 L^4} \quad (6)$$

The diameter of the first Fresnel zone is $(2R\lambda)^{1/2}$, which is 2.7 miles at 50 Mc. An antenna with a beam width of 0.001° would be required to irradiate this zone. If both the transmitting and receiving antennas have beam widths greater than this value (for this particular frequency), the received power is proportional to $A_r A_t A_m$. However, if the transmitting antenna is increased in area until its beam just irradiates the first zone, so that the powers reflected back from all parts of this zone are equal, then $A_m = K/A_t$ and the received power is then proportional only to A_r . A similar situation exists if A_t were held constant and A_r increased until its beam covered the first zone; the received power would be a function of A_t only, and a further increase of A_r would not increase the received power. If $A_t = A_r = A$ and the beam angle is greater than 0.001° for 50 Mc., then $P_r \propto A^2$, until $A = A_1$ and the angle is $< 0.001^\circ$, when $P_r \propto A_1$. This critical angle becomes correspondingly smaller as the wavelength decreases.

B. Smooth Moon, Modulation Effects

The echoing area being determined mainly by the first zone, which has a radial depth of $\lambda/4$, the maximum time delay between any two echoes from this zone corresponds to $\lambda/2$ or $t = 1/2f$. At 50 Mc., this is 0.01 microsecond, and correspondingly less at higher frequencies. Under these conditions, it should, therefore, be possible to transmit all types of existing communication services, including high-definition television, without distortion from relative delays.

If the moon should have only a few areas that can be considered smooth (these need only be about 2.7 miles in diameter to have an echoing area equal to the entire visual area of the moon), the echoes from two or three of these bounce points could produce serious fading. The calculations of Appendix I-A indicate that reflection from two bounce points might account for the variation in amplitude, and even for the complete loss of signal encountered at times, during the Camp Evans moon-radar experiments.^{10,20} Assuming two smooth bounce points, the difference in path length between successive pulses (5 seconds) may be up to 10 feet de-

²⁰ K. A. Norton and A. C. Omberg, "Maximum range of a radar set," *PROC. I.R.E.*, vol. 35, pp. 4-24; January, 1947.

²¹ F. E. Terman, "Radio Engineering," Second Edition, McGraw-Hill Book Co., Inc., New York, N. Y., 1937; p. 610.

²² E. G. Schneider, "Radar," *PROC. I.R.E.*, vol. 34, pp. 528-578; August, 1946.

pending on the location of these points (see Appendix I-A). This distance corresponds to about one wavelength at 110 Mc. If many smooth bounce points were present, the probability of complete cancellation at any instant would be greatly decreased. Fig. 4 illustrates the rate of change of path-length difference for various bounce-point locations.

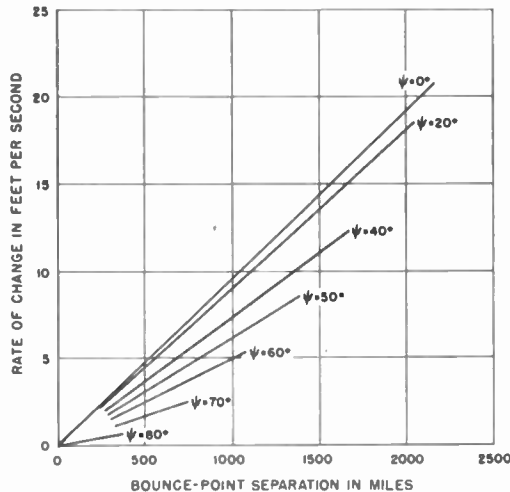

Fig. 4—Rate of change of path-length difference at moonrise or moonset for an earth latitude of 40°. ψ is defined in Fig. 14.

C. Diffuse Moon, Power Considerations

For computing the effects of a diffuse sphere, the assumption is made that Lambert's cosine law of reflection may be applied. This law states that the reflection from a small area is proportional to the cosine of the angle between the incident wave and the normal to the surface, and to the cosine of the angle between the normal and the direction in which the reflection is being observed. The derivation of the equation of reflection from a diffuse sphere is given in Appendix I-B. It is shown that

$$\frac{P_r}{P_t} = \frac{2\rho R^2 A_t A_r}{3\lambda^2 L^4} \tag{7}$$

Comparing this equation to that for the power received from a smooth moon, for equal transmitter power and equal antennas with a beam width $\geq 0.5^\circ$:

$$\frac{P_{r, \text{smooth}}}{P_{r, \text{diffuse}}} = \frac{3}{8}, \tag{8}$$

or 4.3 db less power received in a smooth-moon case than from a diffuse moon.

For maximum utilization of the transmitted energy, the transmitting and receiving antennas should have equal areas, and the received energy is then proportional to the square of this area. When the areas are increased so that the beam width is about 0.2° or less, so that the irradiated area of the moon can be considered essentially flat, then the received energy is proportional to the antenna area, rather than the square of the area. The reasoning is similar to that for the smooth moon, Section III-A.

D. Diffuse Moon, Modulation Effects

With the assumption of a perfectly diffuse moon, the distortion caused by the depth of the moon is analyzed for the case of antenna beam angles large enough ($\geq 0.5^\circ$) to irradiate the entire moon; and for angles small enough ($\leq 0.2^\circ$) so that the irradiated area can be considered flat. Results for intermediate beam angles can be interpolated readily. The analysis will be considered for the case of pulsed signals and amplitude modulation.

1. *Wide Beam, Pulsed Signals:* The radius of the moon being about 1000 miles, any signal reflected from it will have an echo lasting for approximately 0.01 second. This phenomenon restricts the use of moon reflections to pulsed transmission methods that can tolerate this build-up and decay time. Modern teleprinters use a 22-millisecond pulse for a speed of 60 words per minute. The calculated shape of this pulse, when received by reflection from the moon, is shown in Fig. 5. It should be noted that the shape of this curve was derived on the basis of integration of (13) of Appendix I-B. The distortion, or bias, present (about 10 per cent with the relay adjusted to operate at the center of the pulse amplitude) can be tolerated easily with existing equipment.

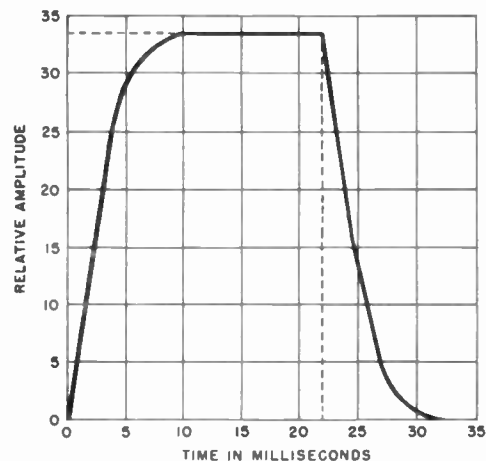

Fig. 5—Distortion of 22-millisecond teleprinter pulse signal as a result of "reverberation" persisting for 10 milliseconds.

2. *Wide Beam, Amplitude Modulation:* The "reverberation time" of about 0.01 second will not affect the use of moon reflections for speech transmission. In this analysis, a perfectly diffuse moon is assumed, so that radio-frequency phase need not be considered. The problem is then analyzed on the basis of the amount of power reflected from the different portions of the moon and corresponding times of arrival at the earth. First, it is assumed that a carrier wave is modulated by a very-low-frequency signal, say, 1 c.p.s. At any instant, then, all waves incident on the moon will have essentially equal amplitude, i.e., the same phase of the modulating wave. Therefore, the wave received at the earth will be a replica of the transmitted wave, somewhat reduced in amplitude but practically unchanged so far as modula-

tion percentage and purity of waveform are concerned. Now, consider a wave modulated 100 per cent with a single high-frequency signal, say, 1 Mc. At any instant, the waves incident on the moon will be of all possible amplitudes (the radius of the moon is about 5400 wavelengths long at this modulating frequency). The resultant wave at the earth will have practically zero modulation, since an almost identical amount of energy is received at each instant. Therefore, the modulation power received by reflection is inversely proportional to modulating frequency in a nonlinear fashion. Further, the modulation power remaining will be distorted. The power in the incident wave is of the form

$$\frac{3}{2} + 2 \sin \omega_s t - \frac{1}{2} \cos 2\omega_s t$$

$$= (1 + \sin \omega_s t)^2 \text{ (Appendix I-C.)} \quad (9)$$

where

$$\omega_s = 2\pi \times \text{modulating frequency.}$$

The power received at earth will have the form

$$K_0 \cdot \frac{3}{2} + K_1 \cdot 2 \sin (\omega_s t + \alpha_1) - K_2 \cdot \frac{1}{2} \cos (2\omega_s t + \alpha_2). \quad (10)$$

Reduction factors K_0 , K_1 , and K_2 differ because K is a function of frequency, as previously indicated. The phase angles α_1 and α_2 are the resultants for the fundamental and second harmonic, respectively, produced by the combination of the various echoes from different parts of the moon. Fig. 6 indicates the factors $K(\omega)$ and $\alpha(\omega)$ as a function of modulating frequency. Obviously, the received voltage will not be of the form $(1 + \sin \omega_s t)$ because of the change in relative amplitude of the ω_s and $2\omega_s$ terms, and the difference between $2\alpha_1$ and α_2 . This difference arises because $\alpha(\omega)$ is not linearly related to frequency.

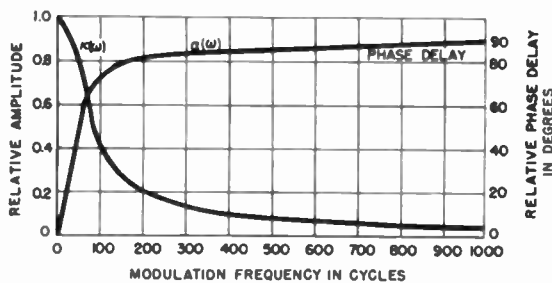

Fig. 6—Power-component reduction $K(\omega)$ and phase shift $\alpha(\omega)$ for amplitude modulation and wide beam.

The output from a linear detector has been studied by expanding the function

$$[K_0 \cdot \frac{3}{2} + K_1 \cdot 2 \sin (\omega_s t + \alpha_1) - K_2 \cdot \frac{1}{2} \cos (2\omega_s t + \alpha_2)]^{1/2} \quad (11)$$

with the aid of the binomial theorem. It is found that the percentage modulation is reduced from 100 to about 9 per cent at 300 cycles and to 0.7 per cent at 3000 cycles. The per cent second harmonic is essentially constant and equal to 12.5 per cent over this band, and the third harmonic decreases from less than 0.5 per cent at 300 c.p.s. to still smaller values at the higher frequen-

cies (inversely proportional to frequency). The ratio of K_2 to K_1 is 1 to 2 above about 100 c.p.s., so that the amplitude of the fundamental is very close to 8 times the amplitude of the second harmonic. Since both K_1 and K_2 are small compared to the d.c. term, expanding with the binomial theorem gives the d.c. term plus half the fundamental and second-harmonic terms, so that their ratio is still 8 to 1, resulting in 12.5 per cent distortion.

For a square-law detector, Appendix I-C shows that for, frequencies above 100 c.p.s., the value of K_2 is about one half K_1 , so that the ratio of ω_s is $2\omega_s$ becomes 8 to 1, resulting in 12.5 per cent second-harmonic distortion. The percentage of modulation in this case is reduced from 133 per cent to about 19 per cent at 300 c.p.s. and 1.9 per cent at 3000 c.p.s. The value of 133 per cent at very low modulating frequencies arises from the use of a square-law detector whose voltage output is similar to the power input represented by (10), so that the ratio of fundamental to direct current is 1.33. For frequencies of about 1000 c.p.s. and higher, the per cent modulation is about twice that obtained with a linear detector. Curves of received percentage modulation and harmonic distortion as a function of modulating frequency for a square-law detector are given in Fig. 7.

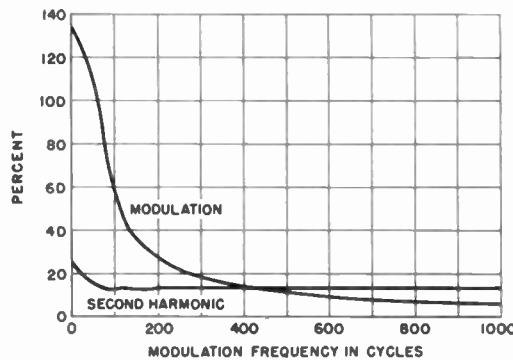

Fig. 7—Per cent modulation and per cent second harmonic for a square-law detector using amplitude modulation and wide beam.

If the transmitter utilized a speech-compression amplifier with a characteristic such that the output voltage was instantaneously proportional to the square root of the input voltage, the transmitted power would be of the form $(1 + \sin \omega_s t)$, and the receiver power of the form $K_0 + K_1 \sin (\omega_s t + \alpha)$. While the various frequencies would still be attenuated as previously, the distortion term would disappear with a square-law detector, and the average modulation percentage of the speech wave would be increased as a result of compression.

3. *Narrow Beams:* The main difference between the use of a "wide" beam, i.e., one which irradiates at least the entire moon (a beam width of 0.5° or more) and a narrow beam (0.2° or less), is that, with the latter, the powers reflected in the direction of the earth from any given portions of the uniformly irradiated area are equal to within 1 db. In the case of the narrow beam, if the

modulating frequency is such that the depth to which the moon is irradiated just equals a half-wavelength of the modulating frequency, then at any instant the power arriving at the earth will have originated during one complete modulation cycle. The returned power for this case will be constant with time, so that the modulation percentage for this particular modulating frequency and beam width is zero. This critical frequency, which has been termed the cutoff frequency, is indicated as a function of antenna diameter and wavelength in Fig. 8. In an actual case, even if the moon were a perfectly diffuse sphere, a minimum response rather than a null would be obtained at this critical frequency; the intensity of a transmitted beam on a plane normal to the direction of transmission is not equal at all points irradiated by the beam.

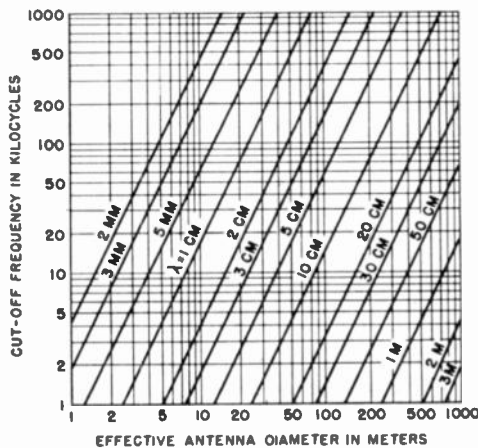

Fig. 8—Cutoff frequency, effective antenna diameter, and carrier wavelength.

Fig. 9, corresponding to the derivation of Appendix I-C-2 illustrates the power-component reduction and phase shift relative to the modulation frequency. Addi-

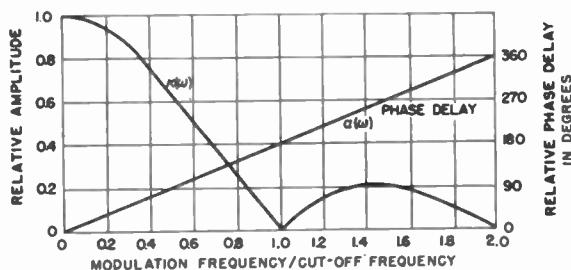

Fig. 9—Power-component reduction and phase shift for amplitude modulation and narrow beam. Modulation is expressed as a fraction of the cutoff frequency f_c .

tional curves showing the per cent modulation and second-harmonic distortion of the reflected wave (for a wave originally modulated 100 per cent) for both square-law and linear detectors as a function of modulating frequency are given in Figs. 10 and 11, respectively. The modulating frequency is not expressed in cycles, but rather as a fraction of the cutoff frequency f_c , whose

half-wavelength is equal to the depth of the moon that is irradiated. When the entire moon is irradiated as in the wide-beam case, there is no cutoff frequency, because equal powers are not reflected back from all given portions of the moon, but it is seen from Fig. 7 that the modulating percentage at 86 c.p.s., whose half-wavelength equals the radius of the moon, is down to 67 per cent, and the percentage modulation of higher-frequency signals is quite low.

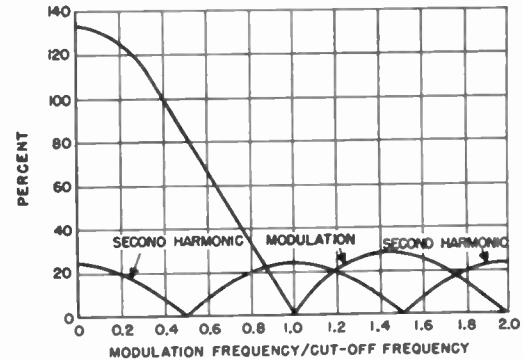

Fig. 10—Per cent modulation and per cent second harmonic for a square-law detector using amplitude modulation and narrow beam.

4. *Narrow Beam, Pulsed Signals:* The principal effect of a narrow beam on teleprinter signals will be to decrease the rise and decay times of the pulses, thus improving operation.

5. *Narrow Beam, Amplitude Modulation.* From Fig. 8, it is seen that, to transmit as high as 3000 c.p.s., an excessively large antenna structure is required in the v.h.f. band, and even at 10 centimeters a parabolic reflector having a diameter of about 125 feet would be necessary.

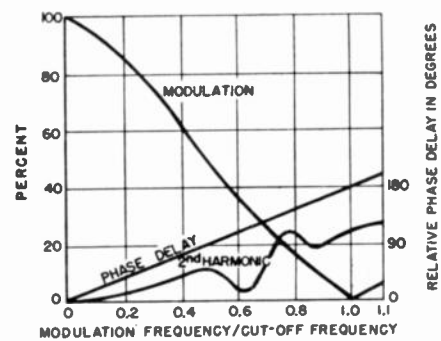

Fig. 11—Per cent modulation and per cent second harmonic for a linear detector using amplitude modulation and narrow beam.

E. *Signal-to-Noise Ratio*

In calculating the signal-to-noise ratio in the input of a receiver matched to its antenna, the formulas given for P_r/P_t in (6) and (7), for smooth and rough moons, respectively, have been used to determine the moon-circuit attenuation. The reflection coefficient ρ is taken

as 10 per cent, as indicated in previous paragraphs. This attenuation is plotted in Fig. 12 against antenna diameter, with wavelength as a parameter, assuming identical antennas for transmitter and receiver. The slope of the curve for attenuation versus antenna diameter for a smooth moon would remain as shown

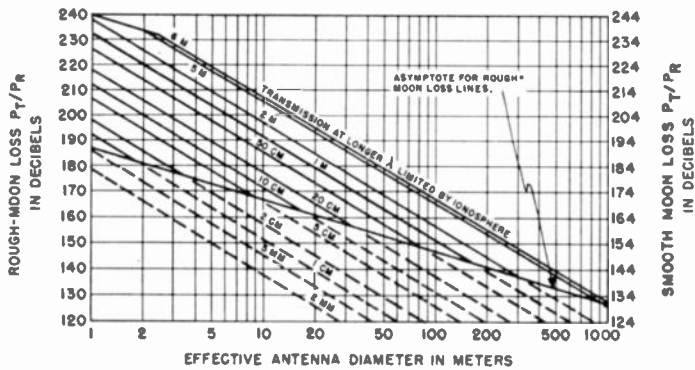

Fig. 12—Moon-circuit attenuation. The dashed lines apply to a smooth moon only.

until the antenna were large enough so that all of the transmitted power irradiated only the first Fresnel zone. The use of a larger antenna would reduce the slope of the curve by a factor of 2. Beam widths of this order are of only academic interest at the present time. For the rough moon, however, a similar situation is reached when the beam angle is about 0.2° , in which case the irradiated area can be considered flat. For narrower angles, the slope of the curve is reduced by 2.

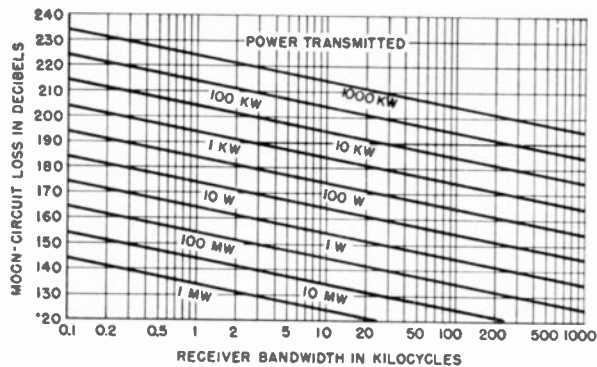

Fig. 13—Transmission characteristic for 0-db carrier-to-noise ratio. Transmitted power varies between 1 mw. and 1000 kw.

Once the loss is obtained for a given wavelength and antenna size, Fig. 13 gives the transmitter power required for unity signal-to-noise ratio in the receiver input for a given bandwidth. These curves assume a receiver noise figure of 10 db, which can be improved on in the very-high-frequency range but is still optimistic for the microwave region.

The above ratios are for continuous-wave transmission. When modulation is applied, the proper modification must be made, if a rough moon is assumed, depending on the modulating frequencies.

IV. CONCLUSION

From the previous discussion, it is seen that a most important consideration respecting a moon-relay communication system is the type of moon surface. If, for example, the moon is smooth in the sense described, any type of transmission can be accommodated: telegraphy, voice, or wide-band transmission; and reasonable transmitting powers can be used for satisfactory signal-to-noise ratio. On the other hand, if the moon is rough, essentially only narrow-band telephony and telegraphy can be accommodated. The possibility of voice transmission is dependent, however, on the availability of large effective transmitting powers and small deterioration of signal-to-noise ratio from cosmic noise and other effects.

It is difficult to anticipate the exact moon surface on the basis of existing experimental information. The Signal Corps data, for example, would seem to indicate that the moon is electrically rough, but with smooth spots, which serve as bounce points for the reflected energy. On the other hand, it might also be postulated that, despite optical evidence to the contrary, an ionosphere exists about the moon somewhat similar to that of the earth, and hence, depending on the frequency, an equivalent smooth reflector is produced by the external surface of this ionized layer.

In addition to the problem of the reflective surface of the moon, it is difficult to anticipate the extent of the various cosmic phenomena, such as cosmic noise and ionization effects, which directly influence the service to be expected. The choice of optimum frequencies, which in turn influences antenna size and transmitter power, is likewise not apparent from present information. A similar situation exists with regard to the fading phenomena which has been reported in the literature but the reasons for which are not definitely known.

It is obvious, then, that a considerably larger amount of experimental data than is now available is required before engineering estimates of equipment requirements and transmission capabilities, in addition to the system economics, can be adequately predicted.

V. ACKNOWLEDGMENT

Original suggestions along the lines of moon-relay communications by H. Busignies, initial calculations and theoretical discussions by Louis Goldstein, and considerable aid in the computations rendered by H. Anderson, are acknowledged.

APPENDIX I

A. Interference between Two Bounce Points on the Moon

Let a plane perpendicular to the axis of the earth be passed through the transmit-receive position, and the projection of the moon with its bounce points on this plane be considered. Referring to Fig. 14, the base line L connects the earth position with the midpoint of the line C joining the two bounce-point projections. L

makes an angle γ with the normal on earth and ψ with the normal on the moon. For L much greater than C , as is the case, the difference in distance from earth between the two bounce points is $C \sin \psi$. Therefore, the

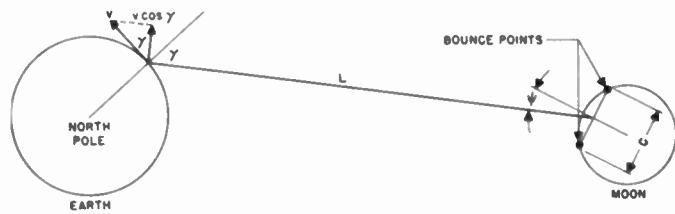

Fig. 14—Multipath transmission.

difference in distance traveled by radar signals is $2C \sin \psi$. Thus, for a variable ψ , the rate of change of path-length difference $(d/dt)\Delta P$ is

$$\begin{aligned} \frac{d}{dt} \Delta P &= \frac{d}{dt} 2C \sin \psi \\ &= 2C \cos \psi \frac{d\psi}{dt} \end{aligned}$$

Since

$$L \frac{d\psi}{dt} = V \cos \gamma$$

where

V = tangential velocity of a point on the surface of the earth,

$$\frac{d}{dt} \Delta P = \frac{2V}{L} \cos \gamma C \cos \psi. \tag{12}$$

Thus, the rate of change of path-length difference will be maximum when the moon is at zenith as seen from earth, and when the earth is at zenith as seen from a point midway between the projected bounce points. The rate of change of path-length difference will be directly proportional both to the straight-line separation of the projected bounce points and to V . V is a maximum of 1520 feet per second at the equator of the earth and equals about 1160 feet per second at 40° of latitude. L varies several per cent but has a mean value of 240,000 miles.

Equation (12) is plotted in Fig. 4 for the particular case of V corresponding to 40° of earth latitude and with the moon at the zenith ($\gamma = 0$). For $\gamma = 90^\circ$, there is no rate of change of path-length difference, while for $\gamma = 84^\circ 16$ minutes or the moon $5^\circ 44$ minutes above horizon, the plotted values would be reduced to 0.1 of the values shown.

B. Determining Reflected Power

To determine the magnitude of the echo from a rough surface, it is necessary to sum the power contributions from each element of that surface. The first problem,

then, is to relate the watts per unit solid angle reflected in a given direction to the incident intensity and direction. Lambert's law is assumed to hold. The flat, rough element of surface dA has incident on it P_0 watts per unit area perpendicular to the direction of arrival, or $P_0 \cos \theta$ watts per unit surface area, where θ is the angle between the direction of arrival and the normal to the element dA . Therefore,

$$\text{Incident power} = P_0 \cos \theta dA \text{ (watts)}$$

and

$$\text{Reflected power} = P_0 \cos \theta dA \rho \text{ (watts),}$$

where

ρ = power reflection coefficient.

Enclose the element of area dA within a sphere, as in Fig. 15. The indicated element of spherical surface ds is, then, $ds = 2\pi(R \sin \eta)(Rd\eta)$, and corresponds to an element of solid angle $d\Omega = 2\pi \sin \eta d\eta$.

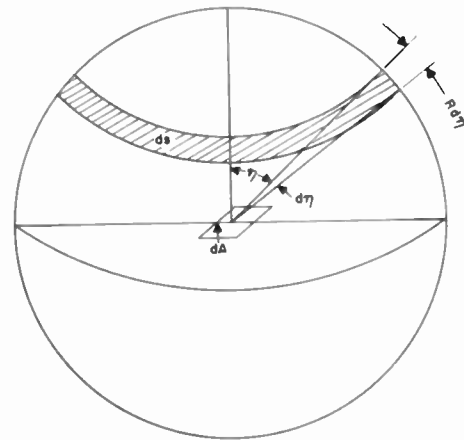

Fig. 15—Reflection from a rough flat surface.

Let P_N = watts per unit solid angle reflected normal to the surface dA .

The watts per unit solid angle reflected in the direction η is, then, $P_N \cos \eta$, and the power intercepted by the surface element ds

$$\begin{aligned} &= P_N \cos \eta \text{ watts per unit solid angle} \times 2\pi \sin \eta d\eta \\ &\quad \text{(solid angle)} \\ &= 2\pi P_N \sin \eta \cos \eta d\eta \text{ (watts)} \\ &= \pi P_N \sin 2\eta d\eta \text{ (watts)}. \end{aligned}$$

The total power intercepted by the upper hemisphere, then,

$$\begin{aligned} &= \int_0^{\pi/2} \pi P_N \sin 2\eta d\eta \\ &= \pi P_N \text{ (watts)}. \end{aligned}$$

But, total power reflected also = $P_0 \cos \theta dA \rho$. Therefore,

$$\pi P_N = P_0 \cos \theta dA \rho$$

and

$$P_N = \frac{\rho P_0}{\pi} \cos \theta dA \text{ (watts per unit solid angle, perpendicular to the elemental area)}$$

or the power reflected back in the direction of the source is

$$P_\theta = P_N \cos \theta = \frac{\rho P_0}{\pi} \cos^2 \theta dA \quad (\text{watts per unit solid angle}).$$

Having found this, it is now possible to find the total reflection in a given direction from the whole surface of the moon. It is assumed that the surface is rough and truly spherical.

As may be seen from Fig. 16, the element of area has the value

$$dA = 2\pi y(Rd\theta).$$

But

$$Rd\theta = \frac{dx}{\sin \theta}$$

and

$$y = R \sin \theta.$$

Therefore,

$$dA = 2\pi R dx.$$

The element of power per unit solid angle reflected by dA toward the earth is, then,

$$\begin{aligned} dP_E &= \frac{\rho P_0}{\pi} \cos^2 \theta dA \\ &= 2\rho P_0 R \cos^2 \theta dx \\ &= 2\rho P_0 \frac{(R-x)^2}{R} dx. \end{aligned}$$

The power returned from the front to the depth x is, then,

$$\begin{aligned} P_E &= \int_0^x 2\rho P_0 \frac{(R-x)^2}{R} dx \\ &= 2\rho P_0 \left[Rx - x^2 + \frac{x^3}{3R} \right], \end{aligned} \quad (13)$$

or, from the whole visible surface,

$$P_E = \frac{2}{3}\rho P_0 R^2.$$

However,

$$P_0 = \frac{P_T G}{4\pi L^2}$$

and

$$G = \frac{4\pi A_T}{\lambda^2}.$$

Therefore,

$$P_E = \frac{2\rho R^2 P_T A_T}{3\lambda^2 L^2}.$$

The received power is, then,

$$\begin{aligned} P_R &= P_E \frac{\text{watts}}{\text{unit solid angle}} \times \frac{A_R}{L^2} (\text{solid angle}) \\ &= \frac{2\rho R^2 P_T A_T A_R}{3\lambda^2 L^4} \end{aligned}$$

or

$$\frac{P_R}{P_T} = \frac{2\rho R^2 A_T A_R}{3\lambda^2 L^4}.$$

This expression yields the moon-circuit loss for the case of a beam wide enough to irradiate the moon uniformly. The relations are expressed graphically in Fig. 12, assuming equal transmitter and receiver effective areas of diameter d .

C. Moon-Reflection Effect on Modulation Components of an Incident Wave

1. *Amplitude Modulation, Wide Beam:* If transmitting and receiving beam angles that are wide compared to the moon are assumed, then, as in Appendix I-B, the

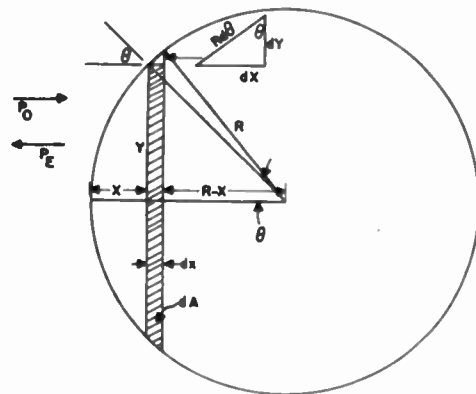

Fig. 16—Rough-moon reflection

element of reflected power toward the earth from a slice x deep and dx thick (Fig. 16) is

$$dP_E = 2\rho P_0 \left(R - 2x + \frac{x^2}{R} \right) dx.$$

Assuming 100-per-cent sine-wave modulation at the transmitter, the transmitted power will be of the form

$$(1 + \sin \omega t)^2$$

or

$$\frac{3}{2} + 2 \sin \omega t - \frac{1}{2} \cos 2\omega t.$$

Counting time for both transmitter and receiver from a plane, tangent to the moon at its nearest point, then, the received power at a given instant will be

$$P_R = \int_0^R \left[\frac{3}{2} + 2 \sin \omega \left(t - \frac{2x}{c} \right) \right]$$

$$- \frac{1}{2} \cos 2\omega \left(t - \frac{2x}{c} \right) \Bigg] \\ X \left[2\rho \left(R - 2x + \frac{x^2}{R} \right) \right] dx.$$

The result of integration, trigonometric manipulation, and normalizing to an average value of 3/2 is that

$$P_R = \frac{3}{2}(K_0) + 2(K_1) \sin(\omega t + \alpha_1) \\ - \frac{1}{2}(K_2) \cos(2\omega t + \alpha_2)$$

where K and α are functions of modulating ω or f , and are, respectively, equal to

$$K(\omega) = \frac{3}{\chi} \left[1 + \frac{4 \cos \chi}{\chi^2} - \frac{8 \sin \chi}{\chi^3} + \frac{8}{\chi^4} (1 - \cos \chi) \right]^{1/2}, \quad (14)$$

$$\alpha(\omega) = \tan^{-1} \left[\frac{1 - \frac{\chi^2}{2} - \cos \chi}{\chi - \sin \chi} \right], \quad (15)$$

where

$$\chi = \frac{2R\omega}{c}$$

and may be interpreted physically as the relative delay in electrical radians at the modulating frequency between an echo from the nearest part of the moon and an echo from the deepest portion irradiated. In this wide-beam case, the moon is irradiated to the very edge.

The above relations are plotted in Fig. 6. Above about 100 c.p.s., $K(\omega)$ is closely equal to $41.1/f$.

The use of $K(\omega)$ and $\alpha(\omega)$ is not restricted to the case of 100 per cent modulation by a single sine wave. If any signal voltage envelope is squared, the expression for the transmitted power envelope as a function of time will be obtained. The effect of a moon reflection on each of the resulting terms, after reduction to the form $A \sin(\omega t + \phi)$, will be a transformation into the term

$$AK(\omega) \sin[\omega t + \phi + \alpha(\omega)]. \quad (16)$$

Thus, the form of the received power for any steady-state modulation may be found.

2. Amplitude Modulation, Narrow Beam: If a transmitting beam b times as wide as the moon is used, where b is small compared to 1, then the maximum depth of the moon reached by the incident power is $R[1 - (1^2 - b^2)^{1/2}] =$ approximately $(b^2/2)R$.

The power returned from any depth down to $(b^2R)/2$ is assumed to be constant. The greatest error in this

assumption results from the nonuniformity of the beam. Then, at any instant the returned power is proportional to

$$\int_0^{b^2R/2} \left[\frac{3}{2} + 2 \sin \omega \left(t - \frac{2x}{c} \right) - \frac{1}{2} \cos 2\omega \left(t - \frac{2x}{c} \right) \right] dx.$$

Again, integration, trigonometric manipulation, and normalizing to an average value of 3/2 results in

$$P_R = \frac{3}{2}(K_0) + 2(K_1) \sin(\omega t + \alpha_1) \\ - \frac{1}{2} \cos(2\omega t + \alpha_2) \quad (17)$$

where

$$K(\omega) = \frac{2}{\chi} \sin \frac{\chi}{2}$$

$$\alpha(\omega) = - \frac{\chi}{2}$$

$$\chi = \frac{b^2R\omega}{c}$$

and has the same physical interpretation as in the wide-beam case.

$$K(\omega) \text{ first goes to zero when } \frac{\chi}{2} = \pi$$

or

$$\chi = 2\pi \\ = \frac{2\pi b^2Rf}{c}$$

or when

$$f = \frac{c}{b^2R} \\ = f_c.$$

This value of frequency f_c has been termed the cutoff frequency. $K(\omega)$ and $\alpha(\omega)$ are plotted in Fig. 9 as functions of f/f_c rather than f .

$$\text{Moreover, } b = \frac{\text{beam width}}{\text{moon width}} = \frac{50 \frac{\lambda}{d}}{\frac{1}{2}} = 100 \frac{\lambda}{d}$$

or

$$f_c = \frac{cd^2}{10^4 \lambda^2 R}. \quad (18)$$

This last relation is plotted in Fig. 8.

Statistical Methods in the Design and Development of Electronic Systems*

L. S. SCHWARTZ†, SENIOR MEMBER, I.R.E.

Summary—A study is made of certain factors affecting tolerance assignment in the production and operational stages of an electronic system. The procedure adopted is first to review very briefly some of the fundamentals of the statistical control of quality and the assignment of valid, economical production tolerances, and second to describe how the principles may be applied in the setting of some operational tolerances for an electronic system. The advantages to design and development derived from a knowledge of how tolerances, both production and operational, are assigned, and how they combine statistically, are discussed.

INTRODUCTION

WHEN THE DESIGNER of an electronic system learns that the bandwidth of his receiver channels cannot exceed a certain value set by operational requirements, he seeks to determine the factors which influence the assignment of bandwidth. These factors may include parameters such as voltage, temperature, and impedance mismatch. It is important that the frequency instabilities which they introduce do not exceed prescribed figures except by, at most, a small amount which can be specified in advance. This is particularly desirable in certain applications where a premium is placed on reliability of operation. But, in order to accomplish this, it is necessary not only that the designer comprehend the purely electronic factors which affect the frequency stability of his system, but also that he understand the meaning of production tolerances in so far as they apply to the components which make up his system, and also how these tolerances combine. Only in this way would it seem possible to fix what we might call operational tolerances.

The mechanical designer quite naturally is in the habit of thinking about production tolerances because of the extremely narrow limits of variability imposed on his product. This, however, is frequently not the case with the electronic system designer, because he thinks in terms of tolerances which are by comparison exceedingly broad, and he may fail to see the need to concern himself with tolerance limits of the order of 1 per cent or less. Before the advent of the interrogator-beacon and other electronic systems which seem to have great possibilities of revolutionizing air navigation and traffic control, this attitude of mind might have appeared justified. But now, when we can see the need for reliability in performance approaching the 100 per cent figure, as exemplified in these systems, we must, at the same time,

see as one the problem of tolerance assignment from the production to the operational stage. It is the object of this paper to show this relationship.

PART I—QUALITY CONTROL

I. Randomness and the State of Statistical Control

Before the methods of statistics can be validly applied in the assignment of tolerance limits, it must be demonstrated that the characteristic under consideration (for example, the inside diameter of a metallic washer) is subject only to chance causes, and that its variations will be purely random. Specifically, a product or quality is said to be in a state of statistical control whenever chance fluctuations in its physical attributes are produced by a constant system of a large number of chance or unknown causes in which no cause produces a predominating effect. It is of great practical importance to be able to recognize when a state of statistical control exists, for, as will be seen, the attainment of a state of statistical control makes possible the achievement of uniform quality and a reduction in tolerance limits.

To obtain a measure of departure from standard quality, and in order to determine that a state of control exists, it has proved sufficient to specify two statistics:¹ the mean and the standard deviation from the mean of a series of measurements, the latter being a measure of the dispersion or scatter about the mean. The mean is given by the expression

$$\bar{X} = \sum_{i=1}^n \frac{X_i}{n} \quad (1)$$

where $X_i = 1, 2, 3 \dots n$ are the measurements. The standard deviation from the mean is

$$\sigma = \sqrt{\sum_{i=1}^n \frac{(X_i - \bar{X})^2}{n}} \quad (2)$$

where \bar{X} is determined by (1). It is shown¹ that the above two statistics convey almost all of the usable information in respect to the specification of standard quality. If the distribution function itself is also specified, the specification becomes complete from the standpoint of both design and control, because we then know the probability associated with any interval X_1 and X_2 , and can set sampling limits on almost all the common statistics.

* Decimal classification: R720. Original manuscript received by the Institute, July 30, 1947; revised manuscript received, January 5, 1948. Presented, 1948 I.R.E. National Convention, March 22, 1948, New York, N. Y.

† Hazeltine Electronics Corporation, Little Neck, L. I., N. Y.

¹ W. A. Shewhart, "Economic Control of Quality of Manufactured Product," D. Van Nostrand Co., Inc., New York, N. Y.; 1931.

Fundamental to the attainment of a state of statistical control is the construction of some form of control chart. Examples are those shown in Figs. 1 and 2. In order to construct the charts, it is necessary to estimate the mean and standard deviation of an unknown distribution which may or may not be in a state of control. This is done by taking samples of data on the char-

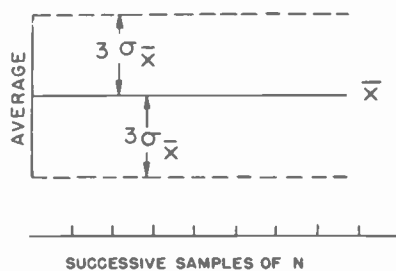

Fig. 1—Form of control chart for deviations from the mean. Sample averages are plotted successively as they are taken.

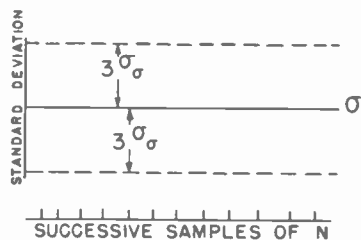

Fig. 2—Form of control chart for deviations from the standard deviation of the lot. Sample standard deviations are plotted successively as they are taken.

acteristic under observation and computing the means and standard deviations of the samples with the aid of (1) and (2). The means and standard deviations of the samples are then combined according to methods outlined by Shewhart,² to give the estimated mean and the standard deviation of the lot. The lot is defined as the largest available amount of material produced under essentially the same conditions. Once the mean and the standard deviation of the lot are estimated, control limits for the charts are assigned as shown in Figs. 1 and 2.³

If one or more of the averages of samples of data falls outside the control limits, that fact is taken as an indication that there is lack of control or an assignable cause of variation in the production process, and we look for trouble. The customary procedure is to eliminate the trouble and set up new control limits. This process is carried through as often as is found necessary. New control limits must also be constructed when there is any change in the conduct of production. Finally, the control chart is useful in indicating trends or periodic effects, even when the points do lie within the control limits.

II. Tolerance Limits

A. The meaning of tolerance limits: Tolerance limits fix the range through which the dimension or quality of a piece part may vary in accordance with a given specification. From the standpoint of economical and efficient production, however, it is insufficient to center our attention on the limits alone, because, although we may desire to have the tolerance range as small as possible, we must recognize that if it is too small the rejections will be excessive. On the other hand, if the tolerance limits utilize the full range allowed by the specification, we may find that there is an avoidable wastage of material. In other words, we must strike a balance between these two considerations. This means that we must think of the percentage of product made under commercial conditions that may be expected to fall within the tolerance range. That is, we should speak of economic tolerance limits with an associated probability of the product falling within the range.

B. The importance of statistical control in setting tolerance limits: Control is necessary in setting an economic tolerance range because, if the quality or dimension of a piece part is statistically controlled in accordance with a probability distribution, the engineer knows the number of rejections that will occur for given limits. Control is necessary where 100 per cent inspection cannot be made, because then we must make inferences from inspection of samples as to whether the assigned tolerances are being met by the lot as a whole. What we infer about the lot from the samples depends on what we assumed about the lot in the first place. But no assumptions whatever can be made about the lot unless the production process is statistically controlled.

C. The assignment of tolerance limits when control is lacking: In this case the maximum and minimum values of a large number of observations appear to hold the most value in setting tolerance limits, but such limits do not permit the most efficient use of material. Statistical theory does not appear to offer much help in specifying tolerance ranges under conditions which are uncontrolled.

*D. Procedure in setting tolerance limits under controlled conditions:*⁴ Following the establishment of control in the production of a piece part, a useful procedure in evolving economic tolerance limits is to employ 100 per cent inspection until about 1000 units have been tested and the data arranged in a frequency distribution. For the data presented in this form, the engineer can readily determine the number of rejections. The tolerance limits thus assigned may lie within, coincide with, or lie outside the limits of the control chart. The former, however, is infrequent. In any case, even if the tolerance limits can be taken in excess of the control limits, steps should be taken to eliminate assignable causes whenever a manufactured product exceeds the control limits.

²See pp. 301-347 of footnote reference 1.

³See pp. 276-277 of footnote reference 1.

⁴W. A. Shewhart, "Statistical Method from the Viewpoint of Quality Control," The Graduate School, The Department of Agriculture, Washington, D. C., 1939.

E. Two aspects of the problem of tolerance assignment: One of the aspects of the problem of tolerance assignment relates to the establishment of tolerances for raw and fabricated materials and piece parts, and the other relates to the specification of tolerance limits for completed units or engineering structures. The first of these presents a problem in statistical estimation which is involved in the construction of control charts. The second is concerned with the designation of over-all tolerances in terms of the tolerances of piece parts. This we shall now discuss.

III. Design Limits

Let us assume that the quality characteristics under study are in a state of statistical control, and that the means and standard deviations have been estimated and tolerance limits set for the component piece parts. Our problem, to determine over-all system tolerances, then involves distribution statistics as distinct from estimation statistics. Here we shall say nothing about the size of the sample. In fact, we shall assume that we are dealing with statistical universes (i.e., vast storehouses of data) and trust that we can use the formal mathematical theory of statistics.

We wish to set tolerance limits on a quality Y which depends on the qualities X_1, X_2, \dots, X_m of m different piece parts, so that a fraction P of the product will be included within these limits in the long run. If a quality Y depends upon the qualities X_1, \dots, X_m of m different piece parts, and it is known that

$$Y = F(X_1, \dots, X_m) \quad (3)$$

and that each of the m component values are controlled about expected values or means

$$\bar{X}_1, \dots, \bar{X}_m$$

with standard deviations

$$\sigma_1, \dots, \sigma_m,$$

then it can be shown that the expected value \bar{Y} and the standard deviation σ_Y of Y , the distribution of the quality Y assembled at random, are given by

$$\bar{Y} = F(\bar{X}_1, \dots, \bar{X}_m) \quad (4)$$

$$\sigma_Y = \left\{ \sum_{j=1}^m a_j^2 \sigma_j^2 \right\}^{1/2} \quad (5)$$

where

$$a_j = \left(\frac{\partial F}{\partial X_j} \right)_{X(1, \dots, m) = \bar{X}(1, \dots, m)}, \quad (6)$$

independent of the nature of the (generally unknown) distributions functions of the individual X_j .

If we wish to determine the standard deviation of a linear function of variables with unknown distributions and equal weights, then

$$\bar{Y} = \sum_{j=1}^m \frac{\bar{X}_j}{m} \quad (7)$$

and

$$\sigma_Y = \left\{ \sum_{j=1}^m \sigma_j^2 \right\}^{1/2}. \quad (8)$$

If each of the m standard deviations is equal to σ_1 , then the standard deviation of the sum is

$$\sigma_Y = \sqrt{m} \sigma_1. \quad (9)$$

The above information will now be applied to obtain some operational tolerances for an electronic system.

PART II—APPLICATION

I. Discussion

There are three distinct situations in the study of certain applications of distribution statistics.

(a) The first situation arises when there is pressure to improve the product continually, rather than just to meet minimum performance. This situation is more apt to obtain under conditions of normal peacetime production than during a war. In this case we suppose that our aim is to reduce the over-all operational tolerances ΔX , and that we do this by reducing the individual operational tolerances ΔX_i to their minimum values by improving the product design. The ΔX_i so obtained are combined statistically to yield ΔX .

(b) A second situation is largely peculiar to wartime conditions and applies where the speed of equipment introduction, rather than cost of production and ultimate quality, are of primary interest. Thus, suppose that it is known from the system requirements that the total deviation on the resultant of a group of characteristics cannot exceed an over-all tolerance of $\pm \Delta X$, and that there are n sources contributing to it. How shall the allowable tolerance of the i th cause be specified? In certain cases in the past the practice has been to assign reasonable and attainable values of ΔX_i , subject to the condition that $\sum |\Delta X_i| = \pm |\Delta X|$ where the summation extends over the n causes. This requirement very often forced the redesign of various system components, since the total ΔX could not be exceeded. Such a process is clearly both expensive and inefficient, since it is evident that, in general, the tolerances will not add algebraically. Specifically, therefore, the problem is to assign the ΔX_i so that their statistical rather than algebraic sum will be equal to ΔX . In effect, this means a relaxation in the ΔX_i .

(c) Finally, let us imagine a situation in which even the statistical sum of component tolerances exceeds the limits set by system performance requirements. In that case, we must examine the assigned component tolerances with a view to reducing them sufficiently so that their statistical sum will fall within the required limits. It would be seen that the statistical method indicates which component tolerances are playing predominating roles and which, therefore, may profitably be pared down, and by how much. In this respect, as in the others, it is a guide to design.

In the discussion to follow, the first situation only will be treated, because of space limitations and also because it is believed that the reader will easily see the

extension of the statistical method to the other two situations.

The writer is acquainted with a pulse-operated interrogator-beacon system developed by the U. S. Navy during the war to which statistical methods could have been applied with considerable advantage, but were not. The experience is replete with excellent examples illustrating problems enumerated above, but it is believed that a discussion of only one of these is sufficient to illustrate the point. It is that concerned with the attainment of frequency stability. It is a rather complex picture, and one is confronted with the fact that certain phases of it cannot be treated statistically but must be handled by means of intelligent guesses alone. Hence, one might think in studying the material about to be presented that undue concern is paid to obtaining exact answers to some points, while others are merely guessed. The justification is that, in the instances where guesses are made, they are believed to represent pessimistic estimates, and it is thought advisable to define as exactly as possible the domain in which it is possible to employ statistics. By so doing, the limits which must be dealt with can be narrowed, and hence whatever answer is given can be offered with a high degree of confidence.

Specifically, we are concerned with the factors which produce frequency drift in an oscillator. They include such things as voltage, temperature, and duty-cycle variations. It is assumed that we wish to achieve the economically best system design; in other words, one in which the over-all frequency drift will more than meet the minimum requirements. We begin with a study of the particular case of drift with duty-cycle variation and see how we would attempt to reduce this to the economical minimum. Investigation is made of the transmitter oscillator tube, a lighthouse triode in which the effect of dissipation as a function of duty cycle is to cause the grid to move relative to the anode, causing a change in interelectrode capacitance and thus in the generated frequency.

In the production of the tube, let us assume that the dimensions of the subelements and their physical and chemical characteristics are the results of production processes that are in a state of statistical control, and that all these lie within properly assigned tolerance limits. It remains then to be assured that the assembly of the grid and its mounting in the tube are statistically controlled. It has been determined that, under operational conditions, the duty cycle of the transmitter oscillator may be made to vary through limits of from 0 to 1 per cent. Hence, one procedure is to mount tubes in a standard oscillator and measure the frequency deviation under a 0 to 1 per cent change in duty cycle. These measurements are brought into a state of statistical control with the aid of a control chart, as described in Part I, by altering the assembly of the grid and/or its mounting in the tube, as may prove necessary. From the statistically controlled data it is found possible to assign tolerance limits on frequency stability such that the

probability is, say, 99 per cent that in the long run all of the frequency deviations resulting from the specified duty-cycle variation will fall within the prescribed limits.

It must be emphasized that these prescribed limits are a function of design. That is, if we change the grid metal from steel to molybdenum, stretch the grid wires, change the way the grid frame is supported—do any or all of these things, still maintaining the production of all components and their assembly in a state of statistical control—then, for the same change in duty cycle, there will be a different maximum frequency shift. Hence, we expect a definite and significant correlation between maximum frequency shift and design. But it cannot be too strongly emphasized that this holds if, and only if, the production of subelements and their assembly is held in a state of statistical control. Otherwise, the maximum frequency shift can be expected to vary wildly.

Let us suppose that we can assign tolerance limits of ± 0.6 Mc. for a 0 to 1 per cent change in duty cycle. The significance of ± 0.6 Mc. in conjunction with the 0 to 1 per cent duty cycle change needs to be examined carefully, for the maximum anticipated variation of 0 to 1 per cent will produce the extreme allowable frequency shift in only a very small percentage of cases. Experience seems to show that, while the exact distribution is unknown, it is at least approximated by a unimodal,

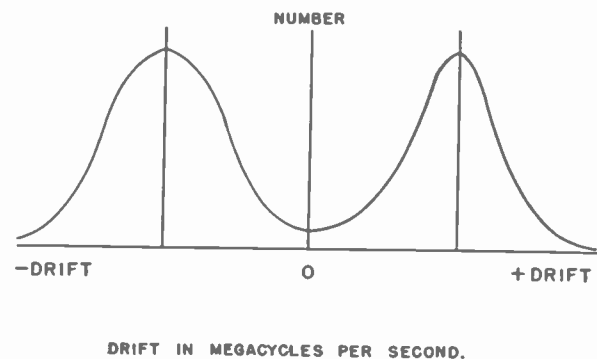

Fig. 3—A more or less typical curve showing the number of observations of a given value of drift as a function of the drift caused by a variation in a system parameter such as voltage, duty cycle, or ambient temperature. The drifts may be either positive or negative, depending on the direction of variation of the parameter. The curves need not be symmetrical.

monotonic curve on each side of zero (in general, asymmetrical), with a tapering off at the tails such that a very small number of tubes can be expected to yield a shift in frequency as great as 0.6 Mc. plus or minus for a 0 to 1 per cent change in duty cycle. (See Fig. 3.)

Furthermore, an average oscillator is not likely to be subjected to the extreme change in duty cycle, since the range of 0 to 1 per cent represents the anticipated operational extreme. Therefore, on the average one would very definitely expect the frequency deviation to be appreciably less than 0.6 Mc. plus or minus.

So far, we have discussed only one factor that influ-

ences frequency drift; namely, duty-cycle variation. There are others, such as plate- and filament-voltage variations, ambient-temperature variations, and the like. The same arguments, employed in the case already considered, apply to the setting of tolerance limits for these. The statements made about the likelihood of extreme variations in operating factors occurring are also pertinent. Now, let us see what the effect is of all these factors, acting together on one piece of equipment. The chances are that the equipment has an average transmitting tube which, if subjected to maximum duty-cycle variation, will not yield the maximum allowed frequency drift from this cause. What is the probability that this equipment will be subjected to extremes of duty-cycle variation? That will depend on the location and circumstance. It will be argued that, where large numbers of equipment are involved, certainly some will experience wide conditions of operation. That is true, but only a few will show maximum frequency drifts for any one parameter such as duty cycle, voltage, and temperature. Furthermore, what is the likelihood that any appreciable number will be subjected to all adverse fluctuations in voltage, temperature, dissipation, etc., at the same time? Also, is it likely that an equipment which shows a large frequency drift for one or more deviating parameters will demonstrate large shifts for others? If the parameters are random, probability is against this. The answers to all the above questions cannot be given in quantitative terms until a mass of empirical operating data, not now available, has been obtained. In any case, we would expect intuitively from the laws of chance that all random parameters would operate simultaneously in the worst way only in a negligible number of instances. This problem may be likened to that of the i.f. amplifier in which, if all allowable component deviations were added unfavorably, the gain would be negligible.

However, let us be very pessimistic and postulate the two following premises:

(a) Each parameter has equal probability for all values within and including its extremes.

(b) Each deviation in performance characteristic resulting from such parameter has equal likelihood for any value between and including its limits.

These are pessimistic because the extreme value for each parameter and for each deviation resulting therefrom is less probable than an intermediate value.

Let us restate the position in the matter of frequency drifts. If we knew that the operating parameter would have a definite value, we could define quite accurately the tolerance limits for the deviation in frequency caused by the given parameter on the basis of the controlled lot. On the average, however, the parameter is distributed in an unknown way. We can assume a distribution that our experience would tell us represents the pessimistic extreme so far as describing the resultant frequency variation is concerned, and then go a step further and assume that the resultant frequency

deviation itself has the same kind of distribution. A convenient distribution to use for this purpose is the rectangular distribution.

Let us now turn our attention to the specific problem in hand and list the parameters⁵ that give rise to frequency deviations. These are: (a) ambient temperature; (b) air pressure; (c) tube plate voltage; (d) tube heater voltage; (e) impedance mismatch; (f) duty cycle; (g) aging of tubes; (h) reset errors of the remote tuning mechanism; (i) setting; and (j) wavemeter.

Under average conditions, variations in parameters (a) through (f) the most important in causing frequency shift, depend on location and circumstance and, therefore, do not follow any definite law. The behavior of parameters (g) and (h) probably can be predicted on the average, once preliminary empirical data are available. Parameters (i) and (j) are dependent to a considerable degree on the state of training of the using personnel, an unpredictable factor.

A word is in order here regarding two of the parameters, i.e., impedance mismatch and reset errors. Impedance mismatch produces frequency pulling in oscillators and is a very important source of frequency drift. It is a function of two quantities which are random with respect to each other; namely, standing-wave ratio and phase. In order to have maximum impedance mismatch, it is necessary to have not only a maximum standing-wave ratio, but one of proper phase as well. In the statistical summation of errors carried out below, it is assumed that a maximum standing-wave ratio exists and that any phase position is equally probable. It would seem that the latter assumption is correct but that the former errs on the pessimistic side in that the limit value of standing-wave ratio is less likely than some intermediate value. Our results, therefore, will be conservative, since we assume maximum values of standing-wave ratio as 100 per cent probable. As sufficient distribution data from standing-wave measurements do not exist at this time, it is impossible to estimate at what intermediate values the most probable values do in fact occur.

Reset errors occur in the remote tuning device. If it positions the transmitter or the receiver on a new frequency channel and then returns the setting to the first channel, the frequency will have altered somewhat. The deviation which will be quoted is the largest recorded for a large number of readings under controlled conditions.

Before performing any statistical operations on these data, perhaps the first thing which should be noted is that not all of the errors are random. Thus, one would expect a certain connection between temperature and pressure. That is, for airborne operations, when the pressure is low, the temperature is low, although the extent of this dependence is a function of location and of altitude. Also, heater- and plate-voltage variations

⁵ We shall consider airborne operation only.

are definitely related. In addition, there is a connection between temperature and impedance mismatch in the airborne case, particularly in that, at low temperatures, ice forms on the antenna, and this induces an appreciable part of the mismatch. Very often, however, the worst cases of frequency pulling are not accounted for in this manner, but arise rather from mismatches in connectors and variations in the characteristic impedance of transmission lines. Aging and reset errors may be somewhat related. Severe dissipation variations may cause appreciable changes in plate voltage in unregulated equipment. Furthermore, frequency drifts caused by duty-cycle, heater- and plate-voltage, and temperature changes may be affected by aging of transmitter and local-oscillator tubes, since the aging may produce changes in their characteristics. Finally, setting, wavemeter, and vibration errors are random with respect to the above.

One might make the following assumption: While some of the deviations are completely random with respect to all or part of the others, none are completely dependent on any of the others. As a rough approximation, one may treat the problem in the following way; Consider temperature and pressure as dependent and the sum of their errors as random with respect to the others. Consider heater and plate voltage together as random with respect to the rest. Consider pulling, duty cycle, aging, reset errors, setting errors, and wavemeter errors as independent and random with respect to all others. Since only filament- and plate-voltage variations appear to be closely dependent, and these are grouped, it is believed that whatever dependence does exist between the errors which are treated as random will not vitiate the results of the present study.

Assume, then, that in the following tables all observations were made under controlled conditions, and that the tolerance limits were set on frequency deviations arising from variations in the operational parameters indicated in the left-hand column. Assume further that these tolerances represent the best performance which can be realized with the techniques available. The figures apply for the case of the airborne beacon transmitter.

(A) AIRBORNE BEACON TRANSMITTER	
Parameters	Tolerances (Mc.)
Ambient air temperature $\pm 50^\circ\text{C}$.	± 0.5
Air pressure	± 0.25 (estimated variation)
Volts, B, ± 10 per cent	± 0.2
Volts, heater, ± 10 per cent	± 0.2
Impedance mismatch (3.5 db standing-wave ratio of worst phase)	± 1.0
Duty cycle (dissipation) 0 to 1 per cent	± 0.6
Aging	± 0.2 (estimated)
Variations arising from reset	± 0.3
Variations in centering the transmitter in the frequency channel ⁴	± 0.2
Variations in wavemeter reading	± 0.3
Total frequency tolerance	± 3.75 Mc.

(B) THE LOCAL OSCILLATOR OF THE AIRBORNE RESPONDER	
Parameters	Tolerances (Mc.)
Ambient air temperature $\pm 50^\circ\text{C}$.	± 0.7
Air pressure	± 0.25 (estimated variation)

Volts, B, ± 10 per cent	± 0.25
Volts, heater, ± 10 per cent	± 0.3
Aging	± 0.2 (estimated)
Variations arising from reset	± 0.3
Variations in centering the local oscillator on the frequency channel ⁴	± 1.0
Variations in wavemeter reading	± 0.3
Total frequency tolerance drift	± 3.30 Mc.

(C) AIRBORNE-BEACON-TRANSMITTER TO AIRBORNE-RESPONDER OPERATION	
The total airborne transmitter tolerance and the airborne responder tolerances are summed.	
Items	Tolerance (Mc.)
Total airborne transmitter tolerance	± 3.75
Total airborne responder tolerance	± 3.3
Total frequency tolerance in air-to-air operation	± 7.05 Mc.

This means that, if we sum the tolerances algebraically, it appears that we need a total receiver bandwidth of 14.1 Mc. It is suspected that the over-all bandwidth requirement is actually less. Hence, let us see what the statistical summation of the same component tolerances will be. In the general case, (5) is applicable. Experience suggests that the respective tolerances compound linearly, and that they have unequal weights because the different deviations have different occurrence rates. Since the information upon which to assign weighting factors is far from adequate, and since we are leaning over backwards to be on the safe side, we shall neglect them in the following discussion. In that case, (8) can be used for computing the over-all standard deviation σ_v . But, having obtained σ_v , how shall we assign the over-all tolerance limits?

It will be recalled that we arbitrarily assumed that each component tolerance was set on a rectangular distribution which, we were sure, represented a pessimistic picture of the actual distribution. Consequently, it was stated that we should feel entirely secure in the belief that results so obtained would be conservative. Also, Shewhart has pointed out⁶ that the distribution of averages of four or more observations from rectangular and triangular universes form normal universes. It follows that the distribution of the sum of four or more is also normally distributed. Furthermore, if each of the four or more variables is from the same kind but from different universes, and the tolerance limits on each are approximately the same, the distribution of the sum of four or more is still normally distributed. Departure from the normal distribution increases with the disparity in the limits. In general, if Fourier integrals of the distribution functions can be evaluated, one may obtain the true resultant tolerance range by means of the method of characteristic functions⁷ for any known distribution of the sum of any number of variables. From a study of this method it may be seen that the outcome of assuming that the distribution of the sum of variables is normal when each variable is distributed rectangu-

⁶ See p. 182 of footnote reference 1.

⁷ M. G. Kendall, "The Advanced Theory of Statistics," Griffin and Co., Ltd., London, vol. I, 1943, p. 90 et seq. and pp. 240-245.

larly is to obtain tolerance limits which are more pessimistic the greater the disparity between component tolerances. Unfortunately, the labor involved in computations with more than four variables by characteristic functions is almost prohibitive, so that, practically, we are forced to content ourselves with the overly conservative results derived from the normal-law approach. Specifically, having found σ_y , we assert that 99.73 per cent of all observations will lie within the over-all tolerance limits $\pm 3\sigma_y$. This would be precisely true if the distribution of the sum were normal. Since the component tolerances are unequal, the distribution is non-normal, and the assigned tolerance limits are conservative.

For convenience, (8) is recorded again:

$$\sigma_y = \left\{ \sum_{j=1}^m \sigma_j^2 \right\}^{1/2}$$

The immediate problem is to compute the σ_j for rectangular distributions with limits given in (a), (b), and (c) above. The standard deviations for the component distributions may be found as follows:⁸

$$\sigma_x^2 = \int_{-\infty}^{\infty} (x - a)^2 dF(x) \quad (10)$$

where σ_x^2 is the variance (square of the standard deviation) of the distribution with mean a . For a rectangular distribution, $dF(x)$ is defined in the following way:

$$F(x) = \frac{\int_{-\infty}^x dx}{\int_{-\infty}^{\infty} dx} \quad (11)$$

Let the tolerance limits of the distribution be $\pm b_i$. Then

$$F(x_i) = \frac{\int_{-b_i}^{x_i} dx_i}{\int_{-b_i}^{b_i} dx_i} = \frac{x_i + b_i}{2b_i} \quad (12)$$

and

$$dF(x_i) = \frac{1}{2b_i} dx_i \quad (13)$$

Also, in a rectangular distribution which we assume is symmetric, $a=0$. So

$$\sigma_{x_i}^2 = \frac{1}{2b_i} \int_{-b_i}^{b_i} x_i^2 dx_i = \frac{b_i^2}{3} \quad (14)$$

Now let us determine the $\sigma_{x_i}^2$ from the component tolerances according to (14). Before finding the individual variances, let us first sum algebraically the quantities that are considered dependent as outlined, page 668. For convenience, let us record them again. They are: temperature and pressure, heater and plate voltage. These we add, and treat the sums as being random with respect to the others.

⁸ S. S. Wilks, "Mathematical Statistics," Princeton University Press, Princeton, N. J., 1946, pp. 8 and 31.

By the methods just outlined, we find that the distribution of the sum of the tolerances for the airborne beacon transmitter has a standard deviation equal to 0.88. If we take $\pm 3\sigma$ as the over-all tolerance limits for the frequency drift, we obtain ± 2.65 Mc. This means that, in the long run, 99.73 per cent of all observations will fall within these limits. In the case of the local oscillator of the airborne responder, the limits for the same probability are ± 2.71 Mc.

In order to obtain the total tolerance involved in air-to-air operation, a quantity which fixes the receiver bandwidth of the airborne responder, we must somehow combine the airborne-beacon and the local oscillator tolerances. While it is probably incorrect to assume that the drifts leading to these two tolerances are random with respect to each other, it is, no doubt, also incorrect to assume that they are completely dependent. That is, we must assume that the correct answer lies somewhere between the results obtained by making the two extreme assumptions. Consider first the case where they are treated as completely dependent. Then we add the tolerances algebraically to get ± 5.36 Mc.

Now consider the case where they are regarded as independent. Then

$$\sigma_{\text{res}} = \sqrt{\sigma_1^2 + \sigma_2^2} = 1.26 \quad (15)$$

For the latter we say that, in the long run, 99.73 per cent of all observations will lie within ± 3.78 Mc. Hence, the true value lies somewhere between ± 3.78 and ± 5.36 Mc. It is impossible to say just where, but it seems that we can say with a very high degree of assurance that the probability is less than 1 per cent that in the long run an observation will fall outside system limits of ± 5 Mc. From this, it appears that the total receiver bandwidth requirement of the airborne responder is 10, and not 14.1 Mc.

II. CONCLUSION

It is concluded that the following advantages may be derived from the use of statistics in the design and development of electronic systems:

(a) Reduction of system variabilities by tightening component tolerances in order to make possible a more economical use of materials and a more efficient system.

(b) Relaxation of component tolerances in order to speed development, production engineering, and manufacture.

(c) The closing of component tolerances to meet system requirements.

In short, an understanding of quality control and statistical distribution theory on the part of the radio engineer can do much to influence system design favorably.

III. ACKNOWLEDGMENT

The author is greatly indebted to C. L. Dolph, formerly at the Naval Research Laboratory and now at the University of Michigan, for many helpful suggestions.

Microwave Propagation Experiments*

LELAND E. THOMPSON†

Summary—Propagation tests at frequencies between 3000 and 4000 Mc. are described. The effect on the received signal of changes in the index of refraction of the atmosphere are discussed, and means are suggested for minimizing signal variations with particular regard to the application of microwave-relay communication systems. Theoretical data is given on diffraction at these frequencies.

INTRODUCTION

WAVE PROPAGATION at frequencies in the range of 2000 to 10,000 Mc. is an important question in the development and expansion of microwave-relay communication systems.

While the normal received signal over a propagation path which is slightly higher than "line-of-sight" is near the free-space value, variations from the normal are frequent and of considerable magnitude. It is well known that variations in the temperature, pressure, and water-vapor gradients in the lower atmosphere cause a change in the refraction of radio waves.

There are two reasons why a change in the refraction of the wave can cause the received signal to fade. First, the index of refraction can change so that the wave path has a curvature reversed from normal. Under this condition the received signal is reduced by trees, hills, or other intervening objects in the wave path. Second, at some level in the atmosphere above the normal propagation path the index of refraction can be such as to bend the wave traveling through this region so that it strikes the receiving antenna out of phase with the wave arriving over the direct path. Both of the above conditions, which produce a fading signal, are of particular importance at microwave frequencies. The first type of fading, caused by diffraction loss,¹ may be held to a practical value by sufficient elevation of the transmitting and receiving antennas. For the second type of fading, the use of two receiving antennas, one above the other and operated in diversity, has been found to be an excellent solution.

Since the elevation of the antennas is important from an economic standpoint, tests were conducted on different propagation paths extending over a period of more than a year and one-half for the purpose of gaining information for use in constructing proposed microwave relay systems.

EQUIPMENT

The signal-strength recordings were made on the three propagation paths of the experimental microwave

* Decimal classification: R112. Original manuscript received by the Institute, June 4, 1947; revised manuscript received, October 21, 1947.

† RCA Victor Division, Radio Corporation of America, Camden, N. J.

¹ The term "diffraction loss" as used in this paper refers to the reduction of the received signal below the free-space value caused by either the proximity of the earth to the propagation path or by an actual obstruction of the propagation path.

relay system between Philadelphia and New York.^{2,3} Profiles of these paths are shown in Fig. 1.

The Philadelphia-to-Bordentown link is 26.5 miles in length, and the path has a clearance above trees in the center of about 100 feet. The Bordentown-to-Ten Mile Run path is 20.5 miles in length and has a clearance

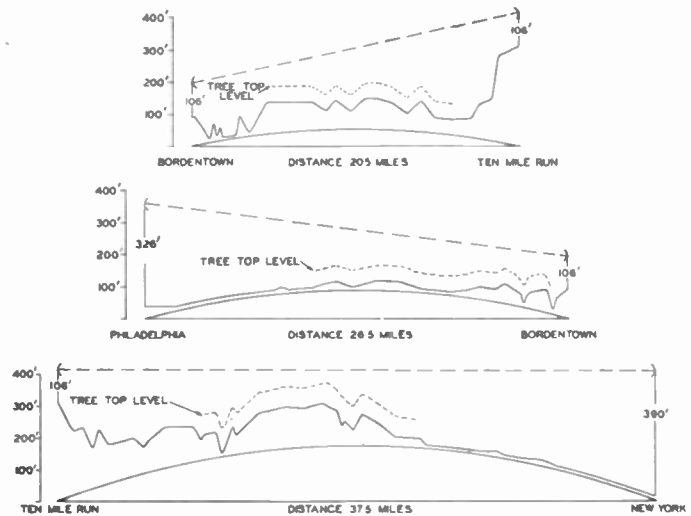

Fig. 1—Profile maps of the experimental propagation paths.

above trees of about 70 feet. The Ten Mile Run-to-New York path is 37.5 miles, and the path is believed to be only about 30 feet above trees and buildings. These values are based on an earth's radius of $4/3$ the normal value.

The transmitter power was approximately 100 milliwatts. Parabolic antenna reflectors were used having a diameter of four feet and a gain of 30 db. The signal-strength recorders connected to the final detectors of the receivers had a recording range of about 10 db above the free-space value of signal to between 24 and 30 db below.

The frequency used during a period of about one year was near 3300 Mc. During the summer of 1946 the frequency was changed to approximately 4000 Mc. Diversity reception was used over the two longer paths for a period of about eight months. The vertical spacing of the antennas was 50 feet. When the change was made to a frequency of 4000 Mc., diversity receivers were installed on all paths with a vertical spacing of 25 feet.

EXPERIMENTAL RESULTS

The normal signal was near the free-space value on the 20.5- and 26.5-mile paths. On the 37.5-mile path the normal signal was about 7 db below the free-space value.

On the two shorter paths, slow fading of the first type

² L. E. Thompson, "A microwave relay system," *Proc. I.R.E.*, vol. 34, pp. 936-942; December, 1946.

³ G. G. Gerlach, "A microwave relay communication system," *RCA Rev.*, vol. 7, pp. 576-600; December, 1946.

due to diffraction appeared to be not more than a few db below the normal signal. On the 37.5-mile path, fading of this type was more severe. During four or five periods through the summer months, a signal reduction of about 23 db below normal, or 30 db below the free-space value, was recorded. Each time the signal reduction was comparatively slow, requiring from 1 to 3 hours to drop to the minimum value and remaining near the minimum for approximately 1 to 2 hours. The signal record of the lower diversity receiver followed the variation in the higher receiver. Because of these characteristics it is believed that the fading was due to a curvature of the wave path which was reversed from normal, and not due to multiple-path interference.

Throughout the summer months multiple-path fading was frequently present on all paths during the night and early morning hours, usually under conditions of high humidity, overcast, and calm atmosphere. The reflection coefficient of the ground-reflected wave over these paths is probably quite small because of the factors involved in such reflection, which are discussed later. In any case, the fading patterns could not be explained on the simple theory of interference between the direct and a ground-reflected wave, such interference varying with changes in the index of refraction of the atmosphere.

It is believed, therefore, that the multiple-path effects were caused by the interference of one or more higher refracted waves with the direct wave. The measurements of the angle of arrival of microwaves described by Sharpless and Crawford^{4,5} also indicate that several waves may arrive at the receiving antenna from different vertical directions. Calculations made from meteorological data and shown by Friend⁶ indicate wave-path bending sufficient to cause the observed effects.

During these periods of fading the signal would frequently drop to the receiver noise level. The duration of the minimum signal was from about one-half minute to several minutes. As many as eight such periods of signal "drop-out" in a single night have been recorded. They may average two or three each night for a period of a week or more, and are usually stopped by a period of clear weather with low humidity. The very low minimums occurred on both the higher receiver and the diversity receiver; sometimes they occurred more often on one than the other, but no instance has been noticed where the signal was below the receiver noise on both receivers at the same time. Thus a vertical lobe structure is present at the receiving location, under these conditions, similar to that observed over water paths, where interference exists between the direct wave and

the wave reflected from the surface of the water. If a given set of conditions is assumed, a picture of the lobe structure can be obtained from calculations of the difference in path length of the different wave paths. Since the conditions of refraction are quite variable, it is believed that such calculations are not of much practical use in determining the best vertical antenna spacing for diversity reception.

It is suggested that there are at least two physical changes which can occur in a layer of air a short distance above the normal wave path to produce a varying signal at the receiver. First, the layer may remain at a substantially constant height for a period of time, but during this time the index of refraction can vary. This would produce a varying amplitude of the second or interfering wave at the receivers, and the signal at the two receivers may vary together or oppositely, depending on the height of the layer. Second, the index of

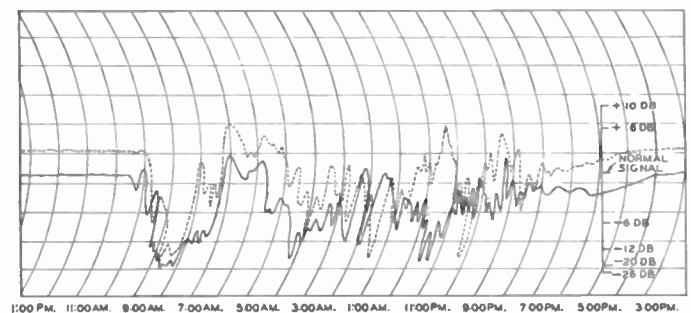

Fig. 2—Transcribed signal recording on the Bordentown to Ten Mile Run path for November 15–16, 1946. The calibration shown is for the main receiver.

refraction of the layer may remain constant and the layer height may vary. This would produce a varying phase of the second or interfering wave with respect to the lower or normal wave, and the minimum or maximum value of the signal would not occur at the same time on both receivers. A combination of these two physical changes, together with the possibility of more than two wave paths, can produce a great variety of fading patterns. The period of fading shown by the recording in Fig. 2 indicates the variable nature of the fading patterns. The signal variations are sometimes the same on the two receivers, and at other times the variations are opposite.

Several interesting conclusions are suggested by a study of a large number of these fading patterns. The minimum signal periods are far more numerous than the periods when the signal is above the normal value. This suggests that the most usual case of multiple-path fading is caused by a second wave path which is about one-half wavelength longer than the direct wave path. If the second path were several wavelengths longer than the direct path, it would be expected that periods of signal above normal would occur as often as periods of minimum signal. It should be noted that this observation was at frequencies between 3300 and 4000 Mc.

⁴ W. M. Sharpless, "Measurement of the angle of arrival of microwaves," *PROC. I.R.E.*, vol. 34, pp. 837–845; November, 1946.

⁵ A. B. Crawford and W. M. Sharpless, "Further observations of the angle of arrival of microwaves," *PROC. I.R.E.*, vol. 34, pp. 845–848; November, 1946.

⁶ A. W. Friend, "A summary and interpretation of ultra-high-frequency wave-propagation data collected by the late Ross A. Hull," *PROC. I.R.E.*, vol. 33, pp. 358–373; June, 1945.

and is particularly true over the two shorter propagation paths. Further evidence to support the above suggestion is that the 20.5-mile path showed less than half as many complete signal cancellations as did the 26.5-mile path. A greater amount of refraction on the higher wave path would be necessary over the 20.5-mile path to produce a wave-path difference of one-half wavelength than would be required at 26.5 miles.

During the winter months complete signal cancellations to below the receiver noise level have not been noticed. The reduction of signal from normal is usually no more than 6 to 10 db. This suggests that the refraction of a second wave path, during the winter months, was not sufficient to produce a wave-path difference of as much as one-half wavelength and with an amplitude approaching the free-space value.

The multiple-path transmissions may also be due to reflections of the wave from discontinuities in the dielectric constant of the atmosphere. Such reflections from air-mass boundaries from 3000 to 30,000 feet above the earth surface have been reported by various workers on ultra-high frequencies. Such reflecting boundaries may occur at lower heights. Reflections of the wave from much higher levels than a few hundred feet might be expected to produce fast variations of the received signal, on the order of a few seconds between maxima and minima. Such fast variations or scintillations have been frequently recorded, but the amplitude of the variations is small, being about 1 or 2 db.

The results with the two receivers spaced 50 feet in the vertical direction appeared to be better than when a spacing of 25 feet was used. However, the tests with different values of receiving-antenna separation were made at different times. Simultaneous tests with several receivers spaced at different heights would be necessary to determine the spacing for the most effective diversity action. The value of diversity reception lies in the fact that the very low signal minimums do not occur at the same time on both receivers. The average signal levels during fading periods is not increased appreciably by the use of the diversity receiver.

An attempt was made to overcome the effects of multiple-path fading by the use of higher transmitter power. For a period of several weeks in the summer a transmitter antenna power of 12 watts was used on the 26.5-mile propagation path. On some nights several periods of signal fading to below the receiver noise level were recorded. The fading at these times was at least 50 db below the free-space value of signal.

Horizontal polarization was used throughout the tests. Momentary tests with vertical polarization over all propagation paths indicated no change in the normal signal.

DISCUSSION OF FADING DUE TO REVERSE WAVE BENDING

The slow type of fading which occurred at the same time on both receivers is believed to be caused by a con-

cave upward curvature of the direct-wave path. The effect is the same as though the radius of the earth was reduced from normal. A line-of-sight path under normal refraction conditions may become below the "line-of-sight" under these conditions. The diffraction loss obtained under these conditions may be caused either by the earth curvature or by a single hill or mountain peak in the propagation path.

It is of interest to investigate the theory of ground-wave propagation when applied to frequencies in the microwave region. It is apparent from a study of Burrows and Gray⁷ that ground constants are unimportant at these frequencies in the calculation of diffraction loss. It is also observed that there is no practical difference between vertical and horizontal polarization.

Within the line-of-sight and for small angles of incidence below 1 degree, the ground-reflected wave is changed in phase at reflection nearly 180 degrees for either polarization and for any value of ground constants.⁸ The magnitude of the reflection coefficient

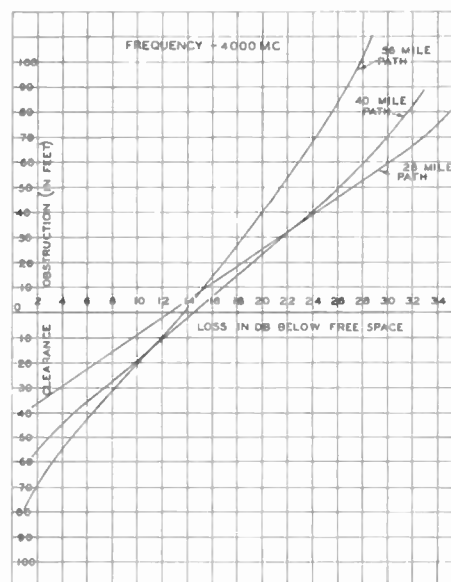

Fig. 3—Diffraction loss due to the earth's curvature.

would be very near 1.0 over a plane earth with either polarization and any value of ground constants. However, at small angles of incidence approaching a grazing path, the divergence of the wave at reflection due to earth curvature is considerable. Thus, for path distances of 25 to 50 miles, the magnitude of the reflection coefficient is 0.2 to 0.4 at an angle between the direct and reflected waves of several minutes, which is the case most often found in practice. Where the angle is 0.5 degree or larger, the reflection coefficient may be 0.9 or larger. These values obtain with a smoothly curved earth surface. Where irregularities in the terrain at the area of reflection are large, the reflection coefficient may be

⁷ C. R. Burrows and M. C. Gray, "The effect of the earth's curvature on ground-wave propagation," *Proc. I.R.E.*, vol. 29, pp. 16-24; January, 1941.

⁸ C. R. Burrows, "Radio propagation over plane earth—field strength curves," *Bell. Sys. Tech. Jour.*, vol. 16, pp. 45-77; January, 1937.

quite small.⁹ The usual practical case of such irregularities is that of hilly terrain, and in this case the hilltops may be spaced a sufficiently great distance apart along the propagation path that reflection can take place on only one or perhaps two hill tops, and the divergence of the wave at reflection would be so large that the amplitude of the reflected wave would be very small.

The diffraction loss at 4000 Mc. due to earth curvature, assuming transmitting and receiving antennas of equal height, is shown by the curves of Fig. 3. Data for these curves were obtained from the formulas described by Burrows and Gray.⁷ For each of the three paths shown, calculations were made based on an antenna height at each end giving a grazing propagation path with normal refraction. The effect of a change in refraction can be represented by assuming a change in the earth's radius, thus producing a path obstruction or clearance. The portion of the curves showing a refraction change such as to give a path clearance was obtained by continuing the curves from the point of grazing to the free-space value of signal which would result from increasing the height of the antennas.

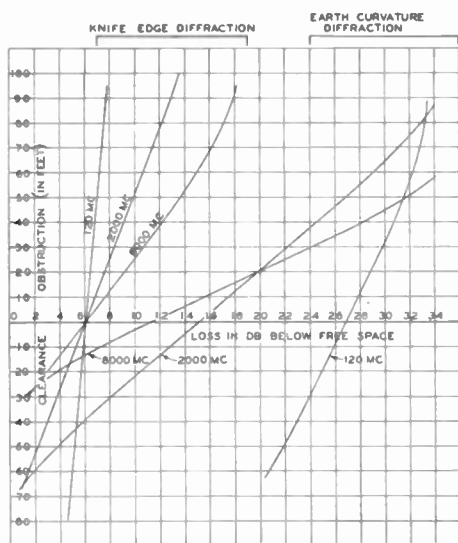

Fig. 4—Comparison of knife-edge and earth-curvature diffraction at various frequencies. Average ground constants were used for the 120-Mc curves. 28-mile propagation path; equal antenna heights.

Signal fading of the diffraction type to about 30 db below the free-space value was recorded on the 37.5-mile path, as noted before. There was one exceptional case of this type of fading which will be described later. From Fig. 3 this signal loss could be caused by earth curvature obstructing the path to a height of 70 feet. Since the path was about 30 feet above grazing under normal conditions, the lowering of the wave path at the center between the transmitter and receiver was about 100 feet. The wave path under normal conditions of refraction has a concave downward curvature with a

radius of about four times the earth's radius. From these values, the upward curvature of the wave path under the unusual condition of refraction was calculated to have a radius of curvature equal to 5.5 times the earth's radius. This is an average value, assuming the same conditions of refraction to exist over the whole signal path. It is probable that the radius of curvature was much smaller than the average over part of the propagation path.

Although the curves of Fig. 3 are based on a smoothly curved earth surface and equal antenna heights at both ends of the path, tests conducted on the 37.5-mile path shown in Fig. 1 with different antenna heights were in agreement with the data of Fig. 3. The normal steady signal on this path was about 7 db below the free-space value. The antenna height at the New York end of the path was increased 50 feet. The clearance at the center of the path was thus increased 25 feet. The normal signal increased 5.4 db. This is nearly the increase indicated on the 40-mile path curve of Fig. 3 for an increase in the path clearance from 30 feet to 55 feet. The antenna height at the Ten Mile Run end of the path was then increased 50 feet. The normal signal increased 2 db, which is also close to that predicted by the 40-mile-path curve of Fig. 3 for an increase in the path clearance from 55 feet to 80 feet.

Trees in the center of the propagation path provide an effective obstruction. The tree tops should be considered as determining the point of grazing incidence, rather than the ground level.

Where a high hill or ridge provides a relatively narrow obstruction in the propagation path, the signal loss can be calculated from knife-edge diffraction theory. In Fig. 4 is shown a comparison of knife-edge

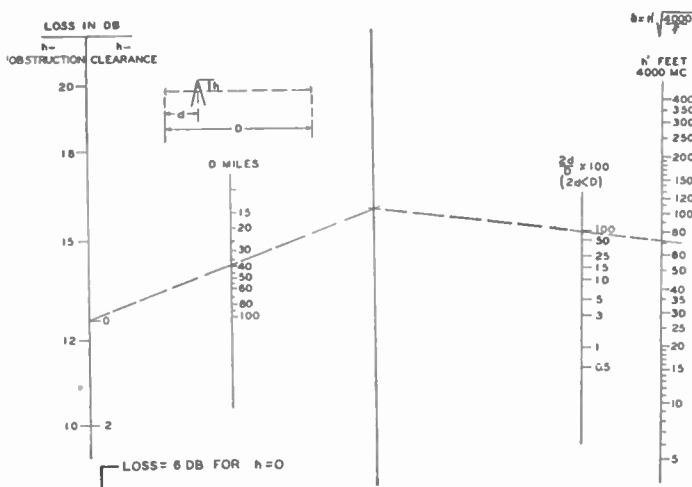

Fig. 5—Nomograph for use in the calculation of antenna height required for a given value of knife-edge diffraction loss.

and earth-curvature diffraction for different frequencies. The knife edge is assumed to be in the center of the propagation path. Several interesting facts are apparent from this data. The approach of earth-curvature

⁹ J. C. Schelleng, C. R. Burrows, and E. B. Ferrell, "Ultra-short wave propagation," *PROC. I.R.E.*, vol. 21, pp. 427-463; March, 1933.

diffraction to knife-edge diffraction with increasing frequency is apparent. It is also observed that fading due to a reverse curvature of the wave path is relatively unimportant at a frequency of 120 Mc.

It is evident that at microwave frequencies a small increase in antenna height above that which just gives a line-of-sight path increases the normal signal to the free-space value, and this is an appreciable increase. It appears to be good practice to design microwave communication systems so that the free-space value of signal is received under normal conditions of refraction. Under conditions of refraction existing during multiple-path transmission, the upper wave path may have sufficient bending to propagate the signal several times the horizon distance. Therefore, where increased power is used in place of an adequate propagation path, interference to other circuits on the same frequency channel is increased.

The nomograph of Fig. 5 may be used to determine antenna elevations necessary at different distances and frequencies to obtain the free-space value of signal under conditions of knife-edge diffraction. These data were obtained by the use of Cornu's spiral. The Fresnel zones of maxima and minima which occur when the knife edge is below the line of sight are not important, since the highest maximum is only 1.4 db above the free-space signal and the lowest minimum only 1 db below.

CONCLUSION

A study of the experimental results has suggested the two causes of fading which were discussed. A third type of fading which did not appear to be of importance at the frequencies used in these tests is caused by attenuation in rain, and has been discussed by Robertson and King.¹⁰

Another type of multiple-path fading has been found on propagation paths which are quite high above grazing and where the amplitude of the ground-reflected wave is large. A change in refraction under these conditions will change the path-length difference between the direct wave and the ground-reflected wave so that at some periods of time the two waves cancel and quite serious fading results. This type of fading has been described by Morf.¹¹ Diversity reception has been found to be very effective under these conditions.^{11,12}

These experimental results may be different than those obtained in other geographical locations because of the dependence on weather conditions. It is to be expected that signal variations greater than those re-

corded in these tests may be experienced. For example, on January 30, 1947, on the experimental circuit between Bordentown and Philadelphia the signal dropped below the range of the recorder for a period of about three-quarters of an hour. The drop and the recovery were simultaneous on the main and the diversity receiver, indicating the diffraction-type fading. Manual tuning observations at the time indicated the presence of the signal, but the amplitude was below the receiver noise threshold. It is estimated that the signal reduction was 35 db below the normal or free-space value. This indicates a reverse bending of the wave path to a degree much higher than had previously been noted. The temperature and humidity measured by the U. S. Weather Bureau at Philadelphia increased rapidly just before the fading period. During the day the temperature reached a high of 70°F., which is very unusual for the month of January. Sufficient data to calculate the index of refraction over the propagation path were not available. The point is that very unusual propagation results may be expected, just as the weather records of a number of years are occasionally broken.

The signal records have shown that the received signal is usually very constant during both stormy weather and clear weather. The periods of greatest signal variation occur when the atmosphere is calm with high humidity and temperature.

No indication of distortion due to selective fading has been found, although the tests with modulation have covered a much shorter period of time than the carrier-recording tests.

The data of Fig. 4 and the results of the tests indicate only a small difference in the diffraction type of fading over the frequency range of 2000 to 8000 Mc., provided the propagation path is sufficiently clear of obstructions to give the free-space value of signal under normal conditions of refraction. The diffraction loss due to earth curvature is less for the higher frequencies unless the path obstruction exceeds a certain value (25 feet in the example shown in Fig. 4).

It is expected that fading of the multiple-path type will increase with frequency, although the use of diversity reception should provide good results throughout this frequency range. Further experimental work of a statistical nature using three or four vertically spaced receivers would increase our knowledge of the factors involved in anomalous refraction and should be undertaken before too-definite conclusions are reached. In the meantime, suitable results are indicated for commercial communication using a moderate amount of r.f. power if diversity reception is used, and if the propagation paths provide a normal signal equal to the free-space value.

For some classes of commercial communication, diversity reception may not be considered necessary. The total percentage of time during which the circuits used in these tests were out due to multiple-path transmis-

¹⁰ S. D. Robertson and A. P. King, "The effect of rain upon the propagation of waves in the 1- and 3-centimeter regions," *Proc. I.R.E.*, vol. 34, pp. 178P-180P; April, 1946.

¹¹ F. P. Morf, "Experiences with multipath transmissions at very-high frequency, ultra-high frequency, and super-high frequency," presented, 1947 I.R.E. National Convention, New York, N. Y., March 6, 1947.

¹² Ross Bateman, "Elimination of interference-type fading at microwave frequencies with spaced antennas," *Proc. I.R.E.*, vol. 34, pp. 662-663; September, 1946.

sion is not large. In other applications (for example, commercial telegraph service) the total percentage of time over a long period during which propagation failures occur is not a measure of the reliability of the circuit. A more accurate measure is the number of circuit failures occurring per day or per week during periods of the most unfavorable weather conditions. For such services, diversity reception is considered necessary.

ACKNOWLEDGMENT

The experiments described here were conducted under the sponsorship of the RCA Victor Division, Radio Corporation of America. Donald S. Bond collaborated in the experiments with diversity reception. A number of engineers of both this organization and the Western Union Telegraph Company assisted in the maintenance of the equipment and calibration of the recorders.

A Portable Microwave Communication Set*

CHESTER E. SHARP†, AND RAYMOND E. LACY†, SENIOR MEMBER, I.R.E.

Summary—A detailed description is given of the design features embodied in oscillator cavities and a single-antenna r.f. radiating system which enables simultaneous transmission and reception over an integral but highly portable radio set operating from 2200 to 2400 Mc. Interference-free amplitude-modulation communication is shown to be obtainable at these frequencies with exceedingly simple circuits.

I. INTRODUCTION

THE DEVELOPMENT of the equipment described in this paper was performed at the United States Army Signal Corps Engineering Laboratories during the late war to provide a microwave radio-communication set to replace the visual signal lamps then utilized by the Field Artillery. Additional technical improvements incorporated duplex radiotelephone facilities in the equipment, allowing its use as a simplified two-wire radiotelephone line. The resulting radio set, namely, Radio Set AN/PRC-3, was classified as confidential for military reasons, based upon the use of relatively unexplored frequency spectrums and newly applied circuit techniques. Declassification was accomplished at the end of the war when technical advances made during the ensuing period, as well as the highly increased caliber of military system requirements, obsoleted the equipment for military-communications-system application.

The application as well as techniques of military communication have undergone considerable evolution during and since the late war. The story of the technical work involved in the war period has been summarized.¹⁻³ Although Radio Set AN/PRC-3 has already reached obsolescence from a military viewpoint, it still represents one of the first, if not the first, portable and operationally simple duplex microwave radiotelephone equipments to be reached in the epoch of portable microwave

communication sets which is being striven for by way of higher-efficiency microwave r.f. tubes, currently under development throughout the industry. Its simplification is in a trend opposite from that being pursued commercially, whereby immense microwave communication equipments are being installed in concrete towers, but it was a forerunner of the small pickup type of microwave communication set currently being utilized commercially for television work. Because of its metamorphic type of evolution from a replacement for an artillery signal lamp to that of a duplex radio-relay type of communication set, the incorporated design factors should not be taken as criteria for such equipment.

When this equipment was designed, the choice of r.f. vacuum tubes was very limited. The transmission parameters, particularly the transmitting r.f. power output, audio bandwidth, antenna pattern, type of modulation, audio levels, number of r.f. channels, and similar design features were all subordinated to the desire for simplified portable equipment utilizing standard available components. Radio Set AN/PRC-3 was designed primarily for use in forward areas of a combat theater, for bridging such obstacles as rivers and ravines as a link in a two-wire field-telephone circuit. The transmission facilities are, therefore, limited, and are not intended for tying into a high-grade telephone circuit or to provide multichannel facilities. This is in contrast to other radio-relay equipments designed for the United States Army communication networks.³

II. MECHANICAL DESCRIPTION

Fig. 1 shows the two major units of the radio set. One unit consists of the antenna assembly case which also contains the receiver-transmitter and is mounted on a tripod. The second major item is the power supply shown in the case beneath the tripod. This consists of a small nonspill storage battery and a vibrator unit. When more than four hours of service is required, a secondary power source is substituted for the storage-battery vibrator unit in combination with the primary unit. This secondary unit is a rectifier for use with commercial 115-volt a.c. supplies. The Army field telephone, shown in Fig. 1, is used in parallel with or in lieu of a two-wire telephone line. The weight of the com-

* Decimal classification: R561XR423.16. Original manuscript received by the Institute August 1, 1947; revised manuscript received, October 16, 1947. Presented, 1947, I.R.E. National Convention, New York, N. Y., March 3, 1947.

† Signal Corps Engineering Laboratories, Coles Signal Laboratory, Red Bank, N. J.

¹ Roger B. Colton, "Army ground communication equipment," *Elec. Eng.*, vol. 64, pp. 173-179; May, 1945.

² William S. Marks, Jr., Oliver D. Perkins, and Willard R. Clark, "Radio-relay communications systems in the United States Army," *Proc. I.R.E.*, vol. 33, pp. 502-504; June, 1945.

³ Raymond E. Lacy, "Two multichannel microwave relay equipments for United States Army communication network," *Proc. I.R.E.*, vol. 35, pp. 65-70; January, 1947.

bination antenna assembly and receiver-transmitter is approximately 20 pounds; the power supply, 22 pounds; and the tripod, approximately 5 pounds. The volume of the total equipment is approximately two cubic feet. Of course, all the standard military physical requirements such as tropicalization, winterization, and vibration resistance are met.



Fig. 1—A relay terminal as a link in a two-wire field-telephone circuit.

The operational simplicity of the equipment may be noted by referring to Fig. 1. Two devices are incorporated in the equipment for use in physical alignment of the antenna. The hollow handle on top of the equipment is provided for visual alignment, and a small aircraft compass, shown mounted on the top portion of the case, is used for determining azimuth in establishing communication during night or foggy weather operations. Two controls are provided. The larger knob on the upper right portion of the chassis panel is a vernier frequency control for the receiver, and the small knob shown on the center lowest portion of the panel is the receiver audio level or gain-control knob. A connector for the power-supply cable is on the right lower portion and the two telephone-line binding posts are on the lower left.

An idea of the internal construction may be obtained by referring to Fig. 2, which is a cutaway view of the main assembly except that the receiver-transmitter chassis is not shown. This view shows the compass in the upper portion, and the antenna dipole and its parasitic reflector plus the paraboloidal dish on the left portion. Also, the simple r.f. duplexing features are shown, whereby a single antenna system is used simultaneously for reception and transmission by the use of two different frequencies. Fig. 3 shows the rear of the "hat-box" unit with the receiver-transmitter chassis removed for frequency-channel alignment.

The only test equipment used with this equipment is the frequency meter. This meter employs a movable concentric plunger in a cylindrical cavity, which may be considered as a quarter-wavelength short-circuited coaxial line. The position of the plunger is adjusted by a micrometer head and the micrometer readings are calibrated for each of eight radio-frequency channels. These micrometer dial readings and their corresponding

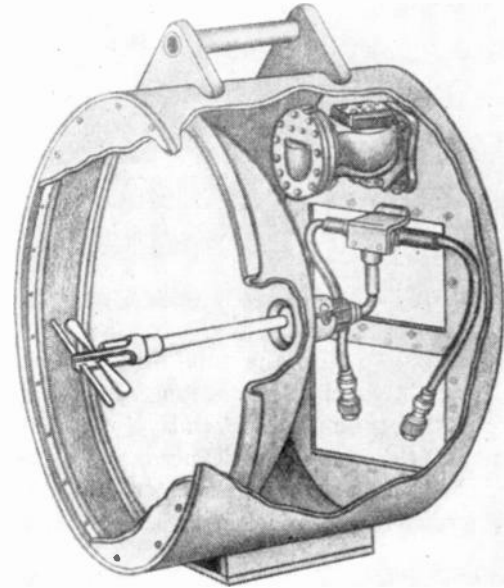

Fig. 2—Cutaway view of the antenna assembly.

channel designations appear on the chart attached to the unit. A single-throw two-position toggle switch located on one side of the meter allows alternative use of the microammeter for measuring necessary circuit currents during channel alignment.

III. ELECTRICAL DESCRIPTION

Fig. 3 shows in detail the arrangement of the electronic elements on the receiver-transmitter chassis. Two cylindrical cavities, as shown, are required in order to achieve duplex operation with its accompanying requirement of a transmitted frequency different from the received frequency. The transmitter oscillator cavity is the one uppermost in the illustration, while the lower cavity is that for the receiver. It may be noted that this latter cavity is attached to the control knob on the front of the panel. This control knob provides a vernier frequency control of the superregenerative receiver, after the r.f. channels have once been aligned, and tunes over a range of 25 Mc. The two small tubes with metal shields mounted near the front panel are miniature triodes. One is a receiver audio amplifier, and the other a cathode modulator for the transmitter oscillator. The two jacks mounted on the front left of the chassis provide a means of checking, with the milliammeter contained within the frequency meter, the cathode current of the oscillator tubes during the initial channel alignment.

The r.f. oscillator tube used in both cavities is a standard lighthouse triode type 2C40. This tube is designed to be fitted into concentric transmission-line-

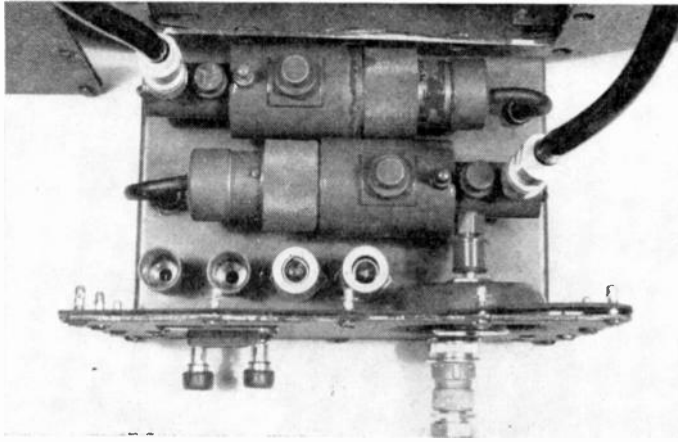

Fig. 3—Top view of the receiver-transmitter chassis.

type resonators, so that the tube and circuits become essentially an integral combination. The parallel-plane structure of this tube permits relatively small electrode areas, low interelectrode capacitances, and close spacing to reduce the electron-transit time as required for operation at microwave frequencies.

cavity is lightweight, compact, and rugged, and its operation has proved to be reliable and efficient. An adjustable feedback probe, designated as item 14, extends from the cathode-line through to the plate-line circuit.

Although the basic principle of operation of these cavities is conventional, it is interesting to note the method of tuning. The space in the large section of the cavity between the cathode and grid conductor forms a coaxial cathode line which may be seen as short-circuited at the opposite end from the vacuum tube. The tuning of this portion of the cavity is accomplished by the adjustable capacitor designated on Fig. 4 as item 6. The plate line is formed in the small section of the cavity by the grid and plate conductor. This line is also short-circuited at the end farthest from the vacuum tube. This portion of the cavity is tuned by the adjustable capacitor designated as item 10. The two circuits as described indicate that the oscillator is of the tuned-plate tuned-cathode type. The adjustable coupling loop shown at the shorted end of the plate line is a modified standard type-N r.f. coaxial connector. This is the antenna connection.

In aligning the radio set to a particular set of r.f. channels, the plate-line tuning capacitor is adjusted until the desired frequency channel is obtained as noted

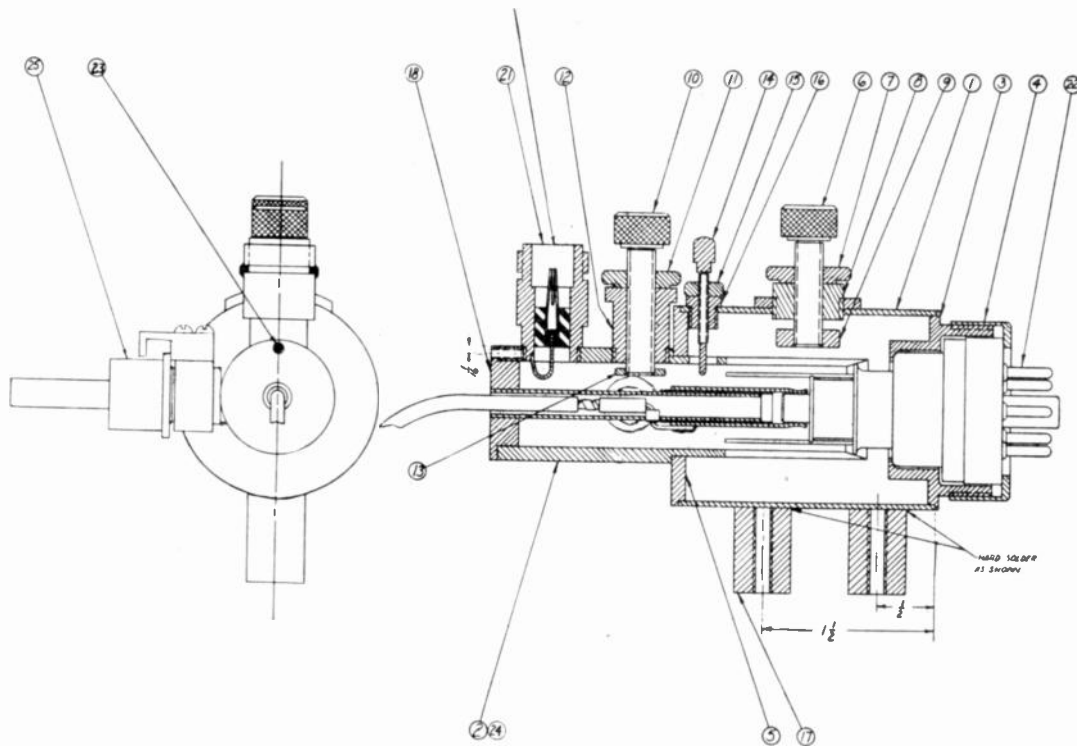

Fig. 4—Oscillator-cavity assembly drawing.

Fig. 4 is an assembly drawing of the double concentric transmission-line-type oscillator cavity with the type-2C40 tube in place. The mechanical and electrical construction of this cavity is the outstanding contribution of this equipment design to electronic techniques. The

on the frequency meter. The cathode-line tuning capacitor and the feedback probe extending from the cathode line through to the plate line are then adjusted. The length of the probe is adjusted for maximum r.f. output. This maximum r.f. output indicates the correct

amount of feedback voltage. Both tuning capacitors and the feedback probe are provided with jam nuts which, when tightened, complete the channel-tuning operation for the transmitter cavity. The receiver cavity tuning differs from the transmitter cavity tuning only in that an adjustable slug of heat-resistant material is inserted in the grid-to-plate line. This slug is connected to the vernier frequency control knob as shown in Fig. 3, and serves to tune the receiver over the vernier frequency range of approximately 25 Mc. The connecting shaft from the control knob to this tuning slug is shown as item 25 of Fig. 4.

The electronics of the cavity circuit may be more easily grasped by referring to Fig. 5. The d.c. equivalent circuit shows that the tube is biased by means of R_k in the cathode circuit rather than the more conventional capacitor-resistor combination usually associated with the grid circuit. It should be noted that this allows the construction of the cavity with a rigidly supported grid contact. C_k is the built-in cathode r.f. by-pass within the tube. The r.f. equivalent circuit shown represents the tuned-plate tuned-cathode type of oscillator.

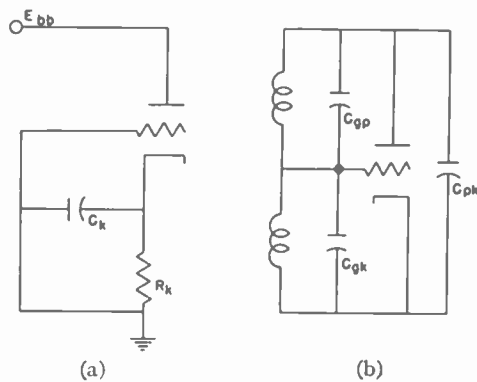

Fig. 5—Equivalent cavity-oscillator circuits; (a) the d.c. equivalent circuit, and (b) the r.f. equivalent circuit.

The block diagram of the radio set in Fig. 6 shows the arrangement of the major circuit components contained within the antenna assembly. The antenna is shown connected in parallel with both the superregenerative detector and the transmitter cavity oscillator. The output from the detector passes through an audio amplifier and a hybrid circuit to the two-wire telephone-line terminals. It may be noted that the receiver and transmitter are tied together electrically at both ends; i.e., at the r.f. terminals into the antenna, and at the audio terminals through the hybrid circuit. This latter circuit, of course, changes the four wires of the transmitter and receiver combination to a two-wire circuit for use with a two-wire telephone line. Here, again, simplicity is achieved by the utilization of a resistance-type hybrid as contrasted to the more conventional hybrid coil or transformer type. The values of resistances used in this hybrid circuit are shown in Fig. 7 as R_3 , R_6 , and R_9 . They were selected as the nearest standard values to match a 600-ohm line. The combination of C_3 , with a value of $0.05 \mu\text{fd.}$, in series with R_6

is provided as a compromise balance net for upwards of two miles of conventional or standard military field-telephone wire. The other output of the hybrid circuit is connected to a small triode audio amplifier, which cathode-modulates the transmitter r.f. oscillator.

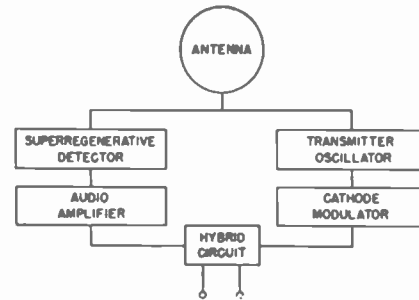

Fig. 6—Block diagram of Radio Set AN/PRC-3.

Fig. 7 is the detailed circuit diagram of the previously shown block diagram of Fig. 6. The receiver portion of the circuit is on the left of the illustration. The receiver consists of a cavity-circuit superregenerative detector. The superregenerative type of reception is one of the main reasons for the obsolescence of this equipment for military communication use because of the somewhat uncontrollable signal-to-noise ratio, sensitivity, intelligence band-width, distortion, and similar transmission parameters, the control of which is a necessity in high-grade radio-relay service. Returning to the circuit diagram of Fig. 7, the output of the detector is taken from the cathode circuit and transformer-coupled to the 6C4 audio amplifier. The audio output of the amplifier is then coupled through the resistance hybrid circuit to the two-wire telephone-line terminal.

The right half of the illustration is the transmitter portion of the circuit. This consists of a cavity circuit, again employing a type-2C40 tube, but in this case as a c.w. oscillator. The r.f. power output from this oscillator is approximately 250 milliwatts, of which the major portion is radiated from the antenna. The antenna gain of approximately 17 db makes this power equivalent to an effective output of about 12 watts radiated by a dipole antenna. The 6C4 triode is the cathode modulator and is transformer-coupled to the cathode of the transmitter oscillator. The 30-millihenry choke, L_1 , prevents self-pulsing from occurring in this cavity circuit.

The total power required by the entire receiver-transmitter circuit is less than 20 watts. The plate and filament voltages are 250 and 6.3 volts, respectively.

The combination storage-battery-vibrator and a.c. rectifier combination power supply is more or less conventional and does not warrant further discussion.

IV. OPERATIONAL CHARACTERISTICS

Many successful demonstrations and operational tests have been made with the experimental models in the vicinity of the New Jersey locations of the Signal Corps Engineering Laboratories and before Army test boards. The practical and reliable range of these radio sets over

rolling country is five miles line-of-sight. The receiver noise level at this range is usually about 35 db below signal level. This noise level, although not desirable for tying into a high-grade commercial system, is satisfactory for a combat-area field-telephone circuit.

Several comparatively long-range point-to-point tests have been conducted from a laboratory test site at an elevation of 400 feet located in Holmdel Township near Matawan, N. J., to another site 48 miles distant located at a 1000-foot elevation, Bloomsbury, N. J., near the Delaware River. A signal-to-noise ratio of about 10 db was realized over this 48-mile line-of-sight path. While most of the operational tests and demonstrations were conducted over land, several interesting tests have been made over water. Reliable communication was maintained between a set mounted on a boat operating several miles off shore and another set located on the shore. During propagation tests conducted in California by Army personnel, one set was located on the California mainland and another set on Catalina Island. Communication was successfully obtained across the intervening 24 miles of ocean.

Extensive experience in the operation of these sets under conditions which would have produced severe interference on lower-frequency sets has indicated complete immunity to electrical noise emanating from sources such as vehicle ignition systems and other man-made electrical interference as well as atmospheric static. This immunity to electrical interference appears to be due to the use of the microwave spectrum above 2000 Mc. Loss of signal strength, impairment or interruption of communication due to heavy fog, snow, heavy rain, or electrical storms has not been experienced to date by these equipments, but the field tests necessarily have been limited in their scope.

The technical advancement in simplified point-to-point radiotelephone equipment represented by this radio set may be realized when one considers the utility of such a simple equipment, which can provide a telephone circuit across central New Jersey from the Atlantic Ocean to the Delaware River with the quasi-privacy provided by the relatively unoccupied microwave spectrum and its easily achieved highly directive radiation pattern.

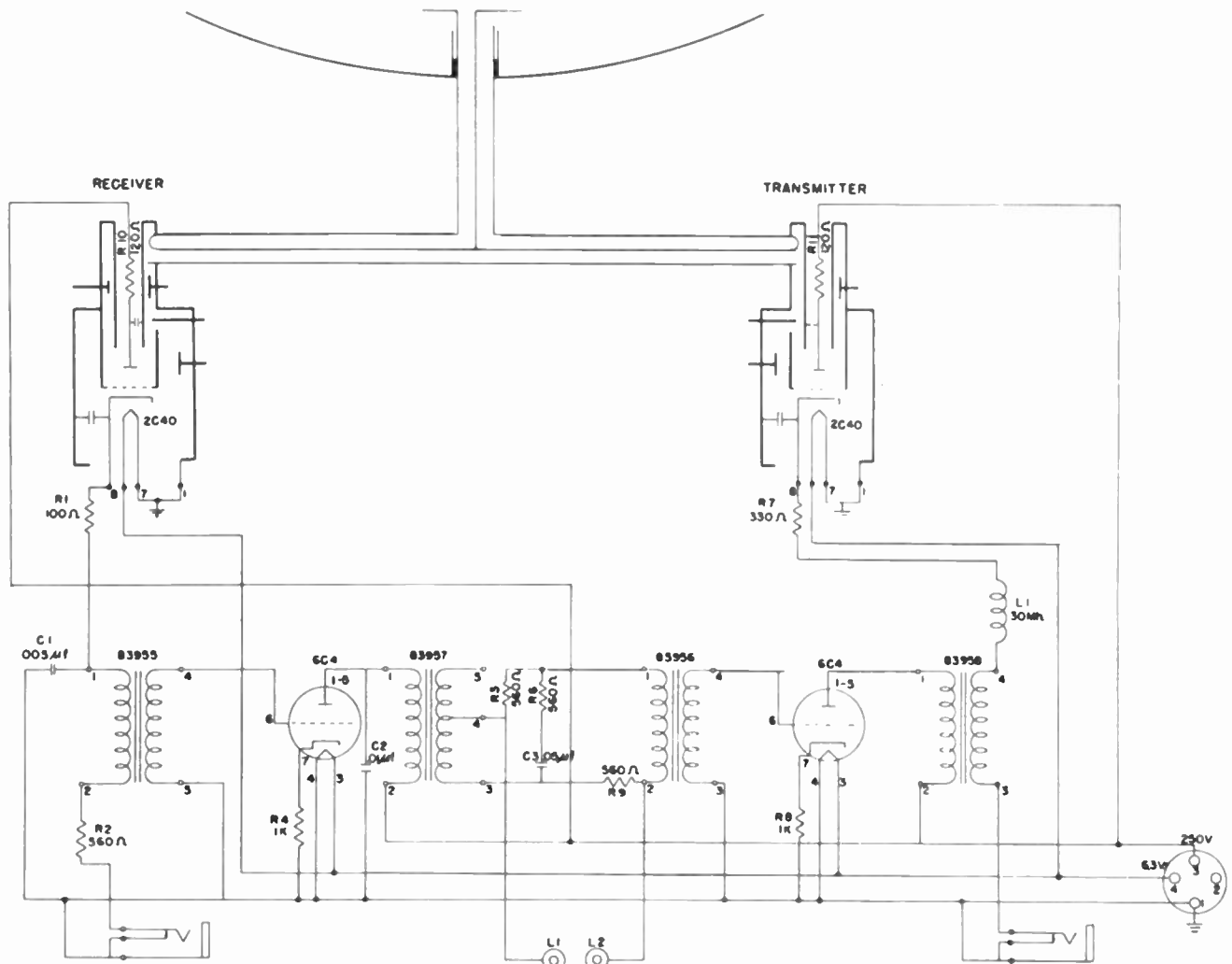

Fig. 7—Circuit diagram of Radio Set AN/PRC-3.

Contributors to Waves and Electrons Section



JESSE E. HOBSON

Jesse E. Hobson (M'45) was born on May 2, 1911, at Marshall, Ind. He received the B.S. degree in electrical engineering in 1932 and the master's degree in 1933 from Purdue University. In 1935 he received the Ph.D. degree from the California Institute of Technology. He became Central Station Engineer with the Westinghouse Electric Corporation in 1937, after two years as an instructor in electrical engineering at Armour Institute of Technology. During his four years with Westinghouse, he was also lecturer in electrical engineering at the University of Pittsburgh. In 1941 he was director of the department of electrical engineering at Illinois Institute of Technology, and in 1944 he was made director of Armour Research Foundation. On March 1, 1948, he was

elected executive director of the Stanford Research Institute.

Dr. Hobson received the Eta Kappa Nu Award as "The Outstanding Young Electrical Engineer of the U. S. in 1940," after having received the Eta Kappa Nu Honorable Mention Award in 1939. He is a member of the American Institute of Electrical Engineers, at present being Chairman of the Chicago Section. He is Chairman of the Program Committee of the Western Society of Engineers, and a member of the Board of Directors of the National Electronics Conference, of which he was its first president in 1944 when the Conference was started.

Since 1945 he has been a member of the Illinois State Board of Examiners for Registration of Professional Engineers, and a member of the Engineering College Research Council. He is a member-at-large of the Division of Engineering and Industrial Research of the National Research Council and a member of that Council's Building Research Advisory Board. He is also a member of the Illinois Engineering Society, American Association of College and University Professors, Society for Promotion of Engineering Education, as well as Sigma Xi, Tau Beta Pi, Eta Kappa Nu, and Sigma Delta Chi. Dr. Hobson is co-author of the book, "Power Transmission and Distribution."



SIDNEY METZGER

Sidney Metzger (A'40-M'46) was born in New York, N. Y., on February 1, 1917. In 1937, he received the B.S. degree in electrical engineering from New York University.

From 1939 to 1945, he was employed at the Signal Corps Laboratories, Fort Monmouth, N. J., working on various radio communication equipments. He joined the Federal Telecommunication Laboratories in 1945, and at present is working on microwave communication systems.

Mr. Metzger is a member of Tau Beta Pi and Iota Alpha.

Raymond E. Lacy (SM'46) was born on March 17, 1916, at Camden, N. J. He was an undergraduate at Drexel Institute of Technology in Philadelphia, Pa., from 1933 to 1938, during which period he also served as a student engineer for five half-year periods with various concerns, including the Potomac Electric Power and Light Company, Washington, D. C.; Philco Corporation, Philadelphia; and Chubbuck and Patrick, consulting engineers, Philadelphia. After receiving the B.S.E.E. degree in 1938 from Drexel, he joined the staff of New York University College of Engineering as graduate assistant in electrical engineering, in which capacity he served for two years. He received the M.E.E. degree from the N.Y.U. Graduate School in 1940. He joined the staff of the Signal Corps Laboratory at Fort Monmouth, N. J., as a radio design engineer in 1940, and has been associated in the design of Army ground radio communication equipment during the ensuing period.

He pursued further graduate work at Brooklyn Polytechnic Institute from 1940 to 1941, and is a member of Tau Beta Pi and Eta Kappa Nu.



RAYMOND E. LACY



LEONARD S. SCHWARTZ

Contributors to Waves and Electrons Section



LELAND E. THOMPSON

Leland E. Thompson was born at Creighton, Neb., on September 18, 1905. He received the B.S. degree in electrical engineering from the University of South Dakota in 1929. From 1929 to 1930 he was employed in the radio engineering department of the General Electric Company. Since 1930, Mr. Thompson has been associated with the Radio Corporation of America, RCA Victor Division, Camden, N. J.



Chester E. Sharp was born on June 2, 1906, at Long Branch, N. J., and received his knowledge of electronics for the most part through self-education. For fifteen years he was engaged in the sales of radio equipment and, during the same period of

crowave receiver design. In 1944, he was further assigned to investigate portable microwave transceiver designs, which led to the design and construction of engineering models of the first man-pack portable microwave radio-relay equipment. In 1946, he received a commendation for meritorious civilian service from the War Department for the first application of frequency modulation to small military radio equipments. In his present assignment with the Radio Relay and Microwave Section at Coles Signal Laboratory, Red Bank, N. J., he acts as consultant on microwave techniques, as well as engineer-in-charge of a group of engineers engaged in research and investigation of microwave techniques as applied to simplified microwave military radio-relay equipment.



Leonard S. Schwartz (S'42-A'45-M'45-SM'47) was born in Pittsburgh, Pa., on May 28, 1914. He attended the University of Pittsburgh from 1932 to 1939, obtaining the B.S. degree in 1936, and the M.S. degree in 1939, majoring in physics. He was called to active duty as an officer in the U. S. Army in 1940, and while on active duty received training in communication engineering at Cruft Laboratory, Harvard University. He remained at Cruft Laboratory for one year as an instructor in communications engineering, and then attended the Massachusetts Institute of Technology Radar School for instruction in microwave radar. Subsequently he was assigned as a project officer on ground radar equipments in the Radiation Laboratory.

In 1944 he was ordered to the Naval Research Laboratory to work on radar developments. He remained there until September, 1947, when he left to join the Hazeltine Electronics Corporation as a senior development engineer.

Mr. Schwartz is a member of the American Physical Society, and an associate member of the American Institute of Electrical Engineers.



For a photograph and biography of DONALD D. GRIEG, see the November, 1947, issue of the PROCEEDINGS OF THE I.R.E.



CHESTER E. SHARP

time, did extensive experimental work in his own laboratory on the design of frequency modulation and television receivers, and also marine and amateur transmitting equipment. In 1940, he joined the Field Radio Section of the Signal Corps Laboratories where he was associated in the design of military field radio equipment. In this capacity he personally designed and constructed the first portable frequency-modulated combination transmitter and receiver, which was the forerunner of a series of military portable field type of f.m. sets.

In 1942, Mr. Sharp was assigned to mi-

Richard Waer (S'42-A'45) was born in Newark, N. J., on December 7, 1921. In 1943, he received the B.S. degree in electrical engineering from Lehigh University. For over two years, he did radar maintenance work in the United States Army ground forces.

In 1946, Mr. Waer joined the Federal Telecommunication Laboratories, and at present is working on microwave communication systems.

He is a member of Tau Beta Pi, Eta Kappa Nu, and Pi Mu Epsilon.



RICHARD WAER

Abstracts and References

Prepared by the National Physical Laboratory, Teddington, England, Published by Arrangement with the Department of Scientific and Industrial Research, England, and *Wireless Engineer*, London, England

NOTE: The Institute of Radio Engineers does not have available copies of the publications mentioned in these pages, nor does it have reprints of the articles abstracted. Correspondence regarding these articles and requests for their procurement should be addressed to the individual publications and not to the I.R.E.

Acoustics and Audio Frequencies.....	683
Aerials and Transmission Lines.....	684
Circuits and Circuit Elements.....	685
General Physics.....	687
Geophysical and Extraterrestrial Phenomena.....	688
Location and Aids to Navigation.....	689
Materials and Subsidiary Techniques..	689
Mathematics.....	690
Measurements and Test Gear.....	691
Other Applications of Radio and Electronics.....	692
Propagation of Waves.....	693
Reception.....	693
Stations and Communication Systems..	694
Subsidiary Apparatus.....	694
Television and Phototelegraphy.....	695
Transmission.....	695
Vacuum Tubes and Thermionics.....	696
Miscellaneous.....	696

The number in heavy type at the upper left of each Abstract is its Universal Decimal Classification number and is not to be confused with the Decimal Classification used by the United States National Bureau of Standards. The number in heavy type at the top right is the serial number of the Abstract. U.D.C. numbers marked with a dagger (†) must be regarded as provisional.

ACOUSTICS AND AUDIO FREQUENCIES

- 016:534** 908
References to Contemporary Papers on Acoustics—A. Taber Jones. (*Jour. Acous. Soc. Amer.*, vol. 19, pp. 926-934; September, 1947.) Continuation of 3747 of January.
- 534.1:621.392.51** 909
Coordinates and the Reciprocity Theorem in Electromechanical Systems—Miles. (*See* 969.)
- 534.1:621.392.51** 910
Further Remarks on Reciprocity—McMillan. (*See* 970.)
- 534.13** 911
The Coupling of Two Acoustical Ducts—A. E. Heins and H. Feshbach. (*Jour. Math. Phys.*, vol. 26, pp. 143-155; October, 1947.) A mathematical paper dealing with propagation along an infinite duct of rectangular cross section. Two of the parallel walls are perfectly rigid, while at the intersection of a cross-sectional plane with the other two walls, a discontinuous change of acoustical properties occurs. The reflection process at the discontinuity is examined.
- 534.2** 912
Reflection and Transmission of Sound by Thin Curved Shells—H. Primakoff and J. B. Keller. (*Jour. Acous. Soc. Amer.*, vol. 19, pp. 820-832; September, 1947.) A mathematical paper using Kirchhoff's theory to produce a nonhomogeneous integral equation for the sound pressure field in an infinite medium containing a curved shell of different material. An approximate solution is obtained by evaluation of a surface integral very similar to that obtained in Kirchhoff's diffraction theory, and this gives expressions for the pressure waves re-

The Institute of Radio Engineers has made arrangements to have these Abstracts and References reprinted on suitable paper, on one side of the sheet only. This makes it possible for subscribers to this special service to cut and mount the individual Abstracts for cataloging or otherwise to file and refer to them. Subscriptions to this special edition will be accepted only from members of the I.R.E. and subscribers to the PROC. I.R.E. at \$15.00 per year. The Annual Index to these Abstracts and References, covering those published from February, 1947, through January, 1948, may be obtained for 2s. 8d., postage included from the *Wireless Engineer*, Dorset House, Stamford St., London S. E., England.

flected from and transmitted through a thin curved shell. The reflection coefficient is expressed as the product of a geometrical factor, a phase-cancellation factor, and a reflectivity factor. The Kirchhoff method is also applied to refraction at a curved surface, and the laws of reflection and refraction are obtained by combining the solutions for these problems.

534.231.3+621.3.011.2:621.395.623.7 913
A Continuously Variable Acoustic Impedance—J. E. White. (*Jour. Acous. Soc. Amer.*, vol. 19, pp. 846-849; September, 1947.) Discussion of the relation between mechanical impedance and electrical load impedance of a loudspeaker, using three complex parameters. Measurements are given showing that the mechanical impedance can be varied over a fairly wide range. See also 3037 of 1943 (Fay).

534.321.9:534.845:551.596.1 914
High Frequency Absorption in Air and Other Gases—L. J. Sivian. (*Jour. Acous. Soc. Amer.*, vol. 19, pp. 914-916; September, 1947.) The absorption coefficients for freely propagated plane waves are deduced qualitatively from preliminary measurements on the absorption of ultrasonic waves in gases inside cylindrical tubes. See also 1989 of 1947 (Schilling et al.).

534.321.9:620.179.1 915
Ultrasonic Resonance Applied to Non-Destructive Testing—Erwin and Rassweiler. (*See* 1112.)

534.321.9.001.8 916
Supersonics—R. Lemas. (*Télev. Franc.*, no. 30, Supplement *Électronique*, pp. 37-40; October, 1947.) A brief review, with mention of some industrial applications.

534.422 917
A Powerful High Frequency Siren—C. H. Allen and I. Rudnick. (*Jour. Acous. Soc. Amer.*, vol. 19, pp. 857-865; September, 1947.) Design, construction, and performance of a high-intensity siren for frequencies of 3 to 34 kc. The measured efficiency was between 17 per cent and 34 per cent for 3 to 19 kc., with an acoustic output of 84 to 176 watts. With modifications, acoustic outputs of 2 kw. were obtained, the efficiency being about 20 per cent. See also 922 below.

534.43:621.395.61 918
Crystal Pickups—L. J. Wheeler and K. G. Lockyer. (*Wireless World*, vol. 53, pp. 412-414; November, 1947.) Design and construction details together with characteristic response curves and suggested input circuits for top correction and equalization.

534.612.4 919
Absolute Calibration of Microphones—G. Buchmann. (*Funk. und Ton.*, no. 1, pp. 30-32, 37-45; 1947.) A description and comparison of methods using (a) the Rayleigh disk in a Kundt's tube, (b) the pistonphone, (c) an auxiliary electrode, and (d) the reciprocity principle.

534.64 920
Measurement of Acoustic Impedances of Surfaces in Water—R. D. Fay, R. L. Brown, and O. V. Fortier. (*Jour. Acous. Soc. Amer.*, vol. 19, pp. 850-856; September, 1947.) An analytical and experimental investigation of water-filled impedance tubes, one a 6-foot length of heavy steel pipe, 8 inches in diameter with a one-half inch wall, and another 8-foot length of Al tube, 5 and one-half inches in diameter, with a one-quarter-inch wall. The phase-velocity of sound in the tubes is nearly constant in the useful frequency range of 1000 to 3500 c.p.s., but less than the velocity of sound in free water. The variation of sound pressure along a tube radius depends upon the frequency.

534.64:534.833 921
A Short-Tube Method for Measurement of Impedance—R. K. Cook. (*Jour. Acous. Soc. Amer.*, vol. 19, pp. 922-923; September, 1947.) The sound pressure within the tube, due to a sound source of known volume velocity, depends on the impedance of the walls of the tube. Impedances can be determined from absolute measurements of sound pressure in a short tube, for both isotropic and anisotropic materials. The short-tube method seems to have definite experimental advantages; temperature and frequency control are not expected to be as critical as in long-tube methods; gases other than air can be readily introduced, and gases such as hydrogen and helium can give important information about absorption due to gaseous viscosity effects in the pores of the acoustic material. See also 2117 of 1946 (Loye and Morgan).

534.7:534.422 922
Too Much Audio—S. Y. White. (*Audio Eng.*, vol. 31, pp. 31, 53; May, 1947.) An account of remarkable physiological effects produced by a turbo-generator with a maximum sound output of about 18 kw. As the rotor is speeded up, the ear ceases to respond at about 800 c.p.s. The eye goes out of focus when the power is about 3 kw. Between 5 and 8 kw., there is a complete loss of muscular control and of memory. With several different rotor disks, the frequency range extends to 24 kc. The total weight of the generator is only about 2 and one-half pounds. At low frequencies, it acts as a simple siren taking up to 200 feet³ per minute

at 60-pound pressure, but at the higher frequencies, resonant chambers are used in the stator to build up a starting pressure about 3 times the static gas pressure.

534.75 923
The Effect of Frequency Spectrum on Temporal Integration of Energy in the Ear—W. R. Garner. (*Jour. Acous. Soc. Amer.*, vol. 19, pp. 808–815; September, 1947.)

534.78 924
Methods of Measuring Speech Spectra—S. S. Stevens, J. P. Egan, and G. A. Miller. (*Jour. Acous. Soc. Amer.*, vol. 19, pp. 771–780; September, 1947.) Three methods were used to analyze speech, (a) square-law integrator (audio spectrometer), (b) linear integrator with tube voltmeter, and (c) RCA noise meter and Esterline Angus graphic recorder. Each method gave substantially the same result. In each case a known acoustic spectrum was compared with an unknown spectrum. This method obviates the necessity for calibrating individual parts of each system separately. The standard spectrum (white noise) was obtained by passing current through a gas tube.

534.78:534.32 925
Phase Effects in Monaural Perception—R. C. Mathes and R. L. Miller. (*Jour. Acoust. Soc. Amer.*, vol. 19, pp. 780–787; September, 1947.) Discussion of experimental results which suggest that changing only the phase of one or more components of a complex wave train can alter appreciably the quality of the sound produced.

534.78:534.32 926
Studies on Pitch Discrimination in Masking: Part 2—The Effect of Signal/Noise Differential—J. D. Harris. (*Jour. Acous. Soc. Amer.*, vol. 19, pp. 816–819; September, 1947.)

534.78:534.32 927
Masking Effect of Periodically Pulsed Tones as a Function of Time and Frequency—R. L. Miller. (*Jour. Acous. Soc. Amer.*, vol. 19, pp. 798–807; September, 1947.)

534.833.4 928
Sound Absorption and Impedance of Acoustical Materials—H. B. Sabine. (*Jour. Soc. Mot. Pic. Eng.*, vol. 49, pp. 262–278; September 1947. Discussion, p. 278.) A review of recent theoretical and experimental investigations into the concept of acoustic impedance as applied to the prediction of the absorbing characteristics of a material, or of a particular construction, in terms of accurately defined and measurable physical properties. Curves are given showing how the physical properties of the materials are related to the sound absorption through the acoustic impedance, and that high absorption depends on the right combination of acoustic resistance and reactance. Application is made to the design of a number of commercial materials.

534.833.4 929
The Properties of Felt in the Reduction of Noise and Vibration—F. G. Tyzzer and H. C. Hardy. (*Jour. Acous. Soc. Amer.*, vol. 19, pp. 872–878; September, 1947.)

534.844:534.861.1 930
Making Reverberation Time Tests in Broadcast Studios—L. P. Reitz. (*Tele-Tech*, vol. 6, pp. 44–48, 92; October, 1947.) An illustration of the manner in which a reverberation analyzer can be adapted to the modern acoustical problems of the architect and building-material manufacturer.

534.845:518.4 931
On the Design of Perforated Facings for Acoustic Materials—R. H. Bolt. (*Jour. Acous. Soc. Amer.*, vol. 19, pp. 917–921; September, 1947.) A design chart such that when the acoustic impedance of an unfaced material is

known, the absorption coefficient for that material with perforated facing can be read directly.

534.851:621.395.813 932
Dynamic Noise Suppressor—H. H. Scott. (*Electronics*, vol. 20, pp. 96–101; December, 1947.) Broad principles were discussed in 991 of 1947. Here, a brief survey of noise-reduction systems is followed by complete technical details of a system to give almost noise-free reproduction of phonograph records. Circuits are given for a 2-tube phonograph version, and a 10-tube broadcast model. Signal-controlled reactance tubes in filter circuits act as gates which control the shape of the audio response curve at low and high frequencies, and pass only the desired audio modulation. The fundamentals of desired high-frequency notes are filtered out and rectified by a control circuit which changes the bias, and hence the capacitance, of the high-frequency gate. Harmonics of low-frequency notes similarly vary the inductance of the low-frequency gate.

534.851:621.395.813 933
Audio Noise Reduction Circuits—H. F. Olson. (*Electronics*, vol. 20, pp. 118–122; December, 1947.) Phonograph record noise is reduced by a single-channel system using Ge diodes as nonlinear elements. Amplitudes of noise level and below are eliminated without discriminating against the useful signal. Octave band-pass filters are used at input and output. Reproduction to 6000 c.p.s. is obtained with the low noise characteristics normally associated with 3000-c.p.s. cutoff. A 3-channel system for broadcast stations, effective to 12,000 c.p.s. is also described. Circuit diagrams and frequency response curves are shown.

534.86:534.322.1 934
High Audio Frequencies—F.L.D. (*Wireless World*, vol. 53, pp. 415–416; November, 1947.) Comment on 3567 of 1945 (Chinn and Eisenberg.) See also 1185 of 1947, 10 and 11 of February and back references.

534.861/862.1 935
Space Acoustics—J. Y. Dunbar. (*Jour. Soc. Mot. Pic. Eng.*, vol. 49, pp. 372–382; October, 1947. Discussion, pp. 383–388.) The effect of area, shape and fittings of a studio on sound quality are discussed. Methods of acoustical treatment of enclosed areas are described and illustrated.

534.861.1 936
Audio Systems for F.M. Broadcasting—J. D. Colvin. (*Audio Eng.*, vol. 31, pp. 11–14, 51; May, 1947.) A discussion of circuit requirements and layout.

621.395.623.7 937
High Fidelity Loudspeaker of Unique Design—J. K. Hilliard. (*Audio Eng.*, vol. 31, pp. 33–34; May, 1947.) Details of a loudspeaker with both a high-frequency diaphragm and a low-frequency cone driven, through a mechanical network, by a single large voice coil.

621.395.623.7 938
Loudspeaker Damping—A. E. Cawkell, J. S. Smith, and P. G. A. H. Voigt. (*Wireless World*, vol. 53, pp. 447 and 487–488; November and December, 1947.) For other contributions to the correspondence see 13 of February.

621.395.623.7 939
Loudspeaker Design by Electro-Mechanical Analysis—A. J. Sanial. (*Tele-Tech*, vol. 6, pp. 38–43, 104; October, 1947.) A detailed analysis of the analogous behavior of electrical circuits and mechanical systems. In the design of a loudspeaker, the method followed involves a process of tentative computations which are successively corrected as the design proceeds. In this way, the best possible values for the various interrelated circuit parameters can be obtained. The method is illustrated by the

design of a typical horn loudspeaker, suitable primarily for voice reproduction.

621.395.623.8 940
Multiple Speaker Matching—J. Winslow. (*Audio Eng.*, vol. 31, pp. 30, 52; May, 1947.) Methods of feeding a number of loudspeakers, either in series or in parallel, from a single amplifier, with proper matching to the output transformer. See also 14 of February (Chrétien) and back references.

621.395.625 941
The "Filmgraph" Sound Recording System—J. H. Jupe. (*Electronic Eng.* (London), vol. 19, p. 389; December, 1947.) A commercial recorder having a flat frequency response from about 75 to 5000 c.p.s. The track is laterally indented on film, and in reproduction, the reverse process is used, with the same sound head and stylus. The recordings are in the "permanent" class and 100 tracks can be recorded side by side on the same film.

621.395.625.2 942
Embossed High-Fidelity Recording—R. Wagner. (*Audio Eng.*, vol. 31, pp. 24–26, 49; May, 1947.) Describes the principal features of a compact and simple recorder, suitable for home use. The 3 and three-quarter inch vinylite disk is 0.01 inch thick and has 515 lines per inch. The under-side of the disk is pre-grooved, so that the disk acts as its own lead screw, guide-point and cutting stylus moving together across the disk as it is rotated.

621.395.625.3 943
Developments in Magnetic Recording—P. T. Hobson. (*Electronic Eng.* (London), vol. 19, pp. 377–382; December, 1947.) Based on a lecture to the British Sound Recording Association.

621.395.625.3:016 944
A Bibliography of Magnetic Recording—D. W. Aldous. (*Electronic Eng.* (London), vol. 19, pp. 390–391; December, 1947.) See also 642 of April (Haynes).

621.395.625.3:621.396.97 945
Magnetic Tape Recorders in Broadcasting—H. A. Chinn. (*Audio Eng.*, vol. 31, pp. 7–10; May, 1947.) The relative merits of wire- and tape-recorders are discussed and the advantages of a paper-or-plastic-base tape are stressed. One type of plastic tape developed in Germany had the magnetic material distributed uniformly throughout the thickness, but suffered from leakage between layers when coiled. A description is given of the Brush BK-401 Soundmirror, which is already in production. This uses a coated paper tape and is a complete recorder and reproducer with push-button control for recording, quick rewinding, and playback. Reprinted in *Electronic Eng.*, vol. 19, pp. 393–395; December, 1947.

621.395.625.6:621.383.4 946
Lead-Sulfide Photoconductive Cells for Sound Reproduction—Cashman. (See 1200.)

621.395.813:621.317.755 947
Simplified Intermodulation Measurement—C. G. McProud. (*Audio Eng.*, vol. 31, pp. 21–23; May, 1947.) A standard test signal is applied to the input of an amplifier and the output is terminated with its normal impedance, across which are connected a high-pass filter and a c.r.o. Analysis of the resulting traces affords a clue to the source of distortion, if any is present, and gives an approximate indication of its amount.

AERIALS AND TRANSMISSION LINES

621.315.687 948
Tapered Coaxial Junctions—S. Herschfeld. (*Electronics*, vol. 20, p. 146; December, 1947.) Design considerations for a reasonably short taper and an adequate match in applications requiring negligible reflections.

621.392.029.64:621.3.017.21 949

Calculation of Losses due to the Joule Effect in Waveguides—J. Oswald. (*Cables and Trans.* (Paris,) vol. 1, pp. 205-219; October, 1947. With English summary.) Of the two usual methods for such calculations, one is not very rigorous and does not reveal either the field perturbations or the variations of the phase velocity; the other is rigorous, but leads to difficult calculations. A method of calculation of the perturbations has the advantages of both methods. It applies to waveguides of arbitrary section and even to coaxial cables or Lecher lines. It is based on a fundamental formula, which is actually Green's formula applied to the Borgnis-Bromwich functions relative to perfectly and imperfectly conducting waveguides. A general expression is given for the boundary conditions. Development of the calculations reveals the perturbation of H waves; the structure of E waves is not appreciably modified. The formulas involve simple and double integrals uniquely related to the functions of Borgnis for perfectly conducting guides. These integrals have a very simple physical significance; their evaluation is extremely easy in the usual cases of guides of circular or rectangular cross section. A table is given of formulas for the numerical calculation of the attenuation in different types of waveguides.

621.392.029.64:621.396.662.3 950
Quarter Wave Coupled Wave-Guide Filters—Pritchard. (See 1000.)621.396.67 951
Standard Reference Antennas—C. E. Smith. (*Communications*, vol. 27, pp. 20, 38; November, 1947.) Characteristics of the omnidirectional uniform spherical radiator, used as the standard theoretical reference, and of the uniform hemispherical radiator, used as a standard of directivity and for computation of gain and efficiency.621.396.67 952
Polyrod Antennas—G. E. Mueller and W. A. Tyrrell. (*Bell Sys. Tech. Jour.*, vol. 26, pp. 837-851; October, 1947.) A microwave endfire aerial consisting of a properly shaped dielectric rod protruding from a metal waveguide is described. Directional patterns are deduced from the theory of dielectric wire transmission, and the effect of phase lag on gain and of tapering on the aerial pattern are obtained. Experimental data on patterns for various lengths and shapes of rod, on cross talk between rods and on methods of feeding are discussed.621.396.67 953
Transmitting Antenna Inductive Coupling Methods—S. Wald. (*Communications*, vol. 27, pp. 14-17; November, 1947.) An undesirable feature of the swinging-link type of aerial coupling is that the self-inductance of the coupling coil makes the aerial circuit reactive and so reduces the power transferred from the tank coil to the aerial. The theory of this type of coupling is discussed together with methods for neutralizing the reactance due to the link coil, and a rational design procedure is developed whereby the circuit parameters can be closely estimated at the first approximation.621.396.67:517.512.2 954
Fourier Transforms in Aerial Theory: Part 4—Fourier Approximation Curves—(See 1068.)621.396.67:621.396.97 955
The Theory of Antenna Design for F.M. Broadcasting—G. Gliński. (*Tele-Tech*, vol. 6, pp. 31-37; October, 1947.) "A systematic review of the main features and characteristics of the principal types, with a mathematical analysis of their properties."621.396.67:621.397.5 956
Television Aerials—N. M. Best. (*Wireless*

World, vol. 53, p. 448; November, 1947.) Authors' reply to comment on 3799 of January by Strafford and Pateman (29 of February).

621.396.67.029.64 957
Omnidirectional Centimetre-Wave Aerial using a Slotted Waveguide and E_{01} Waves—J. Benoit. (*Compt. Rend. Acad. Sci.* (Paris,) vol. 225, pp. 1296-1297; December 22, 1947.) A cylindrical waveguide is used, of internal diameter 10 centimeters, mounted vertically. The radiating elements are resonant slots of length nearly equal to $\lambda_0/2$, where λ_0 is the wavelength in air; they cut the lines of longitudinal current at an angle θ , which in practice does not exceed 20° . A series of n slots is arranged with centers on the same generating line and $\lambda_0/2$ apart, where λ_0 is the wavelength in the guide, the inclinations being alternately positive and negative. With 8 such series of slots arranged round the waveguide, a radiation pattern is obtained which is sensibly circular, the main beam being polarized horizontally.621.396.677 958
An Approach to the Problem of Optimum Directive Antennae Design—A. I. Uzkov. (*Compt. Rend. Acad. Sci.* (U.R.S.S.), vol. 53, pp. 35-38; July 10, 1946. In English.) Given an aerial system arbitrarily situated in space, the directivity achieved in practice will vary with the method of excitation, but cannot exceed an optimum value associated with a unique method of excitation which can be determined analytically.

CIRCUITS AND CIRCUIT ELEMENTS

621.3.012.8 959
Equivalent Schemes for Electric Circuits with Periodic Parameters—I. S. Bruk. (*Compt. Rend. Acad. Sci.* (U.R.S.S.), vol. 53, pp. 221-224; July 30, 1946. In English.) Only a steady state under a sinusoidal change of applied voltage is considered. The recurrence formula relating the complex amplitudes of the different harmonics determines an infinite symmetric matrix which corresponds to a network with n node pairs when $n \rightarrow \infty$. Equivalent schemes of this kind permit qualitative conclusions without calculations. Two examples are given.621.314.3† 960
Magnetic Amplifier Circuits: Neutral Type—A. S. Fitzgerald. (*Jour. Frank. Inst.*, vol. 244, pp. 249-265; October, 1947.) An outline of basic principles. The properties of saturating reactors and practical designs for amplifiers are considered. Methods are discussed for compensation of the rectified current produced in the later stages of a multistage amplifier by the normal magnetizing current of an earlier stage.621.316.313.025 961
An A.C. Network Analyser—(*Engineer* (London), vol. 184, pp. 442-444; November 7, 1947.) A system of variable resistors, reactors, capacitors, and transformers together with voltage sources variable in phase and magnitude which can be arranged to form a scale-down counterpart of the system to be studied. The characteristics of the full-scale system may be evaluated and the effect of system changes predicted. It may also be used to solve mechanical problems that can be expressed in terms of electrical equivalents. Telephone-type apparatus is used for intercommunication and switching. When a problem is set up, all the system characteristics are computed as percentages of a selected voltage and kva. base. An example of the method of operation is given. For another account see *Overseas Eng.*, vol. 21, pp. 156-157; December 1947.621.316.718:621.396.96:371.3 962
The Velodyne—F. C. Williams and A. M. Uttley. (*Jour. I.E.E.* (London) Part IIIA, vol. 93, no. 7, pp. 1256-1274; 1946.) In order

to synthesize the motion of aircraft in radar "trainer" circuits, several time-integrators accepting voltage inputs are needed. The Velodyne was developed to meet special requirements in this connection, and is an electro-mechanical system in which a speed of rotation is held closely proportional to an input voltage by feedback methods. The total number of revolutions of the output shaft is a measure of the time-integral of the input voltage. The paper describes the evolution of the velocity-control system into an integrator, and also into a means of producing mechanical motion accurately related to input voltage according to more complex laws.

621.318.4:518.4 963
The Design of Small Single-Layer Coils—A. I. F. Simpson. (*Electronic Eng.* (London), vol. 19, pp. 353-360; November, 1947.) "Design charts relating the inductance, number of turns, and wire diameter for optimum Q for single-layer solenoid coils on formers of varying diameter."621.319.4 964
Making Power Capacitors—(*Elec. Rev.* (London), vol. 142, pp. 3-7; January 2, 1948.) An illustrated account of the production methods employed at the works of British Insulated Callender's Cables, Ltd., for the manufacture of (a) oil-impregnated and oil-immersed paper-dielectric capacitors, (b) petroleum-jelly-impregnated paper-dielectric capacitors, and (c) electrolytic capacitors.621.319.4:621.315.614.6 965
Paper Capacitors Containing Chlorinated Impregnants: Part 4—Benefits of Controlled Oxidation of the Paper—D. A. McLean. (*Indus. Eng. Chem.*, vol. 39, pp. 1457-1461; November, 1947.) Description of experiments on kraft capacitor paper showing that improved insulation resistance, power factor, and d.c. life result from oxidation by means of controlled baking. Tables and graphs show that the improvements are more pronounced if the paper is subsequently impregnated with chlorinated diphenyl, and also that they persist after exposure to high humidity followed by redrying. For previous parts see 654 and 655 of 1947.621.392:518.61 966
A Computational Method Applicable to Microwave Networks—Dicke. (See 1073.)621.392.5 967
On the Theory of Quadripoles in Closed Chains—P. Satche. (*Rev. Gén. Elec.*, vol. 56, pp. 426-432; October, 1947.) A general study of 4-terminal networks, of which the quadripole is a particular case. By the introduction of new variables which play the same simplifying part as symmetrical coordinates in the case of poly-phase networks, the equations of the 4-terminal network are put into a simple and suitable form. Equivalent networks and the homogeneous line are studied; This work will be extended in a later paper to 3-phase power-line networks and to a more exact examination of the homopolar network.621.392.5 (083.5) 968
Tables of Phase Associated with a Semi-Infinite Unit Slope of Attenuation—D. E. Thomas. (*Bell Sys. Tech. Jour.*, vol. 26, pp. 870-899; October, 1947.) See also 2169 of 1946 (Bode).621.392.51:534.1 969
Coordinates and the Reciprocity Theorem in Electromechanical Systems—J. W. Miles. (*Jour. Acous. Soc. Amer.*, vol. 19, pp. 910-913; September, 1947.) "The (force-voltage, velocity-current) mechanical-electrical analogy yields circuit equations for an electrostatic electromechanical transducer which satisfy the reciprocity theorem, while the (force-current, velocity-voltage) analogy acts similarly for a magnetic transducer." Reversing the two

analogies between the two types of transducer yields equations violating the reciprocity theorem in sign but not in magnitude. This indicates proper choice of coordinates in the application of Lagrange's equations to such systems. See also 370 of 1947 (McMillan) and 970 below.

621.392.51:534.1 970
Further Remarks on Reciprocity—E. M. McMillan. (*Jour. Acous. Soc. Amer.*, vol. 19, p. 922; September, 1947.) Reply to criticism of 370 of 1947. See also 969 above.

621.392.52+621.396.611.3 971
Note on the Parallel-T Network—M. P. Givens. (*Rev. Sci. Instr.*, vol. 18, p. 802; October, 1947.) By using capacitors with high leakage resistance, such as mica capacitors, the rejection ratio can be raised from 8 or 10 to 100 or even 1000. See also 1464 of 1946 (Hastings) and 47 of February (McGaughan.)

621.392.6:518.4 972
Graphical Calculation for Free and Forced Conditions—P. Mourmant. (*Onde Élec.*, vol. 27, pp. 371–384; October, 1947.) The physical behavior of a passive multipole is considered briefly and the graphical representation of natural waves and of generalized impedance are discussed. The paper is mainly concerned with the application of graphical methods to series-parallel circuits to determine their response under various conditions and to investigate impedance and energy relations. The methods are used to analyze the impedance diagram of a II network.

621.396.611.21:621.396.96 973
A Pulsed Crystal Oscillator Circuit for Radar Ranging—D. J. Mynall. (*Jour. I.E.E.* (London), part IIIA, vol. 93, pp. 1207–1214; 1946.) A high precision circuit "which uses the now well-established method of controlling the range timing marker by means of a linear, continuous phase-shifting circuit. Its special features are the use of a pulsed quartz-crystal oscillator as the timing standard and the elimination of the separate, medium-precision timing circuit usually employed to select one range marker from the array potentially offered by the phase-shifting circuit. "Appendices deal with some of the factors involved in the design of the circuit."

621.396.611.33:518.3 974
Efficiency of Inductive Coupling—A. C. Hudson. (*Electronics*, vol. 20, p. 138; December, 1947.) "Power transfer through inductively coupled resistive circuits is given directly from chart, or coil parameters can be found if required efficiency is known."

621.396.611.4 975
Electromagnetic Cavity Resonators—G. de Vries. (*Philips Tech. Rev.*, vol. 9, no. 3, pp. 73–84; 1947.) The forms of oscillation of certain electromagnetic flat-cavity resonators are discussed; i.e., resonators which may be considered as two-dimensional; namely, the forms of oscillation of square plane-cavity resonators and the nonrotation-symmetrical forms of oscillation of round plane-cavity resonators. Further, the forms of oscillation of three-dimensional cavity resonators are dealt with. Then the case of two coupled cavity resonators is discussed, the significance of which in high-frequency technology is analogous to that of coupled oscillation circuits in the region of lower frequencies, namely, to that of a band filter.

621.396.615 976
Valve Oscillator—J. R. Tillman. (*Wireless Eng.* vol. 24, pp. 357–371; December, 1947.) Analysis of a tuned circuit in which oscillations are maintained by a 2-tube amplifier with negative feedback. Amplitude limitation occurs when the input to the grid of the second tube

exceeds the cutoff tube, so that a distorted anode-current wave form is produced. In the analysis, the output of the maintaining circuit is removed and terminated in an impedance similar to that of the frequency-discriminating circuit, to which a wave form is applied having its fundamental frequency component in phase with the amplifier output. The calculated frequency of oscillation agrees with that found by Groszkowski (*Wireless Eng.*, 1933 Abstracts, p. 564), but the present method enables results to be predicted from more easily available data. The frequency stability of this oscillator is shown to be comparable with that of a bridge-stabilized oscillator when the Q of the tuned circuit is greater than 100. See also 2188 of 1945 (Lynch and Tillman.)

621.396.615 977
Blocking Oscillators—R. Benjamin. (*Jour. I.E.E.* (London), part IIIA, vol. 93, no. 7, pp. 1159–1175; 1946.) A general survey of their uses and of design considerations. Examples are given of their use in the generation of pulses at pre-selected repetition frequencies, both synchronized and free-running. Aperiodic triggered pulse-generators are also described and it is shown that delay-lines can be used for the accurate control of pulse length or repetition frequency. The network equations of the equivalent circuit of a blocking oscillator are derived and approximate equations for the pulse shape are obtained for particular cases.

621.396.615 978
Generator of Sub-Standard Metre Waves—L. Liot. (*Radio Franç.*, pp. 4–9; October, 1947.) Circuit and constructional details of a laboratory instrument with an output of about 10 watts on a wavelength of 1.2 meters. Frequency stability of the twin-triode master oscillator is achieved by means of a Kolster grid circuit, with $\lambda/4$ parallel lines for the anode circuit. The twin-triode amplifier uses $\lambda/2$ lines for its grid circuit with coupling to the master oscillator anode circuit. $\lambda/4$ lines are used for the anode circuit, from which the output is taken through two 5000-pF silvered mica capacitors.

621.396.615 979
RC Generator, 50 c/s–1Mc/s—F. Juster. (*Toute la Radio*, vol. 14, pp. 314–318; November, 1947.) Circuit and construction details.

621.396.615 980
Theory of Amplitude-Stabilized Oscillators—P. Aigrain and E. M. Williams. (*Onde Élec.*, vol. 27, pp. 385–391; October, 1947.) Three types are considered: (a) those in which the output is rectified, furnishing a d.c. voltage which is used to control the slope of the oscillating tube; (b) those in which the a.c. voltage is applied to a temperature-sensitive resistor, whose variations control the reaction; (c) those in which a derived d.c. voltage is used to vary the resistance of a control element. Oscillators of type (b) are found to be much more stable than those of type (a), while those of type (c) may have even greater stability, particularly if Pt is used for the control element. Optimum values for the circuit parameters are determined for each type.

621.396.615 981
EF50 as Crystal Oscillator—J. Hum. (*Short Wave Mag.*, vol. 5, pp. 84–86; April, 1947.) With suitable circuits an EF50 functioned well in a crystal oscillator with either triode or pentode connection. In the latter case, the output to a dummy aerial was roughly the same as for a 6V6G tube whose anode current was more than double that of the EF50.

621.396.615.14 982
3-Cm Continuous Range Oscillator—I. M. Gottlieb. (*Electronics*, vol. 20, pp. 146, 188; December, 1947.) Constant power is delivered at any frequency within the range 8,800 to 9,500 Mc. Frequencies are given on a dial, whose readings are checked by using a precision-

calibrated tunable cavity as a wavemeter. Operation and design details are given.

621.396.615.14 983
A Simple 8-cm. Wavelength Microwave Triode Oscillator—C. L. Andrews. (*Gen. Elec. Rev.*, vol. 50, pp. 40–43; November, 1947.) Construction details of an experimental, low-power, single coaxial cavity oscillator which uses a disk-seal, grounded-grid triode, Type 2C39. Prolonged periods of c.w. operation are not recommended but the oscillator may be used continuously when the output is modulated. A simple improvised intensity meter is described. See also 1483 of 1946 (Gurewitsch) and 209 of 1947 (White.)

621.396.615.17:621.396.96 984
A Multiple-Pulse Generator for Synchronized Transmitter Systems—D. M. Mackay. (*Jour. I.E.E.* (London), part IIIA, vol. 93, no. 7, pp. 1199–1206; 1946.) The increasing number of radar sets used in a large warship makes it desirable to synchronize the outgoing pulses so that they can be presented simultaneously on the various displays. The development of a master trigger unit for this purpose is described and typical circuit diagrams are given.

621.396.615.17:621.317.755 985
Ranging Circuits, Linear Time-Base Generators and Associated Circuits—F. C. Williams and N. F. Moody. (*Jour. I.E.E.* (London), part IIIA, vol. 93, no. 7, pp. 1188–1198; 1946.) The target range in radar is obtained by measuring the delay time between the transmission of a r.f. pulse and the reception of the corresponding target echo. A linear timebase is required to measure this delay time accurately and the problems of generating a linear timebase or linearly delayed strobes are discussed in detail. Circuit diagrams are given.

621.396.615.17:621.392.5 986
The Pulse-Testing of Wide-Band Networks—Espley, Cherry and Levy. (See 1101.)

621.396.615.17:621.396.96 987
Automatic Strobes and Recurrence-Frequency Selectors—F. C. Williams, F. J. U. Ritson, and T. Kilburn. (*Jour. I.E.E.* (London), part IIIA, vol. 93, no. 7, pp. 1275–1300; 1946.) These are both systems devised for radar purposes in which a locally generated repetitive pulse (a "strobe") is held in coincidence with an incoming repetitive pulse. In the automatic strobe, the incoming pulse is an echo of the transmitted pulse. In the recurrence-frequency selector, incoming pulses are not, in general, echoes, but are pulses received from a remote transmitter with a fixed repetition frequency. In both cases, a "time discriminator" is used to detect the error in the timing of local pulses relative to incoming pulses. Practical circuits and design details are given, and predicted performance is compared with experimental results.

621.396.622:621.396.619.13 988
Description and Operation of a New F.M. Detector Circuit—D. Mansion. (*Onde Élec.*, vol. 27, pp. 392–396; October, 1947.) The circuit combines in a single tube an oscillator and a reactance tube whose function is to make the oscillator frequency identical with that of the signal. The variation of anode current of the reactance tube is proportional to the frequency deviation of the signal. The operation of each part of the circuit is discussed in detail, and a diagram is given of the actual circuit used in the Philco model 1213, with component values. See also 227 of 1947 (Bradley.)

621.396.645 989
High-Powered R.F. Linear Amplifiers—C. W. Corbett. (*Communications*, vol. 27, pp. 22–25, 36; November, 1947.) A discussion of circuits designed to provide high r.f. power in a.m. transmitters, with low distortion, low

residual noise and high fidelity. Prominence is given to the method of linear amplification developed by Doherty (4020 of 1936), which is an effective combination of class-B and class-C operation and makes possible both high efficiency and linearity.

621.396.645 990
Anode Follower for Audio Gain—R. Knowles. (*Short Wave Mag.*, vol. 5, pp. 80–88; April, 1947.) The anode follower is capable of giving high gain and a distortionless output. Practical circuits are discussed.

621.396.645:539.16.08 991
A General Purpose Linear Amplifier—W. H. Jordan and P. R. Bell. (*Rev. Sci. Instr.*, vol. 18, pp. 703–705; October, 1947.) For use in nuclear-particle counting experiments.

621.396.645 992
Remote Amplifier and Program Meter—D. V. R. Drenner. (*Electronics*, vol. 20, pp. 140, 142; December, 1947.) A B.B.C. circuit; full details are given. Two amplifier stages, using high-slope pentodes, give an over-all gain of 90 db in the region 30 to 10,000 c.p.s. A dual potentiometer regulates both the input voltage to the second stage, and the feedback to the first stage. A special input transformer acts as a low-pass filter with cutoff at 10,000 c.p.s. as also does the output circuit of the second stage. Suitable choice of coupling capacitors gives a rising characteristic at about 2000 c.p.s.

The peak program meter consists of a diode and pentode, the latter having a right-hand-zero meter in the anode circuit. Program voltages are rectified by a diode, which charges the capacitor connected across the grid circuit of the pentode, thereby affecting the anode current.

621.396.645.2 993
An Improved Method for Coupling Valves at Ultra-Short Waves—A. van Weel. (*Philips Res. Rep.*, vol. 2, pp. 126–135; April, 1947.) A method of coupling two tubes, or one tube with an aerial, which eliminates the difficulties due to the finite inductance of the tube internal leads and also simplifies the matching of the tube impedances to the external circuits. The lead inductances and input and output capacitances form a low-pass II filter, in which coarse tuning is accomplished by a series inductor or capacitor and fine tuning by a trimmer normally placed across the grid circuit. Examples are given of the application to tuned line circuits.

621.396.645.2 994
Cathode-Coupling—E. Aisberg. (*Toute la Radio*, vol. 14, pp. 264–269; October, 1947.) A discussion of the basic principles and the advantages of the cathodyne or cathode follower circuit, with applications for which it is particularly suitable on account of its high input impedance, low output impedance, negligible frequency distortion and harmonics, and phase equality between output and input.

621.396.645.2:518.4 995
Graphical Characteristics of Cathode-Coupled Triode Amplifiers—C. J. LeBel. (*Audio Eng.* vol. 31, pp. 40–41; May, 1947.) The characteristics of cathode-coupled amplifiers may be determined rapidly from equivalent triode analysis, using two simple charts to replace the usual laborious computations. See also 3066 of 1947 (Rifkin.)

621.396.645.3 996
Optimum Load Impedance in Power Stages—L. Chrétien. (*T.S.F. Pour Tous*, vol. 23, pp. 208–212; October, 1947.) The optimum value for a class-A triode is not critical. It is better to select a value slightly higher than that corresponding to maximum power output, since this results in considerably reduced distortion with little loss of power. For pentodes, the value is much more critical. It is preferable to select too

low an impedance rather than too high. For symmetrical triode arrangements the use of too low an impedance causes odd harmonics to appear.

621.396.645.36 997
Push-Pull Balance—W. T. Cocking. (*Wireless World*, vol. 53, pp. 408–411; November, 1947.) Discussion of the advantages of push-pull amplification, especially in output stages, with particular emphasis on the elimination of even-order harmonics and the removal of direct polarizing current in the output transformer. The problem of balance in a push-pull system is treated mathematically, and equations are given showing second and third harmonic distortion for a pair of tubes either in parallel or pushpull. An example is given to show how the second-harmonic distortion of a pair of tubes or push-pull varies with the various out-of-balance elements.

621.396.66 998
Tuning Circuits—Obvious and Otherwise—“Cathode Ray.” (*Wireless World*, vol. 53, pp. 442–445; November, 1947.) Discussion of the effect on v.h.f. tuned circuits of stray capacitance, and of the inductance and resistance of tubes and wiring. Certain tuned circuits of apparently abnormal form are resolved into conventional types.

621.396.662.3+621.392.52 999
Calculation of Prototype Filters—P. Grasset. (*Compt. Rend. Acad. Sci. (Paris)*, vol. 225, pp. 799–801; November 3, 1947.) It has been shown previously (660 of 1947) that the insertion loss of a symmetrical nondissipative quadrupole between a source and a load is a complex number A whose real and imaginary parts are given by formulas involving the reactances of the arms of the equivalent T and π networks. From these formulas, a diagram can be constructed representing the position of the point A when the frequency varies from 0 to ∞ , thus giving geometrically the modulus $|A|$ and the argument \hat{A} of A , for all frequencies, without any simplifying hypothesis. This procedure is carried out for prototype filters of one or of two cells, terminated by two equal resistances matched to the filter. The constants of both T and π filters are tabulated and diagrams are given showing A and $|A|$ as functions of a quantity n , which is related to certain reactances inversely proportional to one another. Formulas for the insertion loss in the two cases are also given.

621.396.662.3:621.392.029.64 1000
Quarter Wave Coupled Wave-Guide Filters—W. L. Pritchard. (*Jour. Appl. Phys.*, vol. 18, pp. 862–872; October, 1947.) Rectangular cavities each formed by a pair of spaced inductive irises inserted in the waveguide section are considered; the cavities are separated from each other by $\lambda/4$ sections and are tuned to the same frequency. Matrix analysis is used first to determine the resonant frequency, phase shift, loaded Q and loss in the pass band of a single cavity, and is then extended to the case of n units in cascade. The design procedure to achieve required filter characteristics is outlined, and includes an analysis of the susceptibility of an inductive iris made of metal of finite thickness.

621.396.662.32 1001
Principles and Construction of Low-Pass Filters—S. Coudrier. (*T.S.F. Pour Tous*, vol. 23, pp. 226–228; October, 1947.) Simple calculations with practical examples.

621.396.69+621.385.1 1002
Miniaturization—M. Adam. (*Toute la Radio*, vol. 14, pp. 303–307; November, 1947.) A review of the methods of production of miniature components and circuits, with a table of American miniature tubes.

621.396.69 1003
Printed Vitreous Enamel Components—C. I. Bradford, B. L. Weller, and S. A. McNight. (*Electronics*, vol. 20, pp. 106–108; December, 1947.) A sprayed-enamel printed-silver process for making printed circuits, h.v. connectors, and capacitors with electrical characteristics comparable to those of mica capacitors. See also 1913 of 1947 (Sargrove).

621.396.96 1004
Light-Weight Radar: Its Dependence on Low Consumption Circuits—H. R. Whitfield. (*Jour. I.E.E. (London)*, part IIIA, vol. 93, no. 7, pp. 1215–1218; 1946.) Radar circuits designed for economy in weight and power are described and the use of pulse ratings, tropic-proofed materials and miniature tubes is discussed.

621.396.96 1005
Plan-Position Indicator Circuits—F. C. Williams, W. D. Howell, and B. H. Briggs. (*Jour. I.E.E. (London)*, part IIIA, vol. 93, no. 7, pp. 1219–1255; 1946.) The systems described were developed for use with airborne radar equipments in which the time delay of the echoes is proportional to the distance from the aircraft to the reflecting object (slant range). A correction is necessary in order to display the distance from the reflecting object to a point on the ground vertically below the aircraft (ground range). This correction to the delay time is a function of height and slant range, and the paper describes several “height-correction” circuits. Circuits are also described which eliminate the motion of the display across the c.r. screen due to the velocity of the aircraft. The center of the display is moved at a rate proportional to this velocity, and arrangements can be made to fix the North direction on the display tube for easy comparison with maps. Circuits are considered for both electrostatic and electromagnetic deflection.

GENERAL PHYSICS

53.081+621.3.081.1 1006
On the ‘Rationalization’ of Units and of Electromagnetic Formulae—C. Budeanu. (*Bull. Soc. Franç. Élec.*, vol. 7, pp. 563–572; October, 1947.) Considerations are advanced which lead to the definite rejection of all schemes of so-called rationalization, in favor of units expressed simply in terms of the c.g.s. electromagnetic system, in accordance with the decisions of international congresses and of the Commission Électrotechnique Internationale. A comparison table, giving the dimensions of 25 quantities, includes the factor 4π in 11 “non-rationalized” expressions and in 14 “rationalized” expressions. Moreover, the suppression of the factor 4π in many “rationalized” formulas is of no advantage in numerical calculations, so that rationalization would appear to be a complication without practical utility. See also 1392 and 2383 of 1947 (Dorgelo and Schouten) and 1007 below.

53.081 1007
The Giorgi System of Units in Relation to Tradition, Practice and Instruction—P. Grivet. (*Bull. Soc. Franç. Élec.*, vol. 7, pp. 594–628; November, 1947.) A comprehensive discussion of the c.g.s., electrostatic, and electromagnetic systems of units and of the merits, defects, and practical characteristics of the rationalized Giorgi system. Tables are given of numerous electrical formulas in (a) the nonrationalized, and (b) the rationalized system. See also 2383 of 1947 (Dorgelo and Schouten) and 1006 above.

53.081 1008
Magnetic Units: A Correction—“Cathode Ray.” (*Wireless World*, vol. 53, pp. 447–448; November, 1947.) Correction to 75 of February.

- 535.13 1009
New Representation and More General Form of the Classical Equations of Electromagnetism—É. Durand. (*Compt. Rend. Acad. Sci.* (Paris), vol. 225, pp. 567–569; October 6, 1947.)
- 535.338.1:621.385.1.032.216 1010
Measurement of the Monochromatic Emission from Oxide Cathodes—R. Champeix. (*Compt. Rend. Acad. Sci.* (Paris), vol. 225, pp. 728–729; October 27, 1947.) Very careful determinations of the temperatures of oxide cathodes from brightness measurements for two different heating powers, show that the spectral emissive power varies widely from one cathode to another. The experimental values ranged from 0.07 to 0.26. The cause of such wide variations will be investigated.
- 537.122 1011
The Electron—J. A. Crowther. (*Electronic Eng.* (London), vol. 19, pp. 343–347; November, 1947.) Long summary of a lecture given to celebrate the "Electron Jubilee" (395 of March). The events leading to the acceptance of the corpuscular theory of cathode rays in preference to the wave theory are discussed.
- 537.122:621.3.032.2 1012
Energy Exchanges between Electrons and Electrodes at Constant Potential—P. M. Prache. (*Cables and Trans.* (Paris), vol. 1, pp. 221–225; October, 1947. With English summary.) Very general theory is developed concerning the motion of electrons between electrodes connected to external sources of potential. In certain simple cases, it is possible to deduce the value of the current in the conductors connecting the electrodes to their sources. As an example, the motion of an infinitely thin layer of electrons between plane parallel electrodes is considered.
- 537.291:621.385.833 1013
On the Determination of the Principal Elements of Electron Mirrors—É. Regenstreif. (*Ann. Radioélec.*, vol. 2, pp. 348–358; October, 1947.) A short discussion of the physics of electrostatic lenses and mirrors. Detailed calculations are given for diverging and converging mirrors. Tables are also given for the electron trajectories for an electrostatic lens.
- 537.312.62.029.63 1014
The Surface Impedance of Superconductors and Normal Metals at High Frequencies: Parts 1–3—A. B. Pippard. (*Proc. Roy. Soc. A.*, vol. 191, pp. 370–415; November 18, 1947.) The h.f. resistance of superconducting Sn and Hg is finite at all temperatures, tending to a very low value (probably zero for Hg but not for Sn) at absolute zero. The skin conductivity of Ag, Au, and Sn tends to become independent of d.c. conductivity; this is qualitatively explained by London's theory (867 of 1941) which predicts constancy of skin conductivity when the electron mean free path becomes much greater than the skin depth. Measurements of skin reactance enable the superconducting penetration depth to be deduced; for Hg it is found to be about 7×10^{-6} cm. at 0°K, in agreement with Shoenberg's direct measurements (*Proc. Roy. Soc. A.*, vol. 175, pp. 49–70; March 28, 1940.)
The dependence of penetration depth upon temperature is deduced from resistivity measurements, using the theory developed in the paper, and is in good agreement with reactance measurements. The theory is critically discussed and it is shown that Heisenberg's theory of superconductivity explains satisfactorily the relation between superconducting and normal electrons.
- 538.531 1015
The Self-Inductance of a Wire Curved into a Circular Arc—L. A. Zeitlin. (*Compt. Rend. Acad. Sci.* (U.R.S.S.), vol. 53, pp. 429–432; August 20, 1946. In English.) A general formula is derived, and possible simplifying approximations in various practical cases are considered.
- 538.566 1016
On the Integro-Differential Equation for the Propagation of Electromagnetic Waves in a Medium with Dielectric and Magnetic Viscosity—M. I. Rosovsky. (*Compt. Rend. Acad. Sci.* (U.R.S.S.), vol. 53, pp. 601–604; September 10, 1946. In English.)
- 538.569.4.029.64 1017
A Double Modulation Detection Method for Microwave Spectra—R. J. Watts and D. Williams. (*Phys. Rev.*, vol. 72, pp. 1122–1123; December 1, 1947.)
- 538.569.4.029.64:546.171.1 1018
Saturation Effect in Microwave Spectrum of Ammonia—T. A. Pond and W. F. Cannon. (*Phys. Rev.*, vol. 72, pp. 1121–1122; December 1, 1947.) See also 406 of March (Smith and Carter) and back references.
- 538.569.4.029.64:546.171.1 1019
Anomalous Values of Certain of the Fine Structure Lines in the Ammonia Microwave Spectrum—H. H. Nielsen and D. M. Dennison. (*Phys. Rev.*, vol. 72, pp. 1101–1108; December 1, 1947.)
- 538.691 1020
Motion of Particles in Uniform and Non-Uniform Magnetic Fields—F. Ehrenhaft. (*Compt. Rend. Acad. Sci.* (Paris), vol. 225, pp. 926–928; November 17, 1947.) In the very inhomogeneous field produced by an alnico magnet with a pointed south pole-piece, paramagnetic particles move, in general, toward the plane north pole, while diamagnetic particles move toward the point. An explanation of these anomalous results is suggested.
- 539.16.08 1021
Equation of the Curve $I=f(N)$ relating the Luminous Flux Received by Photon Counters and the Number of Discharges Registered.—S. Lormeau. (*Compt. Rend. Acad. Sci.* (Paris), vol. 225, pp. 865–867; November 10, 1947.) The curves, for counters with CuI or Mg cathodes and an atmosphere of alcohol or argon, are not straight lines; they are approximately parabolic and can be represented by equations of the type $I = aN + bN^2$, where b is small.
- GEOPHYSICAL AND EXTRATERRESTRIAL PHENOMENA**
- 521.15:538.12 1022
On the Magnetism of Celestial Bodies—A. Dauvillier. (*Compt. Rend. Acad. Sci.* (Paris), vol. 225, pp. 839–841; November 10, 1947.) The author considers that stellar and planetary magnetism are not of the same nature and that the second is dependent on the first. Calculation of the ratio of the magnetic moment of the moon to its rotational moment, based on its probable magnetite content, gives a value about a thousand times greater than Blakett's value of approximately 10^{-19} c.g.s. units (3112 of 1947).
- 521.15:538.12 1023
On the Relation between the Magnetic Moment and the Moment of Rotation of Spherical Bodies—A. Giau. (*Compt. Rend. Acad. Sci.* (Paris), vol. 225, pp. 924–926; November 17, 1947.) Amplification of previous theory, giving formulas for the magnetic moment which are valid for all values of the electric charge on the sphere, including zero. See 3892 of 1947 and back references.
- 523.3+523.7:550.384.4 1024
Location of the Currents Causing the Solar and Lunar Diurnal Magnetic Variations—D. F. Martyn and S. Chapman. (*Nature* (London), vol. 160, pp. 535–537; October 18, 1947.) Difficulties are experienced in assigning both the solar and lunar diurnal variations of the geomagnetic field to "dynamo" action in a single ionized region. Although there is evidence that the main part of the solar variation is produced in and near the *D* region, the other regions exhibit too great sunspot variation and too little seasonal variation in conductivity to explain the lunar variations. Statistical studies of ionospheric tides have suggested that ionospheric height movements may be interpreted in terms of the direction of the "dynamo" currents and it has been found that the currents in the *E* and *F* regions are almost exactly out-of-phase with those required for the lunar variations which are probably produced in the *D* region.
Chapman, in a footnote, remarks that Martyn's suggestions imply horizontal inducing motions due to the sun, in the *D*, *E* and *F* layers, which are in phase with one another, and lunar tidal horizontal motions which in the *D* layer are opposite in phase to those in the *E* and *F* layers; on present knowledge this does not seem to be excluded.
- 523.5:621.396.82 1025
Electron Density in Meteor Trails—A. C. B. Lovell. (*Nature* (London), vol. 160, pp. 670–671; November 15, 1947.) At frequencies of 60 to 70 Mc., the main radio echo is obtained only when the aerial beam is directed at right angles to the track of the meteor. This can be explained if the ionization is in the form of a long column of diameter small compared to λ . The intensity of the radiation scattered coherently from such a column was calculated by Blakett and Lovell (707 of 1941) and a formula connecting the electron density, the power scattered back and the constants of the radar set is given here. Experimental results for meteor showers of August and September, 1947, are discussed and found to be in reasonable agreement with the formula.
- 523.72:621.396.822.029.62 1026
Solar Radio Emissions—J. F. Denisse. (*Compt. Rend. Acad. Sci.* (Paris), vol. 225, pp. 1358–1360; December 22, 1947.) A theoretical explanation is given of the solar conditions which favor radio emission and also cause a considerable increase of electron kinetic energy. Numerical calculations are consistent with observations. See also 1759 of 1947.
- 523.75 1027
On the Mechanism of the Discharge of Geoelectric Corpuscles from the Surface of the Sun—Z. R. Mustel. (*Compt. Rend. Acad. Sci.* (U.R.S.S.), vol. 56, pp. 245–247; April 21, 1947.)
- 550.38:525.624 1028
Induction Effects in Terrestrial Magnetism: Part 3—Electric Modes—W. M. Elsasser. (*Phys. Rev.*, vol. 72, pp. 821–833; November 1, 1947.) The theory of inductive coupling developed in previous parts (1834 of 1946 and 98 of 1947) is applied to the interaction of the magnetic and electric modes. The couplings between the modes may be interpreted as a feedback amplifier whereby the field can be maintained by the power delivered to it by the fluid motion. The power for the maintenance of the field is provided from the rotational energy lost by the earth as it is slowed down by the action of the lunar tide.
- 551.508.99:621.396.96 1029
The Use of Airborne Navigational and Bombing Radars for Weather-Radar Operations and Verifications—Miller. (See 1045.)
- 551.510.535 1030
On Certain Physical Phenomena in the Ionosphere and Their Interpretation (the Sporadic F_2 -layer)—J. L. Alpert. (*Compt. Rend. Acad. Sci.* (U.R.S.S.), vol. 53, pp. 107–110; July 20, 1946. In English.) The asymmetry of observed "three-tailed" height versus

frequency characteristics contradicts the theory that the extraordinary wave suffers reflection in the regions of both zeros of its refractive index. An explanation of the appearance of extra "tails" is given in terms of an additional "sporadic F " layer which may be mixed with the ordinary F layer and contains a system of sufficiently large ionized clouds separated by distances large compared to λ . For a sufficiently pronounced "sporadic F " layer the height versus frequency curves will have 4 tails. See also 105 of February.

551.510.535:550.38 1031

F_2 Ionization and Geomagnetic Latitudes—P. H. Liang and E. V. Appleton. (*Nature* (London), vol. 160, pp. 642-643; November 8, 1947.) Liang plots the noon F_2 critical frequencies (f^oF_2) for March and September, 1946, and the midnight f^oF_2 values for the latter month as a function of (a) geomagnetic latitude and (b) dip angle; (a) is preferred. The data are discussed and compared with those of Appleton (2898 of 1946) and Mitra (728 of 1947). The symmetry of the observations about the geomagnetic equator is pointed out, and its significance considered. Appleton agrees that (a) is preferable.

551.510.535:621.396.11 1032

On the Anisotropy Effect of the Ionosphere—J. L. Alpert. (*Compt. Rend. Acad. Sci.* (U.R.S.S.), vol. 53, pp. 699-702; September 20, 1946. In English.) Ionospheric reflection was studied with the apparatus used for the work described in 2093 of 1947 (Alpert and Gorozhankin). The frequency of the 0.5-kw. transmitter was altered stepwise during half-hourly periods of observation. The direct and reflected pulses were received at a distance. Changes in the effective paths of reflection and in the angle of arrival of reflected waves occurred which appeared to be due to "magnetoactive" anisotropy; a somewhat analogous effect can occur in crystals. The changes occur when the incident wave is split up into an ordinary and an extraordinary wave; their character depends upon the angle between the path of ground-wave propagation and the magnetic meridian. A tentative theoretical explanation of the results is given.

551.511 1033

On the Distribution of Angular Velocity in Gaseous Envelopes under the Influence of Large-Scale Horizontal Mixing Processes—C. G. Rossby. (*Bull. Amer. Met. Soc.*, vol. 28, pp. 53-68; February, 1947.) The limiting zonal wind distribution in the atmosphere resulting from thermally produced lateral mixing processes is calculated, the atmosphere being considered as a thin spherical shell. Some of the more striking features of the zonal wind distribution at the tropopause level are explained by assuming a mixing process associated with a tendency toward equalization of the vertical component of the absolute vorticity. The theory also accounts for the observed "equatorial acceleration" of the solar photosphere. The limitation imposed by shearing instability on the zone of constant absolute vertical vorticity is in agreement with the apparent break in the law for solar rotation at about 30° heliographic latitude.

551.594.2:629.132.13 1034

Discharge Currents Associated with Kite Balloons—R. Davis and W. G. Standing. (*Proc. Roy. Soc. A*, vol. 191, pp. 304-322; November 18, 1947.) The currents flowing in the cables of barrage balloons are investigated as a function of balloon height and of vertical electric field near the foot of the cable. In thundery weather, charges of the order of coulombs are transferred by currents ranging from milliamperes flowing for minutes to kilampere flowing for milliseconds. Indications of the charge distribution in clouds and the mechanism of lightning strokes (current > 500

amperes) are obtained; "the proportion of positive to negative discharges appears to be greater at the higher current values."

LOCATION AND AIDS TO NAVIGATION

534.88:551.464.018.4 1035

Anti-Sonar—M. (See 1107.)

621.396.663+621.396.933 1036

New Radio Compasses—(*Wireless World*, vol. 53, pp. 417-419; November, 1947.) Details of aircraft radio equipment exhibited recently at Radlett aerodrome. Comprehensive descriptions with photographs of two new radio compasses manufactured respectively by G. E. C. and Marconi's Wireless Telegraph Company. An intercommunication system, general purpose transmitters and receivers, and a compact v.h.f. R/T link are also mentioned. See also 423 of March.

621.396.9:629.13.014.57 1037

Automatic Controls for Pilotless Ocean Flight—J. M. (*Electronics*, vol. 20, pp. 88-92; December, 1947.) Description of pilotless flight from Newfoundland to England, and of the various control units.

621.396.933+621.396.96 1038

Developments in Airline Radio and Radar Communications and Navigational Facilities—H. J. Brown. (*Proc. I.R.E.* (Australia), vol. 8, pp. 19-21; October, 1947.) Discussion on 426 of March.

621.396.933+621.396.96 1039

Position-Finding by Radio: First Thoughts on the Classification of Systems—C. E. Strong. (*Engineer* (London), vol. 184, pp. 446-447; November 7, 1947.) Long abstract of Chairman's address, Radio Section, I.E.E. The need for revising current terminology for classifying radio position-finding systems is stressed. A time-sharing multiplex system combining radar and communication services to aircraft on a common frequency is described. For another account see *Electrician*, vol. 139, p. 1221; October 24, 1947.

621.396.933:621.396.96 1040

Radar System for Airport Traffic and Navigation Control: Parts 2 and 3—F. J. Kitty. (*Tele-Tech.*, vol. 6, pp. 56-59, 107 and 49-51, 94; September and October, 1947.) Two radar sets operating in the 9000-Mc. band are used. One set scans vertically to determine accurately the angular elevation of the aircraft, and so detects any deviation from a preselected glide path. The second set is similarly used to ensure that the course of the aircraft is along the center line of the runway. Part 1: 114 of February.

621.396.933.1 1041

Hazeltine Lanac System of Navigation and Collision Prevention—K. McIlwain. (*Proc. Radio Club Amer.*, vol. 24, pp. 3-28; February, 1947.) A very comprehensive and detailed account of the system and its operation. See also 2435 of 1947.

621.396.96 1042

Various Papers on Radar Circuit Techniques—See Circuits section.

621.396.96 1043

Targets for Microwave Radar Navigation—S. D. Robertson. (*Bell Sys. Tech. Jour.*, vol. 26, pp. 852-869; October, 1947.) The effective echoing areas of certain radar targets can be calculated by the methods of geometrical optics. Other more complicated structures have been investigated experimentally. This paper considers a number of targets of practical interest with particular emphasis on trihedral and biconical corner reflectors. The possibility is indicated of using especially designed targets of high efficiency as aids to radar navigation.

621.396.96(94) 1044

Lightweight Air Warning and G.C.I. Radar in Australia—J. N. Briton. (*Jour. Inst. Eng.* (Australia), vol. 19, pp. 121-132; June, 1947.) War-time requirements are discussed. Developments to overcome both operational difficulties of transport and climate, and production difficulties due to lack of components, are described in detail.

Meter-wave equipment used during the war is reviewed and new centimeter-wave equipment, developed at the end of the war to eliminate faults of earlier types, is described briefly.

621.396.96:551.508.99 1045

The Use of Airborne Navigational and Bombing Radars for Weather-Radar Operations and Verifications—R. W. Miller. (*Bull. Amer. Met. Soc.*, vol. 28, pp. 19-28; January, 1947.) A brief account of previous work is given, followed by a description of test flights made to investigate the conditions giving rise to weather echoes, and the best means of using radar operationally for weather purposes. Modified radar equipment was used in conjunction with recording meteorological instruments. The results, which are illustrated by radar photographs, show that although weather echoes do not necessarily mean areas of heavy turbulence, the use of airborne radar as a weather aid is definitely justified. There is a need for development of more suitable radar equipment for this purpose.

621.396.96:621.396.621 1046

The Radar Receiver—Morrison. (See 1142.)

621.396.93 1047

Wireless Direction Finding [Book Review]—R. Keen. Iliffe and Sons, London, 4th edition, 1059 pp., 45s. (*Elec. Rev.* (London), vol. 142, p. 18; January 2, 1948.) "The book with its valuable bibliography, now containing over 400 references, can be strongly recommended to all students, engineers and operators who are concerned with the practice of this subject." Radar technique is excluded, but a new chapter describes some modern navigation systems, including gee, loran, decca and consol, and the chapter on beacon systems is considerably enlarged. See also *Wireless Eng.*, vol. 24, p. 372; December, 1947.)

621.396.933 1048

Radio Aids to Navigation [Book Review]—R. A. Smith. Cambridge University Press, London, 114 pp., 9s. (*Wireless Eng.*, vol. 24, p. 373; December, 1947.) The material was originally prepared for the Ministry of Supply (Air) Scientific War Records. "The various systems are briefly described in general terms, sometimes with the aid of block diagrams, and their main characteristics are given." For another review see *Wireless World*, vol. 54, p. 30; January, 1948.

MATERIALS AND SUBSIDIARY TECHNIQUES

535.37 1049

Certain Peculiarities in the Luminescence of the Zinc-Cadmium Phosphors—V. A. Yastrebov. (*Compt. Rend. Acad. Sci.* (U.R.S.S.) vol. 53, pp. 605-606; September 10, 1946. In English.) The effect of heating on the luminescence of ZnS-CdS-Cu phosphors with varying CdS content was investigated. A mercury lamp was used for excitation. It appears that structural changes occur in these phosphors when they are heated through the temperature range 180°C - 330°C ; these changes persist for several hours after cooling. The brightness of the phosphor at a given temperature may be increased temporarily by as much as 40 per cent.

535.37.621.385.832 1050

The Application of Chemically Unstable Phosphors to Cathode Ray Tubes—Head (See 1212.)

- 535.371+621.3.017.143]:546.472.84 1051
Dielectric Losses and Fluorescence of Zinc Silicate—G. Szigeti and E. Nagy. (*Nature*, (London), vol. 160, pp. 641-642; November 8, 1947.) The variations of the fluorescence (2537Å excitation) and conductivity (at 20 Mc., without ultraviolet irradiation) within the temperature range 285 to 665°K are described and discussed. It is deduced that the ultimate absorption of the ultraviolet radiation takes place in centers, the number of which is in close relation to the electrical conductivity.
- 538.221 1052
Thermomechanical Treatment of Ferromagnetic Materials—J. S. Shur and A. S. Khokhlov. (*Compt. Rend. Acad. Sci.* (U.R.S.S.), vol. 53, pp. 39-40; July 10, 1946. In English.) The magnetic properties of a material can be improved by subjecting it to elastic tension or compression while it is cooled from a temperature above the Curie point to room temperature. For maximum effects (a) tension must be used for positive and compression for negative magnetostriction materials, (b) the Curie point must be high enough to permit the release of magnetostriction stresses by annealing, (c) the magnitude of the load must have a certain optimum value, and (d) the energy of magnetostriction stresses produced by elastic stresses must be comparable to the energy of magnetic anisotropy.
- 538.221 1053
Interpretation of High Coercivity in Ferromagnetic Materials—E. C. Stoner and E. P. Wohlfarth. (*Nature* (London), vol. 160, pp. 650-651; November 8, 1947.) It is improbable that the relation of the coercivity to the amplitude of internal stress variations can account for coercivities in excess of 500 oersteds. An alternative theory is outlined, the central idea of which is that "there may occur 'particles' . . . distinct in magnetic character from the general matrix, and less than the critical size, depending on shape, for which domain boundary formation is energetically possible." The mechanism proposed, involving magnetically anisotropic single-domain particles, is likely to be important in powder magnets, nonferromagnetic metals and alloys containing ferromagnetic "impurities" and high coercivity alloys of the dispersion-hardening type. A fuller account will be published shortly; for similar work by Néel see 3151 and 3152 of 1947.
- 538.221 1054
Mechanism of Ferromagnetic Dispersion—J. B. Birks. (*Nature* (London), vol. 160, p. 535; October 18, 1947.) See also 748 of 1947.
- 539.26 1055
Study of Surface Layers by Means of X Rays—C. Legrand. (*Compt. Rend. Acad. Sci.* (Paris), vol. 225, pp. 731-733; October 27, 1947.)
- 546.287 1056
The Production and Properties of Silicones—D. W. Glover and R. L. Bull. (*P.O. Elec. Eng. Jour.*, vol. 40, pp. 120-123; October, 1947.) Fundamental methods of production are described and possible applications mentioned.
- 620.197 1057
Protective Finishing of Electrical Equipment—F. Widnall and R. Newbound. (*Jour. I.E.E.* (London), part II, vol. 94, pp. 512-522; October, 1947. Discussion, pp. 522-528.) Full paper: summary abstracted in 3543 of 1947.
- 621.315.59 1058
Semi-Conductors—H. S. W. Massey. (*Jour. Sci. Instr.*, vol. 24, pp. 220-224; August, 1947.) Based on a lecture given at the Institute of Physics. Relation of the conducting proper-
- ties of a crystal to the energy levels of the electrons within it leads to a useful working model of a semiconductor. The importance of impurities and of departures from the stoichiometric proportions is discussed. Rectifying and optical properties are also considered.
- 621.315.611.011.5+537.226.3 1059
A Remarkable Property of Technical Solid Dielectrics—M. Gevers and F. K. du Pré. (*Philips Tech. Rev.*, vol. 9, no. 3, pp. 91-96; 1947.) The ratio of the temperature coefficient of the dielectric constant to the tangent of the loss angle is found to be approximately constant. This is explained by assuming the presence in the substance of (a) dipoles, (b) semi-conducting regions, or (c) free ions. See also 3929 of January and back references. In 3548 of 1947, the value of the above ratio was given incorrectly as 0.6; it should have been 0.06.
- 621.315.611.011.5+537.226.3 1060
The Relation between the Power Factor and the Temperature Coefficient of the Dielectric Constant of Amorphous Solid Dielectrics—M. Gevers. (*Tijdschr. ned. Radiogenoot.*, vol. 12, pp. 185-200; November, 1947. In Dutch, with English summary.) See 3548, 3572 of 1947 and 3929 of January.
- 621.315.612:621.315.62:620.197.6 1061
The Electrical Properties of Semi-Conducting Ceramic Glazes—J. S. Forrest. (*Jour. Sci. Instr.*, vol. 24, pp. 211-217; August, 1947.) The use of semiconducting ceramic glazes in the design of porcelain insulators for humid conditions is discussed. The glazes comprise relatively large proportions of metal oxides embedded in a glassy matrix. The properties of a glaze incorporating about 7 per cent Fe₂O₃ are considered in detail. In common with other semiconducting materials, the glazes have a surface resistivity ρ which varies with temperature so that $\rho = \rho_0 e^{b/T}$, ρ_0 and b being constants. Disintegration of the glaze (due to cumulative current rise) occurs when the applied voltage exceeds a certain limiting value.
- 621.315.612.4:546.431.82:537.228.2 1062
Electrostrictive Effect in Barium Titanate—W. P. Mason. (*Phys. Rev.*, vol. 72, pp. 869-870; November 1, 1947.) The radial and thickness modes of disks have been examined and the electrostriction constants plotted for ascending and descending voltage gradients; a mechanism for the "thickness effect" is deduced. See also 3547 of 1947 (Roberts).
- 621.316.99 1063
Some Aspects of Earthing—R. E. Rimes. (*P.O. Elec. Eng. Jour.*, vol. 40, part 3, pp. 130-134; October, 1947.) Three factors affect the resistance of earthing systems: (a) the soil, (b) the electrodes, and (c) the connecting leads. Practically all the resistance is in the soil; it is largely dependent on the electrolytes present and is extremely variable. Formulas are derived for the resistances of spherical, rod, and strip electrodes.
- 669.35.24 1064
Nickel-Bearing Copper—(*Metal Ind.* (London), vol. 71, p. 301; October 10, 1947.) A high-conductivity temper-hardened alloy consisting of 1 per cent Ni, 0.2 per cent P, 0.2 per cent S, and the remainder Cu. Physical and mechanical properties are listed.
- 679.5 1065
Investigation of the Resistance to Impact Loading of Plastics—H. Liander, C. Schaub, and A. Asplund. (*ASTM Bull.* pp. 88-94; October, 1947.)
- 679.5:621.3 1066
Plastics for Electrical and Radio Engineers [Book Review]—W. J. Tucker and R. S. Roberts. Technical Press, Kingdon, Surrey, England. 2nd edition, 167 pp., 15s. (*Electrician*, vol. 139, pp. 1299-1300; October 31, 1947.) A survey of the more important compounds and a guide to the design of electrical components embodying plastics. "An excellent general introduction to a complex subject, and contains much information of value, equally to the student and the manufacturer." See also 2952 of 1946.

MATHEMATICS

517.512.2:518.4 1067
Graphical Fourier Analysis—T. C. Blow. (*Electronics*, vol. 20, pp. 194-198; December, 1947.) Ordinates $a_1 \dots a_n$ are marked off at equal intervals of the independent variable. The resultant of a_1 in direction $(360/n)^\circ$, a_2 in direction $2 \times (360/n)^\circ$, etc. is $A_1 n/2$ in direction ϕ_1° . The resultant of a_1 in direction $2 \times (360/n)^\circ$, a_2 in direction $4 \times (360/n)^\circ$ etc. is $A_2 n/2$ in direction ϕ_2 , and so on, the required series being $A_0 + A_1 \sin(\theta + \phi_1) + A_2 \sin(2\theta + \phi_2) + \dots$

517.512.2:621.396.67 1068
Fourier Transforms in Aerial Theory: Part 4—Fourier Approximation Curves—J. F. Ramsay. (*Marconi Rev.*, vol. 10, pp. 81-90; July-September, 1947.) Continuation of 155 of February. Fourier approximation curves are derived for a rectangular wave form. Gibbs' phenomenon is discussed. The transition from Fourier series to Fourier integral is shown graphically, by finding the frequency spectrum of recurrent wave forms with gradually lengthening period, ending with a single pulse. By a change of notation, the transient analysis of circuit theory can be interpreted as the Fourier transform theory of aerials.

The approximation curve to a rectangular pulse obtained by restricting the frequency range of the spectral envelope is considered. The aperture distribution appropriate to a "sectoral" beam is also calculated.

517.544 1069
Schwarz' Inequality and the Methods of Rayleigh-Ritz and Trefftz—J. B. Diaz and A. Weinstein. (*Jour. Math. Phys.*, vol. 26, pp. 133-136; October, 1947.) "Both the Rayleigh-Ritz method and the Trefftz procedure can be derived, in the case of quadratic functionals, by a simple and direct application of Schwarz' inequality and Green's formula." Application to other boundary problems is possible.

518.5:517.9 1070
A Device for the Solution of Ordinary Differential Equations—I. S. Bruk. (*Compt. Rend. Acad. Sci.* (U.R.S.S.), vol. 53, pp. 523-526; August 30, 1946. In English.) An electrical differential analyzer whose integrating element is a RC circuit of large time constant. It is simpler though less accurate than a mechanical integrator. Variables are represented by the voltages of busbars. The operation of the instrument is explained by means of illustrative examples, and compared with that of a mechanical analyzer.

518.5:517.942.9 1071
A Resistor Network for the Approximate Solution of the Laplace Equation—D. C. DePackh. (*Rev. Sci. Instr.*, vol. 18, pp. 798-799; October, 1947.) A device more convenient in some respects than the electrolytic tank, if some degree of approximation in the solution may be tolerated. The two-dimensional Laplace equation requires for its solution a network of equal resistors which form a series of squares, one resistor to each side of a square. For the axially-symmetric form of the equation, it is necessary to graduate the values of the resistors in the two perpendicular directions parallel to the sides of the elementary squares, of which there may be some 200 to 240. In both cases an electrical bond is made at each corner of each square, and the potential at any point, when a suitable voltage is applied across the network, may be measured either by a tube voltmeter, or a potentiometer, according to the accuracy required.

518.5:621.317.733 1072
Bridge Type Electrical Computers—W. K. Ergen. (*Rev. Sci. Instr.*, vol. 18, pp. 564–567; August, 1947.) Full paper. Summary abstracted in 2165 of 1947.

518.61:621.392 1073
A Computational Method Applicable to Microwave Networks—R. H. Dicke. (*Jour. Appl. Phys.*, vol. 18, pp. 873–878; October, 1947.) "A method is devised for computing the properties of a complex microwave network in terms of the properties of the circuit elements which in combination form the network. It is particularly suited to machine computation of the properties of circuits of such complexity that simpler, more direct methods fail. It is also applicable to low-frequency networks. The elements of such networks may be regarded as interconnected by transmission lines of zero length. A numerical example is used to illustrate the method."

518.5 1074
The Theory of Mathematical Machines [Book Review]—F. J. Murray. King's Crown Press, New York, 1947, 116 pp., \$3.00. (*Rev. Sci. Instr.*, vol. 18, pp. 786–787; October, 1947.) "... Goes a long way toward providing a connected picture of the work that has been done in the field prior to the development of electronic devices."

MEASUREMENTS AND TEST GEAR

621.317.3 1075
Measurement of Capacitance, Inductance and Resistance with the Double Voltage Divider—O. Zinke. (*Funk. und Ton.*, no. 1, pp. 11–20; 1947.) A detailed explanation of the method as applied to very large or very small capacitors, and self or mutual inductors.

621.317.3.029.64+621.317.7.029.64 1076
Contribution to the Study of Methods and Apparatus for Measurements in the Centimeter Wave Band—M. Denis and R. Liot. (*Ann. Radioélec.*, vol. 2, pp. 409–438; October, 1947.) The first of a series of articles discussing the theory and technique of u.h.f. measurements. A brief discussion of the distinctive character of such measurements, with an exhaustive treatment of the properties of transmission lines and of detectors for stationary waves. Application is made to the determination of the Q and the shunt impedance of cavities such as those of the rhumbatron. Practical details are discussed.

621.317.33.011.5:546.212-16 1077
Dielectric Loss of Ice—F. X. Eder. (*Funk. und Ton.*, no. 1, pp. 21–29; 1947.) Measurements of the dielectric constant and loss factor were made between 0°C and –50°C for frequencies from 50 c.p.s. to 3000 Mc. With increase of frequency, the dielectric constant falls rapidly from its initial value of about 80 to a value near 2. This low value is reached at about 10 kc. for a temperature of –50°C and at about 100 kc. for –3°C. The loss factor ($\tan \delta$) curves all have a high maximum, which occurs at a lower frequency with decrease of temperature. For –3°C the maximum value is about 2.4 and occurs near 40 kc. while for –50°C the maximum is about 2.1 near 1500 c.p.s. For very high frequencies, both the dielectric constant and the loss factor show little variation with frequency. Comparison of the results with Debye's dipole theory of fluid dielectrics show very good agreement when account is taken of the effect of crystallization, which makes the internal friction, and consequently the molecular relaxation time, appreciably greater for ice than for water. The results are discussed briefly with regard to (a) the effect of icing on the radiation from aerials and on carrier telephony on overhead lines, and (b) electromagnetic wave propagation through ice clouds. See also 2845 of 1947 (Lamb).

621.317.335.029.4+621.317.373.029.4 1078
On a Method of Measuring Very Small Variations of Capacitance and Phase Angle in the Tone- and Low-Frequency Range—L. Wegmann. (*Helv. Phys. Acta*, vol. 20, pp. 405–440; October 25, 1947.) A coincidence method is described in detail. Sensitivity for capacitances of the order of 100 pF, is about the same as with bridge methods, but is definitely superior for capacitances of only a few pF. A disadvantage is that owing to the use of multi-vibrators, only a narrow frequency range is possible without modification of the equipment.

621.317.336.1:621.385.3/.5 1079
The Measurement of Dynamic Mutual Conductance of Valves using the Grounded-Grid Triode Mode of Operation—E. F. Good, H. W. Lamson, and F. Gutmann. (*Jour. Sci. Instr.*, vol. 24, pp. 303–304; November, 1947.) Discussion on 3576 of 1947 (Gutmann) and the author's reply.

621.317.35 1080
The S.A.C.M. Type 2128 High-Speed Level Recorder—R. Blondé and P. Herreng. (*Câbles and Trans.* (Paris), vol. 1, pp. 257–260; October, 1947. With English summary.) A description of apparatus for recording the envelope of a complex voltage, the spectrum of which may extend from 30 c.p.s. to 20 kc., with an amplitude range of about 10,000:1. Applications to the recording of transients, and of frequency response curves, and to reverberation-time measurements, etc., are indicated.

621.317.35:621.396.645 1081
Square Wave Analysis at Audio Frequencies—J. P. Van Duyne and M. E. Clark. (*Audio Eng.*, vol. 31, pp. 27–29 and 52; May, 1947.) Examples are given of the application of square-wave technique in testing amplifiers designed for particular purposes. In production testing, the response curve of an amplifier may be compared with the curves given by two others with characteristics representing the upper and lower acceptance limits. A sequence switch enables all three curves to be seen on a c.r.o. Phase versus frequency characteristics can also be studied; curves are given for a typical amplifier, with and without feedback.

621.317.384+621.317.43 1082
Iron-Loss Measurements [by a.c. bridge and calorimeter]—J. Greig and H. Kayser. (*Elec. Times*, vol. 112, pp. 626–627; November 27, 1947; *Electrician*, vol. 139, p. 1573; November 28, 1947.) Summaries and discussion of I.E.E. paper. The calorimeter method is designed to check the results of measurements by an Owen bridge under conditions involving appreciable nonlinear distortion. Nonincremental a.f. excitation is used; the specimen is in the form of a magnetic ring.

621.317.44:621.315.14 1083
The Measurement of the Magnetic Properties of Fine Wire—P. T. Hobson, E. S. Chatt, and W. P. Osmond. (*Electronic Eng.* (London), vol. 19, pp. 383–388; December, 1947.) Details of apparatus used to present 50-c.p.s. $4\pi I/II$ and B/H curves on a c.r. tube, for wires of diameter 0.004 inch. A maximum field of 1000 oersteds is available for remanence and coercivity measurements. Readings of remanence as low as 100 gauss can be made. An appendix describes, with the aid of photographs, the advantages of the differential forms of the above curves, when applied to the magnetic analysis of alloys.

621.317.714 1084
The Polar Ammeter: A New Alternating Current Measuring Instrument—E. B. Brown. (*Jour. Sci. Instr.*, vol. 24, pp. 197–198; August, 1947.) A moving-coil instrument, in which an alternating flux is provided in the magnet system by means of a 2-pole magnet, coupled to a synchronous motor driven from the source sup-

plying the currents to be measured. The r.m.s. value of the current (component at fundamental frequency) and its phase are directly indicated when suitable adjustments are made to the angular position of the motor stator. The properties and advantages of the instrument are discussed briefly.

621.317.715 1085
New Type of Moving-Coil Galvanometer with Adjustable Sensitivity—G. Dupouy. (*Compt. Rend. Acad. Sci.* (Paris), vol. 225, pp. 1290–1292; December 22, 1947.) In this instrument, the torsional couple of the classical galvanometer is opposed by a magnetocrystalline couple which can be varied within wide limits. This couple is due to the action of an auxiliary magnetic field on a small cylindrical crystal of siderite (FeCO_3), centered on the axis of rotation. The mass of the crystal is about 10 mg, so that increase of moment of inertia is negligible. Variation of the auxiliary magnetic field is effected by screw adjustment of a magnetic shunt across the poles of an auxiliary magnet. Sensitivity data are given for two instruments with sensitivity variations of the order of 7 to 1 and 4 to 1 respectively.

621.317.725 1086
A General Purpose Valve Voltmeter—F. Gutmann. (*Proc. I.R.E.* (Australia), vol. 8, p. 15; October, 1947.) Discussion on 477 of March.

621.317.75:621.391.63 1087
The Modulation of a Beam of Light by a Sector Wheel and a Method of Testing the Waveform—D. T. R. Dighton, H. M. Ross, and A. L. Shuffrey. (*Jour. Sci. Instr.*, vol. 24, pp. 202–205; August, 1947.)

621.317.755 1088
Oscilloscope for Very Low Frequencies—F. Juster. (*Toute la Radio*, vol. 14, pp. 270–274; October, 1947.) Full circuit details and layout of an instrument for operation from 3 c.p.s. to 10 kc. A feature of the push-pull amplifier (which uses triodes for all stages except the output, where pentodes are used with screen connected to anode) is that no capacitors are employed in any part of the circuit.

621.317.755 1089
The Cathode-Ray Oscilloscope—R. Besson. (*Toute la Radio*, vol. 14, pp. 278–281; October, 1947.) An account of its use for detection of faults in the testing of radio receivers.

621.317.755:621.395.813 1090
Simplified Intermodulation Measurement—McProud. (See 947.)

621.317.755:[621.396.619+621.396.813 1091
Alignment of an A.M./F.M. Generator—R. Aschenbrenner. (*Radio Franç.*, pp. 10–14; November, 1947.) Method of using a panoramic receiver and c.r.o. for modulation and distortion measurements. Oscillograms show the results obtained on actual instruments.

621.317.772/621.396.67 1092
Phase Monitor for Broadcast Arrays—B. C. O'Brien and F. L. Sherwood. (*Electronics*, vol. 20, pp. 109–111; December, 1947.) A description of the equipment and method of operation, with diagrams. A coaxial delay line is used and readings are obtained by a null method; calibrations are unnecessary and there is no confusion of quadrants. The phase difference between the currents in any two directional aerials can be found rapidly to within 1°. The equipment is very stable and requires no power supply.

621.317.78.029.5/.6 1093
A New Differential Thermometer for Use in R.F. Power Measurement—J. Dyson. (*Jour. Sci. Instr.*, vol. 24, pp. 208–210; August, 1947.) "The problem of measurement of temperature rise in calorimetric measurements of r.f. power

is stated, with some of the disadvantages of the existing methods." The instrument described used a bimetallic strip immersed in each water stream, with an optical system to measure the difference between the two deflections.

621.317.79 1094

A Comparative Vacuum-Tube Decibel Meter—J. H. Grieveason and A. M. Wiggins. (*Audio Eng.*, vol. 31, pp. 15-17; May, 1947.) "Essentially a linear-scale direct-reading decibel meter, which may be adjusted to indicate the difference in db level between a standard and any other similar device under test. It has been found particularly suitable for testing microphones, audio transformers and amplifiers, loudspeakers, and phonograph pickups."

621.317.79:537.533:621.385.1.032.216 1095

Methods and Apparatus for Measuring the Emission from Oxide Cathodes—J. Riethmüller. (*Ann. Radioléc.*, vol. 2, pp. 329-347; October, 1947.) The cathodes are mounted in double diodes and, after evacuation, are submitted to a formative process at a constant temperature; this results in a considerable improvement in the emission. After stabilization at the test temperature, about 700°C, measurements of the emission are made by a pulse method, the peak voltage normally used being 500 volts, the pulse duration 100 microseconds and recurrence frequency 50 c.p.s. Full details are given of all the apparatus. The results will be given in a later paper.

621.317.79:621.396.615.12 1096

Checking M.F. and H.F. Coils with a Panoramic Analyser—R. Aschenbrenner. (*Radio Franc.*, pp. 10-14; October, 1947.) The analyzer is used as a signal generator giving 1 mv. on a frequency of 472 kc., with a f.m. deviation of either ± 30 kc. or ± 20 kc. Details are given of the method of lining up the m.f. and h.f. circuits of a receiver.

621.317.79:621.396.615.12 1097

High Accuracy Signal Generator—J. J. Bann. (*Electronics*, vol. 20, pp. 168, 174; December, 1947.) Quartz crystal frequency control is used. A variable capacitor permits final adjustment of the frequency of the crystal circuit to exact coincidence with a frequency standard such as *WWV*.

621.317.79:621.396.615.12 1098

A Simplified Signal Generator—H. G. Pratt. (*Radio News*, vol. 38, pp. 42-43, 178; October, 1947.) Modulated r.f. output from 170 kc. to 15 Mc. in four ranges; modulation frequency available separately.

621.317.79:621.396.62 1099

A Combined Signal Tracer and Meter—A.R. Mitchell. (*Murphy News*, vol. 22, pp. 266-268; November, 1947.) Construction and use are discussed. The signal tracer consists of detector (probe), i.f. and output circuit and loudspeaker. The tube voltmeter consists of a double diode, and a cathode-follower which can also be used for measuring resistance.

621.317.791 1100

Electronic Volt-Ohmmeter—N. Pélégat. (*T.S.F. Pour Tous*, vol. 23, pp. 205-207; October, 1947.) Complete circuit details of an a.c. mains instrument using a 0 to 500 micro-ampere meter as indicator and with 6 d.c. voltage ranges (5 volts to 1000 volts max.), 6 a.c. voltage ranges (10 volts to 2000 volts max.) and 6 resistance ranges ($R \times 1$ to $R \times 100,000$).

621.396.615.17:621.392.5 1101

The Pulse-Testing of Wide-Band Networks—D. C. Espley, E. C. Cherry, and M. M. Levy. (*Jour. I.E.E.* (London), part IIIA, vol. 93, no. 7, pp. 1176-1187; 1946. Discussion, p. 1218 and *ibid.*, part III, vol. 94, pp. 141-145; March, 1947.) The equipment contains a pulse

generator, a timebase with a display unit, and an amplifier preceded by an exploring head. The generator produces three types of pulse, one of length 0.02 microseconds and amplitude 35 volts in a cable of 35 ohms; one of length 0.01 microseconds and small amplitude; and one of amplitude variable from 50 microvolts to 0.5 volts. The timebase produces a slow scan of 5 microseconds and a fast scan of 1 microsecond. The amplifier has a bandwidth of 32 Mc. and a gain of 13.5 db per stage. The adjustable capacitance attenuator in the probe head has a low input capacitance of 1.8 pF at maximum attenuation. The use of the equipment for testing lines, feeders, delay lines, filters, and feedback amplifiers is discussed.

OTHER APPLICATIONS OF RADIO AND ELECTRONICS

539.16.08 1102

Design of Metal G-M Counters—M. H. Shamos and I. Hudea. (*Rev. Sci. Instr.*, vol. 18, pp. 586-587; August, 1947.) A simplified design in which metallized pyrex bushings are soldered to the metal end-caps and form protective sleeves over the ends of the central wire.

539.16.08 1103

Discharge Spread in Geiger Counters: Part 1—With Self-Quenching Gases—J. D. Craggs and A. A. Jaffe. (*Phys. Rev.*, vol. 72, pp. 784-792; November 1, 1947.) Counters consisting of a wire anode and a divided cathode of coaxial cylinders were used to measure the spread. When each cathode was closed by a glass window with a central hole, the spread was greatly reduced. It is concluded that the collimation of the photon beam by the windows precluded the photoemission from the cathodes which is mainly responsible for the spread.

539.16.08 1104

Equation of the Curve $I=f(N)$ relating the Luminous Flux received by Photon Counters and the Number of Discharges Registered—Lormeau. (*See* 1021.)

539.16.08:621.318.572 1105

The Model 200 Pulse Counter—W. A. Higinbotham, J. Gallagher and M. Sands. (*Rev. Sci. Instr.*, vol. 18, pp. 706-715; 1947.) "A complete general purpose electronic pulse counter is described which consists of an amplitude discriminator, scale-of-64, and register driver, and is suitable for use with pulse amplifiers in making nuclear measurements."

539.16.08:621.385.15 1106

An Improved Electron Multiplier Particle Counter—J. S. Allen. (*Rev. Sci. Instr.*, vol. 18, pp. 739-749; October, 1947.) Discussion of the design and construction of a 13-stage electron-multiplier tube with over-all multiplication of about 10⁷.

551.464.018.4:534.88 1107

Anti-Sonar—M. (*Elektron* (Linz), no. 7, pp. 138-139; 1947.) Temperature-dependent resistors mounted on the conning tower and near the keel of a U-boat, with a known vertical separation, constituted two arms of a Wheatstone bridge. Out-of-balance voltage was used to obtain direct readings of vertical temperature gradients. Sensitivity adjustment gave 3 ranges of 0 to 3°C per meter, 0 to 6°C per meter and 0 to 9°C per meter. Tests of this equipment were not finally completed at the end of the war. A knowledge of the temperature gradient and the salinity enabled an estimate to be made of the effective sonar echo range. The use of cold-water jets to give a screening effect is discussed briefly.

615.84 1108

Stable Frequency Short Wave Diathermy—R. Brennand. (*Electronic Eng.* (London), vol. 19, pp. 401-403; December, 1947.) Diathermy apparatus designed for easy operation by non-technical personnel. Radiated energy is low

enough for the apparatus to be worked without a screened room. Two models with outputs of 100 watts and 500 watts have been produced, incorporating crystal control of frequency and electronic tuning indicators.

615.84:[621.365.5+621.365.92 1109

The Physics of Industrial Diathermy—A. W. Lay. (*Electronic Eng.* (London), vol. 19, pp. 227-231, 290-294, and 361-362, 364; July, September, and November, 1947.)

620.179:621.317.39 1110

The Application of Electrical Technique to the Service of Some Other Industries—H. C. Turner and G. M. Tomlin. (*Jour. I.E.E.* (London), part II, vol. 94, pp. 501-508; October, 1947. Discussion, pp. 508-510.) A general discussion, with special reference to a magnetic sorting bridge for testing steel parts, a supersonic metal-thickness indicator, a vibration analyzer and a supersonic flaw detector for metals.

620.179.1:621.317.733 1111

Variable-Frequency Metals Comparator—D. E. Bovey. (*Gen. Elec. Rev.*, vol. 50, pp. 45-49; November, 1947.) An improved bridge-type instrument which can be used by a technically untrained operator for the rapid sorting of specimens by comparison with a standard sample. No special preparation of the specimens is necessary and both magnetic and non-magnetic materials may be used. Spot test frequencies in the range 50 to 10,000 c.p.s. are provided. Various experimental applications are discussed, including the sorting of annealed and unannealed steel bars.

620.179.16:534.321.9.001.8 1112

Ultrasonic Resonance Applied to Non-Destructive Testing—W. S. Erwin and G. M. Rassweiler. (*Rev. Sci. Instr.*, vol. 18, pp. 750-753; October, 1947.) Ultrasonic vibrations of continuously varying frequency are applied to the part under test, which is set into longitudinal vibration at its natural frequencies. The consequent reaction on the source is used to produce visible marks on a cathode-ray screen from which the thickness of the part may readily be deduced.

620.179.16:534.321.9.001.8 1113

Design of an Ultrasonic Analyzer—A. A. McK. and F. R. (*Electronics*, vol. 20, pp. 102-105; December, 1947.) Equipment for non-destructive inspection of metal strip and production testing of uniform parts comprises a noise generator, transmitter, piezoelectric transducers, and a recording receiver. Frequencies of 50, 440, 880, and 2000 kc. are used; the position of the flaw can be marked automatically.

621.316.74 1114

Proportioning Temperature Controller—D. Lazarus and A. W. Lawson. (*Rev. Sci. Instr.*, vol. 18, pp. 730-733; October, 1947.) "Unbalance voltage from a potentiometer is amplified by a simple circuit employing a 60-cycle polarized interrupter, and used to control the extent of the on-off cycle of a furnace."

621.319.339:621.386 1115

Discussion of the Practical Application of the Van de Graaff Electrostatic X-Ray Generator—D. T. O'Connor. (*ASTM Bull.*, pp. 57-61; October, 1947.) Some details of the technique used in 2-Mev. radiography of bombs, shells, etc. The greatest thickness of steel penetrated was 15 inches.

621.365.5 1116

High-Frequency Inductive Heating—E. C. Witsenburg. (*Tijdschr. ned. Radiogenoot.*, vol. 12, pp. 201-211; November, 1947. In Dutch, with English summary.) A simplified theoretical treatment of the energy transfer from the work coil to the work, and discussion of the efficiency of the process.

- 621.365.5:621.785.6:669.14 1117
The Surface Hardening of Steel by H.F. Induction Heating—G. Perronne. (*Rev. Gén. Élec.*, vol. 56, pp. 412-420; October, 1947.)
- 621.38.001.8 1118
Automatic Opinion Meter—R. P. Person and T. A. Rich. (*Electronics*, vol. 20, pp. 142, 168; December, 1947.) A general description of its operation, with photographs and diagrams; each unit can accommodate 120 people and measures their average opinion. Degree of opinion is expressed by operating individual dials which control potentiometers and switches in a self-balancing bridge. Allowance is made for no vote, yes, no, and 50-50 opinion. The final indicator is controlled by a thyratron circuit. See also 1533 of 1947.
- 621.384 1119
Electronic Techniques in Nuclear Science—S. A. Korff. (*Electronics*, vol. 20, pp. 81-87; December, 1947.) Description of basic electronic devices developed for accelerating particles and for observing the effects of fast-moving ions and electrons.
- 621.384.6 1120
Electrostatic Accelerator for Electrons—W. W. Buechner, R. J. Van de Graaff, A. Sperduto, L. R. McIntosh, and E. A. Burrill. (*Rev. Sci. Instr.*, vol. 18, pp. 754-766; October, 1947.) Description of the construction of a 2-mv. X-ray generator. It is enclosed in a steel tank in which the gaseous insulating medium is at 200 lb/inch² pressure. A modified form, using sulphur hexafluoride as the insulator, gave a potential of 5.6 mv.
The use of a small focal spot 0.01 inch in diameter and a target current of 300 microampere gave high definition and great penetration.
- 621.384.6:621.318.33 1121
Experiments on the Design of Synchrotron Magnets—W. C. Parkinson, G. M. Grover, and H. R. Crane. (*Rev. Sci. Instr.*, vol. 18, pp. 734-738; October, 1947.)
- 621.385.833 1122
A Corrector System in Electron Optics—F. Bertoin. (*Compt. Rend. Acad. Sci.* (Paris), vol. 225, pp. 801-803; November 3, 1947.) Aberrations due to lens ellipticity are corrected by the use of a system of electrodes, uniformly distributed round the axis and maintained at a potential which is calculable. See also 1521, 2202, and 2531 of 1947 and 214 of February.
- 621.385.833 1123
A Method of Calculating the Aberrations of Form of Electrostatic Lenses—F. Bertoin. (*Compt. Rend. Acad. Sci.* (Paris), vol. 225, pp. 863-865; November 10, 1947.)
- 621.385.833 1124
Fringing Flux Corrections for Magnetic Focusing Devices—N. G. Coggeshall. (*Jour. Appl. Phys.*, vol. 18, pp. 855-861; October, 1947.)
- 621.385.833 1125
Relation between [electron] Lens Defects and Image Sharpness—F. Bertoin. (*Ann. Radioélec.*, vol. 2, pp. 379-408; October, 1947.) A comprehensive theoretical discussion.
- 621.385.833 1126
The Optics of Three-Electrode Electron Guns—S. G. Ellis. (*Jour. Appl. Phys.*, vol. 18, pp. 879-890; October, 1947.) Analytical theory of a simplified electron gun. The electrodes are regarded as plane, and the variations of axial potential as linear.
- 621.385.833:537.291 1127
On the Determination of the Principal Elements of Electron Mirrors—Regenstreif. (*See* 1013.)
- 621.395.645.33:578.088.7 1128
Electro-Encephalograph Amplifier—E. J. Harris and P. O. Bishop. (*Wireless Eng.*, vol. 24, p. 375; December, 1947.) Comment on 680 of April (Johnston).
- 621.396.9:[531.714.7+621.395.61 1129
Shielding Principle provides Electronic Micrometer—(*Jour. Frank. Inst.*, vol. 244, pp. 309-311; October, 1947.) Description of a micrometer developed by M. L. Greenough of the National Bureau of Standards. The current induced in a secondary winding by current flowing in a primary circuit depends upon the variable distance of the secondary from a conducting plate. This principle is used in a micrometer which gives results where a capacitance type of micrometer cannot be used; it may also be applied in microphones, speed indicators, etc.
- 621.398:623.746.48]+623.419 1130
German Guided and Rocket Missiles—E. Burgess. (*Engineer* (London), vol. 184, pp. 308-310, 332-333, 356-358, 381-383, and 407-409; October 3-31, 1947.) Details of the construction of many different types, with some information concerning their control systems.
- 621.398:631.312 1131
Ploughing by Radio—S. P. Osborne and R. W. Dunn. (*Radio Craft*, vol. 19, pp. 20-21, 64; October, 1947.) Description of a radio-controlled tractor plough. The experimental model was developed by Tractors Ltd. in cooperation with the Ministry of Supply and the Royal Aircraft Establishment.
- PROPAGATION OF WAVES**
- 621.396.11 1132
On the Use of Chernikov's Effect for the Propagation of Radio Waves—V. L. Ginsburg. (*Compt. Rend. Acad. Sci.* (U.R.S.S.), vol. 56, pp. 253-254; April 21, 1947. In Russian.)
- 621.396.11:551.510.535 1133
On the Anisotropy Effect of the Ionosphere—Alpert. (*See* 1032.)
- 621.396.11:029.64 1134
Over-Water Refraction of 10-cm. Electromagnetic Radiation—R. B. Montgomery. (*Bull. Amer. Met. Soc.*, vol. 28, pp. 1-8; January, 1947.) An account of the factors affecting nearly horizontal propagation above a spherical earth, particularly, the refraction caused by atmospheric layers close to a water surface. A formula for the dependence of refractive index on atmospheric conditions is quoted, and typical data on the variation of these conditions with height are included.
- RECEPTION**
- 621.396.621 1135
Quality Superheterodyne—S. A. Knight. (*Wireless World*, vol. 53, pp. 472-476; December, 1947.) Detailed circuit and layout of a conventional receiver for medium and long wavelengths. Ease of construction and availability of components were considered in the design.
- 621.396.621 1136
Here's the All Plug-In Receiver—(*Tele-Tech*, vol. 6, p. 57; October, 1947.) An a.c./d.c. set of unit construction for a.m. Each circuit is "canned" for quick replacement.
- 621.396.621 1137
F.M. Receiver Alignment—I. Abend. (*Radio News*, vol. 38, pp. 66-67, 116; October, 1947.) The action of limiters and discriminators is explained sufficiently for successful alignment. In other respects, the procedure is similar to that for a.m. receivers.
- 621.396.621:621.396.619.11 1138
The Synchrodyne—D. G. Tucker. (*Electronic Eng.* (London), vol. 19, pp. 366-367; November, 1947.) Further notes on a receiver shown at Radiolympia (618 of March). Specifications are included for the coils used in the design of the receiver described in 525 and 526 of March. A correction to Fig. 5 of 526 is included.
For a description of the process of demodulation in the receiver see 2364 of 1947. See also 1139 below.
- 621.396.621:621.396.619.11 1139
The Synchrodyne—B. Starnecki, P. K. Chatterjea, D. M. Mackay, T. H. Turney, F. Aughtie, and D. G. Tucker. (*Electronic Eng.* (London), vol. 19, pp. 368-369; November, 1947.) Correspondence on 2364 of 1947 and 525 and 526 of March (Tucker). See also 3638 of 1947 and 1138 above.
- 621.396.621:621.396.619.11 1140
The Synchrodyne—(*Radio Franc.*, pp. 14-16; November, 1947.) A description based on Tucker's account (525 and 526 of March.)
- 621.396.621:621.396.681:621.385.1 1141
Tube Characteristics with 28-Volt Plate Supplies—(*See* 1207.)
- 621.396.621:621.396.96 1142
The Radar Receiver—L. W. Morrison, Jr. (*Bell Sys. Tech. Jour.*, vol. 26, pp. 693-817; October, 1947.) Factors influencing the design of a receiver are discussed firstly from a military aspect and secondly with regard to the character of its input and output signals. The basic scheme for the generalized receiver is described and the design of its various parts is considered in detail.
The requirements of the input circuit, i.f., and video frequency amplifiers are considered. A comparison of input circuit noise for crystal and electron tube converters is made and the construction of several types of each, with their associated beating oscillators, is discussed. The choice of bandwidth, gain, and midband frequency for the i.f. amplifier is considered and the design of input, interstage, and second detector circuits is described with typical examples. Considerations of frequency and amplitude range for the video amplifier determine the gain characteristic, d.c. restoration methods being used to reinsert the d.c. component of the received signal.
The electrical information obtained is displayed by the radar indicator. Types of radar displays are classified and details are given of some of the c.r. tubes and deflection systems used. A description is given of sweep waveform generation, including the hyperbolic sweep for true ground-plan presentation, and range-marker circuits of the liquid-tank and phase-shift types.
Typical automatic-frequency-control and automatic-gain-control circuit designs and i.v. and h.v. power supplies are described and illustrated.
- 621.396.621.53 1143
A 5-10 Converter for the R. 1155—G. Elliott. (*Short Wave Mag.*, vol. 5, pp. 107-111; April, 1947.) Circuit and construction details. A grounded-grid r.f. stage is used, coupled to an 80-ohm aerial feeder.
- 621.396.621.54+621.396.619 1144
Additive and Multiplicative Mixing—J. W. Whitehead. (*Wireless World*, vol. 53, pp. 486-487; December, 1947.) Comment on 235 of February (Mitchell). See also 1145 below.
- 621.396.621.54+621.396.619 1145
Heterodyning and Modulation—K. R. Sturley. (*Wireless World*, vol. 53, p. 488; December, 1947.) Comment on 235 of February. See also 1144 above.
- 621.396.81:621.396.96 1146
Signal Noise Ratio in Radar—M. Levy. (*Wireless Eng.*, vol. 24, pp. 349-352; December, 1947.) On a standard radar receiver display, weak pulses are detected as a rise in the mean level of the noise on the timebase. By using a limiter to prevent the spot deflection from exceeding a certain amount, a bright line is

formed whose brilliance increases when a pulse is present. It is shown statistically that the visibility of small pulses is thus appreciably increased.

621.396.82:621.396.619.13 1147
Interference Problems in Frequency Modulation—F. L. H. M. Stumpers. (*Philips Res. Rep.*, vol. 2, pp. 136–160; April, 1947.) "After a survey of definitions, the general problem of interference with frequency-modulated signals is treated. Special attention is paid to the pauses of the desired signal. The case of equal amplitudes gives rise to some interesting mathematical relations. The loudness level of disturbances is computed. In the last two sections, the interference caused by synchronized transmitters (or by two-path transmission of one signal) is extensively dealt with. Many numerical examples illustrate the theory." See also 2221 of 1947.

621.396.823 1148
Ignition Interference: Part 2—Methods of Suppression—W. Nethercot. (*Wireless World*, vol. 53, pp. 463–466; December, 1947.) Complete screening is effective but introduces special difficulties. Resistor suppression is easier and may give 40 to 50 db. reduction. "Concentrated" resistors of 5000 to 15,000 ohms are used between the coil and distributor and at the plugs. Resistance distributed along special cable is more effective but is not economical. Typical results for two cars are given in the frequency range 30 to 650 Mc. and the design of suppression components is discussed. Part 1: 253 of February.

STATIONS AND COMMUNICATION SYSTEMS

621.39:384 1149
The General Planning and Organization of Colonial Telecommunication Systems—C. Lawton and V. H. Winson. (*Jour. I.E.E.* (London), part III, vol. 94, pp. 245–251; July, 1947. Discussion, pp. 251–259.) Deals mainly with economic and personnel problems. Summary, *ibid.*, part I, vol. 94, pp. 379–380; August 1947. See also 1209 of 1947.

621.39:620.193.21 1150
The Development and Design of Colonial Telecommunication Systems and Plant—C. Lawton and V. H. Winson. (*Jour. I.E.E.* (London), part III, vol. 94, pp. 229–244; July, 1947. Discussion, pp. 251–259.) Discussion of the design of plant and components for the tropics. Summary, *ibid.*, part I, vol. 94, pp. 380–381; August, 1947. See also 1209 of 1947.

621.391.63:621.317.75 1151
The Modulation of a Beam of Light by a Sector Wheel and a Method of Testing the Waveform—D. T. R. Dighton, H. M. Ross, and A. L. Shuffrey. (*Jour. Sci. Instr.*, vol. 24, pp. 202–205; August, 1947.)

621.395.44 1152
F.M. Short Range Carrier System—E. H. B. Bartelink and E. Daskam. (*Electronics*, vol. 20, pp. 112–117; December, 1947.) A simple system for open-wire lines 20 to 30 miles long operates in the range 100 to 400 kc. Wide-band f.m. and limiting are used to minimize audio gain variations due to climatic changes.

621.395.44 1153
Carrier and Pilot Current Terminal Equipment for the Secondary Groups of the 60-Channel Paris-Vierzon Coaxial Cable—P. Moll. (*Cables and Trans.* (Paris), vol. 1, pp. 227–243; October, 1947. With English summary.) A detailed description, with block and circuit diagrams, of equipment developed in the laboratories of the French P.T.T. and tested on the Paris-Vierzon cable; it will be used later for the Paris-Toulouse service. All the frequencies used are multiples of 4 kc. and derived from an oscillator of very high stability. Two pilot fre-

quencies of 300 kc. and 304 kc. respectively are transmitted; their difference frequency is used for direct control of local oscillators.

621.396.1 1154
Atlantic City Conference—(R.S.G.B. Bull., vol. 23, pp. 93–94; November, 1947.) Amateur frequency bands assigned at the Atlantic City Conference. The three regions into which the world is divided are defined and the services to which each band is allocated are listed.

621.396.1 1155
New Frequency Allocations Set—(Tele-Tech, vol. 6, pp. 29–30; October, 1947.) Frequency allocations for the Western hemisphere agreed at the international conference at Atlantic City in May, 1947, are tabulated and discussed briefly.

621.396.1 1156
International Frequency Allocations—(Wireless World, vol. 53, p. 439; November, 1947.) A brief summary of frequency allocations affecting the "European" Region as decided at the International Telecommunications Conference at Atlantic City.

621.396.5 1157
Radio Telephone Terminals—H. Jefferson. (*Marconi Rev.*, vol. 10, pp. 91–101; July–September, 1947.) The essential requirements for long distance v.h.f. R/T terminals are discussed and the merits of hybrid transformers and anti-surge devices are examined in detail. Practical systems in use are described and compared. The various methods of obtaining privacy in R/T systems are also briefly outlined. See also "Terminal Equipments," by F. M. G. Murphy, *Marconi Rev.*, vol. 4, pp. 20–29 and 1–10; May–August, 1934.

621.396.5 1158
Modern Single-Sideband Apparatus of the Dutch P.T.T.—C. T. F. van der Wyck. (*Tijdschr. ned Radiogenoot.*, vol. 12, pp. 127–149; July, 1947. Discussion, pp. 150–151. In Dutch, with English summary.) A short description of early equipment is followed by discussion of the principles and advantages of the equipment now used. Frequency correction is discussed theoretically and practically; the conditions for a stable correction circuit are derived. See also 2118 of 1938 (Koomans).

621.396.61/.62 1159
Adapting the TBY-7 for Amateur Use—W. B. Ford. (*Radio News*, vol. 38, pp. 39–41, 201; October, 1947.) Details of the easy modifications necessary to adapt this war-surplus portable transmitter-receiver unit for amateur use on 28 and 50 Mc.

621.396.619.11/.13 1160
Comparison of A.M. and F.M.—M. G. Scroggie and I. F. Macdiarmid. (*Wireless Eng.*, vol. 24, pp. 374–375; December, 1947.) Comment on 3660 of 1947 (Nicholson). It is emphasized that both systems must be considered on their merits for any particular application. Tests have shown that when a f.m. receiver is on tune there is little to choose between it and a similar a.m. receiver with a series-shunt limiter. See also 4030 of January (Bell) and 543 of March (McKenzie).

621.396.619.16 1161
Coded Pulse Modulation Minimizes Noise—F. R. (*Electronics*, vol. 20, pp. 126–131; December, 1947.) Microwave signals are transmitted as a series of identical, but differently spaced pulses. To regenerate the signal, the repeater transmits a locally generated pulse whenever it receives a noisy pulse, but remains inactive otherwise. The sampling and quantizing methods whereby voice signals are converted into pulse codes are described. A novel c.r. coder tube is used; full details are given. See also 818 of April and back references.

621.396.65.029.64:621.316.726.029.64 1162
Simplified Microwave A.F.C.: Part 2—Jenks. (See 1196.)

621.396.931 1163
New Police Radio—(Wireless World, vol. 53, pp. 457–459; December, 1947.) A two-station a.m. diversity system with radio-link control, used to cover Hertfordshire. A 10-watt 144.3-Mc. transmitter at headquarters controls and modulates two 100-watt transmitters located at opposite sides of the county. They have a frequency separation of 10 kc. centered about 80 Mc. and the mobile receivers have a bandwidth of 40 kc., with the audio response limited to 5 kc. The return 98.5-Mc. link from the cars remotely controls a low-power transmitter at each of the two stations, which communicate with headquarters on frequencies of 154.3 and 154.8 Mc. respectively, the outputs from the two receivers at headquarters being combined. 50-microsecond delay networks are used at the nearer station to compensate approximately for the path difference.

621.396.931 1164
Portable Inductive Radiophone—W. R. Triem. (*Electronics*, vol. 20, pp. 93–95; December, 1947.) A general account of f.m. equipment for 80 and 144 kc. Train-to-train communication up to 2 miles is possible; train-to-station communication up to 20 miles. Output to the loop aerial is 2 and one half watts.

621.396.931 1165
Mobile Radiophone for Taxicabs Proves Its Worth—(Tele-Tech, vol. 6, pp. 52–54; October, 1947.) A description of a low-power f.m. system operating in the 152-Mc. band. The phase-deviation principle is used for generating the f.m. carrier. The receivers use the Foster-Seeley discriminator circuit preceded by a double limiter; the sets are designed for ± 20 kc. deviation and an a.f. range from 350 to 5000 c.p.s. within ± 2.5 db.

621.396.933+621.396.663 1166
New Radio Compasses—(See 1036.)

SUBSIDIARY APPARATUS

621.313.3:621.396.931 1167
A.c. Automotive Generator System for High Output—(Tele-Tech, vol. 6, pp. 55–56, 93; October, 1947.) The elements of the system are a generator producing a.c. instead of d.c., a dry-disk rectifier which converts the a.c. to the d.c. normally used in vehicles, and a voltage regulator unit.

621.314.5 1168
Vibrator for Conversion of D.C. to A.C.—(Jour. Sci. Instr., vol. 24, p. 306; November, 1947.) A nonsynchronous type having contact springs tuned to 3 times the frequency of the reed. The effect is to eliminate chatter and increase contact pressure. A time efficiency (ratio of on-contact to total time) of 90 per cent is claimed.

621.316.722.1:621.316.86 1169
The Use of Non-Linear Resistors for Voltage Correction—G. T. Baker. (*Strouger Jour.*, vol. 6, pp. 73–78; May, 1947.) "Outlines the mathematical theory of the application of carbonundum-ceramic resistors for voltage correction purposes, and analyzes the operational characteristics of various circuits embodying them when subjected to small fluctuations upon a steady voltage."

621.316.722.1:621.396.712:384 1170
Voltage Regulation in Broadcast Stations—L. L. Heltelrine, Jr. (*Communications*, vol. 27, pp. 12–13, 37; November, 1947.) Various applications are discussed briefly, with emphasis on reduction of operating expenses.

621.352.3 1171
Recent Progress in the Study and the Manufacture of Electric Cells—G. Génin. (*Rev.*

Gén. Élec., vol. 56, pp. 421-425; October, 1947.) A review of war-time improvements in cells of the Leclanché type, resulting in satisfactory operation at temperatures from -40°C . to $+55^{\circ}\text{C}$.

621.396.614 1172
High Frequency Inductor Alternators—A. W. Ford. (*G. E. C. Jour.*, vol. 14, pp. 190-200; August, 1947.) Simple analytical theory with vector diagrams. The cases of flux swinging and flux pulsating in both homopolar and heteropolar types are considered. The effect of second harmonic is also discussed.

621.396.68:621.314.222 1173
The Theory and Practice of Constant Voltage Transformers for Radio Power Supplies: Part 2—R. H. Burdick. (*Marconi Rev.*, vol. 10, pp. 102-126; July-September, 1947.) Conclusion of 282 of February. The applications of these transformers to voltage stabilization for rectifier circuits, control of tube filament voltages and filament starting are outlined and the performance of series and parallel types of transformer is discussed. Filament starting and heating are examined in detail.

The principles outlined in part 1 may be used for frequencies up to 500 c.p.s. The effect of stray magnetic fields and their suppression is considered. Dimensions, costs, operating life of equipment, and possible groupings of transformers are discussed briefly.

621.396.68:621.397.6 1174
Modern Methods of Obtaining the Very High Voltage in Television Receivers—(See 1182.)

621.396.68:621.397.6 1175
H.F. Source of High Voltage—Besson. (See 1183.)

621.396.69:621.315 1176
F.M. and TV Transmission Line Installation Problems: Part 1—J. S. Brown. (*Communications*, vol. 27, pp. 8-11, 39; November, 1947.) Discussion of special gas barriers, inner conductors and line supports, elbows, mounting fittings, clamp connectors, flanges, reducers, pressure controls, isolators, etc. To be continued.

621-526 1177
Servo Mechanism Fundamentals [Book Review]—Lauer, Lesnick, and Matson. McGraw-Hill, London, 277 pp., 17s 6d. (*Elec. Rev.* (London), vol. 141, p. 802; November 28, 1947.) A textbook "written from the viewpoint of the engineer engaged upon the design of low-power remote-position-control servomechanisms."

TELEVISION AND PHOTO-TELEGRAPHY

621.397(73) 1178
Facsimile—(*Wireless World*, vol. 53, p. 419; November, 1947.) Summary of paper noted in 289 of February (Sleeper).

621.397.5:535.317.25 1179
Television Resolution Chart—(*Electronics*, vol. 20, pp. 123-125; December, 1947.) Prepared by the Committee on Television Transmitters of the Radio Manufacturers' Association. The chart is designed for standardizing resolution measurements; the basis of its construction and the procedure for using it are explained.

621.397.5:621.396.67 1180
All-Wave Television F.M. Antenna—(*Radio News*, vol. 38, pp. 49, 199; October, 1947.) A short, thick 128-Mc. $\lambda/2$ dipole is connected by inductive rings to the midpoints of a long, thin 65-Mc. $\lambda/2$ dipole. The standing-wave ratio along a 300-ohm transmission line terminated by the aerial is less than 4 to 1 in the 65-Mc. band, and less than 2.8 to 1 in the 128-Mc. band.

621.397.6 1181
Deflector Coil Efficiency—W. T. Cocking. (*Wireless World*, vol. 53, pp. 460-462; December, 1947.) The power required for the magnetic deflection of a c.r. tube is deduced from first principles, assuming an ideal deflector system. A practical case is considered of a 9-inch television tube and deflector having an efficiency of 10.7 per cent relative to the ideal. The reasons for this poor efficiency are analyzed. 66.5 per cent of the power is wasted in the end field of the coils and 13.5 per cent in the external field. See also 573 of March (Schlesinger).

621.397.6:621.396.68 1182
Modern Methods of Obtaining the Very High Voltage in Television Receivers—(*Radio Franç.*, pp. 20-23; October, 1947.) The high cost of satisfactory 50-c.p.s. equipment and its relatively large space requirements have led to the adoption of two other methods (a) the use of a high frequency, developed in a selfoscillator giving the necessary h.t. powers, (b) the use of the energy developed in the fly-back of the c.r. tube sweep circuit. Suitable circuit arrangements for each of these methods are described.

621.397.6:621.396.68 1183
H.F. Source of High Voltage—R. Besson. (*Toute la Radio*, vol. 14, pp. 325-326; November, 1947.) A 6V6 tube, with 300-volt anode voltage, is used as an oscillator on a frequency of about 200 kc. The anode circuit is coupled to a specially wound and insulated coil, the voltage across which is rectified by a tube with good cathode-anode insulation. Voltages of 10 to 12 kv. are easily obtained.

621.397.6:628.972 1184
Television Studio Lighting—W. C. Eddy. (*Jour. Soc. Mot. Pic. Eng.*, vol. 49, pp. 334-341; October, 1947.) Description of a lighting system carried on an overhead network and remotely controlled by one engineer. The lighting intensity may be reduced without spoiling the contrast.

621.397.62 1185
Television at Radiolympia—(*Electronic Eng.* (London), vol. 19, pp. 348-351; November, 1947.) Brief details of various receivers exhibited. See also 618 of March.

621.397.62 1186
Television Receiver Construction: Parts 9 and 10—(*Wireless World*, vol. 53, pp. 420-422 and 481-482; November and December, 1947.) Part 9: power unit; some general notes. Part 10: operating notes and conclusion. For previous parts see 304 of February and back references. Correction, *ibid.*, vol. 54, p. 19; January, 1948.

621.397.62 1187
Television Receiver Design—R. Panton, G. W. Edwards, and G. B. Townsend. (*G.E.C. Jour.*, vol. 14, pp. 200-214; August, 1947.) A general discussion, with special reference to a new table-model television and radio receiver, the main points of which are: (a) effective video response up to 2.8 Mc., (b) picture size 8 inches \times 6 and three-eighths inches, (c) effective audio response 50 c.p.s. to 9000 c.p.s., (d) average sensitivity 4 microvolt (for 50 milliwatt output at 30 per cent modulation), and (e) power consumption 100 to 220 watts.

621.397.62 1188
TV Intercarrier Sound System—L. W. Parker. (*Tele-Tech*, vol. 6, pp. 26-28, 97; October, 1947.) A new television system in which the separation of the picture and sound channels does not take place until the last tube in the vision receiver. The f.m. sound signal is heterodyned with the a.m. vision carrier giving a difference frequency of 4.5 Mc., which is used to convey all the sound intelligence. A suitable arrangement of filters allows the 4.5-Mc. signal to pass to the f.m. discriminator and prevents it from reaching the c.r. tube.

621.397.62 1189
Study of the Detection and Video-Frequency Amplification Stages for 455-Line Television Receivers—J. Barthou. (*Télev. Franç.*, pp. 15-18; October, 1947.) Continuation of 4058 of January. Deals with (a) the use of triodes, (b) the cathodyne (cathode follower), and (c) the working conditions of video amplifiers, with special consideration of stray capacitances, their measurement and correction.

621.397.62 1190
My First Television Receiver—M. Fulbert. (*Télev. Franç.*, pp. 19-27, 30; October, 1947.) A description, with complete circuit and construction details, of a receiver using as few tubes as possible and a relatively low working voltage, but giving good performance.

621.397.62:389.6 1191
Proposed Standards for Television Receivers—M. Chauvierre. (*Radio Franç.*, pp. 24-27; October, 1947.) Proposals made by the television commission of the technical group of the French radio industry (G.T.I.R.). Receivers are assumed to be connected to an aerial by coaxial cable of characteristic impedance 75 ohms. Definitions of sensitivity, distortion stability, etc., are given and discussed, and tentative minimum values of these quantities are suggested for first- and second-grade receivers.

621.397.62:621.385.832 1192
The Choice of the Cathode Ray Tube—L. Chrétien. (*Toute la Radio*, vol. 14, pp. 321-324; November, 1947.) Discussion of the physics and the relative merits of electrostatic and electromotive deflection methods. It is concluded that electromotive deflection is particularly suitable for television receivers.

621.397.62:621.396.621.53.029.62 1193
Frequency Changing on Metre Waves in Television Receivers—P. Roques. (*T.S.F. Pour Tous*, vol. 23, pp. 235-238; November, 1947.) A discussion of the various problems involved, with suggested circuits for improved performance and a complete scheme for the frequency-changer stage, with perfect separation of the image and sound channels.

621.397.645 1194
Low-Frequency Correction of Video Amplifiers—R. Charbonnier and S. Royer. (*Télev. Franç.*, pp. 33-36; October, 1947.) Two correction systems are described and their advantages are discussed. Applications to pulse technique, c.r. oscillography, and electrocardiography are mentioned.

621.397.5 1195
Television Today [Book Review]—R. H. Norris. Rockliff Publishing Corporation, 244 pp., 21 s. (*Electronic Eng.* (London), vol. 19, p. 405; December, 1947.) "The book will undoubtedly appeal most to the person who already has some knowledge of radio or television, and who wishes to bring himself up to date."

TRANSMISSION

621.316.726.029.64:621.396.65.029.64 1196
Simplified Microwave A.F.C.: Part 2—F. A. Jenks. (*Electronics*, vol. 20, pp. 132-136; December, 1947.) Construction of a complete automatic-frequency-control unit having six channels, 30 Mc. apart near 3000 Mc., with emphasis on the physical characteristics of the circuit components. Resonators using invar, nilvar, or Cu and Mo are described. Si-rectifier modulation, loudspeaker-diaphragm sensing modulation, and methods of cavity tuning are considered. Part 1: 847 of April.

621.396.1 1197
Sidebands Again—"Cathode Ray." (*Wireless World*, vol. 53, pp. 468-471; December, 1947.) Explains why a modulated wave must have more than one frequency. See also 4026 of January.

621.396.61.029.62 1198
10-Meter Mobile F.M. Transmitter—R. Frank. (*Radio News*, vol. 38, pp. 44–45, 130; October, 1947.) Construction details.

621.396.61.029.62 1199
A 600-watt Phone Transmitter—R. P. Turner. (*Radio News*, vol. 38, pp. 61–63, 146; October, 1947.) Description of a series cathode modulated transmitter giving 360 to 390 watt modulated carrier-output power on the 10-, 11-, 20-, 40-, and 80-meter amateur bands.

VACUUM TUBES AND THERMIONICS

621.383.4:621.395.625.6 1200
Lead-Sulfide Photoconductive Cells for Sound Reproduction—R. J. Cashman. (*Jour. Soc. Mot. Pic. Eng.*, vol. 49, pp. 342–346; October, 1947. Discussion, pp. 346–348.) The spectral response is from 0.6 μ to 3.6 μ . The high infrared response enables an indirectly heated low-temperature exciter lamp to be used, with heating from an a.c. mains transformer. The frequency response drops 7 db from 30 to 10,000 c.p.s. The cell has a lower impedance and a higher signal-to-noise ratio than a Ca_2O cell and the noise level is not increased by background illumination.

621.383.42 1201
Additivity of the Effects of the Luminous Flux Striking the Different Regions of a Selenium Photocell—J. Terrien and C. Anglade. (*Compt. Rend. Acad. Sci. (Paris)*, vol. 225, pp. 729–731; October 27, 1947.)

621.383.5 1202
Barrier-Layer Photocells—J. Ortusi. (*Ann. Radioelec.*, vol. 2, pp. 359–378; October, 1947.) A review of the construction and properties of such cells, with a discussion of the various theories advanced to explain their action. It is shown that the principal characteristics can be explained by assuming the existence of a barrier layer between metal and semiconductor and by the use of an equivalent circuit. The quantum theory would appear to offer the best explanation of the observed effects. Abstracts are included of 51 relevant papers.

621.385+621.396.694 1203
New "All-Stage" Valve—(*Wireless World*, vol. 53, pp. 483–484; December, 1947.) Sargrove-Tunggram UA55 is a combination of two beam tetrodes symmetrically arranged on either side of a common cathode. By means of suitable connections and operating potentials, the tube can become (a) a high-impedance twin-beam tetrode, (b) a variable- μ tube, (c) a triode oscillator/tetrode mixer, (d) a power amplifier, and (e) a power rectifier. Operating conditions and characteristics are given. A special nonstandard 9-pin base is used. The tube is designed to reduce manufacturing costs of receivers made under the E.C.M.E. system described by Sargrove (1913 of 1947).

621.385.1+621.396.69 1204
Miniaturization—Adam. (See 1002.)

621.385.1 1205
Valve with Trochoidal Electronic Motion—H. Alfvén and H. Romanus. (*Nature*, (London) vol. 160, pp. 614–615; November, 1947.) In the presence of a uniform magnetic field, electrons describe circular paths; the addition of an electrostatic field, perpendicular to the magnetic field, causes these orbits to drift along the direction of equipotential lines, the actual paths of the electrons being trochoidal. The type of tube considered has a number of anodes, connected together electrically but separated mechanically by screens which are individually connected through resistances to a h.v. supply. When a beam of electrons impinges on a screen, it lowers its potential; this causes an equipotential line from the cathode to terminate in the compartment comprised by the anode and the screen, so that the beam remains trapped in that compartment. Application of negative

pulses to the anodes causes the beam to pass from compartment to compartment. Therefore, the complete tube can act as a counter, or as a selector switch. For the latter purpose, compartments can be stacked in two dimensions, the selecting pulses being applied in turn to two sets of anodes.

621.385.1 1206
Microtubes—H. Gernsback. (*Radio Craft*, vol. 19, pp. 17, 91; November, 1947.) A comment on the possibilities of a new subminiature tube announced by the National Bureau of Standards; it is still in the development stage. Its size is comparable to a rice grain, yet it has an expected life of 15,000 to 20,000 hours. See also 866 of April.

621.385.1:621.396.621:621.396.681 1207
Tube Characteristics with 28-Volt Plate Supplies—(*Electronics*, vol. 20, pp. 190, 194; December, 1947.) Summary of 3261 of 1947 (Terlecki and Whitehead).

621.385.1.032.213:621.314.65 1208
Hot-Cathode Mercury-Vapour Valves—R. Suart. (*Radio Franç.*, pp. 19–24; November, 1947.) A review of the principles of operation and an account of construction technique and physical characteristics. Technical details are given of three tubes, VH550, VH7400, and VH8500, which will handle maximum rectified powers of 7.2, 36 and 144 kw. respectively.

621.385.1.032.216:621.396.619.23 1209
High-Vacuum Oxide-Cathode Pulse Modulator Tubes—C. E. Fay. (*Bell Sys. Tech. Jour.*, vol. 26, pp. 818–836; October, 1947.) Discussion of the requirements of pulse modulator tubes and the choice of parameters to meet them. A range of tubes developed to operate at pulse voltages up to 25 kv. and currents up to 18 amperes is described. The chief problems encountered were sparking, cathode emission, and primary grid emission.

621.385.3/.5:621.317.336.1 1210
The Measurement of Dynamic Mutual Conductance of Valves using the Grounded-Triode Mode of Operation—E. F. Good, H. W. Lamson, and F. Gutmann. (*Jour. Sci. Instr.*, vol. 24, pp. 303–304; November, 1947.) Discussion on 3576 of 1947 (Gutmann) and the author's reply.

621.385.4 1211
A New Double Electrometer Valve—G. C. Little. (*Electronic Eng.* (London), vol. 19, p. 365; November, 1947.) An indirectly heated tetrode in which the effects due to fluctuations in the battery-supply potentials and in tube emission are reduced considerably.

The tube has a stability of 2.5 mv. per 1 per cent change in heater current, a figure which may be lowered to 0.1 mv. by using a DuBridge Brown circuit. A high degree of stability is retained over a wide range of input signal, making the tube particularly suitable for input stages in d.c. amplifiers.

621.385.832:535.37 1212
The Application of Chemically Unstable Phosphors to Cathode Ray Tubes—R. B. Head. (*Electronic Eng.* (London), vol. 19, pp. 363–364; November, 1947.) A method is described whereby certain phosphors which are easily spoiled by contact with a moist atmosphere, may be applied to a c.r. tube in a very short time.

The tube is completed up to the sealing-on stage and then a binder consisting of a fog of phosphoric acid droplets is admitted and allowed to settle. The surplus is blown out and the phosphor introduced as a fine powder. All the powder except a single-crystal layer may be removed by vibration and the tube is then ready for sealing on to the pumping system.

621.396.822:519.271 1213
On the Distribution of the Number of Large Deviations in Electric Fluctuations—V. I.

Bunimovich and M. A. Leontovich. (*Compt. Rend. Acad. Sci. (U.R.S.S.)*, vol. 53, pp. 21–23; July 10, 1946. In English.) See also 1219 above.

MISCELLANEOUS

001.92:5 1214
Publication and Classification of Scientific Knowledge—(*Nature* (London), vol. 160, pp. 649–650; November 8, 1947.) Report of a conference organized by the Cambridge Branch of the Association of Scientific Workers. The main problem is to enable scientific workers to get to know of work that interests them. A national distributing agency was suggested which, in return for a subscription, would supply say 1000 papers a year, plus abstracts of a given field or fields. The relative merits of reproduction by reprinting and by microfilm were considered, and various methods of classification discussed. The need for rationalization was indicated by the fact that some 750,000 original papers appear annually in 15,000 periodicals and about one-third of them are abstracted.

026:5 1215
French Scientific Library in London—(*Nature* (London), vol. 160, p. 669; November 15, 1947.) Both books and periodicals can be borrowed by post from the Librarian, Scientific Library, Institut Français du Royaume-Uni, Queensberry Place, South Kensington, London, S.W.7. All library services are free. Microfilms of articles can also be obtained by the Library from France.

06.064 London:621.396 1216
[Olympia] Show Review—(*Wireless World*, vol. 53, pp. 423–438; November, 1947.) For other accounts see 618 of March.

621.396(47) 1217
Survey of Russian Radio, 1917–1947—(*Radiotekhnika* (Moscow), vol. 2, pp. 1–64; November and December, 1947. In Russian.) A series of papers by various authors.

621.396.67 1218
Who Invented the Aerial?—L. Solari. (*Wireless World*, vol. 53, p. 487; December, 1947.) Comment on 4100 of January. See also 1219 below.

621.396.67 1219
The "Elevated Electrode"—(*Wireless World* vol. 53, p. 453; December, 1947.) A letter from Popov published in the *Electrician* of December 10, 1897, does not conflict with the view that the invention of the aerial may be correctly ascribed to Marconi. See also 4100 of January and 1218 above.

016:[621.38/39 1220
Electronic Engineering Master Index—1946 [Book Review]—F. A. Petraglia (Editor). Electronics Research Publishing Co., New York, 202 pp., \$17.50. (*Gen. Elec. Rev.*, vol. 50, p. 57; November, 1947.) First annual supplement to the index noted in 2108 and 3155 of 1946, covering the period July, 1945, to December, 1946. See also *Wireless Eng.*, vol. 24, p. 373; December, 1947.

621.38/39 1221
Electronic Engineering Patent Index—1946 [Book Review]—Electronics Research Publishing Co., New York, 1947, 476 pp., \$14.50. (*Tele-Tech*, vol. 6, p. 93; September, 1947.) A compilation of about 2000 patents issued in the United States during 1946. The first of a proposed annual series.

621.396 1222
Fundamentals of Radio [Book Review]—W. L. Everitt (Ed.). Constable, London, 400 pp., 27 s. 6d. (*Wireless Eng.*, vol. 24, p. 343; November, 1947.) Starts "almost at rock-bottom." The claim to have "covered each topic in such a way as to make clear the functioning of a complete radio system" may broadly be conceded, but to reach an engineering standard in radio, a rather more solid foundation of mathematics and electricity would be necessary.

Announcing A NEW LINE OF SPRAGUE ELECTROLYTIC CAPACITORS



**For operation up
to 450 volts at 85° C.**

With some 7 times as many components in a television receiver as in the average radio, the possibility of service calls is greatly increased. The new SPRAGUE ELECTROLYTIC line offers the first practical solution to this problem.

Designed for dependable operation up to 450 volts at 85° C. these new units are ideally suited for television's severest electrolytic assignments. Every care has been taken to make these new capacitors the finest electrolytics available today. Stable operation is assured even after extended shelf life, because of a new processing technique developed by Sprague research and development engineers, and involving new and substantially increased manufacturing facilities. More than ever before your judgment is confirmed when you **SPECIFY SPRAGUE ELECTROLYTICS FOR TELEVISION AND ALL OTHER EXACTING ELECTROLYTIC APPLICATIONS!** Sprague Electric Company invites your inquiry concerning these new units.

SPRAGUE ELECTRIC COMPANY • NORTH ADAMS, MASS.

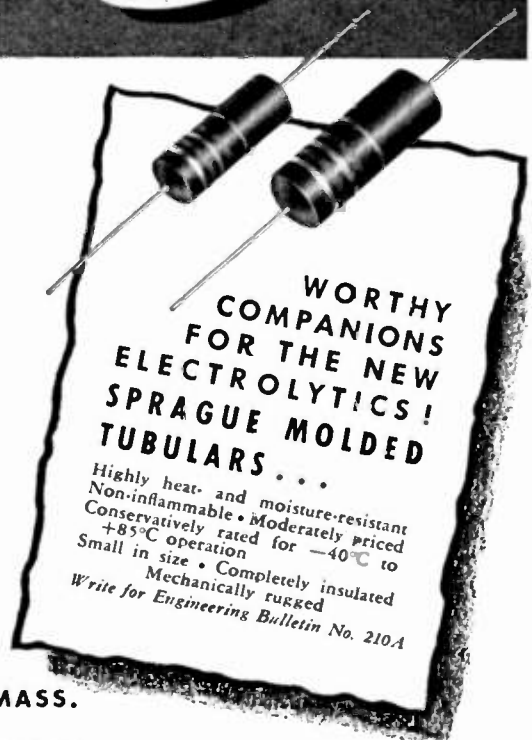

SPRAGUE

Capacitors
* Koolohm Resistors

PIONEERS OF

ELECTRIC AND ELECTRONIC PROGRESS

©Trademarks reg. U. S. Pat. Office

PROCEEDINGS OF THE I.R.E. May, 1948

33A

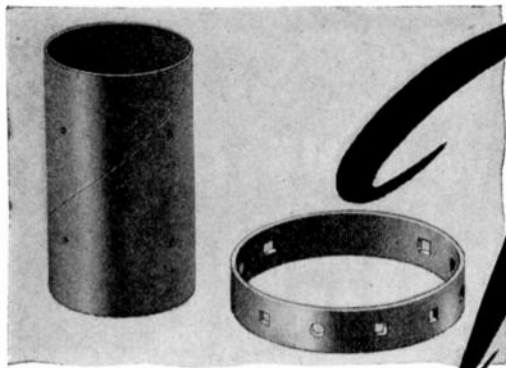

**COSMALITE*
TUBES FOR**

Television
DEFLECTION YOKES

These spirally laminated paper base, Phenolic Tubes are obtainable in sizes and with punching and notching that meet each customer's individual needs.

Quality performance at prices that appeal.

OTHER COSMALITE TYPES INCLUDE . . .

#96 Cosmalite for coil forms in all standard broadcast receiving sets.

SLF Cosmalite for Permeability Tuners.

Spirally wound kraft and fish paper Coil Forms and Condenser Tubes.

Partial List of Radio & Television Receivers in which COSMALITE is used:

Stewart Warner	Howard
Motorola	Belmont
Zenith	Admiral
Farnsworth	Sentinel
Magnavox	Wells Gardner
Bendix Radio	Warwick

Inquiries given specialized attention

*Trade Mark Registered

The **CLEVELAND CONTAINER Co.**

6201 BARBERTON AVE. CLEVELAND 2, OHIO
 • All-Fibre Cans • Combination Metal and Paper Cans
 • Spirally Wound Tubes and Cores for all Purposes
 • Plastic and Combination Paper and Plastic Items

PRODUCTION PLANTS also at Plymouth, Wisc., Ogdensburg, N.Y., Chicago, Ill., Detroit, Mich., Jamesburg, N.J.
 PLASTICS DIVISION at Plymouth, Wisc. • ABRASIVE DIVISION at Cleveland, Ohio
 SALES OFFICES: Room 5832, Grand Central Term. Bldg., New York 17, N.Y., also 647 Main St., Hartford, Conn.
 CANADIAN PLANT: The Cleveland Container Canada, Ltd., Prescott, Ontario



ATLANTA

"The A.C. Network Calculator," by H. P. Peters, Georgia School of Technology; February 27, 1948.

BALTIMORE

"Some Types of Television Interference," by E. W. Chapin and F. D. Craig, Federal Communications Commission; January 27, 1948.

"General Mobile Telephone System," by C. L. Garrett and S. C. Miller, Chesapeake and Potomac Telephone Company; February 24, 1948.

BEAUMONT-PORT ARTHUR

"Frequency Control Methods for F.M. Transmitters," by A. D. Massey, Westinghouse Electric Corporation; January 13, 1948.

"Nucleonics and its Applications," by J. H. Stewart, Industrial Radiography Laboratories; February 18, 1948.

BOSTON

"The Possibilities for Transatlantic F.M.," by L. B. Argulmbau, Massachusetts Institute of Technology; February 26, 1948.

CHICAGO

"Television from Transmitter to Receiver," by H. F. Hafker, D. R. Yoder, H. E. Lawrence, and R. Hansen, Radio Corporation of America; February 20, 1948.

CLEVELAND

"New Developments in Subminiature Tubes," by W. R. Jones, Sylvania Electric Products Inc.; February 19, 1948.

CONNECTICUT VALLEY

"Television," by R. F. Foster, General Electric Company; February 26, 1948.

DAYTON

"The Baldwin Electronic Organ," by J. F. Jordan and P. Mooter, Baldwin Company; February 26, 1948.

DETROIT

"Operating Problems in Television Broadcasting," by L. Spragg, Radio Station WVJ; January 16, 1948.

"Power Line Carrier," by H. W. Lensner, Westinghouse Electric Corporation; February 20, 1948.

LOS ANGELES

"A New Magnetic Tape Recorder With Performance Characteristics To Match F.M. Broadcast Requirements," by H. Lindsay and M. J. Stolaroff, Ampex Electric Corporation; February 17, 1948.

"The Present Status Of High Quality Wire Recording," by R. G. Leitner, Lear, Inc.; February 17, 1948.

"Teleran—Air Navigation and Traffic Control by Means of Television and Radar," by R. W. K. Smith, Radio Corporation of America; February 17, 1948.

LOUISVILLE

"Dielectric Heating," by P. L. Wilson, The Girdler Corporation; February 20, 1948.

MONTREAL

"Reproduction of Sound," by H. F. Olson, RCA Laboratories Division; February 25, 1948.

"Planning, Building, and Operating Canada's International Shortwave Broadcasting Service," by G. W. Olive, J. E. Hayes, D. G. McKinstry, W. A. Nichols, and R. D. Cahoon, Canadian Broadcasting Corporation; March 11, 1948.

NEW YORK

All-Day Symposium on "The Design and Use of Television Receivers," Morning Session Moderator: Arthur Loughren, Hazeltine Electronics Corp.

(Continued on Page 36A)

Get the facts on Western's miniatures!



Western Electric is now offering a group of miniature tubes, including 2 twin triodes and 6 pentodes. They were developed by Bell Telephone Laboratories... are manufactured by Western Electric to the high standards of quality for which

all Western Electric tubes are noted. Data sheets on all these miniatures are available for your design files. Send the coupon for sheets on the types you are interested in—or call your Graybar Representative for full information.

CODE	TYPE	HEATER VOLTAGE	HEATER CURRENT IN MILLIAMPERES	MAX. PLATE VOLTAGE
6AS6	Pentode	6.3	175	180
6AK5	Pentode	6.3	175	180
6AJ5	Pentode	6.3	175	180
5590	Pentode	6.3	150	180
5591	Pentode	6.3	150	180
408A	Pentode	20	50	180
2C51	Twin Triode	6.3	300	300
407A	Twin Triode	20 (parallel) 40 (series)	100 (parallel) 50 (series)	300



DISTRIBUTORS: IN THE U.S.A.—Graybar Electric Company. IN CANADA AND NEWFOUNDLAND—Northern Electric Company, Ltd.

Graybar Electric Company
420 Lexington Ave., New York 17, N. Y.

Please send me data sheets on the tubes circled:

6AS6 6AJ5 5591 2C51
6AK5 5590 408A 407A

Name _____

Company _____

Address _____

City _____ State _____

Western Electric

— QUALITY COUNTS —

For the first time



(Actual Size)

1mc.

... a stable crystal unit in a miniature holder manufactured to tolerance of 0.005% over an extreme range of -55°C to $+90^{\circ}\text{C}$. The new RH-7B crystal exhibits 50% to 80% less frequency shift with a given change in oscillator input capacity. Hermetically sealed, the RH-7B produces high activity (series resistance less than 400 ohms) and meets Army and Navy specifications.

For detailed specifications write for bulletin RHC-X.

REEVES  HOFFMAN CORPORATION
 CHERRY AND NORTH STREETS • CARLISLE, PA.



(Continued from page 34A)

oration; Afternoon Session Moderator: Murray Crosby, Paul Godley Company; February 28, 1948.

"Television Receiving Antennas," by A. Alford, Consultant.

"Television Antenna and R.F. Distribution Systems for Apartment Houses," by H. E. Kallmann, Consultant.

"Automatic Frequency Control of Television Sweep Circuits," by E. L. Clark, RCA Victor Division.

"Standards for Testing Television Receivers," by D. G. Fink, McGraw-Hill Publishing Company.

"Intermediate Frequencies for Television Receivers," by P. F. G. Holst, Crosley Division, AVCO Manufacturing Company.

"Design Considerations in Intercarrier Sound Television Receivers," by S. W. Seeley, RCA Laboratories Division.

"Television Tuners," by A. Valdetaro, Sarks Tarzian.

"Standardization of Transient Response of Television Transmitters and Receivers," by R. D. Kell and G. L. Fredendall, RCA Laboratories Division.

"A Thermionic Device with A Sense of Smell," by W. C. White, General Electric Company; March 3, 1948.

OTTAWA

"The Moter Vessel 'Radel'" by H. Ross Smyth National Research Council; February 12, 1948.

PHILADELPHIA

"Modern High Energy Accelerators," by R. V. Langmuir, General Electric Company; March 4, 1948.

PITTSBURGH

"Marine Radar," by C. London, Westinghouse Electric Corporation; March 8, 1948.

SACRAMENTO

"Design Factors Influencing Radio Spectrum Conservation," by D. E. Noble, Motorola Inc.; January 29, 1948.

"Watts in Glass," by H. B. Little, Owens-Corning Fiberglass Corporation; February 17, 1948.

ST. LOUIS

"Studio Acoustics," by K. C. Morrical, Washington University; February 26, 1948.

SAN DIEGO

"Problems of Architectural Acoustics in Broadcast Studios," by C. R. Moe, San Diego State College; March 2, 1948.

SEATTLE

"Use and Adjustment of Feedback in A.M. Transmitters," by J. C. Herber, Western Electric Company; February 20, 1948.

WASHINGTON

"Ultrasonic Echo-Ranging Applied to Guidance Devices for the Blind," by F. H. Slaymaker, Stromberg-Carlson Company; March 8, 1948.

SUB-SECTIONS

FORT WAYNE

"Cathode-Follower Television Antenna," by G. C. Hills, Belmont Radio Corporation; February 9, 1948.

LANCASTER

"Particle Accelerators in Science and in Industry," by W. P. Simpson, General Electric Company; March 10, 1948.

TOLEDO

"Coaxial Lines," by J. S. Brown, Andrew Corporation; January 26, 1948.

"Electronic Voltmeters and Signal Generators for F.M., A.M., and Television," by C. I. Sheridan, The Triplett Electrical Instrument Company; February 23, 1948.

Now

is your OPPORTUNITY TO BUY TUBES

at *Ridiculously Low Prices*
Transmitting - Special Purpose

Every tube is *Brand New* in original unbroken factory package

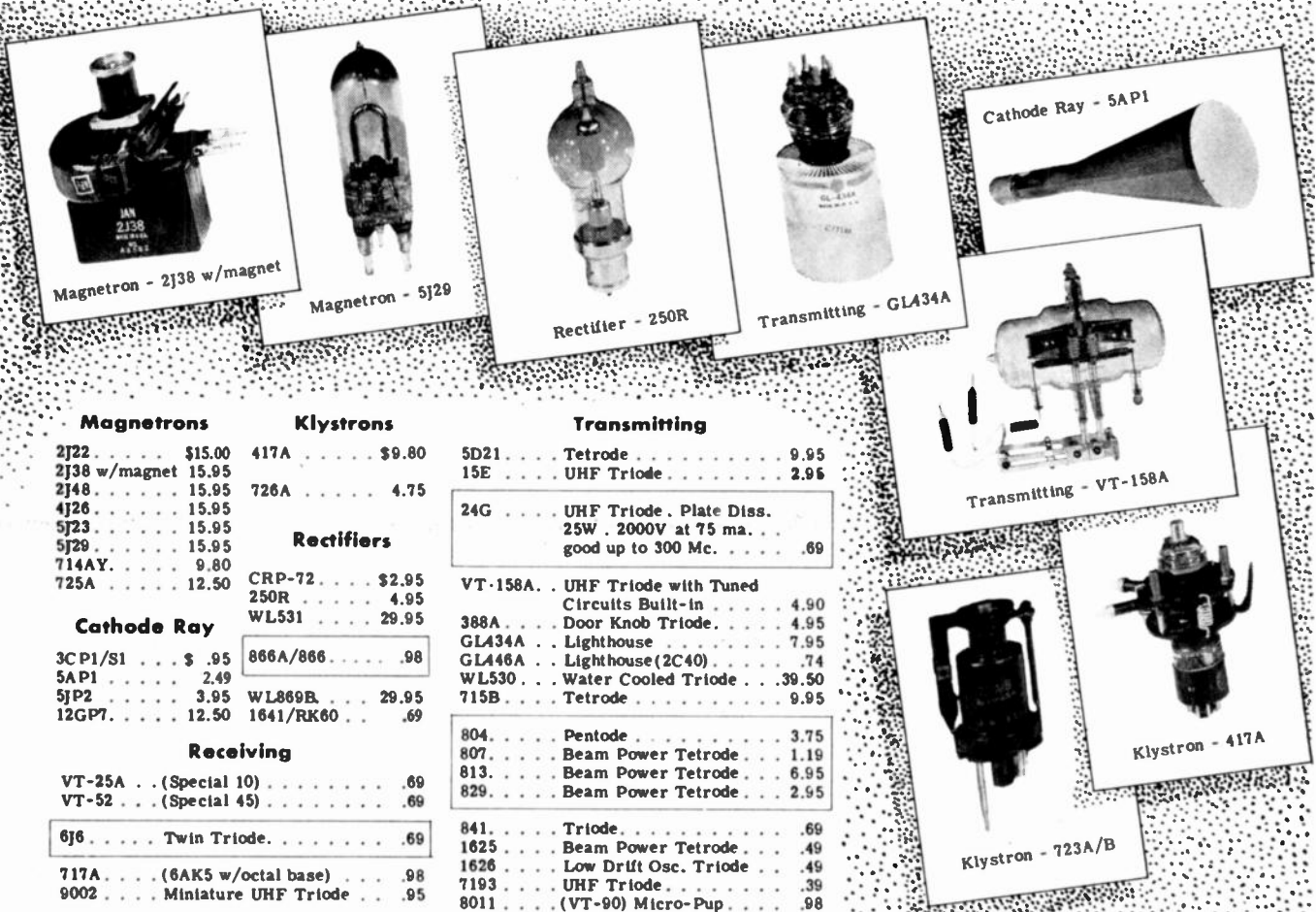

Magnetrons		Klystrons	
2J22	\$15.00	417A	\$9.80
2J38 w/magnet	15.95	726A	4.75
2J48	15.95		
4J26	15.95		
5J23	15.95		
5J29	15.95		
714AY	9.80		
725A	12.50		

Cathode Ray		Rectifiers	
3CP1/S1	\$.95	CRP-72	\$2.95
5AP1	2.49	250R	4.95
5JP2	3.95	WL531	29.95
12GP7	12.50	866A/866	.98
		1641/RK60	.69

Receiving	
VT-25A	(Special 10) .69
VT-52	(Special 45) .69

6J6	Twin Triode	.69
717A	(6AK5 w/octal base)	.98
9002	Miniature UHF Triode	.95

Special Purpose		
1B24	T-R Tube	2.95
724B	Spark Gap Tube	1.95

2051	Thyratron	.49
"	(in lots of 100) ea	.35

VR-150	Voltage Regulator	.60
6AMP	Tungar Rectifier	3.00

Transmitting		
5D21	Tetrode	9.95
15E	UHF Triode	2.96

24G	UHF Triode . Plate Diss. 25W . 2000V at 75 ma69
-----	---	-----

VT-158A	UHF Triode with Tuned Circuits Built-in	4.90
388A	Door Knob Triode	4.95
GL434A	Lighthouse	7.95
GL446A	Lighthouse (2C40)	.74
WL530	Water Cooled Triode	39.50
715B	Tetrode	9.95

804	Pentode	3.75
807	Beam Power Tetrode	1.19
813	Beam Power Tetrode	6.95
829	Beam Power Tetrode	2.95

841	Triode	.69
1625	Beam Power Tetrode	.49
1626	Low Drift Osc. Triode	.49
7193	UHF Triode	.39
8011	(VT-90) Micro-Pup	.98

TERMS - Orders under \$3.00, cash with order; orders over \$3.00 require 20% deposit, balance C.O.D.

ALL PRICES ARE NET, F.O.B. DAYTON, O.

Everything in Electronics

SREPCO

STANDARD RADIO & ELECTRONIC PRODUCTS CO.
 135 E. SECOND ST. DAYTON 2, OHIO.

Don't Delay - Order Today!

**REDUCE "DOWN-TIME"
LOWER WIRING COSTS,
SAFEGUARD PERSONNEL**



INDUSTRIAL SOCKETS

The advanced design of these sockets and the well known high integrity of Amphenol materials and production can save you thousands of dollars in "down-time." Another economy is the speed and simplicity of installation wiring. And these Amphenol sockets are *safe*—they guard highly trained workers and valuable tubes, so don't rely on makeshift equipment!

Included in the wide Amphenol industrial tube socket line is the Super Jumbo 4 pin socket for top or bottom mounting. The exclusive Cloverleaf contacts provide four full lines of contact with tube pins to carry heavy current loads. Outstanding in performance they are equally attractive in appearance—quality on all counts!

So insist on Amphenol when you buy. Write today for complete and well illustrated specifications.

AMERICAN PHENOLIC CORPORATION

1830 South 54th Avenue, Chicago 50, Illinois

COAXIAL CABLES AND CONNECTORS • INDUSTRIAL CONNECTORS, FITTINGS AND CONDUIT • ANTENNAS • RADIO COMPONENTS • PLASTICS FOR ELECTRONICS



UNIVERSITY OF ALBERTA, I.R.E.-A.I.E.E. BRANCH
"Radar and Radio Navigation Aids," by G. Robson and G. Allred, Students; February 25, 1948.

UNIVERSITY OF ARKANSAS, I.R.E. BRANCH
"Radar on the Destroyer," by R. H. Barton, Student; February 18, 1948.

UNIVERSITY OF CALIFORNIA, I.R.E.-A.I.E.E. BRANCH
"Design and Performance of High-Voltage, High-Capacitance Oil Circuit Breaker," by A. E. Brock, Pacific Electric Manufacturing Company; March 4, 1948.

UNIVERSITY OF ILLINOIS, I.R.E.-A.I.E.E. BRANCH
"The Electrical Age," by M. L. Enger, University of Illinois; February 26, 1948.
"Pulse Code Modulation," by L. A. Meacham, Bell Telephone Laboratories; March 8, 1948.

MICHIGAN STATE COLLEGE, I.R.E.-A.I.E.E. BRANCH
"Microwave Demonstration," by W. Dernberger, Michigan Bell Telephone Company; February 5, 1948.

UNIVERSITY OF MICHIGAN, I.R.E.-A.I.E.E. BRANCH
"Multistation Radio Relay Systems," by G. N. Thayer, Bell Telephone Laboratories; February 17, 1948.
Debate with Sigma Rho Tau on Resolved: Engineers Should Unionize; February 25, 1948.

THE COLLEGE OF THE CITY OF NEW YORK, I.R.E. BRANCH
"The Engineer and His Professional Society," by B. E. Shackelford, President, The Institute of Radio Engineers; February 24, 1948.

NORTHWESTERN UNIVERSITY, I.R.E.-A.I.E.E. BRANCH
"The Go of The Brain," by W. S. McCulloch, Illinois Neuropsychiatric Institute; February 13, 1948.

STANFORD UNIVERSITY, I.R.E.-A.I.E.E. BRANCH
"Some Factors in Television Studio Design," by F. R. Brace, Engineering Consultant; February 18, 1948.

UNIVERSITY OF TEXAS, I.R.E.-A.I.E.E. BRANCH
"Power Line Carrier for Rural Subscribers," by M. F. Noster, Southwestern Bell Telephone Company; March 1, 1948.

UNIVERSITY OF WASHINGTON, I.R.E.-A.I.E.E. BRANCH
"Measurements," by N. Eldred, Hewlett Packard Corporation; February 6, 1948.

WAYNE UNIVERSITY, I.R.E.-A.I.E.E. BRANCH
"Radar and Microwaves," by W. H. Dernberger, Michigan Bell Telephone; February 27, 1948.

WORCESTER POLYTECHNIC INSTITUTE, I.R.E.-A.I.E.E. BRANCH
"A Critique of the Methods and Courses of Instruction at the Electrical Engineering Department at Worcester Polytechnic Institute," by L. Leavitt, Worcester County Electric Company, and several staff and student members of Worcester Polytechnic Institute; February 19, 1948.

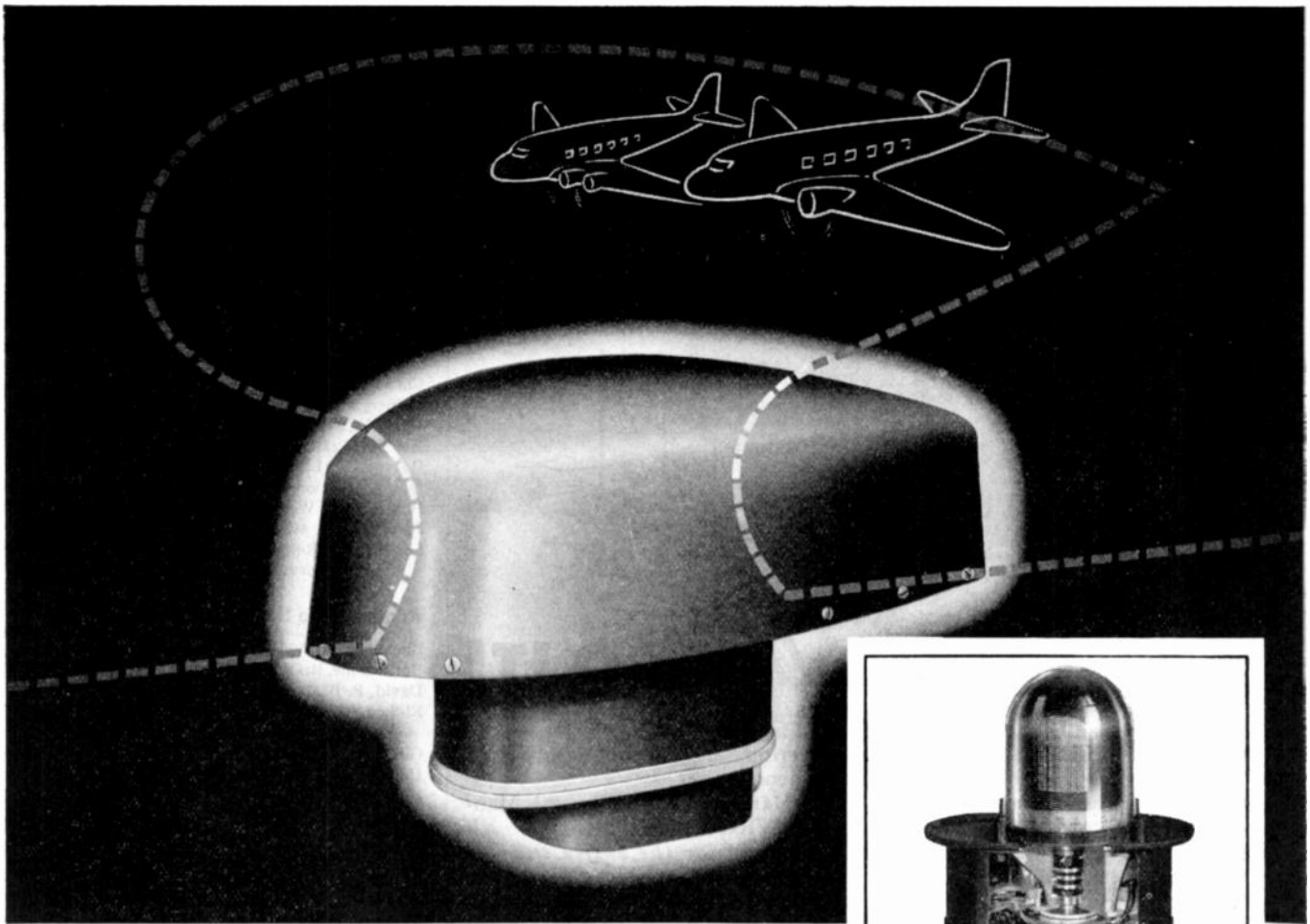

The new, smaller Bendix Iron Core Loop shown here, superimposed in proper proportion on the outline of the air core type that it replaces, is visual evidence of reduction in size accomplished by the use of Stackpole Iron Cores. Air drag is reduced 72% because of this more efficient loop.

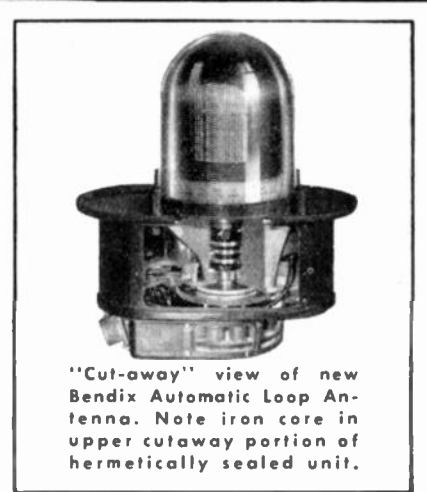

"Cut-away" view of new Bendix Automatic Loop Antenna. Note iron core in upper cutaway portion of hermetically sealed unit.

STACKPOLE IRON CORES REDUCE AIR DRAG 72%

Unusual as it may seem, careful research and modern electronic design has shown that the use of Stackpole Powdered Iron Cores increases the pay load of regular commercial aircraft.

The new Bendix Automatic Loop Antenna as used in Bendix Radio Division's Navigational System is smaller in size and more efficient than the air loop it replaces. Stackpole Iron Cores permit this reduction in size and also increase the efficiency of the loop. Air drag, an all important consideration in aircraft design, is one of the determining factors in establish-

ing the allowable "Pay Load." Air drag at 250 mph, has been reduced by more than 72% by use of this new Bendix loop!

Stackpole Powdered Iron Cores are performing miracles like this for many other manufacturers, too. Improved performance, reduced costs, smaller physical sizes—these are some of the advantages that usually result when Stackpole Iron Cores are designed into inductive circuits. Write on your company letterhead today for full information. Ask for STACKPOLE Bulletin No. RC7B.

STACKPOLE CARBON COMPANY, ST. MARYS, PA.

STACKPOLE

IRON CORE HEADQUARTERS

Want a radio station designed and built?

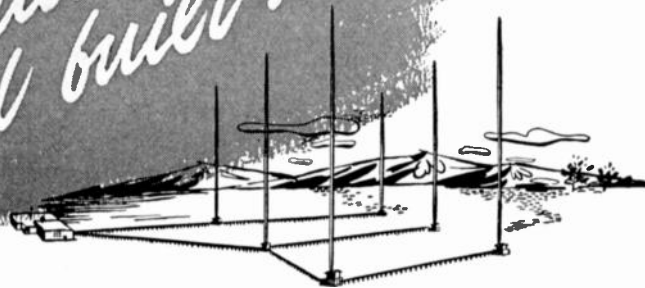

LET *Andrew* DO IT!

The Monona Broadcasting Company, Madison, Wisconsin, had the money but no station. Faced with "impossible" allocation difficulties, they called on Andrew engineers, who succeeded in finding a frequency and designing a directional antenna system. Thus, WKOW was born. Within ten months after the construction permit was granted, Andrew engineers completely designed, built, tuned, and proved performance of a six-tower 10 kw. station — an unusually difficult engineering feat accomplished in record-smashing time. A complete "package" of Andrew transmission line and antenna equipment was used, again emphasizing Andrew's unique qualifications: Complete

engineering service with unsurpassed equipment.

Mr. Harry Packard, General Manager of WKOW, wrote:

"Speaking for the entire staff of WKOW, I would like to congratulate the Andrew Corporation on the remarkable engineering job it performed in helping us get WKOW on the air.

We feel that the technical perfection of our installation is due in great part to the efficiency of Andrew equipment and engineering service.

In particular we wish to thank Mr. Walt Kean of the Andrew Broadcast Consulting Division who was responsible for conceiving and designing the installation, supervising construction of all antenna equipment, and doing the final tuning and coverage surveys."

A total of 13,618 feet of Andrew transmission line and complete phasing, antenna tuning, phase sampling and tower lighting equipment went into this job, complementing the best in engineering with the ultimate in radio station equipment.

So, just write Andrew when you are ready to enter the broadcasting field. Andrew will get you on the air.



Andrew
CORPORATION

363 EAST 75th STREET • CHICAGO 19

TRANSMISSION LINES FOR AM, FM, TV • DIRECTIONAL ANTENNA EQUIPMENT • ANTENNA TUNING UNITS • TOWER LIGHTING EQUIPMENT • CONSULTING ENGINEERING SERVICE



The following transfers and admissions were approved on April 6, 1948, to be effective May 1, 1948:

Transfer to Senior Member

Brustman, J. A., 180 Lalley Blvd., Fairfield, Conn.
 Chu, L. J., 31 Winthrop Rd., Brookline, Mass.
 Clark, R. L., 1502 N. Utah St., Arlington, Va.
 Curtis, R. C., 25 Stanley St., New Haven 11, Conn.
 Dolberg, C. E., 447 Tennis Ave., North Hills, Pa.
 Dyke, E., 317 Hyde Park Ave., Bellwood, Ill.
 Harkins, P. B., 166 Summit Rd., Elizabeth, N. J.
 Harvey, N. L., 17 W. Rogues Path, Huntington Station, L. I., N. Y.
 Hessel, J., 73 Woodland Dr., Fair Haven, N. J.
 Joyner, A. A., 403 Center St., Haddonfield, N. J.
 Lamb, J. J., Remington Rand, Inc., Wilson Ave., S. Norwalk, Conn.

Admission to Senior Member

Blanchard, A., 3001 University Blvd., Houston Tex.
 Burlingame, B. O., 311 E. 72 St., New York 21, N.Y.
 David, P. B., 140 Avenue de Suffren, Paris, France
 El-Said, M. A. H., c/o Egyptian Education Bureau, 2200 Kalorama Rd., Washington 8, D. C.
 Gill, H. A., 6 Eleventh St., Carle Place, N. Y.
 Hafstad, L. R., 1611 Park Rd., Washington, D. C.
 Houtmuller, J., 32, Avenue Albert Lancaster, Brussels, Belgium
 Loo, T. C., Chinese Government Radio Administration, Sassoon House, Shanghai, China
 Monk, N., 463 West St., New York 14, N. Y.
 Ooiman, A., 3762 Casilla, Buenos Aires, Argentina
 Tashjian, D. R., 1245 Leeds Terr., Baltimore, Md.
 Toth, E., 338 Baltimore Ave., Takoma Park 12, Md.
 Vallese, L., Department of Electrical Engineering, Carnegie Institute of Technology, Pittsburgh 13, Pa.
 Zimmermann, H. J., 18A Thomas Rd., Swampscott, Mass.

Transfer to Member

Abramis, B. D., 4328 Illinois St., San Diego 4, Calif.
 Beck, H. M., 3806 S. Capitol St., Washington, D. C.
 Bierach, K. F., Jr., Zenith Radio Corp., 6001 Dickens Ave., Chicago 39, Ill.
 Burns, L. I., Jr., RCA Laboratories, Princeton, N. J.
 Cherry, L. B., Department of Physics and Engineering, Lamar College, Beaumont, Tex.
 Corl, J. L., Sylvania Electric Products, Inc., 40-22 Lawrence St., Flushing, L. I., N. Y.
 Cortright, R. D., 412 E. Melbourne St., Silver Spring, Md.
 Croy, J. R., 4830 S. 28 St., Arlington, Va.
 Davenport, W. B., Jr., 54 Westgate, Cambridge 39, Mass.
 Dearborn, F. K., Jr., 75 Outlook Dr., Lexington, Mass.
 Elbourn, R. D., 5332 Nevada Ave., N.W., Washington, D. C.
 Fouty, R. A., 2031 Fairmont Ave., Columbus 4, Ohio
 Gissler, F. E., 224 Green St., Boonton, N. J.
 Grumich, J., 48-25—54 Rd., Maspeth, L. I., N. Y.
 Harris, H. W., 711 Kentucky, Amarillo, Tex.
 Hastings, C. L., 1604 West End Place, Greensboro, N. C.
 Hodge, J., 1364 Ridgeley Dr., Los Angeles 35, Calif.
 Hogg, C. B., Lamparilla No. 208, Havana, Cuba
 Hopkins, J. E., 510 North St., East Aurora, N. Y.
 Iffland, J. J., 711 Oakland Ave., Ann Arbor, Mich.
 Kahnke, J., 1683 Marshall Ave., St. Paul 4, Minn.
 Kreuzer, B., RCA Victor Division, Bldg. 15-5, Camden, N. J.
 Learned, A. J., 2216 South Ave., Syracuse 7, N. Y.
 Lovan, J. E., 411 Miller, Liberty, Mo.
 Lowers, C. E., Curtiss-Wright Corp., Columbus 16, Ohio



- McElroy, G. E., 100 Hudson Ave., Englewood, N. J.
 Minneman, M. J., 2825 Hilldale Ave., Baltimore 15, Md.
 Mooney, R. E., Box 298, Clinton, Ont., Canada
 Ordnung, P. F., Dunham Laboratory, Yale University, New Haven, Conn.
 Pickaraki, S., 1357 Wilhelmina Rise, Honolulu, T. H.
 Roush, G. E., c/o Philips Laboratories, Inc., Irvington-on-Hudson, N. Y.
 Rubin, M. D., Lab. 19, "G" Bldg., Raytheon Manufacturing Co., Seyon St., Waltham, Mass.
 Shaw, R. H., 66 Old South Head Rd., Vaulcluse, Sydney, N.S.W., Australia
 Smith, F. W., Jr., 160-09 Grand Central Pkwy., Jamaica 2, L. I., N. Y.
 Stello, K. H., 12026 Peoria St., Roscoe, Calif.
 Thurston, W. R., Jr., 275 Massachusetts Ave., Cambridge 39, Mass.
 Weyrauch, H. E., 1926 Fourth St., Bremerton, Wash.
 Yelacy, B., 45 W. 75 St., New York 23, N. Y.
 Yonker, F. H., 1205 E. Pine St., Phillipsburg, Pa.

Admission to Member

- Bonapace, H., Brazilian Aeronautical Commission, 1501-18 St., N.W., Washington 6, D. C.
 Breuer, H. J., 1150 Robertson Way, Sacramento 14, Calif.
 Bricourt, P. A., 2019 Dickson, Sillery, Que., Canada
 Chmilowski, J. B., 11013 S. Prairie Ave., Lennox, Calif.
 Coates, F. M., 4112 Locust, Kansas City 4, Mo.
 Constant, P. C., Jr., 405 E. 61 St., Kansas City 4, Mo.
 Estevez, C. L., Carrera 7a, No. 19-70, Aptdo. Nacional 2605, Bogota, Colombia
 Hackley, C. L., 1081 Keyes Ave., Schenectady 8 N. Y.
 Hall, John R., 446 Pleasant St., South Weymouth, Mass.
 Harris, J. B., 1924 N. 30 St., Kansas City 2, Kan.
 Holland, C. R., 947 James St., Syracuse 3, N. Y.
 Johnk, C. T. A., Electrical Engineering Department, Missouri School of Mines, Rolla, Mo.
 Klekotka, J. A., Villanova College, Villanova, Pa.
 Larson, R. C., 117 Chicago Blvd., Sea Girt, N. J.
 Lemeshka, M. B., RCA Victor Division, New Holland Ave., Lancaster, Pa.
 Marvin, E. L., Box 4, Spickert Knob Rd., Floyd Knobs, Ind.
 Milby, B. C., 615 Church St., Asbury Park, N. J.
 Moltrup, G. R., 247 S. Barnard St., State College, Pa.
 Opperman, A. G., 576 Douglas St., Akron 7, Ohio
 Pearson, J. B., 4114 Lamar, Houston 3, Tex.
 Preston, F. S., c/o Norden Laboratories, Inc., 121 Westmoreland Ave., White Plains, N. Y.
 Friedigkeit, J. H., 825-53 St., Oakland 8, Calif.
 Quanrud, O. G., Headquarters First Air Force, Fort Slocum, N. Y.
 Ruston, J., 244A Summer Ave., Newark 4, N. J.
 Schwenker, R. B., 130-21-220 St., Springfield Gardens, L. I., N. Y.
 Sheitelman, H. D., 2902 Arundel Rd., Mt. Rainier, Md.
 Tai, C., 16, Gordon Square, London, W.C.1, England
 Watson, K. J., Box 383, California State Polytechnic College, San Luis Obispo, Calif.
 Whitney, L. E., 319 Westmoreland Ave., Syracuse 10, N. Y.
 Winlund, E. S., 12606 Everglade, Venice, Calif.
 Witten, E. L., 4834 W. 13 St., Hawthorne, Calif.
 Wrede, D. F., 26, St. Pauls Rd., Tottenham, London, N. 17, England

(Continued on page 42A)



Regulated POWER SUPPLIES

THESE G-E Regulated Power Supplies provide a quick, reliable source of constant d-c voltage. Clean, economical and space-saving, they eliminate the need for expensive batteries that require continuous care, and will prove an indispensable aid in laboratory and production work.

POWER REQUIREMENTS: 105-125 volt, 60-cycle commercial power. Power input 350 watts maximum.

OUTPUT POWER: 250-450 volts d-c (either negative or positive terminal may be grounded as desired). 300 milliamperes maximum.

IMPEDANCE: Approximately 2 ohms at 30 cycles sec. Decreases with increasing frequency.

RIPPLE: Less than (.005) volts, peak to peak.

LOAD REGULATION: Less than 1 percent change in output voltage from no load to full load.

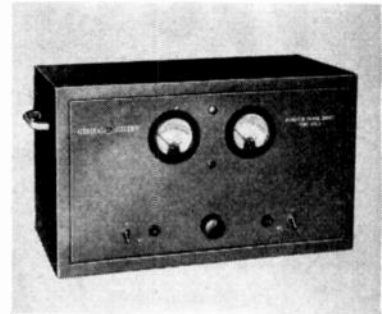

TYPE YPD-2
Range 250-450 Volts

POWER REQUIREMENTS: 105-125 volts, 60-cycle commercial power. Power input, approximately 375 watts.

OUTPUT POWER: 250-400 volts d-c, 200 milliamperes individually from two separate supplies, or 250-400 volts d-c, 400 milliamperes from both supplies when operated in parallel.

RIPPLE AND NOISE: Less than 0.020 volt rms.

LOAD REGULATION: One percent or less change in output voltage from no load to full load, or for line voltage variation from 105 to 125 volts.

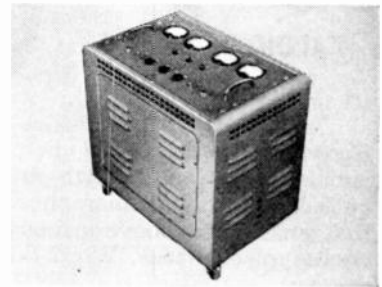

TYPE PS-4 (Dual Regulated)
Range 250-400 Volts

POWER REQUIREMENTS: 105-125 volts, 60 cycle commercial power. Power consumption approximately 800 watts at full load.

D-C OUTPUT: 0.125 ampere from 160 to 1500 volts output.

RIPPLE: Maximum 0.05 volt (peak to peak value).

LOAD REGULATION: 0.15 percent or less change in output voltage from no load to full load at any power line voltage and output voltage within rating.

LINE REGULATION: Less than 0.015 percent output voltage change per volt change in line voltage over specified range.

IMPEDANCE: Less than 10 ohms at 1500 volts and less than 2 ohms at 160 volts output.



TYPE YPD-4
Range 160-1500 Volts

For additional information concerning these units and other precision equipment write: *General Electric Company, Electronics Park, Syracuse, New York.*

GENERAL ELECTRIC

165-03

MAKE THE MOST OF THE

NEW

SHURE

Monoplex

MODEL
"737A"

Available Now!

THE *Only* SUPER-
CARDIOID CRYSTAL
MICROPHONE

Here indeed is *the* crystal microphone of all time—a high-output, unidirectional microphone that ranks far, far above ordinary crystal microphones. Why? Because it is a SUPER-CARDIOID microphone. What does this mean? It means that the "Monoplex" is twice as unidirectional as the Cardioid. It has wide angle pickup across the front of the microphone but it reduces sound pickup from the rear by 15 db—over a broad range of frequencies, and reduces pickup of random sound by 73%! The "Monoplex" employs the same type of acoustic phase-shifting network used in the highest-cost Shure Broadcast microphones. New "Metal-Seal" crystal. The case is pivoted at the rear and can be pointed toward desired sound or upwards for horizontal plane pickup. The "Monoplex" is excellent for high-quality public-address, communications, recording and similar applications. It will operate under adverse conditions of background noise and reverberation where a conventional microphone would be practically useless. Make the most of the "Monoplex"—it is destined for a performance record unique in crystal microphone history!

Manufactured under Shure patents issued and pending.
Licensed under patents of Brush Development Co.

SHURE

Model "737A"

CODE: RUMON

List Price: \$35.50

SHURE BROTHERS, INC.

Microphones & Acoustic Devices

225 W. HURON ST., CHICAGO 10, ILL. • CABLE ADDRESS: SHUREMICRO



HIGH
OUTPUT
(-53db)



(Continued from page 41A)

The following admissions to Associate were approved on April 6, 1948, to be effective as of May 1, 1948:

- Adams, R. T., 102 Fairmount Ave., Chatham, N. J.
Albert, A. A., 1925 S. Christiana Ave., Chicago 23, Ill.
Alterman, F. J., 25-40—31 Ave., Long Island City, L. I., N. Y.
Andrae, P. H., II, Box 616, Tyndall Field, Fla.
Arnold, T. G., Jr., 3301 St. Paul St., Baltimore 18, Md.
Auerbach, A. A., Eckert-Mauchly Computing Corp., 1215 Walnut St., Philadelphia 7, Pa.
Augustine, A. F., 5216 W. 63 Pl., Chicago 38, Ill.
Austin, H. B., Sandia Base Branch, Albuquerque, N. Mex.
Babin, R. S., 105 Galveston St., S.W., Washington 20, D. C.
Bahli, F., 524 Fourth Ave., Bethlehem, Pa.
Baird, C. W., 2327 Monticello Pl., Columbus 3, Ohio
Baldrige, B. H., R.R. 9, Kratzville Rd., Evansville, Ind.
Barbano, E. J., 14 Highland Ave., White Plains, N. Y.
Barlowe, M., 880—59 St., Brooklyn 20, N. Y.
Barton, D. J., 142-12—119 Rd., South Ozone Park 20, N. Y.
Barus, C., 236 Ames St., Dedham, Mass.
Barzilaski, P. M., 9435—85 Ave., Woodhaven, L. I., N. Y.
Berridge, G. J., 311 W. 55 St., New York 19, N. Y.
Bhatnagar, I. S., 7-B Irwin Rd., New Delhi 1, India
Bhonsle, S. B., c/o R.C.A. Institutes Inc., 75 Varick St., New York 13, N. Y.
Bicknell, J. E., Jr., MOQ 141C, Gunter AF Base, Montgomery, Ala.
Biernat, W. M., 1106 N. Marshfield Ave., Chicago 22, Ill.
Birk, E. V., 2353 Lawrence Ave., Toledo 6, Ohio
Blaisdell, W. C., 846 Magie Ave., Elizabeth, N. J.
Blum, M. P., 7334—67 Dr., Middle Village, L. I., N. Y.
Brennan, D. G., 14 Grandview Ave., Waterbury 61, Conn.
Brown, L. C., Jr., 215 W. 23 St., New York 11, N. Y.
Bull, J. T., 1747 Lanier Place, N.W., Washington 9, D. C.
Bulsara, M. S., Crescent Apt., 25-27 Clinton St., Brooklyn 2, N. Y.
Burdin, J. S., Box 1663, University of California, Los Alamos, N. Mex.
Burke, E. W., Jr., 34-10 Linden Place, Flushing L. I., N. Y.
Burns, J. N., 1634 Sherwin, Chicago 26, Ill.
Callan, J. M., 37-55—84 St., Jackson Heights, L. I., N. Y.
Carlisle, S. F., Jr., Hunters Lane, Elmsford, N. Y.
Cawood, D. W., 68 Montague St., Brooklyn 2, N. Y.
Cetiner, E., 735 S. Braddock Ave., Pittsburgh 21, Pa.
Channing, W., Jr., D. E. Makepeace Company, Attleboro, Mass.
Chapman, R. F., 7130—71 Pl., Glendale, N. Y.
Choudhuri, N. K. D., c/o Dr. B. K. Byram, Embassy of India, 635 F St., N.W., Washington, D. C.
Christie, C. J., 79-22—69 Ave., Middle Village, L. I., N. Y.
Chu, C. J., 6 DeMott Ave., Tenafly, N. J.
Clark, J. M., 113 E. Hickory St., Hinsdale, Ill.
Clutts, C. E., 463 West St., New York 14, N. Y.
Cohan, A. H., 714 E. Boston St., Seattle 2, Wash.
Cohen, D., 1248 Clay Ave., New York 56, N. Y.
Colledge, C. H., 11 Duvall Dr., W. Moreland Hills, Washington 16, D. C.
Combelic, D., 1519 Connecticut Ave., Washington 6, D. C.

(Continued on page 44A)

STACK MOUNTING CAPACITORS

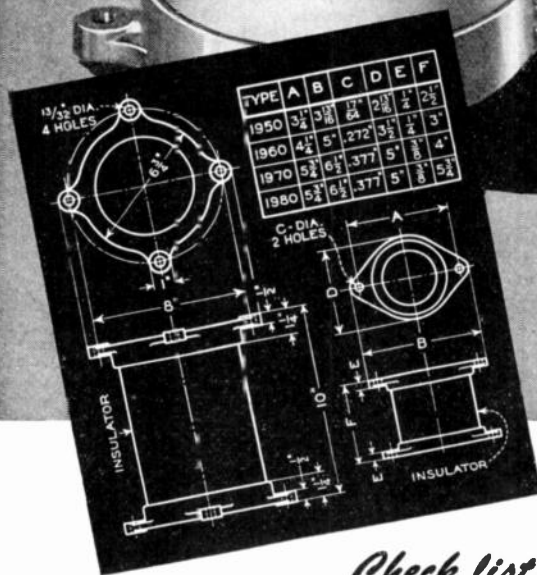

Check list . . .

- ✓ Low-loss glazed ceramic case for long creepage path between terminals.
- ✓ Corona losses eliminated on inside and outside alike.
- ✓ Cast-aluminum terminal ends for low contact resistance between stacked units.
- ✓ Close-tolerance mica units equalize loading of series-connected sections
- ✓ Mica sections rigidly clamped in low-loss non-magnetic clamps

- and heat-treated for maximum capacitance-temperature stability.
- ✓ Mechanical design permits units to be stacked and thereby connected in series, parallel and series-parallel. Dummy units are available to support and insulate active units.
- ✓ Units may be bolted together through holes in aluminum caps.
- ✓ Standard listings; normally available without delay; at the right prices.

● Aerovox popularized this type. Originally a special item made only to order and at custom-built prices, it was Aerovox that selected and standardized the sizes, voltages and capacitances so that standard Aerovox stack-mounting units could be regularly produced, listed and properly priced. The rest is history.

Especially intended for various transmitting and electronic applications, these heavy-duty micas have found wide usage in military and peaceful applications alike. Such units are especially popular in heavy-duty transmitting applications such as grid, plate blocking, coupling, tank and by-pass functions. Also in carrier-current applications.

Special yesterday, standard today, Aerovox stack-mounting mica capacitors have contributed greatly to available quality equipment and outstanding performance.



FOR RADIO-ELECTRONIC AND INDUSTRIAL APPLICATIONS

AEROVOX CORPORATION, NEW BEDFORD, MASS., U.S.A.

SALES OFFICES IN ALL PRINCIPAL CITIES • Export: 13 E. 40th St., NEW YORK 16, N. Y.

Cable: 'ARLAB' • In Canada: AEROVOX CANADA LTD., HAMILTON, ONT.

HIGH PERFORMANCE

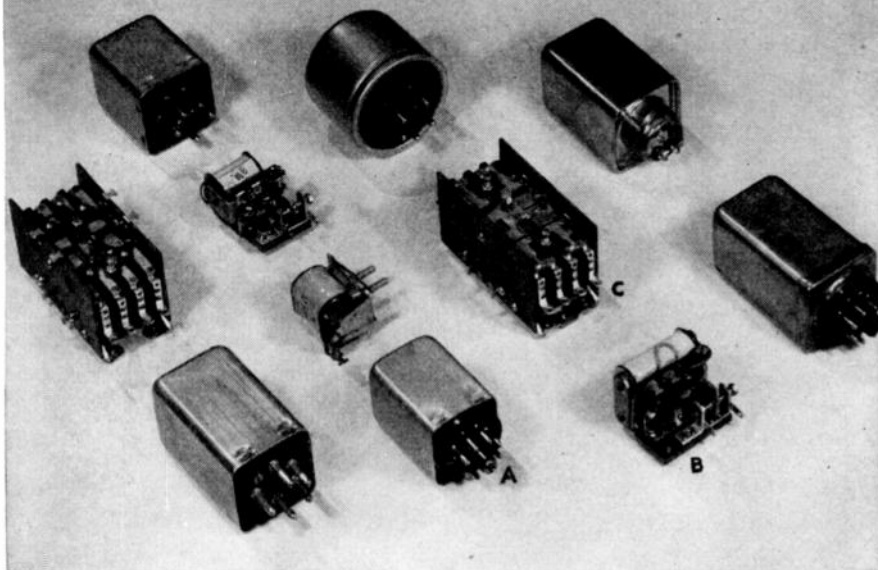

SPECIAL PURPOSE STANDARD RELAYS

In the preparation of relay specifications for particular functions, cases frequently arise which appear to have widespread occurrence.

We have adopted a policy of listing certain of these special purpose relay specifications as standard, especially when the performance results are exceptionally good.

FOR HIGH-SPEED KEYING OR DIALLING
on low to medium dc power, 50-250 volts supply:

Type 41RO-72327-X (A in cut) List \$3.80

- SPDT Relay, 2000 ohm dc coil
- Operate, 4 ma. or less, 5-10 ma. normal current
- Contacts: Tungsten (standard) for 0.5 amp or less, moderate to high voltage, long life; fine silver for higher current, lower voltage, moderate life (e.g. 5,000,000).

Typical timing: Milliseconds

Final coil current 7.5 ma *: source	50V	100V	200V
Open N.C. contact	4 ms.	2.5 ms.	1.5 ms.
Transfer to N.O.	1.5	1.0	.7
Open N.O. contact	1.0	1.0	1.0
Transfer to N.C.			
(Includes Bounce)	3-5	3-5	3-5

*Sufficient external series resistance employed to limit current to this value.

Write for additional data
and timing curves

AC — DC — POLAR TYPES



Sigma Instruments, Inc.

Sensitive RELAYS

94 CEYLON ST., BOSTON 21, MASS.

- HIGH SPEED
- LONG LIFE
- LOW INPUT
- PRE-ADJUSTED



(Continued from page 42A)

- Connelly, E. J., 3 Pearl St., Waterford, N. Y.
 Connolly, J. J., 36 Gramercy Park, New York 10, N. Y.
 Cooper, F., Jr., 6 Hillcrest Ave., Port Dickinson, N. Y.
 Cooper, J. V. B., 40-22 Lawrence St., Flushing, L. I., N. Y.
 Copsey, J. F., 2308 N. Columbus St., Arlington, Va.
 Covici, W., 19 Belshaw Ave., Eatontown, N. J.
 Cox, H. N., 12 Doughty Lane, Fair Haven, N. J.
 Dasburg, A. V., 55 Stonybrook Dr., Rochester 10, N. Y.
 D'Avino, R. F., 4217 Stiles St., Philadelphia, Pa.
 Deeter, C. R., 5725 N. Washington Blvd., Arlington, Va.
 Deeters, E. W., 2249 N. Glebe Rd., Arlington, Va.
 DePino, N., 3821 1/2 Keystone Ave., Culver City, Calif.
 Dingman, E. H., Route 8, Box 342, Salem, Ore.
 Dixon, J. M., 414 W. 120 St., New York 27, N. Y.
 Doolittle, J. H., Goodrich Rd., Clarence, N. Y.
 Douglas, J. C., 1423 St. Mark St., Montreal, Que., Canada
 Drosin, A. B., 418 St. Johns Pl., Brooklyn 17, N. Y.
 DuChatellier, R., 7653 S. Union Ave., Chicago 20, Ill.
 Dyall, W. T., 324 Atkins Ave., Lancaster, Pa.
 Early, J. M., 1353 Highland St., Columbus 1, Ohio
 Edrich, J. G., 246 E. 13 St., New York 3, N. Y.
 Egley, T. H., 406 Main St., Avon, N. J.
 Elfenbein, W., 400 Lexington Ave., Dayton 7, Ohio
 Epstein, M., 51 Barker Ave., Eatontown, N. J.
 Estelle, J. A., 6619 1/2 Kimbark Ave., Chicago 37, Ill.
 Evans, R. E., 376 Mill Hill Rd., Southport, Conn.
 Faist, C. A., Box 238, Spring Valley, N. Y.
 Fannin, B. B., 1510 Noyes Dr., Silver Spring, Md.
 Farkas, R. D., 2202 Ave. 1, Brooklyn, N. Y.
 Feldhaus, J. M., 12 Shadow Lane, Larchmont, N. Y.
 Feltham, C. F., Jr., 14 Westminster Rd., Great Neck, L. I., N. Y.
 Femmer, M. E., R.D. #2, Hopewell Junction, N. Y.
 Fetzer, F., 18 Shelley Ave., Valhalla, N. Y.
 Fishlow, I., 1775 Davidson Ave., Bronx 53, N. Y.
 Fishman, A., 1254 Union St., Brooklyn 25, N. Y.
 Fountain, H. F., 94 Prospect St., New Haven 11, Conn.
 Fowler, G. A., 4119 E. Central Ave., Albuquerque, N. Mex.
 Frankel, B. L., 47 Dickinson Ave., Binghamton, N. Y.
 Frase, R. A., Capitol Radio Engineering Institute, 16 St. & Park Rd., N.W., Washington 10, D. C.
 Freedman, J., 855 Woodgate Ave., Long Branch, N. J.
 Fucci, S., 24 Squire St., New London, Conn.
 Gable, A. W., 844 N. Broad St., Philadelphia 30, Pa.
 Garrison, H. L., Valle Dupar, Magdalena, Colombia, S. A.
 Geiger, J. M., 1505 Archer Rd., New York 62, N. Y.
 Gemulla, W., 1241 Nelson, Chicago 13, Ill.
 Gibson, F. C., Box 376, Broughton, Pa.
 Gibson, J. G., Lexington Park, Md.
 Gikow, E., 12 Crawford St., Eatontown, N. J.
 Glass, L., 25 Murray Rd., Ft. Tilden, N. Y.
 Gleason, R. F., 3338 Brothers Pl., S.E., Washington, 20, D. C.
 Goetz, W. M., 887 Crotona Park N., New York 60, N. Y.
 Goldman, S., R.C.A. Laboratories, 66 Broad St., New York 4, N. Y.
 Gornick, S. A., 1150 N. LaSalle St., Chicago 10, Ill.
 Gould, S., 3 S. Elliott Place, Brooklyn 17, N. Y.
 Gray, W. C., 27 Bruce St., Scotia, N. Y.
 Green, D. W., 121 Joliet St., S.W., Washington 20, D. C.
 Green, M. W., 175 Union Ave., Rutherford, N. J.
 Greene, G. M., E.T., N.A.T.C., Patuxent River, Md.

(Continued on Page 46A)



Split $\frac{1}{2}$ microampere in half

each half drives this
WESTON
***SENSITROL RELAY**

Provides positive control at levels as low as $\frac{1}{2}$ microampere. Operates direct from photocells, thermocouples, resistance bulbs, or any suitable electrical circuit. Non-chattering magnetic contacts handle up to 10 watts at 120 volts.



MODEL 705 TYPE N

It will pay you to submit your relay problems to **WESTON**. The **WESTON** line includes sensitive relays of many types, including the "high sensitivity—high contact capacity" Model 705. Time delay and power relays designed to operate from sensitive relay contacts also available. For engineering coopera-

tion consult our representatives, or write . . . Weston Electrical Instrument Corporation, 591 Frelinghuysen Avenue, Newark 5, New Jersey.

***SENSITROL**—A registered trade-mark designating the contact-making instruments and relays manufactured exclusively by the Weston Electrical Instrument Corporation.

WESTON *Instruments*

ALBANY · ATLANTA · BOSTON · BUFFALO · CHARLOTTE · CHICAGO · CINCINNATI · CLEVELAND · DALLAS · DENVER · DETROIT · JACKSONVILLE · KNOXVILLE · LITTLE ROCK · LOS ANGELES · MERIDEN · MINNEAPOLIS · NEWARK
NEW ORLEANS · NEW YORK · PHILADELPHIA · PHOENIX · PITTSBURGH · ROCHESTER · SAN FRANCISCO · SEATTLE · ST. LOUIS · SYRACUSE · IN CANADA, NORTHERN ELECTRIC CO., LTD., POWERLITE DEVICES, LTD.

EM

IS AN IMPORTANT PART of AM FM TV BROADCASTING

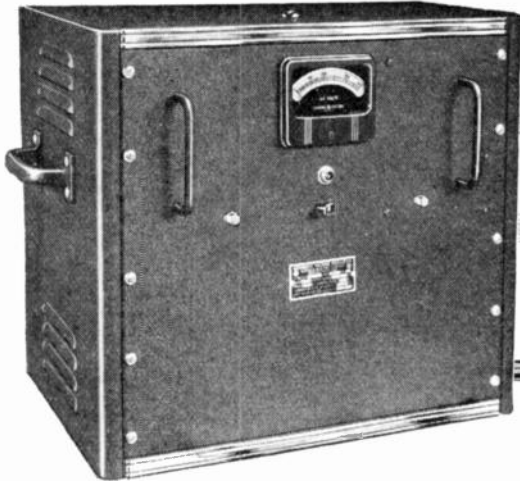

STABILINE Automatic Voltage Regulators Type EM (Electromechanical) are the answer to regulation problems in radio and television transmitting stations . . . high frequency relay stations.

The FCC recommends adequate voltage regulation equipment where the power supplied by the utility varies more than 3% from nominal over a 24 hour period. The STABILINE Voltage Regulator Type EM is ideally suited for this regulation task. Some of the outstanding features include . . . zero waveform distortion, complete insensitivity to the magnitude and power factor of the load, no effect on system power factor, high efficiency and no critical adjustments. Its long-term stability for 24 hour line correction means that Type EM requires negligible attention. Under normal conditions, the output voltage need not be adjusted more than once a month.

The STABILINE Voltage Regulator Type EM consists of an electronic detector circuit controlling a motor-driven POWERSTAT variable transformer. The moving parts are rugged, quality manufactured components which require a minimum of service and attention. The electronic control circuit itself is plug-in type and incorporates the latest advances in detector circuit design. This plug-in feature, combined with the convenient replacement service agreement made at the time of purchase, eliminates maintenance difficulties. The attractive black wrinkle-finished front panel has a 4 inch output voltmeter and screw driver adjustment controls for sensitivity and output voltage setting. Numerous models are available in ratings from 1 KVA to 100 KVA to meet most requirements. Rely on the experience of the Superior Electric Company's staff of voltage control engineers to assist with your voltage regulation problems.

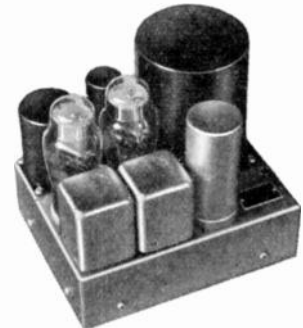

Request Bulletin #448 for detailed information on the STABILINE Type EM and its application in the broadcast field.

Write The Superior Electric Co., 805 Meadow St., Bristol, Conn.



Powerstat Variable Transformers • Voltbox A C Power Supply • Stabiline Voltage Regulators.

NOW! SELF-CONTAINED, EXPERIMENTAL SCHOOL & INDUSTRIAL LAB EQUIPMENT



Kepeco Electronic Instruction Panel Model 104, available separately.

Kepeco Laboratory Multiple Power Supply Model 103, available separately.

Now you can perform electronic experiments simply, easily with the Kepeco Electronic Instruction Panel. Here is a teaching aid that graphically illustrates vacuum tube principles — enables all students to grasp fundamentals in the laboratory.

Extremely versatile, the Kepeco Electronic Instruction panel covers a wide range of tubes, comes with a packet of 23 keyed interchangeable circuit charts, 3 master charts and 12 blank keyed sheets for additional experiments. Panel contains 3 octal tube sockets, 18 binding posts. By placing a keyed circuit diagram on the panel and wiring the circuit, students determine tube and circuit characteristics.

For a basic electronic instructional aid that vastly simplifies the teacher's task, it's the Kepeco Electronic Instruction Panel!

Now you can eliminate the use of cumbersome separate voltage supplies with the Kepeco Laboratory Multiple Power Supply. Designed to be used with the Kepeco Electronic Instruction Panel, this versatile, compact, easy-to-use unit supplies four commonly used voltages, is invaluable for the school or industrial laboratory.

CHECK THESE FEATURES:

- Two continuously variable B supplies, adjustable from 0-300 volts at 120 m.a.
- Variable I-grid supply, adjustable from minus 50 to plus 50 volts at 5 m.a.
- 6.3 volt filament supply at 5 amperes.
- All connections made to sturdy, front panel binding posts.
- Input: 105 to 125 volts, 50 to 60 cycles.
- Two 5Y3 rectifiers, Two 6Y6 control tubes.
- 16" long, 8" high, 8 3/4" deep. Wgt.: 28 lbs.

WRITE FOR FULL INFORMATION TODAY!



Kepeco LABORATORIES
Electronic Instruments

149-14 41st Avenue
Flushing, New York



(Continued from page 46A)

- Kruger, W. C., 25 W. 45 St., New York 19, N. Y.
Kuduk, S. T., The Astatic Corp., Conneaut, Ohio
Laikevich, A., 311 Hickory St., Kearny, N. J.
Lamphear, G., R.F.D. 2, c/o Flieschmans, N. Plainfield, N. J.
Lasley, L., Box 393, Kernersville, N. C.
Leeds, P. M., 1841 Mohegan Ave., New York 60, N. Y.
Leichter, R. J., 319 Kenwood Ave., Syracuse 8, N. Y.
Leiphart, J. P. C., 562 Portland St., S.E., Washington 20, D. C.
Leone, R. J., 208-04—50 Ave., Bayside, L. I., N. Y.
Levine, S., 14 W. 29 St., New York 1, N. Y.
Leydorf, G. E., Electrical Engineering Department, U. S. Naval Academy, Annapolis, Md.
Lichtenstein, A. H., 18 George Ave., Sandringham, Johannesburg, S. Africa
Loiterman, L., 5 Hillcrest Ave., Binghamton, N. Y.
Love, G. D., 334 Brunswick St., Fredericton, N. B., Canada
Lynn, H. F., 1 W. 89 St., New York, N. Y.
MacDowell, K. M., 280 Waltham St., West Newton 65, Mass.
MacKechnie, H. K., 146 Langley Rd., Newton Centre, Mass.
MacLean, G., Locust, N. J.
Mariano, F. J., 219 Prospect Pl., Rutherford, N. J.
Marquis, J. B., 104 AACS Det., Westover Field, Mass.
Mathes, R. H., 100 Irvington St., S.W., Washington 20, D. C.
Mathews, M. M., Jr., 4811—Third St., Arlington, Va.
Matland, C. G., 819 Madison Ave., New York 21, N. Y.
McAlpine, W. N., Box 177, Rio Linda, Calif.
McElroy, T. R., Telegraphers Lodge, Littleton, Mass.
McGary, W. T., 4030 Chouteau Ave., St. Louis 10, Mo.
McKinley, H. W., Belleville, N. J.
Meares, C. W., Radio Station WCBT, Roanoke Rapids, N. C.
Meunier, J. L., 5687 Christophe Colomb St., Montreal 10, Canada
Meyer, G. B., 5615 Clearspring Rd., Baltimore 12, Md.
Miller, R. E., Route 1, Box 458-D, Port Arthur, Tex.
Millman, S., 463 West St., New York 14, N. Y.
Milner, C. T., 221 Shennecossett Pkwy., Groton 2, Conn.
Mindes, A. S., 97 Liberty Ave., Belleville 9, N. J.
Monser, C. S., 49 W. 44 St., New York, N. Y.
Montaperto, J. J., 675 E. 92 St., Brooklyn 12, N. Y.
Moody, R. N., 16 John St. N., Hamilton, Ont., Canada
Mooney, P., 8621 Georgia Ave., Silver Spring, Md.
Moore, J. C., Jr., 49 Williams St., New London Conn.
Morrill, C. D., 2341 N. Haven Blvd., Cuyahoga Falls, Ohio
Morris, R. M., 60 S. Clinton St., East Orange, N. J.
Moser, C. M., 218 S. Ardmore Ave., Los Angeles 4, Calif.
Muma, J., Atlantic Electronics Corporation, 84-70 Parsons Blvd., Jamaica 2, L. I., N. Y.
Nasmyth, P. W., 73 Renfrew Ave., Ottawa, Ont., Canada
Neal, F. R., 1356 E. 58 Pl., Los Angeles 1, Calif.
Neeck, J. E., 58-28—150 St., Flushing, L. I., N. Y.
New, W. J., 660 W. 180 St., New York 33, N. Y.
Newlin, G. C., 1441-A 43 St., Los Alamos, N. Mex.
Newman, S. O., 1654 Prospect Pl., Brooklyn 33, N. Y.
Nolan, T. F., Jr., 1523 S St., S.E., Washington 20, D. C.

(Continued on page 56A)

Your Most Complete Source of Supply for RADIO and ELECTRONIC EQUIPMENT • COMPONENTS • ACCESSORIES

TREMENDOUS STOCKS



TRAINED PERSONNEL



is Newark!

No matter what your need — whether Tubes, Components, Test Equipment, Receivers, Transmitters, or Public Address, you can save time and SAVE MONEY by shopping "Newark" first! As one of the largest distributors of radio and electronic components in America, we've got what you want — IN STOCK!

You'll like dealing with "Newark" because —

- Our tremendous stocks of standard brand merchandise always on hand insure speedy shipment of your order.
- Our highly specialized and competent personnel will know what you're talking about.
- Our Special Order Department performs miracles in getting those hard-to-find items that nobody else has!
- Two centrally located warehouses — New York and Chicago — at your service!

MAIL AND PHONE ORDERS
FILLED PROMPTLY

Speedy, Efficient Service
AS NEAR AS YOUR PHONE!
in NEW YORK
Phone: CI. 6-4060
in CHICAGO
Phone: STAt 2950

NEW YORK
Offices & Warehouse
242 W. 55th St., N.Y. 19

NEWARK CHICAGO
323 W. Madison St
Chicago 6, Ill.
ELECTRIC COMPANY, INC.

New York City Stores: 115-17 W. 45th St. & 212 Fulton St.

POWER EQUIPMENT

"Communications"

RADAR AIRCRAFT INDUSTRIAL



MICROWAVE PLUMBING 10 Centimeter

Sand Load (Dummy Antenna) wave guide section with cooling fins, app. 23" high...\$28.00
Waveguide to flexible coax coupler (RG 18/U) 10" high...\$17.50
Magnetron to waveguide coupler with 721-A duplexer cavity, gold plated...\$45.00

3/8" RIGID COAX—3/8" I.C.
Right angle bend, with flexible coax output pickup loop...\$3.00
Short right angle bend, with pressurizing nipple...\$2.00
30 ft. flexible section, 3/8" rigid to 3/8" rigid...\$7.50
Stub-supported rigid coax, gold plated, 5' lengths, 1/2" length...\$5.00
lt. Angles for above...\$4.50
3/8" coax, rotary joint...\$8.00
Magnetron coupling to 3/8" rigid coax...\$4.00
3/8" coax, rt. angle bend 15" L. OA...\$2.00

3 CM. PLUMBING

(Standard 1" x 1/2" guide unless otherwise specified)

TR cavity for 724-A TR tube, transmission or absorption types...\$3.50
724-A TR tube...\$2.50
Waveguide section, CG 251/APS-15A, 26" long choke to cover, with 180 deg. bend of 2 1/4" rad. at one end...\$4.00
Rotary joint with slotted section and type "N" output pickup...\$8.50
Waveguide section, 12" long choke to cover, 45 deg. twist, & 2 1/4" radius, 90 deg. bend...\$4.50
Stabilizer cavity feeding waveguide section, with filtered output and attenuating slug...\$20.00
Slug Turner/attenuator, W.E. guide, gold plated...\$3.75
TR-ATR Duplexer section with wave-meter iris flange...\$4.00
CG/APS-3, straight waveguide section, 10" choke to cover...\$1.75
Right angle elbow, 5 1/4" choke to cover, 2 1/4" radius, E or H plane...\$5.00
Twist, 90 deg., 6" choke to cover...\$5.00
Waveguide Sections 2 1/2" long, silver plated, with choke flange...\$4.50
Waveguide, 90 deg. bend E plane, 18" long...\$4.00
Rotary joint, choke to choke...\$6.00
Rotary joint, choke to choke, with deck mounting...\$6.00
S-curve waveguide, 8" long cover to choke...\$2.50
Duplexer section for 1B24...\$10.00
3 cm. waveguide, 1 1/2" x 1/2" J.D. 1/16" wall per ft...\$1.25
Circular Choke flanges, solid brass...\$.55
"T" section (TR-ATR) choke to choke, supplied with circ. or sh. flanges...\$3.50
Directional coupler CG 124 APS-15A on 16" section cover to cover 15 deg. bend...\$5.00
Feedback dipole with 90 deg. twist, 7 1/4" long...\$3.50
Waveguide to Type "N" Coax Adapter...\$6.50

1.25 CENTIMETER

Wave Guide Section 1" cover to cover 2.00
T Section choke to cover...4.50
Mitred Elbow cover to cover...3.00
"S" section choke to cover...3.50
Flexible Section 1" long choke to choke...3.00
Rotating Joint...35.00

MICROWAVE ANTENNAS

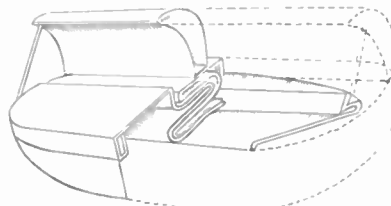

AN/MPG-1 Antenna, Rotary fed type high speed scanner antenna assembly, including horn, parabolic reflector, as illustrated. Less internal mechanisms, 10 deg. sector scan, Approx. 12" L X 4" W X 3" H. Unused...\$250.00

AS 125/APR Cone type receiving antenna, 1000 to 3200 megacycles, New...\$4.50
APS-4 3 cm. antenna, Complete, 1 1/4" dish, Cutler feed dipole directional coupler, all standard 1" x 1/2" waveguide, Drive motor and gear mechanisms for horizontal and vertical scan, New, complete...\$65.00
AN/TPS-3, Parabolic dish type reflector approx. 10' diam. Extremely lightweight construction, New, in 3 carrying cases, \$49.00
RELAY SYSTEM PARABOLIC REFLECTORS; approx. range: 2000 to 6000 mc. Dimensions: 4 1/2" x 3", rectangle, new...\$85.00
TDY "JAM" RADAR ROTATING ANTENNA, 10 cm. 30 deg. beam, 115 v.a.c. drive, New...\$100.00
SO-13 ANTENNA, 24" dish with feedback dipole 360 deg. rotation, New...\$75.00 Used...\$45.00

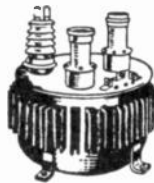

PULSE TRANSFORMERS

W.E. # D166173 HI-Volt input transformer, W.E. Impedance ratio 50 ohms to 900 ohms, Freq. range: 10 kc to 2 mc. 2 sections parallel connected, potted in oil...\$12.00
W.E. KS 9800 input transformer, Winding ratio between terminals 8-5 and 1-2 is 1:1:1, and between terminals 6-7 and 1-2 is 2:1, Frequency range: 380-520 c.p.s. Permalloy core...\$2.00
G.E. # K2731 Repetition Rate: 635 PPS, Pri. Imp: 50 Ohms, Sec. Imp: 450 Ohms, Pulse Width: 1 Microsec, P. Input: 0.5 KV...\$19.50
PK. Sec. Output: 28 KV PK. Peak Output: 800 KW, Bifilar 2.75 Amp.
G.E. K2450A Will receive 13KV, 4 micro-second pulse on pri., secondary delivers 14KV, Peak power out 100KW GE...\$15.00
W.E. # D169271 HI Volt input pulse Transformer...\$9.95
G.E. # K2748A Pulse Input, line to magnetron...\$12.00
Utah Pulse or Blocking Oscillator Transformer, Freq. limits 700-810 cy-3 windings turns ratio 1:1:1 Dimensions 1 13/16 x 1 1/4" 19/32...\$1.50
705-A Rectifier Tube, with ceramic socket...\$1.25

PULSE NETWORKS

G.E. #25E25-1-350-50P2T, 25 KV, 5 sections, "E" circuit, 1 microsecond pulse length, 350 PPS, 50 ohms impedance...\$45.00
G.E. #26E3-5-2000-50P2T, 6KV, "E" circuit, 3 sections, .5 micro-second, 2000 PPS, 50 ohms impedance...\$6.50

MICROWAVE TUBES

Tube	Frg. Range	Pk. Pwr. Out.	Price
2131	2820-2860 mc.	265 KW.	\$15.00
2121A	9345-9405 mc.	50 KW.	\$25.00
2122	3267-3333 mc.	265 KW.	\$15.00
2126	2992-3019 mc.	275 KW.	\$15.00
2127	2965-2992 mc.	275 KW.	\$15.00
2132	2789-2820 mc.	285 KW.	\$15.00
2138 Pkg.	3249-3283 mc.	5 KW.	\$25.00
2155 Pkg.	9345-9405 mc.	50 KW.	\$25.00
3J31	24,000 mc.	35 KW.	\$17.50
W.E. 709A	680-710 mc.	100 KW.	\$35.00
W.E. 720BY	2800 mc.	1000 KW.	\$25.00

(Mfrs. Note: Many Types Available in 1000 Lots)

MAGNETS

For 2J21 (725-A), 2J22, 2J26, 2J27, 2J31, 2J32 and 3J31 Each...\$8.00
4850 Gauss, 5/8" bet. pole faces, 3/8" pole diam...\$8.00
1500 Gauss, 1 1/4" bet. pole faces, 1 1/2" pole diam...\$8.00
1000 Gauss, electromagnet, adjustable 2 1/2" to 3" bet. pole faces, 2 1/4" pole diam...\$12.00

POWER EQUIPMENT

Step down transformer: Amertran Pri: 440/220/110 volts a.c. 60 cycles, 3 KVA, Sec. 115 v. 2500 volt insulation, size: 12" x 12" x 7".....\$40.00

PLATE TRANSFORMER, Amertran Pri: 117 v. 60 cy. Sec. 17,000 v. @ 144 ma, with choke. Oil immersed. Size 26" x 20" x 13".....\$65.00

PLATE TRANSFORMER, Amertran Pri: 220 v. 60 cy. 3 phase, 30 KVA, Sec: 6150, 5620, 5050, 4500 volts Oil filled, 89 gal. with thermostat. Size 64" x 32" x 23", Wt. APX 1500 lbs....\$225.00

VOLTAGE REGULATORS

LINE VOLTAGE REG 2 KV Saturable reactor type Pri 95-130 v 60 cy Sec 115 v 60 cy. 17.4 A 2 KW 100% P.F. Raytheon.....\$160.00

LINE VOLTAGE REG Pri 92-138v 57/63 cy. 1ph 15 A Sec 115v 7.15A. 82 KV 96% P.F. Raytheon.....\$135.00
Self-Contained Unit in Grey Cabinet.

OIL CONDENSERS

.25 mf @ 20000 VDC Aerovox.....\$17.50
1.5 mf @ 6000 VDC Aerovox.....\$12.50

MICA

.08 mf @ 1500 VDC, Sprague MX60 \$11.50
.03 mf @ 2000 VDC, CD 551A-50...\$12.75
.045 mf @ 2000 VDC, Sangamo, G1 \$12.75
.00015 mf @ KV Aerovox 1970-404...\$25.00
.0001 mf @ 20 KV, Sangamo G3...\$25.00
.002 mf @ 15 KV, Sangamo.....\$20.00

LABORATORY ACCESSORIES

Pressurizing unit, MK 23/AP, For transmission line, used with APS-15...\$12.50
Sperry klystron tuner, model 12.....\$2.00
Sine potentiometers, G.E. # 251 x 96 or W.E. # KS 15138 LOI.....\$4.50
CG 27, type "N" cable ass'y, 3' long, male to female.....\$2.50
Flt. xfmr for 872, with socket mounted atop, Pri: 115 v. 60 cy. sec: 5 v @ 10 amps, 35 KV RMS test.....\$12.00
Transformer, Pri: 117 v. 60 cycle, Sec. 17,000 v. @ 144 ma. Oil immersed, with choke.....\$65.00
Phase-shifting capacitor, 180 deg. V.F. # D-150734.....\$2.50
Klystron sockets for 723 A/B and similar types.....\$2 for \$1.00
10 cm. McNally cavity type SG...each \$3.00
Crystal mixer, "S" hand, Complete with type "N" fitting and LN22 crystal...\$3.85
10 cm. Dipole and Reflector with type "N" fitting.....\$2.75
TS 115/APS-2F, 10 cm. antenna in lucite ball, with type "N" fitting.....\$4.50
OAJ Navy type CYT66ADL, 10 cm. antenna in lucite ball, with Sperry fitting...\$4.50
10 cm. feedback dipole antenna, in lucite ball for use with parabola.....\$8.00

INVERTERS

PE 206-A, Input: 28 VDC @ 38 amp. Output: 80 volts @ 500 volt-amps, 800 cycles, Leland, New, complete with enclosed relay, filter, instruction book.....\$12.50
PE 218: Input: 25-28 VDC @ 92 amps. Output: 115 volts @ 1500 volt-amps, 380-500 cycles, New.....\$35.00
Army Reissue.....\$20.00

RADAR SETS

SN RADAR-GE, low power, 5 and 25 miles ranges, Uses GL446 as pulsed oscillator, 5" "A" scope, "S" band. Extremely compact, ideal for demonstration and laboratory work, 115V, 60C operation, Used, Excel. cond.\$600.00

SE 10 CM. SURFACE SEARCH RADAR, W.E., 20,000 to 80,000 yds. range, 250 KW. pk. power input to 706 magnetron, Thyatron modulator, variable pulse rate, Complete set including spare parts, tubes, waveguide and fittings, Send for price and additional information.

RC 145 I.F.F. SET, Consists of xmtr-rev. IC 1067, RA-105A power supply, remote antenna direction controller and indicator X 1 221-A. Transmitter uses 1 KW Pulse oscillator on 150-200 mc. Receiver covers 150-210 mc, using 2 RF stages & 5 IF's. Entire equipment operates from 115 vac, 60 cycles. New, complete...\$190.00

MICROWAVE SPECIALS

10 CM. RF Package, Consists of: 80 Xmtr-receiver using 2J27 magnetron oscillator, 250 KW peak input, 707-B receiver-mixer.....\$150.00
Modulator-motor-alternator unit for above.....75.00
Receiver rectifier power unit for above.....25.00
Rotating antenna with parabolic reflector, New.....75.00
"PPI", rotating yoke type, complete with all necessary oscillator circuits, Ckt tube 5F77, complete with tubes, Used with 80 radar.....\$100.00
RT39/APG-15, Transmitter-receiver, Complete with 2C43 Highthouse plumbing, Ttl. 30 mc. I.F., all enclosed in compact pressurized housing, New, less tubes.....\$100.00
BC 704-A, Indicator from ABE radar equipment, calibrated in nautical miles, New, complete with all tubes.....\$17.50
CP 14 APS-15A Computer, Controls: sweep phasing, range, altitude, Complex slant range-ground range against altitude.....\$15.50
Cursor dial assembly for 7" CR tube, Azimuth calibrated to 360 deg. Roller bearing mechanism.....\$12.50
10 cm. waveguide switch, for switching 1 input to any of 3 outputs, Standard 1 1/2" x 3" sq. flanges, Completes with 115 v. ac or dc arranged switching motor, New, complete.....\$260.00
APS-15 RF PKG. Complete with 725-A magnetron, receiver mixer, and amplifier sections, TR section pulse xfmr, New, complete with RF head and all tubes.....\$150.00

MICROWAVE TEST EQUIPMENT

W.E. I 138 A, Signal generator, 2700-2900 Mc. range, Lighthouse tube oscillator with attenuator & output meter, 115 VAC input, res. Pwr. supply, With circuit diagram, \$50.00
10 cm oscillator cavity for 2C40 light-house tube, with attenuator, thermistor, pickup loop, Heavy silver-plated casting.....\$50.00
TS-238 GP, 10 cm. Echo box with resonance indicator and micrometer adjust cavity.....\$85.00
3 cm. wavemeter: transmission type with square flanges, (Also available in absorption type with square and circular flanges).....\$18.00
3 cm. stabilizer cavity, transmission type.....\$20.00

THERMISTORS
(\$.95 ea.)
Western Electric
D-167332 (Bead)
D-170396 (Bead)
D-168392 (Button)
D-168391 (Bead)

All merchandise guaranteed. Mail orders promptly filled. All prices, F.O.B., New York City. Send Money Order or Check. Shipping charges sent C.O.D.

COMMUNICATIONS EQUIPMENT CO.

131-R Liberty St., New York City 7, N.Y. (Mr. Rosen) Digby 9-4124

VARISTORS
(\$.85 ea.)
Western Electric
D-167176
D-170225
D-168392
D-171121

★

BOEING AIRPLANE COMPANY

Experienced Control and Servomechanism Engineers Needed

Development of: Electronic Control Circuits
High Performance Servo Actuators • Automatic Computers

Analytical Studies of: Dynamical Systems
Aerodynamic Control Techniques • Computation Systems

Problems are related to commercial and military aircraft and guided missiles. Employment is stable and offers opportunity for advancement to those able to assume responsibility. Present staff includes highly qualified physicists, engineers and mathematicians, and insures a stimulating professional environment. Imaginative and original design thinking is particularly encouraged. Liberal patent and publication policy. Apply through Personnel Manager, Boeing Airplane Company, Seattle 14, Washington.

Physicists – Electronic Engineers Needed For Research and Development Laboratory

Interesting opportunities for qualified
GRADUATE ENGINEERS with ELECTRONIC RESEARCH,
DESIGN and/or DEVELOPMENT experience.

Please furnish complete resume of education, experience
and salary expected to Personnel Manager

**BENDIX RADIO DIVISION of Bendix
Aviation Corporation
BALTIMORE 4, MARYLAND**

Engineers – Electronic

Senior and Junior, outstanding opportunity, small growing company. Forward complete resumé giving education, experience and salary requirements to

Box 509

**The Institute of Radio Engineers
1 East 79th St., New York 21, N.Y.**



The following positions of interest to I.R.E. members have been reported as open. Apply in writing, addressing reply to company mentioned or to Box No. ...

The Institute reserves the right to refuse any announcement without giving a reason for the refusal.

PROCEEDINGS of the I.R.E.

1 East 79th St., New York 21, N.Y.

ENGINEER OR PHYSICIST

Engineer or physicist for mathematical research work on vacuum tubes. Should have a good knowledge of microwave tubes and electron optics. Apply Director of Research, 350 Scotland Road, Orange, New Jersey, National Union Radio Corporation.

SCIENTISTS AND ENGINEERS

Wanted for research and advanced development work in the fields of microwaves, radar circuits, gyroscope systems, servomechanisms and general electronics. Scientific or engineering degrees required. Salary commensurate with experience and ability. Inquiry should be directed to Manager, Engineering Personnel, Bell Aircraft Corporation, Buffalo 5, N.Y.

ELECTRICAL ENGINEERS AND PHYSICISTS

An expanding program of teaching and research has created opportunities as instructor, assistant professor and associate professor level in a large mideastern college. Your inquiries are invited. Box 500.

SENIOR ENGINEER

Fine opportunity with a large midwestern radio corporation. Must have a minimum of three years' experience in loud-speaker design and materials used in manufacturing. College education in electronics or equivalent. In replying state age, education, experience and salary requirements. Box 507.

ENGINEERS

Technical college in northern New York is adding several staff members to the Department of Electrical Engineering. Men with some experience in research or design and development in communications—electronics or physics preferred. Salary and rank will be commensurate with training and experience. Box 508.

ELECTRONICS ENGINEER

Graduate electronics engineer, experienced in the application of electronic controls on airborne equipment. Some production and development experience is essential. In reply, give training, experience and other pertinent facts. Box 510.

ENGINEER

Engineer—Transformer (power, audio and pulse). Thoroughly familiar with electronic circuits; production methods. Contact customers for technical purposes. Location about midway between New York and Chicago. Box 511.

(Continued on page 52A)

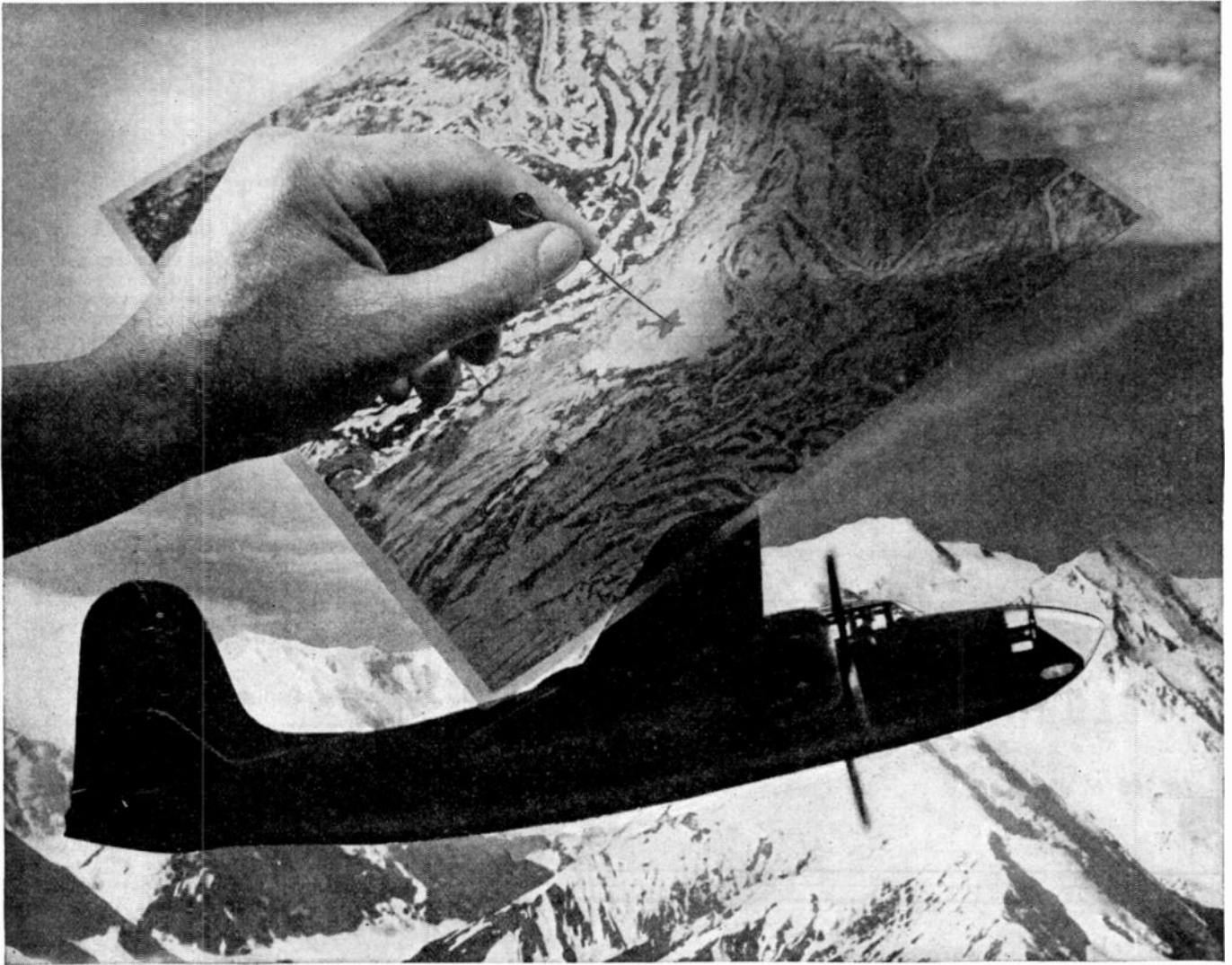

Developed by RCA as an aid to blind bombing in wartime, Shoran is a new Radar yardstick for world mapping.

WANTED! Design and Development Engineers

Shoran, a surveying system with pin-point accuracy, is typical of RCA leadership in Airborne Electronics.

Continued expansion of the diversified aviation activities at RCA have created additional opportunities for experienced design and development electronic engineers.

If you are looking for an opportunity to work with stimulating associates and unequalled equipment with splendid chances for advancement, send us an outline of your training and experience, with full personal details.

Write to: Camden Personnel Division
RCA Victor Division
Camden, New Jersey

ELECTRICAL AND MECHANICAL ENGINEERING POSITIONS OPEN

FOR ELECTRICAL AND MECHANICAL ENGINEERS EXPERIENCED IN DESIGN OF HOME, TELEVISION AND AUTO RADIO RECEIVERS.

COLLEGE EDUCATION DESIRABLE BUT NOT NECESSARY IF SUFFICIENTLY EXPERIENCED. PLEASANT AND ATTRACTIVE WORKING CONDITIONS. PENSION AND INSURANCE PLANS.

Write Details of Education, Experience and Salary Required

QUALIFIED INDIVIDUALS WILL BE GRANTED APPOINTMENTS FOR INTERVIEWS IN BUFFALO AT OUR EXPENSE

COLONIAL RADIO CORPORATION

ENGINEERING DIVISION

1280 MAIN ST.

BUFFALO 9, N.Y.

ELECTRONIC MAJOR

●

Offering recent graduate interested in electronic digital computers, permanent well-paying position. Submit letter detailing experience, personal data, education and salary. Address Box No. 719.

●

THE INSTITUTE OF RADIO ENGINEERS

1 East 79th St., New York 21, N.Y.

Zetka Flat-Faced 15-Inch Cathode Tube Gives Bigger Television Picture

You gain a competitive advantage from this new tube. It yields a 135 sq. in. picture even after being masked. Compare with the average of 123 sq. in. available from ordinary oval shaped 15 inch tube.

The Zetka tube is of the magnetic focus and deflection type. A substantial cathode, indirectly heated, is the electron source. Range of operation is from 9,000 to 15,000 V, anode voltage. Another feature is the ion trap which eliminates the ion spot that forms in the middle of the face on many tubes.

Write for specifications and data sheet today.

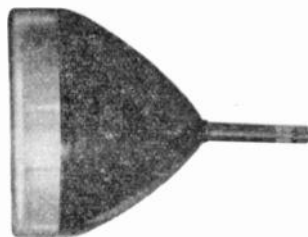

Note the virtually flat face which provides unusually large useful screen area without distortion.

ZETKA LABORATORIES, INC., 131-137 Getty Ave., Clifton, N.J.



(Continued from page 51A)

ELECTRICAL ENGINEERS

Wanted: Electrical engineers with B.S. degree or equivalent experience for engineering application and operational work with electronic equipment—company conducting airborne geophysical surveys involving extensive United States or foreign travel—bonus for flying and overseas duty. Box 512.

MICROWAVE ENGINEERS

Engineers or physicists for research and development in microwave field. Bachelor's degree essential, Master's degree preferred. Positions open at both senior and junior levels. Salary commensurate with ability. Company has long term program and offers excellent working conditions including opportunity for advanced study. Location, Brooklyn, N.Y. Give complete information in reply. Box 513.

ENGINEERS—PHYSICISTS

The Aeronautical Research Center of the University of Michigan at Willow Run, Michigan, has several openings for engineers and physicists with experience in the fields of servo-mechanisms, electronics and instrumentation. Interested applicants should furnish complete outline of experience with letter of application. University of Michigan, Personnel Office, 208 University Hall, Ann Arbor, Michigan.

PURCHASING DIRECTOR

Purchasing Director wanted for nationally known radio manufacturing company. Excellent salary. Permanent. Fine future. Apply: Rawle Deland, 1440 Broadway, New York 18, N.Y.

RESEARCH SCIENTISTS

Scientific research and development positions at the Naval Research Laboratory, Washington, D.C. are open in the fields of physics, mathematics, engineering (including electronics, radio, electrical, mechanical, chemistry, metallurgy, etc.). A Bachelor's degree in the appropriate field from an accredited college or university is essential. Advanced academic standing and pertinent research experience is desirable. Both permanent and summer research and development positions are open. Qualified scientists are invited to communicate with Employment Officer, Code 151 (I), Naval Research Laboratory, Washington 20, D.C.

TECHNICAL RADIO ENGINEER

Radio Engineer, capable of adjusting (or learning) complex directional antennas, for position with Washington consultant. State detailed qualifications, education and salary requirements. Box 514.

ELECTROLYTIC CAPACITOR ENGINEER

Exceptional opportunity for right man who can qualify for development engineering post with leading manufacturer. Please send complete particulars in first letter. Our men know of this advertisement. Reply Box No. 515.

OPPORTUNITIES AT HAZELTINE

We have several openings for development and design engineers who have a thorough knowledge of fundamentals and at least 2 years experience in radio communications or Radar.

Our Laboratories are located in a pleasant suburban section of Long Island, within a half-hour of Times Square.

Please write details of education, experience and salary requirements (all inquiries confidential) to:

Director of Engineering Personnel

HAZELTINE ELECTRONICS CORPORATION

Little Neck, L.I., N.Y.

ELECTRICAL ENGINEER

... to prepare technical manuscripts covering certain operations of the Los Alamos Laboratory. Applicant should have B.S. degree in Electrical Engineering with considerable experience in engineering and technical writing, although any mechanical or electrical training and/or experience would be helpful.

Interested persons may write directly to:

Personnel Manager

P.O. Box 5800, Albuquerque, New Mexico



Positions Wanted By Armed Forces Veterans

In order to give a reasonably equal opportunity to all applicants, and to avoid overcrowding of the corresponding column, the following rules have been adopted:

The Institute publishes free of charge notices of positions wanted by I.R.E. members who are now in the Service or have received an honorable discharge. Such notices should not have more than five lines. They may be inserted only after a lapse of one month or more following a previous insertion and the maximum number of insertions is three per year. The Institute necessarily reserves the right to decline any announcement without assignment of reason.

JUNIOR ENGINEER

B.S.E.E., Carnegie Tech. in September, 1947. Age 22. Single. 2 years Navy electronics experience. Desires position in electronics research design or development. Box 139W.

JUNIOR ENGINEER

Graduate of RCA Institutes. Age 27. Married. Desires work in radio, electronics, television production or development anywhere in U.S. 3 years radio work in Army. Box 140W.

SALES ENGINEER

Sales Engineer: Broadcast Engineer, past three years as Chief Engineer of local station. Interested in entering sales field as an engineer with an established manufacturer of broadcast equipment. Family man. 28 years old; prefer southwest territory. Box 144W.

ELECTRICAL ENGINEER

Electrical Engineer. Age 27. Single. B.E.E., 1949. 5 years experience in testing, development, drafting and maintenance of electrical equipment. Wants New York sales position with electrical or electronic equipment manufacturing company. Sales training must be part of long term program. Write Box 145W.

ELECTRICAL ENGINEER

B.E.E., 1943, C.C.N.Y.; M.S., 1948, Columbia University. Age 27. Married. Six years experience on electronic research, product engineering and instructing including one year AAF service. Available June, 1948. Prefer Omaha, Nebraska or New York. Box 146W.

JUNIOR ENGINEER

School: RCA Institutes, Inc., N.Y.C., 1948. Ex-Petty Officer Telegraphist (Royal Canadian Navy). Married. No children. Experience: Radio assembly. Operation, maintenance and installation of receivers, transmitters (LF, UHF), radar, RDF (LF, VHF), loran. Interested in engineering and sales. Box 147W.

(Continued on page 54A)

WANTED PHYSICISTS ENGINEERS

Engineering laboratory of precision instrument manufacturer has interesting opportunities for graduate engineers with research, design and/or development experience on radio communications systems, electronic & mechanical aeronautical navigation instruments and ultra-high frequency & microwave technique.

WRITE FULL DETAILS
TO
EMPLOYMENT SECTION

SPERRY GYROSCOPE

COMPANY, INC.

Marcus Ave. & Lakeville Rd.
Lake Success, L.I.

SUPERVISORY PRODUCTION ENGINEER

With a minimum of five years' experience in radio tube production engineering, as an executive or supervisory engineer. Plant located in Eastern Pennsylvania area. Submit complete resume to Mr. Edward J. Danneberg, Industrial Relations Director, Tung-Sol Lamp Works Inc., 200 Bloomfield Avenue, Bloomfield, New Jersey.

Now Know Power fed to Antenna
while operating

ROLLIN

VHF - UHF **RF**
WATTMETER
MEASURES
POWER • IMPEDANCE
SWR
70 MC TO ABOVE 400 MC

NOT
ABSORPTION
TYPE

GENERAL
LABORATORY
USE



**DIRECT
INDICATION
OF POWER
AND SWR**

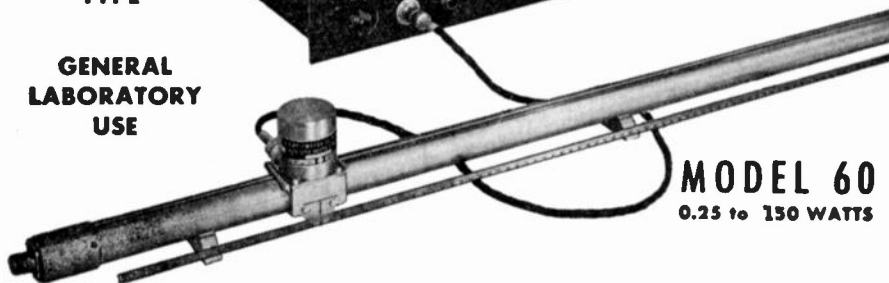

MODEL 60
0.25 to 150 WATTS

- Measures power flowing through transmission line to antenna under wide range of standing wave conditions and antenna impedances.
- Direct reading meter with 4 calibrated ranges; 0.25-5, 5-15, 15-50 and 50-150 watts. Meter has adjustable reference pointer for noting any change in power.
- Precision 50 ohm slotted line with solid dielectric, type N connectors and centimeter scale.
- Accurate step type wire wound controls indicate standing wave ratio (SWR).
- Model 60 is a complete set of equipment for impedance measurements by slotted line method (only r.f. power source required).

WRITE FOR DETAILS

ROLLIN

THE ROLLIN COMPANY
2070 N. FAIR OAKS AVENUE • PASADENA 3, CALIFORNIA

Positions Wanted

(Continued from page 53A)

ELECTRICAL ENGINEER

B.E.E., R.P.I. (Communications), Age 26. Married. 1 child. Two years Navy maintenance of radio and radar equipment. One year Civil Service testing VHF-UHF transceivers. Current development of signal generators. Desires position as sales engineer. Box 148W.

ADMINISTRATIVE ENGINEER

Registered electrical engineer (N.Y.) FCC licenses. Eight years experience in engineering, production, construction and administration; with power, communications and aircraft organizations. Harvard Business School graduate. Navy radar trained veteran. West coast preferred. Box 149W.

ELECTRICAL ENGINEER

B.S.E.E., Columbia, June, 1948. Age 29. Married. 2½ years Naval radar; 1 year Naval Research Lab., 1½ years instructor in theory and shop practice; 5 years experience in production planning and coordinator-metal and woodworking manufacturing. Tau Beta Pi. Desires position in design, development or production anywhere in the U.S. Box 150W.

ENGINEER

B.S.E.E., M.I.T., February, 1943. Completing graduate work for E.E. degree (minor in Business Administration), Standord, June, 1948. Age 27. Married. One child. 3½ years experience Naval shipboard and airborne electronics including assignments with N.R.L. and Airborne Coordinating Group (BuAero). Amateur radio 10 years. Research or development. Box 151W.

TELEVISION ENGINEER

B.E.E., Cooper Union. Age 25. Single. 3½ years experience in development and design of U. S. Navy Airborne I.F.F. and Airborne television receivers, F.M. radar system, civilian television receivers. Also maintenance and operation of radar sets in Army Ground Forces. Desires position in design of electronic equipment; New York City vicinity or northeast. Box 160W.

ENGINEER

B.E.E. (R.P.I., 1941), LL.B. (Brooklyn Law School, 1948). 5 years product and research engineering in electronic servo-control systems. Ex-engineering officer. Seeking position in patents, legal department, or as junior executive. FCC radio telegraph, 1st class, 10 years. Write Box 161W.

ENGINEER

Engineer B.S. in E.E., M.S. in Ae.E. 4½ years experience in development, test and manufacturing of automatic flight control systems for conventional aircraft and guided missiles. Desires position in New York City area. Available in June. Box 162W.

ELECTRONIC ENGINEER

B.S.E.E. from Northeastern University, Boston, September, 1947. Two years experience as Navy radio technician with Navy radar and communications equipment. Some experience in sonar equipment design at Naval Research Lab.,

(Continued on page 55A)

At last...

**AN IMPROVED AND FASTER MEANS
FOR AUDIO WAVEFORM ANALYSIS**

**PANORAMIC
SONIC ANALYZER**

Model AP-1

Now, in a matter of seconds, you can observe differences in waveform content produced by parameter variations. Model AP-1 indicates graphically the frequency distribution and amplitude of audio wave components. Slow painstaking point-by-point frequency checks are eliminated. Ease of operation and simplicity of presentation make Model AP-1 ideally suited for production line as well as for laboratory usage.

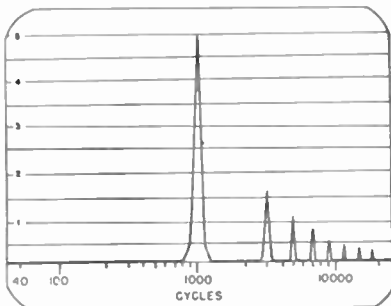

CHECK THESE FEATURES...

- Panoramic graphic presentation of frequency versus voltage amplitude
- Continuous scanning from 40-20,000 c.p.s. in one second
- Wide voltage range 0.05V to 500V
- Simple operation
- Direct simultaneous reading of voltage and frequency
- Automatic variable selectivity for optimum resolution throughout frequency range (see graph below)
- Both linear and log voltage calibrations
- Built-in voltage calibrator
- Frequency scale closely logarithmic

APPLICATIONS...

- Intermodulation measurements
- Harmonic analysis
- Noise investigations
- Acoustic studies
- Vibration analysis
- Material testing

Write now for detailed specifications, price and delivery

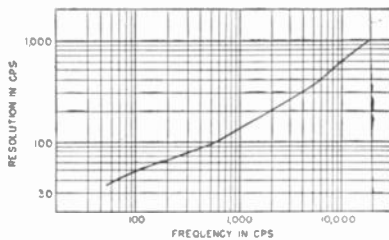

**PANORAMIC
RADIO CORP.**

92 Gold St. Cable Address
New York 7, N. Y. PANORAMIC, NEW YORK

Exclusive Canadian Representative: Canadian Marconi, Ltd.

Positions Wanted

(Continued from page 54A)

Washington, D.C. Hold 1st class phone license. Member Tau Beta Pi. Desire position in research, design or development in N. Y. Metropolitan area. Box 163W.

ENGINEER

Graduate of McGill University. Age 30. Married. Desires work in radio, radar, television research or development. 4 years with National Research Council, Ottawa, on radar development. 6 years of radio experience with other companies. Box 164W.

ELECTRONIC PHYSICIST

B.S. and graduate study in physics, C.R.E.I. graduate, business college. 1 year general engineering, 4 years Naval radar maintenance. Some geophysical experience. Age 26. Married. Foreign or field position desired. Box 165W.

JUNIOR ELECTRICAL ENGINEER

B.E.E., 1943, Cooper Union. M.S., Harvard, 1948. 2½ years design and development industrial controls and measurements, servomotors and synchros. Prefer New York City. Available June. Box 166W.

ELECTRICAL ENGINEER

Electrical Engineer, age 26. B.E.E., M.E.E. Capable research man, desires position in video, medical or physics instrumentation, or other circuit research. Tau Beta Pi, Eta Kappa Nu. Available August. Box 167W.

ENGINEERING PHYSICIST

B.S. Engineering, physics 1941; advanced mathematics; 7 years research and development, electronic, mechanical, optical, hydraulic fire control material; extensive liaison experience; 3½ years Ordnance Officer; employed. Desires shift to nuclear energy field. Box 168W.

JUNIOR ENGINEER

College Junior, Syracuse University. Age 25; Army experience 3 years VHF link-carrier; amateur license; interested in summer 1948 position. Location irrelevant. Box 169W.



PROTECT YOUR FUTURE

BUY YOUR EXTRA SAVINGS BONDS NOW



ANOTHER *New* BROWNING DEVICE

**SWEEP CALIBRATOR
MODEL GL-22**

Pulsed timing marker oscillator for standard oscilloscopes and synchrosopes. Variable amplitude markers. Markers available at 0.1 to 100 microseconds.

Frequency meters. WWV standard frequency calibrator Oscilloscope. Power supply and square wave modulator Capacitance Relay. FM-AM Tuners. FM Tuner.

**WRITE TO
DEPT. A FOR
CATALOG**

**KNOW THE ENTIRE
BROWNING LINE**
ENGINEERED for ENGINEERS



**COMPUTER
ENGINEER**

Nationally known organization seeks experienced engineer to assist in construction and operation of large scale electronic digital computers. This is a permanent position with operating company. To conserve your time and ours, letter should include complete summary of personal and professional data, including education, management and business background, religion, dependents, salary requirements and references. This is an outstanding opportunity for qualified man. Address Box No. 720.

**THE INSTITUTE OF
RADIO ENGINEERS**
1 East 79th St.
New York 21, N.Y.



FINGERTIP CONTROL FOR VARIABLE ELEMENTS

with **S.S.WHITE**
FLEXIBLE SHAFTS

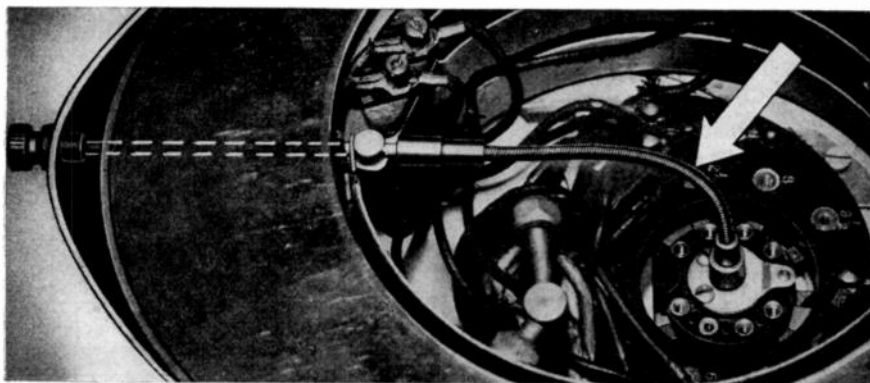

FINGER TIP CONTROL of variable elements in radio and other electronic equipment means—control located *at* the operator's fingertips—and control so smooth and effortless it can be operated *with* the fingertips.

With S.S.White remote control flexible shafts, developed specially for this service, you can satisfy both.

Above you see a typical example. It's the accessory table of a costly, intricate dental unit shown with cover removed. For reasons of assembly and wiring, the designer located the rotary switch where it is. And he placed the control knob where you see it because it is the most convenient point for operation. Placing both in these positions was no problem—thanks to the S.S.White flexible shaft.

Consider the picture for a moment. It makes clear that this use of flexible shafts to couple variable elements and their controls, removes practically all restrictions as to location and gives wider freedom in design.

GET FULL DETAILS IN THIS FREE HANDBOOK

This 260-page book gives complete information and engineering data about flexible shafts and how to select and apply them. We'll gladly send you a copy free, if you write for it on your business letterhead and mention your position.



S.S.WHITE
THE S. S. WHITE DENTAL MFG. CO. **INDUSTRIAL** DIVISION
DEPT. G 10 EAST 40th ST., NEW YORK 16, N. Y.



FLEXIBLE SHAFTS • FLEXIBLE SHAFT TOOLS • AIRCRAFT ACCESSORIES
SMALL CUTTING AND GRINDING TOOLS • SPECIAL FORMULA RUBBERS
MOLDED RESISTORS • PLASTIC SPECIALTIES • CONTRACT PLASTIC MOLDING

One of America's AAA Industrial Enterprises



(Continued from page 48A)

- Nussbaum, R. D., 2133 N. 33 St., Philadelphia 21, Pa.
O'Connell, E. F., Jr., 318 Atlantic St., Bridgeport 4, Conn.
Ohlstein, H., 1365 W. 7 St., Brooklyn 4, N. Y.
O'Meara, W. J., 4-04 Berdan Ave., Fair Lawn, N. J.
Orne, P. W., 58-40—150 St., Flushing, L. I., N. Y.
Pallme, E. H., 375 Oak Place, Mineola, N. Y.
Patterson, H. H., Jr., R. D. & T. Electronics, Naval Ord. Test Station, Inyokern, Calif.
Penwell, G. N., 610 S. 7, Bozeman, Mont.
Perry, T., 4 Pine Tree Lane, Glastonbury, Conn.
Petersen, V. W., Electronics Test Annex, Naval Air Test Center, Patuxent River, Md.
Petrik, A., 67-86 Selfridge St., Forest Hills, L. I., N. Y.
Petrucci, F. A., 19 N. Fourth Ave., Highland Park, N. J.
Piller, S. E., 533 W. 112 St., New York 25, N. Y.
Pollock, A. H., Box 1, Portland, Conn.
Pondrom, A. J., 18 Jean Dr., Florissant 21, Mo.
Porterfield, E. A., 41 Winnebago Rd., Tuckahoe 7, N. Y.
Prochaska, Q. V., Radio Station KDIX, Dickinson, N. Dak.
Ralls, R. H., 4D 1050 Pentagon Bldg., Washington 25, D. C.
Ramsay, W. R., 536 W. 112 St., New York 25, N. Y.
Rank, W. B., 207 Garner St., Houston 17, Tex.
Rathje, E., 435 N. Union Ave., Cranford, N. J.
Raycer, P. M., 333 E. 69 St., New York 21, N. Y.
Raymond, J. L., 11308 Hopkins Ave., Cleveland 8, Ohio
Reed, E. D., 1523 Union St., Brooklyn 13, N. Y.
Reynolds, D. K., 2 Ware St., Cambridge 38, Mass.
Rich, R. S., 1252 Venetia Ave., Coral Gables, Fla.
Richards, G. A., 216 Brookdale Ave., Toronto 12, Ont., Canada
Richardson, H. J., 608 N. Eastside St., Olympia, Wash.
Rider, F. E., WQAM, Miami, Fla.
Ridgers, C. E., 316 Queenstown Rd., Battersea, London S.W. 8, England
Roberts, R. A., 15 Elkins St., South Boston 27, Mass.
Robertson, J. D., 48 Blenheim Dr., Manhasset N. Y.
Robinson, R. O., Jr., 8912 First Ave., Silver Spring, Md.
Rockman, I. A., 186 Fowler Pl., Kenmore 17, N. Y.
Roel, E. L., 1327 E. 21 St., Brooklyn 10, N. Y.
Rosenberg, J., 191 Sandford St., New Brunswick, N. J.
Ross, R. P., 1785 Massachusetts Ave., Washington, D. C.
Rothauge, C. H., 931 N. Bentalou St., Baltimore 16, Md.
Rowley, W. E., Jr., 29 Sullivan Rd., Farmingdale, N. Y.
Roy, J. A. S., Bureau of Ordnance, Navy Dept. Washington 25, D. C.
Rubin, M. H., 159 Charles Ave., Staten Island 2, N. Y.
Rubiato, J. M., Research Laboratory of Electronics, Room 20-A-117, Cambridge 39, Mass.
Russell, W. D., Box 386, New Liskeard, Ont., Canada
Sahasrabudhe, V. B., E. C. Dept., Indian Institute of Science, Bangalore, Malleshwaram, S. India
Sale, P. A., "Pokiok," S. Shore Rd., Smith's Parish, Bermuda
Sands, E. A., 19 E. 80 St., New York, N. Y.
Santisteban, J. A., Box 7296, Louisiana State University, Baton Rouge, La.
Sauer, R. J., 506 Volusia Ave., Dayton 9, Ohio
Sauesser, J. M., Westinghouse Electric Co., 2519 Wilkens Ave., Baltimore, Md.
Saxe, R. E., 83-30 Kew Gardens Rd., Kew Gardens, L. I., N. Y.
(Continued on page 57A)



Cannon Electric Type K Receptacle on Collins Radio's Antenna Loading Unit. Receptacle shown on unit. Plug type illustrated at left.

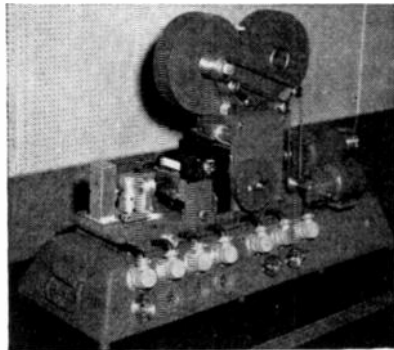

Type P Connectors in Reeves' Sound Recorder. Type P Receptacle shown at right.

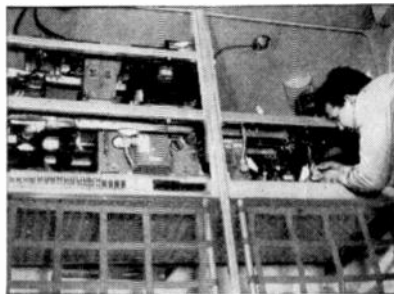

Installation of AN and K Plugs on Bendix radio equipment installed on the Martin "202" transport.

For a general review of Cannon Plugs, with prices, write for C-47 Catalog or specify engineering bulletin for specific type series.

CANNON
ELECTRIC

Development Company

3209 HUMBOLDT ST., LOS ANGELES 31, CALIF.

IN CANADA & BRITISH EMPIRE:
CANNON ELECTRIC CO., LTD., TORONTO 13, ONT.

WORLD EXPORT (Excepting British Empire):
FRAZER & HANSEN, 301 CLAY ST., SAN FRANCISCO



(Continued from page 56A)

- Schecter, H., 5 Liberty Ave., Lexington 73, Mass.
Schmitz, R. A., Remington Rand Laboratory for Advanced Engineering, S. Norwalk, Conn.
Schrader, L. W., Jr., 804 Magie Ave., Elizabeth 3, N. J.
Schwartz, M. B., 31 E. 21 St., Brooklyn 26, N. Y.
Schwartz, R. B., 4304 Kaywood Dr., Mt. Rainier, Md.
Schwarz, H. G., Signal Corps Engineering Laboratories, Fort Monmouth, N. J.
Scott, R. G., 10 Twin Oak Rd., Livingston, N. J.
Seewald, E. C., 136 Osborn Rd., Aberdeen, Md.
Seidman, A., 2952 Fulton St., Brooklyn 7, N. Y.
Shadle, P. W., Brown's Trailer Court, Route 6, Lodi, N. J.
Shaper, H. B., c/o Dyna-Laboratories, 151 Lafayette St., New York, N. Y.
Sharp, D. R., 85 Manderley Dr., Toronto 13, Canada
Shottenfeld, R., 85-77 Chevy Chase St., Jamaica 3, L. I., N. Y.
Siedlarz, J. B., Jr., 1012 Ravine St., Munhall, Pa.
Silber, A., 1 Christopher St., New York 14, N. Y.
Sims, J. C., Jr., Eckert-Mauchly Computer Corp., Philadelphia, Pa.
Skibneski, C. E., 25 W. 39 St., Bayonne, N. J.
Smith, A. E., 127 Joliet St., S.W., Washington 20, D. C.
Smith, H. R., 463 Belleville Ave., Glen Ridge, N. J.
Smith, H. F., Jr., 2617 N. Magnolia Ave., Chicago 14, Ill.
Smye-Rumsby, B. A. A., 13 Charlton Ave., Dover, Kent, England
Sorg, L. F., Pershing Ave., Locust Valley, N. Y.
Sorrows, H. E., Room 302, Radio Bldg., National Bureau of Standards, Connecticut Ave. & Van Ness St., Washington, D. C.
Spence, A. H., Western Electric Co., 555 Union Blvd., Allantown, Pa.
Staudt, W., 61 Locust Hill Ave., Yonkers 2, N. Y.
Stein, S., 6120-23 Ave., Brooklyn 4, N. Y.
Stephens, H. M., 777 S. Westmoreland Ave., Los Angeles 5, Calif.
Stewart, A. E., 2051 Ryer Ave., Bronx 57, N. Y.
Stier, R. J., 543 Hillcrest Ave., Westfield, N. J.
Stillman, A. H., 43 Farrandale Ave., Bloomfield, N. J.
Stocking, M. H., R.D., Avon, Conn.
Stouch, D. H., 538 Telford Ave., Dayton 9, Ohio
Stout, J. V., 4640 York Rd., Baltimore 12, Md.
Strasser, S., 1004 1/2 Fifth Ave., Asbury Park, N. J.
Strothman, R. A., 35 Bingham Ave., Rumsen, N. J.
Sulzberger, T. F., 92 N. Roys Ave., Columbus, Ohio
Swafford, J. E., Box 481, Hampton, Va.
Sweeney, W. R., 17 Wyatt Rd., Garden City, L. I., N. Y.
Thomas, A. R., 601 W. Maunee, Angola, Ind.
Thomas, R. R., Jr., Radio Station WOAY, Oak Hill, W. Va.
Thwing, R. W., 185-34 Dunlop Ave., St. Albans, N. Y.
Tolsch, I. H., 48 Aster Ave., N. Merrick, L. I., N. Y.
Trotter, G. C., 134-A Brattle, Cambridge 38, Mass.
Ussery, P. W., 106 Cromwell St., Montgomery 5, Ala.
Vajapeyan, K., 601 W. 139 St., New York, N. Y.
Vogel, W. H., Jr., Mountain Heights Ave., Lincoln Park, N. J.
Walker, P. F., 419 S. East Ave., Oak Park, Ill.
Wallace, M. W., Federal Telecommunications Laboratories, Nutley, N. J.
Walsh, G. W., 28 Winn St., Belmont 78, Mass.
Waring, R. O., 43-17 Bowne St., Flushing, L. I., N. Y.
Warner, H., 4814 W. Sansom St., Philadelphia 39, Pa.
Watkins, A. E., 242 Sycamore St., Waverly 79, Mass.

(Continued on page 58A)

MEASUREMENTS CORPORATION Model 59

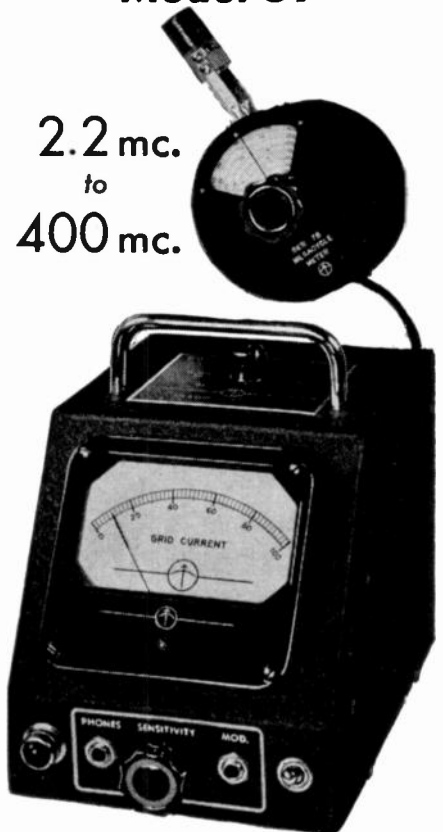

2.2 mc.
to
400 mc.

MEGACYCLE METER

Radio's newest, multi-purpose instrument consisting of a grid-dip oscillator connected to its power supply by a flexible cord.

Check these applications:

- For determining the resonant frequency of tuned circuits, antennas, transmission lines, by-pass condensers, chokes, coils.
- For measuring capacitance, inductance, Q, mutual inductance.
- For preliminary tracking and alignment of receivers.
- As an auxiliary signal generator; modulated or unmodulated.
- For antenna tuning and transmitter neutralizing, power off.
- For locating parasitic circuits and spurious resonances.
- As a low sensitivity receiver for signal tracing.

MANUFACTURERS OF
Standard Signal Generators
Pulse Generators
FM Signal Generators
Square Wave Generators
Vacuum Tube Voltmeters
UNF Radio Noise & Field Strength Meters
Capacity Bridges
Megohm Meters
Phase Sequence Indicators
Television and FM Test Equipment

SPECIFICATIONS:
Power Unit: 5 1/8" wide;
6 1/8" high; 7 1/2" deep.
Oscillator Unit: 3 3/4" diameter; 2" deep.

FREQUENCY:
2.2 mc. to 400 mc.;
seven plug-in coils.

MODULATION:
CW or 120 cycles; or
external.

POWER SUPPLY:
110-120 volts, 50-60
cycles; 20 watts.

MEASUREMENTS CORPORATION
BOONTON  NEW JERSEY



and now the
GREENOHM JR.

★ A chip off the old block! The Greenohm Jr. is a handy, inexpensive, midget, ceramic-cased wire-wound resistor for tight spots and point-to-point wiring. Takes place of cumbersome and costlier bracket-mounted resistors.

Wire winding on fibre-glass core. Axial bare pigtail leads clinched to ends. Encased in green steatite tube filled and sealed with exclusive Greenohm inorganic cement. Won't blister, crack or change shape.

Type C7GJ measures 1 3/4" long by 5/16 dia. 2" leads. 7 watts. Practically zero to 5000 ohms max. Smaller Type C4GJ, 1" long by 5/16 dia. 4 watt. Up to 1000 ohms.



Bulletin No. 110 with complete specs, on request. Also sample. Let us quote.

Controls and Resistors

CLAROSTAT MFG. CO., Inc. - 285-7 N. 6th St., Brooklyn, N. Y.

In Canada: CANADIAN MARCONI CO., LTD.
Montreal, P.Q., and branches



(Continued from page 57A)

- Watson, B., U. S. Naval Tanker Anacostia, c/o Tankers Company, Inc., 17 Battery Pl., New York, N. Y.
- Waxler, D., 97 Joline Ave., Long Branch, N. J.
- Wearn, W. C., c/o Weldon and Carr, 1605 Connecticut Ave., Washington, D. C.
- Webb, J. C., 142 S. Highland Ave., Ossining, N. Y.
- Weintraub, H. H., 1322 College Ave., New York 56, N. Y.
- Weitz, M. L., 290 E. 93 St., Brooklyn 12, N. Y.
- Weltin, O. K., 22 E. 68 St., New York 21, N. Y.
- Westwood, D. H., 215 Mt. Vernon Ave., Haddonfield, N. J.
- Whyman, L. O., R.R. #1, Box 174F, Houston, Tex.
- Wike, E. A., 2446 N. Springfield Ave., Chicago 47, Ill.
- Wilcox, D. E., 3709 W. 105 St., Inglewood, Calif.
- Wild, T. A., 705 Washington Ave., Towson 4, Md.
- Willey, F. G., Box 533, Babylon, L. I., N. Y.
- Wolfe, A. E., Jr., 391 Truman Boyd Manor, Long Beach 10, Calif.
- Wolin, L., 7262 Glenthorne Rd., Upper Darby, Pa.
- Woodmansee, B. S., Murray Hill, N. J.
- Woodruff, J. H., 11 MacDougall St., Auburn, N. Y.
- Wright, G. B., 28 W. Orchard St., Hempstead, L. I., N. Y.
- Yeh, C., c/o Dr. C. K. Jen, 1 Dana St., Cambridge, Mass.
- Yewdall, G. E., 610 Chestnut St., Palmyra, N. J.
- Zeichner, D., 6655 Sedgewick Pl., Brooklyn, N. Y.
- Zuckerman, B., 1302 Turner Ave., Wanamassa, N. J.

News—New Products

These manufacturers have invited PROCEEDINGS readers to write for literature and further technical information. Please mention your I.R.E. affiliation.

(Continued from page 24A)

Adjustable End-Link Coil

The Pitco adjustable end-link coil, a new design of the Pittsburgh Coil Co., Carnegie, Pa., will operate with high efficiency on a variety of circuits and with beam-power tubes. This new coil can be substituted for the standard end-link model wherever desired. It is readily adjustable by moving the end link with the hand, and is available in 75-, 150-, 250-, and 500-watt sizes.

When writing to these advertisers, please mention Proceedings of the I.R.E.

(Continued on page 59A)

**MICRODIMENSIONAL
WIRE & RIBBON
FOR VACUUM TUBES**

WOLLASTON PROCESS WIRE
drawn as small as .000010";
Made to your specifications
for diameter and resistance

WRITE for list of products.

SIGMUND COHN CORP.
44 GOLD ST., NEW YORK

SINCE 1901

What are Your TRANSFORMER SPECIFICATIONS?

Would a slight change from the "standard" electrical specifications improve the performance of your finished product? If so, get in touch with Acme Electric engineers for assistance in designing a "special" transformer from standard parts.

For television, radio, and other electronic applications, Acme produces a wide variety of transformers all with different specifications from standard parts. This means better performance, better quality and often at economy prices.

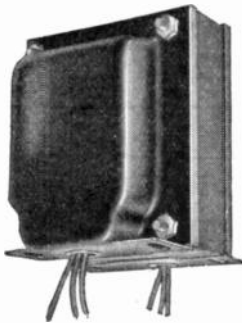

ENCLOSED TYPES

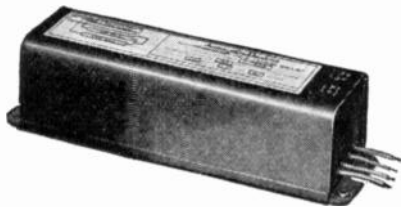

The dies for making transformers that fit into this enclosed case, alone would cost you thousands of dollars. Acme produces to save you this expense.

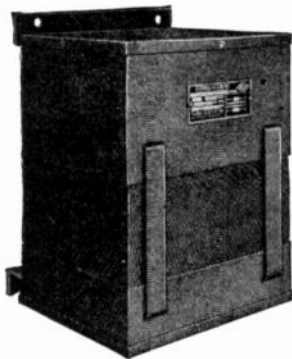

Here is a typical air-cooled design which can be produced to meet a variety of applications. Write for Bulletin 168A for further details.

ACME ELECTRIC CORP.
800 WATER ST. CHIBA, N. Y.



News—New Products

These manufacturers have invited PROCEEDINGS readers to write for literature and further technical information. Please mention your I.R.E. affiliation.

(Continued from page 58A)

Marker Oscillator

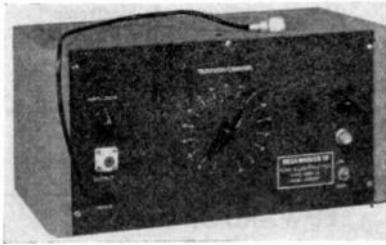

Laboratories and manufacturers of television equipment can now obtain accurate alignment of television receivers by using the *Mega-Marker Senior*, which is a 13-channel crystal-controlled marker oscillator developed by Kay Electric Co., Pine Brook, N. J. The crystal accuracy is 0.01%, which is adequate for all needs of television. In addition, it can be used for the alignment of the local oscillator for all thirteen channels. This is accomplished by using the sound channel to furnish an indication of discriminator output. The single-dial control gives a rapid and efficient means of frequency selection without the necessity of consulting charts or calibration curves. The instrument operates on a standard 60-cycle circuit, and weighs 15 pounds. The manufacturer also makes the *Mega-Pipper* and the *Mega-Marker* to facilitate the alignment of i.f. circuits in the same manner that the *Mega-Marker Senior* does the r.f. channels.

Vacuum Capacitors

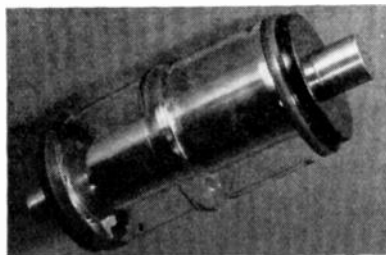

A new line of high-voltage, high-current vacuum capacitors designed for medium- and high-power oscillatory systems is offered by Dolinko and Wilkens, Inc., 101 Hazel St., Paterson 3, N. J. These capacitors feature OFHC copper construction, large-area copper-to-glass seals, and Pyrex bell-shaped envelopes. Vacuum joints are brazed with a high-temperature alloy of low vapor pressure to insure satisfactory operation under heavy loads. The high thermal endurance of the envelope permits exhaust at elevated temperatures and allows attainment of excellent vacuum conditions.

These vacuum capacitors are rated at 32,000 volts and are available in capacitances of 6 to 250 μfd . The maximum dimensions are $6\frac{1}{2}$ inches long and $2\frac{1}{4}$ inches in diameter.

(Continued on page 60A)

ANOTHER *New* BROWNING DEVICE

OSCILLOSYNCHROSCOPE MODEL OL-15A

Versatile laboratory instrument designed for observing phenomena requiring extended range amplifiers and a wide variety of time bases.

Frequency meters. WWV standard frequency calibrator Oscilloscope. Power supply and square wave modulator Capacitance Relay. FM-AM Tuners. FM Tuner.

WRITE TO
DEPT. A FOR
CATALOG

KNOW THE ENTIRE
BROWNING LINE
ENGINEERED for ENGINEERS



BUILD BETTER ELECTRONIC EQUIPMENT with STANDARDIZED



for
ALL
P. A.
NEEDS

Par-Metal Equipment is preferred by Service Men, Amateurs, and Manufacturers because they're adaptable, easy-to-assemble, economical. Beautifully designed, ruggedly constructed by specialists. Famous for quality and economy.

Write for Catalog.



READY-
TO-USE
CABINETS
•
CHASSIS
•
PANELS
•
RACKS

PAR-METAL PRODUCTS CORPORATION

32-62-49th ST., LONG ISLAND CITY 3, N. Y.
Export Dept.: Rocke International Corp.
13 East 40 Street, New York 16

PREMAX

FM-130 Receiving Antennas

Improve Reception
By Reducing Man-Made
Electrical Noise, says
FM Engineer

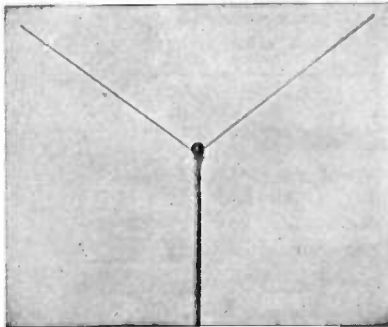

The Chief Engineer of an FM-TV Broadcasting Station says of the Premax FM-130 Receiving Antenna: "... set them up in several very unfavorable locations where man-made electrical noise abounded, and we found the 3d dimensional adjustment in the dipole arms helped considerably to reduce noises in many cases."

Without doubt the Premax Adjustable V Dipole Antenna is the most efficient and practical design made to insure maximum FM signal pickup and, because of its design to permit adjustment of the element angle for strongest reception, it permits a sufficient signal energy at the antenna terminals to minimize the importance of the otherwise difficult task of perfect impedance matching.

Write for Bulletin FMT-148, telling why an adjustable V Antenna is best for FM and TV.

Premax Products

Division of Chisholm-Ruder Co., Inc.

4811 Highland Ave. Niagara Falls, N.Y.

PROFESSIONAL CARDS

W. J. BROWN

Electronic & Radio Engineering Consultant
Electronic Industrial Applications, Commercial and Broadcasting Transmitter and Receiver Design, Test Equipment, etc.
23 years experience in electronic development
P.O. Box 5106, Cleveland, Ohio
Telephone, Superior 1241
Office, 912 Park Building

EDWARD J. CONTENT

Acoustical Consultant
Functional Studio Design

FM - Television - AM
Audio Systems Engineering
Roxbury Road Stamford 3-7459
Stamford, Conn.

STANLEY D. ELENBERGER

Consulting Engineer
INDUSTRIAL ELECTRONICS

Design—Development—Models
Complete Laboratory and Shop Facilities
6309-13—27th Ave.
Kenosha, Wis. Telephone 2-4213

HERMAN LEWIS GORDON

Engineering Consultant—Registered Patent Attorney

Product Development and Design
Electronics — Mechanical Devices — Optics
100 Normandy Drive 1416 F Street, N.W.
Silver Spring, Md. Washington 4, D.C.
Shepherd 2433 National 2497

DAVID C. KALBFELL, Ph.D.

Engineer — Physicist

Complete laboratory facilities
Industrial instrumentation and control
Broadcast engineering and measurements
1076 Morena Boulevard Jackson 1939
San Diego 10, California

News—New Products

These manufacturers have invited PROCEEDINGS readers to write for literature and further technical information. Please mention your I.R.E. affiliation.

(Continued from page 59A)

Recent Booklets

Interesting engineering and production data on the numerous carbon and graphite specialties produced by Stackpole Carbon Co., St. Marys, Pa., has been combined into an attractive and informative 44-page booklet, "Stackpole Carbon Specialties Booklet," which is available on request. Please use your company's letterhead.

(Continued on page 62A)

FAirmount 5105

Express 7764

FRANK MASSA
Electro-Acoustic Consultant

3393 Dellwood Road 3868 Carnegie Avenue
CLEVELAND, OHIO

EUGENE MITTELMANN, E.E., Ph.D.

Consulting Engineer & Physicist
**HIGH FREQUENCY HEATING
INDUSTRIAL ELECTRONICS
APPLIED PHYSICS &
MATHEMATICS**

549 W. Washington Blvd. Chicago 6, Ill.
Phone: State 8021

IRVING RUBIN

Physicist

Radio interference and noise meters, interference suppression methods for ignition systems and electrical devices. Laboratory facilities.

P.O. Box 153, Shrewsbury, New Jersey
Telephone: REDBANK 6-4247

ARTHUR J. SANIAL

Consulting Engineer

Loudspeaker Design; Development; Mfg. Processes. High Quality Audio Systems. Announcing Systems. Test and Measuring Equipment Design.

168-14 32 Ave. Flushing, N.Y.
FLushing 9-3574



Model 2 B 0.45
(450 MA hr. cap.)
Actual Size Illustrated

RECHARGEABLE • NON-SPILL

VITAMITE

1 OZ. BATTERIES

(Smaller Than 2 Pen-Lights)

IDEAL FOR USE WITH

Miniature And Sub-Miniature Filament Type Tubes
for HEARING AIDS, POCKET RADIOS, ETC.

Other Miniature Models weighing from 1 oz. to 1 lb. also manufactured. All models obtainable in Multi-Units from 2 volts to 120 volts.

Write for Data and Literature on Letterhead

THE VITAMITE COMPANY

227 West 64th Street

New York 23, N.Y.

TECHNICAL MANUALS

CUSTOM DESIGNED TO
YOUR SPECIFICATIONS

Planned, written and illustrated by a select staff . . . experts in creating radio and electronic manuals for civilian and military use.

When you call upon Boland & Boyce to create your manuals you are relieved of every detail in their preparation. The entire operation is taken over and completed by a specialized staff with years of experience in publishing books and manuals.

First the requirements for your manual are completely surveyed. The working conditions to which they will be put are studied and the operations or equipment described in the manual are thoroughly analyzed. A complete outline is then prepared and submitted for your approval, along with a dummy of the manual as it will appear when finished. Upon your approval the job is completed and delivered with your satisfaction guaranteed.

Boland & Boyce manuals incorporate only the most modern editorial and illustrative style. Each project is treated with individual attention in technique of presentation and editorial approach. The Boland & Boyce military and civilian manuals now in use throughout the world are our best recommendations.

U. S. Navy
U. S. Signal Corps
Sylvania Electric Products, Inc.
The National Company
Westera Electric Co.
Bell Telephone Laboratories
Maguire Industries, Inc.
Allen B. Dumont Laboratories, Inc.
General Electric Co.
Mine Safety Appliances Co.

Write or wire Boland & Boyce
today for more information

BOLAND & BOYCE INC., PUBLISHERS

MANUAL DIVISION M-2 MONTCLAIR, N.J.

ONE OF A SERIES

GAUGED ALIGNMENT



**WHY BURLINGTON PANEL
INSTRUMENTS PROVIDE
UTMOST RELIABILITY . . .**

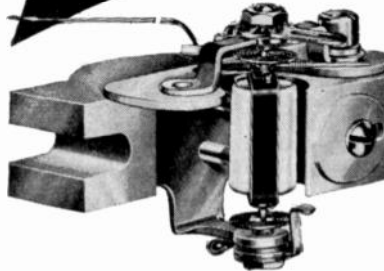

JEWEL SUPPORTS are machined and assembled with aid of precision gauging fixtures to assure perfect alignment. All ranges AC and DC available in 2 1/2", 3 1/2", 4 1/2" rectangular or round case styles and are fully guaranteed for one year against defects in workmanship or material. Refer inquiries to Dept. I 58.

Burlington INSTRUMENT COMPANY
BURLINGTON, IOWA

TWIN Power Supply

**Electronically
Regulated for
Precise
Measurements**



Two independent sources of continuously variable D.C. are combined in this one convenient unit. Its double utility makes it a most useful instrument for laboratory and test station work. Three power ranges are instantly selected with a rotary switch:
175-350 V. at 0-60 Ma., terminated and controlled independently, may be used to supply 2 separate requirements.
0-175-V. at 0-60 Ma. for single supply.
175-350 V. 0-120 Ma. for single supply.

In addition, a convenient 6.3 V.A.C. filament source is provided. The normally floating system is properly terminated for external grounding when desired. Adequately protected against overloads.

- Output voltage variation less than 1% with change from 0 to full load.
- Output voltage variation less than 1 V. with change from 105 to 125 A.C. Line Voltage.
- Output ripple and noise less than .025 V.

Twin Power Supply Model 210
Complete \$130.00
Dimensions: 16" X 8" X 8" Shipping Wt. 35 lbs.
(Other types for your special requirements)
Visit Our Booth No. 286 at the I.R.E. National Convention



FURST ELECTRONICS

North Avenue at Halsted St., Chicago 22, Illinois

News—New Products

These manufacturers have invited PROCEEDINGS readers to write for literature and further technical information. Please mention your I.R.E. affiliation.

(Continued from page 60A)

30-Watt Speaker

A two-way speaker system designed for installation in the home and described as featuring the same components, engineering standards, and configuration of acoustic baffling as in commercial theater equipment has been recently introduced by **Stephens Manufacturing Corp.**, 10416 National Blvd., Los Angeles 34, Calif. This *Tru-Sonic* speaker is available either in a utility cabinet or a deluxe period cabinet.

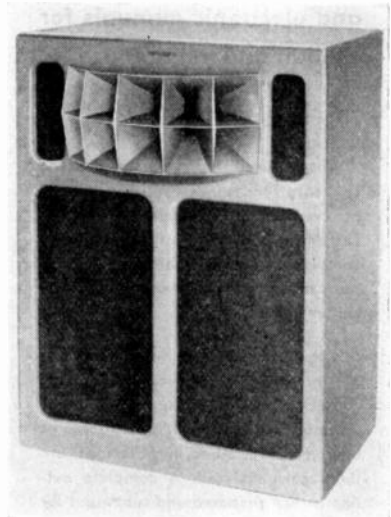

The speaker system is rated at 30 watts and consists of two 15-inch 20-watt low-frequency drivers and a 30-watt high-frequency driver. A 10-cell dispersing horn extends the range beyond 15,000 cycles with good efficiency and a high-frequency attenuator balances room acoustics. The 600-cycle crossover frees the low-frequency drivers of higher-frequency intermodulation or cone breakup. A radical design permits horn loading down to 60 cycles and a special chamber behind the drivers reinforces the bass down to 30 cycles.

The unit weighs 245 pounds, and is 45 inches high by 36 inches wide by 25 inches deep.

Diamond-Stylus Pickup

A variable-reluctance pickup with a diamond stylus of either 2.5 or 3 mil radius has been announced by the Transmitter Division of **General Electric Co.**, Electronics Park, Syracuse, N. Y. It is designed especially for broadcast-station lateral reproduction and provides substantial discrimination against noise due to vertical pickup.

A transcription arm, which is available for use with this pickup, is equipped with cone-face ball bearings for smooth movement on both the vertical and horizontal axes.

(Continued on page 63A)

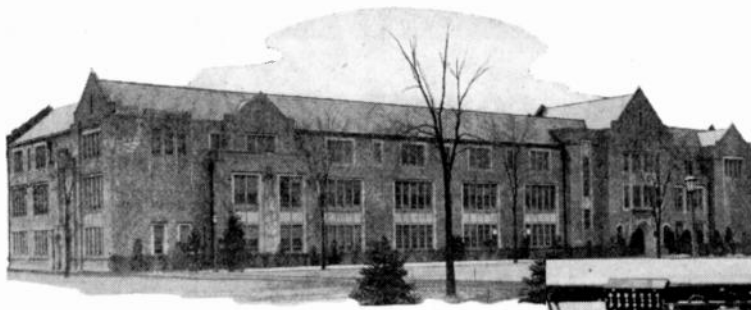

Engineering Building, University of Notre Dame

Student Laboratory Measurements at NOTRE DAME with Z-ANGLE METERS

Dr. H. E. Ellithorn, Associate Professor of Electrical Engineering at the University of Notre Dame has this to say about the Z-Angle Meter:

"The Z-Angle Meters have been in use at Notre Dame for the past four months with great success. The meters have been used to find the open circuit and short circuit impedances of artificial lines and cables; clamped and unclamped impedances of telephone receivers; impedances of two terminal balancing networks as a function of frequency and other impedance tests."

"In the case of the artificial lines and cables, the time necessary to obtain the measurements was reduced to one-half that usually required by ordinary bridge methods."

Write today for Bulletin 508.

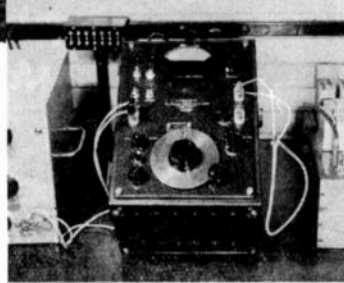

One of Notre Dame's Z-Angle Meters

ITC TECHNOLOGY INSTRUMENT CORP.
1058 MAIN STREET, WALTHAM 54, MASS.

Midwest Office: Alfred Crossley & Associates, 549 W. Randolph St., Chicago 6, Illinois, State 7444

NEY PRECIOUS METALS IN INDUSTRY

NEY-ORO #28B BRUSH CONTACT ON ADVANCE WIRE WOUND POTENTIOMETER RUNS 4,300,000 SWEEPS WITH NO CHANGE IN RESISTANCE

Examine these unretouched photographs of mandrel (wound with Advance #36 B & S) and brush adjusted for 50 gms pressure. There is no appreciable wear on the winding after 4,300,000 sweeps of the brush and the wear on the brush is less than .008". Throughout the test there was no perceptible change in resistance. Truly a remarkable performance when you consider the additional fact that the test was conducted at a speed of 37.5 cycles (75 sweeps) per minute, considerably faster than normal operation. The test was conducted by a leading manufacturer of precision equipment and the complete test data is available on request. It is, we believe, further convincing evidence of the interesting possibilities offered by the use of Ney Precious Metal Alloys in industrial and scientific applications.

Write or phone (Hartford 2-4271) our Research Department.

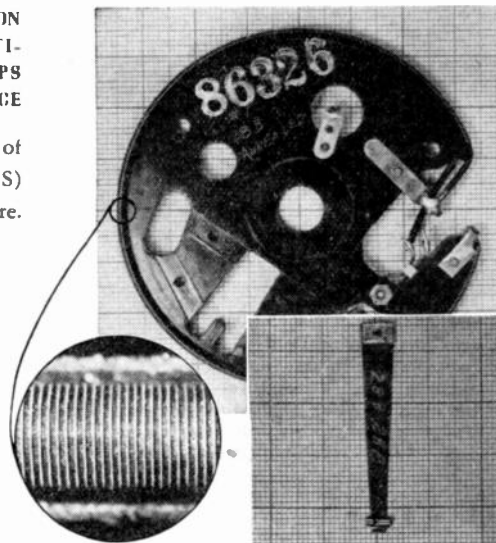

Mandrel and brush shown 40% full size. Section of mandrel 6 $\frac{2}{3}$ x magnification.



THE J. M. NEY COMPANY
171 ELM STREET • HARTFORD 1, CONNECTICUT



Extremely High Voltage Rating In Proportion To Size

When space is limited, yet you need extremely high voltage rating, fine adjustment with uniform voltage breakdown rating throughout the full capacity range, the JOHNSON Type N Neutralizing Condenser is the perfect answer.

Because of their design, these condensers will withstand much higher voltage than conventional flat plate condensers of the same spacing.

High in quality—low in cost, JOHNSON condensers are always a wise choice.



For Complete Details Write For
Latest JOHNSON Catalog

E. F. JOHNSON CO.
WASECA, MINNESOTA

ACCELEROMETER TRANSDUCERS

Unique linear Acceleration Transducers... Measure the acceleration of launching and additional thrust and the acceleration of aerodynamic drag. These instruments provide large electrical potentiometer-type outputs proportional to acceleration. Magnetically damped with ranges from ± 5 G's to ± 100 G's. The type 2414 provides expansion of potentiometer output for special ranges. Standard resistance for these instruments is 5,000 ohms.



Write for complete
information

Type 2413

GM
Giannini & CO INC

REACTION POWER PLANTS • AUTOMATIC FLIGHT EQUIPMENT
285 WEST COLORADO STREET • PASADENA 1, CALIFORNIA

News—New Products

These manufacturers have invited PROCEEDINGS readers to write for literature and further technical information. Please mention your I.R.E. affiliation.

(Continued from page 62A)

Vacuum Coating Unit

A table-model vacuum unit with a Pyrex bell jar 7 inches in diameter and 10 inches high, capable of attaining a pressure of 0.1 micron, is announced by Distillation Products, Inc., 755 Ridge Road West, Rochester 13, N. Y. The unit includes mechanical and oil-diffusion pumps, a Pirani gauge, four electrodes, and a power circuit. When charged with a nonvaporizing load, the bell jar will attain a vacuum of 3×10^{-4} in less than twenty minutes, and will reach 1×10^{-4} under an hour.

This unit may be used for such applications as coating lenses and mirrors with low reflecting surfaces, preparing surface replicas for the electron microscope, metal evaporation, and demonstrations of electronic experiments.

Miniature Wet Battery



This new rechargeable battery, manufactured by Vitamite Co., 227 W. 64th St., New York 23, N. Y., is completely spill-proof since all free-flowing electrolyte has been eliminated. It is smaller than two penlight dry cells, but it delivers 50% more wattage than two type "C" dry cells upon a single charging. It is made leakproof by being enclosed in a one-piece molded-plastic case, which measures $1 \frac{13}{16} \times 7/8 \times 9/16$ inches and weighs 1 ounce. Each is rated at 2.2 volts, and maintains this voltage steadily through 95% of the usable life of any one charging. As delivered by the manufacturer, the battery may be placed upon the shelf indefinitely, due to its dry charge without loss of the original charge until used.

These batteries are ideal for use in pocket radios, hearing aids, photographer's flash guns, walkie talkies, and flashlights. The manufacturer also makes the charging units and similar batteries in multiple units.

(Continued on page 65A)

ANOTHER *New* BROWNING DEVICE

CAPACITANCE RELAY MODEL DD-20

Super-sensitive "brain" for alarm, safety, or signal systems. Operates alarm circuit on capacitance changes of 0.25 mmfd.

Frequency meters. WWV standard frequency calibrator. Oscilloscope. Power supply and square wave modulator. Capacitance Relay. FM-AM Tuners. FM Tuner.

WRITE TO
DEPT. A FOR
CATALOG

KNOW THE ENTIRE
BROWNING LINE
ENGINEERED for ENGINEERS



BROWNING LABORATORIES, INC.
WINCHESTER, MASS.

OFF PRESS!



THE NEW JAMES KNIGHT CRYSTAL CATALOG

You'll want a copy of the new James Knights catalog of "Stabilized" crystals. It contains photos and specifications of many new crystals, crystal ovens, holders, including new filter crystals with standard RMA pigtails. If your distributor cannot supply you, write for your free copy direct.

THE JAMES KNIGHTS CO.
Sandwich, Illinois

AMPERITE MICROPHONES

The ultimate in microphone quality, the new *Amperite Velocity* has proven in actual practice to give the highest type of reproduction in Broadcasting, Recording, and Public Address.

The major disadvantage of pre-war velocities has been eliminated—namely “boominess” on close talking.

- Shout right into the new *Amperite Velocity*—or stand 2 feet away—the quality of reproduction is always excellent.
- Harmonic distortion is less than 1%. (Note: best studio diaphragm mike is 500% higher.)
- Practically no angle discrimination . . . 120° front and back. (Best studio diaphragm microphones . . . discrimination 800% higher.)
- One *Amperite Velocity* Microphone will pick up an entire symphony orchestra.



P.G. Dynamic Models PGH, PGL List \$52.00

Address inquiry attention Dept. I.R.E.

STUDIO VELOCITY, finest in quality; ideal for Broadcasting and Recording.

Models R80H-R80L . . . List \$80.00

There is an *Amperite Microphone* for every requirement.

WRITE FOR ILLUSTRATED 4-PAGE FOLDER giving full information and prices.



Amperite Velocity Microphones for Public Address Models RBHG, RBLG List \$42.00

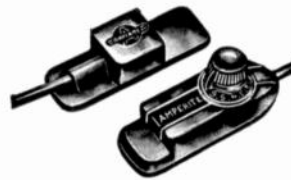

"Kontak" Mikes Model SKH, list \$12.00 Model KKH, list \$18.00

In Canada: Atlas Radio Corp. 560 King St. W. Toronto, Ont.

AMPERITE Company, Inc.

561 BROADWAY NEW YORK 12, N. Y.

Attention Associate Members!

Many Associate Members can qualify for higher membership grades and should certainly do so. Members are urged to keep membership grades up in pace with their present development.

An Associate over 24 years of age who is occupied as a radio engineer or scientist, and is in this active practice three years may qualify for Member Grade.

An Associate who has taught college radio or allied subjects for three years may qualify.

Some may possibly qualify for Senior Grade. But transfers can be made only upon your application. For fuller details request transfer application-form in writing or by using the coupon below.



Coupon

Institute of Radio Engineers
1 East 79th St.,
New York 21, N.Y. 5-48

Please send me the Transfer Application Membership-Form.

Name

Address

Place

State

Present Grade

"A Well Known Name in Radio for Over 25 Years"

NO. 6 OF A SERIES

Carter powers "Taxi Talkie" Communications Equipment

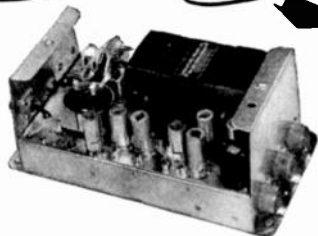

To provide ample and instant power for their two-way mobile radio system, MOBILE COMMUNICATIONS COMPANY uses the famous CARTER GENEMOTOR shown in the chassis illustrated here. These CARTER units are designed to deliver 100,000 transmissions without servicing. Quick power too—trigger fast! Flick the switch and in 3/10 of a second the Taxi Talkie system surges with power!

For illustrated catalog, specifications and technical data on CARTER rotary power supplies, and name of nearest CARTER distributor, WRITE TODAY.

Carter Motor Co.
Chicago, Illinois

2645 N. MAPLEWOOD AVENUE • CABLE: GENEMOTOR

News—New Products

These manufacturers have invited PROCEEDINGS readers to write for literature and further technical information. Please mention your I.R.E. affiliation.

(Continued from page 63A)

Synchronizing Generator

The smallest commercially available television synchronizing generator is announced by the Television Transmitting Equipment Division, **Allen B. Du Mont Labs., Inc.**, 42 Harding Ave., Clifton, N. J. Notwithstanding its diminutive size and weight, it has been engineered for inherent stability, high performance standards and ease of operation to make it ideally adapted to field use. In addition, it can serve as the source of synchronizing signals for all types of television work, such as testing transmitters, experimental television development and laboratory work of an allied nature.

Completely self-contained, this equipment requires only a.c. power. It provides mixed driving, blanking and synchronizing signals. The master oscillatory can be locked to the 60-cycle line or run completely free. It provides half-line driving pulses for utilization of differential delay techniques necessary for long camera cable hookups. Stability of countdown and pulse width of composite signal are essentially independent of tube changes. Regulated power supplies make the unit independent of line-voltage variations.

P.M. Speakers

A new line of permanent-magnet speakers for replacement service has been announced by **Zenith Radio Corp.**, 6001 W. Dickens Ave., Chicago 39, Ill. Popular sizes of speakers ranging from 3½ to 12 inches, in all magnet weights, are included. A 6×9 inch p.m. speaker has been made available because of the large quantities used in post-war automobile receivers. Accompanying the speakers are thirteen transformers which will supply nearly all transformer replacement needs.

Recent Booklets

A new line of small electron tubes, "Special Red" tubes, for industrial and commercial applications where extreme dependability, long life, and resistance to vibration are essential is described in a technical booklet, RSB1000, by the Commercial Engineering Section of the Tube Dept., **Radio Corp. of America**, Harrison, N. J. These tubes are similar in electrical characteristics to their receiving tube counterparts, the 6SL7-GT, 6SN7-GT, and 6SJ7.

(Continued on page 66A)

RMC TRANSCRIPTION CONSOLES

Judged by Quality . . . Durability and Dependability . . . not their LOW PRICE

Advanced style and in attractive gray finish to harmonize with any interior. Furnished with or without RMC Reproducers, Amplifiers, and Turntables, as desired. Turntables of completely new design.

Model illustrated shows the Vertical Only and Lateral Only combination Reproducers with Type TP-16E Turntable mounted in Type BS1 Console, complete \$399.00 F.O.B. Port Chester, N.Y.

Other RMC Transcription Consoles and various combinations, as required, are available.

Write for descriptive, illustrated Bulletin TC-51 which lists prices for many other combinations.

Price subject to change without notice

Sold through local jobber



Export: **Rocke International Corporation**, 13 East 40th Street, New York 16, New York

RADIO-MUSIC CORPORATION
PORT CHESTER . . . NEW YORK

**KEEP POSTED ON
ELECTRON TUBES**

**Use this convenient coupon
for obtaining the RCA tube
reference data you need.**

RCA, Commercial Engineering,
Section EW52, Harrison, N.J.

Send me the RCA publications checked below. I
am enclosing \$..... to cover cost of the books
for which there is a charge.

Name _____
Address _____
City _____ Zone _____ State _____

- Quick-Reference Chart, Miniature Tubes (Free). [A]
- HB-3 Tube Handbook (\$10.00)*. [B]
- RC-15 Receiving Tube Manual (35 cents). [C]
- Receiving Tubes for AM, FM, and Television Broadcast (10 cents). [D]
- Radiotron Designers Handbook (\$1.25). [E]
- Quick Selection Guide, Non-Receiving Types (Free). [F]
- Power and Gas Tubes for Radio and Industry (10 cents). [G]
- Phototubes, Cathode-Ray and Special Types (10 cents). [H]
- RCA Preferred Types List (Free). [I]
- Headliners for Homs (Free). [J]

*Price applies to U. S. and possessions only.



TUBE DEPARTMENT
RADIO CORPORATION OF AMERICA
HARRISON, N. J.





PILOT LIGHT ASSEMBLIES

PLN SERIES—Designed for NE-51 Neon Lamp



Features

- THE MULTI-VUE CAP
- BUILT-IN RESISTOR
- 110 or 220 VOLTS
- EXTREME RUGGEDNESS
- VERY LOW CURRENT

Write for descriptive booklet

The DIAL LIGHT CO. of AMERICA

FOREMOST MANUFACTURER OF PILOT LIGHTS
900 BROADWAY, NEW YORK 3, N. Y.
Telephone—Spring 7-1300

Sign of Transformer Reliability

KENYON For over 20 years, the KENYON "K" has been a sign of transformer reliability. Ever since the cat's-whisker, crystal-set days, KENYON has pioneered high quality transformers. Skillful engineering, progressive design and sound construction have resulted in dependable, conservatively-rated transformers with an enviable record for minimum field rejections. Cut engineering and replacement costs. Improve products. Insure repeat business. Specify KENYON!



Consult KENYON about your transformer problems.

KENYON TRANSFORMER CO., Inc. 840 BARRY STREET
NEW YORK 59, N. Y.

News—New Products

These manufacturers have invited PROCEEDINGS readers to write for literature and further technical information. Please mention your I.R.E. affiliation.

(Continued from page 65A)

Resistor Analysis Council

A special service to design engineers working with resistor problems is offered by **International Resistance Company**, 401 North Broad Street, Philadelphia 8, Pa. Headed by Wm. H. Knowles, Jr., a group of this firm's engineers have formed the "Resistor Analysis Council" to review and make recommendations on resistor requirements in any circuit. Upon request the design engineer will be supplied with a resistor specification sheet, which, when filled out, organizes the many elements of the problem in a remarkably complete, clear and helpful fashion; and makes it easier to determine where standard resistors can be used effectively.

Light-Duty Interrupter

With applications in the communications field where signals of set length, repeated regularly, are required, the **Haydon Manufacturing Company, Inc.**, 245 East Elm Street, Torrington, Conn., announces their series 5400 interrupters, shown below:

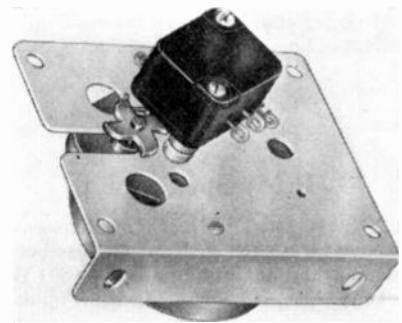

Ranging from 72 pulses or flashes per minute, each of 0.4 second in length, to 1 pulse every two minutes, of one minute duration, the unit is composed of a timing motor, assembled with a 4-lobe cam, steel wire cam follower and peanut Micro-switch. A synchronous timing motor drives the cam at constant speed, and current is fed intermittently to the controlled circuit in equal on and off periods, with an accuracy of plus or minus 20% depending on load and voltage conditions. The unit is only 3" high, 2 1/8" wide by 2 1/4" deep.

New Shakeproof Terminal Catalog

Useful to the design engineer is the very complete 72-page catalog just issued by **Shakeproof Inc.**, 2501 N. Keeler Avenue, Chicago 39, Ill. Catalog A-S-51 covers the entire line of locking and plain terminals offered by this firm, and the illustration method and design data and cataloging is particularly clear and useful.

INDEX AND DISPLAY ADVERTISERS

Section Meetings	34A
Student Branch Meetings	38A
Membership	40A
Positions Open	50A
Positions Wanted	53A
News—New Products	11A

DISPLAY ADVERTISERS

Acme Electric Corporation	59A
Aerovox Corporation	43A
Allied Radio Corporation	YB
American Lava Corporation	YB
American Phenolic Corp.	38A
American Television & Radio Co.	YB
Amperex Electronic Corp.	Cover II
Amperite Co.	64A
Andrew Corporation	40A
Applied Science Corp. of Princeton	YB
Arnold Engineering Co.	28A
Astatic Corp.	21A
Audio Devices, Inc.	YB
Ballantine Laboratories	YB
Barker & Williamson	YB
Barry Corporation	YB
Bell Telephone Laboratories	5A
Bendix Aviation Corp. (Scintilla Magneto Div.)	24A
Bendix Aviation Corp. (Radio Div.)	50A
Bendix Aviation Corp. (Pacific Div.)	YB
Beta Electronics	YB
Bliley Electric Co. (YB)	13A
Boeing Airplane Company	50A
Boland & Boyce, Inc.	61A
Boonton Radio Corp.	YB
W. H. Brady Co.	YB
W. J. Brown	60A
Browning Laboratories	55A, 59A, 63A
Burlington Instrument Corp.	61A
Burnell & Co.	YB
Cambridge Thermionic Corp.	YB
Cannon Electric Development Co.	57A
Capitol Radio Engineering Institute	67A
Carter Motor Co. (YB)	64A
Centralab	8A
Chicago Transformer	YB
Clark Crystal Co.	YB
Clarostat Mfg. Co.	58A
Cleveland Container Co.	34A
Cohan-Epner Co.	YB
Sigmund Cohn Corp.	58A
Collins Radio Co.	YB
Colonial Radio Corp.	52A
Communications Equipment Co.	49A
Concord Radio Corp.	YB
Edward J. Content	60A
Cornell-Dubilier Electric Corp.	Cover III
R. W. Cramer Co.	YB
DeJur Amsco Corp.	YB
Tobe Deutschmann Corp.	9A
Dial Light Co. of America (YB)	66A
Drake Mfg. Company	YB
Allen B. DuMont Laboratories	18A, 30A
Stanley D. Eilenberger	60A
Eitel-McCullough, Inc.	20A
Electric Soldering Iron Co.	YB
Electrical Reactance Corp.	25A
Electro Engineering Works	YB
Electro-Motive Mfg. Corp.	15A
Electro-Seal Corp.	YB
Erie Resistor Corp. (YB)	1A
Ferranti Electric, Inc.	YB
Furst Electronics (YB)	61A
General Aniline & Film Corp. (YB)	22A
General Electric Company	6A & 7A, 27A, 31A

General Radio Company (YB)	Cover IV
G. M. Giannini & Co., Inc.	63A
Paul Godley Company	YB
Herman Lewis Gordon	60A
Harvey Radio Co.	YB
A. W. Haydon Co.	YB
Hazeltine Electronics Corp.	53A
Hewlett-Packard Co.	23A
Hughey & Phillips	YB
Illinois Condenser Co.	YB
Indiana Steel Products Co.	YB
Inductive Equipment Co.	YB
Industrial Products Co.	YB
Insulation Manufacturers Corp.	YB
Jennings Radio Mfg. Co.	YB
E. F. Johnson Co.	63A
David C. Kalbfell	60A
Kay Electric Co.	YB
Kenyon Transformer Co., Inc. (YB)	66A
Kepeco Laboratories, Inc.	48A
James Knights Co.	63A
Kollsman Instrument Division	YB
Lavoie Laboratories	10A
Lehigh Structural Steel Co.	YB
Lenz Electric Mfg. Co.	YB
Macmillan Co.	YB
George Maki	YB
P. R. Mallory & Co., Inc.	3A
Measurements Corporation (YB)	57A
Mepeco, Inc.	YB
J. W. Miller Co.	YB
Eugene Mittelmann	60A
Mueller Electric Co.	YB
Mycalex Corp. of America (YB)	4A
National Carbon Co., Inc.	19A
Newark Electric Co., Inc.	48A

J. M. Ney Co.	62A
J. P. O'Donnell & Sons	YB
Ohmite Mfg. Co. (YB)	12A
Panoramic Radio Corp.	55A
Par-Metal Products Corp. (YB)	59A
Polytechnic Research & Dev. Co., Inc.	31A
Precision Paper Tube Co.	YB
Premax Products (YB)	60A
Presto Recording Corp.	YB
Radio Corporation of America (YB)	32A, 51A, 65A, 68A
RCA Review	YB
Radio Music Corporation	65A
Raytheon Mfg. Co.	16A
Reeves Hoffman Corp.	36A
Revere Copper & Brass, Inc.	14A
Rollin Co.	54A
Irving Rubin	60A
Howard W. Sams & Co., Inc.	YB
A. J. Sanial	60A
Sigma Instruments, Inc.	44A
Sherron Electronics Corp. (YB)	29A
Shure Brothers, Inc. (YB)	42A
Sorensen & Co., Inc.	26A
Sperry Gyroscope Co., Inc. (YB)	53A
Sprague Electric Co.	33A
Stackpole Carbon Co.	39A
Standard Radio & Electronic Products Co.	37A
Stephens Mfg. Corp.	YB
Superior Electric Company	47A
Sylvania Electric Prod. Co., Inc.	YB
Tab	YB
Technology Instrument Corp.	62A
Times Facsimile Corp.	YB
Triplett Electrical Inst. Co.	YB
Truscon Steel Co.	46A
Turner Company	YB
Tung-Sol Lamp Works	53A
United Transformer Corporation	17A
V-M Corporation	YB
Valpey Crystal Corp.	YB
Vitamite Co.	60A
W. M. Welch Mfg. Co.	YB
Western Electric Co. (YB)	2A, 35A
Weston Electrical Instrument Co.	45A
John Wiley & Sons	YB
C. K. Williams & Co.	YB
S. S. White Dental Mfg. Co.	55A
Zetka Laboratories	52A

Those firms coded "YB" in the above index are providing additional product data in advertisements in the I.R.E. Yearbook coming out this summer. I.R.E. Members will find these ads providing working facts.

*"Where
Professional
Radiomen
Study"*



CAPITOL RADIO ENGINEERING INSTITUTE

An Accredited Technical Institute
16th and Park Rd., N. W.
Washington 10, D. C.
Advanced

Home Study and Residence
Courses in Practical Radio-
Electronics and Television.
Approved for Veteran Training.



An entire season of baseball action—from Opening Day to World Series—is yours with RCA Victor television.

You're right in the game — with Television

● Comes the shout "Play Ball!" and there you are . . . right on top of every play.

Through television developments in RCA Laboratories, all the action is yours — the crack of bat against ball — fast infield plays — even side-lights in bull pen, dugout, grandstand and bleachers.

At the ball park, RCA Image Orthicon television cameras — rivalling the

human eye in sensitivity—get all the action in day or night games. Shifts from over-all views of the field, to "close-ups," of individual players are swift and revealing . . .

And at the *receiving end* — your RCA Victor "Eye Witness" home television set gives you brighter, clearer pictures. You can see the ball that the batter misses, or you can watch his home run smash sail over the distant fence.

Today, because of the original and continuing work of RCA scientists, millions can enjoy sports, entertainment, educational and news events, on television. Research at RCA Laboratories—always a "step ahead"—enters every instrument marked RCA or RCA Victor.

When in Radio City, New York, be sure to see the radio, television and electronic wonders at RCA Exhibition Hall, 36 West 49th St. Free admission. Radio Corporation of America, RCA Building, Radio City, New York 20, N. Y.



RADIO CORPORATION of AMERICA

quiet

as a

goldfish



with **C-D Quietones***

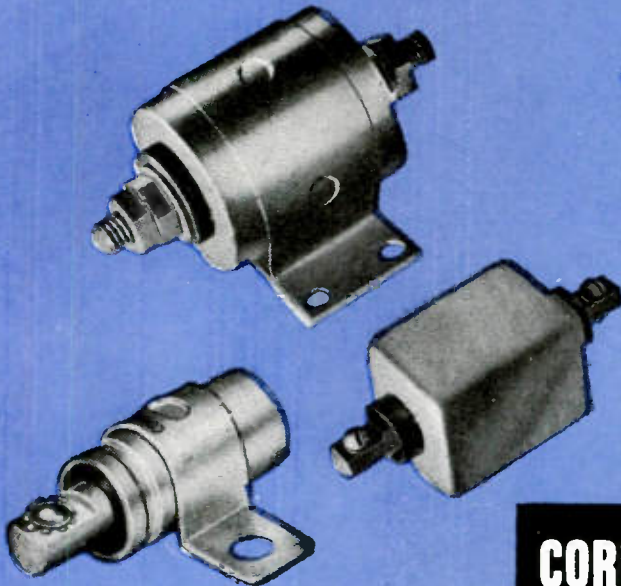

MICA • DYKANOL • PAPER • ELECTROLYTIC

A lot of electronic and electrical equipment is going to sea these days. But it won't stay there long—in fact, it won't even stay sold—unless it is Noise-Proofed against radio interference.

To you—the manufacturer—this means that your product should include C-D Quietones in its basic design. With safety at sea—as well as listening pleasure—at stake, your marine customers demand the kind of interference-free equipment operation C-D Quietones are designed to give. Of the hundreds of Quietone types available, there may be one which will fit your needs to a "T"; if not, our sleeves are rolled up and we're ready in our modern and complete Radio Noise-Proofing Laboratory—to design the specific filter you need. C-D Quietones will solve your radio noise and spark suppression problems speedily, permanently and effectively. Your inquiry is invited. Cornell-Dubilier Electric Corporation, Dept. H5-8, South Plainfield, New Jersey. Other large plants in New Bedford, Worcester, and Brookline, Massachusetts, and Providence, R. I.

Make Your Products More Saleable with C-D Quietone Radio Noise Filters and Spark Suppressors.

An Invitation from C-D
WORLD'S MOST ADVANCED RADIO
"NOISE-PROOFING" LABORATORY
IS AT YOUR SERVICE
without obligation



® Reg. U.S. Pat. Off.

CORNELL-DUBILIER

WORLD'S LARGEST MANUFACTURER OF

CAPACITORS

TO MEASURE

- RESISTANCE
- INDUCTANCE
- CAPACITANCE
- STORAGE FACTOR
- DISSIPATION FACTOR

IN

ANY LABORATORY



COMPLETELY self-contained, portable and always set-up for immediate use, this impedance bridge is indispensable in any laboratory where electrical equipment is used. No hastily putting together a circuit, finding an oscillator and a detector and then a power supply . . . they are all here permanently assembled in an accurate instrument . . . always ready to use at any time.

Over the major portion of its ranges this bridge is accurate for the majority of routine measurements in any laboratory. The ranges are:

RESISTANCE: 1 milliohm to 1 megohm

INDUCTANCE: 1 microhenry to 100 henrys

CAPACITANCE: 1 micromicrofarad to 100 microfarads

STORAGE FACTOR (X/R): .02 to 1000

DISSIPATION FACTOR (R/X): .02 to 1

The bridge includes built-in standards, batteries, a 1000-cycle tone source for a-c measurements, a zero-center galvanometer d-c null detector, and terminals for a headset for 1000-cycle detection. Provision is made for use of an external generator for measurements over a wide range from a few cycles to 10 kilocycles. Direct-reading dials add greatly to the ease and rapidity with which measurements can be made.

TYPE 650-A IMPEDANCE BRIDGE . . . \$240.00
IN STOCK FOR EARLY SHIPMENT

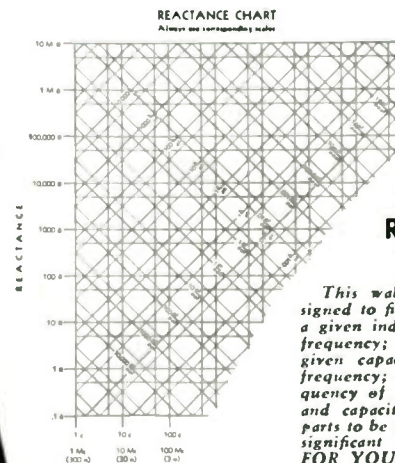

WRITE FOR THIS REACTANCE CHART

This wall-size chart is designed to find the reactance of a given inductance at a given frequency; the reactance of a given capacitance at a given frequency; the resonant frequency of a given inductance and capacitance. It is in two parts to be read to two or three significant figures. WRITE FOR YOUR COPY

IT'S FREE!



GENERAL RADIO COMPANY Cambridge 39, Massachusetts

93 West St., New York 6

920 S. Michigan Ave., Chicago 5

950 N. Highland Ave., Los Angeles 38