

Proceedings



of the I·R·E

A Journal of Communications and Electronic Engineering
(Including the WAVES AND ELECTRONS Section)

A.S. Fite

January, 1948

Volume 36

Number 1



WALTER R. G. BAKER
PRESIDENT, 1947



BENJAMIN E. SHACKELFORD
PRESIDENT, 1948

PROCEEDINGS OF THE I.R.E.

1948 I.R.E. NATIONAL CONVENTION—MARCH 22-25

- High-Frequency Plated Quartz Crystals
- Ionospheric Eclipse of October 1, 1940
- Theory of Amplitude-Stabilization Oscillators
- Velocity-Modulation Tubes for Reception at U.H.F. and S.H.F.
- Phase and Amplitude Distortion in Linear Networks
- A.M. Subcarrier Telemetry System
- Trigonometric Components of F.M. Waves
- Class-A Push-Pull Amplifier Theory
- Tuning Multiple-Cavity Magnetrons
- Theory of Circular Diffraction Antennas
- New Type of Waveguide Directional Coupler
- Series Reactance in Coaxial Lines
- Tracing Electron Trajectories with Differential Analysis

Waves and Electrons Section

- Report on Professional Status
- Frequency-Shift Radio Transmission
- Printed-Circuit Techniques
- Abstracts and References

TABLE OF CONTENTS FOLLOWS PAGE 32A

The Institute of Radio Engineers

the **LITTLE** differences
make
a **WHALE** of a difference

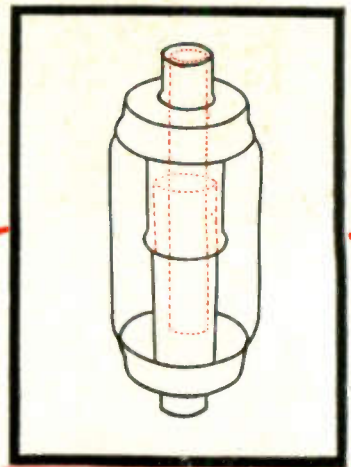

Jonah pulled a good trick when he got a round trip ticket into the whale . . . and we think we pulled a good one when we found a way of putting a heater inside our vacuum condensers to increase efficiency of our out-gassing.

Amperex vacuum condensers are tops because they are not only made of the simplest and best material for the purpose, pure, oxygen-free copper, but because we've succeeded in pulling a whale of a lot of gas out of the condenser by our trick. It takes heat to do it, and a condenser having no filament makes it quite a problem. But . . . by our design, another of those Amperex engineering differences, we can put heat right inside the vacuum condenser, right up against the elements where it does the most good. Of course we use standard out-gassing techniques, too, but we found that it's this Amperex difference that makes a whale of a difference to you, the direct heating of the elements that makes sure the last smidgeon of gas is pumped out.

Curious? The inside plate is tubular and open to the atmosphere. We drop a heater coil in there during pumping, cover the open end with a cap before finishing. (See sketch above)

We realize that such a design factor really can't be called a "little" difference, but there are hundreds of big and little differences in design and workmanship that really make a big difference in the many types of transmitting, rectifying and special purpose tubes that comprise the extensive Amperex line.



re-tube with Amperex

**AMPEREX
ELECTRONIC
CORPORATION**



25 WASHINGTON STREET, BROOKLYN 1, N. Y.
In Canada and Newfoundland: Rogers Majestic Limited
11-19 Brentcliffe Road Leaside, Toronto, Ontario, Canada

El-Menco PRECISION

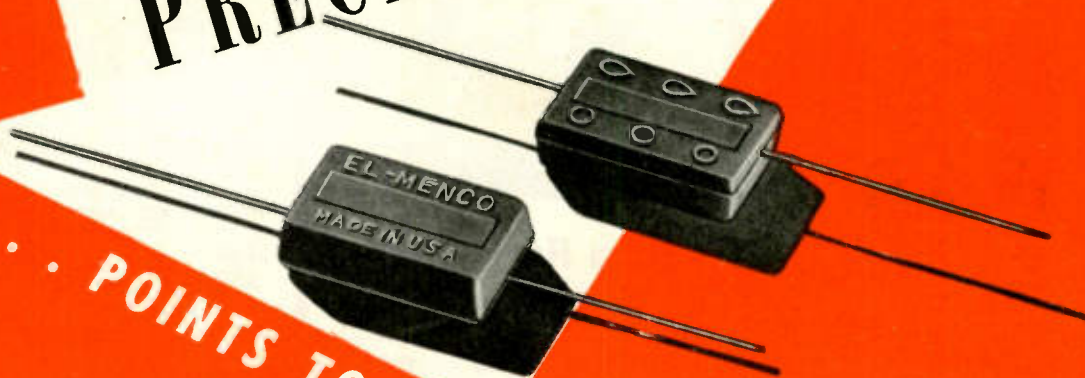

POINTS TO

PROGRESS!

El-Menco

laboratory technicians insist on the highest degree of precision at every step in the manufacture of El-Menco Capacitors. They know the important part capacitors play as components in electronic products and how much depends upon their unfailing performance.

This unfailing performance aids immeasurably in the electronic industry's unfaltering progress. The use of El-Menco Capacitors throughout the electronic industry is an indisputable testimony in behalf of their superiority.



Write on firm letterhead for catalog and samples.

MANUFACTURERS

Our silver mica department is now producing silvered mica films for all electronic applications. Send us your specifications.

Send for samples and complete specifications. Foreign Radio and Electronic Manufacturers communicate direct with our Export Department at Willimantic, Conn., for information.

THE ELECTRO MOTIVE MFG. CO., Inc.
Willimantic, Connecticut

JOBBERS AND DISTRIBUTORS
ARCO ELECTRONICS
135 Liberty St., New York, N.Y.
is Sole Agent for El-Menco Products in
United States and Canada



MOLDED MICA

El-Menco CAPACITORS

MICA TRIMMER

PROCEEDINGS OF THE I.R.E., January, 1948, Vol. 36, No. 1. Published monthly in two sections by The Institute of Radio Engineers, Inc., at 1 East 79 Street, New York 21, N.Y. Price \$1.50 per copy. Subscriptions: United States and Canada, \$12.00 a year; foreign countries \$13.00 a year. Entered as second class matter, October 26, 1927, at the post office at Menasha, Wisconsin, under the act of March 3, 1879. Acceptance for mailing at a special rate of postage is provided for in the act of February 28, 1925, embodied in Paragraph 4, Section 412, P. L. and R., authorized October 26, 1927.

Table of contents will be found following page 32A



3-Phase Regulation

MODEL	LOAD RANGE VOLT-AMPERES	*REGULATION ACCURACY
3P15,000	1500-15,000	0.5%
3P30,000	3000-30,000	0.5%
3P45,000	4500-45,000	0.5%

• Harmonic Distortion on above models 3%.
Lower capacities also available.

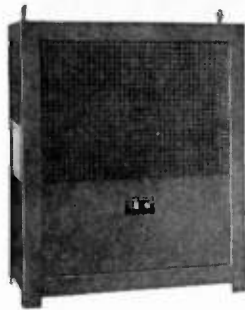

Extra Heavy Loads

MODEL	LOAD RANGE VOLT-AMPERES	*REGULATION ACCURACY
5,000*	500 - 5,000	0.5%
10,000*	1000-10,000	0.5%
15,000*	1500-15,000	0.5%

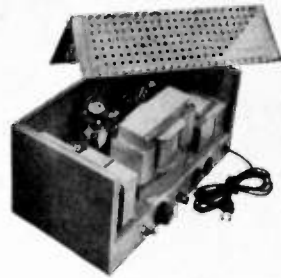

General Application

MODEL	LOAD RANGE VOLT-AMPERES	*REGULATION ACCURACY
150	25 - 150	0.5%
250	25 - 250	0.2%
500	50 - 500	0.5%
1000	100-1000	0.2%
2000	200-2000	0.2%



400-800 Cycle Line INVERTER AND GENERATOR REGULATORS FOR AIRCRAFT.

Single Phase and Three Phase

MODEL	LOAD RANGE VOLT-AMPERES	*REGULATION ACCURACY
D500	50 - 500	0.5%
D1200	120-1200	0.5%
3PD250	25 - 250	0.5%
3PD750	75 - 750	0.5%

Other capacities also available

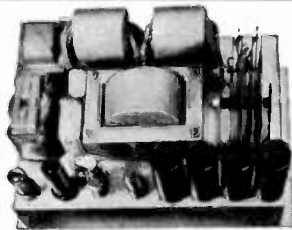

The NOBATRON Line

Output Voltage DC	Load Range Amps.
6 volts	15-40-100
12 "	15
28 "	10-30
48 "	15
125 "	5-10

• Regulation Accuracy 0.25% from 1/4
to full load.

SORENSEN

The First Line of standard electronic AC Voltage Regulators and Nobatrons

GENERAL SPECIFICATIONS:

- Harmonic distortion max. 5% basic, 2% "S" models
- Input voltage range 95-125: 220-240 volts (-2 models)
- Output adjustable bet. 110-120: 220-240 (-2 models)
- Recovery time: 6 cycles: * (9 cycles)
- Input frequency range: 50 to 65 cycles
- Power factor range: down to 0.7 P.F.
- Ambient temperature range: -50°C to +50°C

All AC Regulators & Nobatrons may be used with no load.

*Models available with increased regulation accuracy.

Special Models designed to meet your unusual applications.

Write for the new Sorensen catalog. It contains complete specifications on standard Voltage Regulators, Nobatrons, Incevolts, Transformers, DC Power Supplies, Saturable Core Reactors and Meter Calibrators.

SORENSEN & CO., INC.
STAMFORD CONNECTICUT

Represented in all principal cities.

You get all these features **ONLY** in the *Western Electric 5A Monitor* for FM Broadcasting

CENTER FREQUENCY MONITOR:

Accuracy—better than ± 500 cycles. (± 200 cycles if occasionally adjusted to agree with a primary standard)
Meter Range— $\pm 3,000$ cycles
Terminals for connecting remote meter

MODULATION PERCENTAGE MONITOR:

Accuracy—better than 5% for all readings
Modulation Range Capability—up to 133% (± 100 kc)
Terminals for connecting remote meter

QUALITY DESIGN AND MANUFACTURE:

Designed by Bell Telephone Laboratories.
Built by Western Electric, to Western Electric standards of quality.

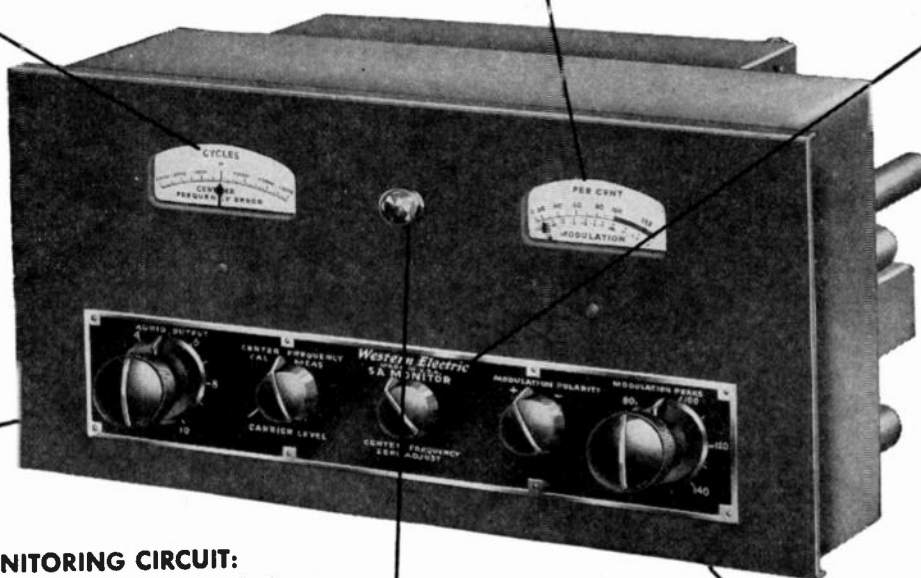

PROGRAM MONITORING CIRCUIT:

Output suitable for either aural program monitoring or FM noise and distortion measurements
Frequency Response— ± 0.25 db, 30 to 30,000 cycles, without de-emphasis; with de-emphasis, response is within ± 0.5 db of the standard 75 microsecond de-emphasis curve
Audio Output Power—output level adjustable up to +12 dbm—permits direct switching of program monitor from transmitter input to 5A Monitor output
Harmonic Distortion—less than 1/4 of 1% from 30 to 15,000 cps
Output Noise—at least 75 db below signal at 100% modulation

MODULATION PEAK INDICATOR:

Indication Lamp—flashes when a selected level of modulation is exceeded
Peak Limit Range—continuously adjustable between 40% and 140% modulation

AM NOISE DETECTOR:

An exclusive feature in the 5A Monitor—the output of this detector—which may be read directly on an electronic voltmeter or noise meter—is automatically referred to 100% amplitude modulation, thus simplifying measurement of transmitter AM noise.

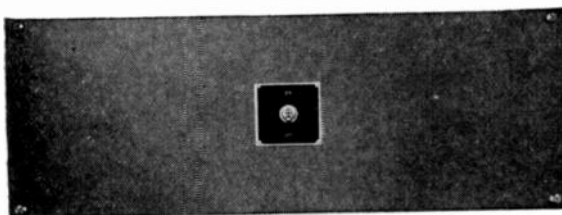

POWER SUPPLY: Newly designed 20C Rectifier (furnished as a part of the 5A Monitor) provides electronically regulated d-c with less than 1 millivolt ripple from 105-125 volta a-c 60 cycles. May be remotely located if desired.

The 5A Monitor includes numerous other valuable features such as: dual thermostats and dual heaters for each crystal—means for checking the inherent noise level of the monitor from its input to output terminals—requires only a low RF input level (1 watt) which can vary from 0.3 to 3.0 watts; i. e., a 10 to 1 variation without affecting the performance of the monitor. To get the complete story on this outstanding monitor value, call your Graybar Broadcast Representative or mail the coupon below.

Western Electric

Distributors: In the U. S. A.—Graybar Electric Company.
In Canada and Newfoundland—Northern Electric Company, Ltd.

—QUALITY COUNTS—



Graybar Electric Company
420 Lexington Avenue, New York 17, N. Y.

Please send me Bulletin T-2437, including curves, schematics and block diagram of the 5A Monitor.

NAME _____
STATION _____
ADDRESS _____
CITY _____ STATE _____

PERSONALLY CONDUCTED THROUGH THE REVERE MILLS



BECAUSE OFHC Copper looks like any other copper, Revere takes great pains to identify it throughout processing, to see it is not lost track of or mixed up with other types. The obvious thing is to mark each piece, which is done, but markings are obliterated by operations such as rolling, and so Revere goes to the length of assigning special personnel to follow each lot of OFHC Copper from one operation to another, watching carefully to be sure each load is kept intact.

In addition, Revere takes full cognizance of the fact that OFHC Copper for radio purposes must have special qualities. In making anodes, it must be deep drawn, and for the feather-edge seal, it must be capable of being rolled or machined down to .002"/.010". By carefully controlling mill processing, grain size is kept at or below permissible limits. Freedom from oxygen, and from voids, is guaranteed by the method of casting the bars from which we roll the forms required. In addition, there is an operation which results in Revere OFHC Copper being not just commercially free but *nearly absolutely free* of internal and external defects. This great care in producing copper for radio and radar purposes probably accounts for the fact that Revere is a preferred source of supply.

REVERE PRODUCTS AND SERVICES

All Revere Metals are processed with the care and attention required to assure that they meet all metallurgical and physical specifications. Revere supplies mill products in non-ferrous metals and alloys, and also electric welded and lockseam steel tube. An important part of our service to industry is the Revere Technical Advisory Service, which will gladly collaborate with you on specifications and fabrication methods.

REVERE

COPPER AND BRASS INCORPORATED

Founded by Paul Revere in 1801

230 Park Avenue, New York 17, New York

*Mills: Baltimore, Md.; Chicago, Ill.; Detroit, Mich.;
New Bedford, Mass.; Rome, N. Y.*

Sales Offices in Principal Cities, Distributors Everywhere



POWER PROBLEMS SOLVED!

BY DESIGNING portable radios around "Eveready" radio batteries, you achieve ultimate compactness and longest operation between battery changes.

"Eveready" "B" batteries are built with an exclusive space-saving design, providing more energy, size for size, than any other "B" battery. Small "Eveready" "A" batteries, used singly or in multiple, also provide remarkably long service where space is limited.

For camera-type portable radios, the "Eveready" No. 467 "B" battery and one or more "Eveready" No. 950 "A" batteries are virtually the standard power supply.

For truly midget portables, the "Eveready" No. 412 22½-volt "B" battery or the "Eveready" No. 413 30-volt "B" battery—with the "Eveready" No. 1016 "A" battery—offer optimum power in the smallest possible space.

For more details on these and other "Eveready" radio batteries, write to National Carbon Company, Inc., and request Engineering Bulletin No. 5.

The registered trade-marks "Eveready" and "Mini-Max" distinguish products of
NATIONAL CARBON COMPANY, INC.
 30 EAST 42nd STREET, NEW YORK 17, N. Y.
 Unit of Union Carbide and Carbon Corporation

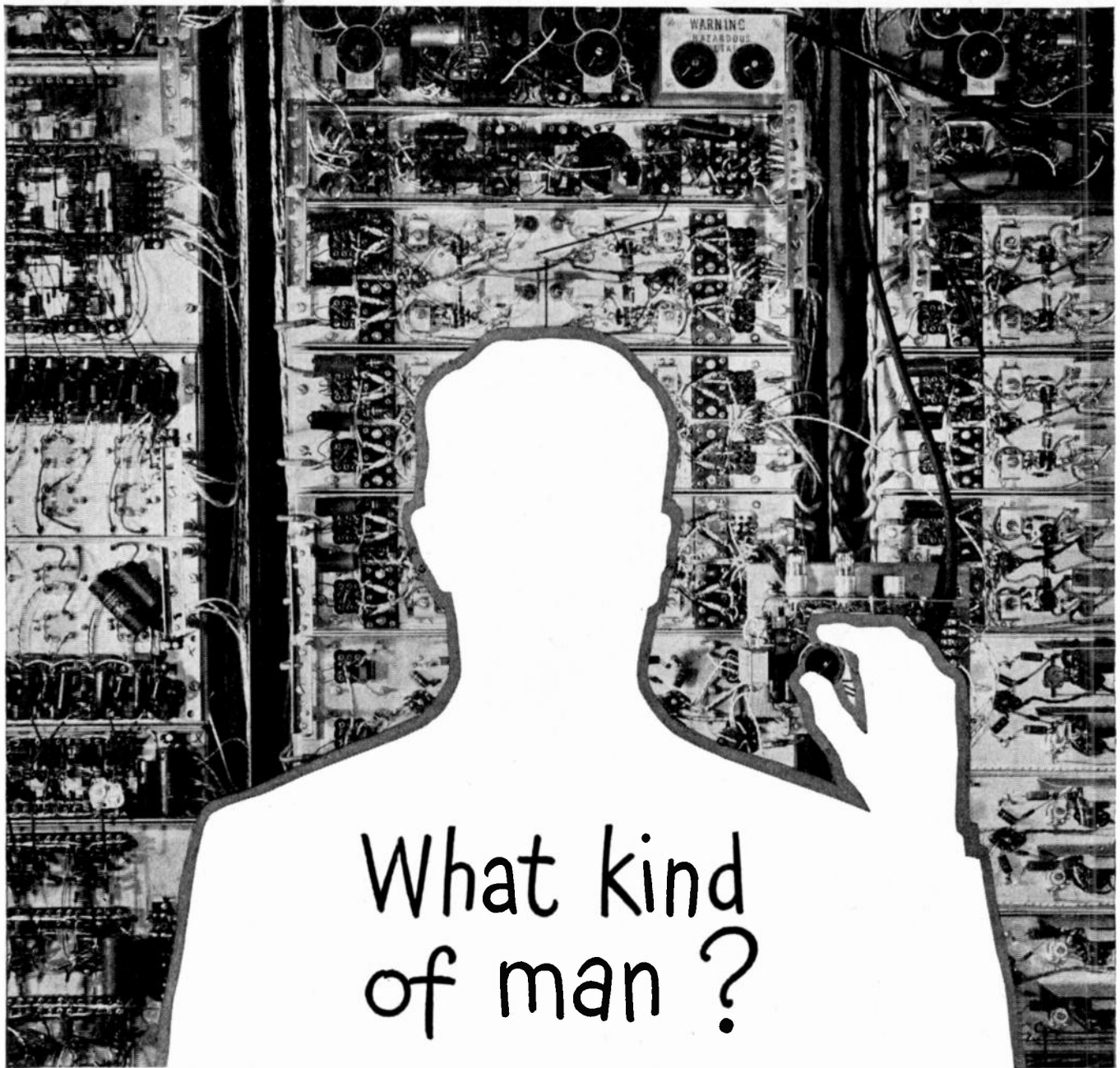

What kind of man ?

WHAT KIND of men are the 2,300 scientists and engineers of Bell Telephone Laboratories?

Men of many types, working in different fields of research, may contribute to each development.

But all have certain characteristics in common: Good minds as a foundation, many years of learning in the fundamentals of their science and the methods of research, and a co-operative attitude — for without co-operation of individuals these products of research could never be produced.

Above all else, however, they have “the spirit to adventure, the wit to question, and the wisdom to accept and use.”

That kind of men can produce the finest telephone equipment in the world — and have done so.



BELL TELEPHONE LABORATORIES

EXPLORING AND INVENTING, DEVISING AND PERFECTING FOR CONTINUED IMPROVEMENTS AND ECONOMIES IN TELEPHONE SERVICE



ARNOLD

That's the
name to
remember in
PERMANENT
MAGNETS

There are values in the use of permanent magnets—increased efficiencies and economies—that should be investigated by many a manufacturer of electrical and mechanical equipment. The past decade has seen great strides in the scope and utility of permanent magnets, and this progress is *important* to you.

Equally important are the *extra* values you'll find in Arnold Permanent Magnets—the natural result of specialization and leadership, and of complete quality control in every production step from melting furnace to final test. • Call in an Arnold engineer to help with your design and planning—write direct or to any Allegheny Ludlum office.

W&D 1099

THE ARNOLD ENGINEERING CO.

Subsidiary of

ALLEGHENY LUDLUM STEEL CORPORATION

147 East Ontario Street, Chicago 11, Illinois

Specialists and Leaders in the Design,

Engineering and Manufacture of PERMANENT MAGNETS



Announcing **ET** Hi-Kaps!

Centralab's New Feed-Thru or Bushing Mounted Capacitors made with high dielectric Ceramic-X!

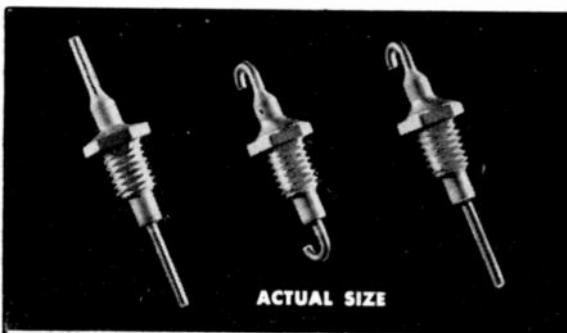
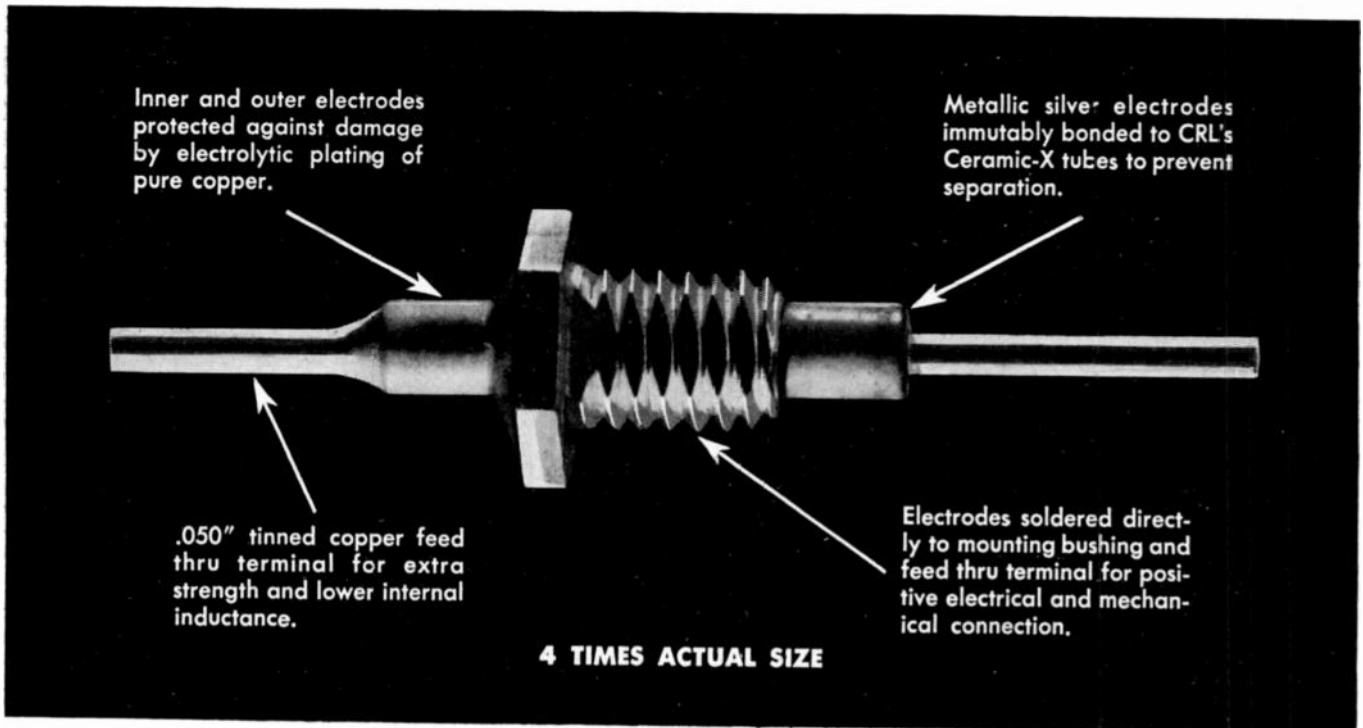

Your choice of leads or terminals

Three types to meet your needs: 1) both ends straight. 2) both ends bent. 3) one end straight, other end bent. Special terminal or lead requirements can be supplied.

New mechanical bond eliminates structural and electrical damage during installation!

HERE, AT LAST, are the Feed Thru or Bushing Mounted Capacitors you have been waiting for! Made with high dielectric Ceramic-X, these new additions to Centralab's growing *Hi-Kap* line once and for all eliminate the problems of damage during installation. Secret of this new CRL development is two tough, mechanical bonds—1) between inner feed-thru terminal and inside diameter of tube, and 2) between mounting bushing and outside diameter of tube. Special high temperature solder is then applied to assure a positive electrical connection. Result: top quality, efficiency, and long life.

FT Hi-Kaps are for use in high frequency circuits where, in addition to feed-thru, a capacity ground to either the chassis or shield is desired. *Ratings:* Capacity from 55 to 2,300 mmf. 500 WVDC. Flash test, 1,000 VDC. See your Centralab representative, or write for bulletin 975.

Look to Centralab in 1948!

First in component research that means lower costs for the electronic industry.

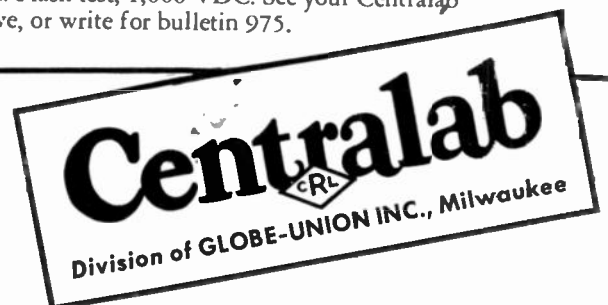

The Best Resistors Are Not Enough

SERVICE IS VITAL

The most complete line of high quality resistors is not enough. IRC considers sincere service—cooperative development work, unbiased recommendations, on time deliveries, genuine help in emergencies and friendly follow thru also vital in meeting advancing demands of industry.

The RESISTOR ANALYSIS COUNCIL is a natural development of this concept. Sponsored by IRC, and established to provide experienced technical aid on your resistor problems—electrical and mechanical. Working together on your specific requirements, confidential analysis may disclose ways to cut assembly costs, eliminate expensive "specials" or improve performance. You may obtain this counsel by sending available data on your resistor problem to the RAC at—International Resistance Company, 401 N. Broad St., Philadelphia 8, Pa.

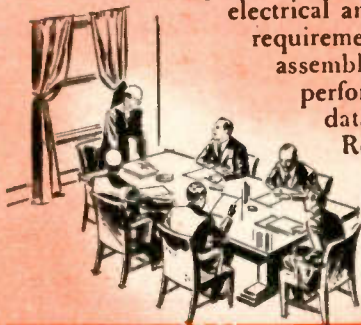

Resistor Analysis Council

A new IRC industry service. Composed of IRC electrical and mechanical engineers plus production specialists, the RAC—Resistor Analysis Council operates as consultant to engineers and designers. Provides confidential analysis of resistor requirements—helps solve electrical, mechanical and cost considerations. RAC's industry knowledge is sufficiently broad that recommendations need not be confined to IRC products. Consult the Resistor Analysis Council on your present or anticipated resistor problems.

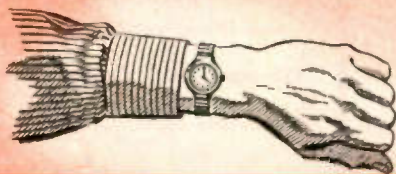

On Time Deliveries

Purchasing Agents and material control executives rely upon IRC's "on time" deliveries. They know that regardless of a product's high quality, assembly line problems are a natural consequence when delivery schedules aren't met. IRC delivers "on time"—also maintains factory stock piles of most popular resistor types and ranges assuring you of real assistance in emergencies.



Complete Line

Only IRC produces such a wide range of resistor types. All your requirements can be readily supplied from one source. Manufacturing all types, IRC's recommendation on the proper resistor for your product is unbiased. For over two decades IRC has concentrated its engineering and manufacturing talent exclusively on resistors. You benefit by this accumulated experience when you specify IRC. Technical Data Bulletins are available on each IRC resistor type.



Industrial Service Plan

Providing speedy "round-the-corner" deliveries on your small order requirements, IRC's distributor network maintains well-stocked shelves of all standard items. No time lost when you need experimental or maintenance quantities in a hurry. When time means money you profit by competent service from the IRC distributor in your area—write for his name and address.

INTERNATIONAL RESISTANCE COMPANY



IN CANADA: INTERNATIONAL RESISTANCE COMPANY, LTD., TORONTO, LICENSEE

Power Resistors • Precisions • Insulated Composition Resistors • Low Wattage Wire Wounds • Rheostats • Controls • Voltmeter Multipliers • Voltage Dividers • HF and High Voltage Resistors

What do you want to know about Vibrator Power Supply Design?



All the answers
are in this unique
new book



Here's the world's first "book of knowledge" about vibrator power supplies: a volume by the country's largest manufacturer of vibrators . . . a book that shares sixteen years of highly specialized experience with you . . . that answers every question on the subject, including mistakes to avoid in designing your new equipment. The information brought you in this volume is compact, complete, entirely original. It can not be duplicated anywhere else. It is as unique in its field as the Mallory Electrical Contact Data Book or the Mallory Resistance Welding Data Book are in theirs.

Although just published, demand for the Vibrator Data Book is already large. You can be sure of getting your copy by ordering *now*—before the first edition runs out. The price is only \$1.00. Free to recognized engineers and teachers when requested on your letterhead.

- Basic Vibrator Structures
- Mallory Standard Vibrators
- Preliminary Design Considerations
- The Choice of a Vibrator
- Basic Power Transformer Characteristics
- Tables, Charts, Graphs and Formulas
- Development of Basic Transformer Formula with Design Examples
- Timing Capacitor Considerations
- Vibrator Power Supply Construction and Interference Elimination
- Vibrator Power Supply Circuits
- Inspection of Vibrators

P. R. MALLORY & CO. Inc.
MALLORY VIBRATORS
AND VIBRATOR POWER SUPPLIES
P. R. MALLORY & CO., Inc., INDIANAPOLIS 6, INDIANA

**MORE MALLORY
VIBRATORS ARE IN USE
TODAY THAN ALL
OTHER MAKES COMBINED.**

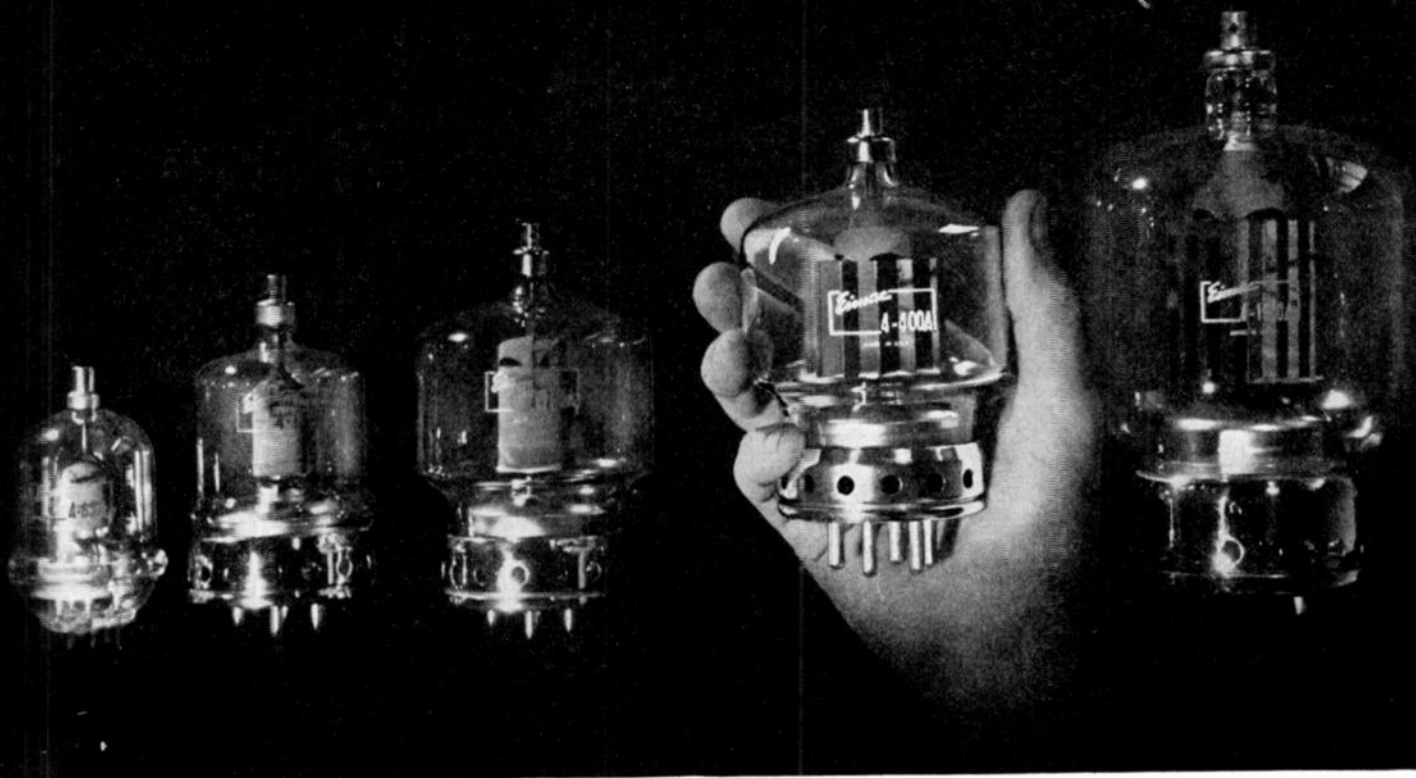

FOR 1 KW FM . . . A NEW RADIATION COOLED TETRODE

ANOTHER in the Eimac line of power tetrodes . . . Type 4-400A embodying stability, high performance, and economy characteristics familiar to all Eimac tetrodes.

PROVEN DESIGN

The 4-400A was created to fill the established need for a tetrode of the internal anode type capable of providing 1 kw FM-broadcast output per pair at low driving power, while operating well below maximum ratings. Type 4-400A inherits the Eimac know-how of tetrode design, it incorporates maximum shielding of the tube input—output circuits, processed non-emitting grids, low-inductance leads, thoriated tungsten filament and a rugged plate contributing to exceptionally long tube life.

AMPLE POWER

In typical operation, at frequencies in the 88-108 Mc FM broadcast band, two 4-400A tetrodes provide over 1000 watts of useful power output, operating at 4000 plate volts, while the plate dissipation is considerably under the maximum rating of 400 watts per tube. Complete operational data and characteristics are available by writing direct.

UNIQUE FEATURE

To assure adequate cooling and extended tube life, the 4-400A must be used in the special Eimac socket and air control chimney. This unique socket makes maximum use of a small amount of air by directing it first on the terminals, around the base seals, through the socket, around the envelope, and then on the plate seal and lead. The socket housing

is of cast aluminum and conveniently mounts below the chassis deck while spring clips on the deck support the pyrex chimney.

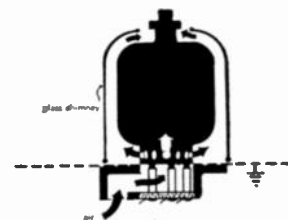

LOW COST

Type 4-400A tetrodes are priced at \$50.00 each, an exceptionally low price considering their power performance capabilities.

DESIGN ASSISTANCE

Let Eimac engineers assist you in your vacuum tube application problems. A letter to the Application Engineering Department will bring you up-to-the-minute data and application suggestions on the 4-400A and other Eimac tube types.

EITEL-McCULLOUGH, INC.

186 San Mateo Avenue
San Bruno, California

Follow the Leaders to

Eimac
TUBES
The Power for R-F

EXPORT AGENTS: Frazar & Hansen—301 Clay St.—San Francisco, Calif.

ISOLATION

...from extraneous radio interference...
for test rooms in laboratory or factory

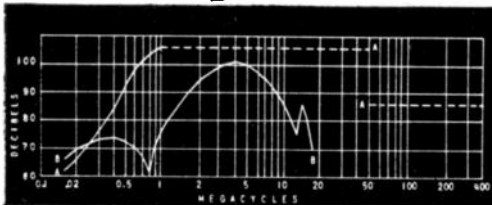
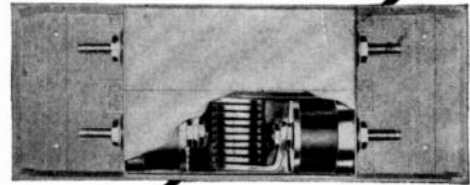

Curve A — Heavy-duty filters; dotted line indicates attenuation beyond range of available measuring equipment.

Curve B — Medium-duty filters.

Installed where the electric power service passes through the screen, these Filterettes provide high attenuation from 150 kc to 400 mc, thus permitting operation of sensitive high-frequency test apparatus in close proximity to electric production equipment, welding generators, repulsion motors, and high-frequency induction heating equipment.

SPECIFICATIONS

Mechanical design and assembly conform to practical electrical installation requirements. Outer housings are of welded steel; knockouts at each end accommodate electrical conduits; heavy, threaded studs facilitate attachment of cable lugs.



Screen Booth Filters

These units employ non-inductive, mineral-oil impregnated capacitors; the inductors, of large cross-section, have low series resistance, hence voltage drop is negligible. Overload ratings are: 150% of ampere rating for one hour; 200% of voltage rating for one minute. Since the filters have no saturable characteristics, performance is uniform for all loads up to maximum ratings.

HEAVY DUTY FILTERS					
Type	Amperes	Volts	Volt. Drop	Freq. Range	Weight
No. 1179-A Two Wire	100	500 a-c/d-c	.2 volts per circuit	0.15 to 400 megacycles	40 lbs.
No. 1182-A Three Wire	100	500 a-c/d-c	.2 volts per circuit	0.15 to 400 megacycles	65 lbs.
MEDIUM DUTY FILTERS (Two Wire)					
No. 1137	20	110/220 a-c 500 d-c	.5 volts per circuit	0.15 to 20 megacycles	17 lbs.
No. 1116	50	110/220 a-c 500 d-c	.5 volts per circuit	0.15 to 20 megacycles	17 lbs.



TOBE DEUTSCHMANN Corporation CANTON, MASSACHUSETTS

LINKING FUNCTION

TO DESIGN

Engineers and Designers who insist on dependable components have adapted SCA Selenium Rectifiers into their circuits. They are specifying SCA products, and are submitting their rectifier problems to us. Our greatly expanded plant facilities, plus the recognized dependability of SCA products, make it possible for us to offer the most complete line of Selenium Rectifiers and self-generating Photoelectric Cells.

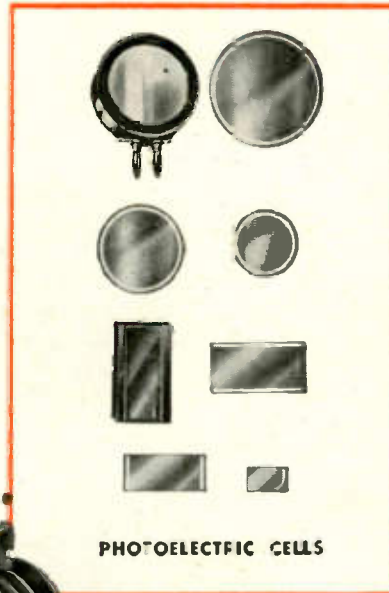

PHOTOELECTRIC CELLS

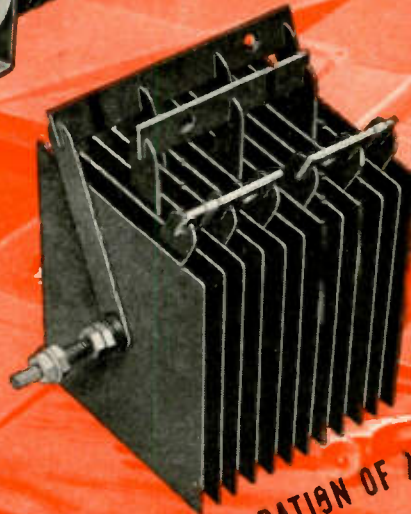
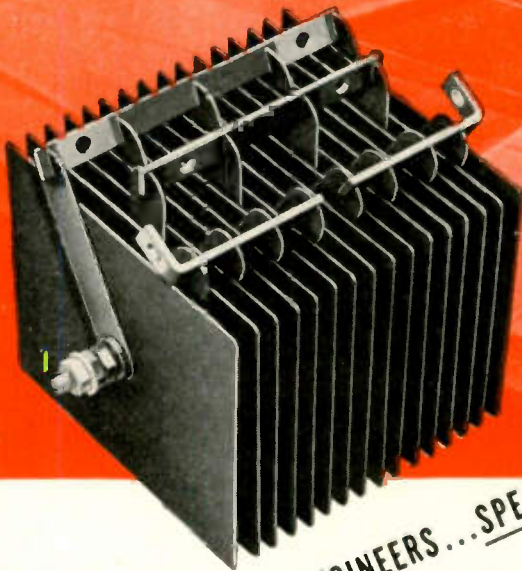

FOLLOW THE ENGINEERS... SPECIFY... SELENIUM CORPORATION OF AMERICA



SELENIUM CORPORATION OF AMERICA

Affiliate of **VICKERS** Incorporated
 2160 EAST IMPERIAL HIGHWAY • EL SEGUNDO, CALIFORNIA
 EXPORT: Frazar & Mosen, Ltd., 301 Clay St., San Francisco 11, Calif.
 Canada: Powertronic Equipment Ltd., 494 King St., E. Toronto 2, Canada

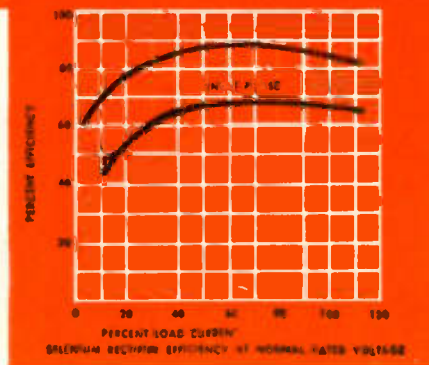

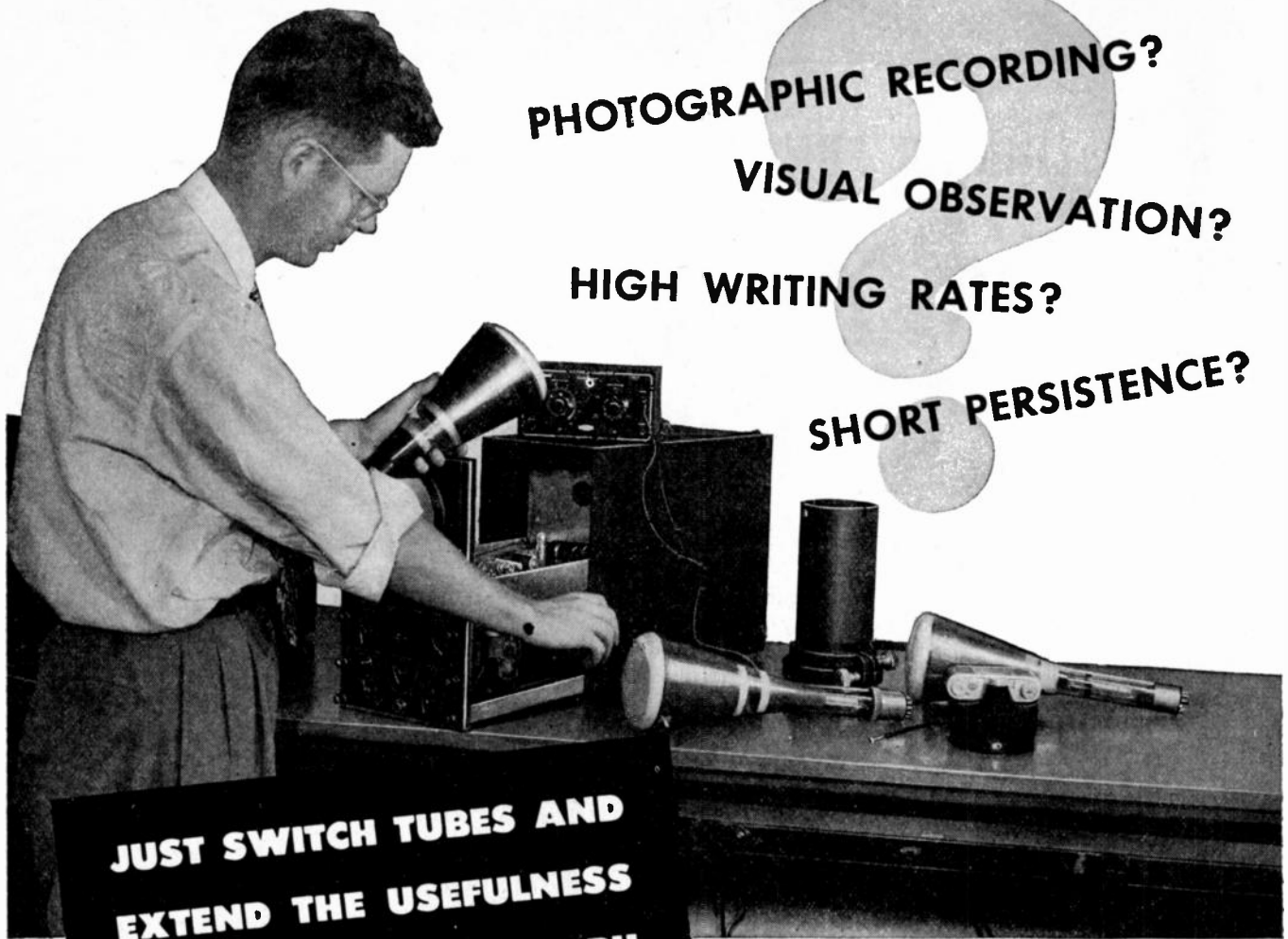

PHOTOGRAPHIC RECORDING?

VISUAL OBSERVATION?

HIGH WRITING RATES?

SHORT PERSISTENCE?

**JUST SWITCH TUBES AND
EXTEND THE USEFULNESS
OF YOUR OSCILLOGRAPH**

SCREEN CHARACTERISTICS AT A GLANCE . . .

The following types of fluorescent screens are available in Du Mont cathode-ray tubes:

P1: Medium persistence green. High visual efficiency. For general-purpose visual oscillographic and indicating applications.

P2: Long persistence blue-green fluorescence and yellow-green persistence. Long persistence at high writing rates. Short-interval excitation.

P4: Medium persistence white for television images.

P5: Extremely short persistence blue for photographic recording on high-speed moving film. Persistence time

for energy drop to 50% is 5 microseconds. Available on special order.

P7: Blue fluorescence and yellow phosphorescence. Long persistence at slow and intermediate writing rates. For filtering out initial "flash" and for high build-up of intensity under repeated excitation, this screen may be used with Du Mont Type 216-J Filter.

P11: Short persistence blue. For recording high writing rates. Persistence time for energy drop to 50% is 10 microseconds.

▶ There's a screen for every oscillographic purpose. But only Du Mont makes all types of screens. By having that extra Du Mont tube with the right screen available, you can cover a wider range of applications more quickly and realize far greater value from your oscillograph, simply by switching tubes.

As a time-, trouble- and money-saver, that extra, dependable, high-quality Du Mont tube should be on hand when you need it. So why not buy it now while you're thinking about it?

And when replacing cathode-ray tubes, always remember that Du Mont tubes are made to RMA specifications and therefore fit any standard oscillograph.

▶ **Use the right screen for the right job.**
Descriptive data on request.

© ALLEN B. DUMONT LABORATORIES, INC.

DUMONT Precision Electronics & Television

ALLEN B. DUMONT LABORATORIES, INC., PASSAIC, NEW JERSEY • CABLE ADDRESS: ALBEEDU, PASSAIC, N. J., U. S. A.

**They Lick Humidity and Vibration
at High Frequencies**

STACKPOLE

Polytite TRIMMER ELECTRODE CORES

Placed in fitted metal sleeves, Stackpole Polytite Trimmer Electrode Core Forms serve as variable capacitors that assure honest-to-goodness capacity stability in high-frequency circuits where humidity and vibration must be considered. The molded Polytite has a high dielectric constant. Cores are moisture repellent and carry a heavy dielectric coating that establishes a path of high leakage resistance between the electrodes. Since these electrode surfaces have short, symmetrical current paths, the inductance may be kept low enough for use in the 200-megacycle range. Standard types provide easy capacity adjustment with a maximum from 20 to 40 mmf., depending on the size.

Write for Stackpole Polytite Trimmer Data Bulletin

STACKPOLE CARBON COMPANY
Electronic Components Division • St. Marys, Pa.

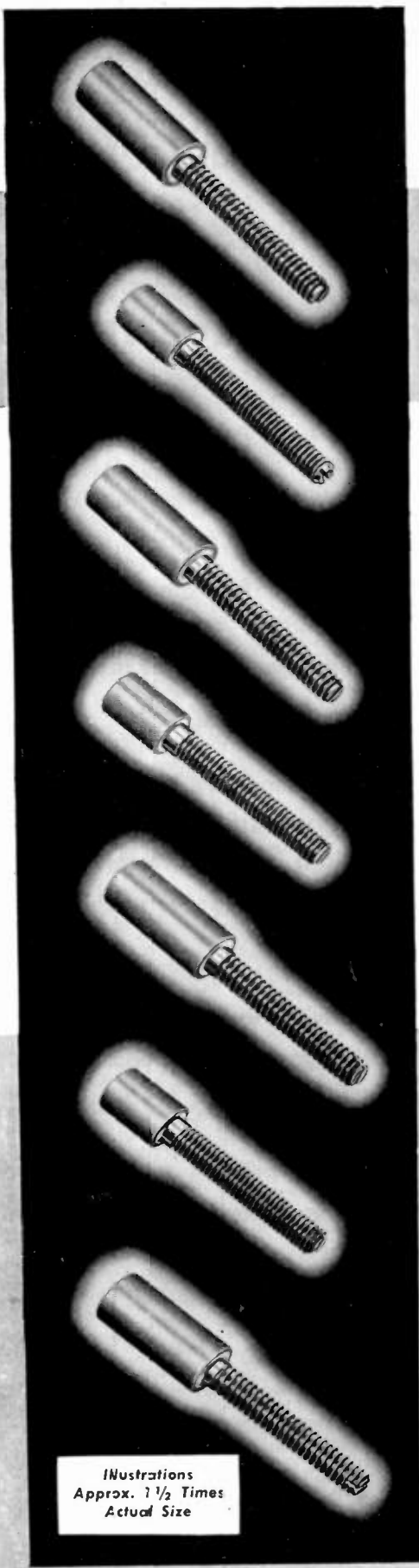

Illustrations
Approx. 1 1/2 Times
Actual Size

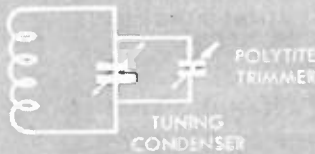

Stackpole Polytite Trimmer Electrode Capacitors are well suited for minimum capacity adjustments in tuned circuits, installed across the tuning capacitor as in Figure 1 or across the tuning inductance as in Figure 2. Trimmers may be mounted directly to the tuning capacitor.



A typical application using two Polytite Trimmer Electrode Capacitors in a circuit where band-spread tuning is desired. Various bands may be covered by the switching of coils and preadjusted trimmers.

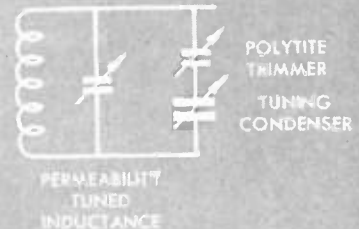

RESISTORS • IRON CORES • SWITCHES

DEFLECTION COIL
SHELL CYLINDER

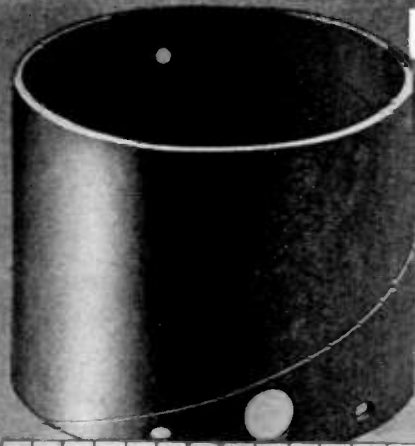

DEFLECTION
COIL CORE

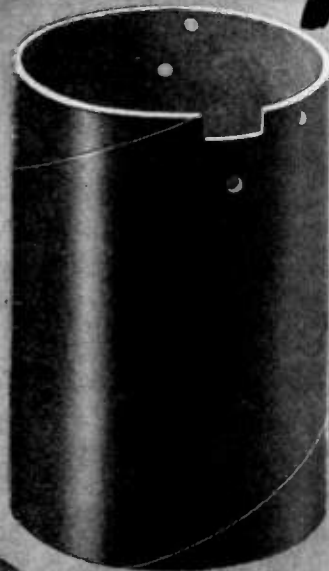
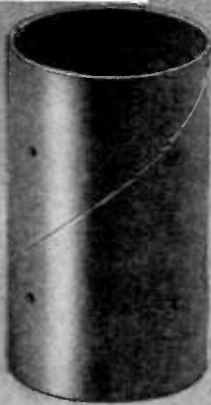

SHELL

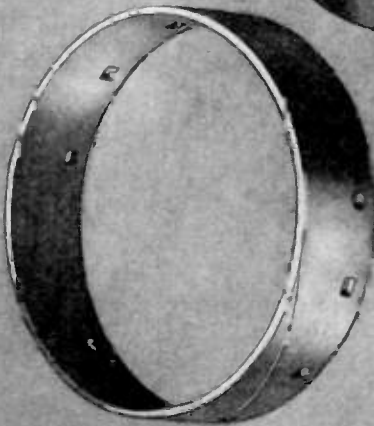

DEFLECTION COIL
TERMINAL RING

RETAINING RING



DEFLECTION SPACER



**PUNCHING AND
NOTCHING AS MAY BE
DESIRED.**

Television RECEIVERS

**PUNCHED COSMALITE
COIL FORMS FOR..***

A new and further step in the ever increasing use of these spirally laminated paper base, Phenolic Tubes. Performance based upon approximately seven years of research.

*

Other Cosmalite Types

#96 COSMALITE for coil forms in all standard broadcast receiving sets.

SLF COSMALITE for Permeability Tuners.

*

Spirally wound kraft and fish paper Coil Forms and Condenser Tubes.

*

Attractive prices. Fast deliveries. Inquiries given specialized attention.

 * Trade Mark Registered

The CLEVELAND CONTAINER Co.

6201 BARBERTON AVE. CLEVELAND 2, OHIO

- All-Fibre Cons • Combination Metal and Paper Cons
- Spirally Wound Tubes and Cores for all Purposes
- Plastic and Combination Paper and Plastic Items

PRODUCTION PLANTS also at Plymouth, Wis., Ogdenburg, N. Y., Chicago, Ill., Detroit, Mich., Jamesburg, N. J.
PLASTICS DIVISIONS at Plymouth, Wis., Ogdenburg, N. Y. • ADDRESS DIVISION at Cleveland, Ohio
SALES OFFICES - Room 223, 1186 Broadway, N. Y. C., also 647 Main St., Hartford, Conn.
IN CANADA - The Cleveland Container Canada Ltd., Prescott, Ontario.





FOR SPECIALTIES

The fields of frequency control, Servomechanisms, etc., are developing rapidly with increasing complexity. UTC is playing a principal role in the development of special components for these and allied fields. A few typical special products are illustrated below:

AUDIO FILTERS

The curve illustrated shows a group of filters affording sixteen separate bands in the audio and supersonic region with 35 DB attenuation at the cross-over points. These have also been supplied spaced further apart (40 DB cross-over), with intermediate bands, permitting flat top band pass action for any selected range from 100 cycles to 200 KC.

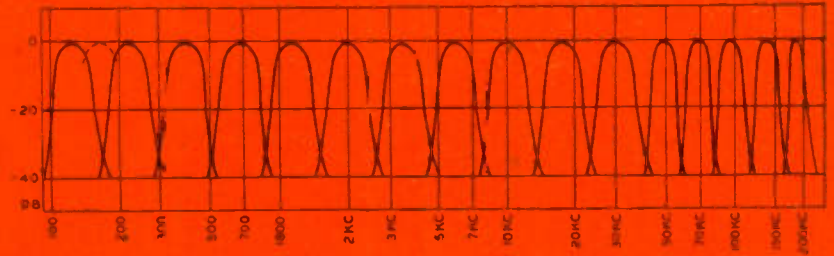

TOROID DUST HIGH Q COILS

UTC type HQ coils have found wide application because of their high Q, stable inductance and dependability. The HQA and HQB types are catalogued. New types HQC and HQD are now available, effecting a Q of over 200 at 50 KC and 100 KC respectively.

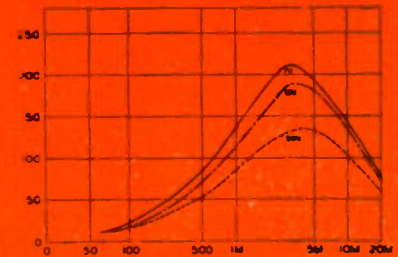
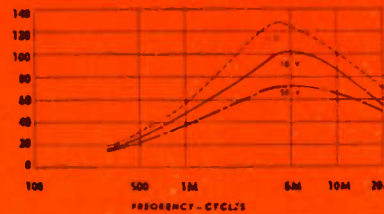

SATURABLE REACTORS

Saturable reactors are used extensively for both power control and phase control. The left curve is that of a small (1" cube) sensitive unit indicating the variation of inductance with saturating DC. The right curve is that of a moderate size power control reactor indicating power to the load with saturating DC.

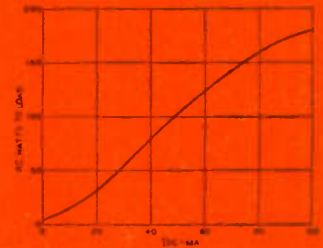
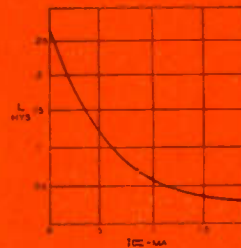

CURRENT LIMITING TRANSFORMERS

This type of transformer is used extensively to extend the life of vacuum tubes by limiting the filament current when cold. The curve at the left is that of a typical transformer of this type for high power amplifier tubes in broadcast service. The curve on the right illustrates limiting action in a high voltage transformer for social service.

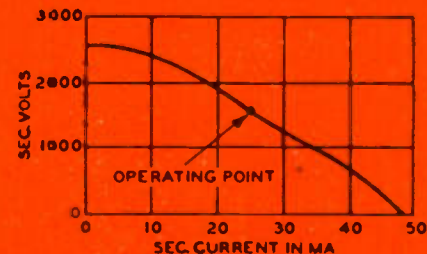
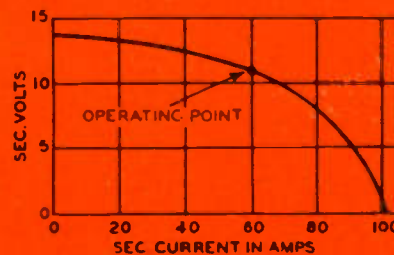

May we design a unit for your application problem.

United Transformer Corp.
150 VARICK STREET NEW YORK 13, N. Y.

EXPORT DIVISION: 13 EAST 40th STREET, NEW YORK 16, N. Y.

CABLES: "ARLAB"

PROFESSIONAL PERFORMANCE—that keeps the original sound alive!

**Make Each
Record a**

**"Personal
Appearance!"**



—with precision control of recording quality



Listen critically: Your station is on the air. There's your announcer's voice . . . the opening music . . . the song . . . the chatter. Is it a 'live' or a 'recorded' program? Not even your trained ears should be able to tell!

Today, truly professional recording reproduces all of the quality and natural beauty of music or speech with full naturalness. It keeps the original sound alive.

You can sum up the reasons for the unexcelled 'live' performance of the Fairchild Unit 523 Studio Recorder in one simple statement: It provides a maximum flexibility of mechanical operation that permits the operator to secure unexcelled quality of reproduction. Fairchild provides instant, infinite variation of pitch from 80 to 160 lines-per-inch by means of a unique planetary-driven lead screw. Operation is controlled by a single, easily accessible knob, as illustrated at the left. This makes it possible to record a very loud passage at 90 lines-per-inch and to follow it with soft passages at 120 or 130 lines-per-inch without dial twisting or the danger of overcutting the next groove.

Timing is accurate to a split-second. Operation is 'WOW'-free. Turntable noise, rumble and vibration are non-existent. And the performance of the Fairchild Unit 541 Magnetic Cutterhead—which is standard equipment on the Unit 523 Studio Recorder—has been engineered for full dynamic range; minimum distortion content and broad frequency range. Want more details? Address: 88-06 Van Wyck Blvd., Jamaica 1, N. Y.

© 1947 I. C. AND I. CORP.



Studio Recorders
Magnetic Cutterheads
Transcription Turntables
Portable Recorders
Lateral Dynamic Pickups
Utilized Amplifiers

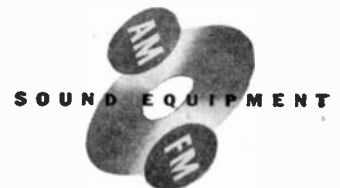

Fairchild CAMERA

AND INSTRUMENT CORPORATION

"THE hottest ham performance ever at this price . . ." That's the verdict of amateurs who have had a chance to try Hallicrafters new Model SX-43.

This new member of the Hallicrafters line offers continuous coverage from 540 kilocycles to 55 megacycles and has an additional band from 88 to 108 megacycles. AM reception is provided on all bands, except band 6, CW on the four lower bands and FM on frequencies above 44 megacycles. In the band of 44 to 55 Mc., wide band FM or narrow band AM just right for narrow band FM reception is provided.

One stage of high gain tuned RF and a type 7F8 dual triode converter assure an exceptionally good signal-to-noise ratio. Image ratio on the AM channel on band 5 (44 to 55 Mc.) is excellent as the receiver is used as a double superheterodyne. The new Hallicrafters dual IF transformers provide a 455 kilocycle IF channel for operating frequencies below 44 megacycles and a 10.7 megacycle IF channel for the VHF bands. Two IF stages are used on the four lower bands and a third stage is added above 44 megacycles. Switching of IF frequencies is automatic. The separate electrical bandspread dial is calibrated for the amateur 3.5, 7, 14, and 28 megacycle bands.

Every important feature for excellent communications receiver performance is included.

Model **SX-43**

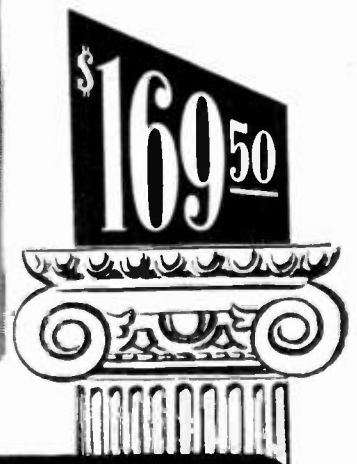

FEATURES FOUND IN NO OTHER RECEIVER AT THIS PRICE

- ALL ESSENTIAL AMATEUR FREQUENCIES FROM 540 kc to 108 MC
- AM - FM - CW RECEPTION
- IN BAND OF 44 TO 55 MC: WIDE BAND FM OR NARROW BAND AM . . . JUST RIGHT FOR NARROW BAND FM RECEPTION
- CRYSTAL FILTER AND EXPANDING IF CHANNEL PROVIDE 4 VARIATIONS OF SELECTIVITY ON LOWER BANDS
- SERIES TYPE NOISE LIMITER
- TEMPERATURE COMPENSATION FOR FREEDOM FROM DRIFT
- PERMEABILITY ADJUSTED "MICROSET" INDUCTANCES IN THE RF CIRCUITS
- SEPARATE RF AND AF GAIN CONTROLS
- EXCEPTIONALLY GOOD SIGNAL-TO-NOISE RATIO
- SEPARATE ELECTRICAL BANDSPREAD CALIBRATED FOR THE AMATEUR 3.5, 7, 14 AND 28 Mc BANDS

BUILDERS OF

Skyphone

AVIATION RADIOTELEPHONE

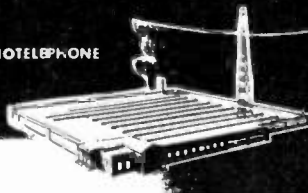

hallicrafters RADIO

THE HALLICRAFTERS CO., MANUFACTURERS OF RADIO AND ELECTRONIC EQUIPMENT, CHICAGO 16, U. S. A.

Sole Hallicrafters Representatives in Canada: Rogers Maritime Limited, Toronto-Montreal



Be Right with.. OHMITE

Wire Wound Resistors

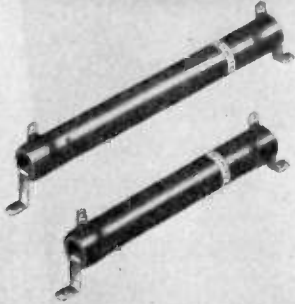

Ohmite offers a complete line of dependable resistors wound on a ceramic tube and protected by vitreous enamel. Ratings from 5 to 200 watts. Available in the fixed type for general use, and in the "Dividohm" type with adjustable lugs for use as a multi-tap resistor or voltage divider. Many standard types and mountings.

Composition Resistors and Potentiometer

"Little Devil" resistors are individually marked. In 1/2, 1, and 2-watt, $\pm 10\%$ tol. Also $\pm 5\%$ in 1/2, 1-w sizes. RMA values, 10 ohms to 22 megohms.

Type AB, 2-watt molded element potentiometer for industrial use. 50 ohms to 5 megohms in linear taper.

Both items sold only through Ohmite distributors.

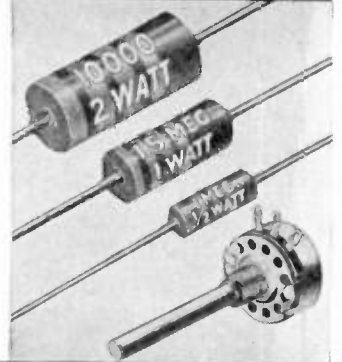

Vitreous Enameled Rheostats

Available in 10 sizes, ranging from 25 to 1000 watts, in a wide range of resistances. Ceramic parts insulate the shaft and mounting. The resistance winding is permanently locked in vitreous enamel. The metal-graphite brush provides unmatched smoothness of action. Engineered and constructed for long, trouble-free life.

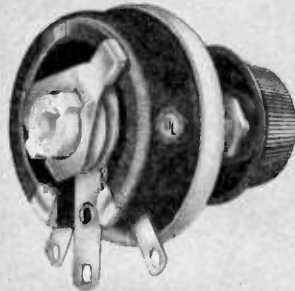

Non-Inductive Resistors

Used as dummy antennas for radio transmitters, load resistors in high-frequency circuits, terminating resistors for radio antennas. Vitreous-enamel type wound on a tubular ceramic core. Also dummy antenna units consisting of several resistors arranged concentrically, connected in parallel. Sizes: 50 to 250 watts.



Radio Frequency Plate Chokes

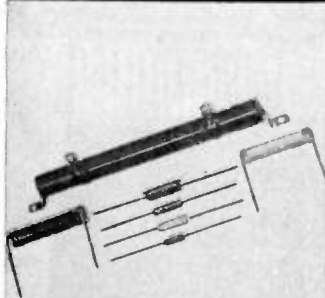

To adequately cover higher radio frequencies now used by amateurs, police, and other communication facilities. Single-layer wound on low power factor steatite or molded plastic cores and covered with a moistureproof coating. Seven stock sizes from 3 to 520 megacycles. Two units rated 600 ma; all others 1000 ma.

All Ceramic Tap Switches

A popular switch for use with tapped transformers in power supply units. Compact, dependable, and convenient to operate. Available in ratings of 10, 15, 25, 50, and 100 amperes, A.C. Contacts are of the silver-to-silver, non-shorting type. Switch shaft is insulated by a strong ceramic hub. Ceramic body is unaffected by arcing.



OHMITE MANUFACTURING CO., 4860 Flournoy St., Chicago 44, U. S. A.

OHMITE

Write on Company Letterhead for Catalog and Engineering Manual No. 40.

Provides 96 pages of useful data on the selection and application of rheostats, resistors, tap switches, chokes, attenuators, and other equipment.



RHEOSTATS RESISTORS TAP SWITCHES CHOKES

new klystron tubes

NOW AVAILABLE FOR MICROWAVE RELAYS

- Four Sperry Reflex Klystron oscillators for microwave relay systems are now available for commercial use. These Klystrons can be used either as transmitting types or local oscillators. They can also be used in the laboratory as bench oscillators in the development of microwave relay systems.
- With these new Klystron tubes, relay techniques are simplified and the mechanical problems associated with lower frequency relay links are overcome.
- Other Sperry Klystrons are available in the frequency range from 500 to 12,000 megacycles. Our Industrial Department will gladly supply further information.



Sperry Gyroscope Company, Inc.

EXECUTIVE OFFICES: GREAT NECK, NEW YORK • DIVISION OF THE SPERRY CORPORATION
NEW YORK • CLEVELAND • NEW ORLEANS • LOS ANGELES • SAN FRANCISCO • SEATTLE

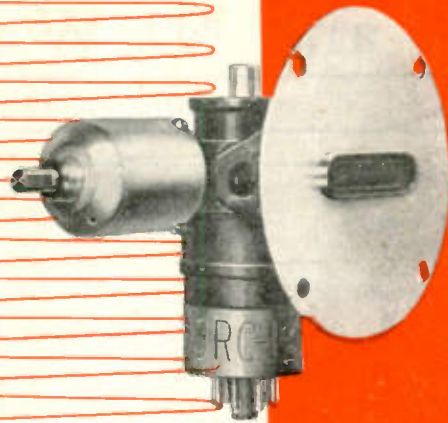

TYPE SRC-12, -20, -21
FREQUENCY 4400-5000 mc
POWER OUTPUT 5 WATTS MAX.

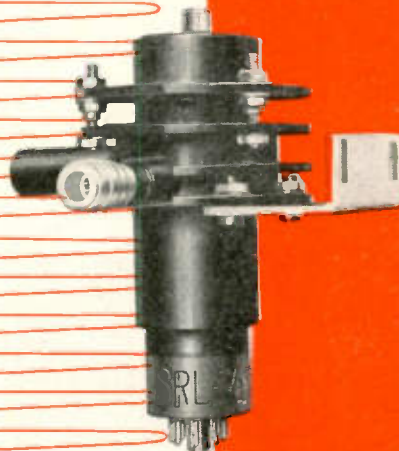

TYPE SRL-7a
FREQUENCY 1825-2100 mc
POWER OUTPUT 5 WATTS MAX.

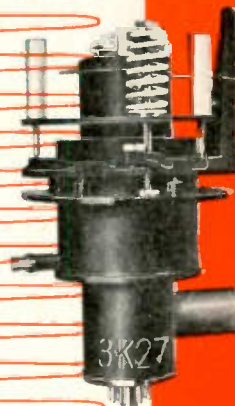

TYPE 3K27
FREQUENCY 750-960 mc
POWER OUTPUT 1.5 WATTS MAX.



TYPE SRC-8 SERIES
FREQUENCY 5500-7800 mc*
POWER OUTPUT 4.5 WATTS MAX.

*The SRC-8 tubes are available in 100 megacycle steps except for 3 models, SRC-8A, SRC-8B, SRC-8C which are bench oscillators in 400 megacycle steps from 5850 to 7050



January, 1948

Portable Radioactivity Meter

Intended for qualitative and semi-quantitative measurement of X, gamma, and beta radiation, a new-model portable meter has been announced by Instrument Development Laboratories., 223-233 W. Erie St., Chicago 10, Ill.



The Model 2610 Meter has three ranges: 0.2, 2, and 20 milliroentgens per hour full scale. These give the instrument a range below the cosmic-ray background and above the health tolerance level. The electronic count-rate circuit uses two hearing-aid-type tubes and is completely battery-operated. A visual reading of the amount of radiation present is given by a meter, and earphones are provided for an aural indication. An adjustable shield can be set to prevent the detection of beta particles, so that the user can distinguish between beta and other radiation.

Mobile Transmitter



Recently announced by Eastern Amplifier Corp., 794 East 140th St., New York 54, N. Y., the Model 600 is a complete self-powered 27-30-Mc. mobile transmitter, designed for portable and mobile use.

This instrument measures only 10½×6×6½ inches including the built-in power supply. It has automatic antenna change-over from receiver to transmitter. The output will load any type antenna from 10 ohms to several thousand ohms. Model 600 uses four tubes, 1 2E30 crystal oscillator and doubler, 1 2E30 power amplifier, 1 2E30 plate modulator, and an OZ4 rectifier.

22A

These manufacturers have invited PROCEEDINGS readers to write for literature and further technical information. Please mention your I.R.E. affiliation.

New Signal Generator

Crystal-controlled precision is combined with portability in the new Model 117 Mini-Signal Generator developed by Premier Crystal Laboratories, Inc., 57-67 Park Row, New York 7, N. Y. According to the manufacturer, with this new device and the appropriate crystal, any frequency from 100 kc. to 10.8 Mc., with harmonic operation for higher frequencies, can be obtained using any 110-volt power supply, a.c. or d.c.

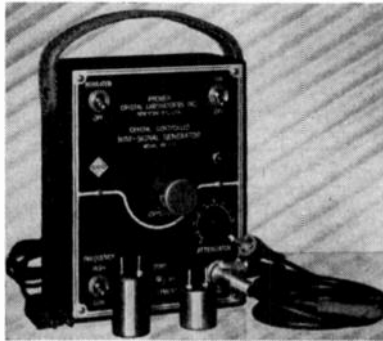

Mounted in a rugged cast-aluminum case, this instrument is suitable for roving inspection in assembly departments and for field checking of communications equipment. It produces an r.f. signal modulated by an audio frequency of approximately 400 cycles, under the control of a continuously variable attenuator and an off-on switch. The generator draws 17 watts, weighs 3½ pounds, measures 3×5×7 inches, and comes equipped with a 6-foot cord and 53-inch leads with insulated clips.

NOTICE

Information for our News and New Products section is warmly welcomed. News releases should be addressed to Mrs. Harriet P. Watkins, Industry Research Division, Proceedings of the I.R.E., Room 707, 303 West 42nd St., New York 18, N.Y. Photographs, and electrotypes if not over 2" wide, are helpful. Stories should pertain to products of interest specifically to radio engineers.

Space-Saving Motor Capacitors

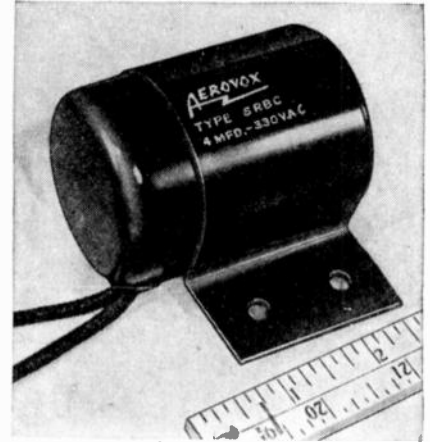

This compact unit is one of a new line of bracket-mounted, armored motor-starting capacitors, (Series SRVC) recently announced by Aerovox Corp., New Bedford, Mass.

These new capacitors are claimed to be fully protected against mechanical damage, dirt, and the usual climatic hazards. The steel casing measures only 2½ inches in diameter by 2½ to 3½ inches long, depending upon voltage and capacitance ratings. Standard ratings are 110, 220, 330, 440, and 660 volts a.c., while capacitances range from 1 to µfd. The flexible pigtail leads from the encased capacitor are brought out through the insulated hole in the cap.

Crystal Phono Cartridge



The Astatic Corp., of Conneaut, Ohio, has introduced a new, low needle-talk reproducer in the low-priced field, designated as type "LT" Crystal Phono Cartridge.

Output voltage, 1.00 volt average at 1000 c.p.s.; minimum needle pressure, ½ ounce; cutoff frequency 4000 c.p.s.; and replaceable Type "T" needle with "Electro Formed" precious-metal playing tip. The manufacturer reports that, in the reproduction of high frequencies, the "LT" cartridge is noticeably free from disagreeable surface noise or needle talk for greater clarity and beauty of tone reproduction.

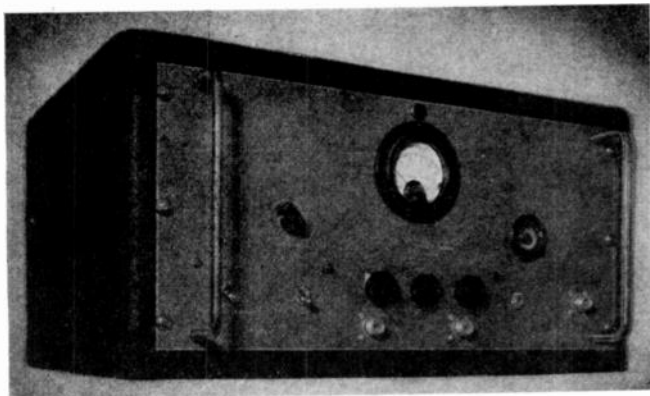

Improved **LAVOIE C-200** **Harmonic Frequency** **Generator with** **0.001% ACCURACY**

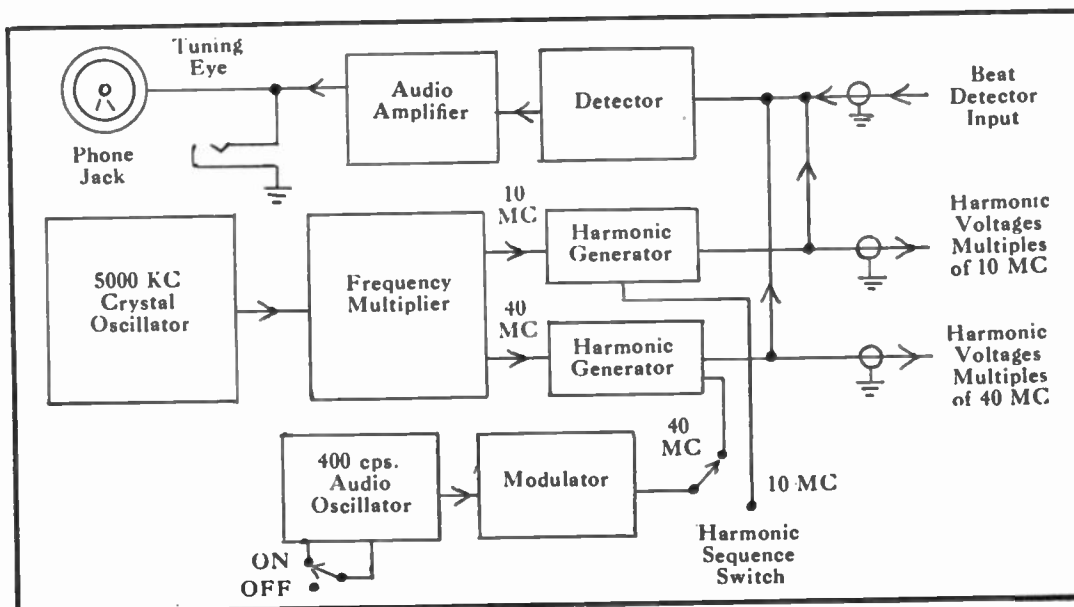

The Harmonic Frequency Generator has been improved for frequency standardization of receivers and frequency meters up to and beyond, 2000 Megacycles. Also, by means of a beat detector built into the instrument, it is possible to standardize oscillators and signal generators with equal facility.

Further circuit refinements have produced a frequency accuracy of 0.001%, which extends from 100 Megacycles to 2000 Megacycles in either 10 Megacycle or 40 Megacycle steps.

The output voltage is supplied at a UG-58/U 50-ohm connector with output coupling controls to obtain peak performance for a given harmonic. A milliammeter is incorporated in the instrument to facilitate easy adjustment of the output controls. The output voltage may be either unmodulated or modulated with 400 cps internal oscillator. The generator provides output voltages every 10 Megacycles or every 40 Megacycles. This selection is made by a

switch on the front panel. The harmonic voltage is in the order of thousands of microvolts for each harmonic with a value of approximately 50,000 microvolts at 100 Megacycles and 1500 microvolts at 1000 Megacycles.

Provision is made for the standardization of signal generators and oscillators by the incorporation of a beat frequency detector in the generator. The output of this beat frequency detector may be monitored, either aurally or visually with a tuning eye indicator.

To facilitate harmonic identification, frequency identifiers can be supplied for any harmonic frequency (multiple of 10 Megacycles) between 100 and 1000 Megacycles. The identifier is adjusted at our factory.

This instrument is supplied with accessories needed for its operation, including tubes, 5 Megacycle crystal, output coupling cable and instruction book.



Write for Illustrated
Descriptive Folder

Lavoie Laboratories

RADIO ENGINEERS AND MANUFACTURERS
MORGANVILLE, N. J.

Specialists in the Development and Manufacture of UHF Equipment

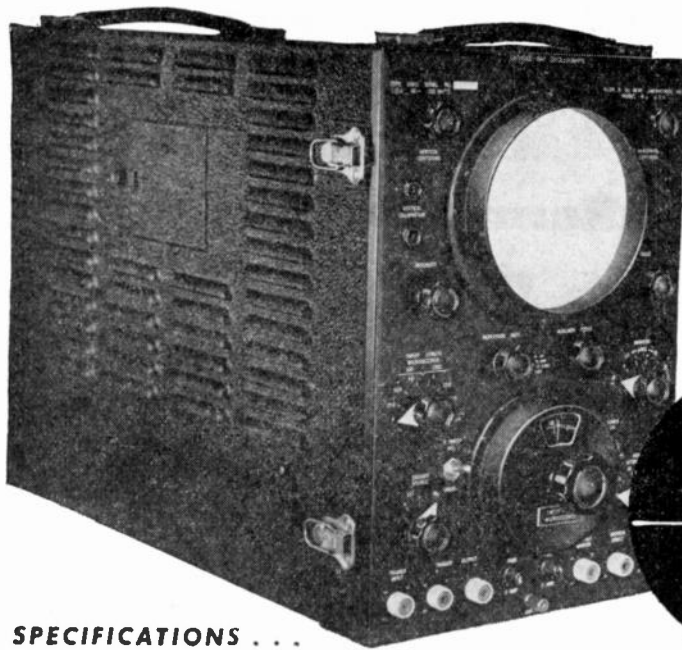

**CRYSTAL-CONTROLLED TIMING MARKERS
ACCURATE TO PLUS/MINUS 0.02%**

**WIDE VARIETY OF SWEEP SPEEDS:
4, 10, 25, 100, 1000 OR 4500
MICROSECONDS MAY BE SELECTED**

**PRECISION, CALIBRATED,
SWEEP-DELAY CIRCUITS**

**EXTENDED WIDE-BAND
AMPLIFIERS: SINE WAVE
RESPONSE DOWN 3 db AT
8 mc, DOWN 6 db AT 11 mc**

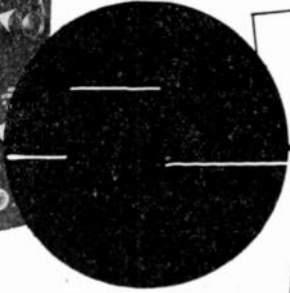

Oscillogram of 1 micro-second pulse passed through video amplifier of Type 256-D Oscilloscope.

SPECIFICATIONS . . .

Type SCP-A cathode-ray tube. 4000 volts accelerating potential. Excellent brilliance and spot size. Sweeps (A): 4500, 1000, 100, 25, 10 and 4 μ sec.

Sweeps (R): 25, 10, 4 μ sec; delayable to cover any portion of the 100 μ sec A Sweep from 4 μ sec up. 25 and 10 μ sec; delayable to cover any portion of the 1000 μ sec A Sweep from 5 μ sec up.

Delay accuracy $\pm 0.1\%$ of full scale. First few microseconds may be observed on the 4 or 10 μ sec A Sweeps. Approx. 0.3 μ sec required to start sweep.

Triggered operation—internal: Provides output pulse of 100 volts peak, positive or negative; rise time 0.3 μ sec; duration 1.0 μ sec; repetition rate 80 to 400 a second on 1000 μ sec and 4500 μ sec ranges; 80 to 2000 a second on 100 μ sec range. Crystal-controlled time marks each 10 and 50 μ sec. Timing mark: rise 0.25 μ sec; duration 1.0 μ sec; accuracy $\pm 0.02\%$.

Triggered operation—external: Trigger input ± 15 volts minimum at 100 volts/ μ sec rise for accurate timing. Trigger amplifier: operation independent of waveform; input trigger rise of

10 volts/ μ sec triggers the sweep. Repetition rate: 2000 max. on 100 μ sec scale; 400 on 1000 μ sec scale. No time marks available.

Intensity Modulation: Input available at Z IN position of markers switch.

Vertical Deflection—Direct: Deflection factor: 70 d-c v/in. Polarity: positive signal deflects upward. Maximum input voltage: 600 v d-c plus peak a-c.

Vertical Deflection—Video Amplifier: Attenuator: 1:1, 3:1, 10:1, 30:1 and 100:1, stepped, R-C compensated. Input Impedance: 1 megohm, 20 μ f. Gain: approx. 125. Sine wave response: Down 3 db at 8 mc; down 6 db at 11 mc. Pulse response: Sum of rise and fall time of 1.0 μ sec pulse with rise and fall of 0.01 μ sec does not exceed 0.08 μ sec when passed through video amplifier. Max. input for undistorted deflection with no attenuation: Approx. 1 v. Deflection: 0.25 v rms and full video gain for $\frac{3}{4}$ " min. Maximum Input Voltage: 600 v d-c + peak a-c. Polarity: Positive signal deflects upwards.

Power: 115 v, single-phase, 60 cps, 220 watts, usable to 1200 cps.

Dimensions: 11 $\frac{1}{2}$ " w., 16 $\frac{1}{4}$ " h., 26" d.; wt. 104 lbs.

All this...and more too,

in the new

DU MONT TYPE 256-D

Cathode-ray
OSCILLOGRAPH

Ideally suited for applications where a variety of sweep lengths, accurate sweep-delay circuits, crystal-controlled timing markers, wide-band video amplifier, and variable internal trigger generator are mandatory.

Such applications embrace television transmitter and receiver research; study of multi-channel, pulse-time modulation systems; nuclear research; and general applications wherein high-speed, short-duration phenomena of low repetition rate are examined.

Immediate delivery! To any destination in continental U.S.A. (Type 256-D; Cat. No. 1296E) delivered price \$1705.00.

© ALLEN B. DU MONT LABORATORIES, INC.

DUMONT Precision Electronics & Television
ALLEN B. DUMONT LABORATORIES, INC., PASSAIC, NEW JERSEY • CABLE ADDRESS: ALBEEDU, PASSAIC, N. J., U. S. A.

MAKING TUBES IS EASY..

If YOU KNOW HOW!



ΚΑΤΑΦΟΡΗΣΙΣ

*...filament coating
made Easier... Better.*

HYTRON CATAPHORESIS COATING MACHINE—Filament wire proceeds from the large spool at top center through oxidizing oven, cataphoresis coating bath, and two small ovens. Finally, the coated wire is wound on the cylinder at the left.

A jawbreaker from the Greek, cataphoresis means simply "the movement of suspended particles through a fluid under the action of an applied electromotive force." At Hytron, filaments are not *sprayed* with electron-emissive coating, because that way precise control cannot be achieved. Rather, coating is electrically deposited by the cataphoretic movement of the carbonate molecules.

Drawn through a special coating solution, the filament wire itself serves as the anode; and a metallic plate, as the cathode. The solution consists of a triple precipitate of barium, calcium, and strontium carbonates plus a binder—all suspended in a special organic medium. A precisely adjusted electromotive

force uniformly deposits and bonds the electrically-charged salts onto the filament wire. Baking problems are simplified; coated wire is spooled directly on a cylinder, ready for use.

This new Hytron method of filament coating is so simple, so precise as to texture, weight, and adhesion. One wonders why it is not universal. The answer is simple. Cataphoresis coating is easy *only* if you possess the trade secret of the Hytron coating formula. Also, the applied voltage, timing, and resultant control of texture and emissive qualities in mass production represent months of persistent research. You profit by superior performance from all Hytron coated-filament tubes.

SPECIALISTS IN RADIO RECEIVING TUBES SINCE 1921

HYTRON

RADIO AND ELECTRONICS CORP.

MAIN OFFICE: SALEM, MASSACHUSETTS



Aerovox Series 26 Bakelite-cased Tubular Capacitors Used Individually or Series-stacked Provide for . . .

VOLTAGES UNLIMITED!



● Name the voltage. These capacitors will handle it. The units shown are for a special high-voltage research project. They are rated at 125,000 volts for single units, 250,000 volts for two units in series. Yet they are *standard* Aerovox items—fully engineered; tried-tested-proven construction; ready to be built at any time—and in time!

Series-stacking builds up to any required voltage. Matched sections insure uniform voltage gradient throughout battery of series-connected capacitors. Plus, of course, Aerovox capacitor craftsmanship.

Originally designed for X-ray, impulse generators and other intermittent dc or continuous ac high-voltage applications such as indoor carrier current coupling, high-voltage test equipment and special high-voltage laboratory work, these *standard* units are now meeting the overnight call for atom-smashing equipment. Indeed, Aerovox is already in the forefront of this Atomic Age.

● Let us quote on your capacitance requirements—from the modest paper tubular or mica, to giant oil or mica capacitors. Engineering data on request.

INTERESTING FEATURES . . .

Oil-impregnated and oil-filled with Aerovox Hyvol D, permitting smaller size and minimum weight.

Adequately insulated and matched sections of uniform capacitance, connected in series.

High-purity aluminum foil with generous number of tab connections. High conductivity. Lower inductive reactance.

Capacitor sections dried and impregnated under high vacuum. Closely-controlled long cycle. Eliminates voids. Higher insulation values. Lower losses.

Special laminated bakelite tubing container. Protected by high-resistance insulating varnish. High dielectric strength. Maximum safety from external flash-overs.

Design provides for low voltage gradient along case at maximum operating voltages.

Dependable operation assured at rated voltages and at ambient temperatures up to 65° C.

Three-piece cast aluminum end-cap terminals, Bakelite-treated cork gaskets locked in to provide hermetic seal.

Caps available with mounting feet for space-saving assemblies in series, parallel, or series-parallel arrangements. Or with plain caps.

In 50,000, 75,000, 100,000 and 150,000 v. D.C. max. ratings per unit. Range from 14" to 32" high; 4³/₈" to 13¹/₂" dia.



FOR RADIO-ELECTRONIC AND INDUSTRIAL APPLICATIONS

AEROVOX CORPORATION, NEW BEDFORD, MASS., U.S.A.

SALES OFFICES IN ALL PRINCIPAL CITIES • Export: 13 E. 40th St., NEW YORK 16, N. Y.

Cable: 'ARLAB' • In Canada: AEROVOX CANADA LTD., HAMILTON, ONT.

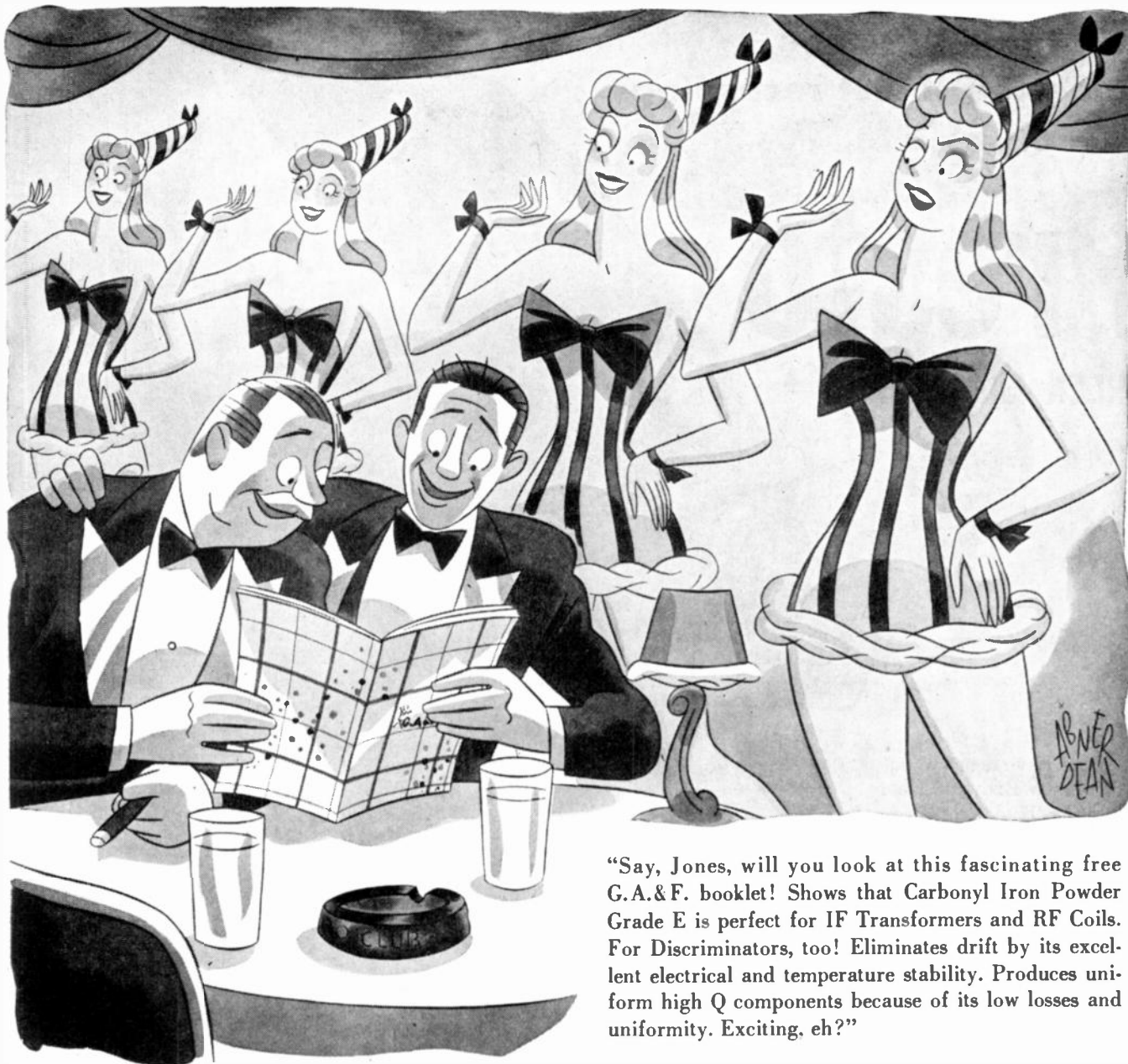

"Say, Jones, will you look at this fascinating free G.A.&F. booklet! Shows that Carbonyl Iron Powder Grade E is perfect for IF Transformers and RF Coils. For Discriminators, too! Eliminates drift by its excellent electrical and temperature stability. Produces uniform high Q components because of its low losses and uniformity. Exciting, eh?"

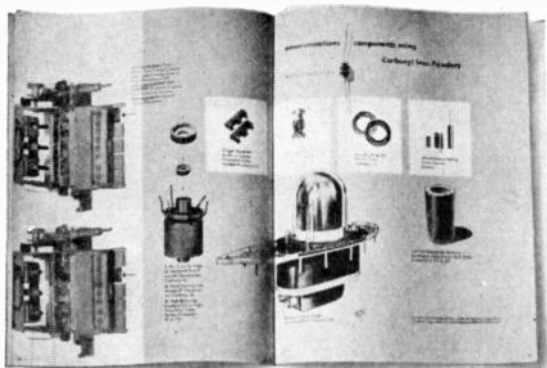

FREE! This easy-to-read booklet that can save money — *real* money — for every radio engineer and electronics manufacturer!

Ask your core manufacturer—he's an authority on the use of G.A.&F. Carbonyl Iron Powders.



G.A.&F.

carbonyl iron powders

An Antara* Product of
General Aniline & Film Corporation

Clip this coupon—Mail it today!

Antara Products, Dept. 13
444 Madison Ave., New York 22, N. Y.

Please send me a free copy of:

G.A.&F. Carbonyl Iron Powders Pollectron dielectrics

Name _____

Address _____

From this package
come the finest recordings
in the world

Presto

GREEN LABEL DISCS

You have heard about Presto Brown Label discs. They're one-side perfect . . . with a flaw on the other side you probably couldn't find. Perfect for one-side recordings, reference recordings and tests, and at greatly reduced cost.

FREE! Presto will send you free of charge a complete bibliography of all technical and engineering articles on disc recording published since 1921. Send us a post card.



RECORDING CORPORATION
250 WEST 55TH STREET
NEW YORK 19, N. Y.

for

FM

COVERAGE and PERFORMANCE



you can't beat Federal's COMPLETE "ONE-PACKAGE" STATION

A broadcast station that's FM by Federal all the way—from microphone to antenna—offers *three exclusive features* that assure maximum coverage at minimum operating cost, and maximum performance with minimum maintenance expense.

1. FEDERAL'S SQUARE-LOOP ANTENNA!

The coverage of an FM station depends primarily on the effective strength of the radiated signal. And Federal's 8-Element, Square-Loop Antenna gives an effective radiated power *more than 8 times* the transmitter rating. Actual installations have repeatedly *proved* its ability to give outstanding coverage—and to withstand high winds and heavy icing loads.

2. FEDERAL'S HIGH-FIDELITY TRANSMITTER!

All Federal FM transmitters feature the exclusive "Frequematic*" modulator—for outstanding fidelity and performance. Maintains center-frequency stability within 0.001%—reduces signal-to-noise ratio to 5600-to-1—uses simple all-electronic circuits with standard receiver tubes—easy to align, simple to maintain.

3. FEDERAL ENGINEERING ALL THE WAY!

Complete FM by Federal means FM at its best, with all components precision engineered to work together. Transmitter console, studio console, transcription units, power supplies—everything from microphone to antenna—designed and coordinated for maximum over-all performance and economy.

When planning your new FM station, remember these exclusive

advantages. And if you want to get on the air *fast*, Federal can now make your complete installation in record time! For further information, write to Federal, Dept. B637.

With this Federal 8-Element Square-Loop Antenna, now on the air at Station WMRC-FM, Greenville, South Carolina, listeners more than 200 miles away—including cities in 6 different states—report excellent reception. Lower photo shows WMRC's transmitter room, with Federal 10-Kw transmitter, console, monitor speaker and power supply.

*Trade Mark

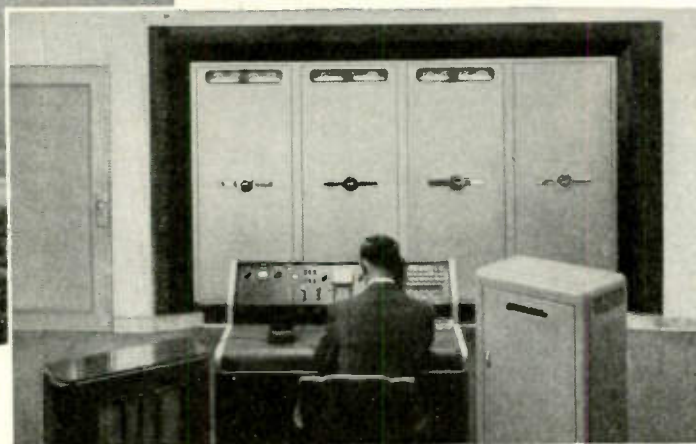

Federal Telephone and Radio Corporation

100 KINGSLAND ROAD, CLIFTON, NEW JERSEY

In Canada:—Federal Electric Manufacturing Company, Ltd., Montreal, P. Q.
Export Distributors:—International Standard Electric Corp. 67 Broad St., N. Y.



FTR
An IT&T Associate

KEEPING FEDERAL YEARS AHEAD... is IT&T's world-wide research and engineering organization, of which the Federal Telecommunication Laboratories, Nutley, N. J., is a unit.

...this is Capacitor

ENGINEERING ACHIEVEMENT EVIDENCE!

The six basic new capacitor types illustrated were pioneered and perfected by Sprague. Each represents a distinct advance over previous types. Each supplies convincing evidence of the progressiveness of Sprague engineering.

*MIDGETS AND MINIATURES

Extending the Boundaries of Practical Electronics

"Make it smaller, make it better" is the ever-recurring demand on design engineers charged with creating today's electronic devices. Sprague *Midget Capacitors are the first small size paper dielectric tubulars to operate dependably at 85° C., to have adequate humidity protection, and to be priced for widespread use. Sprague Miniature Capacitors are even smaller, have adequate humidity protection, and are rated for operation at 65° C.

*HYPASS CAPACITORS

High-Frequency Resonance Problems Solved

Sprague *HYPASS 3-Terminal Network Capacitors have established new standards of performance in eliminating anti-resonant frequencies up to 150 megacycles or more. Conventional methods of by-passing vibrator "hash" usually call for a by-pass capacitor shunted by a mica capacitor. Today, these 3-terminal network capacitors make such compromise methods no longer necessary. If you have a "hash" problem, we'd welcome the opportunity to stack Hypass Capacitors against it.

FLUORESCENT BALLAST CAPACITORS

A Notable Development

Sprague fluorescent ballast capacitors easily withstand the severe combination of high temperature and over-voltage to which they are subjected under blink start conditions. This results from the use, in these capacitors, of a new and exclusive impregnant developed by Sprague. This impregnant, known as *Vitamin Q, is thermally stable at temperatures far higher than those encountered even under most severe ballast conditions.

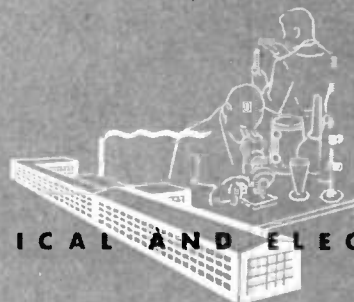
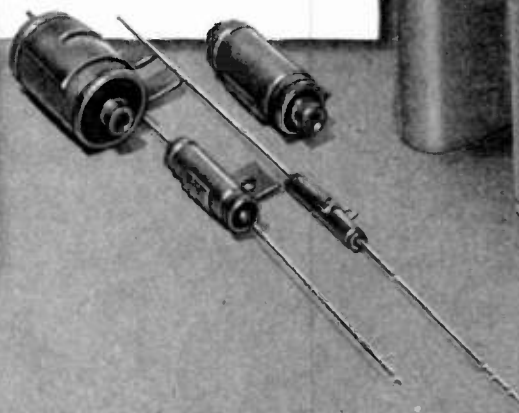
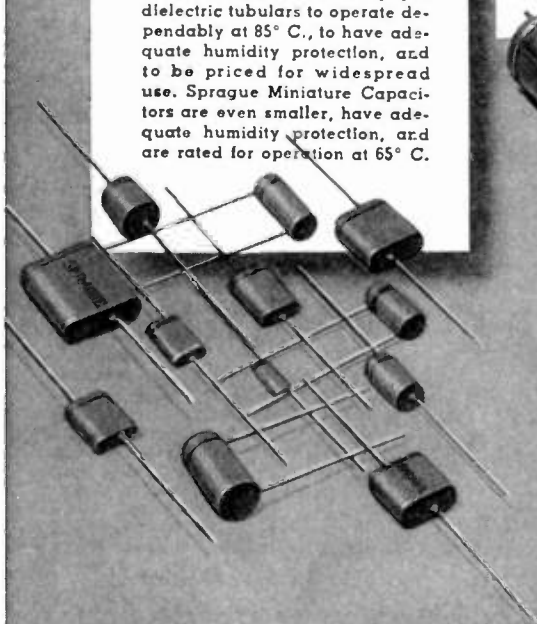

PIONEERS OF ELECTRICAL AND ELECTRONIC PROGRESS

Engineering Leadership

HIGH VOLTAGE HIGH TEMPERATURE OPERATION

*It's All Done with *Vitamin Q!*

The history of capacitor progress is largely the history of new and better dielectrics. The most remarkable advance in this respect came with Sprague's development of a new impregnant—*Vitamin Q. Sprague capacitors impregnated with this material are now setting new standards, throughout industry, for dependable operation at higher voltages and temperatures—and they are usually smaller and lighter than competitive units.

HIGH VOLTAGE COUPLING

Special Sprague Capacitors for Low-Cost Carrier Telephone Systems

Sprague High Voltage Coupling Capacitors are the practical solution to the problem of coupling telephone equipment to existing 7200-volt AC distribution lines. These capacitors are only one-tenth the size and weight of other types previously considered by REA for carrier system services. As a result of the success of their coupling capacitors in rural telephone service, Sprague is now designing coupling capacitors for other uses and at still higher voltages.

AND NOW!

The first truly practical All Purpose Molded Paper Tubular Capacitors

After more than four years of intensive research, plus one of the largest retooling programs in its history, Sprague recently announced a complete line of molded paper tubular capacitors. These new molded tubular capacitors are unique in design and performance characteristics. Their humidity resistance, 85° C. rating, small size, and modest price suggest their use in automotive, FM and television receivers, export sets, and wherever cardboard tubular capacitors have been used in the past.



CAPACITORS

SPRAGUE

*KOOLOHM RESISTORS

SPRAGUE ELECTRIC COMPANY, NORTH ADAMS, MASS.

*TRADEMARK REG. U.S. PAT. OFF.



RECTIFIERS, Vacuum Types { 35W4, 45Z3
117Z3, 1654
6X4

Half-Wave

Full-Wave

DIODE DETECTORS { 1A3, 9006
6AL5

Single Unit

Twin Unit

TRIODE AMPLIFIERS { 6C4, 6J4, 9002
3A5, 6J6, 12AU7

Single Unit

Twin Unit

DIODE-TRIODE AMPLIFIERS { 6AQ6, 6AT6, 12AT6
6BF6, 26C6

High-Mu

Medium-Mu

PENTODE VOLTAGE AMPLIFIERS { 1L4, 155, 1U4, 6AG5, 6AK5
12AW6, 9001

Sharp-Cutoff { 6AU6, 12AU6, 12BA6
1T4, 6BA6, 12BA6
26A6, 9003

Remote-Cutoff

PENTODE POWER AMPLIFIERS { 154, 3A4, 3Q4
354, 3V4, 6AK6

BEAM POWER AMPLIFIERS

PENTAGRID CONVERTERS { 6AQ5, 35B5, 50B5
1R5, 6BE6
12BE6, 26D6
2D21
0A2

THYRATONS

VOLTAGE REGULATORS

There are more than 50 types of RCA miniatures

Miniatures are musts—

most miniatures are RCA

THE TREND IS TO MINIATURES . . . because miniatures offer the engineer a wider latitude in equipment designs for *all* services where light weight and compactness are necessary or desirable . . . and RCA has complements of miniatures for virtually all applications.

Feature for feature, RCA miniatures incorporate electrical and mechanical characteristics that set them apart from other tubes for midget and

auto sets . . . TV and FM receivers . . . commercial and business equipment.

RCA Application Engineers will be pleased to consult with you on the use of RCA miniatures in your future equipment designs. For further information write RCA, Commercial Engineering, Section AR 52, Harrison, New Jersey.

The Fountainhead of Modern Tube Development is RCA



TUBE DEPARTMENT

RADIO CORPORATION of AMERICA

HARRISON, N. J.

BOARD OF DIRECTORS, 1947

Walter R. G. Baker
President

Noel Ashbridge
Vice-President

Raymond F. Guy
Treasurer

Haraden Pratt
Secretary

Alfred N. Goldsmith
Editor

William L. Everitt
Senior Past President

Frederick B. Llewellyn
Junior Past President

1945-1947

Stuart L. Bailey
Keith Henney
B. E. Shackelford

1946-1948

Virgil M. Graham
Donald B. Sinclair

1947-1949

Murray G. Crosby
Raymond A. Heising

1947

J. E. Brown
Frederick R. Lack
Jack R. Poppele
David Smith
William C. White

Harold R. Zeamans
General Counsel

George W. Bailey
Executive Secretary

Laurence G. Cumming
Technical Secretary

E. K. Gannett
Assistant Secretary

BOARD OF EDITORS

Alfred N. Goldsmith
Chairman

PAPERS REVIEW COMMITTEE

Murray G. Crosby
Chairman

PAPERS PROCUREMENT COMMITTEE

Dorman D. Israel
General Chairman

PROCEEDINGS OF THE I.R.E.

(Including the WAVES AND ELECTRONS Section)

Published Monthly by

The Institute of Radio Engineers, Inc.

VOLUME 36

January, 1948

NUMBER 1

PROCEEDINGS OF THE I.R.E.

Benjamin E. Shackelford, President-Elect, 1948.....	2
Technical Journalism..... Lewis Winner	3
2970. High-Frequency Plated Quartz Crystal Units..... R. A. Sykes	4
2971. The Ionospheric Eclipse of October 1, 1940..... J. A. Pierce	8
2972. Theory of Amplitude-Stabilized Oscillators.....	
..... Pierre R. Aigrain and E. M. Williams	16
2973. Application of Velocity-Modulation Tubes for Reception at U.H.F. and S.H.F..... M. J. O. Strutt and A. van der Ziel	19
2974. Phase and Amplitude Distortion in Linear Networks..... M. J. Di Toro	24
2975. Design Principles of Amplitude-Modulated Subcarrier Telemeter Systems..... Cecil K. Stedman	36
2976. Trigonometric Components of a Frequency-Modulated Wave..... Enzo Cambi	42
2977. Class-A Push-Pull Amplifier Theory..... Herbert L. Krauss	50
2978. Methods of Tuning Multiple-Cavity Magnetrons..... R. B. Nelson	53
2979. Theory of the Circular Diffraction Antenna..... A. A. Pistolokors	56
2980. A New Type of Waveguide Directional Coupler..... H. J. Riblet and T. S. Saad	61
2981. The Series Reactance in Coaxial Lines..... Howard J. Rowland	65
Tracing of Electron Trajectories Using the Differential Analyzer	
2982. Introduction..... John P. Blewett	69
2983. Part I—Differential Analyzer Representation..... Gabriel Kron, F. J. Maginniss, and H. A. Peterson	70
2984. Part II—Electron Paths in Magnetrons..... W. C. Hahn and J. P. Blewett	74
2985. Part III—Study of Transit-Time Effects in Disk-Seal Power-Amplifier Triodes..... J. R. Whinnery and H. W. Jamieson	76
2828. Discussion on "Harmonic-Amplifier Design" by Robert H. Brown	
..... A. H. Sonnenschein and Robert H. Brown	84
Contributors to PROCEEDINGS OF THE I.R.E.....	84
Correspondence:	
2986. "Solar Intensity at 480 Mc."..... Crote Reber	88

EDITORIAL DEPARTMENT

Alfred N. Goldsmith
Editor

Clinton B. DeSoto
Technical Editor

Mary L. Potter
Assistant Editor

William C. Copp
Advertising Manager

Lillian Petranek
Assistant Advertising Manager

Responsibility for the contents of papers published in the PROCEEDINGS OF THE I.R.E. rests upon the authors. Statements made in papers are not binding on the Institute or its members.

Changes of address (with advance notice of fifteen days) and communications regarding subscriptions and payments should be mailed to the Secretary of the Institute, at 450 Ahnaip St., Menasha, Wisconsin, or 1 East 79 Street, New York 21, N. Y. All rights of republication, including translation into foreign languages, are reserved by the Institute. Abstracts of papers, with mention of their source, may be printed. Requests for republication privileges should be addressed to The Institute of Radio Engineers.



INSTITUTE NEWS AND RADIO NOTES SECTION

"1 East 79th Street".....	89
National Electronics Conference.....	101
Rochester Fall Meeting—1947.....	102
URSI—I.R.E.....	103
1948 I.R.E. National Convention News.....	104
Industrial Engineering Notes.....	106
Books:	
2987. "Wireless Direction Finding" by R. Keen.....	110
..... Reviewed by P. C. Sandretto	
2988. "The Future of Television," by Orrin E. Dunlap.....	110
..... Reviewed by John D. Reid	111
Sections.....	111
I.R.E. People.....	112

WAVES AND ELECTRONS SECTION

Jerry B. Minter, Chairman, I.R.E. Subsection for Northern New Jersey..	113
The Knolls Atomic Power Laboratory.....	114
2989. Report of the Committee on Professional Status of the Canadian Council of the I.R.E..... R. C. Poulter	115
2990. Frequency-Shift Radio Transmission..... Lester E. Hatfield	116
2991. Printed-Circuit Techniques..... Cleo Brunetti and R. W. Curtis	121
Contributors to Waves and Electrons Section.....	162
2992. Abstracts and References.....	163
News—News Products..... 22A	Student Branches..... 40A
Section Meetings..... 34A	Positions Open..... 50A
Membership..... 40A	Positions Wanted..... 55A
Advertising Index.....	70A

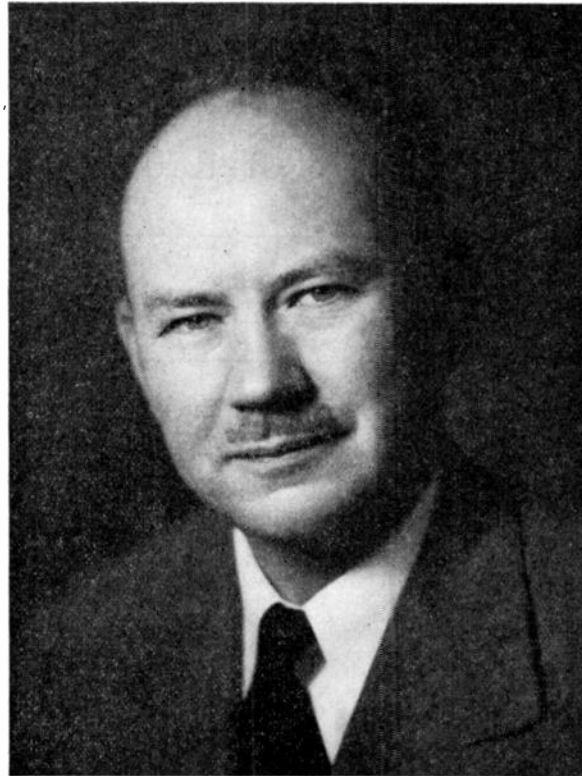

Benjamin E. Shackelford

PRESIDENT-ELECT, 1948

Benjamin E. Shackelford was born on August 12, 1891, in Richmond, Missouri. He received the A.B. degree in 1912 and the A.M. degree in 1913, both from the University of Missouri. In 1916, he received the Ph.D. degree from the University of Chicago.

From 1912 to 1914, Dr. Shackelford assisted in the physics department of the University of Missouri, and in the summer of 1915 he was the first Brush Research Fellow at the Nela Research Laboratory. The following year he joined the staff of Westinghouse Lamp Company, where his activities included work in illumination and incandescent-lamp physics. His direct connection with radio began in 1918 when he undertook the engineering development of radio tubes for the company. He became manager of the radio engineering department in 1925, and his work with Westinghouse continued for approximately five years thereafter.

He became a member of the manufacturing department, Radiotron Division, of the Radio Corporation of America at Harrison, N. J. in 1930, and in 1934 was appointed manager of the patent department, activities

which included the operation of foreign technical agreements. After serving as manager of the company's foreign license service, Dr. Shackelford transferred to New York where he became assistant to the director of research and later to the chief engineer. In 1942, he was appointed engineer-in-charge of RCA's frequency bureau. In 1944, he was made assistant to the vice-president in charge of RCA Laboratories, and in 1945 director of the license department of the RCA International Division.

Dr. Shackelford is a member of the American Physical Society, the American Institute of Electrical Engineers, the Franklin Institute, the American Association for the Advancement of Science, Sigma Xi, Gamma Alpha, and Alpha Chi Sigma.

He joined The Institute of Radio Engineers as an Associate in 1923, transferred to Member grade in 1926, and became a Fellow in 1938. Dr. Shackelford was Chairman of the 1944 Winter Technical Meeting, and he was active on Panels 1 and 2 of the Radio Technical Planning Board.

All too often writers of engineering papers fail to study the natural requirements of the type of periodical in which they desire their papers to appear. This accounts for certain resulting delays and disappointments. Many useful guides for avoiding such difficulties are found in the following instructive guest editorial from an experienced analyst of technical material who is the Editor of *Communications*, and who is, as well, the Editorial Director of *Service*.

—The Editor

Technical Journalism

LEWIS WINNER

Technical journalism is one of the most effective tools of the scientist. It is, however, a complex tool, requiring rather specialized handling. It is necessary, for instance, to analyze the medium in which it is to be used, and there are quite a few to consider: the commercial technical press, the semitechnical or popular press, the school and scientific-body press, the technical trade press, and the general press. Then there is the problem of magazine or book style to consider. And the oral-presentation form is important, too. Each requires a different format.

Unfortunately, too often one paper is asked to serve too many purposes. It is difficult, for instance, to enjoy reading a paper which was originally prepared for oral presentation. For in the oral procedure, graphic illustrations are continuously employed to describe and analyze pertinent facts; the illustrations are constantly in view during the discussion. In the printed version, the illustrations are in a fixed position, and while they can be spotted within sections of the text, any substantial reference to them which may bring the subject matter a few pages away makes reading and interpretation difficult. This is particularly true in commercial magazines, where it is often impossible to devote too many sequential pages to a paper. Major points can be stressed in an oral presentation by vocal emphasis and asides. These factors should be retained in the printed copy by an elaboration of the particular points with the aid of additional data which may include more illustrations.

In preparing copy, the purpose of the text, the audience to whom it is directed, and the topical value of the data must be considered. For instance, the commercial magazine's audience is usually a busy one with limited time available for reading. Articles directed to this audience must be compact, self-contained, and should require little, if any, research. Every effort must be made to include all the facts which will simplify reading and answer questions that are expected to arise during reading. The complex article can be streamlined for magazines with a generous use of base notations and the appendix, particularly where mathematical material is involved.

There are, of course, always exceptions to the rule, such as the need for a rather lengthy article for a commercial journal. This may involve a series of presentations, each of which, however, should cover a phase of the project quite completely. Prior and successive article references can be covered in several pertinent paragraphs, which are usually presented in a box on the initial page of presentation.

In direct contrast, the institute or university journal presentation is of a longer, more formal, treatise nature, offering an extensive interpretation.

Book treatment requires still another approach, with text life, classroom usefulness, and industry service among the major factors of consideration.

There are many facets to technical journalism. They should be studied carefully.

Writers will find the text-analysis procedure a handy and profitable one to follow. And the reader or listener will be grateful, too.

High-Frequency Plated Quartz Crystal Units*

R. A. SYKES†, SENIOR MEMBER, I.R.E.

Summary—A description is given of the general problems relating to the development of high-frequency plated crystal units and of methods used for supporting the quartz blank and adjustment to frequency by the use of evaporated gold.

ALL QUARTZ crystal units used as elements of an electrical network for filter or oscillator applications must have electrodes of some form. These electrodes are conducting surfaces, deposited directly on the surface of the quartz plate in the form of a very thin metal film or flat steel plates held close to the quartz plate.

It is common practice to use evaporated thin films on low-frequency crystal units. In these cases the frequency is determined by one of the larger dimensions of the quartz blank, and hence adjustment to the correct frequency is relatively simple. By grinding an edge, this dimension is reduced, producing an increase in frequency. By alternate grinding and measurement the desired frequency may be obtained.

In the case of high-frequency quartz crystal units employing the thickness-shear mode, where the frequency is determined by the thickness, adjustment to the correct frequency requires that the thickness be reduced by grinding or etching the major surfaces until the frequency reaches the desired value. A grinding procedure of this type would, of course, remove a thin film if it were deposited on the major surfaces for an electrode. Therefore, it has been common practice to use electrodes made from flat steel plates held close to the quartz plate. In most cases, small lands at the corners serve to hold the quartz plate rigidly and provide a small air gap over the major area of the plate. Each operation in the process of adjustment in this manner requires disassembly of the quartz blank from the electrodes.

If a thin metal film is deposited on the major surfaces of a high-frequency quartz plate for electrodes, it is found that a reduction in frequency occurs. This reduction is substantial, even for a thin film, since it is placed on a vibrating system at the position of maximum motion. Mechanical abrasion of this film would produce an increase in frequency the same as grinding the quartz but would probably result in poor stability and, in some cases, complete loss of contact. However, by controlling the mass of the electrode to extreme precision the correct frequency will result with no mechanical adjustment of the thickness. The process of adjustment for the plated-type crystal unit would be to start

with a quartz plate ground to normal mechanical tolerance to a frequency higher than the desired value. The mass of the metal film electrode would then be controlled to such a degree that the resulting frequency of the combination would be the desired frequency.

The high-frequency plated crystal units described here are the result of a development project, the results of which were needed for wartime applications. The purpose of this development initially was to redesign an existing high-frequency clamped-type crystal unit with the following objectives in view:

1. Reduction in area of quartz blank.
2. Simplification of assembly.
3. Reduction in number of parts.
4. Development of a process for mass production of crystal units.

The results of this development can be seen in Fig. 1, which shows a comparison of the plated and clamped-type crystal units. The plated unit utilizes about one-quarter the amount of quartz, has electrodes integral

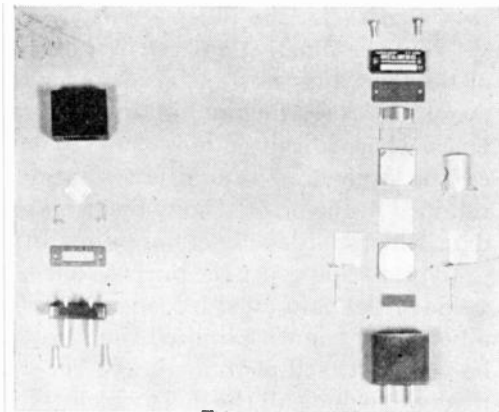

Fig. 1.—Assembly details of plated- and clamped-type quartz crystal units.

with the blank instead of two precision-ground steel electrodes, has fewer parts to assemble, and is adjusted to final frequency by a simple method to be described later. It is the purpose of this paper to describe briefly some of the problems associated with the development of the high-frequency plated crystal unit, and to show the method of solution in some cases.

The problem of mounting the plated quartz blank was simply that of supporting it in a manner that allowed the preferred mode to vibrate freely. The unit as a whole had to withstand mechanical shock. The spring support shown in Fig. 2 was developed for this purpose. The normal condition is shown in the center. The units to the right and left show the blank distorted in the two

* Decimal classification: R214.3. Original manuscript received by the Institute, December 26, 1946; revised manuscript received, March 13, 1947. Presented, 1946 Winter Technical Meeting, January 26, 1946, New York, N. Y.

† Bell Telephone Laboratories, Inc., Murry Hill, N. J.

directions about a diagonal axis. In both cases the bending takes place on the noncontact side of the spring, while the contact side stays in place. This form of support will then allow the unit to stand mechanical shock and vibration, and will not restrict the motion of the high-frequency shear mode since the support is remote from the center of the plate.

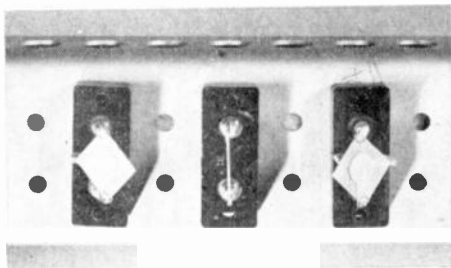

Fig. 2—Wire-type support for plated blank showing allowable distortions.

When a unit such as this is used to control an oscillator and the temperature allowed to vary, a considerable change in the oscillator output results. This change in output results from a variation in crystal quality, as evidenced by a variation in the rectified grid current of the oscillator tube. This change in quality is ascribed to variations in the relative frequency of the wanted and unwanted vibratory modes as the temperature is varied. The same effect may be demonstrated by vary-

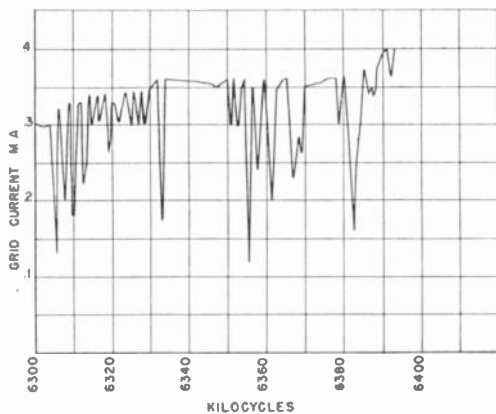

Fig. 3—Activity-versus-frequency characteristic of plated crystal (BT-cut) without damping.

ing the frequency of the main mode, the frequency of the unwanted modes being maintained constant. Such an effect may be produced by changing the mass of the electrode. There is plotted on Fig. 3 a curve of rectified grid current of an oscillator tube as a function of frequency at constant temperature when the frequency has been varied in this way. These deviations are a result of coupling between the main mode and the undesired modes.

Since most of the modes of motion that cause changes in the grid current appear to result from the length and width boundaries,¹ it should be possible to damp out most of these by a suitable material with a high mechanical loss applied near the edge of the plate. A plastic cement was developed to serve this purpose, as well as to improve the mechanical bond between the support spring and the crystal blank. By the addition of silver particles to the cement a better electrical connection is obtained, and thus the effect of the cement is threefold. The effect on the grid-current characteristic of adding the cement is shown in Fig. 4. It may be seen that the

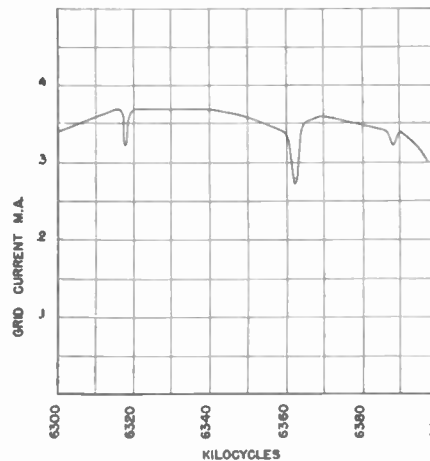

Fig. 4—Activity-versus-frequency characteristic of plated crystal (BT-cut) with damping.

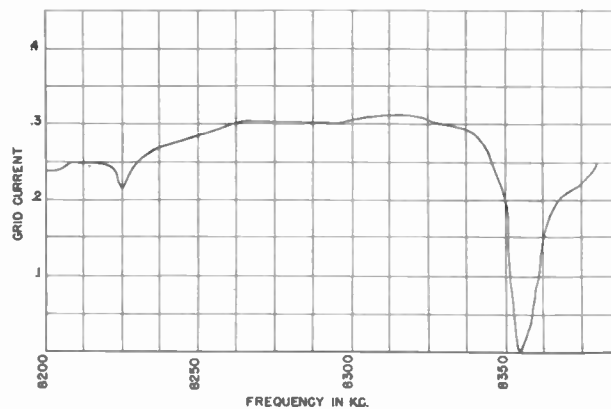

Fig. 5—Activity-versus-frequency characteristic of plated crystal (BT-cut) with damping.

previous condition of Fig. 3 has materially changed, and now it is simply a matter of choosing certain dimensions of length and width that avoid the more serious dips in the characteristic. A similar curve for a considerably different frequency is shown in Fig. 5, which shows that it is not possible to eliminate all the interfering

¹ R. A. Sykes, "Modes of motion in quartz crystals, the effects of coupling and methods of design," *Bell Sys. Tech. Jour.*, vol. 23, pp. 178-189; January, 1944.

modes by means of a damping method and, therefore, it is necessary to predimension the crystal blank for a given final frequency. The dimensioning method is relatively simple, however, since it is only necessary to plot the grid-current characteristic as the frequency of the plate is changed by loading the electrode. Sample curves of this type are shown in Figs. 4 and 5. By choosing clear regions from those curves, it is possible to predetermine blank sizes for other frequencies by simply changing the length and width dimensions in inverse proportion to the change in frequency. An analysis of crystal units using BT-cut quartz blanks in the range of 9 to 10 Mc. led to the dimension curves shown on Fig. 6. This figure gives the quartz-blank sizes for any frequency in this range, and in most cases a choice of several sizes.

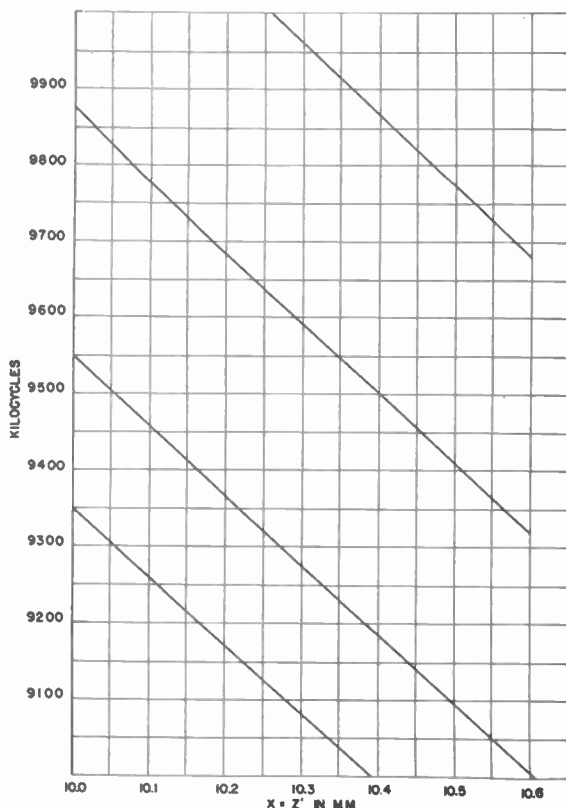

Fig. 6—Dimensions for plated crystal units; BT-cut.

The method of changing the frequency of the blank after an initial electrode is deposited is that of simple evaporation. A schematic to illustrate the method is shown on Fig. 7. This shows a chamber, which may be quickly evacuated by a vacuum pump, containing a crystal unit placed opposite a filament containing a gold bead. The crystal unit and filament are separated by a shield to permit evaporated gold to strike only the surface of the electrode of the crystal unit. Terminals are provided for connection to the filament and to the crystal unit. Since the crystal unit may be made to con-

trol the frequency of an oscillator while evaporation takes place, it is a simple matter to obtain a precise adjustment by comparison with an oscillator of known frequency. When the desired frequency is obtained, the filament is turned off and the adjustment is complete. A

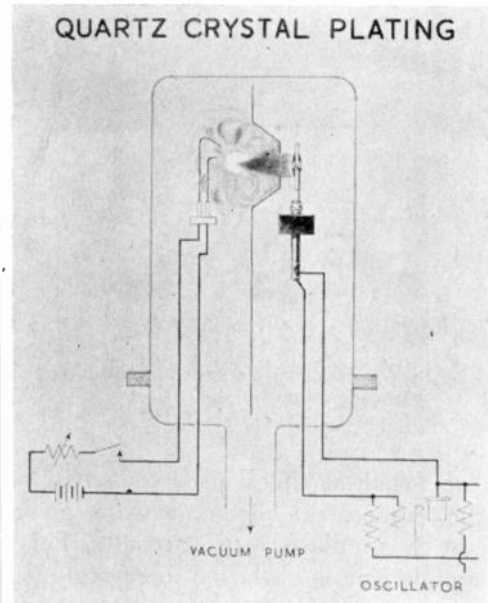

Fig. 7—Evaporator schematic.

production model of an evaporating unit is shown in Fig. 8. This consists of three small chambers of the general design shown in Fig. 7, placed on a turret. The position nearest the operator is for removing the adjusted unit and replacing with a new one. The second position



Fig. 8—Machine for final adjustment of plated crystal units by evaporation process.

clockwise is a prepumping stage, and the third position is for adjustment. By depressing keys with the left hand, the operator can light the filament in the third position. The crystal in the third position is connected to a crystal duplicator and, therefore, one can tell when the final adjustment is complete. The speed of pumping and calibra-

tion is such that all operations can be accomplished in about 15 seconds, giving a production rate of over 200 adjusted units per hour.

The various forms that the completed crystal unit has taken since its original development prior to 1943² are shown in Fig. 9. The first unit at the left shows the original form used in blind-landing equipment for the

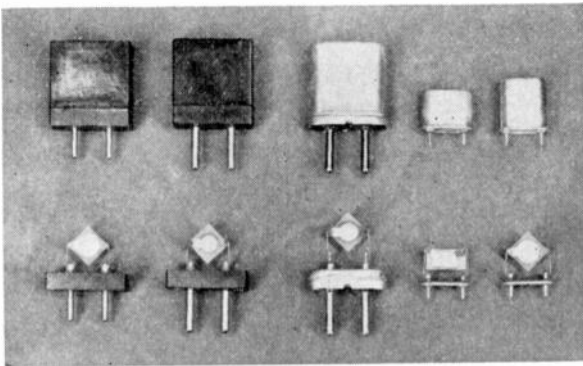

Fig. 9—Various types of high-frequency plated crystal units.

Air Forces. The second unit was developed as a control element for airborne communication equipment. The third unit was a duplication of the second in an hermetically sealed holder to operate in regions of high humidity. The fourth unit was developed as a highly stable unit for use under temperature-control conditions. The fifth unit was developed as a general-purpose high-frequency, hermetically sealed crystal unit combining the desirable features of all units. Since the introduction of this last unit it has been used in many new applications of telephone and other equipment. During the interval from early 1943 to V-J Day, about 2½ million crystal units of this type were manufactured by the Western Electric Company for war applications.

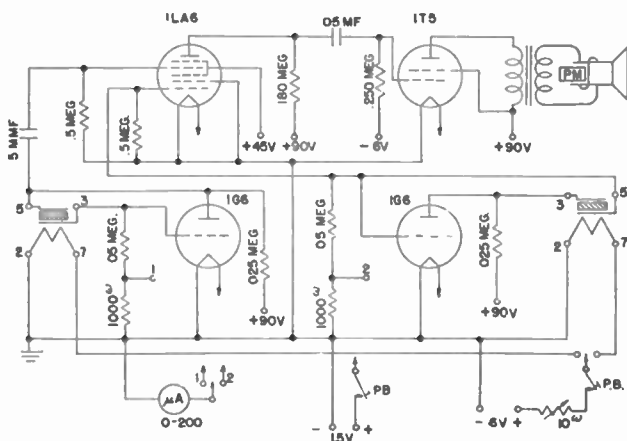

Fig. 10—Circuit of demonstration duplicator.

To demonstrate the method of adjustment by evaporation a crystal unit was constructed similar to the

schematic of Fig. 7, with the assembly enclosed within a vacuum tube. A circuit for use of these units is shown in Fig. 10. It consists simply of two crystal-controlled oscillators, the outputs of which are connected to a modulator, an audio amplifier, and loudspeaker. Means are also provided for controlling the temperature of the evaporator filaments. If the two crystal units are within an audible frequency difference from each other, a beat note will be heard in the loudspeaker. A portable demonstration duplicator using the circuit of Fig. 10 is shown in Fig. 11. The vacuum-tube crystal units with built-in evaporators are shown at the extreme right and left in front. The push button at the left rear turns on the set, and an audible note is heard in the loudspeaker. To demonstrate, it is only necessary to turn on the filament of the crystal unit of the highest frequency. This is done by depressing the push button at the right rear. The rate

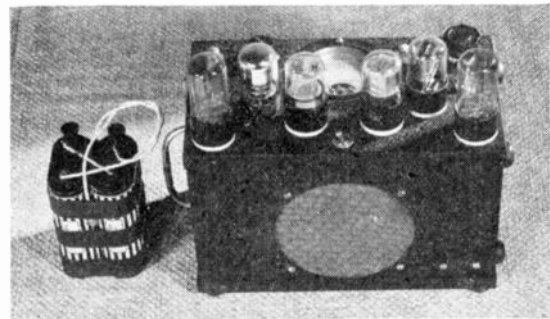

Fig. 11—Demonstration duplicator.

of evaporation may be controlled by the rheostat adjacent to the push button. The change in frequency will be evidenced by a reduction in the beat note heard from the loudspeaker. Repeated demonstrations may be made by plating past zero beat and then using the other crystal unit.

Crystal units of this type provide, for the first time, a completed unit the frequency of which may be changed to a lower value at any time, and may be calibrated to specific frequencies in a particular equipment. The activity curve of Fig. 5 shows a range of over 100-kc. adjustment made with a unit similar to those shown in Fig. 11.

The unit shown in Fig. 11 was used to demonstrate this method of frequency adjustment at the 1946 I.R.E. Winter Technical Meeting.

ACKNOWLEDGMENTS

This development was extended over a period of about two years with many contributions made by engineers of Bell Laboratories and the Western Electric Company. To them the author wishes to extend due credit, and in particular to J. F. Barry and A. W. Warner, who were directly connected with the project and responsible for much of the development.

² U. S. Patent number 2,392,429, January 8, 1946.

The Ionospheric Eclipse of October 1, 1940*

J. A. PIERCE†, FELLOW, I.R.E.

Summary—This discussion presents the variations in the critical frequencies of the various ionospheric layers over Queenstown, South Africa, during the total solar eclipse of October 1, 1940, and compares them with the normal-day data. It is shown that recombination and diffusion cannot completely explain the phenomena in the F₂ layer and that the cooling of the atmosphere by the eclipse may be of major importance. A theory of the formation of the E layer is proposed to account for the observed variations during the eclipse and at night. Minimum values of the apparent recombination coefficients for the E, F₁, and F₂ layers were $1.2 \cdot 10^{-9}$, $6 \cdot 10^{-9}$, and $6 \cdot 10^{-11}$ cm.³/electrons per second, respectively. Some of the present data are compared with those, previously unpublished, which resulted from a similar expedition to Kazakstan, U.S.S.R., in 1936.

INTRODUCTION

C RUF T LABORATORY sent a small expedition to South Africa to observe the behavior of the ionosphere during the total solar eclipse of October 1, 1940. Measurements were made at Queenstown, Cape Province, between September 5 and November 20, in order to obtain background information about the normal characteristics of the ionosphere at that location.

Two types of equipment were used, one automatic and one manually operated. The automatic apparatus, which was built primarily for operation over long periods in Cambridge, records virtual height as a function of time at eight fixed frequencies, the transmitter and the receiver being switched to each frequency in turn. The transmission at each frequency is characterized by a unique phase of the transmitted pulses with respect to their recurrence frequency, so that the eight records appear separately in the recorder. The complete cycle is repeated every 15 seconds, so that the records appear to be continuous, unless they are examined under considerable magnification. Fig. 1 exhibits the reflection patterns at six frequencies for three or four hours in the neighborhood of sunrise. The morning transition from F layer to E layer reflection, through an intermediate region, is shown at the two lowest frequencies, while the increase of F-region critical frequency with time may be followed through the three highest-frequency records. The transmitter for the manually operated equipment consisted of a simple pulse-modulated oscillator which covered the range from 1500 to 15,000 kc. in five bands, each band having a separate antenna system with its fundamental resonant frequency somewhere near the center of the band. The tuning dial was calibrated directly in frequency, and the calibrations were periodically checked against the harmonics of a 100-kc. crystal oscillator. The power output was probably about 300

watts. The receiver was a commercial superheterodyne which was considerably rebuilt in order to improve the time constants and widen the pass band of the i.f. amplifier.

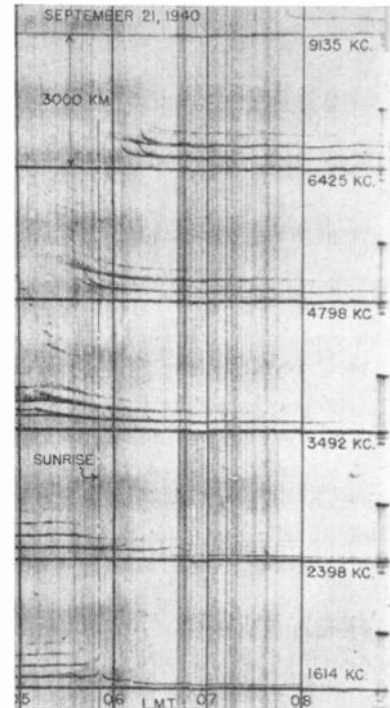

Fig. 1—Sample record from the automatic equipment. A family of fixed-frequency records are plotted one above the other.

On the afternoon of the eclipse a number of determinations of the critical frequencies of the various layers were made after each continuous sweep in order to follow the critical-frequency variations as well as possible while obtaining an adequate amount of data for a study of the changes in the true heights of the layers. After many rehearsals it was found possible to make five or six complete sweeps and twenty-five or thirty additional critical-frequency measurements per hour, and this schedule was successfully maintained for the eight hours centered on the eclipse. During this period especially accurate time marks were recorded by an independent operator. It is believed that time was always known within $\frac{1}{2}$ second and that the greatest errors in frequency determination (including interpolation between marks) were not more than 0.02 Mc.

CRITICAL-FREQUENCY DATA

The variations of the critical frequencies for the various layers on October 1 are exhibited in Fig. 2. The critical frequencies for October 2 for the E and F₂ layers are also shown (by dotted lines) to indicate the extent of

* Decimal classification: R113.412. Original manuscript received by the Institute, January 20, 1947; revised manuscript received, April 29, 1947.

† Cruft Laboratory, Harvard University, Cambridge, Mass.

normal fluctuations. October 2 was chosen from many days on which control data were collected as being the single day which seemed most like the eclipse day in its

hour, although there were occasionally intervals of as much as 5½ minutes between measurements.

Fig. 4 shows the E-layer critical frequency in similar

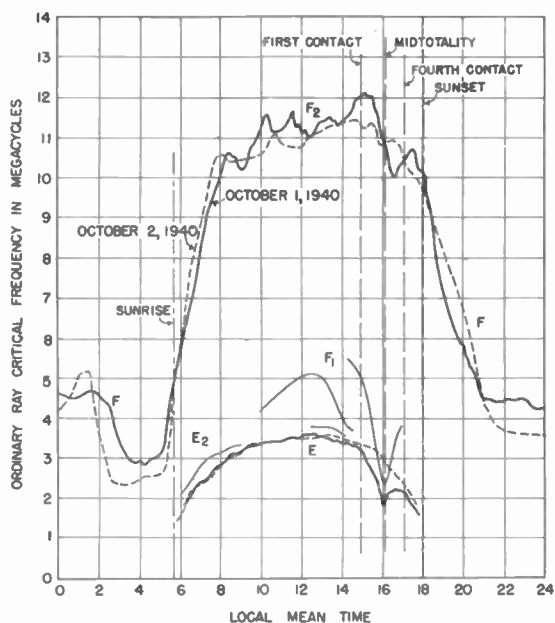

Fig. 2—Critical frequency curves for October 1 and 2, 1940.

general characteristics. Details of the diagram of Fig. 2 are shown in Figs. 3 and 4. Fig. 3 exhibits the F₂-layer critical frequency for the eclipse period, together with a “normal” curve which was obtained by smoothing both diurnal and seasonal critical-frequency curves. The

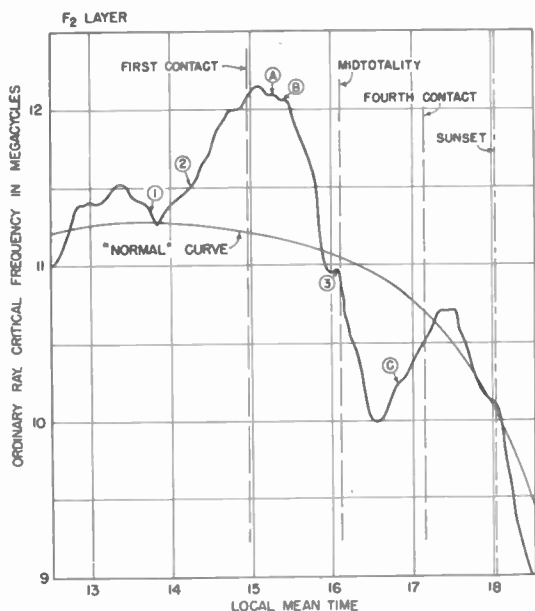

Fig. 3—Detail of the critical-frequency curve for the F₂ layer for the period of the eclipse.

times of the eclipse are those for the estimated true height of the density maximum for the F₂ layer, about 320 km. The sunset time is that for ground-level sunset, including refraction. The curve is based upon about twenty-five determinations of critical frequency per

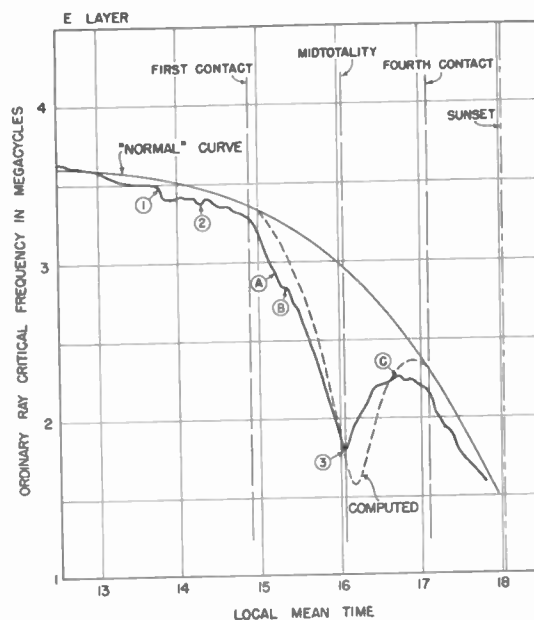

Fig. 4—Effect of the eclipse upon the E-layer critical frequency. The computed curve assumes a recombination coefficient of $2 \cdot 10^{-8}$ cm.³/electrons per second.

detail. In this case the times indicated for the eclipse were computed for a height of 100 km., and the “normal” curve is a part of the mean diurnal curve for the period from September 15 to October 15. The points

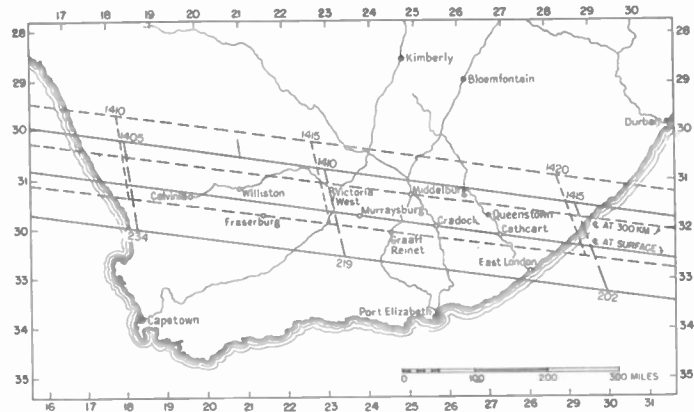

Fig. 5—Map of the path of totality in South Africa. The dotted lines give the region of totality at a height of 300 km.

marked 1, 2, and 3 indicate inflections of the curve which, although small, are coincident with similar bends in the F₂-layer curve of Fig. 3.

The points marked A, B, and C in Figs. 3 and 4 are of more interest. It will be noted that these irregularities in the two curves did not occur simultaneously, but that they did occur at approximately the same intervals after first contact. In other words, these minor bends in the curves occurred, for each layer, as certain areas on the solar surface were covered or uncovered. The map shown in Fig. 5 helps to explain this time relationship.

The three solid lines across the map indicate the center line and the northern and southern limits of totality at the surface of the earth, while the dashed lines show the positions of the minor axis of the shadow at 5-minute intervals—the Universal Time of each instant being the figure at the upper end of the dashed line. The dotted lines give the same information for the eclipse at a height of 300 km. It will be noted that at 14^h15^m U.T. the axis of the shadow reached the earth at a point in the Indian Ocean near East London, while, at 300 km., the shadow was centered on a point approximately above Victoria West, which is very nearly where the center of the eclipse reached the surface 5 minutes earlier. This means that the eclipse occurred roughly 1 second later for each kilometer of height above the surface. This difference of about 4 minutes in the time

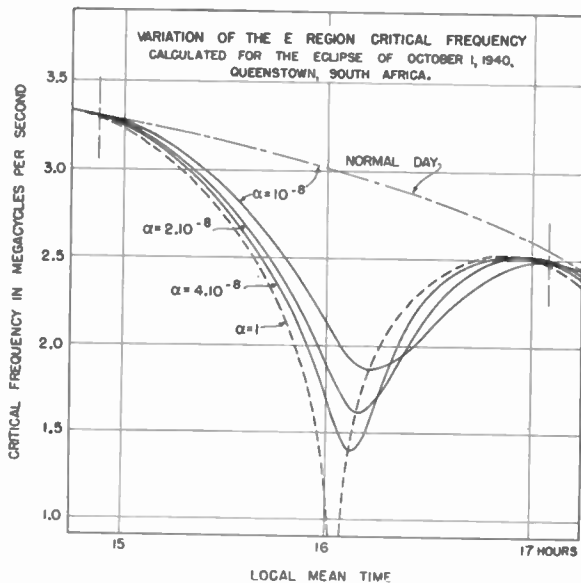

Fig. 6—A family of critical-frequency curves for the E layer, computed for various values of the recombination coefficient.

of arrival of the eclipse at the heights of the E and F₂ layers is almost exactly the difference in time between the appearance of the irregularities marked A, B, and C on the E- and F₂-layer curves. It seems unlikely that these irregularities could all be fortuitous and not simultaneous. Their occurrence may, therefore, be taken as an indication that there are variations in the intensity of the ultraviolet radiation over the solar surface. The irregularities did not coincide with the occultation of emergence of any of the sunspots which were visible at the time of the eclipse.

The computed curve of Fig. 4 was calculated on the very simple theory that the changes in density would follow the equation:

$$\frac{dN}{dt} = -\alpha N^2 + f q_0 \cos \chi \quad (1)$$

where N =electron density, α =recombination coefficient, f =the fraction of the total ultraviolet energy which is not eclipsed at any instant (assumed to be proportional to the uneclipsed area of the solar surface), q_0 =the number of new free electrons produced per cm³. per second at the subsolar point at the height of maximum electron density, and χ =the zenith angle of the sun. The curve, without adjustment, is one of the family shown in Fig. 6 which were calculated by a method similar to that of Hulburt.¹ It was hoped that the time interval between the center of the eclipse and the instant of minimum density of ionization would serve as a measure of the recombination coefficient. Diffusion, of course, would fill in the minimum to some extent, while, if the ionizing energy came more intensely from the central zone of the sun, the density at the minimum might be expected to be lower than the computed value. For these reasons it is not felt that the actual minimum critical frequency can be used as a measure of the rate of recombination until the other influences can be quantitatively analyzed.

Unfortunately, the minimum density of ionization coincided with midtotality, so that no direct solution for the recombination coefficient is possible. Since the general shape of the critical-frequency curve is a good first-order fit to the calculated curve, and since at the beginning of the eclipse the critical frequency drops very sharply, we may deduce that diffusion is, in fact, nearly negligible.

THE E LAYER

The outstanding anomaly to be explained, in the case of the E layer, is the extremely rapid decrease in the density of ionization during the first half of the eclipse; whereas at night the density—although lower—varies hardly at all. The decrease at the beginning of the eclipse cannot be explained on any simple basis as the result of recombination and diffusion. This is shown clearly in Fig. 7 where computed critical frequencies are plotted against time for a high value of recombination coefficient ($\alpha=1$) and for three hypotheses regarding the source of the ionizing ultraviolet light. Curve A is essentially that of Figs. 4 and 5 and assumes that the ionizing energy is radiated uniformly from the whole solar surface. The curve marked B was computed assuming a point source at the center of the sun, and curve C is drawn for the case in which all the energy was assumed to be radiated from the sun's perimeter. Thus the curve corresponding to any assumption about the radiation from the sun must lie somewhere between curves B and C. For the few minutes immediately after first contact, curve C falls as fast as the experimental curve, which is also shown in Fig. 7, but the observed curve continues to fall more rapidly than do any of the computed curves.

¹ E. Hulburt, "The E region of the ionosphere during the total solar eclipse of October 1, 1940," *Phys. Rev.*, vol. 55, pp. 646-647; April 1, 1939.

Thus no recombination and diffusion hypothesis alone can explain the observed behavior of the E layer during the eclipse.

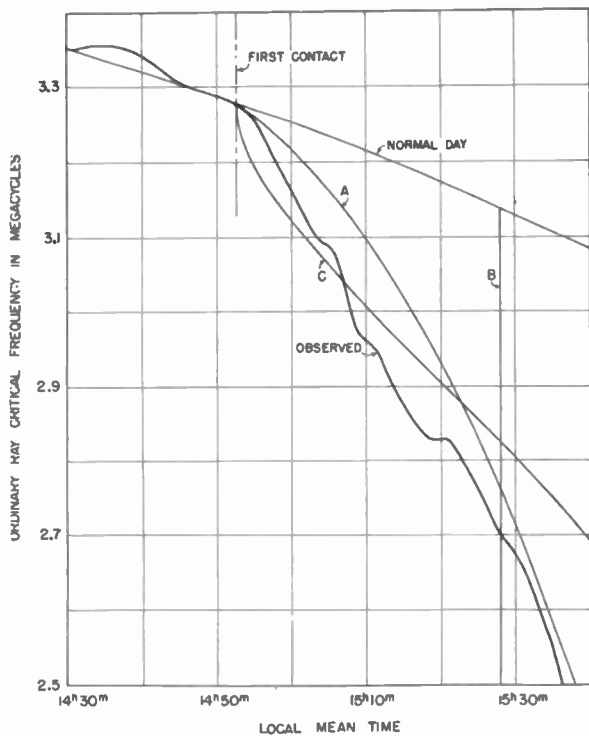

Fig. 7—Comparison between the observed and 3 computed variations of the E-layer critical frequency at the beginning of the eclipse.

It has become more and more clear in recent years that the very existence of the nighttime E layer—although relatively little is known about it—is in major contrast with the correlation between the density of ionization in that layer and the zenith distance of the sun by day. The nighttime layer is a remarkably consistent reflector of medium-frequency waves at oblique incidence. The major source of the ionization can hardly be attributed to meteoric bombardment, although the layer shows great porosity and some sudden fluctuations in height of reflection. The geographical and temporal consistency of the layer is such as to discourage any concepts of ionization by corpuscular radiation. We must therefore attempt to visualize a storage mechanism which will explain the maintenance of ionization at night (of the order of 1/10 of the maximum density in the daytime) and which will not conflict with the behavior of the ionization during an eclipse.

A theory that qualitatively accounts for these phenomena may be constructed upon the assumption of a limited number of processes affecting the electric charges in the atmosphere at the height of the E region. As Wulf and Deming² have shown, the E layer appears at the height where the oxygen in the atmosphere occurs partly

in molecular and partly in atomic form. At greater heights ultraviolet radiation from the sun dissociates O_2 which recombines so slowly that even throughout the night the oxygen remains predominantly atomic, while at lower heights dissociation is only temporary and incomplete. There must therefore be a diurnal change in the height of the O_2/O transition region. At some critical height the atmosphere in the daytime must consist of N_2 , O , and a little O_2 , while at night it reverts toward N_2 , O_2 , and a little O . From Wulf's evidence it appears that this critical height may well be that of the E layer.

It has been shown by Massey³ that the absorption spectrum of atomic oxygen is surprisingly complete for ultraviolet light of wavelengths less than 911 angstroms. It therefore is unlikely that any energy in this wavelength range penetrates as far into the atmosphere as the E region. On the other hand, only photons at wavelengths less than 1014 angstroms have sufficient energy to ionize molecular oxygen directly. It thus seems reasonable to assume that the E layer is produced by ultraviolet radiation in the wavelength range between 911 and 1014 angstroms, and that it is formed at the level in the atmosphere where O_2 is first encountered in abundance.

We may trace the behavior of ionization in the E layer through the following equations, which are assumed not to exclude similar but less probable transitions involving nitrogen but to be sufficient without them:



[Photo-dissociation of oxygen atoms and their recombination. The dissociation occurs only by day but recombination takes place day and night. The recombination is, of course, a process involving triple collisions.]



[Ionization and recombination. This is assumed to be the only process by which free electrons are formed in the E layer and by which they finally disappear.]



[Attachment and photodetachment between free electrons and oxygen atoms. Attachment is much more probable than recombination for a free electron, because there are about 10^{12} oxygen atoms per $cm.^3$ in the E region and only about 10^5 positive ions. In the daytime attachment is only temporary as the solar energy easily reverses the process.]



[Detachment by formation of molecules, because the affinity of an oxygen atom for another atom is greater than for an electron.]

² O. R. Wulf and L. S. Deming, "Production of ionospheric E- and F-regions and lower altitude ionization causing radio fade-outs," *Terr. Mag.*, vol. 43, pp. 283-298; September, 1938.

³ H. S. W. Massey, "Dissociation, recombination and attachment processes in the upper atmosphere—I," *Proc. Roy. Soc. A*, vol. 163, pp. 542-553; December 22, 1937.

The diurnal behavior of the E layer may now be described in the following terms: In the daytime the atmosphere contains a mixture of O and O₂, and the ionization of O₂ and recombination proceed at their natural rates. Attachment of electrons to neutral oxygen atoms occurs many times as frequently as recombination, but photo-detachment rapidly releases the electrons. Soon after noon a balance is established between these four processes. Thereafter recombination and attachment are more frequent than ionization and photo-detachment, because of the increasing zenith distance of the sun and the decreasing ultraviolet energy. At sunset both ionization and photo-detachment cease. The density of free electrons at that time is perhaps 1/10 of that at noon, but many electrons have been stored in the form of negative oxygen ions by (4). At sunset, however, the dissociation (see (2)) of O₂ has ceased and the concentration of O₂ (at a fixed height) is increasing. By (5), whenever an oxygen atom and a negative oxygen ion combine, one of the stored electrons is released. Thus part of the recombination of O into O₂ is accompanied by the detachment of electrons. This release of stored electrons will continue until the atmosphere at the ionized level has reverted entirely to O₂ if that condition is ever reached. The release will be sufficient to counterbalance the effects of recombination and attachment if the number of stored electrons at sunset is sufficiently high and if the reversion to O₂ proceeds at a suitable rate. The net number of released electrons required to maintain the weak E layer at night is not large. The author has elsewhere⁴ deduced it to be of the order of

$$0.1 \frac{\text{free electron}}{\text{cm.}^3/\text{sec.}}$$

This same storage hypothesis is useful in explaining the remarkable increase in the density of ionization of the F layer at sunrise. This effect can now be explained as follows: At and after sunset, electron attachment to oxygen atoms proceeds uncompensated by photo-detachment or by detachment by formation of molecules (see (5)) since collisions are so infrequent that nearly all of the oxygen atoms remain dissociated throughout the night. The density of free electrons decreases primarily through (4) with the result that by sunrise a large reserve of stored electrons has been established. They are then released quickly. The two slopes that are clearly visible in the first and second hours after sunrise (in Fig. 2) may therefore be attributed to the rates of photo-detachment and of ionization proper. The density of free electrons begins to increase before sunrise. This is possible because photo-dissociation is caused by light of wavelengths that are not completely absorbed by passage through the whole depth of the atmosphere. The radiation can therefore pass nearly tangentially to

the earth to affect the F layer in a region 10°–15° west of the sunrise line at the surface of the earth.

Returning to the E layer, the effects of the eclipse may be described as follows: At first contact the approximate balance between ionization, photo-detachment, recombination, and attachment is upset. Since the number of electrons recombining is small compared with the number going into and out of attachment, the unbalance affects the latter process primarily, and the density begins to fall at once. Toward the middle of the eclipse both photo-detachment and photo-dissociation have decreased to small values. At the end of totality the concentration of O₂ is somewhat above normal and there are many stored electrons ready (as at sunrise in the F layer) to be detached as the incoming energy increases after third contact. Conditions are thus favorable for a rapid increase in the density of free electrons, and this increase offsets the time lag to be expected on the simple recombination hypothesis. Because in this case the eclipse occurred in the afternoon and a new equilibrium was established late in the day, the number of electrons held in attachment after the eclipse was less than normal. The density of ionization therefore remained lower than usual because more attachment and less detachment were experienced than on a day without an eclipse.

THE F₁ LAYER

At Queenstown (latitude 31°54'; longitude -26°52') the F₁ layer existed only in rudimentary form during September and October. In this period a separate maximum of ionization could be observed only when the terrestrial-magnetic activity was much greater than normal, except on the day of the eclipse. As is usually the case, the eclipse caused the F₁ layer to exhibit itself in more or less complete form. Except for a short time at the center of the eclipse, however, no cusp was to be found on the virtual-height versus frequency curves, and so no separate curves of critical frequency for this layer have been drawn. Rough curves indicating the location of a rudimentary critical frequency have been shown in Fig. 2. During the half hour or so centered on totality, the critical frequency was well marked. The slope of the curve before totality indicates a recombination coefficient of about 6·10⁻⁹ cm.³/electrons per second on the assumption that recombination alone determines the shape of the curve. This value is about ½ of that for the E layer, although the true heights of the ionization maximums differ by nearly 2 to 1.

The behavior of the F₁ layer is most easily explained in terms of the diagram of Fig. 8. This figure shows the contours of constant ordinary-ray virtual height for the F region, for the afternoon of the eclipse, projected upon the time-frequency plane. It should be noted that the contour interval is not constant throughout the diagram, although it is so in the F₁ part of the figure. The normal behavior of the F₁ layer at this season is to be

⁴ J. A. Pierce, "Abnormal ionization in the E region of the ionosphere," *Proc. I.R.E.*, vol. 26, pp. 892-908; July, 1938.

seen at the left-hand side of the figure. At about 12^h30^m, for instance, the minimum virtual height for the F₁ layer is somewhat less than 220 km. The height increases rapidly, at frequencies between 4 and 5 Mc., and passes through a maximum of about 290 km. at 5.3 Mc. The minimum virtual height for the F₂ layer is a little less than 280 km. A few minutes later, however, at 13^h, there is no maximum which can be interpreted as a dividing line between the F₁ and the F₂ parts of the height-frequency curve, although the height increases rapidly at about 5 Mc. This occasional appearance of an F₁ bump is quite normal and continues until shortly after first contact, when a bump appears which increases in magnitude as the eclipse advances.

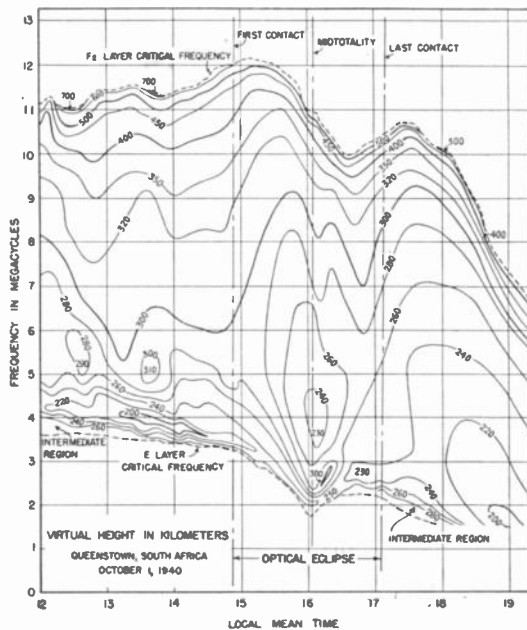

Fig. 8—Contours of constant virtual height of reflection of the ordinary ray from the F region on the afternoon of the eclipse.

Although the F₁ critical frequency must be considered to be imaginary unless a cusp is found on the virtual height-frequency curve, the maximum density of ionization in the F₁ layer varies at a rate which can be measured by the slope of the contours which define the bump. It is this slope which was used to determine the effective recombination coefficient which has been quoted above.

THE F₂ LAYER

The chief effects of the eclipse upon the F₂ layer are easily visualized by a study of the diagram of Fig. 8, especially if the attention is fixed on, for example, the 300-km. contour. At about the time of first contact the virtual-height surface curves quite sharply downward so that a valley forms, having its minimum 15 or 20 minutes before totality. At the time of totality, the heights are rising and reach a maximum 40 minutes or so after midtotality. Thereafter the heights fall rapidly so

that they reach normal within half an hour after the end of the eclipse. It will be noted that the crests of the contours, before totality, tend to lie further to the left at the greater heights, and that the critical frequency is, in effect, the last contour of all. The general effect, disregarding the irregularities in the 280- and 300-km. contours near the time of totality, is that of a giant hand which presses the ionosphere downwards as the eclipse approaches and drags it back up again as the shadow passes by. This force is apparently applied at the top of the ionosphere, since the effects appear first in that most sensitive region, and because the densities are increased by the process of compression and vice versa. According to this argument, the variations in the critical frequency must be considered to be secondary effects of the general compression and expansion.

Some such explanation is necessary, as it is impossible to explain the critical-frequency curve of Fig. 3 on the basis of recombination alone. The maximum rate of decrease of the critical frequency indicates an effective recombination coefficient of about $6 \cdot 10^{-11}$ cm.³/electron per second, but if we assume such a small value we find that the densities would never rise again after the eclipse and that our computed critical-frequency curve would lead quite directly from the experimental minimum at 16^h30^m to the lower-right-hand corner of the figure. There are, therefore, four main characteristics of the critical-frequency curve of Fig. 3 which are difficult to explain: (a) the rise from 14^h to 15^h, which the writer believes to be true eclipse effect although the reasons for this opinion may be somewhat nebulous; (b) the rapidity of the decrease during the middle of the eclipse; (c) the sharpness of the minimum; and, finally, (d) the fact that the critical frequency increased at all after an eclipse which occurred so late in the day.

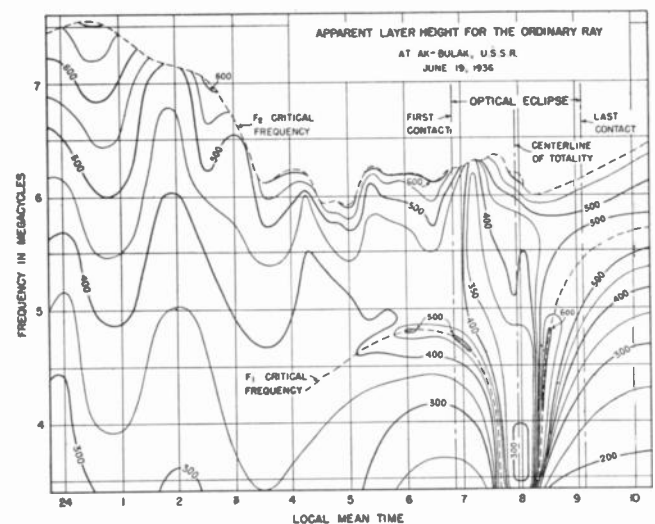

Fig. 9—Contour diagram, similar to that of Fig. 8, drawn for the eclipse of June 19, 1936.

That the various height variations are not fortuitous is indicated by the contour diagram of Fig. 9. This dia-

gram was drawn in 1936, after the Harvard-M.I.T. expedition with which Cruft Laboratory sent a party, and was constructed from the same sort of data used for the 1940 diagram. The data in 1936 were much more limited, so that the figure cannot be relied upon so completely as the current one. Because of a severe magnetic storm which coincided with the eclipse, it was formerly felt that the diagram was nearly worthless, as the F_2 phenomena could not be ascribed to the eclipse with any confidence. It now appears, however, that the events occurring between 06^h30^m and 09^h on June 19, 1936, were probably not seriously influenced by the magnetic storm. The similarity of the two contour diagrams is quite striking. In 1936 the magnetic storm had blown the F_2 layer up to heights which were 100 km. or more greater than the normal, and perhaps for this reason the drop in height at the beginning of the eclipse was greater than in 1940. The rise after totality is not well marked because the F_1 layer occupied most of the frequency range at that time, but with this exception the correspondence is excellent. Even what might be assumed to be accidental phenomena in either case alone may be found in both, such as the pause in the decrease of the F_2 critical frequency at totality and the reversal of one or two of the intermediate contours (400 km. in 1936, and 280 and 300 km. in 1940) at about the same time. The F_1 layer, of course, behaved differently at the two eclipses because of the difference in season, but the extremely rapid effective rate of recombination may be noticed in both cases.

After considering the data from these two eclipse expeditions, the writer feels that the behavior of the F_2 critical frequency is one of the minor effects of an eclipse and that, except for a certain amount of recombination and attachment, the changes are probably a secondary effect of some sort. So far as the F_2 layer is concerned, the major problem is the identification of the mechanism which causes the whole layer to fall and be compressed in the first phase of the eclipse and to rise and expand during the second half.

At present the writer can present only two hypotheses to explain the general behavior of the F_2 layer. The first, and perhaps the best, is that temperature changes in the upper atmosphere cause that part of the atmosphere to contract and expand as a whole during the eclipse. This theory implies the direct heating of the upper atmosphere by a process which does not depend upon ionization and recombination. As this heating energy is cut off by the passage of the moon, the upper atmosphere falls and increases in density. The density of ionization increases in the same ratio, so that the virtual heights decrease for two reasons. The falling of the atmosphere to the westward as the eclipse approaches creates a wind in that direction. This wind has a downward component, insofar as it comes from the higher levels, so that the critical frequency may well increase even before first contact. Since the atmosphere has less than critical

damping, the downward motion of the upper part of the atmosphere may exceed the amount proportional to the cooling before totality, so that the upward rebound begins in the latter part of the first phase. This expansion will assist recombination and attachment in decreasing the ionic density throughout the middle part of the eclipse. It must now be assumed that this rebound, together with the new heating energy which arrives as the unobscured area of the sun increases, carries the atmosphere up to a height beyond its normal position so that the increase in the density of ionization at the end of the eclipse may be ascribed to the return of the atmosphere to its normal height and density.

The other hypothesis results from a slight modification of Chapman's⁵ discussion of the magnetic changes to be expected during an eclipse. As he points out, the recombination effects in a layer (which is here assumed to be the E layer) result in an area in the center of the penumbra in which the conductivity of the atmosphere is less than that of the surrounding regions. Now if the large atmospheric currents described by Bartels⁶ are assumed to flow in the E layer, they must to some extent be deviated outwards around this area of poor conductivity. This action may be represented by superimposing upon the normal diurnal current sheet a system of circulating currents which, in the center of the eclipse area, are directed so as to oppose the flow in the current sheet. As Chapman has shown that the additive effects may be expected to be small in the outlying areas, we shall neglect them and deal only with the opposing current element. At the time and at the location of this eclipse the diurnal current flow is shown by Bartels to be southward, so that the current element due to the eclipse is to the north, a direction nearly normal to the direction in which the moon's shadow moves. This current sets up a magnetic field which is directed downwards on the advancing (eastward) side of the area where the eclipse is total. This field is not stationary but moves with the eclipse at a rate of about a thousand miles per hour with respect to a point on the earth. On the advancing side of the eclipse, then, we have a downward magnetic field plowing towards the east through the ionosphere and therefore accelerating electrons in a northerly direction. Chapman has shown, however, that this moving magnetic field must be small in comparison with the earth's field, so that, instead of moving towards the north, the free electrons will tend to move in planes perpendicular to the earth's field which, at Queenstown, has an inclination of about 30° to the north of the vertical. The electrons, therefore, will move in paths which have a considerable downward component. The mechanism is, of course, reversed after the center of the eclipse passes by.

⁵ S. Chapman, "Influence of solar eclipse upon upper atmosphere ionization," *Mon. Not. R. Ast. Soc.*, vol. 92, pp. 413-420; March, 1932.

⁶ Bartels, "Handbuch der Experimentalphysik," Akademische Verlagsgesellschaft M.B.H., Leipzig, 1928, pp. 624.

It is interesting to note, in this connection, that the frequency separation between the ordinary and extraordinary rays returned from the F_2 layer underwent some interesting changes during the afternoon of the eclipse. This frequency difference is on the average an excellent measure of the intensity of the earth's magnetic field, but is likely to exhibit larger variations than it is easy to explain. The normal separation at Queenstown is 0.439 ± 0.002 Mc., corresponding to a total field, at a height of about 300 km., of 0.31 gauss. On the afternoon of the eclipse the critical frequency was a little higher than usual, with the unfortunate result that during a good part of the eclipse period either the ordinary- or the extraordinary-ray critical frequency lay in the 31-meter broadcast band. As a result it is only safe to say that in the hour centering at 14^h the frequency difference was 0.48 ± 0.02 Mc. and that by 17^h the value was as low as 0.40 ± 0.02 Mc. These variations are in the direction indicated by the above hypothesis but are of an almost unbelievable magnitude. It is unlikely that changes of ± 10 per cent in the earth's magnetic field could occur at the height of the F_2 layer without corresponding magnetic effects appearing at the surface of the earth, unless the E layer forms an amazingly perfect magnetic shield. It is probable, therefore, that we must conclude that these apparent variations in the earth's magnetic field are actually spurious effects due to the reflection of the ordinary and extraordinary rays at different geographical positions at which different vertical distributions of ionic density were to be found, or to some similar phenomenon not directly associated with the eclipse.

ACKNOWLEDGEMENTS

The writer wishes to express his gratitude to H. R. Mimno and other members of Cruft Laboratory for their interest and assistance. Joseph T. deBettencourt, Thomas Joseph Keary, and William O. Reed spent much of their time in preparation for the expedition in the expectation that they would be members of it, and very cheerfully continued to help when the impossibility of finding transportation facilities prevented their departure for South Africa.

A grant from the Milton Fund of Harvard University was drawn upon for more than half of the direct ex-

penses of the expedition, which was also supported by grants or gifts from the American Philosophical Society, the Radio Corporation of America, the Associates of Physical Science at Harvard, and an anonymous private donor. The American South African Line made a substantial contribution in the form of reduced passenger fares and free transportation of eight tons of equipment.

The Department of State was very kind and co-operative in obtaining from the government of the Union of South Africa permission for us to import and operate our transmitting equipment, notwithstanding their state of belligerency. The Union, through the intermediacy of the late H. E. Wood, then director of the Union Observatory and chairman of the South African Eclipse Committee, and B. F. J. Schonland, then director of the Bernard Price Institute of Geophysics of the University of the Witwatersrand (now head of the South African Department of Scientific and Industrial Research) gave us every consideration, extending even to exemption from customs examination and free transportation of our equipment. The municipality of Queenstown was equally kind, providing one of our operating locations, installing antenna poles and power lines, and furnishing electric power, all at cost or less than cost. J. H. Ritchie donated the use of a cottage on his estate together with several acres for the erection of antennas.

S. N. Naude of Stellenbosch University (now Director of the National Physical Laboratory) and R. W. Varder of Rhodes University College generously released four of their graduate students and assistants from their studies and other duties for several weeks so that they might come to Queenstown and assist with the operating program. To these four gentlemen, P. B. Zeeman and J. C. Roelofse from Stellenbosch; M. E. Szendrei and J. A. Gledhill from Rhodes; and to A. C. Verwoerd and L. M. Dugmore of Queens College at Queenstown, the writer finds it completely impossible to express his thanks. Their tireless and cheerful help during the tedious weeks of routine operation and their interest in and enthusiasm for a strange field of research were not only responsible for the writer's continuation in good physical condition but for the maintenance of his morale as well. It is not too much to say that it would have been completely impossible to carry out the field work of the expedition without their help.



Theory of Amplitude-Stabilized Oscillators*

PIERRE R. AIGRAIN†, STUDENT, I.R.E., AND EVERARD M. WILLIAMS†, SENIOR MEMBER, I.R.E.

Summary—The performance of generalized amplitude-stabilized oscillators is analyzed in terms of an amplitude-stability parameter, or stability figure of merit. Theoretical possibilities of stabilization with ballast tubes, lamps of various types, and thermistors are described, together with a novel oscillator circuit.

THE DESIGNATION “amplitude-stabilized oscillators” may appear somewhat ambiguous, since all oscillators are inherently stabilized at some level; it has been applied, however, only to those oscillators in which the amplitude is stabilized at a lower level than would result from characteristic saturation, and in which particular care has been taken to maintain this level at as nearly a constant value as practicable.

Numerous contrivances for achieving stabilization have been described. They may be divided into (a) feedback networks containing essentially constant-current control resistors¹⁻³; (b) feedback networks containing thermistors,⁴ or constant-voltage elements; and (c) automatic gain controls utilizing rectification and variable-gain tubes.^{5,6} Although their theory has been individually discussed in detail, comparison of the general merits of these devices is difficult. It is the purpose of this paper to describe a general theory of amplitude-stabilized oscillators, the merits of each existing scheme of stabilization in the light of this theory, and a new circuit which may be used advantageously in some connections.

In any oscillator the condition for oscillation may be written as

$$\beta K = 1 \tag{1}$$

in which β and K are, respectively, the complex-feedback and amplifier-gain factors. For amplitude-stability calculations, it is convenient to write

$$\beta K = a'b'c' = 1 \tag{2}$$

in which a' is a factor dependent only upon output volt-

age E , b' is a function of circuit constants that are likely to vary in time owing to changes in temperature, supply voltage, or to frequency adjustments, and c' is a constant containing all the stable parameters. If we form the total differential $d(\beta K)$, from (2) we may write

$$\frac{da'}{a'} + \frac{db'}{b'} = 0. \tag{3}$$

The relation between a' and output voltage E may be written, using a factor K_a , as

$$\frac{da'}{a'} = K_a \frac{dE}{E}. \tag{4}$$

The utility of this factor K_a may be demonstrated by combining (3) and (4) to obtain

$$K_a = \frac{-db'}{b'} \cdot \frac{dE}{E}, \tag{5}$$

giving the relation between a change in b' and the resulting change in E . K_a will be called the amplitude-stability factor; this type of factor has been termed

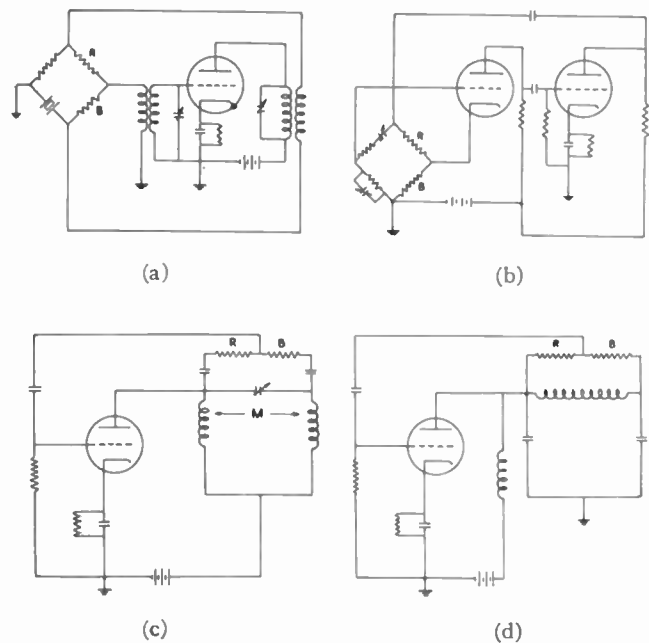

Fig. 1—Typical bridge-stabilized oscillators. (a) The Meacham oscillator. (b) The Wien-bridge oscillator. (c) The stabilized Hartley oscillator. (d) The stabilized Colpitts oscillator.

* Decimal classification: R355.911.4. Original manuscript received by the Institute, February 10, 1947; revised manuscript received; May 21, 1947.

† Carnegie Institute of Technology, Pittsburgh, Pa.

¹ W. G. Shepherd and R. O. Wise, “Variable frequency-bridge-type frequency-stabilized oscillators,” *Proc. I.R.E.*, vol. 31, pp. 256-269; June, 1943.

² L. A. Meacham, “The bridge-stabilized oscillator,” *Proc. I.R.E.*, vol. 26, pp. 1278-1295; October, 1938.

³ F. E. Terman, R. R. Buss, W. R. Hewlett, and F. C. Cahill, “Some applications of negative feedback with particular reference to laboratory equipment,” *Proc. I.R.E.*, vol. 10, pp. 649-655; October, 1939.

⁴ Lawrence Fleming, “Thermistor-regulated low-frequency oscillator,” *Electronics*, vol. 19, pp. 97-100; October, 1946.

⁵ L. G. Arguimbau, “An oscillator having a linear operating characteristic,” *Proc. I.R.E.*, vol. 21, pp. 14-29; January, 1933.

⁶ J. Groszkowski, “Oscillators with automatic control of the threshold of regeneration,” *Proc. I.R.E.*, vol. 22, pp. 145-152; February, 1934.

“asymptotic,” since it describes incremental stability at any one operating condition. Although not as general as some possible factor relating to stability when parameters vary over a wide range, it has been found by the authors to be adequate for purposes of comparison, and

the various schemes listed under (a), (b), and (c) above will be analyzed in terms of this factor.

The majority of amplitude-stabilized oscillators, comprising types (a) and (b) of the three classifications described above, utilize a nonlinear (thermal) circuit element as a part of a bridge circuit, the output of which is the feedback signal. Fig. 1 shows some oscillators of this type: the Meacham oscillator,² the Wien-bridge oscillator,³ and stabilized versions of the Hartley and Colpitts oscillators. Fig. 2 gives an equivalent circuit which may be used in amplitude-stability-factor cal-

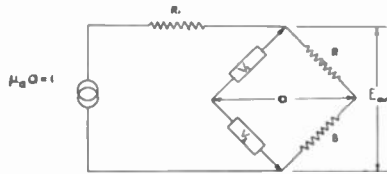

Fig. 2—Equivalent circuit for stabilized oscillators of the type shown in Fig. 1.

culations. In this circuit B and R are nonlinear control and fixed resistors, respectively; V_1 and V_2 are fixed bridge-arm potentials; a is the bridge output; and $\mu_a a$ and R_i are the equivalent voltage and internal resistance of the amplifier.

The amplitude-stability factor of oscillators of this class may be shown to be

$$K_a = \frac{(\mu_a R + R_i)(\eta_B B)}{(R + B + R_i)(R + [1 + \eta_B]B)} \quad (6)$$

The parameter η_B is a property of the regulating element, defined in terms of its resistance B and current I_B as

$$\eta_B = \frac{dB}{B} \cdot \frac{I_B}{dI_B}$$

When designing an oscillator, the values of R may be chosen in such a way as to make K_a in (6) a maximum. The optimum values of R , together with the resulting maximum values of K_a , are given in Table I, which divides oscillators into groups according to the relative μ_a of the oscillator and the range of η_B . A further improvement over the maxima of Table I may be obtained by using a transformer to match the bridge load $R+B$ to the generator impedance R_i .

Oscillators of the automatic-gain-control type, in group (c) above,^{5,6} are advantageous when it is desired to stabilize the amplitude at very low levels. In most cases, however, the nonlinear function which stabilizes amplitude is a characteristic curvature in the amplifier itself, so that harmonic content is not as low as with

TABLE I
OPTIMUM VALUES OF FIXED RESISTANCE R AND RESULTING VALUES OF AMPLITUDE STABILITY FACTOR K_a

<p>Case I. Amplifiers with relatively high μ_a ($\mu_a R \gg R_i$), for which $K_a \cong \frac{\mu_a R \eta_B B}{(R + B + R_i)(R + [1 + \eta_B]B)}$</p>	<p>Case I-A. Relatively high-μ_a amplifiers when $\eta_B > -1$. $K_a \text{ has a maximum value } \frac{\mu_a \eta_B}{\left(\sqrt{1 + \eta_B} + \sqrt{1 + \frac{R_i}{B}}\right)^2}$ when $R = B \sqrt{(1 + \eta_B) \left(1 + \frac{R_i}{B}\right)}$</p> <p>Case I-B. Relatively high-μ_a amplifiers when $\eta_B \leq -1$. $K_a = \infty \text{ when } R = -(1 + \eta_B)B$</p>
<p>Case II. Amplifiers with relatively low μ_a. K_a is given by (6)</p>	<p>Case II-A. Low-μ_a amplifier with control element for which $\eta_B > \frac{R_i^2 - \mu_a B [R_i + B]}{B(\mu_a [B + R_i] - R_i)} > -1.$ $K_a \text{ has a maximum value } K_a = \frac{\mu_a \eta_B}{\left[\sqrt{1 + \frac{\mu_a - 1}{\mu_a} \frac{R_i}{B}} + \sqrt{1 + \eta_B - \frac{R_i}{\mu_a B}}\right]^2}$ for $R = B \sqrt{\left[1 + \left(\frac{\mu_a - 1}{\mu_a}\right) \frac{R_i}{B}\right] \left(1 + \eta_B - \frac{R_i}{\mu_a B}\right)}$</p> <p>Case II-B. Low-$\mu_a$ amplifier with control element for which $-1 \leq \eta_B \leq \frac{R_i^2 - \mu_a B [R_i + B]}{B(\mu_a [B + R_i] - R_i)}$ $K_a \text{ has a maximum value } K_a = \frac{R_i \eta_B}{(B + R_i)(1 + \eta_B)}$ for $R = 0$</p> <p>Case II-C. Low-μ_a amplifier when $\eta_B \leq -1$. $K_a = \infty \text{ for } R = -B(1 + \eta_B)$</p>

nonlinear bridge stabilization. Bridge stabilization can be adapted to low-level, or adjustable-level, operation by using the circuit shown in Fig. 3, in which the re-

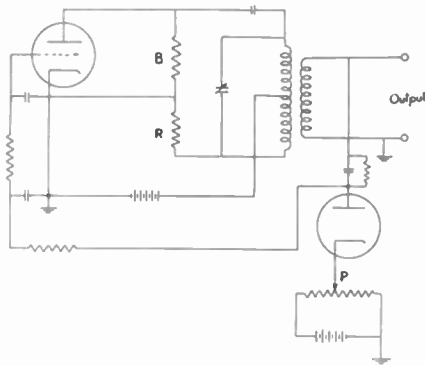

Fig. 3—Circuit of an improved stabilized oscillator with a regulating system of the automatic-volume-control type.

sistance changes of the regulator element result from changes in the output-tube d.c. plate current instead of changes in a.c. output. The d.c. plate current is controlled by the output voltage through the diode rectifier network. The amplitude-stability factor of this oscillator is

$$K_a = \frac{S' E_{out} (\mu_a R + R_i) \eta_B B}{I_0 (R + B) (R + B + R_i)},$$

in which

I_0 = d.c. component of current through $R+B$

$$S' = \frac{S_m}{1 + \frac{S_m E_c B \eta_B}{I_0 (\eta_B + R + B)}}$$

r_p, S_m = output-tube plate resistance and transconductance

E_c = d.c. signal developed by diode network

E_{out} = peak oscillator output voltage.

The amplitude-stability factor with this oscillator is generally higher than that of comparable oscillators because of the use of the output tube as both the a.c. amplifier for the oscillator and a d.c. amplifier for the stabilization arrangement.

COMPARISON OF STABILIZING ELEMENTS

The nonlinear control elements used in oscillator stabilization differ from one another primarily in the magnitude of the parameter η_B (which directly determines the K_a of the oscillator), its sensitivity to ambient temperature variations, and the operating current at which optimum η_B is developed. Ambient temperature sensitivity must be considered since, when it is present, temperature control is necessary. High operating current is undesirable because it requires power tubes in the oscillator circuit and more rugged elements in the other branches of stabilizing bridges.

Langmuir and Jones⁷ have given a theory from which the possible range of η_B may be predicted as $0 < \eta_B < \infty$ for positive-temperature-coefficient materials, and $-2 < \eta_B < 0$ for negative-temperature-coefficient materials. The properties of commercially available regulating elements are summarized in Table II below.

TABLE II
COMMERCIALY AVAILABLE REGULATING ELEMENTS

Type	Optimum η_B	Effect of ambient temperature	Operating current	Resulting amplitude stability
Ballast tube	infinite	negligible	high (hundreds of ma.)	good
Tungsten-filament lamps	about 1.0	negligible	as low as 10 ma. in 3-watt, 115-volt	fair
Carbon-filament lamps	about -0.25	negligible	about the same as tungsten filaments	fair
Thermistor	less than -1	marked	very low	very high

Other types, not commercially available, have some advantages. Schönfeld⁸ has described a very-low-current ballast tube consisting of a fine quartz fiber with an iron coating. Desirable regulating elements may also be con-

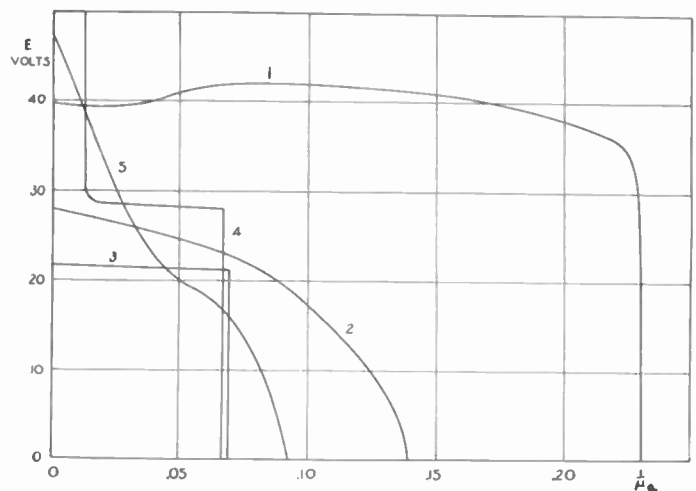

Fig. 4—Output voltages of typical stabilized oscillators, using each of stabilization arrangements discussed in the paper, as functions of μ_a , the amplification factor of the amplifier used in the oscillator. Each of these oscillators uses a 6AC7 tube with a bridge containing a representative regulating element of the type specified, and all are designed to have maximum amplitude stability at about the same value of μ_a . The curves refer to: (1) an ordinary stabilized oscillator using thermistor at 0 degree centigrade ambient temperature, (2) the same oscillator when ambient temperature is 25 degrees centigrade, (3) an improved a.v.c.-stabilized oscillator with platinum-filament regulator element, (4) the same oscillator designed to operate with a tungsten-filament regulator tube (3-watt 115-volt lamp), and (5) an ordinary stabilized oscillator using the same tungsten-filament lamp.

⁷ H. A. Jones, "The ballast resistor in practice," *Gen. Elect. Rev.*, vol. 28, p. 329; May, 1925.

⁸ Schönfeld, "Regelwiderstand zum konstanthalten des stromes bei veränderlichen spannung," German Patent No. 738589.

structed with platinum filaments in a hydrogen atmosphere, since platinum wire is obtainable in very small diameters. The authors constructed such a control element, of 3-micron diameter platinum in a 2-millimeter pressure hydrogen atmosphere, in which η_B is about 8 at 10 ma.

Fig. 4 shows, for comparison, the output voltage of a single 6AC7-tube oscillator as a function of $1/\mu_a$ for each stabilization arrangement. Variations in μ_a represent factors tending to change oscillator level and correspond to variations in b of (3). The influence of ambi-

ent temperature on thermistor stabilization is illustrated by the wide deviation between curves (1) and (2). The rather poor performance of the tungsten lamp may be reconciled with the well-known stable characteristics of commercially available Wien-bridge-stabilized oscillators when it is remembered that the commercial versions operate at very much higher values of μ_a than those for which these curves are prepared. An increase in the minimum design μ_a would, of course, increase the amplitude-stability factor of all the oscillators whose characteristics are shown in Fig. 4.

Application of Velocity-Modulation Tubes for Reception at U.H.F. and S.H.F.*

M. J. O. STRUTT†, SENIOR MEMBER, I.R.E., AND A. VAN DER ZIEL†

Summary—Upon introduction of the notions of gain and noise figure, it appears that preamplifier stages using velocity-modulation tubes are unsuitable at u.h.f. and s.h.f. under operational conditions considered hitherto. A special arrangement, connected with such a tube and consisting of three electrode pairs spaced along the electron stream, is considered in this paper. The first pair is connected to a resonance cavity or line, constituting a pre-circuit. The second pair is connected to the input, and the third pair to the output circuit. It can be shown that the transfer of initial spontaneous velocity fluctuations to density fluctuations along the electron stream may be neglected. The reverse effect is considered in an appendix, and it also is negligible under practical conditions. It is shown that, by the use of a properly detuned pre-circuit, the noise figure may be reduced from a few thousand to, say, 10 under optimal conditions, retaining gain figures of, say, 100. The usefulness of the arrangement under consideration is discussed and estimated to be favorable under actual conditions of operation. With traveling-wave tubes noise figures below 10 are thought to be attainable by application of the present device.

I. INTRODUCTION

IN RECEPTION at v.h.f. (up to 300 Mc.), a high-frequency amplifier stage is often utilized preceding the mixer stage if a particularly low noise level is aimed at. The only comparable preamplifier which is at present available in the higher u.h.f. range (up to 3000 Mc.) or at s.h.f. (up to 30,000 Mc.) is the traveling-wave tube.¹ The common amplifier tubes (pentodes, grounded-grid triodes) often yield practically no useful power gain at these frequencies. Velocity-modulation tubes may have adequate power gain at these frequencies but, on the other hand, normally cause a far-

too-high noise-to-signal ratio at the output of corresponding preamplifier stages.¹⁻⁴

It is the purpose of this paper to show that the application of velocity-modulated preamplifiers is not an entirely hopeless project if special noise-reducing measures are taken into account. These measures consist of the introduction of a pre-circuit between the electron gun and the input circuit.

We shall use a noise figure N , defined as follows⁵⁻⁸: Let P_s be the available signal power at the output of the stage, i.e., the maximum signal power obtainable from the output terminals upon variation of the outer impedance connected to them. Let P_n be the available noise power at the output corresponding to a frequency interval Δf centered around the signal frequency. The available power of the signal source connected to the input terminals of the stage is varied until $P_s = P_n$. Let the value thus obtained be P . Then the noise figure is

$$N = \frac{P}{kT\Delta f} \quad (1)$$

where k is Boltzmann's constant (1.38×10^{-23} Joule per °K), T is the room temperature in °K (293°), and Δf is the frequency interval mentioned above.

* D. K. C. MacDonald, "A note on two definitions of noise figure in radio receivers," *Phil. Mag.*, vol. 35, pp. 386-395; 1944.

† D. O. North and H. T. Friis, "Discussion on noise figures of radio receivers," *PROC. I.R.E.*, vol. 33, pp. 125-126; February, 1945.

‡ R. I. Sarbacher and W. A. Edson, "Hyper and ultra-high frequency engineering," Chapman and Hall, London, 1943.

§ M. J. O. Strutt and A. van der Ziel, "Signal noise ratio at vhf," *Wireless Eng.*, vol. 23, pp. 241-249; 1946.

¶ K. Fraenz, "Measurements of receiver sensitivity at ultra-short waves," *Hochfrequenz. und Elektroakustik*, vol. 59, pp. 105-112 and 143-144; 1942.

‡ H. T. Friis, "Noise figures of radio receivers," *PROC. I.R.E.*, vol. 32, pp. 419-423 and 729; July, 1944.

§ J. Muller, "Sensitivity of valve circuits using velocity-modulation," *Hochfrequenz. und Elektroakustik*, vol. 60, pp. 19-21; 1942.

* Decimal classification: R339.3. Original manuscript received by the Institute, December 31, 1946; revised manuscript received, March 26, 1947.

† N. V. Philips' Gloeilampenfabrieken, Eindhoven, the Netherlands.

‡ R. Kompfner, "The travelling-wave valve," *Wireless World*, vol. 52, pp. 369-372; 1946.

Whereas the noise figures corresponding to pre-amplifier stages at v.h.f. (pentodes or grounded-grid triodes) may be of the order of 10 or 20, or even lower, the figures for velocity-modulation tubes at v.h.f. and s.h.f. have been shown to amount to a few thousand. As the crystal mixer stages have noise figures of the order of 10 at these frequencies, the application of a velocity-modulated amplifier seems to be perfectly useless.

Besides noise figure, power gain g is also important. This gain is defined as the ratio of the available output-signal power to the available input-signal power. If we consider a succession of two stages having the individual noise figures N_1 and N_2 , the resulting noise figure N is

$$N = N_1 + \frac{N_2 - 1}{g}, \quad (2)$$

g being the power gain of the first stage. Thus, in order to obtain a value N below N_2 , the latter corresponding to a mixer stage, we must have a low value of N_1 combined with a considerable power gain g .

II. VELOCITY-MODULATED PREAMPLIFIER

A schematic diagram of an amplifier stage of this kind is shown in Fig. 1. The electrode pair II is connected to the input (antenna) terminals, and the pair III to the output circuit. The input circuit connected to II, as well as the output circuit connected to III, consist of im-

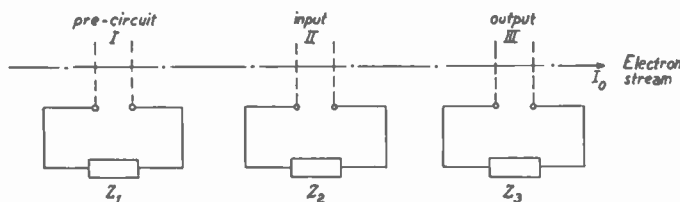

Fig. 1—Schematic diagram of the arrangement discussed in the present paper, consisting of a pre-circuit, an input circuit, and an output circuit, placed consecutively along an electronic stream, each circuit being connected to a pair of electrodes.

pedances Z_2 and Z_3 , respectively. These impedances will in most cases correspond to resonant cavities, which may be tuned or detuned with respect to the input signal frequency. Besides these two electrode pairs a third pair (indicated by I in Fig. 1) connected to an impedance Z_1 is used. This pre-circuit will be shown to cause considerable noise-figure reduction under proper conditions of operation.

The electron stream, passing the three pairs of electrodes, which may be grid- or ring-shaped, shows spontaneous fluctuations of current density as well as of electron velocity. Initial fluctuations of density as well as of velocity may cause density fluctuations at the output electrodes and thus influence the resulting noise figure. We shall assess briefly the relative importance of these effects. Assuming the electronic fluctuation current I_f at a definite point along the beam to be given by

$$\overline{I_f^2} = 2eF^2I_0\Delta f \quad (3)$$

where the horizontal dash indicates averaging either over a long time interval or over a large number of similar electron streams, e is the electronic charge, F^2 is a multiplier which is unity under conditions of "saturated" emission and smaller under different conditions, and Δf is a frequency interval which is small compared with the signal frequency under consideration.

From the theory of velocity-modulated tubes we may infer that a velocity fluctuation at a definite point of an electron stream results in a density fluctuation at a point further down the stream. It may be shown that spontaneous velocity fluctuations along the stream result in negligible density fluctuations under practical conditions (see Appendix).

A further effect to be considered is the eventual decrease of initial current-density fluctuations (i.e. debunching) along the electron stream due to the Maxwellian distribution of electron velocities. Simple estimates of this effect (see Appendix) show that no account need be taken of it, as its magnitude is entirely negligible.

The interception of electrons by gap or grid electrodes may result in spontaneous partition fluctuations superimposed on the electronic stream. If F^2 in (3) is near unity, corresponding to the case of near saturation, no appreciable increase of mean-square output-current fluctuations will result from these partition fluctuations. In other cases their effect may be minimized by proper focusing of the electronic beam so as to reduce the ratio of intercepted current to beam current as much as possible. Furthermore, special methods of compensation may be applied, reducing these partition fluctuations to a relatively negligible fraction of over-all mean-square output fluctuations.⁹

In the present theory complete coherence of fluctuations along the electron beam is assumed. The validity of this assumption under practical conditions is open to question. In the opinion of the authors, careful design of the focusing system might be conducive to such coherence.

Gap widths are assumed to be such that the product $\omega\tau$, in which ω is the angular instantaneous frequency of the fluctuations in question and τ the transit time along the gap, is small compared with unity. Finite gap widths do not alter the results essentially, according to unpublished calculations by the authors.

The resonant impedances of the cavities, or resonant devices connected to the gaps, are assumed to be of small amount compared with the electron-caused impedances across the gaps. The validity of this assumption may be shown in many practical cases, and no essential alteration of final results is to be expected by dropping it.

⁹ M. J. O. Strutt and A. van der Ziel, "Methods for compensating different types of fluctuations in electron tubes and attached circuits," *Physics* (Hague), vol. 8, pp. 1-22; 1941.

III. GAIN AND NOISE FIGURE

We may approximately represent the current fluctuations of the electron stream by an a.c. component $i_0 \exp(j\omega t)$ of slowly fluctuating amplitude i_0 , where $\overline{i_0^2} = I_s^2$ and ω is the angular frequency around which the frequency interval Δf is centered. Due to the a.c., a voltage V_{f1} is obtained across the impedance Z_1 of Fig. 1, given by

$$V_{f1} = -i_0 Z_1 \exp(j\omega t). \quad (4)$$

By this voltage a corresponding current-density fluctuation is caused at the electrode pair *II*. This density fluctuation results in a voltage across the impedance Z_2 which becomes

$$V_{f2} = -i_0(1 - jS_{12}Z_1)Z_2 \exp(j\omega t - \tau_{12}) \quad (5)$$

where jS_{12} is the transconductance from the electrodes *I* to the electrodes *II* and τ_{12} the average time required by an electron to move from *I* to *II*. Similarly, a voltage V_{f3} is caused across the impedance Z_3 expressed by

$$V_{f3} = -i_0 \{ 1 - jZ_1 S_{13} - (1 - jS_{12}Z_1)jS_{23}Z_2 \} Z_3 \exp\{j\omega(t - \tau_{13})\} \quad (6)$$

where jS_{13} is the transconductance from *I* to *III*; jS_{23} is the transconductance from *II* to *III*, and τ_{13} is the average electronic transit time from *I* to *III*, $\tau_{13} = \tau_{12} + \tau_{23}$, τ_{23} being the transit time from *II* to *III*. Fluctuations due to sources other than the electron stream will be ignored.

We shall assume that the signal is due to a constant-current generator of r.m.s.-signal current I_s (angular frequency ω) and of real shunt resistance R_s . The available power of this generator is $P_s = \frac{1}{4}I_s^2 R_s$. In order to achieve impedance matching, we assume that it is allowed to alter R_s and I_s simultaneously, such that the available power P_s remains constant. The shunt resistance R_s may be assumed to be incorporated in Z_2 . As a result, we obtain a r.m.s.-signal voltage across Z_2 amounting to

$$V_2 = I_s Z_2 \quad (7)$$

and across Z_3

$$V_3 = -I_s Z_2 jS_{23} Z_3 \exp(-j\omega\tau_{23}). \quad (8)$$

By (8) and (6), the ratio of average noise voltage squared to signal voltage squared is

$$\begin{aligned} \frac{\overline{V_{f3}^2}}{V_3^2} &= \frac{\overline{i_0^2}}{I_s^2} \left| \frac{1 - jS_{13}Z_1 - (1 - jS_{12}Z_1)jS_{23}Z_2}{jS_{23}Z_2} \right|^2 \\ &= \frac{NkT\Delta f}{P_s}. \end{aligned} \quad (9)$$

Substituting $\overline{I_s^2}$ according to (3) for $\overline{i_0^2}$, we obtain a noise figure of

$$N = \frac{eI_0 F^2}{2kT} R_s \left| \frac{1 - jS_{13}Z_1}{jS_{23}Z_2} - (1 - jS_{12}Z_1) \right|^2. \quad (10)$$

Assuming the real part of the complex impedance Z_3 to be R_3 , the available signal power at the electrodes *III* is $\frac{1}{4}V_3^2/R_3$, and the power gain from the input electrodes *II* to the output electrodes *III* is, hence,

$$g = \frac{\frac{1}{4}V_3^2/R_3}{P_s} = S_{23}^2 \frac{R_3}{R_s} |Z_2|^2. \quad (11)$$

IV. OPTIMAL VALUES OF NOISE FIGURE

We shall first consider the conditions necessary to obtain a noise figure equal to zero. Let

$$\begin{aligned} \frac{1}{Z_1} &= \frac{1}{R_1} + j\omega C_1 \\ \frac{1}{Z_2} &= \frac{1}{R_s} + j\omega C_2. \end{aligned} \quad (12)$$

Here the impedances Z_1 and Z_2 are supposed to correspond to resonant cavities or lines. Especially, the cavity connected to *II* is assumed to have a resonant impedance far in excess of the shunt-source resistance R_s , thus avoiding loss of power and increased noise attending smaller values of this resonant impedance. The first question arising from (10) is, under what conditions to be imposed on Z_1 may the resulting noise figure approach zero? This would mean

$$\begin{aligned} &1 - jS_{13} \left(\frac{1}{R_1} + j\omega C_1 \right)^{-1} \\ &- jS_{23} \left(\frac{1}{R_s} + j\omega C_2 \right)^{-1} \left\{ 1 - jS_{12} \left(\frac{1}{R_1} + j\omega C_1 \right)^{-1} \right\} = 0. \end{aligned}$$

This equation is obtained by simple algebra from (10) and (12). As the three transconductance moduli S_{13} , S_{23} , S_{12} , and also R_s , are positive, the desired zero value would only be attainable for negative values of R_1 , as may be inferred from the above equation. If we exclude these negative values of R_1 , the noise figure attains a minimum value (regarded as a function of R_1) for extremely large values of this resonant resistance. Hence the quality figure of the cavity or line section connected to the electrodes *I* should be as high as possible. Supposing that $1/R_1$ is of negligible value, according to this choice we may determine the required value of C_1 in order to attain a minimum noise figure. This is

$$\frac{1}{\omega C_1} = \frac{S_{13} + R_s^2(\omega C_2 S_{13} - S_{12} S_{23})(\omega C_2 - S_{23})}{S_{13}^2 + R_s^2(\omega C_2 S_{13} - S_{12} S_{23})^2},$$

resulting in a minimum value of noise figure

$$N_{\min} = \frac{eI_0 F^2}{2kT} R_s \frac{S_{23}^2}{S_{13}^2 + R_s^2(\omega C_2 S_{13} - S_{12} S_{23})^2}. \quad (13)$$

We have still the values of R_s and C_2 , which may be varied until (13) attains its lowest level. By (13), this lowest level is zero and is attained if R_s is zero or infinite and also if ωC_2 is infinite. If R_s were infinite, the bandwidth of the amplifier would become far too small. Hence we exclude this case. The case $R_s=0$ would lead to a zero gain figure according to (11) and must therefore be excluded too. The case of infinite ωC_2 leads also to a zero gain figure and thus is of no practical consequence either. On the other hand, the expression (13) has a maximum value, as dependent on ωC_2 and on R_s if

$$\omega C_2 = \frac{S_{12}S_{23}}{S_{13}} \quad \text{and if} \quad \frac{1}{R_s} = \frac{\omega C_2 S_{13} - S_{12}S_{23}}{S_{13}}.$$

These or neighboring values should be avoided. The gain figure (11) is optimal if $\omega C_2=0$. In this case,

$$N_{\min} = \frac{eI_0F^2}{2kT} R_s \frac{S_{23}^2}{S_{13}^2 + S_{12}^2 S_{23}^2 R_s^2} \quad (14)$$

$$g = S_{23}^2 R_s R_3. \quad (15)$$

V. DISCUSSION

The usefulness of the proposed arrangement may be judged best if practical values are inserted for the several quantities under discussion. Then the advance achieved over the simple case without pre-circuit I of Fig. 1 will also become evident as will the prospects of obtaining further advances.

If the electrode pair I of Fig. 1 is short circuited, its influence on the behavior of the amplifier stage will be nil. By (10) we obtain in this case

$$N_0 = \frac{eI_0F^2}{2kT} R_s \left| \frac{1}{jS_{23}Z_2} - 1 \right|^2.$$

Assuming again $\omega C_2=0$, this reduces to

$$N_0 = \frac{eI_0F^2}{2kT} R_s \frac{1 + S_{23}^2 R_s^2}{S_{23}^2 R_s^2}. \quad (16)$$

Thus, by division of (14) by (16) the ratio of the noise figure with to that without pre-circuit I of Fig. 1 becomes

$$\frac{N_{\min}}{N_0} = \frac{S_{23}^2}{S_{13}^2 + S_{12}^2 S_{23}^2 R_s^2} \frac{S_{23}^2 R_s^2}{1 + S_{23}^2 R_s^2}. \quad (17)$$

By the elementary theory of velocity-modulation tubes,

$$S_{23} = \frac{1}{2} \omega \tau_{23} \frac{I_0}{V}. \quad (18)$$

If $I_0=10$ milliamperes, $V=1000$ V, $\omega=2 \times 10^{10}$ (10-centimeter wavelength in vacuum), and the distance l between the electrode pairs II and III of Fig. 1 is 10 centimeters, we obtain from (18) $S_{23}=0.5$ millimhos. Under practical conditions of operation we may assume R_s to

be 20,000 ohms and R_3 to have the same value. Since S_{12} is comparable to S_{23} we may neglect the expression S_{13}^2 as compared with $S_{12}^2 S_{23}^2 R_s^2$ in (14) and (17). Thus $N_{\min}=40$ and $g=100$, by (14) and (15), if $S_{12}=S_{23}$. By these simplifications, (17) yields

$$\frac{N_{\min}}{N_0} \approx \frac{1}{S_{12}^2 R_s^2}, \quad (19)$$

and this becomes 1 per cent under the above assumptions. Thus the pre-circuit I of Fig. 1 causes a reduction of the resulting noise figure by a factor 100. By (14) we obtain approximately

$$N_{\min} = \frac{eI_0F^2}{2kTS_{12}^2 R_s}. \quad (20)$$

Hence, the optimal noise figure obtainable under our assumptions is proportional to

$$N_{\min} \approx \frac{F^2 V^3}{I_0 l^2 R_s}, \quad (21)$$

V being the direct voltage corresponding to the average electronic velocity in the beam, I_0 the beam current, and l the distance between the electrodes I and II. By reducing the voltage V to half its assumed value, we would thus cause a reduction of N_{\min} to $\frac{1}{8}$ of its value, or to $40/8=5$. Furthermore, by abstaining from the utilization of electronic streams emitted under "saturated" conditions, F^2 might be smaller than unity. By an increase of I_0 , l , or R_s the noise figure is reduced as well as by a decrease of F^2 or of V .

The capacitance C_1 corresponding to the impedance Z_1 becomes, under our assumptions,

$$\frac{1}{\omega C_1} \approx \frac{1}{S_{12}}.$$

Inserting the above values, C_1 is about 0.025 micro-microfarad, while $1/R_1$ is assumed to be negligible as compared with S_{12} or with 0.5 millimho. Hence the resonant impedance R_1 of the pre-circuit may be of the same order as that of the circuits connected to the input and the output electrodes (for instance, larger than 20,000 ohms). No excessively high quality figures are thus included in our considerations.

The reduction of noise figure caused by the pre-circuit I is not confined to a single-signal frequency, but extends over fairly broad frequency bands, for instance, 10 Mc.

VI. CONCLUSION

It has been shown that the application of a velocity-modulation tube in an amplifier stage at u.h.f. and s.h.f. leads to noise figures of a few thousand if no special measures for its reduction are introduced. In the present paper an additional pair of electrodes, preceding the input electrodes connected to a resonant line or cavity, detuned capacitively with respect to the signal fre-

quency, so as to be essentially equivalent to a capacitance of given value, is considered. By the use of such a pre-circuit the noise figure of a corresponding amplifier stage may be reduced to 1 per cent of its previous value. Thus, noise figures of the order of 10 to 40 may be obtained, which seem to be of sufficient interest if compared with crystal mixer stages, while power-gain figures of the order of 100 may be achieved. The said pre-circuit was proposed by the authors in 1941 (patents applied for).

It might also be successfully applied to traveling-wave tubes. In this case the noise compensation may be essentially restricted to the input region of the spiral electrode as the gain increases rapidly along it so as to make the fluctuations relatively inappreciable further on.

It should be mentioned that E. Barlow has reported unfavorable results of experimental attempts to obtain noise compensation of the kind considered here.¹⁰ However, an investigation as to the causes of this failure might be worth while, in the opinion of the authors.

Further experiments, conforming carefully to the assumptions stated in Section II, might be useful in view of the theoretical results stated above.

VII. APPENDIX

It is proposed to discuss briefly the decrease of initial current-density fluctuations along an electron stream caused by the velocity distribution of electrons (debunching). Let the number of electrons with velocities corresponding to an accelerating voltage between V and $V+dV$ be dn . We then assume the velocity distribution

$$\frac{dn}{n} = \sqrt{V_1} \frac{dV}{\sqrt{V^3}},$$

where V varies within the interval $V_0 \leq V \leq V_0 + \Delta V_0$. The value of V_1 is determined by the condition

$$\int_{V_0}^{V_0 + \Delta V_0} dn = n, \text{ or } 2\sqrt{V_1} \left(\frac{1}{\sqrt{V_0}} - \frac{1}{\sqrt{V_0 + \Delta V_0}} \right) = 1.$$

This distribution of velocities results in simple formulas and may well serve as a model to judge the influence of more natural distributions, such as a Maxwellian one. The transit time corresponding to a distance x along the stream at a voltage V_0 is indicated by τ_0 , while the transit time at a voltage $V_0 + \Delta V_0$ is $\tau_0 - \Delta\tau$. Hence,

$$\begin{aligned} \tau_0 - \Delta\tau &= \frac{x}{\sqrt{2e_0(V_0 + \Delta V_0)}}, \text{ or} \\ \Delta\tau &= \frac{x}{\sqrt{2e_0}} \left(\frac{1}{\sqrt{V_0}} - \frac{1}{\sqrt{V_0 + \Delta V_0}} \right) \\ &\approx \frac{\tau_0}{2} \frac{\Delta V_0}{V_0} = \frac{x}{2\sqrt{2e_0V_1}} e_0 = e/m. \end{aligned}$$

We consider an initial alternating current at $x=0$ of magnitude $I \exp(j\omega t)$ and assume this current to be entirely due to density modulation. Electrons of velocities between V and $V+dV$ cause a contribution

$$\begin{aligned} \frac{dn}{n} I \exp(j\omega t) \\ = I \exp(j\omega t_1) \sqrt{V_1} \frac{dV}{\sqrt{V^3}} \exp(-j\omega\tau) \end{aligned} \quad (22)$$

to this current. Here t_1 is the time corresponding to a distance x from the initial point and τ is the transit time for this distance at a voltage V . As

$$\tau = \frac{x}{\sqrt{2e_0V}},$$

we have

$$d\tau = -\frac{1}{2} \frac{x}{\sqrt{2e_0}} \frac{dV}{\sqrt{V^3}}.$$

Insertion into (22) yields the electronic current $I_x \exp(j\omega t_1)$, at x

$$I_x = I \frac{2\sqrt{2e_0V_1}}{x} \int_{\tau_0 - \Delta\tau}^{\tau_0} \exp(-j\omega\tau) d\tau.$$

This integration may readily be carried out and leads to

$$\left| \frac{I_x}{I} \right| = \left| \frac{\sin \frac{\omega\Delta\tau}{2}}{\frac{\omega\Delta\tau}{2}} \right|, \quad \Delta\tau = \frac{x}{2\sqrt{2e_0V_1}}.$$

A considerable decrease of this ratio below unity occurs if $\omega\Delta\tau$ is larger than π . This would entail

$$\omega\Delta\tau \approx \frac{\omega\tau_0}{2} \frac{\Delta V_0}{V_0} \geq \pi.$$

If the ratio $\Delta V_0/V_0$ is, for instance, 1/1000, we would have $\omega\tau_0 \geq 2000\pi$. Ordinarily, $\omega\tau_0$ may be of the order of 100, and hence no appreciable decrease of current-density fluctuations is to be reckoned with under practical conditions of operation.

The transfer of velocity fluctuations, at a definite point of the beam, into density fluctuations at a further point may be accounted for by a similar method. Assuming, for simplicity, that the electron beam shows "saturated fluctuations" ($F_2=1$ in (3)), (3) holds for every cross section of the beam because it is a direct consequence of statistical considerations. As the initial density fluctuations are reduced along the beam due to the velocity distribution, a complementary effect must exist, transferring initial velocity fluctuations to density fluctuations, such that (3) remains valid. Hence both effects must be of the same magnitude, so that the transfer of initial velocity fluctuations to density fluctuations is negligible even for $\omega\tau_0$ of the order of 100.

¹⁰ I.R.E. Electron-Tube Conference, New Haven, Conn., June, 1946.

Phase and Amplitude Distortion in Linear Networks*

M. J. DI TORO†, SENIOR MEMBER, I.R.E.

Summary—All practical communication networks exhibit distortions from the ideal linear phase and flat amplitude (all-pass) characteristics. When linear phase together with finite amplitude bandwidth prevail, the build-up time of the step transient response equals the reciprocal of twice the amplitude bandwidth. However, when phase distortion together with all-pass amplitude characteristics prevail, the *finite* (rather than zero) step-response build-up time is ascribed to the concept of *phase bandwidth*. Certain relations between phase and amplitude bandwidths are shown necessary to avoid step and impulse transient response overshoot arising from excessive phase distortion. In particular, attention is confined to networks comprising identical sections in cascade. For most cases of practical interest, it is shown that, as the number of sections increases, cascaded networks have a transmission characteristic approaching that of three networks in cascade. The first network is distortionless and accounts for the pure delay in the system.

The other two networks, which account for the distortion in the system, are of two basic species: (1) all-pass networks with a monotonic phase distortion proportional to ω^n , and (2) zero-phase-shift networks with a monotonic attenuation proportional to ω^m .

Graphs are given of the impulse and step transient responses for such networks with monotonic phase and attenuation distortion. From these are obtained important design data such as the phase bandwidth, the overshoot in the transient responses, the narrowing in effective bandwidth obtained on cascading, etc. An important design parameter determining the transient behavior is the phase distortion at the frequency of amplitude cutoff.

These data reduce to numerical calculation the difficult problem of finding the transient performance of many networks. Examples of typical applications are given for lumped and distributed delay lines, for a stagger-tuned i.f. amplifier, and for uncompensated and series-peaked compensated video amplifiers.

MOTIVATION

THE RAISON D'ETRE of this paper is because of an anomalous result obtained in an experiment during the development of wide-band delay lines.¹ In this experiment a measurement was made of the output versus input steady-state a.c. voltage of a delay line. Fig. 1 shows the measured amplitude-response characteristic. The frequency where the amplitude re-

sponse is down 6 db is approximately the cutoff frequency f_c ; from Fig. 1, this is $f_c = 1.7$ Mc. According to Kupfmuller's rule (to be described below), if this line had a linear phase-response characteristic, then its transient response to a step signal (Heaviside unit function) would show a build-up time of $1/(2f_c) = 1/(2 \times 1.7) = 0.29$ microseconds.

The measured transient response of this line to a step

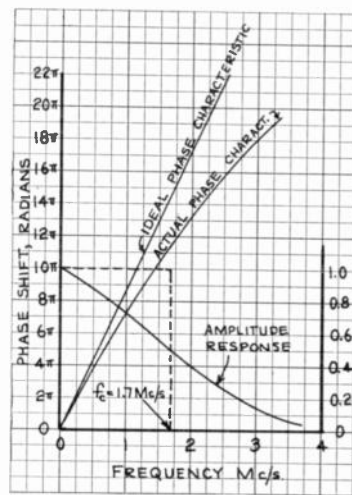

(a)

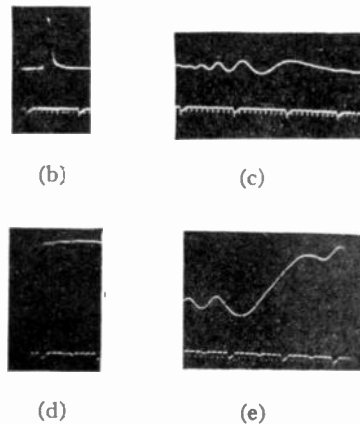

(b)

(c)

(d)

(e)

Fig. 1—Distributed-type delay line: amplitude and phase responses, impulse and step transient responses.

Note: In the transient responses the signals to the left are input signals, those to the right are output signals. The timing pips are spaces 1 and 0.1 microseconds.

* Decimal classification: R148.1×R143. Original manuscript received by the Institute, December 5, 1946; revised manuscript received, August 22, 1947. Presented, 1947 I.R.E. National Convention, March 4, 1947, New York, N. Y.

† Federal Telecommunication Laboratories, Nutley, N. J.

¹ M. J. Di Toro, "Phase-corrected delay lines," to be published in PROC. I.R.E.

signal shows a build-up time estimated to be 0.8 microsecond, rather than the calculated value of 0.29 microsecond. In turn, this means that the effective bandwidth or cutoff frequency of the line is $1/(2 \times 0.8) = 0.62$ Mc. Moreover, a considerable "precursor" ripple is ob-

served and is particularly prominent in the line's transient response to an impulse signal (the latter being the time derivative of the step signal). This ripple, which greatly interfered with the uses of this line, arises because of phase distortion.

In view of this effect of phase distortion of narrowing the effective bandwidth of a network or increasing its step build-up time, the concept of *phase bandwidth* or *phase build-up time* (in contradistinction to amplitude bandwidth and amplitude build-up time) is herein proposed and studied. It will be shown that, for example, even if the above line had an amplitude response ideally flat to infinity, its build-up time would not decrease appreciably.

The spurious ripples in this line may be reduced by decreasing the line's amplitude bandwidth; but this further increases the build-up time, which one should like to have small. Thus the practical question arises: How much desirable ripple reduction may be traded for how much undesirable increase in built-up time? These and other things will be investigated herein and practical design rules evolved.

In view of the mathematical difficulties present, and in order not to let the mathematics eclipse the practical aspect of the results, the text is presented in three parts. Part I gives a presentation of the problem and the solutions and design rules arrived at. Part II gives a number of examples showing the application of these design rules. Part III is a summary of the mathematical aspect of the problem, a complete description of which will appear elsewhere.²

PART I

1) Review of Previous Work

It has been known for quite some time that, for distortionless transmission in linear networks, flat amplitude and linear phase-frequency response characteristics are required.³ Inasmuch as all practical communication networks deviate from these ideal conditions, it is important to know, for design purposes, the corresponding effects on the transient response arising from these deviations.

When deviations from the ideal conditions are confined to the amplitude characteristic alone, i.e., when pure amplitude distortion accompanied by linear phase prevail, the transient response is known for certain important cases. One of the earliest cases investigated for this type of deviation is that given by Kupfmüller⁴ in 1924. He investigated the transient response of an ideal low-pass filter to a step wave. This filter ideally com-

prises an amplitude characteristic which is flat from zero up to a cutoff frequency, and zero beyond. The phase characteristic is assumed linear. The important conclusion reached by Kupfmüller is that the transient response of such a filter to a step wave has a *finite* build-up time equal to the reciprocal of twice the cutoff frequency. Extension of this idea to band-pass filters has been easily done, and the response of linear phase networks having other amplitude characteristics are given below and elsewhere.⁵

All of the above is simple and instructive. Unfortunately, communication networks in which the effects of phase distortion are less than those of amplitude distortion are the exception, rather than the rule. This is not commonly realized. The companion problem of analyzing flat-amplitude-characteristic (all-pass) networks with a phase which deviates from linearity leads to mathematical difficulties. Some of the difficulties were overcome by J. R. Carson⁶ in 1924 when he published the first important paper on pure phase distortion. The need for Carson's analysis arose in connection with the design of long loaded telephone circuits for voice frequencies.⁷⁻⁹ With the introduction of telephotography and television, and consequent emphasis on good transient response, it became recognized¹⁰⁻¹² that stringent phase requirements would have to be met, and circuits for accomplishing this were evolved.^{13,14}

Later, in 1939, another important step toward an appreciation of the effects of both amplitude and phase distortion was taken by H. A. Wheeler¹⁵ in introducing the method of "paired echoes." Simple criteria were made available which correlated small deviations in the phase and amplitude characteristics of networks with corresponding variations in their transient response. For large deviations, such as occur, for example, near the cutoff regions of low- and band-pass filters, the method holds but becomes unwieldy.

In circuits where wave-form preservation is essential, such as video amplifiers, delay lines, etc., the early work-

² M. J. Di Toro, "Frequency spectra of recurrent pulses," *Huzelite Electronics Corp. Rep.* No. 1520W, June 24, 1943.

³ J. R. Carson, "Building-up of sinusoidal currents in long periodically loaded lines," *Bell Sys. Tech. Jour.*, vol. 3, pp. 558-566; October, 1924.

⁴ C. E. Lane, "Phase distortion in telephone apparatus," *Bell Sys. Tech. Jour.*, vol. 9, pp. 493-521; July, 1930.

⁵ H. Nyquist and S. Brand, "Measurement of phase distortion," *Bell Sys. Tech. Jour.*, vol. 9, pp. 522-549; July, 1930.

⁶ J. C. Steinberg, "Effects of phase distortion on telephone quality," *Bell Sys. Tech. Jour.*, vol. 9, pp. 550-566; July, 1930.

⁷ "Symposium on television," *Bell Sys. Tech. Jour.*, vol. 6, pp. 551-652; October, 1927.

⁸ S. P. Mead, "Phase distortion and phase distortion correction," *Bell Sys. Tech. Jour.*, vol. 7, pp. 195-224; April, 1928.

⁹ R. V. L. Hartley, "Steady-state delay as related to aperiodic signals," *Bell Sys. Tech. Jour.*, vol. 20, pp. 222-234; April, 1941.

¹⁰ O. J. Zobel, "Distortion correction in electrical circuits with constant resistance recurrent networks," *Bell Sys. Tech. Jour.*, vol. 7, pp. 438-534; July, 1928.

¹¹ H. W. Bode and R. L. Dietzold, "Ideal wave filters," *Bell Sys. Tech. Jour.*, vol. 14, pp. 215-252; April, 1935.

¹² H. A. Wheeler, "The interpretation of amplitude and phase distortion in terms of paired echoes," *Proc. I.R.E.*, vol. 27, pp. 359-385; June, 1939.

² M. J. Di Toro, "Impulse response of dispersive networks," to be published in *Jour. Appl. Phys.*

³ J. R. Carson, "Electric Circuit Theory and the Operational Calculus," McGraw-Hill Book Co., New York, N. Y., 1926, first edition; p. 185.

⁴ E. A. Guillemin, "Communication Networks," Vol. II, John Wiley Sons, New York, N. Y., first edition; p. 477.

ers in this field,¹⁶⁻²⁰ with some exceptions,²¹ have concentrated on flattening the amplitude characteristic to the exclusion of phase considerations. The unsymmetrical transient responses obtained in these designs are clear evidence that phase distortions of a serious nature precluded these designs from having even faster response, or wider effective bandwidth.

Recently, the importance of linear phase, along with flat amplitude, is finally being realized.²²⁻²⁶ In fact, W. W. Hansen²⁷ has introduced the idea of "transient bandwidth" in arriving at an appraisal of the performance of circuits having both amplitude and phase distortion. Moreover, N. Marcuvitz²⁸ has evolved a design procedure which shows how to adjust the variable parameters in a network in order to approach with increasing accuracy the ideal design objective of both a flat amplitude and linear phase.

2) Statement of the Problem

The method of paired echoes finds its simplest application when used to calculate the transient response of networks in which the deviations or distortions in phase and amplitude characteristics are both small in amplitude and sinusoidal in shape. However, near the cutoff regions of such networks as filters, amplifiers, delay lines etc., the amplitude and phase characteristics may not only oscillate but, what is more important, may deviate entirely in one direction with an ever-increasing magnitude, i.e., deviate in a *monotonic* manner. What is needed are new analyses giving the transient responses for monotonic distortion of both amplitude and phase characteristics. For combined monotonic and oscillatory distortion, one could first find the transient response for the monotonic distortions alone, and then make a small

correction on this response using the small-paired-echo method, the latter being now easily used because of the small magnitude of the oscillatory part of the distortion.

It is proposed to investigate the transient response of networks whose attenuation and phase distortion increase monotonically according to some power of the frequency. In the examples to follow it is shown that monotonic behavior of this type closely approaches the distortion characteristics of a large number of recurrent cascaded networks such as video amplifiers, delay lines, lumped-loaded telephone lines, etc. The latter networks have transmission characteristics which may be replaced approximately, as shown in Fig. 2, by those of

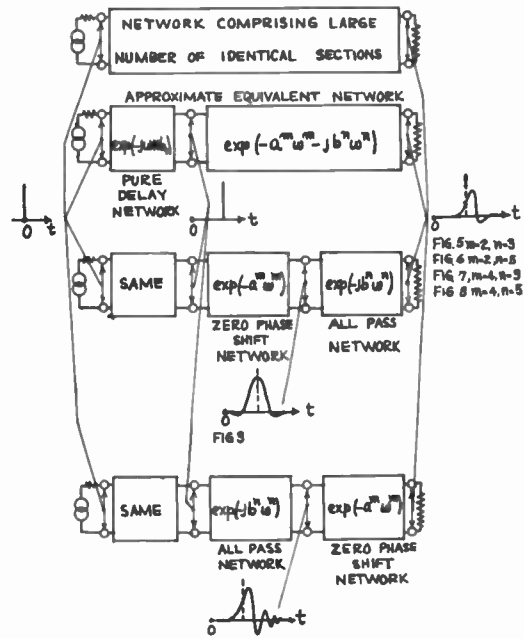

Fig. 2—Approximate resolution of networks into three cascaded sections comprising pure delay, pure attenuation distortion of $(a\omega)^m$ nepiers, and pure phase distortion of $(b\omega)^n$ radians.

three networks in cascade. The first network is distortionless and accounts for the pure delay in the system. The other two networks, which account for the distortion in the system, are of two basic species: (1) all-pass networks with a monotonic phase distortion proportional to ω^n , and (2) zero-phase-shift networks with a monotonic attenuation distortion proportional to ω^m . The transmission characteristic of the distortion replacement network is

$$Y_d(j\omega) = \exp(-a^m \omega^m - jb^n \omega^n), \tag{1}$$

from which it is seen that the attenuation distortion is $(a\omega)^m$ nepiers and the phase shift distortion is $(b\omega)^n$ radians. The transient response of $Y_d(j\omega)$ to a unit impulse²⁹ is

$$y(t) = \frac{1}{\pi} \int_0^\infty \exp(-a^m \omega^m) \cos(\omega t - b^n \omega^n) d\omega \tag{2}$$

while the response to a unit step is the time integral of this.

²⁹ G. A. Campbell and R. M. Foster, "Fourier integrals for practical applications," Bell Telephone System Monograph B-584, Pair 101.

¹⁶ V. D. Landon, "Cascade amplifiers with maximal flatness," *RCA Rev.*, vol. 5, pp. 347-362; January, 1941. See also *RCA Rev.*, vol. 5, pp. 481-497; April, 1941.

¹⁷ S. Butterworth, "On the theory of filter-amplifiers," *Exp. Wireless and Wireless Eng.*, vol. 7, pp. 536-541; October, 1930, London.

¹⁸ J. B. Trevor, "Artificial delay line design," *Electronics*, vol. 18, pp. 135-137; June, 1945.

¹⁹ H. Wallman, "Stagger tuned i.f. amplifiers," M.I.T. Rad. Lab. Rep. 524, February, 1944, (Presented, 1946 I.R.E. Winter Technical Meeting, New York, N. Y.).

²⁰ R. H. Baum, "Design of broad-band i.f. amplifier," Part I, *Jour. Appl. Phys.*, vol. 17, pp. 519-529; June, 1946. Part II, vol. 17, pp. 721-729; September, 1946.

²¹ G. W. Pierce, "Artificial electric lines with mutual inductance between adjacent series elements," *Proc. Amer. Acad. Arts and Sci.*, vol. 57, no. 8, May, 1922.

²² A. V. Bedford and G. L. Fredendall, "Transient response of multistage video frequency amplifiers," *Proc. I.R.E.*, vol. 27, pp. 277-284; April, 1939. See also "Analysis, synthesis and evaluation of the transient response of television apparatus," *Proc. I.R.E.*, vol. 30, pp. 440-457; October, 1942.

²³ H. E. Kallmann, R. E. Spencer, and C. P. Singer, "Transient response," *Proc. I.R.E.*, vol. 33, pp. 169-195; March, 1945.

²⁴ M. J. E. Golay, "The ideal low-pass filter in the form of a dispersionless lag line," *Proc. I.R.E.*, vol. 34, pp. 138P-144P; March, 1946.

²⁵ M. Levy, "The impulse response of electrical networks with special reference to the use of artificial lines in network design," *Elec. Commun.* (London), vol. 22, p. 40; 1944.

²⁶ H. E. Kallmann, "Equalized delay lines," *Proc. I.R.E.*, vol. 34, pp. 646-657; September, 1946.

²⁷ W. W. Hansen, "Transient response of wide-band amplifiers," *Proc. Nat. Elec. Conference*, vol. 1, pp. 544-553; October, 1944.

²⁸ N. Marcuvitz, "Distortionless Correction of Video Networks," M.E.E. Thesis, Polytechnic Institute of Brooklyn, June, 1941.

3) Uncompensated Video Amplifier

As an example of the foregoing, consider the simple case of N cascaded stages of an uncompensated video amplifier. It is assumed that the plate load resistance R of the amplifier is shunted by the tube and stray capacitance C , and fed with the constant current of a pentode tube. The normalized transfer characteristic for N stages is simply

$$T(j\omega) = \frac{1}{(1 + j\omega CR)^N} = \exp - \Gamma(j\omega) \quad (3)$$

where $\Gamma(j\omega)$ is the propagation factor. The latter is easily found by taking the natural logarithm of both sides of (3) and using the expansion $\ln(1+z) = z - (z^2/2) + (z^3/3) -$, etc., which is valid for $|z| < 1$. Hence, for $\omega CR < 1$,

$$\begin{aligned} \Gamma(j\omega) &= j\omega t_d + \Delta A + j\Delta B \\ t_d &= CRN = \text{ideal delay time} \\ \Delta A &= \text{attenuation distortion} \\ &= \omega^2(C^2R^2N/2) - \omega^4(C^4R^4N/4) + \text{etc.} \\ \Delta B &= \text{phase distortion} \\ &= -\omega^3(C^3R^3N/3) + \omega^5(C^5R^5N/5) - \text{etc.} \end{aligned} \quad (4)$$

Amplitude cutoff is at approximately where $\Delta A = 6$ db = 0.69 nepiers, which for N large occurs at the radian frequency ω_0 given by

$$(\omega_0 CR)^2 N/2 = 0.69, \quad \text{or} \quad (\omega_0 CR) = \sqrt{1.38/N}. \quad (5)$$

Using the dimensionless frequency ratio $x = (\omega/\omega_0)$, (3) becomes, because of (4),

$$\begin{aligned} \Delta A &= 0.69x^2 - 0.48(x^4/N) + \text{etc.} \\ \Delta B &= -0.54(x^3/\sqrt{N}) + 0.45(x^5/N\sqrt{N}) - \text{etc.} \end{aligned} \quad (6)$$

In this form it is obvious that, as the number of sections N increases, the attenuation and phase distortion, respectively, approach variation as the square and the cube of the frequency, in the manner indicated by (1) for $m=2$ and $n=3$.

4) General Networks in Cascade

The same procedure followed above may also be applied to more general cascaded networks comprising N cascades each of which has the transfer function $Y_1(p)$ while that of the whole is $Y(p) = Y_1(p)^N$. In general,²⁰

$$Y_1(p) = \frac{1 + g_1p + g_2p^2 + \dots + g_n p^n}{1 + h_1p + h_2p^2 + \dots + h_r p^r} \quad (7)$$

where the g 's and the h 's are all real. To find the propagation factor $\Gamma(p)$, one takes the logarithm of (6) and expands, obtaining, on replacing p by $j\omega$,

$$\begin{aligned} \Gamma(j\omega) &= j\omega t_d + \Delta A + j\Delta B \\ t_d &= N(h_1 - g_1) \\ \Delta A &= \omega^2 [(g_2 - h_2) - (1/2)(g_1^2 - h_1^2)]N + \omega^4 [\quad]N + \text{etc.} \quad (8) \\ \Delta B &= \omega^3 [(g_3 - h_3) - (g_1g_2 - h_1h_2) + (1/3)(g_1^3 - h_1^3)]N \\ &\quad + \omega^5 [\quad]N + \text{etc.} \end{aligned}$$

²⁰ H. W. Bode, "Network Analysis and Feedback Amplifier Design," D. Van Nostrand Co., N. Y., 1945, first edition; p. 25.

This expansion is valid and converges only for a radius of p within the first pole or zero of (7). The whole process herein described is limited to cases where only one term in ΔA is predominant and has a positive sign, and one term in ΔB is predominant. It has been found that a large number of important networks fall within this limitation, especially those stringent types wherein wave form is to be preserved and ripple and overshoot in the transient response are to be avoided.

An interesting observation from (8) is that no distortion, but only a delay, is present in a network when $\Delta A = \Delta B = 0$, or when

$$\begin{aligned} (g_2 - h_2) - (1/2)(g_1^2 - h_1^2) &= 0, \\ (g_3 - h_3) - (g_1g_2 - h_1h_2) + (1/3)(g_1^3 - h_1^3) &= 0, \text{ etc.} \end{aligned} \quad (9)$$

These conditions are similar to those obtained by Marcuvitz²⁸ by a somewhat different process. In practice, only a small number of the conditions (9) can be satisfied, due to the limited number of adjustable variables in the network. For example, for the R - C circuit of Section 3, no adjustment of R or C whatever will remove any of the distortion terms. However, for the series or shunt peaking-coil correction in video amplifiers³¹ one parameter is available (Section 11).

There are a number of reasons why a knowledge of the transient behavior of the monotonic-type network herein considered is important in its own right. For example, it will be shown later that a zero (or linear) phase-shift network whose attenuation is monotonic and of the form $(a\omega)^2$, so that $m=2$, is characterized by no overshoot whatever in its step and impulse transient response. For this reason it could be used as a design objective for stringent conditions wherein overshoot must be eliminated completely. Thus, instead of conditions (9) one would impose the condition in (8) that the factor of ω^2 of ΔA should be positive and finite, while the factors for ω^4 , ω^6 , etc. and ω^3 , ω^5 , etc. of ΔB be zero. Other design objectives are possible, and it is hoped to present these in a later paper.

A further reason for considering networks with monotonic attenuation behaving according to $(a\omega)^m$ is that the transient response may also be obtained of networks with very flat amplitude response characteristics. Thus, as m increases, the amplitude response becomes flatter and approaches the ideal rectangular shape when m is infinite. A flat amplitude response occurs because all of its derivatives (at zero frequency) with respect to frequency are zero up to and including the $(m-1)$ th derivative. The latter is also a property of monotonic stagger-tuned amplifiers,^{16,17,19,20} and is the reason why only a small decrease of amplitude bandwidth occurs when such networks are cascaded.

The general problem of the change in transient response to be expected when identical networks are cascaded is an important one. Networks with either monotonic attenuation or phase distortion preserve their wave form when cascaded singly.²³ When both forms of

³¹ F. E. Terman, "Radio Engineer's Handbook," McGraw-Hill Book Co., 1943, first edition; p. 418.

distortion are present simultaneously, the wave form is preserved only if $m = n$, as shown in Section 8. The monotonic form of response yields readily an answer to the problem of cascading, and is another reason for its importance.

The values of parameters a, b, m , and n in (1) may be determined analytically in simple networks by (8). For most cases, however, they are determined more directly from a measured or computed plot on log-log co-ordinate paper of the attenuation-versus-frequency and phase-versus-frequency characteristics. Suitable practical examples of both these procedures will be given later in Part II.

Except for special values of m and n , no solution of (2) exists in mathematically closed form (i.e., in terms of known and presumably tabulated functions). In view of this, solutions are found at first with the parameters a and b separately zero. This gives the impulse responses of all-pass and zero-phase-shift networks alone. When these two responses are combined, via the Superposition Theorem³² the impulse response (2) of the two species of networks in cascade is obtained.

A glance at the formulas of Part III indicates that, because of their complicated nature, the phenomena being dealt with are also complicated and cannot be reduced to simple terms. To get results of engineering design value, it is necessary to calculate a sufficient number of curves so that their nature may be studied and workable design criteria created. A considerable amount of computational effort has thus been directed at obtaining a series of transient-response plots, a description of which will now be given.

5) Pure Attenuation Distortion ($b = 0$)

When $b = 0$ in (1), attention is confined to zero-phase-shift networks whose attenuation distortion is $\Delta A = (a^m \omega^m)$ nepiers. Fig. 3 shows the impulse and step

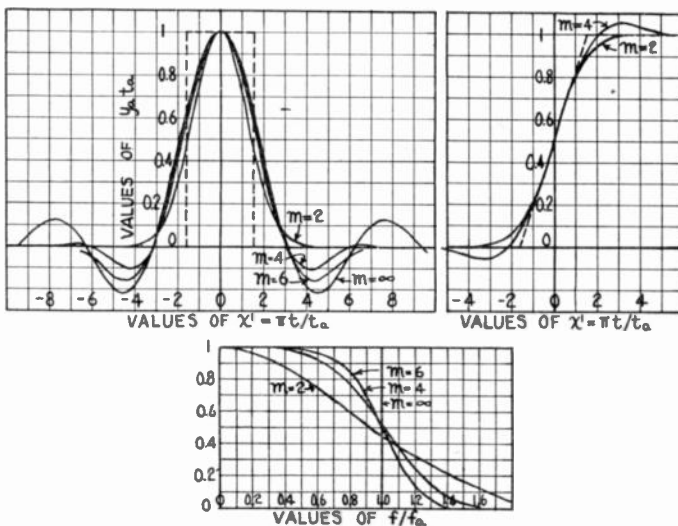

Fig. 3—Impulse and step transient responses, and amplitude-response characteristics of zero-phase-shift networks whose attenuation is $(a\omega)^m$ nepiers.

³² See pair 202 of footnote reference 29.

transient responses for this condition, together with the a.c. steady-state amplitude-response characteristics. All of the curves shown are of universal application, because dimensionless numbers are used for the ordinates and abscissas.

Both the build-up time t_a and the frequency of amplitude cutoff f_a may be uniquely defined in zero- (or linear) phase-shift networks by virtue of the following simple property of the Fourier integral³³

$$y_a(0) = \int_{-\infty}^{\infty} Y(f)df, \quad \text{and} \quad (10)$$

$$Y(0) = \int_{-\infty}^{\infty} y_a(t)dt. \quad (11)$$

Here $y_a(t)$ is the impulse response, and Y is the transfer-admittance function. If by f_a , the cutoff frequency, one implies the frequency width of a rectangle whose height is $Y(0)$, then the area under the amplitude-response characteristic for positive and negative frequencies is $2Y(0)f_a$. But this area is just that of the integral (10); hence, $y_a(0) = y_{a \max} = 2Y(0)f_a$. If $Y(0) = 1$, as in the curves of Fig. 3, then $y_{a \max} = 2f_a$. Also, since $Y(0) = 1$, the area under y_a curve is normalized to unity, as seen by (11).

Now $y_{a \max}$ is the maximum slope of the step response. If the latter would build up at the rate $y_{a \max}$, the time it would take to rise from 0 to 1, the build-up time is $1/y_{a \max}$. Hence, the relationship

$$t_a = 1/2f_a \quad (12)$$

follows. It also follows that t_a is the width of a rectangular impulse whose height is $y_{a \max}$. This rectangle is shown in Fig. 3 as the broken-line impulse-response curve.

The steady-state a.c. amplitude response of the network being considered is $\exp(-a^m \omega^m)$. The parameter (a) is related to the cutoff frequency f_a by

$$f_a = \frac{\Gamma\left(1 + \frac{1}{m}\right)}{2\pi a}. \quad (13)$$

This readily follows from (10) and the Gamma function integral³⁴ defined in Part III.

It is noted that the impulse responses are even functions of time. This is characteristic and is, in fact, an important experimental test for the absence of phase distortion.

6) Pure Phase Distortion ($a = 0$)

An all-pass network having a phase shift (or distortion) of $\Delta B = (b\omega)^n$ responds to an impulse and a step in the manner shown by the curves of Fig. 4. These curves are plotted in universal parameters and were computed from the formulas given in Part III.

³³ See pair 101 of footnote reference 29.

³⁴ For a table of the Gamma Function, see H. B. Dwight, "Table of Integrals and Other Mathematical Data," Macmillan Co., New York, N. Y., 1934; p. 193.

The most outstanding characteristic of these transient responses is that the build-up time for the step responses is finite, even though the bandwidth of the steady-state amplitude-response characteristic is infinite (i.e., the networks are of the all-pass type). Hence the relationship (12) found in the case of zero- (or linear) phase-shift networks is no longer true; the build-up time in networks having phase distortion is not the reciprocal of twice the amplitude cutoff frequency.

A finite build-up time in a network puts a definite upper limit on the speed with which it is capable of transmitting information, independent of whether the finite build-up time is due to limitations of phase distortion or amplitude cutoff.

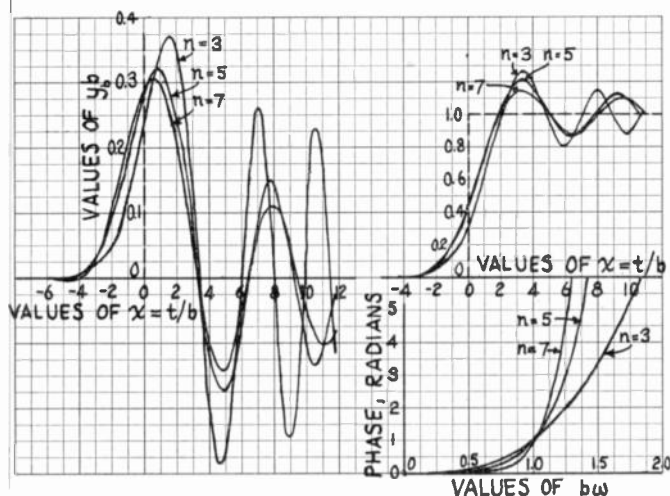

Fig. 4—Impulse and step transient responses, and phase-response characteristics of all-pass networks whose phase distortion is $\Delta B = (bw)^n$ radians.

One is thus led to the concept that the finite build-up time shown by the curves of Fig. 4 may be conveniently considered as due to a finite phase bandwidth. It appears that the most useful definition of phase bandwidth (or frequency of phase cutoff) f_b is that defined by the equation $f_b = 1/2t_b$, in analogy with (12). The intention is to define t_b in the same way as for t_a in zero phase shift networks. Thus, since the area under the impulse response $y_b(t)$ is unity, and if $y_{b \text{ max}}$ is the maximum value of the first peak of y_b , then the width of an equivalent rectangular pulse of unit area and height $y_{b \text{ max}}$ is by definition equal to the build-up time t_b . Likewise, t_b is the time required for the step responses to reach the unity value, provided one assumes that they build up at their maximum rate of $y_{b \text{ max}}$. In dimensionless form, the build-up time is $x_b = t/b = 1/by_{b \text{ max}}$. The curves of Fig. 4 show that x_b is a function of the parameter n appearing in the phase distortion formula $\Delta B = (bw)^n$.

It has been found that an important parameter is the phase distortion ΔB_b at the frequency f_b of phase cutoff. It is given by

$$\Delta B_b = (2\pi b f_b)^n = (b\pi/t_b)^n, \tag{14}$$

and may be determined directly from Table I.

As an example of the application of the data of Table I, consider the usual lossless low-pass filter or artificial line comprising series inductance and shunt capacitances.^{35,36} It is easily shown that the predominant distortion in such a system is, for a large number of sec-

TABLE I

n	(by _b max)	ΔB_b		Value of x at by _b max
		Degrees	Radians	
2	0.5210	153.5	2.679	1.848
3	0.3714	91.02	1.589	1.466
5	0.3220	60.68	1.059	0.950
7	0.3130	50.95	0.8892	0.675

tions, a phase distortion varying as the cube of the frequency. Table I shows that phase bandwidth in such a system (where $n = 3$) extends to the frequency where the phase distortion is 1.59 radians. The higher-frequency components of the step response having phase distortion much greater than this value do not contribute to a faster build-up. In fact, they rather produce the undesirable overshoot and "ringing" characteristic of systems with phase distortion.

The impulse responses shown in Fig. 4 indicate that, for positive values of b , the higher frequencies arrive later than the lower ones. It is proved in Part III that the time at which the impulse response y_b has an instantaneous frequency f_i is exactly the group or envelope

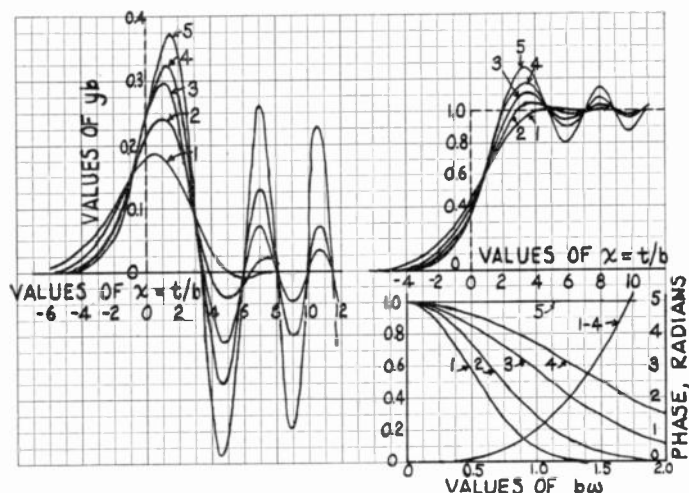

Fig. 5—Impulse and step transient responses, phase- and amplitude-response characteristics of combined networks whose phase distortion is $(bw)^3$ radians, and attenuation distortion is $(a\omega)^2$ nepers.

Note: The curves numbered 1 to 5 are for values of the phase distortion at amplitude cutoff of $\Delta B_a = 0.215, 0.511, 1.73, 4.08,$ and infinity.

time delay³⁷ to be expected of a small bundle of waves or wave packet of bandwidth (df) and center frequency f_i . This group delay is given by the formula:

³⁵ E. Weber and M. J. Di Toro, "Transient in the finite artificial line," *Elec. Eng.*, vol. 54, p. 661; June, 1935.

³⁶ See page 125 of footnote reference 3.

³⁷ See page 227 of footnote reference 12.

$$d(\Delta B)/d\omega = \frac{d}{d\omega} (b\omega)^n = \omega^{n-1}nb^n.$$

7) Combined Phase and Attenuation Distortion

Consider now a cascade of the two network types considered in sections 5 and 6. This combined network has a phase distortion of $\Delta B = (b\omega)^n$ radians and an attenuation distortion of $\Delta A = (a\omega)^m$ nepiers. Its steady-state transfer characteristic is $\exp(-a^m\omega^m - jb^n\omega^n)$, and its response to an impulse is given by (2). As shown in Part III, solutions of (2) are obtained by combining the responses of Figs. 3 and 4 by means of the superposition theorem.

The important values herein considered for m and n are $m=2, 3$ and $n=3, 5$; Figs. 5 and 6 show the responses for $m=2$ and $n=3, 5$; Figs. 7 and 8 are for $m=4$ and $n=3, 5$.

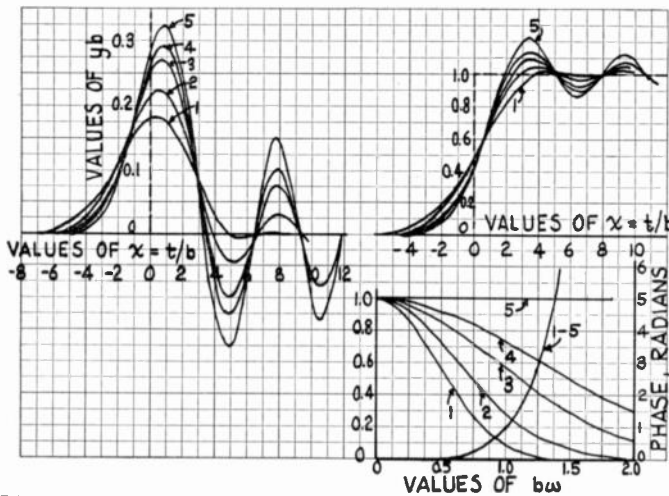

Fig. 6—Impulse and step transient responses, phase- and amplitude-response characteristics of combined networks whose phase distortion is $(b\omega)^5$ radians, and attenuation distortion is $(a\omega)^2$ nepiers.

Note: The curves numbered 1 to 5 are for values of the phase distortion at amplitude cutoff of $\Delta B_a = 0.078, 0.326, 2.49, 10.5$, and infinity.

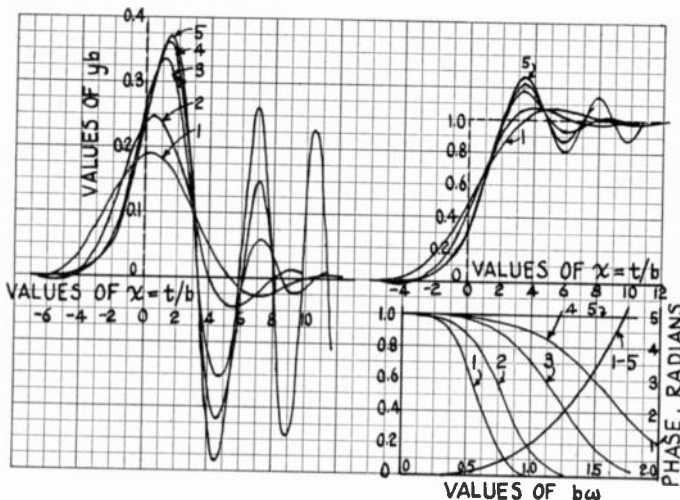

Fig. 7—Impulse and step transient responses, phase- and amplitude response characteristics of combined networks whose phase distortion is $(b\omega)^3$ radians, and attenuation distortion is $(a\omega)^4$ nepiers.

Note: The curves numbered 1 to 5 are for values of the phase distortion at amplitude cutoff of $\Delta B_a = 0.215, 0.511, 1.73, 4.08$, and infinity.

The most important conclusion evident from the responses of Figs. 5 to 8 is that the undesirable ripple and overshoot in the transient response caused by excessive phase distortion can be overcome by a suitable decrease of the amplitude bandwidth.

A parameter of practical value used in the family of responses of Figs. 5 to 8 is ΔB_a , the phase distortion at amplitude cutoff. Using (13), this parameter is

$$\Delta B_a = (b\omega_a)^n = \left[\frac{\Gamma\left(1 + \frac{1}{m}\right)}{(a/b)} \right]^n = (x'/x)^n \quad (15)$$

where $x' = \pi t/t_a =$ abscissa of Fig. 3 and $x = t/b =$ abscissa of Fig. 4. Table II shows the ranges of parameters covered by the family of responses.

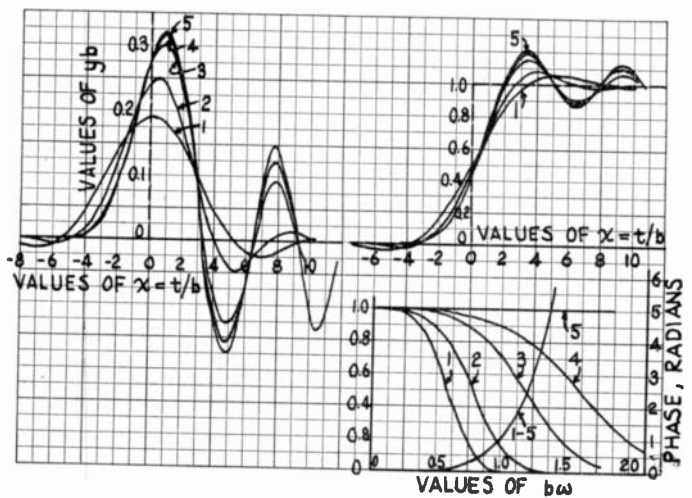

Fig. 8—Impulse and step transient responses, phase- and amplitude-response characteristics of combined networks whose phase distortion is $(b\omega)^5$ radians, and attenuation distortion is $(a\omega)^4$ nepiers.

Note: The curves numbered 1 to 5 are for values of the phase distortion at amplitude cutoff of $\Delta B_a = 0.078, 0.326, 2.49, 10.5$, and infinity.

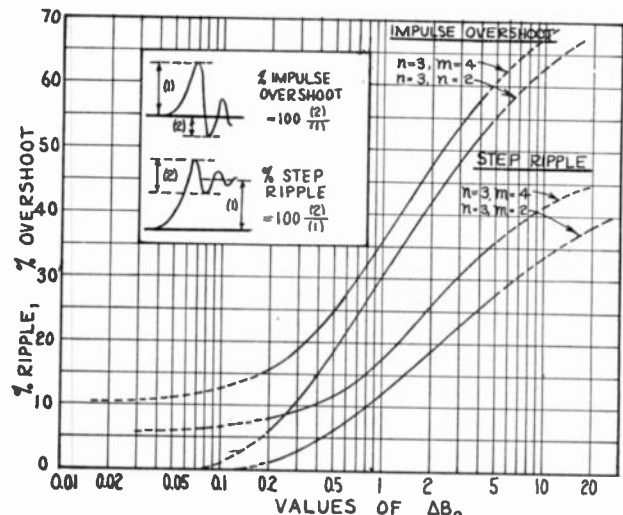

Fig. 9—Impulse overshoot and step peak-to-peak ripple versus the phase distortion at amplitude cutoff ΔB_a , for values of $n=3$, and $m=2, 4$.

TABLE II

Values of $b\omega_a = (x'/x)$	Values of ΔB_a		Values of $c = (a/b)$	
	$n=3$	$n=5$	$m=2$	$m=4$
0.6	0.215	0.078	1.48	1.51
0.8	0.511	0.326	1.11	1.133
1.2	1.73	2.49	0.738	0.755
1.6	4.08	10.5	0.554	0.566

In the practical use of the data given by the family of curves, not all of the details therein shown are necessary at any one time. Interest is confined usually to two things: (1) the over-all build-up time, and (2) the amount of overshoot and ripple. These are considered in the curves of Figs. 9, 10, and 11. It appears as an empirical result of Fig. 11 that the ratio of total effective bandwidth to phase bandwidth is, for a given value of (f_b/f_a) , independent of the value of n but varies only with m .

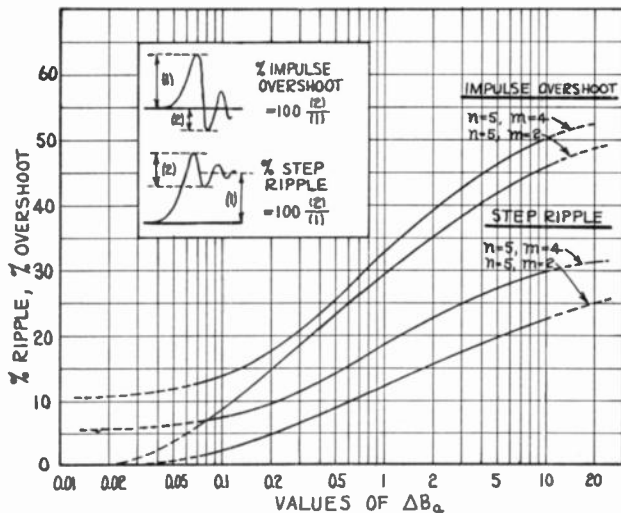

Fig. 10—Impulse overshoot and step peak-to-peak ripple versus the phase distortion at amplitude cutoff ΔB_a , for values of $n=5$, and $m=2, 4$.

8) Cascaded Networks with Like-Degree Distortion

Suppose two networks having transfer admittances of $\exp(-a_1^m \omega^m - j b_1^n \omega^n)$ and $\exp(-a_2^m \omega^m - j b_2^n \omega^n)$ were placed in cascade. The resultant transfer admittance is $\exp(-a^m \omega^m - j b^n \omega^n)$, where $a^m = a_1^m + a_2^m$, and $b_1^n + b_2^n = b^n$.

The new amplitude and phase bandwidths of the combination is, from (13),

$$f_a = \frac{f_{a_1}}{\left[1 + \left(\frac{a_2}{a_1}\right)^m\right]^{1/m}}$$

$$f_b = \frac{f_{b_1}}{\left[1 + \left(\frac{b_2}{b_1}\right)^n\right]^{1/n}} \tag{16}$$

where f_{a_1} and f_{b_1} are the amplitude and phase bandwidths of the first circuit. The over-all value of ΔB_a is

$$\Delta B_a = (b\omega_a)^n = \Delta B_{a_1} \frac{1 + \left(\frac{b_2}{b_1}\right)^n}{\left[1 + \left(\frac{a_2}{a_1}\right)^m\right]^{n/m}} \tag{17}$$

When the two networks are alike, then $b_1 = b_2$, $a_1 = a_2$, and (17) gives

$$\frac{\Delta B_a}{\Delta B_{a_1}} = 2^{(m-n)/m} \tag{18}$$

This shows the important fact that, when two like networks are placed in cascade, the ripple gets larger if

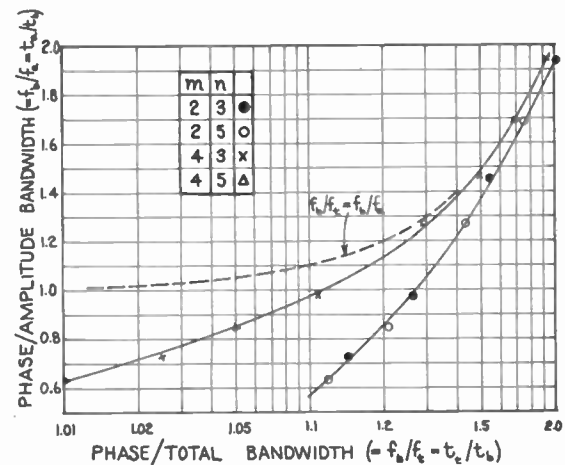
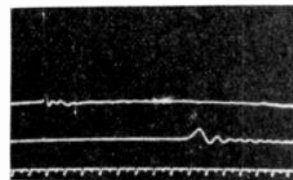
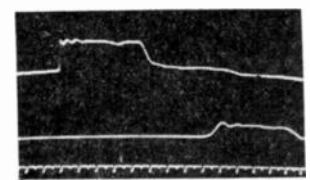

Fig. 11—Phase/total bandwidth versus phase/amplitude bandwidth for values of $m=2, 4$, and $n=3, 5$.



(b)



(c)

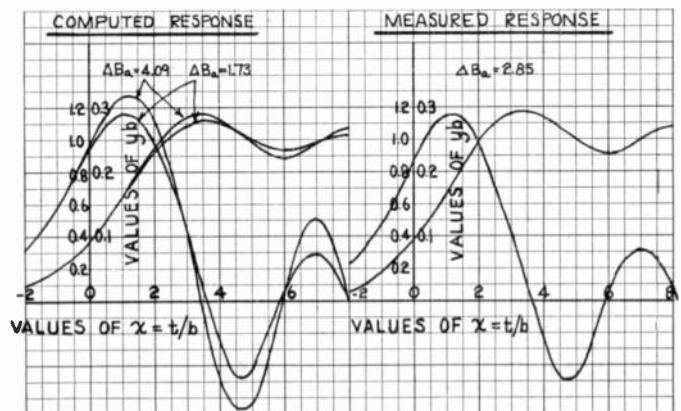

(a)

Fig. 12—Lumped-type delay line: computed and measured impulse and step transient responses.

Note: In the vertical order appearing, the oscillograms are the input signal, the delayed output signal, and 1- and 0.5-microsecond timing pips.

m is greater than n , (since, from Figs. 9 and 10, the ripple increases with increase of ΔB_a); the ripple does not change if $m=n$; and finally, the ripple gets smaller if m is smaller than n .

PART II

9) Delay Line with Lumped Parameters

As a first example showing the application of the foregoing, consider the prediction of the transient behavior of a delay line¹ of a low-pass-filter type comprising fifty-two coils. The measured transient responses are shown in Fig. 12, and the steady-state phase and amplitude responses are given in Fig. 13.

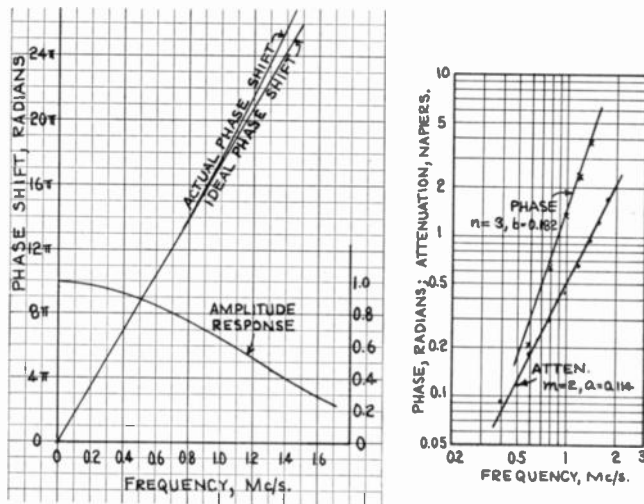

Fig. 13—Lumped-type delay line: measured amplitude- and phase-response characteristics, replotted attenuation, and phase distortion.

At first, it is necessary to determine and plot on log-log co-ordinate paper the curves for ΔA and ΔB , which are the attenuation distortion and the phase distortion (or difference between actual phase shift and the ideal extrapolated phase shift for low frequencies). Straight lines in the log-log graph of Fig. 13 imply that the attenuation and phase are monotonic of the form $a^m \omega^m$ and $b^n \omega^n$. Evidently the distortion present is of the type for which $m=2$ and $n=3$. The other parameters are $a=0.114$ microseconds and $b=0.182$ microseconds. From (15), the phase distortion at amplitude cutoff is

$$\begin{aligned} \Delta B_a &= \left[\Gamma \left(1 + \frac{1}{m} \right) \right]^n / (a/b)^n \\ &= (0.8862)^3 / (0.114/0.182)^3 \\ &= 2.85 \text{ radians.}^{34,38} \end{aligned}$$

Referring to Fig. 9, one finds for $\Delta B_a = 2.85$, and $m=2$, a value of 47 per cent for the impulse-response overshoot, and 22 per cent for the step-response peak-to-peak ripple. The corresponding values noted from an enlarged print of Fig. 12 are 42 and 25 per cent.

³⁸ E. Jahnke and F. Emde, "Tables of Functions," G. E. Stechert & Co., New York, N. Y., 1938; p. 9.

It should be observed that these overshoot and ripple data follow immediately without the necessity of finding the actual transient response. If the latter is desired, however, the family of curves of Fig. 5 for which $m=2$ and $n=3$ may be consulted. There it is found that a curve is computed for $\Delta B_a = 1.73$ radians, and for 4.09 radians. Both of these are curves reproduced in Fig. 12. The required curve for $\Delta B_a = 2.85$ is easily sketched in. A trace of a photographically enlarged image of the oscillogram is also shown in Fig. 12, and compares well with the computed response.

10) Stagger-Tuned Amplifier

As an example of a network comprising a cascade of dissimilar, rather than identical sections, consider the stagger-tuned amplifier.^{16,17} Kallmann, Spencer and Singer,²³ and recently Wallman¹⁹ and Baum²⁰ have published the steady-state frequency-response characteristics for this amplifier. The design objective is to get as flat an amplitude characteristic as possible without, however, regard to the phase characteristic.

For a cascade of seven stagger-tuned stages, the steady-state amplitude and phase characteristics are shown in Kallmann's Figs. 30 and 31. From these may be computed, as in Section 9, the attenuation and phase-distortion curves shown in Fig. 14.

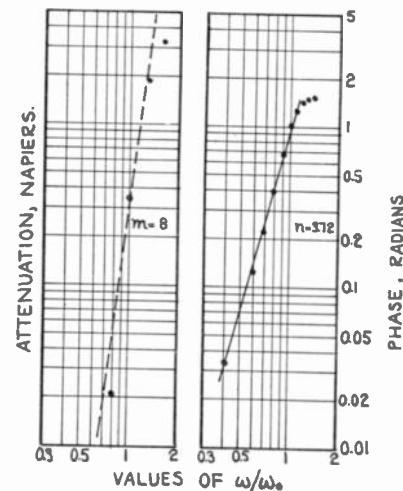

Fig. 14—Attenuation and phase distortion for a seven-stage stagger-tuned i.f. amplifier.

The interesting observation is made that the phase distortion is monotonic, with $n=3.72$, while the attenuation distortion is monotonic but with mixed exponents which are not limited to a single value of m . This is because the network comprises cascaded sections of unequal, rather than equal, characteristics. However, near amplitude cutoff, occurring at about 0.7 napiers attenuation, Fig. 14 indicates that the attenuation may be taken approximately as $[(a\omega_0)(\omega/\omega_0)]^8$ where $a_0=0.87$, and $m=8$. The phase distortion is $\Delta B = [(b\omega_0)(\omega/\omega_0)]^{3.72}$ where $(b\omega_0) = 0.98$. Hence, $a/b = (a\omega_0)/(b\omega_0) = 0.888$, and

so

$$\Delta B_a = \left[\Gamma \left(1 + \frac{1}{m} \right) \right]^n / (a/b)^n$$

$$= (0.94/0.888)^{3.72} = 1.24.$$

Reference to Figs. 9 and 10 shows that, for values of $\Delta B_a = 1.24$, the step ripple is: For $m = 4, n = 3$, step ripple = 20 per cent; for $m = 4, n = 5$, step ripple = 20 per cent. The actual ripple from Fig. 33 of Kallmann's paper is 22 per cent.

The amplitude bandwidth is

$$f_a = \left[\Gamma \left(1 + \frac{1}{m} \right) \right] / 2\pi a,$$

so that

$$\left[\Gamma \left(1 + \frac{1}{m} \right) \right] / (a\omega_0) = 0.94/0.87 = 1.082.$$

To obtain the phase bandwidth, interpolation in Table I gives, for $n = 3.72, \Delta B_b = 1.3$ radians $= (\omega b_0)^{3.72} = (\omega_b/\omega_0)^{3.72} (b\omega_0)^{3.72} = [0.98(\omega_b/\omega_0)]^{3.72}$, so $\omega_b/\omega_0 = 1.096$. Hence, the ratio of phase to amplitude bandwidth is $1.096/1.082 = 1.01$. From Fig. 11, the value of phase to total effective bandwidth is estimated to be 1.1; hence $\omega_0/\omega_b = 1.096/1.1 = 0.998$. The total build-up time is $t_t = 1/2f_t$ or $\omega_0 t_t = \pi(\omega_0/\omega_t) = \pi \times 0.998 = 3.13$. Kallmann's Fig. 33 shows a build-up time of 3.08. In the absence of phase distortion, the build-up time is smaller and is calculated to be $t_a = 1/2f_a$, or $\omega_0 t_a = \pi\omega_0/\omega_a = \pi/1.082 = 2.90$.

11) Cascaded Series-Peaking-Coil Network

As a final example, consider a check on some of the design data given in Part I by their application to one of the rare networks whose transient response can be obtained exactly and in mathematically closed form. The circuit of Fig. 15 is the series-peaking-coil type of compensation used in video amplifiers.³¹ The transfer function for N cascaded decoupled stages is

$$Y(q) = 1/(1 + qd + q^2)^N, \tag{19}$$

where

$$q = p\sqrt{LC}, \quad d = \omega_0 CR, \quad \omega_0 = 1/\sqrt{LC}.$$

Applying (7) and (8),

$$\Gamma(j\omega) = j\omega t_d + \Delta A + j\Delta B$$

$$t_d = Nd\sqrt{LC}$$

$$\Delta A = \omega^2 \left[\frac{d^2}{2} - 1 \right] LCN$$

$$- \omega^4 \left(\frac{1}{2} - d^2 + \frac{d^4}{4} \right) (LC)^2 N + \text{etc.} \tag{20}$$

$$\Delta B = \omega^3 \left(d - \frac{d^3}{3} \right) (LC)^{3/2} N$$

$$- \omega^5 \left(d - d^3 + \frac{d^5}{5} \right) (LC)^{5/2} N + \text{etc.}$$

Some control on the extent and type of the distortion is available by manipulations with the adjustable parameter d of the circuit (d being the reciprocal of the circuit Q at resonant frequency).

For example, when $d = \sqrt{2}$, the factor of ω^2 for ΔA becomes zero and the significant distortion terms, when N is large, are: (1) an attenuation distortion of the type $a^4\omega^4$ where $a = (N/2)^{1/4}/\omega_0$, and (2) a phase distortion of the type $b^2\omega^3$ where $b = (N\sqrt{2}/3)^{1/2}/\omega_0$.

The phase distortion at amplitude cutoff is

$$\Delta B_a = \left(\frac{\Gamma(1.25)}{(a/b)} \right)^3 = 0.59N^{1/4}. \tag{21}$$

The step-response ripple and impulse-response overshoot, the build-up time, and the response wave form may be obtained, respectively, from Figs. 9, 11, and 7. Inasmuch as the impulse overshoot and step ripple increase as ΔB_a increases, (21) shows that the ripple gets worse as N increases.

To fix ideas, consider $N = 100$, and in consequence $\Delta B_a = 1.86$. To obtain the transient response, one ob-

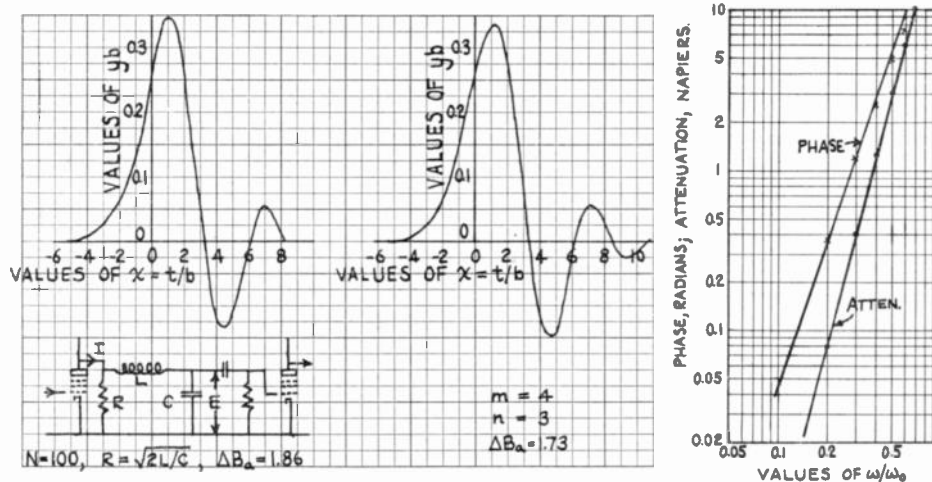

Fig. 15—Series-peaked video amplifier, 100 stages: exact and approximate calculated impulse transient response, attenuation, and phase distortion.

serves that the nearest response shown in Fig. 7 having a value of ΔB_a near 1.86 is that for $\Delta B_a = 1.73$, a plot of which is shown in Fig. 15. The exact phase and attenuation distortion for one hundred cascaded stages as computed from (19), rather than from (20), are shown in Fig. 15 by the crosses and dots. One observes that, as predicted by (20) the phase and attenuation distortion actually vary as the 3rd and 4th power of frequency for the important regions of the spectrum. The exact impulse response of N cascaded stages of this network for any value of d , is³⁹

$$y = \frac{\omega_0 \sqrt{\pi}}{(N-1)!} \left[\frac{x'}{2 \sqrt{1 - \frac{d^2}{4}}} \right]^{N-1/2} (\exp - x'd/2) J_{N-1/2} \left(x' \sqrt{1 - \frac{d^2}{4}} \right) \quad (22)$$

where $x' = \omega_0 t = t \sqrt{LC}$, and J is the Bessel Function of the first kind.

In this form the solution is exact, but difficult to compute when N is large. For the latter condition, a more satisfactory form, whose derivation however will not be shown, is

$$y = \frac{\omega_0}{\sqrt{2}} \left(1 + \frac{1}{24N} + \dots \right) \left(d \sqrt{1 - \frac{d^2}{4}} \right)^{-N+1/2} \cdot (\exp y'') J_{N-1/2} \left[\left(x'' + N - \frac{1}{2} \right) \sqrt{\frac{4}{d^2} - 1} \right] \quad (23)$$

where

$$x'' = \frac{x'd}{2} - (N - \frac{1}{2}),$$

$$y'' = -\frac{1}{2}(N - \frac{1}{2})M^2 \left[1 - \frac{2}{3}M + \frac{1}{2}M^2 - \frac{2}{3}M^4 + \dots \right],$$

and

$$M = x''/(N - \frac{1}{2}).$$

The impulse response for one hundred cascaded stages was computed by (23) and is shown in Fig. 15. The agreement of the two responses of Fig. 15 is interesting, especially in view of the two distinctly different ways in which they were calculated.

PART III

12) Summary of Mathematics of the Problem

No general solution of (2) exists in terms of such functions as Bessel functions, the Hypergeometric series,⁴⁰ etc. The fact is especially evident when it is noted that the differential equation satisfied by (2) is

$$\frac{mc^m}{(\pm j)^{m-1}} \frac{d^{m-1}Y_1}{dx^{m-1}} \pm \frac{jn}{(\pm j)^{n-1}} \frac{d^{n-1}Y_1}{dx^{n-1}} \mp jxY_1 = \frac{1}{\pi} \quad (24)$$

where $c = a/b$, $x = t/b$, $y = (1/b) \times$ (Real part of Y_1).

³⁹ See pairs 205, 570.1, of footnote reference 29.s

⁴⁰ E. T. Whittaker and G. N. Watson, "A Course of Modern Analysis," Macmillan Co., New York, N. Y., 1944.

Except for special important cases, the better way to solve (2) is first to obtain solutions for a and b separately zero, which are the impulse responses for the case of pure phase and pure attenuation distortion, respectively. These two time solutions are then combined by means of the superposition theorem. Numerical integration of the result, using Simpson's rule,⁴¹ then yields the impulse responses when both phase and attenuation distortion appear simultaneously.

13) Pure Phase Distortion ($a = 0$)

The response to an impulse of an all-pass network having a phase distortion of $\Delta B = (b\omega)^n$ radians is, from (2), for $a = 0$,

$$y_b = \frac{1}{\pi} \int_0^\infty \cos(\omega t - b^n \omega^n) d\omega. \quad (25)$$

A useful series solution for the computation of (25) is obtained by a generalization of the contour integration method used by Stokes⁴² and Watson.⁴³ This solution, valid for all x , is

$$y_b = \frac{1}{\pi n b} \sum_{s=0}^{\infty} \frac{(-x)^s}{s!} \Gamma\left(\frac{s+1}{n}\right) \cos \frac{\pi}{2n} [1+s(1+n)] \quad (26)$$

where Γ is the Gamma function, and $x = t/b$.

As true of most series, (26) does not give a physical picture of the oscillatory character of the response. A very useful solution of (25) which does give such a physical picture is obtained by the use of Kelvin's "Principle of Stationary Phase."⁴⁴ The solution, valid only for values of x greater than n , is

$$y_b = \frac{1}{b} \sqrt{\frac{2}{\pi(n-1)n}} (n/x)^{(n-2)/2(n-1)} \cdot \cos \left[(n-1)(x/n)^{n/(n-1)} - \frac{\pi}{4} \right] \quad (27)$$

where $x = t/b$.

On inspection this shows that the instantaneous frequency of the response increases with time, and the amplitude of the response, for n greater than 2, decreases with time. The instantaneous frequency ω_i is the time derivative of the angle of the cosine term: namely, $\omega_i = (t/nb^n)^{1/(n-1)}$. Solving this for t_i , the time when the impulse has a frequency ω_i , one obtains

$$t_i = \omega_i^{n-1} n b^n. \quad (28)$$

As shown in Section 6 of Part I, t_i is the time of arrival or group delay of a small bundle of waves (or wave packet) of center frequency $\omega_i/2\pi$ and width $d(\omega_i/2\pi)$.

⁴¹ F. S. Woods, "Advanced Calculus," Ginn & Co., New York, N. Y., 1926, first edition; p. 139.

⁴² G. G. Stokes, "On the numerical calculation of a class of definite integrals and infinite series," *Trans. Camb. Phil. Soc.*, vol. 9, pp. 166-187; 1856.

⁴³ G. N. Watson, "A Treatise on the Theory of Bessel Functions," Macmillan Co., New York, N. Y., second edition, 1944.

⁴⁴ Lord Kelvin (Sir W. Thomson), "On the waves produced by a single impulse in water at any depth, or in a dispersive medium," *Phil. Mag.*, 5th series, p. 252; 1887.

This group delay is given by the derivative at ω_i of the phase shift with frequency, i.e.,

$$c'(\Delta B)/d\omega = \frac{d}{d\omega} (b\omega)^n = \omega_i^{n-1} n b^n.$$

Solutions of (25) in closed form (i.e., in terms of known and presumably tabulated functions) have been found only for the special cases of $n=2$ and 3 .

For $n=2$, the solution is

$$y_b = \frac{1}{2b\sqrt{2\pi}} [(1+C) \cos(x^2/4) + (1+S) \sin(x^2/4)], \quad (29)$$

where C and S are the Fresnel Integrals^{45,46} to the argument $x/\sqrt{2\pi}$.

And for $n=3$, (25) reduces to Airy's integral,⁴⁷ whose solution reduces⁴⁸ to

$$y_b = \frac{\sqrt{x/3}}{3b} [J_{-1/3} + J_{1/3}], \text{ for } x \geq 0, \text{ and} \\ = \frac{\sqrt{|x|}}{3\pi b} K_{1/3}, \text{ for } x \leq 0, \quad (30)$$

where $J_{\pm 1/3}$ is the Bessel function of the first kind, and $K_{1/3}$ is the modified Bessel function of the second kind; the argument of these Bessel functions is $2(|x|/3)^{3/2}$. The use of Airy's tabulation of (30) for $|x|$ small, together with (27) for $n=3$ is, however, the easiest way to obtain a plot of the curve for this case.

14) Pure Attenuation Distortion ($b=0$)

If the steady-state amplitude-response characteristic of a zero-phase-shift network is $\exp(-a^m \omega^m)$, i.e., if the attenuation is $(a\omega)^m$ nepiers, the response of this network to an impulse is, from (2), for $b=0$,

$$y_a = \frac{1}{\pi} \int_0^\infty (\exp - a^m \omega^m) \cos \omega t d\omega. \quad (31) \quad y = \int_{-\infty}^\infty y_a(t-u)y_b(u)du = \int_{-\infty}^\infty y_a(u)y_b(t-u)du. \quad (35)$$

A series solution suitable for computation is easily found in terms of the gamma function. It is

$$y_a = \frac{1}{m t_a \Gamma\left(1 + \frac{1}{m}\right)} \cdot \sum_{s=0}^\infty \frac{(-1)^s}{(2s)!} \left[\frac{x'}{\Gamma\left(1 + \frac{1}{m}\right)} \right]^{2s} \Gamma\left(\frac{2s+1}{m}\right) \quad (32)$$

where

$$x' = \pi t/t_a, \quad t_a = \frac{\pi a}{\Gamma\left(1 + \frac{1}{m}\right)}.$$

The only solution found in closed form for this species of network is for $m=2$ and ∞ . For $m=2$, either (31) or (32) give⁴⁹

$$y_a = \frac{1}{t_a} \exp(x'^2/\pi). \quad (33)$$

For $m=\infty$, (32) reduces to

$$y_a = \frac{1}{t_a} \frac{\sin x'}{x'}, \quad (34)$$

which is the early result of Kupfmüller.⁴

15) Combined Phase and Attenuation Distortion

A formal double-summation series solution of (2) is easily found, but is of limited use. The only practical way to get any solutions of computational value is by application of the superposition theorem. This states that y (defined by (2)) is given in terms of y_b and y_a (defined by (25) and (31)) by

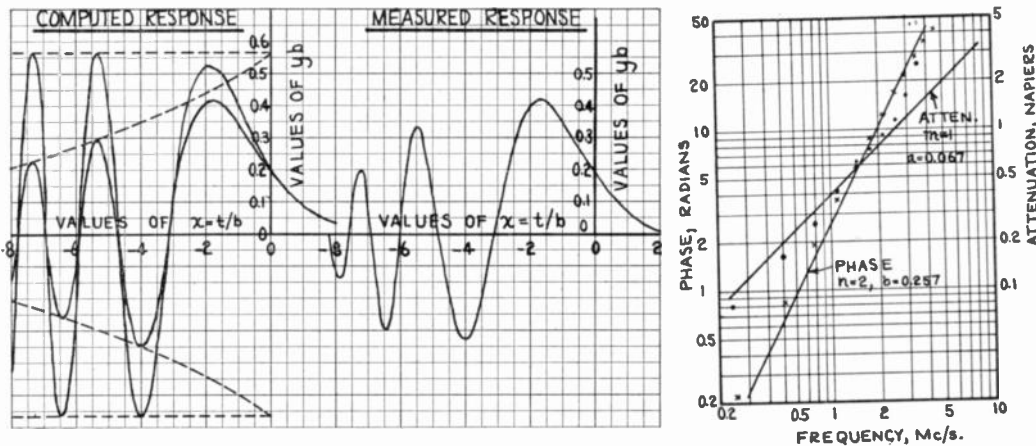

Fig. 16—Distributed-type delay line: computed and measured impulse transient response, measured attenuation and phase distortion.

⁴⁵ See pages 30–32 of footnote reference 29.
⁴⁶ See page 544 of footnote reference 43.
⁴⁷ G. B. Airy, supplement to "On the intensity of light in the neighborhood of a caustic," *Trans. Camb. Phil. Soc.*, vol. 7, p. 595; 1849.
⁴⁸ See page 188 of footnote reference 43.

Some closed-form solutions for special cases of m and n and special ranges of argument have been obtained. When $m=1, n=2$; i.e., when the steady-state trans-
⁴⁹ See pair 704.0, footnote reference 29.

fer function of a network is $\exp(-a\omega - jb^2\omega^2)$, the response to an impulse, for large values of $x (=t/b)$, is

$$y = \frac{1}{b\sqrt{\pi}} (\exp - cx/2) \cos\left(\frac{x^2 - \pi}{4}\right) \quad (36)$$

where $c = a/b$.

Equations (36) and (29) were used to compute the response curves of Fig. 16, the parameters a and b being obtained as usual from the log-log plot of ΔA and ΔB . The agreement with the interesting response of Fig. 1 is quite good. Here the ripple leads, rather than lags, because the phase distortion is negative, and gives rise to a precursor ripple, a phenomenon observed also in other applications.⁵⁰

When $n = 3$, $m = 2$, the transfer function is $\exp(-a^2\omega^2 - jb^3\omega^3)$. The response to an impulse, for large values of x and small values of $c (=a/b)$, is

⁵⁰ M. L. Brillouin, "Propagation des ondes electromagnetiques dans les milieux materials," *Congres International D'Electricite*, vol. 2, pp. 739-788; 1932.

$$y = \frac{\left(x - \frac{c^4}{3}\right)^{1/2}}{3\sqrt{3}b} (\exp - c^2x/3) [J_{1/3} + J_{-1/3}] \quad (37)$$

where $J_{\pm 1/3}$ is the Bessel function of the first kind to the argument

$$\frac{2\left(x - \frac{c^4}{3}\right)^{3/2}}{3^{3/2}}$$

ACKNOWLEDGMENT

For stimulating and helpful discussions regarding this paper, the author is indebted to H. A. Wheeler, consulting radio physicist, and to E. Weber, director of the Microwave Research Institute, and head of the department of electrical engineering at the Polytechnic Institute of Brooklyn.

Design Principles of Amplitude-Modulated Subcarrier Telemeter Systems*

CECIL K. STEDMAN†, SENIOR MEMBER, I.R.E.

Summary—Of the many multichannel radio telemeter systems that are being used for the instrumentation of airplanes and guided missiles, one of the simplest employs a separate amplitude-modulated audio subcarrier for each channel. In this paper a rational basis for the design of such systems is presented. The problems of multichannel overload, cross talk from adjacent channels, filter design criteria, and signal-to-noise ratio are discussed.

The principal contributions of the paper are (1) a new criterion for multichannel overload which is easy to use and is simply related to single-signal overload; and (2) a demonstration that, contrary to general opinion, nothing is gained by spacing filter midband frequencies in such a way that harmonics of lower subcarriers fall outside the pass bands of higher-frequency channel filters. This fact is basic for successful design of an amplitude-modulated subcarrier telemeter because it permits subcarrier frequencies to be spaced much more closely than would otherwise be possible, and so results in improved signal-to-noise ratio.

INTRODUCTION

WITHIN THE past five years, there has been a great deal of interest on the part of aircraft manufacturers and the aeronautical branches of the services in electronic means for remote recording of flight-test data. This interest has been stimulated partly by the need for relaying to the ground flight data from pilotless radio-controlled airplanes or guided missiles, and partly by the desire to simplify the installation problems in airplanes by transferring oscillographs and other delicate equipment to the ground. In most cases it

it necessary to measure a comparatively large number of variables simultaneously. It is impractical to provide a separate radio transmitter and receiver for each variable; consequently, some system of multiplexing must be adopted. The two basic systems for multiplexing are frequency separation and time separation, and a great many varieties and combinations of these two systems have been used for radio telemetering. One of the simplest employs frequency separation with a number of amplitude-modulated subcarriers. With this system the sending equipment consists of a number of audio-frequency oscillators supplying power to an equal number of pickup instruments which amplitude-modulate these subcarriers in accordance with the variable to be measured. The subcarriers are mixed in a master amplifier and, in turn, modulate a radio transmitter (usually f.m.). At the receiving end the radio signal is demodulated; the channels are separated by a set of band-pass filters, and the individual subcarriers are demodulated and recorded. Fig. 1 is a block diagram of a fourteen-channel set developed by the Boeing Aircraft Company. In spite of the simplicity of this system, and its similarity to carrier telephony, some of the design principles are not self-evident and have been generally misunderstood. It is the purpose of this paper to clarify those principles and to provide a sound basis for a straightforward design of a subcarrier telemeter. The questions of principal interest are cross-modulation effects resulting from nonlinearity in the transmission system, criteria for

* Decimal classification: R520X621.375.616. Original manuscript received by the Institute, November 8, 1946; revised manuscript received, March 6, 1947.

† Boeing Aircraft Co., Seattle, Wash.

choice of oscillator frequencies, effects of adjacent-channel cross talk, filter design criteria, and signal-to-noise ratio. These topics and other related questions are treated individually in the following sections.

where the coefficients A_1, A_2, A_3 are at first assumed to be independent of frequency. The input signal is

$$e_0 = A_1 e_i + A_2 e_i^2 + A_3 e_i^3 \tag{1}$$

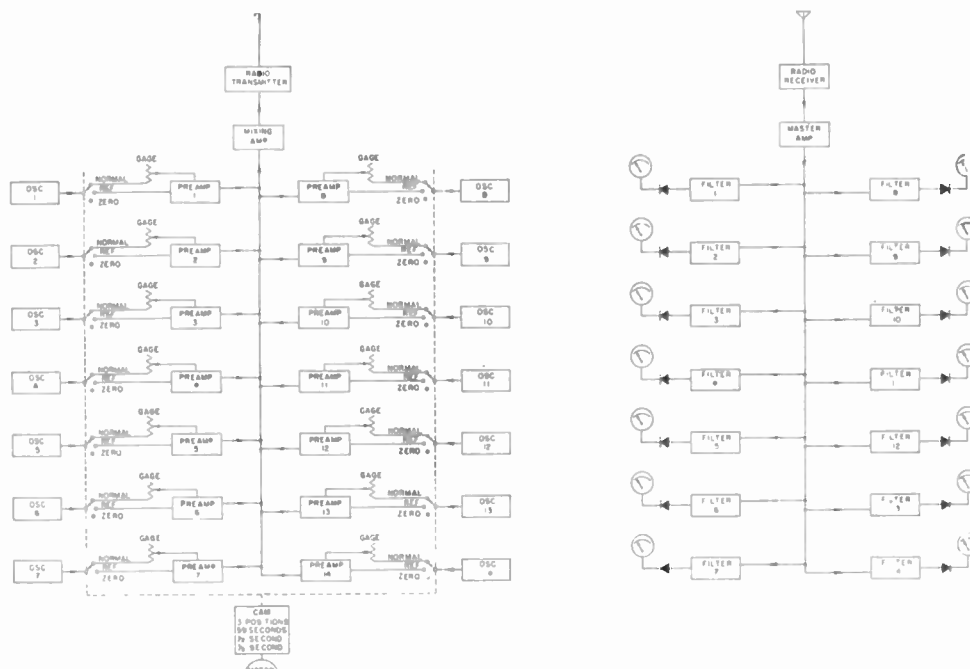

Fig. 1—Block diagram of amplitude-modulated subcarrier telemetry system.

OVERLOAD EFFECTS IN A SUBCARRIER TELEMETER SYSTEM

Any transmission system containing vacuum tubes is more or less nonlinear, with the degree of nonlinearity increasing with increasing signal level. It is usually desirable to operate at the highest permissible levels in order to realize the maximum power-handling capacity of the equipment, or to get the best possible signal-to-noise ratio. Consequently, it is necessary to define quantitatively the highest permissible level. This can be done very readily in the case of a single-frequency signal by stating either the total distortion as measured by a distortion meter, or the percentage of any single harmonic. On the other hand, if the signal consists of a large number of voltages of different frequencies the problem is considerably more complicated. Several excellent papers have been published on the subject, with particular emphasis on applications to telephony.¹

It is proposed to derive here a criterion for overload which is especially applicable to an amplitude-modulated subcarrier telemeter, and to show the relation between that criterion and single-frequency overload.

Effects of Nonlinearity

As a first approximation, let the response characteristic of the transmission system be represented by

¹ R. A. Brockbank and C. A. A. Wass; "Non-linear distortion in transmission systems," *Jour. I.E.E.* (London), vol. 92, Pt. III, pp. 47-56; March, 1945. Includes a bibliography.

$$e_i = \sum_{\alpha=1}^n E_{\alpha} \cos \omega_{\alpha} t. \tag{2}$$

TABLE I
PRODUCTION OF NONLINEAR TRANSMISSION

Source (Term in Eq. (1))	Typical Product	Number of Products of Type	Description
1 $A_1 e_i$	$A_1 E_p \cos \omega_p t$	n	Fundamental
2 $A_2 e_i^2$	$\frac{A_2}{2} E_p^2 \cos 2\omega_p t$	n	2nd harmonic
3	$2 \frac{A_2}{2} E_p E_q \cos (\omega_p \pm \omega_q) t$	$n(n-1)$	cross products
4	$\frac{A_2}{2} E_p$	n	d.c. component
5 $A_3 e_i^3$	$\frac{A_3}{4} E_p^3 \cos 3\omega_p t$	n	3rd harmonic
6	$3 \left(\frac{A_3}{4}\right) E_p^3 \cos \omega_p t$	n	fundamentals
7	$6 \left(\frac{A_3}{4}\right) E_q^2 E_p \cos \omega_p t$	$n(n-1)$	
8	$3 \left(\frac{A_3}{4}\right) E_q^2 E_p \cos (2\omega_q \pm \omega_p) t$	$2n(n-1)$	cross products
9	$6 \left(\frac{A_3}{4}\right) E_p E_q E_r \cos (\omega_p \pm \omega_q \pm \omega_r) t$	$\frac{4}{6} n(n-1)(n-2)$	

The complex output signal is made up of products of the following kinds (with p , q , and r representing specific values of α).

Of these nine types of products, the first, which includes n terms, represents the desired signals in the n telemeter channels. The rest are spurious nonlinear products, and are of varying degrees of importance. If n is large and A_2 is not too much greater than A_3 , the second-order terms are insignificant in comparison with the third-order terms.

In practice, it has been found that the important cross-modulation effects in a fourteen-channel telemeter using a transmission system sufficiently linear to be of any value at all, can be represented well enough by considering third-order terms only. In that case, products of type 6 are responsible for the departure from linearity that is observed when the output of a single-frequency signal is plotted against its input voltage. Products of type 7 represent a change in level of the p th fundamental, observed when signals of other frequencies are applied. Each interfering signal acts separately, so there are $n-1$ such terms for each value of p , and the total effect is obtained by summing over q from 1 to n with $q \neq p$. Products of types 8 and 9 represent a large number of interfering signals covering a wide frequency band. With fourteen channels there are 364 of the former and 1456 of the latter. The number of these lying within the pass band of any one filter can rather easily be determined by actual count. With the Boeing equipment there are approximately 50 that are attenuated less than 3 db in passing through a particular channel, and the number does not vary greatly among the different filters. It should particularly be noticed that the coefficient of each term has a given value independent of the number of signals n . The effect of adding more signals is merely to increase the number of cross-modulation products without changing the levels of those already present. For example, if one signal appears with 2 per cent third harmonic, any number of additional signals of different frequencies can be added without changing the third harmonic of the first one so long as the transmission can still be represented by (1). This shows the inadequacy of harmonic content as a criterion for multichannel overload.

Criterion for Overload

The foregoing study of cross-modulation products indicates that there are two effects of major importance for the overload of a multichannel system. These are:

1. Variation of level of the desired signal resulting from interference with signals in other channels (product of type 7). This effect is of no consequence for telephony, and for that reason has been neglected in the literature. It is of prime importance for telemetering because of the need for quantitative measurement of fundamental signal levels. In principle it could be corrected by calculation, since the levels in all channels are known to a first approximation, but this would be a very laborious procedure.

2. Spurious combination tones (products of types 8 and 9) which are so numerous, and so closely spaced in frequency, that they form a practically continuous spectrum resembling filtered fluctuation noise.

The relative importance of these effects can readily be calculated for any particular set of subcarrier frequencies and filter pass bands. Thus, for the Boeing fourteen-channel system with all signals equal, the per cent change of fundamental is

$$3 \frac{A_3}{4} E^2 \frac{1}{A_1} + 13 \times 6 \frac{A_3}{4} E^2 \frac{1}{A_1} \cong 20 \frac{A_3 E^2}{A_1} \quad (3)$$

The amplitude of one type 8 product as a per cent of the fundamental is $0.75 A_3/A_1 E^2$ and of one type 9 product is $1.5 A_3/A_1 E^2$. The number of these appearing in each filter band is different, but the worst case can be represented approximately by taking 50 of the latter type which have the larger amplitude. The mean-square galvanometer deflection is proportional to the number of products, so the effective noise signal is approximately

$$\sqrt{50} \times 1.5 \frac{A_3}{A_1} E^2 \quad (4)$$

The ratio of the two effects is

$$\frac{\text{change of fundamental}}{\text{r.m.s. cross-modulation noise}} = \frac{20}{1.5\sqrt{50}} = 1.9 \quad (5)$$

Cross-modulation noise varies from channel to channel; however, in the channel represented by (5) the r.m.s. value of the noise is considerably lower than the change of fundamental, and experiments indicate that there are very few peaks of noise in any channel that exceed the change of fundamental. The change of fundamental, which is the same in all channels, therefore provides a reasonable, and readily calculated, measure of the degree of overloading in a multichannel system. For this purpose it has the advantages, compared with a measure based on cross-modulation noise, that the need for determining frequency distribution of the products is eliminated, and statistical questions concerning the recording of noise are avoided. The relative importance of the two effects changes very little if channel levels are somewhat unequal instead of equal as assumed above, or if more channels are added with corresponding increase in total frequency band. If more channels are added in the same band, noise increases relative to change of fundamentals approximately as $n^{0.5}$.

In judging the importance of a certain per cent change of fundamental it must be remembered that, with given interfering signals, the effect is a given percentage of the existing desired signal level, not a given percentage of full-scale signal.

Sources of Nonlinearity

Amplifiers should be operated at levels considerably below their overload points, so that the principal sources of distortion are the modulator and discriminator in the f.m. radio link. The foregoing treatment of cross-modu-

lation effects, which assumes distortion independent of frequency, is directly applicable to the modulation process if the radio transmitter uses phase modulation with $\Delta\theta$ independent of the modulating frequency. However, since r.f. swings are proportional to $f\Delta\theta$, where f is the audio modulating frequency, distortion in the discriminator of the receiver is dependent on the subcarrier frequencies as well as on their amplitudes. This does not involve any new analysis, since the effect is merely to make the effective signal levels in various channels unequal. The previous treatment applies if $f_p E_p$ is written for the equivalent voltage in the p th channel.

The total change of the p th fundamental obtained by summing the 6th and 7th products in Table I is

$$\frac{3}{4} A_3 f_p E_p \left[f_p^2 E_p^2 + 2 \sum_{q=1/(q \neq p)}^n f_q^2 E_q^2 \right]. \quad (6)$$

The amplitude of the desired signal is $A_1 f_p E_p$. Therefore, since the term inside the bracket is nearly the same for all values of p , the percentage change of fundamental is approximately the same in all channels. The total change of fundamental is the sum of that originating in the modulator plus that originating in the discriminator.

Permissible Signal Levels

The permissible signal levels for a multichannel subcarrier telemetry system will be defined in terms of equal signals on all channels. In Table I combine the single term of type 6 with $(n-1)$ terms of type 7, and for simplicity neglect the difference in the coefficient of the former. Then, for n per cent change of fundamental, we have approximately

$$\frac{n \times 1.5 A_3 E_N^3}{A_1 E_N} \times 100 = N = 150n \frac{A_3}{A_1} E_N^2. \quad (7)$$

The single-signal amplitude which gives P per cent third harmonic is given by

$$\frac{0.25 A_3 E_P^3}{A_1 E_P} \times 100 = 25 \frac{A_3}{A_1} E_P^2. \quad (8)$$

If P is measured by means of a wave analyzer with any suitable input signal amplitude, A_3/A_1 can be calculated from (8). Substitution of A_3/A_1 in (7), with any chosen value of N , determines the maximum permissible amplitude E_N for each of the n telemetry channels.

The multichannel load capacity of a system can be related to the more familiar single-channel capacity by setting $N=P$ in (7) and (8), giving

$$\frac{n E_N}{E_P} = \sqrt{\frac{n}{6}}. \quad (9)$$

Therefore, if n is greater than 6, the permissible peak signal $n E_N$ for a certain percentage change of fundamental is greater by a factor $\sqrt{n/6}$ than the single peak signal giving the same percentage third harmonic.

The permissible signal levels have been defined in terms of equal signals on all channels. In practice, the

gauges will not all be giving full-scale signal simultaneously, so that on the basis of operating experience it will be possible to establish a full-scale level somewhat higher than the one determined on theoretical grounds.

EFFECT OF CROSS TALK IN AVERAGING RECTIFIERS

In addition to the study of cross modulation which has been presented above, the general problem of adjacent-channel cross talk must also be analyzed in order to provide a rational basis for design of a subcarrier telemetry. At the receiving station the output of each of the channel filters is passed through a rectifier before being applied to the recording oscillograph. A linear full-wave copper-oxide rectifier circuit is used, so that the galvanometer deflection is proportional to the absolute value of the input averaged over a time interval of the order of the galvanometer period. This type of rectification is far superior to peak rectification, when it is necessary to discriminate against unwanted signals.

In the case of a subcarrier telemetry system, the unwanted signals are carriers or sidebands from adjacent channels which have not been completely attenuated by the filter (cross-modulation products must be minimized by reduction of nonlinearity). The filters are quite sharp, so that the interfering signals are at nearly the same frequency as the desired signal. The resulting beats can therefore be represented by

$$e = \sqrt{V_1^2 + V_2^2 + 2V_1V_2 \cos \Delta\omega t} \cdot \sin \left\{ \omega_1 t + \tan^{-1} \left(\frac{V_2 \sin \Delta\omega t}{V_1 + V_2 \cos \Delta\omega t} \right) \right\} \quad (10)$$

where ω is the desired frequency, $\Delta\omega$ is the beat frequency, and V_1 and V_2 are the amplitudes of the desired and interfering signals, respectively. This resultant signal is very nearly sinusoidal with amplitude varying between the limits $(V_1 \pm V_2)$ at the angular frequency $\Delta\omega$. Therefore, the galvanometer current averaged over an interval long compared with $2\pi/\omega$ but short compared with $2\pi/\Delta\omega$ is proportional to the amplitude of (10), which gives the envelope of the beats. If the galvanometer is able to follow these beats, the performance with the averaging rectifier is not essentially better than with a peak rectifier, and the only remedy for the interference is more filter attenuation. On the other hand, if the galvanometer cannot follow the beats, the effective interference is greatly reduced and would be zero if it were not for the fact that with large amplitude beats the envelope is not sinusoidal and is not symmetrical with respect to a line $e = V_1$. Because of this dissymmetry the average over one beat cycle is somewhat increased by the interfering signal.

By averaging the envelope of (10) over one beat cycle, it can be shown that the average d.c. output of the rectifier is given by

$$\frac{e_{dc}}{V_1} = \frac{2}{\pi} (1 + p) E \left(\sin^{-1} \frac{2\sqrt{p}}{1+p} \right) \quad (11)$$

where E is the complete elliptic integral of the second kind and $p = V_2/V_1$.

The following table, calculated from (11), illustrates the manner in which the per cent error depends upon the magnitude of an interfering signal. These results

TABLE II
CHANGE OF AVERAGE SIGNAL RESULTING FROM BEATS

p	e_{dc}/V_1	p	e_{dc}/V_1
0.1	1.000	0.6	1.093
0.2	1.010	0.7	1.132
0.3	1.022	0.8	1.170
0.4	1.040	0.9	1.219
0.5	1.063	1.0	1.272

will be used later to determine the filter attenuation necessary to eliminate interchannel crosstalk.

FILTER DESIGN CRITERIA

An important question for the design of an amplitude-modulated subcarrier telemeter is the choice of filter characteristics. This includes bandwidth, rate of cutoff, and spacing of midband frequencies or, what amounts to the same thing, choice of subcarrier oscillator frequencies.

It should first be pointed out that, contrary to common opinion, nothing is to be gained by spacing filter midband frequencies in such a way that harmonics of lower subcarriers fall outside the pass bands of higher-frequency channel filters. The unimportance of harmonics resulting from nonlinear transmission is illustrated by the fact that in a typical case 50 third-order cross-modulation products of type 9 (table 1) fall within the pass band (less than 3 db of attenuation) of a single filter. Each one of these has a level about 15 db above the third harmonic, which is therefore completely overshadowed. Furthermore, the cross-modulation products are so numerous that no filter spacing can avoid them, so nonlinear transmission is not a factor in determining the spacing of midband frequencies. These arguments do not, of course, apply to harmonics originating in the subcarrier oscillators or in the gauges, but experience has shown that these can be kept below 1 per cent without great difficulty.

It follows that filter midband spacing is determined only by the required width of flat top and the attenuation necessary to prevent interchannel crosstalk.

Width of Flat Top

If gauge signals contain components extending from zero to f c.p.s., a subcarrier pass band of $2f$ c.p.s. is required to transmit both sidebands. An additional allowance must be made for subcarrier frequency drift and change of filter characteristics with temperature. The Boeing equipment is required to transmit gauge signals to 150 c.p.s. and the filters are flat within ± 0.1 db over a range of 330 c.p.s. Experience has shown that the allowance of ± 15 c.p.s. for oscillator and filter drift is sufficient.

Rate of Cutoff

Interchannel cross talk will exist if filters fail to suppress sufficiently the signals from adjacent channels. The rate of cutoff required to prevent such cross talk depends considerably on the ability of the recording galvanometers to follow the beats caused by interfering signals. Consider first the case of galvanometers which record the beats without attenuation.

The signal in an interfering channel may be modulated at very low frequency, and may therefore remain at the peak of the modulation cycle for considerable periods of time. Consequently, the peak of the cycle should be regarded as full-scale signal for the channel. It follows that the unmodulated signal is 6 db below full scale and the side bands of a 100 per cent modulated subcarrier are 12 db below full scale. If interference from an adjacent channel is to be maintained below 1 per cent of full scale (-40 db), the filter must have at least 34 db. attenuation at the adjacent midband frequency. It also follows from the foregoing discussion that 28-db attenuation is required to suppress a single interfering sideband which may be 150 c.p.s. closer than the adjacent midband frequency. These two criteria determine a minimum permissible cutoff characteristic of the filter.

If the galvanometers attenuate the beats to some extent, the galvanometer attenuation can be subtracted from the attenuation required from the filter. Consider next the case of galvanometers which are unable to follow the beats at all. In this case, the only error caused by the interference results from the change of average current as discussed above. If we are willing never to let signals go below 10 per cent of full scale, then an interfering signal with half that amplitude ($p=0.5$ in Table II) will, at most, cause an error of 6 per cent of the existing signal or 0.6 per cent of full scale. This requires filters with only 20 db attenuation at the adjacent midband frequencies. If the filter cutoff is such that only the interfering sidebands need be considered, 14 db at frequencies 150 c.p.s. closer than the adjacent midband frequencies is all that is required, because sidebands are already 12 db below full scale.

All of the cases discussed above exist in various channels of the Boeing telemeter system. At low frequencies the filter spacing is only 500 c.p.s. with a large galvanometer response to the beats. At high frequencies the filter spacing is 1500 c.p.s., and the galvanometers do not respond appreciably to the beats.

Spacing of Midband Frequencies

The lowest subcarrier or filter midband frequency is determined by the maximum expected signal-modulation frequency. For 150 c.p.s. modulation a suitable value is 2000 c.p.s. Successive higher midband frequencies should be spaced as closely as possible consistent with the flat top and cutoff criteria discussed above, and consistent with economical design. Every effort should be made to keep the individual filter bands as narrow as possible, and to keep the top subcarrier frequency as

low as possible, in order to improve signal-to-noise ratio. One set of 20 three-section filters has been built with $f_1=2000$ c.p.s., $f_{20}=21,300$ c.p.s., and 330 c.p.s. flat top ± 0.1 db. With careful design f_{20} could probably be made still lower without sacrificing the width of flat top.

Other Specifications

The characteristic impedance of the filters is unimportant since the associated equipment can be matched to them. To simplify the driver circuits, the filters should be designed to operate with all inputs bridged. The operating level should be sufficiently high to minimize noise pickup in the system. The filters should be built with components having low temperature coefficients, so that the flat top need not be widened excessively to allow for filter drift.

EFFECT OF REMOVING INVERSE FREQUENCY NETWORK IN RADIO TRANSMITTER

The f.m. radio transmitter used with the Boeing telemeter employs the Armstrong modulation system. The phase deviation at the output of the modulator is, therefore, proportional to the audio input voltage. This phase modulation is mathematically equivalent to a corresponding frequency modulation such that, when the phase is shifted by $\Delta\theta \sin 2\pi ft$, frequency is shifted by $f \omega\theta \cos 2\pi ft$ where f is the modulating frequency. Thus, for a given value of signal input, the frequency deviation is proportional to the modulating frequency.

Usually, frequency modulators of the Armstrong type have an inverse-frequency network that inserts attenuation proportional to frequency in the audio circuit. The effect of this network is to equalize the frequency characteristic of the modulator, making the frequency deviation proportional to the audio voltage and independent of the modulating frequency. However, it is also characteristic of f.m. receivers that the fluctuation-noise output voltage of the discriminator (or the voltage resulting from strong continuous sources of impulse noise) is proportional to frequency. Consequently, for subcarrier telemetry applications using a number of channels spaced throughout the audio spectrum it is desirable to omit the inverse-frequency network, so that the frequency swings resulting from full-scale signal in the various channels will be proportional to audio frequency. The signal-to-noise ratio will then be the same in all channels.

If n subcarriers $f_1, f_2, \dots, f_i \dots f_n$ are used, it can be shown that omission of the inverse-frequency network results in an increase of signal-to-noise ratio (compared with what would otherwise be the noisiest channel) by a factor of

$$nf_n / \sum_{i=1}^n f_i$$

If the subcarrier frequencies are arranged in arithmetic progression starting with quite low frequencies, this ratio equals 2 and represents a 6-db improvement in signal-to-noise ratio. In practice, the frequencies do

not extend to zero, and the spacing increases at high frequency because of filter design problems, so that the gain obtained by omitting the predistortion network may be either more or less than 6 db.

The analysis is considerably more complicated if one is concerned with the ratio of signal to noise resulting from cross-modulation products, because the noise level will not, in general, be the same with the predistorting network in and out. However, the discriminator noise output voltage resulting from cross modulation in the modulator is proportional to frequency, so that in this case also it is advantageous to omit the network.

SIGNAL-TO-NOISE RATIO

The principal points to be considered when evaluating the signal-to-noise ratio of an amplitude-modulated subcarrier telemeter system, or when comparing it with a system of a different kind such as high-speed commutation, are summarized below for convenient reference.

1. If the modulator provides r.f. swings which are proportional to the audio modulating frequency instead of being independent of frequency, a signal-to-noise ratio gain is obtained in the n th channel, which is given by the expression

$$\frac{nf_n}{\sum_{i=1}^n f_i}$$

2. Since the noise output (voltage for a given bandwidth) from the discriminator is proportional to the frequency, it is important to keep all subcarrier frequencies as low as possible. Furthermore, the noise voltage in one filter band is proportional to the square root of the bandwidth. Therefore, for optimum signal-to-noise ratio, the filters should be as sharp as possible and spaced as closely as cross-talk considerations permit. By giving consideration to these requirements it has been possible to build a fourteen-channel system with a noise level of only 1 per cent of full scale.

3. With n channels, the permissible voltage in each channel is greater than $1/n$ times the single-frequency voltage, which gives 1 per cent third harmonic. In practical cases the factor varies from 1.5 to 2.5, depending on the number of channels and the permissible limits of distortion.

4. Not all channels will be called upon to transmit maximum signals simultaneously. For example, a channel may be set up to transmit a full-scale elevator deflection of ± 30 degrees, but during flight it will be near zero most of the time. For this reason it is possible, on the basis of operating experience, to establish somewhat higher permissible maximum signal levels than are indicated by paragraph 3. The possible increase is probably between 1.5 and 2.

ACKNOWLEDGMENT

The assistance of Sidney Bertram with some of the calculations and measurements for this paper is gratefully acknowledged.

Trigonometric Components of a Frequency-Modulated Wave*

ENZO CAMBI†

Summary—The exact solution of the differential equation of a variable-capacitance (or variable-inductance) resonant circuit is given, in a form having a clear physical meaning, and allowing an accurate numerical computation. The explicit expression of the output voltage, as well as the expressions of the charge, and of the current, are written in terms of the two parameters of the nondissipative circuit. The stability of the solutions is discussed, and it is noted that the regions of instability are in number only one-half of those which might be presumed in an investigation of the problem by an approximating Mathieu equation. From the rigorous solutions, approximate expressions are deduced which are valid in the case of small percentages of modulation. The exact results are compared, in a numerical discussion with those of the approximate formulas, as well as with the usual expressions, involving Bessel Functions. The case of the dissipative circuit is discussed briefly, both in the general case and in the case where the dissipative term is comparatively small.

INTRODUCTION

THE MOST elementary method for the production of a frequency-modulated wave is yielded by a resonant circuit, where the inductance or the capacitance is made periodically variable, according to the law of modulation. Hence, the differential equation defining the behavior of such a circuit may be regarded as the standard equation of a f.m. wave.

The equation is written conveniently in terms of the charge q of the capacitor, that is, of the integral

$$q = \int_{-\infty}^t idt.$$

If the inductance is L and the capacitance is variable as $C(1+2\gamma \cos \mu t)$, the equation of the nondissipative circuit is

$$L \frac{d^2q}{dt^2} + \frac{q}{C(1+2\gamma \cos \mu t)} = 0.$$

The equation remains the same if C is fixed and the inductance varies as $L(1+2\gamma \cos \mu t)$. The only difference is that the output voltage is Ld^2q/dt^2 if L is fixed, and q/C if C is fixed.

Assuming as a new variable $x = \mu t$ and writing r for the ratio $\mu\sqrt{LC}$ of the modulating frequency to the static resonant frequency, the equation becomes

$$\frac{d^2q}{dx^2} + \frac{q}{r^2(1+2\gamma \cos x)} = 0. \quad (1)$$

The nature of a frequency-modulated wave has been first investigated, by synthetic methods, by Carson,¹

* Decimal classification: R148.2. Original manuscript received by the Institute, November 21, 1946; revised manuscript received, September 2, 1947. Presented, Research Staff of the Electroacoustical Institute Meeting, Rome, Italy, May 25, 1946.

† Via Giovanni Antonelli 3, Rome, Italy.

¹ John R. Carson, "Notes on the theory of modulation," PROC. I.R.E., vol. 10, pp. 57-64; February, 1922.

who found that the f.m. wave contains an infinite number of trigonometric components, whose frequencies² are approximately $\omega_0 = 1/\sqrt{LC}$; $\omega_0 \pm \mu$; $\omega_0 \pm 2\mu$; . . . etc.; the amplitude of the side-component $\omega_0 + n\mu$ being given by $J_n(\gamma\omega_0/\mu) = J_n(\gamma/r)$ where J_n is the Bessel function of n th order, and of the first kind.

Later, van der Pol³ obtained the same results by considering the differential equation, under the assumption that both numbers, indicated here with γ and r , might be regarded as very small. Such an assumption, which is also necessary, of course, in deducing Carson's results, can be often accepted in the case of f.m. waves for broadcasting purposes, but cannot give satisfactory results in the case of the analysis of warble tones, where both the ratio r of the modulating frequency to mean frequency, and the relative modulation 2γ , may assume fairly large values. The assumption is not even legitimate in the case of radio frequencies, if the wave is heterodyned in such a way as to make the ratio r artificially greater.

The first investigation of the differential equation (1) is that of Barrow,⁴ who, however, in view of the "formidable difficulties" occurring in the solution of (1) by the general Hill's method, discarded the actual equation and replaced it with the Mathieu equation

$$\frac{d^2q}{dx^2} + \frac{1}{r^2} (1 - 2\gamma \cos x) q = 0,$$

to which the actual one can be reduced, if 2γ is small of the first order.

It is obvious that this substitution gives rise to results whose accuracy cannot be easily defined a priori.

The writer has shown that (1) can be solved, however, in its actual form, without making any assumption as to the actual magnitude of the parameters r and γ . The method of solution is similar, at least initially, to Hill's method, but does not require the expansion of the coefficient of q in a Fourier series.⁵ In the present paper, we shall suppose $2\gamma < 1$, the only case of physical importance.

From the accurate solution, valid for any γ , approximate expressions are deduced, valid in the case of small γ . These expressions, although much simpler than

* Throughout the present paper, the word "frequency" is used, for brevity's sake, to denote "angular velocity" ($=2\pi f$).

³ B. van der Pol, "Frequency modulation," PROC. I.R.E., vol. 18, pp. 1194-1206; July, 1930.

⁴ W. L. Barrow, "Frequency modulation and the effects of a periodic capacity variation in a nondissipative oscillatory circuit," PROC. I.R.E., vol. 21, pp. 1182-1203; August, 1933.

⁵ Two mathematical papers by the author have been published in *Atti dell'Acc. Naz. dei Lincei*, October and November, 1946.

Carson's well-known formulas and requiring no foreign tables, are by far more accurate, even from the qualitative point of view.

THE DIFFERENTIAL EQUATION OF THE NONDISSIPATIVE CIRCUIT

We give hereunder a summary of symbols used:

- L = inductance (constant, or mean value)
- C = capacitance (constant, or mean value)
- 2γ = relative modulation of the capacitance (or inductance), that is, if γ is small
- γ = relative modulation of frequency
- μ = modulating frequency (see footnote reference 2)
- r = ratio of modulating frequency to mean (static) resonant frequency
- $p = 1/r$ = ratio of static resonant frequency (= carrier frequency, if γ is small) to modulating frequency
- u = frequency of a trigonometric component of the charge (or current, or voltage), assuming μ as unity
- u_0 = frequency of the central component (tending to p = static resonant frequency, in relative magnitude, when $\gamma \rightarrow 0$).
- t = time
- $x = \mu t$
- q = charge of the capacitor; dq/dt = current; Ld^2q/dt^2 (constant inductance) or q/C (constant capacitance) = output voltage.

The first step of the investigation is to examine whether q can contain some trigonometric term of the form ae^{iux} , having a suitable frequency u . This is analytically equivalent to the experimental determination of an eventual *resonance*, by means of an analyzer.⁶

By directly replacing in the equation, written

$$r^2(1 + 2\gamma \cos x) \frac{d^2q}{dx^2} + q = 0, \quad (1a)$$

it is seen at once that, if q contains one term of said form, it must contain, at the same time, all the terms of the form

$$a_n e^{i(u+n)x},$$

n being any integer, between $-\infty$ and $+\infty$. That is, a possible form for q is

$$q = \dots + a_{-2} e^{i(u-2)x} + a_{-1} e^{i(u-1)x} + a_0 e^{iux} + a_1 e^{i(u+1)x} + a_2 e^{i(u+2)x} + \dots, \quad (2)$$

corresponding to the usual form for an integral of a

⁶ The actual analytical equivalent of tuning an analyzer on some "resonance" of the wave would consist in determining whether some frequency u may exist, making the Fourier integral

$$\int_{-\infty}^{\infty} q e^{iux} dx$$

become infinite in magnitude. The results, however, remain just the same, if we suppose that q may contain (additively) a term ae^{iux} .

Hill's equation. The frequency u and all the amplitudes a are to be determined.

By substituting in (1a), and noting that all the amplitudes must vanish in the left side, we write down an infinite system of linear *homogeneous* equations for the unknown a 's. The general equation of the system is

$$-\gamma r^2(u+n-1)^2 a_{n-1} + [1 - r^2(u+n)^2] a_n - \gamma r^2(u+n+1)^2 a_{n+1} = 0,$$

or, writing A_n for $r^2(u+n)^2 a_n$,

$$\gamma A_{n-1} + \left[1 - \frac{1}{r^2(u+n)^2} \right] A_n + \gamma A_{n+1} = 0$$

for any integral n between $-\infty$ and $+\infty$.

In order that such a homogeneous system may possess nonzero solutions, its determinant (which depends on u) must vanish. Hence, u could be determined by a determinantal equation, as usual; but, differing in this from the case of Hill's equation, the (infinite) determinant is now divergent at ordinary values of u .

The procedure outlined below makes the consideration of the determinant unnecessary and gives, at the same time, both the possible values of u and the corresponding values of the amplitudes A_n or a_n . (It is obvious that, if a_n is the amplitude of a component of q , A_n is, proportionally, the amplitude of d^2q/dt^2 , i.e., of the voltage in the case of constant L .)

Regarding A_n as a function of $u+n$: $A_n = V(u+n)$, the general equation in A_n becomes a *difference equation* for V :

$$\gamma V(u-1) + G(u)V(u) + \gamma V(u+1) = 0,$$

where $G(u)$ is written for brevity instead of $1 - (1/r^2u^2)$. Since the difference equation is a *second-order* one, a double infinity of functions V exist, satisfying the equation for any value of u . If V is such a function, the values $A_n = V(u+n)$ satisfy the linear system *for any value of u* .

As a rule, these values A_n *do not* afford a solution of the differential equation, since a series (2) with the coefficients $a_n = A_n/r^2(u+n)^2$ happens to be generally divergent. *For some values of u* , however, we are able to write a series (2) whose coefficients a_n (or the corresponding terms $A_n = r^2(u+n)^2 a_n$) satisfy the linear system, and which converges in both directions, so as to actually define a solution of (1a).

The difference equation for V is *formally* solved by reducing it to a *first-order* equation in terms of the ratio $V(u+1)/V(u)$ of two consecutive values. In the present case, only *the ratios* of the coefficients a_n (or A_n) are of interest, so that the solution obtained by such a reduction is complete. Through division by $V(u)$, the equation becomes

$$\frac{\gamma}{V(u)} + G(u) + \gamma \frac{V(u+1)}{V(u)} = 0$$

$$\frac{\gamma}{V(u-1)} + G(u) + \gamma \frac{V(u+1)}{V(u)} = 0$$

and, solved recurrently for $V(u)/V(u-1)$ or for $V(u+1)/V(u)$ determines two *independent* expressions for the ratio, which can be written as

$$\frac{V(u)}{V(u+1)} = -\gamma v(-u), \quad \frac{V(u)}{V(u-1)} = -\gamma v(u)$$

if we put $v(u)$ for the continued fraction

$$v(u) = \frac{1}{G(u) - \frac{\gamma^2}{G(u+1) - \frac{\gamma^2}{G(u+2) - \dots}}}$$

The fraction converges for any value of u and r , provided $2\gamma < 1$.

If we construct the terms A_n (starting from an arbitrary value of A_0 , say) by means of either of the relations:

$$\frac{A_n}{A_{n+1}} = \frac{V(u+n)}{V(u+n+1)} = -\gamma v(-u-n);$$

$$\frac{A_n}{A_{n-1}} = \frac{V(u+n)}{V(u+n-1)} = -\gamma v(u+n),$$

where u is provisionally unrestricted, we actually get *formal* nonzero solutions of the linear system for A_n . It can easily be verified, however, that these expressions *do not converge* for $n \rightarrow +\infty$ or $-\infty$, respectively, so that the corresponding series (2), where n extends from $-\infty$ to $+\infty$, is divergent in any case.

A *convergent* solution can be obtained by *separately* satisfying the equations of the system respectively above or below a certain value of n ; for instance, the equations $n \geq 0$, respectively. If we assume

$$\frac{A_n}{A_{n-1}} = -\gamma v(u+n)$$

for $n > 0$, and

$$\frac{A_{-n}}{A_{-(n-1)}} = -\gamma v(-u+n)$$

for the amplitudes with negative suffixes, the set of A_n defined by the first equation converges when the suffix tends to $+\infty$; the second set for $-n \rightarrow -\infty$; the same is obviously true for the terms a_n .

The above values of A_n satisfy all the equations of the linear system, exception being made for the equation $n=0$:

$$\gamma A_{-1} + G(u)A_0 + \gamma A_1 = 0.$$

But, if we divide by A_0 and replace the ratios by the above expressions, we easily note that, if u is a root of

$$-\gamma^2 v(1-u) + G(u) - \gamma^2 v(1+u) = 0, \quad (3)$$

all the equations of the linear system are satisfied, and *the solution converges in both directions*.

It can be shown that the roots of the above *resonance equation*, which can be put in the equivalent form

$$\frac{1}{v(u)} = \gamma^2 v(1-u) \quad \text{or} \quad \gamma^2 v(u)v(1-u) = 1 \quad (3a)$$

(through the definition of $v(u)$), actually annihilate the (ordinarily divergent) determinant of the linear system.

It is easily proved, further, that (3) has two systems of roots, the elements of one system being of the form $u_0 \pm n$, those of the other $-u_0 \pm n$.

If $\gamma=0$, each system reduces to a *single* root, i.e., to the static resonance (p or $-p$); in this case, (3) obviously becomes $1-r^2u^2=0$, as it must be.

Equation (3) is easily solved for its *central* root u_0 . In the vicinity of $u=p$, in fact, the left side of

$$\frac{1}{v(u)} - \gamma^2 v(1-u) = 0$$

behaves very regularly, and varies almost linearly with u , so that, starting from the approximate value $u=p$, the actual value of u_0 can be determined, with a few successive approximations, to any desired degree of accuracy.

On the contrary, if the *side roots* were to be determined by means of (3), it would be noted that their determination becomes very critical, or even impracticable, when the considered root is even at a small distance from the central one. This analytical behavior of the roots is equivalent of a simple physical feature, namely, that the *side resonances* are much *narrower* than the central ones.⁷

However, as soon as u_0 has been determined, the position of all the other roots is automatically known, so that it is by no means necessary to determine them by directly considering (3).

The central root u_0 is close, but not equal, to the static resonance p . In other words, the variability of the capacitance (or inductance) has, as first consequence, a displacement of the mean frequency from that of the static oscillations of the circuit. Later, an approximate formula will be given, defining the displacement in terms of γ ; and p the displacement, which is actually very small, being of the order of γ^2 , is ignored by Carson's analysis.

AMPLITUDE OF THE RESONANCES

As soon as one root of the resonance equation (e.g., the central root u_0) is known, the amplitudes A_n are also obtained at once, by assuming, for instance, that $A_0=1$, and making

$$A_n = (-\gamma)^n v(u_0+1)v(u_0+2) \cdots v(u_0+n)$$

$$A_{-n} = (-\gamma)^n v(-u_0+1)v(-u_0+2) \cdots v(-u_0+n).$$

⁷ In the frequency spectrum of any *permanent* oscillation, any resonance is represented by a *line* of zero width. Since, however, no *permanent* oscillation can exist, the expression "width of a line" has a clear analytical meaning, and gives a quantitative idea of "how critical" a resonance may be.

As stated above, the quantities A_n are (proportional to) the amplitudes of the components of d^2q/dt^2 ; the amplitudes of q (namely, of the voltage in the case of constant C and variable L) are obviously given by

$$Q_n = \frac{u_0^2}{(u_0 + n)^2} A_n,$$

(so as to make $Q_0=1$). Hence, the series

$$q = \dots + Q_{-2}e^{i(u_0-2)x} + Q_{-1}e^{i(u_0-1)x} + e^{iu_0x} + Q_1e^{i(u_0+1)x} + Q_2e^{i(u_0+2)x} + \dots \quad (4)$$

(which can be proved to be actually convergent for all real values of x) represents a first integral of (1).

If we assume for u the value $-u_0$, being also a root of the resonance equation, we obtain a second, independent, integral by simply changing x into $-x$:

$$\bar{q} = \dots + Q_{-2}e^{-i(u_0-2)x} + Q_{-1}e^{-i(u_0-1)x} + e^{-iu_0x} + Q_1e^{-i(u_0+1)x} + Q_2e^{-i(u_0+2)x} + \dots$$

since A_n and A_{-n} are interchanged with one another when the sign of u_0 is changed.

A similar expression for the second derivative is obviously obtained by replacing the amplitudes Q_n by the terms A_n .

The functions $v(u_0+k)$ [k , integer], involved in the expressions of the amplitudes, can be deduced recurrently from the value $v(u_0)$, which has occurred in solving the resonance equation. In other words, it is by no means necessary to compute them by means of continued fractions.

Function $v(u)$, in fact, by virtue of its definition, satisfies the recurrence relations:

$$v(u-1) = \frac{1}{G(u-1)\gamma^2 v(u)};$$

$$\gamma^2 v(u+1) = G(u) - \frac{1}{v(u)}$$

which make it possible to evaluate recurrently all terms required.

The amplitudes of the side resonances are asymmetric, inasmuch as $A_n \neq A_{-n}$, in any case. This circumstance is ignored by the approximate solution given by Carson's analysis, expressing the amplitudes in terms of Bessel Functions. T. Vellat⁸ notices an asymmetry existing under certain laws of modulation, but ignores the fact that asymmetry is a necessary feature of frequency modulation.

Barrow's analysis, although being only approximate, since the considered equation is not the exact one but a Mathieu equation valid when γ^2 is negligible, would lead, of course, to the correct qualitative result; but in Barrow's paper no final, practical formulas for the amplitudes are developed.

⁸ T. Vellat, *Elek. Nach. Tech.*, vol. 18, pp. 149; 1941.

The product $\gamma^n v(u_0+1)v(u_0+2) \dots v(u_0+n)$ tends to zero, in the limit for $n \rightarrow \infty$, since, with the increase of u , the function $\gamma v(u)$ tends to the finite limit $(1 - \sqrt{1 - \gamma^2})/2\gamma$ which is smaller than one, if $2\gamma < 1$.

The product $v(-u_0+1)v(-u_0+2) \dots v(-u_0+n)$, appearing in the expression of the amplitude of a side component *left* of the central one, becomes negligible, on the contrary, as soon as n becomes greater than u_0 . The function $v(u)$ is zero at $u=0$ (provided $p \neq 0$) and is actually very small when u is small; the terms $v(-u_0+k)$ where k is hardly different from u_0 are, therefore, very small, unless p is negligibly small.

In the series for q , therefore, the amplitudes of the terms $e^{\pm i(u_0-k)x}$ where u_0-k is negative are negligibly small; that is, q (and, of course, the voltage) does not contain, practically, "negative frequencies."⁹

Summarizing the above results, we have then written two independent integrals of (1), of the form

$$q_1 = \dots + Q_{-2}e^{\pm i(u_0-2)x} + Q_{-1}e^{\pm i(u_0-1)x} + e^{\pm iu_0x} + Q_1e^{\pm i(u_0+1)x} + Q_2e^{\pm i(u_0+2)x} + \dots$$

where Q_n is given by

$$Q_n = \frac{u_0^2}{(u_0 + n)^2} A_n,$$

with

$$A_{\pm n} = (-\gamma)^n v(\pm u_0 + 1)v(\pm u_0 + 2) \dots v(\pm u_0 + n).$$

From the above independent integrals, two new integrals, also independent from each other, may be written, in real form,

$$\bar{q}_1 = \cos u_0 x + \begin{cases} Q_1 \cos(u_0+1)x + Q_2 \cos(u_0+2)x + \dots \\ Q_{-1} \cos(u_0-1)x + Q_{-2} \cos(u_0-2)x + \dots \end{cases}$$

$$\bar{q}_2 = \sin u_0 x + \begin{cases} Q_1 \sin(u_0+1)x + Q_2 \sin(u_0+2)x + \dots \\ Q_{-1} \sin(u_0-1)x + Q_{-2} \sin(u_0-2)x + \dots \end{cases}$$

The general integral may then be written in a single formula:

$$q = \cos [u_0 x + \phi] + \begin{cases} Q_1 \cos [(u_0+1)x + \phi] \\ Q_2 \cos [(u_0+2)x + \phi] + \dots \\ Q_{-1} \cos [(u_0-1)x + \phi] \\ Q_{-2} \cos [(u_0-2)x + \phi] + \dots \end{cases} \quad (5)$$

within an arbitrary factor. A second arbitrary constant is given by the phase constant ϕ .

It is obvious that, by replacing Q terms with A terms, we write expressions valid for the second derivative of q (output voltage in the case of $L = \text{constant}$); and replacing them with terms of the form

$$I_n = \frac{u_0}{u_0 + n} A_n = \frac{u_0 + n}{u_0} Q_n,$$

⁹ The term "negative frequency" is used, for brevity, to denote the lines of the frequency spectrum which result beyond the axis of zero frequency. Such terms, of course, represent trigonometric terms having *positive* frequency, the sign of the sin component being negative, instead of positive. In other words, "negative" lines of the spectrum simply reflect into positive lines symmetrically with respect to the vertical axis.

we write the expressions of the first derivative, that is, of the current, the amplitude of the central resonance being chosen equal to one.

Among these expressions, those with amplitudes A are more important for applications, since they represent the output voltage in the most common case of constant inductance. The expressions A are also more immediate than expressions Q and I .

The expressions for the charge q (or for the current or voltage) are given in terms of the variable $x = \mu t$. A frequency u_0 , close to p , in terms of x , simply means a frequency $u_0\mu$, close to $p\mu = 1/\sqrt{LC}$, in terms of t . Similarly, a unit interval between the resonances in terms of x means a frequency interval μ in terms of t .

Hence, the frequency spectrum of the solution contains infinite lines spaced by an interval μ around a central frequency, which is close to $\omega_0 = 1/\sqrt{LC}$, and a little higher than this value.

The amplitude of every component (referring to form (5) for the general integral) is A_n , or Q_n , or I_n , as above, according to the variable considered.

APPROXIMATE EXPRESSIONS, IN THE CASE WHERE γ IS SMALL

Although the exact solution of the resonance equation (3) is by no means difficult, it is not worth while to have recourse to such a method of computation when only general information on the behavior of the f.m. wave is desired. In the great majority of cases the (small) displacement of the central resonance from the static value is quite unessential, whereas information on the amplitudes of the various resonances may be of practical interest, regardless of the exact position of the central line.

Finally, the parameter γ (which is one-half of the modulation of the capacitance, or inductance) is actually small in almost all practical cases, so that approximate solutions, giving an error which vanishes with γ , may be very valuable in practice.

We refer to the symmetric form (3) of the resonance equation:

$$1 - \frac{p^2}{u^2} - \gamma^2 v(u+1) - \gamma^2 v(-u+1) = 0 \quad (3b)$$

Since we know that one root of the equation is close to p , let the left side of the equation be evaluated for that value of u . If γ is small the function $v(u)$ may be stopped at its first approximation with an error of the order of γ^2 :

$$v(u) \simeq 1 / \left(1 - \frac{p^2}{u^2} \right).$$

In the present order of approximation, therefore, the left side of (3b) at $u = p$ has the value:

$$- \gamma^2 v(p+1) - \gamma^2 v(-p+1) \simeq - 2\gamma^2 \frac{3p^2 - 1}{4p^2 - 1},$$

and its derivative at that point is

$$2r + [\text{terms of the order of } \gamma^2],$$

so that a more approximate value of the root is given, according to Newton-Fourier's method, by

$$u_0 \simeq p \left\{ 1 + \gamma^2 \frac{3p^2 - 1}{4p^2 - 1} \right\}. \quad (6)$$

If all v fractions are stopped at their first term, as above, we find for the amplitudes A_n (from which the Q_n 's are deduced at once) the expressions¹⁰

$$A_n = (-\gamma)^n \frac{(u_0 + n)!}{u_0!^2} \frac{(u_0 + p)!(u_0 - p)!}{(u_0 + n + p)!(u_0 + n - p)!}; \quad (7)$$

A_{-n} as above, changing the sign of u_0 . The value of u_0 to be introduced in (7) may be given by (6).

If only approximate values of the amplitudes are desired, and the accurate value of u_0 is unessential, we may simply assume for A_n the value given by the above formula, where p is written for u_0 :

$$A_n = (-\gamma)^n \frac{(p + n)!}{p!^2} \frac{(2p)!}{n!(2p + n)!}; \quad (8)$$

A_{-n} as above, changing the sign of p .

In spite of their apparent complexity, (7) and (8) are extremely easy to be computed recurrently, if we write the ratio of two consecutive terms; for example,

$$\frac{A_n}{A_{n-1}} \simeq -\gamma \frac{(u_0 + n)^2}{(u_0 + n)^2 - p^2} \simeq -\gamma \frac{(p + n)^2}{(p + n)^2 - p^2},$$

and start from $A_0 = 1$. If we write, for instance, the last expression as

$$-\gamma \frac{n^2 + 2np + p^2}{n^2 + 2np},$$

the computation is immediate, since p is constant, and n is an integer.

An idea of the accuracy which can be attained by using approximate (7) and (8) is given by the numerical discussion of the next paragraph, where the exact values are compared with those given by (7) and (8), as well as with the standard approximate expressions in terms of Bessel Functions.

DISCUSSION OF A NUMERICAL CASE

The case to be discussed here refers to values of the parameters, which are unusually large in comparison to their customary values. This is done in order to better evidence the deviation, both of the dynamic case with respect to the static case and of the approximate solutions with respect to the true ones. γ is chosen

¹⁰ The symbol $x!$, where x is not an integer, denotes as usual Gauss' Π -function:

$$x! = \Pi(x) = \Gamma(x + 1).$$

equal to 0.1 (relative modulation of the capacitance (say): 20 per cent); $r=0.15$.¹¹

For the same reason, the results are developed to a degree of accuracy which is obviously exceedingly high for practical applications.

The static resonance takes place at $p=1/r=6.6666 \dots$. An approximate value of the dynamic resonance is given by (6) as

$$u_0 \simeq p \left\{ 1 + \gamma^2 \frac{3p^2 - 1}{4p^2 - 1} \right\} = 6.71657$$

to an accuracy of the order of $\gamma^4=0.01$ per cent. At this value of u , the left side of the resonance equation

$$1 - \frac{p^2}{u^2} - \gamma^2 v(u+1) - \gamma^2 v(-u+1) = 0$$

has the value $-0.00041\ 82359$.¹² Since an approximate value of the slope of the curve around $u=p$ is given by $2r=0.3$, it may be presumed that 6.718 may be in excess with respect to the true value of the root. At this point, the left side of the resonance equation is actually $+0.00011\ 31942$; so that, with a linear interpolation, we get 6.71769 54111 as a better approximate value for u_0

At this point, the left side has the value $+0.00000\ 00215\ 38$. By interpolating linearly between this point, and $u=6.718$, we get, as a second approximating value, $u_0=6.71769\ 53531\ 34$, which satisfies the resonance equation to within an error smaller than 10^{-12} . Two steps of successive approximation, that is, two linear interpolations, have been sufficient, therefore, to determine u_0 to twelve decimal figures.¹³

The values of the functions of interest in the computation, at this value of u , are

$$\begin{aligned} 1 - \frac{p^2}{u^2} &= 0.01513\ 46176\ 88; \\ -\gamma^2 v(u+1) &= -0.04375\ 41634\ 43 \\ -\gamma^2 v(-u+1) &= 0.02861\ 95457\ 55. \end{aligned}$$

Once the values of $v(u_0+1)$ and $v(-u_0+1)$ are known, those of $v(\pm u_0+k)$ (k , integer) are deduced immedi-

¹¹ The case of $2p=2/r$, being an integer, may give rise to unstable solutions, as it will be seen later.

¹² It may be useful to remember the method of computation of a continued fraction. If the fraction is written in the form

$$\frac{1}{c_0 - \frac{\gamma^2}{c_1 - \frac{\gamma^2}{c_2 - \dots}}}$$

the following recurrences are computed:

$$\begin{aligned} P_n &= c_n P_{n-1} - \gamma^2 P_{n-2} [P_0 = 1; P_{-1} = 0]; \\ Q_n &= c_n Q_{n-1} - \gamma^2 Q_{n-2} [Q_0 = c_0; Q_{-1} = 1]. \end{aligned}$$

The value of the fraction is the limit of P_n/Q_n for $n \rightarrow \infty$. In a computation to ten decimal figures, the number of intermediate numerators and denominators to be computed, when $\gamma=0.1$, is of five to seven, according to the magnitude of the partial denominators c_n .

¹³ The value 0.1 for γ is quite large. If γ is smaller, of course, the convergence is still better.

ately from the recurrence formulas.¹⁴ The exact values of the amplitudes A_n of the output voltage (if L is constant) are thus deduced at once, as they are given in column I of Table I. The values are compared with: 1) the approximate values given by (7), with the true value of u_0 (column II); 2) the approximate values given by formula (8) (column III); 3) the values computed with the usual expressions in terms of Bessel Functions, giving $J_n(p\gamma)/J_0(p\gamma)$ as approximate value of the amplitude A_n (column IV).¹⁵

TABLE I
ABSOLUTE VALUES OF THE AMPLITUDES A

n	I	II	III	IV
-6	2	2	1	21024
-5	1847	1785	1378	3 77420
-4	2 59683	2 50998	2 06644	56 40276
-3	130 27736	125 93840	108 48806	673 05898
-2	2883 90412	2790 36452	2501 50150	6001 12806
-1	28619 54576	27817 32090	26036 03604	35333 70935
0	Unity	Unity	Unity	Unity
1	43754 16344	39397 62919	41007 75194	35333 70935
2	11057 85895	9489 03916	10043 92765	6001 12806
3	2157 06307	1792 55699	1915 40661	673 05898
4	360 72133	292 38273	314 32314	56 40276
5	54 46822	43 23224	46 67222	3 77420
6	7 65116	5 96134	6 45543	21024
7	1 01875	78047	84712	1003
8	13020	9819	10677	42
9	1611	1197	1304	2
10	194	142	155	—
11	23	16	18	—
12	3	2	2	—

It is seen that the approximation by mean of Bessel functions does not give information regarding the existing asymmetry between "negative" and "positive" components; while, even in the present case where γ is rather large, formula (8), which is of very simple computation, gives a fair approximation to the true behavior of the oscillation.

The negative value $n=-6$ corresponds to the component having $u=0.71769 \dots$, which is the lowest component having positive frequency. It is seen that the exact solution of column I, as well as the approximate solutions of columns II and III, show that components beyond $n=-6$, that is, beyond $u=0$, are quite negligible in amplitude. This circumstance is not apparent in the approximate solution involving Bessel functions.

It can be easily verified that a numerical series of form (4) or (5), where the values Q are computed from the above with the formula $Q_n = u_0^2 / (u_0 + n)^2 A_n$, actually satisfies the differential equation, to within the limits of present accuracy; that is, to within 10^{-10} .

¹⁴ For reasons of numerical convenience it is preferable to compute the recurrence backwards; that is, by decreasing values of the argument. It is found convenient, therefore, to compute directly, by means of the continued fraction, a high v , for instance, in the present case, $v(12.717 \dots)$, so that most of the remaining v 's can be computed by the recurrence formula giving $v(u-1)$ in terms of $v(u)$.

¹⁵ To make the comparison more immediate, the zeros preceding the first significant figure are omitted.

The solution in terms of t is written at once; the central frequency, i.e., the dynamic frequency, is obtained from the static value $1/\sqrt{LC}$, through multiplication by $u_0/p = 1.00765\ 43029\ 70$.

STABILITY OF THE SOLUTIONS

A trigonometrical series of form (4) (with coefficients Q , or A , or I) always represents an *almost periodic* function of x . If we put in evidence the common factor e^{iu_0x} or e^{-iu_0x} , the series can be written:

$$q = e^{\pm iu_0x} [\dots + Q_{-2}e^{\mp 2iz} + Q_{-1}e^{\mp iz} + 1 + Q_1e^{\pm iz} + Q_2e^{\pm 2iz} + \dots]$$

The series in brackets is simply a Fourier series and represents a periodic function of x , with period 2π . If x is increased by 2π , therefore, the series remains unchanged and q is simply multiplied by $\exp(\pm 2\pi iu_0)$. If u_0 is real, the modulus of said expression is unity, so that the modulus of q remains unchanged; the integral is *stable*.

It is known, however, that for any differential equation with periodic coefficients such as (1), there exist values of the parameters p and γ resulting in one, or both, of the independent integrals of the equation being unstable. This means, physically, that under certain conditions the oscillations in the circuit may increase in amplitude beyond any limit or decrease to negligible values, as time increases.

The general theory of such equations also shows that, in the (p, γ) plane, the boundaries of regions of unstable solutions, if any, are given by the values of p and γ , which make of u_0 an integral multiple of $\frac{1}{2}$; that is, a number of the form n or $n + \frac{1}{2}$.

When u_0 is an integer, the multiplying term $e^{\pm 2\pi iu_0}$ has simply the value 1; if u_0 is an odd multiple of $\frac{1}{2}$, the value of the factor is -1 . In the former case, q is simply periodic, with period 2π ; in the latter case, the period is obviously 4π . These periodic functions, which are integrals of the differential equation when p and γ have suitable values, are the *characteristic functions* of the equation.

The equation of the curve (p, γ) , locus of values making u assume an assigned value u_0 , is simply obtained by writing that the resonance equation is satisfied by the given value of u :

$$\frac{1}{v(u_0)} - \gamma^2 v(-u_0 + 1) = 0$$

When u_0 is given, the equation obviously reduces to a relation between p and γ .

When u_0 is an odd multiple of $\frac{1}{2}$, two curves (p, γ) exist satisfying the above relation; the curves delimit a region of unstable solutions in the plane. Both curves start at the point $p = u_0 = n + \frac{1}{2}$; $\gamma = 0$, where they have a contact of order $2n$, and are entirely contained in the strip $\gamma < \frac{1}{2}$.

When u_0 is an *even* multiple of $\frac{1}{2}$, that is, an integer, the curves on the contrary coincide in a single one; that is, *there are no regions* of unstable oscillations starting at $p = 1, 2, 3, \dots$; $\gamma = 0$. Mathieu's equation, differing in this from our equation (1), actually *has* regions of instability beginning at these points, so that, when we replace the actual equation with an approximate Mathieu equation, as in Barrow's analysis, we are led to the erroneous conclusion of the existence of fields of unstable oscillations, which do not actually exist.¹⁶

The adoption of a Mathieu equation as an approximating equation for the circuit might also lead to the conclusion that the regions of unstable oscillations become indefinitely large when γ increases. This is not true. Since the regions of instability are confined in a strip of the plane of finite width $\frac{1}{2}$, the regions are not only limited in area, but decrease very rapidly as u_0 increases, due to the contact of increasing order existing between the boundary curves at their origin $p = n + \frac{1}{2}$, $\gamma = 0$.

The region starting at $p = 3/2$ is already extremely narrow in comparison to the first one ($u_0 = \frac{1}{2}$). Table II

TABLE II
VALUES OF p (FOR GIVEN γ), MAKING $u_0 = \frac{1}{2}, 1, 3/2$

γ	$u_0 = \frac{1}{2}$		$u_0 = 1$	$u_0 = 3/2$	
0	0.50000	0.50000	1	1.50000	1.50000
0.1	0.47137	0.52165	0.99325	1.48905	1.48907
0.2	0.43448	0.53659	0.97170	1.45409	1.45428
0.3	0.38463	0.54360	0.93048	1.38673	1.38763
0.4	0.31159	0.53771	0.85374	1.26028	1.26325
0.45	0.25207	0.52348	0.78327	1.14183	1.14789
0.5	0	0.35355	0.35355	(0.35355)	(0.35355) ¹⁷

gives the co-ordinates of some points of the boundary curves, as deduced from the resonance equation; at the same time, we give some points of the (single) curve $u_0 = 1$.

If the above values are plotted in a graph, as in Fig. 1, it becomes evident that the only region of instability having such dimensions as to make the detection of the instability itself by physical methods possible, is that starting at $p = \frac{1}{2}$. Almost the entire ordinate $p = \frac{1}{2}$ is contained in said region.

The physical meaning of the above remark is evident. When a capacitor is submitted to a difference of potential of frequency ω , the force developed between the plates has a frequency of 2ω . Conversely, according to the present result, when a capacitor is submitted to a mechanical force acting with a frequency double to that of the static oscillation of the circuit, of which the capacitor is an element, the circuit itself can execute

¹⁶ Thus, for instance, out of the shaded areas of Figs. 1, 2, and 6 of Barrow's paper, only those starting at abscissas 0.25, 2.25, 6.25, etc., are actually instability fields of the equation.

¹⁷ An exhaustive proof of the confluence of all the boundary curves in the point $\gamma = \frac{1}{2}$, $p = \sqrt{2}/4$ has not yet been given. The values of the last row must hence be regarded as "likely."

oscillations of increasing amplitude at its natural frequency. Since we have supposed that the circuit be a nondissipative one, the amplitude of the oscillations may increase beyond any limit, owing to the energy absorbed from the driving mechanism by electromechanical resonance.

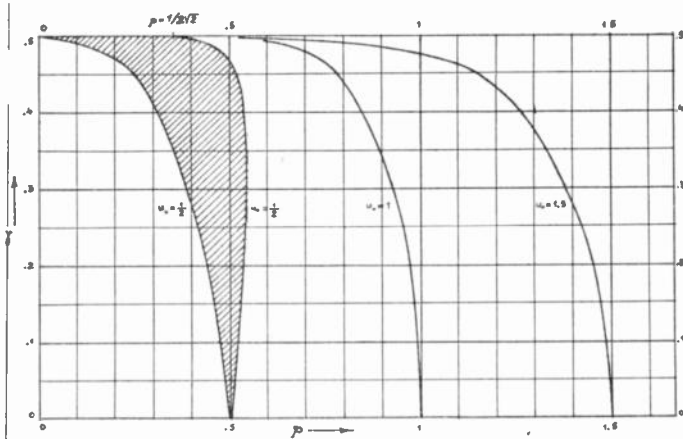

Fig. 1—Stability diagram. The shaded area represents a region of unstable oscillation. A second very narrow region of instability runs along the curve $u_0 = 1.5$.

THE EQUATION OF THE DISSIPATIVE CIRCUIT

Let us presume, for instance, that L is fixed, and the capacitance variable as above. The equation of a circuit having a resistance R , in terms of the charge q , and of the usual temporal variable $x = \mu t$, is:

$$\mu^2 L \frac{d^2 q}{dx^2} + \mu R \frac{dq}{dx} + \frac{q}{C(1 + 2\gamma \cos x)} = 0.$$

The equation is reduced to normal form by writing $q = e^{-(R/2\mu L)x} y$; if we write, further, s^2 for $R^2 C/4L$, and r^2 for $\mu^2 LC$ as above, the final equation is

$$r^2(1 + 2\gamma \cos x) \frac{d^2 y}{dx^2} + [1 - s^2(1 + 2\gamma \cos x)] y = 0.$$

By expanding y in a trigonometric series as usual and substituting it in the equation as above, we are led to conclusions which may be directly obtained from those related to the nondissipative circuit, by replacing the expression

$$G(u) = 1 - \frac{1}{r^2 u^2} = 1 - \frac{p^2}{u^2},$$

wherever it may occur, with the function

$$G'(u) = 1 - \frac{1}{r^2 u^2 + s^2}.$$

Thus, for instance, the resonance equation becomes

$$\frac{1}{w(u)} = \gamma^2 w(-u + 1),$$

where $w(u)$ is the function defined by the continued fraction:

$$w(u) = \frac{1}{G'(u) - \frac{\gamma^2}{G'(u + 1) - \frac{\gamma^2}{G'(u + 2) - \dots}}$$

The static resonance, which happened at $G(u) = 0$ ($u_0 = \pm p$), is now at $G'(u) = 0$, that is, at $u = \pm p\sqrt{1 - s^2}$.

If s is small (as is usually the case) the equation for y may be reduced to the form of the equation giving q in the nondissipative case, provided p is replaced by $p\sqrt{1 - s^2}$. But the integral q of the dissipative case is given by y multiplied by the exponential term

$$e^{-(R/2\mu L)x} = e^{-(R/2L)t},$$

which is steadily decreasing, with the increase of x . Hence, if p , γ , and s are such that the point $(p\sqrt{1 - s^2}, \gamma)$ belongs to a region of stability of the nondissipative equation, that is, if the integral y is stable, the integral q is always damped, according to the time constant $2L/R$ due to the energy dissipation in R .

Permanent oscillation may take place in spite of said dissipation, if the integral y is unstable in itself, according to an exponential law with a time constant equal in magnitude, and opposite in sign, to that of the above factor.

This happens when u_0 has a complex value, such that the real part of iu_0 is just $R/2\mu L$; that is, when the resonance equation of the nondissipative circuit with parameters $p' = p\sqrt{1 - s^2}$, and γ has roots of the form $U - i(R/2\mu L)$, where U is real.

Complex values of the roots of the resonance equation may only occur, obviously, in regions of the (p', γ) -plane, where the solutions y are unstable; that is, practically, only in the region starting at $p' = \frac{1}{2}$. This corresponds, physically, to a driving frequency of the capacitor double to that of the static resonance of the dissipative circuit.

When this is the case, permanent oscillations can take place, since the energy dissipated in the circuit is taken from the driving device of the capacitor.



Class-A Push-Pull Amplifier Theory*

HERBERT L. KRAUSS,† MEMBER, I.R.E.

Summary—Two tubes operating in push-pull, class-A₁, will produce more than twice the power output of a single tube using the same operating voltages, and with optimum load values in each case. This is demonstrated analytically by means of an equivalent circuit. The change in load impedance seen by one tube due to the effect of coupling to the other tube is considered and used to explain the results obtained. Experimental data are presented to verify the theory.

INTRODUCTION

SINCE THE first paper on the operation of push-pull amplifiers by B. J. Thompson,¹ relatively little has been added to our knowledge of the circuit operation. In explaining the increased power output available (with a given percentage distortion) from push-pull amplifiers as compared to single-tube amplifiers, the statement is usually made that because of the elimination of even-order harmonics by the push-pull connection the tubes may be driven harder to obtain a greater output per tube without exceeding the prescribed maximum distortion. However, the case of single and push-pull tubes operating with the same plate voltage, grid bias, and grid signal has not been considered. Under this condition, the push-pull connection will deliver more than twice the output power obtainable from a single tube, using load resistances to give maximum power output in each case,

Symbols

The circuit diagram is shown in Fig. 1, and the symbols are defined in the accompanying list. Subscripts 1 and 2 are used to differentiate between corresponding quantities for the two tubes as indicated in Fig. 1.

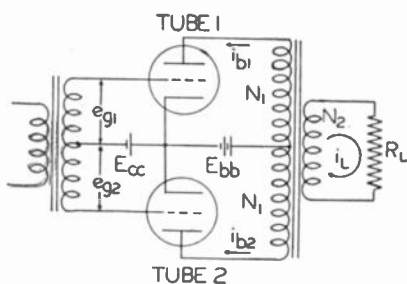

Fig. 1—Push-pull amplifier circuit.

N_2 = number of turns on output-transformer secondary winding

N_1 = number of turns on one-half the primary winding

E_{bb} = plate-supply voltage

E_{cc} = grid-bias voltage

e_b = total instantaneous plate voltage

e_c = total instantaneous grid voltage

e_g = instantaneous varying component of grid voltage

E_g = effective value of the varying component of grid voltage

i_{b0} = quiescent plate current of one tube

i_p = instantaneous varying component of plate current

$i_b = I_{b0} + i_p$ = total instantaneous plate current

$i_d = i_{b1} - i_{b2}$ = net instantaneous magnetizing component of current in the transformer primary

i_L = instantaneous load current

r_p = instantaneous dynamic plate resistance

r_{p0} = dynamic plate resistance of either tube at the quiescent operating point

r_d = dynamic plate resistance of the composite tube

R_L = load resistance on the transformer secondary

$R_{pp} = 4 \left[\frac{N_1}{N_2} \right]^2 R_L$ = plate-to-plate reflected load resistance due to R_L

$R_L' = \left[\frac{N_1}{N_2} \right]^2 R_L$ = reflected load resistance due to R_L across one-half the transformer primary.

THEORY OF PUSH-PULL OPERATION

The usual assumptions are made that the tubes and related circuit elements are identical, and that the load is coupled to the tubes through an ideal transformer having no resistance or leakage reactance. Signal voltage applied to the grids is assumed to be sinusoidal, and to be limited to values giving class-A₁ operation ($\sqrt{2}E_g \leq E_{cc}$).

From an examination of Fig. 1 it is apparent that for the quiescent operating condition (no signal applied) the grid voltages, plate voltages, and plate currents of the two tubes will be identical. Thus,

$$e_{c1} = e_{c2} = E_{cc} \quad (1)$$

$$e_{b1} = e_{b2} = E_{bb} \quad (2)$$

$$i_{b1} = i_{b2} = I_{b0} \text{ of one tube.} \quad (3)$$

When a signal voltage is applied to the input, the center-tapped transformer connections cause the instantaneous changes in grid and plate voltages to be equal and opposite for the two tubes.

$$\Delta e_{c1} = -\Delta e_{c2} \quad (4)$$

$$\Delta e_{b1} = -\Delta e_{b2} \quad (5)$$

* Decimal classification: R363.222. Original manuscript received by the Institute, January 8, 1947; revised manuscript received, February 27, 1947.

† Yale University, New Haven, Conn.

¹ B. J. Thompson, "Graphical determination of performance of push-pull audio amplifiers," Proc. I.R.E., vol. 21, pp. 591-601; April, 1933.

Since the currents i_{b1} and i_{b2} flow in opposite directions in the transformer primary, the net flux-producing current is

$$i_d = i_{b1} - i_{b2}, \tag{6}$$

which is related to the load current (i_L) by

$$i_L = \frac{N_1}{N_2} (i_d) \tag{7}$$

where i_d is assumed flowing in N_1 turns (one-half the primary winding).

But if Δe_{c1} is positive,

$$i_{b1} = I_{b0} + \Delta i_{b1}, \text{ and } i_{b2} = I_{b0} - \Delta i_{b2}. \tag{8}$$

Substitution in (6) gives

$$i_d = \Delta i_{b1} + \Delta i_{b2}, \tag{9}$$

in which the varying components of i_{b1} and i_{b2} add as far as i_d (or i_L) is concerned. This suggests an equivalent circuit for the varying quantities in which the two tubes may be considered as generators in parallel supplying the common load resistance. Let the instantaneous values of the varying components of current be i_{p1} and i_{p2} , and let

$$R_L' = R_L \left[\frac{N_1}{N_2} \right]^2$$

be the reflected load resistance seen across N_1 turns of the primary.

The equivalent circuit is shown in Fig. 2, with the current and voltage directions established by the foregoing discussion. The plate resistances of the two tubes are called r_{p1} and r_{p2} , respectively, since they are not necessarily equal except at the quiescent operating point. The values of μ for the two tubes are assumed equal and constant throughout the operating cycle.³ This equivalent circuit holds for the nonlinear as well as the linear region of tube operation, as long as the nonlinearity can be expressed by variations in r_{p1} and r_{p2} only.

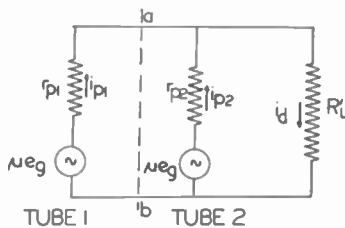

Fig. 2—Equivalent circuit for the push-pull amplifier.

Now consider the composite plate characteristics, load line, and individual-tube operating line ($A-A'$)⁴ shown for triode-connected 6L6's in Fig. 3, with the operating voltages chosen the same as those which

would give good class- A_1 operation with a single tube, and with the load line (representing R_L') chosen to give maximum power output ($R_L' = r_d$). The individual-tube operating line ($A-A'$) is not straight, so it represents a

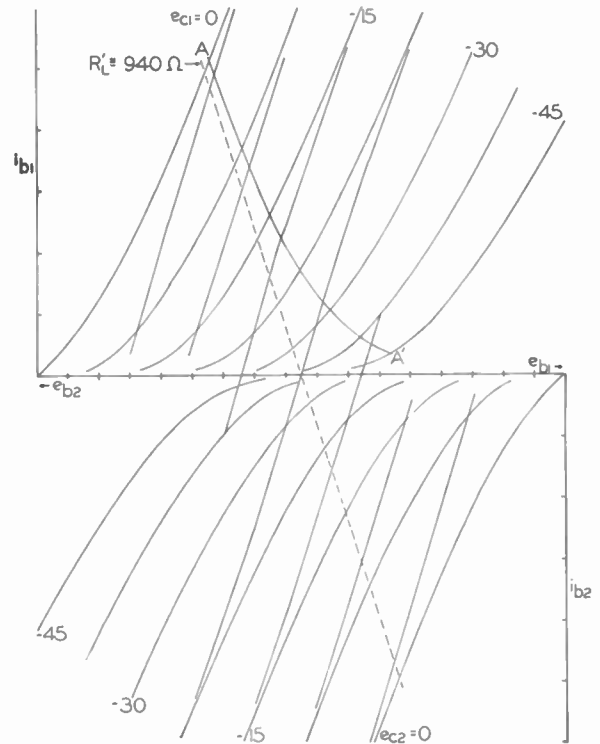

Fig. 3—Composite characteristics for a push-pull amplifier using two 6L6 tubes, triode-connected, with $E_{bb} = 255$ volts, $E_{cc} = -22.5$ volts, $R_L' = r_d = 940$ ohms.

varying load resistance presented to the tube. However, for the optimum load chosen, the slope of $A-A'$ is approximately equal to the negative of the slope of the individual-tube plate characteristics at each of their intersections; so the dynamic plate resistance of the tube sees an equal load resistance throughout the cycle. Thus, the conditions for maximum power transfer⁴ are satisfied at each instantaneous point in the operating cycle; whereas this is not true in large-signal operation of single-tube amplifiers where the load and tube impedances can be matched at only one point in the cycle. Thus, each tube in the push-pull amplifier should be able to deliver more power to the load than it could in single-tube operation, because of the continuous impedance-match.

The equivalent circuit of Fig. 2 will now be solved to verify the preceding discussion. All quantities except the reflected load resistance R_L' and μ are *instantaneous* values, including the varying plate resistances r_{p1} and r_{p2} . Let the load resistance seen by tube 1 be r_{ab} = impedance of the circuit to the right of line $a-b$ in Fig. 2. This impedance cannot be expressed merely as the parallel combination of r_{p2} and R_L' , because of the action of the two equivalent generators in the circuit; i.e., r_{ab} includes

³ M.I.T. Staff, "Applied Electronics," John Wiley and Sons, New York, N. Y., 1943, p. 182.

⁴ See pp. 440-446 of footnote reference 2.

⁴ W. L. Everitt, "Communication Engineering," McGraw-Hill Book Co., New York, N. Y., 1937, pp. 49-52.

the effect of the generated voltage, μe_o , in series with r_{p2} , and this voltage must always be equal to the voltage μe_o in series with r_{p1} to satisfy the conditions for push-pull operation. Therefore, to find the load impedance seen by tube 1, solve for i_{p1} and use the relation

$$r_{ab} = \frac{\mu e_o}{i_{p1}} - r_{p1}. \quad (10)$$

The circuit equations for Fig. 2 are

$$i_d = i_{p1} + i_{p2} \quad (11)$$

$$\mu e_o - \mu e_o = i_{p1} r_{p1} - i_{p2} r_{p2} \quad (12)$$

$$\mu e_o = i_d R_L' + i_{p2} r_{p2}. \quad (13)$$

These combine to give

$$0 = i_{p1} r_{p1} - i_{p2} r_{p2} \quad (14)$$

$$\mu e_o = i_{p1} R_L' + i_{p2} (R_L' + r_{p2}). \quad (15)$$

Solving for i_{p1} gives

$$i_{p1} = \frac{\mu e_o r_{p1}}{r_{p1} (R_L' + r_{p2}) + R_L' r_{p2}}. \quad (16)$$

Then

$$\frac{\mu e_o}{i_{p1}} = r_{p1} + R_L' \left[1 + \frac{r_{p1}}{r_{p2}} \right]. \quad (17)$$

From (10),

$$r_{ab} = R_L' \left[1 + \frac{r_{p1}}{r_{p2}} \right]. \quad (18)$$

To show that $r_{ab} = r_{p1}$ at all times, a relationship between r_{p1} , r_{p2} , and r_d (dynamic plate resistance of the composite tube) must be found. Let the dynamic plate resistance of the composite tube be expressed as

$$r_d = \frac{\Delta e_{b1}}{i_d}. \quad (19)$$

But, as has been shown previously, at any point on the composite tube lines

$$i_d = \Delta i_{b1} + \Delta i_{b2} \quad (20)$$

$$\Delta i_{b1} = \frac{\Delta e_{b1}}{r_{p1}} \quad (21)$$

$$\Delta i_{b2} = \frac{-\Delta e_{b2}}{r_{p2}} = \frac{\Delta e_{b1}}{r_{p2}} \quad (22)^{\dagger}$$

$$r_d = \frac{\Delta e_{b1}}{\frac{\Delta e_{b1}}{r_{p1}} + \frac{\Delta e_{b1}}{r_{p2}}} = \frac{r_{p1} r_{p2}}{r_{p1} + r_{p2}}. \quad (23)$$

[†] The negative sign in the second expression is necessary in order to make it agree with the definition of Δi_{b2} in equation (8).

This equation states that, with $R_L' = r_d$, the plate resistance of the composite tube at any instantaneous operating point is equal to the parallel combination of the plate resistances of the individual tubes (thus further validating the use of the equivalent circuit of Fig. 2).

Since the composite-tube plate characteristics are very nearly straight, parallel lines for class-A₁ operation (see Fig. 3), r_d is almost constant throughout the cycle even though r_{p1} and r_{p2} are varying. This approximation to a constant value would become progressively poorer for class-AB or -B operation. However, for purposes of this analysis r_d will be considered constant, and the equivalent load resistance R_L' will be given the value

$$R_L' = r_d = \frac{r_{p0}}{2} \quad (24)$$

since the plate resistances of the two tubes are assumed equal at the quiescent operating point. Thus, the impedances of load and composite tube will be equal at all times, giving maximum-power-transfer conditions throughout the cycle. Considering the load impedance seen by the individual tube, (23) and (24) may be substituted in (18) to give

$$r_{ab} = r_{p1}, \quad (25)$$

indicating that each tube operates into a load resistance equal to its plate resistance at every point in the cycle. Thus, each tube is also delivering maximum power at all times.

EXPERIMENTAL RESULTS

In order to check the theory, the fundamental-frequency power output of two triode-connected 6L6 tubes was determined both graphically and experimentally for both parallel and push-pull connections. The operating voltages were the same in all cases, and load values giving maximum power output were used. The calculated and measured values agreed perfectly within the limits of experimental error, giving 3.6 watts for parallel and 4.1 watts for push-pull operation. The parallel operation produced 14 per cent second-harmonic distortion, compared to less than 2 per cent third harmonic (negligible second harmonic) with the push-pull connection. The 11 per cent increase in power noted above would be even greater if the distortion in the output of the parallel connection had been held to a tolerable value. Thus, the theory is clearly verified.

ACKNOWLEDGMENT

The author wishes to express his thanks to P. F. Ording of the Department of Electrical Engineering, Yale University, for his helpful criticism and suggestions during the course of this investigation.

Methods of Tuning Multiple-Cavity Magnetrons*

R. B. NELSON†, MEMBER, I.R.E.

Summary—Several methods have been developed for tuning multiple-cavity magnetron oscillators over wide frequency ranges. The most successful of these involves simultaneous variation of both the inductance and capacitance of all the resonant cavities by a single tuning motion. Tuning ranges of better than 1.4 to 1 have been obtained with good efficiency throughout.

As an example, a magnetron is described which tunes from 760 to 1160 megacycles, delivering over 2 kilowatts continuous-wave power at any frequency setting.

INTRODUCTION

WHEN THE need arose during the war for power oscillators to give continuous frequency coverage over several octaves, a program was started at the General Electric Research Laboratory, under the sponsorship of Division 15 of the National Defense Research Committee, to develop tunable continuous-wave magnetrons. The advantages obtainable from wide tuning ranges of each tube prompted two lines of development. The first of these was to start with a type of tube inherently easy to tune, the split-anode magnetron, and try to improve its undesirable electronic characteristics. A second approach was to use multi-cavity magnetrons, which are known to be good, efficient oscillators, but which are inherently hard to tune. In this paper are described some methods which were developed to give them a wide tuning range.

INTERNAL TUNING

The logical way to tune an oscillator with multiple tank circuits is to vary simultaneously the resonant frequency of each circuit. In a magnetron the cavities are arranged symmetrically so it is easy to work on all of them with a single tuning member. In Fig. 1 is shown a simple method of internal tuning, which had been used previously. The flat tuning disk forms parallel-plate capacitors with the tops of the anodes and the flat straps. Vertical motion of the disk varies these capacitances and hence the resonant frequencies of all the cavities. The variable capacitance is effectively shunted across the normal built-in capacitance of the tank circuits. Since it varies inversely with the plate separation, the tuning curve of the oscillator is the hyperbolic relation shown in Fig. 4. Of course, the usable portion of this curve is limited by mechanical considerations such as the total length of motion available for the disk, accuracy and parallelism of the capacitance plates, thermal expansion of parts, etc. In the frequency range

between 500 and 1500 megacycles, it is not hard to get a useful tuning ratio of 1.2 to 1 with the capacitance disk.

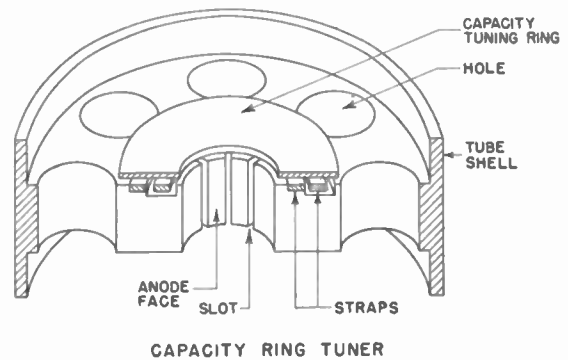

Fig. 1—Lowering the capacitance tuning ring increases capacitance to the anodes and straps. The lower curve in Fig. 4 shows the variation in resonant frequency produced.

A similar effect is obtained by varying the effective inductance of the cavities. In Fig. 2 the tuning disk

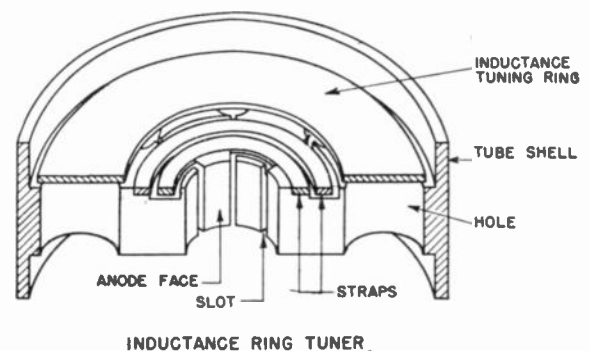

Fig. 2—Lowering the inductance tuning ring reduces the inductance of the holes. The upper curve in Fig. 4 shows the resulting change in resonant frequency.

covers up the holes of a hole-and-slot magnetron, thus constricting the magnetic flux and raising the resonant frequency as it approaches the cavities. The tuning curve has the same general hyperbolic shape as for capacitive tuning, but is of course in the opposite direction, since the inductance is reduced by the proximity of the tuner, while the capacitance is increased.

Both simple inductance and capacitance tuning have several disadvantages. First, the tuning curves are essentially nonlinear. (This defect can be mitigated somewhat by shaping the tuning elements to penetrate into holes in the resonator elements, giving variable-area instead

* Decimal classification: R355.912.1. Original manuscript received by the Institute, October 21, 1946; revised manuscript received, December 13, 1946.

† Research Laboratory, General Electric Co., Schenectady, N. Y.

of variable-separation capacitors.¹⁾ Second, the characteristic impedance of the resonant cavities is materially changed by the tuning. The characteristic impedance is $\sqrt{L/C}$, where L and C represent the effective lumped values of the distributed constants, and the resonant frequency is $1/2\pi\sqrt{LC}$. It follows that, if either L or C is varied, the characteristic impedance changes in the same ratio as the frequency. Varying characteristic impedance makes more difficult the problems of load matching and modulation over a wide range of frequencies.

INDUCTANCE-CAPACITANCE TUNING

The most effective tuning method found was a simultaneous variation of inductance and capacitance of the cavities. Fig. 3 shows the first practical structure for doing this. A capacitance ring on one side of the anode block is rigidly connected to an inductance ring on the other. The entire structure is moved up and down by micrometer screws, the motion being transmitted through the vacuum envelope by flexible metal bellows.

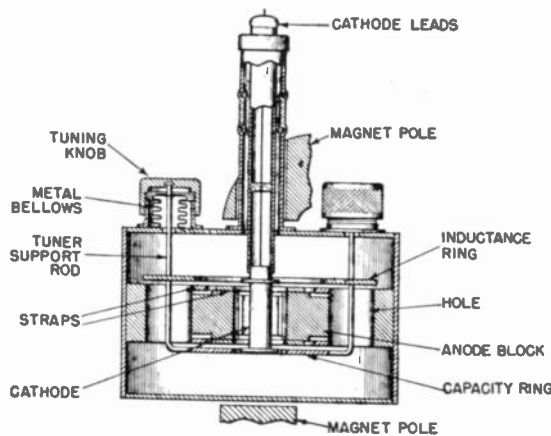

Fig. 3—The two tuning rings move as a unit, one approaching the anode block as the other recedes.

As the tuning structure is raised, the capacitance disk comes nearer to the anodes, increasing the effective capacitance. Simultaneously the inductance disk moves away from the holes, increasing the inductance. Both effects add to produce a large decrease in frequency. Fig. 4 shows the type of tuning curve obtained. The individual rings produce curvatures in opposite directions, so the combination gives a long, linear tuning range.

Since L and C are varied in the same direction, the characteristic impedance $\sqrt{L/C}$ is to a first approximation kept constant as the oscillator is tuned.

Magnetrons such as shown in Fig. 3 have been successfully used as tunable oscillators between 500 and 1500 megacycles. Useful frequency ratios of 1.4 to 1 are easily obtainable.

¹ J. B. Fisk, H. D. Hagstrum, and P. L. Hartman, "The magnetron as a generator of centimeter waves," *Bell Sys. Tech. Jour.*, vol. 25, p. 167; April, 1946.

One source of trouble is present in this structure, however. The two tuning rings with their supporting members form a complicated mechanical structure which is difficult to cool. It also has a large number of electrical resonances. When the oscillator is tuned near one of these resonant frequencies a parasitic oscillation is excited in the tuning structure, heating it up and reducing the oscillator efficiency.

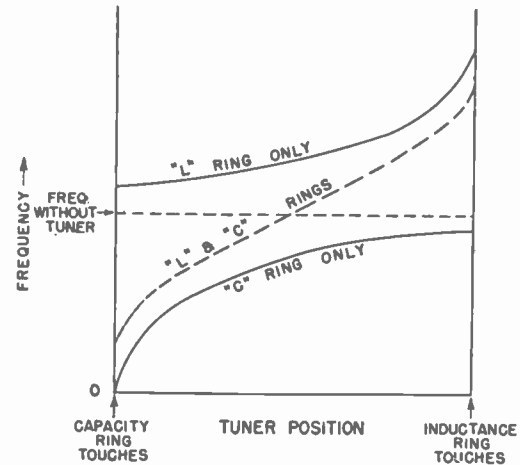

Fig. 4—The solid curves are those obtained with the single disks of Figs. 1 and 2. The dashed line is the tuning curve of the ganged tuner in Fig. 3.

SINGLE-DISK TUNER

Parasitic resonances of the tuner were eliminated by a further development in which both "L" and "C" tuning are done by a single disk. If one tuning member is to

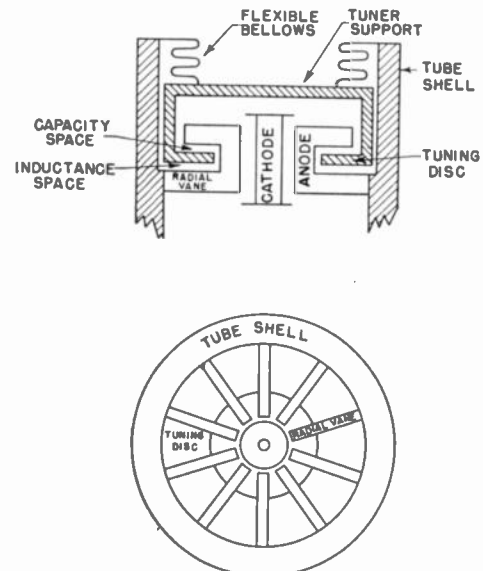

Fig. 5—By properly shaping the anode vanes, motion of a single tuning disk varies both inductance and capacitance.

perform both functions, it is necessary to vary its position with respect to both the parts of the tank circuits where the capacitance is concentrated and those which determine the inductance. To do this, while keeping the mechanical motion small, the best solution is to have

put seal and the flexible bellows are cooled by air blasts, while the anodes and the tuner are water cooled.

Fig. 7 is a photograph of the completed tube, cut open.

PERFORMANCE

The measured tuning curve of this tube is shown in Fig. 8, the S shape being due to the combination of nonlinear inductance and capacitance variations. Fig. 9 is a performance chart at 900 megacycles. With

optimum operating conditions, a power output of over 4 kilowatts was obtained from these tubes. Plate efficiencies measured as high as 85 per cent, but varied considerably over the tuning range.

ACKNOWLEDGMENTS

The author wishes to thank A. W. Hull for his advice and interest in this work. The assistance of T. C. Swartz and Miss H. C. Hertha is gratefully acknowledged.

Theory of the Circular Diffraction Antenna*

A. A. PISTOLKORS†

Summary—The object of this investigation is a study of the electromagnetic field produced by a diffraction antenna in the form of a circular gap made in a conducting plane. An e.m.f. is applied across the gap. The method of investigation is based on the classical diffraction theory by Fresnel and Kirchhoff. The expressions for E and H are obtained and applied to the calculation of electric field intensity at a great distance, and the directive patterns are plotted. The current distribution in the screen is then studied and the expression for the gap admittance is obtained. The surface current density appears as a sum of an infinite number of partial or wave modes. The radiation conductance rises step-wise with increasing radius like the radiation conductance of an oscillating sphere excited at the equator.

I. INTRODUCTION

A CIRCULAR diffraction antenna consists of a gap made in a well-conducting unlimited plane as shown in Fig. 1. The disk cut out of the plane is submitted to the action of a high-frequency potential difference. The lines of electric force directed radially then exist only in the aperture. In the remainder of the plane, because of its good conductivity, the tangential

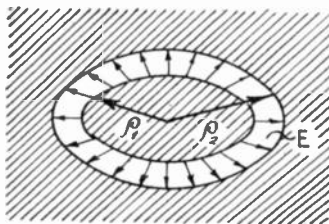

Fig. 1—Circular diffraction antenna consisting of a circular split in a conducting plane.

component of electric force may be considered to be zero.

The magnetic lines of force will be circles concentric with the antenna; therefore, the electric-current density on the conducting plane will be directed radially. The

* Decimal classification: R120. Original manuscript received by the Institute, December 2, 1946.

† Leningrad Institute of Communication Engineering, Leningrad, U.S.S.R.

electric and magnetic field distribution is similar to that of a vertical cylindrical antenna, concentric with the disk.

The idea of employing diffraction antennas is not new. The elementary diffraction antennas, such as a round aperture and a linear split made in the envelope of endovibrators (hollow electromagnetic resonators), were investigated by Neumann.¹

2. GENERAL FORMULAS FOR ELECTRIC AND MAGNETIC FIELD

This investigation will be based upon the classical diffraction theory by Fresnel and Kirchhoff. Let v be a scalar function continuous in the domain of integration equaling one of cartesian components of the electric field. Let G be the Green's function in space over the conducting plane:

$$G = e^{-ikr}/r - e^{-ikr'}/r'$$

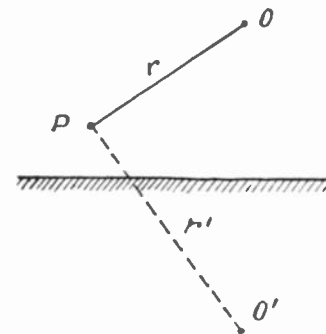

Fig. 2—The position of the screen, of the point O , and their image O' .

where r is the distance from the observation point O seen in Fig. 2 to the point P , whose co-ordinates are variables of integration; r' is the distance from the image O' of the point O to the same point P ; and $k = 2\pi/\lambda$, where λ is the wavelength.

¹ M. S. Neumann, "Radiation of electromagnetic energy through apertures," *Izvestija Elektropromyshlennosti Slabogo Toka*, vol. 6, pp. 11, 1940. (In Russian.)

The Green's function vanishes on the plane where $r=r'$. When v is the value of the function at the point O , and v_0 the value on the plane, then the following relation exists²

$$4\pi v = - \int_s v_0 \frac{\partial g}{\partial n} ds. \tag{1}$$

The derivative is taken in the direction of external normal n ; integration is extended over the whole conducting plane S . Practically, the integration must be carried out only over the surface of the gap, while in the remaining part of the plane the tangential component of electric field is zero as stated above.

In this case (1) reduces to:

$$\begin{aligned} 4\pi v &= - 2 \int_s v_0 \partial/\partial r (e^{-ikr}/r) \cos(n, r) ds \\ &= - 2 \int_s v_0 \partial/\partial n (e^{-ikr}/r) ds. \end{aligned} \tag{2}$$

Let the conducting surface (screen surface) be the XY plane, the internal normal be parallel to the Z axis. Let v be E_x or E_y —one of two cartesian components of the sought electric field. The radial component E_r may be found upon calculating E_x for $y=0$ (E_y for $x=0$). Then

$$E_r = | E_x |_{y=0} = 1/2\pi \int_s E_{x0} \partial/\partial z (e^{-ikr}/r) ds \tag{3}$$

where E_{x0} is the electric field intensity in the plane XY .

The magnetic field intensity may be found from the first Maxwell equation:

$$i\omega\epsilon E = \text{curl } H$$

which, in the case of cylindrical co-ordinates $r'\phi'\zeta'$ of the observation point O , leads to:

$$i\omega\epsilon E_r = - \partial H_\phi / \partial \zeta'$$

From this we obtain

$$\begin{aligned} H_\phi &= - i\omega\epsilon \int E_r d\zeta' = - i\omega\epsilon/2\pi \int \int_s E_{x0} \partial/\partial z (e^{-ikr}/r) ds d\zeta' \\ &= i\omega\epsilon/2\pi \int_s E_{x0} (e^{-ikr}/r) ds \end{aligned} \tag{4}$$

as

$$\partial/\partial z (e^{-ikr}/r) = - \partial/\partial \zeta' (e^{-ikr}/r).$$

Equations (3) and (4) offer the basic formulas for further calculations.

3. FIELD AT A DISTANT ZONE. DIRECTIVE PATTERNS

By virtue of (2) and (3), and recalling that

$$\partial/\partial r (e^{-ikr}/r) = - ik/re^{-ikr}(1 - 1/ikr),$$

² P. Frank and R. Mises, "Differential and Integral Equations of Mathematical Physics" (Russian edition), 1937, chap. 20, pp. 3 and 4.

we obtain

$$E_r = - ik/2\pi \int E_{x0} e^{-ikr}/r (1 - 1/ikr) \cos(z, r) ds. \tag{5}$$

For great values of r the second term inside the parentheses may be neglected with respect to unity, and

$$E_r = - ik/2\pi \int E_{x0} e^{-ikr}/r \cos(z, r) ds.$$

At a great distance the rays from different points of the gap are parallel, and all values of r in the denominator may be assumed equal. Hence,

$$E_r = - ik \cos \theta / 2\pi r \int E_{x0} e^{-ikr} ds$$

where $\cos \theta = \cos(z, \pi)$.

According to Fig. 3,

$$r = r_0 - \rho \cos \phi \sin \theta$$

where ρ is the radius of the circle and r_0 is the distance from their center, and

$$E_{x0} = E_0 \cos \phi$$

where E_0 is the radial component of electric field intensity at the surface of the gap.

Generally speaking, E_0 is some function of r , showing how the electric field in the gap varies in a radial

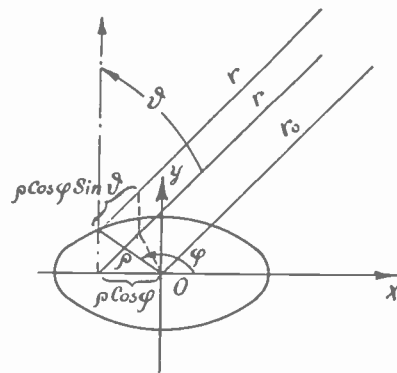

Fig. 3—The geometrical constructions necessary for calculating the electric field at a great distance.

direction. This function depends upon the construction of the gap and cavity beyond it, and also on the mode of excitation or feeding the antenna. Introducing no hypothesis as to the character of function E_0 in our calculations we shall assume the gap to be sufficiently small. Thus, integrating over the surface of the gap, and recalling that the element of area is $ds = r dr d\phi$, we may write

$$\int E_0 r dr = \rho E_0$$

where \mathcal{E}_0 is the potential difference between the edges of the gap. Then

$$E_r = -ik\rho\mathcal{E}_0 \cos\theta e^{-ikr_0}/2\pi r_0 \int_{-\pi}^{\pi} \cos\phi e^{ik\rho\cos\phi\sin\theta} d\phi.$$

Applying the following formula, known from the theory of Bessel functions,

$$\mathfrak{J}_1(x) = -\frac{i}{\pi} \int_0^{\pi} \cos\omega \cdot e^{ix\cos\omega} d\omega$$

we obtain

$$E_r = \frac{\kappa\rho\mathcal{E}_0}{r_0} e^{-ikr} \cos\theta \mathfrak{J}_1(\kappa\rho \sin\theta). \tag{7}$$

At a great distance from the source, the electric vector E of a spherical wave is perpendicular to r and forms an angle $\pi-\theta$ with E_x ; $E_x = -E \cos\phi$. Therefore we obtain for r.m.s. values of E and \mathcal{E}_0

$$E = -\frac{\kappa\rho\mathcal{E}_0}{r_0} \mathfrak{J}_1(\kappa\rho \sin\theta) \tag{8}$$

and $e^{-i(kr_0-\pi)}$ for the phase.

The electric-field intensity is proportional to the e.m.f. applied and to the radius of the circle. The increasing of radius results in new maxima and minima appearing in the vertical-plane directive pattern shown in Fig. 4.

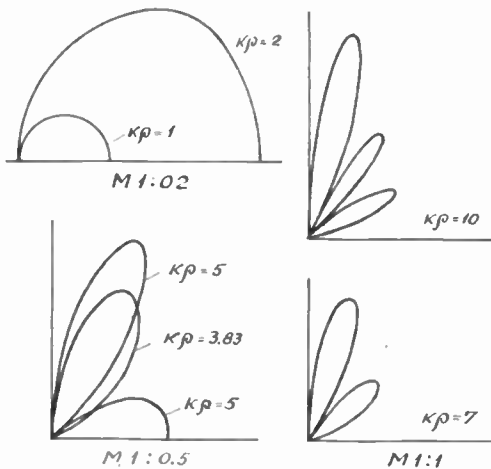

Fig. 4—Directional characteristics in a vertical plane of field produced by circular diffraction antennas of varying radii.

It will be noted that the number of complete petals of the directive pattern equals the number of roots in-

TABLE I
FIRST 10 ROOTS OF BESSEL FUNCTION $\mathfrak{J}_1(x)$ AND CORRESPONDING RADIUS OF CIRCULAR ANTENNAS

Root No.	1	2	3	4	5	6	7	8	9	10
Value of root	3.83	7.02	10.17	13.32	16.47	19.62	22.76	25.90	29.05	32.19
Radius of antenna ρ/λ	0.61	1.12	1.62	2.12	2.62	3.12	3.62	4.12	4.62	5.12

cluded in the argument of Bessel function. The values of radii corresponding to the first 10 roots are given in Table I.

If the radius is small with respect to the wave length, we may put

$$\mathfrak{J}_1(\kappa\rho \sin\theta) = \frac{1}{2}\kappa\rho \sin\theta.$$

Then

$$E = \frac{\mathcal{E}_0\kappa^2\rho^2}{2r_0} \sin\theta.$$

The small circular diffraction antenna is thus equivalent to the earthed Hertzian doublet. As the field produced by the doublet of length l is

$$E = \frac{60kl\mathfrak{J}}{r_0} \sin\theta,$$

the moment of doublet current $\mathfrak{J}l$ equals

$$\mathfrak{J}l = \mathcal{E}_0\kappa\rho^2/120, \tag{9}$$

and the radiated power

$$P_e = 40(kl)^2\mathfrak{J}^2 = \mathcal{E}_0^2\kappa^4\rho^4/360. \tag{10}$$

Thus, in the case of a circular antenna of small radius, the radiated power rapidly falls off with decreasing radius.

Now let us treat the small circular diffraction antenna from a new standpoint. Let a disk of ρ radius be erected at a height $d \ll \rho$ over a conducting plane. Such an antenna is an umbrella antenna with a round flat-top of ρ radius and a vertical wire of the length d . Let \mathfrak{J} be the current in the vertical wire. The capacitance of the disk is $C = \rho^2/36d \cdot 10^{-11} F$; its susceptance is $\omega C = (\omega\rho^2/36d) \cdot 10^{-11}$. If a potential difference \mathcal{E}_0 is applied to the disk with respect to the plane, then

$$\mathfrak{J} = \mathcal{E}_0\omega C = 10^{-11}\mathcal{E}_0\omega\rho^2/36d = \mathcal{E}_0\kappa\rho^2/120d.$$

This leads back to the expression (9). Thus the small circular diffraction antenna and an umbrella antenna are equivalent if in both cases the disk possesses the same potential with respect to the plane.

In addition to Fig. 4 one will note that several concentric circular slits, with properly adjusted amplitudes and phases of their e.m. forces, allows us to vary the vertical directive pattern of the antenna within large limits. If this pattern is given as a function $f(x) = f(\sin\theta)$, then it may be expand in a Fourier-Bessel series

$$f(x) = \sum_{m=1}^{\infty} a_m \mathfrak{J}_1(\lambda_m x)$$

where λ_m is a root of order m and

$$a_m = \frac{2}{\mathfrak{J}_1'^2(\lambda_m)} \int_0^1 f(t) \mathfrak{J}_1(\lambda_m t) t dt.$$

The concentric antennas must have the radii shown in Table I; the amplitudes of their e.m. forces must be equal to a_m . We shall obtain the predetermined directive pattern with a degree of approximation depending upon the number of applied circular antennas.

4. CALCULATION OF THE CURRENT ON THE SCREEN

In the system of units used here, the numerical value of linear density of the current sheet equals the tangential component H_ϕ of magnetic field; the latter may be computed from (4). Owing to the circular symmetry we may put $\phi=0$ for the considered point of the screen surface, which we shall call the observation point. Thus the distance r between this point and the source of radiation on the surface of the gap will be

$$r = \sqrt{r'^2 + r''^2 - 2r'r'' \cos \phi}$$

where r' and r'' are distances from the origin of coordinates to the radiating point and the point of observation; ϕ is the angle between r' and r'' .

The integration must be carried out over the surface of the gap. Putting $r'dr'd\phi$ instead of ds , we obtain

$$H_\phi = \frac{i\omega\epsilon}{\pi} \int_{\rho_1}^{\rho_2} \int_0^\pi E_0 \cos \phi \frac{e^{-ikr}}{r} r' dr' d\phi.$$

Here ρ_1 and ρ_2 are the inner and outer radii of the gap. Instead of E_{0z} , the value $E_0 \cos \phi$ is substituted. To compute the integral the following expression of spherical wave function e^{-ikr}/r may be employed.²

$$\frac{e^{-ikr}}{ikr} = \begin{cases} \sum_{m=0}^{\infty} (2m+1) \psi_m(kr'') \zeta_m^{(2)}(kr') P_m(\cos \phi) & r'' < r' \\ \sum_{m=0}^{\infty} (2m+1) \psi_m(kr') \zeta_m^{(2)}(kr'') P_m(\cos \phi) & r'' > r'. \end{cases} \quad (11)$$

Here

$$\psi_m(kr) = \sqrt{\frac{\pi}{2kr}} \mathfrak{J}_{m+1/2}(kr)$$

where $\mathfrak{J}_{m+1/2}$ is the Bessel function of half order.

$$\zeta_m^{(2)}(kr) = \sqrt{\frac{\pi}{2kr}} H_{m+1/2}^{(2)}(kr)$$

where H^2 is the Hankel function of second kind (in accordance with + before the exponent of the time factor $e^{i\omega t}$ accepted here.

$G_m(\cos \phi)$ are the Legendre polynomials of argument

$$x = \cos \phi.$$

Assuming the gap to be very narrow, we may put

$$\int_{\rho_1}^{\rho_2} E_0 \zeta_m^{(2)}(kr') r' dr' = \rho \mathcal{E}_0 \zeta_m^{(2)}(k\rho)$$

where ρ is the mean radius of the slit.

Then

$$H_\phi = \frac{\omega\epsilon k\rho \mathcal{E}_0}{\pi} \sum_{m=0}^{\infty} (2m+1) \psi_m(kr'') \zeta_m^{(2)}(k\rho) \int_0^\pi P_m(\cos \phi) \cos \phi d\phi \quad (12)$$

for $r'' < \rho$. For the points outside the circle ($r'' > \rho$) we may use the same expression after ρ and r'' change places.

The expression obtained also gives the surface current density yH_ϕ . It will be more convenient for us to introduce the "zone current" \mathfrak{J}_4 flowing into the circle of radius r'' . Evidently

$$\mathfrak{J}_4 = 2\pi r'' \mathfrak{J} = 2\pi r'' H_\phi.$$

After having substituted r'' by r , having evaluated the integrals and carried out some simplifications, we reduce (12) to

$$\begin{aligned} \mathfrak{J}_4 = \frac{\pi \mathcal{E}_0}{80} k\sqrt{\rho r} & \left\{ \mathfrak{J}_{3/2}(k\rho) [\mathfrak{J}_{3/2}(kr) - i\mathfrak{J}_{-3/2}(kr)] \right. \\ & + \mathfrak{J}_{7/2}(k\rho) [\mathfrak{J}_{7/2}(kr) + -i\mathfrak{J}_{-7/2}(kr)] \\ & + \frac{55}{64} \mathfrak{J}_{11/2}(k\rho) [\mathfrak{J}_{11/2}(kr) - i\mathfrak{J}_{-11/2}(kr)] \\ & + \frac{875}{1024} \mathfrak{J}_{15/2}(k\rho) [\mathfrak{J}_{15/2}(kr) + -i\mathfrak{J}_{-15/2}(kr)] + \dots \\ & + \frac{(4p-1)(2p-1)}{p} \left[\frac{(2p-3)!!}{2^{p-1}(p-1)!} \right]^2 \mathfrak{J}_{4p-1/2}(k\rho) \\ & \cdot [\mathfrak{J}_{4p-1/2}(kr) + -i\mathfrak{J}_{-4p-1/2}(kr)] + \dots \left. \right\}; \end{aligned} \quad (13)$$

Here $(2p-3)!!$ denotes the product $1.3.5 \dots (2p-3)$. If $r < \rho$, r and ρ must change positions in the above expression.

It appears from (13) that the current on the screen may be considered as consisting of an infinite number of "space harmonics" or wave modes. The harmonic of the order p is represented by the Bessel functions of the order $\pm 4p-1/2$. Inside the circle formed by the slit we have standing waves expressed by $\mathfrak{J}_{4p-1/2}(kr)$. Outside of this circle there exist progressive waves, expressed by the sum

$$\mathfrak{J}_{4p-1/2}(kr) - i\mathfrak{J}_{-4p-1/2}(kr).$$

The amplitude and phase relations between different wave modes are governed by the radius of the circular antenna, namely, by the values of the functions $\mathfrak{J}_{4p-1/2}(k\rho) + -i\mathfrak{J}_{-4p-1/2}(k\rho)$ for the waves inside the circle and by the values of $\mathfrak{J}_{4p-1/2}(k\rho)$ for the waves beyond them.

5. THE ANTENNA ADMITTANCE AND THE RADIATED POWER

Now let us turn our attention to the current flowing out of the gap ($r=\rho$). Dividing this current by potential different \mathcal{E}_0 , we obtain the diffraction antenna admittance $y=g_e+ib$.

$$g_e = \frac{\pi k\rho}{80} [\mathfrak{J}_{3/2}^3(k\rho) + 0.875\mathfrak{J}_{7/2}^2(k\rho) + 0.860\mathfrak{J}_{11/2}^2(k\rho) + 0.855\mathfrak{J}_{15/2}^2(k\rho) + \dots]. \quad (14)$$

$$b = -\frac{\pi k\rho}{80} [\mathfrak{J}_{3/2}(k\rho)\mathfrak{J}_{-3/2}(k\rho) + 0.875\mathfrak{J}_{7/2}(k\rho)\mathfrak{J}_{-7/2}(k\rho) + 0.860\mathfrak{J}_{11/2}(k\rho)\mathfrak{J}_{-11/2}(k\rho) + 0.855\mathfrak{J}_{15/2}(k\rho)\mathfrak{J}_{-15/2}(k\rho) + \dots]. \quad (15)$$

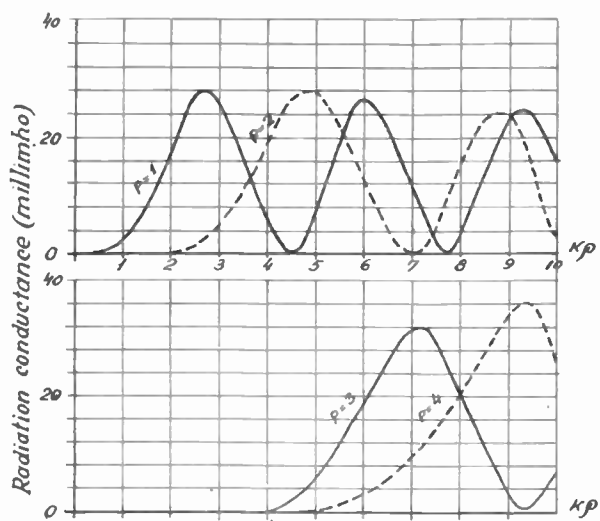

Fig. 5—Radiation conductance of first four wave modes as functions of $2\pi\rho/\lambda$.

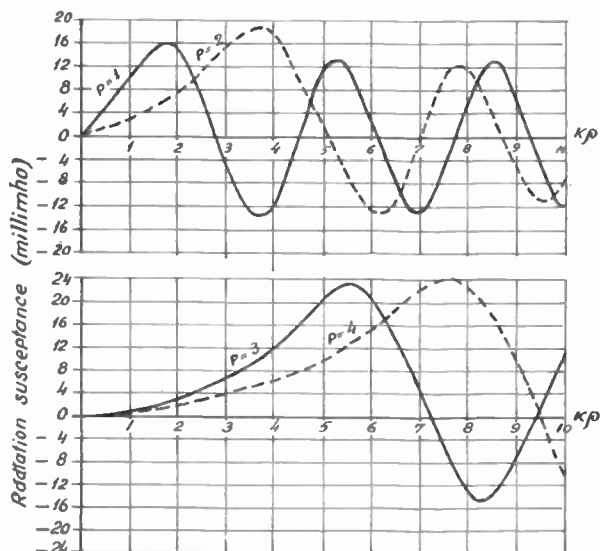

Fig. 6—Radiation susceptance of first four wave modes as functions of $2\pi\rho/\lambda$.

The radiation conductance g_e defines the power radiated from the antenna. In Fig. 5 the real parts of admittances of the first few modes are plotted as functions of the diffraction-antenna radius. Similar curves for susceptance are shown in Fig. 6. New wave modes originate with increasing antenna radius; their susceptances fall in an oscillating manner with further increase in the radius.

The series representation (14) converges rapidly enough and allows us to compute and to plot the curve of total radiation conductance as function of antenna radius (see Fig. 7). It rises step-wise as the radius increases. It is interesting to note that the radiation con-

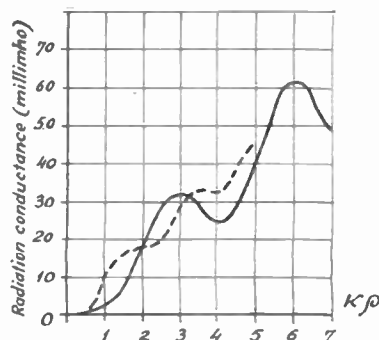

Fig. 7—Total radiation conductance as function of $2\pi\rho/\lambda$. The dotted curve shows the radiation conductance of a sphere, calculated by Stratton and Chu.

ductance curve of an oscillating sphere calculated by Stratton and Chu³ possesses a similar shape, the external e.m.f. being applied across an infinitesimal strip at the equator. This conductance is shown on Fig. 7 by a dotted curve; here ρ means the radius of the sphere.

In the case of a small radius, (14) reduces to

$$g_e = k^4\rho^4/360$$

in accordance with (10).

Computation of the total antenna susceptance by means of (15) leads to infinitely great values. This is a consequence of our assumption that the gap is infinitely narrow; such a gap must possess an infinitely great admittance (as in the case of the sphere studied by Stratton and Chu).

If we wish to obtain a finite value of susceptance we must introduce some conditions concerning the construction of the gap. The finite value of susceptance may also be obtained in the case of a given electric field distribution across the gap. One will note that approximate values of susceptance calculated by means of (15), as in the case of a conducting sphere, remain capacitive with increasing radius within large limits.

³ J. A. Stratton and L. J. Chu, "Steady-state solutions of electromagnetic field problems, part II, forced oscillations of a conducting sphere," *Jour. Appl. Phys.*, vol. 12, pp. 236-240; March, 1941.

A New Type of Waveguide Directional Coupler*

H. J. RIBLET†, ASSOCIATE, I.R.E., AND T. S. SAAD†, ASSOCIATE, I.R.E.

Summary—A type of waveguide directional coupler is described which has been carefully measured over a 12 per cent wavelength band centered at 3.3 centimeters. It combines the advantages of high directivity, low input standing-wave ratio, ease of design, and universality of application. Sufficient theory is given to explain the principles of its operation, and to allow its performance to be duplicated at other wavelengths. A number of design and performance curves are included.

INTRODUCTION

THE PAPERS by Early¹ and Mumford² have discussed the applications of directional couplers, while Harrison³ has written an extensive report which describes several different types of directional couplers giving experimental data on their performance. The "magic-tec" bridge⁴ or "transmission-line" bridge⁵ is a special form of directional coupler which is used widely, not only for test purposes but also as an essential component of certain microwave radar and communication systems. For an indication of the important part played by this type of directional coupler in the microwave art, reference is made to a paper by Schneider.⁶ Of especial interest, accordingly, is the performance data given later in this paper for a directional coupler, of the type to be described, designed to operate as a bridge circuit.

Fig. 1 shows a diagram of a four-terminal waveguide network which will be a directional coupler, if power incident on terminal 1 divides in some ratio between terminals 3 and 4 without reaching terminal 2, while power incident on terminal 3 divides between 1 and 2 without reaching 4, assuming matched output terminals. When the power incident at 1 splits evenly between 3 and 4, the directional coupler is called a bridge circuit.

If power in at 1 is denoted by P_i and power out at 1, 2, 3, and 4 is denoted by P_1 , P_2 , P_3 , and P_4 , respectively, then the performance of the directional coupler is specified in terms of the coupling, P_4/P_3 , the directivity, P_4/P_2 , and the input standing-wave ratio.

It is the object of this article to describe a class of waveguide directional couplers, all stemming from the same basic scheme, which appears to be superior to any

waveguide directional couplers studied to date, by having both improved directivity and coupling characteristics and a flexibility which allows designs for special purposes to be readily accomplished from a few experimental curves and simple theoretical considerations.

BASIC DIRECTIONAL COUPLER

Fig. 1 shows one of these directional couplers. Two guides are fastened together along a common flat face, and pairs of slots are cut in the common wall to couple

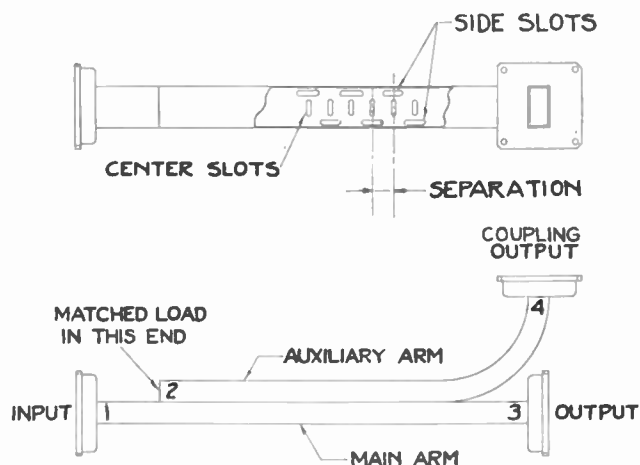

Fig. 1—Basic directional coupler.

power from one guide to another. One slot of each pair is placed near the center of the guide, while the other parallels the guide and lies near one of its edges. The centers of both slots fall on a line perpendicular to the axis of the guide. With suitable design a single pair by itself acts as a directional coupler, so that these pairs may be cascaded to form more complex directional couplers, as shown in Fig. 1.

We shall consider first the problem of determining the behavior of a single pair of slots. The field distribution for the $TE_{0,1}$ mode propagating in the positive z direction is

$$\begin{aligned} E_x &= j \sqrt{\frac{\mu}{\epsilon}} \frac{2b}{\lambda_0} H_0 \sin \frac{\pi y}{b} e^{j(\omega t - 2\pi/\lambda_0 z)} \\ H_y &= j \frac{2b}{\lambda_0} H_0 \sin \frac{\pi y}{b} e^{j(\omega t - 2\pi/\lambda_0 z)} \\ H_z &= H_0 \cos \frac{\pi y}{b} e^{j(\omega t - 2\pi/\lambda_0 z)}. \end{aligned} \quad (1)$$

We have used the notation of Slater⁷ except that $\gamma = j(2\pi/\lambda_0)$. b is the width of the guide, and a is its

⁷ J. C. Slater, "Microwave Transmission," McGraw-Hill Book Co., chapter 3, New York, N. Y., 1942.

* Decimal classification: R310.3×R142. Original manuscript received by the Institute, January 31, 1947; revised manuscript received, April 24, 1947.

† Submarine Signal Co., Boston, Mass.

¹ H. C. Early, "A wide-band directional coupler for wave guide," *Proc. I.R.E.*, vol. 34, pp. 883-887; November, 1946.

² W. W. Mumford, "Directional couplers," *Proc. I.R.E.*, vol. 35, pp. 160-166; February, 1947.

³ R. J. Harrison, "Design considerations for directional couplers," *M.I.T. Rad. Lab. Rep. No. 724*; December, 1945.

⁴ W. A. Tyrell, "Hybrid circuits for microwaves," *Proc. I.R.E.*, vol. 35, pp. 1307-1313; November, 1947.

⁵ A. Alford, "High-frequency bridge circuits and high-frequency repeaters," U. S. Patent 2,147,809, February 21, 1939.

⁶ E. G. Schneider, "Radar," *Proc. I.R.E.*, vol. 34, pp. 551-552; August, 1946.

height. The power flow in the positive z direction is given by

$$S = \frac{1}{2} \text{Re} \int (E_x \bar{H}_y) ds = \sqrt{\frac{\mu}{\epsilon}} \frac{(2b)^2 ab}{\lambda_0 \lambda_0^4} H_0^2, \quad (2)$$

where the integration is taken over the cross section of the waveguide, and \bar{H}_y is the complex conjugate of H_y .

For a discussion of the question of the coupling of waveguides by means of small holes in the infinitesimally thin common wall between them, the reader is referred to reports by Bethe.⁸ The consequence of these arguments is that the amplitude factor of the lowest-mode wave traveling to the right in the auxiliary or upper guide of Fig. 1, when excited by a wave of unit amplitude traveling to the right in the lower guide, is

$$A = \frac{jk}{2S_a} (PE_x^{(1)} E_x^{(2)} - M_1 H_y^{(1)} H_y^{(2)} - M_2 H_z^{(1)} H_z^{(2)}), \quad (3)$$

while the amplitude factor of the wave traveling to the left is given by

$$B = \frac{jk}{2S_a} (PE_x^{(1)} E_x^{(2)} + M_1 H_y^{(1)} H_y^{(2)} - M_2 H_z^{(1)} H_z^{(2)}). \quad (4)$$

$E_x^{(1)}$ is the magnitude of the x component of the unit electric field in the lower guide evaluated at the center of the hole; $E_x^{(2)}$ is the same, except that it is evaluated for unit field in the upper guide, with similar definitions for $H_y^{(1)}$, $H_y^{(2)}$, $H_z^{(1)}$, and $H_z^{(2)}$. P , M_1 , M_2 are positive real numbers, called polarizabilities, determined by the shape of the hole. They are independent of the wavelength for small holes. S_a as used by Bethe is $2S$ as defined above, and $k = 2\pi/\lambda_0$.

The effect of walls of finite thickness is not considered in the reports by Bethe, but may be treated by including in each term of (3) and (4) a factor which expresses the voltage attenuation experienced by a mode of the given type traveling below cutoff, a distance equivalent to the thickness of the wall. As may be easily seen, consideration of physical arguments indicate that, for a narrow slot in a waveguide wall, the only exciting field which need be considered is the one which gives a current flow across the long dimension of the slot. Accordingly, all further arguments in this article will be based on this premise.

With this in mind, we see that each slot of Fig. 1 couples the two guides in only one way. The amplitudes A_i and B_i of the waves excited by a centered transverse slot will be proportional to $-M_1$ and M_1 , respectively, while the amplitudes A_L and B_L of the waves excited by a longitudinal slot will both be proportional to

$$-M_2 \left(\frac{\lambda_0}{2b} \right)^2.$$

A pair of slots will then have infinite directivity when

⁸ H. Bethe, "Lumped constants for small irises," M.I.T. Rad. Lab. Rep. Nos. 43-22; March, 1943. Also "Theory of side windows in wave guides," M.I.T. Rad. Lab. Rep. Nos. 43-27; pp. 19; April, 1943.

$$M_1 = M_2 \left(\frac{\lambda_0}{2b} \right)^2. \quad (5)$$

For identical slots in 1- \times $\frac{1}{2}$ -inch waveguide, this happens at a wavelength of 3.25 centimeters.

Let us consider the problem of calculating the power flow from the main guide into the auxiliary guide through a pair of these slots as a function of frequency. Taking (1) to define the unit field in both waveguides, we have

$$A_i = \frac{-jk}{2S_a} M_1 H_y^{(1)} H_y^{(2)} = \frac{-2j\pi}{ab} \sqrt{\frac{\epsilon}{\mu}} \frac{1}{\lambda_0} M_1,$$

while the amplitude factor of the wave coupled by the longitudinal slot is

$$A_L = \frac{-jk}{2S_a} M_2 H_z^{(1)} H_z^{(2)} = \frac{-2j\pi}{ab} \sqrt{\frac{\epsilon}{\mu}} \frac{\lambda_0}{(2b)^2} M_2.$$

The total amplitude factor will be determined by adding A_i and A_L . The field in the auxiliary guide is then

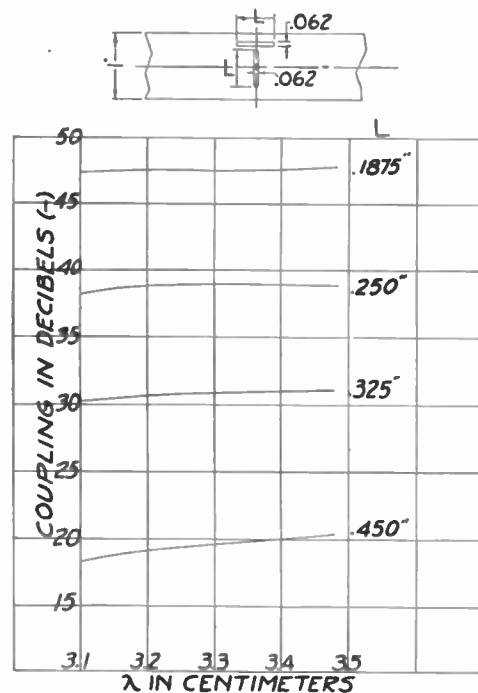

Fig. 2—Dependence of coupling on slot dimensions.

$A_i + A_L$ times the expressions given in (1). The ratio of the power out of the auxiliary guide to that entering the main guide is easily seen to be

$$\frac{P_{\text{out}}}{P_{\text{in}}} = (A_i + A_L)^2 = \frac{4\pi^2}{a^2 b^2} \frac{\epsilon}{\mu} \left\{ \frac{M_1}{\lambda_0} + \frac{M_2 \lambda_0}{(2b)^2} \right\}^2. \quad (6)$$

If M_1 and M_2 are independent of the frequency, this ratio will have a stationary value when

$$M_1 = M_2 \left(\frac{\lambda_0}{2b} \right)^2.$$

Thus, we have the rather nice result that the condition

for maximum directivity is also the condition for a stationary value of the coupling. This shows that, to obtain directional couplers which maintain reasonably constant coupling over wide bands, we have only to use small slots.

Actually, even a short slot has a small amount of frequency dependence which will result in greater power transfer with increasing frequency. Since the longitudinal and transverse slots have compensating frequency characteristics, by increasing the size of the longitudinal slot it is possible to construct directional couplers with very flat coupling characteristics.

Fig. 2 gives a series of coupling versus frequency curves for one type of double-slot pair. The dimensions given for the length of the slots include the semicircular ends.

CASCADED DIRECTIONAL COUPLERS

When cascading directional couplers of this type, we should like to know how the coupling, directivity, and standing-wave ratio are affected by increasing the number of coupling elements. In an effort to answer these questions, the senior author undertook an investigation of the theory of cascaded coupling elements.⁹ Equations (23) of this paper tell how the coupling depends on the number of directional couplers in the cascade. These equations are, when $n/2$ is replaced by k ,

$$\frac{V_4}{V_3} = \frac{\cosh k_o \gamma l}{\sinh k_o \gamma l} \quad (k_o = \text{odd integer}),$$

$$= \frac{\sinh k_e \gamma l}{\cosh k_e \gamma l} \quad (k_e = \text{even integer}),$$
(7)

where V_4 and V_3 are the voltages at terminals 4 and 3, respectively, of Fig. 1. The results of that paper are immediately applicable to our problem, because a double-slot pair of perfect directivity is equivalent electrically to a pair of the suitably spaced apertures used in deriving equations (6), at a fixed frequency. This results from the type of electrical symmetry which they have in common. The coupling as defined earlier is

$$\left| \frac{V_4}{V_3} \right|^2;$$

and γ is $j(2\pi/\lambda_o)$, while l is the spacing between apertures necessary to give perfect directivity. It will unify the formulas to write $l = \lambda_o/4 + \Delta$. Then

$$\left| \frac{V_4}{V_3} \right|^2 = \frac{\cos^2 k_o \left(\frac{2\pi}{\lambda_o} \right) (\lambda_o/4 + \Delta)}{\sin^2 k_o \frac{2\pi}{\lambda_o} (\lambda_o/4 + \Delta)}$$

$$= \frac{\sin^2 k_o \frac{2\pi}{\lambda_o} \Delta}{\cos^2 k_o \frac{2\pi}{\lambda_o} \Delta},$$
(8)

and, since it can easily be seen that the same expression also holds for k_e , we have as a result that the coupling depends on the square of the tangent of the number of elements. As long as we deal with weak couplings, doubling the number of directional couplers increases

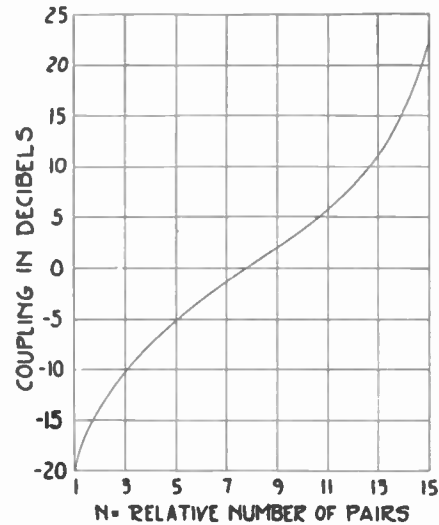

Fig. 3—Universal coupling curve.

the coupling by 6 db. A graph of this function expressed in decibels for the values of principal interest is given in Fig. 3. In practice, this curve has allowed us to predict within a few tenths of a decibel the coupling to be expected of a cascade of known slot pairs.

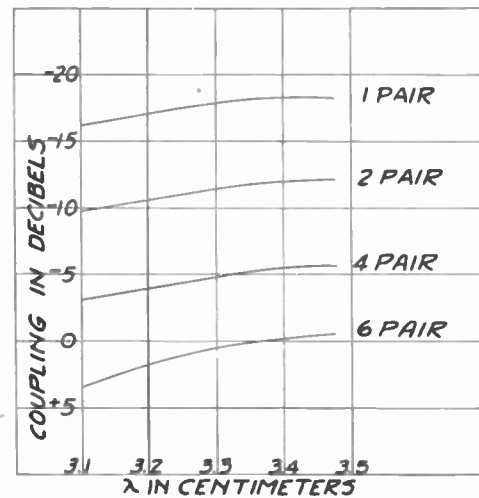
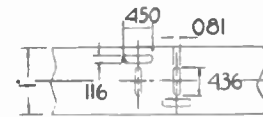

Fig. 4—Dependence of coupling on number of slot pairs.

Experimental results are given in Fig. 4, which gives the coupling observed with directional couplers consisting of various numbers of slot pairs. Incidentally, as long as the slot pairs are reasonably directive, intrinsically, the spacing between sets of pairs is not critical.

⁹ H. J. Riblet, "A mathematical theory of directional couplers," Proc. I.R.E., vol. 35, pp. 1294-1307; November, 1947.

For example, the couplings of the two 20-pair directional couplers of Fig. 5 were identical.

It is pointed out in the theoretical article on directional couplers referred to above that, for the small-aperture type of directional coupler with which we are dealing, high directivity and low standing-wave ratio are related to each other. It may be argued that slots in thin walls of adjacent guides will act as secondary radiators which must reradiate equally into the two guides. Thus, energy which reaches terminal 2 is proportional to that which results in a standing wave at terminal 1. Clearly, spacing the pairs a quarter-wavelength apart will improve the directivity, since it will reduce the standing-wave ratio. How this works out in practice is shown in Fig. 5, which gives directivity versus frequency for 1, 4, 10, and 20 pairs of slots. The measured standing-wave ratio for this type of directional coupler is ordinarily less than 1.05.

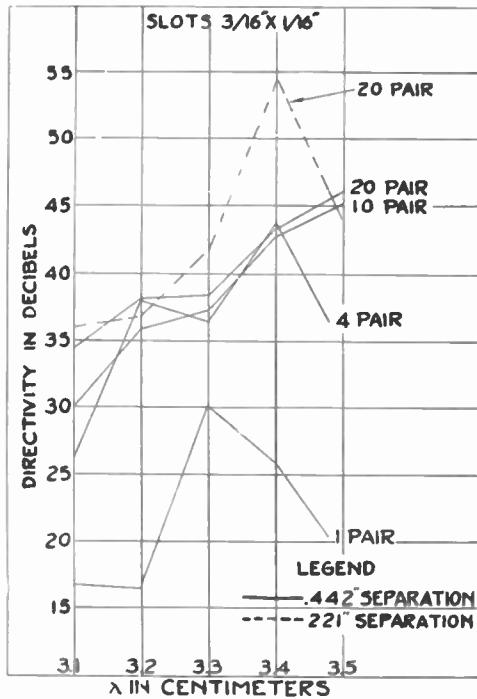

Fig. 5—Dependence of directivity on number of slot pairs.

ACTUAL PERFORMANCE

In order to determine the over-all performance of directional couplers constructed using this scheme, we designed a 22-db directional coupler and tested it over the frequency band from 3.1 to 3.5 centimeters. The input s.w.r., the directivity, and the coupling over this band for the final directional coupler are shown in Fig. 6. The variation in coupling represents the frequency sensitivity of the slots, since no effort was made to obtain compensation by increasing the size of the longitudinal slots. A double-slot bridge was built and carefully tested, with results shown in Fig. 7. The very constant coupling was obtained by the device of making the longitudinal slots somewhat longer than the transverse slots.

A collection of samples is shown in Fig. 8. The waveguide assembly at the back of the picture shows the arrangement used in measuring high directivities. Here it is possible to see the ends of the slidable tapered

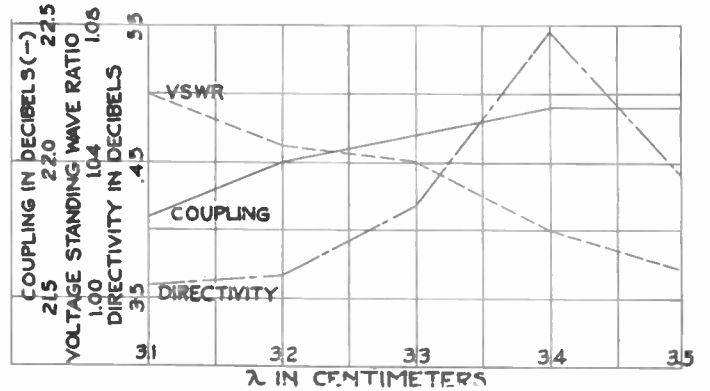

Fig. 6—Performance data of directional coupler. 20 pairs of slots $\frac{3}{16} \times \frac{1}{16}$ inch \times 0.221 separation.

loads used in making the measurements. Just in front of it is the directional coupler whose performance data are given in Fig. 6. The two short sections are bridge circuits, the shorter of which has the coupling char-

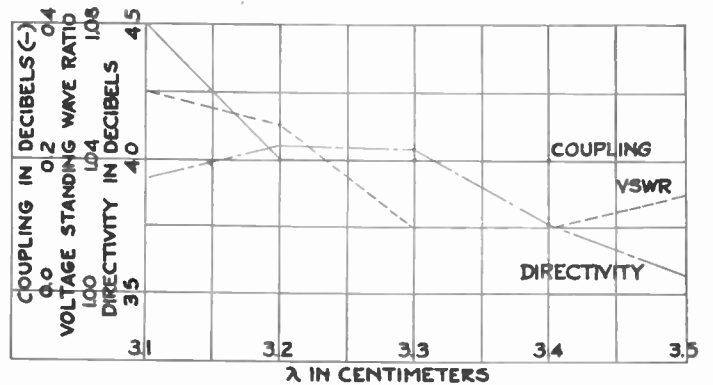

Fig. 7—Performance data of bridge circuit. 24 pairs of slots. Center slots = 0.294 \times 0.0707 inch, side slots = 0.303 \times 0.110 inch; thickness of guide is 0.022 inch.

acteristics given in Fig. 4, while the performance of the longer one is shown in Fig. 7. For scale, it is to be remembered that all our measurements have been made

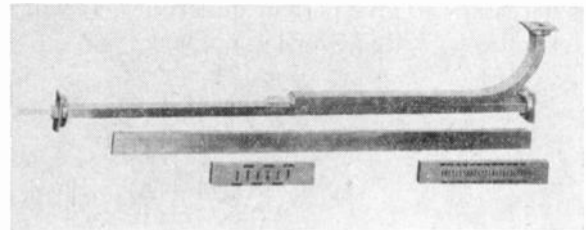

Fig. 8—Photograph of experimental models.

on $\frac{1}{2}$ \times 1-inch waveguide. Low-pressure measurements suggest that these bridge circuits are equal and possibly superior to other known types of 3-centimeter bridge circuits for handling high power.

The Series Reactance in Coaxial Lines*

HOWARD J. ROWLAND†, SENIOR MEMBER, I.R.E.

Summary—An experimental investigation has been conducted to determine the effect of a reactance placed in series with the inner conductor of a coaxial line. It was found that capacitive reactances appear in parallel with the inserted series reactance, and in parallel with the resultant impedance of the line at the point where the series reactance is placed. These capacitances can be determined experimentally, and in usual cases are found to be between 10^{-14} and 10^{-12} farads. The results of these data have been extended to show the capability of the series reactance as a matching network in coaxial lines, and also its use with hollow cylindrical dipoles.

In the course of this investigation it was necessary to determine the capacitance appearing at a step discontinuity in the inner conductor of a coaxial line. The results are in good agreement with values predicted in a previous paper.¹

I. INTRODUCTION

FROM DISSIPATIONLESS-transmission-line theory we have an expression for the impedance Z_d at any point on a coaxial line in terms of the load impedance Z_l , the distance d from the load, and the characteristic impedance of the line Z_0 , which we will assume to be a pure resistance.

$$Z_d = Z_0 \frac{Z_l + jZ_0 \tan Bd}{Z_0 + jZ_l \tan Bd}$$

By rationalizing this expression we get

$$Z_d = R_d + jX_d$$

Let us vary the distance d until $R_d = z_0$ and call this point d_0 . We then have

$$Z_{d0} = Z_0 + jX_{d0}$$

If we now put a reactance $-jX_{d0}$ in series with the line at this point, we have

$$Z_{d0} = Z_0 + jX_{d0} - jX_{d0}$$

$$Z_{d0} = Z_0,$$

and we see that the line is matched to the load.

In many antenna-matching problems we find the impedance presented over the required frequency band at some point on the feed line is favorably set up for series-reactance compensation. Several antennas designed to operate in the 100-Mc. region were successfully matched by this method in the manner shown by Fig. 1. However, when this method was tried at frequencies above 200 Mc., it was noticed that calculated values were at variance with experimental results to a degree higher

than could be attributed to experimental error. It was this fact which caused the author to investigate the properties of the series reactance in coaxial lines.

Frequencies in the neighborhood of 3000 Mc. were chosen for the experiments as a compromise between mechanical and electrical considerations, the frequency being high enough to definitely bring out the effects we were looking for, and yet low enough so that mechanical tolerances could be held without too much difficulty.

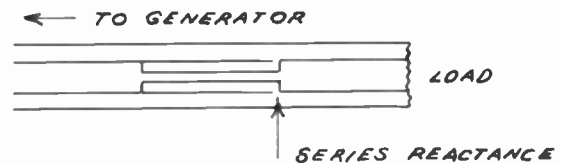

Fig. 1

II. DETERMINATION OF THE PROPERTIES OF THE SERIES REACTANCE

With reference to Fig. 2, we determine the impedance at P from knowledge of the standing-wave ratio on the line and the position of the minimum voltage with respect to a short circuit at point P . If we neglect for the moment any capacitance effects across the mouth of the reactance or across the line where the reactance is placed, the impedance at Q would be

$$\begin{aligned} Z_q &= R_p + jX_p + jZ_r \tan \Gamma d \\ &= R_p + j(X_p + X_r) \end{aligned}$$

where

Z_r = the characteristic impedance of the reactance

d = the depth of the reactance

$B = 2\pi/\lambda$

$X_r = Z_r \tan Bd$.

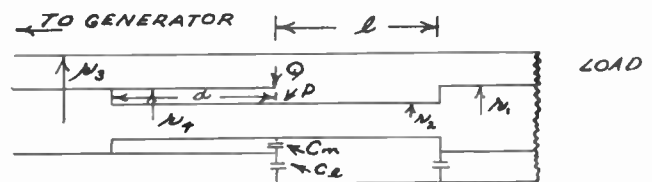

Fig. 2

$$\begin{aligned} r_1 &= 0.1875'' \\ r_2 &= 0.076'' \\ r_3 &= 0.408'' \end{aligned}$$

$$\begin{aligned} r_4 &= 0.176'' \\ Z_p &= 35.33 + j6.14 \text{ ohms.} \end{aligned}$$

* Decimal classification: R117.1. Original manuscript received by the Institute, October 22, 1946; revised manuscript received, January 24, 1947.

† The Workshop Associates, Inc., Newton Highlands, Mass.

¹ J. R. Whinnery, H. W. Jamieson, and Theo Eloise Robbins, "Coaxial line discontinuities," Proc. I.R.E., vol. 32, pp. 695-709; November, 1944.

As we vary the parameter d over a distance greater than $\lambda/2$, we find no change in the real part of Z_q , but

the imaginary part varies from zero to \pm infinity. If we plot Z_q as a function of d on a Smith Chart, we get a circle with its center on the $x=0$ line. This will be a circle of constant R_p .

However, two effects which modify this analysis are found:

1. A capacitance C_m appears across the mouth of the reactance. To determine the value of the imaginary part of Z_q , we must now insert X_{C_m} in parallel with X_r .

$$Z_q' = R_p + j \left(X_p + \frac{X_r X_{C_m}}{X_r + X_{C_m}} \right).$$

The value of X_{C_m} can be determined by plotting the voltage-standing-wave ratio on the line as a function of d . We find the maximum value of v.s.w.r. appears for some value of $d = d' < \lambda/4$. For a parallel-resonant circuit, we have antiresonance appearing when

$$X_{C_m} = -X_r;$$

therefore,

$$X_{C_m} = -Z_r \tan Bd'.$$

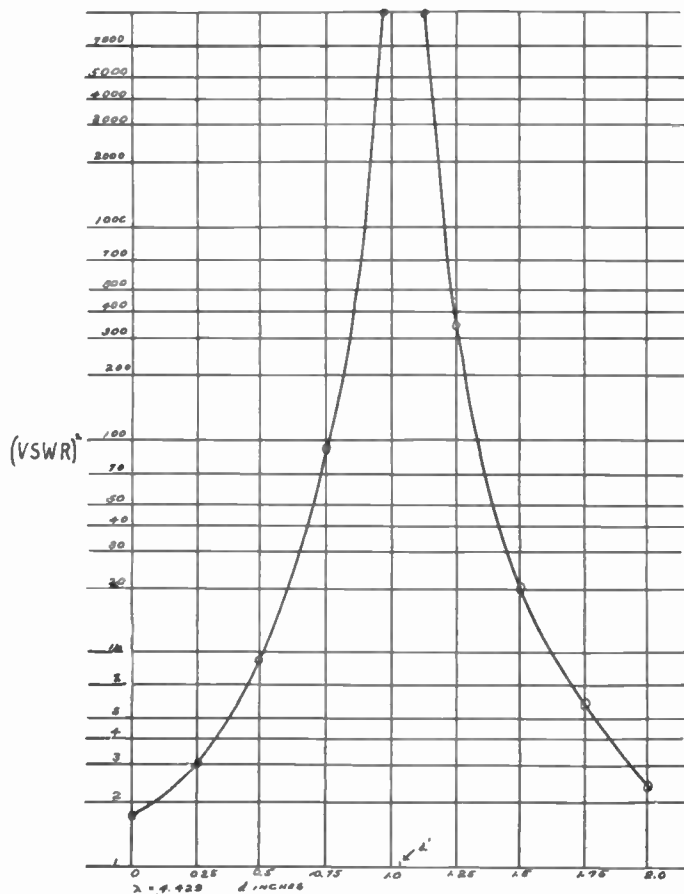

Fig. 3

A graph showing this effect appears in Fig. 3.

The value of C_m was determined in this manner and found constant from 2380 to 3300 Mc.

2. A capacitance C_l appears in parallel with Z_q' . The expression for the impedance at Q now becomes

$$Z_q'' = \frac{R_p X_{cl}^2 + j[(x_t + X_{cl})X_t X_{cl} + X_{cl} R_p^2]}{R_p^2 + (X_t + X_{cl})^2}$$

where

$$X_t = X_p + \frac{X_r X_{C_m}}{X_r + X_{C_m}}.$$

If we allow X_t to become infinite,

$$Z_q'' = jX_{cl}.$$

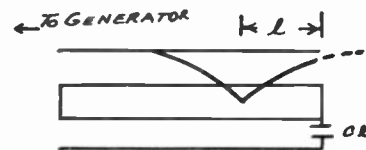

Fig. 4

This means we have effectively an open line with a capacitance across the end as shown in Fig. 4.

To determine the value of X_{cl} , we find the distance l to the first minimum voltage point. Then

$$X_{cl} = -Z_0 \tan Bl$$

where Z_0 is the characteristic impedance of the line at Q .

If on a Smith chart we plot Z_q'' as a function of d , we get a circle with its center on a line passing through the points $(r=1, x=0)$ and $r=0, x=X_{cl}/Z_0$. That is, with the exception of values of d which approach zero. We then tend to conditions which can be determined from footnote reference 1.

With $\lambda = 4.429''$ and using the constants shown in Fig. 2, we find $X_{C_m} = -460$ ohms and $X_{cl} = -399$ ohms. A plot of Z_q'' as a function of d is shown in Fig. 5.

If the value of l in Fig. 2 becomes small, as pictured in Fig. 1, the value of X_{C_m} for any given frequency becomes smaller and X_{cl} becomes larger. This is again in agreement with footnote reference 1.

III. EXAMPLE OF IMPEDANCE-MATCHING TECHNIQUE

A ground-plane type of antenna was required to work over two bands, 175 to 185 Mc. and 205 to 215 Mc. The v.s.w.r. at any point within the two bands had to be kept below 1.5:1, when connected to 52-ohm transmission line. The elements were adjusted so that a point on

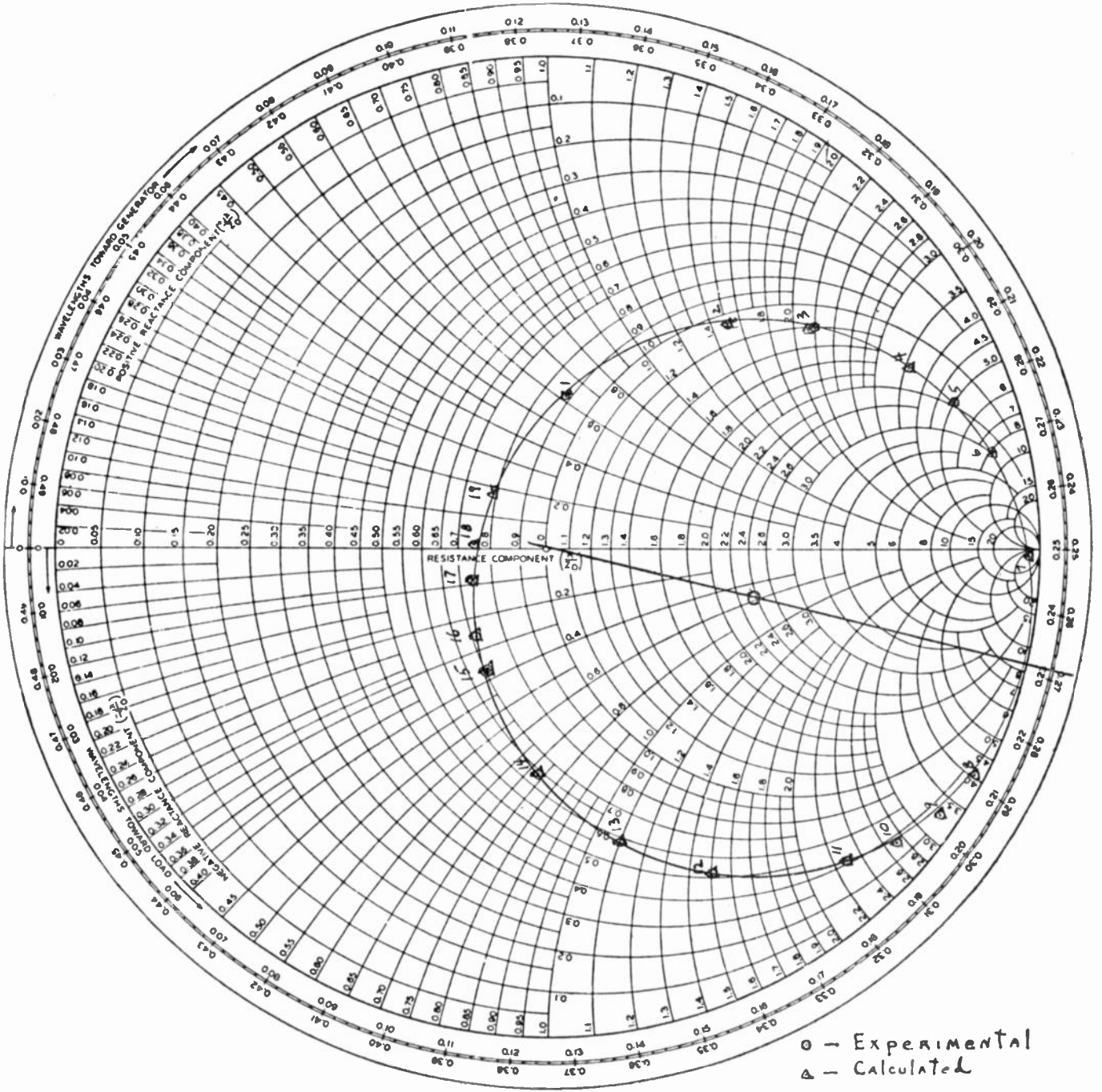

Fig. 5

d''	d''	d''	d''
1.—0.303	6.—0.863	11.—1.263	16.—1.998
2.—0.563	7.—0.947	12.—1.408	17.—2.106
3.—0.661	8.—1.125	13.—1.538	18.—2.179
4.—0.762	9.—1.166	14.—1.703	19.—2.289
5.—0.810	10.—1.213	15.—1.926	

the line near the antenna presented the impedance shown in curves *R* and *X* in Fig. 6. An inspection of the curves shows that, if the imaginary component can be canceled out, the antenna will meet the specifications. A reactance inserted in the inner conductor with its mouth at the point mentioned above and having the

properties $Z_r = 23.5$ ohms and $d = 11.78$ inches will give the compensation curve $+X$ shown in Fig. 6. The compensation curve has been corrected for X_{cm} , but X_{oi} was found large enough to be neglected.

The resulting v.s.w.r. as a function of frequency is shown in Fig. 7.

IV. USE OF THE SERIES REACTANCE IN HOLLOW DIPOLES^{2,3}

In a paper by S. A. Schelkunoff,⁴ a family of curves is found giving the resistive and reactive components of

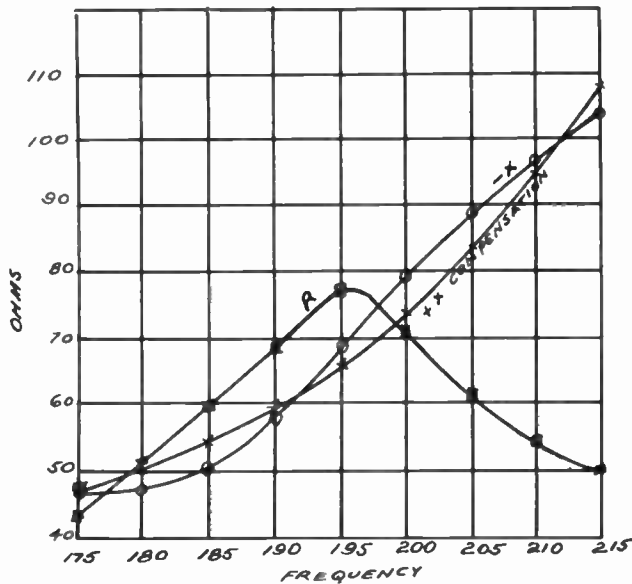

Fig. 6

cylindrical dipoles as a function of l/λ and a parameter called K_a . l is $\frac{1}{2}$ the total length of the dipole, and the parameter K_a is given by

$$K_a = 276 \log_{10} \frac{2l}{r} - 120$$

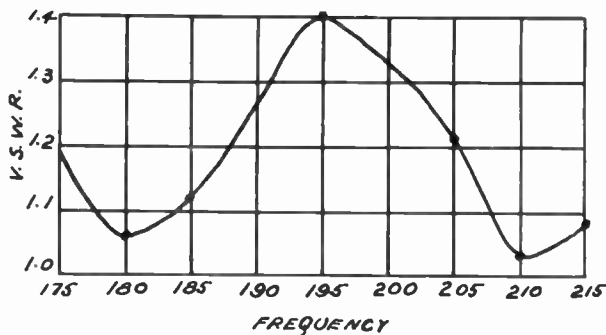

Fig. 7

where r is the radius of the dipole. Fig. 8 shows the curves for $K_a = 500$.

Let us assume that we wish to feed a dipole with 300-ohm line. If we pick $l/\lambda = 0.338$ and choose r to make $K_a = 500$, we find an impedance across the terminals of the dipole

$$Z = 300 + j320 \text{ ohms.}$$

² G. H. Brown and J. Epstein, "A pretuned turnstile antenna," *Electronics*, vol. 18, pp. 102-107; June, 1945.

³ F. D. Bennett, P. D. Coleman, and A. S. Meier, "The design of broad-band aircraft-antenna systems," *Proc. I.R.E.*, vol. 33, pp. 671-700; October, 1945.

⁴ S. A. Schelkunoff, "Theory of antennas of arbitrary size and shape," *Proc. I.R.E.*, vol. 29, p. 493; September, 1941.

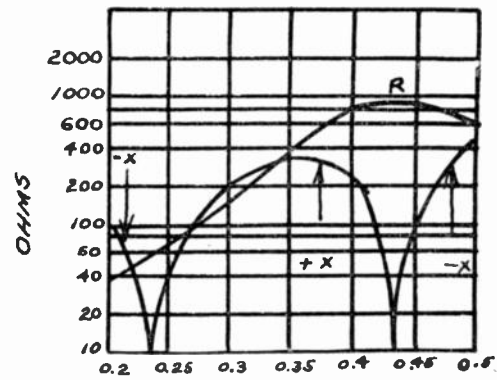

Fig. 8

If we now introduce a series reactance equal to $-j160$ ohms between each arm of the dipole and the line as shown in Fig. 9, the line will see a pure resistance of 300 ohms, and the system will be matched. In general, by controlling the length of a dipole and the value of the series reactance, we can present any pure resistance to the feed line from about 10 to 1000 ohms.

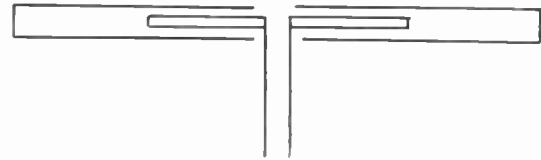

Fig. 9

Another application of value relates to controlling the phase of the current on a dipole. We will attempt to design a turnstile antenna in which the two sets of dipoles are fed in parallel from the same point on the feed line. If we again refer to Fig. 8 and choose l/λ to be 0.22 (always remembering, of course, to choose r so that $K_a = 500$), we then have a dipole whose impedance is

$$Z = 50 - j50 \text{ ohms.}$$

The tangent of the phase angle ϕ will be

$$\tan \phi = \frac{X}{R} = -1$$

$$\phi = -45^\circ.$$

Now take a similar dipole and introduce a series reactance of $+j50$ ohms between each arm and the line, as shown in Fig. 10. This gives an impedance

$$Z = 50 + j50 \text{ ohms.}$$

The tangent of the phase angle ϕ' will be

$$\tan \phi' = \frac{X}{R} = +1$$

$$\phi' = +45^\circ.$$

If we put these two dipoles at right angles to each other on the line as in Fig. 10, we then have the following conditions satisfied for an omnidirectional pattern in azimuth:

1. The currents on each dipole are equal.
2. The current on one dipole is 90 degrees out of phase with the current on the other dipole.
3. The two elements are spatially 90 degrees apart.

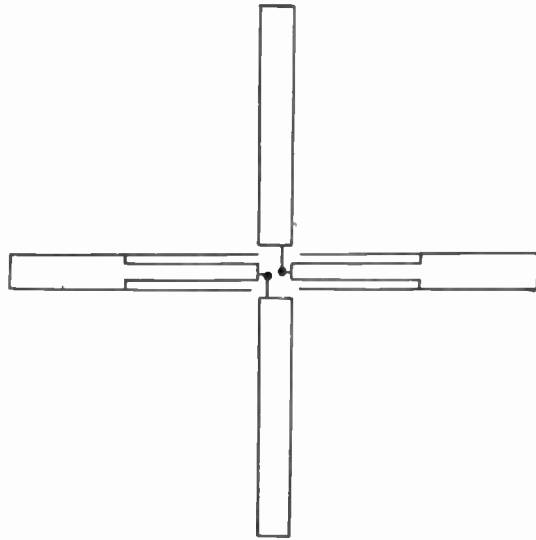

Fig. 10

The impedance presented to the line by the parallel combination will be

$$Z = 50 + j0 \text{ ohms.}$$

The azimuth pattern in power taken of this arrangement is shown in Fig. 11.

V. CONCLUSION

The series reactance is a valuable tool for impedance matching. It is not only useful in matching impedances

directly, as shown in this paper, but can be used in combination with sleeve transformers and parallel compensation with results far better than either one alone. It has a distinct mechanical advantage over parallel com-

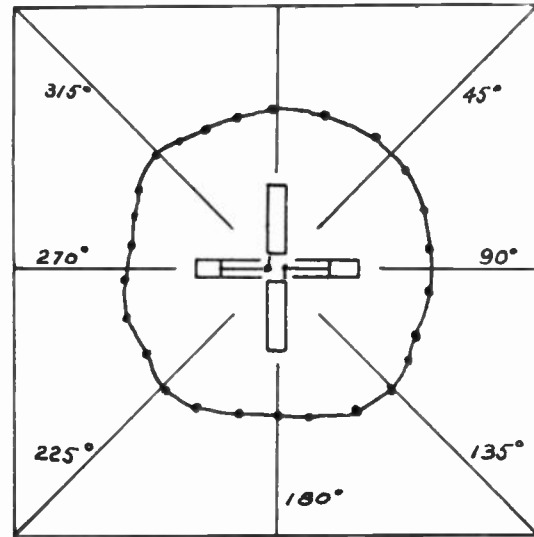

Fig. 11

penation in that it does not require a stub protruding from the line and possibly interfering with the antenna pattern.

It is useful in hollow dipoles for impedance matching and in constructing arrays which usually require a complicated phasing mechanism.

As a final word, the value of footnote reference 1 to anyone doing impedance work at frequencies higher than 200 Mc. cannot be emphasized too strongly.

Tracing of Electron Trajectories Using the Differential Analyzer*

Introduction

JOHN P. BLEWETT†, ASSOCIATE, I.R.E.

Summary—The differential analyzer is used to give a graphical solution of electron paths in the magnetron and triode oscillators with d.c. and r.f. applied anode potential. A d.c. space charge is approximated in the magnetron; otherwise no space charge is included.

The results are of interest in explaining experimental results. In particular, the magnetron paths show a marked tendency towards synchronism, and the triode results indicate that the required peak cathode emission is larger than was supposed.

IN MOST conventional vacuum tubes the majority of the design features result from mechanical considerations. The grid of a triode is not a permeable

plane but a structure of wires. The anode is often not a plane or a circular cylinder but a complex form not at all amenable to analytical representation. The tube designer is then faced with an analytically insoluble problem when he attempts to trace the paths of electrons through the structure which he has designed. The same problem arises in the design of electron guns and beam tubes. The situation is further aggravated when

* Decimal classification: R138. Original manuscript received by the Institute, January 23, 1947; revised manuscript received, May 27, 1947. The work described was supported by the OSRD under Contract No. OEMsr-931.

† Formerly, General Electric Co., Schenectady, N. Y.; now, East Patchogue, Long Island, N. Y.

electron-transit time becomes important or when magnetic fields are applied in addition to the usual electric fields.

A variety of "models" have been devised to give some representation of the form of the electron paths in vacuum tubes. The favorite model for electrostatic devices appears to involve a rubber membrane stretched over blocks scaled to represent the electrode form and having heights proportional to the potentials applied to the various electrodes. A ball from a ball bearing rolled over the surface of this model will follow a path which can be a fairly accurate representation of the true electron path. The accuracy of this approximation is limited by such factors as friction between balls and rubber and gyroscopic effects due to the angular momentum of the balls. If rapidly varying potentials are to be applied to the electrodes, construction of the model becomes a major mechanical problem. This model breaks down completely if magnetic fields are involved.

Other models are available but are generally inferior either in performance, in flexibility, or in mechanical simplicity. A new and straightforward method for tracing electron trajectories seems, therefore, to be badly needed. The manifold field of application should make such a method extremely valuable.

The analytical procedure for determining electron trajectories involves nothing more than an integration of the equations of motion of the electron. These equations written in their general form:

$$m\dot{v} = eE + (e/c)(v \times H)$$

appear very simple. The difficulty in dealing with them lies only in the limited scope of the available mathematical techniques. In view of this situation, mechanical and electrical integration procedures have been

devised in the form of "differential analyzers."¹⁻³ The differential analyzer performs mechanical or electrical integrations on information which may be fed to it in any one of a variety of ways. The object of the present research has been the evolution of methods for giving the analyzer the pertinent information about electric and magnetic fields and initial conditions, and setting up appropriate connections within the analyzer so that the machine itself will draw a picture of the electron trajectory. The methods which have been worked out are believed to be original and appear to have considerable generality and power.

Thus far, only two-dimensional problems have been solved. The methods used could be extended without difficulty to structures having axial or some other types of symmetry. Three-dimensional problems could be solved, but the procedures would be materially complicated and new methods would be required for presentation of the results. The effects of uniform magnetic fields are easily included. Extension of the method to nonuniform magnetic fields would add complication but would be entirely possible.

This report falls into three sections. Part I deals with the method of representing the fundamental equations for solution on the differential analyzer. Part II discusses the application of the method to a split-anode magnetron structure. Part III is devoted to ultra-high-frequency triodes of the "disk-seal" type.

¹ V. Bush, "A differential analyzer: A new machine for solving differential equations," *Jour. Frank. Inst.*, vol. 212, pp. 447-448; October, 1931.

² H. P. Kuehni and H. A. Peterson, "A new differential analyzer," *Trans. A.I.E.E. (Elec. Eng., May, 1944)*, vol. 63, pp. 221-228; May, 1944.

³ F. J. Maginniss, "Differential analyzer applications," *Gen. Elec. Rev.*, vol. 48, pp. 54-57; May, 1945.

Part I—Differential Analyzer Representation*

GABRIEL KRON†, F. J. MAGINNISS†, AND H. A. PETERSON‡

1. ELECTROSTATIC FIELDS

As a concrete example, consider a three-element vacuum tube with both a.c. and d.c. potentials applied to both grid and plate. No magnetic field is present. The components of acceleration of an electron in such an electrostatic field are

$$\frac{d^2x}{dt^2} = -\frac{e}{m} E_x \quad (1)$$

$$\frac{d^2y}{dt^2} = -\frac{e}{m} E_y \quad (2)$$

E_x and E_y are here defined by

$$E_x = [V_c + V_g \sin \omega t] E_{gx}' + [V_B + V_p \sin(\omega t + \phi)] E_{px}' \quad (3)$$

$$E_y = [V_c + V_g \sin \omega t] E_{gy}' + [V_B + V_p \sin(\omega t + \phi)] E_{py}' \quad (4)$$

where

V_c = d.c. voltage on grid wires

V_g = peak a.c. voltage on grid wires

V_B = d.c. voltage on plate

V_p = peak a.c. voltage on plate

ω = angular frequency of a.c. voltage on both grid and plate

ϕ = angle by which a.c. plate voltage leads a.c. grid voltage.

* Decimal classification: R138. Original manuscript received by the Institute, January 23, 1947; revised manuscript received, May 27, 1947.

† General Electric Co., Schenectady, N. Y.

‡ Formerly, General Electric Co., Schenectady, N. Y.; now, University of Wisconsin, Madison, Wis.

$E_{gx'}$, $E_{gy'}$, $E_{px'}$, and $E_{py'}$ are field plots of the x and y components of electric field strength for two conditions of potential. $E_{gx'}$ and $E_{gy'}$ are plotted as functions of position for the condition of 1 volt on the grid wires and zero volts on the plate and cathode. $E_{px'}$ and $E_{py'}$ are plotted with 1 volt on the plate and zero volts on grid and cathode. After substituting (3) and (4) in (1) and (2), respectively, performing certain algebraic operations, and integrating each equation once, there results

$$\frac{dx}{dt} = -\frac{e}{m} \left\{ V_c \int E_{gx'} d \left[t - \frac{V_g}{\omega V_c} \cos \omega t \right] + V_b \int E_{px'} d \left[t - \frac{V_p}{\omega V_B} \cos (\omega t + \phi) \right] \right\} \quad (5)$$

$$\frac{dy}{dt} = -\frac{e}{m} \left\{ V_c \int E_{gy'} d \left[t - \frac{V_g}{\omega V_c} \cos \omega t \right] + V_b \int E_{py'} d \left[t - \frac{V_p}{\omega V_B} \cos (\omega t + \phi) \right] \right\} \quad (6)$$

and x and y are determined by integrating (5) and (6):

$$x = \int \frac{dx}{dt} dt \quad (7)$$

$$y = \int \frac{dy}{dt} dt. \quad (8)$$

Equations (5) through (8) are the fundamental equations and are in the form set up on the analyzer.

Of interest in a study of this nature are the currents induced in the grid and the plate by the moving electrons. In particular, the magnitudes of the fundamental components of these currents were obtained. The Fourier coefficients of the fundamental components are

$$\left. \begin{aligned} a_{1g} &= \frac{1}{T} \int_0^T i_g \cos \omega t dt \\ b_{1g} &= \frac{1}{T} \int_0^T i_g \sin \omega t dt \\ a_{1p} &= \frac{1}{T} \int_0^T i_p \cos \omega t dt \\ b_{1p} &= \frac{1}{T} \int_0^T i_p \sin \omega t dt \end{aligned} \right\} \quad (9)$$

where T is the period of the a.c. voltage, and i_g and i_p are the total currents induced in grid and plate, respectively, by a moving electron.

If the electron-transit time is less than one cycle of the a.c. voltage, the values of the coefficient at the end of the run are the same as they will be at the end of one cycle. If the run (electron-transit time) lasts longer than one cycle but less than two cycles, the reading taken at the end of the run will contain the contribution of each of two electrons which were in the interelectrode space, one of which was covering the latter part of its travel while the other was going through its first cycle.

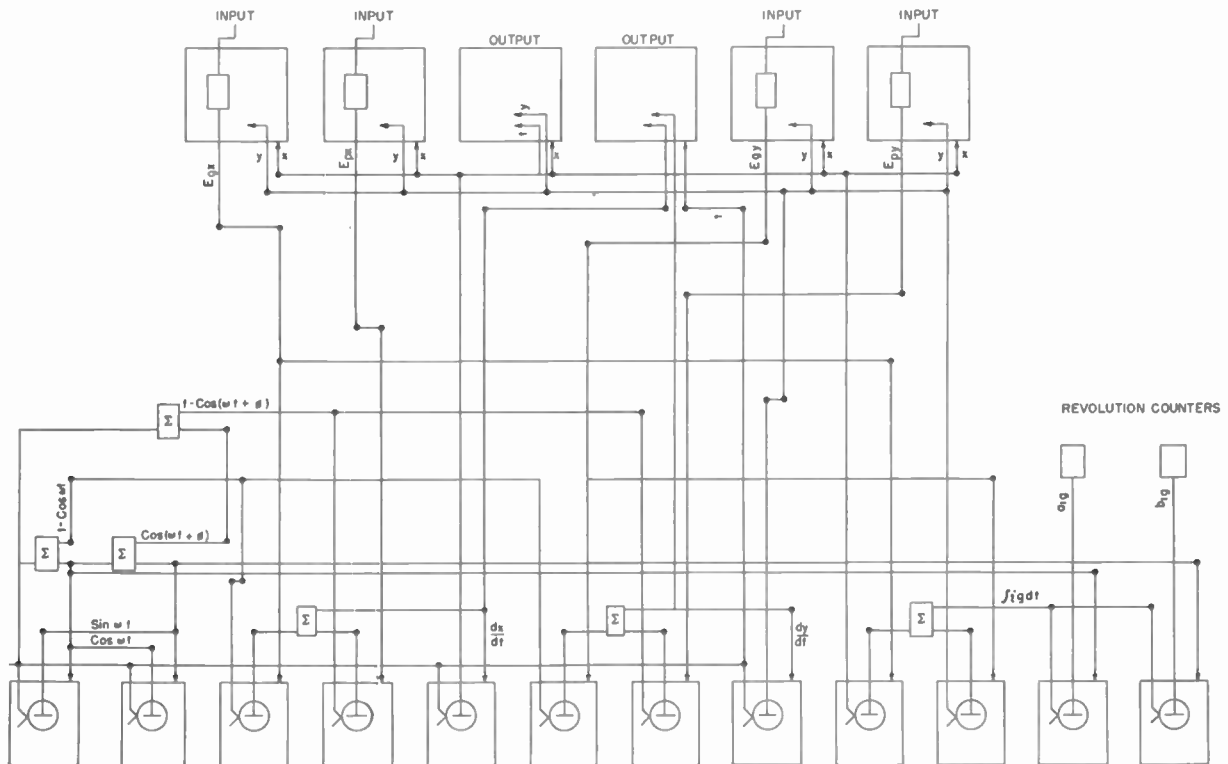

Fig. 1—Differential-analyzer schematic for tracing electron trajectories in electric fields.

For setting up on the differential analyzer, equations (9) are written

$$\left. \begin{aligned} a_{1o} &= \frac{1}{T} \int_0^T \cos \omega t \, d \int i_o dt \\ b_{1o} &= \frac{1}{T} \int_0^T \sin \omega t \, d \int i_o dt \\ a_{1p} &= \frac{1}{T} \int_0^T \cos \omega t \, d \int i_p dt \\ b_{1p} &= \frac{1}{T} \int_0^T \sin \omega t \, d \int i_p dt \end{aligned} \right\} \quad (10)$$

It may be shown that (see Part III, Section 2-b)

$$\left. \begin{aligned} i_o &= E_{ox}' \frac{dx}{dt} + E_{oy}' \frac{dy}{dt} \\ i_p &= E_{pz}' \frac{dx}{dt} + E_{py}' \frac{dy}{dt} \end{aligned} \right\} \quad (11)$$

so

$$\left. \begin{aligned} \int i_o dt &= \int E_{ox}' dx + \int E_{oy}' dy \\ \int i_p dt &= \int E_{pz}' dx + \int E_{py}' dy \end{aligned} \right\} \quad (12)$$

Equations (12) are then substituted in equations (10) to give the required coefficients.

Fig. 1 shows the differential-analyzer schematic connection diagram for the solution of these equations.

2. ELECTROSTATIC AND MAGNETIC FIELDS

The motion of an electron in an electrostatic field is described by the general equations in rectangular co-ordinates as follows:

$$\left. \begin{aligned} \frac{d^2 x}{dt^2} &= -\frac{e}{m} E_x \\ \frac{d^2 y}{dt^2} &= -\frac{e}{m} E_y \\ \frac{d^2 z}{dt^2} &= -\frac{e}{m} E_z \end{aligned} \right\} \quad (13)$$

where $-E_x$, $-E_y$, and $-E_z$ are the components of electric field strength in the x , y , and z directions.

The motion of an electron in a magnetic field is subject to another set of differential equations, also for rectangular co-ordinates, as follows:

$$\left. \begin{aligned} \frac{d^2 x}{dt^2} &= \frac{e}{mc} \left(B_z \frac{dy}{dt} - B_y \frac{dz}{dt} \right) \\ \frac{d^2 y}{dt^2} &= \frac{e}{mc} \left(B_x \frac{dz}{dt} - B_z \frac{dx}{dt} \right) \\ \frac{d^2 z}{dt^2} &= \frac{e}{mc} \left(B_y \frac{dx}{dt} - B_x \frac{dy}{dt} \right) \end{aligned} \right\} \quad (14)$$

where B_x , B_y , and B_z are the components of magnetic flux density in the x , y , and z directions. Both (13) and (14) are in e.s.u.

In a specific problem under study, B_x and B_y were zero, and B_z was constant throughout the region under observation. Also, E_z was zero. E_x and E_y were functions of space co-ordinates (x and y) in the region of study, and also in part were sinusoidal functions of time. In the absence of space charge, the portions E_x and E_y which are not functions of time can be separated from that portion which varies with time so that (13) and (14) may be written

$$\frac{d^2 x}{dt^2} = -\frac{e}{m} \left(E_{1x} + E_{2x} - \frac{B_z}{c} \frac{dy}{dt} \right) \quad (15)$$

$$\frac{d^2 y}{dt^2} = -\frac{e}{m} \left(E_{1y} + E_{2y} + \frac{B_z}{c} \frac{dx}{dt} \right)$$

where the subscript 1 designates the component of electric field strength varying only with space co-ordinates and not with time, while the subscript 2 designates the component of electric field strength varying both with space co-ordinates and with time.

It is possible to solve these equations readily on the differential analyzer in the following manner: For the configuration under study, first consider only the d.c. potentials applied to the electrodes. For this condition a flux plot of equipotential lines can be obtained, possibly by flux plotting, or by solving Laplace's equation on a suitable d.c. calculating board. From this flux plot, the components of field strength in the x and y directions ($-E_{1x}$, $-E_{1y}$) can be obtained at any point. Lines of constant $-E_{1x}$ and $-E_{1y}$ can then be drawn giving separate plots of constant gradient for the x and y directions. Similarly, separate plots of constant gradient for the x and y directions can be obtained for the a.c. voltages ($-E_{2x}$, $-E_{2y}$), with no d.c. voltages applied. Thus, four field plots of lines of equal gradient are required in order to solve (15) mechanically on the differential analyzer.

In order to solve (13) on the analyzer, it is only necessary to multiply mechanically the E_{2x} and E_{2y} quantities by the proper time function, in this case a sinusoidal function. Thus, (15) may be written

$$\left. \begin{aligned} \frac{d^2 x}{dt^2} &= -\frac{e}{m} \left(E_{1x} + E_{2x} \sin \omega t - \frac{B_z}{c} \frac{dy}{dt} \right) \\ \frac{d^2 y}{dt^2} &= -\frac{e}{m} \left(E_{1y} + E_{2y} \sin \omega t + \frac{B_z}{c} \frac{dx}{dt} \right) \end{aligned} \right\} \quad (16)$$

The solution thus requires four input tables, one for each field plot of lines of equal gradient. On each input table, the x and y co-ordinates are determined by the values of x and y defining the position of the elec-

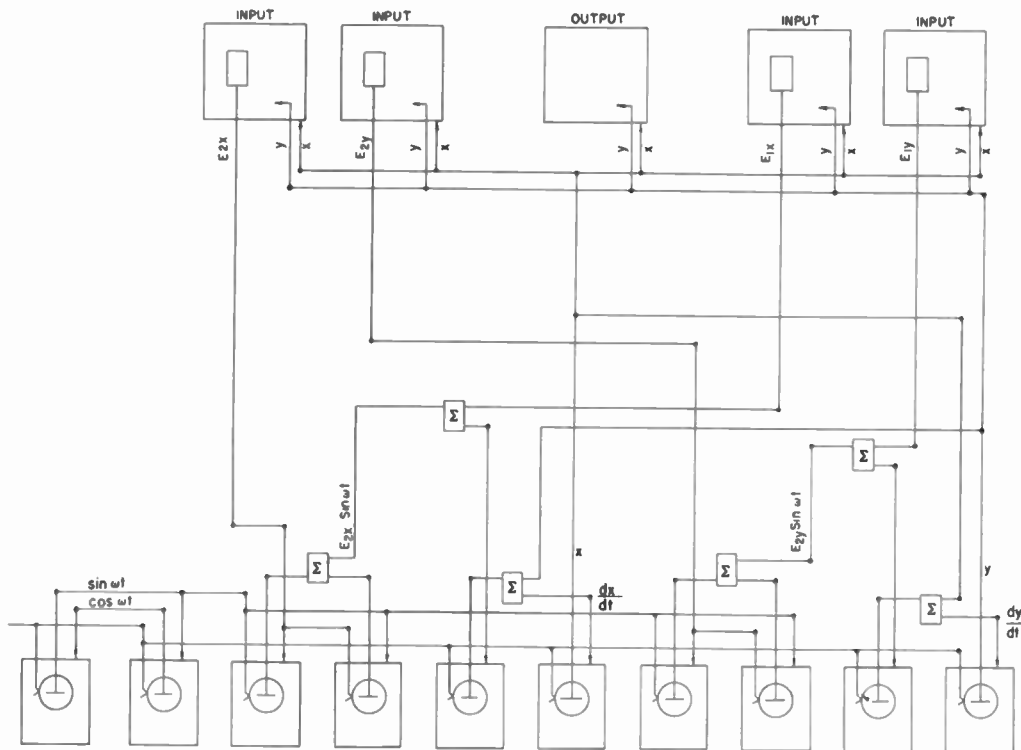

Fig. 2—Differential-analyzer schematic for tracing electron trajectories in electric and magnetic fields.

tron at any time. Each input-table operator continuously puts into the machine, by means of a hand crank, a quantity proportional to the gradient at the point occupied by the electron at any given time. The quantities E_{2x} and E_{2y} are multiplied by the sine function before being added to the E_{1x} and E_{1y} quantities, respectively, to give the resultant field strength (a.c. and d.c.) acting upon the electron at any point in space and at any time.

The equations as set up on the analyzer were as follows:

$$\begin{aligned} \frac{dx}{dt} &= K_1 \int E_{1x} dt + K_2 \int E_{2x} \sin \omega t dt + K_3 y + K_4 \\ \frac{dy}{dt} &= K_1 \int E_{1y} dt + K_2 \int E_{2y} \sin \omega t dt - K_3 x + K_5. \end{aligned} \quad (17)$$

The differential-analyzer connection diagram is shown in Fig. 2. Several simple cases whose solutions are known were run with this set-up in order to measure the accuracy attainable with the analyzer in treating a problem of this kind. The circular path followed by an electron in a uniform magnetic field and no electric field and several types of trochoidal path of the type traced by an electron in crossed uniform electric and magnetic fields were reproduced by the analyzer with an accuracy

of two or three parts per thousand per cycle of the path. With more complex electric field configurations the accuracy will, of course, be limited by the accuracy with which the field plots are constructed and by the ability of the operator to follow these plots correctly. Checks on the reproducibility of such paths indicated accuracies of the order of 1 per cent per cycle of whatever periodic path was involved.

Fig. 2 of Part II of this paper shows a representative solution for a typical split-anode magnetron configuration with both a.c. and d.c. voltages applied. This case, of course, is of greatest interest from a practical standpoint, and illustrates the importance of the analyzer in studying such complex cases. The electron starts from the cathode with zero initial velocity, encircles the cathode three times, and finally, on the fourth time around, arrives at the anode.

It should be apparent that space charge can be approximated in the solution, provided the assumed resultant effects are the same for both a.c. and d.c. applied potentials, or at least that the a.c. and d.c. effects are independent of each other, and are incorporated in the original flux plots from which the plots of lines of equal gradient are obtained. This is not a valid assumption for general use, but, with proper caution, may be used for a large number of practical conditions where the paths of individual electrons are under study.

Part II—Electron Paths in Magnetrons*

W. C. HAHN†, ASSOCIATE, I.R.E., AND J. P. BLEWETT‡, ASSOCIATE, I.R.E.

1. INTRODUCTION

In the magnetron, electrons are subjected to three fields—a uniform magnetic field, a static electric field, and an alternating electric field. The magnetron problem can, in the first approximation, be considered to be two-dimensional, as though the anode and cathode structures extended to infinity in the axial direction. The method for setting up this problem on the differential analyzer has been outlined in Part I of this paper.

This method has been applied to a split-anode magnetron having the configuration shown in Fig. 1. As a

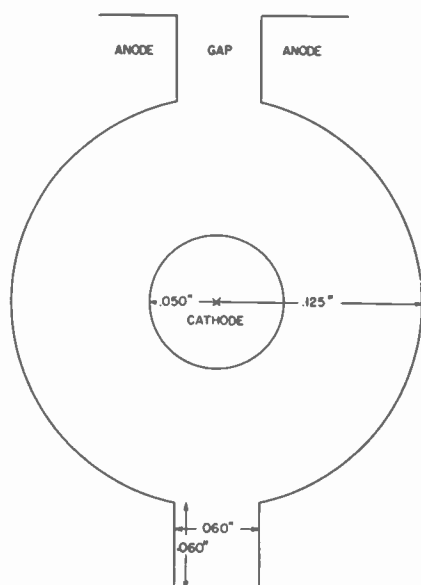

Fig. 1—Split-anode-magnetron configuration.

first test, d.c. conditions only were considered. A flux plot was made, neglecting any possible effects of space charge, and from it were derived plots of the E_x and E_y components of electric field. Several electron paths were run on the machine for anode voltages corresponding to cutoff conditions in the magnetron. Since, in a static field, the velocity at a point is directly deducible from the potential at that point, this procedure could be used as a check on the accuracy of the method.

It soon became apparent that the largest source of error lay in the plots of the field components. If incorrect values of E_x and E_y are inserted in the equations of

motion, the apparent energy of the particle may not be conserved. For example, some of the "electrons" originating at the cathode returned to the cathode surface with velocities corresponding to about 50 electron volts of energy. Although this error is a small percentage of the 1000 volts applied to the anode, it does represent a large error in the total velocities near the cathode. An approximate calculation indicates that errors in E_x and E_y of 1 per cent were responsible for the errors which were observed. For many cases of interest the present degree of accuracy may be quite satisfactory, especially if the electron does not return to the vicinity of the cathode before being collected.

In the final flux plots for the analyzer setup, in which a.c. fields were taken into account, a rough attempt was made to include space-charge effects. At least in the neighborhood of the cathode, the potential is believed to have approximately a parabolic form. The flux plots were modified slightly, particularly in the neighborhood of the cathode, to simulate these conditions and to give the condition of zero gradient at the cathode which is known to obtain for the space-charge-limited condition.

2. INITIAL CONDITIONS

Since the field pattern in its modified form gave zero gradient at the cathode, it was no longer possible to start an electron at the cathode with zero velocity. Several approximate starting methods were tested. Electrons were started with a variety of initial velocities and directions, or were started a short distance outside the cathode with computed velocities. The results obtained were not even internally consistent and were extremely sensitive to the assumed initial conditions.

Consistent results were finally achieved with a procedure which is based on an integration of Poisson's equation. If a.c. variations in fields are assumed to be negligible in the immediate neighborhood of the cathode, Poisson's equation may be written

$$\frac{\partial}{\partial r}(rE_r) = 4\pi\rho r = 2I \frac{dt}{dr}$$

where ρ and I are charge density and current. Since, in the absence of a.c. disturbances, there are no azimuthal variations in any variables, this equation can be integrated to give

$$E_r = \frac{2It}{r}$$

where t is now the transit time of the electron from the cathode to the point whose radius is r . If the cathode is

* Decimal classification: R138X R355.912.1. Original manuscript received by the Institute, January 23, 1947; revised manuscript received, May 27, 1947.

† General Electric Co., Schenectady, N. Y.

‡ Formerly, General Electric Co., Schenectady, N. Y.; now, East Patchogue, Long Island, N. Y.

finite in size and we do not depart far from the cathode, r is effectively constant, so that the electric field near the cathode is proportional to the electron's transit time. In this discussion, the effects of current returning to the cathode have been neglected, a procedure which may not be justified in all cases.

Application of the above theorem permits mechanical integration with respect to time, if the input is connected to a crank manipulated by the operator and E_x and E_y are obtained on the output side. To facilitate this operation, a small percentage of the motion of the crank was added to the output of the integrator. At the beginning of the path, the integrators were given initial settings so that, as the machine started, a value of E_x or E_y corresponding to a constant times the transit time would be automatically inserted. As the electron moved away from the cathode, it would ultimately reach a point where finite gradients could be read from the plot. From this point on, the procedure described in Part I was followed.

3. ELECTRON TRAJECTORIES

It can be shown analytically that the path of an electron in an inhomogeneous electric field and a strong magnetic field has a distorted trochoidal form, oscillating around a mean path which tends to follow the equipotentials of the electric field. It is, however, extremely difficult in most cases to determine how rapidly this mean path deviates from the equipotentials. The paths run on the analyzer under conditions simulating very-low-frequency operation showed in a striking fashion the tendency of the paths to stick to equipotentials. Paths plotted for an electrostatic condition in which one of the anode segments has a high positive potential with respect to the cathode while the other segment has a low positive potential were shown to terminate on the less positive segment. A series of such paths shows that even at low frequencies a negative-resistance characteristic can be expected between the two anode segments. This behavior is observed in actual tubes and the negative-resistance characteristic can be checked by static measurements. Graphs of these characteristics are to be found in most textbooks which discuss the magnetron.

At high frequencies, it is known that the electron tends to synchronize with the effective rotating field produced by the a.c. voltage over a wide range of frequencies. This fact also was demonstrated by paths run on the analyzer. The loops of the rough trochoidal path, each of which takes approximately one Larmor period, open or close as the frequency is raised or lowered, so that the electrons always take approximately one a.c. cycle to complete a revolution around the cathode. A typical path is shown in Fig. 2.

Although the general characteristics of the electron paths followed a consistent pattern, it was found to be difficult to reproduce the paths in detail. The fine structure of the paths depends strongly on small changes in

the assumptions involved in the flux plots. It would, of course, have been possible to obtain a true picture of the d.c. space-charge distribution by running a series of

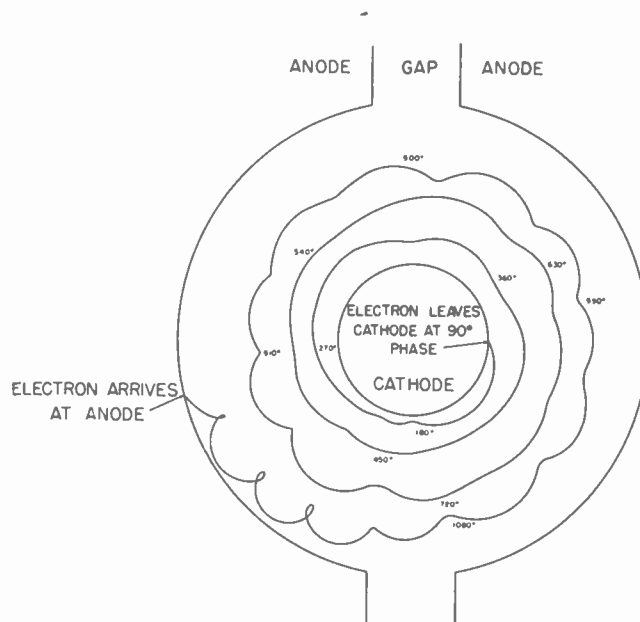

Fig. 2—Typical electron trajectory in split-anode magnetron. Magnetic field = 1500 gauss; d.c. voltage = 1750; a.c. r.m.s. voltage = 400; and frequency = 360 Mc.

paths, performing a numerical integration of Poisson's equation, and checking the deduced field against the original assumptions. A second approximation based on this result would presumably give a more accurate field plot. A series of such successive approximations should finally give a correct field distribution. The a.c. space-charge effects, however, could follow only from a procedure so cumbersome as to be impracticable.

A further difficulty at the present stage of the art lies in the long time necessary in calculating the path of an electron between the cathode and anode. A single path takes almost an hour to run on the analyzer. Of course, the same path would have taken a month or more to calculate numerically. However, a complete study of the magnetron would include the tracing of paths for a number of starting positions on the cathode surface and for a number of starting times with respect to the a.c. wave. Because of the pressure of other matters this procedure has not been completed.

4. ESCAPING ELECTRONS

Considerable trouble has been experienced in operating magnetrons because of electrons which escape in some fashion from the anode and bombard the tube envelope. The trajectories run on the analyzer indicate that at least some of these electrons have escaped through the gaps between the anode segments. Several trajectories have been observed which passed through the gaps and left the anode structure at high speeds. Presumably the analyzer could now be used to trace the

electrons through such structures as may be proposed for shielding the tube envelope by intercepting these electrons.

5. SECONDARY ELECTRONS

The question has frequently been raised as to the behavior of secondary electrons liberated at the more-negative anode segment. If such electrons were drawn across the gap and collected on the more-positive segment, they would constitute a load across the r.f. circuit and lower the apparent efficiency of the tube. The analyzer should be able to yield valuable information in answer to this question. A few electron paths starting at the anode faces have been run, but as yet the results

are inconclusive. Secondaries have been observed which followed long and devious paths through the tube and finally escaped through the anode gaps. In most cases, however, the secondaries appear to return to a point close to their point of origin after a very short excursion.

6. CONCLUSION

The work done thus far on tracing electron paths in magnetron structures has been merely of an exploratory nature. Qualitative observations indicate that, although the solutions are rather sensitive to errors in flux plotting, the techniques evolved give promise of yielding much valuable information regarding magnetron behavior.

Part III—Study of Transit-Time Effects in Disk-Seal Power-Amplifier Triodes*

J. R. WHINNERY†, SENIOR MEMBER, I.R.E., AND H. W. JAMIESON‡, MEMBER, I.R.E.

1. INTRODUCTION

The study to be described was undertaken because the efficiencies obtained in power amplifiers and oscillators using the disk-seal tubes in the 3000-Mc. region were much lower than the corresponding low-frequency values. It was not known to what extent transit-time effects were responsible for the low efficiencies and other observed high-frequency effects; and no complete analyses of large-signal transit-time electronics were available in the literature, although there have been a number of excellent beginnings.^{1,2} The methods of study of electron paths by the differential analyzer, described by Kron, Maginniss, and Peterson in Part I of this paper, seemed to provide an excellent means for studying the limitations imposed by the electronics of the tube, and were therefore utilized. The studies were performed for a 2C39 disk-seal tube, which is one of the most useful triodes for microwave power-amplifier purposes.³

It was necessary to make certain assumptions in order to apply the analyzer solution, the most serious of which was the neglect of space charge in affecting the electron motion. The neglect of space charge was made after a comparison of results from Chao-Chen Wang's¹

parallel-plane analysis and results of a parallel-plane analysis of Salzberg¹ neglecting space charge. It was found that the transit-time phenomena of importance were all revealed by the analysis neglecting space charge, and in many important calculations the magnitudes also agreed well.

Initial velocities of electrons were neglected. The geometrical configuration of the parallel-wire grid and its spacings with respect to anode and cathode were included, but edge effects were neglected, so that the problem was two-dimensional. All magnetic fields inside the tube were assumed negligible, so that the analysis inside the tube could proceed as a quasi-static problem. This last assumption has been justified in detail by Brillouin.²

2. SETTING UP OF THE PROBLEM

a. The Electron Paths

In Section 1 of Part I, the manner of setting up the differential equations of electron motion on the differential analyzer is described. Four plots are necessary for a three-element tube. One is a plot from which the value of electric field in the x direction at any point in the tube can be obtained when the grid is at unit potential and the plate and cathode are grounded. This field may be called E_{ox}' . Similarly, E_{oy}' , the y component of electric field under the same conditions, is required, as are E_{px}' and E_{py}' , the x and y components of electric field calculated with the plate at unit potential and the grid and cathode grounded. The total x component of electric field is then obtained by multiplying E_{ox}' by the actual instantaneous grid-cathode voltage, and adding to the product of E_{px}' and the plate-cathode voltage.

Each of these voltages has a d.c. part and a sinusoidally varying part, with an arbitrary phase angle between the two sinusoids.

* Decimal classification: R138.5×R339.2. Original manuscript received by the Institute, January 23, 1947; revised manuscript received, May 27, 1947.

† Formerly, General Electric Co., Schenectady, N. Y.; now, University of California, Berkeley, Calif.

‡ Formerly, General Electric Co., Schenectady, N. Y.; now, Hughes Aircraft Co., Culver City, Calif.

¹ Chao-Chen Wang, "Large signal high-frequency electronics of thermionic vacuum tubes," *PROC. I.R.E.*, vol. 29, pp. 200-214; April, 1941. (A similar unpublished analysis, neglecting space charge, has been shown to us by Dr. B. Salzberg of the Naval Research Laboratory.)

² L. Brillouin, "Transit-time and space charge in a plane diode," *Elec. Commun.*, vol. 21, pp. 110-123; 1944.

³ H. W. Jamieson and J. R. Whinnery, "Power amplifiers with disk-seal tubes," *PROC. I.R.E.*, vol. 34, pp. 483-489; July, 1946.

$$E_x = E_{ox}'[V_c + V_o \sin \omega t] + E_{px}'[V_b + V_p \sin(\omega t + \phi)] \quad (1)$$

$$E_y = E_{oy}'[V_c + V_o \sin \omega t] + E_{py}'[V_b + V_p \sin(\omega t + \phi)]. \quad (2)$$

The sinusoids required above were generated by two integrators of the differential analyzer.

The plots used to feed the values of E_{ox}' , E_{oy}' , E_{px}' , and E_{py}' into the analyzer were contours of constant field values, for the tube configuration sketched in Fig. 1, as pictured in Figs. 2 to 5. The numbers on the plots which represent the strengths of the field components

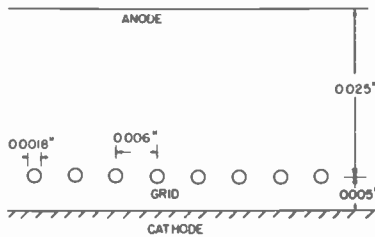

Fig. 1—Cross section showing configuration of the 2C39 tube.

have been multiplied by a scale factor and a constant amount (3000) has been added to each for convenience in setting up the analyzer. It should also be noted that the plots are not continued all the way to the plate, but are stopped as soon as the x components of field become negligible and the y components substantially constant. The values for the plots were calculated by a method of conformal transformations and line images.⁴ Each plot is placed on a table with a pointer following the electron path as given by the analyzer so that an operator can "crank-in" the proper field value read from his particular plot. The total fields are formed according to (1) and (2) in the analyzer, and the proper acceleration for the electron at that position is thus given. With the parameters V_c , V_o , V_b , V_p , ω , and ϕ in (1) and (2) chosen, and the initial conditions of starting time and place along the cathode selected, the path of the electron may then be obtained, within the limits of accuracy imposed by the assumptions discussed earlier.

b. The Induced Currents

If power outputs and power gains are to be calculated, it is necessary to know the induced currents in the tube electrodes, or at least their fundamental components. This information may also be obtained from the analyzer, by making use of a theorem⁵ that may be stated as follows:

⁴ B. Salzberg, "Formulas for the amplification factor for triodes," *Proc. I.R.E.*, vol. 30, pp. 134-138; March, 1942.

⁵ Simon Ramo, "Currents induced by electron motion," *Proc. I.R.E.*, vol. 27, pp. 584-585; September, 1939.

Given a moving charge in a region near several electrodes, the instantaneous induced current to any particular electrode from that charge may be found by multiplying the charge magnitude by the scalar product of the charge velocity at that instant and a particular electric field vector for the instantaneous position of the charge. This electric field is calculated by removing all charges, raising the desired electrode to unit potential and leaving all other electrodes grounded.

The particular fields required for finding induced currents to the grid and plate are those already fed into the machine from the four basic plots, and the electron-velocity components are available in the analyzer, so the induced current can be formed.

$$i_o = \Delta q \bar{v} \cdot \bar{E}_o' = \Delta q (v_x E_{ox}' + v_y E_{oy}') \quad (3)$$

$$i_p = \Delta q \bar{v} \cdot \bar{E}_p' = \Delta q (v_x E_{px}' + v_y E_{py}'). \quad (4)$$

The fundamental components of these induced currents are of interest in power calculations, and they were obtained in this study in place of the induced currents themselves. The integrations to give the sine and cosine fundamental components of induced grid current are:

$$(i_{o1}) \cos = \frac{1}{\pi} \int_0^{2\pi} i_o \cos \omega t d(\omega t) \quad (5)$$

$$(i_{o1}) \sin = \frac{1}{\pi} \int_0^{2\pi} i_o \sin \omega t d(\omega t), \quad (6)$$

and similarly for i_p . Since $\sin \omega t$ and $\cos \omega t$ are obtainable from the analyzer, these integrations can be performed and the final results for a particular electron, representative of a spread of electrons in space and time, read on counters.

c. Miscellaneous Information

For complete energy balances, it is necessary to have the final velocity of electrons at each electrode so that the energy lost in heat at that electrode may be calculated. The x and y velocity components versus time were plotted on plotting tables. The final velocities appeared also on counters where they could be read with greater accuracy.

Average currents, required for the d.c. calculations, are computable from the actual number of electrons (or charge groups) reaching an electrode in a complete cycle.

3. CHOICE OF PARAMETERS

Once the geometrical configuration of interest was selected and the required field plots constructed, the next step was the selection of the remaining unknown parameters in (1) and (2). These parameters are the same as those that must be selected in a conventional class-C analysis at low frequencies, except that at low frequencies the phase between the plate and grid a.c. voltages is almost invariably selected as 180° to cor-

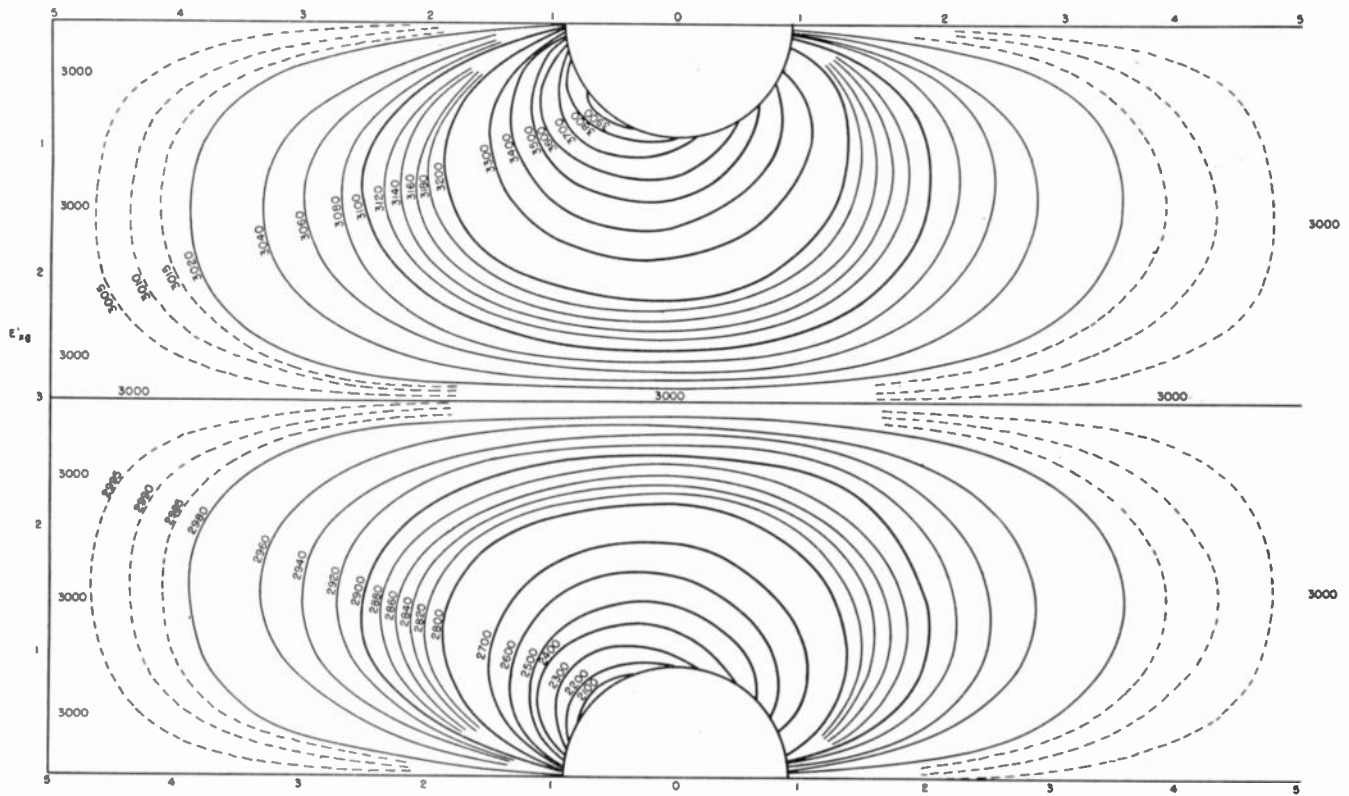

Fig. 2—Contours of constant E_{0z}' for the 2C39 tube.

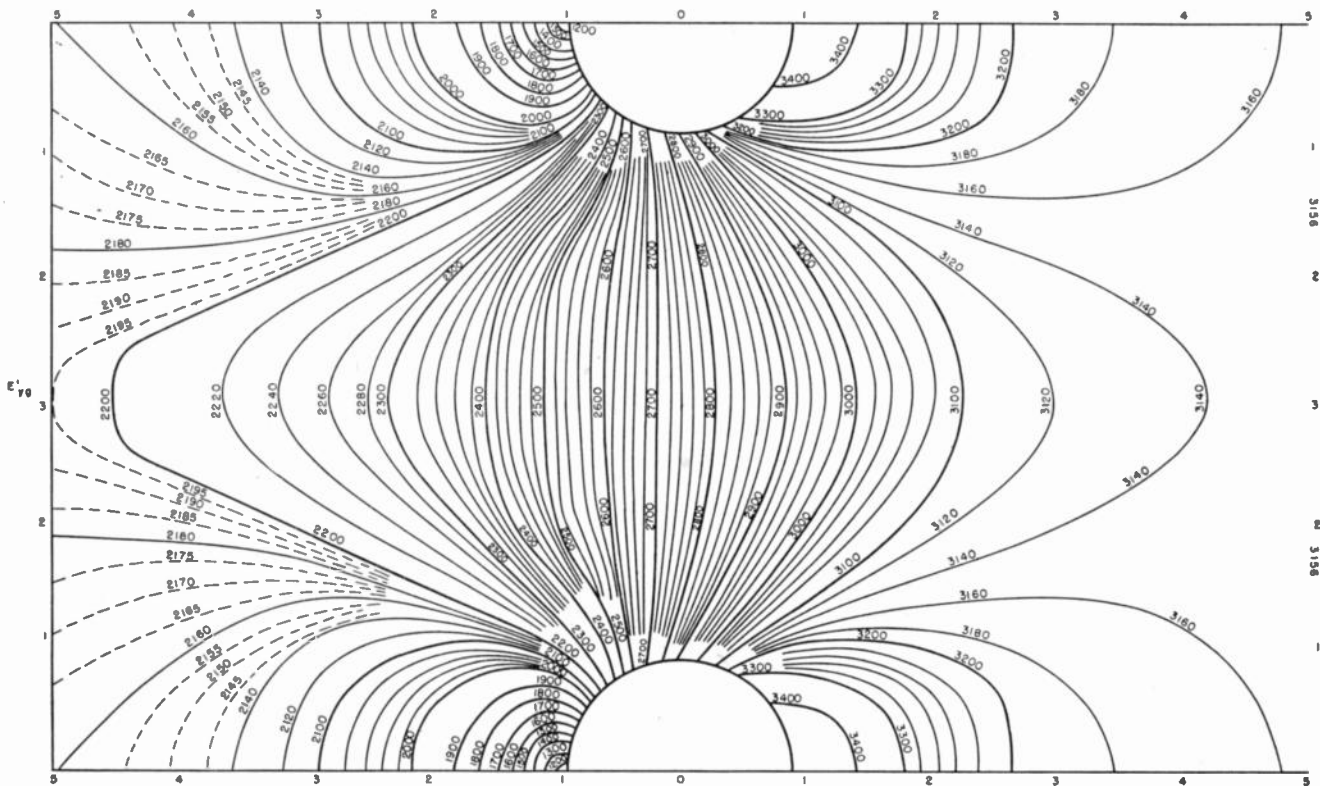

Fig. 3—Contours of constant E_{0y}' for the 2C39 tube.

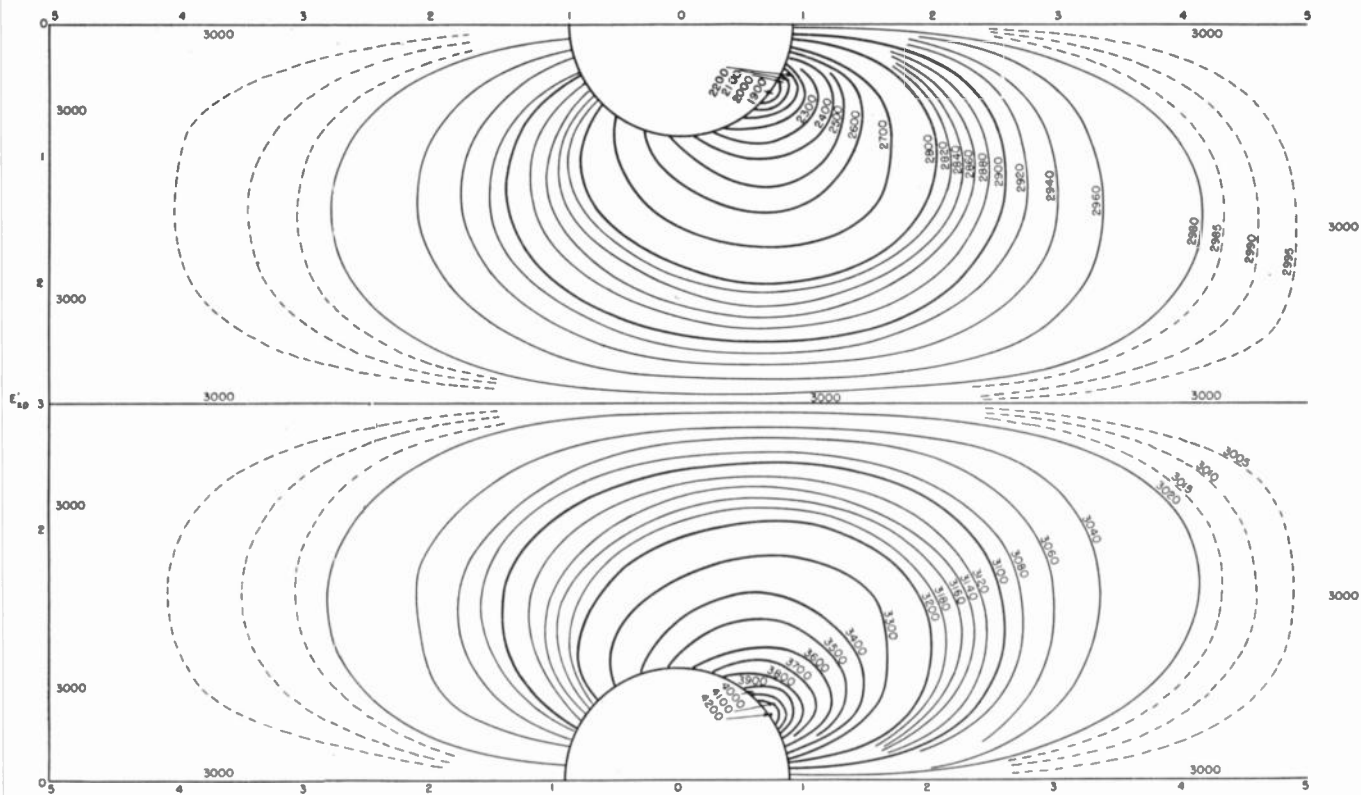

Fig. 4—Contours of constant E_{pz}' for the 2C39 tube.

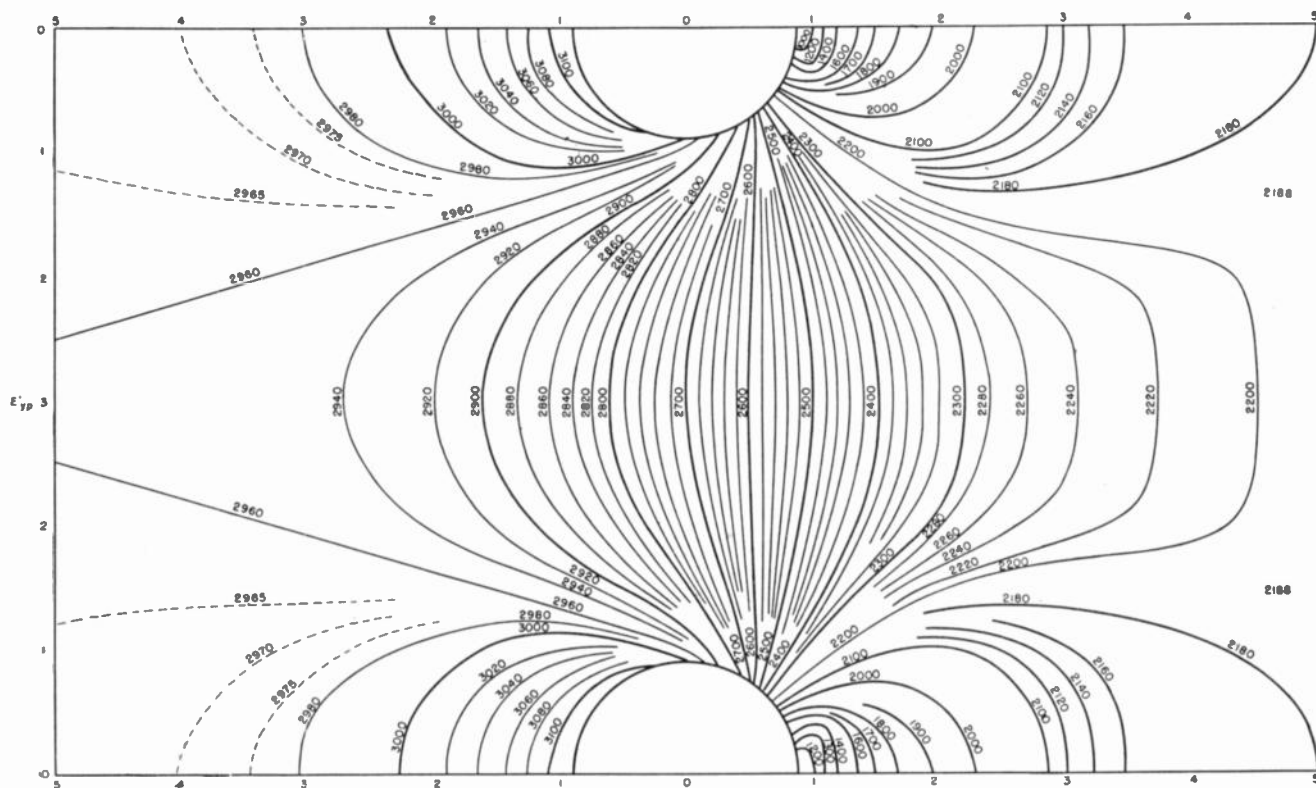

Fig. 5—Contours of constant E_{py}' for the 2C39 tube.

respond to operation with a pure resistance load. When transit times are important, there is an additional phase lag inside the tube which results in a phase displacement between the fundamental component of plate current and the grid-cathode r.f. voltage which produces it. There is a corresponding phase displacement between plate-cathode and grid-cathode voltages even with a pure resistance load, and this phase angle is not known until the problem is solved. Some reasonable phase angle must be assumed and the analysis carried through, after which the load impedance in *magnitude and phase angle* can be calculated. If the angle of impedance does not correspond to a desired impedance, a new analysis must be undertaken with a new assumed phase angle.

Several electrons must be taken at various starting points along the cathode, and several starting times must be used throughout the cycle, so that 25 or 30 electrons must be studied for any given selection of parameters. Also, since there were not enough integrators to give plate induced current and grid induced current at the same time, it was necessary to repeat each run when both plate and grid quantities were desired. For this reason only three different cases were studied.

TABLE I
SUMMARY OF CASE I

	Neutralized		Unneutralized	
	Temper- ature— Limited	Space- charge— Weighted	Temper- ature— Limited	Space- charge— Weighted
$V_B = 800$				
$V_c = -15$				
$\phi = -270^\circ$				
$V_p = 400$				
$V_g = 25$				
<i>power in:</i>				
d.c. drive	60.88	43.68	60.88	43.68
total	63.59	45.00	59.96	42.42
<i>power out:</i>				
load	11.35	4.20	8.78	1.62
plate dissipation	43.50	40.29	43.50	40.49
grid dissipation	0.06	0.02	0.06	0.02
cathode dissipation	0.51	0.58	0.51	0.58
bias supply	0.15	0.07	0.15	0.07
total	55.57	45.36	53.00	42.78
Y_{Load}	$\frac{1}{7073} + \frac{1}{j4591}$	$\frac{1}{19,100} + \frac{1}{j4925}$	$\frac{1}{9150} + \frac{1}{j1365}$	$\frac{1}{49,600} + \frac{1}{j1394}$
$Y_{Driving}$	$\frac{1}{115.4} + \frac{1}{-j884}$	$\frac{1}{236} + \frac{1}{j303}$	$\frac{1}{-340} + \frac{1}{j742}$	$\frac{1}{-249} + \frac{1}{j303}$
plate efficiency	18.6%	9.6%	14.4%	3.7%
power gain	4.2	3.19	oscillating	oscillating
d.c. plate current	0.0761	0.0546	0.0761	0.0546
d.c. grid current	0.0102	0.0048	0.0102	0.0048
average returned current	0.0584	0.0564	0.0584	0.0564

In all cases, the d.c. plate potential was that currently used in our tests of the tubes and was not changed. Frequency was selected as 3000 Mc. In the

first case studied, the a.c. swings were chosen to correspond to our best estimates of the r.f. swings in an actual amplifier. The phase angle was taken from a previous parallel-plane analysis, assuming a pure resistance load. As it turned out, this phase angle did not correspond to a pure resistance load according to the differential-analyzer result for the actual configuration, and was corrected in a later study. The magnitude of r.f. plate voltage was increased for Case II with phase angle and other parameters remaining the same. Calculated power output was increased, but the impedance required turned out to be unattainable. In Case III the phase angle between plate and grid a.c. voltages was revised to correspond more nearly to a resistance load. The impedance was reasonable, and efficiency was improved. The grid bias and drive voltages were also increased in Cases II and III. Detailed performance figures are given in the next section. Parameters for Cases I and III are given in Tables I and II.

TABLE II
SUMMARY OF CASE III

	Neutralized		Unneutralized	
	Temper- ature— Limited	Space- charge— Weighted	Temper- ature— Limited	Space- charge— Weighted
$V_B = 800$				
$V_c = -27$				
$V_p = 720.6$				
$V_g = 45$				
$\phi = 36.16^\circ$				
<i>power in:</i>				
plate d.c. drive	57.44	97.04	57.44	97.04
total	61.16	103.46	56.24	98.53
<i>power out:</i>				
load	31.2	58.0	28.30	55.0
plate dissipation	29.42	40.94	29.42	40.94
grid dissipation	0.21	0.21	0.21	0.21
cathode dissipation	0.86	2.33	0.86	2.23
bias supply	0.42	0.93	0.42	0.93
total	62.11	102.31	59.21	99.31
Y_{Load}	$\frac{1}{7850} + \frac{1}{j12,500}$	$\frac{1}{4220} + \frac{1}{j22,000}$	$\frac{1}{8690} + \frac{1}{j2220}$	$\frac{1}{4460} + \frac{1}{j2060}$
$Y_{Driving}$	$\frac{1}{272} + \frac{1}{j678}$	$\frac{1}{158} + \frac{1}{j294}$	$\frac{1}{-841} + \frac{1}{-j192}$	$\frac{1}{682} + \frac{1}{-j306}$
plate efficiency	54.2%	59.8%	49.3%	56.7%
power gain	8.40	9.0	oscillating	37 (regenerating)
d.c. plate current	0.071	0.118	0.071	0.118
d.c. grid current	0.016	0.021	0.016	0.021
average returned current	0.047	0.103	0.047	0.103

4. STUDY OF CURVES

Since a few hundred curves were obtained from the plotting tables of the analyzer, it would be impossible to reproduce all of these here. A few typical examples are shown, all from Case I.

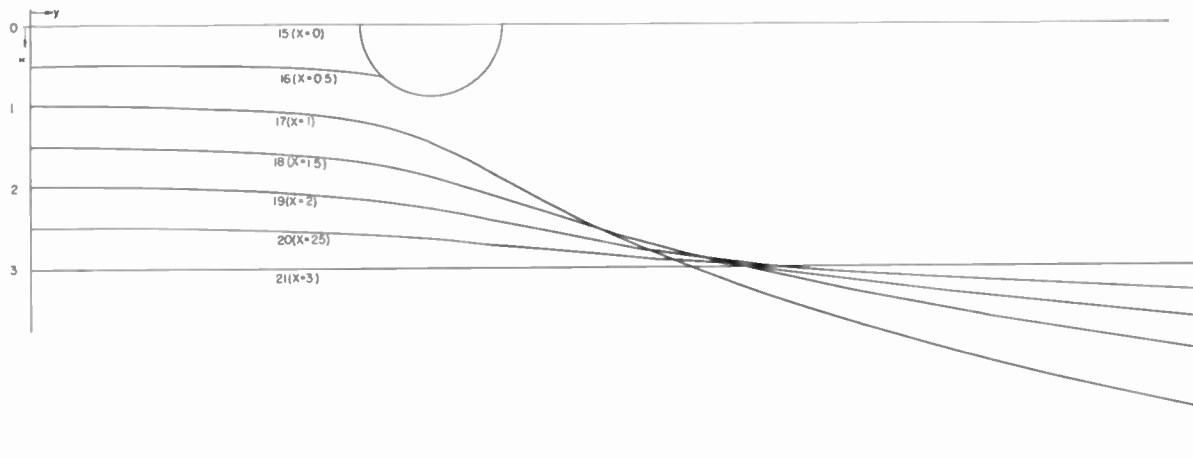

Fig. 6—Electron trajectories for $\alpha=0.4$ radians.

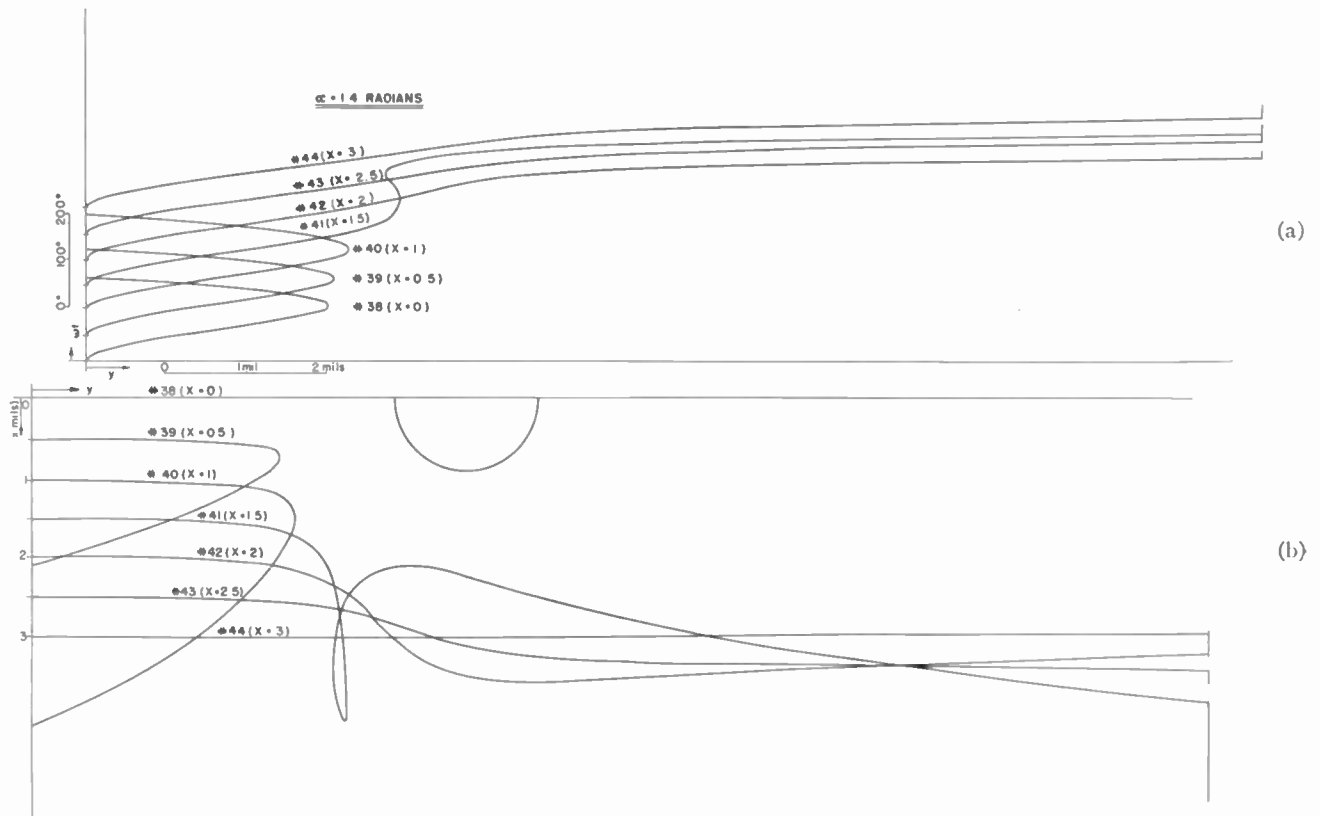

Fig. 7—(a) Time vs. distance plots for $\alpha=1.4$ radians. (b) Electron trajectories for $\alpha=1.4$ radians.

Figs. 6, 7(b), and 8 show electron trajectories, or x versus y plots, for α (the electrical angle, referred to grid-cathode voltage, at which electrons leave the cathode) equal to 0.4, 1.4, and 1.8 radians, respectively. In each figure, the several curves are for electrons started at points 0.0005 inches apart along the cathode. In Fig. 6 for $\alpha=0.4$, all electrons either cross to the anode or strike the grid. In Fig. 7(b) for $\alpha=1.4$, electrons starting from the cathode within a distance 0.0015 inches from the point directly under the grid wire are

returned to the cathode. Electron number 41 ($x_0=0.0015$ inch) is a critical electron, but all electrons starting beyond this pass through to the anode without difficulty. It should be noted that the path of electron number 41 could not be duplicated in repeat runs because of its sensitivity to small variations in the information cranked in by the operators, but paths of other electrons could be reproduced with great accuracy. In Fig. 9, for $\alpha=1.8$, all electrons are returned to the cathode after a short excursion into the cathode-grid space.

Plots of time versus distance and the two components of velocity versus time were obtained from all runs. Fig. 7(a) shows the time versus distance plot for $\alpha = 1.4$ radians. The several curves are displaced vertically by an arbitrary amount to minimize confusion. Figs. 8(a) and 8(b) show the y and x components of velocity (to different scales) for the $\alpha = 1.4$ electrons.

capacitance in the actual tube; or, in other words, this has been assumed to be neutralized by some external feedback. By unneutralized, it is meant that this capacitance has been considered in making the calculations. Its magnitude is known fairly accurately, and can be checked from the field plots. Since the plate-cathode voltage is assumed, the current fed through this

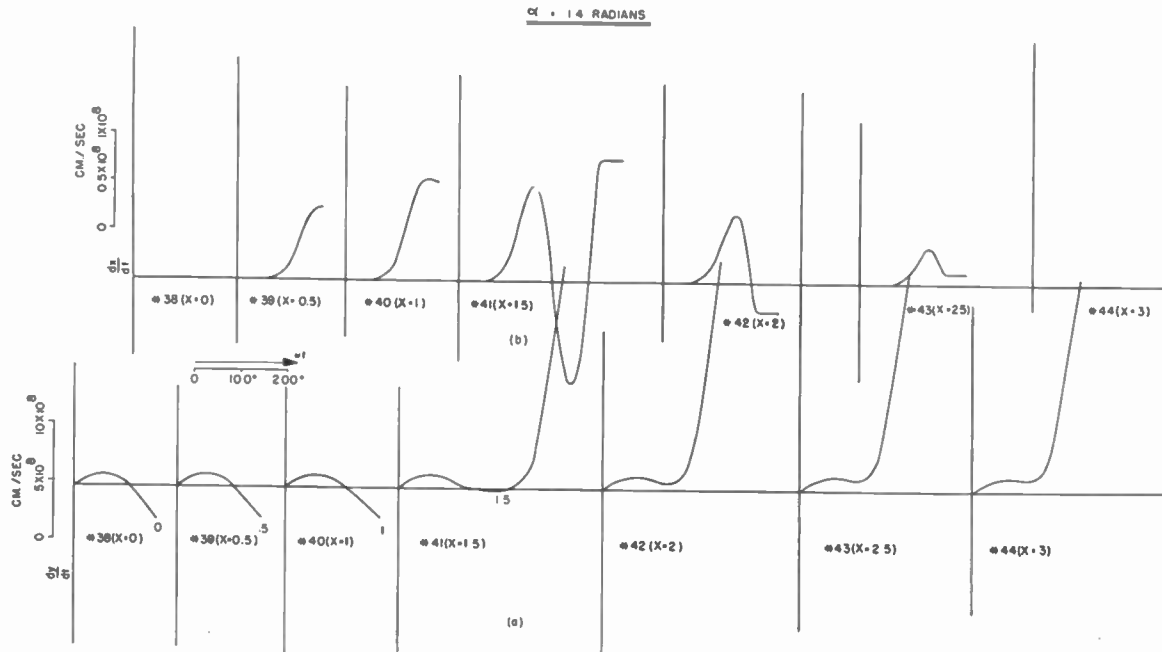

Fig. 8—Electron velocities for $\alpha = 1.4$ radians.

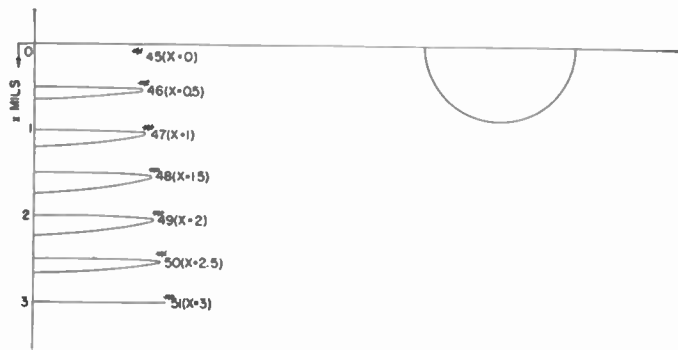

Fig. 9—Electron trajectories for $\alpha = 1.8$ radians.

5. POWER BALANCES

The results of a reduction of the analyzer data for two of the three cases listed previously are tabulated in Tables I and II. Several calculations are made from each result; and the results designated neutralized or unneutralized, temperature-limited, or space-charge-weighted. A grid-return circuit connection is assumed in all calculations.

By neutralized, it is meant that no account has been taken of the finite feedback due to the plate-to-cathode

capacitance can be calculated and added vectorially to the induced currents.

In the "temperature-limited" case, we have been consistent in our neglect of space charge, both in its effect on electron paths and on the strength of the current drawn from the cathode at any instant. In the "space-charge-weighted" case, the effects of space charge on electron paths are neglected, but the amount of current leaving the cathode is weighted according to the instantaneous strength of field at the cathode. This, of course, does not give the actual current leaving the cathode at any instant; but we believe that the results indicate the differences that may be expected when space charge influences the current leaving the cathode, as it does over at least a part of the cycle under typical operating conditions.

In studying the tables, one should note the consistency of the power balance or agreement between total power in and total power out. In Case I it is excellent for the two space-charge-weighted examples and fair for the temperature-limited example when the size of the steps used for the summations is taken into consideration. In Table II all power balances are good. This agreement proves nothing about the correctness of conclusions, but it is a good indication of the self-consistency of the calculations, since the several powers have been calculated in different ways, the d.c. powers

from average values, the r.f. powers from induced currents, and the dissipation powers from final velocities of electrons striking the electrodes.

The plate efficiency is uniformly low in Case I. It was somewhat better in Case II (not shown) where r.f. plate-cathode voltage was increased without changing phase angle (but here load impedances were so high as to be unattainable), and was very good compared with actually obtained 3000-Mc. efficiencies in Case III (Table II), where the phase angle between grid-cathode and plate-cathode voltages was changed. This last efficiency was uniformly high regardless of the conditions assumed, neutralized or unneutralized, temperature-limited or space-charge-weighted. Possible reasons why such efficiencies are not obtained in practice will be discussed in a later section.

The load impedances or admittances are expressed so that the load may be interpreted as a resistance in parallel with a reactance. Thus the first value of load admittance in Table I corresponds to 7070 ohms resistance in parallel with 4590 ohms inductive reactance. The impedances for Case III are the only ones that are predominately resistive and reasonable in value. The impedance for the neutralized, space-charge-weighted calculation, for example, corresponds to 4220 ohms resistance in parallel with 22,000 ohms capacitive reactive reactance. The net impedance is predominately resistive and the 4000-ohm load resistance is probably attainable without being limited by circuit losses *if care is used*.

Several other items are worth study. First, it may be said that most of the results are within reason, though a few are somewhat surprising. For example, the heat dissipated by electrons striking the grid is essentially negligible. At lower frequencies, trouble from grid heating has been observed, so the present result would seem questionable. It should be remembered, however, that the low grid dissipation was a direct result of the particular transit-time conditions, for even the first electrons experienced some retarding field before they struck the grid and so hit with a low velocity. Later electrons were repelled from it completely. This situation would not exist at low frequencies. Also, the resistive component of input impedance is higher than expected, but as yet we have no careful measurements of the impedance referred to the electron stream, so it cannot be said to be a violation of experimental results. The division between d.c. grid current and plate current agrees well with measured values. The power gain under the best conditions is larger than any we have obtained when trying for large outputs, as is the plate efficiency.

The electrons returned to the cathode are of interest. Although the power dissipated in back-heating by these electrons is not large compared with the total d.c. powers, it is primarily supplied from the r.f. driving power, and the back-heating power is an appreciable

part of this. The amount of current returned is seen to be of the same order as the current actually reaching the plate, so it is of great importance in decreasing the power-output capabilities of the tube.

6. CONCLUSIONS

Results of the study described in this report indicate that the electronics of the tube should permit plate efficiencies of around 50 per cent and power gains of 8 or 9 for a 2C39 power amplifier at 3000 Mc., which represents considerably better performance than we have obtained in practice. Even in the one case which yielded such calculated results, load impedances of 4000 to 8000 ohms were required, which means that the shunting effects of losses should represent a much higher impedance in order for the circuit efficiency to be reasonable. Measurements on cavities used prior to the analyzer study showed that we did not have such high impedances. When the cavities were improved by redesigning plungers and by-passes, the plate efficiency nearly doubled, increasing from around 10 to 20 per cent, but this last figure is still appreciably less than the value predicted by the analyzer.

The returned current to the cathode is one of the most important results of the large-signal transit-time effects, since it adds to the r.f. driving power and decreases from the useful current into the grid-plate region. It has been observed frequently in practical amplifiers by the increase in cathode brilliance when driving power was turned on. In many amplifiers the 60-cycle heater power could be removed entirely without appreciably changing operating conditions once the amplifier was operating.

The largest loss of the d.c. power comes from plate dissipation, and the analysis clearly shows the fundamental conflict in a triode between the desire for small transit times in the output space and low velocities of impact at the anode. Both of these are required for high efficiency. In a tetrode the conflict is largely removed because the electrons are first accelerated by the screen grid; and even if they are reduced to zero velocity at the plate, their average velocity through the screen-grid to plate space may be appreciable and the transit time relatively small.

Finally, we may say that the differential-analyzer method seems very promising to us for future studies. It would first be desirable to revise the procedure so that fewer runs need to be made for any given case, since this seriously limits the number of parameters that can be varied. For example, fewer electrons might be taken along the surface of the cathode. Some runs could be taken without studying input quantities so that the run would not have to be duplicated. We do not yet have any very good ideas on the inclusion of space-charge effects without reverting to the idealized parallel-plane tube.

Discussion on

"Harmonic-Amplifier Design"*

ROBERT H. BROWN

A. H. Sonnenschein:¹ Robert H. Brown, in his paper on the design of harmonic amplifiers, makes the statement that, for the proper use of Terman's method, it is necessary to make certain arbitrary assumptions regarding the various components of the grid current.

Fortunately, this is not the case. The curves showing the distribution of the space-current components can easily be utilized to analyze the grid current, if the following precautions are taken. First, instead of using the angle of space-current flow, it is necessary to use the angle of grid-current flow. This is easily calculated from a knowledge of the grid bias and the driving voltage. Second, since the grid current does not follow the same general law as the space current, it is necessary to determine the proper exponent α . This can be easily done by a logarithmic plot of the static grid-current characteristics. In cases where the space-current follows the $3/2$ power law, the grid current will usually follow what is close enough to a square law for practical purposes.

The subsequent procedure of subtracting the various grid-current components from the corresponding values

* PROC. I.R.E., vol. 35, pp. 771-777; August, 1947.

¹ College of the City of New York, 3569 Broadway, New York 31, N.Y.

of the space current for the determination of the grid and plate dissipation, driving power, and harmonic output, remains unchanged.

R. H. Brown:² A. H. Sonnenschein has pointed out the necessity for revising the treatment of grid currents as outlined in the older form of Terman's analysis. His suggestions should prove valuable in cases where one does not require the certainty of a complete graphical analysis.

It has been my experience that often a number of trial designs must be made before the desired performance of a harmonic amplifier can be hit upon. For economy of time, it is advantageous to make all but the last one or two by a rapid and approximate analytical method. The procedure outlined in Appendix I is that which I have found most suitable for this purpose. There ought to be cases where satisfactory designs could be obtained at some saving of time by finishing off with a Terman analysis employing Sonnenschein's modifications, without going through a complete graphical procedure.

² Formerly, Engineering Research Department, Sylvania Electric Products, Inc., Bayside, N. Y.; now, Walla Walla College, College Place, Wash.

Contributors to the Proceedings of the I.R.E.



PIERRE R. AIGRAIN

Pierre R. Aigrain (S'46) was born in Poitiers, France, on September 28, 1924. He attended schools in France and entered the French Naval Academy in 1942, graduating in 1944. After a short period of active duty with the F.F.I., he came to the United States to receive flight training at various Naval Air Stations.

Since late 1945, Lieutenant Aigrain has been on detached service as a graduate student in the electrical engineering department at the Carnegie Institute of Technology, from which he received the degree of master of science in 1946. He is a member of Sigma Xi.



For a photograph and biography of JOHN P. BLEWETT, see page 1585 of the December, 1947, issue of the PROCEEDINGS OF THE I.R.E.



Enzo Cambi was born in Rome, Italy, on July 23, 1910. He was graduated as a Doctor of Engineering from the University of Rome in November, 1932. In 1934 he worked, under a scholarship at the Physical Institute, University of Rome, for the constitution of the future Electroacoustical Institute of the University. From 1936 to 1937 Dr. Cambi was an acoustical designer for the new Motion Picture Studios "Cinecitta" in Rome. In May, 1937, he became chief of



ENZO CAMBI

the technical department of the Studios, and in October, 1943, was promoted to technical director. The Studios ceased their activity in May, 1944. At present, he is working independently as a consultant for theoretical questions at the Electroacoustical Institute, and the Seamless Tube Manufacture "Dalmine."



M. J. DI TORO

Michael J. Di Toro (A'37-SM'45) was born on June 24, 1910, in Campobasso, Italy. He entered the Polytechnic Institute of Brooklyn in 1927, from which he received the E.E. degree in 1931, the M.E.E. degree in 1933, and the D.E.E. degree in 1946. He joined the research laboratories of the Thomas A. Edison Company in 1934, where he was engaged in electroacoustical research and development of recording and reproducer equipment, loudspeakers, microphones, and related sound apparatus. In 1941 he became associated with the Hazeltine Electronics Corporation laboratories in Little Neck, N. Y., where he was senior electrical engineer in charge of the development of telemetering systems, v.h.f. wavemeters, delay lines, and their application in pulse detection systems and television.

In 1946, Dr. Di Toro joined the Microwave Research Institute of the Polytechnic Institute of Brooklyn as senior research associate, becoming assistant to the director in 1947. He was in charge of work on u.h.f. power meters, f.m. transient studies, and electronic computers. He also taught mathematics and electroacoustics in the undergraduate and graduate departments of the Polytechnic Institute. He is now with the Federal Telecommunication Laboratories, in Nutley, N. J.

Dr. Di Toro became a licensed professional engineer of the State of New York in



W. C. HAHN

1945. He is a member of the Acoustical Society of America, the American Institute of Electrical Engineers, and the American Physical Society. He has also been elected to the honorary fraternities of Eta Kappa Nu and Sigma Xi.



W. C. Hahn (A'36-SM'45) received the B.S. degree at the Massachusetts Institute of Technology in 1923. Following a student engineering course at General Electric Company, he was sent to the Chicago office of this firm until 1932. From 1933 to 1944 Mr. Hahn was in the engineering general department at the Schenectady works. Since then he has been in the Research Laboratory.



H. W. JAMIESON

H. W. Jamieson (A'42-M'45) was born in Shreveport, La., on January 19, 1918. He was graduated from the University of California with a B.S. degree in electrical engineering in 1939. In January, 1940, he was employed by the General Electric Company, where he was with the instrument-transformer development section until July, 1941. He was with the high-frequency development section of the General Engineering Laboratory until August, 1942. In 1944, he was a graduate of the three-year advanced engineering program and until August, 1945, was associated with the Electronics Laboratory and Research Laboratory of that company. Mr. Jamieson is now with the radio division of the Hughes Aircraft Company in Los Angeles, Calif.



Herbert L. Krauss (S'40-A'42-M'46) was born in Topeka, Kan., on August 24, 1916. He received the B.S. degree in electrical engineering from the University of Kansas in 1939, and the M.E. degree from Yale University in 1941. During the summer of 1941 he worked in the research laboratories of the Sperry Gyroscope Company, and returned to Yale in the fall to teach in the department of electrical engineering. Mr. Krauss is now an assistant professor at Yale, teaching courses in communication engineering.

Mr. Krauss is a member of the American Institute of Electrical Engineers, the Yale



HERBERT L. KRAUSS

Engineering Association, Sigma Xi, and Tau Beta Pi.



Gabriel Kron was born on July 23, 1901, in Hungary. He received the B.S. degree in electrical engineering from the University of Michigan in 1924, and the honorary M.S. degree in 1936. Mr. Kron has engaged in design, research, and development work with Robbins and Myers, Lincoln Electric, Westinghouse, and several other electrical companies both in this country and abroad. Since 1934, he has been with the General Electric Company, serving in the capacity of consulting engineer since 1938.



F. J. Maginniss received the B.S. degree in physics from New York University in 1937. In 1940 he was granted an M.S. degree in physics by the University of Pennsylvania. During 1939 and 1940 he was a member of the staff of the Moore School of Electrical Engineering at the University of Pennsylvania. Since 1941 he has been employed in the analytical division of the central station engineering divisions of the General Electric Company in Schenectady, N. Y.



GABRIEL KRON



F. J. MAGINNISS

R. B. Nelson (M'46) was born at Powell, Wyo., on December 10, 1911. He attended the San Diego State College and the California Institute of Technology, where he received the B.S. degree in physics in 1935. He was a graduate student and teaching Fellow at the Massachusetts Institute of Technology, and received the Ph.D. degree in physics there in 1938. Dr. Nelson has been employed in the Electron Optics Laboratory of the Radio Corporation of America Manufacturing Company, at Harrison, N. J.; in the radio section of the National Research Council of Canada at Ottawa; and is presently on the staff of the General Electric Company's research laboratory at Schenectady, New York. He is a member of the American physical Society.

Harold A. Peterson was born on December 28, 1908, at Essex, Iowa. He entered the University of Iowa at Iowa City in 1928 and received the B.S. degree in electrical engineering in 1932. In 1933 he received the M.S. degree in electrical engineering from the same institution. For another year he continued advanced studies and served as research assistant at the University of Iowa. In 1934 he joined the General Electric Company as a test engineer, and from 1937 until



R. B. NELSON

1946 he was an engineer in the analytical division of the Central Station Engineering Divisions of the General Electric Company at Schenectady. In 1946 he joined the staff of the University of Wisconsin as professor of electrical engineering. He is a Fellow of the American Institute of Electrical Engineers, and a member of the American Society of Mechanical Engineers. He is also a member of Sigma Xi and Tau Beta Pi.

J. A. Pierce (SM'45—F'47) was born in Spokane, Wash., in 1907. He received the B.A. degree in physics in 1933 from the University of Maine. From 1934 to 1941 he was engaged in research, primarily on the physics of the ionosphere, at Cruft Laboratory, Harvard University. From 1941 through 1945 he was a staff member of the Radiation Laboratory of the Massachusetts Institute of Technology, where he assisted in the development of the loran system. He is now a research fellow at Cruft Laboratory, working in the fields of radio propagation and long-range pulse transmission and utilization.



HAROLD A. PETERSON

A. A. PISTOLKORS

A. A. Pistol Kors was born on October 11, 1896, at Moscow, Russia. He graduated from the First St. Petersburg Gymnasium in 1914. During World War I Professor Pistol Kors served in the Radio Corps of the Caucasian Army. He was chief of the Bakou Radio Station, Caucasus, from 1919 to 1920. He became chief and instructor at the Post Office Radio School at Vladikavkaz, North Caucasus, in 1920. Entering the Moscow High Technical School in 1923, he received the E.E. degree in 1927. In 1926 he joined the Lenin Radiolaboratory at Nizhni-Novgorod. Professor Pistol Kors is currently affiliated with the Leningrad Institute of Communication Engineering.

For a photograph and biography of HENRY J. RIBLET, see page 497 of the May, 1947, issue of the PROCEEDINGS OF THE I.R.E.

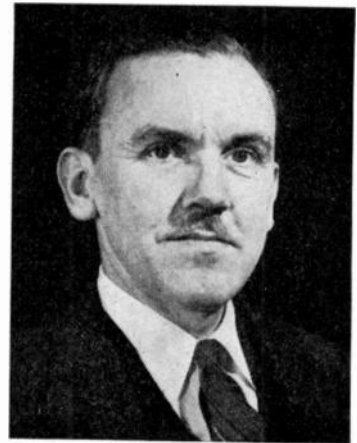

J. A. PIERCE

Howard J. Rowland (SM'46) was born in New York, N. Y., on October 11, 1917. From 1937 to 1938 he was an assistant in the physics department of Long Island University, and from 1939 to 1940 he engaged in research on magnetic suspensions for the physics department of the Brooklyn Polytechnic Institute. In 1940 Mr. Rowland was appointed assistant in physics at the Massachusetts Institute of Technology. In 1943 he became a research associate, and from 1943 to 1945 was a staff member of the Radiation Laboratory, specializing in antenna work. Since 1945 he has been chief engineer of the Workshop Associates, Inc., Newton Highlands, Mass.

Theodore S. Saad (A'45) was born in West Roxbury, Mass., on September 13, 1920. He received the B.S. degree in electrical engineering in 1941 from the Massachusetts Institute of Technology. He worked for Sylvania Electric Products, Inc. in their fluorescent lamp division from 1941 to 1942. In 1942 he joined the Radiation Laboratory at the Massachusetts Institute of Technology. Since then he has been engaged in the design, development, and testing of microwave radar components. In 1945 he joined



HOWARD J. ROLAND

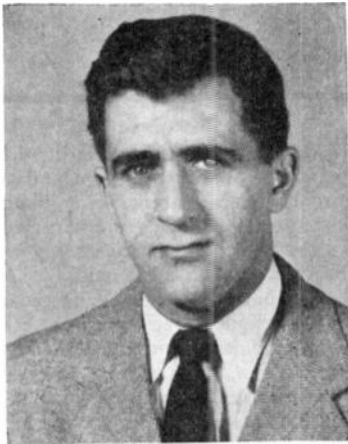

THEODORE S. SAAD

the radar engineering staff of the Submarine Signal Company, where he is presently employed.



Cecil K. Stedman (SM'44) was born in England in 1908. He was graduated from the University of British Columbia in 1930, and received the Ph.D. degree in physics from Purdue University in 1936. From that time until 1941 he was successively appointed instructor, assistant professor, and associate professor of physics at Purdue University. He was associated with Harvard University from 1941 until 1943. Since 1943 Dr. Stedman has been in charge of physical research for the Boeing Aircraft Company of Seattle, Wash.



M. J. O. Strutt (SM'46) was born at Soerakarta, Java, in 1903. From 1921 to 1927 he studied at the University of Munich; the Institute of Technology at Munich; and the Institute of Technology at Delft, Holland. He was graduated from Munich in 1924, and received, from Delft, his degree in electrical engineering in 1926, and the degree of Doctor of Technical Science in 1927. During 1926 and 1927, Dr. Strutt served also as a member of the staff at Delft and as a patent engineer.



CECIL K. STEDMAN

In 1927 he joined the Philips Lamp and Radio Company, Ltd., Eindhoven, The Netherlands, participating in research on electroacoustics from 1930 to 1933. Later he was in charge of the research group on reception and ultra-high-frequency tubes. In 1945 Dr. Strutt became an electronics consultant.

He is a member of the Royal Institute of Engineers at the Hague, the Dutch Radio Society, the Dutch Mathematical Society, and the Society for the Advancement of Physics and Medicine at Amsterdam.



M. J. O. STRUTT



ROGER A. SYKES

Roger A. Sykes (A'29-M'42-SM'43) was born in Windsor, Vt., in 1908. He attended the Massachusetts Institute of Technology, taking the co-operative course in electrical engineering, and received the B.S. degree in 1929 and the M.S. degree in 1930. He joined the radio research laboratory of Bell Telephone Laboratories in 1930, and was engaged in the early research and development of selective networks employing quartz crystals as elements. Later work resulted in the design of electrical, electro-mechanical, and electroacoustical networks involving piezoelectric crystals and coaxial elements.

Since 1945 Mr. Sykes has been in charge of the apparatus group in the Bell Telephone Laboratories, responsible for the design of crystal units for filter and oscillator applications.



A. VAN DER ZIEL

A. van der Ziel was born at Zandweer, The Netherlands, on December 12, 1910. In 1934 he received the D.Sc. degree from the University of Groningen. Since 1934 he has been a member of the research staff of Natuurkundig Laboratorium der N. V. Philips' Gloeilampenfabrieken at Eindhoven, The Netherlands. Dr. van der Ziel is a member of the American Physical Society.



For a biography and photograph of J. R. WHINNERY, see page 497 of the May, 1947, issue of the PROCEEDINGS OF THE I.R.E.



Everard M. Williams (S'36-A'41-SM'44) was born at New Haven, Conn., in 1915. He received the B.E. degree in 1936 and the Ph.D. degree in 1939 from Yale University. During the summer of 1937 he was employed by the General Electric Company, and during the academic year 1938 and 1939 he was the recipient of a Charles A. Coffin Fellowship from this company. From 1939 to 1942 he was an instructor in electrical engineering at the Pennsylvania State College. From 1942 to 1945 he was chief engineer of the development branch, Special Projects Laboratory, Radio and Radar Subdivision, ATSC, Wright Field, Ohio. Since 1945 he has been associate professor of electrical engineering at the Carnegie Institute of Technology, Pittsburgh, Pa.



EVERARD M. WILLIAMS

Correspondence

Solar Intensity at 480 Mc.*

In Fig. 1 is shown the solar-intensity data at 480 Mc. taken at Wheaton, Ill., earlier this year. The graph may be explained with the following comments:

The data represents noon-day solar intensity as measured at 480 Mc. It is the background intensity as of the day indicated. Short-time variations such as swishes and bursts are not included. The ordinate is in volts. A figure of 0.25 volts corresponds to the intensity of radiation arriving from a disk $\frac{1}{2}^\circ$ in diameter at a temperature of about one million degrees; 0.50 volts represents 4 million degrees, etc. Days upon which bursts were encountered are indicated. Swishes were observed on several days near February 12, March 10, and April 6, 1947.

* Received by the Institute, July 21, 1947.

These dates correspond to times when a very large group of spots was near the center of the solar disk. Bursts rose from a few tens to several thousands of times the background intensity and lasted from a few minutes to an hour or more. Swishes usually rose only from 10 to 150 per cent above the background level and lasted only a second or less. Sometimes overlapping swishes would produce grinding noises. The phenomena of swishes and bursts are apparently quite different, but both originate in the sun as demonstrated by their absence when the collector is turned away from the sun.

For a description of the great burst of November 21, 1946, see *Nature*, vol. 158, pages 945; December 28, 1946.

The best estimate of solar diameter at 480 Mc. is about 0.7 degree. This corresponds to a steady background level or un-

disturbed days. Thus the background level must originate in the corona. On days of great spots the apparent solar diameter shrinks to less the 0.1 degree, indicating the spots must be sending forth energy which overrides the corona background.

The equipment used in taking the solar data has been acquired by the National Bureau of Standards and will be moved to the Sterling Va., Propagation Laboratory sometime this summer. The Central Radio Propagation Laboratory is embarking on comprehensive investigations of solar and cosmic noise. Part of this work will involve continuous monitoring of the sun from rising to setting at 160 and 480 Mc.

GROTE REBER
U. S. Department of Commerce
National Bureau of Standards
Washington 25, D. C.

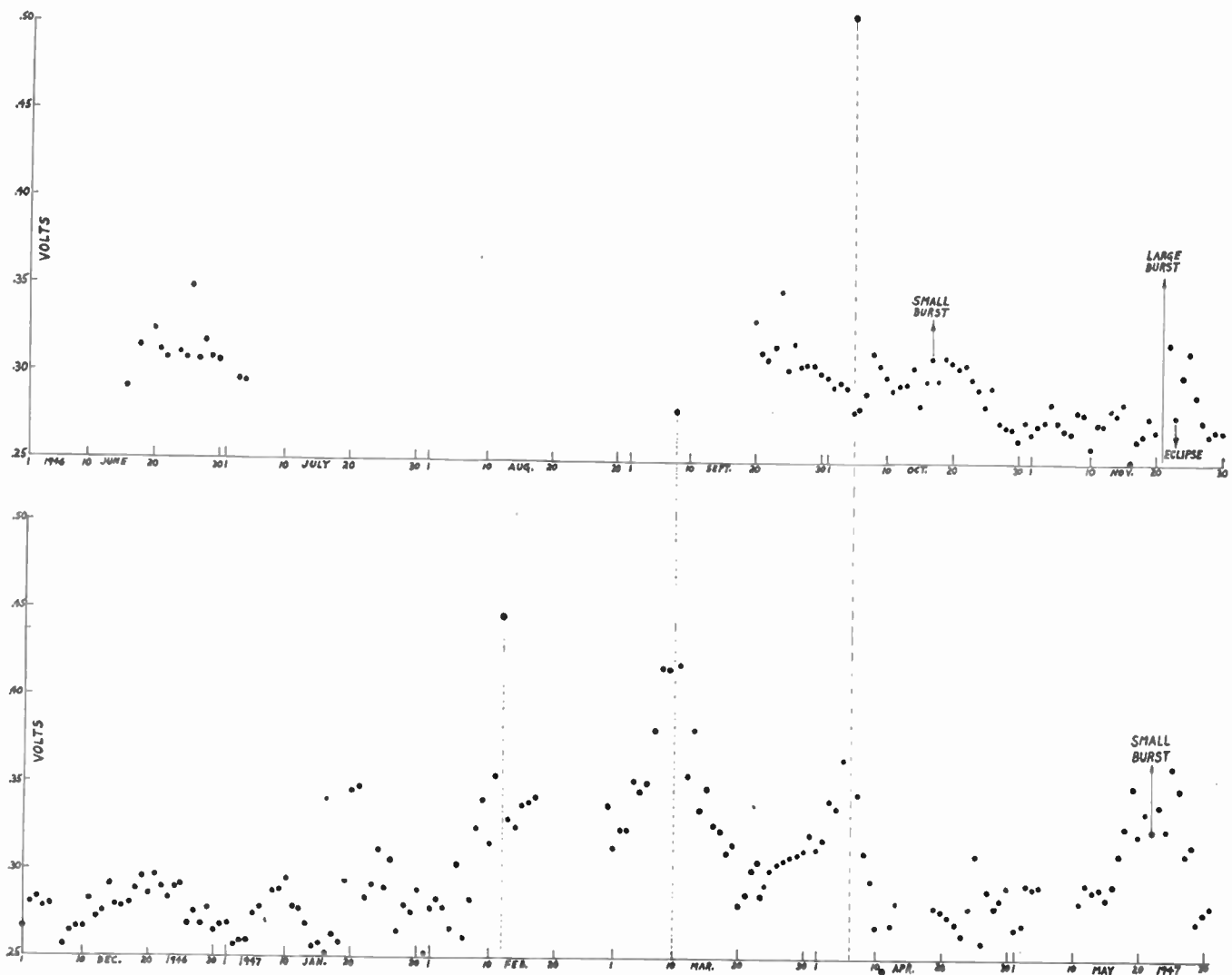

Fig. 1

Institute News and Radio Notes

1 East 79 Street

A Pictorial Tour of the Home of The Institute of Radio Engineers

Pictured immediately below is the international headquarters of The Institute of Radio Engineers, as seen from across Fifth Avenue. Constructed of gray granite, the structure combines utilitarian and esthetic qualities in high degree. At the left below is a view of the front of the building as seen from across 79 Street; while at the right is a photograph of the main facade of Chenonceaux, the four-century-old French chateau after which the mansion was modeled. The I.R.E. building is located in a particularly pleasant residential section, and the attractive vistas from its windows include the broad lawns and wooded areas of Central Park.

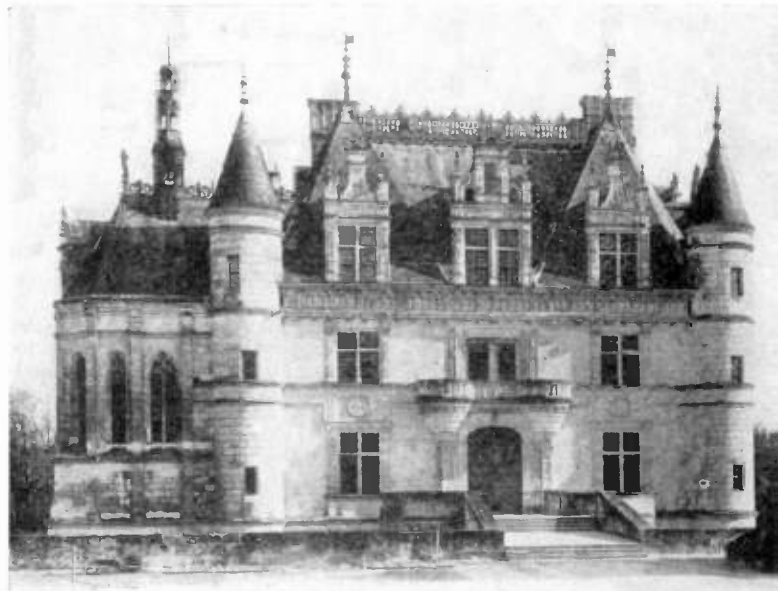
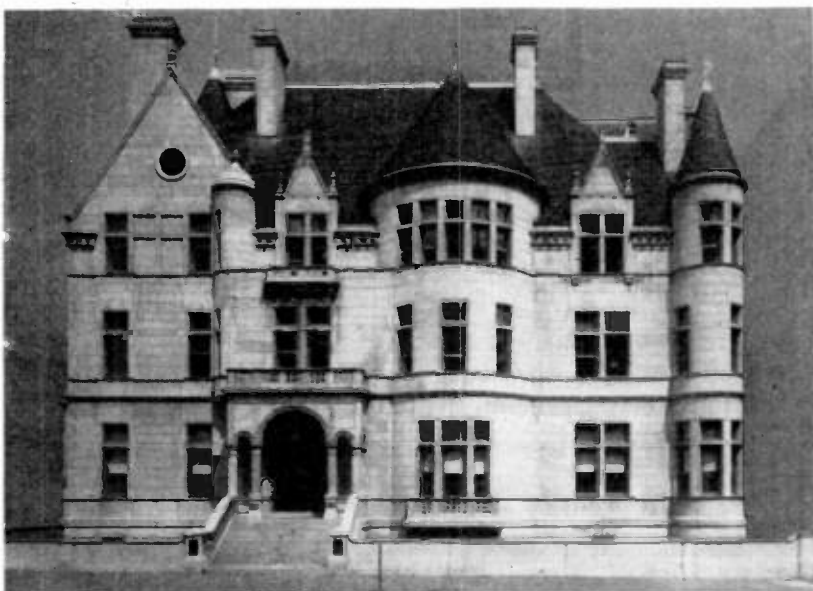
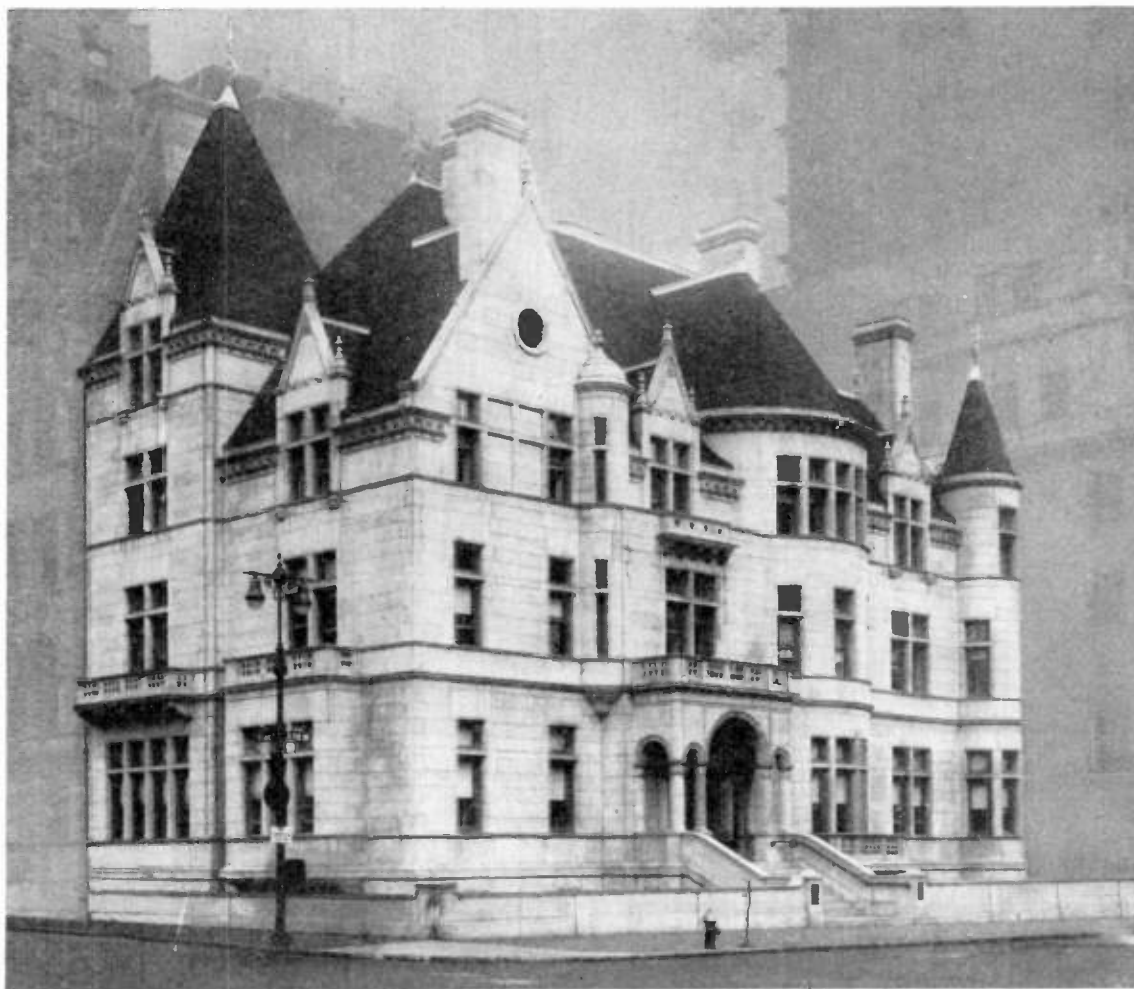

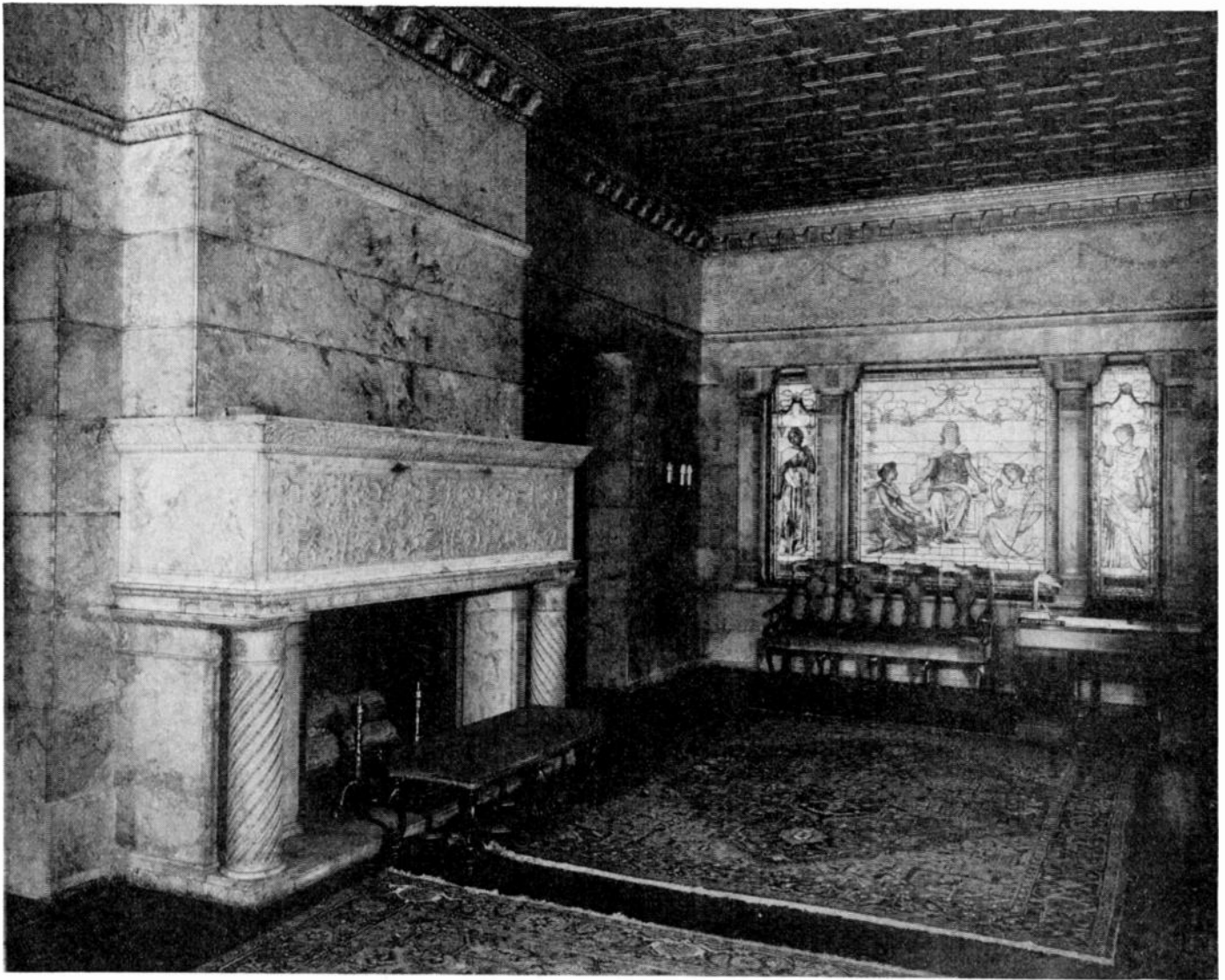

Visitors are greeted in the magnificent entrance lobby above, rich in rear-illuminated stained-glass windows, a mosaic frieze of rare beauty, and Italian marble. This view, looking to the left, shows the massive fireplace which, with the walls, is of intricately carved terrazzo marble. Oriental rugs enrich the handsomely inlaid floor, while the gold-leaf ceiling has retained its luster for more than half a century.

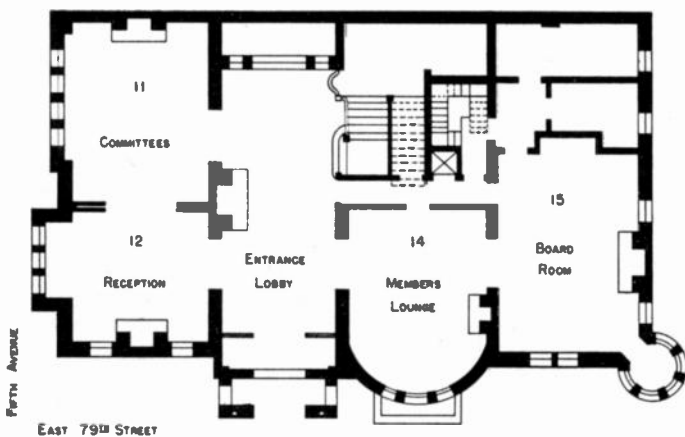

Sketch of first-floor plan, identifying principal rooms and showing room numbers. Rooms in corresponding locations on other floors have the same terminal numbers; thus: rooms 2, 12, 22, 32, and 42 all are corner rooms facing the intersection of Fifth Avenue and East 79 Street.

THE MONTH of December marked the completion of the first year of occupancy by The Institute of Radio Engineers of its permanent headquarters at 79 Street and Fifth Avenue in New York City. During that year the final touches of reconstruction and adaptation were added, and recently the Office Quarters Committee was discharged with commendation for having successfully fulfilled its mission. This seems a fitting time, therefore, to present to the membership of the Institute a pictorial report on its new home.

The I.R.E. building is one of rare architectural beauty, both within and without. Acquired by the Institute in 1945 at a cost comparable to the realty appraisal value of the land alone, when it was built as a family mansion in 1889 the house was designed to be one of the show places of New York City.

A structure of great impressiveness and dignity, its exterior closely resembles the main facade of Chenon-

(Continued on page 93)

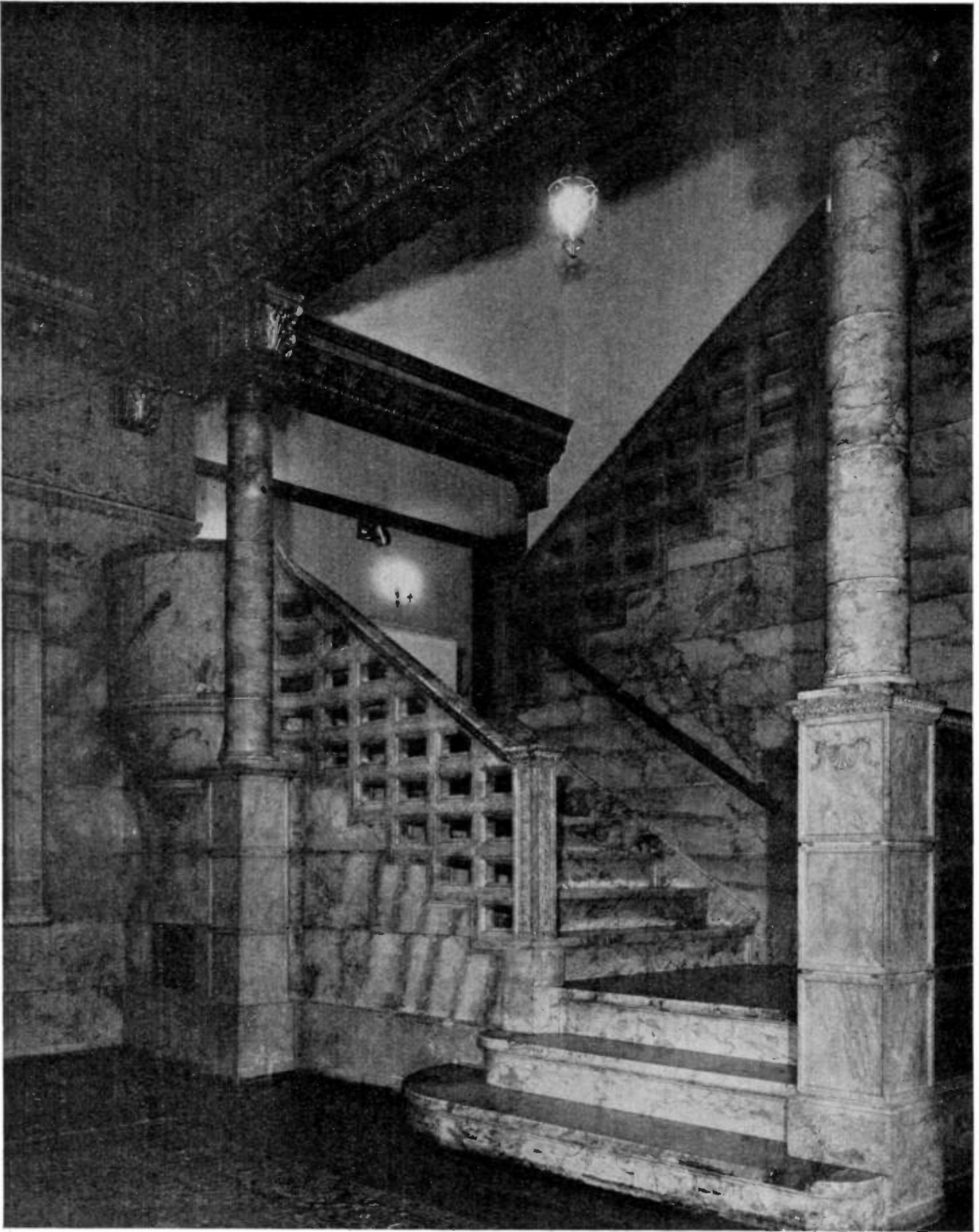

Looking to the right in the entrance lobby, this photograph shows the decorative marble staircase which is widely renowned as one of the finest in the country. The mosaic frieze visible in this and other views is made of half-inch blocks of colored stones put in place by artisans especially imported from Italy for the purpose.



S

From the entrance lobby, we enter the sitting room, room 11, used as a committee meeting room (see the schematic floor plan on page 90). *Above*—This view shows a corner of room 11, looking into room 12, the reception room. Elaborate fireplaces grace both rooms. Note the paneled walls and elaborately carved friezes and ceilings. *Right*—Moving now into room 12 and looking back, we see into room 11 with its similarly ornate fireplace and also several of the old masters of the 16th-century Dutch and Italian schools adorning the walls of both rooms.

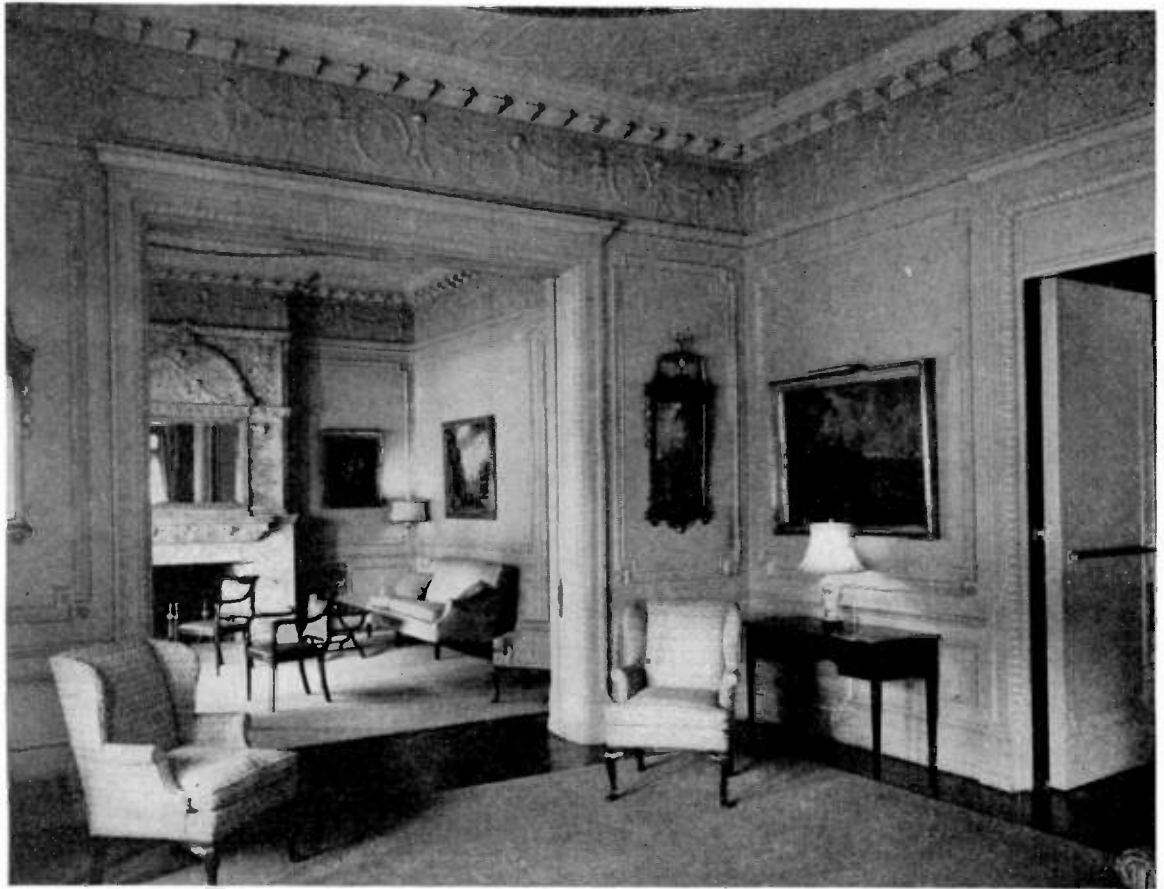



Above—Another view of the reception room (12), also used for committee meetings when occasion demands, with a further glimpse into room 11. This view well displays the combination of spaciousness and graciousness which characterizes the decor.

Right—This photograph is a long view from room 12, looking through the lobby and room 14, the members lounge, to the Board room. Discernible here are the heavy double-thickness floors and massive hardware which exemplify the solid timeless construction of the building.

(Continued from page 90)

ceaux, the famous French chateau on the River Cher built in 1513 and occupied by Diane de Poitiers during the reign of Henry II. The architects who planned this mansion, now the home of the Institute, carefully preserved the appearance and spirit of the chateau. The round towers, the steep-pitched tile roofs, the window design and grouping, even the moat surrounding the building—all are faithful adaptations of the four-century-old Chenonceaux.

The interior of the house is a mixture of French and Italian, with a magnificent entrance hall and rooms that are large, airy, and well-lighted. On these pages appear pictures of the main floor of the I.R.E.'s new home. The

(Continued on page 95)



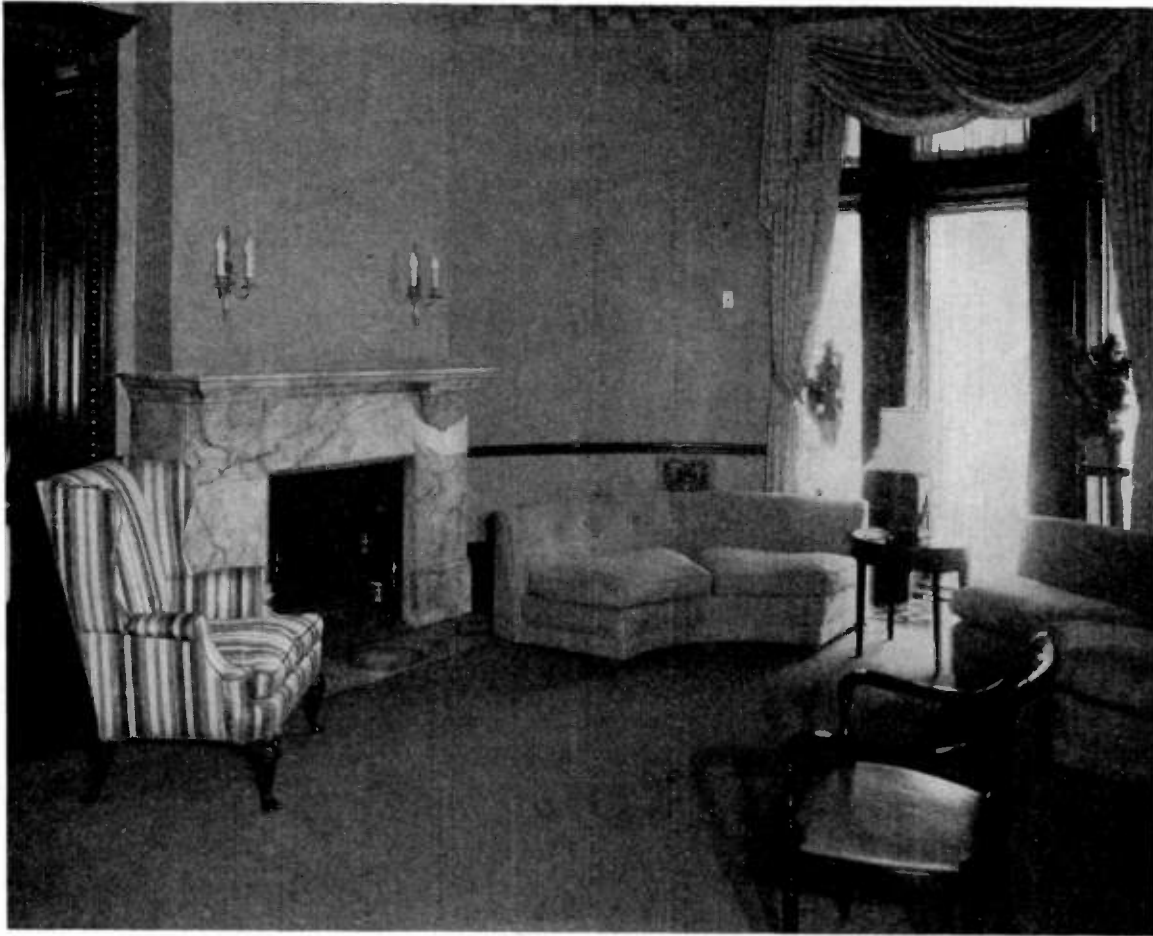

S

Above—A glimpse of the members' lounge room, showing the circular bay facing onto 79 Street, which in earlier days was the anteroom wherein guests at the mansion assembled for cocktails before dinner.

Right—The Board of Directors meeting room, also used for certain committee meetings. Once the dining room, its wainscoted walls, beamed ceiling, and lavishly carved marble fireplace with bas-relief cupids typified the height of luxury in the "era of elegance" and still do service in this later day to convey a sense of dignity and consequence to proceedings conducted in this room.

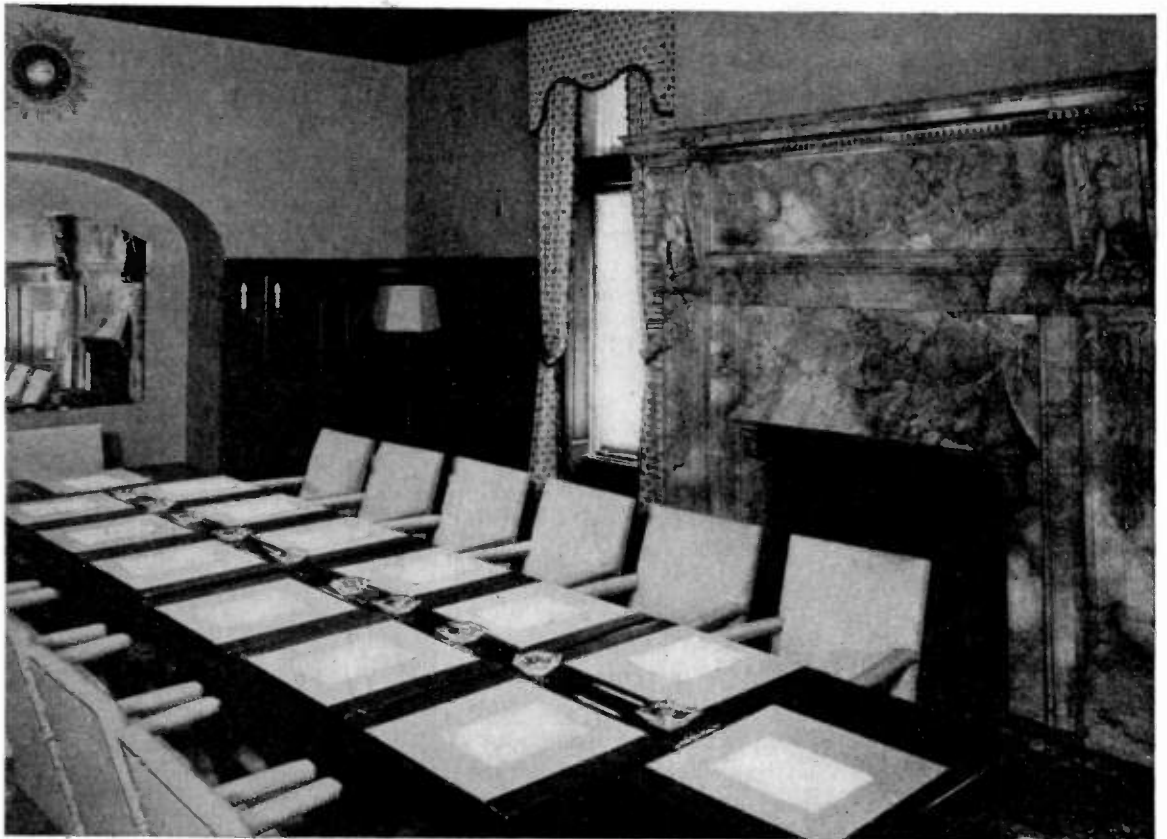

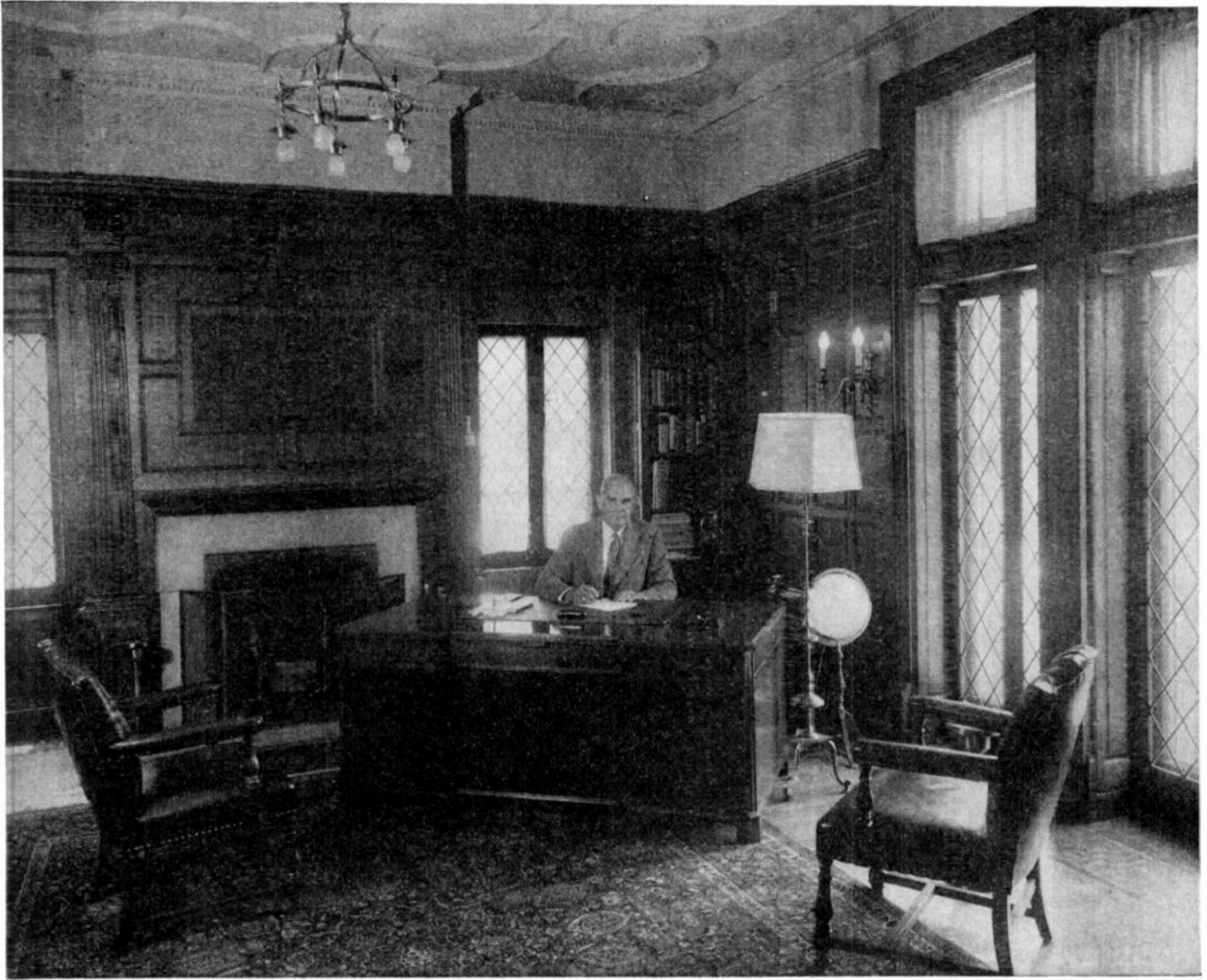

The office of the Executive Secretary (room 22), on the second floor, corresponds in location with room 12 on the first-floor plan. Formerly the library of the mansion, the fine paneled wainscoting and bookshelves have been retained intact.

(Continued from page 93)

rooms on this floor are devoted to the activities of the Institute's official family, providing meeting places for its directors, officers, committees, and members. Offices for the permanent headquarters staff are located on the remaining floors, representative views of which appear on this and following pages.

The arrangement of the rooms on this floor has been purposely made flexible so that each may be used for any of several purposes. Thus, for example, when required, four or even more different Institute committees may meet simultaneously in the various rooms on this floor. All interiors on this floor were installed by one of New York City's best-known decorating concerns and retain the spirit of the original baroque magnificence of the mansion while at the same time affording a suitable setting for the headquarters of a professional society.

The completed I.R.E. headquarters establishment

represents the sum of the efforts of numerous officials, members, and friends of the Institute. The original vicissitudes of the search for a suitable building to house the I.R.E. establishment have been detailed earlier¹ and for reasons of space will not be repeated here.

Suffice it to recall that the primary requirement—the provision of finances—was met by the enthusiastic support of the membership of the Institute and its friends in the communications-and-electronic industry in their contributions to a building fund. Of this fund, approximately two-thirds has been spent for the land and the building, including the necessary alterations made to conform with the building and fire laws of New York City. The interest on the balance, invested principally in United States Treasury Bonds, it is hoped will cover the maintenance and operating costs of the building.

¹ R. A. Heising, "Our new home," *PROC. I.R.E.*, vol. 34, pp. 77W-78W; February, 1946.



Above—Corresponding to room 11 on the first-floor plan is the second-floor office (room 21) of the Assistant Secretary (left) and Technical Secretary (right) of the Institute. This and all other office quarters in the building have been completely replastered, redecorated, and re-equipped. *Right*—The secretaries' room (room 23), with the private secretaries to the Executive Secretary and the Technical Secretary, is located above the entrance lobby conveniently near to their respective offices.



The Editorial Department is located on the third floor of the building. At the right is shown the office of the Technical Editor (room 34); below, the office of the Assistant Editor (room 33).

At the lower right is a partial view of the two rooms (31 and 32) housing the three editorial assistants and the stenographic and clerical personnel of the Editorial Department. Brightly lighted and cheerful, these rooms induce the appropriate atmosphere for efficient production of Institute publications.



S



Also on the second floor is the office of the Office Manager (room 24) above, and the General office (room 25) below, where the multitudinous clerical details of operations involved in properly serving the Institute's membership are performed.





The Bookkeeping Department (room 35) above is located on the third floor, while the Admissions Department (room 41) below, which processes all membership applications, is on the fourth floor.





The Addressograph Room (room 5) above, and the Mail Room (room 6) below, are located in the first basement. The heating plant and service installations are in the sub-basement of the building.



National Electronics Conference

CHICAGO—NOVEMBER 3, 4, AND 5, 1947



1947 NATIONAL ELECTRONICS CONFERENCE, EDGEWATER BEACH HOTEL, CHICAGO

Walter Evans addressing the Monday noon luncheon in the Marine Dining Room of the Edgewater Beach Hotel. On Mr. Evans' right: A. B. Bronwell, H. K. Smith, W. O. Swinyard, E. O. Neubauer, T. J. Higgins, O. D. Westerberg, and R. J. Donaldson. On Mr. Evans' left: W. L. Everitt, G. H. Fett, H. S. Renne, R. E. Beam, and E. H. Schulz.

The National Electronics Conference, Inc., a nonprofit organization serving as a national forum for the presentation of authoritative technical papers on electronic research, development, and application held its annual meeting at the Edgewater Beach Hotel, Chicago, on November 3, 4, and 5, 1947. The total registration was 2475, exclusive of 550 courtesy admissions to the exhibits only. There were 20 technical sessions at which a total of 78 technical papers were presented.

The Conference got off to an auspicious start at the general meeting on Monday morning, November 3, at which W. L. Everitt of the University of Illinois and executive vice-president of the conference presided. G. H. Fett of the University of Illinois and program chairman for the Conference told briefly of the Conference objectives, which are to serve as a national forum for the presentation of authoritative technical papers and electronic research, development, and application. George D. Stoddard, President of the University of Illinois, presented a talk on "Science as a Guide to Education," and L. V. Berkner of the Joint Research and Development Board spoke on "Electronics Comes of Age."

A. B. Bronwell of Northwestern University and President of the conference, presided at the Monday luncheon, which was attended by 591 engineers. The main address was given by Walter Evans, vice-president of Westinghouse Electric Company, on the subject of "Research and Development for Government Projects." Mr. Evans charged that the nation "shows a persistent record of hind-sightedness in applying its tremendous civilian research know-how to military matters," and further urged that "we must modernize our thinking about military procurement to include scientific brains—along with bullets, and beans, and brawn, and the other measurables," if we are to live in peace in this atomic age. He spoke for a "realistic appraisal of the dangers, and common sense planning now," to minimize the possibilities of armed aggression. Mr. Evans proposed sweeping changes in na-

tional preparedness thinking under which science and industry would be admitted to full membership, along with the military, in top-level planning councils; and suggested that American security be entrusted to "a great integrated combat team of four triple-threat department" as follows: a military high command, a nationwide research organization, an industrial militia to convert the scientists' models to production-line equipments, and an Army, Navy, and Air Force adequate to test equipment in the field and to train efficient operating and maintenance personnel.

The Tuesday luncheon, a joint AIEE-NEC affair with an attendance of 568, was presided over by J. E. Hobson, Armour Research Foundation, chairman of the Chicago section of the American Institute of Electrical Engineers. B. D. Hull, President of AIEE, gave a talk on "An American Engineer Association." The attendance at the Monday evening banquet, which featured the regular Edgewater Beach Hotel floor show, was 587.

An unusual amount of interest was shown in the session on "Operation of Electronic Research." It appears that engineers as well as management are anxious to learn more about this all important subject. Papers were presented by R. M. Bowie, Sylvania Electric Company, L. T. DeVore, University of Illinois, G. E. Ziegler, Midwest Research Institute, and A. S. Brown of Wright Field, all on various aspects of research. The joint AIEE-NEC session on Industrial Electronics also seemed to hold a great deal of interest. This session was attended by a group of AIEE men from the Midwest General Meeting of the AIEE, which was held concurrently with the National Electronics Conference.

Publication of the *Proceedings of the 1947 National Electronics Conference* is under the direction of T. J. Higgins of the Illinois Institute of Technology. The majority of the papers presented at the Conference will be published in this publication, and copies may be ordered at \$4.00 each from R. E. Beam, Secretary, in care of the Electrical Engineering Department, Northwestern University,

Evanston, Illinois. Further information concerning this or other conferences may be had from the same source.

Engineers, in addition to those above, who contributed materially to the success of the Conference include E. O. Neubauer of the Illinois Bell Telephone Company, who had charge of arrangements, R. J. Donaldson of the Commonwealth Edison Company, who took care of hotel registrations, and H. S. Renne of *Radio-Electronic Engineering* magazine who handled publicity. The Conference treasurer was E. H. Schulz of the Armour Research Foundation.

The National Electronics Conference, Inc., is sponsored jointly by the Illinois Institute of Technology, Northwestern University, the University of Illinois, the American Institute of Electrical Engineers and The Institute of Radio Engineers, with the co-operation of the Chicago Technical Societies Council. Plans are already under way for the 1948 conference, which will also be held at the Edgewater Beach Hotel. Tentative dates are November 4, 5, and 6, 1948.



B. E. SHACKELFORD

Dr. Benjamin E. Shackelford, President of The Institute of Radio Engineers, addressing members of the 1947 National Electronics Conference at the November 4 luncheon.

Rochester Fall Meeting-1947



Left—Speakers table at the 1947 Rochester Fall Meeting. Left to right: Max F. Balcom, president of RMA; George W. Bailey, executive secretary, I.R.E.; John W. Van Allen, RMA general counsel; Benjamin E. Shackelford, president-elect, I.R.E.; Fred S. Barton, British Ministry of Supply; and Ralph A. Hackbusch, Canadian RMA. *Right*—Dr. Barton receiving the 1947 Fall Meeting plaque from R. A. Hackbusch.



Left—W. R. G. Baker, 1947 I.R.E. president, and B. E. Shackelford, president-elect of the Institute for 1948, before the I.R.E. booth in the exhibit hall. *Right*—Max F. Balcom, RMA president, addressing the gathering at the annual Fall Meeting banquet, with R. A. Hackbusch at the right. Registered attendance totalled 856.



Left—Virgil Graham, chairman of the Rochester Fall Meeting Committee; E. F. Carter, who spoke on "Engineering Responsibility in Today's Economy," and B. S. Ellefson, Monday afternoon session chairman. *Center*—George W. Bailey, executive secretary of I.R.E., speaking at the annual Fall Meeting banquet. *Right*—Laurence G. Cumming, technical secretary of I.R.E. who discussed "The Organization of the Work of the I.R.E. Technical Committees."

URSI-I.R.E. Meeting

OCTOBER 20-22, 1947

The second joint meeting of the year was held by the International Scientific Radio Union, American Section, and The Institute of Radio Engineers, in Washington, D. C., on October 20-22, 1947. It was expected, in view of the large attendance at the spring meeting this year, that the second meeting would be well received and well attended, and these expectations were borne out. Fifty papers were presented at the sessions, covering the same broad aspects of radio as did the spring meeting. By carefully scheduling the papers, it was possible to have them all presented without the necessity of parallel sessions. The registered attendance at the meeting was 430, of which about 90 came from outside the Washington area. As an additional feature, an evening session was held on October 20, at which Captain Paul D. Miles, chief of the Frequency Allocation Division of the Federal Communications Commission, and Mr. Francis C. de Wolf, chief of the Telecommunications Division of the State Department, gave very interesting talks on the International Telecommunications Conferences which were held in Atlantic City from May to October, 1947. In addition, a German motion-picture film was shown as an illustration of an advanced stage of photographic technique.

Through the courtesy of the Interior Department, the sessions were held in the New Interior Department Auditorium; abstracts of the papers presented were printed through the courtesy of the National Research Council. A few copies of these abstracts are still available and may be obtained upon request from Dr. Newbern Smith, National Bureau of Standards, Central Radio Propagation Laboratory, Washington, D. C. Titles and authors of papers presented are as follows:

- "Meteoric Effects in the Ionosphere," L. A. Manning, Stanford University, Calif.
- "Magneto-Ionic Effects at High Latitudes," James C. W. Scott and Frank T. Davies, Canadian Defense Research Board, Ottawa, Canada
- "Harmonic Analysis of F2-Layer Characteristics," M. Lindeman Phillips, National Bureau of Standards, Washington, D. C.
- "Spatial and Time Variations in F2 Critical Frequencies," T. N. Gautier, National Bureau of Standards, Washington, D. C.
- "Ionospheric Observations during Solar Eclipse, May 20, 1947," Preliminary Report. A. H. Shapley and J. M. Watts, National Bureau of Standards, Washington, D. C.
- "Motion Pictures of the Ionosphere during a Total Solar Eclipse," J. M. Watts, National Bureau of Standards, Washington, D. C.
- "High-Frequency Attenuation in the Ionosphere," J. W. Cox, Canadian Defense Research Board, Ottawa, Canada
- "'Extra-Receiver' Noise at 100 Megacycles," J. H. Trexler, Naval Research Laboratory, Washington, D. C.
- "Microwave Solar Radiation during a Total Eclipse," John P. Hagen, T. B. Jackson, R. J. McEwan, C. B. Strang, Naval Research Laboratory, Washington, D. C.
- "Solar Noise Bursts, 10.7 Centimeters," A. E. Covington, National Research Council, Ottawa, Canada
- "Atmospheric Noise Measurement in the Low-Frequency Range," Robert S. Hoff and Raymond C. Johnson, Engineering and Industrial Experiment Station, University of Florida, Gainesville, Fla.
- "A Method of Measuring Angle-of-Arrival," A. W. Straiton and W. E. Gordon, The University of Texas, Austin, Tex.
- "What are 'Angels'?"—Herbert B. Brooks, William B. Gould, and Raymond Wexler, Evans Signal Laboratory, Belmar, N. J.
- "Observations of Low-Frequency Propagation during Sudden Ionosphere Disturbances," Martin Katzin, Naval Research Laboratory, Washington, D. C., and Arthur M. Braaten, RCA Laboratories, Riverhead, L. I., N. Y.
- "Vertical-Incidence Ionosphere Measurements at 100 kc." R. A. Helliwell, Stanford University, Calif.
- "Simultaneous Observations of Field-Intensity Measurements of WWV at Needham, Mass., and at Intervale, N. H. during the Summer of 1947," H. T. Stetson and G. W. Pickard, Massachusetts Institute of Technology, Cambridge, Mass.
- "Shunt-Excited Flat-Plate Antennas with Application to Aircraft Structures," J. V. N. Granger, Electronics Research Laboratory, Harvard University, Cambridge, Mass.
- "Calculation of Doubly Curved Reflectors for Shaped Beams," A. S. Dunbar, Naval Research Laboratory, Washington, D. C.
- "Broad-Band Metallic Lenses," W. E. Kock, Bell Telephone Laboratories, Inc., Holmdel, N. J.
- "Fundamentals of Resonance," Keats A. Pullen, Jr., Ballistic Research Laboratories, Aberdeen Proving Ground, Md.
- "Testing Repeaters with Circulated Pulses," A. C. Beck and D. H. Ring, Bell Telephone Laboratories, Inc., Holmdel, N. J.
- "Criteria for Stability in Circuits Containing Non-Linear Resistance," Capt. L. V. Skinner, University of Illinois, Urbana, Ill.
- "Ultra-High-Frequency Measurements," W. R. Thurston, General Radio Co., Cambridge, Mass.
- "Electronic Phase Meter," E. F. Florman and A. Tait, National Bureau of Standards, Washington, D. C.
- "General Expressions for the 'Q' of a Circuit," Paul J. Selgin, National Bureau of Standards, Washington, D. C.
- "Some Notes on Modern Quartz Oscillator Design," Bertram C. Hill, Jr., Naval Research Laboratory, Washington, D. C. (Now with Reeves-Hoffman Corp., Carlisle, Pa.)
- "A Magnetic Phase Modulator for use in Telemetry," M. G. Pawley, National Bureau of Standards, Washington, D. C.
- "Design and Performance of Vacuum-Tube Oscillators," Carl S. Roys, Syracuse University, Syracuse, N. Y.
- "A Precise Resonance Method of Microwave Impedance Measurements with Application to Aircraft Antenna Models, Four-Terminal Networks and Waveguides," Ming S. Wong, Aircraft Radiation Laboratory, Wright Field, Dayton, Ohio
- "Variations in the Constants of Richardson's Equation as a Function of Life for the Case of Oxide-Coated Cathodes on Nickel," Harold Jacobs and George W. Hees, Sylvania Electric Products, Inc. Kew Gardens, N. Y.
- "The Memory Tube and Its Application to Electronic Computation," Andrew V. Haeff, Naval Research Laboratory, Washington, D. C.
- "A Magnetron Resonator System," E. C. Okress, Westinghouse Electric Corporation, Lamp Division, Bloomfield, N. J.
- "Modes in Interdigital Magnetrons," Joseph F. Hull, Signal Corps Engineering Laboratories, Bradley Beach, N. J.
- "Diode Magnetrons as a Reactance Tube for Ultra-High Frequencies," L. Greenwald and A. Fischler, Signal Corps Engineering Laboratories, Bradley Beach, N. J.
- "Wide-Band Velocity-Modulated Amplifying Tubes," E. Touraton, R. Zwobada and C. Dumousseau, Laboratoire Central de Telecommunications, Paris, France
- "The Propagation of Electromagnetic Waves along Helical Wires," Philip Parzen, Federal Telecommunication Laboratories, Inc., New York 4, N. Y.
- "Analysis of Pulses with Frequency Shifts During the Pulse," R. T. Young, Naval Research Laboratory, Washington, D. C.
- "Results of the Flight Tests of a Course Line Computer with Omni Radio Range and Radio Distance Measuring Equipment," Francis J. Gross, CAA Experimental Station, Indianapolis, Ind.
- "Dielectric Constants of H₂O, D₂O, and Nitrobenzene at 3.2 cm," A. H. Ryan, Naval Research Laboratory, Washington, D. C.
- "Conductivity of Ionized Gases in the Microwave Region," L. Goldstein and N. Cohen, Federal Telecommunication Laboratories, New York, N. Y.
- "Microwave Q Measurements in the Presence of Series Losses," L. Malter and G. R. Brewer, Naval Research Laboratory, Washington, D. C.

- "Microwave Test Equipment," W. J. Jones, Signal Corps Engineering Laboratories, Bradley Beach, N. J.
- "R.-F. Components for Millimeter Wavelengths," Harold Herman, Naval Research Laboratory, Washington, D. C.
- "Radio Direction Finder set AN/CRD-1," William Todd, Signal Corps Engineering Laboratories, Bradley Beach, N. J.
- "An Approach to the Approximate Solution of the Ionosphere Absorption Problem," J. E. Hacke, Jr., The Pennsylvania State College, State College, Pa.
- "Band-Pass Filter Utilizing Parallel-T Networks in Signal and Feedback Paths," Paul T. Stine, Naval Research Laboratory, Washington, D. C.
- "Transfer Characteristics of a Bridged Parallel-T Network," Charles F. White, Naval Research Laboratory, Washington, D. C.
- "Single-Tube Harmonic Generator Design," H. H. Grimm, Naval Research Laboratory, Washington, D. C.
- "Noise in Vacuum-Type Photocells at High Current Levels," Robert F. Morrison, National Bureau of Standards, Washington, D. C.
- "Amplification of Noise by a Tuned Amplifier," Israel Rotkin and Philip R. Karr, National Bureau of Standards, Washington, D. C.

Of particular interest were the paper presented by W. E. Kock of the Bell Telephone Laboratories on broad-band metallic lenses, which involved the development of the metallic refractive medium, and the paper on the memory tube as applied to electronic computing, presented by A. V. Haeff of the Naval Research Laboratory.

UNIVERSITY OF ILLINOIS ENGINEERING OPENINGS

The Department of Electrical Engineering at the University of Illinois at Urbana will have openings for both graduate teaching assistants and research assistants. These assistantships are open to electrical engineering graduates with excellent records. Applications should be made not later than March 15, 1948.

There are a number of fellowships available to students who expect to take graduate work in electrical engineering. These include the following, with the stipend for an academic year:

Jansky & Bailey	\$ 750
Motorola, Inc.	750
Westinghouse Educational Foundation	1,000
University of Illinois	500 & 900

Application for these fellowships may be made by writing to the Dean of the Graduate College, University of Illinois, Urbana. The closing date for fellowship applications is February 15, 1948.

C. E. Bergman, a graduate of University of Oklahoma, is the present holder of the Motorola Fellowship; J. H. Baldwin, a graduate of University of British Columbia, the Westinghouse Fellowship; and A. W. Lo of Yen-ching University of China, a University of Illinois Fellowship, all in electrical engineering.

1948 I.R.E. National Convention News

Committee Organization Completed; Plans Under Way for Largest Gathering in Institute History

Having chosen as its theme, "Radio-Electronic Frontiers," the 1948 I.R.E. National Convention General Committee is hard at work these days on arrangements to fulfill the implied promise—to reveal those frontiers to the thousands of I.R.E. members and friends who are expected to throng the Hotel Commodore and Grand Central Palace in New York City next March 22, 23, 24, and 25.

Organization of the General Committee was completed and first meetings held in October, with periodic meetings of both the main committee and special committees since that date. Plans so far approved include all of the outstanding features of the unprecedentedly successful 1947 convention, plus a number of new procedures designed to avoid congestion and delays, and better enable those attending to participate in sessions and activities of interest.

Outstanding among the additions to the program is the decision to hold a General Meeting of the Institute's membership at the first session on Monday morning, March 21. In this meeting members will receive reports on I.R.E. activities from its officials and will be enabled to discuss and act upon matters of organizational interest. A unique opportunity will thus be provided for a substantial portion of the active membership to participate in a democratically functioning forum.

Other details of the program will be reported in subsequent issues of the PROCEEDINGS, as plans mature. Even at this writing, however, it is apparent that the 1948 Convention unquestionably will be one which every engineer or person interested in the radio and electronic fields will want to attend.

A larger and even more diversified Radio Engineering Show than last year's is forecast by Exhibits Manager William C. Copp, on the basis of advance space sales and announced exhibitor's plans. Practically every prominent radio manufacturing firm will be represented, affording engineers an unparalleled opportunity for visual examination of

available products and consultation with manufacturers' representatives.

The organization of the General Committee for the 1948 Convention, which includes the chairmen of the special committees, is as follows:

1948 I.R.E. NATIONAL CONVENTION COMMITTEE

Chairman:

George W. Bailey

Vice Chairman:

I. S. Coggeshall

General Committee:

Austin Bailey
Stuart L. Bailey
Edward J. Content
Elizabeth Lehmann
James E. Shepherd

Secretary:

Emily L. Sirjane

Exhibit Manager:

William C. Copp

Banquet Committee:

Trevor H. Clark

Cocktail Party Committee:

Rodney D. Chipp

Facilities Committee:

E. K. Gannett

Finance Committee:

Murray G. Crosby

Hotel Arrangements Committee:

George McElrath

Institute Activities Committee:

L. G. Cumming

President's Luncheon Committee:

E. Finley Carter

Printed Program Committee:

G. M. K. Baker

Proceedings Liaison Committee:

Clinton B. DeSoto

Publicity Committee:

Virgil M. Graham

Registration Committee:

F. A. Polkinghorn

Sections Activities Committee:

Alois W. Graf

Technical Program Committee:

Charles R. Burrows

Women's Activities Committee:

Mrs. F. B. Llewellyn

Calendar of COMING EVENTS

I.R.E. National Convention
March 22-25, 1948

Chicago Section I.R.E. Conference
April, 17, 1948

Cincinnati Spring Meeting
April 24, 1948

Syracuse RMA-I.R.E. Spring Meeting
April 26-28, 1948

Board of Directors

November 12, 1947

Des Moines-Ames Section. Mr. Graham moved that the Board adopt the recommendation of the Executive Committee that the petition for the formation of a Des Moines-Ames Section be approved. (Unanimously approved.)

Appointments Committee. Mr. Henney moved that Mr. Haraden Pratt, Chairman; Mr. S. L. Bailey, Dr. W. R. G. Baker, Mr. V. M. Graham, Mr. J. V. L. Hogan, Mr. F. R. Lack and Dr. B. E. Shackelford be appointed to the Appointments Committee. (Unanimously approved.)

Awards Committee. President Baker presented the report of the 1947 Awards Committee, Dr. F. B. Llewellyn, Chairman, a copy of which had been distributed to the Board members. The following actions were taken:

a. Mr. Henney moved that the report of the Awards Committee be received. (Unanimously approved.)

b. Medal of Honor for 1948. Dr. Shackelford moved that Mr. L. C. F. Horle be awarded the Medal of Honor for 1948, and that the following citation, as recommended, be accepted:

"To Lawrence C. F. Horle for his contributions to the radio industry in standardization work, both in peace and war, particularly in the field of electron tubes, and for his guidance of a multiplicity of technical committees into effective action."

(Unanimously approved.)

c. 1948 Morris Liebman Memorial Prize. Mr. Graham moved that the 1948 Morris Liebman Memorial Prize be awarded to Mr. Stuart W. Seeley, and that the following citation, as recommended, be accepted:

"To Stuart W. Seeley for his development of ingenious circuits related to frequency modulation."

(Unanimously approved.)

d. 1948 Browder J. Thompson Memorial Prize. Mr. Graham moved that the 1948 Browder J. Thompson Memorial Prize be awarded to Mr. William H. Huggins, and that the following citation, as recommended, be accepted:

"To William H. Huggins for his paper on 'Broadband Noncontacting Short Circuits for Coaxial Lines,' which appears in three parts in the September, October, and November issues of the PROCEEDINGS for 1947."

(Unanimously approved.)

Fellow Awards. Dr. Everitt moved that the Board approve the following Fellow Awards, as recommended by the Awards Committee, the grade of Fellow to be effective as of January 2, 1948:

Millard W. Baldwin	John A. Hutcheson
Leslie H. Bedford	John E. Keto
Harold S. Black	Nils E. Lindenblad
Robert M. Bowie	Knox McIlwain
Dudley E. Chambers	Donald W. R. Kinley
John B. Coleman	Larned A. Meacham
A. Earle Cullum, Jr.	David Packard
Robert B. Dome	John R. Pierce
Bennett S. Ellefson	Albert Rose

John J. Farrell	Arne Schleimann-Jensen
Henry C. Forbes	Robert E. Shelby
Edward W. Herold	James E. Shepherd
William R. Hewlett	David B. Smith

(Unanimously approved.)

The Editor's Award. Mr. Pratt moved that the Board accept the recommendation of the Awards Committee for the establishment of a new Award, to be known as "The Editor's Award"; further, that Editor Goldsmith collaborate with the Awards Committee in composing the formal terms of the Award and the Scroll to be presented for the Award; further, that "The Editor's Award" for 1949 be based on the papers published during the period from the September 1947 through the August 1948 issues of the PROCEEDINGS, and annually thereafter for the corresponding period. (Unanimously approved.)

Dr. Heising moved that the Board approve the appointment of the following as members of the Committee on Professional Groups, and that the responsibility for the further development and promulgation of the Group System be transferred to this Committee in accordance with the plan proposed in the Planning Committee report of November 12, 1947:

Chairman
W. L. Everitt

Tube Electronics Conference
F. B. Llewellyn
W. B. Nottingham

Television Group
T. T. Goldsmith, Jr.
John D. Reid

Rochester Fall Meeting
V. M. Graham
S. W. Seeley

Ohio State Broadcast
J. H. DeWitt
A. B. Chamberlain

Standards Committee
A. B. Chamberlain

URSI-I.R.E.-Wave Propagation
Newbern Smith
Murray G. Crosby

I.R.E.-RMA-Transmitters
W. H. Doherty
M. R. Briggs

Audio Group
Leo Beranek
Karl Kramer

Microwave Group
F. E. Terman
W. L. Barrow

Planning Committee-Chairman
R. A. Heising

Technical Secretary
L. G. Cumming

(Unanimously approved.)

Beaumont-Port Arthur Section. Mr. Henney moved that the Board approve the petition for the formation of a Beaumont-Port Arthur Section. (Unanimously approved.)

Student Branches. Mr. Lack moved that the Board approve the petitions for the formation of Student Branches at the following schools:

Carnegie Institute of Technology (I.R.E.-AIEE Branch)

George Washington University (I.R.E. Branch)
Pratt Institute (I.R.E. Branch)
University of Tennessee (I.R.E. Branch)

and that the Board approve the Constitution as submitted by the University of Minnesota, and the petition for the formation of an I.R.E.-AIEE Branch at that University. (Unanimously approved.)

Executive Committee

November 11, 1947

Review of Technical Committee Activities. Mr. Lack moved that the Planning Committee review the activities of the Technical Committee of the Institute and prepare a statement of policies and duties governing the activities of these Committees. Since it is believed that up to the present in some instances the activities of these committees have been solely in the realm of standardization, other suitable activities of these groups might be explored. (Unanimously approved.)

National Council of the State Boards of Engineering Examiners. Executive Secretary Bailey was a guest at a banquet of the National Council of the State Board of Engineering Examiners, held at the Hotel Pennsylvania on October 28, 1947. Colonel C. E. Davies, toastmaster, remarked that this was probably the first time that all the secretaries of practically all of the major engineering societies in the country were assembled in one gathering.

American Documentation Institute. Mr. Lack moved that The Institute of Radio Engineers, Inc., name Dr. J. H. Dellinger of the National Bureau of Standards, Washington, D. C., the nominee of the Institute to the American Documentation Institute for a term of three years, beginning with the next annual meeting. (Unanimously approved.)

I.R.E. Representatives on the ASA Committees. Mr. Lack moved that the following be appointed as I.R.E. representatives on ASA Committees: ASA Sectional Committee C-42: J. C. Schelleng, and H. A. Wheeler. ASA Subcommittee on Abbreviations: L. G. Cumming. (Unanimously approved.)

1948 CHICAGO SECTION I.R.E. CONFERENCE

The Chicago Section of the Institute will hold a Chicago I.R.E. Conference on April 17, 1948.

Information concerning the 1948 Chicago I.R.E. Conference will be published in the March and April issues of *Scanfax*. This literature will be mailed to all I.R.E. members in Region 5.

Notice

The new I.R.E. television standard, "Standards on Television: Methods of Testing Television Transmitters—1947," is now available. The price is \$0.75 per copy, including postage to any country.

Orders may be sent to The Institute of Radio Engineers, Inc., 1 East 79 Street, New York 21, N. Y., enclosing remittance and the address to which copies are to be sent.

Minutes of Technical Committee Meeting

TECHNICAL COMMITTEE ON PIEZO-ELECTRIC CRYSTALS

Date.....November 3, 1947
Place.....I.R.E. Headquarters
Chairman.....Professor W. G. Cady

Present

W. G. Cady, *Chairman*

W. G. Cady	K. S. Van Dyke
C. F. Baldwin	W. P. Mason
W. L. Bond	P. L. Smith
	R. A. Sykes

Dr. Van Dyke moved that Dr. Smith's proposal on "The Piezoelectric Relation,

Symbols and Units" be accepted. This motion was seconded and unanimously carried. It was agreed that the title was too long and should be "Relations, Symbols and Units for Piezoelectric Crystals." The Chairman is to edit this report and write a summary. After Committee endorsement, it will be submitted to the Standards Committee. The proposal of Mr. Bond on Rotation Systems was accepted and is to be treated in the same manner as the above proposal. Mr. Bond's paper, "Crystal Axis Nomenclature," is to be re-titled by the Chairman and treated as the previous two proposals. Dr. Van Dyke described a study he is making of the self-consistency of measured constants of piezoelectric crystals. The committee's reaction was enthusiastic. Dr. Cady informed the committee that it has been made a standing committee.

Specialization in Technical Meetings

The Board of Directors is giving consideration to the establishment of "Groups" or "Divisions" within the Institute membership to promote meetings in specialized fields. Several national scientific and engineering societies utilize the Division or Group system successfully, and since the field of radio has become very broad and the membership very large the Board feels the time has come when it is necessary to provide for specialization within the Institute. To this end the Planning Committee is drawing up plans for initiating the Group or Division system in the near future.

In general, the purpose of Groups or Divisions is to allow our membership to be grouped according to their various interests, just as we now provide for membership grouping into Sections according to geographical location. A Group organized for a particular subdivision of the radio field will be governed by a committee or group of officers elected by the Group membership. Such officers will promote meetings in their specialized fields in any or all of several ways. They may hold national meetings on their subject, they may hold Regional or Sectional meetings on their subject, or they may be in charge of certain meetings at a general convention at which papers and discussions on their subject are given. In Sections they may be expected to provide a member on the Program Committee, or even a separate committee in large sections, to secure papers in their field, and promote meetings. In other words, there are a variety of ways in which formal organized groups will be able more effectively to promote meetings of interest to their specialized membership than is now possible.

The grouping system is not entirely new in the Institute as we have elements of it already operating without having regularly provided for them. The Electronics Technical Committee promotes a meeting each year on vacuum-tube electronics. The Rochester Fall Meeting promotes a meeting which is largely de-

voted to broadcast receivers. We have co-operated with other organizations for promoting other specialized technical meetings, such as with the U.R.S.I. for meetings on wave propagation in Washington, the Broadcast Conference at Ohio State University, and the National Electronics Conference at Chicago. It is now planned to make provision and promote in a more logical and organized manner groupings of members for fields which up to the present have not been taken care of.

The Groups may do other things than promote specialized meetings. It is thought they may promote and secure the preparation of tutorial or general survey papers in their field to bring their members up-to-date, as well as generally to educate new members. It is conceivable that there are other activities of interest to their Group which they may promote. The publication of papers in all fields, however, will continue to be made in the PROCEEDINGS, or in its Waves and Electrons Section. It is conceivable, in the course of time, as the Institute grows and the number of papers increases radically, that our publications may be increased in number and take on a specialized aspect. Nothing is yet planned in this direction.

The method of promoting and inaugurating groups in specialized fields is now under consideration, and no definite plan has as yet been decided upon. The membership will be kept informed of progress on this work, and it is not impossible that a special meeting of interested people may be called at the time of the New York National Convention next March. If plans have not matured fully at that time, the subject will be discussed at the Sections Committee Meeting at that Convention. In the meantime the Chairman of the Planning Committee would be pleased to receive suggestions from interested members.

R. A. HEISING

Chairman, Planning Committee

NEW ASA STANDARD

A new American Standard on "Method of Determining Transmission Density of Motion Picture Films" has been approved by the Sectional Committee on Motion Pictures, Z22, functioning according to the procedure of the American Standards Association. The sponsor for this Sectional Committee is the Society of Motion Picture Engineers.

The document of approval bears the ASA number Z22.27 of 1947 and refers to the supporting material which is entitled: "American Standard for Diffuse Transmission Density," produced by the Committee on Standardization in the field of photography, Z38, also functioning according to the ASA procedure. This comprehensive standard on transmission density is document Z38.2.5-1946, approved on March 5, 1946, by the Sectional Committee under the sponsorship of the Optical Society of America.

Copies of the corresponding documents can be obtained at a price of \$0.50 from the American Standards Association, 70 East 45th Street, New York 17, N. Y. They may be of value particularly to communications engineers interested in the use of photographic images in television and facsimile systems.

Industrial Engineering Notes¹

NEW BROCHURE FOR SCHOOLS

"School Sound Recording and Playback Equipment," published in the fall of 1947, by RMA in co-operation with the United States Office of Education, is a sequel to "School Sound System," which came out in 1946. These brochures set forth basic standards which school personnel may use in selecting equipment suitable to their instructional needs.

RADIO INTERFERENCE BIBLIOGRAPHY

An extensive and classified index of published information concerning radio-interference suppression has been compiled in a report prepared by the Aeronautical Board and is available for general use. According to information received from Lt. Colonel Loran J. Anderson, USAF, secretary of the board, it contains reports of research conducted in the effectiveness of shielding, measurement of filter attenuation, design of interference-free electrical equipment, reduction of susceptibility of receivers, measurement of radio interference, and the generation and propagation of radio interference.

NEW TEST SET DEVELOPED BY SIGNAL CORPS

Equipment capable of measuring radio interference within the frequency range of 150 kc. to 40 Mc. has been developed by Signal Corps engineers. It is known as Test Set AN/URM3 and uses a stable radio noise

¹ The data on which these NOTES are based were selected, by permission, from "Industry Reports," issues of October 17, 24, and 31, and November 7, 1947, published by the Radio Manufacturers' Association, whose helpful attitude in this matter is here gladly acknowledged.

generator as an interference reference standard. The new method employed will determine, it is claimed, the exact extent to which noise suppression has been accomplished, and may lead to the solution of certain major noise problems encountered in industry and government.

ELECTRONIC FOREIGN PATENT APPLICATIONS

The Office of Technical Services, United States Department of Commerce, recently issued a list of inventions, including a score of electronic patents, for which the United States Government holds the right to file foreign patent applications. Full information on any invention in the list can be obtained by writing to John C. Green, director, Office of Technical Services, Department of Commerce, Washington 25, D. C.

NEW NATIONAL BUREAU OF STANDARDS MANUAL

A separate manual, now available as NBS Circular C465, explains how the monthly predictions in "Basic Radio Propagation Predictions—Three Months in Advance" (CROL Series D) may be used in calculations of usable and working frequencies for radio sky-wave transmission. The new circular may be obtained from the Superintendent of Documents, Washington 25, D. C., at 25 cents a copy.

BIBLIOGRAPHY ON PROTECTIVE COATINGS FOR METAL

A bibliography of technical reports on protective coatings for metal has been published by the Office of Technical Services. This includes various specifications of the United States Army as well as research reports and patent applications from Germany, and cites author, title, price, reference number, and a brief abstract of each of the 250 reports listed. It may be obtained by writing to the Reference Service, Office of Technical Services, Department of Commerce, Washington 25, D. C.

SIGNAL CORPS DEVELOPS AUTOMATIC WEATHER STATION

An automatic weather station designed to replace manned stations where it is impossible to maintain observers has been developed by the Signal Corps. The equipment contains elements for measuring atmospheric pressure, temperature, relative humidity, wind direction, and rainfall. It also contains a coding device which takes readings of the various weather instruments and converts these readings to code signals which are sent through a radio transmitter to the receiving point.

IONOSPHERIC PHENOMENA RECORDED AUTOMATICALLY

Model C-2, an automatic recorder of ionospheric phenomena, developed by the radio laboratory of the Bureau of Standards, will provide data on ionosphere characteristics through automatic and continuous measurements of critical frequency, and the heights of various layers.

NEW CALIBRATION SYSTEM FOR LENSES

Dr. Irvine C. Gardner of the National Bureau of Standards has developed an improved system for calibrating the diaphragm openings of a photographic lens. It is said to have an important bearing on television. This method of marking apertures, in contrast to the system that has been in use, takes into account the losses of light from absorption, reflection, and scattering within the lens, the Bureau stated. It thus permits a more accurate control of light during an exposure, with corresponding results in improved picture uniformity and quality.

A detailed description of the new calibrating system was published in the December, 1946, issue of "The Technical News Bulletin," a Bureau of Standards publication. Copies may be had by writing to the Superintendent of Documents, United States Government Printing Office, Washington 25, D. C. Price, 10 cents.

REPORT ON MAGNETIC MATERIALS

A report describing the development of magnetic materials in Japan, including four which are not made in the United States, was released in November by the Office of Technical Services. One important new application of magnetic materials in Japan has been the use of an iron-aluminum alloy "Alfer," a nickel substitute, in magnetostriction sound projectors and microphones. Mimeographed copies (PB-76031) are available at the Office of Technical Services, Department of Commerce, Washington 25, D. C., at \$1.75 each. Orders should be accompanied by check or money order payable to the Treasurer of the United States.

SERVICEMEN'S EXPERIMENTAL CLINIC

The first sessions of the newly formed experimental clinic for radio servicemen and technicians will open Sunday evening, January 11, 1948, at the Bellevue-Stratford Hotel in Philadelphia, Pa. Following the meeting of the Pennsylvania servicemen the sessions will continue through Monday and Tuesday, January 12 and 13.

NEWLY ADOPTED INTERNATIONAL RADIO REGULATIONS

Frequencies and types of emission utilized in lifeboat radio equipment were affected by changes in the International Radio Regulations adopted at the Atlantic City Conference last year. The F.C.C. in its announcement on October 23, 1947, suggested "that all interested parties, and manufacturers in particular, guide themselves accordingly in order that new equipments using former authorized frequencies and types of emission may be so designed that they can, when necessary, be readily adjusted to the different frequencies." The Commission rule pertaining to this service became effective on September 1, 1947.

SHIP RADAR ON REGULAR BASIS

Effective December 10, 1947, the F.C.C. adopted an order establishing ship radar

stations as a new class of station within the Ship Service. This places them on a regular basis, rather than the former experimental one. The license period has been extended to four years. Copies of the order (mimeograph No. 12002), may be obtained from the Secretary of the Federal Communications Commission, Washington 25, D. C. License applications are obtainable from the F.C.C. Office of Information, New Post Office Building, Washington 25, D. C.

RESULTS OF INTERNATIONAL RADIO CONFERENCE PUBLISHED

Copies are now obtainable of the final acts of the International Telecommunication Conference. This includes the Convention and its annexes, the radio regulations together with the resolutions and recommendations of the Atlantic City Conference. The document, published in English and French and bound in one volume, is on sale at the American Radio Relay League, West Hartford, Conn. The price, including postage and wrapping costs, is \$1.50.

F.C.C. REPORTS ON AM BROADCASTING

On November 4, 1947, the F.C.C. issued "An Economic Study of Standard Broadcasting." The 112-page mimeographed report presents cost and revenue data designed to help prospective applicants evaluate their chances of establishing a profitable station. It does not include f.m. or television broadcasting. No provisions to print the document have been made but mimeographed copies may be had, while the supply lasts, from the F.C.C. Office of Information, Washington 25, D. C.

NATIONAL RADIO WEEK

Paul A. Walker, who was recently appointed by President Truman as Acting Chairman of the F.C.C., speaking on the significance of National Radio Week, said: "This year's observance of National Radio Week is highly significant. It occurs at a time when radio is undergoing its greatest expansion and development. It marks the dawn of a new era in utilizing this modern marvel for a constantly unfolding variety of purposes. Radio is knitting the post-war world into a more compact and effective communications system." He then mentioned some of the varied uses which radio serves, making of it "today's jack-of-all-trades," and went on to give details of the growth of both radio and television. "The growth of radio stations is reflected in the number of commercial radio operators, which now exceeds 336,000," he said, "The amateur fraternity alone accounts for some 80,000 operators and 75,000 stations. About 25,000 radio-equipped vehicles are testing two-way radiotelephone service. Short-distance radiocommunication services for industries and citizens appear to be just around the corner. Coaxial cable and microwave relay are supplementing wire systems, besides holding promise for broadcast use." National Radio Week is sponsored by the National Association of Broadcasters and the Radio Manufacturers Association.

TWENTY BROADCAST APPLICATION FORMS REDUCED TO SEVEN

Present application forms pertaining to all classes of broadcast services except international, facsimile, and experimental, will be withdrawn after February 29, 1948, the F.C.C. announced on October 23, 1947. Seven unified and compact forms will replace the twenty now in use and will serve for applicants for new standard f.m. and television stations as well.

RULES ADOPTED FOR CITIZENS' RADIO SERVICE

Technical requirements for operation and procedures for obtaining type approval of equipment to be used in the Citizens' Radio Service have been determined, the F.C.C. announced. This will make possible the design of equipment intended for use or operation in the 460-470-Mc. frequency band to the service, and will permit manufacturers to make such equipment available to the public at the time licensing procedures are adopted as well as to request prior type approval, if they so desire.

MARINE SERVICES RULES AND 1948 MEETINGS

At its meeting in Washington, D. C., in the State Department, on October 28, 1947, the Radio Technical Commission for Marine Services completed its charter membership list and made plans to hold a semi-annual general assembly meeting about the middle of March, 1948.

F.C.C. Commissioner E. M. Webster (A'30-M'38-SM'43-F'44) reported on the effects of the Atlantic City Conference in the marine services. He noted that the F.C.C. "Rules Governing Ship Stations," and "Rules Governing Coastal and Marine Relay Services," will require amendment if not complete revision as a result of the world conference. "Much remains to be done to implement the Atlantic Radio Regulations," Commodore Webster said. "Some of these become effective on January 1, 1949, others, principally frequency allocations, on a date to be fixed by a special administrative conference scheduled to be held in the spring of 1949." He then listed the following future conferences which will effect the implementation of the Atlantic City documents, insofar as the marine services are concerned: Safety of Life at Sea: London, April 1948; C.C.I.R.: Stockholm, September, 1948; Inter-American: Bogota, Colombia, October, 1948; and the Treaty Conference with Canada, relative to Great Lakes ship radio problems, for which no date was set at the time of the meeting.

INDUSTRY'S ABILITY TO MEET EMERGENCY NEEDS EVALUATED

With the view of determining the capability of industry to produce the quantities and categories of equipment needed in an emergency, the Army-Navy Munitions Board Committee on Communications and Electronic Equipment held an organizational meeting in the Fall of 1947. The chairman was Colonel Fred W. Kunesh, chief of the Industrial Mobilization Branch, Office of the Chief Signal Officer.

TELEVISION CHANNEL HEARING

On November 17, 1947, more than thirty-five companies and organizations participated in the oral argument on the F.C.C. proposal to eliminate the sharing of certain television channels with other radio services and to assign to the 44-50-Mc. band nongovernment fixed and mobile radio services.

INCREASED PRODUCTION FOR TELEVISION, F.M.-A.M. SETS

The over-all total of 1,339,980 receivers produced by RMA member companies in September, against 1,265,835 in August, is the highest monthly record since April, 1947.

Following are the totals for the production of f.m.-a.m. and television sets produced for the first three quarters of 1947, according to a tabulation of Haskins & Sells weekly reports: f.m.-a.m., 678,772; television, 101,388; all sets, 12,371,915.

F.M. RURAL NETWORK APPROVED

Rural Network, Inc., owned by Rural Radio Foundation, a nonprofit group comprising nine farm organizations, received conditional grants from the F.C.C. for six new f.m. stations to serve rural areas of New York State. The stations are to operate with 1 kw. power at Newfield, De Ruyter, Cherry Valley, Highmarket, South Bristol, and Wethersfield, N. Y. Six is the maximum number of f.m. stations which can be operated by the same interest.

F.M. AND TELEVISION STATIONS

A total of 328 f.m. stations and 14 television stations were on the air, according to the F.C.C. records, early in November of 1947. New Stations which went on the air the latter part of the past year were: Los Angeles, Calif. (KFI-FM); Huntington, W. Va., (WHTN-FM); Knoxville, Tenn. (WKPB); Akron, Ohio (WAKR-FM); Mason City, Iowa, (KGLO-FM); Mobile Ala. (WKRK-FM); Jamestown, N. Y. (WJTN-FM); Muncie, Ind. (WLBC-FM); Gastonia, N. C. (WGNC-FM); Stamford, Conn. (WSTC-FM); Louisville, Ky. (WBOX); Rock Island, Ill. (WHBF-FM); Cleveland, Ohio. (WHKX); Roanoke, Va. (WSLS); Cleveland, Ohio (WEWS); San Bernardino, Calif. (KBMT); High Point, N. C. (WHPE-FM); Bangor, Me. (WGUY-FM); Twin Falls, Iowa (KTFI-FM); Dallas, Tex. (KIXL-FM); Anniston, Ala. (WHMA); Rocky Mount, N. C. (WCEC); Lawrence, Mass. (WLAW); Chicopee, Mass. (WACE-FM); Asbury Park, N. J. (WJLK); and Roanoke, Va. (WSLS-FM).

An f.m. station located at Johnston, Pa., received a conditional grant in October from the F.C.C. and two stations to be located at Biloxi, Miss., and Milwaukee, Wis. received similar grants in November. The Board of Education of the city of Atlanta, Ga., received a construction permit for a noncommercial f.m. station. A new commercial television station at Parma, Ohio also received a conditional permit. By the middle of November, 1947, a total of six

licensed commercial television stations were in operation, and eight others are operating under special temporary authority. The F.C.C. has granted construction permits for 64 television outlets.

EXCISE TAXES: AUGUST-SEPTEMBER

Collections of excise taxes on radio sets and phonographs together with their components for August, 1947, were \$5,084,018.07; a decline of \$1,460,189.94 from the August figure was recorded for September, 1947, or, \$3,623,828.13. The September, 1946, total was \$4,473,663.34.

TUBE SALES UP IN SEPTEMBER

Recorded sales of receiving tubes for September totalled 16,385,547. The cumulative sales from January to September, 1947, were 145,540,732.

BROADCAST STATION INCOME REPORT

The net income of the nation's standard radio broadcasting stations in 1946 amounted to \$76,466,426, a decrease of 8.5 per cent from 1945. It increased by 8 per cent when the total number of standard stations on the air rose from 901 to 1025. This jump in revenues, however, was overshadowed by a 14 per cent increase in broadcast expenses.

COMPARATIVE SALES FOR SECOND QUARTER OF 1947

A statistical report released by the Security and Exchange Commission for twelve radio and television manufacturing companies gave their cumulative net sales for the second calendar quarter of 1947 as \$232,255,000. This was an increase of \$15,146,000 over the first quarter of \$217,109,000, and a rise of \$107,532,000 over sales of \$124,723,000 in the second quarter of 1946. Seven parts manufacturers had net sales of \$18,338,000 for the second quarter of 1947, an increase of \$296,000 over the \$18,042,000 reported for the first quarter, and a rise of \$4,893,000 over second quarter sales of \$13,445,000 in 1946.

RADIO IN EVERY ROOM CAMPAIGN

Max F. Balcom, president of RMA, speaking at the Radio Executive Club of New York at a luncheon on October 29, 1947, explained how a new concept of "saturation" raises radio industry's sights by enlarging the potential market. Among the honor guests were RMA directors Benjamin Abrams and Fred Lack, an I.R.E. Director; vice-president R. E. Carlson, of Newark, and W. J. Barkley, of New York and Cedar Rapids, Iowa, and executive vice-president Bond Geddes.

Mr. Balcom pointed out that an appropriate listening plan could involve providing facilities for each member of a family to listen simultaneously to the radio program of his or her choice. This plan, allowing for an average of four rooms to each home, indi-

cates that only 37.5 per cent of actual saturation has been reached, instead of the supposed 90 per cent. "At the beginning of this year," he said, "there were 38,128,000 families in the United States and an estimated 34,800,000 of them had at least one radio in their homes. With the new concept as a goal, the potential market for new home sets, not counting replacements, is close to 100 million. He predicted that all-industry radio and television set production for 1947 would exceed 17 million units and establish a new record. Production by RMA member companies alone would exceed 16 million sets," he said.

"Most of the technical problems involved in television," he pointed out, "with the exception of color transmission, have been solved. Production problems are being ironed out as the unit volume increases, and as production rises the average unit cost, and doubtless the unit price, will gradually be lowered." He added, however, that despite the growing popularity of television, he did not believe it would make of radio broadcasting merely an auxiliary to video transmission. "The outlook for the radio industry in 1948 and the years ahead is excellent," Mr. Balcom said. "New techniques are beginning to appear. Miniature receiving and transmitting tubes, the printing electronic circuit, and other technical developments point the way to an increasing variety of very small receivers, such as vest pocket or wrist watch radios. The forthcoming Citizens Radio Communication Service—an outgrowth of the wartime walkie-talkie—and the rapidly expanding uses of radio devices on planes, ships, trains, taxicabs and buses, not to mention military electronic developments, are ushering in a new industrial era."

EXTRA ELECTRICITY CHARGES FOR TELEVISION SERVICE

Discriminatory rates for electric current for television receivers, secured by two municipally owned power companies at Norwich and Wallingford, Conn., authorizing rate increases for users of such receivers, were opposed by the RMA. Data presented to the RMA Board of Directors by its engineering department show that power demand and power factor for such television sets does not contrast with the demand and power factor of many domestic appliances, which, in the opinion of the Board, nullifies the need for distinctive rates for television receivers. A Television Anti-Discrimination Committee, headed by Dr. W. R. G. Baker, President of The Institute of Radio Engineers, was appointed toward the latter part of October by RMA President Balcom. Other members of the committee are: Bond Geddes, Larry F. Hardy, H. J. Hoffman, Hamilton Hoge, J. H. McConnell, Robert C. Sprague, and John W. Van Allen.

PLAN FOR AUTHORIZED SERVICEMEN PRESENTED BY RMA

The proposal for authorized servicemen to be designated by radio dealers in cooperation with radio distributors will be outlined by the RMA Service Committee to the association's Board of Directors at their

January meeting. It will be detailed and presented for consideration by the RMA Set Division to the Board also in this month.

RMA ACTIVITIES

The following supplements the report on the RMA Fall Conclave in the December issue. The individual estimates of industry leaders on 1948 set production ranged from 8 to 18 million receivers. The average of such individual opinions inclined toward a minimum of about 12 million and a maximum of about 15 million sets. Similarly, individual and personal opinions of tube manufacturers averaged production of 167 million tubes in 1948.



Dr. W. R. G. Baker, director of the RMA engineering department, was appointed RMA representative on the Radio Technical Planning Board upon the resignation of Ray Manson. Director Fred Lack was appointed an alternate representative.



Five sections of the RMA Parts Division held their first semiannual meeting in October, in accordance with the policy adopted at the June convention by the Executive Committee. These were: Coils, E. M. Keys, alternate chairman; Metal Stampings and metal Specialties, S. L. Gabel; Record Changers and Phonomotor Assemblies, Allen W. Fritzche; Special Products, William R. MacLeod; and Wire-wound Resistors, Roy S. Laird, alternate chairman.



George E. Wright, of the Bliley Electric Company, Erie, Pa., was appointed chairman of the Piezoelectric Quartz Crystal section, and organization was completed on this section.

RMA MIDWINTER CONFERENCE

The RMA Board of Directors' conference on Thursday, January 22, 1948, will conclude the three-day midwinter meetings which will be held at the Stevens Hotel in Chicago. Several parts division sections and the Advertising Committee are meeting on Tuesday, January 20, and the Set Division and Parts Division Executive Committees will meet on Wednesday, January 21.

RMA SPRING MEETING: APRIL 26-28

Virgil M. Graham, associate director of the RMA Engineering Department, and a Director of the I.R.E., announced early in November, 1947, that the RMA Spring Meeting will be held on April 26, 27, and 28 at the Hotel Syracuse, Syracuse, N. Y. Tentative plans are for technical sessions in the mornings of the first two days, with committee meetings in the afternoons. A banquet will be held on the second evening, and the third day will be devoted to inspection trips. This meeting is sponsored by the Transmitter Section of the RMA engineering department in the interest of transmitter and transmitting tube engineers and manufacturers. Mr. R. Briggs of the Westinghouse Electric Corporation,

Baltimore, is chairman, and J. J. Farrell, of the General Electric Company, Syracuse, is in charge of the technical program.

RMA ENGINEERING MEETINGS

- October 21—Committee on Sound Systems
- October 21—Committee on Speakers
- October 21—Executive Committee, Sound-Equipment Section
- October 21—Subcommittee on U.H.F. Television Systems
- October 22—Committee on Amplifiers
- October 22—Committee on Microphones
- October 22—Executive Committee, Sound-Equipment Section
- October 28—Committee on Dry-Disk Rectifiers
- October 29—Subcommittee on Television Receivers
- October 30—Subcommittee on Transmitting Tubes
- November 5—Subcommittee on Glass Characteristics
- November 6—Subcommittee on Pickups and Needles
- November 7—Subcommittee on Phonograph Records
- November 13—Committee on Phonograph Records
- November 13—Committee on Cathode Ray Tubes
- November 17—I.R.E. Subcommittee, on 1938 Standards Revision
- November 17—Committee on Variable Air Capacitors
- November 17—R.F. and I.F. Transformers
- November 17—Subcommittee on Tube Sockets
- November 17—Variable Control Resistors and High-Frequency Switches
- November 17—Vibrating Interrupters and Rectifiers
- November 17—Executive Council
- November 17—Subcommittee on Record Changers
- November 18—I.R.E. Committee on Radio Receivers
- November 18—Committee on Tube Sockets
- November 18—Subcommittee on Magnetic Recording
- November 18—Committee on Communications Receivers
- November 18—Thermoplastic Hookup Wire
- November 18—Subcommittee on Paper Capacitors
- November 18—Seminar RMA-UL Relations
- November 18—Committee on Dry Batteries
- November 18—Committee on Ceramic Dielectric Capacitors
- November 18—Committee on Packaging
- November 18—Committee on Thermoplastic Hookup Wire
- November 19—Committee on Television Receivers
- November 19—Committee on Phono Combinations and Home Recording
- November 19—Committee on Acoustic Devices
- November 19—Committee on Tube Sockets
- November 19—I.R.E. Committee on Television
- November 19—Committee on Power Transformers

Books

Wireless Direction Finding, by R. Keen

Published (1947) by Iliffe & Sons, Ltd., Dorset House, Stamford Street, London SE 1, England. 4th edition 1004 pages+18-page index+37 pages bibliography+xii pages. 653 figures, 5×7½. Price 45/-.

Keen's "Wireless Direction Finding" hardly needs an introduction, for it was first published in 1922. In his first edition the author stated that "An attempt has therefore been made to describe the principles and practice of wireless and position finding in this country in such a way that the subject may be grasped easily by the engineer, the radio telegraphist in charge of direction finding installation, or the general student of wireless telegraphy tackling this field of wireless work for the first time."

Adhering to his stated purpose, the author has produced a book without resorting to more than simple mathematics. The greater portion of the book is a description of the principles and circuitry involved in direction-finding systems, together with the errors and other phenomena associated with the taking of radio bearings. A very large portion of the book is devoted to description of specific direction-finding equipment.

After a short historical chapter, the author presents a chapter on "Propagation of Electromagnetic Waves" and eleven chapters specifically to direction finders. One chapter deals with maps, and another with astronomy applied to direction finding. The book's 18 chapters are completed with a chapter on "Wireless Beacon Systems," one on "Wireless Navigation Systems including Gee, Loran, Decca and Consol," and one on "Aircraft Approach and Landing Systems." Comparing this last (4th) edition with the previous (3rd) edition, the fields covered in both editions are essentially the same, except that the new edition has a chapter on "Wireless Navigation Systems." One wonders why the author chose to add this chapter, although he already deviated from purely directional systems when he added a chapter in the early edition on "Aircraft Approach and Landing Systems" on page 337 of his third edition. The field of the new wireless navigation systems is extremely large and, in many respects, is larger than that of the direction finders alone; therefore, since the author chooses to go into very great detail on certain aspects of direction finding (for example, the method of anchoring an antenna), one wonders why he added a single chapter to cover a very large field in a superficial manner.

Chapter 2 on the "Propagation of Electromagnetic Waves" finds the addition of 5½ pages devoted to v.h.f. Propagation. These 5½ pages replace the ½ page in the older book on "Ultra Short Waves," and constitute an improved treatment of the subject, if not a complete one.

Chapter 4, formerly entitled "Frame Aerial Reception," has been modified and is now called "Transmission Lines and D.F.

Principles." It is, however, essentially the same chapter with the addition of some 12 pages on transmission lines. Chapter 4 also has 1½ pages devoted to the screened loop. This important subject has long been ignored by Mr. Keen and, while it is still our opinion that the treatment is not adequate for this device which has found such extensive use, it is nevertheless a valuable addition. Chapter 4 also mentions the iron-cored loop, although there seems to be very little said of the low-impedance untuned loop so popular in aircraft direction finders. Mention is made of the cathode follower, which is an important addition.

Chapters 5, 6, 7, 8, and 9 remain essentially unchanged in the new work, but the title of Chapter 10 is changed from "Short Wave Direction Finding" to "Direction Finding on Frequencies of 3 to 300 Mc." One wonders why the author chose to group the discussion of direction finding over such a tremendous range of frequencies in the same chapter. It is well known that direction finding in the range of 3 to 30 Mc. (approximately) is greatly affected by the ionosphere and its vagaries, whereas at frequencies above 30 Mc. (certainly above 100 Mc.), the ionosphere can be disregarded, but other considerations enter. Actually it was found that Chapter 10 said little about direction finders in the higher-frequency range.

In Chapter 12 on "Wireless Beacon Systems," we find the addition of the Civil Aeronautics Administration omnidirectional radio range, but few details are given as it is explained largely in terms of the Luck development. The discussion of v.h.f. radio ranges (both aural and visual) is quite good.

Chapter 13 on the "Aircraft Direction Finder Installation" finds mention of wing coils, a very primitive direction finder, but no mention of the automatic direction finder which is on most of the aircraft flying in the world today; however, we find that the author has not omitted the automatic direction finder, but that it appears briefly in Chapter 16 "D.F. Systems Using Special Methods of Presentation." Just why direction finders with automatic presentation should be separated from other types is not understood.

Chapter 14 on "Direction and Position Finding Using the Loop and Adcock D.F.," has a valuable addition in the form of a brief discussion on the Gaussian Law and notes on elementary statistics, although this chapter does not mention the automatic statistical computer developed during the war.

Chapter 15 has been improved by the addition of a discussion on the SCS-51 instrument-landing system, but there is no mention of GCA equipment.

Comments on Chapter 17 have already been made. In this chapter, the author attempted to cover Gee, Loran, Decca, Consol and other systems in a single chapter. This chapter is very satisfactory for the purpose of giving a cursory picture of this subject.

Last, but not least, is Mr. Keen's very extensive bibliography covering important works since 1893. This bibliography, occupying

some 53 pages, is worth while to all researchers in the field of direction finding.

To summarize, Mr. Keen's work is an important addition to the library of any engineer who is interested in direction finders. This book has had such a long life that it approaches a classic in radio engineering literature. We cannot but wish that the author had written the new edition as an improvement on his earlier direction-finding works, and had not attempted to discuss more subjects in less detail.

P. C. SANDRETTO
International Telephone & Telegraph Co.
New York, N. Y.

The Future of Television (revised edition), by Orrin E. Dunlap

Published (1947) by Harper and Brothers, 49 East 33 St., New York 16, N. Y. 176 pages+4-page index+13-page appendix+xi pages. 18 illustrations. 5½×8½ inches. Price, \$3.00.

The revised edition of this book, originally published in 1942, is written for the non-technical reader. It will be found of interest by all who work with television, perhaps to a greater degree by those connected with programming for television.

Its claim to authority can be based on the numerous quotations of prominent persons in the field of television program production and criticism. The experience of the BBC with television is largely quoted.

The book is slow starting and the first two chapters are mainly promotional. The chief matters of interest will be found in the middle of the book. Chapters 3 to 9 inclusive are titled: "Television in the Home," "Television Programs that Click," "Backstage with the Camera," "Television and Movies," "Does Television Threaten the Theatre," "The Outlook for Sound Broadcasting," and "News Telecasts and Sports."

The chapter titles are descriptive of their contents, with the exception that the discussion of legal aspects of television programming is hidden at the end of Chapter 8.

The book is essentially nontechnical and rarely becomes involved in discussions of engineering points. One amusing error occurs in Chapter 3 (Page 37) where the matter of television converters is briefly discussed. The author states that, previous to the adoption of f.m. for television sound, "conversion was possible since the broadcast receivers were designed for amplitude modulation and the images at that time were also on amplitude modulation."

An appendix titled "Historic Steps in Television" gives 11 pages of dates concerning television in the period of 1867 to 1947. Of the 150 dates listed as significant in television history, it is not surprising that slightly more than 50 per cent are concerned with RCA or NBC.

JOHN D. REID
Crosley Division—Avco Mfg. Co.
Cincinnati 25, Ohio

Sections

Chairman		Secretary	Chairman		Secretary
P. H. Herndon c/o Dept. in charge of Federal Communication 411 Federal Annex Atlanta, Ga.	ATLANTA January 16	M. S. Alexander 2289 Memorial Dr., S.E. Atlanta, Ga.	E. T. Sherwood Globe-Union Inc. Milwaukee 1, Wis.	MILWAUKEE	J. J. Kircher 2450 S. 35th St. Milwaukee 7, Wis.
F. W. Fischer 714 Beechfield Ave. Baltimore 29, Md.	BALTIMORE	E. W. Chapin 2805 Shirley Ave. Baltimore 14, Md.	R. R. Desaulniers Canadian Marconi Co. 211 St. Sacrement St. Montreal, P.Q., Canada	MONTREAL, QUEBEC February 25	R. P. Matthews Federal Electric Mfg. Co. 9600 St. Lawrence Blvd. Montreal 14, P.Q., Canada
John Petkovsek 565 Walnut Beaumont, Texas	Beaumont— Port Arthur	C. E. Laughlin 1292 Liberty Beaumont, Texas	J. E. Shepherd 111 Courtenay Rd. Hempstead, L. I., N. Y.	NEW YORK February 4	I. G. Easton General Radio Co. 90 West Street New York 6, N. Y.
W. H. Radford Massachusetts Institute of Technology Cambridge, Mass.	BOSTON	A. G. Bousquet General Radio Co. 275 Massachusetts Ave. Cambridge 39, Mass.	L. R. Quarles University of Virginia Charlottesville, Va.	NORTH CAROLINA— VIRGINIA	J. T. Orth 4101 Fort Ave. Lynchburg, Va.
A. T. Consentino San Martin 379 Buenos Aires, Argentina	BUENOS AIRES	N. C. Cutler San Martin 379 Buenos Aires, Argentina	K. A. Mackinnon Box 542 Ottawa, Ont. Canada	OTTAWA, ONTARIO January 15	D. A. G. Waldock National Defense Headquarters New Army Building Ottawa, Ont., Canada
R. G. Rowe 8237 Witkop Avenue Niagara Falls, N. Y.	BUFFALO-NIAGARA January 21	R. F. Blinzler 558 Crescent Ave. Buffalo 14, N. Y.	P. M. Craig 342 Hewitt Rd. Wyncote, Pa.	PHILADELPHIA February 5	J. T. Brothers Philco Radio and Tele- vision Tioga and C Sts. Philadelphia 34, Pa.
J. A. Green Collins Radio Co. Cedar Rapids, Iowa	CEDAR RAPIDS	Arthur Wulfsburg Collins Radio Co. Cedar Rapids, Iowa	E. M. Williams Electrical Engineering Dept. Carnegie Institute of Tech. Pittsburgh 13, Pa.	PITTSBURGH February 9	E. W. Marlowe 560 S. Trenton Ave. Wilkinburgh PO Pittsburgh 21, Pa.
Karl Kramer Jensen Radio Mfg. Co. 6601 S. Laramie St. Chicago 38, Ill.	CHICAGO January 16	D. G. Haines Hytron Radio and Elec- tronics Corp. 4000 W. North Ave. Chicago 39, Ill.	Francis McCann 4415 N.E. 81 St. Portland 13, Ore.	PORTLAND	A. E. Richmond Box 441 Portland 7, Ore.
J. F. Jordan Baldwin Piano Co. 1801 Gilbert Ave. Cincinnati, Ohio	CINCINNATI January 20	F. Wisel Crosley Corporation 1329 Arlington St. Cincinnati, Ohio	N. W. Mather Dept. of Elec. Engineering Princeton University Princeton, N. J.	PRINCETON	A. E. Harrison Dept. of Elec. Engineering Princeton University Princeton, N. J.
W. G. Hutton R.R. 3 Brecksville, Ohio	CLEVELAND January 20 January 22	H. D. Seielstad 1678 Chesterland Ave. Lakewood 7, Ohio	A. E. Newlon Stromberg-Carlson Co. Rochester 3, N. Y.	ROCHESTER January 15	J. A. Rodgers Huntington Hills Rochester, N. Y.
C. J. Emmons 158 E. Como Ave. Columbus 2, Ohio	COLUMBUS February 13	L. B. Lamp 846 Berkeley Rd. Columbus 5, Ohio	E. S. Naschke 1073-57 St. Sacramento 16, Calif.	SACRAMENTO	G. W. Barnes 1333 Weller Way Sacramento, Calif.
L. A. Reilly 989 Roosevelt Ave. Springfield, Mass.	CONNECTICUT VALLEY January 15	H. L. Krauss Dunham Laboratory Yale University New Haven, Conn.	R. L. Coe Radio Station KSD Post Dispatch Bldg. St. Louis 1, Mo.	ST. LOUIS	N. J. Zehr Radio Station KWK Hotel Chase St. Louis 8, Mo.
Robert Broding 2921 Kingston Dallas, Texas	DALLAS-Ft. WORTH	A. S. LeVelle 308 S. Akard St. Dallas 2, Texas	Rawson Bennett U. S. Navy Electronics Laboratory San Diego 52, Calif.	SAN DIEGO February 3	C. N. Tirrell U. S. Navy Electronics Laboratory San Diego 52, Calif.
E. L. Adams Miami Valley Broadcast- ing Corp. Dayton 1, Ohio	DAYTON January 15	George Rappaport 132 E. Court Harshman Homes Dayton 3, Ohio	L. E. Reukema Elec. Eng. Department University of California Berkeley, Calif.	SAN FRANCISCO	W. R. Hewlett 395 Page Mill Rd. Palo Alto, Calif.
P. O. Frincke 219 S. Kenwood St. Royal Oak, Mich.	DETROIT January 16	Charles Kocher 17186 Sioux Rd. Detroit 24, Mich.	J. F. Johnson 2626 Second Ave. Seattle 1, Wash.	SEATTLE February 12	J. M. Patterson 7200—28 N. W. Seattle 7, Wash.
N. J. Reitz Sylvania Electric Prod- ucts, Inc. Emporium, Pa.	EMPORIUM	A. W. Peterson Sylvania Electric Prod- ucts, Inc. Emporium, Pa.	C. A. Priest 314 Hurlburt Rd. Syracuse, N. Y.	SYRACUSE	R. E. Moe General Electric Co. Syracuse, N. Y.
F. M. Austin 3103 Amherst St. Houston, Texas	HOUSTON	C. V. Clarke, Jr. Box 907 Pasadena, Texas	C. A. Norris J. R. Longstaffe Ltd. 11 King St., W. Toronto, Ont., Canada	TORONTO, ONTARIO	C. G. Lloyd 212 King St., W. Toronto, Ont., Canada
R. E. McCormick 3466 Carrollton Ave. Indianapolis, Ind.	INDIANAPOLIS	M. G. Beier 3930 Guilford Ave. Indianapolis 5, Ind.	O. H. Schuck 4711 Dupont Ave. S. Minneapolis 9, Minn.	TWIN CITIES	B. E. Montgomery Engineering Department Northwest Airlines Saint Paul, Minn.
C. L. Omer Midwest Eng. Devel. Co. Inc. 3543 Broadway Kansas City 2, Mo.	KANSAS CITY	Mrs. G. L. Curtis 6003 El Monte Mission, Kansas	R. M. Wainwright Elec. Eng. Department University of Illinois Urbana, Illinois	URBANA	M. H. Crothers Elec. Eng. Department University of Illinois Urbana, Illinois
R. C. Dearle Dept. of Physics University of Western Ontario London, Ont., Canada	LONDON, ONTARIO	E. H. Tull 14 Erie Ave. London, Ont., Canada	L. C. Smeby 820—13 St. N. W. Washington 5, D. C.	WASHINGTON February 9	T. J. Carroll National Bureau of Standards Washington, D. C.
Walter Kenworth 1427 Lafayette St. San Gabriel, Calif.	LOS ANGELES January 20	R. A. Monfort L. A. Times 202 W. First St. Los Angeles 12, Calif.	J. C. Starks Box 307 Sunbury, Pa.	WILLIAMSPORT February 4	R. G. Petts Sylvania Electric Prod- ucts, Inc. 1004 Cherry St. Montoursville, Pa.
O. W. Towner Radio Station WHAS Third & Liberty Louisville, Ky.	LOUISVILLE	D. C. Summerford Radio Station WHAS Third & Liberty Louisville, Ky.			

SUBSECTIONS

Chairman		Secretary		Chairman		Secretary	
P. C. Smith 179 Ida Avenue Akron, Ohio	Akron (Cleveland Sub- section)	J. S. Hill 51 W. State St. Akron, Ohio		A. R. Kahn Electro-Voice, Inc. Buchanan, Mich.	SOUTH BEND (Chicago Subsection) January 15	A. M. Wiggins Electro-Voice, Inc. Buchanan, Mich.	
J. D. Schantz Farnsworth Television and Radio Company 3700 E. Pontiac St. Fort Wayne, Ind.	FORT WAYNE (Chicago Subsection)	S. J. Harris Farnsworth Television and Radio Co. 3702 E. Pontiac Fort Wayne 1, Ind.		W. M. Stringfellow Radio Station WSPD 136 Huron Street Toledo 4, Ohio	TOLEDO (Detroit Subsection)	M. W. Keck 2231 Oak Grove Place Toledo 12, Ohio	
F. A. O. Banks 81 Troy St. Kitchener, Ont., Canada	HAMILTON (Toronto Subsection)	E. Ruse 195 Ferguson Ave., S. Hamilton, Ont., Canada		W. A. Cole 323 Broadway Ave. Winnipeg, Manit., Can- ada	WINNIPEG (Toronto Subsection)	C. E. Trembley Canadian Marconi Co. Main Street Winnipeg, Manit., Can- ada	
A. D. Emurian HDQRS. Signal Corps Engineering Lab. Bradley Beach, N. J.	MONMOUTH (New York Subsection)	Ralph Cole Watson Laboratories Red Bank, N. J.					

I.R.E. People

L. PETER GRANER

L. Peter Graner (SM'44), died suddenly of a heart attack on September 24, 1947. He had just returned from Eindhoven, Holland.

Mr. Graner was born in Budapest, Hungary, on June 23, 1892, and studied at the Technical School at Karlsruhe, where he received a diploma as electrotechnical engineer. In 1919 he joined the Philips Company at Eindhoven, first in the laboratory and later in the incandescent lamp factory. Coming to America in 1923, he started his own business as a consulting engineer in 1928, and three years later became an American citizen. He assisted in the founding of the North American Philips Company, Inc., which was one of his first clients, and later Philips Laboratories, Inc. He was president and director of L. P. Graner, Inc., consulting engineers, director and vice-chairman of Philips Laboratories, Inc., director of North American Philips Company, Inc., and director of Sprague Electric Company. He was a member of the American Institute of Electrical Engineers, New York Electrical Society, New York State Professional Engineers, Society of American Military Engineers, and the Illuminating Engineering Society.

In his quiet unofficial way, Mr. Graner did a great deal during the war years for his adopted country and for the Dutch cause. On April 5, 1946, he received a citation from the War Department "for valuable and beneficial services . . . in aiding the development of new measures and methods which proved of great advantage to the War Department in the successful prosecution of the war."

A friend, Dr. E. Hijmans of Eindhoven, wrote this illuminating tribute to his memory: "Wherever he went he knew how to make himself well liked by his unbiased, absolutely honest personality, which he gave to the full to whomever was privileged to win his friendship. No one ever called upon him in vain. Now he is gone. We have very, very much to thank him for."

He is survived by his mother and by his widow, Mrs. Kathryn Patterson Graner.



L. PETER GRANER



HAROLD S. OSBORNE

On October 9, 1947, at the 42nd Convention of Tau Beta Pi, Dr. Harold S. Osborne (A'14-M'29-SM'43-F'45), chief engineer for the American Telephone and Telegraph Company, was initiated into Tau Beta Pi.



PAUL J. LARSEN

PAUL J. LARSEN

On November 15, 1947, Paul J. Larsen A'37-M'41-SM'43) entered upon his new duties as associate director of the Los Alamos Scientific Laboratory, Los Alamos, N. M., where the first atomic bomb was assembled and tested in July, 1945. His appointment to this post was made at the request of the United States Atomic Energy Commission by the University of California which operates the laboratory.

Mr. Larsen was born in Copenhagen, Denmark, in 1902, and came to this country in 1912. He attended the City College of New York, Columbia University, and the Newark College of Engineering. His first job was with the Marconi Wireless Telegraph Company in connection with development of Signal Corps radio apparatus during World War I. Later he was associated with the Bell Telephone Laboratories and Radio Corporation of America. Leaving RCA in 1930, he devoted his time to a private consulting practice until 1939 when he joined the Baird Television Corporation as chief engineer in charge of television equipment for theatres. Two years later he became associated with the Department of Terrestrial Magnetism, Carnegie Institution, Washington, D. C. and assigned to the proximity-fuze research project.

He became associated with the Applied Physics Laboratory of The Johns Hopkins University, Silver Spring, Md., in 1942, and has been granted a leave of absence to accept his new post. Mr. Larsen has been engaged for some years in the development of the radio proximity (VT) fuze and fire-control programs for the Navy Bureau of Ordnance. For this work he received two Navy awards for meritorious service.

In addition to his membership in various motion picture and television industry boards and committees, he is a Fellow and member of the Board of Governors of the Society of Motion Picture Engineers, chairman of its Television Engineering Committee, and a member of its Standards and Review Committees. Mr. Larsen has served as chairman of the I.R.E. Television Committee, and as a member of other technical committees of the Institute.

I.R.E. Subsection for Northern New Jersey



JERRY B. MINTER

CHAIRMAN

Jerry Burnett Minter II (A'38-VA'39) was born on October 31, 1913, in Fort Worth, Texas. He received the B.S. degree in electrical engineering in 1934 from the Massachusetts Institute of Technology.

In 1935 he was employed by Boonton Radio Corporation in the development of band-pass intermediate frequency transformers, and in 1936 he was active in the development of aircraft radio receivers at the Radio Frequency Laboratories of Boonton, N. J. During the latter part of 1936 he was engaged by Malcolm P. Ferris to take charge of the development of a signal generator, a

radio noise and field-strength meter, and several other projects. After the death of Mr. Ferris, Mr. Minter and some of his associates organized the Measurements Corporation of Boonton in 1939. Since that time he has been vice-president and chief engineer of Measurements Corporation.

Mr. Minter is a Fellow of the Radio Club of America, a member of the American Society for Metals, and is now serving as Chairman of the Northern New Jersey Subsection of the I.R.E., which was organized early in October, 1947.

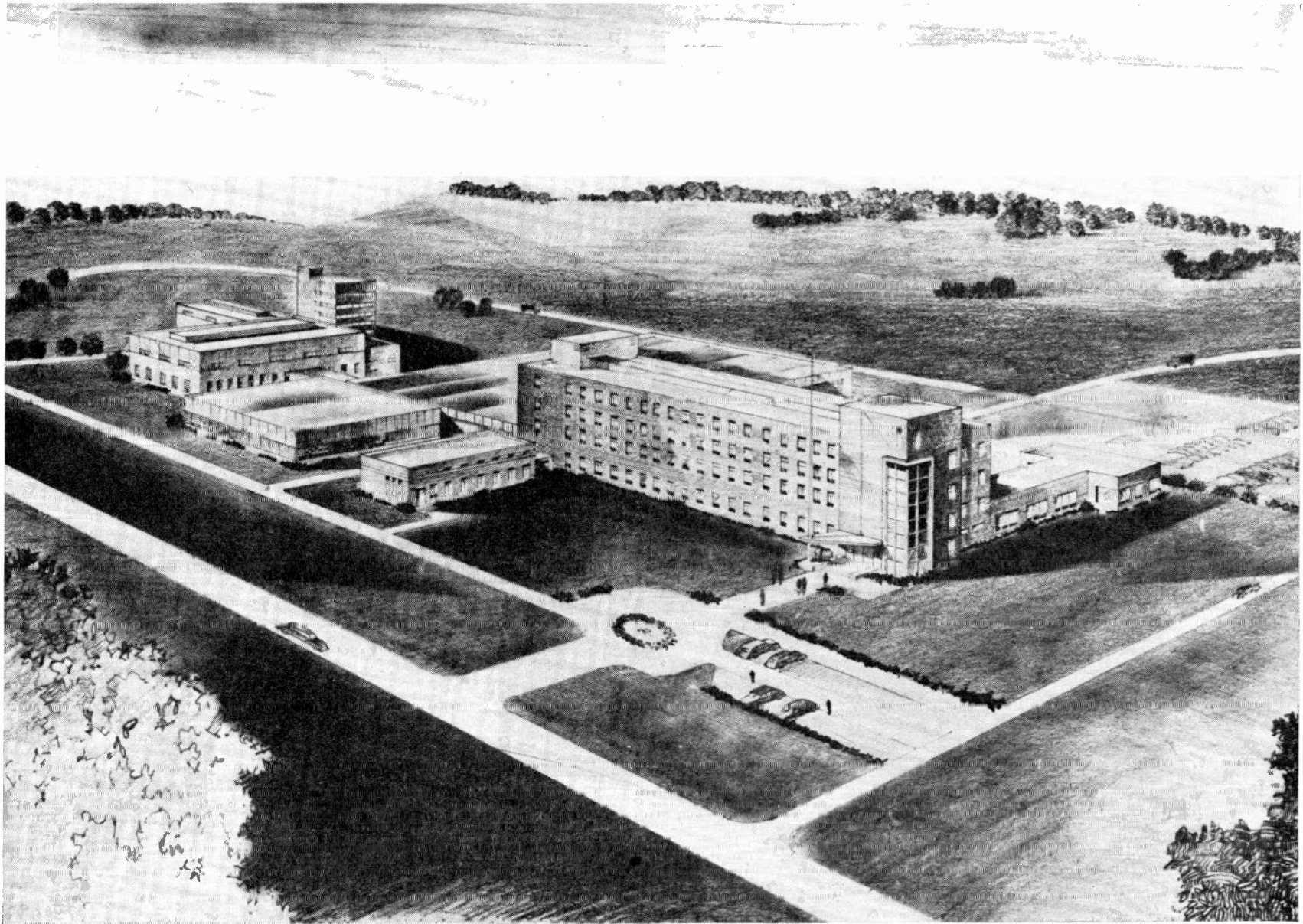

THE KNOLLS ATOMIC POWER LABORATORY

In this Government-owned and General-Electric-Company-operated research center, electronic instrumentation and controls will doubtless find many new and significant applications.

Report of the Committee on Professional Status of the Canadian Council of the I.R.E.*

R. C. POULTER†, SENIOR MEMBER, I.R.E.

IN CONSIDERING the many factors which influence the professional standing of the radio engineer and scientist in Canada, it is at once apparent that there is bound to be a wide diversity of opinion.

Since the report of last year's Committee dealt exhaustively with such questions as a possible change in the syllabus of courses given in engineering colleges, it does not appear that any useful purpose can be served by pursuing the matter further in this report. Those interested in this matter are referred to last year's report which appeared on page 61 of the PROCEEDINGS OF THE I.R.E. for January, 1947.

It is the opinion of the committee that, while changes in course syllabuses may be needed, and are in fact probably overdue, the chief needs at the moment are (a) to find out how the radio engineer and scientist is regarded by employers and prospective employers, by members of his own profession, by members of other branches of the engineering and scientific professions, and by other professions; (b) to determine the legal status, if any, of such recognition; and (c) to make suitable recommendations to this council in order that appropriate action may be taken.

There has been a good deal of speculation as to the exact positions of the engineer in the radio and communications fields and of the physicist as well; and, also, of the relations existing between these two classes of trained workers and of the extent to which their work overlaps or merges. Likewise, there has been some speculation as to what actually constitutes a radio engineer or physicist.

If we are to adopt a realistic attitude towards this whole question, then we shall be forced to admit that in, most instances, in Canada, the professional workers in radio are employed in engineering departments and that they are, therefore, regardless of their training, classed as engineers. In a smaller number of cases, such workers are employed directly as physicists, although there are certainly instances where the work might be said to lie on the borderline between the two professional spheres.

This is no reflection whatever on either the physicist or the engineer, but simply indicates that in this field, at any rate, the line of demarcation is perhaps becoming less distinct.

What appears to be needed is some clarification as to the status of the professional worker—some sort of yardstick or standard which would be recognized instantly by all employers and by all other professional people.

Anyone who examines the history of professions will be struck by the fact that in

practically no case was general professional recognition forthcoming until legal standing was attained. This was true of the medical, dental, and legal professions, and in later years in other fields such as optometry.

Examinations, such as might be conducted by a technical society, do not appear to be sufficient, and on this continent rarely carry much weight. If examinations are necessary, it may be better to have them conducted by a legally constituted professional association instead of a technical organization.

The practice of engineering in Canada is now regulated by the Professional Engineers Acts, which are in force in nearly all provinces. In some provinces marked progress has been made in professional legislation and in its enforcements, and it is now illegal for anyone to call himself an engineer or to practice engineering, regardless of education and experience, unless he is a member of the Association of Professional Engineers of the province in which he resides. In Ontario, for example, there are now 6000 registered professional engineers, and by the end of the year it is probable that an additional thousand members will be added to the roll of the association. Although this association admits graduates of recognized engineering schools without examination, it requires that nongraduates shall have five years acceptable engineering experience and write all or part of the examinations.

So far as the professional radio worker is concerned, it does not appear reasonable that he should be forced to secure special legislative dispensation. Indeed, even if he did, he would still be required to join his provincial professional engineering association if he wanted to call himself an engineer or to practice engineering, for this is the law of the land.

So far as the graduate engineer with sufficient experience is concerned, this presents no problem. He simply becomes a member of the Association of Professional Engineers and as such is automatically granted recognition as a professional engineer.

The graduate physicist is, however, in a different situation in that, since his course does not include the so-called fundamentals of engineering, which the professional associations demand, he would have to write at least some of the association's examinations.

The nongraduate would likely be required to write all of the examinations, depending in some instances upon his age and experience.

There arises, of course, the question as to whether the graduate of a physics course actually needs to worry about registration in a professional association at all. It may be said that his university degree gives him all the standing he requires. Similarly, it may be said that membership in The Institute of Radio Engineers in the professional

grades is all that is necessary. The Institute is a major engineering and scientific society of considerable standing in its own right. However, in the case of the physicist, it all depends upon the circumstances. If the physicist occupies a position which is labeled "Engineering," then he must by law meet the requirements of the provincial association. If, on the other hand, he is doing work, say, of research nature, he may not be required by law if he is directly responsible to a registered engineer who signs all reports and plans.

However, there is much to be gained from the professional standing that results from membership in a professional association. It may, of course, be argued that the requirements for registration in a professional association in the case of the radio engineer or radio physicist may sometimes be unjust. There are already signs that the professional associations themselves are beginning to wonder if their present stand is fully justified. As the matter now stands, however, they have little choice in the matter, although it is realized that there is no legislation on the statute books that cannot be amended as conditions require.

The professional associations in Canada have taken the stand that they cannot have a different set of admission requirements for each division within a given branch of engineering. To grant special consideration to the specialist in electronics would invite demands for similar treatment from the specialist in illumination, the transmission-line designer, the relay specialist, and so on *ad infinitum*. Everyone engaged in any branch of engineering is expected to have a knowledge of the broad fundamentals which are supposed to apply to all branches of engineering. But¹ in recent years the Councils of

¹ Since this report was presented the Council of the Association of Professional Engineers of the Province of Ontario has given careful consideration to the problem of the registration of graduates in Honor Science who are performing professional engineering work.

At a recent meeting Council approved of the following basis for registration of graduates in Honor Science:

1. Examination Requirements

The maximum examination requirements for graduates of accepted universities in Honor Science, the practice of which constitutes professional engineering, will be as follows:

(a) Applicants with Bachelor's degree:

- (1) Submit a suitable thesis.
- (2) Pass an examination in Engineering Economics, Management, Specifications, and Ethics.

- (3) Pass those examinations special to the branch in which applicant seeks registration and which the Councilors of that branch recommend after giving due regard to the university examinations passed by the applicant and his experience.

(b) Applicant with Master's degree:

The same as above, with exception that no thesis is required.

(c) Applicants with Doctor's degree:

Acceptable without examinations, subject to satisfactory record of engineering experience.

2. Engineering Experience

The engineering experience granted for attendance at an accepted university will be, in the case of graduates in Honor Science, the actual time spent in instruction as an undergraduate. Postgraduate experience must be in acceptable engineering fields.

* Decimal classification: R070. Original manuscript received by the Institute, September 18, 1946.
† 25 Otter Crescent, North York, Toronto, Ontario, Canada.

such associations have found it increasingly difficult to deal with applications received from physics graduates and others who appear to be engaged in engineering and have felt compelled to adhere to the requirements of their Acts by insisting on at least partial examinations.

May it not be possible that the whole scope of the professional associations may some day be widened to include "scientists" as well as engineers, thus becoming provincial associations of professional engineers and scientists? There are indications that there is some serious thinking being done along this line. It might be well for the

Canadian Council of the I.R.E. to look into the matter further.

Recommendations

This committee suggests that improved professional standing for all professional radio workers is a worthy aim and should be achieved by:

- (a) Seeking a proper definition as to the terms "radio engineer" and "radio physicist."
- (b) Improving the syllabus of courses purporting to train men for this field.
- (c) Encouraging as many qualified mem-

bers as possible to transfer to the professional grades in the Institute.

The committee suggests that registration in the provincial associations for all professional radio workers is to be desired and, if achieved, would automatically provide the higher professional status which appears to be so desirable.

This committee recommends that negotiations be opened with the professional associations, these negotiations to take the form of informal discussions whenever possible. The committee believes that the associations would be sympathetic and would be willing to extend co-operation.



Frequency-Shift Radio Transmission*

LESTER E. HATFIELD†, SENIOR MEMBER, I.R.E.

Summary—The different methods of obtaining carrier-frequency shift of communications transmitters are described, as well as the results of using the different methods, and the final model that has proved satisfactory for this type of service.

INTRODUCTION

THE ADVENT of mechanical automatic radio transmission¹ for point-to-point operation has necessitated the development of a keying system different from on-off or c.w. type of operation.

In order that a new method could be adapted for commercial circuits, it must be designed for maximum over-all gain, ease of operation, longer period of usable time per day, and should be capable of handling high-speed Morse, radio printer signals, facsimile, and full photo transmission.

The method developed is known as "frequency-shift keying" and is a device for enabling a radio transmitter to emit two *different* radio frequencies^{2,3} one for the "mark" and one for the "space" signal, rather than the usual interrupted single-frequency carrier. In photo transmission, the frequency is varied from the "mark" to "space" frequency in proportion to the gray values of the photo text.

* Decimal classification: R423. Original manuscript received by the Institute, November 15, 1946; revised manuscript received, January 27, 1947.

† Hazeltine Electronics Corp., Little Neck, L. I., N. Y.

¹ Austin Bailey and T. A. McCann, "Application of printing telegraph to longwave radio circuits," *PROC. I.R.E.*, vol. 19, pp. 2177-2179; December, 1931.

² Balth van der Pol, "Frequency modulation," *PROC. I.R.E.*, vol. 18, pp. 1202-1205; July, 1930.

³ Edwin Armstrong, "A method of reducing disturbance in radio signaling by a system of frequency modulation," *PROC. I.R.E.*, vol. 24, pp. 689-690; May, 1936.

Such a system was first developed in the communication laboratories during the latter part of the 1930's and was used with great success during the Byrd South Pole expedition of 1939-1940.⁴

FREQUENCY-SHIFT PRINCIPLES

Radio-frequency-shift keying is used primarily for comparatively long-distance communications in the h.f. radio-frequency range.⁵ Also, it has been proved satisfactory in the low-frequency ranges from 50 to 600 kc. The frequency-shift keyer can be connected to existing transmitter installations designed so that the closing of a telegraph key or radio printer contacts (referred to as a telegraph marking signal) causes the transmitter to emit a frequency above the normal assigned frequency of the transmitter. The opening of the telegraph key or radio printer contacts (referred to as a spacing signal) causes a frequency lower than the normal assigned frequency of the transmitter to be emitted.

The amount of shift between the "mark" and "space" frequency is usually less than 1000 c.p.s., and is adjusted for a fixed amount, except for the transmission of photographs, in which case the shift varies between a maximum fixed amount.

The maximum amount of shift permitted by the Federal Communications Commission is the 0.01 per cent tolerance set for the over-all stability of the transmitter, which includes the oscillator drift, etc. In order

⁴ Robert M. Sprague, "Frequency-shift radiotelegraph and teletype system," *Electronics*, vol. 17, pp. 126-132; November, 1944.

⁵ Chris Buff, "Frequency shift keying technique," *Radio*, vol. 30, pp. 14-18; August, 1946.

to determine whether a transmitter is within the frequency tolerance, the "mark" and "space" frequencies should be measured; their midpoint is the emitted frequency. This emitted frequency should be the same as the assigned carrier frequency. The maximum shift permitted between the 2- to 22-Mc. range (assuming oscillator drift is zero) is shown in Fig. 1.

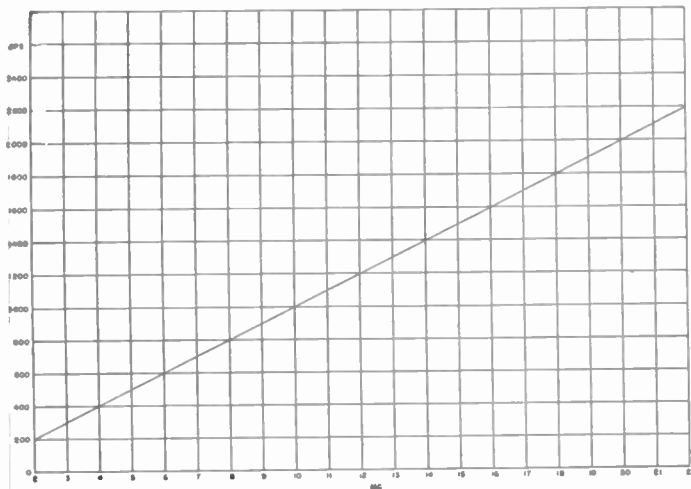

Fig. 1—Maximum shift in c.p.s. versus carrier frequency in megacycles under F.C.C. regulations.

For purposes of discussion, a value of 850 c.p.s. will be used as the total shift, although in actual commercial practice values as low as 200 c.p.s. are used in the h.f. range.

A simple system of keying (Fig. 2) consists of two radio-frequency oscillators. Where the space-frequency oscillator operates on 9,999,575 c.p.s. or 425 c.p.s. lower than the assigned frequency of 10 Mc., the "mark"-frequency oscillator operates on 10,000,425 c.p.s., or 425 c.p.s. higher than the assigned frequency of 10 Mc., thus resulting in a total frequency shift of 850 c.p.s. These oscillators can be either crystal-controlled or self-excited.

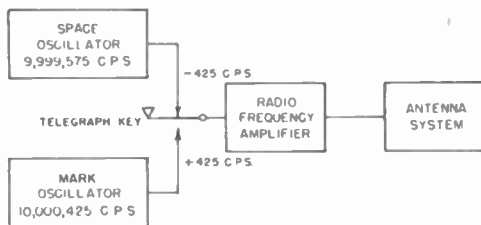

Fig. 2—Basic circuit of frequency-shift keying.

When the transmitted frequency is greater than that of the oscillator by use of frequency doublers, triplers, etc., then the amount of shift must be reduced or divided by the same number used for multiplying the frequency between the oscillator and the antenna, in order to hold the same amount of final transmitted shift over the frequency range of the transmitter.

Therefore, as the frequency multiplication in the transmitter increases, the amount of shift at its point of generation must be reduced. From a standpoint of flexibility, the amount of shift should be reduced by the following factors, 1-2-3-4-6-8-9-12, when the oscillator covers a frequency range of 1 to 7 Mc. and the transmitter range covers 2 to 24 Mc.

METHODS

The methods and control of the required shift are many, with respective advantages and disadvantages; some of those which have been investigated are reported here, including a final design which is being manufactured commercially at the present time.

The system employing only the regular crystal of the transmitter would be the best method if it could be used advantageously. Fig. 3 shows a system utilizing two quartz crystals, one for "mark" and one for "space."

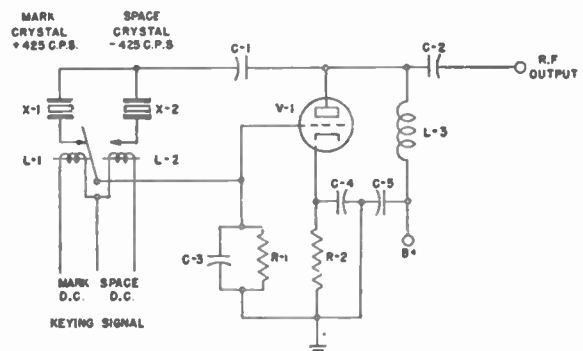

Fig. 3—Frequency-shift keying by mechanical switching of quartz crystals of the r.f. oscillator.

This system is practical, but has its disadvantages in that it requires two crystals for every frequency and a different amount of shift. Also, one great fault observed is that transients are generated in the transmitter when the shift changes from "mark" to "space." During this interval of time the transmitter acts as an interrupted or c.w. transmitter, with the carrier reducing to zero. This can cause sideband generation and blocking which may be more troublesome as a source of interference, in

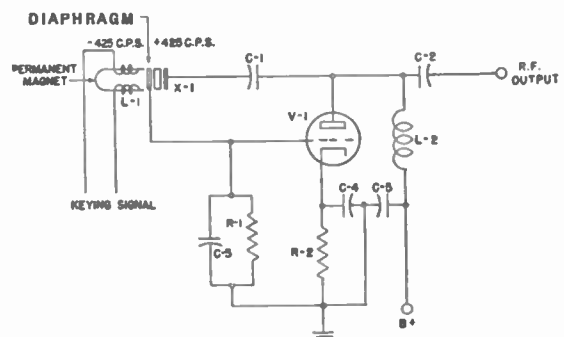

Fig. 4—Frequency-shift keying by the mechanical changing of the quartz-crystal air gap of the r.f. oscillator.

addition to cross-channel interference, than if the transmitter was keyed as a regular c.w. transmitter.

The system of changing the air gap of the crystal by use of a moveable mechanical plate (Fig. 4), controlled by a pulling force on a diaphragm (such as is used in headphones), has the disadvantage that the pulling magnetic flux must be very closely controlled by voltage regulation in order to control the fixed amount of shift; also, the displacement of the moving element from the "mark" to "space" is not constant and linear. In addition, each crystal must be calibrated in its holder and operating circuit to permit ease of operation. These disadvantages tend to outweigh the advantages.

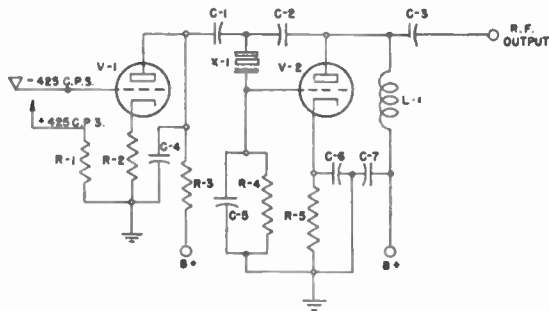

Fig. 5—Frequency-shift keying by changing the effective shunting capacitance of the quartz crystal of the r.f. oscillator.

Another system of changing the effective capacitance of the crystal (Fig. 5) is by the use of a triode with the crystal in the plate circuit and by controlling the grid of the tube to reduce and increase the emission of the tube. This system requires that the crystal used must be of special type and selected for this use.

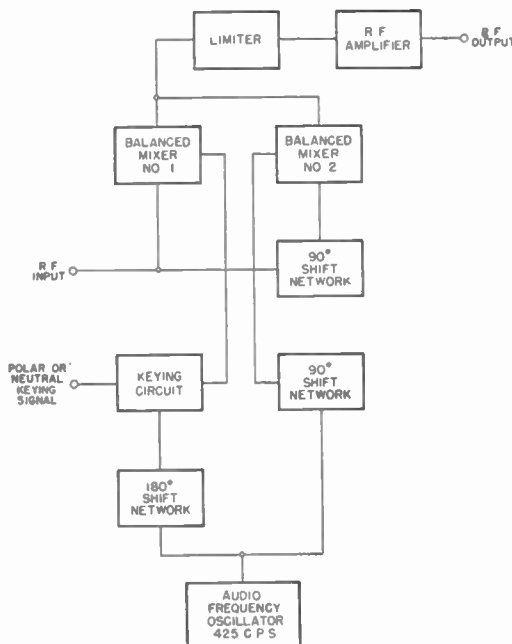

Fig. 6—Frequency-shift keying by raising and lowering the r.f. signal by an audio frequency.

A system which permits the use of the regular crystal or oscillator of the transmitter is achieved by the method of raising and lowering the transmitted radio frequency by an audio frequency (Fig. 6) equal to one-half the normal shift. This is accomplished by amplitude modulation of the radio frequency with an audio frequency, and then allowing only the upper sideband frequency to be transmitted for the marking signal and the lower sideband frequency for the spacing signal. This system has one disadvantage in that the frequency goes through zero, the same as a c.w. transmitter, and thus there are two effects present in the transmitter simultaneously; one is the change of frequency from "mark" to "space," and the other is the turning on and off of the carrier.

A method which has proved successful is the use of a reactance tube with a self-excited oscillator. The output of this oscillator is mixed with the transmitter oscillator (which is lower in frequency by an amount equal to the frequency of the self-excited oscillator) to produce two new frequencies in the output of the combination, one representing the sum of the frequencies of the two oscillators and the other the frequency of the difference of the two oscillator frequencies. By the use of a tuned circuit, it is possible to reject one and select the other. In practice, the sum frequency is selected and the difference frequency is rejected (Fig. 7). This system has

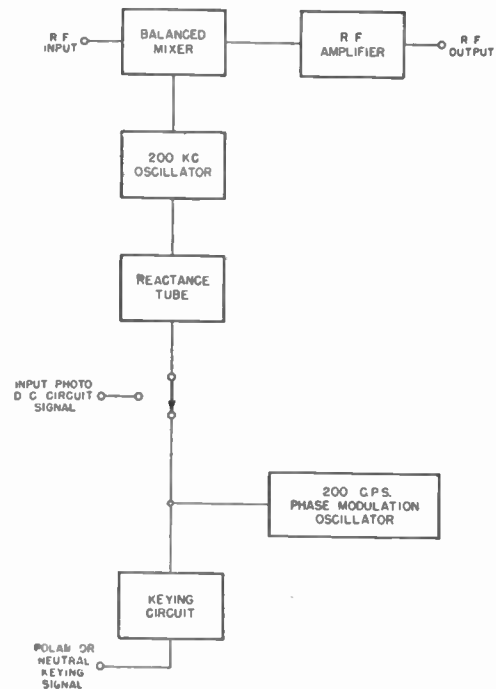

Fig. 7—Frequency shift keying by the use of a reactance tube.

the advantage that the output of the reactance tube can be made linear with linear d.c. input, and thus it is possible to transmit photographs covering the full gray scale with a high degree of definition.

The gain resulting^{5,6} in a circuit using frequency shift has been found to be from 12 to 20 db over that using on-off or c.w. transmission, depending upon the transmitting antenna used, the receiving antenna, the type of receiver, receiver converter, and the ability of the transmitter to perform efficiently when its carrier is on continuously.⁷ Some transmitters intended for c.w. use have power transformers designed only for intermittent duty and keying rates of about 300 w.p.m. maximum. When these transmitters are converted over to frequency shift, the power output must be reduced considerably or new power-rectifier transformers installed.

TESTS

Tests were performed on a transmitter at a keying rate of 100 w.p.m. (five characters per word). The transmitter was of the type where keying for c.w. operation is performed⁸ after the oscillator, and the keyers for frequency-shift tests were also installed after the oscillator.

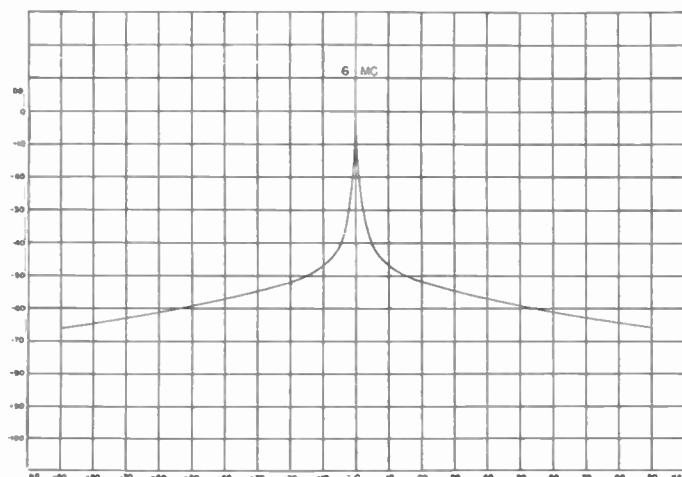

Fig. 8—Sideband attenuation of a normal c.w. transmitter; keying rate, 100 w.p.m.

If a c.w. transmitter is of the type where the keying impulse controls the r.f. amplifiers and the oscillator, the results of the c.w. tests would be improved. The sideband attenuation of the test, when the transmitter was operated on c.w., is shown in Fig. 8, which indicates average performance for this type of transmitter.

The type of keyer described in Fig. 6 was tried next. Its output is the same as that described in Figs. 3 and 5, which is a combination of frequency-shift and c.w. operation. The results were not as good in sideband attenuation as when the transmitter was operated on c.w.

⁵ H. O. Peterson, John B. Atwood, H. E. Goldstine, Grant E. Hansell, and Robert E. Schock, "Observations and comparison on radio telegraph signaling by frequency shift and on-off keying," *RCA Rev.*, vol. 12, pp. 11-32; March, 1946.

⁷ Murray G. Crosby, "Frequency modulation noise characteristics," *Proc. I.R.E.*, vol. 25, pp. 472-514; April, 1937.

⁸ Reuben Lee, "Radiotelegraph keying transient," *Proc. I.R.E.*, vol. 22, pp. 213-235; February, 1934.

due to the generation of uncontrolled transients. The results of this test are shown in Fig. 9.

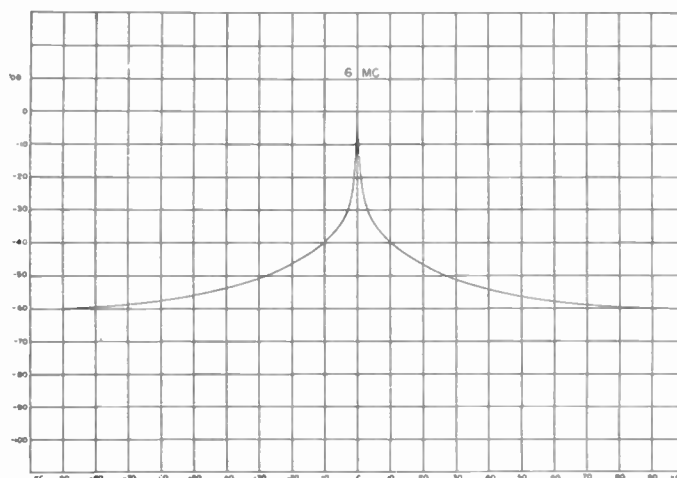

Fig. 9—Sideband attenuation of transmitter using nonreactance keyer; keying rate, 100 w.p.m.

The type of keyer outlined in Fig. 7 was tested next and the results were as expected, for the carrier is under control at all times since the change from the "mark" to "space" frequency has a definite slope and thus cannot generate unwanted transients. The results are shown in Fig. 10.

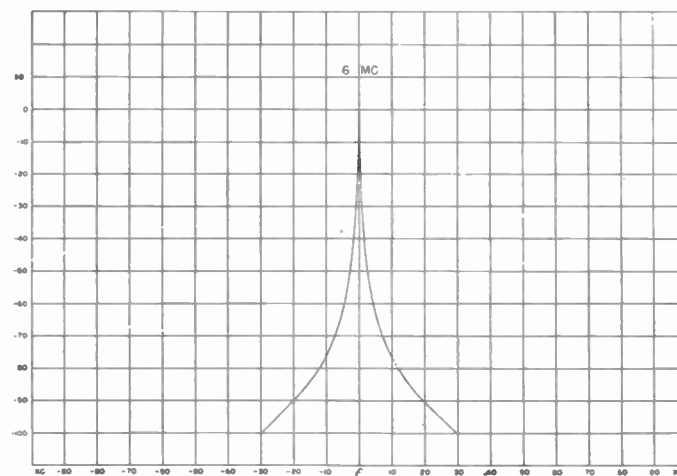

Fig. 10—Sideband attenuation of transmitter using reactance keyer; keying rate, 100 w.p.m.

The reactance-type keyer utilizes a free 200-kc. oscillator which is shifted 850 c.p.s. by the use of a reactance tube which has a linear output, regardless of the input keying voltage. This applies except in the case of photo transmission; then the keying circuit is not used and a linear demodulator is employed to change the tone from the photo transmitter into a linear d.c. voltage in relation to the intelligence of the picture. The oscillator of the transmitter, whether self-excited or crystal, must be operated 200 kc. below normal. When the

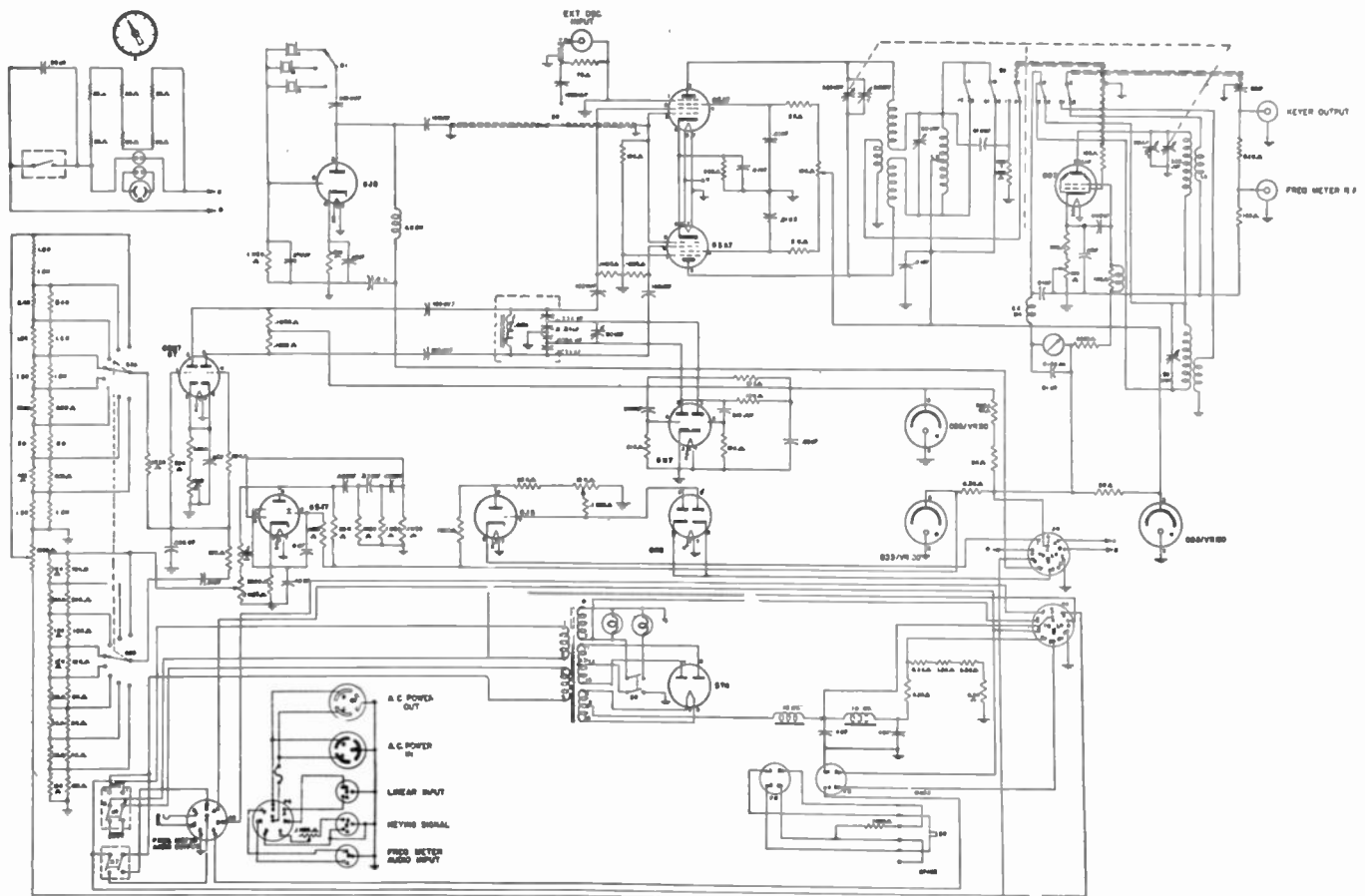

Fig. 11—Schematic diagram of reactance-type frequency-shift transmitter keyer.

transmitter oscillator frequency is added to that of the 200-kc. oscillator of the keyer, the correct normal oscillator frequency is again available; the difference frequency of the transmitter oscillator and the 200-kc. oscillator is 400 kc. lower than the normal frequency, and this is removed by a filter which consists of an inductor and a variable capacitor.

Another advantage can be obtained with the use of the reactance-type keyer which is very beneficial if the receiver antenna is confined to a simple structure where the use of diversity, either double or triple, is not available. That is the use of phase modulation of the frequency-shifted signal at a rate of 200 c.p.s., and an angular displacement not exceeding one radian, at the output terminals of the transmitter (Fig. 11). This is accomplished by the use of a phase-shift oscillator tuned to 200 c.p.s. and inserted in the input of the reactance tube. The output of the 200-c.p.s. oscillator must have adjustable control, the same as the system and range at the shift control, in order to reduce its voltage to a proportional degree of the frequency multiplication which takes place in the transmitter. This will permit the control of the angular ratio within the limits of one radian at the transmitter output.

The effect of the phase modulation causes the transmitted signal to scan the receiving antenna, and thus

reduces the amount of effective fading and multipath effects. When phase modulation is used with a diversity receiving system, no advantage is gained or apparent to the writer.

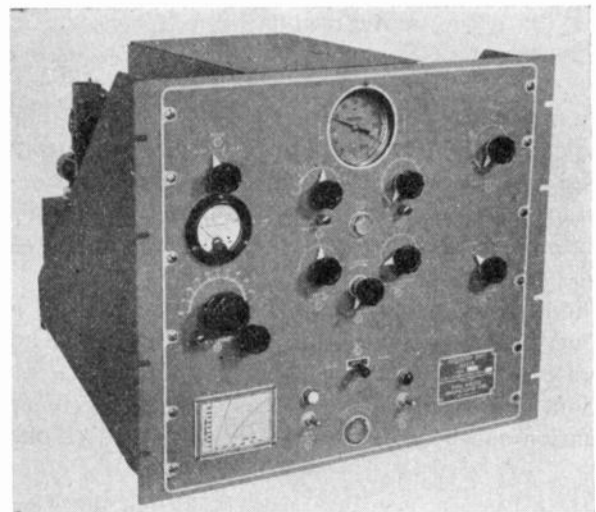

Fig. 12—Reactance-type frequency-shift transmitter keyer.

The schematic drawing of the system as outlined in Fig. 7 is shown in Fig. 11. Fig. 12 represents a photograph of the unit manufactured commercially.

Printed-Circuit Techniques*

CLEDO BRUNETTI†, SENIOR MEMBER, I.R.E., AND ROGER W. CURTIS†, SENIOR MEMBER, I.R.E.

Summary—A comprehensive treatment of the complete field of printed circuits is presented. Circuits are defined as being “printed” when they are produced on an insulated surface by any process. The methods of printing circuits fall in six main classifications: (1) *Painting*. Conductor and resistor paints are applied separately by means of a brush or a stencil bearing the electronic pattern. After drying, tiny capacitors and subminiature tubes are added to complete the unit. (2) *Spraying*. Molten metal or paint is sprayed on to form the circuit conductors. Resistance paints may also be sprayed. Included in this classification are an abrasive spraying process and a die-casting method. (3) *Chemical deposition*. Chemical solutions are poured onto a surface originally covered with a stencil. A thin metallic film is precipitated on the surface in the form of the desired electronic circuit. For conductors the film is electroplated to increase its conductance. (4) *Vacuum processes*. Metallic conductors and resistors are distilled onto the surface through a suitable stencil. (5) *Die-stamping*. Conductors are punched out of metal foil by either hot or cold dies and attached to an insulated panel. Resistors may also be stamped out of a specially coated plastic film. (6) *Dusting*. Conducting powders are dusted onto a surface through a stencil and fired. Powders are held on either with a binder or by an electrostatic method.

Methods employed up to the present have been painting, spraying, and die-stamping. Principal advantages of printed circuits are uniformity of production, and the reduction of size, assembly and inspection time and cost, line rejects, and purchasing and stocking problems. Production details as well as precautions and limitations are discussed. Many applications and examples are presented including printed amplifiers, transmitters, receivers, hearing-aid sub-assemblies, plug-in units, and electronic accessories.

I. INTRODUCTION

PRINTED ELECTRONIC CIRCUITS are no longer in the experimental stage. Introduced into mass production early in 1945 in the tiny radio proximity fuze for mortar shells developed by the National Bureau of Standards, printed circuits are now the subject of intense interest on the part of manufacturers and research laboratories in this country and abroad. From February to June, 1947, this Bureau received over one hundred inquiries from manufacturers seeking to apply printed circuits or printed-circuit techniques to the production of electronic items. Proposed applications include radios, hearing aids, television sets, electronic measuring and control equipment, personal radiotelephones, radar, and countless other devices.

The first mass production of complete printed circuits as they are known today was set up at the plant of Globe-Union, Inc., at Milwaukee, Wis., and a subsidiary plant at Lowell, Mass. Facilities were provided for daily production of over 5000 printed electronic sub-assemblies for the mortar fuze shown in Fig. 1(a). The plate, on which a complex electronic circuit was printed, was made of thin steatite 1.75 inches long

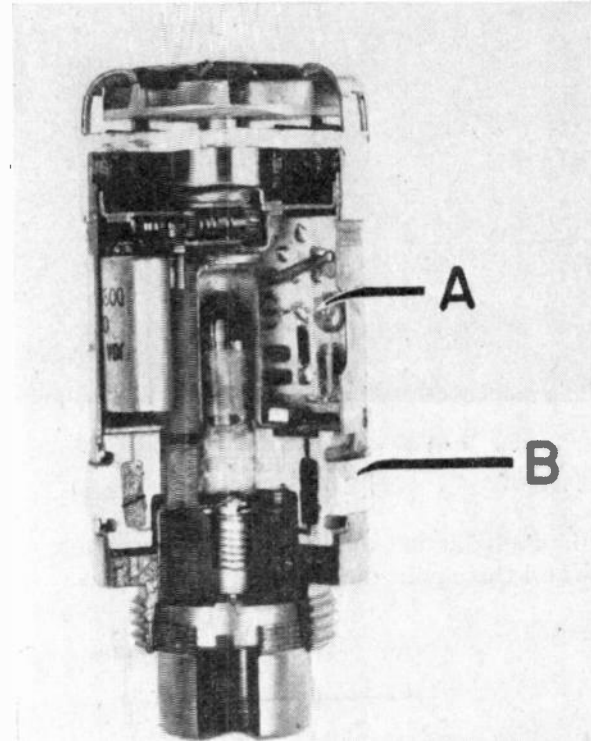

Fig. 1—Cut-away model of a simulated radio proximity fuze for mortar shell, showing an electronic control circuit on steatite block B, and the remainder of the circuit painted on steatite plate A.

and 1.25 inches wide. The circuit was produced by the stenciled-screen process pioneered by the Centralab Division of Globe-Union. Fig. 2 shows a two-stage am-

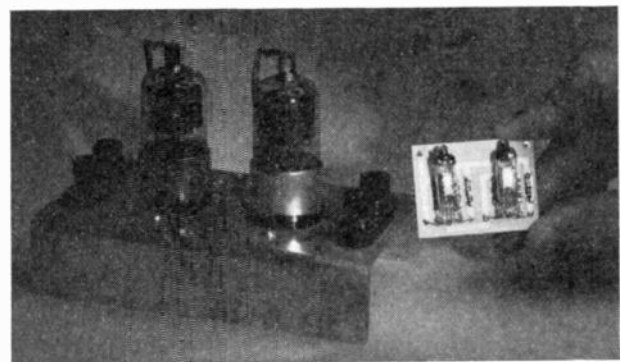

Fig. 2—Comparison of a two-stage voltage amplifier printed on a ceramic plate (right), with an equivalent amplifier constructed according to present-day radio practice (left).

plifier printed on a thin ceramic plate, alongside a similar amplifier constructed according to present-day

* Decimal classification: R361.218. Original manuscript received by the Institute, September 3, 1947.

† National Bureau of Standards, Washington 25, D. C.

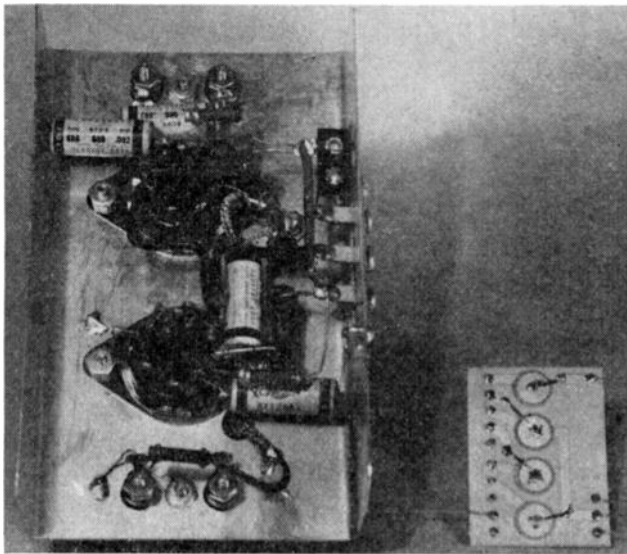

Fig. 3—View of bottom sides of printed and conventional units of Fig. 2.

standard production methods. The reverse side of the units and the circuit diagram are seen in Figs. 3 and 4.

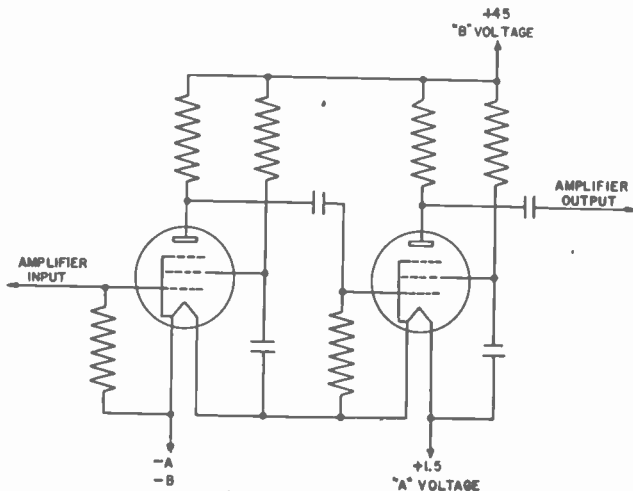

Fig. 4—Circuit diagram of the two-stage amplifier of Fig. 2.

Other printing processes, such as spraying and stamping, have reached the production lines, and today we find many manufacturers in mass production of whole radio sets or subassemblies by one or another of the printed-circuit techniques.

Manufacturers are producing thousands of special printed electronic circuits per day. Many of these are resistor-capacitor units, such as filters and interstage-coupling circuits. One unit is shown in Fig. 5. It is made by the stenciled-screen process and designed with various combinations of resistors and capacitors so as to provide coupling circuits useful in most applications. The portion of the circuit which has been printed is shown within the dotted rectangle of Fig. 5. This unit also serves as a single-stage amplifier simply by wiring to a triode. This arrangement is shown at the left in Fig. 6.

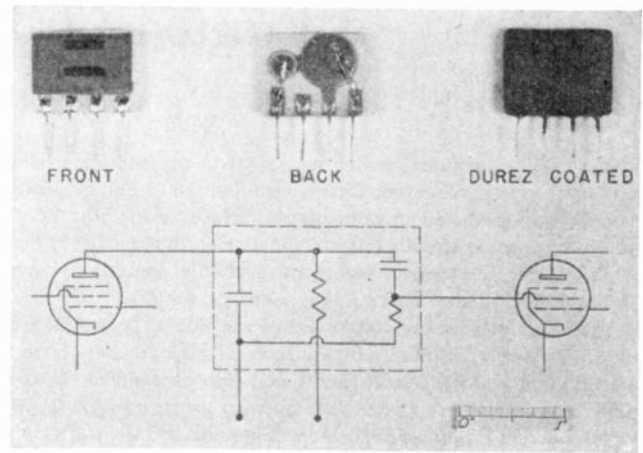

Fig. 5—Printed interstage-coupling unit, made by the stenciled-screen process.

A London concern has designed, and is now using, an automatic equipment which starts with a molded plastic plate and turns out a completely wired (printed) radio panel in twenty seconds. Other manufacturers are employing spraying procedures using scotch-tape stencils and metal-spraying equipment. Another large produce of electronic items stamps the electronic circuit out of 0.005-inch sheet copper.

The principal physical effect of printing circuits is to reduce electronic-circuit wiring essentially to two dimensions. The effect is enhanced where it is possible to employ subminiature tubes and compact associated components. A properly designed printed circuit offers size reduction comparable to the best of standard miniature electronics practice, and in certain cases affords a degree of miniaturization unobtainable by other means. Just how much space saving may be realized depends upon the application. Standard electronic components are now available in such miniature size that complete amplifiers may be built into volumes of less than one cubic inch using standard methods. This is exemplified

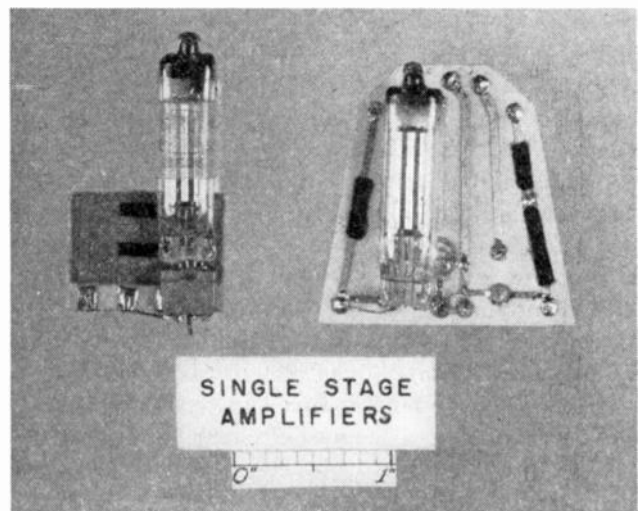

Fig. 6—Single-stage amplifiers printed on steatite plates by the stenciled-screen process.

in modern hearing-aid designs. The greater part of the volume of a hearing aid, for example, is occupied by the microphone, transformers, batteries, earphones, etc. The actual wiring occupies a small fraction of the total volume; hence, even if the wiring were eliminated completely, it would not represent a substantial further reduction in the total volume of the unit. In the printed electronic circuit, a large part of the volume is occupied by the base material. By providing thinner base materials,¹ or better, by applying the wiring to an insulated outer or inner surface already present in the assembly such as, for example, the tubes themselves or part of the plastic cabinet, a significant reduction in volume occupied by the wiring may be had. The development of truly diminutive electronic devices now awaits only the availability of smaller microphones, transformers, speakers, batteries, etc.

While size reduction is the factor which has attracted the most attention, there are other equal or more important advantages to be gained from the use of the techniques. Uniformity of production, reduction of assembly and inspection time and costs, and reduction of line rejects make the processes attractive, even in applications where size is not important. Purchasing and stocking of electronic components and accessories are reduced considerably, since many items are eliminated and others, such as the wide variety of resistors usually carried, are replaced by a few types of paints. Obsolescence of components is also avoided in great part.

In present assembly-line practices, wiring represents one of the larger items of production cost. Wires must be cut to length, bent into shape, twisted together or around soldering lugs, and individually soldered or connected. As there are over a hundred soldering operations in even the small radio sets, the cost of labor and materials for soldering alone represents an important item. In a television set the number of soldering operations is nearer 500. The new wiring processes eliminate as much as 60 per cent of the soldering needed for conventional circuits. A single operator on a production line may turn out thousands of plates each day.

Certain types of electronic circuits adapt themselves better to the printing technique than others. Standard amplifier circuits are readily printed, as are tee pads and similar attenuating circuits and, in general, any electronic configuration that does not have included within it large transformers and similar unusually bulky items. Even in this case, the printed wiring may be arranged with useful eyelets or sockets to which the larger components are attached in the same manner as the tubes.

Because of the early experience on printed circuits acquired by the National Bureau of Standards during and subsequent to its wartime program of radio-proximity-fuze design, and the demands of other government agencies and industry for more information on the subject, a

comprehensive study of printed-circuit techniques was undertaken. This study revealed a large number of methods for condensing the size of electronic assemblies, for mechanization of chassis wiring, and for reducing electronic wiring essentially to two dimensions. Although it would be beyond the scope of any single paper to attempt to cover thoroughly all the possible methods and processes, an effort has been made to present a reasonably complete treatment of the more important ones. They fall into six main classifications: (1) painting, (2) spraying, (3) chemical deposition, (4) vacuum processes, (5) die-stamping, and (6) dusting. The first five are illustrated pictorially in Fig. 7. Some of the processes are new; some have been used for years. Others have not been applied to production of electronic circuits, but are included because they point the way to new techniques.

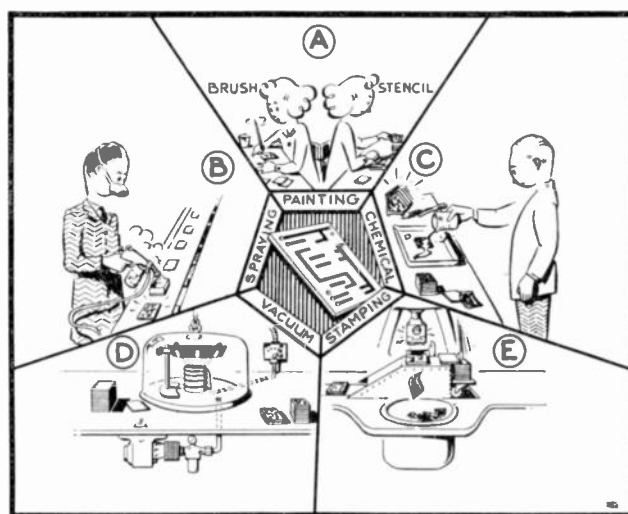

Fig. 7—Examples of five of the six main classifications of printed-circuit processes.

All are methods of reproducing a circuit design upon a surface, and as such fall under the general classification of printing² processes. Electronic circuits produced by any of these methods will be called printed electronic circuits. The processes differ mainly in the manner in which the conductors³ are produced. Resistors and capacitors are applied by methods which, in general, may be used interchangeably with any of the processes.

Painting: Metallic paints for conductors, inductors, and shields are made by mixing a metal powder with a liquid binder to hold the particles together, and a solvent to control the viscosity. Resistance paints are made in somewhat the same manner, using carbon or metallic powders. The circuit is painted on the surface by brush or stencil. It is fired at elevated temperatures. Tiny capacitors and subminiature tubes are added to complete the electronic unit.

² "Printing" is defined in the dictionary as "the act of reproducing a design upon a surface by any process."

³ The term "conductors" herein is used to denote the leads or that part of the circuit wiring which connects the electronic components, such as the resistors, inductors, etc.

¹ Ceramic plates 0.01-inch thick have been produced by mass-production techniques.

Spraying: Molten metal or paint is sprayed onto an insulating surface with a spray gun. In some processes, metals in the form of wire, powder, or solutions are supplied to the gun and sprayed directly on the surfaces through stencils to form the conductors and to fasten in place resistors, capacitors, and other electronic components which have previously been placed in depressions on the surface. Resistance paints may also be sprayed. Chemical spraying is possible using a spray gun with two openings, one ejecting silvering material and the other a reducing liquid. In another method, a metallic film on an insulated surface is subjected to an abrasive blast through a stencil bearing the circuit pattern. Included in this classification is the die-casting method. A special low-melting-point alloy is cast directly into grooves in the insulating surface. Expansion on cooling holds the metal in place.

Chemical deposition: A metallic solution, such as silver, is prepared by adding ammonium hydroxide to a solution of silver nitrate. A reducing agent is used to precipitate metallic silver on the insulating surface. A stencil is employed to define the circuit. Thin films are formed which may serve as resistors or conductors. Electroplating is used to increase the conductance of the part of the wiring serving as the conductors.

Vacuum processes: The coating metal is made up in the form of a cathode, or placed in a container in an evacuated chamber opposite the plate on which the pattern is to appear. Raising the metal to proper temperature distills it onto the plate through a suitable stencil to define the circuit. Resistors as well as conductors are made in this way.

Die-stamping: Circuit wiring is punched out of metal foil and attached to one or both sides of an insulating panel. A variation is to use a heated die with the circuit-wiring pattern on its face. Pressing the die on a thin sheet of metal foil over a plastic surface prints the complete wiring in a single step. The heat causes the foil to adhere strongly to the surface. The process is applicable to production of inductors and resistors.

Dusting: Metallic powders with or without a binder are dusted onto a surface in a wiring pattern and fired. The powder may be held to the surface by coating the latter with an adhesive through a circuit-defining stencil. The powder adheres to the surface in the desired circuit pattern and fuses strongly to it on firing. An electrostatic method of holding the powder on, prior to firing or flashing, has been developed. The process is adaptable to making resistors and conductors. Electroplating may be used to increase the conductance where necessary.

In this country, considerable interest is being displayed in the painting, spraying, and die-stamping methods. A good deal of experience has been accumulated and practical methods of operation adaptable to mass production worked out. Review of progress in foreign countries also reveals development and usage of some of the methods, particularly in England and Ger-

many. The literature is replete with methods of depositing metals on nonmetallic materials. A large number have been patented long ago and the patents expired. Early methods consisted of applying finely divided graphite or metal powders to wax coatings on the surfaces. The chemical-reduction methods were probably the first to be used for producing thin metallic films on nonconducting surfaces for decorative arts. Some have been used for over one hundred years. The resulting films were usually very thin, and plating was used to increase the thickness.

Before entering on a detailed description of the individual methods, it will be of value to consider some general facts. Not all the components of an electronic circuit may be printed. The practice is adaptable to conductors, resistors, capacitors, inductors, shields, and antennas. By printing the circuit on a base plate of high dielectric constant, one may print the capacitors, wiring, and inductors all in a single operation. The capacitors in this case may be made up by silvering equal areas on opposite sides of the plate. This practice is applicable to uses where high capacitance between leads and components may be tolerated, such as in phase-shift networks comprising only resistor and capacitor elements. It is desirable that the circuits and components adhere strongly to the base plate. The wiring should be of low resistance and of sufficient size to carry large currents without appreciable heating. The resistors and other printed components should be stable under rated electrical loads and should show a minimum aging effect. The complete printed circuit should withstand fairly severe temperature and humidity exposures, rough handling, and mechanical abuse.

The six main classifications of printed circuits will now be discussed in detail.

II. PAINTING

This process is now well adapted to the production of printed circuits. Paints for resistors may be made up, as well as conductor paints. The process has been the subject of considerable attention in the laboratories of the National Bureau of Standards and in industry. Suitable metallic paints have been developed for use on most types of surfaces from glass to plastics. In those applications in which the base material may be raised to elevated temperatures, the paint may be fired onto the surface with excellent adhesion. For materials such as plastics, which cannot be raised to high temperatures, satisfactory results are obtained, although the adhesion of the paints is considerably less than is obtained by firing. Printing the conductors is the easiest part of the operation. Printing resistors is a more difficult problem, especially where it is necessary to hold them within close tolerances.

The painting of conductors follows, in general, the practice used in pottery manufacture of burning metal oxides containing ceramic fluxes onto hard insulating surfaces. As is well known, pottery is decorated by mix-

ing finely ground metal powders and fluxes with oil and turpentine, and applying the mixture to the surface either by brush or through a stencil. It is then baked at temperatures of the order of 450 to 750°C., sufficient to melt the flux and reduce the metal oxide. The metals are used because of the color they impart to the pottery. Chromium, iron, and cobalt, for example, result in green, brown, and blue colors, respectively. Unfortunately, the silicates or borates of the various metals, except the noble metals, are poor conductors.

While it would appear to be a brief step from the pottery methods to those now used in painting electronic circuits, a considerable amount of research has gone into developing paints of sufficiently high conductance and adhesion that may be applied in a practicable way.

1. Paints

A. Constituents

Paints for printed circuits are made up of selected combinations of constituents, examples of which are included in Table I.

a. Pigment. The pigment is the conducting material for the circuit wiring. For the leads, powdered silver, silver oxide, silver nitrate, or organic combinations of silver are generally used. Silver has proved to be a most practicable metal for this purpose. Not only is it highly conductive, but silver films are easily produced. Copper

or noble-metal powders or salts may also be used effectively. Though salts of other metals might be employed, some form corrosion products which have such high resistance as to make them useless. The need for additional research in this direction is evident.

The cost of the silver is usually a small item; in fact, the relatively small amount required makes the cost of the actual silver paint no more than that of copper required for ordinary wiring. One ounce of silver is sufficient to paint as many as 125 average two-stage amplifier sections. Sheet silver, such as that used in the production of Edison cells, properly ground, is an excellent pigment for conductor paints. Flake silver in small particles works very well on most surfaces.

The pigment for resistors is usually carbon black, colloidal graphite, or a "flake" type of microcrystalline graphite. Carbon black and colloidal graphite appear better for screen painting and spraying. Flake graphite is used only for brush painting. Lampblack has been tried, but the more common types available apparently do not have the proper physical properties to produce reasonable values of resistances. One of the theories advanced is that the configuration of the pigment particles must be such that they overlap or bridge one another in the finished resistor. It is an empirical fact that the shape and size of the pigment particles do play an important part in the resultant electrical properties of the circuit.

TABLE I
COMPOSITION OF PAINTS

Constituent	Function	Applications	
		Conductors	Resistors
Pigment	Conducting material	Powdered silver Silver oxide Silver nitrate Powdered copper	Carbon black Colloidal graphite Flake graphite
Binder	Holds pigment together and binds it to plate	Linseed oil Cottonseed oil Castor oil Resin Lacquer For refractory base plates: Lead borate Lead silicate Ethyl silicate	Phenol-aldehyde resins Melamine aldehyde Vinylite resins Silicone resins Styrene resins Methacrylate resins
Solvent	Dissolves binder if in solid form and adjusts viscosity of mixture	Chlorinated solvents Alcohols Aromatics Ketones Acetates	Chlorinated solvents Alcohols Aromatics Ketones Acetates
Reducing agent	Converts metallic salt to pure metal at low temperature	Formaldehyde Hydrazine sulfate Hydrazine hydrate	
Filler	Increases electrical resistance by separating pigment particles		Powdered mica Mineralite Asbestos dust (iron free)
Protective coating	Protection against abrasion and atmospheric conditions		Phenolic lacquers Silicone resins Vinylite lacquers Melamine formaldehyde lacquers

b. Binder. This is the constituent which holds the pigment together so that it may be painted on the surface, and also serves to bind the pigment to the plate. A resin is used which can be easily dissolved. Satisfactory synthetic resins are the phenolics dissolved in acetone or silicones dissolved in chlorinated hydrocarbons. Although essential oils such as lavender oil are recommended as suitable binders, they are more or less a carry-over from other metalizing techniques. The essential oils, as a rule, are aldehydes which tend to reduce the salt or oxide to metal. Vegetable oils like linseed, cottonseed, china, soy bean, or even castor oil contain unsaturated acids which, in the process of oxidation or drying, have a tendency to absorb the oxygen from the metal oxide, thus converting it to metal. In those cases where the metallic oxide is not reduced, it is held to the surface entirely by the binder. The conductance and adhesion, therefore, are determined by the amount and type of binder employed. Where the paints are applied to surfaces that are not entirely rigid, the vinylite resins provide needed flexibility. For certain plastics, nitrocellulose or ethyl-cellulose lacquers provide quick drying action at low temperatures. The phenolic resins are usually used to bond resistance paint. They yield excellent stability in respect to changes in temperature. Lead borate, lead silicate, sodium borosilicate, and similar fluxes⁴ are recommended as binders for ceramic and glass. While a stronger bond to the surface is had by firing, the use of ethyl silicate as a binder for silver oxide on glass and steatite without firing produced a satisfactory bond.

c. Solvent. The solvent is used to dissolve the binder if it is in solid form, and to adjust the viscosity of the pigment-binder mixture. Most of the common aromatic and aliphatic solvents may be used in paints for printed circuits. Typical examples are alcohol, acetone, ethyl acetate, butyl acetate, cellosolve acetate, carbitol acetate, amyl acetate, turpentine, and butyl cellosolve. One manufacturer recommends either high-boiling solvents of the glycol-ether type or high-boiling lacquer thinners of the ester-ketone type.⁵ Lacquer thinners such as butyl acetate, as well as glycol-ether solvents such as methyl cellosolve, are also recommended. Solvents which mildly attack the surface of the base plate, such as toluene on a polystyrene base, usually improve the adhesion.

d. Reducing Agent. This constituent is used to reduce the metallic compound to metal when the base material will not stand high firing temperatures; for example, a plastic. Formaldehyde and hydrazine sulfate are used to convert silver oxide to pure silver. They are driven off at the relatively low temperature of 70°C., considerably less than the temperature required to reduce silver oxide by the firing process.

e. Filler. This is the material used to spread or separate the particles of pigment to increase the electrical resistance. Powdered mica, mineralite, diphenyl, and powdered chlorinated diphenyls are typical types of fillers employed.

B. Conductor Paints⁶

Although paints for the conductors may be made up in the laboratory, there are available, commercially, excellent products which have been developed as the result of careful research. Not only are there a variety of preparations for special purposes but the manufacturers have demonstrated unusual ability and co-operation in making up special paints for specific applications. The commercial paints require no additional attention prior to application.⁷ Whereas practically all paints may be used on highly refractory material such as glass and steatite, it is best in purchasing paint for use on plastics, cloth, and paper to request formulations especially suited for that purpose. The intended manner of application should also be stated. There are paints suited for polystyrene or for lucite and plexiglass; others are especially prepared for the prime base materials such as glass and steatite. One can go so far as to specify the degree of scratch or abrasion resistance desired. Although paints are available for painting on paper and on cloth (such as Metaplast 17A), one must expect the conductance to be affected by use, especially by folding. The silver content is usually adjusted according to the manner in which the paint is to be applied. If it is to be brushed on, a paint of at least 50 per cent silver by weight is recommended. For spraying, a silver content of 35 per cent by weight is suitable, while for application by use of a stencil screen the silver content should be as much as 60 per cent by weight.⁵ The composition and viscosity are selected to suit the method of application. The unused paint should be checked often, perhaps once or twice a day, in order to keep the composition of the paint from varying due to the evaporation of the solvent. About the only additional precaution which must be observed is that of thoroughly stirring the paint before using. For this purpose, it has been found convenient to place the container on its side on a set of mechanical rolls, as shown in Fig. 8. This allows constant and uniform stirring with the container sealed, thus preventing loss of solvent which would occur should the stirring be carried out in an open vessel.

There are several ways of preparing conducting paints in the laboratory. In one the pigment is dispersed in the

⁶ Conductor paints are used not only for conductors but for inductors, capacitors, electrodes, shields, and other low-resistance elements.

⁷ American manufacturers include E. I. duPont de Nemours Co., Inc., and Metaplast Co., Inc. A paint consisting of silver suspended colloiddally in oil was sold in Germany under the name of Mattsilber K, produced by W. C. Heraeuse GmbH. Platinschmelze, Hanau, Germany (see Bibliography, reference 3). A study of a British publication (see Bibliography, reference 4) on silvered-ceramic capacitors, and inductors indicates the availability of silver paints with suitable electrical properties on the British market.

⁴ The term "flux" is used to designate a binder, and not a cleansing agent.

⁵ See Bibliography, reference 2.

TABLE II
CONDUCTOR PAINT FORMULAS*

Base Plate Material	Ceramics	Glass	Thermosetting-Type Plastics	Thermoplastic Type Plastics
Processing temperature	450°C. to 800°C.	450°C. to 650°C.	25°C. to 175°C.	25°C. to 75°C.
Pigment	Finely ground silver powder 65 per cent	Finely ground silver powder 65 per cent	Finely ground silver powder 70 per cent	Finely ground silver powder 70 per cent
Binder	Cellulose resin 13 per cent + Finely divided, low-softening-point glass 12 per cent	Cellulose resin 13 per cent + Finely divided, low-softening-point glass 12 per cent	Cellulose resin, methacrylate resin, phenolic resins 20 per cent	Methacrylate resin, polystyrene resin 20 per cent
Solvent	Acetates or cellosolve derivatives 10 per cent	Acetates or cellosolve derivatives 10 per cent	Acetates, ketones, or cellosolve derivatives 10 per cent	Ketones, benzene, toluene, or ethylene-dichloride 10 per cent

* All percentages are by weight.

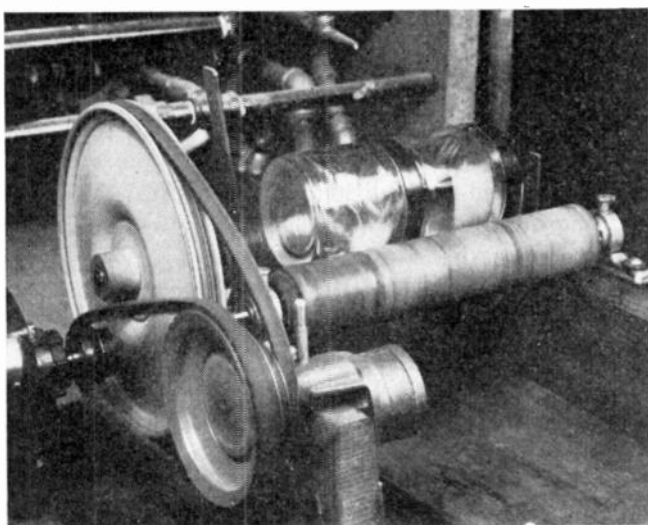

Fig. 8—Mixing of paint prior to using.

binder and applied to the surface. The unit is then elevated to the proper temperature required to drive out the solvent and to adhere the metal to the plate. To improve the bond, a flux may be added and a similar procedure followed. The units must now be raised to a temperature above that at which the flux melts, and below the melting point of the metal. Although silver oxide may be reduced at approximately 400°C., on steatite a temperature of 700°C. to 800°C. is usually employed.⁸ As the temperature is raised, in a typical example of paint, the solvent evaporates at 150°C., followed by the binder at 200°C. At 400°C. the flux melts, and at 800°C., the silver forms into a smooth conducting film. The particles of silver are spread evenly over the surface and held tightly to the base plate by the flux. The firing temperature depends on both the flux used and the material of which the base plate is made. A minimum amount of flux should be used, just enough to bond the silver

⁸ Silver melts at 961°C.

tightly to the plate. Excess flux reduces the conductance of the silver film. Care must be exercised in preventing the temperature from rising high enough to produce tiny metal globules, which weaken the bond to the plate and interfere seriously with the conductance. A satisfactory formula for a flux-type paint is five parts of metallic silver or silver oxide and one part of binder, such as lead borate, ground together in a paint mill with enough vegetable oil to give the paint the proper consistency. The viscosity may be adjusted further, if desired, by adding a small amount of acetone.

Silver-oxide paints using laboratory-prepared lacquers as binders and containing vitreous materials such as lead-silicate glass (softening point about 550°C.) or lead borate (softening point about 500°C.) in several percentages have been successfully prepared in the laboratory. The paints were applied to steatite plates and dried under infrared lamps for several minutes, then fired in a muffle furnace at 800°C. to 850°C. for one to one and one-half hours. Metallic silver of low resistance was deposited, attached firmly to the plate. Other sample formulas used in the laboratory are shown in Table II.

C. Resistor Paints

The resistor paint consists of the conducting pigment (such as carbon black or powdered graphite in carbon resistors or a metallic salt in resistors of the metal-film type), a binder (such as phenolic resin in solution), a filler (such as mineralite), and a solvent (such as alcohol). These ingredients are varied in proportion to produce resistances varying in value from a few ohms to hundreds of megohms. They usually are printed in widths from 3/64 to 3/32 inch and in lengths from 1/8 to 3/8 inch.

The choice and ratio of ingredients govern the degree of adhesion to the base plate and determine other physical and electrical characteristics. In present prac-

TABLE III
RESISTOR PAINT FORMULAS

Approximate Resistance	Approximate Thickness*	Pigment	Binder	Solvent	Processing Temperature
1000 ohms	0.003 inch	38% Graphite	62% Silicone resin		275°C.
2000 ohms	0.003 inch	3% Carbon black 27% Graphite	70% Silicone resin		275°C.
5000 ohms	0.003 inch	4% Carbon black 19% Graphite	71% Silicone resin		275°C.
25,000 ohms	0.003 inch	12% Carbon black 38% Graphite	17% Phenolic resin	33% Phenolic resin thinner	175°C.
25,000 to 50,000 ohms	0.0015 to 0.003 inch	7% Carbon black	72% Silicone resin	21% Benzene	275°C.
25,000 to 50,000 ohms	0.0015 to 0.003 inch	4% Carbon black	74% Silicone resin	22% Benzene	275°C.
45,000 ohms 10 megohms	0.001 to 0.004 inch	12% Carbon black 27% Graphite	20% Crystallite	12% Toluene 29% Ethylene dichloride	50°C.
50,000 ohms 10 megohms	0.001 to 0.004 inch	11% Carbon black 23% Graphite	66% Ethyl cellulose lacquer		50°C.

* All resistors were approximately 0.10-inch wide and 0.40-inch long. All percentages are by weight.

tice the paints are mixed by the user, who determines experimentally the proper formulation to obtain the desired resistance in the specified area.⁹ As an example, good results in the 1- to 10-megohm range on a steatite base were achieved at the Bureau using 7 per cent colloidal graphite, 46.5 per cent Dow resin 993, and 46.5 per cent benzene. A second useful formula was 15 per cent colloidal graphite, 9 per cent lampblack, 29 per cent bakelite BL-68, and 47 per cent bakelite thinner BS-68. Two coats were applied. The first was dried at 75°C. for 15 minutes, after which the second was applied and the whole unit baked at 150°C. for one hour. On temperature cycling over the range +50°C. to -50°C., the average resistance change was approximately ± 10 per cent (as shown by curve A in Fig. 27).

In the present state of the art it is not feasible to present a set of resistor paint formulations which one may use without special attention in the laboratory. Resistors may be painted readily only after careful practice. A paint formula which is successful to one experimenter may not work well for another because of the manner in which the ingredients are mixed, the quality of the ingredients, the amount of evaporation of solvent prior to application, or any number of other small but important factors. However, the data of Table III are pre-

⁹ Resistor paints for printed circuits, unlike conductor paints, are not readily available commercially. There are many suppliers of carbon black, graphite, and other paint constituents. High-resistance graphite paints which can be applied by the silk-screen process are Dispersion No. 22 or No. 154, manufactured by Acheson Colloids Corp., Port Huron, Mich. They are dispersions of colloidal graphite in organic solvents. Highly pure electrical-furnace non-fusible graphite is used. Concentrated dispersions of colloidal graphite in distilled water may be applied direct to glass, ceramics, and other materials to form electrically conductive (resistance) films that are chemically inactive and nonfusible. While this practice is satisfactory to form a base for electroplating or for electrostatic shields, it is not readily adaptable to printing resistors.

sented as a compilation of formulas used to print resistors of the values indicated.

There is need for additional experimental work in developing improved methods of printing resistors and in clarifying the theory of resistor composition and performance. This is especially true with carbon resistors. At the present time, the best resistor mixes are considered to be those in which the conducting element is predominately or entirely carbon black¹⁰ dispersed in a suitable resin. However, carbon black is high in resistivity, so that it has been necessary to add acetylene black or graphite to bring the average value within practical limits. There are many types of carbon black, each characterized by particle size, particle arrangement, the type of gas used in its manufacture, and its impurities, particularly surface impurities.

Current knowledge points to the use of carbon blacks of relatively small size for resistor paints, those of particle diameter in the range 20 to 50 millimicrons. The carbon black should have its surface impurities, principally oxygen, removed by calcining. This is done by heating to a temperature of approximately 1050°C. for four hours, preferably in a nitrogen atmosphere. The oxygen concentration is reduced to a limit of about one-half of one per cent.

After calcining the carbon black, it is best to disperse it in the binder by ball milling, using, for example, flint balls. The size and density of the balls and the speed of the mill are all-important factors in this operation. The dispersion may be checked by measuring the resistance,

¹⁰ "Carbon black" here is interpreted to mean carbon produced by impinging the flame of hydrocarbon gas on a metal surface such as a plate or channel. Also known as channel black, gas black, or impingement black.

which decreases asymptotically with time as the milling proceeds. When the resistance has reached a minimum, the milling should be stopped. A good ball-milling technique applied for 72 hours usually assures adequate dispersion of the carbon in the resin. The resin plays an important part in the dispersion, and considerable practice has been necessary to determine the best type of resin to use. It must have good solvent release.

Much also remains to be learned about the factors contributing to noise in resistors. Noise appears to be a function of particle size; the finer the carbon, usually, the less the noise. This is perhaps partly due to the fact that smaller particles present more contacts. A good deal of experimentation, including X-ray and electron-microscope studies, is now under way, seeking to clarify the relationship of carbon particle size and shape, particle arrangement in solution, and other factors, to resistor performance.

2. Surface Preparation

The insulating surface on which the circuits are to be printed may first have to be treated to improve the adhesion. The methods described herein are adaptable to all of the printing processes. Adhesion to methyl methacrylate (lucite, plexiglass, etc.) may be increased by roughening the surface, as by sand blasting. Roughening produces a minute granular surface to which better mechanical bonding may be had. When this is done, however, the surface becomes porous and the internal strength of the plastic may be reduced, causing the plate to buckle. In such instances, precautions should be taken to coat the surface after printing the circuit. Glass surfaces may be prepared by etching with hydrofluoric acid fumes or sand blasting. Etching may also be used, if necessary, on glazed ceramic materials. Glass may be sandblasted or sprayed with other abrasive materials. Usually, suitable protective stencils or coatings are used to confine the roughening to that portion of the surface occupied by the circuit.

The next step is to make sure that the surface is absolutely clean, for the bonding or adhesion may be weakened considerably by the presence of impurities. The impurities prevent direct contact between metal and surface while of themselves providing a poor or useless base on which to form the circuit. The problem of cleaning is not difficult. Customary procedure may be followed and standard cleaning materials used.¹¹ In selecting the chemicals, it is important to consider the type of surface being cleaned. A material suitable for glass, for example, might produce undesirable effects if tried on plastics.

On hard-surfaced material such as glass and ceramics, after washing the surface with water followed by a rinsing with a suitable detergent, the surface may be swabbed with a dilute solution of nitric acid. If soap is used as the detergent, it should be rinsed off well with

distilled water. Detergents such as aerosol are preferred because they form water-soluble compounds with magnesium and calcium solids commonly found in tap water.¹² If the cleansing is carried out thoroughly, one operation should be sufficient. If desired, one may follow with a second operation by treating the surface with a dilute solution of potassium hydroxide.¹³ The second operation, commonly followed in silvering mirrors, may not be necessary in printing electronic circuits. Glazed surfaces may be cleansed of paraffin and carbonized organic materials by using a mixture of chromic and sulfuric acid. In stubborn cases, the material may be placed in the solution and heated slightly.

Thermoplastics such as lucite or plexiglass may be cleansed with a dilute solution of trisodium phosphate, then rinsed in water and dried to remove any oil. For certain types of plastics, such as the phenolics, the surface may be cleansed with ordinary carbon tetrachloride followed by swabbing with a very dilute solution of potassium hydroxide or warm chromic acid. In one practice, this is followed with a quick dip in a strong caustic-soda solution or nitric acid.

3. Application of Conductor Paints

A. Circuit Layout

In many applications the arrangement of the circuit can be chosen in any convenient manner. The circuit may be painted in the same way it would be drawn on paper. Eyelets would be placed where the tube elements are later to be attached. It will generally be found more convenient and economical, however, to lay out the printed circuit in such a way as to keep the length of leads to a minimum and to avoid crossovers. Crossovers are handled by going through the base plate and continuing on the opposite side, by going around the edge, or by cementing or spraying a thin layer of insulating material over the lead crossed.

It is important to emphasize that observation of good electronic wiring practice is as essential to the successful design of printed circuits as it is in standard circuits. In printed circuits the parts are usually placed closer to each other, so that caution must be exercised to see that the components do not affect each other adversely while the circuit is in operation. In one experience, poor performance of a printed oscillator in the 150-Mc. range was traced to excessive grid-to-ground capacitance resulting from excess silver in a groove of the base plate. The heavy silver deposit in the groove, being at ground potential and also near the grid terminal of the oscillator tube, by-passed the r.f. current from the tank inductor.

¹² Carl Bosch, of Heidelberg, Germany, has described a procedure for cleaning glass which is very good. He washes the glass with a potassium-nitrate and sulfuric-acid solution. In this way, any chemical action taking place results principally in gaseous products which evaporate. Then follows a hot-water dip, after which a blast of steam is played on the surface. The surface is dried while still hot in a water-vapor atmosphere. It dries instantaneously without forming minute water droplets which, on drying, might leave nonuniform traces of materials dissolved in the water.

¹³ See Bibliography, references 6 and 7.

¹¹ See Bibliography, references 5, 6, and 7.

Reducing the width and depth of the silver line restored the electrical performance to normal.

Proper attention to circuit layout may produce many desirable advantages, such as the electrostatic shielding of leads from one another. A ground lead painted between two other leads acts as an electrostatic shield in a manner similar to the screen in a screen-grid tube. This effect has been used to good advantage in providing hum reduction by shielding grid leads from the filament leads in the manner described.¹⁴

B. Brushing

The paint may be applied to the surface in any one of a number of ways, depending upon the type of apparatus available and the electrical tolerances required. When close electrical tolerances are not needed, the paint may be simply brushed on.

For brushing, an ordinary soft camel-hair brush may be used. After the paint is stirred and the viscosity adjusted, it is applied in smooth, even strokes, care being taken to avoid air bubbles or films between the base plate and the paint, or other imperfections which ultimately might result in blisters or cracks in the paint.

If the conductors are to be held to close dimensional tolerances, more care is necessary in applying the paint so as to maintain the necessary degree of uniformity between assemblies. There are, however, a large number of radio and electronic applications where, except for a few components, close tolerances in current-carrying capacity are not needed, nor is exact electrical duplication of subsequent assemblies important.

C. Stenciling

a. Stencil Material. The simplest stencil is one in which the pattern is cut from a thin sheet of metal, plastic, paper, or cloth, and the paint applied in a manner similar to that in which commercial packages are labeled. Uses of this type of stencil are limited. Electronic assemblies for hearing aids, radios, etc., are produced uniformly at high rates of speed by using a thin screened stencil made of cloth or metal. The higher the quality of the screen and the finer the weave, the greater the uniformity in production. By employing a finer mesh, the edges are more sharply defined and the variation from assembly to assembly will be reduced.

Screens made of silk have found wide use in printed-circuit work. Metal screens have also worked out satisfactorily, and in many cases have proved more practical than silk screens. They are prepared by the same process as silk screens. Either stainless steel, copper, phosphor bronze, or similar materials may be used. It should be possible to use screens made of glass mesh. The mesh size usually used varies from around 74 to 200 mesh.¹⁵ Stainless-steel screens of 300 mesh have been used to

print silver leads. With screens of 120 mesh, it is practicable to print resistors of ± 20 per cent tolerance or better.

Stenciled screens for printed circuits may be purchased commercially. Separate stencils are used for the conductors and resistors. Stencils are often used for preparing the plate; that is, for cleaning and roughening, and for applying protective resin coatings to resistors and inductors.

b. Preparation of Stencil. The screen is prepared by stretching it tightly over a wooden¹⁶ frame. A photographic method is used to impart the circuit design to it.

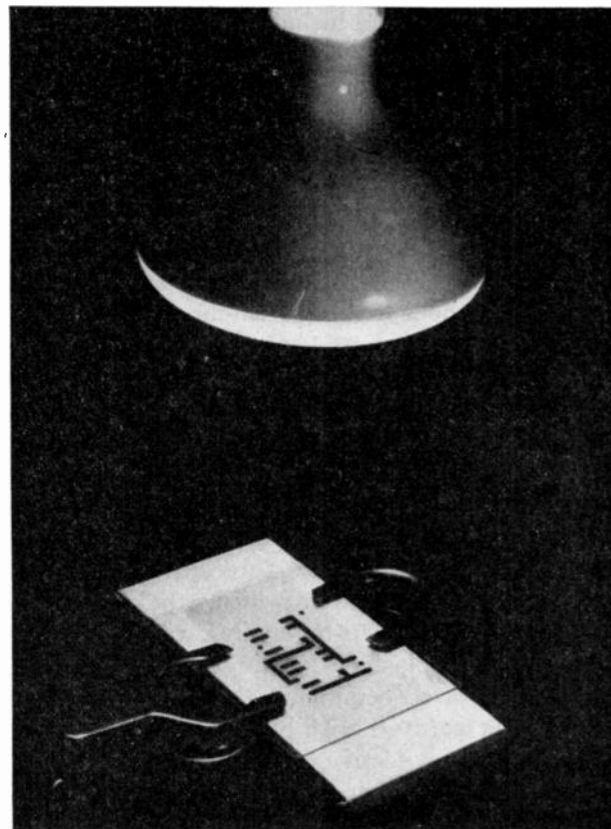

Fig. 9—Preparation of stenciled screen. The screen, coated with photosensitive material, is exposed to strong light through a photographic positive of the circuit pattern.

The screen is coated with a thin film of material, such as gelatin or polyvinyl alcohol, and photosensitized with potassium dichromate.¹⁷ When subjected to strong ultraviolet light, the film becomes insoluble in water. To im-

¹⁶ Metal, plastic or other types of frames may be employed.

¹⁷ A formula recommended by duPont (see Bibliography, reference 9) is polyvinyl alcohol 11.5% by weight, potassium dichromate (saturated solution) 5% by weight, water 83.5% by weight (color with dark-blue pigment dye). The alcohol (polyvinyl alcohol is supplied as a water-soluble powder) is dissolved in cold water, then heated and filtered. The solution may be poured into a shallow tray and the screen dipped into it sufficiently to coat the entire outside surface. The screen with coated side up is whirled in a suitable device to distribute the solution uniformly over the entire surface. After drying in a dark room, it may be exposed through the photographic positive to a 1500-candle-power arc lamp, 3 feet away, for about 5 minutes. It is developed by a light spray of cold water on the underside of the screen. The meshes may be blown open with light blasts of air to insure good detail. The screen is then dried and ready for use.

¹⁴ See Bibliography, reference 8.

¹⁵ Mesh classifications are:

6xx = 74 mesh	10xx = 109 mesh	14xx = 139 mesh
8xx = 86 mesh	12xx = 125 mesh	16xx = 157 mesh

part the stencil pattern to the film, a photographic positive of the pattern desired is held tightly against the sensitized screen and exposed to light as in Fig. 9. Those parts of the film which are not exposed to the light are water-soluble and wash out in cold water, leaving the design of the pattern to be printed. Fig. 10 shows a typical screen prepared in this manner. Polyvinyl alcohol yields a highly satisfactory blocking material for the screen. Although gelatin has not proved as good, it usually gives acceptable performance. It is important that the blocking material be selected such that it will not be attacked by solvents in the paint.

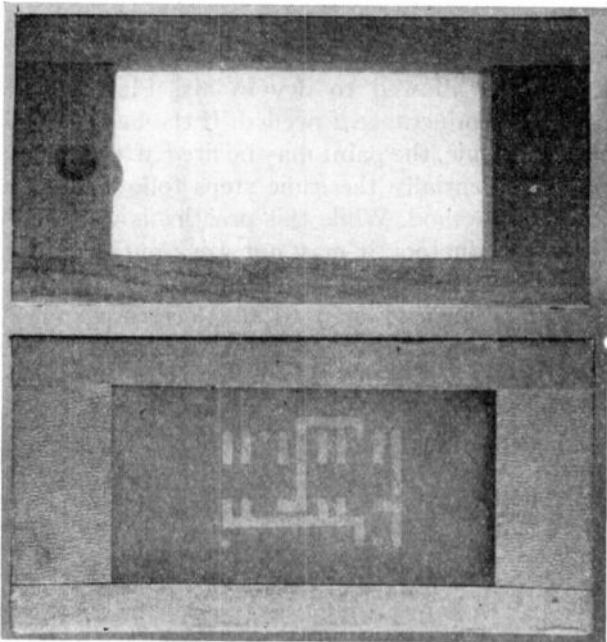

Fig. 10—The stenciled screen before and after the pattern is applied photographically.

Silk screens once stenciled may not be restenciled satisfactorily. To use the metal screens for new designs, the blocking material may be removed by soaking them in a hot hydrogen-peroxide solution, containing 3 per cent H_2O_2 , for 30 minutes to an hour. Scrub with hot water, dry, and remove any remaining traces of organic material in an open flame.

c. Stenciling Procedure. This practice is basically the same as any stenciling procedure, although certain precautions must be observed. For example, extreme care must be exercised to see that the screen is level and contacts all parts of the work evenly. This may be accomplished without difficulty by using a well-designed holder for the screen which positions it properly over the work plate and allows intimate contact with the latter without forcing the screen. A retractable stencil holder is shown in Fig. 11. The mechanical assembly is designed to swing the screen clear of the plate after the printing operation.

The next step is to place the paint on one end of the top surface of the screen and bring the plate on which the wiring is desired into contact with the bottom sur-

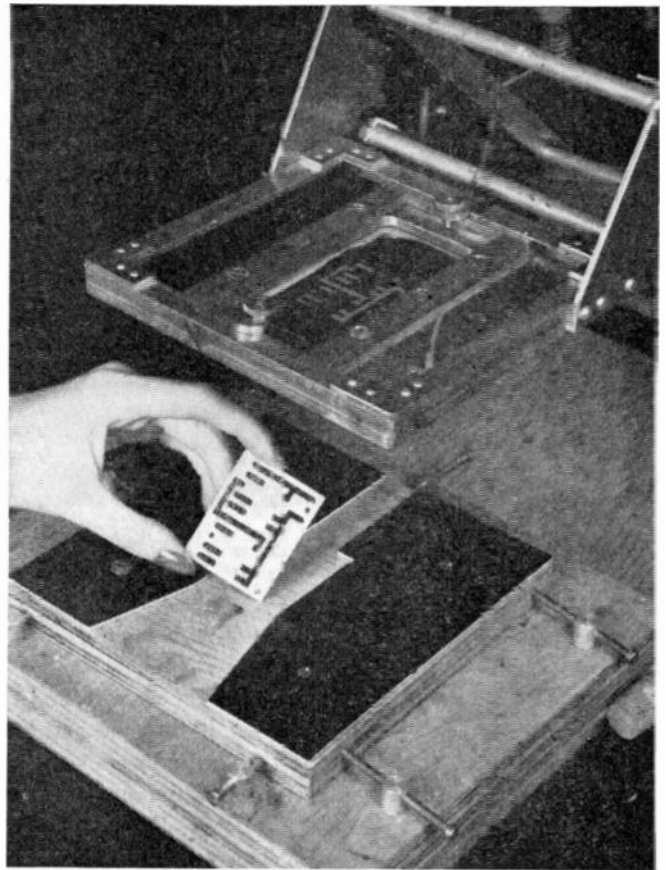

Fig. 11—A retractable stencil holder for applying paint to an insulated plate. The holder moves forward and down over a plate held in the platen. The plate shown has just been removed from the platen.

face. A neoprene bar or "squeegee" is moved across the top surface, forcing the silver paint ahead and through the open mesh of the screen pattern, as illustrated in Fig. 12. A uniform film thickness is obtained and very



Fig. 12—Application of paint through a stenciled screen. A single smooth stroke of the squeegee is required.

little paint is wasted. When the screen is removed, the plate bears a design which conforms identically to that of the stencil pattern. Fig. 13 shows a steatite plate before and after stenciling operations.

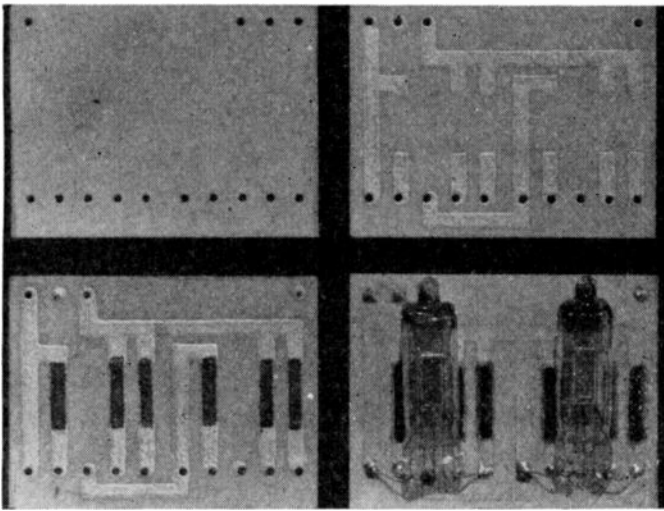

Fig. 13—Four stages in printing an electronic circuit by the stenciled-screen process: top left, blank steatite plate; top right, conductor pattern of silver paint applied through the silk screen; lower left, six resistors added with carbon paint, using a second stencil; lower right, subminiature tubes soldered in place.

Neoprene makes an effective squeegee, as it has the right degree of pliability. However, it may be attacked by ingredients in the paint. If this happens, a squeegee constructed of Buna-N rubber or other comparatively inert material should be used.

Mesh marks will be left by the screen if the paint is allowed to get too thick, or if too much pressure is exerted on the squeegee. It is not out of order to emphasize the need for checking the viscosity to see that the paint composition is maintained within close limits, if uniform electrical performance is to be obtained. Other simple precautions are necessary, such as maintaining the underside of the screen free of paint during printing, and to see that paint does not remain in the open meshes of the screen at the end of the day's operation. If the impression appears smeared, it will be best to clean the screen by going through the painting operation a few times over a spare base plate rather than to attempt to wipe the screen. Silk screens may be cleaned by using special commercially prepared solvents, applied very carefully with a soft cloth so as not to rub off the blocking portion.

D. Other Methods of Applying Paint

Other methods of applying the paint are apparently limited only by the ingenuity of the user. Some which appear to have good possibilities include the use of decalcomanias, the application of ordinary printing, engraving, and lithographing techniques, intaglio process, and the special pencils, fountain pens, and fountain-type brushes. Printing electronic circuits by the decalcomania process is feasible and useful in applying the circuits to cylindrical and irregularly shaped objects, including vacuum tubes. The procedure is to print the circuit on a thin film which may be transferred to the final surface. After transfer, the film is removed by firing. The firing operation may also serve to drive out

residual solvents and binder from the paint and to fuse the metal to the final surface. The wiring may be applied to the decalcomania film by many of the methods described above, including stamping.

Attention has been directed towards developing and using methods of printing electronic circuits involving the standard processes of printing. Here, also, precedents have been set; for example, metal designs are printed directly on china using rubber stamps. Exactly the same practice is applied to printing circuits by using a rubber stamp bearing the circuit-wiring pattern on its face. The stamp is first pressed onto a pad saturated with conducting ink and then onto the surface to be printed. If air-drying ink is used and the base material, for example, is plastic, the ink may be allowed to dry in air. Plating will increase the conductance if needed. If the base material is glass or ceramic, the paint may be fired after the impression and essentially the same steps followed as in the silk-screen method. While this practice is well suited to printing conductors, it may not work out well with resistors if close tolerances are necessary.

It is now an easy step to the letterpress or offset printing processes used to print literature.¹⁸ Fig. 14

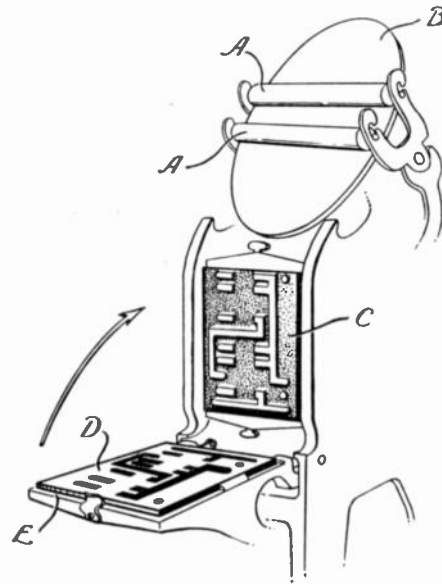

Fig. 14—Printing press for printing electronic circuits.

shows a printing press arranged to print an electronic circuit on an insulated plate *D*. The soft rollers *A* first pass over the ink plate *B*, which is coated with conducting ink. On the return motion they sweep over block *C*, which carries the metal pattern of the circuit to be printed, and coat it with a layer of ink. In the final step, carrier *E* presses the plate firmly against *C*, printing the desired pattern on plate *D*. Units of this type may print a layer of silver paint 2 or 3 mils thick. To increase the conductance, the printing may be repeated.

¹⁸ See Bibliography, reference 10.

A variation of this process is to interpose an additional roller between *C* and *E* to transfer the print from *C* to *D*. In this manner, plate *D* is retained in a fixed position during the printing.¹⁹

The printing-press process has been used to print spiral-loop antennas on the internal surface of radio cabinets. It is adaptable to any type of base plate. After the paint has been applied, the plate is subjected to the usual drying or firing procedure. A paint which has proved successful for use in the printing press consists of a colloidal suspension of metallic silver but with silver oxide and other inorganic materials kept to an absolute minimum. Up to 70 per cent silver may be used. The binder and solvent are volatile below 300°C. This paint produces an even coating which adheres strongly to the base plate after firing at 300°C. Coatings of fair conductance¹⁹ are obtained even after firing at 100°C.

The technique of printing metal decorations on paper from steel and copper plates offers a possible field for exploration in printed circuits. Other variations suggested are the direct application of paint to the insulating surface by means of a rubber, metal, or plastic block with the circuit design prepared as a cavity or deep etch to hold an appreciable quantity of paint. The primitive and seldom-used method of employing an ordinary lead pencil to draw a high-resistance line on a sheet of paper should not be overlooked. The principal objection is the low conductivity and wide variation in resistance of the line. It is conceivable that pencils may be developed which contain better conducting leads, so that not only resistors but conductors may be drawn. Such a pencil might find use in applications such as laboratory work where it is desired to arrive at a rapid estimate as to how various circuit configurations perform electrically.

To date, no satisfactory method of applying the paint by dipping the work into it has been found. The principal drawback to this method is the inability to control the thickness of the paint. Tear drops are formed and an uneven distribution of paint usually results. With plastics, dipping allows more of a chance for the solvent to attack the base material. It is possible that a satisfactory means of employing it might be worked out, using glass, steatite, and other hard base materials. Tear drops and fat edges may be eliminated by means of a recently described electrostatic method²⁰ which removes the excess paint, leaving a smoothly coated surface. While this technique has not been tried in connection with printed circuits, it appears to have possibilities for printing circuits both by dip and flow coating.

A process has been developed for applying the printed-circuit technique to thermosetting plastics in such a manner that the circuit can be formed into cup-shaped or irregularly shaped forms.²¹ It consists of

applying the paint to an organic insulating supporting structure (paper impregnated with phenolic lacquer) and curing both the paint and plastic simultaneously. Although it has been tried only with thermosetting base materials, it appears feasible for application to thermoplastic materials as well. Any desired thickness of metallic conductor may be applied, as well as resistors and other component parts. A measure of the flexibility of this process is afforded by the fact that external connections to the circuit may be made through eyelets on the base material. The eyelets may be applied after printing without danger of cracking the base. An antenna printed by this process is shown in Fig. 15. Note the eyelets, to which external leads are readily soldered.

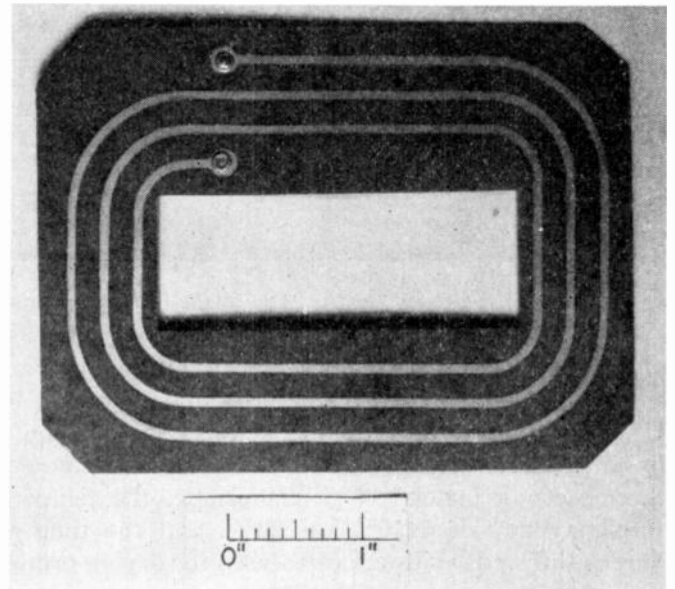

Fig. 15—Loop antenna printed on a plastic sheet.

E. Drying

After applying silver wiring to ceramic plates, they are heated to remove the binder and solvents and to bond the silver to the plate; see Fig. 16. Properly fired silver has the typical dull metallic silver appearance and will adhere to the ceramic surface with a tensile strength of approximately 3000 pounds per square inch, when the paint is made up of finely divided metallic silver or silver oxide uniformly dispersed in a suitable binder. The degree of bonding or adherence of the fired silver depends on the surface condition of the ceramic before the paint is applied. To obtain the strength quoted, the surface must be absolutely free of dust, dirt, grease, or other contaminants.

As with most techniques, the successful painting of electronic circuits depends upon the careful observation of small points. The manner in which the coating is dried is important and may be determined experimentally for the type of paint used. Instructions may be obtained from the paint manufacturer. For example, one manufacturer specifies a 3-hour drying at 50°C. for silver paint which is manufactured for use on thermo-

¹⁹ See Bibliography, reference 11.

²⁰ See Bibliography, reference 12.

²¹ Developed by Herlec Corporation.

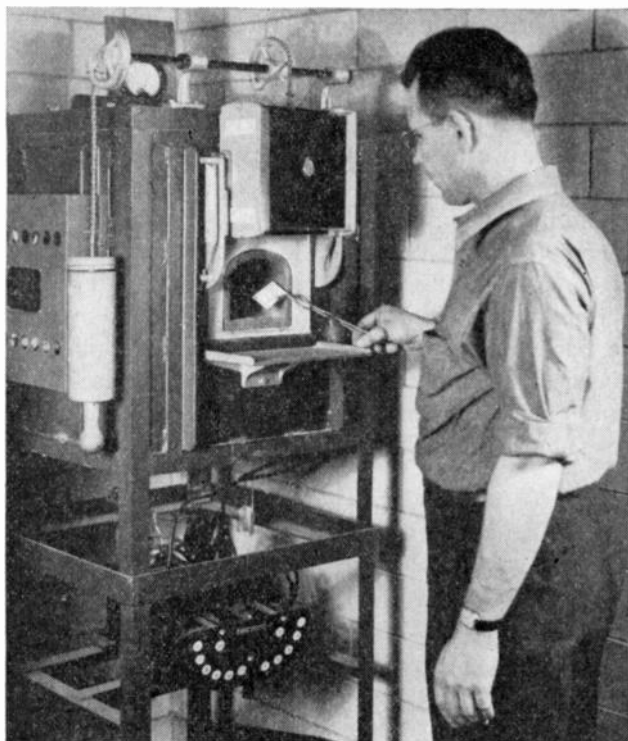

Fig. 16—Placing a printed steatite plate in the furnace for firing.

plastics applied by means of a screen. Other paint and spray preparations dry satisfactorily in one hour at 40° C. or overnight at room temperature.⁵ Longer drying is to be preferred if time allows. If the basic material is thermosetting instead of thermoplastic, the temperature may be raised 10°C. or 20°C. and the time reduced. Infrared lamps are often used for drying printed circuits.

Dielectric heating may be employed to heat the paint after application to the surface. By designing a suitable set of electrodes under which the work is slowly passed on a conveyor belt, it is possible to drive the binder and solvents out of the paint by treating them as the dielectric in a high-frequency dielectric-heating system. It is suggested that binder and solvent materials be selected which, if possible, have high loss factors, i.e., a high product of dielectric constant and power factor. Thus, acetone is preferred over alcohol. This method may be useful in working with base materials such as thermoplastics which will not stand high baking temperatures. In dielectric heating, the heat can be centered in the material it is desired to evaporate from the paint.

4. Application of Resistor Paints

A. Carbon-Film Resistors

Resistors may be painted by brushing or stenciling the resistance material onto the wiring surface. In brushing, the same technique is followed as for the conductors. In the stenciling method, stencils are employed with openings at positions corresponding to blanks in the conductor wiring stencil. The position of the openings in one example may be seen by referring to Fig. 13,

in which are shown plates before and after resistors have been applied.

Excellent results have been obtained using a simple squeegee, as is done in painting conductors. The stenciled screen is prepared in the same way. Resistors of better quality are produced with two applications of paint through an 80-mesh silk or 120-mesh copper screen, using a pressure-controlled squeegee. As might be expected, the pressure and speed of the squeegee bar moving across the screen play an important part in the uniformity of the resistance produced. Using similar paints, stencils, and base plates, the pressure-controlled squeegee yields a considerably larger percentage of resistors within fixed tolerance ranges than the hand-wiping method because of the difficulty of exerting the same pressure each time the bar is moved across the screen. Any paint remaining in the screen after one operation will affect the value of the resistors painted in the subsequent operation.

A pressure-controlled squeegee used by one manufacturer is illustrated in Fig. 17. The work is moved accurately into position against the screen by a pedal-operated elevator. The screen is held securely in place while the squeegee, which rides on a carriage, sweeps

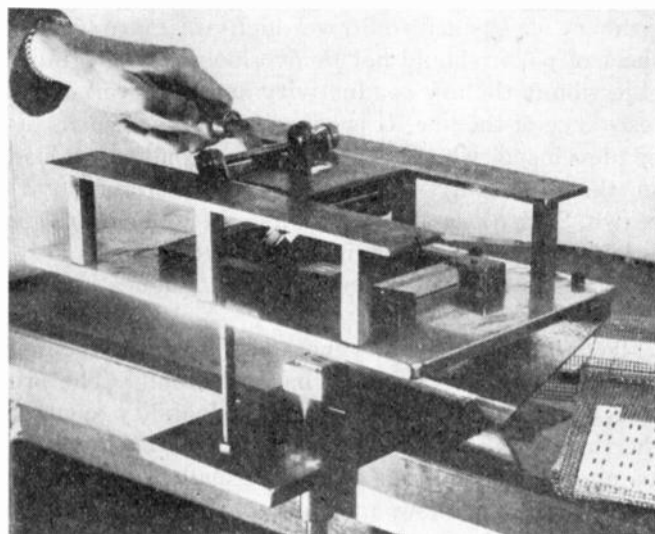

Fig. 17—Pressure-controlled painted-resistor applicator.

over it. The squeegee may be adjusted for angular position and securely locked in place. The carriage is constrained to move only in a horizontal direction within close vertical tolerances. In this manner, pressure over the screen is maintained uniform as the device sweeps back and forth. Although designed to produce uniform resistors, the device is applicable to silver painting, as well as to applying a lacquer coating to the resistors.

As powdered carbon has more of a tendency to adhere to the screen than silver, clogging may occur. The difficulty is relieved by proper selection of the other paint ingredients. Use of a screen with larger mesh openings may also be used. Typical silk-screen mesh sizes vary

TABLE IV
VARIATION IN PILOT PRODUCTION OF PRINTED RESISTORS

Number of Resistors Tested	Minimum Resistance (ohms)	Average Resistance (ohms)	Maximum Resistance (ohms)	Mean Deviation from Average (per cent)	Outside $\pm 10\%$ Tolerance (per cent)	Outside $\pm 20\%$ Tolerance (per cent)
38	4.5	5.9	10.6	± 11.7	21.0	13.0
61	1500	1600	1800	± 3.1	9.8	0
61	48,000	54,000	59,000	± 3.0	1.6	0
61	81,000	93,000	110,000	± 5.0	8.2	0
376	800,000	1,800,000	2,100,000	± 4.5	9.5	1.6
91	3,200,000	3,600,000	4,200,000	± 2.8	2.2	0
35	7,200,000	8,400,000	9,500,000	± 4.5	11.5	0

from 74 to 200. The latter is useful only for painting high values of resistance for which carbon of very small particle size is used.

Not only the paint formulation, but the width, length, and number of coats of resistor material may be varied to increase the range of resistor values possible. Practice has shown that closer uniformity may be had using several coats to build up the resistor. The paint should be allowed to dry between coats. The drying cycle between coats is determined by practice and may vary from exposure to air for 5 minutes at room temperature to a 10-minute exposure at 75°C . Filing or grinding may be employed to increase the resistance after the resistor has dried. A small dental grinder serves well for this purpose. To decrease the resistance, additional paint is brushed on. In this manner individual resistors may be adjusted to very close tolerances.

The type of stencil and the accuracy with which it is made are important factors influencing the reproducibility of painted resistors. The stencil must adhere closely to the base plate. Paper masks have been used to position the resistors and determine their size, but, although they adhere closely to the surface, they tend to leave ridges at the sides of the resistor. Adoption of the silk or metal screen has eliminated the ridges and given remarkable improvement in uniformity. It should be possible to obtain better than 80 per cent yield of resistors within ± 15 per cent tolerance with production-line methods. Those few that ordinarily require closer tolerances may be adjusted as described above. The distribution of a limited number of resistors of values ranging from 5.9 ohms to 8.4 megohms produced by the silk-screen method on a small pilot line is shown in Table IV. From 79 to 98 per cent were within ± 10 per cent of their average value. Greatest spread was observed with the smallest (5.9-ohm) resistors. Those of 1500 ohms and above were held within limits much closer than is required in usual electronic set manufacture. On an amplifier chassis, one manufacturer successfully uses four resistance-paint formulations and makes a total of from eight to sixteen applications of resistance paint to the two sides of the base plate. In this manner, resistors of close tolerance are produced. The operation, although seemingly complex, is readily adaptable to the assembly line, since the applications and subsequent drying adapt themselves either to

manual or automatic operation using either the conveyor-belt or pass-along system. After the resistors have been air-dried the paint is finally cured in an oven. Curing is effected at the proper temperature to convert the heat-polymerizable resin into an infusible state. For carbon paint in a bakelite resin binder, the curing temperature is approximately 150°C . One practice is to oven-dry the first side of the plate for 20 minutes at 150°C ., then paint the second side and oven-dry the assembly for two hours at the same temperature.

It would be highly desirable to be able to print the complete useful resistor range with a single paint formulation. While this is theoretically possible, it may require printing some resistors in unreasonable sizes or placing unattainable tolerances on the physical dimensions of other resistors. A practical compromise is to

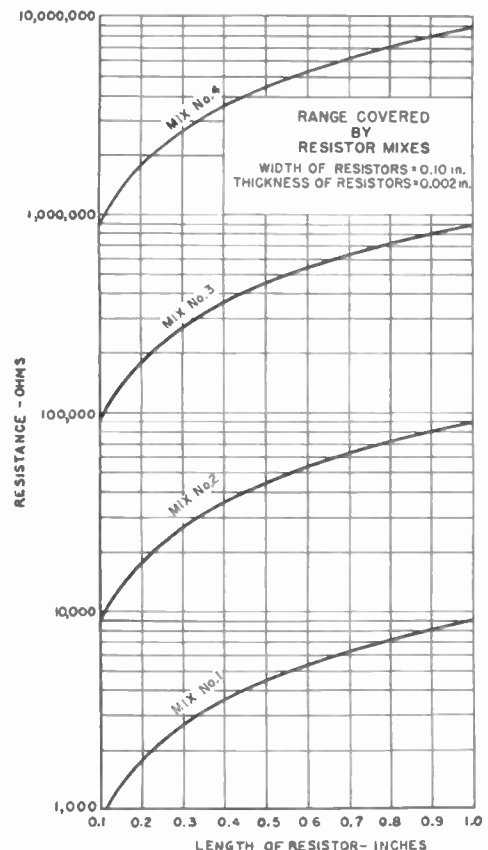

Fig. 18—Typical range covered by carbon resistor mixes.

cover the range from 3 ohms to 200 megohms with from three to six resistor mixes, using one or more applications of the paint. Fig. 18 shows a coverage of the range 1000 ohms to 10 megohms using four mixes and two applications of paint.

If the design permits, some advantage may be gained by placing the low values of resistance on one side of the plate and the higher values on the other. This reduces the number of repetitions per face required to produce the requisite number and range of resistors. High values of resistance may be painted in a small space by zig-zagging the lines in any of the several variations used to denote resistors in conventional wiring diagrams. If resistors of large power capacity are needed, they may be painted on the inside of the cabinet housing the set. The resistance may also be divided in two or more parts, each placed on a separate wall to dissipate the heat better and further increase the power rating.

Reports show that, during the past war, German plants produced carbon-film resistors in fairly large quantities. At one plant²² a colloidal suspension of carbon in lacquer was used, followed by firing in an oven at 250°C. Only single resistors or cylindrical ceramic sticks were manufactured.²³ The 0.25-watt size was 0.16 inch in diameter and 0.6 inch long. Tolerances of ± 10 per cent were met by production methods. The carbon-film type of resistors were claimed to yield superior performance over the molded type, and particularly to have a lower noise level.

B. Metal-Film Resistors

Metal-film resistors are produced by depositing a thin film of metal on a suitable base. In one method²⁴ this is done by painting a dilute solution (as low as 1 per cent) of palladium resinate in ketone on a ceramic base material, drying in air for 30 minutes, and heating to 750°C. for an hour to an hour and one-half. Under the high temperature, an extremely thin layer of palladium is deposited on the ceramic surface and the residue burned off. The noble metals are used in this process, since they remain substantially stable and nonoxidizable at the high temperature. The palladium is deposited chemically as the temperature passes the range 200°C. to 400°C. The temperature is kept in this range for 15 to 30 minutes, after which it is raised to 750°C. for an hour to completely oxidize the ash or residue and insure thorough precipitation of the palladium.

Resistors up to 1 megohm may be produced in this way. Higher values are difficult to produce by the painting method, principally because of the problem of depositing a uniformly thin or narrow strip. However, the resistors have better characteristics than wire-wound resistors, i.e., low positive temperature coefficient, good

stability, low noise level, very good frequency characteristics, and good heat dissipation. The adherence to the ceramic base is particularly strong.

5. Capacitors

It was stated that capacitor components of printed circuits may be printed by using a base material of high dielectric constant and painting silver disks of the correct area on opposite sides of the plates. The capacitance is effectively that formed by the two silvered areas and the dielectric between them. This practice is now used in applications where the high-dielectric-constant base material does not affect the electrical performance adversely, or where it may be advantageously used in designing the circuit.

Where it is necessary to use base plate materials of low dielectric constant, one accepted practice is to solder capacitors directly to a single silvered area on the base plate. The miniature thin-disk type of high-dielectric-constant capacitors having ceramic dielectrics have proven very satisfactory for this use.²⁵ Titanium compounds and other dielectric materials have been developed which exhibit a wide range of dielectric constants. The principal problem has been the control of dielectric losses and performance with temperature. The capacitance for printed-circuit use is controlled not only by the chemical formula of the dielectric but the thickness of the disk and the area of silvering on the faces. Dielectric constants ranging from 40 to 10,000 have been used for capacitors from 6.5 to 10,000 μmfd . They are from 0.020 to 0.040 inch thick and 0.125 to 0.5 inch in diameter. Higher-dielectric-constant materials are available, but their electrical losses and extreme variation with temperature in certain temperature ranges limit their use. Properties of barium-strontium-titanate dielectrics have been measured and reported by the National Bureau of Standards.²⁶ Examination of this work will show that it is possible to select mixtures to meet a wide variety of applications.

The capacitors are soldered to the plate with a low-temperature solder, such as 20 per cent tin, 40 per cent bismuth, and 40 per cent lead. This solder has a melting point of 110°C. Soldering is accomplished by laying the capacitors over a silvered area of the plate, after tinning the surface, and simply pressing down on top with a soldering iron. Preheating and the low-temperature solder prevent the dielectric from fracturing during the soldering operation. High-dielectric-constant ceramic capacitors used at the Bureau have not exhibited appreciable hysteresis with temperature. Upon cooling, they return to their original value. In special cases, the thermal shock received on soldering may cause a small permanent change.

Any type of capacitor may be soldered to a printed-circuit assembly, but those described above have the

²² See Bibliography, reference 13.

²³ No record is available of the printing of complete electronic circuits in Germany, although metalized electronic components such as capacitors and inductors on ceramic forms were developed.

²⁴ See Bibliography, reference 14.

²⁵ See Bibliography, references 15 and 16.

²⁶ See Bibliography, reference 16.

greatest economy of space and adapt themselves very well to the printed-circuit technique.

Capacitors may be built on the base plate by spraying alternate layers of a conductor, such as silver paint, and a high-dielectric-constant lacquer. The base plate may have a high-dielectric-constant material molded into it as a filler, so that silvered areas on opposite sides of the base material will form a capacitor. By molding the space for the dielectric thinner than the rest of the plate, it is possible to obtain larger capacitors without weakening the base plate.

Another capacitor particularly adaptable to printed-circuit techniques is the vitreous-enamel-dielectric type.²⁷ It consists of alternate layers of dielectric and conductive materials, built up by spraying and fired together, producing a capacitor which appears to be a solid plate of vitreous material. This capacitor may itself be used as a base for printed circuits, and may be built up to any reasonable size and in such a way that the base plate contains any reasonable number of capacitors. Thus, the circuit can be printed over the capacitors, making a very compact assembly. These units may be made with any capacitance value, if enough volume is provided. The usual volume allowance is 0.02 μfd per cubic inch for a working voltage of 500 volts d.c. The power factor is low enough so that Q 's of 3500 may be had above 250 $\mu\mu\text{fd}$. and 1000 for 10 $\mu\mu\text{fd}$. Temperature coefficient is approximately +100 p.p.m./°C. up to 125° C. They are stable, and, in general, are equivalent to mica capacitors. They can be produced to tolerances of ± 1 per cent if desired. Average production batches show over 50 per cent under 5 per cent tolerance. One of the important features of this type of construction is that it is entirely mechanized, so that it should be possible to turn out printed-circuit assemblies, including capacitors, wiring, and resistors, in an entirely automatic process. This should make possible inexpensive mass-produced electronic sets.

6. Inductors

The printed-circuit technique may be used at high as well as low frequencies. The lowest frequency for which inductors may be printed is limited by the printing area available. For a given area, however, the inductance may be increased by printing the inductor in multiple layers. Circular or rectangular spiral inductors²⁸ may be printed flat on the base plate in the same manner as the wiring leads, using silver paint. To increase the inductance, a layer of insulation is painted over the inductor, after which a second inductor is printed. Any number of layers may thus be built up to form inductors of high inductance. The usefulness of this method is limited principally by the distributed capacitance and the Q required of the inductor. Multiple-layer inductors may also be printed on cylindrical tubing.

²⁷ See Bibliography, reference 17.

²⁸ See Bibliography, reference 18.

The multiple-layer idea need not be restricted to inductors. Several circuits may be printed on the same plate, one above the other, by interposing a layer of insulation between them, either by painting, spraying, etc. The proximity of the circuits to each other must be taken into account in laying out the design, so that undesirable couplings are avoided.

It is possible to print reasonably high- Q inductors by first applying silver paint and then silver plating. Spiral inductors in the 2-meter band have been printed on a circle 0.625 inch in diameter. A Q of 125 is obtained by silver-plating to a thickness of approximately 0.002 inch. Inductors painted on glass and steatite tubes have performed very satisfactorily in oscillator circuits.

Inductors of silver fired onto cylindrical ceramic forms have been manufactured for some time.²⁹ Better adhesion of the silver to the ceramic is had when the metal is fired onto the surface, using a suitable flux, than when some other method, such as chemical reduction of the metal, is used.

The inductance of printed inductors on an insulating surface is low not only because of the limited space employed for them, but because they operate in a medium of low permeability. One side is principally exposed to air, while the other side has the insulating base material, also of low permeability, in its field. A method of increasing the inductance is to eliminate some of the center turns and fill the area with a magnetic paint made as a colloidal suspension of powdered magnetic material. A modification is to print intertwined spirals of silver and magnetic material, or, if the magnetic paint is made nonconducting, the whole inductor may be sprayed or painted with it.

To increase the inductance, the base plate may be molded with a cylindrical indentation so that a small cylindrical magnetic slug may be dropped into it and cemented into place. The base plate itself may be molded with a magnetic filler added to the plastic or ceramic. Another method is to paint or place a magnetic disk in the insulating plate below the painted inductor, followed by a second magnetic disk above the inductor. The combination may be painted on by first painting the magnetic disk. When this dries, a glaze or similar insulating surface is applied over it, followed by painting the flat spiral inductor, then another layer of insulating material, and finally, a second magnetic disk. The disk tends to shield the inductor, thus eliminating undesirable magnetic couplings to other parts of the circuit. Obviously, extension of the practice may be made to printing inductors on cylindrical or other non-planar surfaces, such as vacuum tubes. Inductors may also be printed on two pieces of base material which can be moved relative to each other to make a variable tuning unit.³⁰

The important characteristics of the spiral inductors used in printed circuitry are the inductance, the dis-

²⁹ See Bibliography, reference 19.

³⁰ See Bibliography, reference 20.

tributed capacitance, and the loss. Since the inductor is in intimate contact with the base plate, which is a dielectric, the characteristics of the dielectric are important. The distributed capacitance is increased by a material having a high dielectric constant, and the loss is increased (Q decreased) by material having a large dielectric loss. The inductance may usually be calculated, but the distributed capacitance and the loss have to be determined empirically.

The inductance of a thin, flat spiral in a medium whose permeability is unity may be computed by the formula²¹

$$L = 0.0319an^2 \left[2.3 \left(\log_{10} \frac{8a}{c} \right) \left(1 + \frac{c^2}{96a^2} \right) + \frac{3c^2}{80a^2} - \frac{1}{2} \right] \text{microhenrys}$$

where a = average radius of the inductor in inches
 n = number of turns
 c = radial thickness of the inductor in inches.

When the inductor starts at the center, $c = 2a$, and the formula simplifies to

$$L = 0.0776an^2 \text{ microhenrys}$$

or

$$L = 0.0194dn^2 \text{ microhenrys}$$

where d is the outside diameter of the inductor (i.e., $d = 4a$).

An inductor having 20 turns with a 2-inch outside diameter would have an inductance of 16 microhenrys.

Since the total self-inductance of two coils in series is $L = L_1 + L_2 \pm 2M$ and the mutual inductance for unity coupling is $M = \sqrt{L_1 L_2}$, it should be possible to obtain nearly four times the inductance of a single inductor by painting a similar inductor on the reverse side of a thin ceramic plate and connecting the two in series aiding. This will decrease the Q of the inductive circuit, however, since more flux is included in the dielectric material.

The mutual inductance of two inductors may be utilized in other ways, such as making antenna-coupling inductors, grid-to-plate coupling inductors, band-pass filters, etc. These can either be printed side by side, one inside the other, or on opposite side of the base plate. A compact band-pass filter may be made by printing inductors and the plates of the shunt capacitors on directly opposite sides of a sheet of thin dielectric material. Variable inductive or capacitive coupling between the two sections of the filter may be obtained by arranging so that either one of the inductors or capacitor plates may be shifted relative to its mate.

The maximum inductance available in the usual size of plane-spiral inductor without magnetic core material is of the order of 60 microhenries, usually limiting their

use to frequencies above 0.5 Mc. The upper frequency limit will be set by the distributed capacitance of the inductor in addition to the interelectrode capacitance of the tube. Printed inductors for frequencies in excess of 500 Mc. may be simply a pair of parallel lines.

Unfortunately, the values of inductance obtainable from flat-spiral printed inductors of any reasonable size are not large enough to allow r.f. chokes to be used; hence, where possible, chokes should be avoided in printed-circuit design. If chokes must be used, they may be soldered directly to the printed wiring. It is good practice to design the circuit so as to require small capacitors and inductors, and to use printed resistors in place of chokes. (This is illustrated in Fig. 44, in which a 2200-ohm resistor has the same function as a B+ choke.)

Printed solenoidal inductors are important in such applications as the printing of circuits on the envelope of a vacuum tube. (Samples of this practice are shown in Fig. 46.) The formula for the inductance in this case is

$$L = \frac{r^2 n^2}{9r + 10L} \text{ microhenrys}$$

where r is the radius and L the length, in inches, and n is the number of turns.

7. Electron Tubes

A large variety of subminiature tube types are available which are applicable to the design of practically every type of low-power electronic circuit. These include many types of triodes for amplifiers and oscillators (including u.h.f. types), electrometers, gas-filled thyatrons, phototubes, and diodes, tetrodes (also a twin tetrode), diode-pentodes, converters, and a large number of different kinds of pentodes. The subminiature tubes have very low drain (10 to 200 ma. at 1.5 to 6.0 volts), and work well as voltage amplifiers. Their power output varies from a few milliwatts to almost 1 watt. Triodes of general-purpose and u.h.f. types are available with amplification factors of 20 to 60 and mutual conductances of 5500 to 6500 micromhos. At 500 Mc. some of them deliver as much as 700 milliwatts of output. R.f. pentodes have mutual conductances up to 5000 micromhos and plates resistances from 0.1 to 3.0 megohms.

The accomplishment of complete two-dimensional electronic circuits by incorporating the tube within the ceramic base plate is brought into the realm of practical possibility by certain recent developments.²² Vacuum tubes have been produced with part-ceramic and part-metal envelopes. The tube elements are held in ceramic forms metalized at the edges and sealed to metal end pieces. In one development the ceramic is metalized by applying a molybdenum-iron paint²³ and firing at 1330°C. for 30 minutes. To improve soldering to the edge, it is brushed with a paint consisting of

²¹ See Bibliography, reference 21.

²² See Bibliography, references 22 and 23.

²³ See Bibliography, reference 22.

nickel powder stirred in 10 per cent collodion. The solvent, on evaporation, leaves a nickel film which wets hard solder well. The tube elements and leads are also soldered to the ceramic in this way. The molybdenum-iron layer provides a vacuum-tight junction between the ceramic and metal at all temperatures. Utilizing this practice, the internal structure of a subminiature tube may be mounted in a slot in the ceramic plate and the space sealed off by a thin ceramic wafer soldered to the plate. Tube leads may be brought out by several convenient methods. Ceramics such as steatite not only have excellent electrical characteristics but their mechanical properties are superior to those of the usual type of glass employed in vacuum tubes.

8. Protective Coatings

Protection against abrasion, humidity, and other effects is obtained by applying special resin coatings over the resistors. Baking the coating produces a scratch-proof as well as humidity-proof envelope. It also renders the resistors more stable against the effects of temperature cycling. If desired, the coatings may be applied to the printed conductors and inductors, as well. Suitable protective coatings include: (a) silicone resin in toluene, (b) polyvinyl acetate chloride lacquer, (c) polystyrene lacquer, and (d) phenol-aldehyde lacquers. The type of coating selected depends, in part, on the type of binder used as an ingredient in the resistor paint. If a phenolic binder is used, a corresponding phenolic lacquer coating which cures at approximately the same temperature as the paints should be used. If the coating requires higher curing temperature than the resistor paint, there is danger of carbonization of the paint when the coating is fired. If a phenolic base material is used, it is good practice to specify a phenolic binder in the paint as well as a phenolic lacquer for the coating.

The coating may be applied through a screen stencil in the same manner as the paint. A coarse screen, 74 to 86 mesh, is usually employed. As with the resistors, improved results are obtained by applying a double coat of resin with a 5- to 10-minute drying at elevated temperature (75°C.) between coats. Infrared lamps work well for this purpose. If followed with a one-hour baking at 150°C., the resulting coating will strongly resist abrasion, cracking, and the tendency to chip. Where the electronic set is to be used under severe tropical conditions, an additional tropicalization treatment may be necessary.

If the protective coating is applied properly, the resistance stability with time, under load or under extreme humidity conditions, will be very good. When a set of resistors painted on steatite was exposed for 100 hours in 95 per cent relative humidity at 43°C., the average resistance change was -10 per cent for values in the range 5 ohms to 10 megohms. This was not a permanent change, for on drying the resistors returned to their original values.

The protective coating may cause a change in the value of the resistor under certain conditions. One manufacturer who had developed a good resistance paint to be used with the hand-painting or spraying process experienced disturbing results on applying the same paint through a stenciled screen. After painting the resistors, a protective coat of resin was applied. Excellent results were attained when the resistors were hand-painted or sprayed. Resistors produced with the same paint applied through a screen showed as much as 600 per cent increase in value as the result of application and baking of the protective coating. An investigation revealed a porous condition in the stenciled resistor. A rearrangement of percentages of binder and filler in the paint corrected the condition so that application of the protective coating caused no changes in the value of the resistance.

9. Plating

The most practical way to increase the conductance of printed elements is to electroplate over the initial printing. A good rule is to print a thin layer of the order of 0.0005 inch or less and to electroplate on top of this. Copper plating on silver is very practical for increasing the conductance, using the usual acid-copper-sulfate bath.²⁴ Best results are obtained if the initial layer is plated at low current density, i.e., a deposition rate of 0.0005 inch per hour⁵ for the first 10 minutes. Copper plating baths are inexpensive, easy to prepare, and require little maintenance; hence they adapt themselves well to electroplating circuits printed in silver. A procedure followed in increasing the thickness of the coating is first to plate the initial silver layer with copper and then add a final silver coating over the copper. This facilitates soft-soldering direct to the leads.

Other metals may be plated directly on the silver, if desired. Good results are obtained by dipping the printed plate into a dilute sulfuric-acid bath and rinsing with water, then plating. It is clear that the materials in the plating bath should be selected so as not to attack either the base material or any of the paint constituents.

10. External Connections

External leads and tubes may be soldered directly to the silver or to eyelets on which the silver wiring terminates, providing a solder having about 2 per cent of silver to saturate against further absorption of silver is used.

A solder-dipping technique may be used for soldering tubes and external leads to the printed circuits. The tube leads are placed in holes or eyelets at which the printed wiring terminates. The assembly is heated in air at approximately 230°C. and then dipped into a solder bath at 200°C. for about 20 seconds. When withdrawn, the terminal and tube leads are neatly soldered in place and, in fact, a thin layer of solder coats all of the

²⁴ See Bibliography, reference 24.

printed silver leads. At low frequencies, this extra coating on the leads has the same effect as plating, i.e., increased current-carrying capacity as well as conductance. If the assembly has painted resistors, the protective lacquer covering usually applied to them after painting keeps them from becoming coated with solder. When the wiring contains high-frequency inductors, the solder coating has been found to increase the losses in the inductors, i.e., decrease the Q of the inductors. This may be due to a combination of increased capacitance between turns as well as decreased average conductance of the leads at high frequencies. If the frequencies are such that the current flows entirely in the skin of the conductor, the tinned coating on top of the silver forces the currents to flow partially in the silver layer and partially in the higher-resistance skin of the solder. To avoid this loss of Q , a protective coating of lacquer is put over the inductors which prevents tinning during the solder dip.

The solder bath is prepared as follows. The solder (63 per cent lead, 37 per cent tin) is first made molten by heating to 200°C . A layer of opal wax is then formed over the solder, after which polypale rosin is melted in the liquid. In this manner, three layers are formed. As the unit is dipped into the bath, the rosin cleans the parts to be soldered; the second layer, the opal wax, forms a protective film to prevent the solder from adhering to the prelacquered resistors and inductors; the third layer, the solder, attaches the units to their position. Upon removal from the solder bath, the unit is shaken to remove excess solder, then dipped in solvents to remove the excess rosin and wax.

The technique of soldering by dipping subjects the resistors to a thermal shock of 200°C . A result typical of one hundred 1-megohm resistors is shown in Fig. 19, in which the resistance decreased 8 per cent during a 20-day period after dipping, and thereafter increased about 1 per cent in 25 days.

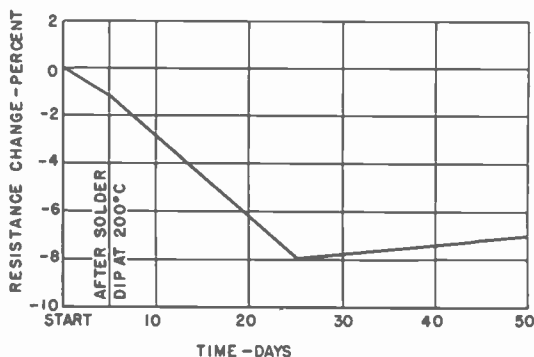

Fig. 19—Change of resistance of printed resistor with time. Typical result obtained on test of 1-megohm resistors.

In some cases it may be advisable to use induction heating for soldering operations. High-frequency induction heating adapts itself well to soldering the thin capacitors usually employed with printed circuits, and also for soldering other leads to the base plate. By

using high frequency, heat will be generated in the thin silver layers as well as in the solder and leads in the junction, thus producing a more ideal bond.

III. SPRAYING

1. Metal and Paint Spraying

A. Technique and Apparatus

Spraying of conducting films on insulating surfaces, like the spraying of ordinary lacquers and paints, not only has popular appeal but is fairly easy to adapt to production-line practice.³⁵ The practice of spraying metallic and carbon paint onto insulating surfaces through stencils has been used with success. The same paints are used as for the stenciled-screen process. Special equipment is unnecessary, the ordinary lacquer-spraying equipment being completely satisfactory. By using a spray gun with a properly controlled spray pattern, and with the work attached to a moving conveyor belt (20 to 30 feet per minute), a good degree of uniformity may be obtained in the spraying assembly. Spray guns which automatically stir the paint in the container, such as those employing suction feed with the container adjacent to the gun, are recommended. In spraying resistors, the electrical values may be controlled by means of the conveyor-belt speed as well as by regulating the flow of the material from the gun. In addition to paints, molten streams of metal may be sprayed directly through circuit-locating stencils. The metal may be supplied to the spray gun in either wire, powder, or liquid form. Precautions must be taken to prevent the films from being coarse, thick, and non-homogeneous, and to adhere strongly to the surface. The latter is accomplished by roughening such as by spraying with an abrasive material, or by treating the surface with special lacquers.³⁶

Spraying apparatus must be provided which will raise the metal to molten form. Suitable guns are available commercially. The wire gun is very convenient, since it allows spraying almost any type of metal that can be supplied in the form of wire. The metal is heated in the gun by means of a hydrogen-acetylene or other flame. Compressed air is usually employed to atomize the melted metal and drive it over to the work. If metal powder is used, a special injector is required to feed the

³⁵ Another method of circuit wiring in two dimensions which accomplishes the same results as spraying is a die-casting process wherein the system of conductors is die-cast (see Bibliography, references 26, 27, 28) instead of sprayed into the desired pattern on an insulated base. The base plate may be of any suitable material that will stand the temperature, such as certain plastics, phenolics, or ceramics. Recesses for the conductors are molded into the base plate and an alloy chosen for the conductors which expands on cooling, so that the finished product is a compact solid unit. In one method a low-melting-point alloy (less than 500°C .) is forced into recesses in the base plate under pressure. The metal is at a temperature near its melting point and is either in a liquid or plastic state. Soldering lugs, tube sockets, switches, or other inserts may be installed and the metal cast around them. If the lugs are tinned and if the die-casting material alloys with the tin, a soldered joint is made which provides good electrical contact and mechanical strength.

³⁶ See Bibliography, reference 25.

powder to the flame. The molten-metal gun contains a heated chamber which maintains the metal at the proper temperature prior to injection into the compressed-air stream.

Molten metal may be sprayed on wood, bakelite, plastic, and even ceramic surfaces. Manufacturers of high-voltage insulators have long employed the technique to coat the insulators in order to distribute the electric field properly over the surface. Experience gained in this practice is directly applicable to printing circuits. Adherence of the sprayed metal to the surface is entirely mechanical, and hence not as strong as when the metal is fused on. The adhesion on ceramics may be improved by glazing³⁷ the surface prior to roughening it. Further increase in adhesion may be had by using a glaze containing metallic particles. The adhesive strength of sprayed silver on ceramics is greater than sprayed copper. In order to take advantage of this and the greater economy of copper, it is frequent practice to spray a thin layer of silver followed by a thicker layer of copper to obtain the desired conductance.

Helical resistors for electric heating are made by setting up a metal spray gun on the carriage of a lathe and spraying a helix on a ceramic tube, using the thread-cutting mechanism of the lathe.³⁸ No stencil is required, but the spray-gun beam must be defined by a suitable aperture.

In a German plant³⁹ resistors were made by spraying a mixture of graphite and ceramic flux on a porcelain body and firing at 900°C. for two minutes. A colloidal graphite known as Hydrokollag was used, dissolved in water. The ceramic flux was composed of:

Red lead	30%
Sodium silico fluoride	23%
Zinc oxide	10%
Feldspar (Swedish)	10%
Kaolin	2%
Sodium titanium silicate	20%
Other	5%

These materials were first fused to molten glass, then quenched in water and ground to a very fine powder. For resistances from 40 to 1000 ohms, a ratio of ten parts of flux, one part of Hydrokollag, and one part (by weight) of water was used. Higher values, up to 10,000 megohms, were made by adding a filler such as lampblack in proper proportions and by slight variations in the above ratio of constituents. A graphite layer of approximately 0.002 inch was sprayed on for the lower resistor values. Several coats were used. After firing the resistors were coated with lacquer and baked at 150°C. for four hours.

A conducting pattern having good adhesion may be applied to hard or smooth surfaces by a method analogous to that used in the manufacture of printer's letterpress plates.⁴⁰ The desired pattern is printed on

the surface using a muffle lacquer, i.e., one having either an urea-aldehyde resin or phenolic-aldehyde resin base, modified by china-wood oil and colophony. After printing, but while the lacquer is still sticky, a layer of metal powder is dusted on. The lacquer is hardened by heating to 170°C. for one hour. A layer of the same metal is then sprayed over the hardened metalized lacquer. The adhesion of this metal layer is said to be three to seven times as great as that obtained by sandblasting the surface and directly spraying metal on without the lacquer. The pattern may be built up by plating or spraying other metals to any required thickness. In variations of the process, the sprayed metal may be applied prior to hardening the lacquer. After hardening the unit may be dipped into an alloy of lead, tin, and cadmium at 120°C. to deposit the conducting layer.

B. Abrasive-Spraying Methods

In one of the simpler methods of spraying molten metal, a plastic base plate is used.⁴¹ Shallow grooves are cut into the chassis by sandblasting, using a mask with lines cut out where connections are to be made. Following this, all component parts are placed either on the chassis or within the surface with their leads and terminals set in the grooves. The second mask is then placed over the chassis and molten silver or copper sprayed into the grooves. On hardening, the metal provides the connections between parts. A layer 0.002 to 0.005 inch thick is built up.

The process combines the complete wiring and soldering of all components of the electronic chassis. Standard capacitors and inductors are used, although spiral inductors, especially in the high-frequency range, may be sprayed on in this manner. This method, treated in patents issued over seventeen years ago, has been adopted by some radio and television manufacturers.

Another example of this practice⁴² is to spray the circuit wiring onto an insulating surface through a stencil and to connect ordinary components, such as inductors and capacitors, thereto by soldering or by attaching to terminals. This practice has been used in making small filter panels in large quantities. Manufacturers employing the popular spraying methods have introduced many variations, such as using a protective stencil made of masking tape.⁴³ This tape has an adhesive on one side and is easily applied to the surface. It is strong enough to protect the face of the insulating surface from the effects of sandblasting and metalizing. Stencils are produced rapidly by die-cutting in continuous strips. The extra components, such as sockets, resistors, inductors, capacitors, and special terminals, may be assembled on one side of a panel prior to sandblasting. The contacts of these components are led through the panel and appear in grooves formed by the

³⁷ See Bibliography, reference 4.

³⁸ See Bibliography, reference 29.

³⁹ See Bibliography, reference 30.

⁴⁰ See Bibliography, reference 25.

⁴¹ See Bibliography, references 31, 32, and 33.

⁴² See Bibliography, reference 34.

⁴³ See Bibliography, reference 33.

sandblasting procedure. These contacts or terminals are roughened during the sandblasting, thus contributing to a better bond with the sprayed conductor. No soldering is required. The procedure is applicable to both sides of the insulating plate. Conductors on opposite sides of the plate may be connected by metal eyelets or similar means inserted prior to sandblasting.

Another novel method adaptable to electronic wiring involves "spraying-off" the metal from a metal-plated plastic to leave the desired circuit wiring.¹⁴ A plastic or other insulator having on its surface a thin evaporated coating of metal, such as silver or copper, is coated with a photosensitive material. The material is then exposed to light through a shield or photographic negative bearing the pattern of the circuit desired. The photosensitive material is developed in such a fashion that the areas exposed to light are removed. The remaining portions of the fixed photographic material act as a protective resist, so that when the surface is exposed to a spray of abrasive material the metal is removed from all parts not covered by the resist. Using this method, circuit wiring may be printed with a dimensional tolerance of ± 0.0002 inch.

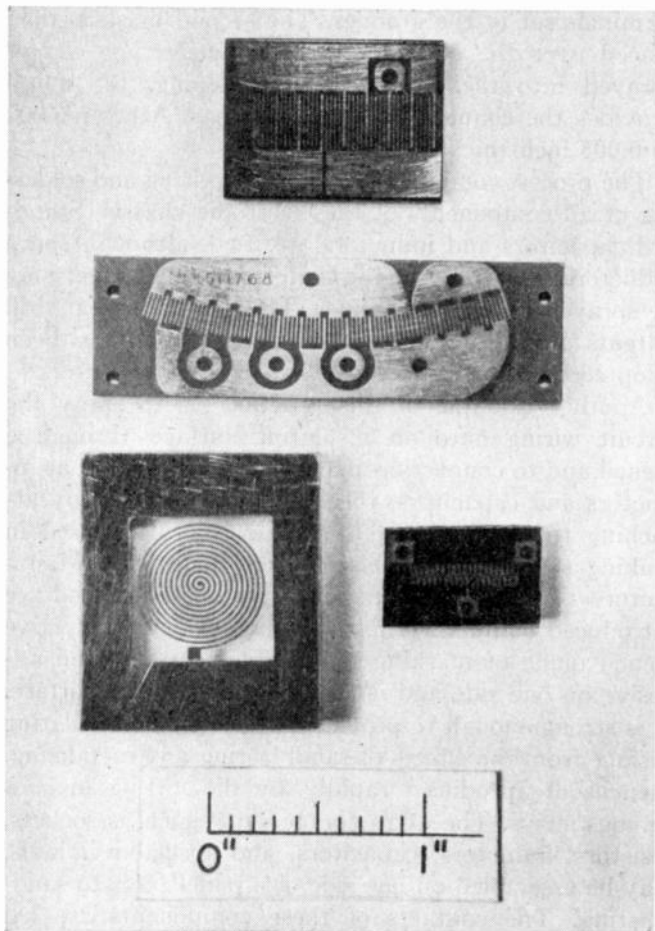

Fig. 20—Electronic items made by abrasive-spray process. Top and center, radiosonde commutators; lower left, v.h.f. inductor; lower right, center-tapped resistor.

¹⁴ Kenyon Instrument Co., Inc.

The process is applicable for circuit wiring, including inductors. It may also be used to trace out contacting segments and other related components of electric systems, such as radiosonde elements. Fig. 20 shows four items produced in this manner. The two at the top are radiosonde commutators on a phenolic base. The lower left is a spiral inductor on plastic; the component at the right is an 1800-ohm resistor on bakelite.

2. Spraying-Milling Technique

A significant step in the application of printed-circuit techniques to the production of radio sets has been made by the development in England of a completely automatic apparatus for wiring panels.¹⁴ Known as the Electronic Circuit Making Equipment, it is a spraying-milling technique designed for automatic manufacture of panels for a small a.c.-d.c.-line-operated broadcast-receiver set. A plastic plate is utilized into which has been molded indentations to provide capacitors, inductors, and mountings for other components. The plate is fed into an automatic machine which sandblasts both sides, sprays the surfaces with zinc, mills the surfaces to remove the surplus layer of metal, tests the resulting circuit, sprays on graphite resistors through stencils, inserts tube sockets and miscellaneous small hardware, tests the unit again, and applies a protective coating over the panel, all at the rate of a 7-inch panel each 20 seconds. Tubes, electrolytic capacitors, loudspeakers, etc., are attached in the standard manner. Sockets, switches, and variable capacitors are eyeletted in place.

The circuit wiring and inductors are determined by grooves molded in the original plastic plate. Inductors, for example, are spiral grooves which are filled with metal during the spraying process. Capacitors are formed by leaving thin webs in the mold when making up the original plate and spraying metal on both sides of the web in the regular spraying operation. For large capacitors, the whole base plate is molded using a high-dielectric-constant plastic filler. Inductors, capacitors, and wiring are all formed by the same spraying operation. After the sprayed metal has dried the top layer is milled off, leaving the circuit properly defined. Resistors are then added by spraying on a dispersed graphite solution through a stencil, followed by burnishing and aging. Resistors up to 1-watt capacity are printed.

Eighty hand-soldered connections are avoided by this method in the small set manufactured. The need for hand assembly of thirty components is eliminated. A special feature of the apparatus is that each operation is controlled separately by electronic circuits and operates only on the arrival of a panel. Should two successive panels be rejected in the automatic test at any point along the line, all previous operations are held up until a personal inspection is made. All panels beyond that point are continued on to completion.

3. Electrostatic Spraying

A novel method of electrostatic spraying may find application in electronic circuit work.²¹ In this method the work is carried on a conveyor belt between electrodes charged to high potential, of the order of 100,000 volts d.c. The work is at ground potential. Paint is sprayed into the area between the electrodes. The finely atomized particles of paint become charged with the same polarity as the electrodes. Electrostatic force then pulls them strongly toward the work, which is at ground potential and located within the spraying zone. Smooth and uniform deposition of paint over the entire surface is possible with proper design. Very little paint is wasted, as paint particles which would normally miss the work change their course and return to it because of the electric charge on them. In the printed-circuit application, the plates on which the paint is to be sprayed would be nonconductors. In order to attract the ionized paint particles to the work, the plates to be painted would be laid upon an electrically grounded metal-mesh belt.

4. Chemical Spraying

Spraying of silvering solutions is accomplished by using a dual-orifice spray gun. One orifice ejects the silvering solution, while the second sprays the reducing solution. The solutions leave the nozzles such that they are thoroughly mixed before reaching the insulating surface. More complex solutions may be handled by multiple-nozzle spray guns,⁴⁵ or a single-nozzled unit may be used in which the solutions are mixed just prior to entering the nozzle.

IV. CHEMICAL DEPOSITION

The methods in this classification involve the deposition of metallic films on an insulating surface by the reduction of metallic salts in solution. Although much of the material described under Section II might properly be grouped under the heading of chemical methods, for practical reasons a separate classification is preferred. The chemical methods described in this section, in general, are not as simple to apply as the paints. The silvering solutions must be handled properly by experienced personnel. They have had wide application to silvering mirrors and various types of glass vessels and in preparing nonmetallic materials for electroplating.

One of the principal methods⁴⁶ of chemical deposition is that in which a silvering solution is made up by adding ammonia to a solution of silver nitrate.⁴⁷ This silvering solution is then mixed with a reducing solution prepared, for example, by dissolving cane sugar in water

and adding nitric acid.⁴⁸ The mixture is poured over the insulating surface, the latter bearing a stencil with the circuit pattern in it. As the silver precipitates from the mixture, it deposits uniformly over the surface.⁴⁹ Removal of the stencil leaves the wiring pattern desired. The stencil should not be affected adversely by the mixture, but should be designed so that it will adhere closely to the surface, and such that it may be removed by peeling off or by evaporation at low temperature.

The films formed are very thin and cannot be soldered to directly. They may be built up by repeating the silvering process as often as desired. For high conductance, the circuit may be plated. The bond between the deposited film and surface is entirely mechanical, there being no chemical combination with the surface; consequently, the adherence is less than is obtained by the firing processes.

Additional details on the silvering processes, including many variations of the chemicals employed as well as the processes, may be found scattered profusely throughout the literature.⁵⁰ Not only silver films but those of copper, nickel, gold, iron, and other metals and those of alloys such as silver-copper may be deposited on non-metallic surfaces by chemical methods. An interesting variation is offered by the possibility of selecting the metallic salts so that metal films of different colors are deposited, thus allowing the printing of colored electronic circuits. Circuits of different colors may be used for identifying different sections in a multisection unit, for classifying as to frequency and volume ranges, and other uses. Usually, however, such metallic salts produce high-resistance films and, as such, may be used to produce resistors of limited wattage.

Lead-sulphide infrared photoelectric cells⁵¹ are made by chemically precipitating lead sulphide onto the supporting glass between parallel metal electrodes. The electrodes, which are of interest here, consist of a large number of alternate layers of gold and platinum. They are deposited by applying chloride solutions of the metal believed to be made by dissolving the chlorides in natural oil of lavender and alcohol and adding some pitch for stickiness. On heating, the chlorides are reduced to metal. The procedure is repeated with the opposite metal to obtain alternate layers.

As in the other methods, best results are obtained if the surface is first cleaned properly. General procedures for cleaning are described elsewhere in this paper. Strong, uniform adherence to glass surfaces has been obtained by first tinning the glass; that is, by lightly

⁴⁸ Nitric acid inverts the sugar to dextrose and levulose. Formaldehyde, rochelle salts, sodium or potassium tartrate or tartaric, citric or tannic acid, also serve satisfactorily as reducing agents.

⁴⁹ The alkaline silver solutions should not be allowed to evaporate and form dry residues as there is danger of explosion. They should be mixed only as needed. Unused solution should be treated by adding hydrochloric acid which precipitates the silver and removes the danger (see Bibliography, reference 5).

⁵⁰ See Bibliography, references 5, 6, 7, 36, and 37.

⁵¹ See Bibliography, reference 3.

⁴⁵ See Bibliography, reference 35.

⁴⁶ See Bibliography, reference 5.

⁴⁷ Silver nitrate is dissolved in water and precipitated in hydroxide form, using an alkaline hydroxide such as sodium or ammonium hydroxide. The precipitate is automatically redissolved in the solution by using an excess of the alkaline hydroxide.

swabbing it with a 10 per cent solution of tin-chloride.⁵² Lead acetate, thorium nitrate, or other salts of metal which are strongly adsorbed by the glass may be used.⁵³ This practice should be useful in applying electronic circuits to the glass envelopes of vacuum tubes.

Special treatment is necessary in order to apply the chemical-reduction methods to plastics. For good adherence, the surface should be roughened either chemically, as by etching, or mechanically by a careful abrasive treatment. A method which has proven successful for preparing methyl methacrylates (Lucite, Plexiglas, etc.) for silvering consists in treating the surface with sodium hydroxide for 12 to 48 hours. This renders the surface receptive to silver⁴⁵ so that, when the silvering mixture is poured over it, a firmly adhering metal film results. Several variations of this method also have been described.⁵⁴

The chemical-deposition methods, although used extensively in the manufacturing of mirrors and other products, may currently be classified in the realm of laboratory methods not fully developed for mass production of printed electronic circuits. Their position, however, is similar to that of some of the vacuum processes described herein which only a short time ago were considered strictly small-scale methods, but today are used to produce electrical components by the millions.

V. VACUUM PROCESSES

Another set of techniques employed to produce metallic layers on nonmetallic surfaces which may be adapted to electronic wiring are those of cathode sputtering and evaporation.⁵⁵ The methods are fairly similar. In the sputtering process, the metal to be volatilized is made the cathode, and the material to be coated the anode. A high voltage is applied between them after evacuation. Metal emitted from the cathode is attracted to the plate by maintaining the plate at positive potential. In the evaporation process, the metal is heated in a vacuum to a temperature at which it evaporates onto the work located near by.

1. Cathode Sputtering

Cathode sputtering is probably the oldest of the methods for depositing metals on a surface in a vacuum. The necessity for working with a vacuum appears to pose a major obstacle to mass production. A closer study will show, however, that the difficulties are not substantially greater than those attending processes requiring heating of the work to fusing or firing temperatures. Vacuum methods of silvering mirrors are now employed on a mass-production scale.

In both the sputtering and evaporation processes, the work is covered with a suitable circuit-defining stencil

and placed in the chamber opposite the cathode. For sputtering, the chamber is evacuated to a pressure of the order of 0.001 mm. of mercury. Higher pressures may be used in certain cases. These pressures may be obtained with a good mechanical pump. The shape of the cathode which is made of the metal to be sputtered may take on any convenient form. It may be in the form of a straight wire, a wire grid, or a thin sheet. If the work occupies a large area, more than one cathode may be necessary. To obtain a uniform deposition of metal on the work, the cathode and work should be placed as nearly parallel to each other as possible. Optimum spacing is determined experimentally, and may be of the order of $\frac{1}{2}$ inch to 6 inches.

A practical arrangement would be to have the cathode located over the work, which lies on a horizontal metal anode. The latter is charged to a potential varying from 500 to 20,000 volts, depending on the space and the pressure. D.c. is preferred with the plate at positive potential, although pulsating d.c. or a.c. may be used. The high voltage may be obtained from a neon-lighting transformer, as the currents required are very small.

Any of a large number of metals may be used for sputtering, including silver, copper, platinum, gold, etc. A vapor of metal is formed which completely coats the work, including its protective stencil. In both sputtering and evaporation, the practice is confined to producing very thin films which may later be plated to achieve the desired conductance. Electrically conducting films as thin as 0.1×10^{-6} inch may be deposited satisfactorily, although for electronic circuits it is desirable to make the film thicker, so that satisfactory electroplating may be achieved without difficulty.

As the thickness of the layer deposited depends on the spacing between the cathode and article, irregularly shaped objects will be covered with variable thicknesses of metal. For conductor wiring this is not a serious matter as, in general, the conductance is sufficient so that variations in it produce negligible effects on circuit performance. Both sputtering and evaporation will adapt themselves well to coating circuit wiring on inside surfaces of housings to which a protective mask or stencil may be applied.

2. Evaporation

The lesser complexity of the evaporation process and the possibility of evaporating uniform films of metal on nonmetallic surfaces has led to its general adoption by industry. One of the principal applications at present is in the production of paper capacitors. Thin aluminum or zinc films evaporated onto impregnated paper now yield capacitors not only of miniature size, but having other valuable properties, such as self-healing, i.e., the ability to remove short circuits automatically. These capacitors are made on a large scale using mass-production techniques.

⁵² See Bibliography, references 6 and 38.

⁵³ See Bibliography, reference 38.

⁵⁴ See Bibliography, reference 6.

⁵⁵ See Bibliography, reference 7.

No high-voltage source is needed for the evaporation. The metal is simply heated in a vacuum until it vaporizes onto the work. The properties of the metal layers deposited do not differ practically from those applied by the sputtering method. Adhesion is about the same, although not as strong as that obtained by the fusing methods. Pressures of the order of 0.001 to 0.00001 mm. are usually employed. For best results the pressure must be reduced until the molecular mean free path equals or exceeds the maximum internal dimension of the chamber.

The arrangement of the apparatus is similar to that for cathode sputtering. Tungsten filaments may be used. The metal is placed directly on the filaments in the form of small hairpins or wire. The tungsten filaments are heated by electric current until the metal hairpins or wires are vaporized, and the molecules transported to the target plate. Other shapes of filaments may be employed, such as flat-shaped in the form of a trough, or carrying dents to hold the metal to be evaporated.⁵⁵ For evaporating aluminum, filaments have been used with the aluminum prefused to the tungsten. Another variation is to use twisted strands of filament wire with the metal to be evaporated appearing as one or more of the twisted strands in parallel with the real filament. A variation which might be classified as a combination of sputtering and evaporation is to replace the filament with an arc formed between rods of the metal to be evaporated. On forming the arc, the metal is vaporized. The practice is similar to that of the carbon arc lamp, except that the operation is carried out in vacuum. Although not necessary, application of a high potential to the work, as is done in cathode sputtering, may improve results with this method.

Practically all metals may be evaporated, the principal requirement being that their vaporizing point falls below the melting point of the filament. The practice has been used successfully to evaporate films of copper, silver, iron, platinum, lead, aluminum, gold, and tin. Table V shows evaporation temperatures of the metals.⁵⁵

Although the metals attached to the filament will melt just before evaporating, they are held to the filament by surface tension. As silver and copper do not wet the tungsten filament very well, tantalum or molybdenum may be substituted when using these metals.

Thermal evaporation may be accomplished in a more practical way without the use of electric filaments. The simplest method is to place the metal in a vessel and heat it to vaporizing temperature, as shown in Fig. 21. The heat may be applied either by means of a flame or by induction heating.⁵⁶ In the induction-heating method, the metal may be placed in an insulated crucible, either in the form of powder or larger granules, or as a chemical compound, and the induction coils placed around the crucible. Heat generated in the metal by eddy currents causes it to be melted. The plates to be coated may be

TABLE V
EVAPORATION TEMPERATURE OF METALS

Metal	Evaporation Temperature* (Degrees Centigrade)	Metal	Evaporation Temperature* (Degrees Centigrade)
Mercury	47	Lead	727
Cesium	160	Tin	875
Rubidium	177	Chromium	917
Potassium	207	Silver	1046
Cadmium	268	Gold	1172
Sodium	292	Aluminum	1188
Zinc	350	Copper	1269
Magnesium	439	Iron	1421
Strontium	538	Nickel	1444
Lithium	548	Platinum	2059
Calcium	605	Molybdenum	2482
Barium	632	(Carbon)	2522
Bismuth	640	Tungsten	3232
Antimony	700		

* Temperature at which vapor pressure equals 10^{-2} mm. of mercury.

placed upside down on a supporting grid over the crucible. Metal stencils or masks may be used. Mica sheets have also proven satisfactory. If handled properly, the masks may be used over again, cleaning being accomplished by washing in dilute nitric acid. The use of a shadow stencil, that is, a single stencil permanently placed over the crucible to throw a shadow pattern of metal over the plate to be coated, may prove satisfactory. Obvious and perhaps difficult precautions attend this method.

The practice of evaporation is not limited to small assemblies. Long used to silver- or chromium-plate mirrors, vacuum chambers have been built to handle work several square feet in area. If the electronic subassemblies are small, a number of them may be placed on the tray in the chamber and coated simultaneously, either by the evaporating or sputtering process.

Electric shields and other equipment have been made up by evaporating aluminum onto a nonconducting surface. After the proper conductive layer has been achieved, air is allowed to enter the chamber while the evaporation continues. Thus, a thin layer of aluminum

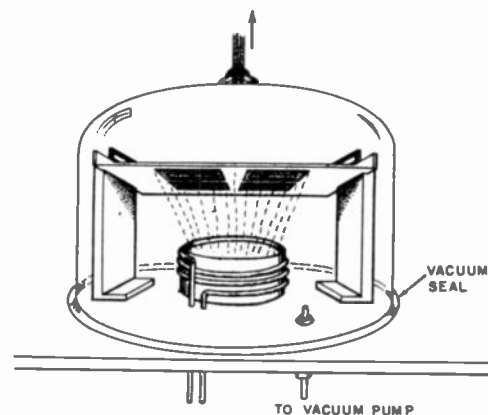

Fig. 21—Vacuum chamber for application of printed circuits by evaporation.

⁵⁶ See Bibliography, references 40 and 41.

oxide is formed over the conducting surface to provide a good insulator. Practices such as these are forerunners of new printed-circuit techniques.

A German method of coating the inner surface of a fluorescent screen with a very thin film of aluminum⁵⁷ embodies principles of interest to printed-circuit investigators. The film serves as a reflector of light behind the screen, yet must allow electrons to pass through it without too much loss in velocity. The technique of producing this film is rather delicate. The first step is to form a thin, water-insoluble film of organic material, such as collodion, paraffin, or an acetate, over a thin layer of water covering the screen. This is done by placing a small amount of liquid solution of the material on the water. The solvent evaporates and leaves a thin, smooth film on the water. After a drying process, the film drops snugly onto the screen. The aluminum is then evaporated onto this film of organic material. When the tube is processed later the heating breaks down the organic film, which is vaporized and pumped out, leaving the aluminum film attached to the fluorescent screen.

3. Resistors

The thin films formed by sputtering or evaporation may also serve as resistors.⁵⁸ In this case, plating is not used. The approximate resistance may be calculated from the resistivity of the metal evaporated and its dimensions. Stencils are used to confine the metal to the proper position and area desired. Waveguide attenuators have been made in this way by evaporating a very thin film of nichrome on pyrex or soft plate glass. In one process⁵⁹ the nichrome film is covered with a protective layer of magnesium fluoride applied directly to the nichrome film while the chamber is still evacuated. The protective layer prevents oxidation and corrosion of the resistance film. The low temperature coefficient of the nichrome is preserved in this method.

Accurately defined areas may be coated by the evaporation process, thus improving the uniformity of the resistors. A practice which works well, when the number of resistors to be evaporated onto an insulating panel is small, is to wire the panel to a resistance bridge. As the resistor is deposited the bridge indicator drops gradually until the precise resistance is attained, at which time the evaporator is automatically shut off. The resistor in Fig. 20 was applied by evaporating silver onto bakelite.

⁵⁷ See Bibliography, reference 3.

⁵⁸ Carbon-film resistors on ceramic rods have also been produced by cracking hydrocarbons at high temperature. Resistors with temperature coefficient of the order of 0.1 per cent/°C. are made this way (see Bibliography, reference 13). The resistance film is formed by cracking vaporized benzol in a carbon-dioxide atmosphere at 950°C. This produces a carbon film approximately 0.0004 inch thick on the ceramic rod. Carbon dioxide is used to improve the uniformity of the carbon film. It is reported that 80% of the resistors fall within ± 20 per cent tolerance limits. Values up to 2 megohms have been produced. The resistance is controlled by the volume of benzol used and the oven temperature.

⁵⁹ See Bibliography, reference 42.

VI. DIE-STAMPING

1. Preformed Conductors

In the production of electronic assemblies for certain types of proximity fuzes during the war, it was found advantageous to preform the connecting wires and component leads. These were dropped into position in a plastic chassis in such a manner that all terminals requiring soldering appeared opposite each other. Soldering of the terminals completed the assembly.

Similar methods have been employed successfully elsewhere in industry. Punch presses are used to preform stiff copper wires into shape. The formed wires are automatically dropped in a jig containing all the electrical components. A multiple welding device is lowered and all junctions are spot-welded in one or two operations. The mechanization is carried a step further by feeding the electrical components into the jib by means of properly designed hoppers or with pneumatic guns.

Thin copper strips can be substituted for the leads in the previous operation. They may be die-stamped into the same form as the preformed leads, and welded in the same manner. Strips are coated with an insulating lacquer to prevent short circuits in crossover. One manufacturer punches a grid out of 1/16-inch copper plate. After silver plating, the grid is placed over an array of projecting lugs attached to various electrical components. It is soldered to all the lugs in a single automatic operation. Those parts of the grid not desired are clipped out, and the remainder form the complete wiring of a telephone set.

Metal foil, either plain or paper-backed, may be used for stamping out the complete wiring for the electronic circuit. To avoid damaging the foil when complex circuits are stamped from thin metal sheets, the stamping may be carried out in two or more operations, using metal dies in parallel. High-frequency induction-heating methods may be used to solder leads to the foil.

2. Stamped Embossing

Radio set manufacturers are now employing spiral loop antennas die-stamped from a copper or aluminum sheet a few thousandths of an inch thick.⁶⁰ One design shown in Fig. 22 is formed by feeding into an automatic punch press a composition or plastic panel with the metal sheet over it. The press has a vertical reciprocating steel die with a continuous helical cutting edge. The latter is in the form of convolutions of gradually decreasing diameter. In a single stroke the die cuts the metal sheet and attaches it to the panel. The metal foil is coated on one side with a thermoplastic cement. The heated die sets the cement. The result is a combined antenna and back or housing for a receiver. The shape of the die is such that not only is the metal cut, but a cross section will show it to be arcuated and thus approximately a semicylindrical hollow conductor. The

⁶⁰ See Bibliography, reference 43.

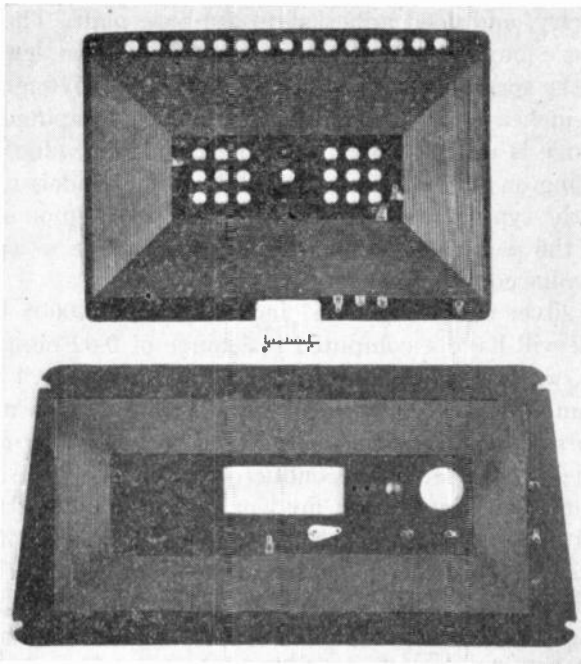

Fig. 22—Loop antennas stamped from single pieces of sheet copper onto insulated bases.

die may also be V- instead of arc-shaped. The severed edges are separated, leaving an air gap between the turns. This is shown in the close-up in Fig. 23. Pressed fiberboard, wood, plastic, lucite, and a wide variety of materials may be used for the supporting panel.

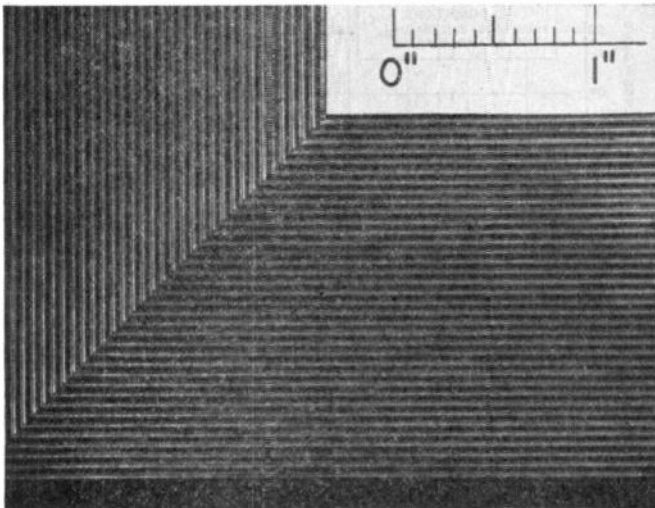

Fig. 23—Close-up of loop antenna stamped from a single sheet of copper.

Compared with the conventional solenoid or basket-weave types of loop antennas, this stamped-embossed design not only is more economical but has comparable or better electrical performance.⁶¹ For radio-receiver application, the usual insulation between turns is omitted, resulting in lower distributed capacitance and higher effective Q than the other types. The dielectric and loss factors of the panel material, of course, have an important effect on the Q , since the panel is situated in the

⁶¹ See Bibliography, reference 44.

field of the inductor. Not only antennas but high-frequency inductors, electrostatic shields, and similar electronic equipment may be manufactured by this process.

A similar development⁶² may be used for circuit wiring. A thin sheet of insulating material has a series of parallel conductors fastened to it by the stamping process described above. The other side has a similar series at right angles. The circuit is made by making connections through the plate at appropriate places by eyelets or pins. Tube sockets and components may be fastened in place by similar methods.

3. Hot Stamping

The hot-stamping process used in the marking of leather and plastic materials lends itself to the mechanization of electronic circuit manufacture. In this method a hot die, engraved with the pattern of the conductors, including inductors, is pressed onto the plastic with a thin sheet of gold, silver, or other conducting foil between the hot die and the plastic. The foil adheres to the plastic where the pressure and heat from the die have been applied, and can be brushed away at other places, leaving a pattern of conductors. Samples produced for the Bureau using gold foil were very satisfactory. The resistors may be applied in the same way, using resistor material deposited on a film of plastic previous to the hot-stamping operation. Since foils as thick as 0.002 inch may be used, very good electrical properties are obtained, particularly with inductors made by this method. Other components to complete the electronic circuit may be added by riveting, soldering, or spot welding.

It is possible to produce a strongly adhering metal film on rubber by placing metal foil (stamped in any desired configuration) in a mold with the rubber and vulcanizing.⁶³ When the foil is removed a layer of metal sulphide is left on the rubber, sharply defined by the foil contour. The surface is then treated with a reducing agent, such as by immersion in a copper-cyanide bath. Thus, the sulphide is converted to metal which may be used with or without plating. In place of the foil, silver-oxide paint may be painted or sprayed on the rubber through a stencil. It is reduced in the same manner after vulcanization.

VII. DUSTING

The dusting techniques lend themselves favorably to the printing of electronic circuits. Tungsten and molybdenum powder have been used to metallize ceramic bodies by dusting the powder and binder on the surface and firing. In electroplating nonconducting materials, metal powders have been used to form a conducting film for the plating. An initial layer of bonding material or adhesive ink holds the powder in place. It is applied with a rubber stamp or by similar printing means.⁶⁴

⁶² See Bibliography, reference 45.

⁶³ See Bibliography, reference 46.

⁶⁴ See Bibliography, reference 47.

To extend the technique to printed circuits, somewhat the same procedure is followed. A suitable bonding material is selected, such as shellac, wax, or any of the synthetic resins, dissolved in alcohol or benzine, and sprayed or painted onto the surface. A stencil bearing the circuit pattern is placed over it and leafed silver powder dusted on. A variation is to apply the bonding material, instead of the paint, through the stencil. The powder is sprinkled on after the stencil is removed and while the bonding surface remains somewhat tacky. The bonding film should be kept as thin as possible, consistent with absorbing enough metal to yield the desired conductivity. The unit is then subjected to a temperature which drives off the bonding material and fuses the metal to the plate. If the bonding material is mixed with the powder and applied, it must have enough of a gummy property to adhere to the surface and hold the metal powders in place.

Another way of dusting an electrical circuit onto a nonconducting surface is to sprinkle a thin layer of metal powder through a thin, nonflammable stencil. The metal is melted by flashing a flame over the stencil. Such a technique requires expert care in applying; hence its practicability may be limited.

An electrophotographic method has been developed⁶⁵ to hold the powder to the surface in the proper pattern prior to flashing. It is applicable to any of the usual nonconducting surfaces, including paper. The surface is first coated with a 1-mil layer of photoconductive material, such as sulfur or anthracene, and then placed under an electrostatic charging device. The electrostatic field introduces a charge on the photosensitive material. Exposure to light through a positive photograph of the circuit desired removes the charge from that portion of the photosensitive material illuminated and leaves an electrostatic latent image. A mixture of leafed silver powder and a binder dusted onto the surface adheres only to the charged image. Flashing with a flame melts the silver into place, completing the wiring.

If, after the silver is dusted over the plate, a paper sheet is placed on top and the combination inserted into another charging field, the paper attracts the metal powder and holds it securely until it is flashed permanently into place. As many as five copies can be made from one original. The process appears to adapt itself to the manufacture of printed-circuit decalcomanias. Photosensitive materials are available which hold their charge for as long as 500 hours and produce useful prints after that time. Although some work has been done in applying electrophotography to printing electronic circuits, practical details have yet to be worked out.

VIII. PERFORMANCE

1. Conductors

The principal desirable characteristics of the conductors are high conductance, adequate current-carrying

capacity, and good adhesion to the base plate. The resistance may be computed from the cross section, length, and the specific resistance of the material (0.626 microhm-inches at 20°C. for pure silver). The computed resistance is usually lower than the measured value, depending on the manner of application, the binders used, and the type of drying or firing. For silver fired on steatite, the measured resistance may be as much as twice the value computed for pure silver.

A silver conductor 0.062 inch wide and 0.0005 inch thick will have a computed resistance of 0.02 ohm per inch, which is equivalent to No. 36 copper wire.⁶⁶ The current-carrying capacity of such a conductor is more than sufficient for all currents used in low-power electronic circuits. A silver conductor 0.125 inch wide and about 0.0005 inch thick fired on steatite did not fuse until the current reached 18 amperes, while another 0.0625 inch wide carried 8 amperes for 9 minutes before fusing.

Fig. 24 shows a loading curve for a typical conductor on steatite having a length of 0.841 inch, a width of 0.041 inch, and an estimated thickness of 0.001 inch. Tests were made with the steatite plate in open air, without forced circulation. The current was allowed to flow for several hours at each value, or until no further increase in re-

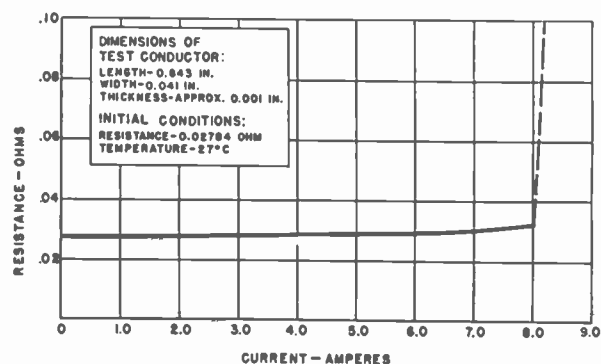

Fig. 24—Change in resistance with current of silver conductor fired on steatite.

sistance was observed. The conductor carried 8 amperes for several hours, showing an over-all increase in resistance of 15 per cent, but when the current was increased to 9 amperes it failed after 35 minutes. This conductor has a current-carrying capacity equivalent to a No. 32 copper wire. This performance shows the effect of the close thermal contact between the silver and the steatite base material and the increased radiating properties of the flat printed strip. For silver fired on steatite, the heat-dissipating ability together with the short over-all length of the printed conductors make them equivalent in performance to electronic circuits wired with conventional copper wire.

On plastic bases, where firing is not possible, the printed leads have a higher resistance. A lead 1 inch long and 5/64 inch wide showed a resistance of $\frac{1}{2}$ ohm and a current-carrying capacity of only $\frac{1}{2}$ ampere before

⁶⁵ See Bibliography, reference 48.

⁶⁶ Wire size numbers are A.W.G. (B & S).

the plastic base softened and the silver peeled off. Even this exceeds the currents usually flowing in low-power electronic circuits. However, since heating tends to loosen the bond between the deposited metal and the plastic base, an experimental determination of the current-carrying capacity should be made for each particular case. Lower and more consistent values of resistance are to be had simply by increasing the number of coats of paint or by plating.

In some cases, such as inductors which require a high Q value, the resistance of the conductor may not be low enough. It is quite practical to decrease the resistance to almost any desired value by electroplating silver or other metals over the conductor printed on the base material.

Conductor patterns made by the spraying or die-casting process have a large enough cross section so that their resistance will be low enough, even though the metal does not have as low a specific resistivity as pure silver or copper. This may not be true for certain types of sprayed or die-cast inductors, where, if high Q is required, it may be necessary to resort to silver plating. Circuits made by the die-stamping process, where materials such as silver or copper of thickness in the range 0.002 to 0.005 inch are used, produce inductors that are usually satisfactory without further processing.

2. Resistors

A. Load Characteristics

Among the principal factors affecting the power dissipated by a resistor are the paint mixture, the base material on which it is printed, and the surface area. The paint itself determines the maximum temperature to which the resistor may safely be raised; the composition of the base material, the area of the resistor and, to some extent, its color determine the rate at which the heat is conducted away. The close contact of the printed resistor with the base material, in the case of glass or ceramic, prevents local heating and gives the resistor better power dissipation than might be expected. Resistors painted on plastics tend to loosen from the base material on heating, and hence must be operated at lower power levels.

Intermittent load tests of 1000 hours duration were made on several $\frac{1}{2}$ -megohm resistors painted on steatite. The load was applied for 1.5 hours, then turned off for one-half hour, and the cycle repeated.⁶⁷ Commercial paint types⁶⁸ I and II were applied to make resistors 0.25×0.078 inch (area = 0.02 square inch). For paint type I and power loads of 0.10 and 0.15 watt, after 1000 hours of operation the resistance decreased 0.4 and 0.7 per cent, respectively; with resistors made of type II paint, the decrease was 10.0 and 12.0 per cent respectively. These tests illustrate the dependence of resistor performance on paint mix.

While no standard method of rating the printed resistors for power dissipation has yet been established, it is important that steps be taken to do this soon. Fig. 25 shows typical results of an intermittent load test using higher wattages than on the previous test and 100,000-ohm carbon resistors 0.002 inch thick and 0.038 square inch area (0.1×0.38 inch) painted on steatite. The re-

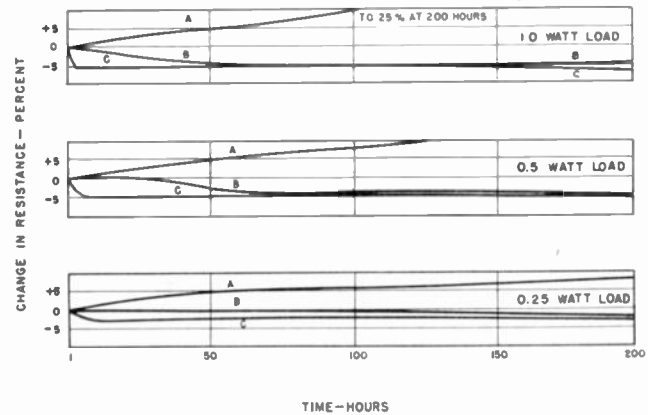

Fig. 25—Load tests on printed and commercial carbon resistors having a nominal value of 100,000 ohms. Printed resistors were 0.38 inch long, 0.10 inch wide, and 0.002 inch thick. Curve A is for a commercial 0.25-watt resistor, curve B is for a 0.5-watt resistor, and curve C for a printed resistor.

sistors were operated for 200 hours at loads of 0.25, 0.50, and 1 watt, respectively. As a control, commercial fixed composition 0.25- and 0.5-watt carbon resistors were also subjected to the same loads. The curves show clearly that the printed resistors perform very well compared to the commercial resistors. Although the resistance of the printed resistors decreases 3 to 5 per cent, it soon stabilizes at a constant value.

Typical results of another determination of power dissipation are shown in Fig. 26. Two 1500-ohm re-

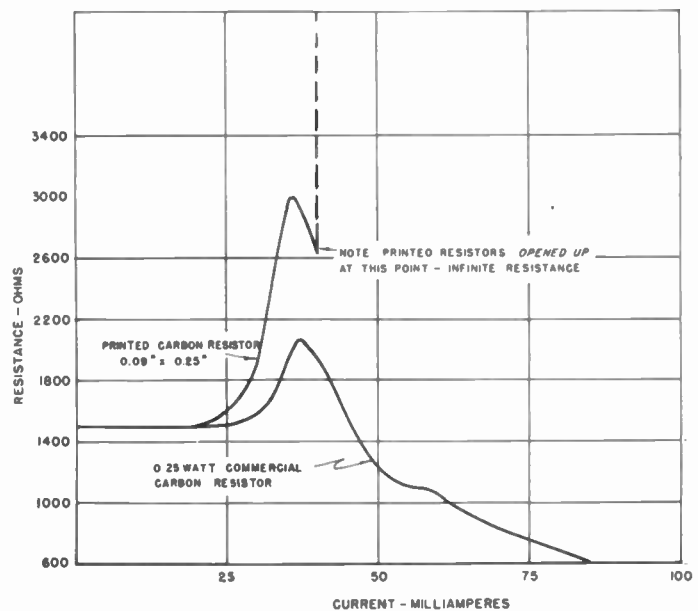

Fig. 26—Comparison of the current-carrying capacity of an average carbon resistor with a 0.25-watt commercial carbon resistor. Both are nominally 1500 ohms.

⁶⁷ See Bibliography, reference 49.

⁶⁸ Data supplied by Centralab Division, Globe-Union, Inc.

sistors, one printed and one 0.25-watt fixed composition, were subjected to increasing current until they failed. The current was increased in small steps and allowed to stabilize at each value before going to the next. Both resistors withstood 20 milliamperes (0.6 watt) before any effective change in resistance took place. Further increase in current caused both to increase in resistance rapidly, peaking at approximately 37 milliamperes and then decreasing. This increased current apparently causes a change in some of the constituents of the resistors. It is important to note that the printed resistor opened on excess current, whereas the fixed composition resistor decreased in value. The opening of the printed resistor under excess load may be a desirable property as it will not sustain heavy overload currents with the consequent damaging of other parts of the circuit. The conclusion to be reached from these tests is that printed resistors compare favorably under load with those of the commercial fixed composition type.

Since the size of the printed resistors is not standard, it is not practical to specify power rating in terms of watts per resistor. It can be specified as watts per square inch of area exposed to the air. In the first of the two tests reported above, an area of 0.038 square inch dissipated 1 watt, giving a dissipation factor of 26 watts per square inch, while in the second test an area of 0.023 square inch dissipated 0.6 watt, giving the same dissipation factor. This factor has been considered representative of average performance.

Allowing a reasonable factor of safety, the carbon resistors described above may be rated at 10 watts per square inch. A 0.25-watt resistor will then occupy an area of 0.025 square inch, and may be printed on a strip 0.1 wide by 0.25 inch long. A strip 0.1 inch wide will have a power rating equal to its length in inches. This power rating cannot be applied generally to all types of printed resistors. Ratings of other types of printed resistors will depend on the several factors outlined earlier.

B. Noise Characteristics

Comparative noise measurements were made⁶⁸ between 1-megohm resistors printed on steatite and the quietest of the commercial, fixed composition, cylindrical 0.5-watt carbon resistors. The test was made by applying a 45-volt d.c. bias to the resistor and measuring the noise voltage. Using the commercial resistor as a reference, the noise level of two painted resistors made with the commercial paint formula, type I, was found to be +3 and +5 db for resistors 0.375×0.094 inch and, 0.25×0.078 inch, respectively. When the paint formula was altered to type II, the noise level of the 0.25×0.078 inch resistor increased from +5db to +35 db, illustrating the need for careful formulation when quiet resistors are desired. These results are typical for these resistor paints. Type I paints may be used in hearing aids and other circuits of high gain level. Type II is satisfactory for low-gain amplifiers and electronic control units.

C. Temperature Characteristics

The selection of a good resistance formula requires careful attention to the character, quality, and quantity of the ingredients. An example of the variations in behavior to be expected is shown by curve *B* in Fig. 27, obtained from resistors made with the formula 12.5 per

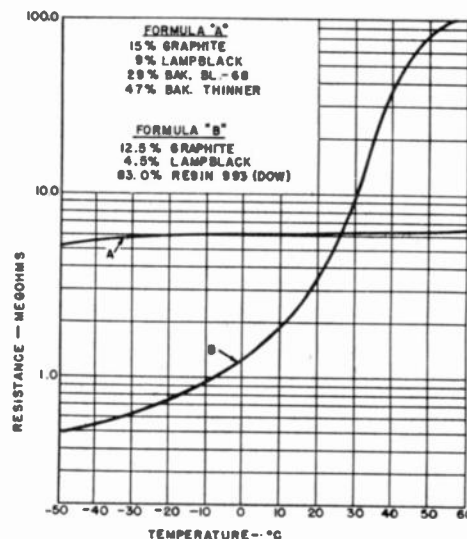

Fig. 27—Effect of composition on the resistance versus temperature characteristics of printed resistors.

cent colloidal graphite, 4.5 per cent lampblack, and 83 per cent Dow resin 993. The wide variation on the same temperature-cycling exposure may or may not be considered desirable, depending on the application. Where normally a flat temperature characteristic is desired, the shaped response of formula *B* might be very useful in compensating against a negative temperature response caused by other elements in the circuit. It also serves as an excellent temperature-indicating element over the range plotted, and may find use in devices such as the radiosonde. The resistance-temperature characteristics

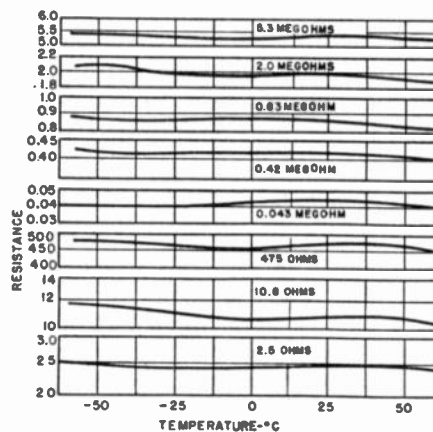

Fig. 28—Resistance versus temperature characteristics of printed resistors.

for a wide range of production-line resistors printed on steatite are shown in Fig. 28. Over the extreme temperature range plotted, the maximum variation in resistance from the average is seen to be of the order of ± 5 per cent.

Any particular formulation must be checked for its ability to adhere to the base material. This is usually done by temperature-cycling tests. If the conductor and resistor paints still adhere after several temperature cycles over a range exceeding that to be encountered in practice, they may be considered satisfactory.

3. Capacitors

The aging of titanium-oxide ceramic capacitors generally follows an exponential relation between time and capacitance. The constants depend on the particular material used for the dielectric. The temperature coefficient of these capacitors must be carefully chosen for the particular application. Some of the higher-dielectric-constant materials display peaks in their temperature versus capacitance curve. These peaks may change the value of the capacitor by a factor of 5 or 10, and may be very sharp. They can often be shifted to different temperature regions by a change in composition. These characteristics may be used in providing temperature compensation for circuits, where required. A variety of slopes are available by properly choosing the composition. Typical temperature versus capacitance curves are shown in Fig. 29, while a sharper-peaked curve of the type used for temperature compensation is shown

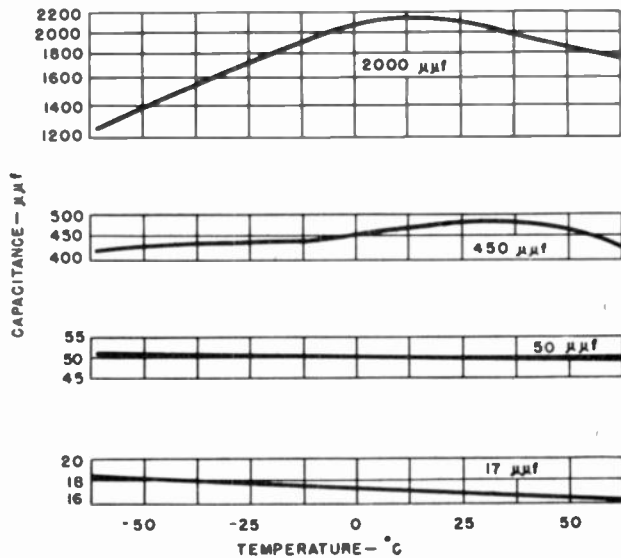

Fig. 29—Capacitance versus temperature characteristics of ceramic-disk capacitors.

in the dielectric-constant versus temperature curve of Fig. 30. In case the characteristics of a single capacitor are not satisfactory, several units having peaks at different temperatures may be connected in parallel, so that the combined effect is the one desired.

Since the ceramic materials in these capacitors are not hygroscopic, there should be no particularly adverse humidity effects, even in the unprotected state. The effects of humidity and fungus may be reduced by a wax dipping or lacquer.

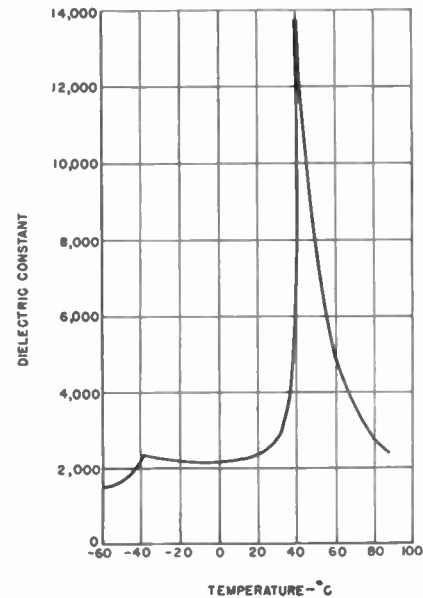

Fig. 30—An example of the sharp peaks in the dielectric-constant versus temperature characteristics of very-high-dielectric-constant ceramic capacitors.

The dissipation factor also may vary through wide limits over the usual temperature range. The losses are higher for the capacitors using the higher-dielectric-constant materials, and for that reason they are not always suitable for all applications. Q values between 400 and 10,000 are typical. The d.c. resistance (insulation resistance) is closely associated with the dissipation factor. In cases where high insulation resistance is necessary, such as grid coupling capacitors, the ceramic capacitors should be checked prior to use. The voltage rating is higher on ceramic capacitors than on small units of most other types, so that, for printed-circuit applications, capacitors of the usual thickness, 0.02 to 0.04 inch, have a working voltage of 300 to 600 volts d.c. Capacitors in the ranges from 7 to 10,000 μmf are readily manufactured to tolerances of ± 5 , ± 10 , and ± 20 per cent.

4. Inductors

A. Temperature Characteristics

Inductors having thin metallic lines on a ceramic form show very small variations in inductance with temperature. The fused-on coating, being thin and somewhat elastic, does not tear away from the ceramic surface when subjected to extreme temperature cycling. This is true though even the thermal-expansion coefficient of the metal is greater than that of the ceramic. For all practical purposes, a combination of metal on ceramic behaves as though the expansion were due to the ceramic alone.

Inductors of this type are reported to have been produced in quantity in Germany.

B. Loss Characteristics

The design of oscillators usually requires a high value of Q in the tank-circuit inductor. Printed inductors for

oscillators, therefore, are often plated to yield high Q . A spiral inductor made of silver lines 0.03 inch wide and 0.0003 inch thick printed on steatite had a Q of 25. Electroplating the inductor to a thickness of 0.001 inch increased the Q to 125. Silver inductors painted on fused quartz were also developed during the war for the Signal Corps. These inductors, spirals on a flat surface, had a Q of 80 after firing. The Q was increased to between 150 and 200 by electroplating. Where inductors are printed on glass or ceramic tubes and the conductor built up by electroplating to a thick layer, Q 's of 175 to 200 are not hard to obtain.⁶⁹ Since the metal parts of the vacuum tube are located inside the inductor, the Q of inductors painted on tube envelopes is actually lower than this.

In special cases, the Q of a solenoidal inductor on a ceramic form has been increased by grinding away the ceramic material between the conductors, leaving practically an air-core inductor which is supported by a ceramic material having a low coefficient of thermal expansion. When used in an oscillator in combination with a capacitor having a negative temperature coefficient equal to the small positive coefficient of the ceramic inductor, a frequency stability approaching that of quartz crystals was obtained.

Like spiral inductors, the inductance of solenoidal inductors may be increased by painting magnetic paint between the conductors or on the inside and outside of the solenoid.

The distributed capacitance of these inductors is relatively large, and depends on the spacing between turns, the thickness of the conductor, and the dielectric constant of the base material.

C. Tuning Adjustment

The tuning or factory adjustment of spiral inductors can be accomplished in several ways. A metallic plate brought into close proximity to the inductor will change its inductance. In one case an inductor having an inductance of 0.22 microhenries was reduced to 0.12 microhenries when a thick brass plate having an area of 30 per cent of that of the inductor was moved within 0.1 inch of the inductor. The Q dropped from 100 to 50.

A powdered-metal screw in the center of the inductor may be used for tuning. This works well as a means of increasing the mutual coupling between two plane-spiral inductors painted one above the other. Another expedient is a mechanical contact arm which makes contact over the last turn of the inductor.

A magnetic powder may be painted over the inductor or an intertwined spiral of magnetic paint located between the turns of the inductor. Adjustment is made by scraping off the required amount of magnetic material to reduce the inductance to the desired value.

It is evident that the above tuning methods reduce the Q of the inductor when used to produce large changes

in inductance. They should be used only when small adjustments are necessary, and when some loss of Q may be tolerated.

5. Printed Assemblies

A. Temperature Characteristics

The temperature performance of printed amplifiers has been studied, and reveals some interesting possibilities in correcting adverse temperature characteristics. The average-gain versus temperature and peak-frequency versus temperature curves of a group of printed amplifiers employing disk capacitors are shown in Fig. 31. Note the rise followed by a rapid drop as the tem-

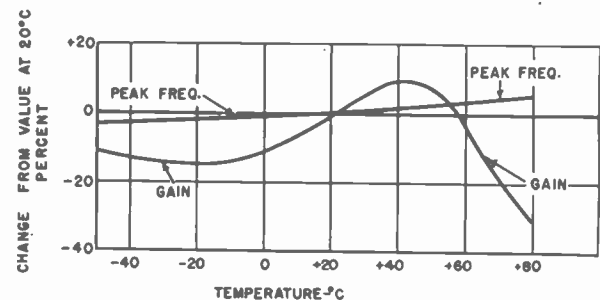

Fig. 31—Change in peak frequency and gain with temperature of a printed amplifier on a steatite plate.

perature is increased. For comparison, an amplifier made up of standard (not printed) components is shown in Fig. 32. It is evident that some temperature compensation has already been obtained by printing the ampli-

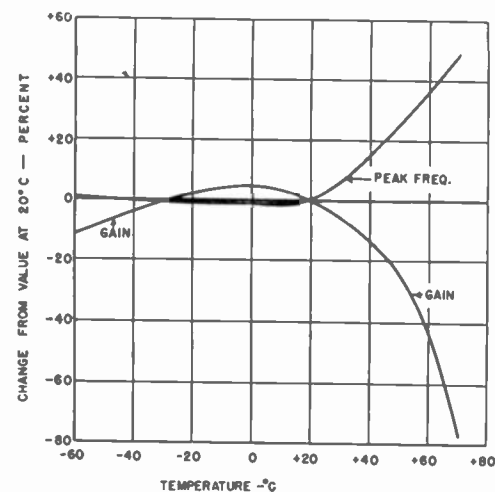

Fig. 32—Change in peak frequency and gain with temperature of an amplifier constructed with standard miniature components.

fier. A study of the temperature coefficient of the coupling and output capacitors led to the choice of dielectrics with special temperature characteristics, with the result shown in Fig. 33, in which the gain curve is boosted at high temperatures as desired, and straightened out without seriously affecting the peak-frequency curve.

⁶⁹ See Bibliography, reference 50.

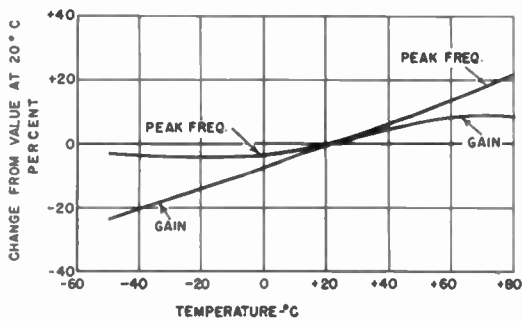

Fig. 33—Peak-frequency and gain characteristics of a corrected printed amplifier.

B. Aging Characteristics

The aging of audio amplifiers printed on steatite plates was studied over a period of 75 days.⁶⁸ The units tested had essentially an inverted V-shaped gain versus frequency characteristic, making it possible to study not only the change in peak amplification with time, but also the change in the frequency of peak amplification. The results shown in Fig. 34 are the average of eight units tested. The total decrease in peak amplification

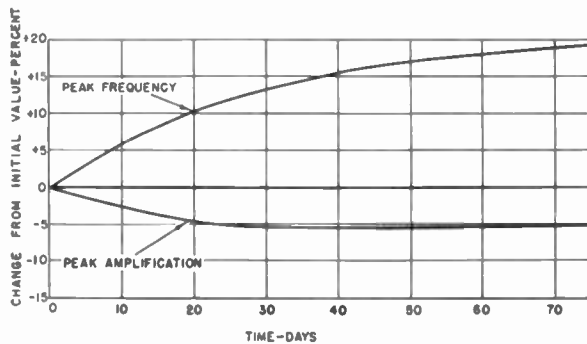

Fig. 34—Age characteristics of a printed amplifier.

over this period was 6 per cent, while the peak frequency drifted upwards 19 per cent. Most of the change occurred in the first 25 days. This is considered good performance, since it includes the aging effects not only of the printed wiring and resistors but of the capacitors (ceramic type), the subminiature tubes, and the steatite base plate.

IX. APPLICATIONS

Experimentation at the National Bureau of Standards has proved the practicability of applying the new methods to the manufacture of radio and electronic equipment. Several types of amplifiers, special electronic sets, and small radio transmitters and receivers made in the Bureau's laboratories have shown performance qualities comparable to equipment built along conventional lines, as well as improved miniaturization and ruggedness. Complete circuits may now be printed not only on flat surfaces but on cylinders surrounding a radio tube or on the tube envelope itself.

Now actively being developed by various laboratories are printed circuits for electronic controls using gas-filled tubes, electronic units for hearing aids, i.f. strips

for radar and u.h.f. equipment, subminiature portable radio transceivers, electronic circuits for business machines, electronic switching, and recording equipment, including telephone apparatus and devices such as the radiosonde. Other activity includes manufacture of special components such as antennas, interstage-coupling units, microwave components, shields, etc., and the printing of graphs with conducting lines over which contacting arms move to select answers to functions of one or more independent variables.

1. Amplifiers and Subassemblies

Several steatite plates with circuits printed on them are shown in Fig. 35. This illustrates to a small extent the variety of shapes and figures to which the process is adaptable. All but the cylindrical amplifier in the lower left corner were applied with stenciled screens. The cylindrical unit was painted with a brush. The resistors

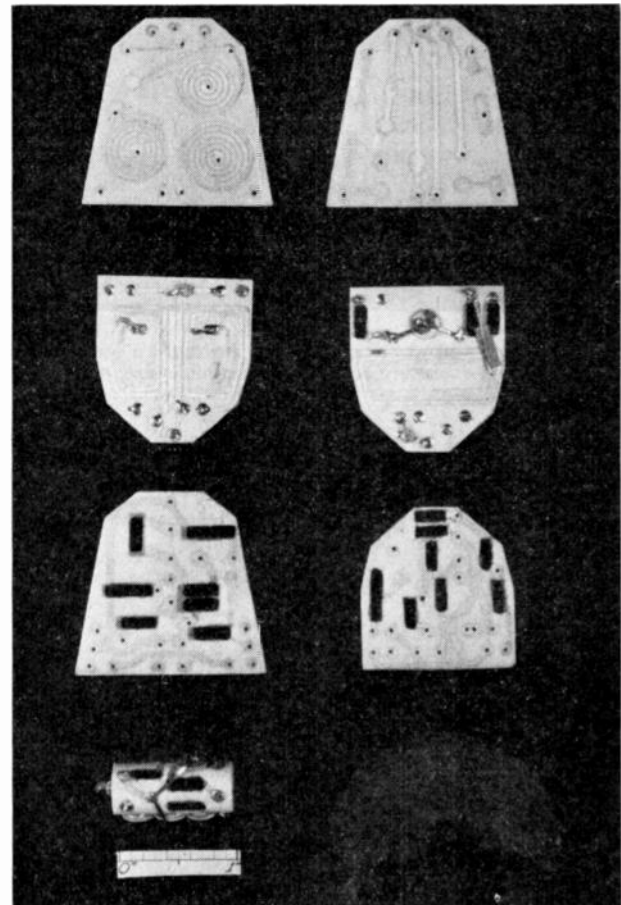

Fig. 35—Circuits printed on steatite plates or steatite cylinder. Light lines are silver conductors and inductors; dark rectangles are resistors; circular disks are ceramic capacitors.

(black rectangles) bear coats of protective lacquer. Note the circular and rectangular spiral inductors. The pair second from the top are the front and back sides of a plate for an oscillator unit. Note that the horizontal rectangular spiral inductor (on the right) is coupled to the two vertical rectangular spirals (on the left) through the ceramic plate. These are the plate, grid, and antenna

coupling inductors of a short-wave transmitter. The plates illustrate methods of attaching foil strips to the disk capacitors, and some examples of how crossovers are accomplished in the wiring. Five completed printed assemblies are shown in Fig. 36. Subminiature tubes are used. The two-stage resistance-coupled amplifier of Fig. 2 is printed on a thin steatite plate 1.5 inches wide and 2 inches long. Both the silver circuit wiring and graphite resistors were printed, using stencils and a squeegee. This unit employs a pair of CK-505AX subminiature voltage-amplifier pentodes.⁷⁰

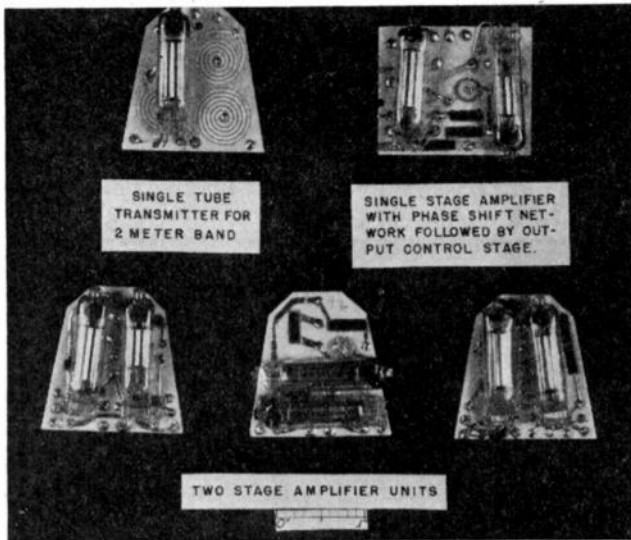

Fig. 36—Examples of electronic circuits printed on steatite plates by the stenciled-screen process. To minimize size, subminiature tubes are employed.

Fig. 37 shows a two-stage amplifier painted on the envelope of a miniature 6J6 tube. This is a complete unit

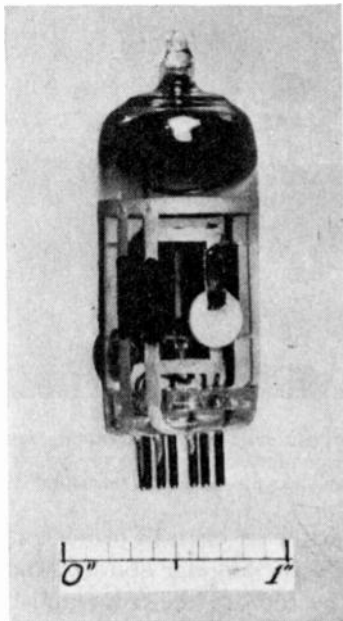

Fig. 37—A two-stage amplifier painted on the glass envelope of a twin-triode miniature vacuum tube (type 6J6) using the stenciled-screen process.

⁷⁰ See Bibliography, reference 51.

requiring only plugging into a power supply to operate. The circuit wiring was applied with a stencil wrapped around the tube. The developed stencil and wiring arrangement are shown in Fig. 38. For painting circuits on tube envelopes, paints are used that do not require baking at extremely high temperatures to drive out binder and solvents. In this way tube performance is not deteriorated by gases which may be released from its metal parts by the heat. The circuit may be applied to the tube envelope either before or after the tube elements are in place. A glass tube was employed in the unit of Fig. 37, although a metal tube might have been used after first coating the metal envelope with a layer of lacquer or other insulating material. A tube with a ceramic envelope may be used.

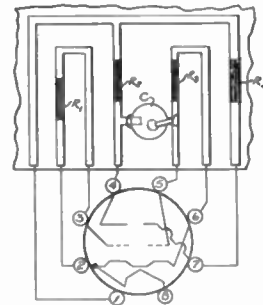
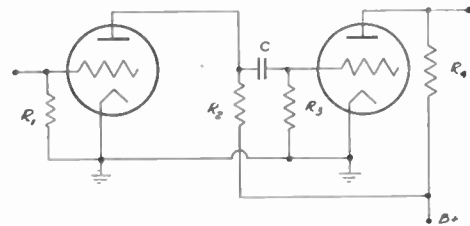

Fig. 38—Circuit diagram and developed stencil for the two-stage amplifier of Fig. 37.

Lead wires from the circuit to the tube prongs are painted on with a brush. Leads may also be soldered to points on the tube envelope itself, ribbon-type leads usually being employed. Lead crossovers are to be avoided in the printing. When this is impossible, crossovers on glass may be made by painting a thin layer of insulating lacquer over the lead to be crossed and, when the lacquer has dried, painting the crossover lead on top of it. Another method is to place or cement a thin insulated strip, such as scotch tape, over the lead and run a foil strip or ribbon over it. The crossover ribbon is connected to the circuit by a drop of silver paint or solder at its ends (see Fig. 35, unit second from top, at right). The wiring of the unit of Fig. 37 was accomplished without crossovers.

The idea can be applied to any nonconducting surface. Thus, electric circuits can be printed on the ceramic covers of electric components such as the normal type of i.f. inductor cases, or on the inside of the plastic

cabinet of a radio, or other piece of radio or electronic equipment. Another suggestion of perhaps limited practicability is that special radio and electronic circuits may be printed on flexible or nonflexible sheets, such as the page of a magazine, and issued periodically in the same manner as crossword puzzles. Eyelets would be placed on the pages at appropriate points to which radio tubes, speaker, power supply, and other components may be soldered to complete the circuit. These circuits might be useful to experimenters, provided the currents used are small.

Fig. 39 shows an amplifier printed by one manufacturer as a unit suitable for a hearing aid.⁷¹ It is a three-stage amplifier with a gain of 10,000. Included are a miniature volume control and especially designed clips

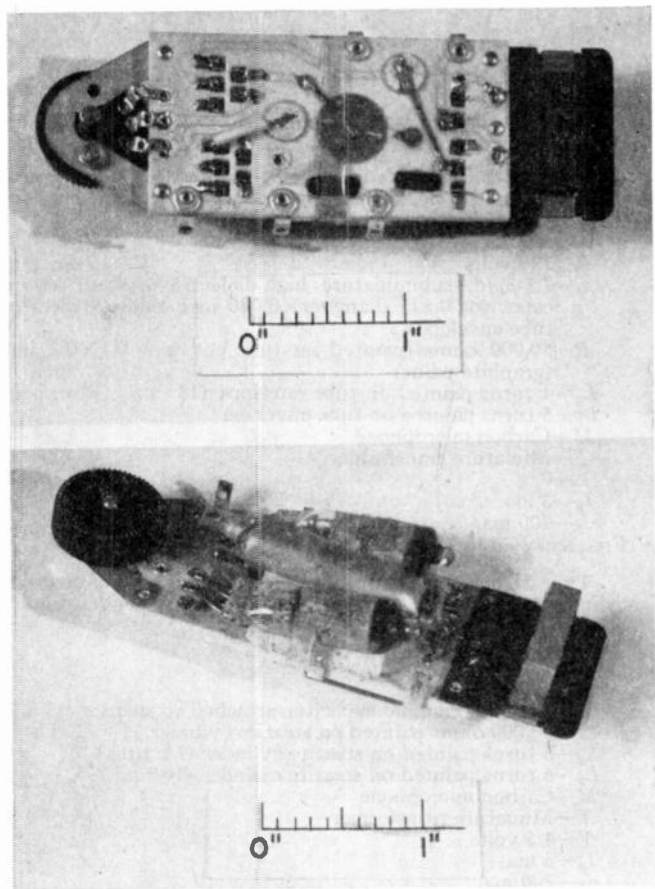

Fig. 39—Hearing-aid-type amplifier printed on a ceramic plate.

to hold the subminiature tubes. It was printed on a ceramic plate by the stenciled-screen process. The single-stage amplifiers of Fig. 6 were also made by this process.

One manufacturer has placed on the market a variety of printed coupling circuits in which the dielectric material⁷² for the capacitors is the base plate itself. Conductors and capacitors are printed in the same stenciling operation. The result is an unusually compact unit.

⁷¹ Several hearing-aid companies are developing subminiature hearing aids with printed circuits. One hearing-aid manufacturer has scheduled production of printed sets.

⁷² The dielectric constant of the base plates may be as high as 90,000.

Even when entirely coated with a protective plastic cover, the units are only approximately 0.06 inch thick. A diode filter circuit consisting of a resistor and two capacitors is 0.19 inch wide and 0.5 inch long. Other units, such as audio coupling circuits and a.c.-d.c. radio sub-assemblies consisting of three resistors and three capacitors, are 0.5 inch wide and 1.0 inch long.

2. Transmitters and Receivers

Figs. 40, 41, and 42 show a number of radio transmitters and receivers produced by the printed-circuit technique. Designed to operate in the band 132 to 144 Mc., these examples illustrate only a few of the wide number of variations possible in printing circuits.⁷³ Silver and carbon paints were used to make the sets.

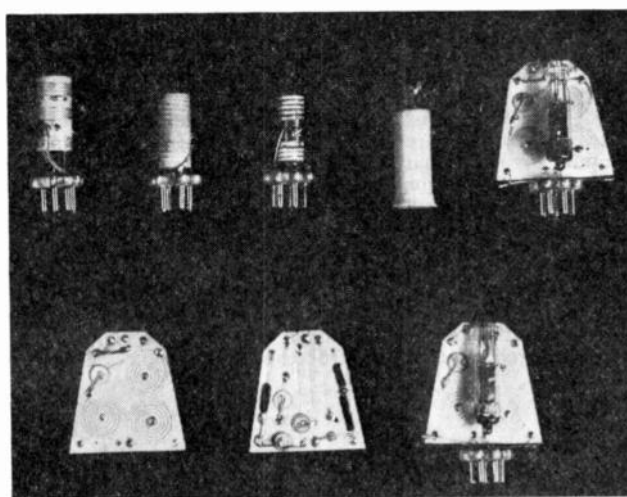

Fig. 40—Top row: Five types of subminiature 132-to-144-Mc. radio transmitters, utilizing printed-circuit techniques. All types are grid-modulated and require only connection to a microphone and battery to operate. The oscillator circuits of the two units at the left are printed on the outer surface of a thin steatite cylinder housing the subminiature tube. The circuit of the unit at center is painted on the glass envelope of a 6K4 subminiature triode $\frac{3}{8}$ inch in diameter and $1\frac{1}{2}$ inches long. The transmitter second from the right is painted on the glass envelope of a T-2 tube measuring $\frac{1}{2}$ inch in diameter and 1 inch in length. The circuit of the transmitter at the extreme right is painted on a $3/32$ -inch steatite plate, 1.5 inches wide, and the same in length.

Bottom row: Developmental stage of a steatite-plate transmitter. The plate at the left carries three silvered spiral inductors and a single high-dielectric-constant ceramic capacitor. The reverse side of the plate (center) shows the silver wiring, three (black rectangular) resistors, and four circular ceramic capacitors. Next is the complete transmitter with subminiature tube and battery plug-in added.

The five types of transmitters shown in the upper half of Fig. 40 are single-tube grid-modulated units and require only connection to modulator and battery to operate. Electrical circuit diagrams for the transmitters, together with design details, are shown in Figs. 43 and 44. In the two units at the upper left of Fig. 40 the oscillator circuit is printed on the outer surface of a thin steatite cylinder. The tube is inserted within the cylinder and the combination wired to a battery plug. A close-up view of this unit is shown at the right in Fig. 45.

⁷³ See Bibliography, references 52, 53, 54, and 55.

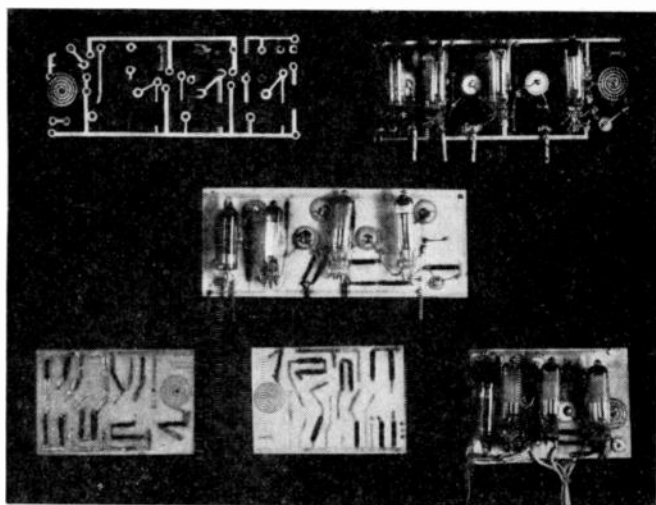

Fig. 41—Top row: Four-tube radio receiver printed on a $3/32$ -inch lucite plate, 2 inches wide and 5 inches long. The silver circuit wiring (applied through a stencil) is shown on the plate at the left, with the completed receiver at the right. Battery and speaker are omitted.

Center row: Four-tube radio receiver unit printed on a thin steatite plate. All receivers have four stages, consisting of an input stage of square-law detection followed by two stages of pentode amplification and a triode output stage feeding a permanent-magnet-type speaker.

Bottom row: Two developmental stages of a four-tube radio receiver printed on a thin steatite plate, 2 inches wide and 3 inches long. The plate at the left shows a complete circuit wiring (less tubes and capacitors) applied free hand with a camel's-hair brush, except for the spiral inductors. Wiring on the center plate was applied with a squeegee through silk-screen stencils. The leads from the complete receiver at the right are for a battery and speaker.

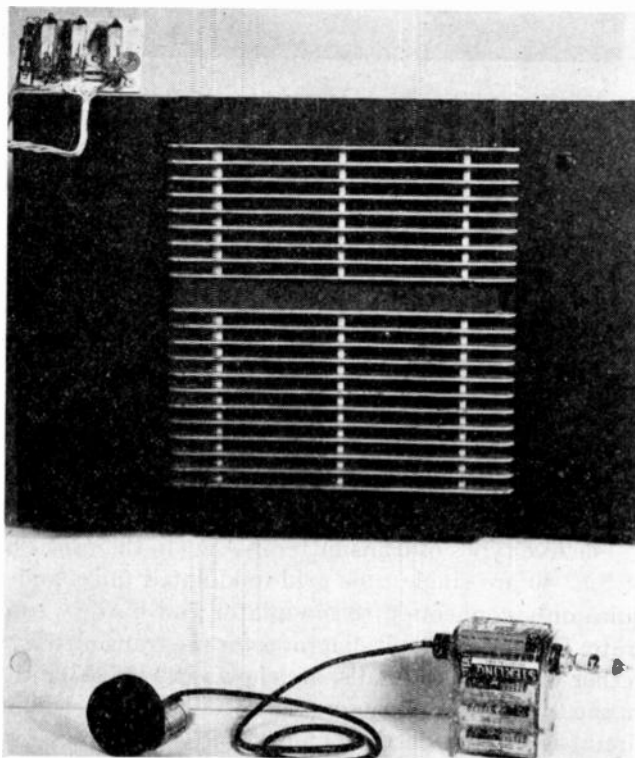

Fig. 42—Subminiature printed transmitter and receiver. The 2×3 -inch printed receiver (top) has sufficient power to operate the standard 10-inch console speaker. The transmitter assembly (below) consists of a power pack with the tube transmitter and microphone cable plugged into opposite sides.

The unit in the top center of Fig. 40 is a transmitter with the circuit painted on the envelope of the subminiature tube, a 6K4. It was made by first wrapping a stencil of the inductor pattern around the tube, using masking tape. The glass envelope was then etched in fumes of hydrofluoric acid. After etching, the hydrofluoric acid was neutralized with strong caustic-soda so-

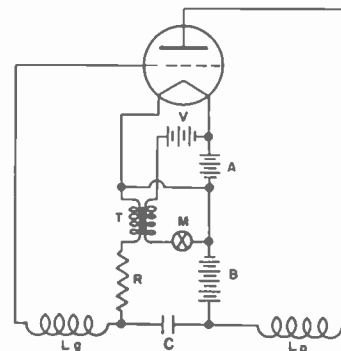

Fig. 43—Circuit diagram and design data for two types of subminiature printed transmitters.

Type I has the electronic circuit painted on glass envelope of a miniature triode, and has the following circuit constants:

Tube—6K4 Sylvania subminiature triode

A—6 volts

B—120 volts

C— $7.5\text{-}\mu\text{fd.}$ subminiature high-dielectric-constant ceramic capacitor 0.125 diameter \times 0.030 inch thick, attached to tube envelope

R—50,000 ohms (painted on tube envelope 0.1×0.3 inch) (graphite paint)

L_g —4 turns painted on tube envelope (15 t.p.i.) (silver paint)

L_p —5 turns painted on tube envelope

M—Carbon microphone

T—Miniature transformer

V—0

I_p —3 ma.

I_f —200 ma.

Freq uency—136 Mc.

Type II has the electronic circuit painted on a thin steatite cylinder with a subminiature tube inside the cylinder, and has the following circuit constants:

Tube—Raytheon subminiature triode

A—1.5 volts

B—120 volts

C— $7.5\text{-}\mu\text{fd.}$ ceramic capacitor attached to steatite cylinder*

R—50,000 ohms painted on steatite cylinder

L_g —3 turns painted on steatite cylinder (16 t.p.i.)

L_p —6 turns painted on steatite cylinder (16 t.p.i.)

M—Carbon microphone

T—Miniature transformer

V—4.5 volts

I_p —3 ma.

I_f —200 ma.

Frequency—116 Mc.

* Cylinder is 1-inch long, 0.5-inch o. d., 0.03-inch wall thickness.

lution, and the envelope washed thoroughly with soap and water and rinsed in distilled water. The conducting paint (Sauereisen Conductalute) was applied to the etched surface and allowed to dry in the air. To improve the Q of the inductor, it was silver-plated in a silver-cyanide bath by applying a current of 0.2 ampere for 15 minutes, depositing a layer approximately 0.003 inch thick.⁷⁴ The grid-leak resistor was painted on using car-

⁷⁴ Where strong adhesion is desired, it has been found advantageous to copper-plate over the initial painted inductors prior to silver-plating. A simple copper-sulfate bath may be used. Plating at 4 amperes for about $\frac{1}{2}$ minute will deposit approximately 0.0005 inch of copper film.

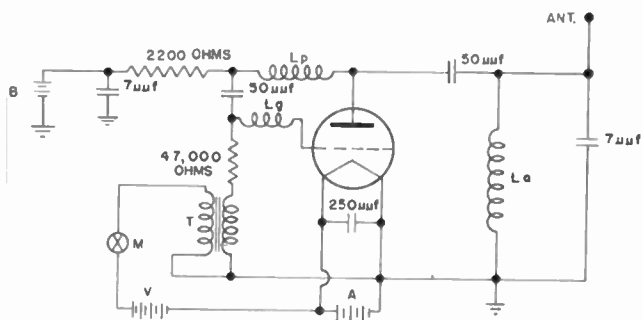

Fig. 44—Circuit diagram and design data for a subminiature radio transmitter painted on a flat steatite plate.

Tube—Raytheon subminiature triode

- A—1.5 volts
- B—120 volts

L_p — $4\frac{3}{4}$ turns, spiral wound on steatite plate, 7/16 inch o.d.

L_g — $4\frac{3}{4}$ turns, spiral wound on steatite plate, 7/16 inch o.d.

L_r — $5\frac{1}{2}$ turns, spiral wound on steatite plate, 5/8 inch o.d.

M—Carbon microphone

T—Miniature transformer

V—4.5 volts

I_p —3 ma.

I_f —200 ma.

Frequency—140 Mc.

Capacitors are of the ceramic-disk type attached to the steatite plate. Resistors are painted on the steatite plate.

bon paint and dried at a temperature of 50°C. under an infrared lamp. The addition of a tiny high-dielectric ceramic capacitor completed the circuit on the tube envelope.

The circuit for the unit second from the top right in Fig. 40 is painted on the glass envelope of a T-2 tube measuring $\frac{1}{4}$ inch in diameter and 1 inch in length. The silver inductors were applied with a ruling pen mounted on a lathe, with the tube held in the chuck and rotated by hand. Samples of this work are shown in Fig. 46. Both tube and circuit have been coated with a thin layer of plastic cement to protect against rough handling and

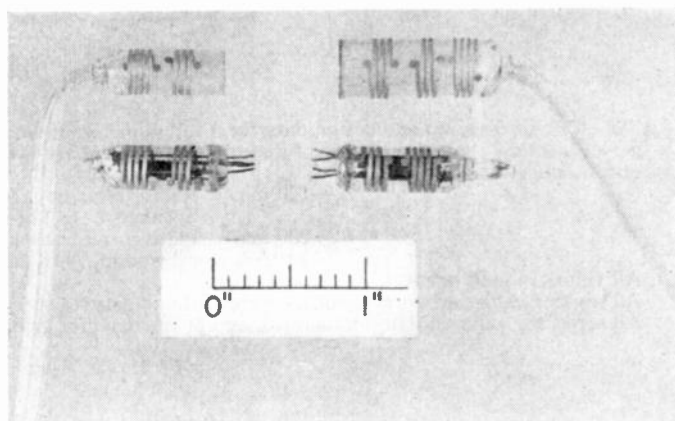

Fig. 46—Examples of inductors applied to glass tube envelopes with ruling pen and lathe.

humidity. A close-up of the tube and circuit is shown at the left in Fig. 45. The wiring diagram is in Fig. 43. The manner in which the leads are brought out from the circuit to the batteries, microphone, and antenna is illustrated in Fig. 47. The unit is housed in a small plastic container.

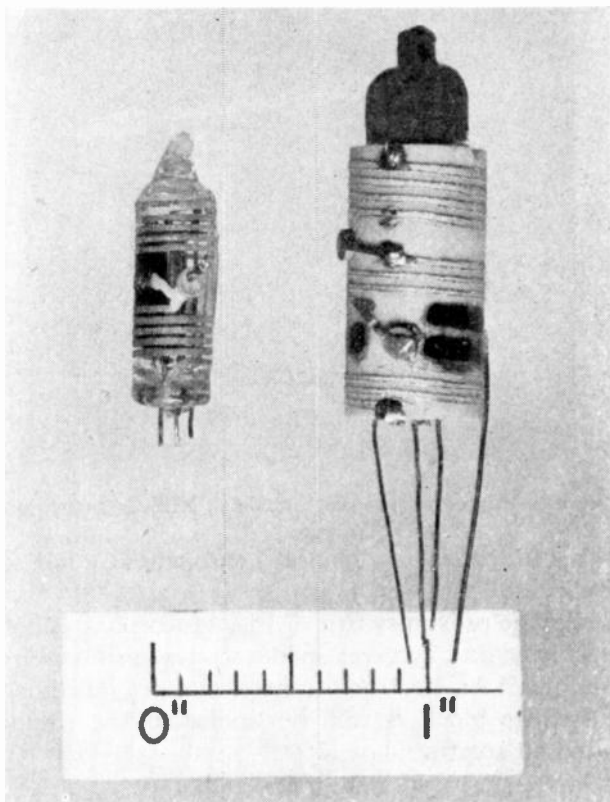

Fig. 45—Close-up view of printed transmitters. Left, circuit painted on the glass envelope of a subminiature tube using ceramic disk capacitor; right, circuit on a thin ceramic cylinder housing a subminiature triode.

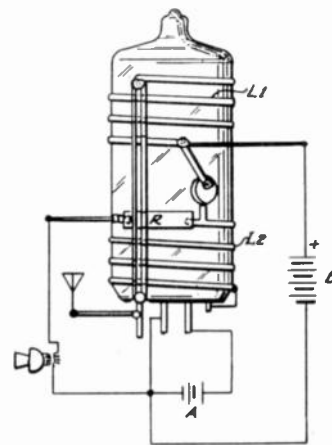

Fig. 47—Schematic arrangement of the transmitter shown at the left of Fig. 45.

The circuit of the transmitter at the right in Fig. 40 was stenciled on a $\frac{3}{32}$ -inch steatite plate 1.5 inches wide and the same in length. The circuit for this transmitter is that of Fig. 44. The development of the flat-plate transmitter (both sides) is shown at the bottom of Fig. 40. The top side carries the three spiral inductors and a 50- μ fd. coupling capacitor. The bottom side bears the remainder of the circuit wiring, including three resistors (the dark rectangles) and four capacitors. One of the re-

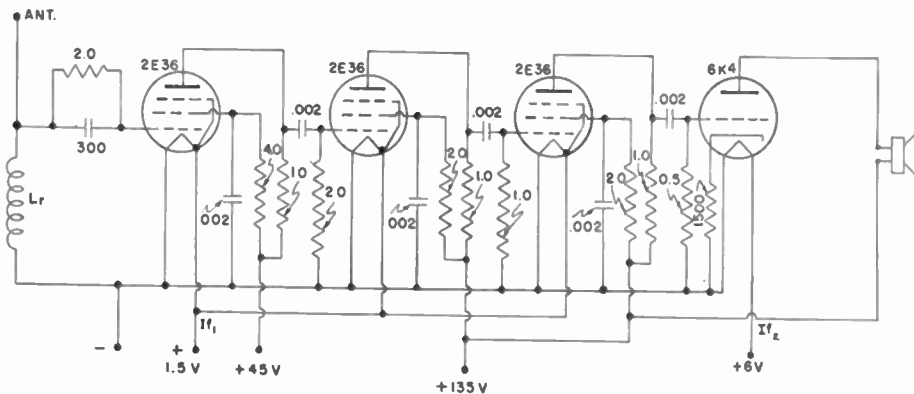

Fig. 48—Circuit diagram and design data for a subminiature radio receiver printed on a thin plate, 2 inches wide and 3 inches long. The receiver has four stages consisting of an input stage of square-law detection followed by two stages of pentode amplification and a triode output stage.

I_{f1} —120 ma. Radio frequency, 140 Mc.
 Speaker, 6- to 12-inch diameter p.m. or miniature magnetic
 I_{f2} —200 ma. Plate current through speaker, 2.5 ma.
 L_r , $4\frac{1}{2}$ turns, spiral wound, 7/16 inches

All values in μmfd or megohms

All resistor values are in megohms, except cathode-bias resistor, which is 1500 ohms.

All capacitor values are in microfarads, except the detector grid capacitor, which is 300 μmfd .

sistors, though not shown in the circuit diagram, is connected to the grid inductor. It serves as a blocking resistor for measuring the oscillator grid voltage. Wiring of the units was completed by soldering the subminiature tubes and leads for the antenna, batteries, and microphone directly to the silver wiring on the steatite plate.

The receivers shown in Fig. 41 are all wired with the circuit of Fig. 48. Two of the units are on steatite plates 2×3 inches and 2×5 inches (bottom and center, respectively), while the third is on a 2×5 -inch lucite plate. They employ a square-law detector stage followed by two stages of pentode amplification, and a triode output stage feeding the loudspeaker. The input tuning is broad so as to allow reception over the complete band of 132 to 144 Mc. All but the unit in the lower left-hand corner were made by the stenciled-screen process. The circuit of the other, with the exception of the spiral inductor, was painted on with a camel-hair brush. The spiral inductors have all been silver-plated. As silver plating is relatively easy, it was found convenient to plate all wiring on the base in the same operation at a rate of 0.2 ampere for 15 minutes in a silver-cyanide bath. After the resistors were applied through a stencil and the capacitors soldered to eyelets in the lucite plate, the complete surface was coated with a thin layer of lucite cement for protection against humidity and other effects.

Standard miniature microphones, speakers, and batteries complete the operating units. The units also operate satisfactorily with standard large-size microphones or speakers. The transmitter of Fig. 41 is plugged into a power pack, while the standard-size carbon microphone with matching transformer is plugged into the other end. The 2×3 -inch receiver, Fig. 42, mounted on the 10-inch console speaker has sufficient power to operate the



Fig. 49—Printed plug-in unit encased in NBS Casting Resin.

speaker so that it may be heard throughout a fair-sized auditorium.⁷⁵

The radio proximity fuze of Fig. 1 incorporates both a transmitter and receiver made by the printed-circuit technique.⁷⁶ An electronic control circuit is included in the steatite block *B*; the remainder of the circuit is printed on steatite plate *A*.

⁷⁵ Personal transceivers incorporating printed circuits are being engineered and may shortly appear on the market. One manufacturer has designed them for the proposed Citizens Communication Band, 460 to 470 Mc.

⁷⁶ See Bibliography, reference 55.

3. Printed Plug-in Units

The ease of replacing defective printed subassemblies in an installation introduces new possibilities in manufacture and maintenance particularly applicable to complex equipment and to rural and foreign markets, where maintenance is a difficult problem. This advantage is realized by the use of printed plug-in subassemblies, an example of which appears in Fig. 49. Principal units of a set can be removed, tested, and replaced in the same manner as tubes are handled. It should be useful in areas where skilled repair men are not available, and in applications where it is necessary to do trouble-shooting under difficult conditions. With all major subassemblies wired in plug-in fashion, if necessary the repair man can replace all the subassemblies in the set, taking the old units back to the shop for checking. The subassembly of Fig. 49 has been encased in a special casting resin⁷⁷ developed at the Bureau, useful at frequencies up to and

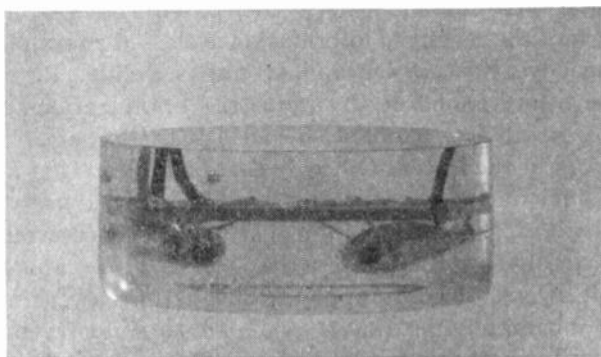
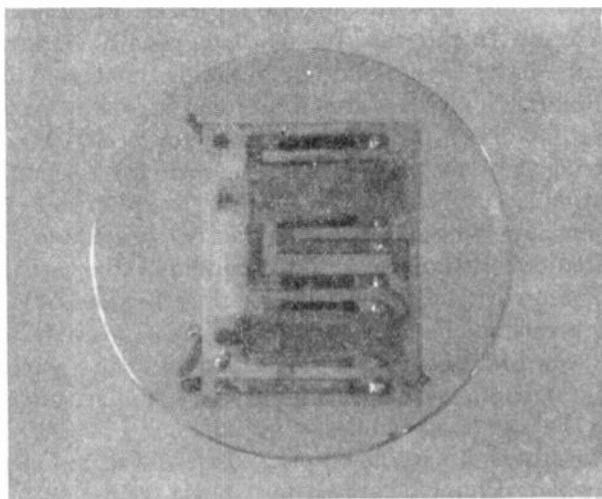

Fig. 50—Two-stage amplifier printed on a ceramic plate and encased in NBS Casting Resin.

beyond the v.h.f. range. It is thus protected against manual and atmospheric abuse. A two-stage amplifier printed on steatite and potted in NBS Casting Resin is shown in Fig. 50.

⁷⁷ See Bibliography, reference 56.

4. Metallizing in Electronics

The electrical industry now employs printed-circuit techniques in making up a large number of electrical components. Typical are the production of silvered ceramic capacitors, lamps, and vacuum tubes such as cathode-ray tubes with inner walls metalized, insulators partially metalized for soldering thereto, metal seals to glass or ceramics, etc.⁷⁸

Paper and thin plastic sheets are prepared as electrostatic shields and as reflectors of electromagnetic waves by evaporating thin, almost molecular, layers of metal onto the surface. Glass attenuators for precision measurements of microwaves are made by evaporating thin layers of metal on glass. The thickness of film is controlled by measuring the conductance during deposition. Precision metalized glass resistors⁷⁹ for use in pulse circuits are also made this way, as are waveguide pads and other microwave equipment.

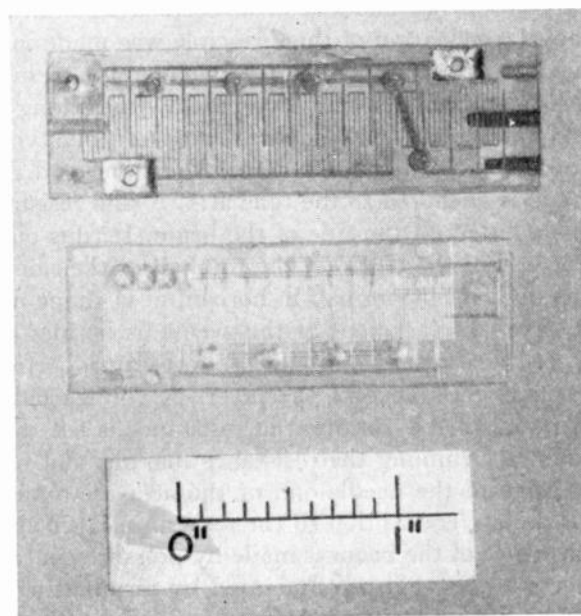

Fig. 51—Radiosonde commutator made by printed-circuit techniques.

Both sputtering and evaporation have been used to plate crystals successfully.⁸⁰ The process not only affords a splendid way of making electrical contact to the crystal face but, by controlling the thickness of the metal layer, the crystal frequency may be changed over a limited range while the crystal is oscillating freely in the evaporating chamber.

Metal-to-glass seals have been made successfully by spraying a thin coat of aluminum onto glass heated to about 400°C.⁸¹ The aluminum with its oxide is believed to dissolve partially in the glass to form a vacuum-tight bond. Copper is sprayed over the aluminum to facilitate soldering.

⁷⁸ See Bibliography, references 57, 58, and 59.

⁷⁹ See Bibliography, references 58 and 59.

⁸⁰ See Bibliography, reference 57.

⁸¹ See Bibliography reference 3.

The radiosonde switch of Fig. 51 shows a practical method of making electronic accessories. Conventionally made by laboriously assembling eighty thin rectangular metal strips separated by insulators, it affords a good example of the advantages of the new process. A plastic strip is molded with grooves, as shown in the lower view. A conductive layer is then applied by chemical reduction of silver. (An alternative method would be to apply silver paint generously over the surface.) After drying, the top surface is ground down, leaving the grid desired and completing the unit.

5. Electromechanical Application

Strain gages are used to measure changes in dimensions of mechanical systems. They may be made by applying a layer of resistance paint to the surface under study and measuring the change in resistance as the member is stressed. The paint is applied in the usual manner and coated with a protective layer to maintain the calibration independent of atmospheric conditions.

A novel application of this principle was made in developing an extremely lightweight phonograph pickup.⁸² It consists of a flexible cantilever beam, $\frac{1}{2}$ inch long and approximately 0.06 inch square, made of polystyrene. The needle is permanently attached to one end. The other end is anchored to the tone arm. A thin resistance layer is painted on the side of the beam. It runs out to the free end of the beam on the top half of the side and returns on the bottom half in horizontal U-shape manner. Lateral displacement of the needle as it rides over the record flexes the beam and produces a proportional variation in resistance of the layer. A voltage change proportional to the variation in resistance is fed to the amplifier. By running the resistance line out and back, connections to the needle end of the arm are avoided. In this design, connection to the resistance layer at the tone arm end of the beam is made by pressure contacts. These contacts could be eliminated by terminating the resistance lines into painted silver strips, to which fine wires may be soldered directly.

Resistance values of 75,000 to 100,000 ohms are used. Duplicating the arrangement on the opposite side of the beam increases the sensitivity by taking advantage of a mechanical push-pull effect. It was found that the variation in resistance with strain was a linear function over a wider range than used in the phonograph pickup. It is of interest to note the author's report that the resistance pickup was completely free of hiss or background noise. A coat of lacquer protected the resistance such that actual immersion in water did not appreciably affect the performance.

X. CONCLUSION

The present status of printed circuits may be summed as follows. The conductors of an electronic circuit may readily be printed by any one of a large number of successful methods. Many of these methods, described

herein, have been proved in practice on production lines. The principal item requiring further attention to achieve over-all perfection in printing circuits is the development of improved methods of printing resistors. While much is known about printing resistors, and values have been printed in large-scale production covering almost the entire range needed in modern electronic manufacturing, much remains to be learned about resistor manufacture before all of the extensive requirements imposed on them by their use in modern electronic sets may be met satisfactorily. Even here the present status is good. Mass-production lines have been set up and are producing printed circuits in their entirety at the rate of thousands per day.

A manufacturer does not, however, need to set up his plant to produce sets that are printed in every electronic detail to take advantage of printed circuits. Some have introduced the novel process by printing only a sub-assembly or an interstage network of a complex set. Some have printed only the conductors, and have used standard resistors and capacitors for the remainder of the circuit. In this case the methods usually employed to date have been painting, spraying, and cold die-stamping. Hundreds of thousands of electronic sets of all types have been produced in this country and abroad utilizing these techniques in one or more subassemblies. Printing circuit conductors and using standard resistors and capacitors has proved an attractive way of adopting printed-circuit practice with a minimum of disturbance to engineering and production. Engineering and production personnel have been quick to recognize the advantages to be gained in production by using printed-circuit techniques which simplify, mechanize, and reduce the cost of assemblies.

The status of patents on printed-circuit techniques is one which cannot be stated in explicit terms. As mentioned above, many of the techniques are adaptations of processes patented long ago, which patents have expired. Much of the technical information is classed as standard knowledge of the art and is unpatentable. Patents have been applied for by industrial organizations and some by the Government. Because of the large backlog of work in the Patent Office, it is not expected that final decisions on these applications will be reached early. It is thought that most of the patents in process relate principally to specific and perhaps limited processes and applications. Patents applied for by the Government may ultimately be made available to industry on a nonexclusive basis without charge. Concerns planning to use printed circuits commercially are advised to check the patent situation in the same manner as would be employed in adapting any new manufacturing process.

XI. ACKNOWLEDGMENT

Acknowledgment is made of substantial contributions to the data and facts on the stencil-screen process by the Centralab Division of Globe-Union, Inc. This organiza-

⁸² See Bibliography, reference 60.

tion is collaborating with the Bureau in research on printed circuits on steatite bases. Other organizations whose assistance is acknowledged are Herlec Corporation; Metaplast Co., Inc.; E. I. duPont de Nemours Co., Inc.; Battelle Memorial Institute; Columbian Carbon Co.; Remington Arms Co., Inc.; Kenyon Instrument Co., Inc.; Altair Machinery Corporation; and Franklin Airloop Corporation.

Appreciation is expressed for the valuable leadership of Harry Diamond, Chief of Division 13 of the National Bureau of Standards, under whose general direction this work was carried out. Acknowledgment is also made of the valuable data and facts contributed by Philip J. Franklin, Robert L. Henry, John J. Gurtowski, Morris Weinberg, Clara Grace Moon, and Alice G. Robertson.

XII. BIBLIOGRAPHY

- Cledo Brunetti and A. S. Khouri, "Printed electronic circuits," *Electronics*, vol. 5, pp. 104-108; April, 1946.
- "Conductive Silver Coatings," Metaplast Technical Manual, Sec. 51, Metaplast Company, Inc., New York, 11 N. Y.
- C. W. Hansell, "Miscellaneous Developments in German Science and Industry," Report C-60 of Joint Intelligence Objectives Agency Report No. 68, June, 1945.
- E. Rosenthal, "Metal coatings on ceramics," *Electronic Eng.* (London), vol. 18, pp. 241, 242, 261; August, 1946.
- I. C. Gardner and F. A. Case, "The Making of Mirrors by the Deposition of Metal on Glass," *Nat. Bur. Stand. Circ. No.* 389, January 6, 1931.
- Samuel Wein, "Metallizing Non-conductors," Metal Industry Publishing Co., 11 West 42nd St., New York 18, N. Y.
- John Strong, "Procedures in Experimental Physics," Prentice-Hall, Inc., New York, N. Y., 1939.
- J. A. Sargrove, "New methods of radio production," *Jour. I.E.E.* (London), vol. 7 (New Series) January-February, 1947.
- E. I. duPont de Nemours Company, Inc., Electrochemicals Dept., Wilmington, Del., Technical Data Bulletins Nos. 8-843 and 8-4602.
- U. S. Patent No. 1,563,731, Charles Ducas, "Electrical Apparatus and Method of Manufacturing," December 1, 1925.
- P. D. Hopf, "New types of silver coating," *Electronic Eng.* (London), vol. 19, p. 193; June, 1947.
- Emory P. Miller, "Electrostatic paint spraying and detearing," *Electronics*, vol. 18, p. 336; November, 1945.
- "Electrostatic spraying and electrostatic detearing," *Ind. Fin. Mag.*, May-June, 1946.
- Nurnberger Schraubenfabrik und Eleckrowerk, Nuremberg, Germany.
- U. S. Patent, No. 2,281,843, Joseph W. Jira, "Metal Film Resistor," May 5, 1942.
- A. von Hippel et al., "High dielectric constant ceramics," *Ind. and Eng. Chem.*, vol. 38, p. 1097; November, 1946.
- E. N. Bunting, G. R. Shelton, and A. S. Creamer, "Properties of barium-strontium, titanate dielectrics," *Jour. Res. Nat. Bur. Stand.*, RP1776, vol. 38, March, 1947.
- E. I. duPont de Nemours Company, Inc., Electrochemicals Dept., Wilmington, Del., New Products Bulletin No. 16.
- U. S. Patent, No. 1,837,678, S. C. Ryder, "Inductance Coil Particularly Adapted for Use with Radio Tuning Devices," December, 1931.
- U. S. Patent No. 2,297,488, R. Luderitz, "Radio-Frequency Coil and Electrostatic Shield," September, 1942.
- U. S. Patent No. 1,647,474, F. W. Seymour, "Variable Pathway," November, 1927.
- F. E. Terman, "Radio Engineers Handbook," New York, N. Y.; McGraw-Hill Book Co., p. 62.
- "German Metal Ceramic Technique and Metal Ceramic Decimeter Tubes," Series No. 26, Vacuum Tube Development Committee.
- R. J. Bondley, "Metal ceramic brazed seals," *Electronics*, vol. 20, pp. 97-99; July, 1947.
- U. S. Patent No. 33,721, Justis Von Liebig, "Improvement in Electroplating with Copper and Other Metals," November 12, 1861.
- British Patent No. 555,297, Philips Lamps Lmt'd., London, "Improvement in or Relating to the Application of Metallic Layers to Non-metallic Surfaces," August 16, 1943.
- British Patent No. 515,354, N. V. Philips' Gloeilampenfabrieken, Improvements in Conductors for Electric Apparatus," December 4, 1939.
- Swiss Patent No. 205,694, N. V. Philips' Gloeilampenfabrieken, "Electrical Apparatus," September 16, 1939.
- U. S. Patent No. 2,244,009, Johannes N. Hiensch and Eduard M. H. Lips, "Electrical Apparatus," June 3, 1941.
- U. S. Patent No. 1,256,599, Max Ulrich Schoop, "Process and Mechanism for the Production of Electric Heaters," February 19, 1918.
- Rosenthal Isolatoren Werke, Selb, Bavaria.
- French Patent No. 686,445, M. Robert Kapp, April 14, 1940.
- British Patent No. 349,706, A. W. Ruysenaers, "Radio-apparatus," June 4, 1931.
- J. T. Collier, "Metallized circuits," *Melco News*, vol. 4, (published by Metallizing Engineering Co., Inc., Long Island City, N. Y.), pp. 6-7; July, 1947.
- U. S. Patent No. 2,066,511, Herbert G. Arlt, "Wiring Device," January 5, 1937.
- U. S. Patent No. 2,136,024, H. Schneider, "Process and Apparatus for Producing Metallic Coatings on Various Articles," November 8, 1938.
- U. S. Patent No. 2,063,034, Erich Freund, "Method of Producing Metallic Coatings on a Cellulose Ester Base," December 8, 1936.
- U. S. Patent No. 2,273,613, W. F. Bartoe, "Process for Preparing Mirrors," February 17, 1942.
- U. S. Patent No. 2,030,476, H. E. Smith, "Method of Producing Mirrors," February 11, 1936.
- "Metallized Paper Capacitors," Hobart Publishing Co., Box 4127, Chevy Chase Station, Washington, D. C. Also James I. Cornell, "Metallized Paper Capacitors," *The Solar System*, vol. 4, p. 5; November-December 1946.
- U. S. Patent No. 1,584,728, T. W. Case, "Method of Manufacturing Mirrors," May 18, 1926.
- U. S. Patent No. 2,164,332, M. E. Macksoud, "Apparatus for Applying Mirror Surfaces to the Interior of Lamp Bulbs," July 4, 1939.
- "Metallized Glass Attenuators," Polytechnic Institute of Brooklyn, N.D.R.C. Div. 14, Report No. 360, April, 1945.
- U. S. Patent No. 2,401,472, A. W. Franklin, "Structural Unit," June 4, 1946.
- Edwin N. Kendall, "Receiver loop antenna design factors," *Communications*, vol. 25, p. 62; November, 1945.
- W. W. MacDonald, ed., "Stamped wiring," *Electronics*, vol. 20, p. 82; June, 1947.
- U. S. Patent No. 1,527,241, A. J. G. Warren, Caterham Valley, Surrey, England, "Producing Metallized surfaces on Rubber," February 24, 1925.
- British Patent No. 269,729, C. Parolini, "Process for the Production of Electrically Insulating Plates Provided with a System of Connections, More Particularly Ebonite Plates for use in Radio Outfits," April 28, 1927.
- Battelle Memorial Institute, Columbus, Ohio:
U. S. Patent No. 2,221,776, C. F. Carlson, "Electron Photography," November 19, 1940; U. S. Patent No. 2,297,691, C. F. Carlson, "Electrophotography," October 6, 1942; U. S. Patent No. 2,357,809, C. F. Carlson, "Photographic Apparatus," September 12, 1944.
- Joint Army-Navy Test Specifications, F-3c(13) May, 1944.
- Bulletin EI-B-3, Corning Glass Works, Corning, N. Y., December 2, 1946.
- "Electron Tube Characteristic Data for Sub-Miniature Tubes," issued by Thermionics Branch, Evans Signal Laboratory, Belmar, N. J., October, 1946.
- Cledo Brunetti and W. J. Cronin, "Subminiature printed radio transmitters and receivers," *Nat. Bur. Stand. Tech. News Bull.*, vol. 31, no. 5, p. 53; May, 1947.
- A. F. Murray, "Evolution of printed circuits for miniature tubes," *Tele-Tech.*, vol. 6, p. 58; June, 1947.
- K. Rose, "Materials and techniques for printed electrical circuits," *Materials and Methods*, vol. 25, pp. 73-76; March, 1947.
- Wilbert S. Hinman, Jr. and Cledo Brunetti, "Radio proximity fuze design," *Jour. Res. Nat. Bur. Stand.*, RP. 1723, vol. 37, July, 1946.
- P. J. Franklin and M. Weinberg, "NBS casting resin," *Jour. Res. Nat. Bur. Stand.*, vol. 31, p. 78; July, 1947.
- K. M. Laing, "Plating quartz," *Communications*, vol. 26, p. 26; April, 1946.
- "Metallized Glass Resistor Unit," Publication PB-5188, U. S. Department of Commerce, Washington, D. C.
- "Metallized Glass Attenuator and Miscellaneous R. F. Test Accessories," Publication PB-6586, U. S. Department of Commerce, Washington, D. C.
- K. J. Germeshausen and R. S. John, "Phonograph pickup," *Electronic Ind.*, vol. 5, pp. 78, 118; November, 1946.

Contributors to Waves and Electrons Section



CLEDO BRUNETTI

Cledo Brunetti (A'37-SM'46) was born on April 1, 1910, at Virginia, Minn. He was graduated at the head of his class in electrical engineering at the University of Minnesota in 1932. Continuing with graduate work as a teaching fellow and instructor, he obtained the first Ph.D. degree in electrical engineering granted at the University. From 1937 to 1941 he was on the faculty of Lehigh University as assistant professor of electrical engineering. In 1941-1942 he lectured on radio at George Washington University, evening classes. During the summers of 1939 and 1940 he was research associate in the radio section of the National Bureau of Standards. In May, 1941, he left Lehigh to work at the Bureau on the development of the radio proximity fuze. Later he became alternate chief of the electronics development section. In 1943 he organized and headed the production engineering section of the Ordnance Development Division. At present, he is chief of the pilot engineering section.



ROGER W. CURTIS

In 1941, Dr. Brunetti was recognized by Eta Kappa Nu as America's outstanding young electrical engineer. He is a member of Sigma Xi, Tau Beta Pi, and Eta Kappa Nu.



Roger W. Curtis (SM'48) was born in Lansing, Mich., on October 4, 1904. He received the A.B. degree from the University of Michigan in physics in 1926, and the Ph.D. from the Johns Hopkins University in 1934. He was engaged at the National Bureau of Standards on electrical measurements, including a determination of the absolute ampere until 1940. At that time he went to the Naval Ordnance Laboratory to assist in the degaussing program and with the development of acoustic devices. He later worked at the Navy Department and at the Harvard Underwater Sound Laboratory on the development of underwater acoustic and electronic devices, and returned to the National Bureau of Standards in 1944 where he is now working on the development of the radio proximity fuze. Dr. Curtis is a member of the American Physical Society, Sigma Xi, and the Washington Philosophical Society.



Lester N. Hatfield (A'30-M'45-SM'47) was born on December 25, 1908, in Clare-shom, Alberta, Canada. He was graduated from the State College of Washington in 1933 with the degree of B.S. in electrical engineering. From 1930 to 1933, he was chief engineer of radio station KWSC. From 1933 to 1943, he was affiliated with the Columbia Broadcasting System in New York as technician and engineer. From 1943 to 1946, he served as a lieutenant in the Naval Reserve with the electronics division of the Bureau of Ships. During 1946 and the first part of 1947 he was chief engineer of Press Wireless Manufacturing Corporation. He is now associated with the Hazeltine Electronics Corporation in Little Neck, New York.



R. C. Poulter (A'30-M'37-SM'43) was born and educated in England, and began his career in the electrical and radio field in London, Ontario, where he was engaged in electrical construction and wattmeter and instrument repair. From 1922 to 1925 he was in charge of the radio department of Benson and Wilcox Electric Company. He participated in early research on electropolygraphs and heart sound amplifiers in conjunction with Dr. Ramsay and Dr. Ward at the University of Western Ontario in 1923 and 1924.



LESTER N. HATFIELD



In 1926 he became associated with Fada Radio Ltd. in Toronto as test engineer, and in 1928 he joined the Hugh C. MacLean Publications Ltd. staff as an editor, from which he resigned in 1936 to become Director of Education of the Radio College of Canada. In 1936 Mr. Poulter became president and managing director of Poulter Publications Ltd.

Mr. Poulter is a registered professional engineer and a member of the American Institute of Radio Engineers. He has been chairman of the Publicity Committee of the I.R.E. Toronto Section, and was chairman of that Section in 1938-1939. He is a member of the Public Relations Committee of the Institute; director of public relations, Canadian Radio Technical Planning Board; chairman, Publicity Committee of the Association of Professional Engineers of the Province of Ontario, and editor of *The Professional Engineer*, journal of the Association. He is also chairman of the Publicity Committee and the Committee of Professional Status of the Canadian Council of the I.R.E.



R. C. POULTER

Abstracts and References

Prepared by the National Physical Laboratory, Teddington, England, Published by Arrangement with the Department of Scientific and Industrial Research, England, and *Wireless Engineer*, London, England

NOTE: The Institute of Radio Engineers does not have available copies of the publications mentioned in these pages, nor does it have reprints of the articles abstracted. Correspondence regarding these articles and requests for their procurement should be addressed to the individual publications and not to the I.R.E.

Acoustics and Audio Frequencies.....	163
Aerials and Transmission Lines.....	164
Circuits and Circuit Elements.....	165
General Physics.....	167
Geophysical and Extraterrestrial Phenomena.....	168
Location and Aids to Navigation.....	169
Materials and Subsidiary Techniques.....	169
Mathematics.....	171
Measurements and Test Gear.....	171
Other Applications of Radio and Electronics.....	172
Propagation of Waves.....	173
Reception.....	173
Stations and Communication Systems.....	173
Subsidiary Apparatus.....	174
Television and Phototelegraphy.....	174
Transmission.....	175
Vacuum Tubes and Thermionics.....	175
Miscellaneous.....	176

The number in heavy type at the upper left of each Abstract is its Universal Decimal Classification number and is not to be confused with the Decimal Classification used by the United States National Bureau of Standards. The number in heavy type at the top right is the serial number of the Abstract.

ACOUSTICS AND AUDIO FREQUENCIES

- 016:534 **3747**
References to Contemporary Papers on Acoustics—A. Taber Jones. (*Jour. Acous. Soc. Amer.*, vol. 19, part 1, pp. 706–713; July, 1947.) See also 2306 of September.
- 534 **3748**
Program of the Thirty-Third Meeting of the Acoustical Society of America—(*Jour. Acous. Soc. Amer.*, vol. 19, part 1, pp. 722–738; July, 1947.) Titles and abstracts of 78 papers, with author index.
- 534.231.3 **3749**
Acoustical Impedance of Enclosures—F. B. Daniels. (*Jour. Acous. Soc. Amer.*, vol. 19, part 1, pp. 569–571; July, 1947.) Formulas are derived for the acoustical impedance of three types of enclosures: a sphere, a cylinder, and a narrow rectangular box. The solutions are valid throughout the entire range from adiabatic to isothermal conditions.
- 534.232:621.396.67 **3750**
On the Radiation Problem [of a Vibrating Cylinder] at High Frequencies—L. Lax and H. Feshbach. (*Jour. Acous. Soc. Amer.*, vol. 19, part 1, pp. 682–690; July, 1947.) The polar diagram and impedance of an acoustically vibrating cylinder of arbitrary cross-section, large compared with the wavelength, are considered for various pressure and velocity distributions. Rapidly converging series solutions are obtained to an integral equation. The method has applications to radiation from electromagnetic shells whose surface distributions are specified.
- 534.24:551.510.52 **3751**
Reflection of Sound Signals in the Troposphere—G. W. Gilman, H. B. Coxhead, and F. H. Willis. (*Bell Sys. Tech. Jour.*, vol. 26, p. 390; April, 1947.) Summary of 330 of March.

The Annual Index to these Abstracts and References, covering those published from January, 1946, through December, 1946, may be obtained for 2s. 8d., postage included from the *Wireless Engineer*, Dorset House, Stamford St., London S. E., England.

- 534.321.9 **3752**
Ultrasonic Absorption [in Liquids] from 75 to 280 Mc/s.—R. A. Rapuano. (*Phys. Rev.*, vol. 72, pp. 78–79; July 1, 1947.) A preliminary report. The pulse-echo method has been adapted by the use of an acoustic delay line consisting of a rod of fused quartz with polished parallel end faces.
- 534.321.9 **3753**
Ultrasonic Absorption in Liquids from 100 to 225 Mc/s.—R. A. Rapuano. (*Phys. Rev.*, vol. 72, p. 184; July 15, 1947.) Summary of Amer. Phys. Soc. paper. Description of apparatus for examining the frequency dependence of the absorption, in order to investigate relaxation processes. Results for water are given.
- 534.321.9 **3754**
Ultra-Sound Waves made Visible—G. W. Willard. (*Bell Lab. Rec.*, vol. 25, pp. 194–200; May, 1947.) Supersonic waves in a liquid give a closely spaced system of compression and rarefaction regions with different optical refractive indexes. Such a system behaves like an optical line grating, so that diffraction effects are obtained when a beam of light is passed at right angles through the supersonic beam in the liquid. Photographs exhibit many points of resemblance between supersonic and optical beams.
- 534.321.9:546.49 **3755**
Propagation of U.H.F. Sound in Mercury—G. R. Ringo, J. W. Fitzgerald, and B. G. Hurdle. (*Phys. Rev.*, vol. 72, pp. 87–88; July 1, 1947.) An outline of experiments in the frequency band 100 to 1000 Mc. The results are compared with measurements made at lower frequencies by other experimenters. No significant change with frequency was observed in the speed of propagation or in the “frequency-free” absorption coefficient.
- 534.321.9.001.8 **3756**
Opportunities in Ultrasonics—S. Y. White. (*Audio Eng.*, vol. 31, pp. 30–32 and 47; June, 1947.) Possible industrial applications of ultrasonic mechanical vibrations are briefly considered.
- 534.321.9.001.8:621.396.611.21 **3757**
Laboratory Supersonic Generators and Their Applications—H. Tscherning. (*Rev. Gén. Élec.*, vol. 56, pp. 319–327; August, 1947.) The principles of piezoelectric oscillators are discussed briefly and descriptions are given of practical apparatus of the piezoelectric and of the magnetostriction type suitable for the production of supersonic waves in liquids. Applications include the preparation of emulsions, many chemical and metallurgical processes, biological effects and the measurement of Young's modulus in metal rods.
- 534.417:534.88 **3758**
The German Use of Sonic Listening—L. E. Holt. (*Jour. Acous. Soc. Amer.*, vol. 19, part 1, pp. 678–681; July, 1947.) “The most successful German sonic listening device, the GHG Gruppen Horch Gerät, is described in general terms. Reference is made to the types of ships using the equipment and to the arrangement and placement of the hydrophone arrays. A brief account is given of the steps taken by the Germans to improve the operation of the GHG by streamlining the array and by altering its position on the hull. The simple but efficient electrical training device is explained, and bearing accuracy and range data, as reported by the Germans, are presented. The paper is based on technical reports received from Germany and on subsequent investigations. The most important of the sources consulted is the Navy Technical Mission Report prepared by Mr. L. Batchelder.”
- 534.43:621.395.61 **3759**
Moving Iron Pickups—E. H. Francis. (*Wireless World*, vol. 53, pp. 285–286; August, 1947.) General discussion with special reference to the effect of inductance on frequency response, the impedance versus frequency characteristic and frequency correction. A suggested preamplifier circuit with frequency correction is given.
- 534.43:621.395.67 **3760**
Transition Frequency Compensation—C. G. McProud. (*Audio Eng.*, vol. 31, pp. 10–11; July, 1947.) RC equalizing networks compensate for recording loss which occurs at frequencies below 300, 500, or 800 c.p.s. on various manufacturers' records. Networks are given for crystal and magnetic pickups.
- 534.771 **3761**
A Pulse-Tone Technique for Clinical Audiometric Threshold Measurements—M. B. Gardner. (*Jour. Acous. Soc. Amer.*, vol. 19, part 1, pp. 592–599; July, 1947.) Description of a portable version of the equipment used for testing over 1,000,000 people at the 1939–1940 Worlds Fair in America (1403 of 1941). Operators and subjects both prefer the pulse-time to the standard manually interrupted tone method.
- 534.771 **3762**
Auditory Thresholds of Short Tones as a Function of Repetition Rates—W. R. Garner. (*Jour. Acous. Soc. Amer.*, vol. 19, part 1, pp. 600–608; July, 1947.)
- 534.833.4 **3763**
Acoustical Properties of Homogeneous, Isotropic Rigid Tiles and Flexible Blankets—L. L. Beranek. (*Jour. Acous. Soc. Amer.*, vol. 19, part 1, pp. 556–568; July, 1947.)
- 534.843 **3764**
The Effect of Non-Uniform Wall Distributions of Absorbing Material on the Acoustics of Rooms—H. Feshbach and C. M. Harris. (*Bell*

Sys. Tech. Jour., vol. 26, pp. 389–380; April, 1947.) Summary of 342 of March.

534.86:534.322.1

3765

Frequency Range Preference for Speech and Music—H. F. Olson. (*Jour. Acous. Soc. Amer.*, vol. 19, part 1, pp. 549–555; July, 1947.) Tests with an acoustical 5000-c.p.s. low-pass filter placed between a light orchestra and the audience indicated that the full frequency range was preferred. The tests are part of a series designed to find out why most listeners prefer a restricted frequency range in monaural reproduced speech and music.

534.861.1

3766

The Acoustical Planning of Broadcasting Studios—J. McLaren. (*B.E.C. Quart.*, vol. 1, pp. 194–208; January, 1947.) A brief survey of the basic problems of sound insulation and correction. Successful B.E.C. wartime improvisations are indicated. Acoustical correction experiments and methods are described. In particular, a pulse technique analogous to radar can be used for investigating the acoustic properties of large buildings.

621.395.61:534.6

3767

Application of the Methods of Automatic Regulation to Electroacoustic Apparatus. Method of Obtaining the Response Curves of Microphones—A. Moles. (*Onde Élec.*, vol. 27, pp. 276–283; July, 1947.) Methods similar to the automatic gain control used in radio circuits can be applied to a microphone preamplifier to obtain a correction of the amplification proportional to the instantaneous value of the sound field. The correcting voltage may be derived from a standard microphone with uniform response characteristics. Details are given of a method for the direct recording of microphone or loudspeaker response curves, including particulars of the automatic regulation of the output of the sound source used. See also 1306 of June.

621.395.61/.62/.089.6:534.417

3768

The Practical Application of the Reciprocity Theorem in the Calibration of Underwater Sound Transducers—P. Ebaugh and R. E. Mueser. (*Jour. Acous. Soc. Amer.*, vol. 19, part 1, pp. 695–700; July, 1947.)

621.395.623:534.6

3769

Experiments on Artificial Ears—I. Barducci. (*Alla Frequenza*, vol. 16, pp. 132–146; June to August, 1947. In Italian, with English, French and German summaries.) Determination of the dependence of the response curve of telephone receivers on cavity volume, coupling conditions and shape. Discussion of the results shows that it is possible to calculate the acoustic parameters of a telephone receiver and an artificial ear from the geometrical and physical data of the system.

621.395.623.7

3770

The Distribution of Acoustic Power—L. Chrétien. (*TSF Pour Tous*, vol. 23, pp. 137–138; June, 1947.) Various circuits for feeding loudspeakers. Continuation of 2317 of September.

621.395.625

3771

The Recording and Reproduction of Sound: Parts 1 to 4—O. Read. (*Radio News*, vol. 37, pp. 52–54, 50–52 and 153, 61–63 and 108, and 65–67 and 126; March to June, 1947.) The history, development and applications of all currently known methods. Descriptions are given of (a) lateral disk recording, (b) basic methods for embossing sound on film or disk, (c) magnetic recording on tape, disk or wire, (d) optical film recording and (e) magnetic cutters for home recording and for high-fidelity broadcast transcribing. Parts 5 to 7, 3772 below.

621.395.625

3772

The Recording and Reproduction of Sound: Parts 5 to 7—O. Read. (*Radio News*, vol. 38,

pp. 55–57 and 135, 57–59 and 148, and 62–64 and 147; July to September, 1947.) Description of the crystal cutter and its use for constant-amplitude and constant-velocity recording, various methods of magnetic recording on wire, tape, and magnetically coated materials, and various types of microphones used in recording. For parts 1 to 4 see 3771 above. To be continued.

621.395.625.3:621.396.97

3773

Adapting Paper Tape Recorders for Broadcasting—R. S. O'Brien. (*Audio Eng.*, vol. 31, pp. 10–14 and 48; June, 1947.)

621.395.667

3774

Response Equalization—J. W. Straede. (*Radio Craft*, vol. 18, pp. 34–35 and 77; September, 1947.) A simple system in which the bass attenuation may start at any of 5 (or more) frequencies, or the lower frequencies may be either kept constant or boosted. Similar arrangements can be made for the high frequencies.

621.395.92

3775

Hearing Aid Miniature—(*Wireless World*, vol. 53, p. 229; June, 1947.) The multitone Type MT3 is a deaf aid with a built-in crystal microphone. The unit is 3 and one-fourth inches \times 1 and eleven-sixteenths inches \times one-half inch and with the lightest of a range of battery packs weighs 6 and one-half oz.

AERIALS AND TRANSMISSION LINES

621.315.1:621.3.015.3

3776

Theory of the Propagation of Surge Waves on Two Parallel Lines—M. Cotte. (*Rev. Gén. Élec.*, vol. 56, pp. 343–352; August, 1947.) Theory is given for the case of lines without resistance and with considerable coupling. On the induced line, it is shown that two voltage waves without current and two current waves without voltage may be propagated. The experimental results obtained by Mauduit (3777 below) and Rogowski with surge waves are explained with the aid of symbolic calculus.

621.315.1:621.3.015.3:621.317.755

3777

Oscillographic Study of Surge Waves and Oscillations in an Experimental Overhead Line—A. Mauduit. (*Rev. Gén. Élec.*, vol. 56, pp. 331–343; August, 1947.) A surge wave, started by a capacitor discharge at one end of an overhead line whose other end is open, is successively reflected at the two ends and gives rise to a stationary damped oscillation, the line vibrating as a quarter-wave line. The damping obtained with various line terminations, and with return by earth or a parallel wire, is considered. When the far end is earthed through a resistance equal to the characteristic impedance Z of the line, there is no reflection and the surge wave dies away without oscillation; but a wave can be induced in a parallel return line. The cases in which this line is open at both ends or is earthed at the origin are considered. A remarkable result is that if the parallel return line is earthed at the origin through an impedance nearly equal to Z , no wave is induced in the parallel line by a surge wave in the original line.

621.315.21:621.395.822.1

3778

Splicing of Cables with Systematic Permutation—G. Chardon. (*Cables and Trans.* (Paris), vol. 1, pp. 77–86; April, 1947. With English summary.)

621.315.21.011.2

3779

Maximum Tolerable Impedance Deviations in Repeated Cable Sections—R. Belus, P. Herreng, and J. Ville. (*Cables and Trans.* (Paris), vol. 1, pp. 3–12; April, 1947. With English summary.) Discussion of the conditions to be fulfilled by mean-square values of impedance deviations of individual cable lengths, a number of which are connected in series between two successive repeaters.

621.315.212+621.392.029.64

3780

Transmission of Electromagnetic Guided Waves through a Series of Symmetrical and Equidistant Obstacles—J. Lévy. (*Cables and Trans.* (Paris), vol. 1, pp. 103–113; July, 1947. With English summary.) When a waveguide or concentric cable has obstacles uniformly distributed along it, its transmission properties cease to vary uniformly with the frequency as soon as the distance between consecutive obstacles is comparable with the wavelength. When the number of obstacles is great enough, the cable or guide acquires the properties of a multiple band filter. Methods of calculating the limits of the pass and attenuating bands are given and applied to the case of a coaxial cable with a series of evenly distributed insulating disks.

621.315.212.029.6: [621.317.333+621.317.37

3781

The Voltage Characteristics of Polythene Cables—R. Davis, A. E. W. Austen, and W. Jackson. (*Jour. I.E.E.* (London), Part I, vol. 94, pp. 283–284; June, 1947.) Summary of 3179 of November.

621.315.212.011.2

3782

Note on the Statistical Study of Impedance Irregularities in Coaxial Pairs—G. Fuchs. (*Cables and Trans.* (Paris), vol. 1, pp. 13–30; April, 1947. With English summary.) Previous mathematical results are reviewed and new statistical relations are established. A detailed study is made of the distribution of zeros and maxima or minima of the impedance-deviation curve as a function of the frequency interval between two successive measurements. Calculated and experimental results are in good agreement.

621.392

3783

Power Reflection—P. M. Prache. (*Cables and Trans.* (Paris), vol. 1, pp. 31–37; April, 1947. With English summary.) The transmitted and reflected powers at an interconnection point between a generator or a transmission line and a receiving impedance are calculated as functions of the power which would theoretically be transmitted at the same point to an impedance equal to the characteristic impedance. A coefficient of reflection of available power is defined as the ratio of the power actually reflected to the maximum power obtainable from the source. This coefficient remains unaltered when a nondissipative quadripole is interposed.

621.392.029.64

3784

Receiving Vibrator in a Waveguide—I. I. Volman. (*Radioelekhnika* (Moscow), vol. 2, pp. 27–35; January, 1947. In Russian with English summary.) The vibrator input resistance is computed taking account of the reflections at the load terminating the waveguide. The standing-wave ratio as well as the position of the electric field nodes relative to the receiving vibrator, arbitrarily loaded, are determined.

621.392.029.64

3785

The Effects of Curvature and Curvature Discontinuities on Wave Propagation in Guides of Rectangular Cross-Section—M. Jouguet. (*Cables and Trans.* (Paris), vol. 1, pp. 39–60; April, 1947. With English summary.) A full mathematical treatment of the subject. Some of the results obtained have been reported previously in short nonmathematical papers. See also 2669 of October, 2000 of August and back references.

621.392.029.64

3786

The Effects of Curvature on the Propagation of Electromagnetic Waves in Guides of Circular Cross-Section—M. Jouguet. (*Cables and Trans.* (Paris), vol. 1, pp. 133–153; July, 1947. With English summary.) A complete account of the work already noted in 2000 of August and back references.

621.392.029.64:534.11 3787

A Mechanical Analogy for Transverse Electric Waves in a Guide of Rectangular Section—Makinson. (See 3844.)

621.392.029.64:621.317.3 3788

Definition and Measurement of the Coefficient of Reflection in Waveguides—J. Ortusi. (*Ann. Radioléc.*, vol. 2, pp. 173-194; April, 1947.) Definitions are given, for a type of guided wave, of the coefficients of reflection and transmission and of the apparent impedance. Two methods of measuring reflection coefficients are fully described, the first a direct method and the second a very accurate zero method. The results obtained are in perfect agreement with theory.

621.392.029.64:621.317.3 3789

Experimental Determination of Input Resistances of Vibrator in a Rectangular Waveguide—I. I. Volman and A. I. Shpuntov. (*Radiotekhnika* (Moscow), vol. 2, pp. 36-48; January, 1947. In Russian with English summary.) Comparison of the experimental results with theory shows that the current distribution along the vibrator is not sinusoidal. The results support theoretical conclusions as to the effect of waveguide walls and of reflections at the terminating load.

621.392.2:621.315.212.2 3790

Concentric Line—H. Bondi and S. Kuhn. (*Wireless Eng.*, vol. 24, pp. 222-223; August, 1947.) Curves of critical wavelength and wave impedance of $H_{n,1}$ modes in terms of the conductor diameters, are given. The critical wavelength of the H_{11} mode is approximately equal to the mean of the circumferences of the inner and outer conductors.

621.392.4.029.58+621.396.67.029.58]:621.317.3 3791

The Testing of High-Frequency Aerial Systems and Transmission Lines—E. J. Wilkinson. *PROC. I.R.E.* (Australia), vol. 8, pp. 17-18; May, 1947.) Comment on and amplification of 2672 of October.

621.392.43 3792

An Exponential Transmission Line Employing Straight Conductors—W. N. Christiansen. (*A.W.A. Tech. Rev.*, vol. 7, pp. 229-240; April, 1947.) Reprint of 3023 of November.

621.392.43 3793

An Eight-Wire Transmission Line for Impedance-Transformation—W. N. Christiansen and J. A. Guy. (*A.W.A. Tech. Rev.*, vol. 7, pp. 241-249; April, 1947.) The characteristic impedance Z_0 of an eight-wire line comprising two identical four-wire transmission lines arranged about a common axis is given by a simple expression involving $\cot \theta$, where θ is the angle through which one set of four wires is turned with respect to the other set. An approximately exponential variation of Z_0 can be obtained by varying θ and the wire spacing in linear steps. The design and construction of such a line transforming from 131 to 262 ohms is described. See also 3023 of November.

621.396.67 3794

The Radiation Patterns of Dielectric Rods—Experiment and Theory—R. B. Watson and C. W. Horton. (*Phys. Rev.*, vol. 72, p. 159; July 15, 1947.) Summary of Amer. Phys. Soc. paper. The radiation pattern for a dielectric rod, obtained theoretically by considering an equivalent surface distribution of electric and magnetic currents, has been measured for polystyrene rods of rectangular cross section and of length 3 to 10 λ . The width of the major lobes and the positions of the first two minor lobes agree well with theory for rod lengths up to 5 λ , but the heights of the first minor lobes show poorer agreement.

621.396.67:534.232 3795

On the Radiation Problem [of a Vibrating Cylinder] at High Frequencies—Lax and Feshbach. (See 3750.)

621.396.67:621.396.96 3796

Radar Antennas—H. T. Friis and W. D. Lewis. (*Bell Sys. Tech. Jour.*, vol. 26, pp. 219-317; April, 1947.) A comprehensive survey paper divided into three parts. Part 1 defines gain, effective area, free-space transmission loss, etc., and develops radiation-patterns of various basic ideal and amplitude-tapered apertures of uniform phase, large compared with the wavelength, by the Huyghens source method. The effects of square and cubic aperture phase variations, representing common practical illumination distortion, are also considered. Part 2 deals with methods of aerial construction; possible methods are classified and basic designs formulated. Parabolic aeriels, metal plate lenses, cosecant aeriels, and lobing and scanning techniques are considered in some detail. Part 3 details shipborne, airborne and ground radar aeriels developed by the Bell Laboratories.

621.396.67:[621.396.97+621.397.5 3797

Triplex Antenna for Television and F.M.—L. J. Wolf. (*Electronics*, vol. 20, pp. 88-91; July, 1947.) Details of a single four-bay superturnstile aerial used for simultaneous operation of a f.m. transmitter and the visual and aural transmitters of a television station, with negligible coupling between transmitters. The power gain is 6.4 for f.m. and 5 for television.

621.396.67:621.396.97 3798

F.M. [Broadcast] Antenna Uses Waveguide Principle—G. G. Greene. *FM and Telev.*, vol. 7, p. 38; July, 1947.) A new design requiring only two short waveguide sections arranged at right angles and fed 90° out-of-phase. High gain and freedom from icing are claimed.

621.396.67:621.397.5 3799

Television Aeriels—N. M. Best and R. D. Beebe. (*Wireless World*, vol. 53, pp. 293-295; August, 1947.) Design considerations are discussed in detail with special reference to the reflector array with $\lambda/8$ spacing. Curves indicate the comparison between $\lambda/4$ and $\lambda/8$ reflector spacing. The close-spaced array has a more even gain over the transmitting band and better signal-to-noise ratio in the sound channel.

621.396.671 3800

Partially Screened Open Aeriels—A. Colino. (*Wireless Eng.*, vol. 24, p. 248; August, 1947.) Comment on 2681 of October (Burgess).

621.396.671:621.317.79.083.7 3801

Theoretical and Experimental Study of a Feeder Reflectometer—A. R. Volpert. (*Radiotekhnika* (Moscow) vol. 2, pp. 3-23; February, 1947. In Russian, with English summary.) Construction and operation of an instrument for remote measurement of the standing-wave ratio in aerial feeders.

621.396.677 3802

Metal-Lens Antennas—W. E. Kock. (*Bell Sys. Tech. Jour.*, vol. 26, p. 391; April, 1947.) Summary of 1013 of May.

CIRCUITS AND CIRCUIT ELEMENTS

621.318.371.011.2/.4 3803

Q of Solenoid Coils—R. G. Medhurst. (*Wireless Eng.*, vol. 24, p. 281; September, 1947.) Author's reply to comment on 1694 of July by Callendar (3046 of November).

621.318.572 3804

Scale of N Counting Circuits—B. Howland. (*Electronics*, vol. 20, pp. 138 and 178; July, 1947.) A generalized Eccles-Jordan circuit having N states of stable equilibrium,

can be obtained by interconnecting N tubes symmetrically so that conduction in one tube cuts off current in all the others. This can be done with multigridded tubes since conduction in any one tube will make the voltage of one grid in each of the others negative. The small number of sensitive grids in most tubes sets an upper limit to N.

A diode-triode circuit avoids this limitation but requires too many tubes to be practical. A simplification requiring relatively few tubes and interconnections is obtained if each tube, when conducting, cuts off two tubes opposite it in the circuit.

Decade counters can best be constructed by combining scale-of-5 and scale-of-2 counters.

621.318.572 3805

A Fast Coincidence Circuit with Pulse Height Selection—P. R. Bell, S. DeBenedetti, and J. E. Francis, Jr. (*Phys. Rev.*, vol. 72, p. 160; July 15, 1947.) Summary of Amer. Phys. Soc. paper. A system using two channels: a pulse-height selector and a differentiation and delay circuit, so enabling simultaneous or delayed coincidences between pulses (within specified height limits) to be determined to about 0.3 microsecond.

621.318.572 3806

A Diode Coincidence Circuit—J. D. Shipman, Jr., B. Howland, and C. A. Schroeder. (*Phys. Rev.*, vol. 72, p. 181; July 15, 1947.) Summary of Amer. Phys. Soc. paper.)

621.318.572 3807

Frequency Meter for Random or Uniformly Spaced Pulses—H. L. Schultz. (*Rev. Sci. Instr.*, vol. 18, pp. 223-225; April, 1947.) An electronic instrument "capable of operating at random rates of about 5000 pulses per second on the average with less than 2 per cent error caused by resolving time." A resolving time in the vicinity of 1 microsecond can be achieved. Provision is made for the operation of a counter at low rates.

621.318.572 3808

Tone Burst Generator—R. G. Roush. (*Electronics*, vol. 20, pp. 92-96; July, 1947.) Four single-cycle multivibrators controlled by a free-running multivibrator serve as an adjustable electronic switch. Two circuits can be switched at the same adjustable repetition rate but with independently controllable duration and spacing times.

621.319.4 3809

Capacitor Manufacture—(*Elec. Rev.* (London), vol. 140, pp. 911-912; May 30, 1947.) Use of pilot plant for small-scale manufacture of new types, to ensure the highest possible quality in quantity production.

621.319.4 3810

Hermetic Low-Voltage Paper Capacitors—I. I. Morozov (*Radiotekhnika* (Moscow) vol. 2, pp. 51-62; February, 1947. In Russian with English summary.) Various methods are described for vacuum-tight seals and the electrical characteristics are given for various types of liquid and solid impregnants. Aging effects are discussed and accelerated life tests are described.

621.319.4:621.315.614.6 3811

Paper Capacitors Containing Chlorinated Impregnants—Effects of Sulfur—D. A. McLean, L. Egerton, and C. C. Houtz. (*Bell Sys. Tech. Jour.*, vol. 26, p. 392; April 1947.) Summary of 655 of April Note. Universal Decimal Classification of 655 should read as above.

621.38/.39](084.2) 3812

Graphical Symbols for Electronic Diagrams—(*Electronics*, Buyers' Guide Issue, vol. 20, pp. 122-123; June, 1947.) A chart including new symbols proposed by the Institute of Radio Engineers.

sponse variation within ± 1 db from 25 to 20,000 c.p.s.

621.396.662 3838

Attenuators with Linear Response—C. Dreyfus-Pascal and R. Gondry. (*Toute la Radio*, vol. 14, pp. 179-181; June, 1947.) Combinations of suitably chosen resistors and capacitors give an attenuator with response linear up to 1 Mc.

621.396.662.3: [621.395.61:534.43] 3839

Simple RC Filters for Phonograph Amplifiers—G. L. Rogers. (*Audio Eng.*, vol. 31, pp. 28-29 and 48; June, 1947.) Designed for improved reproduction with magnetic type pickups.

621.396.662.3.029.3 3840

Tuned A. F. Filters: Part 2—H. E. Styles. (*Wireless World*, vol. 53, pp. 282-284; August, 1947.) Design of a correction filter for a crystal pickup. For part 1 see 3486 of December.

621.396.69+621.396.621 3841

Robot Makes Radios—Hallows. (See 4010.)

GENERAL PHYSICS

53.081 3842

On the Absolute Systems of Electrical Units—E. Brylinski. (*Rev. Gén. Élec.*, vol. 56, pp. 235-236; May, 1947.) Discussion shows that certain systems, particularly that of Gauss, can be used with advantage in the domain of pure theory, but for practical purposes, a system is required involving only four fundamental units. See also 2383 of September and 1392 of June (Dorgelo and Schouten).

530.12:538.3 3843

On the Kinematics of Uniformly Accelerated Motions and Classical Electromagnetic Theory—E. L. Hill. (*Phys. Rev.*, vol. 72, pp. 143-149; July 15, 1947.) "A study is made of the 4-dimensional conformal group of transformations in space-time as the extension of the Lorentz group permitting the introduction of uniformly accelerated reference frames into relativity theory. The problem of the motion of a particle is discussed, as well as the implications for the classical-type electron theory developed by Dirac."

534.11:621.392.029.64 3844

A Mechanical Analogy of Transverse Electric Waves in a Guide of Rectangular Section—R. E. B. Makinson. (*Jour. Sci. Instr.*, vol. 24, pp. 189-190; July, 1947.) If a stretched rubber strip is clamped at the edges and excited transversely at one end, its vertical displacement and slope at any point correspond to the electric and magnetic vectors respectively. Such a model can be used to predict the effects of various waveguide configurations on H_{0m} waves.

535.338 3845

The Molecular Beam Magnetic Resonance Method. The Radiofrequency Spectra of Atoms and Molecules—J. B. M. Kellogg and S. Millman. (*Bell Sys. Tech. Jour.*, vol. 26, p. 391; April, 1947.) Summary of 1731 of July.

535.343.31-31:[546.212+546.212.02] 3846

Inter-Molecular Vibration Spectrum of Water—R. C. Johnson, R. C. Weidler, and D. Williams. (*Phys. Rev.*, vol. 72, p. 158; July 15, 1947.) Summary of Amer. Phys. Soc. paper. Studies of the spectra of liquid H_2O and D_2O between 1.5μ and 24μ . The observed absorption extends from 10μ to 21μ for H_2O , and from 12μ to 22μ for D_2O .

536.48 3847

Low-Temperature Physics and the Theory of Metals—E. B. Mendoza. (*Metal Treat.*, vol. 14, no. 49, pp. 20-28; Spring, 1947.) A description of the techniques used, including that for obtaining temperatures below $1^\circ K$ by adiabatic

demagnetization of a paramagnetic salt, together with an account of the impact of these techniques on the theory of atomic structure.

537.228.1:621.396.611.21 3848

Thermal Voltage of a Quartz Crystal—R. K. Cook, M. Greenspan, and P. G. Weissler. (*Phys. Rev.*, vol. 72, p. 175; July 15, 1947.) Summary of Amer. Phys. Soc. paper. The mean-square noise voltage is given by $C_1 k T / C_0^2$, where C_1 is the crystal capacitance and C_0 is the input capacitance of the amplifier plus the shunt capacitance of the crystal. The noise spectrum is concentrated in the region of the resonant frequency of the crystal. At $0.01^\circ K$ the peak charge would be about one electron.

537.291 3849

Control of Electron-Beam Dispersion at High Vacuum by Ions—L. M. Field, K. Spangenberg, and R. Helm. (*Elec. Commun.*, vol. 24, pp. 108-121; March, 1947.) Based on the book referred to in 4071 below. When a high-density electron beam is passed through a field-free drift space, a dispersion of the beam occurs at much higher gas pressures than was expected from previous theories. A new approximate theory of positive ion removal (i.e., from the beam) is given which has had considerable success in predicting the effects observed. Further, as a result of the new theory, an "ion trap" has been invented which prevents such dispersion.

537.291:621.384.1.032.21 3850

Cathode-Design Procedure for Electron-Beam Tubes—Helm, Spangenberg, and Field. (See 4071.)

537.312.62 3851

The Practical Possibilities of Superconductivity—K. M. Koch. (*Elektrotech. und Maschinenb.*, vol. 64, pp. 125-130; July and August, 1947.) A review of present knowledge including experimental results of many investigators, and a discussion of applications to magnetic screening, photo cells and h.f. circuits. The importance of developing improved refrigeration technique is stressed. A new theory appears to be necessary to account for all the phenomena.

537.312.62 3852

The Magnetic Threshold Curves of Superconductors—J. G. Daunt. (*Phys. Rev.*, vol. 72, pp. 89-90; July 1, 1937.) Discussion of experimental results favors the view that the threshold curves are approximately parabolic functions of temperature. The 3 to 2-power function suggested by Sienko and Ogg (*Phys. Rev.*, vol. 71, p. 319) is not supported by known magnetic or calorimetric data.

537.312.62:621.396.622 3853

Radio Frequency Detection by Superconductivity—D. H. Andrews and C. W. Clark. (*Phys. Rev.*, vol. 72, p. 161; July 15, 1947.) Summary of Amer. Phys. Soc. paper. A r.f. voltage modulated at 400 c.p.s. is detected by a strip of superconducting CbN. There are several temperature zones of detection which increase with applied d.c. but are independent of frequency. The intensity of detection varies widely with frequency.

537.5 3854

The Kelvin Lecture. Electrical Discharge through Gases—I. B. Loeb. (*Electrician*, vol. 138, pp. 1162-1164; May 2, 1947.) A historical review of the subject.

537.523.3 3855

Notes on Impulse Corona Studies in Air—H. J. Hall. (*Phys. Rev.*, vol. 72, p. 185; July 15, 1947.) Summary of Amer. Phys. Soc. paper. Results obtained with positive and negative pulses up to 60 kv., of duration 1 to 2 microseconds and repetition rates 250 to 2000 per second.

537.525:621.385.18 3856

The Effect of a Direct Current Potential on the Initiation of a Radiofrequency Discharge—F. Kirchner. (*Phys. Rev.*, vol. 72, p. 348; August 15, 1947.) The effect discussed by Varela (2937 of September) was described by the author in 1925 (*Ann. Phys.*, (Lpz.), vol. 77, p. 287) and a satisfactory explanation given.

537.531:535.341 3857

Contribution to the Study of the Measurement of the Absorption of X Rays by Matter—J. Devaux. (*Ann. Radioélec.*, vol. 2, pp. 109-132; April, 1947.) A complete account of the author's method (2069 of August) with practical apparatus details and applications to organic liquids, H, C, O, N and to the point-to-point study of the composition of a binary alloy.

537.56:535.61-31 3858

Ion-Content of Air Irradiated by Ultraviolet Light—G. R. Wait. (*Phys. Rev.*, vol. 72, p. 158; July 15, 1947.) Summary of Amer. Phys. Soc. paper. The number and mobility of various types of ions were examined. The results suggest an explanation for the coincidence of radio fade-outs and solar flares.

537.583:621.385.1.032.216 3859

Variations in the Constants of Richardson's Equation as a Function of Life for the Case of Oxide Coated Cathodes on Nickel—H. Jacobs and G. Hees. (*Phys. Rev.*, vol. 72, p. 174; July 15, 1947.) Summary of Amer. Phys. Soc. paper.

538.11 3860

The Mechanism of Magnetic Attraction—G. W. O. H. (*Wireless Eng.*, vol. 24, pp. 253-254; September, 1947.) The observed effects are explained by considering the forces acting on orbital electrons in a nonuniform magnetic field.

538.221 3861

Ferromagnetic Resonance at Microwave Frequencies—W. A. Yager and R. M. Bozorth. (*Phys. Rev.*, vol. 72, pp. 80-81; July 1, 1947.) "Supermalloy" foils were used as the narrow walls of a resonant cavity formed from a section of rectangular guide. The cavity was connected through a standing-wave detector to a 1.25-centimeter wavelength source; measurements were made of the apparent permeability as a function of the strength of a static magnetic field applied in the plane of the foils. From the characteristics of the sharp resonance phenomenon observed at $H=4920$ oersteds, a value of 2.17 for the Landé splitting factor was derived. The experimental results were also consistent with a relaxation time of 1.2×10^{-9} second using a damping term of the form suggested by Frenkel. See also 747 of April (Griffiths).

538.3 3862

On the Electromagnetic Energy of an Isolated System—L. Bloch. (*Rev. Gén. Élec.*, vol. 56, pp. 270-275; June, 1947.) Various classical expressions for electromagnetic energy are cited, including the case where the medium is the seat not only of charges and currents, but also of electric and magnetic moments. It is shown that the Maxwell-Lorentz theory includes a term of simple form for the interaction between the ether and matter. The possible use of a similar term is suggested when the electromagnetic field is replaced by a meson field and the electrons by neutrons. This would help in understanding the passage from electromagnetic physics to nuclear physics.

538.3 3863

Electromagnetic Field of Multipoles—V. Berestetski. (*Zh. Eksp. Teor. Fiz.*, vol. 17 no. 1., pp. 12-18; 1947. In Russian.)

- 538.56** **3864**
Electromagnetic Waves in a Vacuum: Relative Directions of the Electric and Magnetic Vectors—G.W.O.H. (*Wireless Eng.* vol. 24, p. 277; September, 1947.) Comment on 3503 of December (Japolsky).
- 538.566** **3865**
Calculation of the Reflecting Power of an Arbitrarily Stratified System—A. Herpin. (*Compt. Rend. Acad. Sci.*, (Paris) vol. 225, pp. 182–183; July 21, 1947.) A method using a matrix characteristic of each medium, such that the corresponding matrix for passage from the first to the last medium is simply the non-commutative product of the partial matrices. Reflection and transmission formulas are given. The method can be extended to isotropic layers for any incidence, doubly refracting layers, etc.
- 538.569.4.029.64** **3866**
Paramagnetic Resonance Absorption at 9000 Mc/s for Five Salts of the Iron Group—R. L. Cumberow, D. Halliday, and G. E. Moore. (*Phys. Rev.*, vol. 72, p. 173; July 15, 1947.) Summary of Amer. Phys. Soc. paper.
- 538.569.4.029.64** **3867**
Stark and Zeeman Effects in Microwave Spectroscopy—D. K. Coles and W. E. Good. (*Phys. Rev.*, vol. 72, p. 157; July 15, 1947.) Summary of Amer. Phys. Soc. paper.
- 538.569.4.029.64:546.171.1** **3868**
Precision Frequency Measurements of Microwave Absorption Lines and Their Fine Structure—W. E. Good and D. K. Coles. (*Phys. Rev.*, vol. 72, p. 157; July 15, 1947.) Summary of Amer. Phys. Soc. paper. The absorption frequencies of ammonia and other gases have been measured with accuracy better than 1 in 106. Frequency markers 0.008-centimeter⁻¹ apart are provided in the 1.25-centimeter region by harmonics from a 240-Mc. crystal-controlled oscillator. When frequencies are plotted against rotational quantum numbers, the results show deviations from a smooth curve, which are interpreted as a K-type doubling for which only one component of the doublet exists. See also 3097 of November.
- 538.569.4.029.64:546.171.1** **3869**
Hyperfine Structure in the Microwave Spectrum of Ammonia—R. J. Watts and D. Williams. (*Phys. Rev.*, vol. 72, p. 157; July 15, 1947.) Summary of Amer. Phys. Soc. paper. Recent studies are discussed and the observed spacings and relative intensities of the satellite lines are compared with the theoretically predicted values.
- 538.569.4.029.64:546.171.1** **3870**
Collision Broadening of the Inversion Spectrum of Ammonia at Centimetre Wavelengths: Part 1—Self-Broadening at High Pressure—B. Bleaney and R. P. Penrose. (*Proc. Phys. Soc. (London)*, vol. 59, pp. 418–428; May 1, 1947.) Experiments on the absorption spectrum of ammonia between 0.6 and 0.9 centimeters⁻¹ are described, and the absorptions at pressures of 10- and 60-centimeters Hg are compared with those computed from the measurements on individual lines at a pressure of 0.5-centimeter Hg (3507 of December) assuming that line widths are proportional to pressure. At 60-centimeter pressure, the observed attenuation at the lower frequencies is greater than that computed; reasons for this are discussed.
- 538.569.4.029.64:546.171.1** **3871**
[Suggested Explanation of] Anomalous Values of Certain of the Fine Structure Lines in the Ammonia Microwave Spectrum—H. H. Nielsen and D. M. Dennison. (*Phys. Rev.*, vol. 72, pp. 86–87; July 1, 1947.)
- 538.569.4.029.64:546.265.2** **3872**
The Microwave Absorption Spectrum of Carbonyl Sulfide—R. E. Hillger, M. W. P. Strandberg, T. Wentink, and R. L. Kyhl. (*Phys. Rev.*, vol. 72, p. 157; July 15, 1947.) Summary of Amer. Phys. Soc. paper.
- 538.632** **3873**
On the Sign of the Hall Effect—A. Carrelli. (*Nuovo Cim.*, vol. 3, pp. 40–49; February 1, 1946. In Italian, with English summary.) A modern interpretation of the effect is considered and applied to Bi. Measurements of the Hall constants for Bi-Sb alloys are given and discussed.
- GEOPHYSICAL AND
EXTRATERRESTRIAL PHENOMENA**
- 523.53:621.396.82** **3874**
The Radio Detection of Meteor Trails and Allied Phenomena—E. V. Appleton and R. Naismith. (*Proc. Phys. Soc. (London)*, vol. 59, pp. 461–472; May 1, 1947. Discussion, pp. 472–473.) The results of observations of (a) transient bursts of atmospheric ionization and (b) abnormal or sporadic E-layer ionization, are described; these effects are explained as due largely to sporadic meteors.
- 523.53:621.396.82** **3875**
Whistling Meteors—D. W. Heightman and T. W. Bennington. (*Wireless World*, vol. 53, p. 219; June, 1947.) Comment on 2407 of September (Garratt).
- 523.7+550.385**“1947.01/.03” **3876**
Solar and Magnetic Data, January to March, 1947, Mount Wilson Observatory—S. B. Nicholson. (*Terr. Mag. Atmo. Elec.*, vol. 52, p. 268; June, 1947.)
- 523.74:550.38** **3877**
A Slow Corpuscular Radiation from the Sun—K. O. Kiepenheuer. (*Astrophys. Jour.*, vol. 105, pp. 408–423; May, 1947.) Experimental data are presented showing that the solar filaments are sources of a slow corpuscular radiation having a mean speed of about 500 kilometers per second. Sunspots and coronal patches in the neighborhood of the filaments destroy the correlation between the received corpuscular radiation and the filaments. The phenomena are also discussed from a theoretical standpoint; the calculated corpuscular speed is in agreement with the observed value.
- 523.746:550.385** **3878**
Sunspots and Telegraphy—C. H. Cramer. (*Elec. Eng.*, vol. 66, pp. 557–560; June, 1947.)
- 523.746**“1947.01/.03” **3879**
Provisional Sunspot-Numbers for January to March, 1947—M. Waldmeier. (*Terr. Mag. Atmo. Elec.*, vol. 52, p. 174; June, 1947.)
- 523.75:550.385** **3880**
Magnetic Effects of Visible Solar Eruptions—P. Bernard. (*Compt. Rend. Acad. Sci.*, (Paris), vol. 224, pp. 1811–1813; June 30, 1947.) Several instances are quoted where observed solar eruptions have been accompanied by sharp variations of one or more of the magnetic elements (*H*, *V* and *D*). A possible explanation is given of time discrepancies between eruptions and corresponding magnetic variations.
- 523.75:550.385:621.396.11** **3881**
Solar Limb Flare and Associated Radio Fade-Out, April 15, 1947—E. T. Pierce. (*Nature*, (London), vol. 160, p. 59; July 12, 1947.) Severe magnetic disturbances on April 17 and 18 and a major radio fade-out on April 15 are correlated with the appearance of a flare on the south-west edge of the sun's disk on April 15.
- 537.591** **3882**
Various Papers on Cosmic Rays—(*Phys. Rev.*, vol. 72, pp. 171–173; July 15, 1947.) Summaries of the following papers at the Washington Meeting of the Amer. Phys. Soc., May, 1947: The Latitude Effect of the Mesotron Component up to Elevations of 35,000 Feet, by M. Schein, P. S. Gill, and V. Yngve. Discussion of a Possible Method for Measuring Masses of Cosmic-Ray Mesotrons, by W. H. Furry. Positive Excess of Slow Mesotrons at an Altitude of 11,500 Feet, by M. Correll. Theoretical Considerations on Large Air Showers, by H. A. Bethe. Interpretation of Cosmic-Ray Ionization Bursts in Cylindrical Chambers by Pulse Shapes, by H. Bridge. A Study of the Structure of Air Showers at 11,500 Feet, by R. W. Williams and B. Rossi. Cosmic-Ray Induced Nuclear Disintegrations at 11,500 feet, by B. Rossi and R. W. Williams. High Energy Cosmic-Ray Air Showers, by P. J. Ovrebo and H. L. Kraybill. Atmospheric Showers of Cosmic Rays, by C. G. Montgomery and D. D. Montgomery. A V-2 Cosmic-Ray Experiment, by C. J. Perlow. Further Cosmic-Ray Experiments Above the the Atmosphere, by E. H. Krause and S. E. Gollan. Methods in Cosmic-Ray Measurement in Rockets, by L. W. Fraser, R. P. Petersen, H. E. Tatel, and J. A. Van Allen.
- 537.591** **3883**
On the Measurement of the Intensity of Cosmic Radiation by the Telescope Method—S. A. Azimov, V. I. Veksler, N. A. Dobrotin, G. B. Zhdanov, and A. L. Liubimov. (*Zh. Eksp. Teor. Fiz.*, vol. 17, no. 1, pp. 79–86; 1947. In Russian.)
- 537.591** **3884**
Measurements of Cosmic Ray Intensity at 3860 m and 5000 m above Sea Level—S. A. Azimov, V. I. Veksler, G. B. Zhdanov, and A. L. Liubimov. (*Zh. Eksp. Teor. Fiz.*, vol. 17, no. 2, pp. 87–91; 1947. In Russian.)
- 537.591** **3885**
On the Absorption and Disintegration of Mesons when Stopped—M. Conversi, E. Pancini, and O. Piccioni. (*Nuovo Cim.*, vol. 3, pp. 372–390; December 1, 1946.)
- 537.591** **3886**
On the [cosmic ray] Electron Component of the Lower Atmosphere—G. Bernardini, B. N. Cacciapuoti, and B. Querzoli. (*Nuovo Cim.*, vol. 3, pp. 349–371; December 1, 1946. In Italian, with English summary.)
- 537.591** **3887**
Measurement of the Slow Meson Intensity at Several Altitudes—B. Rossi, M. Sands, and R. F. Sard. (*Phys. Rev.*, vol. 72, pp. 120–125; July 15, 1947.)
- 537.591:5** **3888**
The Place of Cosmic Ray Research in the Physical Sciences—P. M. S. Blackett. (*Science and Culture (Calcutta)*, vol. 12, pp. 514–519; May, 1947.) The particles composing cosmic radiation are of fundamental importance because of their extremely high energy. Cosmic-ray research has also provided experimental confirmation of the existence of atomic particles predicted by nuclear theory, and has important connections with cosmology, geomagnetism, and meteorology.
- 537.591:5** **3889**
Experimental and Theoretical Evaluation of the Density Spectra of Extensive Showers—G. Cocconi, A. Loverdo, and V. Tongiorg. (*Nuovo Cim.*, vol. 3, pp. 50–56; February 1, 1946. In Italian, with English summary.)
- 537.591:5** **3890**
The Transition Effect for Large Bursts of Cosmic-Ray Ionization: Part 2—C. G. Montgomery and D. D. Montgomery. (*Phys. Rev.*, vol. 72, pp. 131–134; July 15, 1947.) For part 1 see *Phys. Rev.*, vol. 56, p. 640; 1939.

- 538.12:521.15 3891
Magnetic Fields of Astronomical Bodies—H. W. Babcock. (*Phys. Rev.*, vol. 72, p. 83; July 1, 1946.) "... within the uncertainties of the observations, the magnetic dipole moments of the earth, sun, and 78 Virginis ... are proportional to their angular momenta. ..." On the assumption that this proportionality has universal application, numerical deductions are made concerning the magnetic moment of the Andromeda Nebula (M31). See also 3112 of November (Blackett) and 3892 below.
- 538.12:521.15 3892
On the Magnetism of Masses in Rotation—A. Giau. (*Compt. Rend. Acad. Sci.*, (Paris) vol. 224, pp. 1813-1815; June 30, 1947.) It is shown that Blackett's formula for the magnetic moment of a quasi-spherical rotating mass (3112 of November) can be deduced very easily from the author's unitary theory of gravitation and electromagnetism. (*Portugaliae Phys.*, vol. 2, no. 1, pp. 1-98; 1946. *Portugaliae Math.* vol. 5, no. 3, pp. 145-192; 1946.) See also 3891 above.
- 550.372 3893
A New Method for the Determination of the Electric Constants of the Earth's Surface—K. F. Niessen. (*Philips Res. Rep.*, vol. 1, pp. 465-475; December, 1946.) Two vertical transmitting dipoles are used, one situated immediately above the other, and the other dipole is rotated slowly in a vertical plane. The phase difference is measured between the signals received from the two dipoles in a very distant high-flying aircraft moving towards the dipoles along a line in the plane of rotation of the upper dipole. From a knowledge of the two positions of the rotating dipole at which the phase difference is (a) zero, and (b) changes discontinuously by π , it is possible to calculate the dielectric constant and conductivity of the ground.
- 550.38"1945" 3894
Mean Monthly Values of Magnetic Elements, Christchurch, New Zealand, All Days of 1945—H. F. Baird. (*Terr. Mag. Atmo. Elec.*, vol. 52, p. 188; June, 1947.)
- 550.38"1946.07/.12" 3895
Five International Quiet and Disturbed Days for July to December 1946—W. E. Scott. (*Terr. Mag. Atmo. Elec.*, vol. 52, p. 265; June, 1947.)
- 550.384.4:551.594 3896
Electric Current as a Probable Cause of Daily Magnetic Variation—K. Terada. (*Terr. Mag. Atmo. Elec.*, vol. 52, pp. 189-200; June, 1947.) Translation of a Japanese paper read in 1941 at a meeting of the Physico-Mathematical Society of Japan.
 Simple formulas are derived for estimating, from observed magnetic data, the height of the ionospheric current sheet which could cause the daily variations of the earth's magnetic field. It is concluded that the height is about 100 kilometers, and that the implications of this result are in agreement with ionospheric radio-exploration data.
- 550.385"1931/1940" 3897
Dual Laws of the Course of Magnetic Disturbances and the Nature of Mean Regular Variations—A. P. Nikolsky. (*Terr. Mag. Atmo. Elec.*, vol. 52, pp. 147-173; June, 1947.) An analysis of magnetic storm data obtained from high-latitude observatories of the U.S.S.R. particularly Tikhaya Bay, during 1931 to 1940.
- 550.385"1947.01/.03" 3898
Principal Magnetic Storms [January to March, 1947]—(*Terr. Mag. Atmo. Elec.*, vol. 52, pp. 270-288; June, 1947.)
- 551.51:525.624 3899
Atmospheric Oscillations—(*Observatory*, vol. 67, pp. 128-131; August, 1947.) Report of Royal Astronomical Society discussion, January, 1947.
- 551.510.5:525.624:550.384 3900
Terrestrial Influences in the Lunar and Solar Tidal Motions of the Air—O. R. Wulf and S. B. Nicholson. (*Terr. Mag. Atmo. Elec.*, vol. 52, pp. 175-182; June, 1947.)
- 551.510.53 3901
Exploration of the Upper Atmosphere by Means of Rockets—H. E. Newell, Jr. (*Sci. Mon.*, vol. 64, pp. 453-463; June, 1947.) Details of some of the special equipment used in V-2 rocket experiments at White Sands, New Mexico, including spectroscopy and cosmic-ray apparatus, telemetering, etc. A full account of the contribution of the Naval Research Laboratory is given in Upper Atmosphere Reports No. 1 and No. 2 (*Naval Research Laboratory Reports* R-2955 and R-3030, October 1, and December 30, 1946.)
- 551.510.535 3902
The True Height of an Ionospheric Layer—J. A. Pierce. (*Phys. Rev.*, vol. 71, pp. 698-706; May 15, 1947.) A method is described "for the analysis of ionospheric sweep-frequency records in terms of the scale height and true height of maximum of the layer of Chapman form which most closely fits the observed data. It is shown that the height of maximum determined by the method of Appleton [395 of 1938], Booker, and Seaton [2145 of 1940] is the height of a parabolic layer which is not coincident with the parabola that most closely fits the Chapman distribution.
- 551.510.535 3903
On the Evaluation of the Parameter σ_s in Chapman's Formula for Determining the Ionic Density of the E-Layer—M. M. Sengupta and S. K. Dutt. (*Indian Jour. Phys.*, vol. 21, pp. 1-6; February, 1947.) σ_s has a diurnal and seasonal variation between the limits 0.1 and 0.02 for latitudes 24° to 30° N or S.
- 551.593.9+551.594.5 3904
Emission Spectra of the Night Sky and Aurorae—A.H. (*Observatory*, vol. 67, pp. 121-127; August, 1947.) Report of an international conference in London in July, 1947.
- 551.594 3905
Currents of Atmospheric Electricity—J. A. Chalmers and E. W. R. Little. (*Terr. Mag. Atmo. Elec.*, vol. 52, pp. 239-260; June, 1947.) Description of recordings of the charge brought to an electrically isolated area by conduction and precipitation, and of the apparatus used. Point-discharge is also considered. Some special phenomena are analyzed.
- 551.594:550.384.4 3906
Diurnal Variations of Computed Electric Currents in the High Atmosphere—E. Sucksdorff. (*Terr. Mag. Atmo. Elec.*, vol. 52, pp. 201-215; June, 1947.)
- 551.594.21 3907
Some Aspects and Recent Results of Electromagnetic Effects of Thunderstorms—H. A. Norinder. (*Jour. Frank. Inst.*, vol. 244, pp. 109-129 and 167-207; August and September, 1947.) "A comprehensive article concerning the electromagnetic properties and effects of lightning discharges obtained at the Institute [of High Tension Research in the University of Uppsala, Sweden] mainly during the war time and up to date." See also 3804 of 1945 and 1784 of July.
- 551.594.21 3908
Atmospheric Electricity and Lightning—J. Frenkel. (*Jour. Frank. Inst.*, vol. 243, pp. 287-
- 307; April, 1947.) Author's translation of a Russian paper. See also 2186 of 1946.
- LOCATION AND AIDS TO NAVIGATION**
- 534.88:534.417 3909
The German Use of Sonic Listening—Holt. (See 3758.)
- 621.396.933 3910
Radio Technique in the Service of Long-Range Navigation [Loran]—E. Ya. Shchegolev. (*Nauki i Zhizn*, no. 2, pp. 2-7; 1947. In Russian.)
- 621.396.933:621.396.96:629.139.83 3911
Landing Aircraft with Ground Radar—J. S. Engel. (*Elec. Commun.* (London), vol. 24, pp. 72-81; March, 1947.) Description of a mobile equipment for assisting the landing of aircraft under conditions of poor visibility. A 10-centimeter search radar, replaced for the last 10 miles by a 3-centimeter precision radar, is operated from the airfield and corrects the course of the aircraft; appropriate instructions to the pilot are transmitted by R/T on a frequency in the band 100 to 150 Mc. The pilot is thus brought to a position 50 feet above the runway, after which landing is accomplished without further assistance from the ground.
- 621.396.933:629.13.052 3912
Radio Sounder for Measurement of Aircraft Height above Ground—P. Giroud and L. Couillard. (*Ann. Radiotelec.*, vol. 2, pp. 150-172; April, 1947.) A f.m. transmitter on the aircraft radiates vertically downward. The wave reflected from the ground is picked up on a separate receiving aerial and superimposed upon a fraction of the transmitted wave, giving a beat frequency which is directly proportional to the aircraft height. In the case of the "Aviasol" apparatus, the beat-frequency is read directly on a dial instrument with two ranges, 0 to 300 meters and 0 to 1500 meters. Details are given, with photographs and circuit diagrams, of transmitter, receiver, dipole aeriels and indicator.
- 621.396.96 3913
Basic Equations in Radiolocation—S. I. Tetelbaum. (*Radiotekhnika* (Moscow), vol. 2, pp. 24-34; February, 1947. In Russian with English summary.) Relations are derived between the transmitted power, receiver sensitivity and the maximum range for nonradiating objects.
- 621.396.96:621.396.615.17:621.317.755 3914
Radial Time Bases—Dummer and Franklin. (See 3829.)
- 621.396.96:621.396.67 3915
Radar Antennas—Friis and Lewis. (See 3796.)
- MATERIALS AND SUBSIDIARY TECHNIQUES**
- 531.788.7 3916
The Design of an Ionization Manometer Tube—D. L. Hollway. (*Proc. I.R.E.* (Australia), vol. 8, pp. 14-19 and 4-10; April and May, 1947.) A recently developed ionization manometer tube is described having a high sensitivity substantially independent of electrode potential variations. Published measurements of ionization efficiency are compared and used to predict the sensitivity with different gases. Errors from various causes are considered. The curves used in the sensitivity calculation apply to any design.
- 533.5:621.3.032.53 3917
Metal-Ceramic Brazed Seals—R. J. Bondley. (*Electronics*, vol. 20, pp. 97-99; July, 1947.) A new method involves applying titanium hydride to the ceramic, then brazing to metals or similarly prepared ceramics with silver or

- any other metal that melts at 1000°C. The resulting seals are strong and ideal for micro-wave tubes.
- 533.5:621.3.032.53 3918
Glass-to-Metal Seals—N. S. Freedman. (*Metal Ind.* (London), vol. 70, pp. 378-380; May 23, 1947.) A plating process for the electro-deposition of silver on steel to withstand the temperatures encountered in the manufacture of h.f. tubes.
- 535.37 3919
The Short-Period Time Variation of the Luminescence of a Zinc Sulphide Phosphor under Ultra-Violet Excitation—M. P. Lord, A. L. G. Rees, and M. E. Wise. (*Proc. Phys. Soc.* (London), vol. 59, pp. 473-502; May 1, 1947.) A photographic method is described which permits observations up to 400 meters from the end of irradiation. The results are interpreted in terms of a bimolecular law, assuming two types of activating center.
- 535.37:621.385.832 3920
The Efficiency of Cathodoluminescence as a Function of Current Density—S. Lasof. (*Phys. Rev.*, vol. 72, p. 165; July 15, 1947.) Summary of Amer. Phys. Soc. paper.
- 535.37:621.385.832 3921
Performance Characteristics of Long-Persistence Screens, Their Measurement and Control—R. E. Johnson and A. E. Hardy. (*Phys. Rev.*, vol. 72, p. 165; July 15, 1947.) Summary of Amer. Phys. Soc. paper. The efficiency of the primary-layer (phosphorescent) phosphor bears no consistent relation to screen performance, unless a method of pulsed light excitation is used. Average curves are given which show the variation of performance with baking temperature and the construction of the phosphor.
- 535.37:621.397.5:621.385.832 3922
Application of the I.C.I. Color System to the Development of the All Sulphide Television White Screen—A. E. Hardy. (*Phys. Rev.*, vol. 72, p. 166; July 15, 1947.) Summary of Amer. Phys. Soc. paper.
- 538.213 3923
Complex Permeability of Permalloy—M. H. Johnson, G. T. Rado, and M. Maloof. (*Phys. Rev.*, vol. 72, pp. 173-174; July 15, 1947.) Summary of Amer. Phys. Soc. paper. The behavior of 45-Permalloy and Mo-Permalloy is similar to that of magnetic iron. For method of measurement see 2852 of October and 3182 and 3183 of November.
- 546.41/.431].64:621.385.1.032.21 3924
The Methods of Manufacture of Carbonates for Valve Cathodes—C. Biguet and C. Mano. (*Le Vide* (Paris), 6 pp.; July to September, 1946. Reprint.) Methods for the carbonates of Ba, Sr, and Ca. The crystalline structure depends on the method used and this may account for observed differences in the emissive properties.
- 548.0:537:546.331.2 3925
Elastic, Piezoelectric, and Dielectric Properties of Sodium Chlorate and Sodium Bromate—W. P. Mason. (*Bell Sys. Tech. Jour.*, vol. 26, pp. 391-392; April, 1947.) Summary of 752 of April.
- 549.514.51 3926
Variations in Crystal Quartz—C. P. Glover and K. S. Van Dyke. (*Phys. Rev.*, vol. 72, p. 175; July 15, 1947.) Summary of Amer. Phys. Soc. paper.
- 620.197:669.58 3927
Zinc Plating for Correction Resistance and Decorative Finishing—W. F. Coxon. (*Metal Treat.*, vol. 14, no. 49, pp. 38-40; Spring, 1947.)
- 620.197:679.5 3928
Stabilizing Electrical and Mechanical Characteristics of Circuits [by Embedding Them in a Casting Resin]—*Electronics*, vol. 20, pp. 136, 138; July, 1947.) A suitable resin, developed by the National Bureau of Standards, has the required h.f. characteristics, quick polymerization with small volume change at low temperature and atmospheric pressure, and low viscosity and surface tension so that it penetrates into small openings.
Rubber jackets fitted round tubes protect them from thermal and mechanical shock.
- 621.315.611.011.5+537.226.3 3929
The Relation Between the Power Factor and the Temperature Coefficient of the Dielectric Constant of Solid Dielectrics: Part 5—M. Gevers. (*Philips Res. Rep.*, vol. 1, pp. 447-464; December, 1946.) Results are given of measurements of the power factor and of the temperature coefficient of the dielectric constant of a number of well-known materials as functions of temperature and frequency. Anomalous cases are discussed. It is shown that all the experimental results are in accordance with the theory advanced in part 4 (3572 of December).
- 621.315.612.4:546.431.823:538.662.13 3930
Curie Point of Barium Titanate—M. G. Harwood, P. Popper, and D. F. Rushman. (*Nature* (London), vol. 160, pp. 58-59; July 12, 1947.) A range of temperatures, 122° to 129°C, is found in which the tetragonal and cubic forms of BaTiO₃ coexist, the cubic phase appearing at 122°C and the tetragonal disappearing at 129°C. A high permittivity maximum is observed at 125°C.
- 621.315.616 3931
Low-Loss Plastic Insulation Materials—J. H. Parliman. (*Electronics*, Buyers' Guide Issue, vol. 20, pp. 116-121; June, 1947.) Electrical, mechanical, and chemical properties of materials commercially available are tabulated and briefly discussed.
- 621.315.616 3932
The Current-Creep Problem with Artificial [Insulating] Materials—B. Frischmuth. (*Schweiz. Arch. Angew. Wiss. Tech.*, vol. 10, pp. 156-160; May, 1944.) Discusses the mechanism of current creep and tracking. The author considers an irregular distribution of surface conductivity necessary for the occurrence of current creep.
- 621.315.62:621.315.612.6 3933
Toughened Glass Insulators—(*Elec. Rev.* (London), vol. 141, pp. 461-466; September 26, 1947.) Description of production processes for pin-type (6.6 to 33 kv.) and disk-type insulators for power lines with mechanical strengths up to 60,000 pounds. See also 875 of 1941 (Hogg: E.R.A.)
- 621.316.99 3934
Present-Day Technique of Earthing of Electrical Installations—D. Petrocokino. (*Rev. Gén. Élec.*, vol. 56, pp. 193-217; May, 1947.) A comprehensive review, including discussion of methods for protection of apparatus and personnel and for lightning protection, earthing of neutral points of power systems, etc. Consideration of shock effects shows that many old types of earth connection are very inefficient. Earthing technique requires revision.
- 621.318.2 3935
Permanent Magnets—J. L. Salpeter. (*Proc. I.R.E.* (Australia), vol. 8, pp. 8-14, 10-17, 4-8, and 4-17; April to July, 1947.) A comprehensive discussion of (a) the demagnetization curve and the figure of merit for a permanent magnet, (b) the nature of ferromagnetism and ferromagnetic alloys, and (c) magnetic anisotropy and magnetic hardness.
- 621.318.2:518.4 3936
Permanent Magnets—"Cathode Ray"—(*Wireless World*, vol. 53, pp. 300-306; August, 1947.) Methods for obtaining the data necessary for the design of a permanent magnet with given air-gap dimensions and flux density. General procedures, based on the relations between magnetic flux, reluctance, and magnetomotive force, are deduced by analogy with Ohm's law. Approximate graphical methods are outlined, using data obtainable from the B-H curve, and are illustrated by practical examples.
- 621.318.22 3937
Modern Magnetic Materials—H. E. Finke. (*Materials and Methods*, vol. 25, pp. 72-76; June, 1947.) Comparison of the physical and mechanical properties of modern magnetic alloys including the alnicos, cunife, cunico, vectolite, and silmanal.
- 621.318.323.2.042.15 3938
Permeability of Dust Cores—P. R. Bardell. (*Wireless Eng.*, vol. 24, p. 249; August, 1947.) Reply to 3163 of November (Friedlaender).
- 621.318.323.042.15 3939
Permeability of Dust Cores—H. W. Lamson. (*Wireless Eng.*, vol. 24, pp. 267-270; September, 1947.) Expressions are derived for the longitudinal and transverse permeabilities of dust cores in terms of the dimensions of the magnetic granules, and other parameters. The ratios of the longitudinal to the transverse permeabilities are functions of the elongation of the granules; measurements of these permeabilities, made on a molybdenum-permalloy dust core, confirm Bardell's hypothesis of granular elongation (1693 of July). See also 3555 of December and back references.
- 621.357.9:669.27-426 3940
An Electrolytic Method for Pointing Tungsten Wires—W. G. Pfann. (*Metals Tech.*, vol. 14, TP2210, 4 pp.; June, 1947.) For forming points on wires 0.002 to 0.01 inch in diameter such as are required in crystal rectifiers. An aqueous potassium hydroxide solution containing a certain amount of copper is used as the electrolyte. Summary in *Metal Ind.* (London), vol. 71, p. 110, 112; August 8, 1947.
- 621.775.7:016 3941
Powder Metallurgy: An Indexed Bibliography of the Literature: Part 1—G. H. S. Price. (*Metal Treat.*, vol. 14, no. 49, pp. 42-65; Spring, 1947.) Over 600 references are given.
- 621.775.7:669.337 3942
Electrolytic Copper Powder—(*Metal Ind.* (London), vol. 71, pp. 226-227; September 12, 1947.) Abstract of B.I.O.S. report on production methods in Germany.
- 621.791.353:669.018.21 3943
Metallic Joining of Light Alloys: Parts 5 to 7—(*Light Metals*, vol. 10, pp. 214-223, 273-275, and 365-368; May, June, and July, 1947.) Application of electrical fusion to the joining of Al wire and strip; survey of patent literature on typical apparatus; theory and techniques of flame welding of Al. For parts 1 to 4, see 2152 of August and 2467 of September. To be continued.
- 621.946.148.12 3944
New Diamond Die Drilling Method Revolutionizes Industry—(*Jour. Frank. Inst.*, vol. 243, pp. 424-428; May, 1947.) A new method for small dies used in drawing and shaping extremely hard and fine wire has been developed at the National Bureau of Standards. The process is carried out in ten steps combining h.v. electrical, i.v. electrolytic, and mechanical drilling, requires no specially skilled operators, produces better dies and saves almost 100 man-hours compared with older processes. For

a complete account see *Jour. Res. Nat. Bur. Stand.*, vol. 38, pp. 449-464; May, 1947. (C. G. Peters *et al.*).

669.14:538.652:621.314.1/.2 3945

Magnetostriction of Transformer Steel subjected to Thermomagnetic Treatment—Ya. S. Shur and A. S. Khokhlov. (*Zh. Eksp. Teor. Fiz.*, vol. 17, no. 1, pp. 7-11; 1947. In Russian.)

669.152.5 3946

A New Magnetic Alloy—(*Machinery* (London), vol. 70, p. 490; May 8, 1947.) "Hipercor," a new ductile alloy for motors and generators. For another account see 2820 of October.

678:016 3947

Advances in Rubber during 1946—E. F. Riesing and J. O. Calouette. (*Mech. Eng.*, vol. 69, pp. 373-379; May, 1947.) A review of developments in synthetic and natural rubbers, vulcanization, etc., with a bibliography of 172 papers.

679.5:016 3948

Advances in Plastics during 1946—H. M. Richardson. (*Mech. Eng.*, vol. 69, pp. 370-372, 382; May, 1947.) A short review of progress, with a bibliography of 118 papers.

679.5 3949

British Catalogue of Plastics [Book Review]—E. Molloy (Ed.). National Trade Press, London, 704 pp., 50s. (*Elec. Rev.* (London), vol. 140, p. 930; June 6, 1947.) "This guide to selection, processing and uses is encyclopaedic in character and dimensions. . . . Specialist articles by thirty-five contributors are followed by makers' recommendations on moulding, fabricating and finishing. . . . A too-brief reference to uses in the electrical industry is mainly illustrative, while nine pages are devoted to the radio industry."

MATHEMATICS

517.9 3950

Perturbations of Discontinuous Solutions of Non-Linear Systems of Differential Equations—N. Levinson. (*Proc. Nat. Acad. Sci.*, vol. 33, pp. 214-218; July, 1947.)

517.93:621.392 3951

A Note on Van Der Pol's Equation—de Bruijn. (See 3814.)

518.5 3952

Recent Developments in Calculating Machines—D. R. Hartree. (*Jour. Sci. Instr.*, vol. 24, pp. 172-176; July, 1947.) Based on a lecture to the Manchester and District Branch of the Institute of Physics, similar to the account noted in 2480 of September. Photographs of parts of recent United States machines are included here.

518.5 3953

High-Speed Electronic Digital Computers—(*Jour. Frank. Inst.*, vol. 243, pp. 323-326; April, 1947.) A short account of developments contemplated in connection with the production by the National Bureau of Standards of two electronic computers for the Bureau of Census and the Office of Naval Research.

518.5 3954

An Electronic Computer for Crystal Structure Analyses—R. Pepinsky. (*Phys. Rev.*, vol. 72, p. 175; July 15, 1947.) Summary of Amer. Phys. Soc. Paper. For computation of two-dimensional Fourier series connected with electron densities in a crystal unit cell. The method is based on that of Bragg for the summation of simulated interference fringes.

MEASUREMENTS AND TEST GEAR

529.7 3955

Modern Methods of Timekeeping—(*Observatory*, vol. 67, pp. 132-136; August, 1947.)

Report of Royal Astronomical Society discussion, March, 1947, when the relative merits of various methods, including astronomical observation and pendulum and quartz clocks, were considered.

621.317.081.3+53.081.3 3956

The Impending Change in the Electrical Units—F. B. Silsbee. (*Phys. Rev.*, vol. 72, p. 159; July 15, 1947.) Summary of Amer. Phys. Soc. paper. See also 2833 and 2834 of October.

621.317.1.011.5:621.392 3957

Drude's Second Method Applied to the Measurement of Dielectric Permeabilities and to the Determination of Dipole Moments on the $\lambda=10$ cm. Wave—A. P. Kapustin. (*Zh. Eksp. Teor. Fiz.*, vol. 17, no. 1, pp. 30-40; 1947.) In Russian, with English summary.) A magnetron with a ribbon circuit was used to measure the dielectric permeabilities of various binary systems and the dipole moments of molecules.

621.317.3:621.392.029.64 3958

Definition and Measurement of the Coefficient of Reflection in Waveguides—Ortusi. (See 3788.)

621.317.333+621.317.37]:621.315.212.029.6 3959

The Voltage Characteristics of Polythene Cables—R. Davis, A. E. W. Austen, and W. Jackson. (*Jour. I.E.E.* (London), Part I, vol. 94, pp. 283-284; June, 1947. Summary of 3179 of November.)

621.317.336+621.317.733 3960

H.F. Impedance Measurements [Impedance] Bridge for the Range 10 kc/s-6 Mc/s.—L. Katchatouroff and R. Delavenne. (*Câbles and Trans.* (Paris), vol. 1, pp. 61-76; April, 1947. With English summary.) A discussion of the principal features of various types of impedance bridges and a description of a new bridge with equal ratio arms. Special attention was paid to the elimination of parasitic impedances. Results are given of tests made by the Laboratoire Nationale de Radioélectricité.

621.317.336 3961

Impedance Measurements at V.H.F.—E. G. Hills. (*Electronics*, vol. 20, pp. 124-128; July, 1947.) In the region from 44 to 216 Mc. the slotted transmission line is a simple device for measuring impedances. When used with a variable-reactance line that balances out reactive impedances, accuracy of measurement is increased and the apparatus can be readily adapted to measurements of aerial phasing and directivity. The method is suitable for large and rapid changes of frequency.

621.317.34 3962

Highly-Selective Transmission-Measuring Equipment for Communication Circuits—D. G. Tucker. (*Jour. I.E.E.* (London), Part I, vol. 94, p. 282; June, 1947.) Summary of 3181 of November. The full paper is also published in (*Jour. I.E.E.* (London), Part II, vol. 94, pp. 247-252; June, 1947.)

621.317.374 3963

A New Alternating Current Bridge for Precision Measurements—J. W. L. Köhler and C. G. Koops. (*Philips Res. Rep.*, vol. 1, pp. 419-446; December, 1946.) A detailed description of a bridge permitting the use of ratios of 1, 10, 100, and 1000 to 1. With any of these ratios phase differences may be measured with errors not exceeding 10^{-6} radians at frequencies between 1 and 100 kc. Using a variable air capacitor of 50 to 15,000 microfarads as a secondary standard, the losses of any capacitor between 50 microfarads and 1 microfarad can be measured.

The construction allows the ratio to be changed quickly and conveniently. The final design consists of a fixed center part having four

points to which the four branch impedances are connected. An exhaustive analysis of the various factors affecting the performance of the bridge is given.

621.317.39:531.765 3964

A Millisecond Chronoscope—R. S. J. Spilsbury and A. Felton. (*Jour. I.E.E.* (London), Part I, vol. 94, p. 284; June, 1947.) Summary of Measurements Section paper. A portable instrument of simple design. The range is 2.0 to 1000 milliseconds and accuracy is of the order of 0.5 millisecond for short intervals and 0.5 per cent for long intervals. Another summary noted in 1137 of May.

621.317.726 3965

A Pulse Peak Kilovoltmeter—L. U. Hibbard. (*Jour. Sci. Instr.*, vol. 24, pp. 181-186; July, 1947.) The instrument measures pulses of length greater than 0.25 microsecond recurrence frequency not less than 50 c.p.s., and maximum amplitude 30 kv., to an accuracy of 3 per cent. The attenuator is of the capacitor type and incorporates guard rings, so that its characteristics can be calculated accurately. The effects of stray capacitance and of pulse characteristics on the accuracy are discussed.

621.317.738:621.385.1 3966

A Radio-Frequency Interelectrode-Capacitance Meter—F. J. Lehany and W. S. McGuire. (*A.W.A. Tech. Rev.*, vol. 7, pp. 271-282; April, 1947.) The design and calibration of the instrument, which is direct reading in the range 0.0001 to 2 microfarad. A system of interchangeable shielded panels enables it to be used for a wide variety of tubes, with accuracy within 5 per cent.

621.317.76:621.396.621.54 3967

Measurement of Superheterodyne Tracking Errors—H. A. Ross and P. M. Miller. (*A.W.A. Tech. Rev.*, vol. 7, pp. 327-336; April, 1947.) The nominal i.f. of the receiver is heterodyned against a crystal oscillator adjusted to the exact value. The frequency of the resultant beat note is used as a measure of the tracking error over the tuning range.

621.317.79:621.315.212 3968

Theory and Design of the Reflectometer—B. Parzen and A. Yalow. (*Elec. Commun.* (London), vol. 24, pp. 94-100; March, 1947.) The "reflectometer" has been designed for the measurement of standing-wave ratios, reflection coefficient, and power transfer on coaxial lines operated at frequencies of 1000 Mc. and below.

621.317.79:621.396.615.12 3969

A Signal Generator for Frequency and Amplitude Modulation—W. S. McGuire. (*A.W.A. Tech. Rev.*, vol. 7, pp. 283-293; April, 1947.) Output in the range 3 to 14 Mc. is obtained by the beat-frequency method, using a variable-frequency oscillator tunable over the range 23 to 34 Mc. and a constant-frequency 20-Mc. oscillator, derived by multiplication from a 5-Mc. oscillator to which f.m. is applied by a reactance tube, with a maximum deviation of ± 25 kc., giving a maximum deviation of ± 100 kc. in the output. A 400-c.p.s. modulation oscillator is included and provision made for a.m.

621.317.79:621.396.615.12 3970

The Standard Generator, 10 kc/s-55 Mc/s, of the Société Alsacienne de Constructions Mécaniques (S.A.C.M.)—G. Couanault and P. Herreng. (*Câbles and Trans.* (Paris), vol. 1, pp. 155-162; July, 1947. With English summary.) Full details of a generator for which amplitude modulation from 0 to 100 per cent can be provided by a 400-c.p.s. internal oscillator or by an external source of frequency (a) 30 c.p.s. to 15 kc., (b) 50 c.p.s. to 3 Mc., or by a telegraph relay.

- 621.317.79:621.396.615.12]:621.396.621.001.4 3971
Central Signal Generator for [Receiver] Production Testing—F. Miller. (*Electronics*, vol. 20, pp. 100–105; July, 1947.) Modulated frequencies are supplied to 25 test stations. Coupling, impedance matching, attenuator design, radiation and leakage are discussed.
- 621.317.79.089.6:621.396.615.12/.14 3972
A Method of Calibrating Standard-Signal Generators and Radio Frequency Attenuators—G. F. Gainsborough. (*Jour. I.E.E.* (London), Part I, vol. 94, pp. 280–281; June, 1947.) Summary of 3202 of November.
- OTHER APPLICATIONS OF RADIO AND ELECTRONICS**
- 534.321.7/.9].001.8 3973
Applications of Sonic and Ultrasonic Vibrations—A. A. McKenzie and F. Rockett. (*Electronics*, Buyers' Guide Issue, vol. 20, pp. 140–141; June, 1947.) A list, arranged according to frequency, ranging from the killing of germ life in canned foods to submarine detection and the emulsification of immiscible liquids.
- 534.321.9.001.8:621.396.611.21 3974
Laboratory Supersonic Generators and Their Applications—Tscherning. (See 3757.)
- 537.531:535.341 3975
Contribution to the Study of the Measurement of the Absorption of X Rays by Matter—Devaux. (See 3857.)
- 537.533.8 3976
A Microwave Secondary Electron Multiplier—M. H. Greenblatt and P. H. Miller, Jr. (*Phys. Rev.*, vol. 27, p. 160; July 15, 1947.) Summary of Amer. Phys. Soc. paper. Electrons are accelerated between two flat plates by a 3000-Mc. field whose strength is such that the transit time is a half-period, and are finally drawn off, after secondary multiplication, by a positive collector.
- 539.16.08 3977
Portable Geiger-Müller Counters—W. Hushley and K. Feldman. (*Canad. Jour. Res.*, vol. 25, Sec. F, pp. 226–235; May, 1947.) A description of three types of portable G-M counter suitable for field use. The high voltage in each tube is supplied by means of a multi-vibrator circuit, and the pulse from the tube is fed to a trigger circuit which operates headphones. Details of circuit design and application are given.
- 539.16.08 3978
A General Method for Determining Coincidence Corrections of Counting Instruments—T. P. Kohman. (*Phys. Rev.*, vol. 72, p. 181; July 15, 1947.) Summary of Amer. Phys. Soc. paper.
- 539.16.08 3979
Fluctuations for Proportional Counters—H. S. Snyder. (*Phys. Rev.*, vol. 72, p. 181; July 15, 1947.) Summary of Amer. Phys. Soc. paper.
- 539.16.08 3980
Properties of Ion Counters Operating at Low Potentials—J. A. Simpson, Jr. (*Phys. Rev.*, vol. 72, p. 181; July 15, 1947.) Summary of Amer. Phys. Soc. paper.
- 539.16.08 3981
Low Voltage Self-Quenching Counters—S. H. Liebson. (*Phys. Rev.*, vol. 72, pp. 181–182; July 15, 1947.) Summary of Amer. Phys. Soc. paper.
- 539.16.08 3982
The Discharge Mechanism of Self-Quenching G-M Counters—S. H. Liebson. (*Phys. Rev.*, vol. 72, p. 187; July 15, 1947.) Summary of Amer. Phys. Soc. paper.
- 539.16.08:537.525.3:621.316.722.078.3 3983
The Voltage Stabilization Properties of the Continuous Corona Discharge—I. H. Blifford and H. Friedman. (*Phys. Rev.*, vol. 72, p. 185; July 15, 1947.) Summary of Amer. Phys. Soc. paper. An electronic stabilizer using positive wire continuous corona discharge between coaxial cylinders provides regulation to 0.1 per cent at 40 kv. for loads up to 10 ma. See also 1596 of June.
- 551.508.1 3984
A Coding Radiosonde of Rational Design—N. Gibbs, L. Gibbs, and E. W. Pike. (*Phys. Rev.*, vol. 72, p. 160; July 15, 1947.) Summary of Amer. Phys. Soc. paper. Meteorological data are converted into Morse letter groups, so that only a receiver is required on the ground. The sonde construction is simple and economical.
- 621.316.7:621.313.2/.3]-9 3985
Basic Procedures in Motor Control: Parts 2–4—G. W. Heumann. (*Gen. Elec. Rev.*, vol. 50, pp. 41–46, 41–48, and 40–51; June to August, 1947.) D.c. shunt and compound motors, amplidyne control circuits and a.c. induction motors. Part 1, 3212 of November.
- 621.316.726:621.313.333 3986
Adjustable Frequency Control of High-Speed Induction Motors—G. W. Heumann. (*Elec. Eng.*, vol. 66, pp. 576–579; June, 1947.) Abridged version of A.I.E.E. paper. Details of amplidyne and thyatron control systems.
- 621.317.792 3987
A Lightning Warning Device—B. F. J. Schonland and P. G. Gane. (*Trans. S. Afr. Inst. Elec. Eng.*, vol. 38, pp. 119–123; April, 1947. Discussion, pp. 123–125.) The device gives audible warning of the occurrence of flashes within about 7 or about 20 miles, according to the position of a switch. Corona current in the aerial is used to give warning of imminent nearby flashes to ground.
- 621.318.572 3988
Electronic Relays—R. van Steenkiste. (*Bull. Sci. Ass. Inst.* (Montefiore) vol. 60, pp. 193–199; July, 1947.) Describes the use of triodes, thyratrons, photoelectric cells and neon tubes as relays for d.c. or a.c. circuits.
- 621.318.572 3989
A Diode Coincidence Circuit—J. D. Shipman, Jr., B. Howland, and C. A. Schroeder. (*Phys. Rev.*, vol. 72, p. 181; July 15, 1947.) Summary of Amer. Phys. Soc. paper.
- 621.318.572:531.76 3990
Interval Timer—E. L. Deeter and W. K. Dau. (*Electronics*, vol. 20, pp. 86–87; July, 1947.) "Timing periods in 0.1-second increments for the range 0.1 to 100 seconds can be set up on direct reading dials. The period depends upon reduction of control-tube bias by discharge of an RC circuit."
- 621.38:621.791.7 3991
Electronic Welding Equipment—M. Félix. (*Bull. Sci. Ass. Inst.* (Montefiore), vol. 60, pp. 163–175; June, 1947.) A general description of methods and apparatus for spot and seam welding, and butt resistance welding, including the use of thyratrons and ignitrons.
- 621.38.001.8 3992
Industrial Applications of Electronic Techniques—H. A. Thomas. (*Jour. I.E.E.* (London) Part I, vol. 94, pp. 309–331; July, 1947. Discussion, pp. 331–338.) Full paper. Summary noted in 2523 of September. A bibliography of 81 papers is included.
- 621.38.001.8 3993
Electronics—A New Branch of Technics—S. E. Teleshevski. (*Nauka i Zhizm*, no. 2, pp. 8–12; 1947. In Russian.) Short historical survey.
- 621.38.001.8 3994
Electronics in Measurement—L. G. Gitzendanner. (*Gen. Elec. Rev.*, vol. 50, pp. 24–29; August, 1947.) Descriptions of a photoelectric recorder, spectrophotometer, vibration-velocity meter and other devices.
- 621.383.001.8:535.247.4 3995
Sensitive Photoelectric Photometer—F. T. Gucker, Jr. (*Electronics*, vol. 20, pp. 106–110; July, 1947.)
- 621.384+621.319.3 3996
The Palletron, a New Electron Resonator and Its Proposed Application to the Generation of Potentials in the Million-Volt Range—A. M. Skellett. (*Phys. Rev.*, vol. 72, p. 180; July 15, 1947.) Summary of Amer. Phys. Soc. paper. Design of a proposed megavolt voltage generator, with experimental results on a small model.
- 621.384 3997
The Electron Mechanics of Induction Acceleration—J. A. Rajchman and W. H. Cherry. (*Jour. Frank. Inst.*, vol. 243, pp. 261–285 and 345–364; April and May, 1947.) The equations of electron motion in the betatron are developed and, with the aid of a potential function, previously reported conditions of equilibrium, stability and oscillation damping are derived for the region of parabolic and of non-parabolic variation of the potential. The application of an auxiliary radial electric field is discussed in detail without materially complicating the analysis. Experimental work complementing the theory is described.
- 621.384:621.396.611.4 3998
Acceleration of Electrons by a Single Resonant Cavity—F. L. Hereford, Jr. (*Phys. Rev.*, vol. 72, pp. 159–160; July 15, 1947.) Summary of Amer. Phys. Soc. paper. Energies of 0.75 Mev. at 17 microamperes were obtained from a cavity resonant at $\lambda 75$ centimeters, using a pulse length of 4 microseconds and 60 pulses per second. The energy spectrum is remarkably narrow, about 50 kev. See also 2997 of 1946 (Brown, Pulley, and Gouden).
- 621.384:621.396.611.4.029.62 3999
Cavity Accelerator for Electrons—H. L. Schultz, R. Beringer, C. L. Clarke, J. A. Lockwood, R. L. McCarthy, C. G. Montgomery, P. J. Rice, and W. W. Watson. (*Phys. Rev.*, vol. 72, pp. 346–347; August 15, 1947.) A linear electron accelerator consisting of a series of cylindrical cavities, operating in the TM mode which are not mutually coupled. Frequency and phase coherence in the separate cavities are provided by a master oscillator driving separate power amplifiers for the excitation of the various cavities. The system is designed for pulse operation at 580 Mc.
- 621.384.6 4000
Note on the 2.8 MeV Betatron—W. B. Lasich and L. Riddiford. (*Jour. Sci. Instr.*, vol. 24, pp. 177–179; July, 1947.) The construction and operation of a small laboratory betatron having a total ionization intensity equivalent to 1 gm. of radium.
- 621.385.1.001.8:531.768.087 4001
A Vacuum Tube for Acceleration Measurement—W. Ramberg. (*Elec. Eng.*, vol. 66, pp. 555–556; June, 1947.) For another account see 2528 of September.
- 621.385.833 4002
Experimental Determination of Astigmatism and of the Focal Surfaces in Electron Optics—A. Cazalas. (*Compt. Rend. Acad. Sci.* (Paris) vol. 225, pp. 178–180; July 21, 1947.)
- 621.385.833 4003
Limit of Resolution of the Decentred Elec-

trostatic Objective—H. Bruck. (*Compt. Rend. Acad. Sci. (Paris)*, vol. 224, pp. 1818-1820; June 30, 1947.) A formula is derived by considering the objective as made up of three independent elementary lenses, the two outer ones weakly divergent and the central one strongly convergent.

621.398+621.314.12 4004
Electric Positioning Systems of High Accuracy for Industrial Use—D. E. Garr. (*Gen. Elec. Rev.*, vol. 50, pp. 17-24; July, 1947.) Description of a system using selsyns, tubes, an amplidyne, and a d.c. motor.

PROPAGATION OF WAVES

538.566.2 4005
Refraction of Plane Non-Uniform Electromagnetic Waves between Absorbing Media—L. Pincherle. (*Phys. Rev.*, vol. 72, pp. 232-235; August 1, 1947.) It is shown that after refraction there are two possible positions for the propagation vector in the second medium. Energy flow considerations show that each solution holds within a certain range of values of the (complex) angle of incidence, the transition between the two solutions being discontinuous. Polarizations perpendicular and parallel to the plane of incidence are considered.

621.396.11 4006
Observations on the Propagation of Ultra-Short Waves—G. Latmiral and G. Barzilai. (*Alta Frequenza*, vol. 16, pp. 147-173; June to August, 1947.) In Italian, with English, French, and German summaries.) A critical discussion. It is pointed out that the phase diagram of aerials above the earth must be considered, that the radiation diagram may not be independent of distance and that reflection must not be supposed to occur at a single point. The finite dimensions of the reflecting zone, when the earth's surface is uneven, can produce notable variations in the signal strength of the reflected ray. U.s.w. fading may be reduced by the use of aerials connected together without phase synchronism.

621.396.11 4007
Radio-Wave Propagation and Electromagnetic Surface Waves—P. S. Epstein. (*Proc. Nat. Acad. Sci.*, vol. 33, pp. 195-199; June, 1947.) A short critical account of the development of Sommerfeld's classical theory. Another interpretation of Sommerfeld's equations, hitherto overlooked, shows that the surface-wave is not generated by the aerial and can have an independent existence.

621.396.11.029.58:551.510.535 4008
Doppler Effect in Propagation—R. E. Burgess, F. S. Atiya, L. Essen, and H. V. Griffiths. (*Wireless Eng.*, vol. 24, pp. 248-249 and 279-280; August and September, 1947.) Criticism and correction of a statement by Griffiths (3254 of November) which implied that absolute velocity could be measured, thereby flouting the principles of relativity.

621.396.812.029.64 4009
Further Observations of the Angle of Arrival of Microwaves—A. B. Crawford and W. M. Sharpless. (*Bell Sys. Tech. Jour.*, vol. 26, p. 389; April, 1947.) Summary of 1183 of May.

RECEPTION

621.396.621+621.396.69 4010
Robot Makes Radios—R. W. Hallows. (*Radio Craft*, vol. 18, pp. 20-21, 81; September, 1947.) Another account of the E.C.M.E. (Electronic Circuit Making Equipment) described in 1913 of July (Sargrove).

621.396.621 4011
A New Approach to F.M./A.M. Receiver Design—D. G. F. (*Electronics*, vol. 20, pp. 80-85; July, 1947.) Full description of a double

superheterodyne receiver; the second local oscillator is crystal-controlled and good selectivity, sensitivity, and signal-to-noise ratio are obtained with a minimum number of components.

621.396.621 4012
Clipping and Clamping Circuits—N. W. Mather. (*Electronics*, vol. 20, pp. 111-113; July, 1947.) Basic circuits for removing that portion of a signal which exceeds a predetermined level or for passing only signals exceeding the clip level, and for restoring or changing average values of signals having level portions.

621.396.621:621.396.619.13 4013
Designing an F.M. Receiver: Part 2—T. Roddam. (*Wireless World*, vol. 53, pp. 203-206; June, 1947.) Limiter and discriminator circuits are considered in detail. For part 1 see 2365 of September; an omission from Fig. 3 of this article is corrected.

621.396.621.029.5 4014
Universal Receiver RU95—G. de Champs. (*Ann. Radioléc.*, vol. 2, pp. 137-149; April, 1947.) The frequency range is 50 kc. to 30 Mc. The general electrical design is discussed, the various stages being considered separately, and practical constructional details are given. Examination of all the factors involved in the calculation of the signal-to-noise ratio shows that the sensitivity approximates to the theoretical maximum. The construction and operation of the crystal filter is described and typical performance results of the receiver are given.

621.396.621.029.62 4015
BC-624 on Two Meters—L. W. May, Jr. (*Radio Craft*, vol. 18, pp. 24-25 and 63; September, 1947.) Details of the modifications necessary for 2-meter reception.

621.396.621.029.62 4016
Designing a 2 Meter Communication Receiver—R. B. Tomer. (*Radio News*, vol. 38, pp. 57-59 and 146; September, 1947.) Full constructional details of a 144 to 148-Mc. superheterodyne, incorporating an S-meter and a noise limiter. Special features include the use of separate assemblies in the more critical sections such as the i.f. channel, local oscillator, mixer, and r.f. amplifier.

621.396.621.52 4017
The Application of Super-Regeneration in Frequency-Modulation Receiver Design—C. E. Tapp. (*Proc. I.R.E. (Australia)*, vol. 8, pp. 4-7; April, 1947.) The principles of f.m. and super-regeneration are outlined and their combination in f.m. receivers suggested. A relatively small number of tubes and tuned circuits would be required.

621.396.622:537.312.62 4018
Radio Frequency Detection by Superconductivity—Andrews and Clark. (*See* 3853.)

621.396.813.015.3:621.396.645 4019
Analysis of Nonlinear Distortion Owing to Transients in High-Power Class B Amplifiers—A. M. Pesarevsky. (*Radiotekhnika (Moscow)*, vol. 2, pp. 35-50; February, 1947.) In Russian with English summary.) A study of the distortion due to transients in the anode and grid circuits and of the effect on this distortion of the complex character of the amplifier load.

621.396.823 4020
Interference from Industrial R.F. Heating Equipment—A. Turney. (*Brit. Elec. and Allied Ind. Res. Ass. Tech. Report M/T88.*) The investigation is confined to four sets of apparatus of powers ranging from 2.5 to 45 kw. operating on frequencies from 600 kc. to 20 Mc. Both frequency and amplitude modulations were observed. An unscreened 25-kw. equipment operating at 15 Mc. produced fields greater than

100 mv./m. over an area of half a square mile. Enclosing the apparatus in simple perforated steel cabinets gives considerable reduction in interference. Summary in *Wireless World*, vol. 53, p. 326; September, 1947. See also *Elec. Eng.*, vol. 19, pp. 251-255; August, 1947.

621.396.828.029.62 4021
Reflector Antenna Solves "Skip" Problem—W. L. Campbell. (*Elec. World*, vol. 128, pp. 88, 90; August 2, 1947.) Serious interference with reception in Portland, Oregon, from eastern f.m. stations was very much reduced by using a 3-element beam aerial for reception only. The aerial has two parasitic elements, one a reflector and the other a director, giving a front-to-back ratio of 30 db. Addition of further reflectors is proposed to eliminate the slight residual interference.

STATIONS AND COMMUNICATION SYSTEMS

621.391.63:621.397.5 4022
Photovision—A. Z. (*Toute la Radio*, vol. 14, p. 175; June, 1947.) A short account of the Allen B. Du Mont system and possible applications of such systems.

621.391.64:621.327.44 4023
Modulation of the Resonance Lines in a Cesium Arc—J. M. Frank, W. S. Huxford, and W. R. Wilson. (*Phys. Rev.*, vol. 72, pp. 156-157; July 15, 1947.) Summary of Amer. Phys. Soc. paper. The light from a Cs arc Type CL2 is modulated by applying an alternating potential across the electrodes. The radiation is received by a photo cell and displayed on an oscillograph together with the arc current and potential. The ratio of light to current modulation is about 0.8 for modulating frequencies below 1 kc. and varies inversely as the square root of the frequency between 1 kc. and 1 Mc. See also 3241 of November.

621.394/.395] "1939/1945" 4024
Progress in Telephony and Telegraphy—(*Engineering (London)*, vol. 163, pp. 402-403 and 441; May 16 and 23, 1947.) Summary of 1206 of May (Radley).

621.395.44 4025
The Basic Principles of Carrier-Current Telephony—H. Jacot. (*Tech. Mitt. Schweiz. Telegr.-Teleph. Verw.*, vol. 25, pp. 47-58 and 97-105; April 1, and June 1, 1947.) A general account, with discussion of modulation methods, filters, including bridge-type crystal filters, h.f. generators for carrier currents, and the principal features of the System-U, developed by Siemens in Germany before the war, and of the Bell Laboratories' System-K.

621.396.1 4026
Channels of Communication: Why and How They Require Bands of Frequency—"Cathode Ray." (*Wireless World*, vol. 53, pp. 223-226; June, 1947.)

621.396.44:621.315.052.63 4027
A New Single-Side-Band Carrier System—B. E. Lenehan. (*Elec. Eng.*, vol. 66, pp. 549-552; June, 1947.) Two-phase currents, of the signal and carrier frequencies, are produced by phase-splitting circuits, and the outputs are multiplied together by two copper-oxide ring modulators. The carrier frequency is suppressed by passing d.c. through the signal paths.

621.396.619 4028
Modulation Types and Characteristics—Rockett. (*See* 4061.)

621.396.619:621.396.822 4029
Noise Reduction with Bandwidth in the Principal Modulation Systems—W. Nowotny. (*Elektrotech. und. Maschinenb.*, vol. 64, pp. 116-125; July to August, 1947.) A comparison of characteristic signal-to-noise ratios, with particular reference to pulse modulation, in-

cluding both pulse time and pulse phase modulation. The relative ratios are given in a table and a diagram.

621.396.619.11/13 4030
Comparison of A.M. and F.M.—D. A. Bell. (*Wireless Eng.*, vol. 24, p. 279; September, 1947.) Comments on Nicholson's paper (3660 of December) emphasizing the advantages of f.m. over a.m.

621.396.619.16:621.396.5 4031
Methods and Equipment used in Multiplex Pulse Transmission—G. Potier. (*Onde Élec.*, vol. 27, pp. 215-230 and 284-291; June and July, 1947.) The general principles of pulse modulation are outlined and the various methods hitherto used for modulation of pulse amplitude, duration, or position are described. Methods of selecting the pilot pulses in receiving equipment are discussed and also the selection and detection of the signal pulses. Illustrative examples are given.

621.396.65.029.62/64:621.396.619.16 4032
A Multichannel Microwave Radio Relay System—H. S. Black, J. W. Beyer, T. J. Grieser, and F. A. Polkinghorn. (*Bell Sys. Tech. Jour.*, vol. 26, pp. 388-389; April, 1947.) Summary of 1219 of May.

621.396.712 4033
Continuity Working—R. T. B. Wynn. (*B.B.C. Quart.*, vol. 1, pp. 184-193; January, 1947.) A new method of presenting broadcast programs allowing complete cooperation between program staff and engineers even during the broadcast. The program is controlled by an announcer from the continuity studio, sound-insulated from but connected to the continuity room, where two operators are responsible for the technical presentation. The technical facilities are described and the duties of those responsible for both technical and artistic presentation are discussed.

621.396.712.3 4034
Planning a Studio Installation: Part I—J. D. Colvin. (*Audio Eng.*, vol. 31, pp. 7-9, 41; July, 1947.) Concerned only with the audio equipment, wiring, etc. Each step in the planning is treated separately, then the steps are combined and the whole scheme completed.

621.396.931 4035
Mobile Radio-Telephone Service Links Nation—F. E. Butler. (*Radio News*, vol. 37, pp. 45-47 and 118; May, 1947.) Fixed and mobile stations operate in the bands 152 to 162 Mc. and 30 to 44 Mc. respectively. A selective signalling device provides 2030 combinations. Crystal control and phase modulation are the main features in the 30-watt transmitters.

621.396.931 4036
F.M. Communications at CP's [Canadian Pacific] Toronto Yard—(Telegr. Teleph. Age, vol. 65, p. 6; May, 1947.) Shunting engines have been fitted with two-way f.m. radio communication equipment. The system has a possible range of 15 miles.

621.306.931:621.396.81.029.62 4037
153-Mc/s. F.M. for Forestry Service—R. L. Atkinson. (*FM and Telev.*, vol. 7, pp. 23-26, 61; July, 1947.) A survey of results in the State of Florida with 15-watt and 30-watt transmitters shows that 20-mile communication ranges were consistently obtained.

621.396.932 4038
Modern Marine Radio—D. F. Bowers and E. F. Cranston. (*Wireless World*, vol. 53, pp. 221-222; June, 1947.) Two alternative standardized installations made by the Marconi Company for merchant ships are described, one for medium frequencies and the other for medium and high frequencies. Each consists of

a transmitter, communication receiver, automatic alarm device, and d.f. receiver. The transmitter frequency can be changed rapidly to predetermined values, and the equipment may be removed and serviced with the power on.

SUBSIDIARY APPARATUS

621.526 4039
The Development of Servo Mechanisms—(Elec. Times, vol. 111, pp. 579-584; May 22, 1947.) Summary of the following papers read at the recent I.E.E. Convention on Servo-mechanisms. Fundamental Principles of Automatic Regulators and Servo Mechanisms, by A. L. Whiteley. Elements of Position Control by K. A. Hayes. The Use of Servos in the Army during the Past War, by E. J. Douch. The Nature of the Operator's Response in Manual Control and Its Implications in Controller Design, by A. Tustin. Some Servo Mechanisms used by the Royal Navy, by J. O. H. Gairdner. Some Naval Applications of Electrical Remote-Positional Controllers, by W. E. C. Lampert. The Use of Servo Mechanisms in Aircraft, by A. A. Hall. The Theoretical Foundations of Process Control, by G. H. Farrington. Automatic Voltage Control of Generators, by C. Stewart. Amplitude Regulating Systems, by B. Adkins. Automatic Control in the Chemical Industry, by J. W. Broadhurst, F. C. Broderick, A. W. Foster, and G. E. Wheeldon, with four appendices. Some Industrial Electronic Servo and Regulator Systems, by E. W. Forster and L. C. Ludbrook. Electronic Servo Simulators, by F. C. Williams and F. J. V. Ritson.

621.318.5:621.398:621.396.621 4040
Receiver Remote Control—J. F. O. Vaughan. (*Wireless World*, vol. 53, pp. 212-214; June, 1947.) A system using isolating capacitors and two relays enables a receiver to be switched on an off from an extension speaker by a push button without using additional connecting wires.

621.319.3.027.89 4041
Aluminium and Magnesium in the Electrical Industries [Electrostatic Generators]—B. J. Brajnikoff. (*Light Metals*, vol. 10, pp. 325-332; July, 1947.) An account of the principles and construction of h.v. electrostatic generators, giving voltage up to 25 mv. Al is used largely in the construction of these generators.

621.319.33 4042
New Electrostatic Influence Generator—P. Jolivet. (*Compt. Rend. Acad. Sci. (Paris)*, vol. 225, pp. 177-178; July 21, 1947.) Similar in construction to that previously described (1934 Abstracts, *Wireless Eng.*, p. 53) but with as moving connections. The combs are connected through resistors to the corresponding armatures.

621.319.33 4043
Electrostatic Influence Machines and the Modernizing of Their Technique—P. Jolivet. (*Rev. Gén. Élec.*, vol. 56, pp. 243-255; June, 1947.) A short historical review is given, with a new classification of such machines. The operation of generators with a new method of inductor mounting is described and also research on generators operating in compressed air. Technical details are given of machines actually constructed for use in compressed gas, which enables much higher output voltages to be reached. The design of generators of this type for still higher voltages is discussed. An output of 15 ma, at 150 kv. appears practicable.

621.319.33 4044
Electrostatic Sources of Electric Power—J. G. Trump. (*Elec. Eng.*, vol. 66, pp. 525-534; June, 1947.) A general article on their produc-

tion and use. The Van de Graaff belt generator is described, with details of modern generators of this type. Modifications include the control of the electric field round the upper terminal by means of intermediate metallic equipotential shields, and confining the charge on each belt by spaced conducting rods connected to the column sections and mounted close and parallel to each side of the belt. The insulation for these generators is either compressed gas or high vacuum, and the properties of some typical gases are given. The proposed use of vacuum-insulated electrostatic machinery, an a.c. synchronous motor, and a d.c. generator for operation in a high vacuum, and the direct use of atomic power by means of a vacuum-insulated motor of the type described, are also discussed.

621.396.682:621.316.722.076.7 4045
Stabilizing Direct-Voltage Supplies—J. W. Hughes. (*Wireless Eng.*, vol. 24, pp. 224-230; August, 1947.) "A graphical method of assessing the performance of the gas-discharge tube stabilizer circuit is described, and a means of ensuring that the tube 'strikes' with low supply voltages is indicated."

621.396.682:621.316.722.1 4046
Voltage-Regulated Power Supplies—P. Koontz and E. Dilatash. (*Electronics*, vol. 20, pp. 119-123; July, 1947.) A simplified design theory. Actual values of circuit elements necessary to build a power pack and electronic regulator are calculated. Practical suggestions are given for physical layout and elimination of ripple.

621.396.682:621.397.62 4047
Television E.H.T. [extra-high voltage] Supply—W. T. Cocking. (*Wireless World*, vol. 53, pp. 207-211; June, 1947.) The design of rectifier systems for supplying high voltage for television receiver c.r. tubes using the voltage developed across the line amplifier output transformer at flyback. Equations and experimental data are given showing the effect of stray capacitance across the transformer primary and the use of a tapped primary to step up the flyback voltage. A voltage doubling rectifier system using components rated at half the output voltage is described.

TELEVISION AND PHOTOTELEGRAPHY
621.397.335 4048
Television Synchronization—A. W. Keen. (*Wireless World*, vol. 53, p. 220; June, 1947.) Comment on 2261 of August (Cocking).

621.397.335 4049
Investigation of the Range of Stable Synchronization of a Synchronizing Generator—V. N. Gorshunov. (*Radiotekhnika (Moscow)*, vol. 2, pp. 62-72; January, 1947. In Russian with English summary.) The results obtained are shown graphically and a stability criterion is derived.

621.397.5 4050
Television—V. K. Zworykin. (*Jour. Frank. Inst.*, vol. 244, pp. 131-145; August, 1947.) A general description of modern television apparatus, including the RCA simultaneous color system.

621.397.5:535.37:621.385.832 4051
Application of the I.C.I. Color System to the Development of the All Sulfide Television White Screen—A. E. Hardy. (*Phys. Rev.*, vol. 72, p. 166; July 15, 1947.) Summary of Amer. Phys. Soc. paper.

621.397.5:535.88 4052
Projection Television—(Wireless World, vol. 53, pp. 227-228; June, 1947.) With plastic lenses, nonspherical surfaces can be produced cheaply, so that large-aperture systems combining high optical efficiency with freedom from spherical aberration become possible.

- 621.397.5:535.88 4053
The Projection of Images on a Screen—R. Aschen. (*Télev. Franc.*, vol. 28, pp. 11-12, 34; August, 1947.) Describes various types of optical systems and discusses briefly the production of moulded correction lenses of plexiglass.
- 621.397.5:535.88 4054
Reflective Optical System for Projection Television—V. K. Zworykin. (*Radio News*, vol. 38, pp. 54-56 and 155; September, 1947.) A description of the RCA system using a high current sharp-focus kinescope operated at 27-kv., a spherical mirror and a moulded plastic correction lens to give a 20X15-inch picture.
- 621.397.5(73) 4055
Progress in Television—G. R. Town. (*Elec. Eng.*, vol. 66, pp. 580-590; June, 1947.) A general discussion on the latest position in the United States, dealing with the immediate future and its commercial problems. Monochrome television will not be ousted rapidly by color television, as the F.C.C. have stopped the commercialization of color television until it has reached a satisfactory state of development.
- 621.397.62 4056
Television Receiver Construction: Parts 6 and 7—(*Wireless World*, vol. 53, pp. 278-281 and 330-334; August and September, 1947.) Part 6: Discussion of c.r. tube mounting. Part 7: Description of the complete receiver unit, with list of components. For previous parts see 3687 of December and back references.
- 621.397.62 4057
Learn as You Build—Television—A. Lieb-scher. (*Radio News*, vol. 38, pp. 39-42 and 141; September, 1947.) Complete construction details for a television receiver using a 3-inch tube.
- 621.397.62 4058
Study of the Detection and Video-Frequency Amplification Stages for 455-Line Television Receivers—J. Barthou. (*Télev. Franc.*, pp. 18-21; August, 1947.) An explanation of the particular features of these stages and the functions of the various circuits and components, to enable service men, etc., to understand the operation of the apparatus they have to handle.
- 621.397.62:621.396.682 4059
Television E.H.T. [extra-high voltage] Supply.—Cocking. (See 4047.)
- TRANSMISSION**
- 621.396.61.029.62:621.396.712 4060
Frequency-Modulated Broadcast Transmitters for 88-108 Megacycles—L. Everett. (*Elec. Commun.* (London), vol. 24, pp. 82-93; March, 1947.) A detailed description of a series of transmitters having r.f. outputs of 1, 3, 10, 20, and 50 kw. respectively. The transmitters are crystal controlled and the radiated center frequency is maintained to within ± 1 kc. A 75-micro-second pre-emphasis circuit is provided at the a.f. input.
- 621.396.619 4061
Modulation Types and Characteristics—F. Rockett. (*Electronics*, Buyers' Guide Issue, vol. 20, pp. 124-125; June, 1947.)
- 621.396.619.16 4062
Spectrum Analysis of Pulse Modulated Waves—J. C. Lozier. (*Bell. Sys. Tech. Jour.*, vol. 26, pp. 360-387; April, 1947.) The elementary theory of spectrum analysis is reviewed and discussed. A complex pulse is resolved into a series of rectangular pulses, the spectra of which are known and can be combined vectorially. The spectra of pulse-position and pulse-width modulation are thus determined; as the pulse repetition rate is increased, pulse-position modulation approximates to a form of phase modulation, while pulse-width modulation approximates to amplitude modulation of the pulse repetition frequency and of its harmonics present in the unmodulated pulse.
- 621.396.645:621.396.822:621.396.97 4063
Preamplifier Noise in F.M. Broadcasting—A. E. Richmond. (*Audio Eng.*, vol. 31, pp. 15-16, 45; July, 1947.) Methods of testing and improving the signal-to-noise ratio are discussed.
- VACUUM TUBES AND THERMIONICS**
- 621.383.4+546.28 4064
A New Bridge Photo-Cell Employing a Photo-Conductive Effect in Silicon. Some Properties of High Purity Silicon—G. K. Teal, J. R. Fisher, and A. W. Treptow. (*Bell Sys. Tech. Jour.*, vol. 26, pp. 392-393; April, 1947.) Summary of 1961 of July.
- 621.385.029.63/.64 4065
The Travelling-Wave Tube—R. Kompfner. (*Wireless Eng.*, vol. 24, pp. 255-266; September, 1947.) Expressions are derived for the amplification and noise factor of the travelling-wave tubes. The modulation of the beam by the wave is first considered neglecting any reaction of such modulation on the wave; similarly the wave produced by a modulated beam is investigated, neglecting the effect of the wave on the modulation. The reaction of the modulated beam on the modulating wave is then determined and by repeating this process for an infinite number of actions and reactions, the complete interaction is calculated.
 A coaxial line with a helical inner conductor is suitable for providing a wave having a velocity to which electrons can be accelerated easily. The development of such tubes up to 1944 is described. See also 2286 of August.
- 621.385.029.64/.64 4066
Tentative Theory of the Travelling-Wave Valve—J. Bernier. (*Onde Élec.*, vol. 27, pp. 231-243; June, 1947.) Reprint of 2974 of October, with correction of a slight error in that paper.
- 621.385.029.63/.64 4067
Tentative Theory of the Travelling-Wave Valve—J. Bernier. (*Ann Radioélec.*, vol. 2, p. 195; April, 1947.) Correction to 2974 of October.
- 621.385.1+621.396.694 4068
New Receiving Valves—(*Wireless World*, vol. 53, pp. 228-229; June, 1947.) Details of British tubes with B8A base. See also 3717 of December.
- 621.385.1+621.396.694 4069
Contemporary Receiving Tubes—J. D. Aske. (*Electronics*, Buyers' Guide Issue, vol. 20, pp. 126-129; June, 1947.) Tubes classified according to their functions for comparison with other types. See also 2976 of October.
- 621.385.1:621.317.738 4070
A Radio-Frequency Interelectrode-Capacitance Meter—Lehany and McGuire. (See 3966.)
- 621.385.1.032.21:537.291 4071
Cathode-Design Procedure for Electron-Beam Tubes—R. Helm, K. Spangenberg, and L. M. Field. (*Elec. Commun.*, vol. 24, pp. 101-107; March, 1947.) Based on a book entitled "The Production and Control of Electron Beams," and published as secret material during the war and now out of print. The design procedure is an extension of the work of J. R. Pierce (4275 of 1940). Charts are given from which a cathode structure can readily be determined for any current and voltage and at any angle of beam convergence, over a wide range of these variables.
- 621.385.1.032.21:546.41/.431] 4072
The Methods of Manufacture of Carbonates for Valve Cathodes—Biguenet and Mano (See 3924.)
- 621.385.1.032.216:537.583 4073
Variations in the Constants of Richardson's Equation as a Function of Life for the Case of Oxide Coated Cathodes on Nickel—H. Jacobs and G. Hees. (*Phys. Rev.*, vol. 72, p. 174; July 15, 1947.) Summary of Amer. Phys. Soc. paper.
- 621.385.2 4074
The High Frequency Response of Thermionic Diodes—E. H. Gamble. (*Phys. Rev.*, vol. 72, p. 160; July 15, 1947.) Summary of Amer. Phys. Soc. paper. The temperature-limited and space-charge-limited operations of planar and cylindrical diodes are analyzed. The transient build-up of current in a planar diode on the sudden application of an external voltage is determined.
- 621.385.3/.5 4075
Study of Grid Current—U. Zebstein. (*Toute la Radio*, vol. 14, pp. 168-172; June, 1947.) Discussion of: (a) the complex nature and the consequences of grid current, (b) the possibilities of using modern tubes with the minimum of grid current, and (c) the photoelectric effect in electrometer tubes.
- 621.385.83.032.29 4076
High Current Electron Guns—L. M. Field. (*Bell Sys. Tech. Jour.*, vol. 26, p. 390; April, 1947.) Summary of 1967 of July.
- 621.385.832 4077
A Cathode-Ray Tube for Viewing Continuous Patterns—J. B. Johnson. (*Bell Sys. Tech. Jour.*, vol. 26, p. 390; April, 1947.) Summary of 1640 of June.
- 621.385.832:535.37 4078
Performance Characteristics of Long-Persistence Screens, Their Measurement and Control—Johnson and Hardy. (See 3921.)
- 621.385.832:535.37 4079
The Efficiency of Cathodoluminescence as a Function of Current Density—S. Lafof. (*Phys. Rev.*, vol. 72, p. 165; July 15, 1947.) Summary of Amer. Phys. Soc. paper.
- 621.396.615.14 4080
Possibility of Oscillation at Ultra-High Frequency of Conventional Vacuum Tubes—F. Cappuccini. (*Alta Frequenza*, vol. 16, pp. 196-200; June to August, 1947.) In Italian, with English, French and German summaries.)
- 621.396.615.142.2 4081
On the Theory of the Klystron—Ya. Z. Tsipkin. (*Radiotekhnika* (Moscow), vol. 2, pp. 49-61; January, 1947.) In Russian with English summary.) From the author's criterion for the stability of systems with retarded feedback, the self-excitation conditions of transit and reflection klystrons are determined. From these conditions, the relation between self-excitation regions and parameters determining the klystron operation is deduced simply.
- 621.396.615.142.2 4082
External Cavity Klystron—P. G. Bohlke and F. G. Breeden. (*Electronics*, vol. 20, pp. 114-118; July, 1947.) Development and characteristics of a 10-centimeter klystron with an external cavity. Output is about 100 milliwatts. With a coaxial cavity, the klystron covers the wavelength range 7 to 14 centimeters in single-mode operation; with a radial cavity, the range is 6.5 to 8.1 centimeters.
- 621.396.615.142.2 4083
A Relatively High Power Klystron Oscillator using a Circuit Resembling the Hartley—Yu. A. Katsman. (*Bull. Acad. Sci. (U.R.S.S.), sér phys.*, vol. 10, no. 1, pp. 87-92; 1946.) In Russian.) A modification of Lüdi's klystron (57 of 1942) is discussed (Fig. 1), in which a resonant coaxial line is used, whose ends are loaded with different capacitances. By suitably choosing these capacitances, the required ratio of the

standing-wave voltages at the ends of the line can be obtained. One of these voltages can be used as the buncher voltage; the other will then represent the output voltage of the klystron. The system is thus divided into two parts and is similar to the well known Hartley circuit.

The operation of the system is discussed and the necessary conditions are established for the balancing of the phases and amplitudes.

621.396.615.17 4084
The Application of the Radiotron Type 807 Valve as a Frequency Doubler—G. L. Edgcombe and J. G. Downes. (*A.W.A. Tech. Rev.*, vol. 7, pp. 251–269; April, 1947.) It is shown that 26-watt output with an anode efficiency of 50 per cent is both theoretically and practically realizable.

621.396.622.6:546.28 4085
Development of Silicon Crystal Rectifiers for Microwave Radar Receivers—J. H. Scaff and R. S. Ohl. (*Bell. Sys. Tech. Jour.*, vol. 26, pp. 1–30; January, 1947.) Characteristic curves of early types are given. The need for a stable, easily replaceable type brought about the ceramic cartridge rectifier and later the shielded rectifier, the construction of which is discussed in some detail. The applications and performance of various types are given and improved modern production methods are indicated. See also 771 of 1946 (Cornelius).

621.396.622.63:546.28+289 4086
Silicon and Germanium Rectifiers—(See 3831.)

621.396.822 4087
A Theory of Flicker Noise in Valves and Impurity Semi-Conductors—G. G. Macfarlane. (*Proc. Phys. Soc.*, vol. 59, pp. 366–375; May 1, 1947.) Discussion, pp. 403–408.) A theory of contact noise at low frequencies assuming diffusion of mobile impurity centers on to the contact surface. A formula is derived for the flicker noise which is applicable to emission from oxide-coated filaments and to contacts in photoconductive cells and rectifiers. "The spectral power density of the noise is found to depend on current j and frequency f as j^{x+1}/f^2 where $1 < x < 2$."

621.396.822 4088
Spontaneous Fluctuations of Electricity in Thermionic Valves under Retarding Field Conditions—D. K. C. MacDonald and R. Fürth. (*Proc. Phys. Soc.*, vol. 59, pp. 375–388; May 1, 1947. Discussion, pp. 403–408.) The measured fluctuations are compared with those generated by a diode operating under saturation conditions. Under certain conditions of current and differential resistance of the tube, the classical Schottky formula is obeyed. The necessary limiting current can be calculated. Measurements of this type can be used for determining cathode temperatures in diodes.

621.396.822:519.24 4089
Statistical Analysis of Spontaneous Electrical Fluctuations—R. Fürth and D. K. C. MacDonald. (*Proc. Phys. Soc.*, vol. 59, pp. 388–403; May 1, 1947. Discussion, pp. 403–408.) Fluc-

tuations were produced in a receiver of high natural frequency (0.1 to 1.0 Mc.) and narrow bandwidth (1 to 6 kc.) and recorded by means of a single-stroke c.r.o. The fluctuations were thus displayed as rapid oscillations, with the natural frequency of the receiver, whose amplitude R varied slowly and irregularly in time. The distribution function of R within a statistically stationary series of observations and the correlation between values of R separated by a finite time interval were found to be in good agreement with statistical theory.

MISCELLANEOUS

371.3:621.396 4090
Technical Educational Requirements of the Modern Radio Industry—P. L. Gerhart. (*RCA Rev.*, vol. 8, pp. 186–191; March, 1947.)

5+6]:05(43):778.1 4091
Photostat Copies of German Scientific and Technical Papers—(*Nature* (London), vol. 160, p. 427; September 27, 1947.) A photostat service to provide workers in Great Britain with the full text of papers appearing in current German scientific journals, of which a very full list is sent regularly to the Bureau of Abstracts (9-10, Savile Row, London, W. 1). Any scientist requiring the full text of a German article referred to in a British Abstract publication should write direct to Research Branch E.C.O.S.C. (Photostat Service) 77 H.Q. C.C.G. (B.E.) A.V.A.—Göttingen, B.A.O.R. Payment is made in sterling to the Director of Accounts, Photostat Service, Foreign Office (German Section) Norfolk House, St. James' Square, London S.W.1, at the rate of one guinea for the first 10 pages and 2s. 6d. for each additional page.

621.3.016.25 4092
The Sign of Reactive Power—(*Elec. Eng.*, vol. 66, pp. 627–628; June, 1947.) Further comment on 971 of April; see also 2642 of September and back references.

621.38/.39](083.72) 4093
Wartime Words and Their Meanings—C. DeVore. (*Electronics*, Buyers' Guide Issue, vol. 20, pp. 108–113; June, 1947.) Concise definitions of nearly 600 code names, abbreviations, slang, and technical terms added to the language of electronics during the war years.

621.39"1939/1945" 4094
Telecommunications in War—A. S. Angwin (*Engineering* (London), vol. 163, pp. 367–368; May 2, 1947.) Summary of I.E.E. Radiocommunication Convention speech. See also 2644 of September.

621.395:061.24 C.C.I.F. 4095
Short Account of the Work of the 14th Plenary Assembly of the C.C.I.F. [Comité Consultatif International Téléphonique] at Montreaux—R. Sueur. (*Cables and Trans.* (Paris), vol. 1, pp. 115–119; July, 1947. With English summary.) The principal recommendations are given and briefly analyzed. See also 3373 of November (Schless).

621.396 4096
Future Trends in Radio Communication—C. C. Paterson. (*Engineering* (London), vol. 163 p. 379; May 9, 1947.) Radiocommunication Convention speech. See also 2649 of September.

621.396/.397:06.064 Paris 4097
Radio and Television at the Paris Fair, 1947—G. Giniaux. (*TSF Pour Tous*, vol. 23, pp. 123–126; June, 1947.)

621.396(494) 4098
The 25th Anniversary of Radio-Suisse—A. Ch. (*Tech. Mitt. Schweiz. Telegr.-Teleph. Verw.*, vol. 25, pp. 154–158; August 1, 1947. In French.) A review of the development of the society and of present radio communication facilities.

621.396 Marconi Company 4099
Marconi Company's Jubilee—(*Engineer* (London), vol. 183, pp. 386–387; May 2, 1947.) Marked by an exhibition, showing the development of Marconi's invention from the first crude apparatus with a range of a few miles, to the most modern apparatus in world-wide use today.

621.396.67 4100
Who Invented the Aerial—Marconi or Popov?—(*Wireless World*, vol. 53, p. 338; September, 1947.) Translation of some passages of an article by Marquis Luigi Solari in the April to May number of the Italian paper *L'Antenna*, confirming that Marconi was the inventor.

621.396.69 4101
[1947] Chicago [Radio] Parts Show—(*Radio Craft*, vol. 18, pp. 41–46; May, 1947.) List of exhibitors, with brief descriptions of a few of the exhibits.

015(73) 4102
United States Government Publications [Book Notice]—United States Government Printing Office, Washington. A monthly catalogue, price \$2.25 per annum (\$2.85 abroad) issued by the Superintendent of Documents and including titles of a large number of papers issued by the Scientific Research and Development Office.

43–3=2 4103
German-English Dictionary for Electronics Engineers and Physicists [Book Review]—B. R. Regen and R. R. Regen. J. W. Edwards, Ann Arbor, Mich., 1946, 358 pp., \$6.00. (*Electronics*, vol. 20, pp. 260, 262; September, 1947.) Nearly 21,000 German technical terms in the fields of electronics and physics are listed alphabetically with English equivalents. Brief explanatory definitions are sometimes added.

621.3 4104
Principles of Electrical Engineering [Book Review]—T. F. Wall. George Newnes Ltd., London, 40s. (*Electronic Eng.*, vol. 19, p. 269; August, 1947.) Unusual emphasis is given to fundamental aspects common to heavy and light current engineering. The mathematical treatment is always elegant and within the capacity of the undergraduate, who "will do well to build upon Dr. Wall's book as a foundation."

PRECISION

• • • AS EXEMPLIFIED BY

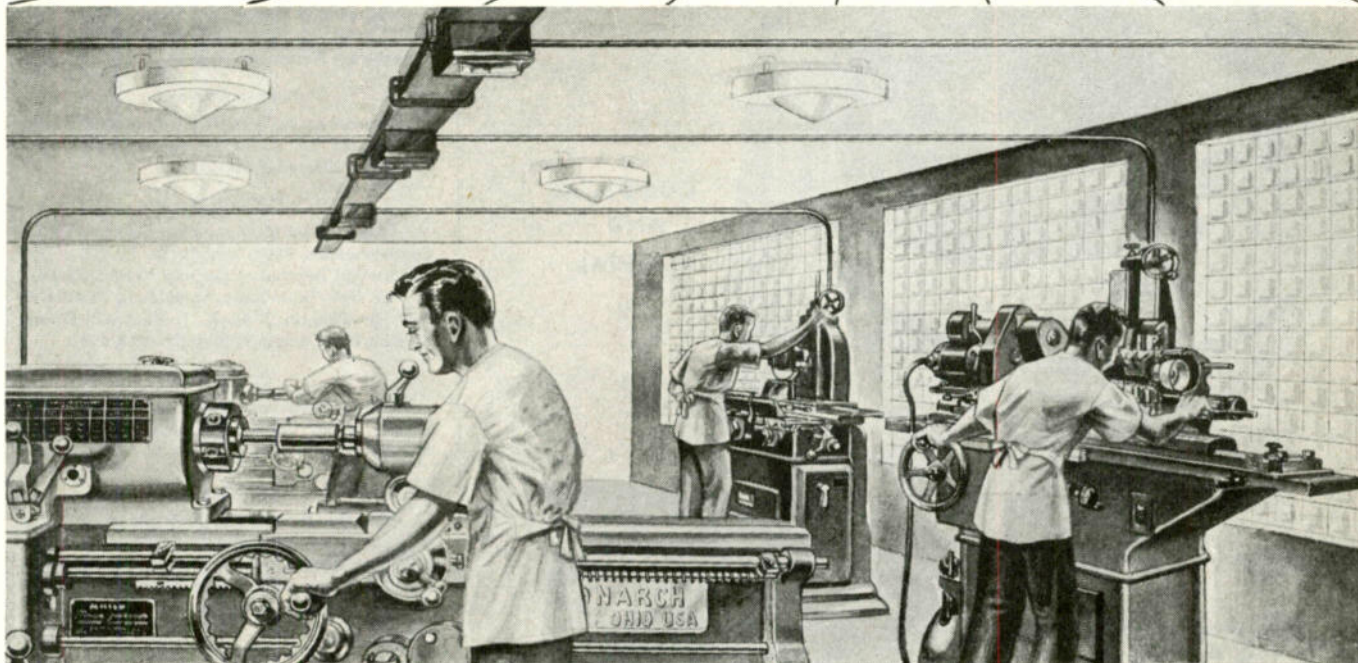

SHERRON'S ELECTRO-MECHANICAL LABORATORY

Mechanical accuracy is indispensable in modern electronics design. Our concept of its importance — in terms of precision control and fool-proof operation of electronics devices—is demonstrated in our addition of the Sherron precision electro-mechanical laboratory.

Humidity-temperature-and-dust-controlled, the Sherron electro-mechanical laboratory is fully geared to solve electro-mechanical manufacturing problems on a model or pro-

TOTYPE basis for electronics manufacturers.

The most modern precision machines and tools make up the apparatus of this laboratory . . . lathes, shapers, jig bores, heat treating equipment, locators, millers. Plus a full complement of standards, gauges, mechanical measuring instruments.

Combined with Sherron's electronics research and development laboratory, sheet metal fabrication facilities, this mod-

ern precision electro-mechanical laboratory climaxes the all-inclusive electronics service Sherron offers to electronics manufacturers.

Among the many electro-mechanical projects this department is geared for are: (1) Special Development Precision Wave Guides; (2) Computers; (3) Mechanical Equipment for Electronoptics; (4) Vacuum Tube Structures; (5) Precision Tuning Units; (6) Precision Drive Mechanisms; (7) Servo Mechanisms.



SHERRON ELECTRONICS CO.

Division of Sherron Metallic Corporation

1201 FLUSHING AVENUE • BROOKLYN 6, NEW YORK

**QUALITY SHORT CUT TO
MASS PRODUCTION OF TV RECEIVERS...**

**COMPACT,
CUSTOM-WIRED**

**DUODECAL
AND
DIHEPTAL**

AMPHENOL

**CATHODE RAY TUBE
SOCKET ASSEMBLIES**

• Amphenol custom-wired cathode ray tube socket assemblies are unusually compact. Leads are grouped within the housing in unit cable form and brought through the side of the socket in any of six positions. This effects a further saving of space. High voltage lead may be segregated from main trunk wires. Safety socket cap enclosing all wiring connections is easy to remove. Recessed socket front shields operator or serviceman from high voltages; serves also as a guide for tube insertion. Creepage barriers between contacts provide long leakage paths and positive lead wire separation. *For manufacturer's applications, sockets are furnished in wired assemblies.*

Duodecal Tube Sockets: For most popular television viewing tubes with a maximum of twelve pins on a pin circle diameter of 1.063 inches.

Diheptal Tube Sockets: Made in two sizes, for small (2.050 inch) diameter tube bases, also for medium (2.250 inch) diameter bases. Both provide for a maximum of fourteen pins on a 1.750 inch diameter pin circle.

*Complete technical data, and prices, are available.
Write for them today!*

AMERICAN PHENOLIC CORPORATION

1830 SOUTH 54TH AVENUE • CHICAGO 50, ILLINOIS

COAXIAL CABLES AND CONNECTORS—INDUSTRIAL CONNECTORS, FITTINGS AND CONDUIT—ANTENNAS—
RADIO COMPONENTS—PLASTICS FOR ELECTRONICS



ATLANTA

"New Instruments for F.M. Broadcasting and Microwave Applications," by I. G. Easton, General Radio Company; October 24, 1947.

BALTIMORE

"Power Line Carrier," by M. H. Wood, Westinghouse Electric Corporation; November 18, 1947.

BOSTON

"Microwave Filters Using Quarter-Wave Couplings," by R. M. Fano, Massachusetts Institute of Technology; November 13, 1947.

BUFFALO-NIAGARA

"Radar as an Aid to Aviation and Marine Navigation," by R. C. Jensen, General Electric Company; November 20, 1947.

CEDAR RAPIDS

"Applications of Radio in the Common Carrier Communication Field," by D. B. Harris, Northwestern Bell Telephone Company; October 15, 1947.

"A New Wide-Band Modulation System for A.M. Broadcasting," by R. J. Rockwell, Crosley Broadcasting Company; November 19, 1947.

CINCINNATI

"Beam Deflection Mixer Tubes," by E. W. Herold, Radio Corporation of America Laboratories; November 18, 1947.

COLUMBUS

"Circular Polarization for F.M. and Effect of Feed on Pattern of Wire Antennas," by C. E. Smith, United Broadcasting Company; and R. A. Fouty and D. C. Cleckner, Ohio State University Research Foundation; October 10, 1947.

CONNECTICUT VALLEY

"Servomechanisms in Application," by J. L. Bower, Yale University; November 20, 1947.

DALLAS-FORT WORTH

"Theory and Application Notes on the Use of Intermodulation Test Equipment," by J. K. Hillard, Altec-Lancing Corporation; November 4, 1947.

DAYTON

"Voltage Regulating Devices," by C. H. Humes, Sola Electric Company; November 13, 1947.

DETROIT

"Magnetic Recording," by T. E. Lynch, The Brush Development Company; September 19, 1947.

"The Functions and Organization of the Field Engineering and Monitoring Division of the Federal Communications Commission," by E. H. Lee, Federal Communications Commission; October 17, 1947.

INDIANAPOLIS

"An Electronic Course Computer for Aerial Navigation," by F. J. Gross, Civil Aeronautics Association; September 26, 1947.

"Airborne Magnetometers," by D. E. Brewer, Esterline Angus Company; October 24, 1947.

LONDON (Canada)

"Talk Tracks that Turn," by H. A. Blachford, Public Relations Representative; November 7, 1947.

LOS ANGELES

"The Bell System Plan for Transmission of Television Video Signals," by E. H. Schreiber, Pacific Telephone and Telegraph Company; November 18, 1947.

Election of Officers; November 18, 1947.

(Continued on page 38A)



A size, type, style *Triplet-made* for every need

"Half a Century of Instrument Know-How Is Built into These Fine Electrical Meters" . . . in sizes from 2" to 7" in a wide variety of case shapes and mounting arrangements.

No matter how specialized your requirements may seem, the chances are that Triplet has already engineered and tooled up for a design so nearly akin that a few inexpensive changes or additions will suffice.

Triplet . . . A Self Contained Electrical Instrument Factory . . . From screw machine parts to plastic moldings, from moving elements to dial faces, all are fabricated in Triplet's modern air-conditioned factory. Equipped with special humidity and dust controls in assembly rooms. This self-con-

tained factory means one overall profit markup with better quality control and consequent savings to you.

Complete meter satisfaction is yours in performance, appearance, and dependability. Let Triplet add lustre and give precision performance to your instrument panel.

"Complete Engineering Service" . . . Triplet maintains a field engineering staff available on short notice. These engineers are ready to help you with your problems and to bring you the latest practices in instrumentation from the Triplet laboratories. Complete facilities for shock, vibration and humidity testing as required under JAN specs.

Be sure your files are up-to-date with current Triplet catalog and descriptive literature. Address, Dept. H-18 and specify any particular types in which interested

Sizes 2" to 7"
Round or Square

A.C., D.C.,
R.F., Rectifier or Dynamometer

Triplet can supply on short notice electrical meters in 2", 3", 4", 5", and 7" sizes in round, rectangular, square and fan shapes; wide flange, narrow flange, flush projection and portable. Molded and metal cases. Rear illumination, special dials and other features available on most models.

TRIPLET ELECTRICAL INSTRUMENT CO. • BLUFFTON, OHIO

Representatives in Principal U. S. and Canadian Cities



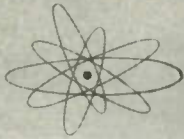

Designers

Television Transformers...tailored to your needs

1. Line supply voltage and frequency
2. High voltage d-c required
3. D-c milliamperes required
4. Filament volts and amperes
5. Sub-panel or above-panel mounting
6. Description of rectifier circuit
7. Winding insulation voltage required
8. Maximum ambient temperature

TELL US THESE ↖
WE SHIP THESE ↗

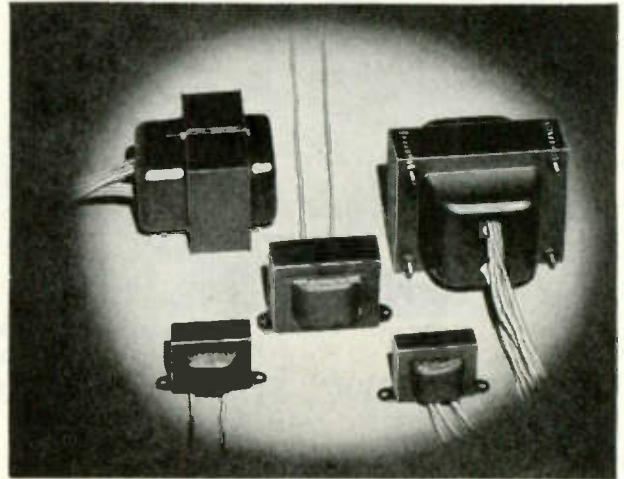

Whatever your transformer needs—power units like these, or special designs for deflection yokes, horizontal or vertical sweeps, or oscillators—General Electric can supply them . . . and quickly. G.E. offers its facilities and engineering

“know-how” to television manufacturers in tailoring these transformers to their requirements. Just tell us your specifications and we will meet them to your complete satisfaction. Power-supply transformers are available now in core-

and-coil and enclosed-case styles as standard units designed for television applications. Units for other uses are tailor-made from standard parts. Ask your G-E representative for more information; you'll be pleased with the prices and shipments he will offer you.

**NEW PYRANOL CAPACITORS
SAVE SPACE, WEIGHT, MONEY**

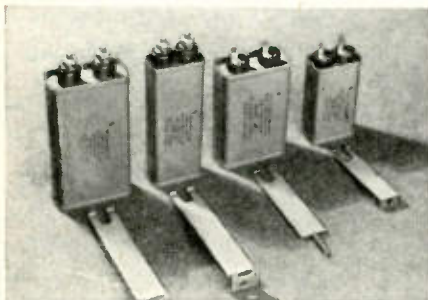

If you have been using 600-volt d-c capacitors on circuits rated 400 volts or less, you're in for a substantial saving in weight, size and cost by specifying General Elec-

tric's new 400-volt Pyranol units. Compared with 600-volt ratings, these new, standard, 400-volt capacitors will save you from 24 to 51 per cent in volume, 23 to 33 per cent in weight, and approximately 10 per cent in cost. They are available in 2-, 4-, 6-, 8- and 10-muf ratings with solder-lug or screw-thread terminals optional on the four larger sizes; the 2-muf size comes with solder-lug terminals only.

New developments, such as silicones and new paper, are continually improving the quality of G-E capacitors. They also permit our engineers to handle your new requirements to your complete satisfaction. Write for quotation on any

capacitor needs, or check Bulletin GEA-2621 for more information on the new d-c line described above.

**NEW,
SMALLER
SELENIUM
RECTIFIER**

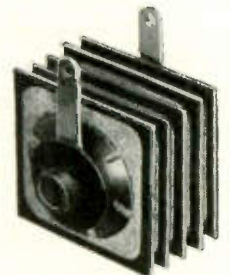

This new General Electric selenium rectifier, less than one inch long and one inch square, is available now for receiver and other elec-

GENERAL  ELECTRIC

Digest

TIMELY HIGHLIGHTS ON G-E COMPONENTS



tronic applications. It costs little and mounts in places where a rectifier tube and socket won't fit. Tests prove that this new selenium rectifier will outlast several 117-volt rectifier tubes. Installation is easier too—only two soldering operations and a minimum of mounting hardware are required.

These rectifiers have an exceptionally high inverse-peak rating, and the inverse current is extremely low even with peak voltages up to 350 volts. At rated current output, the forward drop is five volts or less. Ratings are based on ambients of 50 to 60 C. Check Bulletin 21-127 for more information on this and other General Electric radio rectifiers.

NEW MACHINABLE PLASTIC FOR UHF INSULATION

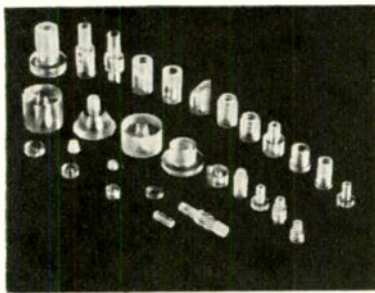

A new arrival in the plastics insulator field is G-E No. 1422, which offers characteristics of advantage in the manufacture of ultra-high-frequency equipment, television, FM, radar, and radio sets, and many other electronic applications. Possessing a dielectric constant of 2.5 to 2.6 with a power factor of .0006 to .0009 at 3000 mc, G-E No. 1422 exhibits unusual heat resistance and excellent machinability.

Indicative of its machinability is the industrial production of r-f con-

ductor beads from G-E No. 1422 on automatic and semi-automatic screw machines. As a low-loss dielectric in the hands of the electric-equipment designer, it affords an excellent low-cost means of producing experimental models and small production quantities through the use of standard machine shop tools. Check coupon for technical report.

HANDLES 12 CIRCUITS SIMULTANEOUSLY

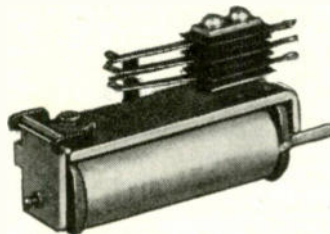

This new telephone-type relay is capable of handling as many as 12 circuits in a wide variety of contact combinations. Designed for multipurpose use in industrial electronic apparatus, communications and signaling equipment, these devices have service lives measured in millions of operations. Working from five basic contact arrangements, combinations can be stacked to satisfy intricate circuit switching requirements. Silver, palladium, or tungsten contacts can be supplied; the choice depends on rating and life specifications.

More than 500 different coils are available, with ratings ranging

from 1 to 250 volts, and 0.1 to 26,000 ohms. This varied selection of coil ratings makes it possible to match closely the coil voltage and resistance with the rating of the energizing circuits. Check Bulletin GEA-4859 for full details.

TO MEASURE TUBE LIFE



Now available for immediate delivery, General Electric Type KT time meters are ideal for inclusion in transmitters and other electronic equipment where knowledge of tube "on time" is important. They can record operating time in hours, tenths of hours, or minutes, and are built in four forms: round or square for panel mounting, portable with attached base, or for conduit mounting. Those designed for panel mounting are housed in small Textolite cases that harmonize with other panel devices.

Telexon motor drive assures an accurate record of tube operation over a long period of time. They can also be used on electronic production tools, such as resistance welders, to keep an accurate record of machine operating time. Researchers use them for measuring time intervals, verifying circuit operation, and life testing. Bulletins GEA-3299 and GEA-1574 have full details.

GENERAL ELECTRIC COMPANY, Section C642-16

Apparatus Department, Schenectady 5, N. Y.

Please send me:

- | | | |
|-----------------------------------|----------------------|---|
| <input type="checkbox"/> GEA-2621 | 400-v D-c Capacitors | <input type="checkbox"/> 21-127 Selenium Rectifier |
| <input type="checkbox"/> GEA-3299 | Type KT Time Meter | <input type="checkbox"/> GEA-4859 Telephone-type Relay |
| <input type="checkbox"/> GEA-1574 | | <input type="checkbox"/> Report on G-E No. 1422 Plastic |

NOTE: More data available in Sweets' File for Product Designers.

Name.....
 Company.....
 Address.....
 City..... State.....



(Continued from page 34A)

MONTREAL

"Facsimile," by F. A. Heister, Radio Inventions, Inc.; October 29, 1947.

"V.H.F. and Microwave Communications," by J. B. Knex, RCA Victor Company; November 19, 1947.

NEW YORK

"A Computer for Electronic Control of Printing," by J. W. Ludwig, Electronic Control Corporation; October 23, 1947.

"Recent Advances in the Theory of Communication," by A. G. Clavier, Federal Telecommunication Laboratories; B. D. Loughlin, Hazeltine Electronics Corporation; J. R. Pierce, Bell Telephone Laboratories; and C. E. Shannon, Bell Telephone Laboratories; November 12, 1947.

NORTH CAROLINA-VIRGINIA

"Operating Problems and their Solutions," by W. P. Seagraves, Station WPTF; November 21, 1947.

OTTAWA

"Visual and Radar Observations on the Perseid Meteor Shower of August, 1947," by P. M. Millman and D. W. R. McKinley, Dominion Observatory and National Research Council; November 27, 1947.

PHILADELPHIA

"The Teleran Air Navigation and Traffic Control System," by D. H. Ewing, RCA Victor Division; November 6, 1947.

PORTLAND

"An Oscilloscope for the Observance of Various Waveforms up to Frequencies of 10 Mc.," by H. Vollum, Tektronix, Inc.; October 23, 1947.

PRINCETON

"Ferromagnetism—Phenomena and Materials," by R. M. Bozorth, Bell Telephone Laboratories; November 13, 1947.

SACRAMENTO

"Simplified 2-Meter Control," by J. Reinarts, Radio Corporation of America; October 30, 1947.

ST. LOUIS

"Radio-Frequency Heating," by R. H. Schnelder, Westinghouse Electric Corporation; November 20, 1947.

SAN DIEGO

"Notes on Standing Wave Measurements on Transmission Lines," by L. E. Swarts, Jr., United States Navy Electronics Laboratory; November 4, 1947.

SAN FRANCISCO

"Radio-Frequency Heating," by R. Bollaert, Westinghouse Corporation; November 5, 1947.

SYRACUSE

"Industrial Atomic Power," by E. H. Bancker, General Electric Company; November 24, 1947.

WASHINGTON

Movie Shorts, courtesy of Westinghouse Electric and Manufacturing Company; November 10, 1947.

WILLIAMSPORT

"The Application of Electronics to Railway Operation," by H. W. Richards, Electronic Railway Signal Company; November 19, 1947.



Comparator inspection of "Electro-Formed" precious Metal tip of replaceable "T" Type Needle used in the "LT" Cartridge.

● Matched to the Cartridge, this new Type "T" Needle is the only one that can be used, thus assuring the constancy of quality reproduction regardless of the number of times the needle may be changed.

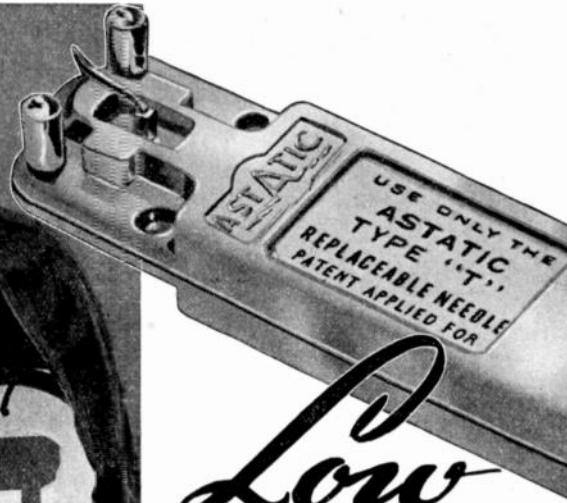

Low NEEDLE TALK MODEL "LT" CARTRIDGE

... Meets Exacting Specifications of Many Leading Phonograph Manufacturers

● In the design and manufacture of this new "LT" Crystal Cartridge, The Astatic Corporation is supplying to the radio phonograph industry, a dependable, low needle talk reproducer, at an attractively low price. Its use is highly recommended with all types of record changers and manually operated phonographs. Note these features:

1. Low Needle Talk
2. Low Needle Pressure
3. Low Price
4. Replaceable "T" Needle
5. Cutoff Frequency, 4,000 c.p.s.
6. Output Voltage, 1.00 volt (Avg. at 1,000 c.p.s.)
7. Needle Guard Posts
8. Standard Dimensions

Special "LT" and "QT"
Literature is Available

For those who prefer a de luxe Reproducer, Astatic suggests earnest consideration of the "QT" (Quiet Talk) CRYSTAL CARTRIDGE—with matched, replaceable "Q" Needle, sapphire or precious metal tipped.

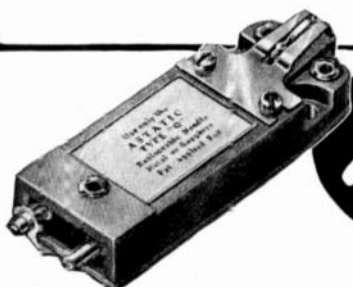

NOW...FOR THE FIRST TIME...

AN ENTIRELY NEW SYSTEM OF DETECTION

Completely eliminates static!

● These two new Hings Detectors absolutely and positively eliminate static and interference in reception for the first time. Where others have tried before with "squelch" and "limiter" circuits, International Electronic has succeeded completely through two entirely new systems of detection—the Noise Neutralizing Detector for AM, and Triggered Detector for CW and CS!

These new instruments mean revolutionary improvement in any type of point-to-point communication . . . are particularly indispensable to police and aircraft networks, ship-to-shore and overseas communication, to automatic printers, tape recorders, alarms and similar operations. They again make practical the use of low-frequency and high-frequency transmission.

Hings Noise Neutralizing Detector
for Voice and AM

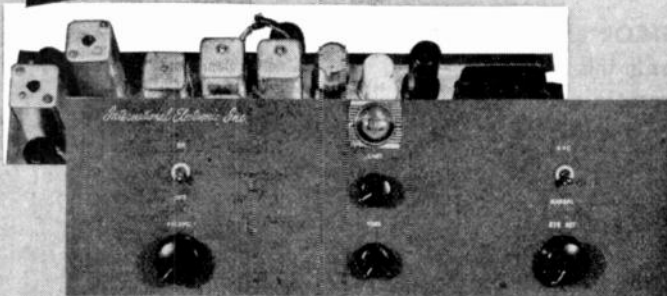

Hings Triggered Detector
for CW and CS



for VOICE and AM

The Hings Noise Neutralizing Detector for AM ("NND" for convenience in reference) brings you all of these vital advantages:

- Neutralizes all noises such as static and ignition completely.
- Permits greater signal-to-noise ratio and vastly improved selectivity.
- Introduces a new operating threshold for AM.
- Permits standby operation of receiver with maximum sensitivity and without atmospheric interference.

- NND is controlled in its phase and amplitude by a second self-generated carrier. Damage to incoming signal and intelligence from impulse saturation or shock is literally repaired.
- Gives clean reproduction through interference for facsimile.
- Eliminates static streaks from television.
- Maintains fidelity of modulation.
- Incorporates self-contained AVC.

for CW and CS

The Hings Triggered Detector for CW and CS ("TD" for sake of brevity) offers the following tremendously important features:

- Permits completely silent standby with both tone and DC reproduction of any signal period.
- Provides selectivity of better than 300 cycles in heavy static without any circuit noise.
- Permits direct operation of automatic equipment or relays.
- Allows tone-selection to suit the operator.

- Internally generated signal is controlled by incoming signal and not by noise shocks.
- Stands noise many thousands of times the amplitude of the signal.
- Suitable for selecting desired CW signal from interfering signals.
- Supplies direct or inverted keying energy.
- For automatic printers, marker spaces can be varied.
- Recommended for handling as high as 150 words per minute.

Manufactured under one or more Hings and Garstang patents.

Both the Hings NND and the TD are supplied in standard rack mounting, suitable for operation with any communications receiver. They are provided with self-contained audio-system and power supply, and connect to the IF circuit of the normal receiver. When ordering specify the IF frequency of the receiver with which the Hings Detectors are to operate. Send for illustrated booklet describing operation and stating engineering details. Engineering services are available for applying the Hings NND and TD to present commercial receivers.

Fixed Frequency R.F. Panels for use with NND and TD will be available shortly.



INTERNATIONAL ELECTRONIC CORPORATION • INDIANAPOLIS
Affiliated with Electronic Laboratories of Canada Ltd., Vancouver, B. C.

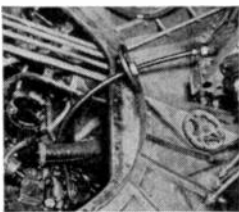
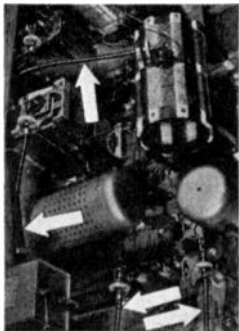
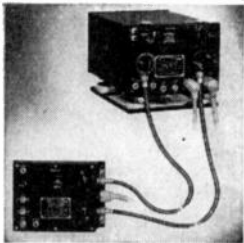
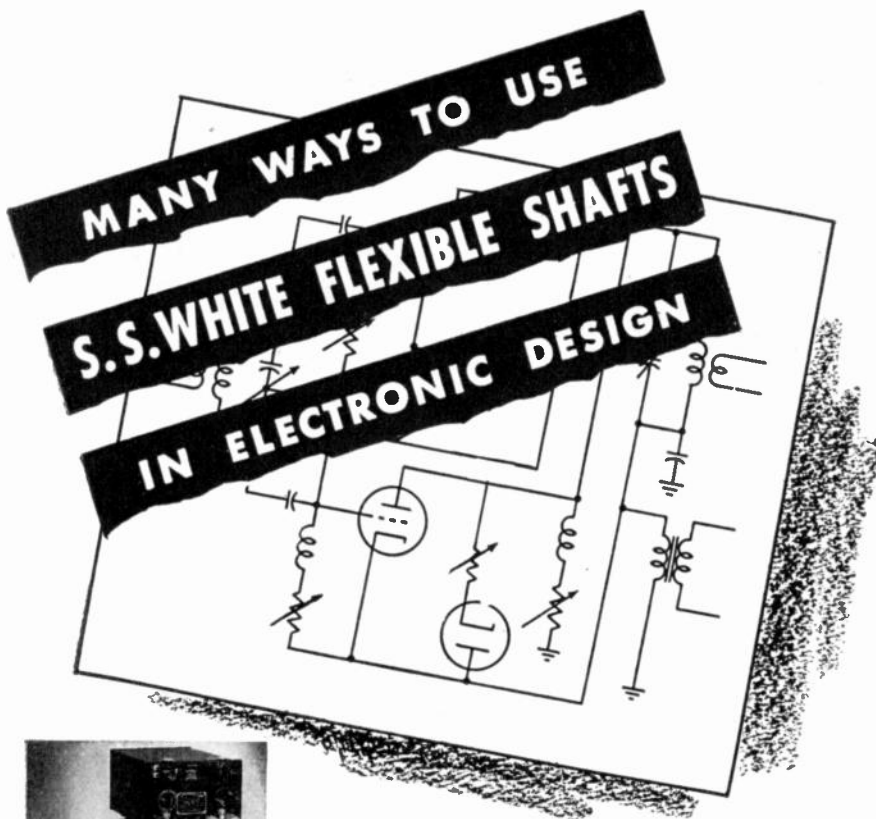

- **USE THEM FOR REMOTE CONTROL**
over long distances and short—as in this aircraft radio receiver. S.S.White remote control type shafts are readily installed and when properly applied, are as easy, smooth and sensitive in operation as a direct connection.
- **USE THEM AS COUPLINGS**
to link variable elements to outside controls—as in this broadcast transmitter. They allow you to locate elements and controls to the best advantage from the standpoints of circuit efficiency, assembly, wiring, servicing and operation.
- **USE THEM FOR POWER DRIVES**
to operate instruments and other mechanisms requiring rotary power—as with this electric tachometer generator. S.S.White shafts of the power drive type meet every need for positive, reliable operation between practically any two points, regardless of curves, obstacles or distance.

WRITE FOR 260-PAGE HANDBOOK

It gives full facts and technical data on flexible shafts and how to apply them. Copy sent free if you write for it on your business letterhead and mention your position.



S.S. WHITE INDUSTRIAL
THE S. S. WHITE DENTAL MFG. CO. DIVISION
DEPT. G 10 EAST 40th ST., NEW YORK 16, N. Y.



FLEXIBLE SHAFTS • FLEXIBLE SHAFT TOOLS • AIRCRAFT ACCESSORIES
SMALL CUTTING AND GRINDING TOOLS • SPECIAL FORMULA RUBBERS
MOLDED RESINS • PLASTIC SPECIMENS • CONTACT PLASTIC MOLDING

One of America's AAAA Industrial Enterprises

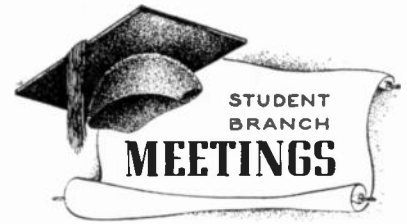

UNIVERSITY OF ALBERTA, I.R.E. BRANCH
"Use of the Seismograph in Oil Explorations,"
by R. D. Hall and K. Provost, Students; November
19, 1947.

UNIVERSITY OF CALIFORNIA, I.R.E.—
A.I.E.E. BRANCH
"Electronics Applied to Mass Spectrography,"
by W. A. Thurston, Shell Development Company;
November 7, 1947.

COLLEGE OF THE CITY OF NEW YORK,
I.R.E. BRANCH
"Professional Engineers in Training," by Nor-
man Alpert, Instructor; October 28, 1947.
"Stamped Circuits," by Milton Koenigstein,
Franklin Manufacturing Company; November 18,
1947.

NORTH CAROLINA STATE COLLEGE, I.R.E. BRANCH
"Directional Couplers," by C. S. Wright, Stu-
dent; November 12, 1947.

RUTGERS UNIVERSITY, I.R.E.—A.I.E.E.
BRANCH
"Resolved—the Engineering Curriculum
Should be Lengthened to Five Years," Open Forum;
October 22, 1947.
"Laying of Submarine Cables," and "Manufac-
ture of Cables," Moving Pictures of the Okonite
Company; November 12, 1947.

STANFORD UNIVERSITY, I.R.E.—A.I.E.E. BRANCH
"Some Effects of Electronics on Naval Opera-
tions in the Pacific During World War II," by John
R. Redman, Rear Admiral, USN; November 5,
1947.

UNIVERSITY OF TEXAS, I.R.E.—A.I.E.E. BRANCH
"The Writing of Reports for Electrical Engi-
neering Laboratories," by Professors W. R. Warner
and W. A. Helwig, and Students N. Isaloe and J.
Ford; October 15, 1947.
"The Selection of a Site for a Power Plant," by
N. B. Gussett, City Public Service of San Antonio;
October 21, 1947.



The following transfers and admissions
were approved on December 9, 1947, to be
effective as of January 2, 1948:

Transfer to Senior Member

- Dike, S. H., 14 D Cedar Dr., Baltimore 20, Md.
- Glasford, G. M., 271 Brook Ave., Passaic, N. J.
- Hoisington, D. B., 48-02 Browvale Lane, Little
Neck, L. I., N. Y.
- Kennedy, A., 299 Innes Rd., Wood-Ridge, N. J.
- LaPierre, V. M., Panagra, Lima, Peru, South Amer-
ica.
- Lehr, P. N., 75-40 Austin St., Forest Hills, N. Y.
- Lescarbours, A. C., The Adshop, Croton-on-Hud-
son, N. Y.
- Mahalingam, N., 223 International House, New
York 27, N. Y.
- Schlegelmilch, R. O., 20 Elizabeth Pkwy., Eaton-
town, N. J.

(Continued on page 42A)

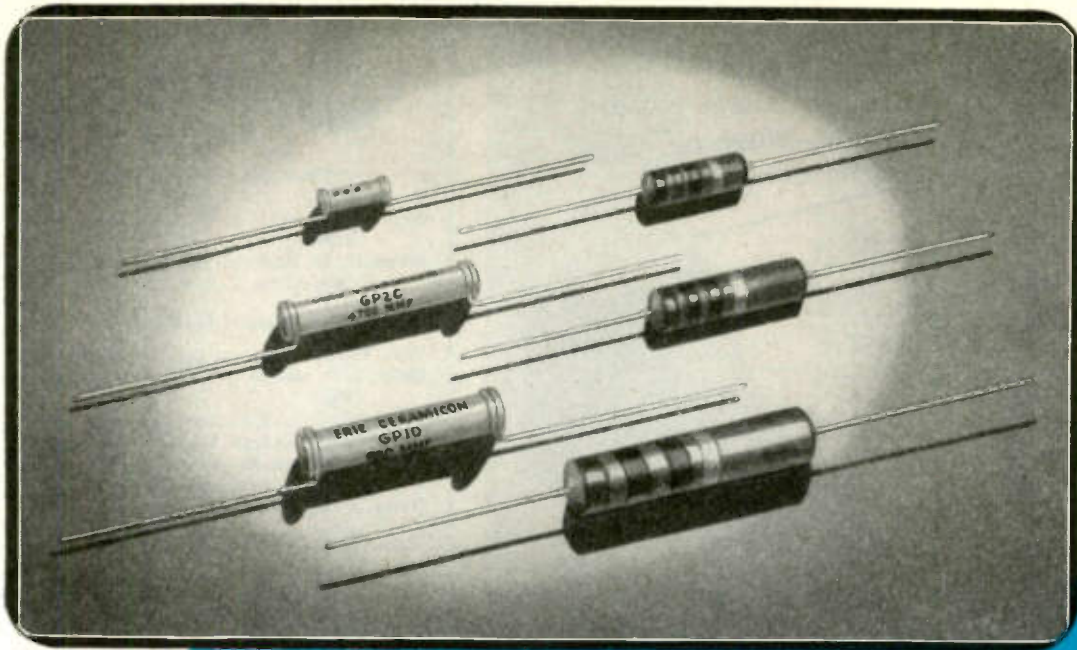

Use ERIE "GP" CERAMICONS*

GENERAL **P**URPOSE

ERIE "GP" Ceramicons have a wide range of adaptability covering practically all by-pass and coupling applications in which the condenser is not directly frequency determining. They are made in insulated styles in popular capacity values up to 5,000 MMF, and in non-insulated styles up to 10,000 MMF.

GOOD **P**ERFORMANCE

The low cost of ERIE "GP" Ceramicons is achieved by mass production, with no sacrifice in quality. Because of their basic, simple construction they have higher resonant frequencies. This factor is increasingly important in the higher frequencies used in FM and Television.

GREATER **P**RODUCTION

High capacities are available in ERIE "GP" Ceramicons in extremely compact sizes. Because they are tubular in shape they require less space than many types of rectangular shaped condensers of equal capacities. Their physical properties and their sturdy construction make them easy to handle in the assembly line, and speed up production.

GROWING **P**OPULARITY

More and more radio manufacturers are standardizing on ERIE "GP" Ceramicons, because they find that these silver ceramic condensers make possible lower product cost with improved efficiency. If you haven't switched to "GP" Ceramicons for by-pass and coupling applications, write Erie Resistor for full details.



*Ceramicon is the registered trade name of silvered ceramic condensers made by Erie Resistor Corporation.

Electronics Division
ERIE RESISTOR CORP., ERIE, PA.
 LONDON, ENGLAND • TORONTO, CANADA



The MAGIC of VHF

OMNI-DIRECTIONAL RANGES
RUNWAY LOCALIZERS
VISUAL-AURAL RANGES
SIMULTANEOUS VOICE
GCA

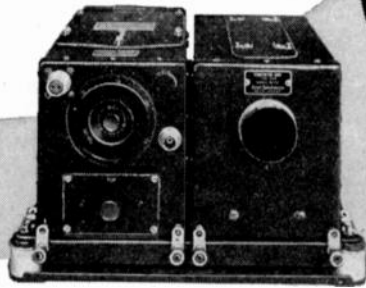

All the outstanding advantages of VHF communication and navigation are combined in two new Systems designed and manufactured by Aircraft Radio Corporation.

THE TYPE 15A VHF OMNI-DIRECTIONAL RANGE RECEIVING SYSTEM

provides an unlimited number of courses from the new VHF Omni-Directional Ranges, as well as operation on VHF Runway Localizers and Visual-Aural Airways Ranges. Simultaneous voice feature is included on these ranges. The tunable A.R.C. Receiver makes it possible to receive VHF communications on any frequency selected while in flight — no need for several receivers to cover the entire VHF band.

THE TYPE 18 VHF TRANSMITTING SYSTEM normally is used in combination with the Type 15 to provide complete 2-way VHF Communication — or it may be used alone for dependable, powerful VHF Transmission. Additional transmitters may be added to cover a wider range of frequencies if such coverage is required.

Units of the type 18 System have been Type-Certificated by the CAA for use by scheduled air carriers. Yet their light weight and moderate cost make them ideally suited to the operational requirements of executive-type aircraft. Other combinations of A.R.C. equipment are available to meet every operational need.

The dependability and performance of these VHF communication and navigation systems spells increased safety in flight, more efficient aircraft operation. Specify A.R.C. for your next installation.



(Continued from page 40A)

Stephens, T. C., 1311 B Ave., N.E., Cedar Rapids, Iowa.

White, W. D., Airborne Instruments Laboratory, Mineola, L. I., N. Y.

Admission to Senior Member

Cook, W. A., 48 Misiones, Buenos Aires, Argentina
Fisher, J. F., 1509 W. Tioga St., Philadelphia 40, Pa.

Hirshman, C. L., 6 Bramley Mansions, Bramley Rd., Southgate, London, N. 14, England
Piper, C. A., 85 Van Reypen St., Jersey City 6, N. J.
Weiss, H. G., Box 1663, Los Alamos, N. M.
Wilson, J. E., 1520 San Rae Dr., Dayton 9, Ohio

Transfer to Member Grade

Auditore, C. J., 40-71 Elbertson St., Elmhurst, L. I., N. Y.

Beckhardt, T. G., 1906 Ave. R. Brooklyn 29, N. Y.
Bedford, P. L., 9511 Seminole St., Silver Spring, Md.

Bowne, W. L., 21 Foxcroft Rd., Winchester, Mass.
Clark, R. R., 8292 Wisconsin Ave., Detroit 4, Mich.
deOnis, A., Brentwood Transmitting Station, Mackay Radio and Telegraph Co., Brentwood, L. I., N. Y.

Dewitz, G. H., 917 Mill Hill Terr., Southport, Conn.
Fallain, F. D., 1914 Miller Rd., Flint 3, Mich.

Fraser, R., 122 Cutter Mill Rd., Great Neck, L. I., N. Y.

Gulden, E. V., 140 Oak Knell Dr., Dayton 9, Ohio
Hauser, P. D., 1430 Gascho Dr., Dayton 3, Ohio
Herson, J. L., 1262—21 St., N.W., Washington 6, D. C.

Head, J. W., 18868 Bretton Dr., Detroit 23, Mich.
Hoenig, W., 127 West 82 St., New York 24, N. Y.
Kaye, H. W., 4 Cromwell Place, White Plains, N. Y.

Kellher, J. J., 257 N. Thomas St., Arlington, Va.
Lealie, J. M., 355 King St., W., Toronto, Ont., Canada

Lewis, G. E., 4373 Cleveland, San Diego 3, Calif.
Marsh, H. S., 329 S. Lee St., Alexandria, Va.
Meier, D. J., Watson Laboratories, Red Bank, N. J.
Metcalf, D. E., 1749 Magnolia Ave., Los Angeles 6, Calif.

Pickett, J. H., Aerovox Canada, Ltd., 1551 Barton, E., Hamilton, Ont., Canada

Pratt, R. L., 152 DeSoto St., Pittsburgh 13, Pa.
Rahman, S. M. F., 608 S. Dearborn St., Chicago, Ill.
Rao, M. K., c/o Dr. N. Alahasingari, Maharnipetta P. O., Vizagapatam, S. India

Record, W. V., 2260 Grande Ave., Cedar Rapids, Iowa

Schulz, S. W., 3132 Fourth St., S.E., Minneapolis, Minn.

Shuey, R. L., 1106 Francisco St., Berkeley 2, Calif.
Spittle, S. E., 30 John St., Red Bank, N. J.

Spragg, L. A., 14996 Alexander, Detroit 23, Mich.
Swarthe, E., 5118 Harold Way, Los Angeles 27, Calif.

Swarthout, W. M., 13 Teel Street Pl., Arlington 74, Mass.

Tavaniotis, C., Devon Hotel, 70 W. 55 St., New York 19, N. Y.

Von Tersch, L. W., Electrical Engineering Dept., Iowa State College, Ames, Iowa

Watkins, D. A., 1608½ Washington Ave., S.E., Cedar Rapids, Iowa

Admission to Member Grade

Ankers, R. E., Jr., 1601 N. Rhodes St., Arlington, Va.

Autuori, V. A., 67 Broad St., New York, N. Y.
Barr, E. M., 25 Southland Dr., Henrietta, N. Y.

Beckwith, R. W., 235 Shaver Ave., North Syracuse, N. Y.

Beeman, K. R., 2619 Milam St., Houston 6, Tex.

(Continued on page 44A)



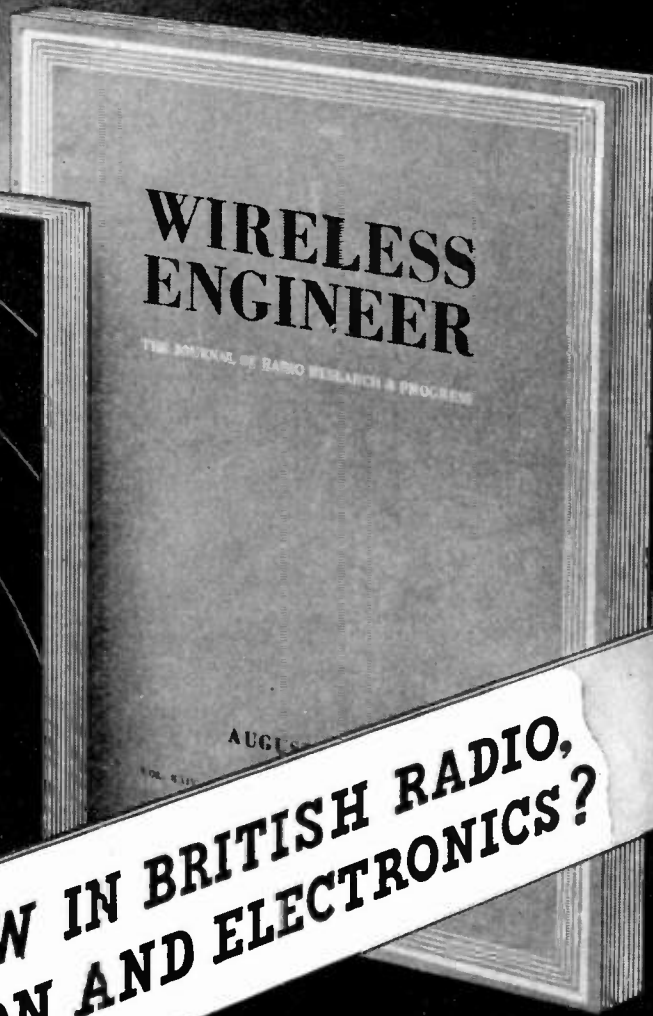
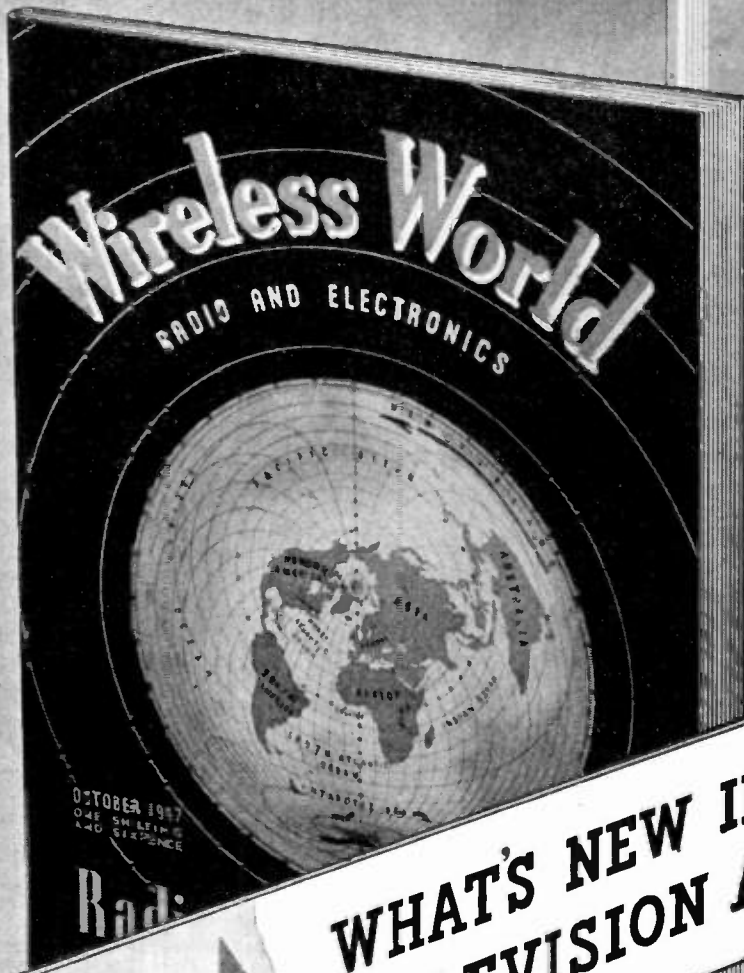

**WHAT'S NEW IN BRITISH RADIO,
TELEVISION AND ELECTRONICS?**

**THESE AUTHORITATIVE JOURNALS WILL
KEEP YOU CLOSELY IN TOUCH WITH
BRITAIN'S LATEST DEVELOPMENTS.**

WIRELESS WORLD is Britain's leading technical magazine in the general field of radio, television and electronics. Founded over 35 years ago, it has consistently provided a complete and accurate survey of the newest British technique in design and manufacture. The October issue is a special Radiolympia Show number, reporting fully on Britain's first post-war National Radio Exhibition. WIRELESS WORLD is published monthly, 20 shillings (\$4) a year.

WIRELESS ENGINEER is read by research engineers, designers and students, and is accepted internationally as a source of information for advanced workers. The Editorial policy is to publish only original work and representatives of the National Physical Laboratory, the British Broadcasting Corporation and the Engineering Department of the British Post Office are included on the Editorial Advisory Board. WIRELESS ENGINEER is published monthly, 32 shillings (\$6.50) a year.



Subscriptions can be placed with British Publications Inc., 150 East 35th Street, New York 16, N.Y., or sent direct by International Money Order to Dorset House, Stamford St., London, S.E.1, England. Cables: "Iliffepres. Sedist, London."

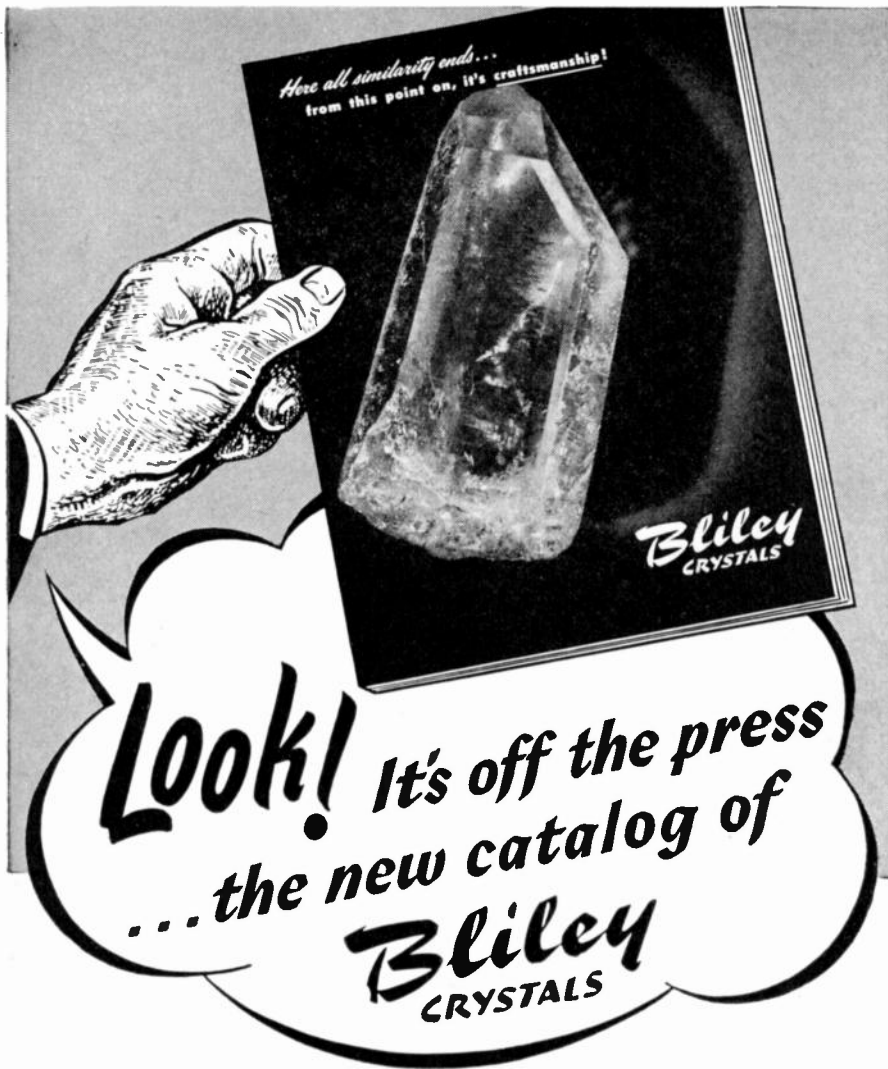

GET YOUR COPY FROM YOUR **Bliley**
REPRESENTATIVE OR DISTRIBUTOR . . .



Herb Becker
1406 S. Grand Ave.
Los Angeles 15, Cal.



Gerard McL. Cole
920 N. Michigan Ave.
Chicago 11, Illinois



Dave M. Lee
2626 Second Ave
Seattle 1, Wash



M. B. Patterson
1124 Irwin-Keaster Bldg.
Commerce & Ervay St.
Dallas, Texas



Clyde H. Schryver
108 Walthow Bldg.
Kansas City 6, Mo.



Ronald G. Bowen
1886 S. Humboldt St.
Denver 10, Colo.



Walter T. Honnigan
43 Leon St., United Bldg.
Boston 15, Mass.



Wm. E. McFadden
85 E. Gay St.
Columbus, Ohio



C. M. Robinson
207 Scott Block
Winnipeg, Man., Can.



Fred Stevens
15126 E. Warren Ave.
Detroit 24, Mich.



Henry W. Burwell
105 Forrest Ave. Bldg.
Atlanta 3, Ga.



Fred B. Hill
256 First Ave. N.
Minneapolis, Minn.



R. W. Mitscher
Ellicott Square Bldg.
Buffalo 3, N. Y.



F. Edwin Schmitt
136 Liberty St.
New York 6, N. Y.



George O. Tanner
600 Grant St.
Pittsburgh 19, Pa.

H. R. Gray, Astral Electric Co., 56-58 Wellington St. E., Toronto 1, Ont., Can.

BLILEY ELECTRIC COMPANY • ERIE, PENNSYLVANIA



(Continued from page 42A)

- Chapin, W. R., St. Louis Globe-Democrat, 1133 Franklin Ave., St. Louis 1, Mo.
 Chester, W. G., 913 N. Woodington Rd., Baltimore 29, Md.
 Dougherty, J. W., 2617 S. 71 St., Philadelphia 42, Pa.
 Eichberg, R. L., 4402 N. Pershing Dr., Arlington, Va.
 Fitzwilliam, J. P., 408 S. 17 St., Manhattan, Kan.
 Frias, D. E., Mendoza 223, Tucuman, Argentina
 Gensler, E. J., 43 Manhasset St., Buffalo 10, N. Y.
 Goldberg, B., 27 Prospect Ave., Atlantic Highlands, N. J.
 Gulick, E. C., 166 Earl Lane, Hatboro, Pa.
 Hill, F. P., 2641 Elder Lane, Franklin Park, Ill.
 Langworthy, R. E., 1879—17 St., Cuyahoga Falls, Ohio
 Leasure, R. B., 12 N. Oak St., Kingston, Ohio
 Licwinko, L. S., 3501 S. Stafford St., Arlington, Va.
 Lippmann, S. A., 1961 Hazelwood, Detroit 6, Mich.
 McMahon, G. V., 453 West 70 St., Chicago 21, Ill.
 Montgomery, G. F., 4557 S. Chelsea Lane, Bethesda 14, Md.
 Myrbeck, E. R., Cruft Laboratory, Harvard University, Cambridge, Mass.
 Nelson, G. R., 306 E. Forrest Lane, Oak Ridge, Tenn.
 Roberts, R. E., Asst. Controller Telecoms., Seremban, Negri Sembilan, Malaya
 Roemer, C. E., 418 Broad Sq., Carlstadt, N. J.
 Rogers, J. A., 13 Kingsley Rd., Brighton 5, Sussex, England
 Smith, C. H., General Delivery, Anchorage, Alaska
 Smith, W. N., Osage Rd., Anchorage, Ky.
 Stateman, M. J., 415 W. 56 St., New York 19, N. Y.
 Zelazo, N. K., 500—18 St., S., Arlington, Va.

The following admissions to Associate were approved on December 9, 1947, to be effective as of January 2, 1948:

- Alexander, J. H., Jr., 219 E. Meyers St., Pittsburgh 10, Pa.
 Allen, G. W., 100 Riverside Dr., Riverside 15, R. I.
 Ansel, D. E., 4631—37 W. Racine Ave., Chicago 40, Ill.
 Appleby, G. E., 1337 N. Dearborn St., Chicago 10, Ill.
 Bailey, F. W., 2733 Newell St., Los Angeles 26, Calif.
 Behagen, E. L., 3251A N. Fifth St., Milwaukee 12, Wis.
 Bell, R. E., 120 W. Maple St., Charlotte, Mich.
 Bhatnagar, H. M., c/o The National Radio & Engineering Company, Ltd., 26 Sleater Rd., Bombay 7, India
 Bhoumick, N. P., Dept. of Electrical Tech., Science Institute, Bangalore, Malleswaram, Mysore, S. India
 Black, T. L., 123 Eldorado St., Syracuse 6, N. Y.
 Borgsteadt, J. B., 3364—18 St., N.W., Washington 10, D. C.
 Brousseau, A. T., 3364—18 St., N.W., Washington 10, D. C.
 Carr, D. G., 916 Lincoln Ave., Highland Park, Ill.
 Cecil, J., Box 1072, Midland, Tex.
 Charlebois, J. C., Gordon Ave., Verdun 19, Que., Canada
 Claffey, M. C., 4308 N. Kenmore, Chicago 13, Ill.
 Clarke, I. A., 3343 N. Sydenham St., Philadelphia 40, Pa.
 Coleman, M. J., 152 Derby St., Johnstown, Pa.
 Decker, D. D., 208 N. Mayfield, Chicago 44, Ill.
 Denniston, R. L., Box 312, Alamogordo, N. M.
 Eastman, C. W., Hq. 59 AACS Group, APO 942, c/o Postmaster, Seattle, Wash.
 Edwards, M. W., 31 Longview Ave., White Plains, N. Y.

(Continued on page 46A)

HERE'S FLAT RESPONSE UP TO 700 MC

hp 410A VACUUM TUBE VOLTMETER

with its new *-hp-* low-capacity diode probe, measures all the important radio voltages without disturbing circuits under test.

CHECK THESE FACTS ABOUT THE NEW *-hp-* PROBE*:

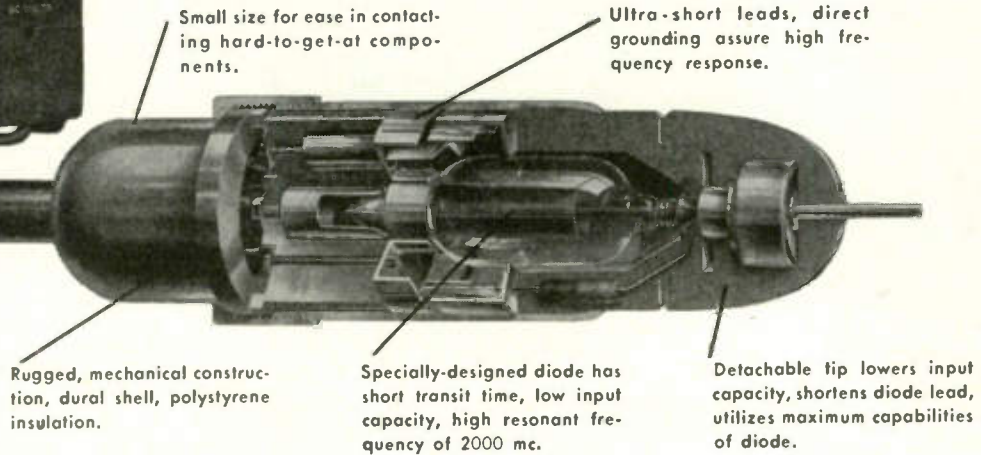

Rugged, mechanical construction, dural shell, polystyrene insulation.

Specially-designed diode has short transit time, low input capacity, high resonant frequency of 2000 mc.

Detachable tip lowers input capacity, shortens diode lead, utilizes maximum capabilities of diode.

*Reproduced actual size

The specially-designed diode, in combination with the *-hp-* probe design, makes possible the exceedingly flat frequency response shown graphically in Figure 1.

With this flat frequency response are combined the factors of low input capacity and high input resistance. The variation of these factors with

frequency is shown in Figure 2. The input resistance and reactance are high throughout the entire range of the instrument, and thus measurements are made without appreciable detuning or loading of circuit. Maximum measuring accuracy is assured.

In addition to swiftly, easily, accurately making uhf radio measure-

ments, this *-hp-* 410A is a convenient voltage indicator up to 3000 mc. And it serves equally well as an audio or d-c voltmeter, or an ohmmeter. A-c measurements are made in 6 ranges...full scale readings 1 to 300 v. D-c full scale readings from 1 to 1000 v in 7 ranges. Input resistance all ranges—100 megohms. As an ohmmeter, the *-hp-* 410A measures resistances from 0.2 ohms to 500 megohms in 7 ranges.

In short, this *-hp-* 410A Vacuum Tube Voltmeter is ideal for obtaining most important parameters in radio design, manufacture, or servicing. Write today for full details. Hewlett-Packard Company, 1407D Page Mill Road, Palo Alto, California.

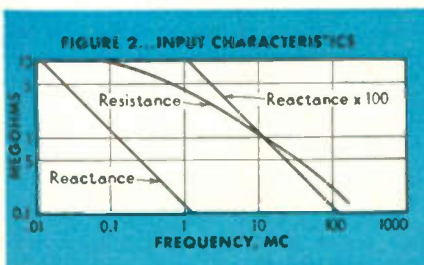
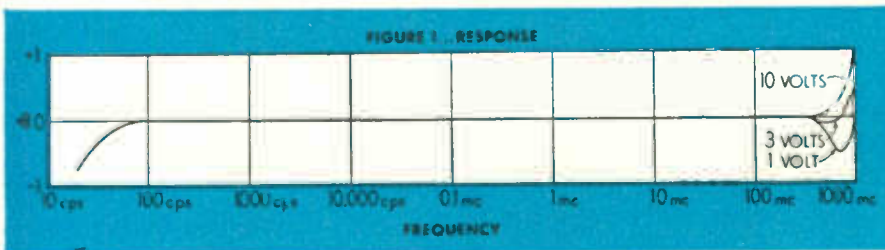

hp laboratory instruments
FOR SPEED AND ACCURACY

Noise and Distortion Analyzers Wave Analyzers Frequency Meters
Audio Frequency Oscillators Audio Signal Generators Vacuum Tube Voltmeters
Amplifiers Power Supplies UHF Signal Generators Attenuators
Square Wave Generators Frequency Standards Electronic Tachometers

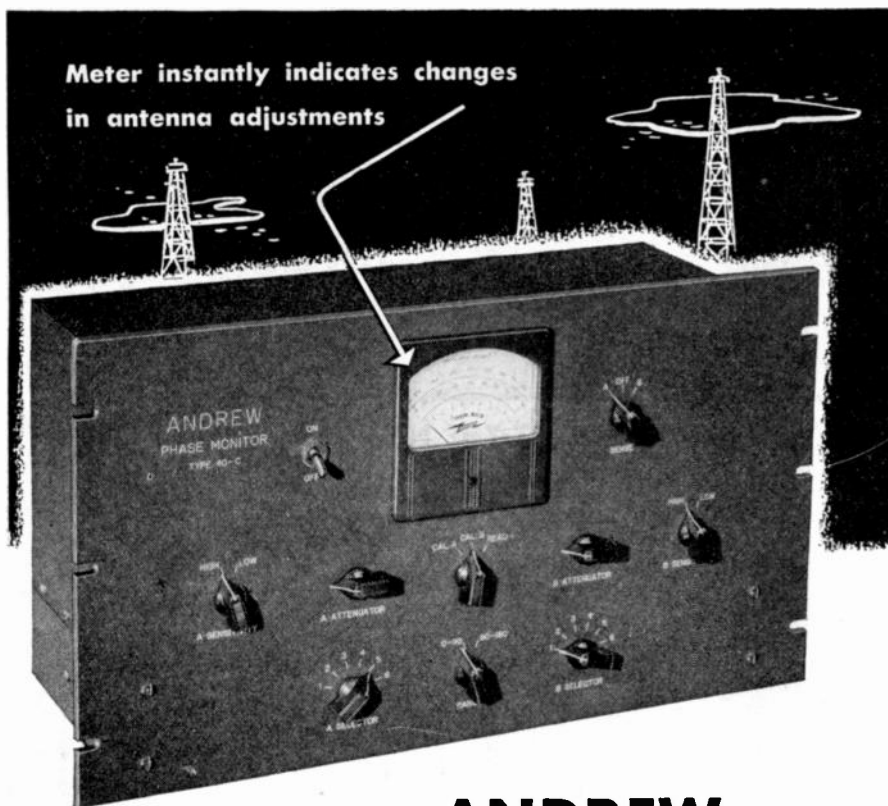

New
MODEL 40-C

ANDREW PHASE MONITOR

The ANDREW Type 40-C Phase Monitor is a modern, new instrument, designed to facilitate adjustment and maintenance of broadcast directional antenna arrays. Accurately measuring both angle of phase difference and ratio of antenna current amplitude, it provides a quick, direct check on antenna system adjustment.

An exclusive Andrew feature permits measurement of current ratios and phase angles in degrees on a single meter. This affords immediate observation of the effects of small antenna circuit adjustments.

Sensitivity is high—better than one volt from 550 to 1600 KC.

Six individual input circuits accommodate directional systems utilizing as many as six towers.

Write for Bulletin 47 for full details. Prompt placement of your order will assure delivery when needed.

Many stations already have purchased this new Phase Monitor; among them are:

CJCA	KJAY	WBOC	WKBZ
CKCH	KLOU	WBTM	WKOW
KCBC	KOGT	WDEV	WKVM
KCRG	KOLO	WGAD	WRGA
KDSH	KSBW	WGIO	WROW
KFSA	KSEL	WGTM	WRWR
KGFM	KVGB	WHHT	WSAV
KGHI	KVOH	WHIS	WTMC
KGIL	KVVC	WINZ	WVIS
KGNC	KXOA	WJLS	WWOK
KGO	WAGF	WJMS	WWXL
KITO	WBBC	WJRD	

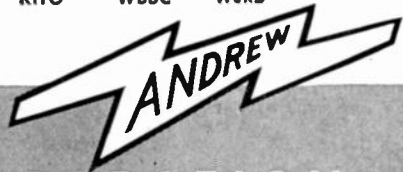

ANDREW CORPORATION
363 EAST 75TH STREET · CHICAGO 19, ILL.

Pioneer Specialists in the Manufacture of a Complete Line of Antenna Equipment



(Continued from page 44A)

- Franklin, L. F., General Delivery, North Fork, Calif.
- Fuller, L. C., Jr., 39 St. Paul's Rd., Ardmore, Pa.
- Gondek, E. P., 3138 W. Warren Blvd., Chicago 12, Ill.
- Gordon, D. H., 2127—33 Ave., San Francisco 16, Calif.
- Gourley, R. B., 99 W. Genesee St., Baldwinsville, N. Y.
- Grealge, R. L., 142 E. Palmer Ave., Jackson, Mich.
- Hansen, W. G., 4839 Arvilla Lane, Houston 4, Tex.
- Hawley, W. E., 548 W. Spring St., Lima, Ohio
- Hennelly, J. P., 6237 S. Normal Blvd., Chicago 21, Ill.
- Holt, D. J., 221 E. Lake Dr., Decatur, Ga.
- Honer, R. E., 4174 Osborne Rd., Chamblee, Ga.
- Huddleston, W. B., 4417 Darsey, Bellaire, Tex.
- Hylas, A. E., 29 Lester Ave., Westwood, N. J.
- Jacobson, H. R., 4904 William St., Omaha 2, Neb.
- Jahnke, C. E., American Television, Inc., 5050 Broadway, Chicago, Ill.
- Jenkins, P. M., 1719 Larrabee St., Chicago 14, Ill.
- Johnson, C. W., 667 Fellows Ave., Syracuse 10, N. Y.
- Johnson, V. N., Box 64, Angola, Ind.
- Kauder, A. J., 2214 W. Dunlop St., San Diego 11, Calif.
- Kawal, W. T., CCS, GHQ SCAP, APO 500, c/o Postmaster, San Francisco, Calif.
- Kitto, C. E., 381 Concord Ave., Toronto 4, Ont., Canada
- Klawinski, R. J., American Television, Inc., 5050 Broadway, Chicago, Ill.
- Krishnaswamy, P., c/o Kosala, Thyagarayanagar, India Command, Madras 17, India
- Kulosa, A., Jr., 4547 N. Drake Ave., Chicago 25, Ill.
- Leach, J. A., 141st AACCS Sq., Det. 47, APO 239, c/o Postmaster, San Francisco, Calif.
- Lehman, H. W., 2410 E. Ave., N.E., Cedar Rapids, Iowa
- Leibowitz, S., 86 W. Bowery St., Akron 8, Ohio
- Lichty, J. R., Transmitter Division, Electronics Dept., General Electric Co., Syracuse, N. Y.
- Lichty, R. E., 205 Normal Ave., Normal, Ill.
- Lieberknecht, J. A., 868½ W. 42 St., Los Angeles, Calif.
- Lieberman, E., 1612—70 St., Brooklyn 4, N. Y.
- Lindberg, E., 221 Lexington Ave., Buffalo 13, N. Y.
- Lurion, E., 1344 W. 39 St., Los Angeles 37, Calif.
- Makstein, F. I., 3440 Gates Pl., New York 67, N. Y.
- Manogjan, H., 20 Fenner, Cranston, R. I.
- McCoig, K. W., 97 Spruce St., Ottawa, Ont., Canada
- McCormack, T. L., 9 Nashua St., Somerville, Mass.
- McGowan, M. L., 2703 Spaulding St., Omaha 11, Neb.
- McIntire, O. E., 407 W. South, Angola, Ind.
- Miller, J. R., 2752 Meadowbrook Dr., S.E., Cedar Rapids, Iowa
- Milstein, E., 7936 S. Kimbark Ave., Chicago 19, Ill.
- Mitchell, H. E., Box 72, P.O. Sarina, Nth, Queensland, Australia
- Mitra, G. B., 286/A Ras Behari Ave., Calcutta, Ballygunt, India
- Morton, R. F., Route 1, Ravenna, Ohio
- Nielsen, C. W., 434 Cornell Place, Louisville 7, Ky.
- Oakes, H. S., 4222 Westhill Ave., Montreal, Que., Canada
- Oursler, D., 6347 Kenmore Ave., Chicago 40, Ill.
- Painchaud, P. A., 1035½ Kingston Ave., Los Angeles, Calif.
- Pennington, K., 3208 Portland Ave., Louisville 12, Ky.
- Peterson, R. M., 509 S.W. Oak St., Portland 4, Ore.
- Porter, E. A., 109 Boonton Ave., Boonton, N.J.
- Rabe, W. A., Box 238, Angola, Ind.
- Rao, V. B. T., Dept. of Physics, Andhra University, Waltair, S. India

(Continued on page 48A)

NOW *One* INSTRUMENT FOR ELECTRONIC MEASUREMENTS

WESTON ELECTRONIC ANALYZER

Incorporating:

1. A conventional Volt-Ohm-Milliammeter with self-contained power source.
2. A high-impedance electronic Volt-Ohmmeter using 115 volt, 60 cycle power.
3. A stable, probe-type, Vacuum Tube Voltmeter, for use to 300 megacycles.



Model 769

Accurate a-c measurements .25 volt to 120 volts, 50 cycles to 300 megacycles.

Extremely small R.F. Probe ($3\frac{1}{2}$ " x $\frac{3}{4}$ " dia.). Probe constants, 5 megohms paralleled by 5 mmfd., approx.

New unity gain d-c amplifier provides absolute stability with line voltage variations from 105 to 130 volts.

D-C Electronic amplifier ranges 3 to 1200 volts at 15 megohms, resistance ranges 3000 ohms to 3000 megohms.

Conventional 10,000 ohm per volt d-c ranges 3 to 1200 volts, 1000 ohm per volt a-c rectifier ranges 3 to 1200 volts.

Resistance ranges 3000 to 300,000 ohms where a-c power is not available.

Entire Model 769 protected from external RF influences.

Uses standard commercial types of tubes replaceable without recalibration.

Size only 10" x 13" x $6\frac{1}{8}$ ".

Full details from your local WESTON representative. Literature available . . . Weston Electrical Instrument Corporation, 589 Frelinghuysen Avenue, Newark 5, N. J.



ALBANY • ATLANTA • BOSTON • BUFFALO • CHARLOTTE • CHICAGO • CINCINNATI • CLEVELAND
DALLAS • DENVER • DETROIT • JACKSONVILLE • KNOXVILLE • LITTLE ROCK • LOS ANGELES
MERIDEN • MINNEAPOLIS • NEWARK • NEW ORLEANS • NEW YORK • PHILADELPHIA
PHOENIX • PITTSBURGH • ROCHESTER • SAN FRANCISCO • SEATTLE • ST. LOUIS
SYRACUSE • IN CANADA, NORTHERN ELECTRIC CO., LTD., POWERLITE DEVICES, LTD.

**SPEED!
ACCURACY!
SIMPLICITY!
EFFICIENCY!**



**Automatic
PUSH-BUTTON SELECTION**

**The NEW Precision
Multi-Master**

Series 847

**5000 and 1000 OHMS PER VOLT
DC—1000 OHMS PER VOLT AC**

High speed, 54 range, high sensitivity, AC-DC multi-range tests set. Ranges to 6000 volts, 200 megohms, 12 amperes, + 70 DB.

A rugged, high sensitivity, general purpose AC-DC test set, designed to withstand the continuous use associated with electronic maintenance and service, classroom instruction, production testing, etc. • 200 microampere, 4½" meter. • All standard functions at only two jacks. • 200 megohm insulation resistance test range. • Recessed 6000 volt safety jacks. • Etched-Anodized aluminum panels resistant to moisture and wear. • Conservatively and professionally designed.

RANGE SPECIFICATIONS

- ★ 24 AC-DC voltage ranges to 6,000 volts at both 5,000 and 1,000 ohms per volt DC. 1,000 ohms per volt AC. Initial range 0-3 volts.
- ★ 3 DC current ranges to 12 amperes.
- ★ 6 ohmmeter ranges to 200 megohms.
- ★ 8 decibel ranges —26 DB to +70 DB.
- ★ 8 output ranges to 6,000 volts.

MODEL 847-L; modern, shallow, Bakelite laboratory types case\$42.90
MODEL 847-P; portable, hardwood case with tool compartment and cover\$44.90

(Prices complete with batteries and High-Voltage test leads.)

ASK to see the full "Precision" line of Quality Test Instruments on display at all leading radio parts and equipment distributors. Signal generators, Vacuum Tube Voltmeters, Tube Testers, Multi-range Test Sets, etc.

Write for new Precision 1948 Catalog

**PRECISION
APPARATUS CO., Inc.
92-27 Horace Harding Blvd.
Elmhurst 12, N. Y.**

Export Division: 458 Broadway, N. Y. City, U.S.A.
Cables: MORHANEX



(Continued from page 46A)

- Redler, W. M., 6602 Connecticut Ave., Chevy Chase 15, Md.
Ritter, F. O., 10-40—117 St., College Point, N. Y.
Rockwell, J. R., 691 Kildare Rd., Windsor, Ont., Canada
Sanders, R. W., 940 E. Seventh St., National City, Calif.
Saulnier, G. S., U. S. Navy Electronics Laboratory, Code 434, San Diego 52, Calif.
Scott, V. J., Jr., 203 Morgan Blvd., Valparaiso, Ind.
Seamans, J. O., 2336 Elizabeth Ave., Winston-Salem 7, N. C.
Shappee, C. E., Route 1, Montpelier, Ohio
Shooner, R. J., 301 Second St., Angola, Ind.
Sloan, A. C., 3743 N. Lawndale, Chicago 18, Ill.
Smith, F. B., Box 255, Piedmont, S. C.
Smith, L. R., 115 N. Denison St., Baltimore 29, Md.
Snow, V. M., 122 W. Kelso St., Inglewood, Calif.
Sreenivasan, A. P., Grandi Nagar, 186, 6th Cross, Bangalore City, Mysore, India
Stavrou, N. C., Box 301, Winston-Salem, N. C.
Stilin, F. L., 28 Grand View Ave., Sault Ste. Marie, Ont., Canada
Swigart, J. W., Box 17, Pleasant Lake, Ind.
Taucer, C. W., 1st Signal Radio Maintenance Sq., Kelly Field, San Antonio, Tex.
Taylor, A. K., 801 Melrose Ave., Verdun, Montreal 19, Quebec, Canada
Taylor, M., Jr., "A" Btry., 571st F.A. Bn., Fort Riley, Kan.
Toner, J. W., 87-04—80 St., Woodhaven 21, N. Y.
Topol, S., 3945 4th St., S.E., Washington, D. C.
Trichinotis, J., 3822 W. Flournoy St., Chicago 24, Ill.
Turner, R., 217 Jerrys Lane, Erdington, Birmingham 23, England
Venkatasubramanian, T. R., 22 Kiladar St., Teppakulam Post, Trichinopoly, India
Viebranz, A. C., Sylvania Electric Prods., Inc., 70 Forsyth St., Boston, Mass.
Walden, L. H., 737 Cornish Dr., San Diego 7, Calif.
Warnick, A., 2745 Richton, Detroit 6, Mich.
Wilhelm, C. J., 4445 S. Talman Ave., Chicago 32, Ill.
Wooley, E. E., Apt. D-2-D, Lacona, Rodman, Panama, Canal Zone
Yoder, J. R., 12 Wenzel Terr., Stamford, Conn.

News—New Products

These manufacturers have invited PROCEEDINGS readers to write for literature and further technical information. Please mention your I.R.E. affiliation.
(Continued from page 22A)

Air Flow Switches

Air Flow Switches are now being manufactured by Coral Designs, Box 248, Forest Hills, N. Y., as a standard item, according to a recent announcement.

These switches are used as safety switches to insure against tube failure due to lack of air flow, and they are being employed in 3-, 10-, and 50-kw. broadcast transmitters in which they are used to indicate the resulting static pressure due to impact caused by air flow.

Other units are used not only to indicate air failure, but also to insure proper maintenance and operation of equipment by indicating when a change in static pressure in a system takes place due to conditions created by unclean air filters, failure by personnel to open louvers on ducts leading outdoors, etc.

Installation is very simple, and all units are provided with means of adjustment for regulating the unit for the desired air flow in the field.

**MEASUREMENTS
CORPORATION
Model 59**

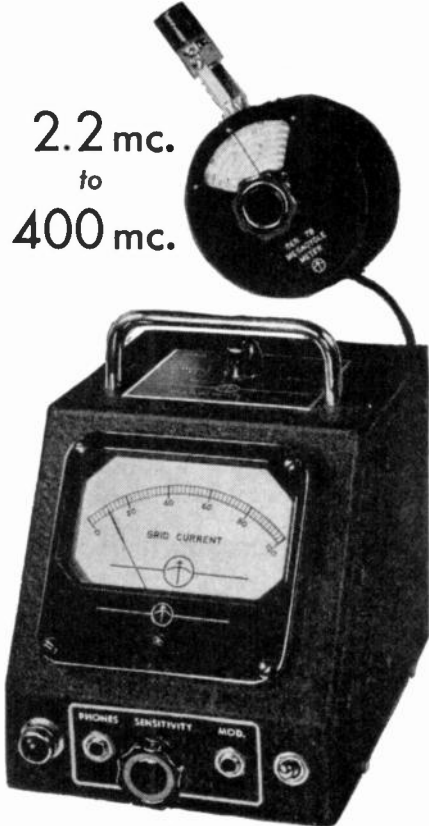

**2.2 mc.
to
400 mc.**

**MEGACYCLE
METER**

Radio's newest, multi-purpose instrument consisting of a grid-dip oscillator connected to its power supply by a flexible cord.

Check these applications:

- For determining the resonant frequency of tuned circuits, antennas, transmission lines, by-pass condensers, chokes, coils.
- For measuring capacitance, inductance, Q, mutual inductance.
- For preliminary tracking and alignment of receivers.
- As an auxiliary signal generator; modulated or unmodulated.
- For antenna tuning and transmitter neutralizing, power off.
- For locating parasitic circuits and spurious resonances.
- As a low sensitivity receiver for signal tracing.

MANUFACTURERS OF
Standard Signal Generators
Pulse Generators
FM Signal Generators
Square Wave Generators
Vacuum Tube Voltmeters
UHF Radio Noise & Field Strength Meters
Capacity Bridges
Megohm Meters
Phase Sequence Indicators
Television and FM Test Equipment

SPECIFICATIONS:
Power Unit: 5½" wide; 6½" high; 7½" deep.
Oscillator Unit: 3¾" diameter; 2" deep.

FREQUENCY:
2.2 mc. to 400 mc.; seven plug-in coils.

MODULATION:
CW or 120 cycles; or external.

POWER SUPPLY:
110-120 volts, 50-60 cycles; 20 watts.

MEASUREMENTS CORPORATION
BOONTON NEW JERSEY

News—New Products

These manufacturers have invited PROCEEDINGS readers to write for literature and further technical information. Please mention your I.R.E. affiliation.

Relay Used With Thermostat

A significant application for a low-cost, totally enclosed relay has been reported by the manufacturer, Sigma Instruments, Inc., 70 Ceylon St., Boston 21, Mass.

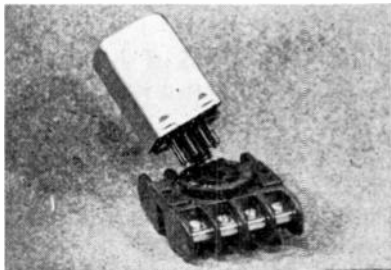

A widely used, effective, and inexpensive means of accurate temperature control consists of a sensitive mercury thermostat which switches the coil circuit of a relay, the relay in turn controlling the load.

The Sigma Series 41 relay is suited for this application. One standard type operates with only 2 ma. at 115 volts a.c. in the coil circuit. The relay contacts are suitable for loads typical of this service, such as solenoid valves, incandescent indicator lamps, and resistance heaters. Replacement after damage or long service is made easy by plug-in mountings. Pictured is the Type 41RO, which weighs only 3 oz. and is $1\frac{1}{4}$ inches \times $1\frac{1}{4}$ inches \times 2 inches high above the base. This relay, in combination with the new Amphenol socket, permits screw connections to the relay.

Standing Wave Detector

Among a series of new developments in the field of electronic test equipment is a standing-wave detector measuring $\frac{1}{2} \times \frac{1}{2}$ inch, recently introduced by DeMornay-Budd, Inc., 475 Grand Concourse, New York, 51, N. Y.

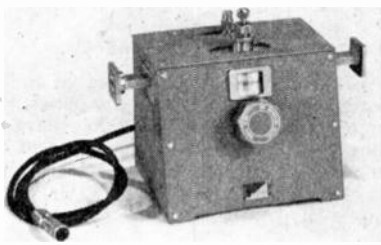

This new detector operates on the frequency band from 23,000 to 27,000 Mc.

The main block and waveguide extremities are machined from a solid steel block. Square-type choke and cover flanges are used for the two waveguide couplings.

The entire unit is gold-plated over-all, both interior and exterior, and is mounted in a self-supporting cabinet finished in baked wrinkle gray.

(Continued on page 58A)

FOR IMMEDIATE DELIVERY!

INDUSTRIAL and TELEVISION

POCKETSCOPE

MODEL S-II-A

by **WATERMAN!**

An OSCILLOSCOPE
of UNUSUAL
VERSATILITY,
UTILITY and
PERFORMANCE



A 3 INCH
OSCILLOSCOPE
for MEASURING
AC and DC!

\$99

F. O. B., PHILADELPHIA

Amplifiers for vertical and horizontal deflection as well as intensity... Linear time sweep from 4-cycles to 50-kc with blanking of return trace... Sensitivity up to 100 mv/in... Fidelity up to 350-kc through amplifiers... Attenuators for AC and for DC... Push-pull amplifiers... Anti-astigmatic centering controls... Trace expansion for detail observations.

Chassis completely insulated from input circuits assures safety in industrial applications... Direct connections to deflecting plates and intensity grids from rear... Retractable light shield... Detachable graph screen... Handle... Functional layout of controls.

COMPLETELY PORTABLE!
8 $\frac{3}{4}$ lbs. . . . 11" x 7" x 5"



WATERMAN PRODUCTS CO., INC.
PHILADELPHIA 25, PA.

Sales Engineers Wanted

Leading manufacturer of communications radio equipment requires a number of full-time sales engineers to handle the sale and installation of two-way VHF Mobile radio. Salary plus commissions, with expense allowance. Car and first or second class phone license essential.

The men we want will be capable of earning from \$400 to \$600 per month, working from their own home.

Please write for personal interview giving details of experience and qualifications.

Box 503
Institute of Radio Engineers
1 East 79th Street
New York 21, New York

Wanted Engineers Physicists

opportunities for graduate engineers with research, design and/or development experience on radio communication systems, electronics and mechanical aeronautical navigation instruments and ultra-high frequency and Micro-wave Techniques. Write full details to

Personnel Manager
FEDERAL
TELECOMMUNICATION
LABORATORIES
500 Washington Ave.
Nutley, N.J.

ELECTRONICS POSITIONS AVAILABLE

Men with Master's or Doctor's Degrees in Electrical Engineering or Physics, or engineers or physicists with a Bachelor's Degree plus experience in the design or development of electrical and/or mechanical computers, integrators, comparators, gyro-mechanisms or servomechanisms.

Excellent working conditions.

Salary commensurate
with ability.

Call in person or write:

Employment Department
Curtiss-Wright
Corporation

4300 East Fifth Avenue
Columbus 16, Ohio



The following positions of interest to I.R.E. members have been reported as open. Apply in writing, addressing reply to company mentioned or to Box No. ...

The Institute reserves the right to refuse any announcement without giving a reason for the refusal.

PROCEEDINGS of the I.R.E.
1 East 79th St., New York 21, N.Y.

PRODUCTION DESIGN ENGINEER

Engineer, preferably with radio-phonograph mechanical design background, capable of producing practical low cost, mass production designs starting from performance specifications. The work involves specification for purchase of components, establishing of inspection and quality standards, coordination of appearance styling, and follow up of initial production. Reply giving a brief résumé of personal data, educational background, and details of type of product worked on, and extent of responsibility over the past ten years. Box 492.

ELECTRONIC THEORIST

Our New York laboratory is seeking an electrical engineer or physicist to carry on theoretical investigations of problems associated with vacuum tubes, thermionics and microwave equipment and to interpret theoretical developments in terms of experimental results. M.S. or equivalent in experience in the field of thermionics and microwave engineering desired. Send résumé outlining age, education, experience, salary requirements to: Supervisor of Employment, Industrial Relations Department, Sylvania Electric Products, Inc., 40-22 Lawrence Street, Flushing, N.Y.

MECHANICAL DESIGN ENGINEER

Having experience in quantity production of small metal stampings and component assemblies. Pleasant working conditions with electronics equipment manufacturer in small Minnesota town. Box 493.

MASS SPECTROMETRY

Engineer with advanced degree and experience in electronics, ion-optics, and high-vacua techniques to take charge of long term program in development and research in field of mass spectrometry at an eastern university. Salary \$5,000-\$8,000. Box 495.

ELECTRONIC CIRCUIT ENGINEERS

For design, construction and test of electronic circuit components and systems in forms suitable for field operation of a complete electronic field installation. Ingenuity, imagination and capable theoretical inclinations suitable for research laboratory work are desired. Send résumé outlining age, education, experience and salary requirements to: Supervisor of Employment, Industrial Relations Department, Sylvania Electric Products, Inc. 40-22 Lawrence Street, Flushing, New York.

(Continued on page 52A)

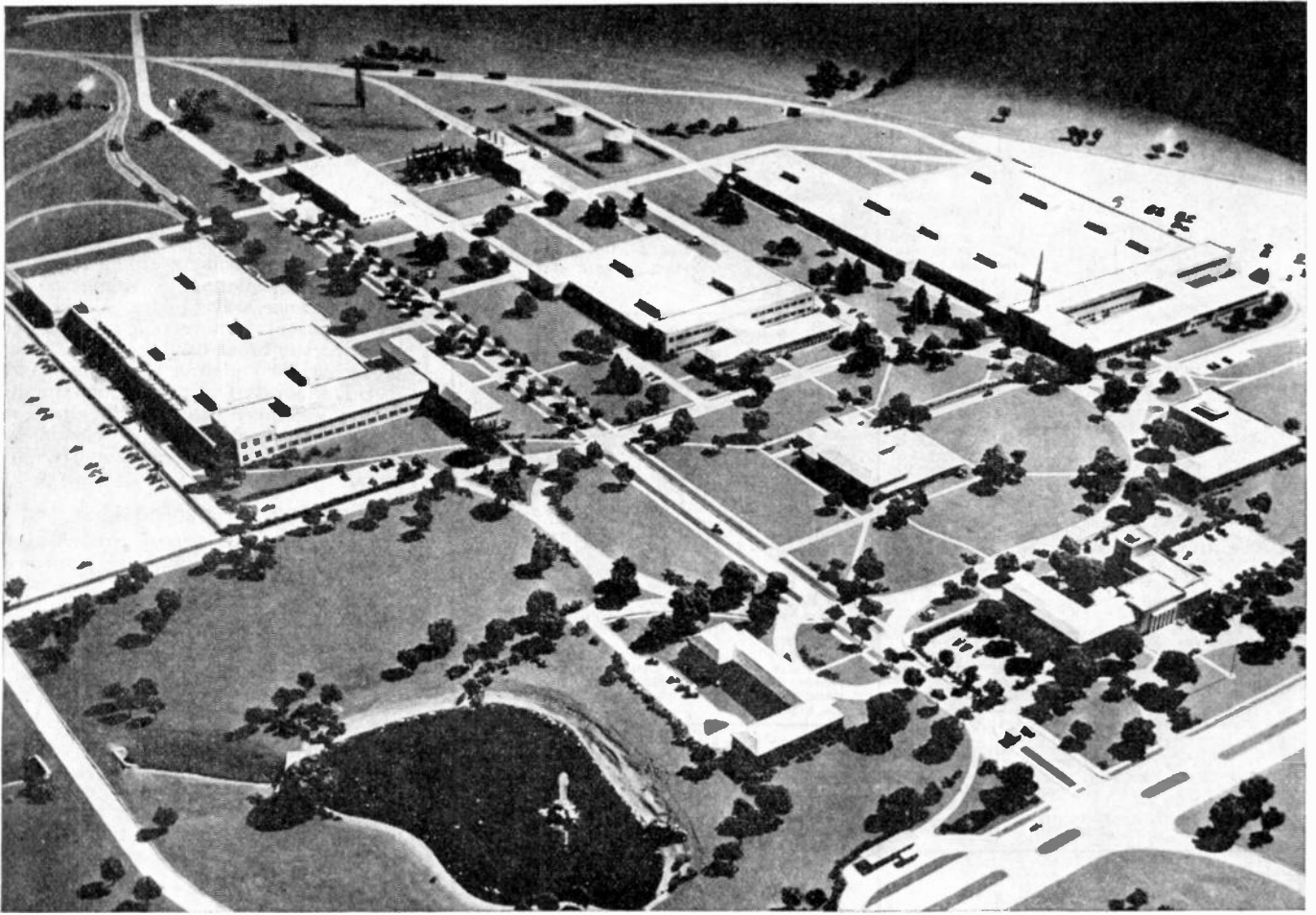

Electronics Park, Syracuse, New York

ENGINEERS

The Electronics Department has need for additional experienced engineering personnel for its enlarged operation at Electronics Park.

- **RADAR DESIGN**
- **TRANSMITTER DESIGN**
- **RECEIVER DESIGN**
- **ADVANCED DEVELOPMENT**

Please forward all inquiries to Personnel Section, Reception Building, General Electric Company, Electronics Park, Syracuse, New York.

All applications confidential

GENERAL  **ELECTRIC**

FINEST QUALITY "Communications" LOWEST PRICES

MICROWAVE ANTENNAS

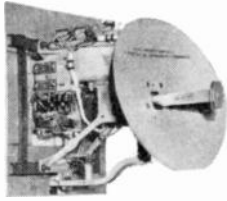

3 CM. ANTENNA WITH DISH 14 1/2". Cutler Feed horizontal and vertical scan with 28 V DC drive motor and drive mechanism. Complete. New. **\$65.00**
Relay System Parabolic reflectors approx. range: 2000 to 6000 Mc. Dimensions 4. -5' x 3' New. **\$85.00**
 Dipole for above **\$5.00**
 TDY "Jam" Radar rotating antenna, 10cm. 30 deg. beam, 115V AC drive. New **\$100.00**
SO Surface Search Radar rotating antenna, 10cm. 24" dish, complete with drive and selsyn motors. New **\$90.00**
 Used **\$45.00**
10 Cm Horn, rectangular to square-to circular RF assembly ending in horn, radiating circularly polarized beam. Waveguide input. Complete with flange **\$35.00**
Parabolic Peel, Radiation pattern approx. 25 deg. in horizontal, 33 deg. in vertical planes **\$20.00**
Cone Antenna, AS 125 APII, 1000-3200 mc. Stub supported, with type "N" connector **\$4.50**

MICROWAVE TUBES



3J31 (1 cm) **\$17.50**
 Magnet for 3J31 **8.00**
2J32 (10 cm) **25.00**
 Magnet for 2J32 **10.00**
2J38 (10 cm) with magnet **37.50**
2J55 3 Cm. packaged magnetron, 9345-9405 Mc. 50 KW Peak Power output. Waveguide output **45.00**
WE700A (L band) **45.00**
WE7201X (S band) 1000 KW 25.00
2K25-723AP Klystron **7.75**
QK 59, QK 60, QK 62. Tunable packaged Magnetrons, 10 cm **ea. 45.00**
 Small Quantities of Other Types. Write for Information.

MICROWAVE PLUMBING

10 CENTIMETER

Sand Load (Dummy Antenna) wave guide section with cooling fins, app. 23" high **\$28.00**
Rigid Coax Directional Coupler CU-90/U1 20 DB drop, has short right angle, about 8" **5.50**
Coax Rotary Joint with mounting plate **8.00**
Dipole Antenna in lucite ball, for use with parabolic **5.00**
Flexible Coaxial connector, rigid coax to rigid coax 3/8" diam. **2.50**
10 CM Dipole and Reflector with type "N" fitting **2.75**
Waveguide to flexible coax coupler (RG 18 U), with flange. Gold plated. App 10" high **17.50**
Rigid coax slotted section CU-60/AP **5.00**
Stub-supported rigid coax, gold plated, 5" lengths **5.00**
10 Cm. McNally cavity. Silver Plated. Type SG **3.00 Ea.**
Crystal Mixer, "S" Band, Complete with Type "N" fitting and LN22 crystal **3.85**
10 Cm waveguide, 5'9" choke to cover Per section **12.00**
Per set of 4 sections **45.00**

3 CENTIMETER

Wave Guide Sections 2.5' long, silver plated with choke flange **\$5.75**
Wave Guide 90 deg. bend E Plane 18" long **4.00**
Wave Guide 90 deg. bend E plane with 20DB directional coupler **4.75**
Wave Guide 18" long "S" curve **2.00**
Rotary Joint choke to choke **6.00**
Rotary Joint choke input: round guide output S-Curve Wave Guide 8" long cover to choke **5.25**
Duplexer Section using 1B24 **10.00**
Wave Guide 5' length per foot **1.50**
Pick-up loop with adjustable tuning section **1.50**
3 Cm Wavemeter Maquiro 1528TFX-24GA **15.00**
3 Cm stabilizer cavity, tunable transmission type, Model 1551 (TFX 11 GA) **20.00**
3 Cm waveguide, 1 1/2" x 1/2" 15 Ft. lengths available. Per Ft. **1.50**

1.25 CENTIMETER

Wave Guide Section 1" cover to cover **\$2.00**
T Section choke to cover **4.50**
Mitred Elbow cover to cover **3.00**
Mitred Elbow and "S" sections choke to cover **5.50**
Flexible Section 1" long choke to choke **3.00**

CONNECTORS

UG 21/U. Type "N", Male **\$.85**
UG 88/U. Gold Plated **\$.95**



PULSE MODULATOR

W. E. No. D-151756 Contains multivibrator, amplifier, rectifier; air and oil sections. Designed for 400 cycle operation. Has following tubes; 1-3E29, 1-6AG7, 1-8016, 1-705A. Size: 18"Lx10"Wx15"H **\$49.95**

PULSE TRANSFORMERS

GE # K 2731
 Repetition Rate: 635 PPS, Pri. Imp: 50 Ohms, Sec. Imp: 450 Ohms, Pulse Width: 1 Microsec. Pri. Input: 0.5 KV PK, Sec. Output: 28 KV PK, Peak Output: 1800 KV, Bifilar: 2.75 Amp. **\$19.50**
All Standard Name Items
Type G.E. K2450A Will receive 13KV, 4 micro-second pulse on pri., secondary delivers 14KV Peak power out 100KW GE **\$15.00**
HI Volt. Magnetron input transformer W.E. # D-166173 with cooling fins **\$12.00**
UX 4298E Raytheon Pri. 4 KV, 1 microsecond Sec. 16 KV, 1 amp. Fil pri. 115 v. 400 Cycle, Raltheon **\$15.00**
HI Volt input pulse Transformer W.E. # D169271 **9.95**
Pulse Input, line to magnetron. G.E. K2748A **12.00**
Utah Pulse or Blocking Oscillator Transformer Freq limits 700-810 cy-3 windings turns ratio 1:1:1 Dimensions 1 13/16 x 1 1/2 x 1 13/32 **7.5**

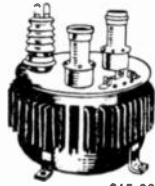

RADAR SETS

S09-10CM. SURFACE SEARCH 4, 20 and 80 mile ranges Raytheon, 250 KW peak power input to 2J27 magnetron. Complete set including: spare parts, tubes, wave guides and fittings. Send for price and add'l. info.
S013-IDENTICAL TO S09. Complete set, used. Consists of: transmitter and receiver, PPI scope modulator, motor alternator, rectifier, power unit and new rotating antenna **\$325.00**
SN RADAR-GE, low power, 5 and 25 miles ranges. Uses GL464 as pulsed oscillator. 6" "A" scope. "S" band. Extremely compact, ideal for demonstration and laboratory work. 115V 60C operation. Used, Excel. cond. **\$600.00**
140-600 Mc DIRECTIONAL ANTENNA
140-310 Mc cone and 300-600 Mc cone, each consisting of 2 end fed half wave conical section with enclosed matching stub for reactance changes with changing frequency. New, complete with mast, guys, cables, carrying chest **\$49.50**

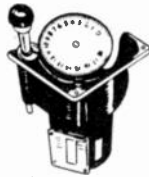

MICROWAVE TEST EQUIPMENT

Wave guide experimental kit. Consists of:
 One direct-reading wavemeter, app 2800-3400 mc. (cavity type); One dummy load w/crystal probe. One line stretcher full wave; two wave guide to RG 18/U coax couplers; two 1' sections w/flanges complete **\$250.00**
10 CM ECHO BOX, complete with micrometer adjust cavity & resonance indicator. Type TS 238/G1. With calibration chart **\$105.00**
10 CM WAVEMETER, Model "SL". Micrometer adjust cavity with micrometer resonance indicator. Includes 115 VAC operation converter section. In grey metal carrying case, complete with cables & spares. Made by Western Electric **\$135.00**
W. E. I 138-A. Signal generator, 2700-2900 Mc. range. Lighthouse tube oscillator with attenuator & output meter. 115 VAC input, reg. Pwr. supply. With circuit diagram **\$50.00**

SPECIALS

10 Cm. RF Package. Consists of: SO Xmtr.-receiver using 2J27 magnetron oscillator, 250 KW peak input. 707-B receiver-mixer **\$150.00**
Modulator-motor-alternator unit for above **\$75.00**
Receiver rectifier power unit for above **\$25.00**
Rotating antenna using dipole feed and parabolic reflector. New Less Hood **\$75.00**
Used RT39AP15 Transmitter-receiver. Lighthouse tube oscillator, .5 KW. App. 2700 Mc. operation. With lighthouse and TR tubes **\$100.00**

WIRE RECORDING MAGAZINES

Magazine for KS 1200 9 recorder, made by W. E. Comes with wire for 1/2-hour recording. Has elapsed time indicator, recording and erase features. Size 14 1/4" L x 7" W x 5 1/4" H. Less Drive Motor **\$39.50**



(Continued from page 50A)

ELECTRONIC ENGINEERS

Unusual opportunities for senior engineers experienced in recording sound on film and magnetic tape recording; microwave-antennae, wave guides, mixers, cavity resonators; receiver engineer—design experience in broad band receivers. Radar preferred. Two or three years' experience in U.H.F. work. Outstanding opportunity for top flight men with a small aggressive company. Write Melpar, Inc. Employment Section, 452 Swann Ave., Alexandria, Virginia.

ENGINEER OR PHYSICIST

Engineer or physicist for mathematical research work on vacuum tubes. Should have a good knowledge of microwave tubes and electron optics. Apply Director of Research, 350 Scotland Road, Orange, New Jersey, National Union Radio Corporation.

SCIENTISTS AND ENGINEERS

Wanted for research and advanced development work in the fields of microwaves, radar circuits, gyroscope systems and general electronics. Scientific or engineering degrees required. Salary commensurate with experience and ability. In-

(Continued on page 53A)

INSTRUMENTATION ENGINEERS

Wanted for

PILOTLESS AIRCRAFT, AND GUIDED MISSILE DEVELOPMENT

Must be graduate Engineers with design and development experience in one or more of the following: Miniature or subminiature circuits and assemblies, Sensing and End Instruments, FM, AM, & Pulse Transmitters. Organizing & Supervising ability required. Los Angeles Area. Write complete detail of Education, Experience, and Salary expected.

Box 504

The Institute of Radio Engineers

1 East 79th St. New York 21, N.Y.

All merchandise guaranteed. Mail orders promptly filled. All prices, F.O.B. New York City. Send Money Order or Check. Shipping charges sent C.O.D.

COMMUNICATIONS EQUIPMENT CO.

131-R Liberty St., New York City 7, N.Y.

Digby 9-4124

PREMAX

NOW!

**Cover All
Frequencies
Between
44 and 216
mc. with**

One Antenna

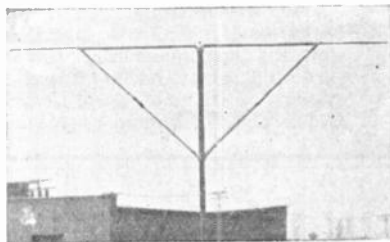

A Premax Antenna having a "V" dipole element with extended arms, meets the demand for all TV and FM frequencies from 44 mc. to 216 mc. The dipole elements are of seamless aluminum tubing and assembly fittings are solid aluminum castings. The novel "V" type design allows proper impedance matching to a 300-ohm line.

Total assembled weight with straight-grained hardwood support mast and cross-arm is about 4 pounds.

See it at your radio jobber's. If he cannot supply you, write direct for specifications and prices.

Premax Products
Division of Chisholm-Ryder Co., Inc.

Division Chisholm-Ryder Co., Inc.
4811 Highland Ave. Niagara Falls, N.Y.

POSITIONS OPEN

quiries should be directed to Mgr. Engineering Personnel, Bell Aircraft Corp., Buffalo 5, N.Y.

JUNIOR ENGINEER—Editor and Writer

Excellent opportunity for experienced writer in radio and electronic fields to edit technical publication and handle articles for electronic, broadcast, aviation and amateur radio press. Congenial surroundings in attractive midwest city. Please give full particulars as to background, experience, age and salary in first letter. Collins Radio Company, Cedar Rapids. Iowa.

ENGINEERS AND PHYSICISTS

Several openings available in radar and in medium and ultra high frequency design work, Positions are in an engineering department of a progressive middle western manufacturer. Physicists will find unusual opportunities in the Research Dept. A degree from a recognized engineering college is essential as well as good industrial experience. Address reply to Collins Radio Co., Cedar Rapids, Iowa.

ELECTRICAL ENGINEERS AND PHYSICISTS

An expanding program of teaching and research has created opportunities as instructor, assistant professor, and associate professor level in this large mid eastern college. Your inquiries are invited. Box number 500.

(Continued on page 54A)

**PHYSICISTS
ENGINEERS**

The establishment of a new section in our research laboratory requires the services of Junior and Senior Electronic Engineers, Servo Engineer and Physicists.

An excellent opportunity to grow with this expanding group and receive responsibility commensurate with your ability.

EMPLOYMENT SECTION

**Bendix Aviation
Corporation
Research Laboratories
4855 Fourth Avenue
Detroit, Michigan**

*Something NEW
Has been added*

**3 Half Waves
in Phase
Instead of 2**

By adding an additional half wave dipole to its well-known beacon antenna, the Workshop has stepped up the power gain from $2\frac{1}{2}$ to $3\frac{1}{2}$ times that of the ordinary coaxial dipole.

Other new design features include a new molded fiberglass housing for greater strength, less weight, and lower operating losses.

Design Highlights

- Low angle of radiation concentrates energy on the horizon.
- Symmetrical design makes azimuth pattern circular.
- Can be fed with various types of transmission lines. Special fittings are available for special applications.
- Entirely enclosed in non-metallic housing for maximum weather protection.
- Designed specifically for 152-162 mc. with a low SWR over the band.

Available for immediate delivery through authorized distributors or your equipment manufacturer.

**THE
WORKSHOP
ASSOCIATES
INCORPORATED**

Specialists in High-Frequency Antennas
**66 NEEDHAM STREET
Newton Highlands 61, Mass.**

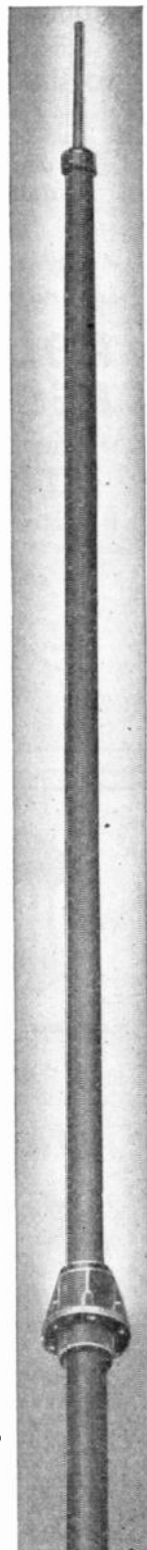

PAT. APP. FOR

TO PLOT free-field polar characteristics of loudspeaker output or microphone sensitivity;

TO RECORD directional characteristics of lighting fixtures or lighting systems;

TO DRAW directional patterns of antenna system gain;

TO MAKE continuous plots, in the complex plane, of such quantities as impedance and transfer constants when a parameter such as frequency is varied:

USE

*Airborne Instruments
Laboratory's Type 116*

POLAR RECORDER

IT PLOTS voltage as a radial distance against angular position.

IT IS ADAPTABLE to any task recordable in POLAR COORDINATES.

For Descriptive Material, write:

Airborne Instruments Laboratory
INCORPORATED

160 OLD COUNTRY ROAD • MINEOLA, N. Y.

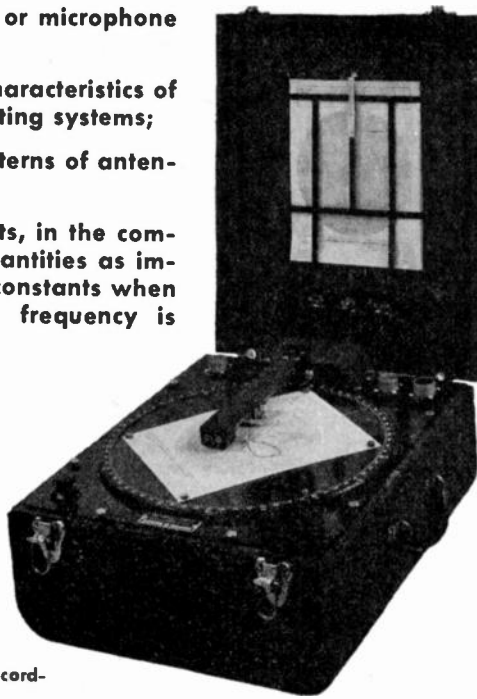

(Continued from page 53A)

SALES ENGINEER

Manufacturer's representative wants assistant to cover Connecticut territory. Must have sales experience and knowledge of electronic components. Salary, expense allowance and commission. Please furnish complete background information. Box 501.

MECHANICAL ENGINEER

Mechanical engineer to prepare technical manuscripts covering certain operations of the Los Alamos Laboratory. Applicant must have a B.S. degree in mechanical engineering and considerable experience in engineering and technical writing. Interested persons may write directly to Employment Director, P.O. Box 1663, Los Alamos, New Mexico.

ACOUSTICAL ENGINEER

Acoustical engineer wanted with experience in microphones or pickup design. Must know mechanical and acoustical circuits. Write details of experience and education to Engineering Department, Electro-Voice, Inc. Buchanan, Michigan.

ENGINEERS

- (1) Mid-western manufacturer has opening for electronic engineer with background in electronic circuit design and instrumentation. Experience with pulse technique, servosystems or telemetering procedures is desirable. Unlimited opportunity



PILOT LIGHT ASSEMBLIES

**PLN SERIES—Designed for
NE-51 Neon Lamp**



Features

- THE MULTI-VUE CAP
- BUILT-IN RESISTOR
- 110 or 220 VOLTS
- EXTREME RUGGEDNESS
- VERY LOW CURRENT

Write for descriptive booklet

The DIAL LIGHT CO. of AMERICA

FOREMOST MANUFACTURER OF PILOT LIGHTS
900 BROADWAY, NEW YORK 3, N. Y.
Telephone—Spring 7-1300

WANTED PHYSICISTS ENGINEERS

Engineering laboratory of precision instrument manufacturer has interesting opportunities for graduate engineers with research, design and/or development experience on radio communications systems, electronic & mechanical aeronautical navigation instruments and ultra-high frequency & microwave technique.

WRITE FULL DETAILS

TO

EMPLOYMENT SECTION

**SPERRY
GYROSCOPE**

COMPANY, INC.

Marcus Ave. & Lakeville Rd.
Lake Success, L.I.

Positions Open

in a specialized field. Submit complete résumé and salary desired.

- (2) Electrical designer with drafting experience and knowledge of mechanical layout. Experience in design of automatic test equipment desirable. State salary expected.
- (3) Electro - mechanical draftsman. Must know symbols and be able to make composite layouts of electrical sub-assemblies. State Salary desired. Write Box 502.

ELECTRONIC ENGINEERS

Opportunity for experienced electronic engineers in established and expanding development company. We design and produce electronic controls and computer equipment. Contact Electronic Associates, Inc., Long Branch, N. J. Telephone L. B. 6-1100 Attention: Mr. Arthur L. Adamson, Personnel Manager.

EXECUTIVE ENGINEER

This notice is inserted by a large manufacturer of radio and television receivers. We have an opening for the one right top executive engineer who really belongs in such an organization. The position is that of heading up all phases of design, development and research engineering. It is probably the toughest engineering chief job in the industry. It pays \$25,000.00. Don't waste your time and ours unless you are unqualifiedly sure that you are completely ready for this assignment. Our own key personnel are aware of this announcement. Write to Box 499.



Positions Wanted By Armed Forces Veterans

In order to give a reasonably equal opportunity to all applicants, and to avoid overcrowding of the corresponding column, the following rules have been adopted:

The Institute publishes free of charge notices of positions wanted by I.R.E. members who are now in the Service or have received an honorable discharge. Such notices should not have more than five lines. They may be inserted only after a lapse of one month or more following a previous insertion and the maximum number of insertions is three per year. The Institute necessarily reserves the right to decline any announcement without assignment of reason.

ELECTRICAL ENGINEER

Graduate electrical engineer experienced in development and manufacture of FM and television antennas wishes to associate on an incentive basis with firm interested in manufacture of antenna line. Located in Chicago area. Box 124W.

ENGINEER

B.E.E. June 1948, Ohio State. Experience: 2½ years radio officer U.S. Merchant Marine; 9 months broadcasting station; 7 months FM transmitter; 7 months
(Continued on page 56A)

"Wow-Meter"

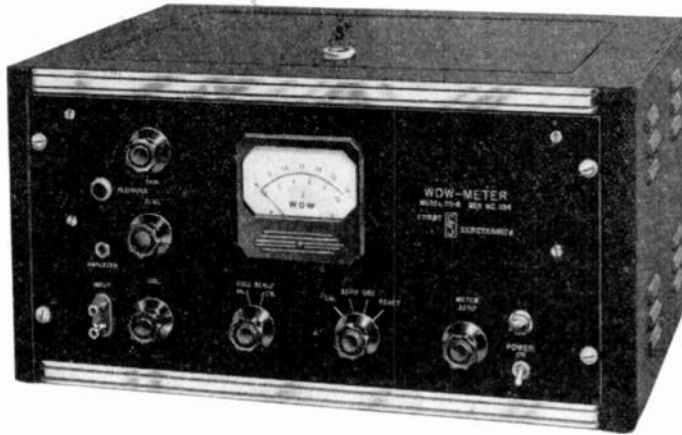

Newly developed direct-reading instrument simplifies measurements of variations in speed of phonograph turntables, wire recorders, motion picture projectors and similar recording or reproducing mechanisms.

The Furst Model 115-S "Wow-Meter" is suitable for both laboratory and produc-

tion applications and eliminates complex test set-ups.

The Model 115-R incorporates an additional amplifier stage so that a direct-inking recorder may be connected for qualitative analysis of speed variations. Send for Bulletin 115.



Designers and Manufacturers of Specialized Electronic Equipment

FURST ELECTRONICS

North Avenue at Halsted St., Chicago 22, Illinois

FOR LOW HUM... HIGH FIDELITY

SPECIFY KENYON TELESCOPIC SHIELDED HUMBUCKING TRANSFORMERS

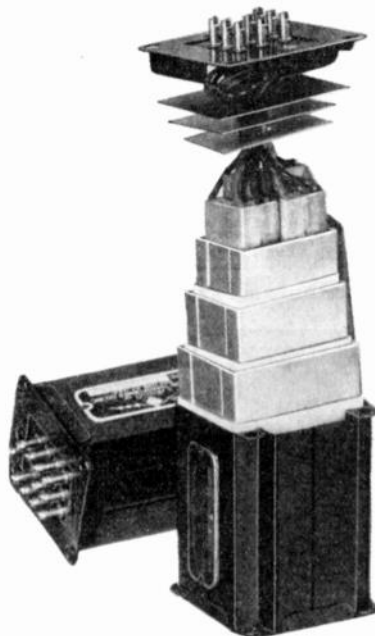

For low hum and high fidelity Kenyon telescopic shield transformers practically eliminate hum pick-up wherever high quality sound applications are required.

✓ CHECK THESE ADVANTAGES

- ✓ **LOW HUM PICK-UP** . . . Assures high gain with minimum hum in high fidelity systems.
- ✓ **HIGH FIDELITY** . . . Frequency response flat within ± 1 db from 30 to 20,000 cycles.
- ✓ **DIFFERENT HUM RATIOS** . . . Degrees of hum reduction with P-200 series ranges from 50 db to 90 db below input level . . . made possible by unique humbucking coil construction plus multiple high efficiency electromagnetic shields.
- ✓ **QUALITY DESIGN** . . . Electrostatic shielding between windings.
- ✓ **WIDE INPUT IMPEDENCE MATCHING RANGE.**
- ✓ **EXCELLENT OVERALL PERFORMANCE** . . . Rugged construction, lightweight-mounts on either end.
- ✓ **SAVES TIME** . . . In design . . . in trouble shooting . . . in production.

Our standard line will save you time and money. Send for our catalog for complete technical data on specific types.

For any iron cored component problems that are off the beaten track, consult with our engineering department. No obligation, of course.

KENYON TRANSFORMER CO., Inc.

840 BARRY STREET NEW YORK, U. S. A.

Positions Wanted

(Continued from page 55A)

television research. 1st class radio telephone, 2nd class radio telegraph, HAM licenses. Desires electronic research or development work. Vicinity Cleveland or New York City. Box 127W.

ELECTRICAL ENGINEER

Graduate electrical engineer. Age 24. Two years' naval electronic experience. Desires assisting production man in technical duties and paper work. Is ambitious, willing to work hard so eventually can assume duties of production manager. Interviews at your convenience. Box 128W.

ELECTRONIC ENGINEER

Available—Registered electrical engineer. Age 41. 13 years' experience in estimating, supervising and procurement for electrical power construction, designing, developing and specifications for power and electronic equipment. Desires permanent position in design and development for electronic equipment with opportunity for advancement. Box 129W.

ENGINEER

M.S.E.E. in 1947. Single. Age 28. Two years' electronic work in the Navy. Two years teaching. B.S.E.E. in 1942. Prefer development or research. Box 133W.

ADMINISTRATIVE ENGINEER

Relieve top level engineering personnel of technical-administrative duties; 5 years' responsible experience National Bureau of Standards; project coordination and planning; new systems development; preparation of technical reports, engineering specifications; electronics procurement; technical representative for outside contacts. Age 27. Intelligent, initiative, ability to secure cooperation of others. Box 134W.

ENGINEER

B.E.E. New York University, 1944. Age 24. Single. Ex-communications officer. Desires work as executive's assistant or sales engineering in the radio-electronics field. Interesting work and opportunity for advancement primary importance. Box 135W.

JUNIOR ENGINEER

B.S.E.E. Carnegie Tech. in September 1947. Age 22. Single. 2 years' Navy electronics experience. Desires position in electronics research design or development. Box 139W.

JUNIOR ENGINEER

Graduate of RCA Institutes. Age 27. Married. Desires work in radio, electronics, television production or development anywhere in U. S. 3 years radio work in Army. Box 140W.



Your Most Complete Source of Supply for
RADIO and ELECTRONIC
EQUIPMENT • COMPONENTS • ACCESSORIES

TREMENDOUS STOCKS

is Newark!

No matter what your need — whether Tubes, Components, Test Equipment, Receivers, Transmitters, or Public Address, you can save time and **SAVE MONEY** by shopping "Newark" first! As one of the largest distributors of radio and electronic components in America, we've got what you want — **IN STOCK!**

You'll like dealing with "Newark" because —

- Our tremendous stocks of standard brand merchandise always on hand insure speedy shipment of your order.
- Our highly specialized and competent personnel will know what you're talking about.
- Our Special Order Department performs miracles in getting those hard-to-find items that nobody else has!
- Two centrally located warehouses — New York and Chicago — at your service!

MAIL AND PHONE ORDERS FILLED PROMPTLY

Speedy, Efficient Service AS NEAR AS YOUR PHONE!

NEW YORK
Offices & Warehouse
242 W. 55th St., N.Y. 19

NEWARK
ELECTRIC COMPANY, INC.

CHICAGO
323 W. Madison St
Chicago 6, Ill

New York City Stores: 115-17 W. 45th St. & 212 Fulton St.

NEY Precious Metals in Industry

for example

WHEN USED AS SLIDING CONTACTS ON POTENTIOMETERS, GREATLY IMPROVED PERFORMANCE MAY BE EXPECTED.

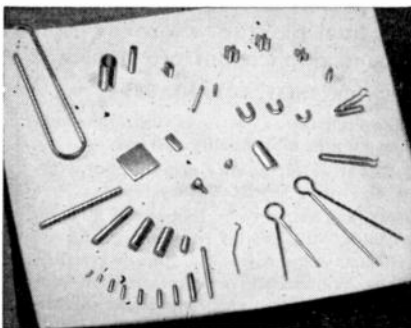

NEY-ORO #28

for Slip Ring Brush Contacts

This is a special alloy developed for use as brush contacts against coin silver slip rings. Laboratory tests and reports from users indicate life of better than 10 million revolutions with no electrical noise.

The oscillograph reproduced below shows the excellent linearity obtained when a potentiometer of fine quality was modified by the installation of PALINEY #7 precious metal sliding contacts . . . an improvement from $\pm .22\%$ to $\pm .12\%$ was obtained in linearity. Further tests proved that this performance can be held over an

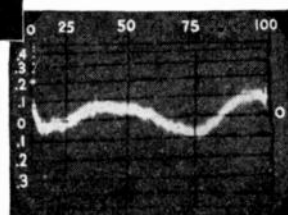

extended service life (full test data available on request).

In addition, Ney offers industrial users a wide range of precious metal alloys for many specialized applications as well as gold solders and fine resistance wires (bare or enameled).

Write or phone (HARTFORD 2-4271) our Research Department.

THE J. M. NEY COMPANY 171 ELM ST. • HARTFORD 1, CONN.
SPECIALISTS IN PRECIOUS METAL METALLURGY SINCE 1812





... AS DISTINCTIVE AS YOUR
fingerprint!

Surprenant's improved SPIRALON is just that! Colors are spirally applied over every inch of its tough, vinyl insulation, furnishing a choice of any one, two, or even *three*, of the nine Army-Navy specified color tracers. These, in turn, provide a total of four colors per wire . . . or a maximum of *eleven hundred and twenty* distinctively coded, solid-color combinations to make identification easy—even in the most complex installations.

Non-inflammable, non-corrosive, flexible and tough under temperature extremes, SPIRALON is obtainable with or without a thin jacket of trans-

parent Dupont nylon to further preserve every electrical property and resist oils, dilute acids, alkalis, abrasion and fungus attack. APPROVED UNDER SPECIFICATION JAN-C-76 Type WL, SPIRALON can't fray, crack or rot—and offers a higher rupture point than braid or lacquers. These superior features are available at no extra cost in all standard wire types and sizes—or carefully manufactured to your most exacting specifications.

Investigate SPIRALON today! Write Dept. G, Surprenant Mfg. Co., 199 Washington St., Boston 7, Mass., for technical data and samples.

SPIRALON "O" (with nylon jacket)

★ SPIRALON (without nylon jacket)

Surprenant
MFG. CO.

Pioneers in Plastics Extrusions



© 1947
 S. MFG. CO.

CUSTOM EXTRUDERS, DESIGNERS, FABRICATORS, MANUFACTURERS OF FLEXIBLE PLASTICS PRODUCTS • INSULATED WIRE AND CABLE

FLEXIBILITY

FOR FABRICATION OF SPECIAL
CRYSTAL UNITS

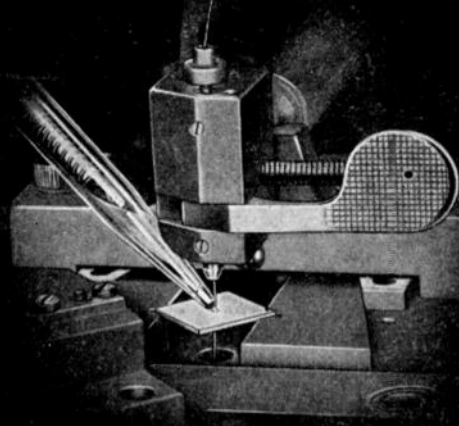

PREPARING SPECIAL CRYSTAL BLANKS FOR MOUNTING



REEVES-HOFFMAN
CORPORATION

SALES OFFICE: 215 EAST 91 STREET, NEW YORK 28, N. Y.
PLANT: 321 CHERRY STREET, CARLISLE, PA.

News—New Products

These manufacturers have invited PROCEEDINGS readers to write for literature and further technical information. Please mention your I.R.E. affiliation.

(Continued from page 49A)

Television Program Console

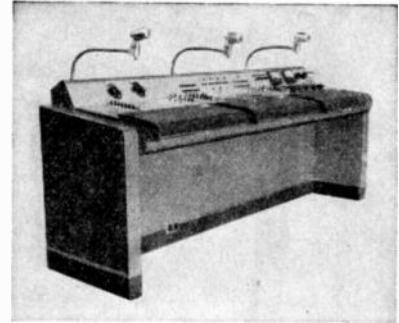

This new desk-like television program console, containing all the circuits and controls to carry on the necessary supervision and composition of a television program, has been designed by the Transmitter Division, Electronics Dept., General Electric Co., at Syracuse, N. Y.

The new console is divided into three sections for the program director, video operator and audio operator. Communication facilities are provided at each position so that directions may be transmitted to achieve continuity of programming.

Some of the construction details are: elevation to permit full view; internal access accomplished through hinged control surfaces and vertical doors on front face; terminal boards for all external connections; switching, mixing, and fading of any of six channels; and microphones on flexible arms. The console weighs approximately 650 pounds, and is 36½ inches high by 90½ inches wide by 26 inches deep.

New Wire Recorder

A new high-fidelity wire recorder has been introduced by Electronic Sound Engineering Co., 4344 W. Armitage Ave., Chicago, Ill., and is being sold under the trade name "Polyphonic Sound."

There is available with this recorder a 15-inch, dual-channel auxiliary speaker. This speaker connects with a jack on the front panel and carries the lower range down to 50 c.p.s.

The built-in 6-inch speaker, with a range up to 10,000 c.p.s. has a special diaphragm to insure smooth reproduction of high frequencies.

Input facilities consist of a low-level input for a microphone and a front-panel input arrangement for high-level sound by direct connection with a radio or record player. The microphone has a response of 60 to 10,000 c.p.s. The unit is being manufactured in an optional cabinet of walnut or natural finish birch. Designed for table-top operation, it comes with a portable carrying case.

The Z-Angle Meter . . . ONE OF RAULAND'S MOST WIDELY USED INSTRUMENTS!

At The Rauland Corporation, well-known manufacturers of communication and sound equipment, the Z-Angle Meter is indispensable. Used to measure the impedance of microphones, speakers, and transformers, the Z-Angle Meter has simplified and speeded up testing procedure. J. J. O'Callaghan, Chief Engineer of The Rauland Corporation makes this statement.

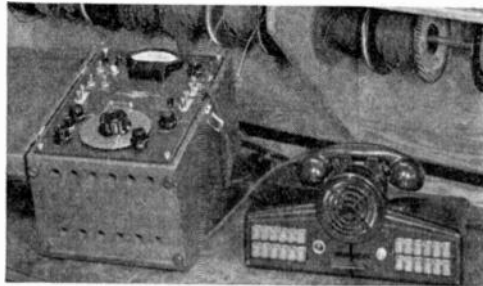

"It is so convenient to measure impedance with the Z-Angle Meter . . . it has become one of our most widely used instruments, quickly furnishing a mass of data which previously had taken a great deal of time and effort to accumulate."

If you have a problem in direct measurement of impedance and phase angle at audio frequencies, turn it over to the Z-Angle Meter.

**SEND FOR BULLETIN
127 TODAY**

ENGINEERING REPRESENTATIVES

CHICAGO: 1024 Superior Street, Oak Park 37, Illinois
Phone: VILlAge 9245

HOLLYWOOD: 423 Guaranty Building, Hollywood 28, Calif.
Phone: HOLlywood 5111

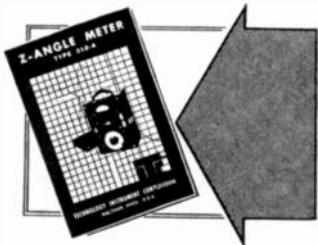

TECHNOLOGY INSTRUMENT CORP.
1058 MAIN ST., WALTHAM 54, MASSACHUSETTS

**MICRODIMENSIONAL
WIRE & RIBBON
FOR VACUUM TUBES**



Wires drawn to .0004" diameter.

Ribbon rolled to .0001" thickness.

Alloys for special requirements.

WRITE for list of stock alloys.

SIGMUND COHN CORP.

44 GOLD ST., NEW YORK

SINCE 1921



News—New Products

These manufacturers have invited PROCEEDINGS readers to write for literature and further technical information. Please mention your I.R.E. affiliation.

F. M. Transmitter

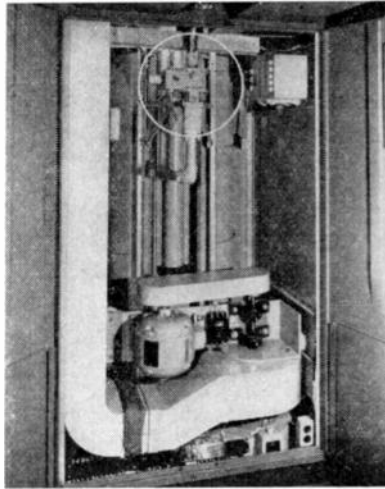

The 506B-2 10-kw. f.m. transmitter is a unit of the new radio broadcasting equipment of Western Electric Company, 195 Broadway, New York, N. Y. The final stage of the transmitter uses a single forced-air-cooled tube. This view, looking through the open rear doors of the center cabinet, shows the 3A power and impedance monitor mounted in the coaxial transmission-line output of the transmitter.

Pulse Generator

Radar Engineers, Arcade Bldg., Seattle 1, Wash., announce a new pulse generator, Type PG-5, covering a range of pulse widths from 0.1 to 2.0 microseconds with rise and fall times of 0.05 microseconds.



A positive trigger input of from 10 to 20 volts is required for each output pulse, the latter being variable in amplitude from -20 to +20 volts. The unit measures 9x9x10 inches, weighs 12 pounds, and consumes 40 watts at 115 volts, 60 cycles.

(Continued on page 60A)

NOW! in 1,000 pages

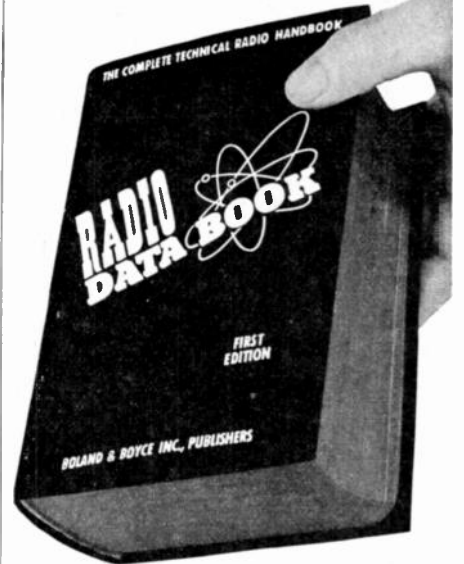

Handsomely bound in RED and GOLD

All data and basic knowledge in radio and electronics digested into 12 sections . . . in a complete, quick to find, easy to read, handbook form.

Plan every operation in radio and electronics with the Radio Data Book. This new radio bible will be your lifelong tool . . . you will use it every day, on the board, at the bench, in the field! Use it for construction, troubleshooting and testing. The RADIO DATA BOOK will be your invaluable aid in design, experiment and in layout. It will help make your production better, faster and easier. In any and every operation in radio and electronics, you will use the RADIO DATA BOOK!

The RADIO DATA BOOK is a work of complete authority, prepared by engineers with many years of practical experience. They have been assisted by the Boland & Boyce staff of editors skilled in preparing electronics manuals for the U. S. Signal Corps for many years. These men have worked for several years gathering material for this book . . . all the knowledge of radio principles and operation . . . all the statistics . . . all the newest developments in electronics . . . every possible angle and detail. Eighteen months were spent digesting this material into the most concise, the clearest, and the most readable form. The result is this invaluable manual . . . The RADIO DATA BOOK. Whether you use this book for general reference, for scientific instruction, or for education, one thing is certain—the practical help, the daily usefulness you will derive from it will prove to be worth many, many times its astonishingly low price!

Advanced Sale . . . first printing. Only 10,000 available. . . . To make sure to get your RADIO DATA BOOK, mail your order NOW!

12 sections . . . 1000 pages . . . Completely illustrated

- Section 1. THE 150 BASIC CIRCUITS IN RADIO.
- Section 2. COMPLETE TEST EQUIPMENT DATA.
- Section 3. TESTING, MEASURING AND ALIGNMENT.
- Section 4. ALL ABOUT ANTENNAS.
- Section 5. SOUND SYSTEMS.
- Section 6. ELECTRICAL AND PHYSICAL CHARACTERISTICS OF RADIO COMPONENTS.
- Section 7. COMPLETE TUBE MANUAL.
- Section 8. CHARTS, GRAPHS AND CURVES.
- Section 9. CODES, SYMBOLS AND STANDARDS.
- Section 10. 50 TESTED CIRCUITS DESIGNED FOR OPTIMUM PERFORMANCE.
- Section 11. DICTIONARY OF RADIO AND ELECTRONIC TERMS.
- Section 12. RADIO BOOK BIBLIOGRAPHY.

12 complete books in one only **\$5.00!**
Less than 42c per book!

MAIL THIS COUPON TODAY!

BOLAND & BOYCE INC., PUBLISHERS IRE-1
460 BLOOMFIELD AVE., MONTCLAIR 4, N. J.

Please send me a copy of THE RADIO DATA BOOK. Enclosed is \$5.00.

NAME
ADDRESS
CITY ZONE
STATE

BOLAND & BOYCE INC., PUBLISHERS

BENDIX-SCINTILLA

the finest ELECTRICAL CONNECTORS
money can build or buy!

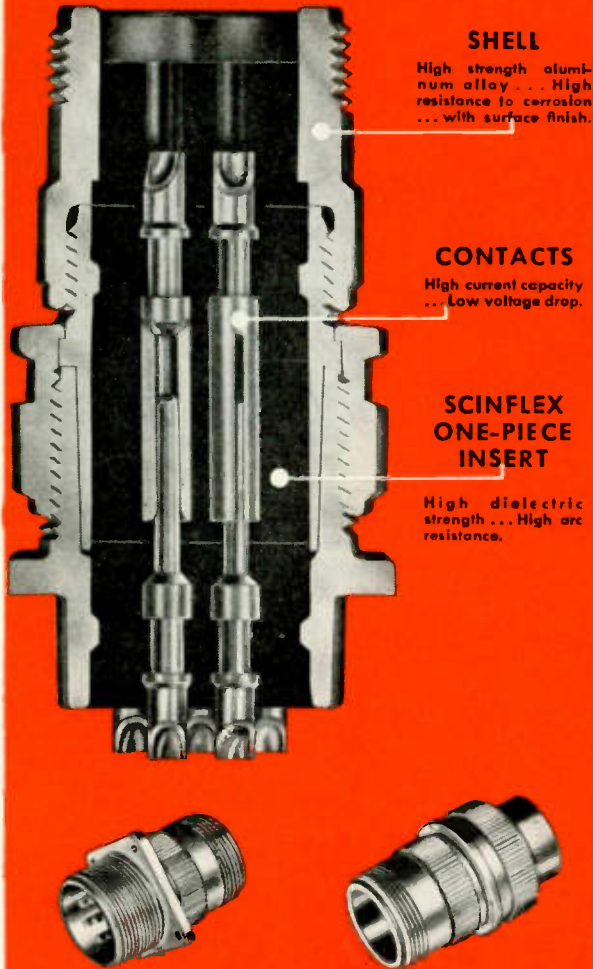

SHELL

High strength aluminum alloy... High resistance to corrosion... with surface finish.

CONTACTS

High current capacity... Low voltage drop.

SCINFLEX ONE-PIECE INSERT

High dielectric strength... High arc resistance.

AND THE SECRET IS SCINFLEX!

Bendix-Scintilla* Electrical Connectors are precision-built to render peak efficiency day-in and day-out even under difficult operating conditions. The use of Scinflex—a new Bendix-Scintilla dielectric material of outstanding stability—makes them vibration-proof, moisture-proof, pressure-tight, and increases flashover and creepage distances. Under extremes of temperature, from -67°F. to $+300^{\circ}\text{F.}$, performance is remarkable. Dielectric strength is never less than 300 volts per mil. The contacts, made of the finest materials, carry maximum currents with the lowest voltage drop known to the industry. The simplicity and soundness of design is demonstrated by the fact that Bendix-Scintilla Connectors have fewer parts than any other connector on the market—an exclusive feature that means lower maintenance cost and better performance.

*REG. U.S. PAT. OFF.

Write our Sales Department for detailed information.

- Moisture-proof, Pressure-tight • Radio Quiet • Single-piece Inserts
- Vibration-proof • Light Weight • High Arc Resistance • Easy Assembly and Disassembly • Less parts than any other Connector

Available in all Standard A.N. Contact Configurations

**BENDIX
SCINTILLA**

SCINTILLA MAGNETO
SIDNEY, N. Y.
DIVISION OF



News—New Products

These manufacturers have invited PROCEEDINGS readers to write for literature and further technical information. Please mention your I.R.E. affiliation.

(Continued from page 59A)

New Test Oscillator

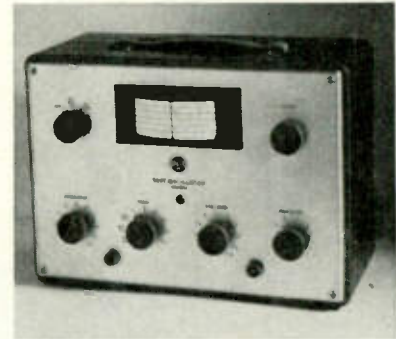

Recently announced by the RCA Victor Division, Radio Corporation of America, Camden, N. J., a new portable test oscillator, designated Type WR-67A, is claimed to be the first of its kind to provide three fixed frequencies for high speed servicing of superheterodyne and t.r.f. receivers. The three channels provide the necessary aligning signals without need for adjusting the tuning controls: 455kc. for i.f. channels; 600 kc. and 1500 kc. for r.f. local-oscillator circuits.

The WR-67A is housed in a blue-gray hammeroid case, and is styled with a brushed, anodized aluminum panel. It measures $13\frac{1}{2}$ inches long, $9\frac{1}{2}$ inches high, and $7\frac{1}{2}$ inches deep, and weighs 15 pounds.

New General-Purpose Relay

Comar Electric Co., 2701 Belmont Ave., Chicago 18, Ill., recently announced their new multi-purpose Type "C" Relay, designed for general circuit-control applications.

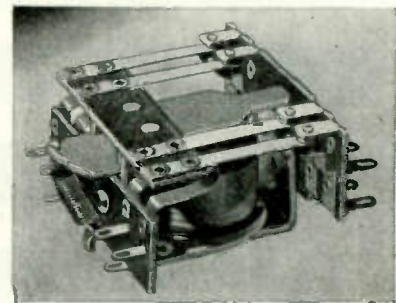

According to the manufacturer, this new relay has been specially engineered to provide high efficiency at low cost and is readily adaptable to a wide range of relay requirements. A single screw mounting simplifies coil removal. Average coil consumption, $7\frac{1}{2}$ va. Contact current capacity, 5 amperes at 115 volts a.c. Available in any Contact arrangement up to 4-pole double-throw. Supplied with fine silver contacts or other specified material. Weighs only 3 ounces.

High Frequency Test Equipment

LABORATORY RECEIVERS for the range of 80-300, 300-1000, 1000-2000 and 2,000-4,000 megacycles, 110 v, 60 c.p.s.

MICROWAVE GENERATORS for any portion of the S band, pulse modulation, variable width and delay, power meter for internal and external metering, calibrated attenuator, 110 v, 60 c.p.s.

MICROWAVE GENERATORS, 1000-2000 megacycles, 2000-4000 megacycles, metered output pulse modulation, variable width and delay

MICROWAVE CONVERTERS, 10 cm.

ATTENUATORS AND LOSSY LINES

Type N connectors, UG 12, 21, 24, 25, 27, 30, 58, 83, 86, 245U. U.H.F. connectors, SO 239, PL259, 83 IAP, UG266U.

PATCH CORDS, 50 ohm, type N connectors various lengths.

HIGH VOLTAGE CAPACITORS

Particulars on Request

ELECTRO-IMPULSE LABORATORIES

P.O. Box 250 Red Bank
New Jersey

News—New Products

These manufacturers have invited PROCEEDINGS readers to write for literature and further technical information. Please mention your I.R.E. affiliation.

High-Altitude Vacuum Tube

A new vacuum-tube design for use on high voltages at altitudes up to 60,000 feet has been announced by **Amperex Electronic Corp.**, 25 Washington St., Brooklyn, N.Y. The development work was sponsored by the Air Materiel Command of the U. S. Army Air Forces, and the tube is especially important in control circuits of guided missiles.

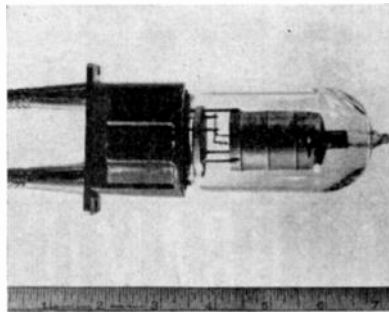

The base of the tube is of glass and is tapered and ground to fit the socket like a glass bottle stopper. This construction excludes all air, which, at high altitude, causes flash-over between terminals.

The original tube, a high-vacuum half-wave rectifier rated at 14,000 peak inverse volts, can deliver an average plate current of 125 ma. and a peak plate current of 750 ma. Although rated only 14,000 volts peak, this tube-socket combination will handle voltages as high as 35,000 volts peak.

The new design is applicable to all types of high-voltage vacuum tubes which may be subjected to similar high-altitude conditions. When used in areas which are strongly radioactive, tubes of this type will not break down externally due to ionization.

New u.h.f. Tube GL-5648

A new electronic tube to perform at frequencies up to 2500 Mc. under full plate input, Type GL-5648, has been developed by the Tube Division of **General Electric Co.**, Electronics Department, Schenectady, N. Y., for commercial radar, f.m. and television, and studio-to-transmitter link applications.

A forced-air-cooled triode of "light-house" design, the new u.h.f. tube for oscillator service and grounded-grid power amplifier applications has a cathode voltage of 6.3 volts. Its interelectrode capacitances: grid-cathode, 7.25 μfd ; grid-plate, 1.95 μfd ; cathode-plate, 0.035 (max) μfd .

Maximum ratings of the GL-5648 under Class-C telegraphy conditions include a d.c. plate voltage of 1000 volts and plate input of 100 watts. When used as a grid-separation oscillator at 500 Mc. the new tube offers a power output of 25 watts.

(Continued on page 62A)

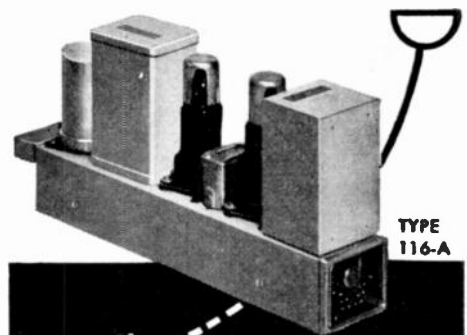

FROM
MICROPHONE
TO **LINE**

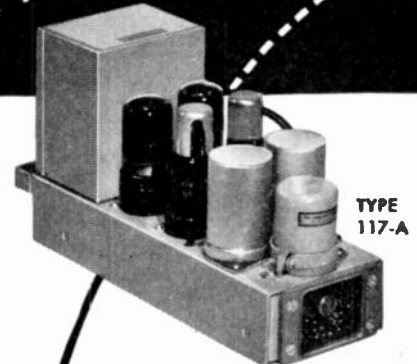

● YOU NEED

Only two types of PLUG-IN amplifiers...Type 116-A as a pre-amplifier or booster...Type 117-A as a program amplifier, monitor, or booster.

Only two types of tubes, 1620's and 6V6GT's.

● YOU SAVE

By conserving rack space.
By simplified maintenance...
Just PLUG-IN a spare amplifier should trouble occur.

● YOU HAVE QUALITY

These amplifiers are built to the Langevin standard of high quality performance...They exceed the FCC specifications for FM.

The complete story of "PLUG-IN Amplifiers by Langevin" is ready for you now in booklet form...write for it today.



The Langevin Company
INCORPORATED

SOUND REINFORCEMENT AND REPRODUCTION ENGINEERING
NEW YORK: 39 W. 65 St. 23 • SAN FRANCISCO: 1050 Howard St. 3
LOS ANGELES: 1000 N. Seward St. 38

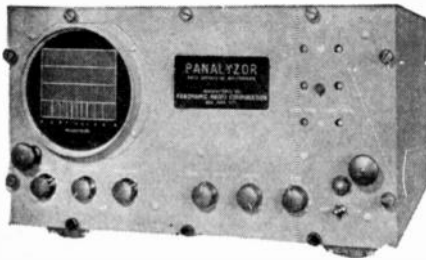

Designed for
YOUR APPLICATION
PANADAPTOR

Whether your application of spectrum analysis requires high resolution of signals closely adjacent in frequency or extra broad spectrum scanning, there is a standard model Panadaptor to simplify and speed up your job. Standardized input frequencies enable operation with most receivers.

	MODEL SA-3 TYPES						MODEL SA-6 TYPES		
	T-50	T-100	T-200	T-1000	T-10000	T-6000	T-1000	T-10000	T-20000
Maximum Scanning Width	50KC	100KC	200KC	1MC	1MC	6MC	1MC	10MC	20MC
Input Center Frequency	455KC	455KC	455KC	5.25MC	10.2MC	30MC	5.25MC	30MC	30MC
Resolution at Maximum Scanning Width	2.5KC	3.4KC	4.4KC	11KC	11KC	25KC	11KC	75KC	91KC
Resolution at 20% of Maximum Scanning Width	1.9KC	2.7KC	4KC	9KC	7.5KC	22KC	7.5KC	65KC	75KC

Investigate these
APPLICATIONS OF PANADAPTOR

- *Frequency Monitoring
- *Oscillator performance analysis
- *FM and AM studies

WRITE NOW for recommendations, detailed specifications, prices and delivery time.



Get the RMC VERTICAL-LATERAL COMBINATION INCLUDING 2 ARMS.. VERTICAL HEAD . . . LATERAL HEAD . . . AND EL-3 EQUALIZER



EL-3 EQUALIZER
(PATENTS PENDING)

for simplified operation
plus finest reproduction
. . . without compromise

Sold through local jobber.

Write for Speaker Bulletin EL3-51

Export: Rocke International Corporation, 13 East 40th Street, New York 16, New York

RADIO-MUSIC CORPORATION
PORT CHESTER • NEW YORK

Specially Priced: \$174.00 net,
F.O.B. Port Chester, N.Y.

A new low price made possible by an ever-increasing demand with resultant volume production.

Use the new EL-3 EQUALIZER with both Vertical and Lateral recordings. Use one arm for Vertical only and one arm for Lateral only on one turntable or separate tables. Connect both to the new EL-3 EQUALIZER and obtain the acme of perfection in reproduction from your records and transcriptions. By simply switching the new EL-3 EQUALIZER from Vertical equalization to Lateral changes from one arm to the other, at the same time, correct equalization is thrown in.

News—New Products

These manufacturers have invited PROCEEDINGS readers to write for literature and further technical information. Please mention your I.R.E. affiliation.

(Continued from page 61A)

Dual-Beam Cathode-Ray Oscilloscope

A new Type 279 dual-beam cathode-ray oscilloscope is announced by Allen B. DuMont Laboratories, Inc., Instrument Division, Clifton, N. J.

This instrument features the two-gun Type SSP-A cathode-ray tube containing two separate and completely independent electron guns. The oscilloscope provides each gun with separate controls for intensity, focus, and X-, Y-, and Z-axis modulations.

A power source of 115/230 volts, 50-60 cycles, operates the instrument. Power consumption is 300 watts. Over-all dimensions are: 22 1/2 inches wide, 17 1/2 inches high, 22 1/2 inches deep. Weight is 125 pounds. It is housed in a gray-wrinkle, rack-type cabinet.

Alternating-Voltage Comparator

This instrument, which functions at any frequency between 50 and 1,250 c.p.s., is of significant interest to research laboratories, engineering schools, standardizing agencies, electrical testing laboratories, power companies, and manufacturers of electromechanical and electronic equipment.

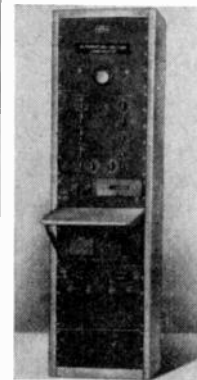

The availability of the alternating-voltage comparator was recently announced by Arma Corporation, 254-36th St., Brooklyn 32, N.Y., in a statement issued by Herbert C. Guterma, president of the corporation. It was developed during

the war to make possible the high accuracy of fire-control computers, and is now offered commercially to other firms.

The manufacturer claims that with the Arma alternating-voltage comparator laboratory measurement of a.c. voltage and phase angle can be made with an accuracy of 1 part in 50,000.

Range of application of this instrument includes the measurement of vectorial ratios essential to computer development; transformation ratio of transformers and networks; power factor of transformers; power factor and Q of resistors, capacitors, and inductors; capacitance or inductance, by reference to a suitable standard; ratio of two currents; and power factor of a.c. machines. It is a complete, self-contained electronic measuring instrument.

(Continued on page 66A)

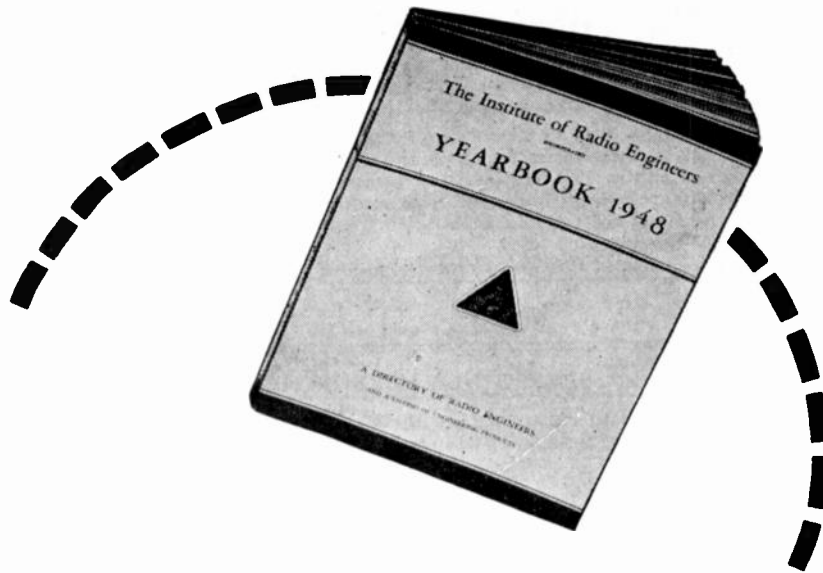

Do Radio Engineers Know What You Make?

- **They Need Specifications**—for Radio and Electronic Engineers control the technical buying of a two-billion-dollar industry. These men alone are competent to set specifications for, and authorize the purchasing of complicated equipment, instruments, tubes, materials and components that only a trained and experienced electronic engineer understands. These men are the key to your sales—and need the product specifications your advertising provides.

- **The Market**—is over 17,000 qualified radio engineers, working in 3000 manufacturing firms, radio and communication stations, engineering research laboratories, government bureaus and services and in production control divisions of large plants. They are the members of The Institute of Radio Engineers, selected both by stiff membership requirements at the beginning, and high enough dues through the years to insure active and interested readers.

- **Why Engineers will use this Directory!** The true value of reference advertising in a directory is "constant use and service." This is a source-reference book edited by engineers for engineers and it lists engineers as well as firms and products. I.R.E. members will find themselves and their friends listed both alphabetically, and geographically in "The I.R.E. Yearbook." Personal interest is the key to keeping and using The I.R.E. Yearbook.

- **3 Directories in 1**—Not only is it the only published personnel list of radio and electronic engineers, but combined in the same covers and always at hand is an alphabetical list of nearly 3000 firms supplying the industry, with code-keys to their products. In addition there is a product index for advertisers only. This classifies in 100 fundamental and understandable groups set up by engineers, the products, instruments and materials they need.

RATES			For "Proceedings of I.R.E. Contract Advertisers"		GENERAL DATA
Space	Rate	Size	6 Times	12 Times	
1 page	\$250.	7" x 10"	\$225.	\$200.	Advertising rates and sizes of units are identical to "The Proceedings of the I.R.E." Closing date is Jan. 31st annually.
2/3 page	180.	4 1/2" x 10"	160.	140.	
1/3 page	100.	2 1/2" x 10"	90.	80.	
1/6 page	60.	1 1/4" x 4 7/8"	55.	50.	
		2 1/4" x 4 7/8"			
		4" x 2 1/2"			

Agency Discount 15%. Cash Discount 2% 10 days.



The annual reference book of radio engineers

I.R.E. YEARBOOK

THE INSTITUTE OF RADIO ENGINEERS
303 West 42nd Street, New York 18, N. Y. CI-6-6357

WILLIAM C. COPP — *National Advertising Manager*

SCOTT KINGWILL
Central States Representative
35 E. Wacker Drive
Chicago 1

HANNON AND WILLSON
Pacific Coast Representatives
412 West 6th St. Los Angeles 14

INFORMATION SERVICE

I.R.E. Yearbook and I.R.E. Industry Research Division

A two-fold service is available without cost to firms supplying products for or rendering technical services to the radio-and-electronic industry. (1) The I.R.E. Yearbook, which is noted for its reference value, lists more than 3,000 firms and furnishes product or industry classification. (2) A classified index of products and services is maintained by the I.R.E. Industry Research Division. Radio engineers continuously draw upon this bank of statistical data.

These two sources of information are not only invaluable to I.R.E. members and other engineers, but the proper listing of your company may bring you new business.

Check off the appropriate items and send this questionnaire today: Industry Research Div., Proceedings of the I.R.E. Room 707, 303 West 42nd St., New York 18, N.Y.

Please read carefully and fill out completely.

PERSONNEL INFORMATION

In addition to data regarding products and/or services you render the radio-electronic field, please supply information requested below.

Firm Name Chief Engineer

Street Town Zone State

The proper person to receive information and announcements—

On Product Data Title

On Advertising Title

Classifications to Be Checked by Non-Manufacturing Firms Rendering Services to the Radio-Electronic Field

- | | | |
|--|--|--|
| <input type="checkbox"/> 501. Books & Book Publishers.
<input type="checkbox"/> 502. Broadcasting Stations & Communication Cos.
<input type="checkbox"/> 503. Consulting Engineers:
<input type="checkbox"/> a. Acoustical.
<input type="checkbox"/> b. Electrical.
<input type="checkbox"/> c. Mechanical.
<input type="checkbox"/> d. Radio.
<input type="checkbox"/> 504. Distributors & Jobbers of Radio & Electronic Equipment & Supplies. | <input type="checkbox"/> 505. Frequency Measuring & Monitoring Services.
<input type="checkbox"/> 506. Laboratories & Custom Builders of Equipment.
<input type="checkbox"/> 507. Recording Studios & Services.
<input type="checkbox"/> 508. Technical Schools & Institutions.
<input type="checkbox"/> 509. Transcription Libraries. | <i>Wholesale Radio Dealers, see Distributors & Jobbers.</i>

Classification If Not Listed
.....
.....
..... |
|--|--|--|

Products to Be Checked by Radio-Electronic Manufacturers

- | | | |
|---|--|--|
| <input type="checkbox"/> 1. Aircraft & Airport Radio Equipment.
<input type="checkbox"/> 2. Amplifiers, Audio Frequency.
<input type="checkbox"/> 3. Antennas:
<input type="checkbox"/> a. AM Broadcast Transmitting.
<input type="checkbox"/> b. Dummy.
<input type="checkbox"/> c. FM Broadcast Transmitting.
<input type="checkbox"/> Miscellaneous Types.
<input type="checkbox"/> e. Receiving, all services.
<input type="checkbox"/> f. Television Transmitting.
<input type="checkbox"/> 4. Antenna Phasing Equipment & Accessories:
<input type="checkbox"/> a. Feeder Lines & Accs.
<input type="checkbox"/> b. Phasing Equipment.
<input type="checkbox"/> c. Tower Lighting Equipment.
<input type="checkbox"/> 5. Attenuators.
<input type="checkbox"/> 6. Batteries:
<input type="checkbox"/> a. Dry "A".
<input type="checkbox"/> b. Dry "B".
<input type="checkbox"/> c. Dry Miniature.
<input type="checkbox"/> d. Wet Primary.
<input type="checkbox"/> e. Wet Secondary.
<input type="checkbox"/> 7. Blowers & Cooling Fans. <i>Bridges, see Testing Equip.</i>
<input type="checkbox"/> 8. Cabinets, Wooden.
<input type="checkbox"/> 9. Cables:
<input type="checkbox"/> a. Coaxial.
<input type="checkbox"/> b. Microphone.
<input type="checkbox"/> c. Pre-Formed Harnesses.
<input type="checkbox"/> d. Shielded.
<input type="checkbox"/> e. Ultra-High Freq. | <input type="checkbox"/> 10. Capacitors, Fixed:
<input type="checkbox"/> a. Ceramic.
<input type="checkbox"/> b. Electrolytic.
<input type="checkbox"/> c. Mica.
<input type="checkbox"/> d. Oil Filled.
<input type="checkbox"/> e. Paper.
<input type="checkbox"/> f. Pressurized Gas.
<input type="checkbox"/> g. Vacuum.
<input type="checkbox"/> 11. Capacitors, Variable:
<input type="checkbox"/> a. Neutralizing.
<input type="checkbox"/> b. Precision.
<input type="checkbox"/> c. Temperature-Freq. Compensating.
<input type="checkbox"/> d. Trimmer.
<input type="checkbox"/> e. Tuning.
<input type="checkbox"/> f. Vacuum.
<input type="checkbox"/> 12. Ceramics:
<input type="checkbox"/> a. Coil Forms.
<input type="checkbox"/> b. Ground Mica.
<input type="checkbox"/> c. Rods.
<input type="checkbox"/> d. Sheets.
<input type="checkbox"/> 13. Chassis & Relay Rack Cabinets, Metal. <i>Coil Forms, see Ceramics.</i>
<input type="checkbox"/> 14. Coils:
<input type="checkbox"/> a. Chokes, AF & RF.
<input type="checkbox"/> b. Miscellaneous Types.
<input type="checkbox"/> c. Toroids.
<input type="checkbox"/> d. Transformer Coils.
<input type="checkbox"/> e. Tuning.
<i>Condensers, see Capacitors.</i>
<input type="checkbox"/> 15. Connectors. <i>Consoles, see Amplifiers.</i> | <input type="checkbox"/> 16. Converters:
<input type="checkbox"/> a. Frequency.
<input type="checkbox"/> b. Rotary, <i>see Motor Generators.</i>
<input type="checkbox"/> c. Vibrator.
<input type="checkbox"/> 17. Core Materials:
<input type="checkbox"/> a. Complete Cores.
<input type="checkbox"/> b. Laminations.
<input type="checkbox"/> c. Powdered Iron.
<input type="checkbox"/> 18. Crystals:
<input type="checkbox"/> a. Oscillating Quartz.
<input type="checkbox"/> b. Piezo-Electric.
<input type="checkbox"/> c. Rectifier.
<i>Discs, Recording, see Recording Equipment.</i>
<input type="checkbox"/> 19. Drafting Equipment & Supplies. <i>Dynamotors, see Motor Generators.</i>
<input type="checkbox"/> 20. Electronic Control Equip.:
<input type="checkbox"/> a. Air Conditioning Controls.
<input type="checkbox"/> b. Burglar Alarm & Protection Devices.
<input type="checkbox"/> c. Combustion & Smoke Control Equip.
<input type="checkbox"/> d. Fire Prevention Eq.
<input type="checkbox"/> e. Photo-Electric Control Devices.
<input type="checkbox"/> f. Production Controls, Counting & Sorting Equipment.
<input type="checkbox"/> g. Variable Speed Motor Controlling Eq.
<input type="checkbox"/> 21. Equalizers. |
|---|--|--|

Products to Be Checked by Radio-Electronic Manufacturers

- | | | |
|--|---|--|
| <p><input type="checkbox"/> 22. Facsimile Equipment.</p> <p><input type="checkbox"/> 23. Filters:
 <input type="checkbox"/> a. Band Pass.
 <input type="checkbox"/> b. Noise Elimination.
 <input type="checkbox"/> c. Sound Effect.</p> <p><input type="checkbox"/> 24. Frequency Meas. Equip.:
 <input type="checkbox"/> a. Audio Frequency.
 <input type="checkbox"/> b. Primary Standards.
 <input type="checkbox"/> c. Radio Frequency.
 <input type="checkbox"/> d. Secondary Standards.</p> <p><input type="checkbox"/> 25. Fuses & Fuse Holders:
 Generators:
 a. Power, see Motor.
 b. Signal, see Frequency Meas. Equip., also Testing Equip.</p> <p><input type="checkbox"/> 26. Graphic Recorders.</p> <p><input type="checkbox"/> 27. Hardware:
 <input type="checkbox"/> a. Binding Posts.
 <input type="checkbox"/> b. Bushings.
 <input type="checkbox"/> c. Dials & Tuning Controls.
 <input type="checkbox"/> d. Flexible Shafts.
 <input type="checkbox"/> e. Lugs.
 <input type="checkbox"/> f. Screws.
 <input type="checkbox"/> g. Springs.</p> <p><input type="checkbox"/> 28. Induction Heating Equip.</p> <p><input type="checkbox"/> 29. Inductors.</p> <p><input type="checkbox"/> 30. Insulation:
 <i>(Also see Ceramics)</i>
 <input type="checkbox"/> a. Cloth.
 <input type="checkbox"/> b. Glass Seals.
 <input type="checkbox"/> c. Mica.
 <input type="checkbox"/> d. Paper.
 <input type="checkbox"/> e. Varnished Cambric.</p> <p><input type="checkbox"/> 31. Jacks & Jack Fields.</p> <p><input type="checkbox"/> 32. Keys:
 <input type="checkbox"/> a. Switching.
 <input type="checkbox"/> b. Telegraph.
 <i>Knobs, see Moulded Prods.</i></p> <p><input type="checkbox"/> 33. Lacquers:
 <input type="checkbox"/> a. Finishing.
 <input type="checkbox"/> b. Fungus Proofing.
 <input type="checkbox"/> c. Protecting.
 <input type="checkbox"/> d. Waterproofing.</p> <p><input type="checkbox"/> 34. Loudspeakers & Headphones.</p> <p><input type="checkbox"/> 35. Machinery, Fixtures, & Tools for Radio-Electronic Mfg.</p> <p><input type="checkbox"/> 36. Magnets:
 <input type="checkbox"/> a. Electro.
 <input type="checkbox"/> b. Permanent.
 <i>Measuring Equipment, see Testing Equipment.</i></p> <p><input type="checkbox"/> 37. Metals:
 <input type="checkbox"/> a. Copper.
 <input type="checkbox"/> b. Ferrous.
 <input type="checkbox"/> c. Non-Ferrous.
 <input type="checkbox"/> d. Precious & Rare.</p> <p><input type="checkbox"/> 38. Meters:
 <input type="checkbox"/> a. Ammeters.
 <input type="checkbox"/> b. Frequency Indicating.
 <input type="checkbox"/> c. Power Level.
 <input type="checkbox"/> d. Vacuum Tube Voltmeters.
 <input type="checkbox"/> e. Voltmeters.
 <input type="checkbox"/> f. Wattmeters.
 <i>Mica, see Insulation.</i></p> <p><input type="checkbox"/> 39. Microphones.</p> <p><input type="checkbox"/> 40. Monitoring Equipment:
 <input type="checkbox"/> a. Frequency.
 <input type="checkbox"/> b. Modulation.</p> <p><input type="checkbox"/> 41. Motor Generators:
 <input type="checkbox"/> a. Dynamotors.
 <input type="checkbox"/> b. Motor Generators.
 <input type="checkbox"/> c. Rotary Converters.</p> | <p><input type="checkbox"/> 42. Motors, Very Small.</p> <p><input type="checkbox"/> 43. Moulded Products & Moulding Services:
 <input type="checkbox"/> a. Cabinets.
 <input type="checkbox"/> b. Insulators.
 <input type="checkbox"/> c. Knobs, etc.
 <input type="checkbox"/> d. Plastic Parts.
 <input type="checkbox"/> e. Phenolic Sheet.</p> <p><input type="checkbox"/> 44. Optical Systems, Mirrors, Screens & Accessories.</p> <p><input type="checkbox"/> 45. Oscillators:
 <input type="checkbox"/> a. Audio Frequency.
 <input type="checkbox"/> b. Radio Frequency.
 <input type="checkbox"/> c. Square Wave Generators.</p> <p><input type="checkbox"/> 46. Oscillographs & Accessories.</p> <p><input type="checkbox"/> 47. Panels.</p> <p><input type="checkbox"/> 48. Phonograph & Transcription Pickups:
 <input type="checkbox"/> a. Crystal Cartridges.
 <input type="checkbox"/> b. Magnetic Cartridges.
 <input type="checkbox"/> c. Playback Arms, only.
 d. Preamplifiers, see Amplifiers.</p> <p><input type="checkbox"/> 49. Pilot Lights & Assemblies.</p> <p><input type="checkbox"/> 50. Plastics:
 <input type="checkbox"/> a. Raw Materials.
 <input type="checkbox"/> b. Rods.
 <input type="checkbox"/> c. Sheets.</p> <p><input type="checkbox"/> 51. Plugs.</p> <p><input type="checkbox"/> 52. Power Supplies.</p> <p><input type="checkbox"/> 53. Pumps, Vacuum.
 <i>Racks, see Chassis.</i></p> <p><input type="checkbox"/> 54. Radar Equipment & Associated Apparatus. <i>(Also see Aircraft & Airport Eq.)</i></p> <p><input type="checkbox"/> 55. Radio Receivers:
 <input type="checkbox"/> a. Broadcast.
 <input type="checkbox"/> b. Communications.
 <input type="checkbox"/> c. Fixed Frequency.
 <input type="checkbox"/> d. Freq. Modulation.
 <input type="checkbox"/> e. Special Purpose.
 <input type="checkbox"/> f. Television.</p> <p><input type="checkbox"/> 56. Record Changers.</p> <p><input type="checkbox"/> 57. Recording Equip. & Supp.:
 <input type="checkbox"/> a. Blanks.
 <input type="checkbox"/> b. Cutting Heads.
 <input type="checkbox"/> c. Magnetic Wire Recorders.
 <input type="checkbox"/> d. Needles.
 <input type="checkbox"/> e. Turntables & Mchs.</p> <p><input type="checkbox"/> 58. Rectifiers:
 <input type="checkbox"/> a. Metallic.
 <input type="checkbox"/> b. Meter Rectifiers.
 <input type="checkbox"/> c. Vacuum Tube. <i>(Also see Power Supp.)</i>
 <i>Regulators, Voltage, see Voltage Regulators.</i></p> <p><input type="checkbox"/> 59. Relays:
 <input type="checkbox"/> a. Keying.
 <input type="checkbox"/> b. Power.
 <input type="checkbox"/> c. Stepping.
 <input type="checkbox"/> d. Telephone Types.
 <input type="checkbox"/> e. Time Delay.
 <input type="checkbox"/> f. Vacuum Enclosed.</p> <p><input type="checkbox"/> 60. Remote Controlling Equip.:
 <input type="checkbox"/> a. Automatic Tuning Mechanisms.
 <input type="checkbox"/> b. Remote Switching Mechanisms.</p> <p><input type="checkbox"/> 61. Resistors:
 <input type="checkbox"/> a. Fixed.
 <input type="checkbox"/> b. Precision.
 <input type="checkbox"/> c. Vacuum Sealed.
 <input type="checkbox"/> d. Variable.
 <input type="checkbox"/> e. Wire Wound.</p> <p><input type="checkbox"/> 62. Sockets:
 <input type="checkbox"/> a. Receiving Types.
 <input type="checkbox"/> b. Transmitting Types.</p> <p><input type="checkbox"/> 63. Solder:
 <input type="checkbox"/> a. Cored.
 <input type="checkbox"/> b. Plain.
 <i>Speakers, see Loudspeakers.</i></p> | <p><input type="checkbox"/> 64. Switches:
 <input type="checkbox"/> a. Circuit Breaking.
 <input type="checkbox"/> b. Key.
 <input type="checkbox"/> c. Power.
 <input type="checkbox"/> d. Receiver Wave Band Changing.
 <input type="checkbox"/> e. Rotary.
 <input type="checkbox"/> f. Time Delay.
 <input type="checkbox"/> g. Transmitter Wave Band Changing.</p> <p><input type="checkbox"/> 65. Testing & Measuring Equip.:
 <input type="checkbox"/> a. Bridges.
 <input type="checkbox"/> b. Capacitor Testing.
 <input type="checkbox"/> c. Inductance & "Q" Testing.
 <input type="checkbox"/> d. Resistance Testing.
 <input type="checkbox"/> e. Vacuum Tube Testing.
 <input type="checkbox"/> f. Wave Form Analyzers & Distortion Testing.</p> <p><input type="checkbox"/> 66. Transformers:
 <input type="checkbox"/> a. Audio Frequency.
 <input type="checkbox"/> b. Hermetically Sealed Types.
 <input type="checkbox"/> c. High Fidelity Audio Types.
 <input type="checkbox"/> d. Power Components.
 <input type="checkbox"/> e. Pulse Generating Types.
 <input type="checkbox"/> f. Radio Frequency.</p> <p><input type="checkbox"/> 67. Transmitters:
 <input type="checkbox"/> a. Amplitude Modulation.
 <input type="checkbox"/> b. Communication.
 <input type="checkbox"/> c. Freq. Modulation.
 <input type="checkbox"/> d. Police & Emergency.
 <input type="checkbox"/> e. Television.
 <input type="checkbox"/> f. Ultra-High Freq.</p> <p><input type="checkbox"/> 68. Ultra-High Frequency Equipment & Accessories:
 <input type="checkbox"/> a. Antennas & Reflectors.
 <input type="checkbox"/> b. Measuring & Testing Equipment.
 <input type="checkbox"/> c. Tuning Elements.
 <input type="checkbox"/> d. Wave Guides.</p> <p><input type="checkbox"/> 69. Vacuum Tubes:
 <input type="checkbox"/> a. Cathode Ray.
 <input type="checkbox"/> b. Geiger Mueller.
 <input type="checkbox"/> c. Industrial Types.
 <input type="checkbox"/> d. Klystrons & Magnetrons.
 <input type="checkbox"/> e. Receiving Types.
 <input type="checkbox"/> f. Rectifiers.
 <input type="checkbox"/> g. Special Purpose & Phototubes.
 <input type="checkbox"/> h. Television Tubes.
 <input type="checkbox"/> i. Transmitting Types.
 <input type="checkbox"/> j. Voltage Regulator.
 <i>Varnishes, see Lacquers.</i></p> <p><input type="checkbox"/> 70. Vibrators, Power Supply.</p> <p><input type="checkbox"/> 71. Voltage Regulators:
 <input type="checkbox"/> a. Automatic.
 <input type="checkbox"/> b. Manually Controlled.</p> <p><input type="checkbox"/> 72. Waxes & Sealing Compounds.</p> <p><input type="checkbox"/> 73. Wire:
 <input type="checkbox"/> a. Copper.
 <input type="checkbox"/> b. Precious Metal.</p> |
|--|---|--|

Products Not Listed Above

IMPORTANT—Mail Today To:
Industry Research Division,
Proceedings of the I.R.E.,
Room 707, 303 W. 42nd St.,
New York 18, New York.

TRANSDUCERS

by **AUTOFLIGHT**
FOR LINEAR
ACCELERATION

Unique Linear Acceleration Transducers... lightweight, small, rugged, dependable. Linear electrical signal output proportional to acceleration. High angular resolution. Mass weight magnetically damped for optimum performance under all conditions.



Write for detailed information.



G. M. GIANNINI & CO., INC.
285 WEST COLORADO ST.
PASADENA 1, CALIFORNIA



first in facsimile
for broadcasting and point-to-point communication!

FINCH TELECOMMUNICATIONS
INCORPORATED
SALES OFFICE:
10 EAST 40th STREET, NEW YORK
FACTORIES: PASSAIC, N. J.

News—New Products

These manufacturers have invited PROCEEDINGS readers to write for literature and further technical information. Please mention your I.R.E. affiliation.

(Continued from page 62A)

Magnetic Tape Recorder

The new Model 900D *Magnetape* Recorder, now being produced by the Magnephone Div., Amplifier Corp. of America, 398-1 Broadway, New York, N. Y., is providing business organizations with uninterrupted telephone monitoring for a full 8-hour day, and is being used for prolonged radio-broadcast monitoring.

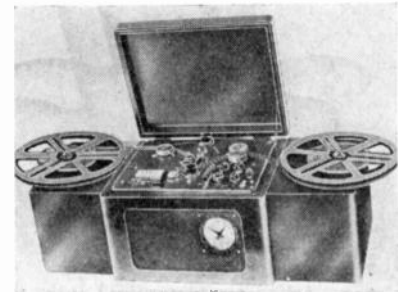

Advanced design principles provide a constant tape pull regardless of build-up in the take-up reel. A mechanical feature is the constant speed drive attained through a special type of synchronous motor employed to drive a combination flywheel and capstan pulley which keeps the tape feeding at an unvarying speed.

The manufacturer states that reels can be played back a thousand times with no loss of fidelity; reels can be erased, and re-recorded again and again; reels can be edited, with unwanted sections cut out, and the tape spliced with ordinary scotch tape.

By utilizing an optionally available built-in automatic program timer, 32 quarter-hour programs may be automatically recorded on a single reel.

This unit features a choice of response ranges from 70 to 9000 cycles for 3½ hours of play at a tape speed of 7½ inches per second; 80 to 5000 cycles for 6 hours of play at a tape speed of 4 inches per second; and 100 to 3500 cycles (voice recording) for 8 hours of play at tape speed of 3 inches per second.

* * *

NOTICE

Information for our News and New Products section is warmly welcomed. News releases should be addressed to Mrs. Harriet P. Watkins, Industry Research Division, Proceedings of I.R.E., Room 707, 303 West 42nd St., New York 18, N. Y. Photographs, and electrotypes if not over 2" wide, are helpful. Stories should pertain to products of interest specifically to radio engineers.

KEEP POSTED ON ELECTRON TUBES

Use this convenient coupon for obtaining the RCA tube reference data you need.

RCA, Commercial Engineering, Section AW52, Harrison, N.J.

Send me the RCA publications checked below. I am enclosing \$..... to cover cost of the books for which there is a charge.

Name _____
Address _____
City _____ Zone _____ State _____

- Quick-Reference Chart, Miniature Tubes (Free). [A]
- HB-3 Tube Handbook (\$10.00)*. [B]
- RC-15 Receiving Tube Manual (35 cents). [C]
- Receiving Tubes for AM, FM, and Television Broadcast (10 cents). [D]
- Radiotron Designers Handbook (\$1.25). [E]
- Quick Selection Guide, Non-Receiving Types (Free). [F]
- Power and Gas Tubes for Radio and Industry (10 cents). [G]
- Phototubes, Cathode-Ray and Special Types (10 cents). [H]
- RCA Preferred Types List (Free). [I]
- Headliners for Hams (Free). [J]

*Price applies to U. S. and possessions only.

TUBE DEPARTMENT

RCA RADIO CORPORATION of AMERICA
HARRISON, N. J.



Specify
MYCALEX

LOW LOSS INSULATION

Where high mechanical and electrical specifications must be met.

MYCALEX 410
(MOLDED MYCALEX)

makes a positive seal with metals
... resists arcing, moisture and high temperatures.

27 years of leadership
in solving the most
exacting high frequency
insulating problems.

**MYCALEX CORPORATION
OF AMERICA**

"Owners of 'MYCALEX' Patents"
Plant and General Offices: Clifton, N.J.
Executive Offices: 30 Rockefeller Plaza
New York 20, N.Y.

SINCE 1874
ORIGINAL ODHNER
"THE MACHINE TO COUNT ON"

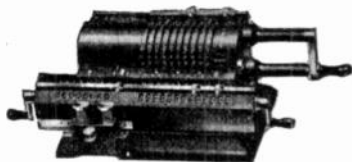

**A HANDY CALCULATOR
NEW BACK TRANSFER
DEVICE SPEEDS UP
CALCULATIONS**

HERE'S THE ANSWER to the engineer's demand for a low priced, fast calculator. Entirely portable. Unexcelled for sturdy construction. Hundreds of auxiliary uses in large organizations. Keep one on every desk, where quick calculations are necessary.

Available from stock.

IVAN SORVALL

210 Fifth Ave., New York 10, N.Y.

Ask for Bulletin AQ-13

News—New Products

These manufacturers have invited PROCEEDINGS readers to write for literature and further technical information. Please mention your I.R.E. affiliation.

Heterodyne Detector

In announcing a new heterodyne detector which features high sensitivity and a wide frequency range, the Kalbfell Laboratories, Inc., 1076 Morena Blvd., San Diego 10, Calif., claim that the instrument will measure signals of 100 microvolts and is usable from 500 cycles to 50 Mc. Dr. Kalbfell explains that this wide frequency range is possible because no r.f. amplification is employed.

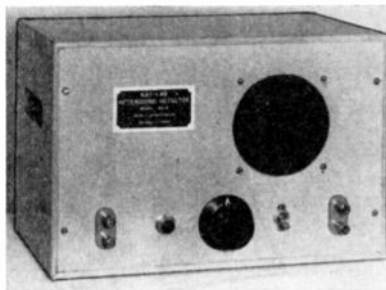

The heterodyne detector is used to compare an unknown frequency with that of a signal generator. This system permits the comparison of fundamental frequencies over the entire range, thereby eliminating the ambiguity which often exists in heterodyne frequency meters operating from harmonics of a narrow-band built-in oscillator.

In addition to measuring frequency, the detector will also demodulate an amplitude-modulated signal, without the use of a second oscillator. The circuit consists of a pentagrid converter and a high-gain audio amplifier with loudspeaker.

Capacitance Bridge

Designed by General Radio Co., 275 Massachusetts Ave., Cambridge, 39, Mass. to fill the gap between a.f. bridges and r.f. types, the new Type 716-C Capacitance Bridge measures capacitance and dissipation at all frequencies between 30 cycles and 300 kc.

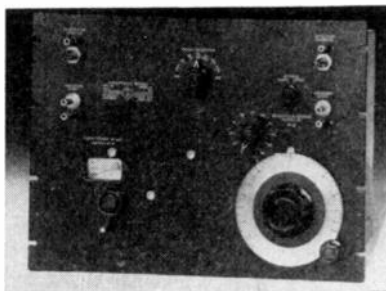

Aside from its common use in the measurement of capacitors, this wide-

(Continued on page 68A)

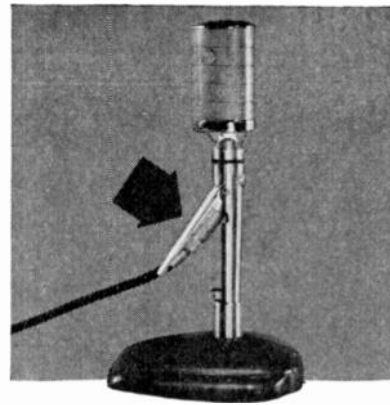

**RCA STANDARDIZES
ON "XL" PLUGS**

... for popular microphone models such as the "Announce" (Type KN-1A) (shown above), Junior Velocity (MI-4036), Aeropressure (MI-6026, MI-6027), Program Velocity (MI-12002, MI-12003), Aerodynamic (MI-6226, MI-6228), because Cannon XL's are quality plugs, yet in the moderate price class and available everywhere.



The RCA Junior Velocity Microphone, a low cost, lightweight model is equipped with XL-3-12 for speedy interchange of cable.

RCA is a big user not only in the XL but also the Cannon "P", DP, "K" and "AN" series in many types of equipment. Cannon's reputation for quality



XL-3-12 PLUG
LIST \$1.20

XL-3-11 PLUG
LIST \$1.25

and dependability is assured in RCA equipment fitted with Cannon Plugs.

Write for FREE new XL-377 BULLETIN and list of 200 Cannon Electric Distributors.

SINCE 1915

CANNON
ELECTRIC

Development Company

3209 HUMBOLDT ST., LOS ANGELES 31, CALIF.
IN CANADA & BRITISH EMPIRE:
CANNON ELECTRIC CO., LTD., TORONTO 13, ONT.
WORLD EXPORT (Excepting British Empire):
FRAZER & HANSEN, 301 CLAY STREET
SAN FRANCISCO 11, CALIFORNIA
REPRESENTATIVES IN PRINCIPAL CITIES

HIGH PERFORMANCE Relays

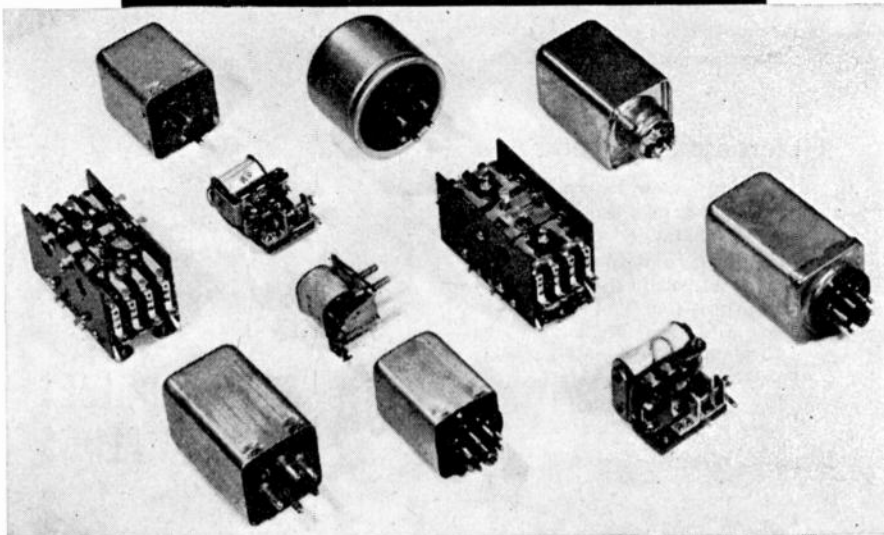

Sigma's specialty is the supplying of relays to meet unusually exacting requirements. Such success as we enjoy is due as much to willingness to study applications in detail as to basically good relay designs.

You are urged to take advantage of this in submitting your problem, by stating particulars of purpose and function, permitting us to see the relay as part of a complete system.



Sigma Instruments, Inc.

Sensitive RELAYS

94 Ceylon St., Boston 21, Mass.

**STAMINA—ACCURACY
—RELIABILITY—
AT LOW COST**
You can count on these features when you specify SIGMA RELAYS

- HIGH SPEED
 - LOW INPUT
 - LONG LIFE
 - CLOSE TOLERANCE
- AC DC POLAR

AMPERITE MICROPHONES



Studio Velocity
Models R80H, R80L
List \$80.00



P. G. Dynamic
Models PGH, PGL
List \$32.00

Address Inquiry
attention Dept. I.R.E.

The ultimate in microphone quality, the new *Amperite Velocity* has proven in actual practice to give the highest type of reproduction in Broadcasting, Recording, and Public Address.

The major disadvantage of pre-war velocities has been eliminated—namely "boominess" on close talking.

● Shout right into the new *Amperite Velocity*—or stand 2 feet away—the quality of reproduction is always excellent.

● Harmonic distortion is less than 1% (Note: best studio diaphragm mike is 500% higher).

● Practically no angle discrimination . . . 120° front and back. (Best studio diaphragm microphones—discrimination 800% higher.)

● One *Amperite Velocity* Microphone will pick up an entire symphony orchestra.

There is an *Amperite* Microphone for every requirement.

WRITE FOR ILLUSTRATED 4-PAGE FOLDER giving full information and prices.



Velocity Microphones
for Public Address
Models RBHG, RBLG
List \$42.00



"Kontak" Mikes
Model SKH, list \$12.00
Model KKH, list \$18.00

In Canada:
Atlas Radio Corp.
580 King St. W., Toronto

AMPERITE Company
561 BROADWAY NEW YORK

News—New Products

These manufacturers have invited PROCEEDINGS readers to write for literature and further technical information. Please mention your I.R.E. affiliation.

(Continued from page 67A)

frequency-range capacitance bridge is particularly suited for the measurement of dielectric constant and dissipation factor of dielectric materials as a function of frequency. The frequency range covered is sufficient to show the effects of interfacial polarization at low audio frequencies and of dipole dipolarization in polymers. The effect of surface water films on insulators can be measured, as can the Boella effect in resistors.

Supplied in a walnut cabinet, the weight is 53½ pounds; or, for rack mounting, the bridge weighs 41½ pounds. Write to the manufacturer for further information.

New Spectroradiometer

Mass production of luminescent materials, used as the coating on viewing screens of television cathode-ray tubes, is tremendously stepped-up by a remarkable test instrument, according to the RCA Victor Division, Radio Corporation of America, Camden, N. J.

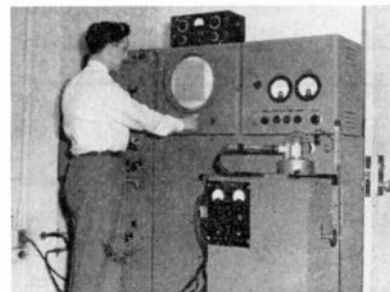

The Spectroradiometer, now in use at RCA's plant at Lancaster, Pa., is shown being demonstrated by its designer and builder, Austin E. Hardy, head of the Physical Testing Laboratory in the Lancaster plant, where test batches of luminescent materials are precisely analyzed by this instrument to insure lifelike reproduction of television pictures.

Small-Size Relay Delivers Extreme Output

Developed recently by Allied Control Co., 2 East End Ave., New York 21, N. Y., the BO Power Relay is claimed to be one of the smallest relays giving the greatest output, and tests indicate that it has good mechanical and electrical life.

This multipurpose relay was designed for convenience of wiring, together with small mounting area; and its applications are widened by the fact that the BO is available for either a.c. or d.c. coil operation. Contact arrangement provides double-pole, double-throw or double-break with ¼-inch contacts rated at 15 amperes.

PROFESSIONAL CARDS

W. J. BROWN

Electronic & Radio Engineering Consultant
Electronic Industrial Applications, Commercial and Broadcasting Transmitter and Receiver Design, Test Equipment, etc.
23 years experience in electronic development

P.O. Box 5106, Cleveland, Ohio
Telephone, Superior 1241
Office, 912 Park Building

EDWARD J. CONTENT

Acoustical Consultant
Functional Studio Design

FM - Television - AM
Audio Systems Engineering
Roxbury Road Stamford 3-7459
Stamford, Conn.

HERBERT A. ERF

Architectural Acoustics
Consultant

STUDIO DESIGN
Standard Broadcast—FM—Television
Cleveland 15, Ohio
3868 Carnegie Avenue EXpress 1616

DAVID C. KALBFELL, Ph.D.

Engineer — Physicist

Complete laboratory facilities
Industrial instrumentation and control
Broadcast engineering and measurements
1076 Morena Boulevard Jackson 1939
San Diego 10, California

FAirmount 5105 EXpress 7766

FRANK MASSA
Electro-Acoustic Consultant

3393 Dellwood Road 3868 Carnegie Avenue
CLEVELAND, OHIO

EUGENE MITTELMANN, E.E., Ph.D.

Consulting Engineer & Physicist
HIGH FREQUENCY HEATING
INDUSTRIAL ELECTRONICS
APPLIED PHYSICS &
MATHEMATICS

549 W. Washington Blvd. Chicago 6, Ill.
Phone: State 8021

IRVING RUBIN

Physicist

Radio interference and noise meters, Interference suppression methods for ignition systems and electrical devices. Laboratory facilities.

P.O. Box 153, Shrewsbury, New Jersey
Telephone: REDBANK 6-4247

ARTHUR J. SANIAL

Consulting Engineer

Loudspeaker Design; Development; Mfg. Processes. High Quality Audio Systems. Announcing Systems. Test and Measuring Equipment Design.

168-14 32 Ave. Flushing, N.Y.
FLushing 9-3574

News—New Products

These manufacturers have invited PROCEEDINGS readers to write for literature and further technical information. Please mention your I.R.E. affiliation.

Velocity Microphone

A new velocity microphone for public address is now being manufactured by Amperite Co., Inc., 561 Broadway, New York 12, N. Y.



It is claimed that this new design incorporates all the advantages of a ribbon microphone and eliminates the few causes of dissatisfaction. The manufacturer states, for example, that it will give high-fidelity top-quality reproduction on either close talking or distant pickup; that performers may shout directly into the new microphone without "blasting" effects in the reproduction; and that there is very little difference in pickup as a performer pulls away from the instrument.

The entire microphone has a frequency response of 50 to 11,000 c.p.s. ± 2 db. Output is -62 db.

NOTICE

Information for our News and New Products section is warmly welcomed. News releases should be addressed to Mrs. Harriet P. Watkins, Industry Research Division, Proceedings of I.R.E., Room 707, 303 West 42nd St., New York 18, N. Y. Photographs, and electrotypes if not over 2" wide, are helpful. Stories should pertain to products of interest specifically to radio engineers.

We will be grateful if you will mention PROCEEDINGS of the I.R.E. when writing to our advertisers.

Just Published

Here is an outstanding new book that covers practically all the mathematics needed to solve *everyday* design problems in radio, electronics, radar, and allied fields. Relates fundamental concepts to physical applications. Deals with the solution of typical problems and gives applications that represent most recent advances in radio engineering.

Mathematics for Radio Engineers

By Leonard Mautner, Research Engineer
Allen B. Du Mont Laboratories

For

- Practicing Engineers
- Radio School and College Students
- Radio Technicians
- Radio Service Men

327 Pages \$5.00

Illustrated.
Graded
Problems and
Answers



This practical, easy-to-read text includes mathematical analysis of frequency, amplitude and phase modulation—spectrum analysis of television sawtooth and synchronizing pulses—Wien bridge circuit analysis—determinant oscillators—differentiation, integration and sawtooth generation circuits for television.

Send for a Copy on Approval

PITMAN PUBLISHING CORPORATION
2 West 45th Street New York 19, N.Y.

COME

To the 1948

IRE National Convention and
Radio Engineering Show

March 22-25 at New York's
Hotel Commodore and Grand
Central Palace

Hear

Over 100 Technical papers on
16 basic and important engineering
topics by leaders in the field.

See

163 Engineering Exhibits of the
latest product and equipment
developments—2 full floors at
Grand Central Palace.

The Institute of Radio
Engineers

INDEX AND DISPLAY ADVERTISERS

Section Meetings	34A
Student Branch Meetings	40A
Membership	40A
Positions Open	50A
Positions Wanted	55A
News—New Products	22A

DISPLAY ADVERTISERS

Aerovox Corporation	26A
Airborne Instruments Laboratory, Inc.	54A
Aircraft Radio Corp.	42A
American Phenolic Corp.	34A
Amperex Electronic Corp.	Cover II
Amperite Co.	68A
Andrew Corporation	46A
Arnold Engineering Co.	7A
Astatic Corporation	38A
Barker & Williamson	71A
Bell Telephone Laboratories ..	3A, 6A
Bendix Aviation Corp. (Scintilla Magneto Div.)	60A
Bendix Aviation Corp. (Research Laboratories)	53A
Bliley Electric Company	44A
Boland & Boyce, Inc.	59A
Cannon Electric Development Co.	67A
Capitol Radio Engineering Insti- tute	70A
Centralab	8A
Cleveland Container Co.	16A
Sigmund Cohn & Co.	59A
Communications Equipment Co.	52A
Edward J. Content	69A

Cornell-Dubilier Electric Corp.,	Cover III
Curtiss-Wright Corp.	50A
Tobe Deutschmann Corp.	12A
Dial Light Co. of America	54A
Allen B. DuMont Labs., Inc.	14A, 24A
Eitel-McCullough, Inc.	11A
Electro Impulse Laboratories ..	61A
Electro Motive Mfg. Co., Inc. ...	1A
H. A. Erf	69A
Erie Resistor Corp.	41A
Fairchild Camera & Instrument Corp.	18A
Federal Telephone & Radio Corp.	29A
Federal Telecommunication Labo- ratories	50A
Finch Telecommunications, Inc. ...	66A
Furst Electronics	55A
General Aniline & Film Corp.	27A
General Electric Company	36A & 37A, 51A
General Radio Co.	Cover IV
G. M. Giannini & Co., Inc.	66A
Hallicrafters Company	19A
Hewlett-Packard Company	45A
Hytron Radio & Electronics Corp.	25A

Illiffe & Sons	43A
International Electronic Corp. ...	39A
International Resistance Corp. ...	9A
I.R.E. Yearbook	63A, 64A & 65A
D. C. Kalbfell	69A
Kenyon Transformer Co., Inc.	55A
Langevin Manufacturing Corp. ...	61A
Lavoie Laboratories	23A
P. R. Mallory & Co., Inc.	10A
Frank Massa	69A
Measurements Corp.	48A
Eugene Mittelman	69A
Mycalex Corp. of America	67A
National Carbon Co., Inc.	5A
Newark Electric Co., Inc.	56A
J. M. Ney Company	56A
Ohmite Mfg. Co.	20A
Panoramic Radio Corp.	62A
Pitman Publishing Corp.	69A
Precision Apparatus Co., Inc. ...	48A
Premax Products	53A
Presto Recording Corp.	28A
Radio Corp. of America	32A, 66A, 72A
Radio-Music Corporation	62A
Reeves-Hoffman Corp.	58A
Revere Copper & Brass, Inc.	4A
Irving Rubin	69A
A. J. Sanial	69A
Selenium Corp. of America	13A
Sherron Electronics Company ...	33A
Sigma Instruments, Inc.	68A
Sorensen & Co.	2A
Ivan Sorvall	67A
Sperry Gyroscope Co., Inc. ...	21A, 54A
Sprague Electric Co.	30A & 31A
Stackpole Carbon Co.	15A
Surprenant Mfg. Co.	57A
Technology Instrument Corp. ...	58A
Triplett Electrical Instrument Co.	35A
United Transformer Corp.	17A
Waterman Products Co., Inc.	49A
Western Electric Company	3A
Weston Electrical Inst. Co.	47A
S. S. White Dental Mfg. Co.	40A
Workshop Associates, Inc.	53A

*"Where
Professional
Radiomen
Study"*



CAPITOL RADIO ENGINEERING INSTITUTE

An Accredited Technical Institute
16th and Park Rd., N. W.
Washington 10, D. C.

Advanced
Home Study and Residence
Courses in Practical Radio-
Electronics and Television.
Approved for Veteran Training.

FOUR FAMOUS **B&W** INSTRUMENTS THAT BELONG IN YOUR LAB!

You can use these instruments to speed:

- Selection of Components
- Special Audio Circuit Analysis
- Routine Performance Checks
- All-around Audio Circuit Design and Experimentation

For the first time, here is truly high quality equipment, priced within the range of even the small laboratory. These four new B&W instruments are the products of an organization fully acquainted with the needs of today's research, engineering and experimental laboratories.

Each is designed for a specific purpose, but each one will assist you in many important ways. With these four new instruments in your lab you can get the answers you need—accurately and quickly. They'll speed your work and pay for themselves many times over in a relatively short time. Your complement of laboratory equipment is not complete without at least one of each of these new tools to help you "step up" your program of projects. Write for descriptive folders.

B&W

FREQUENCY METER Model 300



The B&W Audio Frequency Meter provides an accurate and convenient means of making direct measurements of unknown audio frequencies within its range up to 30,000 cycles. The circuit consists of an input voltage gain amplifier followed by two limiting amplifiers, the last of which feeds an RC integrating circuit and full wave rectifier whose DC voltage output increases linearly with frequency. Integral power supply. A high-impedance input circuit plus low-input operating voltage permits the unit to be operated from the phone jack of a standard receiver for measuring the audible beat between two R.F. carriers. Extremely useful for routine checking of audio oscillators or tone generators.

B&W

AUDIO OSCILLATOR Model 200



The B&W Audio Oscillator consists of a modified Wien Bridge R.C. oscillator and a two stage inverse feedback output amplifier with self-contained power supply. This unit is characterized by small size, light weight and ease of operation combined with outstanding performance. Ideal for use in distortion measurements, frequency measurements or in any application where a stable, accurately calibrated source of frequencies between 30 and 30,000 cycles is required. No zero reset or line calibration is required. An ideal portable unit which may be taken to the job.

B&W

DISTORTION METER Model 400



The B&W Distortion Meter is a sensitive instrument having a wide range of applications in the audio frequency measurements field. The circuit consists essentially of a Wien bridge null balance included in a feedback amplifier, capable of complete fundamental frequency suppression but producing no attenuation of frequencies removed one octave or more, in combination with a sensitive vacuum tube voltmeter and accurately calibrated attenuator. Complete with integral power supply. Ideal for measuring low level audio voltages and determining their noise and harmonic content. Also used for measuring frequency and gain characteristics of audio amplifiers or any other application where a vacuum tube voltmeter is required in the audio range. The variable frequency selective filter provides a single frequency suppression circuit for the frequency range of 50 to 15,000 cycles. Its small size and light weight combine with outstanding performance to make it an ideal unit for either laboratory or field work.

B&W

SINE WAVE CLIPPER Model 250



The B&W Sine Wave Clipper is a device for generating a test signal that is particularly useful for examining the transient and frequency response of audio circuits. It is a great time saver when used in experimental work, or on equipment under development. A sine wave analysis after every change of a component becomes time consuming and tedious. By means of the Sine Wave Clipper, the effect of making changes in a circuit may be seen immediately, thus guiding the course of development in the proper direction.

Write for complete descriptive folders

BARKER & WILLIAMSON, Inc.
Radio Manufacturing Engineers
Dept. PR-18, 237 FAIRFIELD AVENUE, UPPER DARBY, PENNA.



for DISTORTION and BRIDGE MEASUREMENTS at 2 to 15,000 Cycles

• This highly stable oscillator with unusually low distortion is of the resistance-tuned type and operates on the inverse feedback principle developed by General Radio.

The Type 1301-A Low-Distortion Oscillator is especially suitable as an a-f power source for bridge use, for general distortion measurements, to obtain frequency characteristics and to make rapid measurements of distortion in broadcast transmitter systems.

FEATURES

- WIDE FREQUENCY RANGE—20 to 15,000 cycles (with Range Extension Unit, 2 to 15,000 cycles)
- CONVENIENT TO USE—27 fixed-frequencies, selected by two push-button switches, in logarithmic steps—any desired frequency between steps obtained by plugging in external resistors
- THREE OUTPUT IMPEDANCES—600-ohm balanced to ground; 600-ohm unbalanced; 5,000-ohm unbalanced
- EXCEPTIONALLY PURE WAVEFORM—Distortion not more than following percentages: with 5,000-ohm output 0.1% from 40 to 7,500 cycles; 0.15% at other frequencies. With 600-ohm output 0.1% from 40 to 7,500 cycles; 0.25% from 20 to 40 cycles and 0.15% above 7,500 cycles
- HIGH STABILITY—Frequency is not affected by changes in load or plate supply voltage. Drift less than 0.02% per hour after few minutes operation
- ACCURATE FREQUENCY CALIBRATION—Adjusted to within $1\frac{1}{2}\% \pm 0.1$ cycle
- NO TEMPERATURE OR HUMIDITY EFFECTS—In ordinary climatic changes, operation is unaffected.

• The normal range of this oscillator is 20 to 15,000 cycles. The Range Extension Unit (above) lowers this range by a full decade to 2 to 15 cycles, greatly extending its usefulness to frequencies considerably below that heretofore practicable.

With its very high stability, unusually low distortion and many operating conveniences, the Type 1301-A Oscillator fills a universal need in distortion and bridge measurements.

TYPE 1301-P1 RANGE EXTENSION UNIT\$70

TYPE 1301-A—LOW DISTORTION OSCILLATOR\$395.00
ORDER NOW—A few in stock



GENERAL RADIO COMPANY Cambridge 39, Massachusetts

90 West St., New York 6

920 S. Michigan Ave., Chicago 5

950 N. Highland Ave., Los Angeles 38