

# Proceedings



of the I·R·E

**A Journal of Communications and Electronic Engineering**  
(Including the WAVES AND ELECTRONS Section)

**June, 1947**

Volume 35

Number 6

PROCEEDINGS OF THE I.R.E.  
Generation of Centimeter Waves  
Selective Demodulation  
Cathode-Follower Input  
Admittance  
Exponential Transmission Lines  
Waves and Electrons  
Section

The Job Ahead  
A Technical Audit  
1-Millionth-Second Radiography  
Band-Pass Amplifier Design  
Abstracts and References

TABLE OF CONTENTS PAGE FOLLOWS PAGE 32A

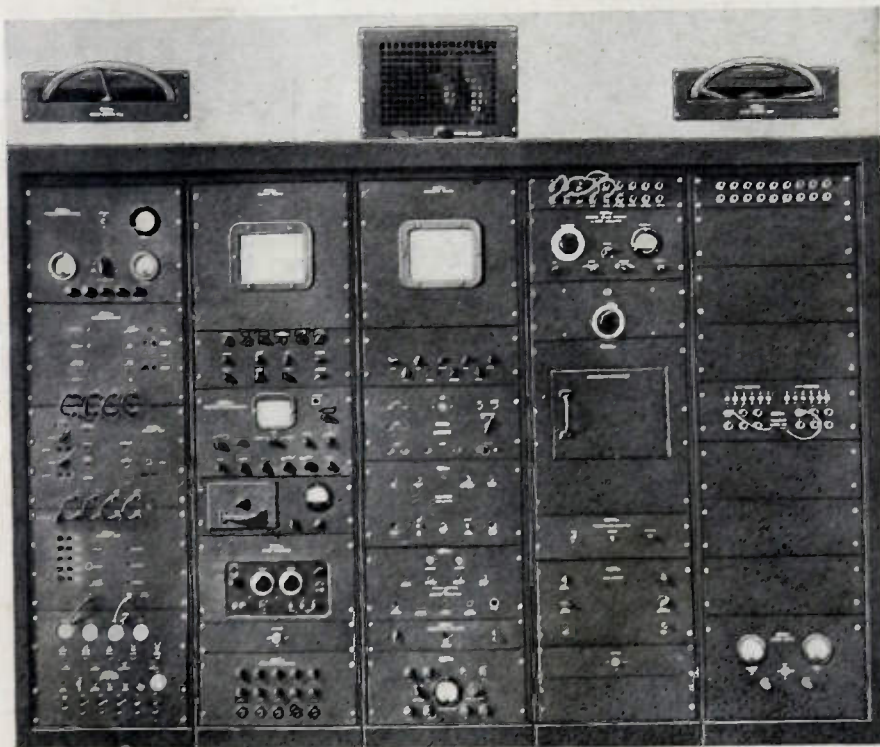

*Gilfillan Bros. Inc.*

*(The above photograph was secured through the courtesy of the Los Angeles Section of the Institute)*

#### TELEVISION SYNCHRONIZING, SIGNAL, AND CONTROL EQUIPMENT

The development and utilization of television synchronizing and image signals requires intricate electronic equipment. Shown above are: a synchronizing signal generator, a monitoring receiver, a monoscope video signal generator, sources of audio-frequency signals, and a group of video and audio transmitters selectable at will. The equipment is intended for development and line testing of television receivers.

**West Coast I.R.E. Convention**  
Sponsored by the  
San Francisco Section, I.R.E.  
September 24-25-26

# The Institute of Radio Engineers



# TRANSFORMERS FOR EVERY APPLICATION

LINEAR  
STANDARD



HYPERM  
ALLOY



ULTRA  
COMPACT



COMMERCIAL  
GRADE



OUNCER



SUB  
OUNCER



SPECIAL  
SERIES



VARIABLE  
INDUCTOR

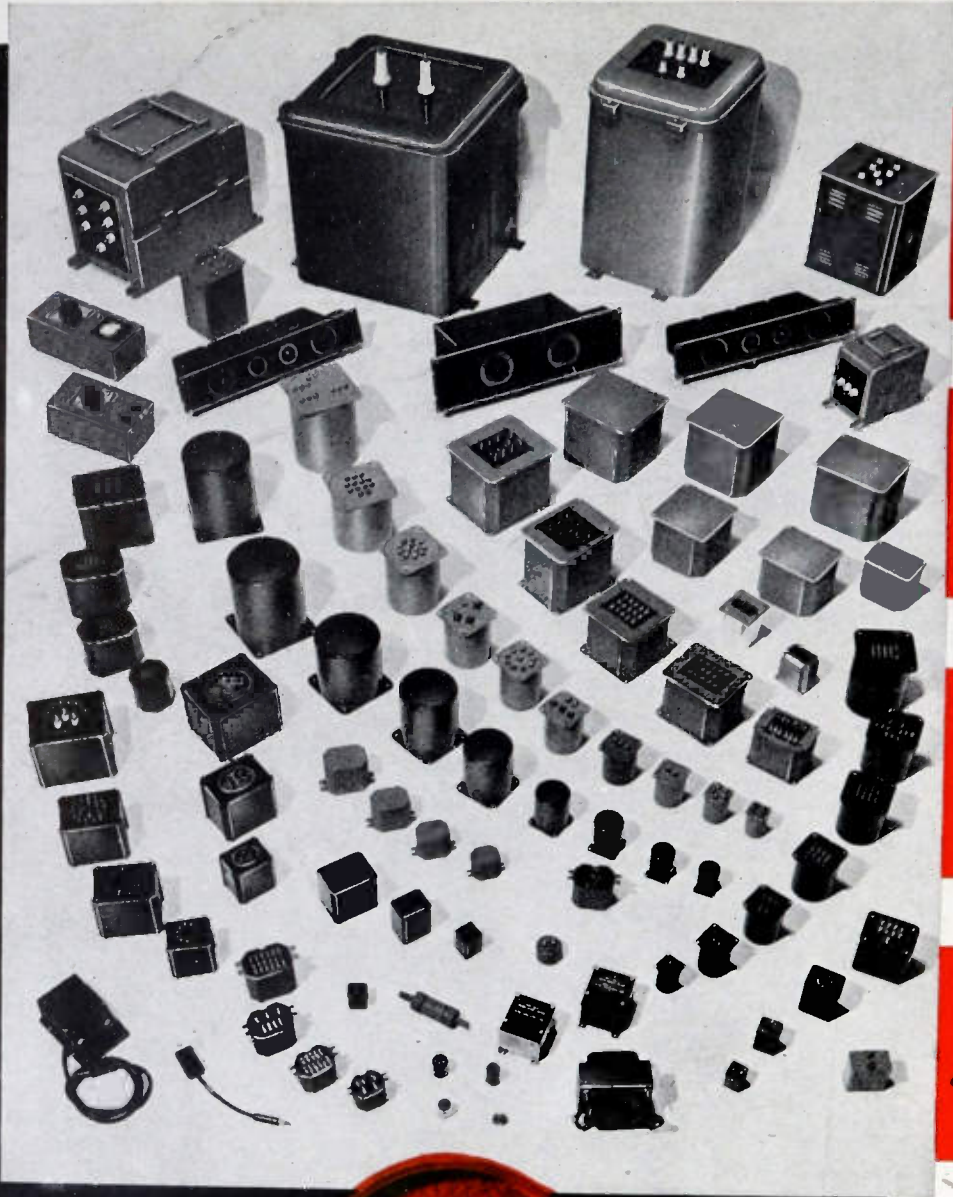

*Foremost Manufacturers of Transformers to the Electronic Industry*

*United Transformer Corp.*

150 VARICK STREET

NEW YORK 13, N. Y.

EXPORT DIVISION: 13 EAST 40th STREET, NEW YORK 16, N. Y.,

CABLES: "ARLAB"



## LAST WORD IN **LONGER LASTING** FLUORESCENT LAMP CAPACITORS

Check these advantages  
of **SUPEREX\***

### Fluorescent Ballast Capacitors

- ✓ SMALL SIZE
- ✓ LONG LIFE
- ✓ STABLE CHARACTERISTICS AT HIGH TEMPERATURES
- ✓ LOW POWER FACTOR
- ✓ NON-FLAMMABLE
- ✓ UNDERWRITERS' LABORATORIES LISTED

Exceptionally long life at high ambient temperatures is the prime requirement for capacitors used in fluorescent lamp ballasts. Major ballast manufacturers have made certain of this extra reliability by specifying SupereX Capacitors.

Designed for use at temperatures of 75° C, SupereX treated capacitors show exceptional stability of electrical characteristics on long-term life tests.

SupereX capacitors are available in a full line of ratings and container shapes for every lamp auxiliary. Write for Bulletin SPA-110.

**Solar Manufacturing Corporation**  
285 Madison Ave., New York 17, N. Y.

★Trade Mark

# SOLAR CAPACITORS

*"Quality Above All"*



PROCEEDINGS OF THE I.R.E., June, 1947, Vol. 35, No. 6. Published monthly in two sections by The Institute of Radio Engineers, Inc., at 1 East 79 Street, New York 21, N.Y. Price \$1.50 per copy. Subscriptions: United States and Canada, \$12.00 a year; foreign countries \$13.00 a year. Entered as second class matter, October 26, 1927, at the post office at Menasha, Wisconsin, under the act of March 3, 1879. Acceptance for mailing at a special rate of postage is provided for in the act of February 28, 1925, embodied in Paragraph 4, Section 412, P. L. and R., authorized October 26, 1927.

Table of contents will be found following page 32A



# Why this team brings you better ELECTRON TUBES

1925. This was one of the earliest photoelectric cells. It was made by Western Electric for use in commercial picture transmission over telephone wires.

1918. This "peanut" tube, the Western Electric 215A, was developed for service in World War I. It was the first commercial tube whose filament was powered by a single dry cell . . . made possible compact, light weight radio equipment.

1912. The first effective high-vacuum tube, developed by the Laboratories for long distance telephony, was capable of operation at both audio and radio frequencies, and thus marked the beginning of modern electronics.

1919. The introduction of the copper-to-glass seal made water cooled tubes practical. The resulting high power tubes were used for broadcasting and for transoceanic radio-telephony.

1940. The beating oscillator, used in the great majority of radar systems. This tube generated a wave in the receiver with which the received microwave was reduced in frequency for amplification.

1937. This microwave generator, the 368A, was the first commercial tube to generate frequencies higher than 1500 mc. This type of tube was used by Western Electric in the first absolute altimeter.



**-QUALITY COUNTS-**



**1940.** Bell Laboratories produced the first American multicavity pulsed magnetron from a British model. The team of Western Electric and Bell Laboratories developed 75 new and improved magnetron designs by extending operation into the 10 cm, 3 cm and finally the 1 cm bands, and produced over 300,000 of these wonder tubes of World War II.

**1942.** This tiny 6AK5, operating in the vicinity of 400 mc, proved itself invaluable as an amplifier in radar receivers. Design specifications were supplied to other manufacturers by Western Electric to speed war production.

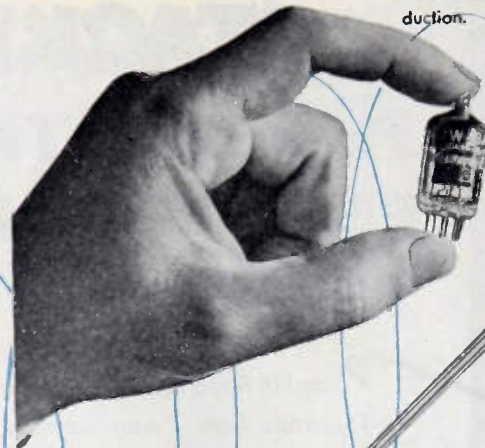

**1945.** The Bell Laboratories traveling wave tube, still in the research stage, amplifies over a band 40 times wider than present tubes—may be able to amplify dozens of color or black and white television programs simultaneously.

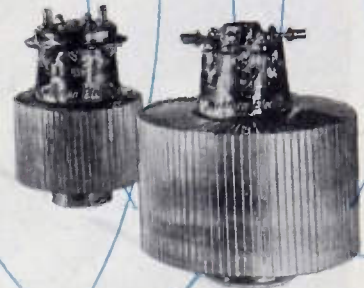

**TODAY.** These new forced air cooled FM transmitting triodes are among the latest in the line of tubes designed by Bell Telephone Laboratories and made by Western Electric. Their thoriated tungsten filaments, rugged construction, flexible terminal arrangements and many other features make them tops in performance in the 88 to 108 mc band.

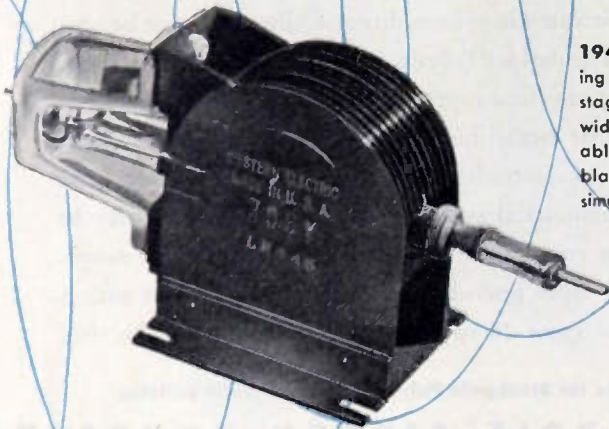

**O**VER 34 years ago in the laboratories of Western Electric, De Forest's Audion was improved and developed into the high vacuum tube and put to work for the first time amplifying telephone and radio frequency currents. And for over 34 years Western Electric and its research associate Bell Telephone Laboratories have been foremost in designing new and better electron tubes. Every tube shown here and many developments basic to the tube art are examples of that leadership. More than 10 years ago, for instance, Bell Laboratories first used microchemistry to determine what gases were destructive to tube elements, and with Western Electric developed a manufacturing technique to keep these damaging elements out—thus increasing tube life many-fold. Every one of the more than 300 codes of electron tubes now being made by Western Electric from Bell Laboratories' designs has the same unequalled background of research and manufacturing skill.



## BELL TELEPHONE LABORATORIES

World's largest organization devoted exclusively to research and development in all phases of electrical communications.

# Western Electric

Manufacturing unit of the Bell System and the nation's largest producer of communications equipment.

*They Lick Humidity and Vibration  
at High Frequencies*

# **STACKPOLE**

## **Polytite TRIMMER ELECTRODE CORES**

**P**laced in fitted metal sleeves, Stackpole Polytite Trimmer Electrode Core Forms serve as variable capacitors that assure honest-to-goodness capacity stability in high-frequency circuits where humidity and vibration must be considered. The molded Polytite has a high dielectric constant. Cores are moisture repellent and carry a heavy dielectric coating that establishes a path of high leakage resistance between the electrodes. Since these electrode surfaces have short, symmetrical current paths, the inductance may be kept low enough for use in the 200-megacycle range. Standard types provide easy capacity adjustment with a maximum from 20 to 40 mmf., depending on the size.

Write for Stackpole Polytite Trimmer Data Bulletin

**STACKPOLE CARBON COMPANY**

*Electronic Components Division • St. Marys, Pa.*

Stackpole Polytite Trimmer Electrode Capacitors are well suited for minimum capacity adjustments in tuned circuits, installed across the tuning capacitor as in Figure 1 or across the tuning inductance as in Figure 2. Trimmers may be mounted directly to the tuning capacitor.

A typical application using two Polytite Trimmer Electrode Capacitors in a circuit where band-spread tuning is desired. Various bands may be covered by the switching of coils and preadjusted trimmers.



**RESISTORS • IRON CORES • SWITCHES**



# New SILICONE\* BUSHINGS..

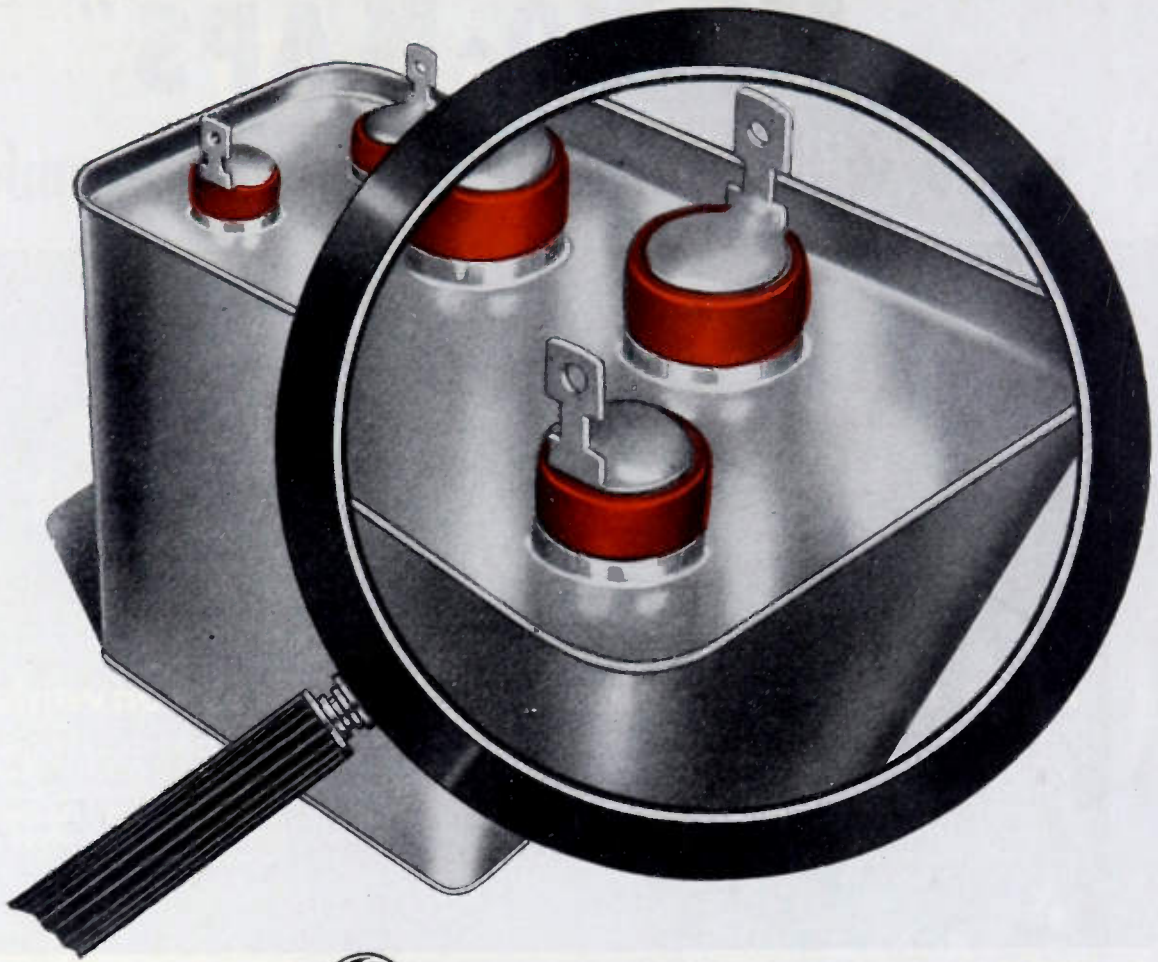

## add to reliability of CAPACITORS

Here is a new development of importance to all users of specialty capacitors. It is General Electric's new silicone bushing—available only on G-E capacitors.

This new bushing gives greater dependability and longer life for capacitors. Being elastic, it is self-sealing—permanent, for all practical purposes, in both physical and dielectric properties. Inserted through the openings in the top of the capacitor casing, it seals by compression—without adhesives or gaskets. It retains its elasticity over a wide range of temperatures and will not shrink, pull away, or loosen during the life of the capacitor.

This bushing has other advantages—all of which add to the reliability of

G-E capacitors. The single piece construction provides permanently high dielectric strength and insulation resistance. It is highly resistant to oils, alkalies, and acids; it will not support fungus growth.

Silicone bushings will be used on all General Electric Pyranol\* capacitors having solder-lug terminals. This new G-E first is one more reason for selecting General Electric capacitors. Others, all adding to dependability and long life, include the positive sealing of casings by double rolling or roll-crimping and soldering, the use of highest grade materials and superior processing methods, with strict quality control. Apparatus Dept., General Electric Company, Schenectady 5, N. Y.

\*Reg. U.S. Pat. Off.

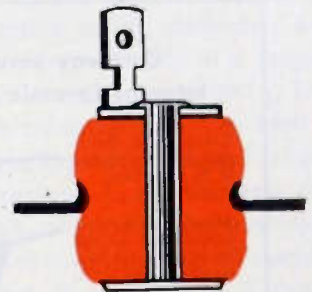

\* This bushing represents one of the newest uses for the recently developed G-E family of chemicals called silicones. Permanently elastic, formed to close tolerances, it seals itself by compression to the capacitor casing.

# GENERAL ELECTRIC

407-142

Announcing a new line of television capacitors

# "HI-VO-KAPS"

made with Centralab's original Ceramic-X

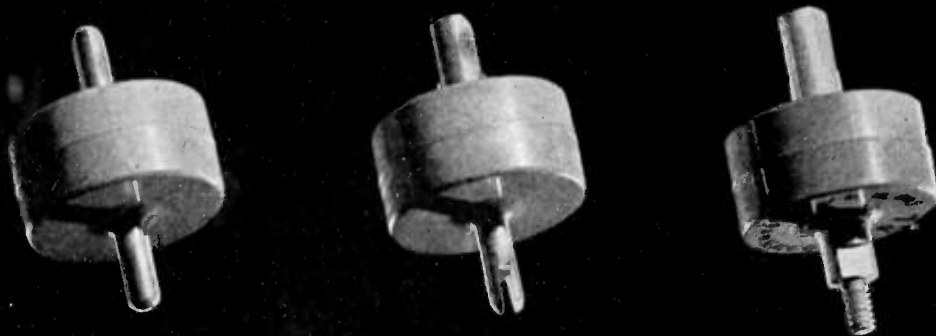

## Three types of terminals for flexibility, convenience

**ROD TYPE:** .160" diameter rod type terminals. Designed for use with conventional fuse or clip-type connections. Terminals are solid brass, silver-plated and soldered directly to electrodes.

**SLOT-AND-THREAD TYPE:** .160" diameter with  $\frac{1}{16}$ " x  $\frac{1}{16}$ " slot in one terminal. Other terminal tapped 6-32,  $\frac{3}{16}$ " deep for "twinning" or convenient chassis mounting.

**DUO-THREAD TYPE:** one terminal tapped 6-32,  $\frac{3}{16}$ " deep full threads. Other terminal, 6-32, male thread  $\frac{1}{4}$ " length. Designed for convenient series or tapped series connections.

### Cutaway view shows integral ceramic construction

Solid brass terminals, soldered directly to electrodes.

Metallic silver electrodes fired directly to high dielectric constant Ceramic-X.

Low loss, mineral filled phenolic resin.

Three terminal types for strong, fast connections.

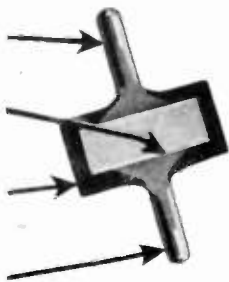

## The smallest high voltage capacitors ever designed exclusively for television circuits!

ANOTHER "FIRST" for Centralab! "Hi-Vo-Kaps" are made with Centralab's original Ceramic-X, combining high voltage, small size and terminal connections to fit virtually any television application!

Designed and developed by Centralab in response to stated requirements of television project engineers, "Hi-Vo-Kaps" are for use as filter and by-pass capacitors in video amplifiers — for high DC voltages with small component AC voltages (not for use in temperature compensation or resonant circuits).

*Ratings:* 10,000 WVDC, 15,000 VDC flash test, 500 mmf., — 50% — 20% capacity at 1 megacycle (2½% higher at 1 kilocycle). *Dimensions:* diameter — .990", length — .510". Overall length varies with terminal types, maximum—1.597". Send for Bulletin 946.



Ceramic Trimmers  
Bulletin 630



Ceramics  
Bulletin 720



Variable Resistors  
Bulletin 697

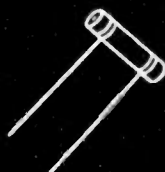

Ceramic Capacitors  
Bulletin 630



Selector Switches  
Bulletin 722

**Centralab**  
Division of GLOBE-UNION INC., Milwaukee



HERE'S FLAT RESPONSE UP TO 700 MC



# 410A VACUUM TUBE VOLTMETER

with its new *-hp-* low-capacity diode probe, measures all the important radio voltages without disturbing circuits under test.



## CHECK THESE FACTS ABOUT THE NEW *-hp-* PROBE\*:

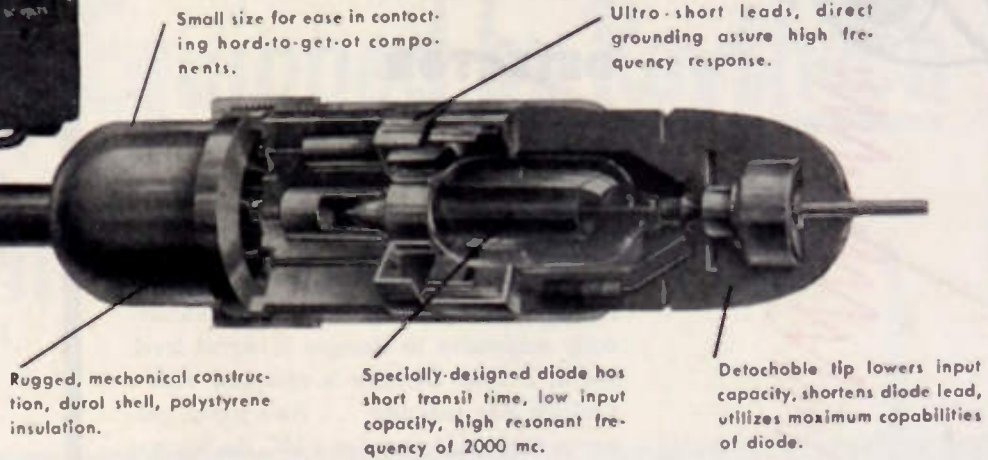

\*Reproduced actual size

The specially-designed diode, in combination with the *-hp-* probe design, makes possible the exceedingly flat frequency response shown graphically in Figure 1.

With this flat frequency response are combined the factors of low input capacity and high input resistance. The variation of these factors with

frequency is shown in Figure 2. The input resistance and reactance are high throughout the entire range of the instrument, and thus measurements are made without appreciable detuning or loading of circuit. Maximum measuring accuracy is assured.

In addition to swiftly, easily, accurately making uhf radio measure-

ments, this *-hp-* 410A is a convenient voltage indicator up to 3000 mc. And it serves equally well as an audio or d-c voltmeter, or an ohmmeter. A-c measurements are made in 6 ranges ... full scale readings 1 to 300 v. D-c full scale readings from 1 to 1000 v in 7 ranges. Input resistance all ranges - 100 megohms. As an ohmmeter, the *-hp-* 410A measures resistances from 0.2 ohms to 500 megohms in 7 ranges.

In short, this *-hp-* 410A Vacuum Tube Voltmeter is ideal for obtaining most important parameters in radio design, manufacture, or servicing. Write today for full details. Hewlett-Packard Company, 1407D Page Mill Road, Palo Alto, California.

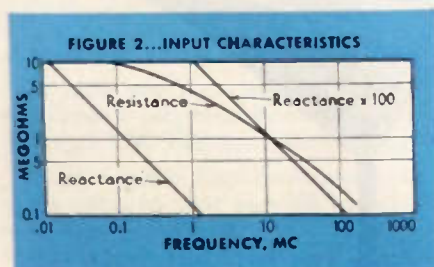
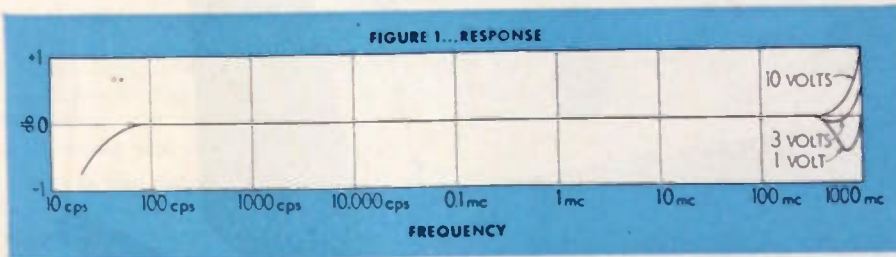

**hp laboratory instruments**  
FOR SPEED AND ACCURACY

- |                                |                         |                        |
|--------------------------------|-------------------------|------------------------|
| Noise and Distortion Analyzers | Wave Analyzers          | Frequency Meters       |
| Audio Frequency Oscillators    | Audio Signal Generators | Vacuum Tube Voltmeters |
| Amplifiers                     | Power Supplies          | Attenuators            |
| Square Wave Generators         | Frequency Standards     | Electronic Tachometers |

# SEE what your ears miss!



## SHERRON

## R. F. NULL

## DETECTOR

Noise can't interfere with the indications registered on this new Sherron instrument. Where din and hubbub would nullify aural manifestations, you can count on the visual features of Model SE-518 to provide the findings, clearly, unmistakably. Instantaneously responsive to changes of signal level, the R. F. Null Detector is equipped with a Cathode Ray indicator . . . As a signal generator to provide power at 1 MC, the Sherron R. F. Null Detector is invaluable. It also serves as a sensitive detector at the same frequency. Both generator and detector are housed in the same cabinet.

*Frequency: 1 MC*

*Generator Output:*

*0-5 volts*

*Detector Gain:*

*500,000 plus*

*Harmonic Suppression:*

*2nd down*

*more than*

*100 db*

*Power Require-*

*ments: 115*

*volts, 60 cycles,*

*120 watts*



Model  
SE-518

## SHERRON ELECTRONICS CO.

Division of Sherron Metallic Corporation

1201 FLUSHING AVENUE • BROOKLYN 6, NEW YORK



# Over 100 Stations Fully Equipped by Raytheon in Less Than One Year

## An enviable record based on advanced engineering and modern design

● More and more station owners every day are turning to Raytheon for the very finest in broadcast equipment. Raytheon is leading the way with simplified circuit design, thorough engineering and complete dependability.

Across the nation, enthusiastic station owners and engineers (both AM and FM) praise the high fidelity, servicing accessibility and low-cost maintenance of Raytheon broadcast equipment—from Single-Channel Remote Amplifiers to 5 KW Transmitters. With Raytheon equipment they find it far easier to set up programs—and operation is so simple and logical that errors are cut to a minimum.

Be sure you have *all* the facts before you buy. Investigate Raytheon's complete line of speech input equipment and both AM and FM Transmitters ranging from 250 to 10,000 Watts.

These superb Raytheon products assure the most practical application to *your* specific broadcast problem . . . bring you the finest in modern high fidelity and engineering excellence. Write or wire for illustrated specification bulletins, including complete technical data.

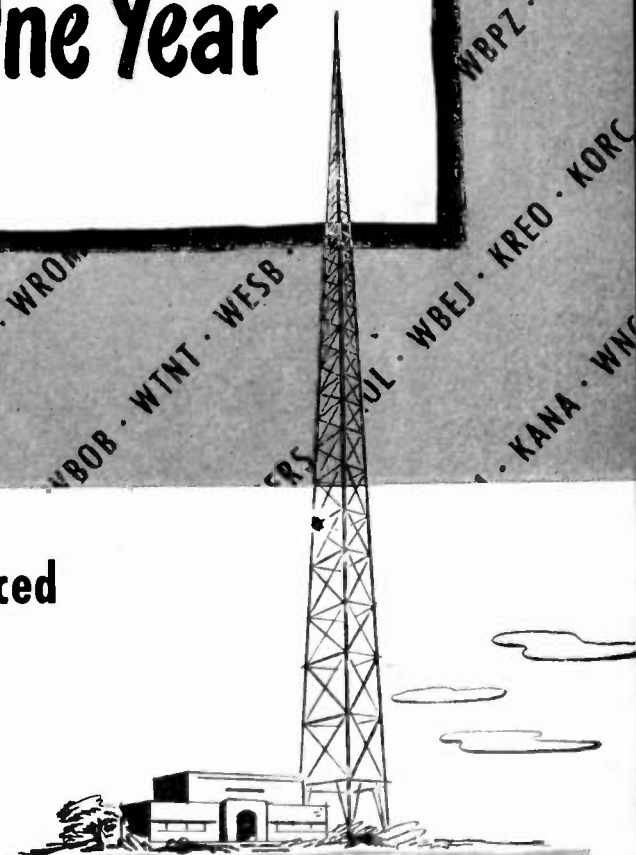

**RAYTHEON**

*Excellence in Electronics*

RAYTHEON MANUFACTURING COMPANY  
BROADCAST EQUIPMENT DIVISION  
7475 N. ROGERS AVE., CHICAGO 26

*Devoted to Research and Manufacturing for the Broadcasting Industry*

### COMPACT ENERGY FOR PHOTOFLASH CAPACITORS

Progress in practical flash photography has been greatly facilitated by new smaller, lighter capacitors incorporating the exclusive Sprague Vitamin Q impregnant. Write for engineering bulletin No. 201.

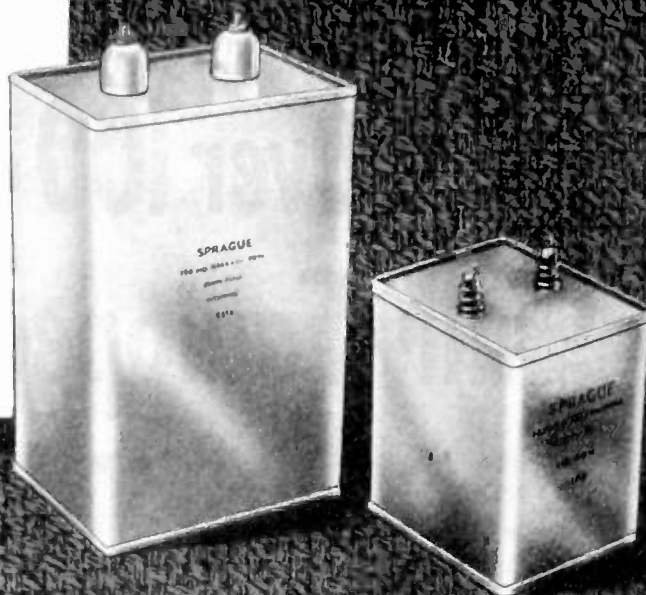

### GUARDING AGAINST FLUORESCENT BALLAST FAILURES

A major fluorescent lighting problem has been one of finding ballast capacitors to withstand the combination of severe temperature and voltage conditions—and again Sprague Vitamin Q impregnant has proven the answer. Sprague Fluorescent Ballast Capacitors rated at 330v. AC not only give maximum life under normal temperature and voltage conditions, but can be operated at 460v. AC at 85° C. for 1,000 hours—without deterioration or major change in power factor. Thus they assure adequate safety factor under blink start conditions.

## It's all done with \* VITAMIN Q!

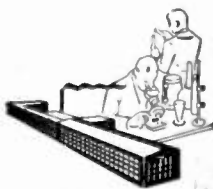

# SPRAGUE

The history of capacitor progress is inseparably linked with the development of new and better dielectrics. Throughout the years, the aim has been to increase the amount of energy that can be stored in a capacitor of given size and to improve performance characteristics all along the line.

The most remarkable advance in these respects has come with the development of the exclusive oil dielectric—Sprague Vita-

min Q. Throughout industry, Sprague Capacitors impregnated with this material are setting new standards for smaller, lighter units for dependable operation at higher voltages and higher temperatures and for greatly improved insulation resistance.

The units illustrated are typical of the many new capacitor designs now available using Sprague Vitamin Q.

\*Trademark Reg. U. S. Pat. Off.

ELECTRIC COMPANY, NORTH ADAMS, MASS.

PROCEEDINGS OF THE I.R.E. June, 1947



**MAKING TUBES IS EASY...**

*If YOU KNOW HOW!*



*Meet* OUR MUTUAL FRIEND  
THE COMMERCIAL ENGINEER

► **Friendly**, tactful, impartial, trained to serve, these Hytron commercial engineers form the liaison between us—maker and user of electronic tubes. Few in the radio tube plant can be circuit specialists. Few outside the tube plant can be tube specialists. Both of us need these commercial engineers trained to see clearly both sides of our common problems and help us solve them.

Often their job begins with a request for advice in selecting a tube. Investigation of the circuit application helps them recommend an available type, a slight redesign, or a brand new type. If a new type is found to be the only practicable and economical solution, they cooperate with design and production engi-

neers to achieve the performance desired.

Specification of adequate factory testing procedures and preparation of characteristics sheets do not end their work. Returns are closely checked. If trouble occurs, they go into the field, help dig out the facts, and offer possible solutions—improvements in tube or application. And they stick tenaciously with the problem until it is solved.

Using a wealth of test equipment and know-how, these boys really sweat to make it easy to make Hytron tubes which will make you happy. Busy as the one-armed paperhanger, yet they always welcome the tube problems of equipment engineers. They are nice guys, and we thought you would like to meet them.

SPECIALISTS IN RADIO RECEIVING TUBES SINCE 1921



**HYTRON**

**RADIO AND ELECTRONICS CORP.**

MAIN OFFICE: SALEM, MASSACHUSETTS

# HIGH VOLTAGE; NO DANGER

*Portable - Rugged - Safe!*



## DU MONT Type 263-A HIGH-VOLTAGE POWER SUPPLY

► High voltage is the keynote of modern oscillography. Especially for brilliant traces at ultra-high speeds.

Type 263-A High-Voltage Power Supply was designed with present and future needs in mind. It provides a dependable yet inexpensive power supply for modernizing and extending the usefulness of certain types of cathode-ray oscillographs when examination of extremely high writing rates is required.

So here's a complete high-voltage power supply. Suitable for any application where high voltage at low current is called for. Consists of radio-frequency oscillator with its own power supply, an r.f. step-up transformer, a half-wave rectifier, and a high-voltage filtering and metering system.

Compact. Light. So designed that inexperienced personnel may handle it with safety. And it is made still safer in case of accidental contact with high voltage, because very little power is stored in its filtering circuit. Furthermore, no equipment damage will result if output is short-circuited. Rugged mechanical construction permits field or laboratory use.

Surely Type 263-A is a "must" instrument whether for high-voltage oscillography or general use!

► **Details on request!**

### Salient Oscillographic Features . . .

- ✓ 10,000 volt intensifier potential available for use with cathode-ray oscillographs.
- ✓ Visual observation of single transients hitherto invisible.
- ✓ Photography of extremely high writing rates (for example, 2000 km./sec. on SRP11 at 10 kilovolts).
- ✓ Observation of entire waveshapes of short duration on long persistence screens.
- ✓ Convenient use with Type SRP-A Multi-band High-voltage Cathode-ray Tube.

### Working Details . . .

- ✓ Continuously variable d-c output from 5,000 to 10,000 volts with loads up to 200 microamperes.
- ✓ Regulation within 20% from no load to 200 microampere load.
- ✓ Ripple voltage on output less than 0.5%.
- ✓ Power supply: 115 volts, 50-60 cps.
- ✓ Power consumption: 100 watts.
- ✓ Dimensions: 10 $\frac{1}{2}$ " h. x 8 $\frac{1}{2}$ " w. x 14 $\frac{3}{4}$ " d.
- ✓ Weight: 24 pounds.

© ALLEN B. DUMONT LABORATORIES, INC.

# DUMONT Precision Electronics & Television

ALLEN B. DUMONT LABORATORIES, INC., PASSAIC, NEW JERSEY • CABLE ADDRESS: ALBEEDU, PASSAIC, N. J., U. S. A.



**THE OPERATION**

**BROADCASTING** that earns the approval of station managers and listeners alike under any and all local conditions for reliability, efficiency and economy.

**THE EQUIPMENT**

**COLLINS 21A 5Kw Air Cooled BROADCAST TRANSMITTER** made by **COLLINS RADIO COMPANY**, 11 West 42nd Street, New York 18, N. Y.

The new Collins 21A has been the choice of keen executives for close to a score of installations in recent months. Knowledge and experience gained by Collins engineers during war time are reflected in improved design, longer life, higher safety factors and unusual standards of trouble free operation.

**THE AMPEREX tubes THAT DO THE JOB!**



AMPEREX experience in communication goes back a quarter of a century. The same record of performance, long life and economy marks Amperex tubes for industrial, rectification, electro medical and special purpose use. As tube specialists concerned with all electronic developments Amperex engineers are in a position to give detached counsel and information

Write Application Engineering Department.

POWER TUBE SPECIALISTS SINCE 1925

COMMUNICATION  
RECTIFICATION  
INDUSTRIAL  
ELECTRO-MEDICAL  
SPECIAL PURPOSE

**AMPEREX**  
ELECTRONIC CORPORATION



25 WASHINGTON STREET, BROOKLYN 1, N. Y., CABLES: "ARLAB"

In Canada and Newfoundland: ROGERS MAJESTIC LIMITED, 622 Fleet Street West, Toronto 2B, Canada

# SYLVANIA RESEARCH NEWS



JUNE

Prepared by SYLVANIA ELECTRIC PRODUCTS INC., Bayside, L. I.

1947

## INTRICATE LABORATORY TECHNIQUES GUARD QUALITY OF TUNGSTEN IN SYLVANIA TUBES

### Basic Studies of Wire Conducted at Each Stage of Production to Insure Electronic Tube Perfection

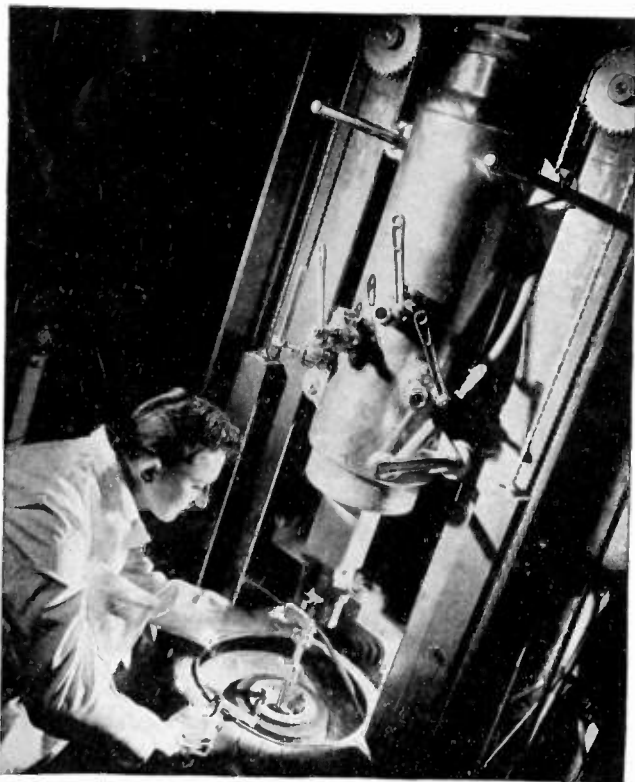

Tungsten for radio tubes (and incandescent lamps) is prepared by heating the powdered tungsten bars to incandescence in sintering bottle. Researcher is placing tungsten bar between electrodes which will pass 150 kw through slug and heat it to 6800° F. Hydrogen atmosphere prevents oxidation. During sintering operation the porous tungsten powdered bar is transformed into a homogeneous metallic slug which can be swaged and drawn down to wire of a diameter as low as .0004".

Two of the many metallurgical tests constantly carried on by Sylvania Electric are illustrated here.

To insure electronic tube perfection — to have Sylvania radio tubes measure up to long-established Sylvania standards — every important type of research technique is utilized.

Here electron microscopes, giving magnifications of thousands of times, are employed. Hardness testers, sag testers, gas analysis equipment, tensile testers are but a few of the methods used to guard the high quality of tungsten utilized.

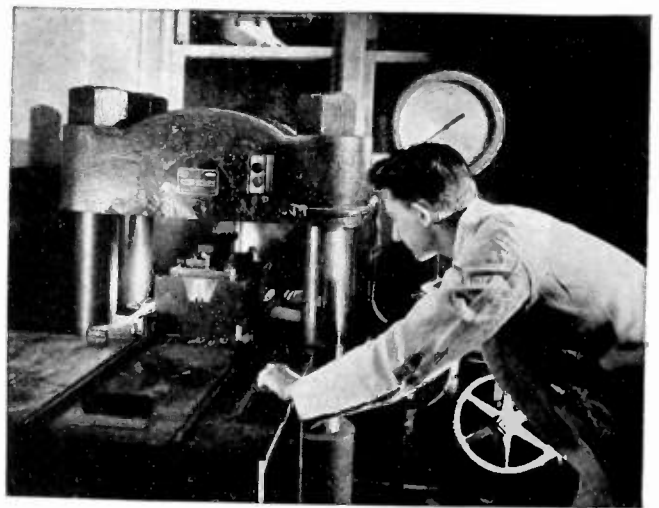

Prior to sintering operation shown at left, tungsten bars of approximately 1/2" square are prepared by pressing finely divided metal powder under hydraulic pressures of up to 300 tons. The equipment used to pursue such studies is illustrated in the above photograph.

Both of the photographs shown here are indicative of the fundamental studies that have resulted in the development and maintenance of tungsten wire of superior quality.

Radio Tube Division, Emporium, Pa.

# SYLVANIA ELECTRIC

MAKERS OF RADIO TUBES; CATHODE RAY TUBES; ELECTRONIC DEVICES; FLUORESCENT LAMPS, FIXTURES, WIRING DEVICES; ELECTRIC LIGHT BULBS



The new 9728-410P high voltage AN connector insert, newest addition to the Amphenol family. It is one of more than 200 types available for use with the five basic shells shown.

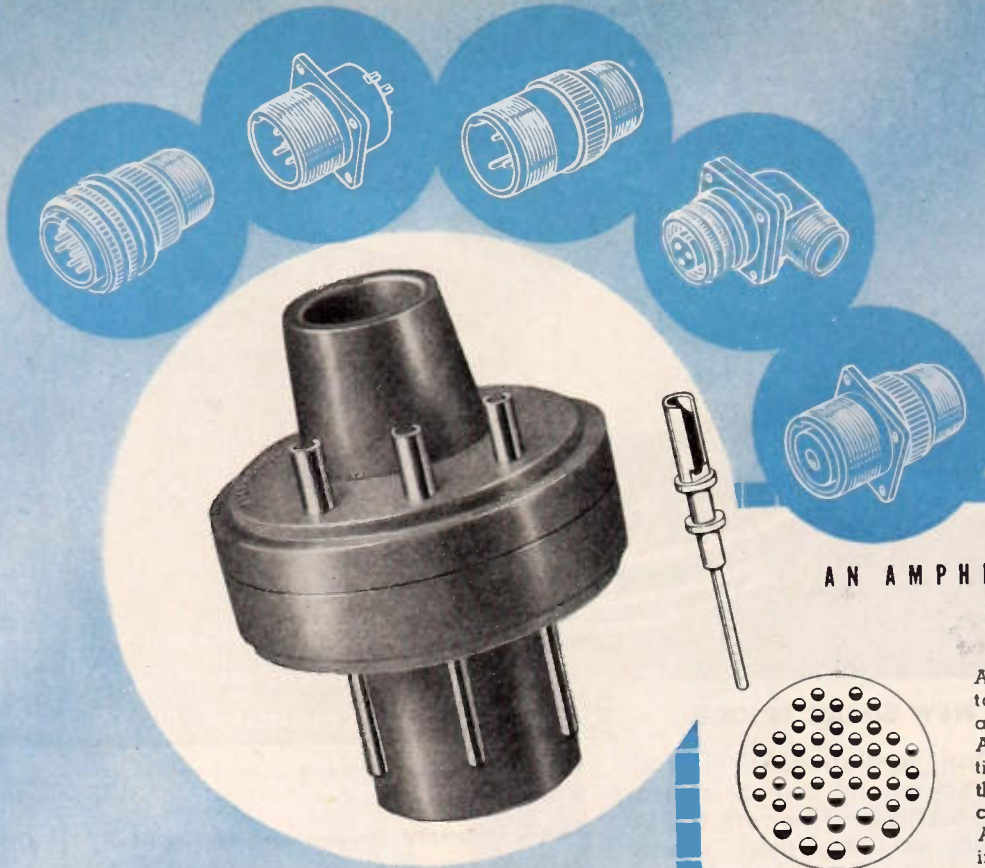

### AN AMPHENOL EXCLUSIVE

Non-rotating solder terminals and aligned solder wells

Amphenol terminals do not rotate, and they are properly aligned for fast, easy soldering. Ask the men on your production line how many hours a day this feature will save. Other exclusive features of Amphenol AN connectors will be described in a later issue.

## How **AMPHENOL** AN Connectors

# Step Up Your Profit Potential

Standardized AN connectors provide a fast, fool-proof way to connect any industrial electronic equipment which frequently must be disconnected from associated equipment or power source.

Their use also permits the prefabrication of associated wiring to accommodate one or many circuits. This greatly simplifies and lowers the cost of electronic installations. AN connectors also permit such equipment to be completely tested at the factory before shipment to user. Upon arrival it then can be connected for operation in minutes.

These advantages combine to widen the field in which electronics may practicably be applied. Thus they offer an increased sales and profit potential to makers of electronic devices.

The Amphenol AN connector family offers you a number of important points of mechanical and electrical superiority. It is comprised of over 200 styles of dielectric inserts. These are interchange-

able in any of the five major Amphenol metal shell designs (each of which is available in eighteen sizes). The practically endless variety of possible combinations offers an efficient solution to any industrial electronic connector problem.

Amphenol inserts handle currents up to 200 amperes, voltages up to 22,000. Housings include types which are pressure-proof, moisture-proof and explosion proof. Standard elements also are available for thermocouple installations.

Amphenol, long the leading builder of AN connectors for aircraft, ships, tanks and ordnance, is still completely tooled for large scale production. This makes these connectors available to industry at costs far below prewar levels. Write today for complete technical and cost data.

**AMERICAN PHENOLIC CORPORATION**  
1830 SOUTH 54TH AVENUE, CHICAGO 50, ILLINOIS

COAXIAL CABLES AND CONNECTORS • INDUSTRIAL CONNECTORS, FITTINGS AND CONDUIT • ANTENNAS • RADIO COMPONENTS • PLASTICS FOR ELECTRONICS

# CAPABILITIES.....25 kw zero to 110 Mc.

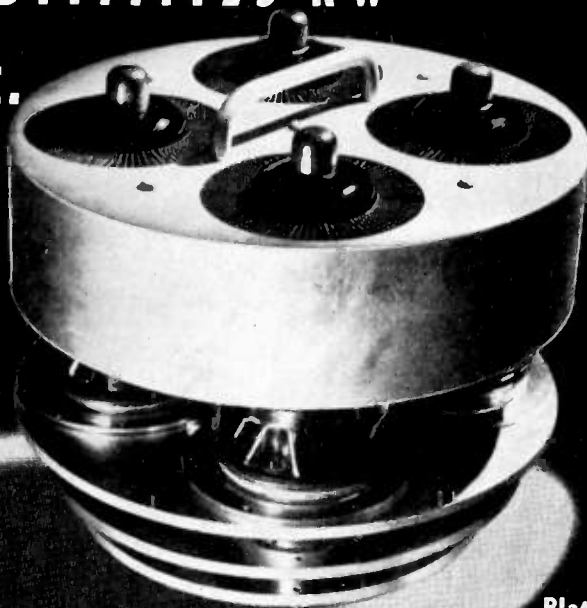

**TYPE 3X12500A3**

**Plate voltage 5000 volts  
Plate dissipation 12,500 watts  
Transconductance 80,000  $\mu$ mhos**

## A REVOLUTIONARY NEW EIMAC TRIODE

YES... The 3X12500A3 is truly revolutionary... packaged power... that will fill not several, but all applications for a power-amplifier or oscillator from zero to 110 Mc. It will do a low frequency job better than "special low frequency" tubes. It's performance at vhf has long been the aim of vacuum tube researchers. The 3X12500A3 is smaller (over-all 11"x9") and lighter (net 32 lbs.) than any comparable tube... Yes, it is truly a revolutionary tube.

- Audio**
- Induction heating
  - Broadcasting
  - Dielectric heating
  - Communication
  - Television
  - Industrial
  - FM Broadcasting
  - Research

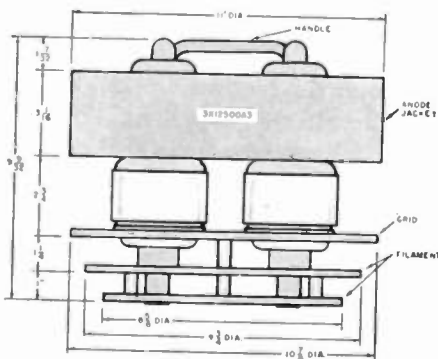

### RADIO FREQUENCY POWER AMPLIFIER Grounded-Filament Circuit

Class-C Telegraphy (Key-down conditions, per tube)

**MAXIMUM RATINGS (Frequencies below 85 Mc.)**

D-C PLATE VOLTAGE	5000 MAX. VOLTS
D-C PLATE CURRENT	8 MAX. AMPS.
PLATE DISSIPATION	12,500 MAX. WATTS
GRID DISSIPATION	600 MAX. WATTS

**TYPICAL OPERATION (Frequencies below 50 Mc., per tube)**

D-C Plate Voltage	3500	4000	5000	volts
D-C Grid Voltage	-420	-360	-400	volts
D-C Plate Current	7.2	6.4	8	amps
D-C Grid Current	2	1.7	1.9	amps
Peak R-F Grid Input Voltage	735	630	710	volts
Driving Power (Approx.)	1.3	0.95	1.35	kw
Grid Dissipation	480	350	590	watts
Plate Input	25.2	25.6	40	kw
Plate Dissipation	5.2	5.6	10	kw
Plate Power Output	20	20	30	kw

### RADIO FREQUENCY POWER AMPLIFIER Grounded-Grid Circuit

Class-C FM Telephony or Telegraphy

**MAXIMUM RATINGS (Frequencies below 110 Mc.)**

D-C PLATE VOLTAGE	4000 MAX. VOLTS
D-C PLATE CURRENT	8 MAX. AMPS.
PLATE DISSIPATION	12,500 MAX. WATTS
GRID DISSIPATION	600 MAX. WATTS

**TYPICAL OPERATION (110 Mc., per tube)**

D-C Plate Voltage	3700	4000	volts
D-C Grid Voltage	-450	-550	volts
D-C Plate Current	7.2	7.4	amps.
D-C Grid Current	0.9	1.1	amps
Driving Power (approx.)	6.4	7.6	kw
Useful Power Output	27.4	30	kw
Apparent Overall Efficiency	102	101	per cent

**EITEL-McCULLOUGH, Inc.**  
1653 San Mateo Avenue, San Bruno, California

Follow the Leaders to

**Eimac**  
TUBES  
The Power for R-F

EXPORT AGENTS: FRAZAR & HANSEN, 301 CLAY ST., SAN FRANCISCO 11, CALIFORNIA



W2XMN, Alpine, New Jersey  
The Pioneer  
FM Station of the World  
ALSiMag Insulated

ALSiMAG

BRANCH OFFICES:  
(Telephone Numbers)  
NEW YORK  
BOSTON  
PHILADELPHIA  
WASHINGTON  
CLEVELAND  
CHICAGO  
ST. LOUIS  
SAN FRANCISCO  
LOS ANGELES



**ALSiMag**

... the pioneer antenna structure for FM (frequency modulation) transmission erected by Major E. H. Armstrong at Alpine, New Jersey is equipped with Super Low-Loss ALSiMag 196 Insulators. You, too, can use this fine Steatite material at no increase in price over the ceramic material you are now using. Ask for our new trade literature. It contains helpful, money saving suggestions.

STEATITE

AMERICAN LAVA CORPORATION  
CHATTANOOGA, TENN.

COMMUNICATIONS FOR DECEMBER 1939

**ALSiMAG INSULATION IN THE PIONEER FM ANTENNA STRUCTURE**

**STILL GOING STRONG!**

This page advertisement in electronic and communications magazines in 1939 announced that Major Edwin H. Armstrong's pioneer antenna structure for FM transmission was equipped with ALSiMag 196 insulators.

Most of the original ALSiMag insulators in W2XMN are still in use today. They are giving entire satisfaction in spite of the fact that one of the transmission lines up the tower, originally designed for 42 megacycles, is carrying 92 megacycles.

There has been no electrical failure of any ALSiMag insulator in W2XMN. A few have been replaced after

heavy ice falls. There is no insulator in existence today which will stand up when squarely hit by a heavy ice fall with drops of several hundred feet. That is one of the problems challenging our Research Division.

In the spring of 1947, W2XMN will replace the vertical transmission line conductors with conductors of considerably larger size. These new and larger conductors will have new and larger insulators . . . of ALSiMag. Perhaps that is the best evidence of the satisfactory performance of ALSiMag insulators in the World's Pioneer FM Station.

**ALSiMAG**

46TH YEAR OF CERAMIC LEADERSHIP  
**AMERICAN LAVA CORPORATION**  
CHATTANOOGA 5, TENNESSEE

SALES OFFICES: ST. LOUIS, MO., 1123 Washington Ave., Tel: Garfield 4959 • NEWARK, N. J., 671 Broad St., Tel: Mitchell 2-8159 • CAMBRIDGE, Mass., 38-B Brattle St., Tel: Kirkland 4498  
CHICAGO, 9 S. Clinton St., Tel: Central 1721 • SAN FRANCISCO, 163 Second St., Tel: Oouglas 2464 • LOS ANGELES, 324 N. San Pedro St., Tel: Mutual 9076 • PHILADELPHIA, 1649 N. Broad St.



June, 1947

## Binding Post

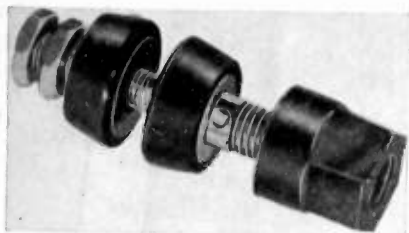

A new binding post, Type DF30, manufactured by **The Superior Electric Company**, 47 Church Street, Bristol, Conn., meets the need for a multi-purpose electrical connector. In contrast to the usual connectors which permit only one or two methods of connection, the new binding post offers five ways of connecting leads; permanent clamping of wire up to size #12 through the center hole, looping of wire around the center shaft and clamping, plug-in connection of a standard  $\frac{3}{4}$ " banana plug, clip-lead connection, and spade-lug connection. In addition to the versatility of connection, this unit provides complete insulation of the binding post from the mounting panel. Rated at 30 amperes, it may be mounted on any panel up to  $\frac{3}{4}$ " thick.

## Roto Switch

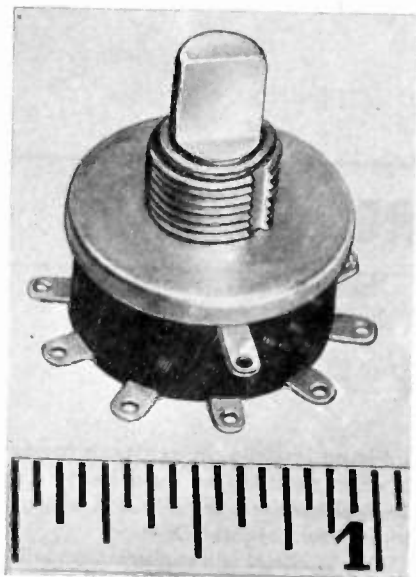

A new miniature rotary switch only  $\frac{3}{4}$ " in diameter, with a contact pressure of 2 $\frac{1}{2}$  pounds, has been developed by **Grayhill**, 1 No. Pulaski Road, Chicago 24, Ill. Designated as the Series 5000 Roto Switch, it can be used in almost any circuit combination up to 5 amperes, breaking up to 1 ampere at 110 volts. The switch can be rotated 360° in either direction.

These manufacturers have invited PROCEEDINGS readers to write for literature and further technical information. Please mention your I.R.E. affiliation.

## Plug-in Amplifiers

The **Langevin Company**, 37 W. 65 Street, New York 23, N. Y., announces two new types of plug-in amplifiers which, it is stated, will provide complete audio facilities with a minimum of different types of tubes, facilitate maintenance, and conserve space without effecting quality or overload safety factors.

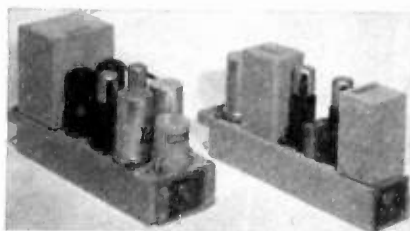

Both amplifiers, Type 116-A (right) and Type 117-A (left), have identical frequency response characteristics of  $\pm 1$  db. over the range of 30 to 15,000 cycles. Type 116-A has a 40 db. gain and may be used as a pre-amplifier or booster amplifier. Type 117-A has a 50 db. gain and may be used as a program, booster, or monitor amplifier.

## Panel Meters

**Shurite Meters**, 61 Hamilton St., New Haven 8, Conn., announces a complete line of alternating and direct current, 2" and 2 $\frac{1}{2}$ ", panel meters. Two round cases and one rectangular case are available in AC and DC ammeters, milliammeters, voltmeters, and also resistance meters. All DC meters are polarized-vane solenoid type, and AC meters are double-vane repulsion type, with an accuracy within 5%.



All models are flush-mounting type of black-enameled brass construction. Bracket, ring or screw mounting, and narrow or wide flange denote design differences. Zero adjusters are supplied when required on two of the DC case types.

## Radio Pack Set

Designed primarily for railroad two-way radio communications, the type MRT-2B VHF pack-set has been recently designed for portable use by **Bendix Radio Corporation**, E. Joppa Road, Baltimore, Md. The retractable vertical-rod antenna, when fully extended, measures 36 inches. The antenna is so designed that only when it is fully extended is the set turned "On."



The overall size of this unit is approximately 11 $\frac{1}{2}$ " high, 9" wide, and 4" deep. It weighs slightly more than 15 pounds including the power supply. Two power supplies are provided so that one may be recharged while the other is in use. Transmitter and receiver are both crystal controlled.

## Streamlined Microphone



A new microphone, "The Conneaut," Type 600-S, having a relatively high output and wide frequency range up to 10,000 cycles has recently been placed on the market by **The Astatic Corporation**, Conneaut, Ohio.

(Continued on page 48A)



# DE MORNAY • BUDD STANDARD TEST EQUIPMENT

For Precision Measurements in the Microwave Field

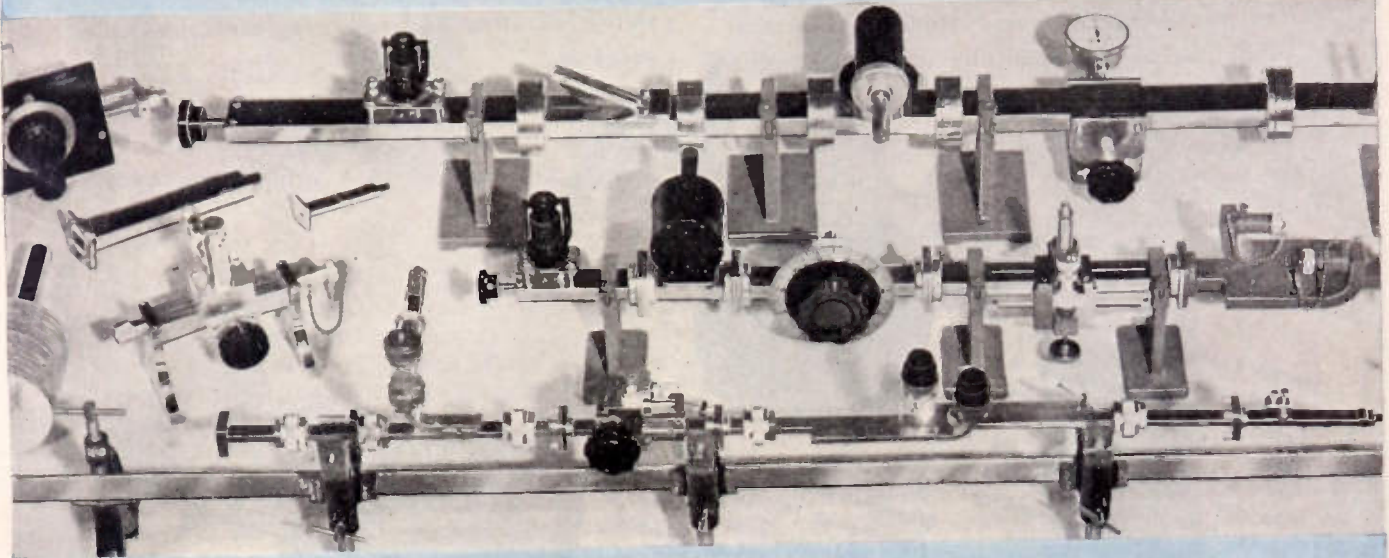

The complete line of De Mornay-Budd standard test equipment covers the frequency range from 4,000 mcs. to 27,000 mcs. It provides all R. F. waveguide units necessary for delicate, precision test work requiring extremely high accuracy in attenuation measurements, impedance measurements, impedance matching, calibration of directional couplers, VSWR frequency measurements, etc.

To eliminate guesswork, each item of this De Mornay-Budd test equipment is individually

tested and, where necessary, calibrated, and each piece is tagged with its electrical characteristics. All test equipment is supplied with inner and outer surfaces gold plated unless otherwise specified.

**NOTE: Write for complete catalog of De Mornay-Budd Standard Components and Standard Bench Test Equipment. Be sure to have a copy in your reference files. Write for it today.**

The three test set-ups illustrated above include:

Tube Mount  
Flap Attenuator  
Frequency Meter  
Calibrated Attenuator  
Tee  
Stub Tuner

Tunable Dummy Load  
Standing Wave Detector  
Type "N" Standing Wave Detector  
Directional Coupler  
High Power Dummy Load  
Cut-Off Attenuator

Stands, etc.

DE MORNAY  
BUDD



EQUIPMENT  
FOR  
97% OF ALL  
RADAR SETS

DE MORNAY • BUDD INC., 475 GRAND CONCOURSE, NEW YORK 51, NEW YORK. CABLE ADDRESS "DEMBUD," N. Y.

# Tolerance is Important...

... Especially when it comes to radio parts. That's why National parts are precision-made with tolerances measured as close as .0002".

Operational results justify this close attention to detail for every National precision condenser is mechanically and electrically

interchangeable and can be depended upon to fit the specifications called for. Production flows smoothly when you use National parts because their closely-tooled tolerances and sturdy construction make replacements unnecessary...

Please write to Department  
17, National Company,  
for further information

Send for your copy of the new National  
catalog containing over  
600 parts today.

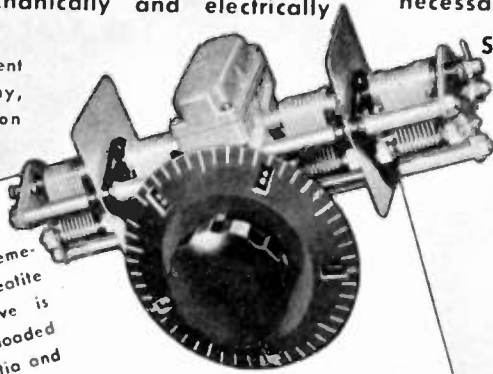

This PW Condenser is of extremely rigid construction with Steatite stator insulation. The drive is through an enclosed preloaded worm gear with 20 to 1 ratio and the rotor shaft is parallel to the panel. Plate shape is straight-line frequency when the frequency range is 2:1.

PW Condensers are available in 2, 3, or 4 sections in either 160 or 225 mmf per section. A single-section PW Condenser with

grounded rotor is supplied in capacities of 150, 200, 350 and 500 mmf, single spaced, and capacities up to 125 mmf, double spaced.

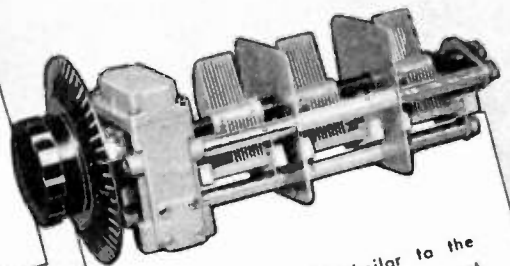

The NPW model is similar to the other PW Condenser models, except that the rotor shaft is perpendicular to the panel. Three sections... each 225 mmf.

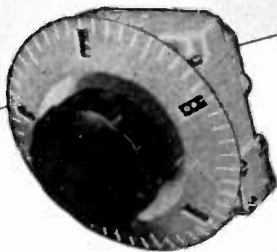

NPW-O uses parts similar to the NPW Condenser. Drive shaft perpendicular to panel. One TX-9 coupling supplied.

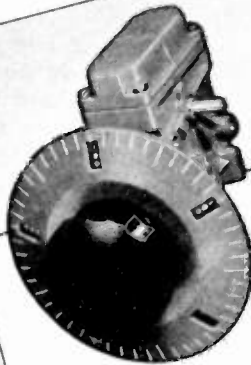

The PW-O uses parts similar to the PW Condenser. Drive shaft parallel to panel. Two TX-9 couplings supplied.

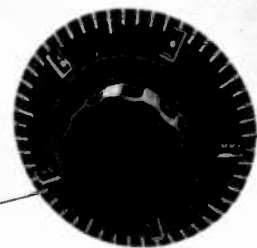

The PW-D micrometer dial can be read direct to one part in 500. It revolves ten times in covering the complete range and fits a  $\frac{1}{8}$ " diameter shaft.



**National  
Company, Inc.**  
Malden, Mass.

MAKERS OF LIFETIME RADIO EQUIPMENT



# FEDERAL'S

## BALANCED HF CABLE

### KT-51

# HAS THE RIGHT TWIST

for Peak Performance  
of FM and Television  
Receivers



HERE'S A NEW HF cable that will keep your FM and Television receivers working at peak performance—free from locally-induced interference, even in the most adverse locations. Where the performance of such costly equipment is at stake, it will pay you to specify Federal's KT 51—the finest high frequency lead-in cable available. More costly—but worth more!

The *twisted*, dual-conductor cable cancels any noise or signals not stopped by the double *braided shields*... because it's electrically balanced and stays that way in service, in any position. It's a rugged cable, too—remarkably resistant to abrasion, acids, alkalies, oils and greases, as well as smoky atmospheres and weather.

Don't let the lead-in wire be the "weak link" in otherwise perfect equipment. Be sure it's KT 51—the HF cable with the "right twist" to assure interference-free operation. For complete details, write to Dept.

#### ELECTRICAL CHARACTERISTICS

Nominal Attenuation (db/100 ft.)	Maximum Capacity Unbalance	1%
Frequency	Nominal Characteristic Impedance (ohms)	95
10 mc	Nominal Capacitance per ft. (uuf)	16
30 mc	Volts (rms)	2000
100 mc		
300 mc		
400 mc		

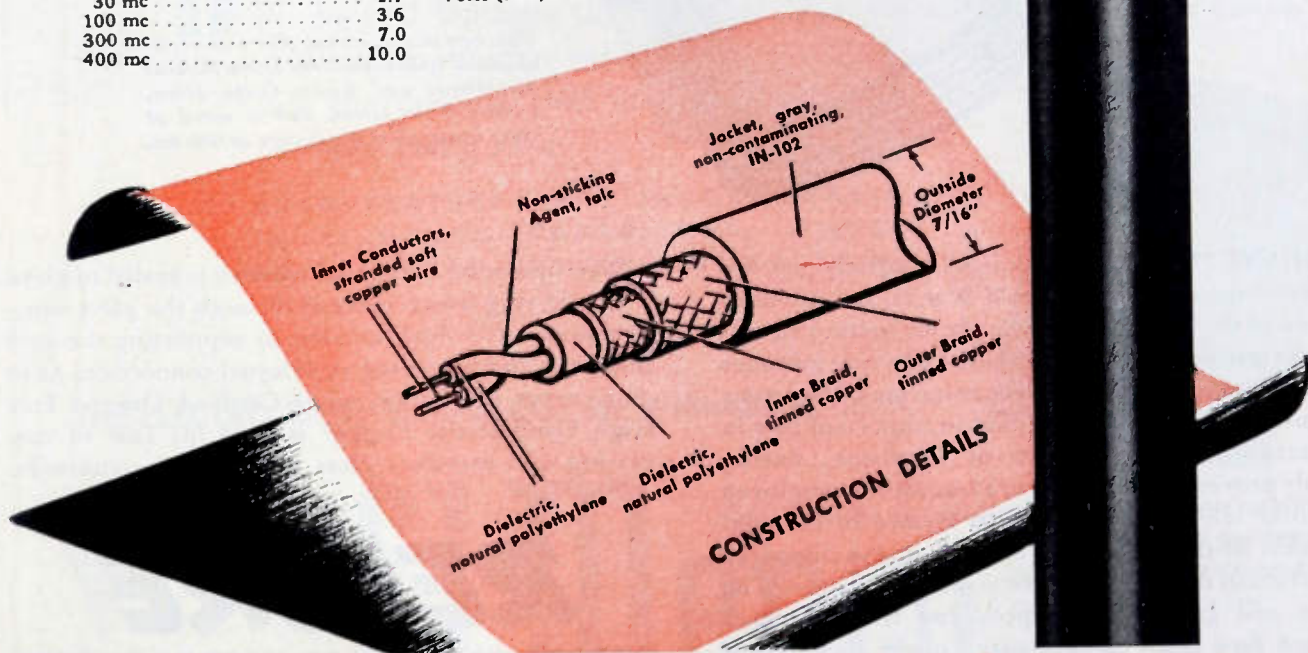

## Federal Telephone and Radio Corporation

In Canada:—Federal Electric Manufacturing Company, Ltd., Montreal  
Export Distributor—International Standard Electric Corporation, 67 Broad St., N. Y. C.



100 Kingsland Road,  
Clifton, New Jersey

# REVERE COPPER IN THIS 6C22



*This type 6C22 vacuum tube was developed and is manufactured by the Federal Telephone and Radio Corporation, Clifton, New Jersey, and is rated at 1000 watts, plate dissipation at 600 mc.*

**T**HIS 6C22 tube, the result of a closely-guarded development during World War II, is a modified version of the tube used extensively for pulsing signals in radio transmission and may have had a vital influence in jamming enemy radar communications. Peacetime pursuits indicate that it will play an important part in furthering the development of television, having already proved of great value in a transmitter employed for color television. An unusual feature in the construction of this tube is to be seen in the one-piece formation of the anode and water-cooled radiator. The anode and grid ring are produced from Certified Oxygen Free High Conductivity Copper Bar, Revere Alloy 103-C, being formed by cold working in a 600-ton coining press.

Machining consists of drilling the center hole and milling the radiator slots. Each piece receives a special

rolling operation in the area where it is sealed to glass. The grid ring which extends through the glass structure performs a dual function in supporting the grid internally and providing an external connection. As in other types of vacuum tubes Certified Oxygen Free High Conductivity Copper is used for ease of out-gassing and excellent glass bonding characteristics.

## **REVERE** COPPER AND BRASS INCORPORATED

*Founded by Paul Revere in 1801*

230 Park Avenue, New York 17, New York

*Mills: Baltimore, Md.; Chicago, Ill.; Detroit, Mich.; New Bedford, Mass.;  
Rome, N. Y.—Sales Offices in Principal Cities. Distributors Everywhere.*





# HIDDEN VALUES



Modern designs — new finishes — promises of greater performance. These are the things that sell today's products.

**B**ut the real features that *keep the products sold* are the hidden values — the parts inside the product that insure performance promises being kept.

**SUCH FEATURES ARE INCORPORATED IN EL-MENCO CAPACITORS, WHOSE QUALITY IS BEYOND QUESTION.**

Send for your copy of the latest Catalog.



THE ELECTRO MOTIVE MFG. CO., Inc. Willimantic, Conn.



MOLDED MICA

# EL-MENCO CAPACITORS

Foreign Radio and Electronic Manufacturers communicate direct with our Export Department at Willimantic, Conn. for information.

MICA TRIMMER

# Centralab reports to

**JUNE 1947**

Revolutionary new Slide Switch reduces lead inductance for improved AM-FM performance!

Wide silver-plated brass contacts for low inductance.

Double-wipe clips assure constant pressure and low internal resistance.

Positive coil spring index.  $\frac{1}{4}$ " slide movement per position.

Flat, one-plane design permits coil-mounting directly over switch.

**I** Designed for peak AM and FM performance plus maximum reliability and long service life, Centralab's new slide switch now gives you flat, horizontal design that saves space, permits convenient location to coils, reduced lead inductances. "Twisted

ear" mounting on base or panel from .038" min. to .052" max. Optional size or length of unit — min. 5 clips per side, max. 20 clips per side. 2 or 3 position, shorting type contacts. Movement of slide per position —  $\frac{1}{4}$  inch. Send for bulletin 953.

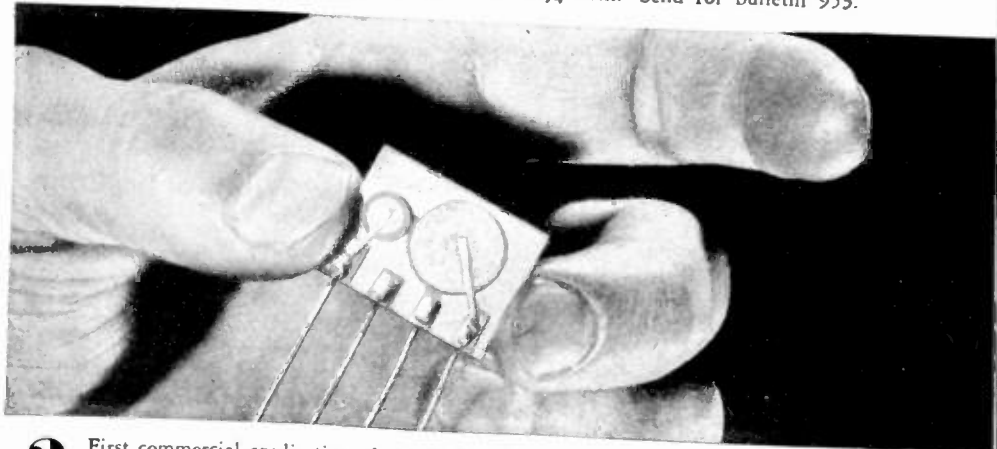
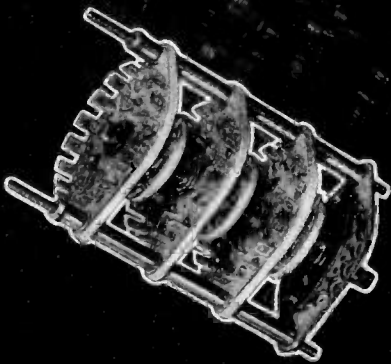

**2** For transmitters, power supply converters, X-ray equipment, etc., CRL's medium-duty power switches are now available. Efficient performance up to 20 megacycles.

**3** First commercial application of the "printed circuit" and now available for the first time, Centralab's new *Complate* offers a complete interstage coupling circuit which combines into one unit the plate load resistor, the grid resistor, the plate by-pass capacitor and the coupling capacitor.



# Electronic Industry

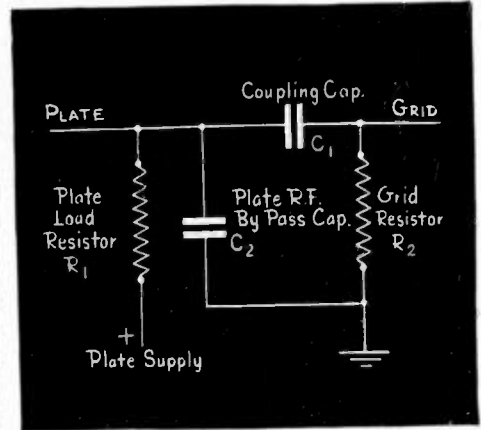
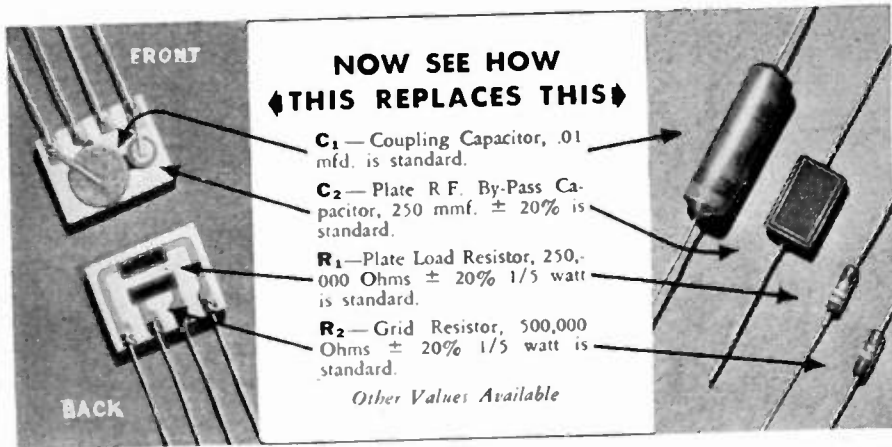

**4** Integral Ceramic Construction: Each *Couplate* is an integral assembly of "Hi-KAP" capacitors and resistors closely bonded to a steatite ceramic plate and mutually connected by means of metallic silver paths "printed" on the base plate. Think of what that means in terms of time and labor savings! Send for bulletin 943.

**5** Only four soldered connections are now required by the *Couplate* instead of the usual eight or nine . . . (see above). That means fewer errors, lower costs!

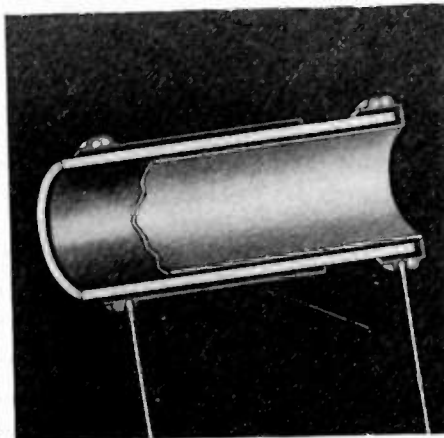
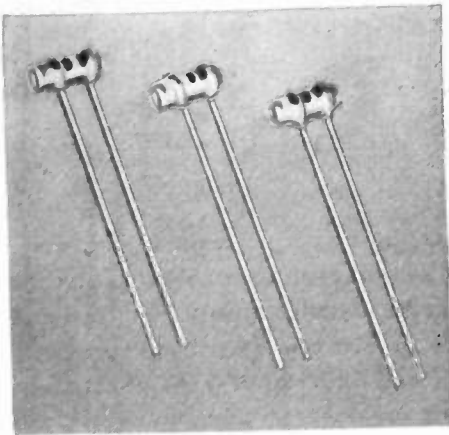

**6** Watch for something new in CRL's line of dependable, high quality ceramic by-pass and coupling capacitors. Soon available at your nearby Centralab distributor!

**7** There's none better than this line of ceramic capacitors which combines economy, small size and extreme dependability.

**8** Made from Centralab's original Ceramic-X, this complete line is result of our continuing research in high dielectric constant ceramics. Order bulletin 933.

Look to Centralab in 1947! First in component research that means lower costs for electronic industry. If you're planning new equipment, let Centralab's sales and engineering service work with you. Get in touch with Centralab!

# Centralab

DIVISION OF GLOBE-UNION INC., MILWAUKEE, WIS.



# ARNOLD

That's the  
name to  
remember in  
**PERMANENT  
MAGNETS**

There are values in the use of permanent magnets—increased efficiencies and economies—that should be investigated by many a manufacturer of electrical and mechanical equipment. The past decade has seen great strides in the scope and utility of permanent magnets, and this progress is *important* to you.

Equally important are the *extra* values you'll find in Arnold Permanent Magnets—the natural result of specialization and leadership, and of complete quality control in every production step from melting furnace to final test. • Call in an Arnold engineer to help with your design and planning—write direct or to any Allegheny Ludlum office.

W&D 1099

**THE ARNOLD ENGINEERING CO.**

Subsidiary of

**ALLEGHENY LUDLUM STEEL CORPORATION**

147 East Ontario Street, Chicago, Illinois



*Specialists and Leaders in the Design*

*Engineering and Manufacture of PERMANENT MAGNETS*



# Making Broadcast History!



## NEW RING-SEAL POWER TUBES FOR FM AND TELEVISION

—110 to 220 mc frequency at max ratings  
—1.5 to 6.4 kw typical Class C output

GENERAL ELECTRIC'S great 1947 series of ring-seal power tubes spells more efficient performance to those who build—or use—FM and television transmitters. Modern as tomorrow's telecast, these v-h-f tubes need minimum neutralization . . . are directly designed for grounded-grid circuits . . . meet in every way the *new* requirements of *new* station equipment going into service.

Ring-seal design—a G-E development—makes it possible to plug in a tube quickly, so that time off the air is cut to seconds. Firm terminal

contacts with *wide surface areas* are another ring-seal advantage—moreover, all contacts are silver-plated to reduce r-f losses. An important aid to dependability and long life is the use, throughout the tube, of strong, enduring fernico metal-to-glass seals.

Your nearest G-E electronics office will be glad to give you prices and full information, as well as arrange for you to secure circuit application advice when desired. Or write direct to *Electronics Department, General Electric Company, Schenectady 5, N. Y.*

**G. E.'s MANUAL OF TRANSMITTING TUBES IS YOUR MOST COMPLETE, UP-TO-THE-MINUTE GUIDE!**

Profusely illustrated—packed with performance and application data. Comes to you for \$2. Also, for an annual service charge of \$1 new and revised pages will be sent you regularly as issued. Order direct from General Electric Company, enclosing payment, or giving authority on your company letterhead to invoice you.

**OVER 600 LARGE PAGES \$2.00**

**GENERAL  ELECTRIC**  
101-F5-0000

FIRST AND GREATEST NAME IN ELECTRONICS

### GL-7D21

Tetrode, forced-air cooled. 110 mc frequency at max ratings. Typical power output (Class C telegraphy) 1,575 w.



### GL-5513

Triode, forced-air cooled. 220 mc frequency at max ratings. Typical power output (Class C telegraphy, grounded-grid service) 2.45 kw.



### GL-5518

Triode, forced-air cooled. 110 mc frequency at max ratings. Typical power output (Class C telegraphy, grounded-grid service) 6.4 kw.



### GL-9C24

Triode, water and forced-air cooled. 220 mc frequency at max ratings. Typical power output (Class C telegraphy, grounded-grid service) 6.4 kw.





6AK5 CATHODE TYPE,  
VOLTAGE AMPLIFIER

# ... Impromptu Discussions about Miniature Tubes



"A lot of useful new things in electronics have come out of the war. Take that 6AK5 cathode type, voltage amplifier. TUNG-SOL made millions of them for radar receivers. They are the perfect, popular priced tube for FM, television and most applications up to 200 Megacycles.

"The TUNG-SOL 6AK5 is small and compact with the internal element structure mounted on short direct leads to the glass bottom base. There is a minimum of internal 'ginger bread.' This simple ruggedness of design, high electrical efficiency, low temperature cathode assure long trouble-free service.

"The wide band merit factor of the 6AK5 is as much as 25% greater than that for tubes previously used in this service. The small grid-cathode spacing, the low cathode lead inductance and low input capacitance all provide the exceptionally high input impedance of about 10,000 ohms at 100 megacycles. Together with the 5,000 micromhos transconductance, all these figures mean that 'low frequency' gain figures can become a reality in your new FM or television receiver

design. Carried further, this tube offers an ideal solution to the frequency converter problem. In mixer operation with a separate oscillator, the 6AK5 gives good gain and remarkably low noise which will increase the usable sensitivity of your television receiver.

"You are planning on some new equipment, Joe. Why don't you ask the TUNG-SOL Engineers about using 6AK5's in it? Those boys know their stuff and will give you sound, impartial advice. You know TUNG-SOL is headquarters for Miniatures."



**TUNG-SOL**  
*vibration-tested*  
**ELECTRON TUBES**

**TUNG-SOL LAMP WORKS INC., NEWARK 4, NEW JERSEY**  
Sales Offices: Atlanta • Chicago • Dallas • Denver • Detroit • Los Angeles • New York  
Also Manufacturers of Miniature Incandescent Lamps, All-Glass Sealed Beam Headlight Lamps and Current Intermittors



# Power Resistors on Short Delivery Cycle

Whatever your needs in power resistors there's an IRC resistor to do the job... readily available for immediate delivery. Four types of power wire wound resistors... each particularly suited to certain circuit or design applications... all unexcelled in essential electrical and mechanical characteristics... provide proven solutions to voltage dropping problems where power dissipation is necessary. Write for complete information regarding specifications, characteristics and delivery, stating products in which you are interested. International Resistance Company, 401 N. Broad Street, Philadelphia 8, Pennsylvania. In Canada: International Resistance Company, Ltd., Toronto, Licensee.

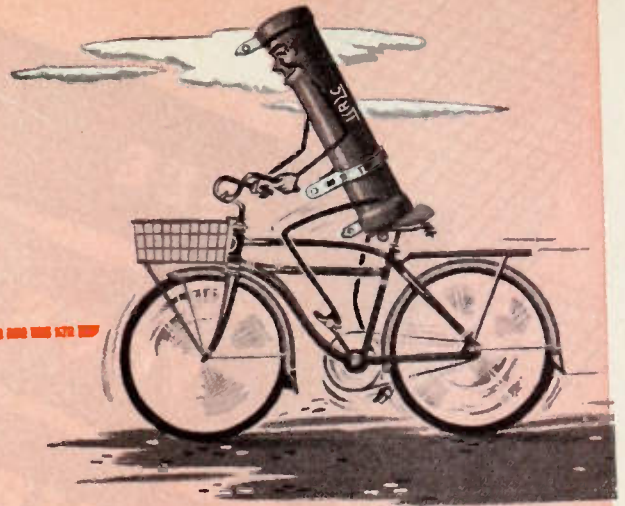

**PWW Resistors**

For exacting heavy-duty applications. Tubular power wire wounds of extreme mechanical strength. Available in two coatings for high temperature or high humidity conditions. Fixed, adjustable and non-inductive types in full range of sizes, ohmic values and terminals.



**FRW Resistors**

For voltage dropping in limited space applications. Flat power wire wounds of lightweight construction. Designed for vertical or horizontal mounting singly or in stacks. Mounting brackets serve as conductors of internal heat. Fixed adjustable and non-inductive types in full range of sizes and ohmic values.

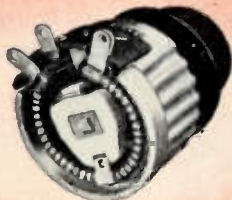

**PR Rheostats**

All metal construction permits operation at full load with as little as 25% of winding in use, with only slight increase in temperature rise. Available in 25 and 50 watt ratings. Type PR-25: diameter 1<sup>21</sup>/<sub>32</sub>"', depth behind panel 3<sup>1</sup>/<sub>32</sub>"', standard resistance values 1 to 5,000 ohms. Type PR-50: diameter 2<sup>23</sup>/<sub>32</sub>"', depth behind panel 1<sup>1</sup>/<sub>8</sub>"', standard resistance values 0.5 to 10,000 ohms (higher values on special orders).

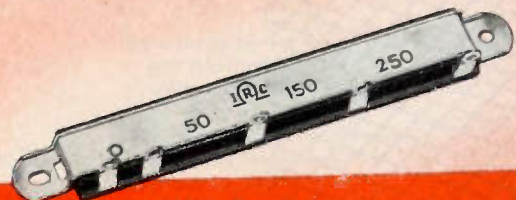

**MW Resistors**

For applications where low temperature rise, space and weight are vital factors. Encased in special phenolic compound for complete protection. Unique design of mounting bracket aids rapid heat dissipation. Multi-section feature permits exceptional flexibility for voltage dividing applications.

$$I = \frac{E}{IRC}$$

**INTERNATIONAL RESISTANCE COMPANY**

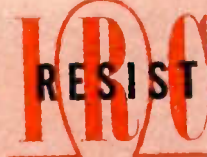

Power Resistors • Precisions • Insulated Composition Resistors • Low Voltage Wire Wounds • Rheostats • Controls • Voltmeter Multipliers • Voltage Dividers • HF and High Voltage Resistors

**SEE**

**★ YOUR**

**★ DISTRIBUTOR**

**for  
electronic**



There are still millions of dollars worth of war surplus transmitters, receivers, tubes and various other types of electronic equipment being offered for sale to manufacturers, jobbers and wholesalers.



This may be your once-in-a-lifetime opportunity to take advantage of these bargains. All you do is contact one of War Assets Administrations approved distributors and learn what is available.



For your convenience we are listing the names and addresses of those companies appointed to serve you. They will be happy to quote items, price and delivery. Just call, write, or phone and see how *you* can "Save with Surplus."



★ OFFICE OF AIRCRAFT AND ELECTRONICS DISPOSAL

**WAR ASSETS ADMINISTRATION**



Offices located at: Atlanta • Birmingham • Boston • Charlotte • Chicago  
Cincinnati • Cleveland • Denver • Detroit • Grand Prairie, Tex.  
Houston • Jacksonville • Kansas City, Mo. • Los Angeles • Louisville • Minneapolis  
Nashville • New Orleans • New York • Omaha • Philadelphia • Portland, Ore.  
Richmond • St. Louis • Salt Lake City • San Antonio • San Francisco • Seattle • Spokane • Tulsa



# equipment

American Condenser Co.  
4410 No. Ravenswood Avenue  
Chicago 40, Illinois

Automatic Radio Mfg. Co., Inc.  
122 Brookline Avenue  
Boston 15, Massachusetts

Belmont Radio Corporation  
3633 So. Racine Avenue  
Chicago 9, Illinois

Carr Industries Inc.  
1269 Atlantic Avenue  
Brooklyn 16, N. Y.

Communication Measurements  
Laboratory  
120 Greenwich Street  
New York 6, New York

Cole Instrument Co.  
1320 So. Grand Avenue  
Los Angeles 15, California

Electronic Corporation of America  
353 West 48th Street  
New York 19, N. Y.

Electro-Voice, Inc.  
Carroll & Cecil Streets  
Buchanan, Michigan

Emerson Radio & Phonograph Corp.  
76 Ninth Avenue  
New York 11, N. Y.

Essex Wire Corporation  
1601 Wall Street  
Ft. Wayne 6, Indiana

General Electric Company  
Building 267, 1 River Road  
Schenectady 5, New York

General Electronics Inc.  
1819 Broadway  
New York 23, N. Y.

Hammarlund Mfg. Company, Inc.  
460 West 34th Street  
New York 1, New York

Hoffman Radio Corporation  
3761 South Hill Street  
Los Angeles 7, California

Hytron Radio & Electronics Corp.  
76 Lafayette Street  
Salem, Massachusetts

Johanns & Keegan Inc.  
62 Pearl Street  
New York 4, N. Y.

E. F. Johnson Company  
206 Second Avenue, S. W.  
Waseca, Minnesota

National Union Radio Corporation  
57 State Street  
Newark 2, New Jersey

Navigation Instrument Co., Inc.  
P. O. Box 7001, Heights Station  
Houston, Texas

Newark Electric Co., Inc.  
242 West 55th Street  
New York 19, New York

Radio Parts Distributing Company  
128 W. Olney Road  
Norfolk 10, Virginia

Smith-Meeker Engineering Company  
125 Barclay Street  
New York 7, N. Y.

Southern Electronic Company  
611 Boronne Street  
New Orleans, Louisiana

Standard Arcturus Corporation  
99 Sussex Avenue  
Newark 4, New Jersey

Sylvania Electric Products, Inc.  
Emporium, Pennsylvania

Technical Apparatus Company  
165 Washington Street  
Boston 8, Massachusetts

Tobe Deutschmann Corporation  
863 Washington Street  
Canton, Massachusetts

Tobe Deutschmann Corporation  
6919 San Fernanda Rd.  
Glendale, California

Tung-Sol Lamp Works, Inc.  
95 Eighth Avenue  
Newark 4, New Jersey

W & H Aviation Corporation  
Municipal Airport  
Rochester 3, New York

1118

# 12

*Reasons Why*

it pays  
equipment  
manufacturers  
to deal with

# RCA



RCA LABORATORIES  
PRINCETON, N. J.

THE FOUNTAINHEAD OF MODERN TUBE DEVELOPMENT IS RCA

### RCA TUBE APPLICATION ENGINEERING SERVICE —

Twelve field engineering specialists devote their time *exclusively* to the design problems of equipment manufacturers. They're ready to pitch in and help you at any time.

### RCA TUBE APPLICATION ENGINEERING LABORATORIES —

RCA maintains tube application laboratories at Harrison, Lancaster and Chicago. The services of these laboratories are at the disposal of all RCA tube customers.

### RCA CIRCUIT INVESTIGATIONS —

RCA carries on independent research in circuit design for the exclusive benefit of its customers. Engineering reports are provided as a free service.

### RCA TUBE DEVELOPMENT —

RCA works years ahead in tube design—anticipates future requirements. That's why you get the types of tubes you want *when* you want them.

### RCA ENGINEERING LITERATURE —

As the fountainhead of modern tube development, you can look to RCA for the most authoritative and comprehensive technical literature on tubes.

### RCA MANUFACTURING FACILITIES —

RCA tubes are manufactured in ultramodern plants equipped with RCA-designed, high-speed precision machinery—your assurance of uniform, dependable quality tubes of whatever type, in any quantity.

### RCA QUALITY CONTROL —

Quality controls begin with the raw material and are followed through in every successive step of manufacture and assembly to the final tube. That's why RCA tubes are consistently good.

### RCA SALES SERVICE —

A staff of seasoned sales representatives are within convenient reach. They're available *when* you want them.

### RCA DISTRICT OFFICES —

RCA's Tube Department maintains four convenient district offices in Harrison, Cleveland, Chicago and Los Angeles to serve equipment manufacturers. You can get prompt service from the office nearest you.

### RCA DISTRIBUTION —

RCA's Tube Department maintains bulk tube stocks in three warehouses strategically located in Jersey City, Chicago and Los Angeles for quick service.

### RCA PRICING —

Mass-production techniques and the RCA "Preferred-Type Tube Plan" have consistently operated to reduce manufacturing costs—which means lower prices to you.

### RCA ENGINEERING LEADERSHIP —

The vast resources of experience and ability that account for RCA's engineering leadership, are of direct benefit to RCA customers—a final reason why it pays to deal with RCA.



**TUBE DEPARTMENT**  
**RADIO CORPORATION of AMERICA**  
**HARRISON, N. J.**



# PROCEEDINGS OF THE I.R.E.

(Including the WAVES AND ELECTRONS Section)

Published Monthly by

The Institute of Radio Engineers, Inc.

VOLUME 35

June, 1947

NUMBER 6

## BOARD DIRECTORS, 1947

Walter R. G. Baker  
*President*

Noel Ashbridge  
*Vice-President*

Raymond F. Guy  
*Treasurer*

Haraden Pratt  
*Secretary*

Alfred N. Goldsmith  
*Editor*

William L. Everitt  
*Senior Past President*

Frederick B. Llewellyn  
*Junior Past President*

1945-1947

Stuart L. Bailey  
Keith Henney  
B. E. Shackelford

1946-1948

Virgil M. Graham  
Donald B. Sinclair

1947-1949

Murray G. Crosby  
Raymond A. Heising

1947

J. E. Brown  
Frederick R. Lack  
Jack R. Poppele  
David Smith  
William C. White

⊙

Harold R. Zeamans  
*General Counsel*

⊙

George W. Bailey  
*Executive Secretary*

Laurence G. Cumming  
*Technical Secretary*

⊙

## BOARD OF EDITORS

Alfred N. Goldsmith  
*Chairman*

●

## PAPERS REVIEW COMMITTEE

Murray G. Crosby  
*Chairman*

●

## PAPERS PROCUREMENT COMMITTEE

Dorman D. Israel  
*General Chairman*

●

## PROCEEDINGS OF THE I.R.E.

J. E. Brown, Board of Directors, 1947.....	546
Radio Jargon..... H. F. Smith	547
2799. The Generation of Centimeter Waves..... H. D. Hagstrum	548
2800. Selective Demodulation..... Donald B. Harris	565
2801. Input Admittance of Cathode-Follower Amplifiers..... Herbert J. Reich	573
2802. An Exponential Transmission Line Employing Straight Conductors..... Wilbur N. Christiansen	576
Correspondence:	
2651. "Magnetic-Wire Response"..... Edgar Reich	581
2651. "Demagnetizing Coefficient"..... R. E. Burgess	581
Contributors to PROCEEDINGS OF THE I.R.E.....	582

## INSTITUTE NEWS AND RADIO NOTES

### SECTION

Report of the Secretary—1946.....	583
Chicago I.R.E. Conference, April 19, 1947.....	588
I.R.E. People.....	590
Minutes of Technical Committee Meetings.....	591
Sections.....	594

## WAVES AND ELECTRONS

### SECTION

Lawrence R. Quarles, Chairman, North Carolina-Virginia Section.....	596
The Industrial Scientist as Citizen..... John Mills	597
2803. The Job Ahead..... Charles R. Denny	598
2804. A Technical Audit..... W. R. G. Baker	599
2805. One-Millionth-Second Radiography and Its Applications..... Charles M. Slack, and Donald C. Dickson, Jr.	600
2806. Exact Design and Analysis of Double- and Triple-Tuned Band-Pass Amplifiers..... Milton Dishal	606
Contributors to Waves and Electrons Section.....	626
2807. Abstracts and References.....	627
Section Meetings..... 35A	Positions Open..... 50A
Membership..... 38A	Positions Wanted..... 54A
Advertising Index.....	70A

## EDITORIAL DEPARTMENT

Alfred N. Goldsmith  
*Editor*

Clinton B. DeSoto  
*Technical Editor*

Mary L. Potter  
*Assistant Editor*

William C. Copp  
*Advertising Manager*

Lillian Petranek  
*Assistant Advertising Manager*

Responsibility for the contents of papers published in the PROCEEDINGS OF THE I.R.E. rests upon the authors. Statements made in papers are not binding on the Institute or its members.

Changes of address (with advance notice of fifteen days) and communications regarding subscriptions and payments should be mailed to the Secretary of the Institute, at 450 Ahnaip St., Menasha, Wisconsin, or 1 East 79 Street, New York 21, N. Y. All rights of republication, including translation into foreign languages, are reserved by the Institute. Abstracts of papers, with mention of their source, may be printed. Requests for republication privileges should be addressed to The Institute of Radio Engineers.





## J. E. Brown

Board of Directors, 1947

J. E. Brown was born on September 11, 1902, in Greenport, Long Island, and studied electrical engineering at Cornell University.

From 1924 to 1937 he was a radio inspector with the Radio Division of the United States Department of Commerce, the Federal Radio Commission, and the Federal Communications Commission. During this period he was engaged in the development of radio field-intensity measuring equipment and methods of measuring field intensities of broadcast stations. He resigned from the Federal Communications Commission in 1937 to assume direction of television activities of the Zenith Radio Corporation. In 1943 he became assistant vice-president and chief engineer of the company, and he still holds this position.

Mr. Brown joined The Institute of Radio Engineers as an Associate in 1924, transferred to Member in 1928, and to Senior Member in 1943. He is a charter member of the Detroit Section, where he served as vice-chairman in 1932; in 1937 he was chairman of the Chicago Section. On the I.R.E. Board of Directors in 1938 and 1947, he has also been a member of many Institute Committees which include currently Nominations, Television, Radio Receivers, and Modulation Systems.

Active in the Radio Manufacturers Association, the National Television System Committee, and the Radio Technical Planning Board, Mr. Brown has been chairman of committees on television in each of these organizations. He is a member of the Radio Engineers Club of Chicago.



Those who refuse cynically to believe that "language was given to man to conceal thought" will find much to applaud and to follow in the following clear guest editorial from the editor of *Wireless World* (London). Great benefits flow from the use of terminology which is clear, uniform, and unequivocal. And serious evils and confusion follow casual, vague, or confusing use of language.  
—The Editor

## Radio Jargon

H. F. SMITH

For better or worse, a very large proportion of the technical radio terms used in all countries are taken directly from English or else translated literally from that language. This would be cause for self-congratulation to both Americans and British, who share the English tongue, if we could rest assured that the terms we have chosen were descriptive, lucid, and free from ambiguity.

Few would argue that this object has been achieved; indeed, we find growing confusion and lack of descriptiveness. The position naturally deteriorated during the war, when intensive development took place under conditions where the coining of undescriptive or even deliberately misleading words was condoned or even positively encouraged, on the grounds that it would convey no useful information to the enemy.

The old-timer, who has grown up in the radio art, can generally look after himself, but let us not make life unnecessarily difficult for the rising generation and for the non-English speaker. What justification have we for using "oscilloscope" and "oscillograph" to describe the same thing? By the ordinary usage of language the words would not be taken for synonyms, and their use as such must have puzzled many students and outsiders.

There is not even uniformity between American and British terminology, but it would be unrealistic and over-idealistic to plead for a standard technical terminology throughout the English-speaking world. The American could no more easily be divorced from his "tube" than the Englishman from his "valve." Equally unrealistic at this late stage is the idea that well-established terms of long standing, however confusing or undescriptive they may be, can be cleared away.

But it is perhaps not too late to plead for some measure of agreement on the use of new words for describing new things. Take "radar"; an official United States publication tells us that a radio echo is inherent in all radar systems. But the word is already being used here (under protest from some of us, I should add) to describe devices that make use of a triggered response instead of a natural echo. More loosely, it is beginning to be applied to any new radio position-finding system.

This is not just a plea for pedantic accuracy, and still less a diatribe against mere inelegance in radio terminology. It is a matter of more than domestic or even Anglo-American concern. We who share the English language have a world-wide responsibility towards other users of our radio jargon. At a time when the language of radio is, through its electronic off-shoots, encroaching on so many fields of human endeavor, it is worth while to take some pains to avoid ambiguity and confusion.

# The Generation of Centimeter Waves\*

H. D. HAGSTRUM†

*Summary*—The electronic devices used most extensively, recently, for the generation of centimeter waves are discussed. The physical form, operating capabilities, and the basic physical principles of operation of the triode, velocity-variation, and magnetron oscillators are presented. An attempt is made to show how these oscillators are related to one another. For a variety of reasons, particular emphasis is placed on the magnetron oscillator.

## INTRODUCTION

THE DEVELOPMENT of radar during the war years has included a thoroughgoing exploitation of all the previously known means of generation of very-high-frequency electromagnetic radiation, and has witnessed the appearance of these generators in new and revolutionary forms, capable of performance unknown with their predecessors. The discussion in this paper will be restricted to those oscillators which have been used as generators in the centimeter-wave region, that is, in the wavelength region for which the centimeter is the convenient unit of wavelength. As representative of about the middle of the region in which the devices to be described are of most use, one may take 10 centimeters wavelength, corresponding to a frequency of 3000 megacycles.

There are three types of generators which have been used extensively in the centimeter-wave region for radar and upon which considerable effort has been expended during the war. These are the triode in a special form known as the disk-seal or "lighthouse" triode; the velocity-variation oscillator in both the double resonator or klystron, and the single-resonator or reflex-klystron forms; and the magnetron oscillator.

## THE TRIODE OSCILLATOR

In any oscillator in which electrons are used as the agents by which energy is transferred from the primary direct-current source to the radio-frequency oscillation, electrons which have gained kinetic energy of motion from the direct field transfer a part of this energy to the radio-frequency field set up by the radio-frequency circuit. A net transfer of energy is achieved because some means of electron selection and rejection, sorting, or bunching is operative. The necessary criterion is either that more electrons interact favorably with the radio-frequency fields than interact unfavorably, or that

electrons which interact favorably do so over a longer time interval than those which interact unfavorably. The three types of oscillators to be discussed in this paper differ in the way this is accomplished.

In the triode oscillator the electron current which reaches the anode is amplitude-modulated by the radio-frequency potential variations of the grid. The phase is arranged so that more electrons are admitted to the grid-anode region when the radio-frequency field component there retards and extracts energy from them than when it accelerates and thus gives energy to them. Of importance are the phase difference between the grid and anode radio-frequency potentials, determined by the circuit, and the electron-transit time, determined by the average electron velocity and the interelectrode spacings. If, as has usually been the case, the phase difference between the grid and anode potentials is  $\pi$  radians, it is clearly necessary that the transit time of the electron be a small fraction of the period of oscillation.

Over a period of many years the attempt has been made to extend the frequency range of the triode oscillator to higher and higher frequencies. In this attempt, the two main problems encountered have been to find proper circuit arrangements for the oscillator and to circumvent difficulties associated with the finite electron transit time from cathode to anode. This is a relatively familiar story, however, and need not be repeated here.<sup>1-4</sup>

The most recent development of triode-type oscillators has been that of the so-called disk-seal or "lighthouse" triodes.<sup>5,6</sup> Here a more complete integration than was previously possible has been achieved between the tube and the circuit elements in a manner eliminating radiation losses and the normal and stray capacitances and couplings. This was done by making use of the natural form which the "tank circuit" takes in the centimeter-wave region, namely, the resonant cavity; and by arranging to connect the tube into it in a manner which presents practically no discontinuity in the conducting walls. Fig. 1 shows a schematic cut-away view of a disk-seal triode.

<sup>1</sup> B. J. Thompson and G. W. Rose, "Vacuum tubes of small dimensions for use at extremely high frequencies," *Proc. I.R.E.*, vol. 21, pp. 1707-1721; December, 1933.

<sup>2</sup> B. Salzberg and D. G. Burnside, "Recent developments in miniature tubes," *Proc. I.R.E.*, vol. 23, pp. 1142-1157; October, 1935.

<sup>3</sup> M. J. Kelly and A. L. Samuel, "Vacuum tubes as high-frequency oscillators," *Bell Sys. Tech. Jour.*, vol. 14, pp. 97-134; January, 1935.

<sup>4</sup> A. L. Samuel, "Extending the frequency range of the negative grid tube," *Jour. Appl. Phys.*, vol. 8, pp. 677-688; October, 1937.

<sup>5</sup> E. D. McArthur and E. F. Peterson, "The lighthouse tube: a pioneer ultra-high-frequency development," *Proc. Nat. Electronics Conf.*, October, 1944.

<sup>6</sup> E. D. McArthur, "Disk-seal tubes," *Electronics*, vol. 18, p. 98; February, 1945.

\* Decimal classification: R355.912.1×R133. Original manuscript received by the Institute, May 7, 1946; revised manuscript received, November 15, 1946. This paper is the writeup of a lecture on "Generation," presented in the Fall Lecture Series (1945), sponsored jointly by the Communications Group, New York Section, American Institute of Electrical Engineers, and the New York Section of the Institute of Radio Engineers. Because of the limitations on publishing space, it has been necessary to reduce drastically those parts of the paper for which published material is generally available.

† Physical Research Department, Bell Telephone Laboratories, New York, N. Y.



Since the only stray coupling between output and input cavities is that from anode to cathode through the

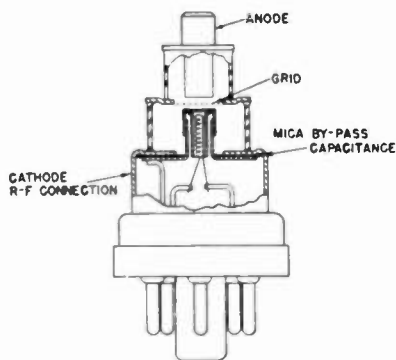

Fig. 1—A partial cross-sectional view of the 2C40-type, disk-seal or "lighthouse" triode. The scale may be judged from the standard octal base used. The figure is reproduced from Fig. 1 of the Bulletin ET-B1 of the General Electric Company, by whose courtesy it is included here.

grid, the phase between grid-plate and cathode-grid cavities may be adjusted to take into account reactive effects when the transit time becomes an appreciable fraction of the period of oscillation. Beyond this, the success of the disk-seal triode is in no small part to be accounted for by the ability of the structure to maintain small clearances between the electrodes and to permit duplication of these dimensions from tube to tube. In Fig. 2 are shown several types of disk-seal tubes developed during the war.

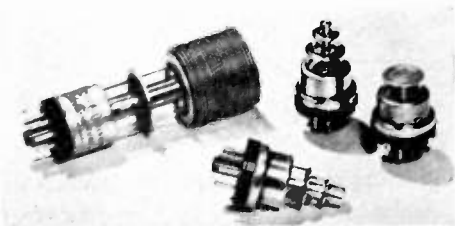

Fig. 2—A group of disk-seal tubes developed in recent years. Tubes of this type have been operated to better than 3000 megacycles and can generate several watts of centimeter-wave energy. Reproduction by courtesy of the General Electric Company.

### VELOCITY-VARIATION OSCILLATORS<sup>7-13</sup>

In the velocity-variation-type oscillator, the fundamental requirement for oscillation, namely, that more electrons give energy to the radio-frequency oscillation

<sup>7</sup> A. Arsenjewa-Heil and O. Heil, "Elektromagnetic oscillations of high intensity," *Zeit. für Phys.*, vol. 95, pp. 752-762; November and December, 1935. English translation in *Electronics*, vol. 16, pp. 164-178; July, 1943.

<sup>8</sup> W. C. Hahn and G. F. Metcalf, "Velocity-modulated tubes," *Proc. I.R.E.*, vol. 27, pp. 106-116; February, 1939.

<sup>9</sup> R. H. Varian and S. F. Varian, "A high-frequency oscillator and amplifier," *Jour. Appl. Phys.*, vol. 10, pp. 321-327; May, 1939.

<sup>10</sup> A. E. Harrison, "Graphical methods for analysis of velocity-modulation bunching," *Proc. I.R.E.*, vol. 33, pp. 20-32; January, 1945.

<sup>11</sup> J. R. Pierce, "Reflex oscillators," *Proc. I.R.E.*, vol. 33, pp. 112-118; February, 1945.

<sup>12</sup> D. L. Webster, "Cathode-ray bunching," *Jour. Appl. Phys.*, vol. 10, pp. 501-508; July, 1939.

<sup>13</sup> *Klystron Technical Manual*, Sperry Gyroscope Company, Great Neck, N. Y., 1944.

than take energy from it, is achieved by a mechanism of velocity variation and drift. A uniform beam of electrons, homogeneous in velocity, after passing through a radio-frequency field at one point at which the electron velocities are varied, is allowed to drift through a field-free region in which the beam forms itself into bunches whose frequency of arrival at a second point is that of the radio-frequency oscillation. The interaction of this bunched beam with a second radio-frequency field (it may be the same field traversed in the reverse direction), in such phase that the electrons in the bunches are decelerated by the field, achieves the desired energy transfer to the radio-frequency oscillation. The advantages of this mechanism over that operative in the triode oscillator are these: The electrons are accelerated by the radio-frequency field in a radio-frequency field-free region, making it possible to effect the interaction with the radio-frequency fields over short distances at full electron velocity. This makes possible a short transit time in the radio-frequency fields and thus more effective use of the electrons in the beam. Secondly, unwanted interaction between the radio-frequency field which varies the electron velocity and that which extracts energy from the electrons is effectively eliminated or sidestepped either by the separation of the two at some distance as in the double-resonator klystron, or by making them identical as in the reflex klystron. These features, together with the facts that the velocity-variation oscillator quite naturally makes use of the cavity-type resonator, and because the drift distances and electron velocities necessary are of convenient magnitude, make it ideally suitable for the generation of radio-frequency energy in the centimeter-wave region.

The reader is undoubtedly familiar with the double-resonator klystron and single-resonator or reflex-klystron types. Both have been discussed exhaustively in the literature.<sup>7-13</sup> It will be of interest to compare the electronic mechanism, phase relationships, the Applegate diagram, and electronic tuning of these oscillators with the similar features of the magnetron oscillators. Two representative klystron oscillators are shown in Figs. 3 and 4.

### THE MAGNETRON OSCILLATOR<sup>14</sup>

#### General Description

The multicavity magnetron oscillator has three principal components: an electron interaction space with concentric cathode and anode, a multiple resonator

<sup>14</sup> J. B. Fisk, H. D. Hagstrum, and P. L. Hartman, "The magnetron as a generator of centimeter waves," *Bell Sys. Tech. Jour.*, vol. 25, p. 167; April, 1946. This material has come to be common knowledge among those who have carried out the wartime development of the magnetron oscillator. Reports have been issued by the British Committee on Valve Development (CVD Magnetron Reports), by the Radiation Laboratories at the Massachusetts Institute of Technology and Columbia University, and by the participating industrial laboratories. Presentations of experimental and theoretical work are soon to be published by other research groups. No attempt has been made to denote the specific sources of the work done since 1940.

system, and an output circuit. Each of these is illustrated schematically in Fig. 5. In the electron interaction space

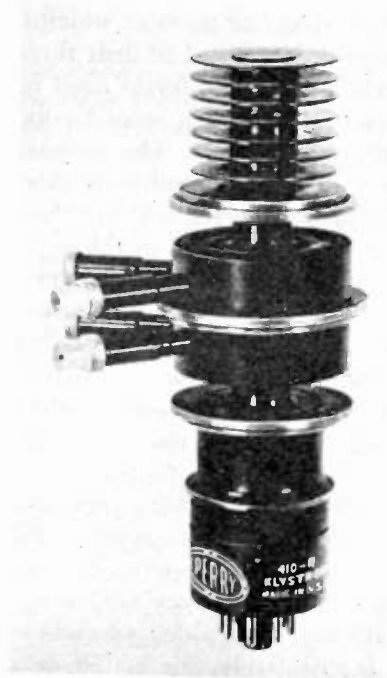

Fig. 3—A photograph of a double-resonator klystron, the 410-R of the Sperry Gyroscope Company, shown without a tuning mechanism attached. The frequency range of this oscillator is 2700 to 3330 megacycles. It produces 20 to 40 watts continuous-wave output power. The size of the oscillator may be judged from its base. The photograph is reproduced by courtesy of the Sperry Gyroscope Company.



Fig. 4—A photograph of a typical reflex-klystron oscillator designed by the Bell Telephone Laboratories and built by the Western Electric Company. This oscillator, in frequency, ranges from 2400 to 10,000 megacycles, and has been used extensively as a beating oscillator in radar. Powers range from 35 to 250 milliwatts, depending upon the frequency range. Other reflex oscillators similar to this extend the frequency range to 1200 megacycles on the one end of the band and to 24,000 megacycles on the other.

between the cathode and the multisegment anode, electrons emitted from the cylindrical cathode move under the action of the radial direct electric field, the axial direct-current magnetic field, and the radio-frequency field set up by the resonator system between the anode

segments. These electronic motions result in a net transfer of energy from the direct electric field to the radio-frequency field. The radio-frequency interaction field is the fringing electric field appearing between the anode segments. The radio-frequency energy, fed into the resonator system by the electrons, is delivered through the

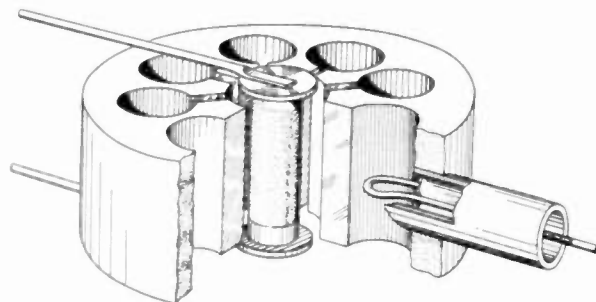

Fig. 5—A schematic diagram designed to show the principal component parts of a centimeter-wave magnetron oscillator. The resonator system and output circuit each represents one of several types used in magnetron construction.

output circuit to the useful load. The output circuit shown in Fig. 5 consists of a loop inductively coupled to one of the hole and slot cavities, feeding a coaxial line.

To operate such a magnetron oscillator, one must place it in a magnetic field of suitable strength and apply a voltage of proper magnitude to its cathode, driving the cathode negative with respect to the anode. This voltage may be constant or pulsed. With suitable values of the operating parameters, the magnetron oscillates as a self-excited oscillator whenever the direct voltage is applied.

#### *Electron Motions in Electric and Magnetic Fields—The Direct-Current Magnetron*

Before beginning a discussion of the electronics of the magnetron oscillator, it would be well to review briefly electron motions in various types and combinations of electric and magnetic fields, and the operation of the direct-current magnetron.<sup>15</sup>

An electron, of charge  $e$  and mass  $m$ , moving in an electric field of strength  $E$ , is acted upon by a force, independent of the electron velocity, of strength  $eE$ , directed oppositely to the conventional direction of the field. If the field is constant and uniform, the motion of the electron is identical to that of a body moving in a uniform gravitational field like that of the earth near its surface.

An electron moving in a magnetic field of strength  $B$ , however, is acted upon by a force which depends on the magnitude of the electron velocity  $v$  on the strength of the field, and on how the direction of motion is oriented with respect to the direction of the field. The force is directed normal to the plane of the velocity and magnetic-field vectors and is of magnitude proportional to

<sup>15</sup> A. W. Hull, "The effect of a uniform magnetic field on the motion of electrons between coaxial cylinders," *Phys. Rev.*, vol. 18, pp. 31-38; July, 1921. This was the first report on the direct-current cylindrical magnetron.



the velocity, the magnetic field, and the sine of the angle  $\theta$  between them. Thus the force is the cross or vector product of  $\vec{v}$  and  $\vec{B}$ :

$$\vec{F} = e[\vec{v} \times \vec{B}], \quad F = Bev \sin \theta.$$

An electron moving parallel to a magnetic field ( $\sin \theta = 0$ ) feels no force. One moving perpendicular to a uniform magnetic field ( $\sin \theta = 1$ ) is constrained to move in a circle by the magnetic force at right angles to its path. Since this force is balanced by the centrifugal force, the radius  $\rho$  of the circular path depends on the electron momentum and the strength of the field, that is,

$$Bev = \frac{mv^2}{\rho},$$

yielding

$$\rho = \frac{mv}{eB}. \tag{1}$$

The time  $T_e$  required to traverse the circle is independent of the radius of the path and, hence, of the velocity

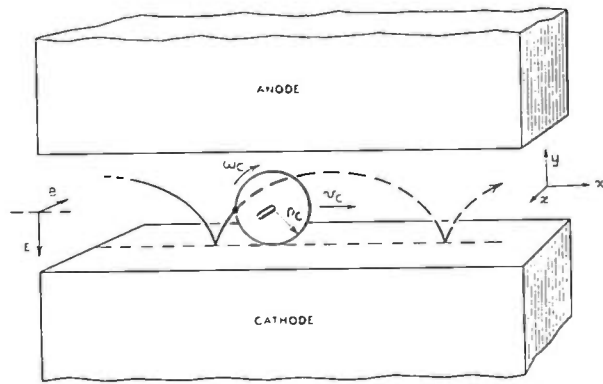

Fig. 6—The cycloidal path of an electron which started from rest at the cathode in crossed electric and magnetic fields for the case of parallel-plane electrodes. The mechanism of generation of the orbit by a point on the periphery of a rolling circle is depicted.

of the electron;  $T_e = 2\pi\rho/v = 2\pi m/eB$ . Thus, the frequency of traversing the circular path, the so-called cyclotron frequency, depends on magnetic field alone and is given by

$$f_c = \frac{\omega_c}{2\pi} = \frac{1}{T_e} = \frac{1}{2\pi} \frac{e}{m} B. \tag{2}$$

In the magnetron, electronic motion in crossed electric and magnetic fields is involved. Consider first such motion between two parallel-plane electrodes, neglecting space charge. If, as in Fig. 6, the electric field is directed in the negative  $y$  direction and the magnetic field in the negative  $z$  direction, and if the electron starts from rest at the origin, the orbit is a cycloid given by the parametric equations:

$$\left. \begin{aligned} x &= v_c t - \rho_c \sin \omega_c t = \rho_c (\omega_c t - \sin \omega_c t), \\ y &= \rho_c (1 - \cos \omega_c t), \end{aligned} \right\} \tag{3}$$

in which:

$$v_c = \frac{E}{B}, \tag{4}$$

$$\rho_c = \frac{m}{e} \frac{E}{B^2}, \tag{5}$$

$$\omega_c = \frac{e}{m} B. \tag{6}$$

This motion may be regarded as a combination of rectilinear motion of velocity  $v_c$  in the direction of the  $x$  axis, perpendicular to both  $E$  and  $B$ , and of motion in the  $xy$  plane about a circular path of radius  $\rho_c$ , at a frequency  $\omega_c/2\pi$ , the cyclotron frequency. Fig. 6 shows the resulting cycloidal path and its generation by a point on the periphery of the rolling circle. Even for cylindrical geometry, it is often convenient to think in terms of the plane case.

In the case of cylindrical geometry with radial electric and axial magnetic fields, the electron orbit, neglecting space charge, approximates an epicycloid generated by rolling a circle around on the cylindrical cathode. The orbit is not exactly an epicycloid because the radial motion is not simple harmonic, which state of affairs arises from the logarithmic variation of the direct-current electric field with radius. The approximation of the epicycloid to the actual path is a convenient one, however, because the radius of the rolling circle, its frequency of rotation, and the velocity of its center, for the epicycloid, all approximate those for the cycloid of the plane case. These approximations improve with increasing ratio of cathode to anode radii. Several electron orbits in a direct-current cylindrical magnetron are shown in Fig. 7 for several magnetic fields.

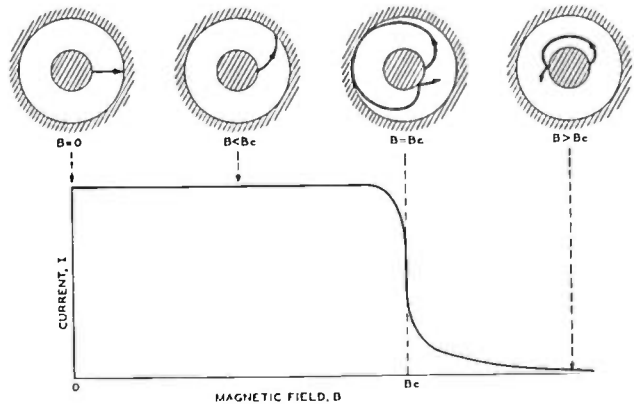

Fig. 7—Electron paths in a cylindrical direct-current magnetron at several magnetic fields above and below the cut-off value  $B_c$ . The electrons are assumed to be emitted from the cathode with zero initial velocity. Below these orbits is plotted the variation of current passed by a cylindrical direct-current magnetron at constant voltage as a function of magnetic field. The orbits of electrons at four different magnetic fields are shown above the corresponding regions of the current characteristic.

It is clear from this simplified picture of the orbits in a direct-current cylindrical magnetron without space charge that, at a given electric field, an electron orbit for a sufficiently strong magnetic field may miss the

anode completely and return to the cathode. The critical magnetic field at which this is just possible is called the cut-off value  $B_c$ . A current-versus-magnetic-field curve in addition to the electron orbits corresponding to four regions of the curve is shown in Fig. 7. For the case of parallel-plane electrodes, the cut-off relation between the critical anode potential and magnetic field  $V_c$  and  $B_c$  and the electrode separation  $d$  is obtained by equating the electrode separation to the diameter of the rolling circle. Thus,

$$d = 2 \frac{m(V_c)}{e} \left( \frac{V_c}{d} \right) \frac{1}{B_c^2},$$

from which

$$V_c = \frac{eB_c^2 d^2}{2m}.$$

For the cylindrical case, the relation may be shown to be:

$$V_c = \frac{eB_c^2 r_a^2}{8m} \left[ 1 - \left( \frac{r_c}{r_a} \right)^2 \right]^2 \quad (7)$$

in terms of cathode and anode radii  $r_c$  and  $r_a$ .

#### The Fundamental Electronic Mechanism of the Magnetron Oscillator

The direct-current magnetron may be converted into an oscillator suitable for the generation of centimeter waves, if it is arranged to introduce radio-frequency fields into the anode-cathode region. How this is done in the case of the type of magnetron oscillator in most common use today has been seen in the discussion of Fig. 5.

The electrons in the interaction space of the magnetron oscillator are the agents which transfer energy from the direct field to the radio-frequency field. As such, they must move subject to the constraints imposed by the direct radial electric and direct axial magnetic fields, considering, for the moment, the radio-frequency fields to be small. Under these conditions, as has been seen for the direct-current cylindrical magnetron (Fig. 7 for  $B > B_c$ ), electrons follow approximately epicycloidal paths which progress around the cathode. The mean velocity of this progression, that of the center of the rolling circle, depends upon the relative strengths of the electric and magnetic fields (see (4) for the plane case). By proper choice of direct voltage  $V$  between cathode and anode and of magnetic field  $B$ , the mean angular velocity of the electrons may be set at any desired value.

The radio-frequency electric fields in the interaction space, with which the electrons moving as described above must interact, are the electric fields fringing from the slots in the anode surface. These fields are provided by the  $N$  coupled oscillating cavities of which the magnetron-resonator system is composed. Such a system of resonators may oscillate in a number of different modes. At this point, however, only that mode in which the

magnetron oscillator is generally operated, the  $\pi$  mode, will be considered. This is the mode for which the oscillations in adjacent resonators are  $\pi$  radians out of phase and for which the potential variation around the magnetron interaction space is a standing wave like that plotted in Fig. 8.

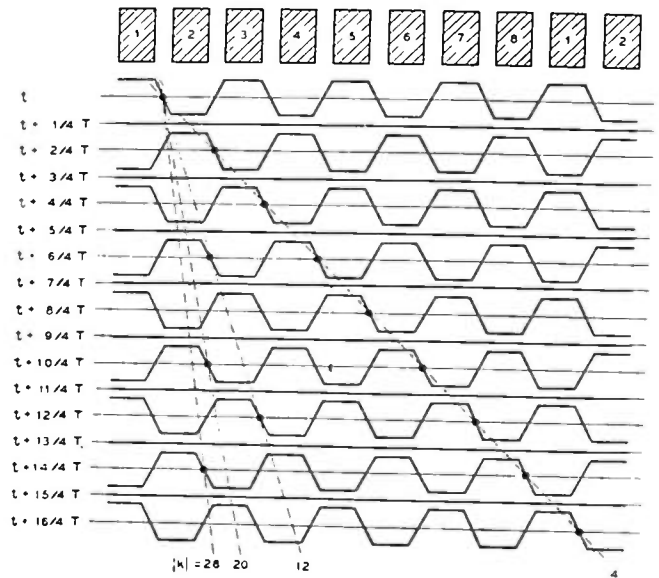

Fig. 8—A plot showing the  $\pi$ -mode anode potential wave at several instants in an eight-resonator magnetron and the mean paths of electrons which interact favorably with the radio-frequency field. The plot is developed from the cylindrical case, the shaded rectangles at the top representing the anode segments.

As in any oscillator, oscillation in the magnetron is possible only if more energy is transferred to the radio-frequency field by electrons driven against it than is taken from the radio-frequency field by electrons accelerated by it. This can be accomplished only if the mean angular velocity of the electrons is such as to make them pass successive gaps in the anode at very nearly the same phase in the cycle of the radio-frequency field across the gaps. Then it is possible for an electron, which leaves the cathode in such phase as to oppose the tangential component of the radio-frequency field across one anode gap, to continue to lose energy gained from the direct field to the radio-frequency field at successive gaps. Electrons which gain energy from the radio-frequency field are driven back into the cathode after only one orbital loop and are removed from further motion detrimental to the oscillation. This process of selection and rejection forms groups or bunches of electrons which sweep past the anode slots in phase to be retarded by the radio-frequency field component. The criterion that the electron drift velocity shall be such as to keep these bunches in proper phase is analogous to the condition that the drift angle in a velocity-variation oscillator be such as to cause the electron bunches to cross the gap of the second or catcher cavity in phase to lose energy to the radio-frequency field across the gap.

The condition placed upon the mean angular velocity of the electrons may be discussed more readily by reference to Fig. 8. Focus attention on an electron which



crosses the gap between anode segments 1 and 2 at the instant  $t$  when the radio-frequency field is maximum retarding, that is, the potential on segment 1 is maximum and on segment 2 minimum. It is clear that this electron can cross the next gap in the same phase if the time required to reach it is  $(|p| + 1/2) T$ , in which  $p$  is any integer and  $T$  is the period of radio-frequency oscillation. In Fig. 8 four lines are drawn representing the mean paths of electrons moving with such velocities as to make  $p = 0, 1, 2,$  and  $3$ . Each line crosses a gap when the radio-frequency field is maximum retarding, that is, when the potential has the maximum negative slope at the center of the gap. As will be seen later, a more convenient parameter, to be called  $k$ , is that whose absolute magnitude  $|k|$  specifies the number of radio-frequency cycles required for the electron to move once around the interaction space.  $|k|/N$  is then the number of cycles between crossings of successive anode gaps, which for the  $\pi$  mode of Fig. 8 must take on the values:

$$\frac{|k|}{N} = |p| + 1/2, \quad p = 0, \pm 1, \pm 2, \dots,$$

or the values given by the more general expression, applicable to any mode:

$$\frac{|k|}{N} = |p| + \frac{n}{N}, \quad p = 0, \pm 1, \pm 2, \dots$$

In this expression,  $n/N$  is the phase difference between adjacent resonators expressed as the fraction of a cycle;  $k$  may thus assume the values given by:

$$\left. \begin{aligned} k &= n + pN, \\ p &= 0, \pm 1, \pm 2, \dots \end{aligned} \right\} (8)$$

The mean angular velocity which the electrons must possess is then given by:

$$\frac{d\theta}{dt} = \frac{2\pi}{kT} = \frac{2\pi f}{k} \quad (9)$$

For the  $\pi$  mode ( $n = N/2$ ) it is seen that the negative integers  $p$  give the same series of values for  $|k|$  as do the positive integers including zero. The sequence is  $|k| = 4, 12, 20, 28, \dots$ . Reference to Fig. 8 indicates that electrons may travel in either direction around the interaction space and interact favorably with the radio-frequency field, provided their mean angular velocity is given by (9) with values of  $k$  specified by (8). That this should be so is clear from the fact that the anode potential wave is a standing wave with respect to which direction has no meaning. Fig. 8 also makes clear how an electron moving with velocity different from that corresponding to the lines shown will fall out of step with the field and, on the average, be accelerated as much as it is retarded, thus effecting no net energy transfer.

The actual electron orbits do not correspond to simple translation but, as has been discussed, to rotation superposed on translation. However, the epicycloid-like scal-

lops in the orbit are of no significance to the fundamental electronic mechanism. It is the mean velocity of the electron motion around the interaction space, specified by the relative values of  $V$  and  $B$ , that is of importance.

The similarities between the electronic mechanism of the magnetron oscillator and those of the triode and velocity-variation oscillators may now be seen. In Fig. 9 an attempt has been made to depict schematically the

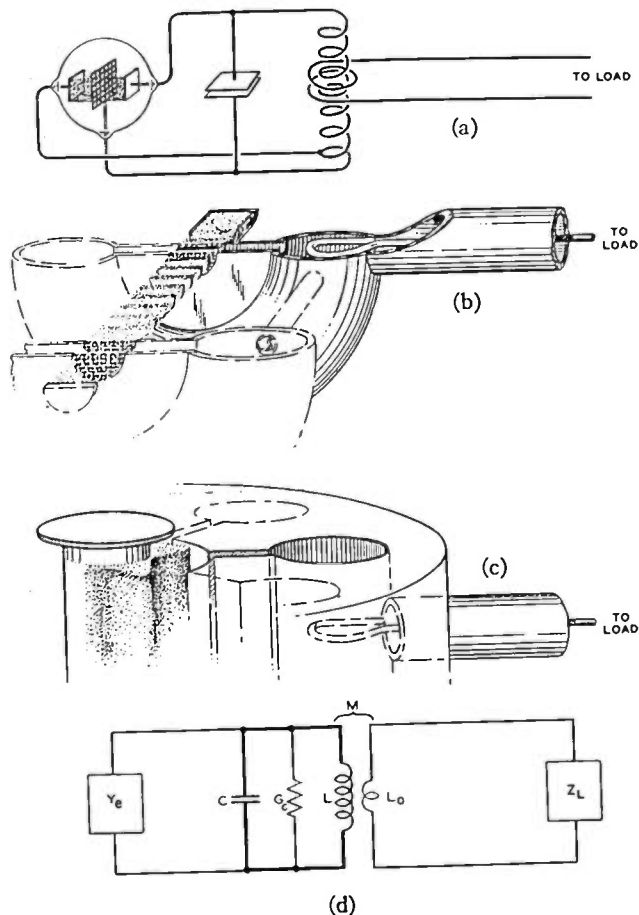

Fig. 9—A schematic diagram depicting the parallelism among the triode oscillator, the velocity-variation oscillator, the centimeter-wave magnetron oscillator, and an equivalent lumped-constant circuit. In the figure an attempt is made to align corresponding parts vertically above one another.

parallelisms between these types of oscillators and a simplified equivalent lumped-constant circuit. In the magnetron, bunches or groups of electrons are formed by the interaction of the electrons and the radio-frequency field. These spokes in the space-charge cloud sweep past the anode gaps in phase to give up energy, gained from the direct field, to the radio-frequency fields across the gaps. The "bunching" field in the magnetron is thus the same field as that to which energy is transferred. In this sense the magnetron is analogous to the reflex klystron in which a single cavity is used as both buncher and catcher. How the bunches of electrons are formed in the magnetron interaction space will be discussed in greater detail when the traveling-wave picture of the electronic mechanism is presented.

### Other Types of Magnetron Oscillators

The multicavity magnetron oscillator discussed above is one of three types<sup>16</sup> of magnetron oscillators which may be distinguished by the nature of the electronic mechanism by means of which energy is transferred to the radio-frequency field. Oscillation of the so-called *negative-resistance magnetron oscillator* depends upon the existence of a static negative-resistance characteristic between the two halves of a split anode.<sup>17</sup> The so-called *cyclotron-frequency magnetron oscillator* operates by virtue of resonance between the period of radio-frequency oscillation and the period of the cycloidal motion of the electrons (rolling-circle frequency which in plane geometry equals the cyclotron frequency).<sup>18</sup> The so-called *traveling-wave magnetron oscillator* depends in its operation upon resonance, that is, approximate equality, between the mean translational velocity of the electrons and the velocity of a traveling-wave component of the radio-frequency interaction field.<sup>19</sup>

#### The Negative-Resistance Magnetron Oscillator—Type I

In the negative-resistance magnetron oscillator<sup>20-22</sup> the anode is split parallel to the axis into two halves between which the radio-frequency circuit is attached. The transit time from cathode to anode is not involved in the mechanism, except that it must be small relative to the period of the radio-frequency oscillation. The static negative-resistance characteristic arises from the fact that under certain circumstances the allowable orbits for the majority of electrons terminate on the segment of lower potential, irrespective of the segment toward which they start. These electrons, being driven against the radio-frequency component of the field, give energy gained in the direct field to the radio-frequency field.

#### The Cyclotron-Frequency Magnetron Oscillator—Type II

Not long after the invention of the direct-current magnetron, oscillations between anode and cathode were found to occur near the cut-off value of magnetic field.<sup>23</sup>

<sup>16</sup> The feedback type of magnetron oscillator, discussed by Hull, in which the magnet winding is coupled to the plate circuit, is not considered as it is essentially an audio-frequency device. K. Okabe, in his book, "Magnetron-Oscillations of Ultra Short Wavelengths," Shokendo, 1937, distinguishes five types, but it is not clear just how his types C and E are to be identified.

<sup>17</sup> These oscillations have been called Habann, quasi-stationary, or dynatron oscillations, and correspond to Okabe's type D.

<sup>18</sup> These oscillations have been called electronic oscillations by Megaw, transit-time oscillations of the first order by Herriger and Hülster, and correspond to Okabe's type A.

<sup>19</sup> These oscillations are the running-wave type discussed by Posthumus, the transit-time oscillations of higher order of Herriger and Hülster, and correspond to Okabe's type B.

<sup>20</sup> E. Habann, "A new generator," *Jahrb. d. drahtl. Telegr. u. Teleph.*, vol. 24, pp. 115-120 and 135-141; 1924.

<sup>21</sup> G. R. Kilgore, "Magnetron oscillators for the generation of frequencies between 300 and 600 megacycles," *Proc. I.R.E.*, vol. 24, pp. 1140-1157; August, 1936.

<sup>22</sup> E. C. S. Megaw, *Jour. I.E.E.* (London), vol. 72, pp. 326-348; April, 1933.

<sup>23</sup> A. Zacek, "On a method of generating very short electromagnetic waves," *Cos. Pro. Pest. Math. a Fys.* (Prague), vol. 53, pp. 578; 1924. A summary appeared in *Jahrb. d. drahtl. Telegr. u. Teleph.*, vol. 32, p. 172; 1928.

Later it was shown that the oscillation period is equal to the electron transit time from the vicinity of the cathode to the vicinity of the anode and back.<sup>24</sup>

The electronic mechanism must be explained in terms of electrons moving in the direct radial electric and axial magnetic fields and the superposed radial radio-frequency electric field. This may be done as follows: An electron leaving the cathode in such phase as to gain energy when moving from the cathode toward the anode will also gain energy during its return, striking the cathode with more energy than it had when it left. There, such an electron is stopped from further motion during which it would continue to absorb energy from the radio-frequency field at the expense of the oscillation. The electron orbit is shown in Fig. 10. An electron

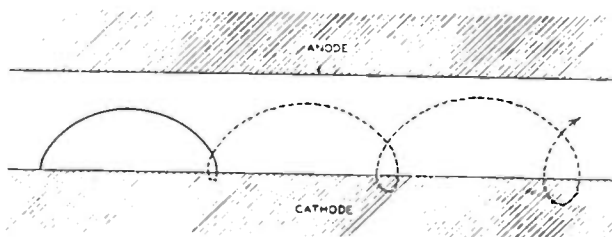

Fig. 10—The orbit of an electron which gains energy from the radio-frequency field in a cyclotron-frequency or type-II magnetron oscillator. The orbit is continued as a dashed line indicating how it would be traversed were it not stopped by the cathode. The direct-current electric force on the electron is directed from cathode to anode.

leaving the cathode in the opposite phase, on the other hand, loses energy when moving toward the anode and again on its return toward the cathode. As is shown in Fig. 11, it reverses its direction after the first trip with-

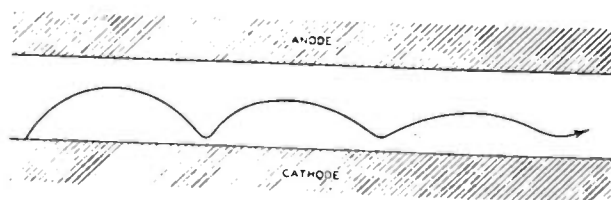

Fig. 11—The orbit of an electron which loses energy to the radio-frequency field in a cyclotron-frequency or type-II magnetron oscillator. The direct-current electric force on the electron is directed from cathode to anode.

out reaching the cathode surface and starts over on a second loop of smaller amplitude, remaining in the same phase and continuing to lose energy to the field. This process continues until all the energy of the rotational component of the electron motion has been absorbed by the radio-frequency field. If the electron is not removed at this stage, in its subsequent motion the rotational component will build up, extracting energy from the radio-frequency oscillation. Means such as tilting the magnetic field or placing electrodes at the ends of the

<sup>24</sup> K. Okabe, "On the short-wave limit of magnetron oscillations," *Proc. I.R.E.*, vol. 17, pp. 652-659; April, 1929.

tube have been used to remove the electrons from the interaction space when all the rotational energy has been absorbed. It is possible to maintain the oscillations and extract power from them because electrons which give energy to the field can do so over many cycles, whereas electrons of opposite phase can gain energy over only one cycle before they are removed.

Magnetrons oscillating in this manner have been built with split anodes.<sup>24,25</sup> Here the radio-frequency field with which the electron interacts is more tangential than radial but the criterion for oscillation is the same, namely, resonance between the field variations and the rotational component of the electron motion. Operating efficiencies of 10 to 15 per cent have been obtained. It was with a magnetron of this type, having an anode diameter of 0.38 millimeter, that radiation of wavelength as low as 0.64 centimeter was generated.<sup>26</sup>

The type-II magnetron oscillator has been almost entirely superseded by the type-III magnetron oscillator as a generator of centimeter waves. In the main, this is the result of the impossibility of removing electrons emitted from an extended cathode area from the interaction region at the proper stage in their orbits. This inherent drawback is not shared by the type-III magnetron, which may be operated at higher efficiency without critical adjustment of orientation in the magnetic field or of the potential of auxiliary electrodes.

#### *The Traveling-Wave Magnetron Oscillator—Type III*

Oscillations have been found to occur in the magnetron which are independent of any static negative resistance characteristic and which can occur at frequencies widely different from the cyclotron frequency. In 1935<sup>27</sup> the electronic mechanism of these oscillations was correctly interpreted as an interaction of the electron with the tangential component of a traveling-wave component of the radio-frequency interaction field, whose velocity is approximately equal to the mean translational velocity of the electron. Later,<sup>28</sup> the role of the radial component of the rotating electric field in keeping the electrons in proper phase was recognized. Magnetrons of wavelength as short as 75 centimeters, operating at better than 50 per cent efficiency, were built prior to 1940, but performance such as was later to be attained with this type of magnetron at much shorter wavelengths was not attained then, perhaps primarily because of the use of a small cathode and the lack of a good resonator. It was a magnetron of type III which the British devised and brought to America in 1940. The British magnetron was a 10-centimeter oscillator, intended for pulsed operation, having a tank circuit con-

sisting of eight resonators built into the anode block as shown in Fig. 5.<sup>29,30</sup>

Multicavity magnetron oscillators, developed from the British prototype, are now available at wavelengths ranging from approximately 0.5 to 50 centimeters. Both pulsed and continuous-wave generators of this type have been made. The upper limit of peak power is now about 100 kilowatts at 1 centimeter, 3 or 4 megawatts at 10 centimeters. Operating voltages may be less than 1 kilovolt or more than 40 kilovolts. The direct-current magnetic fields essential to operation range from 600 to 15,000 gauss.

#### *The Interaction Field and the Modes of Oscillation of the Resonator System*

The electronic mechanism of the traveling-wave-type magnetron oscillator like that of Fig. 5, oscillating in its so-called  $\pi$  mode, has already been discussed in terms of electron motions through the radio-frequency fields at the gaps in the multisegment anode. To extend the discussion to other points of view and for other modes of oscillation of the magnetron resonator system, it is necessary to treat in more detail the interaction field and its relation to the modes of oscillation.

The cylindrical magnetron anode structure is a series of  $N$  resonators connected in a ring. The oscillation in each resonator of this array of coupled resonators is specified by a differential equation in terms of a parameter, such as current or voltage, the constants of the circuit itself, and the mutual interaction between the circuit and its neighbors. Each solution of the set of simultaneous differential equations for all the resonators involved corresponds to a definite phase shift between adjacent resonators. The allowed values of this phase shift depend upon the boundary conditions imposed by the connecting together of the resonators into a ring. Under these circumstances only those modes of oscillation are possible for which the total phase shift around the ring is  $2\pi n$  radians,  $n$  being any integer including zero. The oscillations in adjacent cavities then differ in phase by  $2\pi n/N$  radians. This means that only those waves traveling around the anode block which constructively interfere are possible solutions. These are waves which, after leaving an assumed starting point and traversing the anode once, arrive back in phase with the wave, then leave in the same direction.

Each mode of oscillation of the multiresonator system has a resonant frequency different from the frequency of any other mode and from the frequency of one of the  $N$  resonators oscillating freely and uncoupled from its neighbors. In the general case of  $N$  coupled resonators, as in the case of two coupled resonators, the modes of oscillation have different resonant frequencies

<sup>24</sup> H. Yagi, "Beam transmission of ultra-short waves," *Proc. I.R.E.*, vol. 16, pp. 715-741; June, 1928.

<sup>25</sup> C. E. Cleeton and N. H. Williams, "The shortest continuous radio waves," *Phys. Rev.*, vol. 50, p. 1091; December, 1936.

<sup>27</sup> K. Posthumus, "Oscillations in a split anode magnetron," *Wireless Eng.*, vol. 12, pp. 126-132; March, 1935.

<sup>28</sup> F. Herriger and F. Hulster, "The oscillation of magnetrons," *Hochfrequenz. und Elektroakustik*, vol. 49, pp. 123-132; April, 1937.

<sup>29</sup> N. F. Alekseev and D. D. Malairov, "Generation of high-power oscillations with a magnetron in the centimeter band," *Jour. Tech. Phys. (U.S.S.R.)* vol. 10, pp. 1927-1300; 1940. Republished in English, *Proc. I.R.E.*, vol. 32, pp. 136-139; March, 1944.

<sup>30</sup> A. L. Samuel obtained U. S. Patent No. 2,063,342, December 8, 1936, for a similar device.



because of the effect of the mutual coupling between the resonators.

The interaction fields for the several modes of oscillation of the resonator system are thus to be distinguished by the number  $n$  of repeats of the field pattern around the interaction space. Since the potential at the anode radius is nearly constant across the faces of the anode segments and varies primarily across the slots, the azimuthal variation of the field cannot be purely sinusoidal but must involve higher-order harmonics. For a mode of frequency  $f = \omega/2\pi$ , corresponding to a phase difference between adjacent resonators of  $2\pi n/N$ , the anode potential wave is of periodicity  $n$  around the anode, and may be written as a Fourier series of sinusoidal component waves traveling in opposite directions around the interaction space:

$$\left. \begin{aligned} V_{r-f} &= \sum_k A_k e^{j(\omega t - k\theta + \gamma)} + \sum_k B_k e^{j(\omega t + k\theta + \delta)} \\ k &= n + pN, \quad p = 0, \pm 1, \pm 2, \dots \end{aligned} \right\} \quad (10)$$

Note that the summations are taken over all integral values of  $k$  given by (8).

The interaction field for any mode of periodicity  $n$  is thus represented by two oppositely traveling waves, whose fundamentals are moving with angular velocities  $\omega/n = 2\pi f/n$ , and whose component amplitudes  $A_k$  and  $B_k$  in general are not equal.  $\gamma$  and  $\delta$  are arbitrary phase constants.

The expression (10) may be reduced to the form:

$$\left. \begin{aligned} V_{r-f} &= \sum_k (A_k - B_k) \cos(\omega t - k\theta + \gamma) \\ &+ \sum_k 2B_k \cos\left(\omega t + \frac{\gamma + \delta}{2}\right) \cos\left(k\theta - \frac{\gamma - \delta}{2}\right) \\ k &= n + pN, \quad p = 0, \pm 1, \pm 2, \dots \end{aligned} \right\} \quad (11)$$

which shows that the complete field pattern may be considered to consist of a rotating wave superposed on a standing wave, each having a fundamental component of periodicity  $n$ .

The fact that the periodicities  $k$  of the harmonics in (10) or (11) are those for which  $k$  has the values given by (8) may be determined from a Fourier analysis of the complete anode potential waves like that of Fig. 8.

The terms in (10) and (11) for which  $|k| = n$  are the fundamental components; those for which  $|k| \neq n$  are called the Hartree harmonics. Any sinusoidal component for which the number of complete cycles around the anode is greater than  $N/2$  is thus a harmonic of the complete field pattern for one of the modes whose fundamental is of periodicity  $n = 1, 2, \dots, N/2$ .

Physically distinguishable modes of oscillation exist only for the values of  $n$  less than or equal to  $N/2$  including zero. However, this accounts for only  $N/2 + 1$  of the  $N$  modes of oscillation which one expects a system of  $N$  resonators to possess, because in general the frequency of a mode specified by the parameter  $N$  (except for the values 0 and  $N/2$ ) is a double root for a per-

fectly symmetrical anode structure. The mode is thus a doublet and is said to be degenerate. One would expect this on mathematical grounds from the fact that the general solution in (10) has four arbitrary constants, whereas a singlet solution of the system of second-order differential equations specifying the oscillations should have no more than two.

This degeneracy of the modes of the resonator system may be removed if the symmetry of the system is destroyed by the presence of a disturbance or perturbation at one point (a coupling loop in one of the cavities, for example) which provides the necessary additional boundary condition. Removal of the degeneracy makes possible only standing waves as complete solutions of the simultaneous differential equations specifying the oscillation. Thus, in (11)  $A_k = B_k$  and the first summation representing a rotating wave vanishes. The second summation may be broken up into two patterns: one, cosine-like with respect to the asymmetry as origin, whose frequency is altered from the degenerate value; and a second, sine-like with respect to the asymmetry as origin, whose frequency is the same as the degenerate value. This situation prevails for  $n = 1, 2, \dots, N/2 - 1$ , contributing  $N - 2$  modes. The remaining two modes of the resonator system, for which  $n = 0$  and  $N/2$ , are singlet modes even in the symmetrical anode. For the  $n = 0$  mode, whose field pattern is independent of angle, the component whose frequency is undeviated from that of the degenerate pair corresponds to the trivial case of zero amplitude at all points. Similarly, for the  $n = N/2$  mode (the  $\pi$  mode), the cosine-like pattern gives zero potential at each anode segment, an equally trivial case. Thus each of the  $N$  modes of the multicavity resonator system has been accounted for.

As an example, plots of the field configurations for the modes of a magnetron having eight resonators are shown in Fig. 12. For clarity, only the electric field lines of the fundamental component ( $p = 0$ ) of each mode are shown in the interaction space. Only the magnetic field lines are shown in the resonators. Below these is plotted the distribution in potential for each of the fundamentals,  $\sin n\theta$  and  $\cos n\theta$ ,  $n = 0, 1, 2, 3$ , and 4. For the  $n = 0$  mode the magnetic flux threads through all the resonators in the same direction and returns through the interaction space. That all the segments are in phase and the interaction space field is independent of angle may be seen. That there is but one  $\pi$  mode is also seen from the fact that the  $\cos 4\theta$  term corresponds to zero potential on all the anode segments. The first Hartree harmonic for the  $n = 1$  mode, namely, that for which  $p = -1$  ( $\sin 7\theta$  plotted instead of  $\sin -7\theta$ ), having seven repeats ( $k = 7$ ) or a total phase shift of  $14\pi$  radians around the anode, is also plotted in Fig. 12 in addition to the fundamental. The fact that it yields the same variation of anode-segment potential around the anode as the fundamental is apparent.

In recapitulation, one may say that for each value of  $n$  the total radio-frequency interaction field pattern is

generally composed of a rotating wave superposed on a standing wave. If the degeneracy of the mode is removed, only the standing wave remains. The electronic

these cases. There interactions, of interest in understanding the magnetron oscillator, have not been used much in practice and will not be discussed further here.

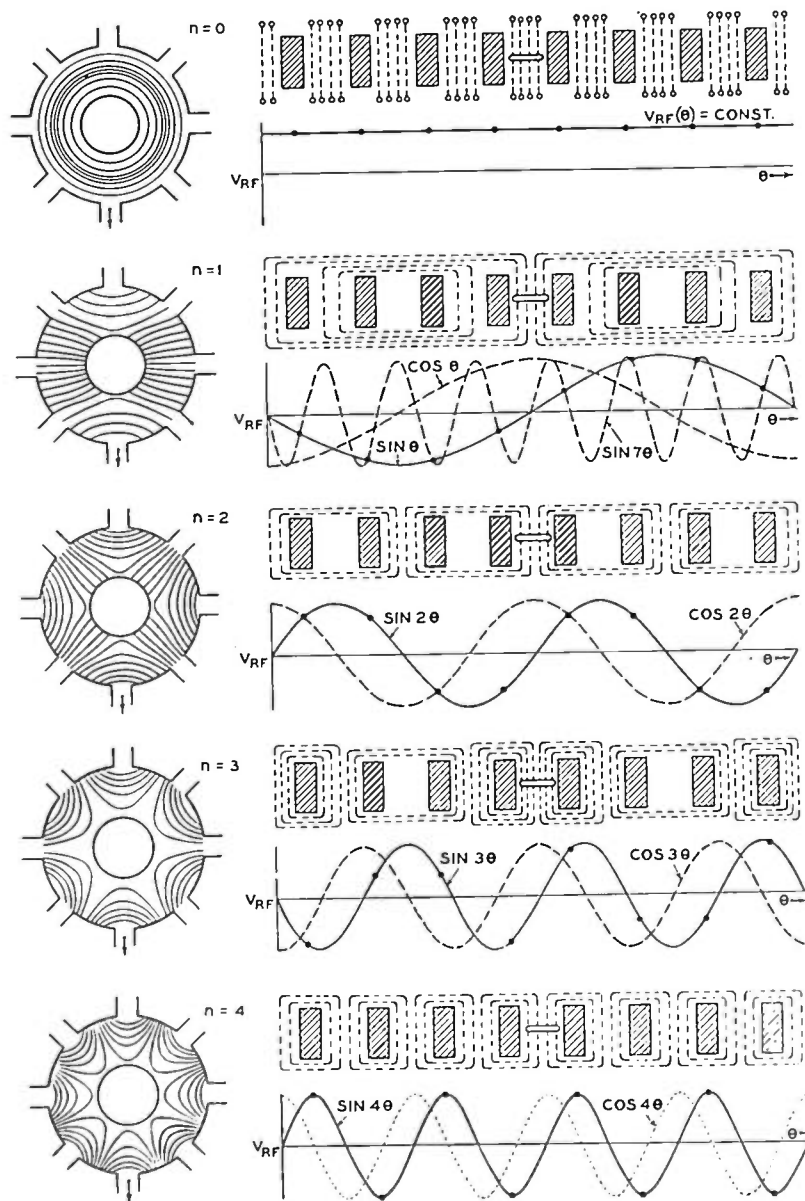

Fig. 12—Configurations of electric fields, magnetic fields, and anode potentials for the  $n=0, 1, 2, 3,$  and  $4$  modes of a resonator system having eight resonators. For each field pattern of periodicity  $n$ , the configuration of the electric lines of force in the magnetron interaction space is shown at the left, the configuration of the magnetic lines threading the resonators is shown at the upper right, and anode potential waves are shown at the lower right. The interaction field plots represent only the fundamental components in each case. The arrow shown in one of the slots in each case indicates the resonator which is coupled to the output circuit. The field lines in each plot are spaced correctly relative to one another but not relative to those in any other plot. At the center of the developed anode is a representation of the output loop. For each mode the magnetic lines are shown for the instant when radio-frequency-current flow is maximum and all anode segments are at zero potential.

interaction with standing total wave on the anode for the  $\pi$  mode has already been discussed. This magnetron oscillator is called the traveling-wave type because its electronic mechanism may be discussed in terms of electronic interaction with one of the sinusoidal traveling-wave components of periodicity  $k$  given in (10).

Electrons may interact favorably with the interaction fields of modes other than the  $\pi$  mode, resulting in a net transfer of energy from the direct to the radio-frequency fields. Plots similar to that of Fig. 8 may be drawn for

#### The Traveling-Wave Picture of the Electronic Mechanism

For each value of  $k$  in (10), whether or not  $A_k = B_k$ , there are two oppositely traveling sinusoidal wave components of periodicity  $k$ . Since each such component requires  $k$  cycles of the radio-frequency oscillation to complete one trip around the interaction space, its linear velocity at the anode surface is  $2\pi r_a/k$ , corresponding to an angular velocity of  $2\pi f/k$ . The electronic mechanism of the traveling-wave or type-III magnetron oscillator may be discussed in terms of electron

interaction with these sinusoidal traveling-wave components present in the interaction field. This might at first appear to be difficult, in view of the many components of several possible modes. By mode-frequency separation, the means of which are mentioned later, it is generally possible to restrict oscillation to only one mode, usually the  $\pi$  mode. Further, the fact that the electronic motion in crossed direct electric and magnetic fields results in a mean drift of electrons around the interaction space enables one to restrict his attention to a single traveling wave corresponding to the fundamental or a single Hartree harmonic of the field of this mode; for it is possible, in principle at least, by proper adjustment of  $V$  and  $B$  to equate the mean angular velocity of the electrons to the angular velocity,  $2\pi f/|k|$ , of any one of the traveling-field components. When this is true, only the field of this component has an appreciable effect upon the electron motion. With respect to the fields of the oppositely traveling component of the same harmonic (same  $k$ ), and the components of all other harmonics (different  $k$ ), the electron finds itself drifting rapidly through regions of accelerating and decelerating field with no net energy transfer. From the point of view of the electron, the fields of the other components vary so rapidly as to average out over any appreciable interval of time. The only exception to these statements occurs when a harmonic of periodicity  $k'$  of another mode of frequency  $f'$  has the same angular velocity as the harmonic of periodicity  $k$ , that is, when  $2\pi f'/|k'| = 2\pi f/|k|$ . Should this occur, the magnetron may have a tendency to "mode," that is, to operate either steadily or intermittently in a mode other than the  $\pi$  mode. In the calculation of electron motions, the restriction to the field of a single traveling-wave component has been called the "rotating-field approximation."

The consideration of the electronic mechanism has thus been reduced to that of the motion of electrons under the combined influence of the radial direct electric field, the axial direct magnetic field, and a sinusoidal field wave traveling around the interaction space. From what has been said thus far it is clear that for energy to be transferred to the radio-frequency field it is necessary that the mean electron velocity very nearly equal that of the traveling wave. Then an electron, leaving the cathode in such phase as to find itself moving in a region of decelerating tangential component of the radio-frequency field, may continue to move with this region and lose energy to the field. In contrast to the type-II transit-time magnetron oscillator, the energy transferred to the radio-frequency field in this case is the potential energy of the electron in the radial direct electric field. The energy in the rotational component of the motion remains practically unaffected and the electron orbit from cathode to anode looks something like that plotted in Fig. 13, for the case with plane electrodes. On the other hand, an electron which leaves the cathode in such phase as to gain energy in a region of accelerating tangential radio-frequency field is removed at the cathode after

only one cycle of the epicycloid-like motion. If this did not occur, the electron would continue to move with the

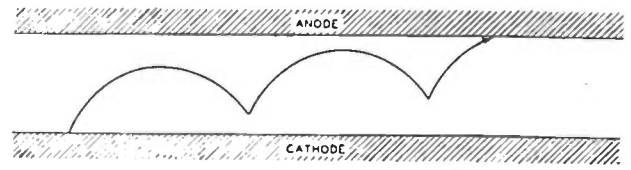

Fig. 13—The orbit of an electron which is losing energy to the radio-frequency field in a traveling-wave or type-III magnetron oscillator. The direct electric force on the electron is directed from cathode to anode.

field and absorb energy. Its orbit is shown in Fig. 14. It is instructive to compare the orbits of the two categories of electrons in the traveling-wave magnetron oscillator with the orbits of corresponding electrons in the cyclotron-frequency type of magnetron (Figs. 10 and 11). In each case, it is the fact that "favorable" electrons may interact for a considerably longer time than "unfavorable" electrons which makes possible a net energy transfer between the direct and radio-frequency fields.

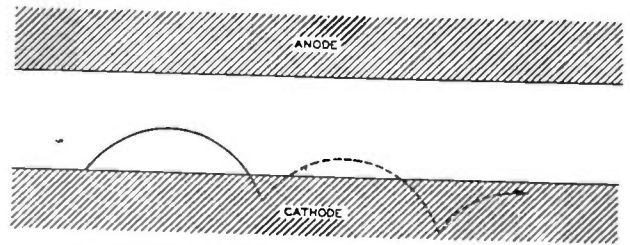

Fig. 14—The orbit of an electron which gains energy from the radio-frequency field in a traveling-wave or type-III magnetron oscillator. The orbit is extended as a dashed line as though the cathode were not there. The direct electric force on the electron is directed from cathode to anode.

One may now compare the traveling-wave picture of the electronic mechanism with that presented earlier in which the motion of electrons past the gaps in the anode structure is considered. An electron, moving so that  $|k|/N = |p| + (n/N)$  cycles of the radio-frequency oscillation elapse between its crossing of two successive anode gaps, is thus moving around the interaction space in synchronism with a traveling component of the  $k$ th harmonic of the interaction field. Both points of view are of value. That involving the motion of electrons past the anode gaps is more fundamental, physically. That in terms of a traveling-wave component, on the other hand, is more convenient in calculations of electron orbits including space-charge effects where, by transformation to a co-ordinate system rotating with the field, it is possible to deal with motions in static fields.

#### Phase Focusing

It has been seen from two points of view how groups of electrons which move around the interaction space of the magnetron oscillator are formed by a process of selection and rejection of electrons by the tangential component of the radio-frequency field. However, space-



charge debunching and the discrepancy at all but one radius between the mean velocity of translation of the electrons and the velocity of the interaction field would tend to disperse these groups and prevent efficient interaction, were it not for the phase focusing provided by the radial component of the radio-frequency field.

The mechanism of the phase focusing may be discussed either in terms of the interaction of electrons with the actual fields existing at the anode gaps or in terms of the traveling-wave picture of the electronic mechanism. The fundamental mechanism involved depends upon the effect of the radial component of the radio-frequency field in aiding or opposing the radial direct field. If the radial radio-frequency field increases the net radial field in which the electron finds itself at any instant, the mean velocity of the electron increases, as can be seen from (4) for the plane case. Similarly, a decrease in the net radial electric field, caused by the radio-frequency radial component, results in decreased electron translation velocity.

Consider an electron which crosses an anode gap at the instant the radio-frequency field there is maximum retarding, that is, an electron which is to be found on the plane marked  $M$  in Fig. 15 at this instant. It ex-

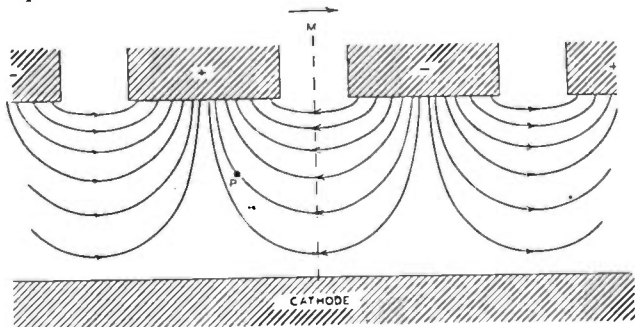

Fig. 15—A plot of lines of electric force on an electron (drawn for the plane case) for the fundamental of the  $\pi$  mode. It is shown for the purpose of explaining the phase focusing property of the radial field component. The plane of maximum opposing force on the electron intersects that of the figure along the line  $M$ . The force on the electron due to the direct electric field is directed from cathode to anode.

periences about as great an increase of velocity by virtue of the radial component aiding the direct radial field before crossing the gap as decrease by virtue of the radial component opposing the direct radial field after crossing the gap. Another electron which is lagging behind the electron just considered is to be found opposite a positively charged anode segment, as at  $P$  in Fig. 15, when the radio-frequency field passes through its maximum value. Since the radio-frequency field component decreases with time after this instant, the effect of the radial component of the field on the electron velocity after crossing the gap will be less than its effect before crossing the gap, the net effect being one of increasing the mean velocity of translation, bringing the electron more nearly into the proper phase. An electron which leads the electron first considered, on the other hand, will be found opposite the negatively charged anode segment beyond the gap when the radio-frequency field

is maximum, and for it the net effect of the radial component is to reduce the mean velocity of the electron, bringing it also more nearly into the proper phase.

In discussing the mechanism of phase focusing from the traveling-wave point of view, the field lines of Fig. 15 may be considered to be those of the traveling-wave component with which the electrons are interacting. Then the whole field pattern indicated moves to the right, as shown by the arrow above the plane of maximum retarding tangential field at  $M$ . An electron which falls behind the position  $M$  to the point  $P$ , for example, finds itself in a stronger net radial electric field which increases its mean translational velocity, tending to bring it back to the position  $M$ . The reverse holds for an electron which runs ahead of the plane  $M$ .

#### Space-Charge Configuration

The over-all picture of the electronic mechanism in the type-III magnetron oscillator thus presents a spoke-

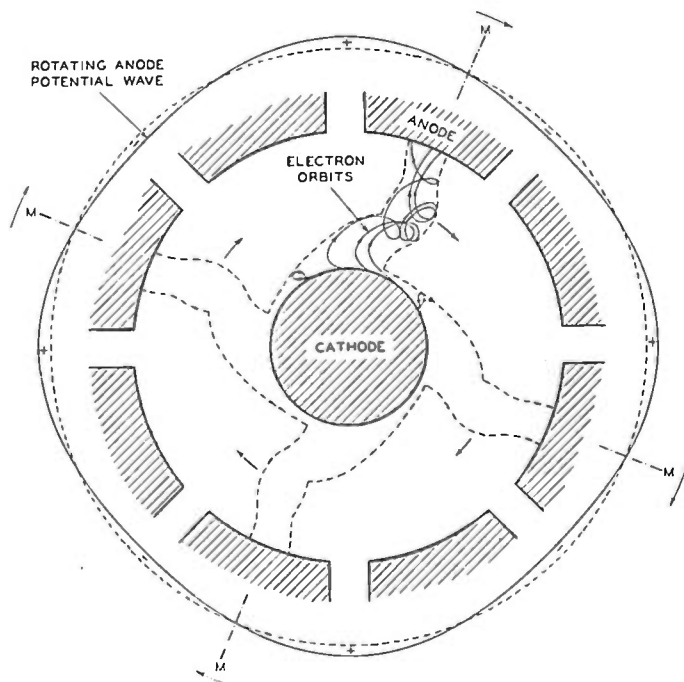

Fig. 16—The orbits of four electrons which left the cathode in different phases in one period of the radio-frequency field, plotted in a co-ordinate system rotating with the anode potential wave. The dashed lines enclose the orbits of the electrons, and hence delineate the boundaries of the space-charge cloud which rotates around the cathode in synchronism with the anode-potential wave. Planes of maximum retarding tangential field are represented by the lines  $M$  (see Fig. 15). This figure is reproduced by courtesy of the British Committee on Valve Development (CVD) and is taken from the CVD Magnetron Report No. 41.

shaped space-charge cloud of electrons wheeling around the cathode in synchronism with the anode potential wave, each spoke in a region of maximum retarding field. This picture of what is happening has been very handsomely confirmed by actual orbital calculations taking account of space charge. The result of one such calculation is shown in Fig. 16. The orbits of four electrons which were emitted from the cathode in different phases in one repeat of the anode radio-frequency field are plotted in a set of co-ordinates rotating with the

radio-frequency field component. One electron is returned to the cathode, and the other three reach the anode. The spoke-shaped structure is clear, and its position with respect to the rotating anode potential wave is as expected. The number of spokes of the cloud is equal to the order of the component of the mode with which the electrons are interacting. In the case of Fig. 16 there are four spokes, since the magnetron is operating in the fundamental of the  $n=4$  mode ( $k=4$ ,  $p=0$ ).

#### Induction by the Space-Charge Cloud

Another view of the mechanism by which the electrons drive the resonator system may be obtained by considering the effect of the space-charge spokes in inducing current flow in the anode segments themselves. For example, the oscillation of the resonator block in its  $\pi$  mode corresponds to the periodic interchange of electric charge from each anode segment around a resonating cavity to the next anode segment. This oscillation is maintained, much in the manner of a pendulum escapement drive, by the spoke of negative space charge appearing in front of an anode segment at that instant in the oscillation cycle when it can aid in building up the net positive charge on the segment. At the same instant the adjacent segments, being opposite a "gap" in the space-charge wheel, may build up a negative charge.

The radio-frequency current  $I_{rf}$ , induced in the anode structure, thus results from the motion of the spoke-shaped space-charge cloud in the interaction space. It is not to be confused with the total circulating radio-frequency current in the resonator system. Whereas  $I_{rf}$  must be in phase with the space-charge cloud, it need not be in phase with the radio-frequency voltage  $V_{rf}$  between the anode segments. In terms of the electron motions, this means that the spokes of the space-charge cloud may lead or lag the maxima in the tangential field. In general, the electronic admittance defined by the ratio of  $I_{rf}$  to  $V_{rf}$  may thus include a susceptance as well as a conductance. The product of  $V_{rf}$  and the in-phase component of  $I_{rf}$ , integrated over a period of one cycle of radio-frequency oscillation, equals the energy per cycle which is delivered to the load. This amount of energy is twice that transferred in the half cycle during which the spokes of space charge move against the field from positions in front of one set of alternate anode segments to similar positions in front of the adjacent anode segments.

In each spoke of the electron space-charge cloud, individual electrons progress from cathode to anode. The direct current  $I$  passed by the magnetron is made up of electrons which strike the anode from the ends of the space-charge spokes. If the magnetron is driven at greater direct current, the space charge in the interaction space increases but the phase of its structure with respect to the traveling anode wave does not change to a first approximation. Thus both the in-phase and quadrature components of  $I_{rf}$  increase with no change in electronic admittance. One of the second-order effects

which arise from small shifts in the phase of the rotating space-charge structure is the shift at constant load of operating frequency with direct current passed by the magnetron. This shift is called the frequency "pushing" and is measured in megacycles per second per ampere.

#### Necessary Conditions for Oscillation

After having discussed the electron motions in the interaction space of the type-III magnetron oscillator, the viewpoint will now be changed to that looking from the outside in, so to speak, and it will be asked what conditions relating measurable parameters are imposed by the nature of the electronic mechanism. Beyond the geometrical parameters of cathode and anode radii  $r_c$  and  $r_a$  one can determine the direct voltage  $V$  applied between cathode and anode; the magnetic field  $B$  in which the magnetron is placed; the direct current  $I$  drawn by the anode; the frequency of oscillation  $f$ ; and, from impedance measurement, the radio-frequency load presented to the electrons by the resonator, output, and load.

Perhaps the most fundamental condition for oscillation of the traveling-wave magnetron is that imposed by the requirement of synchronism between the electron drift and the radio-frequency field. As has been indicated, the angular velocity of a rotating component of a Hartree harmonic of the interaction field of order  $k$  is  $2\pi f/|k|$ . An approximate expression for the mean angular velocity of the electrons may be determined by neglecting the variation of electric field with radius and calculating the angular velocity midway between cathode and anode, thus:

$$\frac{v}{(r_a + r_c)/2} = \frac{E/B}{(r_a + r_c)/2} = \frac{V/(r_a - r_c)B}{(r_a + r_c)/2} = \frac{2V}{(r_a^2 - r_c^2)B}$$

Equating this to the angular velocity  $2\pi f/|k|$ , one obtains the relation

$$V = \frac{\pi f}{|k|} r_a^2 B \left[ 1 - \left( \frac{r_c}{r_a} \right)^2 \right]. \quad (12)$$

In this derivation it should be recognized that the velocity  $2\pi f/|k|$  may be considered either to be the velocity of traveling component of the radio-frequency field with which the electron interacts or the mean velocity which the electron must have to maintain proper phase with the total radio-frequency fields existing across the anode gaps.

Posthumus<sup>27</sup> derived an expression, assuming negligible cathode diameter, which is similar to (12). By the same method as that used above, Slater has derived an expression differing from (12) by a term which results from the use of a more accurate value for the electron translational velocity at the midpoint between cathode and anode in cylindrical geometry. Slater's expression is

$$V = \frac{\pi f}{|k|} r_a^2 B \left[ 1 - \left( \frac{r_c}{r_a} \right)^2 \right] - 2 \frac{m}{e} \left[ \frac{\pi f r_a}{|k|} \right]^2 \left[ 1 - \left( \frac{r_c}{r_a} \right)^2 \right]. \quad (13)$$

Hartree has derived an expression from a consideration of the conditions under which electrons are just able to reach the anode with infinitesimal amplitude of radio-frequency voltage in the  $k$ th harmonic. It is:

$$V = \frac{\pi f}{|k|} r_a^2 B \left[ 1 - \left( \frac{r_c}{r_a} \right)^2 \right] - 2 \frac{m}{e} \left[ \frac{\pi f r_c}{|k|} \right]^2 \quad (14)$$

In a sense this condition represents a cut-off relation for the oscillating magnetron analogous to Hull's cut-off relation for the direct-current magnetron [see (7)].

Plotted on a  $V-B$  graph, (12), (13), and (14) represent parallel straight lines. The line of (12) passes through the origin; the so-called Hartree line of (14) is tangent to the direct-current cut-off parabola; the so-called Slater line of (13) lies above the Hartree line but below the line of (12). Each of the above expressions indicates that the electrons will drive a given harmonic of the radio-frequency interaction field in a type-III magnetron oscillator only at values of direct voltage and magnetic field which bear a definite relation. This relation expresses the fact that  $V/B$  is very nearly constant [see (12)].

In Fig. 17 are plotted as an illustration the Hartree lines for the fundamentals ( $p=0$ ) of the  $n=1, 2, 3,$  and  $4$  modes and for the  $k=-5$  harmonic ( $p=-1$ ) of the

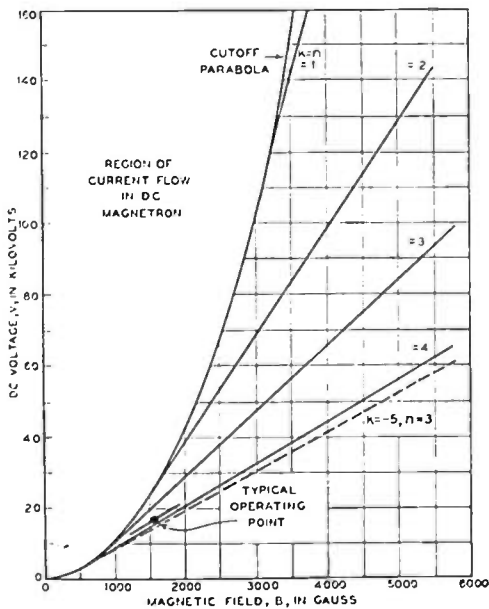

Fig. 17—A  $V-B$  plot for a typical magnetron having eight resonators showing the cut-off parabola and Hartree lines for several rotating-field components. The ranges of direct-voltage and magnetic field have been extended considerably beyond values ever applied to such a tube to show the lines for the fundamentals of all of the modes.

$n=3$  modes of a 10-centimeter magnetron with eight resonators. Since the operating voltage is found to increase with increasing current, oscillation at a constant anode current takes place along a line (such as the Slater line, for example) lying slightly above and parallel to the Hartree line (see Fig. 17). The separation of the operating line from the Hartree line increases with increasing direct current.

The necessary conditions for oscillation discussed

above have been of great value in the identification of the modes of operating magnetrons and as the starting point in the design of new magnetrons for given wavelengths, magnetic field, and voltage.

*The Performance Chart*

Another fundamental performance characteristic of the operating magnetron is the  $V-I$  plot or performance chart. In Fig. 18 such a chart is plotted for the same magnetron used as the example for Fig. 17. In it are plotted contours of constant magnetic field, radio-fre-

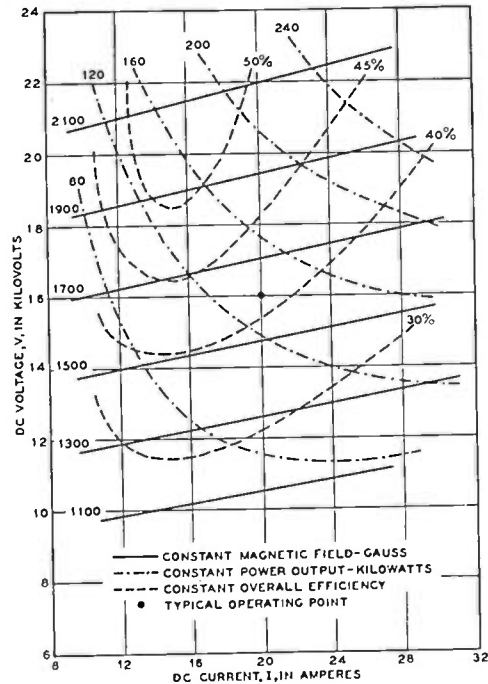

Fig. 18—A  $V-I$  plot or performance chart for a magnetron having eight resonators. The typical operating point is that plotted in Fig. 17.

quency power output, and over-all efficiency. The fact that the constant magnetic-field contours are nearly horizontal and spaced as they are is a manifestation of the oscillation conditions of (13) and (14). The increase of voltage with current is an effect attributable to the space charge quite independent of the condition of synchronism between field and electrons, for if the magnetron is to deliver more power at a given magnetic field, the induced radio-frequency current must increase. This entails increased space charge and a greater direct-current flow. To maintain the increased space charge additional direct voltage is required.

*The Electronic Efficiency*

The performance chart also shows the not too surprising fact that more power may be drawn from the magnetron as the voltage and current are increased. More interesting are the increases of the over-all efficiency with voltage and the maximum through which the efficiency passes with increasing current. This variation of over-all efficiency  $\eta$  is to be attributed to changes in the electronic efficiency  $\eta_e$  since the other factor involved in the over-all efficiency, the circuit efficiency  $\eta_c$ , is essentially constant over the diagram ( $\eta = \eta_e \eta_c$ ).



The increase of electronic efficiency with voltage, and hence magnetic field, may be explained by the picture of electron motions in the interaction space. The highest electronic efficiency is attained when the electrons reaching the anode do so with least kinetic energy. The energy lost at the anode per electron is that gained as kinetic energy beyond the last cusp of the orbit. By bringing the last cusp closer to the anode, corresponding to a reduction of the amplitude of the rotational component of the electron motion, the fractional energy lost at the anode may be reduced. Thus, according to (5), for the radius of the rolling circle this energy loss should vary as  $V/B^2$  or, since  $V/B$  is approximately constant, as  $1/B$ ,  $\eta_e$  increasing with  $B$ . In terms of electron orbits for a plane magnetron, Fig. 19 shows how increase in

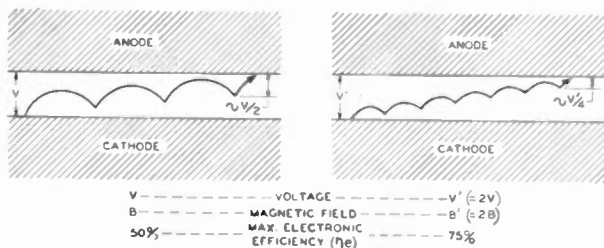

Fig. 19—Orbits of electrons which transfer energy to the radio-frequency field, plotted for operation of the magnetron at two different magnetic fields.

voltage and magnetic field increases the electronic efficiency. The dependence of electronic efficiency on  $B$  predicted by this simple picture is in accord with the dependence predicted by more sophisticated theories.

#### The Radio-Frequency Circuit of the Magnetron Oscillator

Although the radio-frequency circuit of the magnetron oscillator must of necessity incorporate special features, its characteristics may be studied and specified in ways similar to those applied to other types of radio-frequency circuits in the centimeter-wave region. Thus, from suitable measurements on the nonoscillating magnetron, one may identify the modes of oscillation of the resonator system, which is connected to its load through a given output circuit, and, for each, specify a natural frequency of resonance, unloaded, loaded, and external  $Q$ 's, as well as a characteristic admittance of the system.

#### The Resonator System

In Fig. 20 is shown a series of resonator blocks for pulsed magnetron oscillators ranging in frequency from 700 to 24,000 megacycles. The rings or wires connected to the anode segments are the so-called straps to be discussed later. The smallest resonator system of Fig. 20 is a so-called "rising-sun" system having "vane"-type resonators of alternate size. It, also, is mentioned briefly later.

#### Separation of Mode Frequencies

The frequencies of several of the modes of oscillation possessed by the multicavity magnetron-resonator system would ordinarily be quite closely grouped near that

of the  $\pi$  mode, were not steps taken to separate them. From the point of view of the electronics of the magnetron one might think such proximity of mode frequencies to be no problem, because the different modes, even if of the same frequency, generally require different conditions relating the operating parameters  $V$  and  $B$  for oscillation [see (14)]. From the circuit point of view, however, close proximity of the mode frequencies is clearly undesirable, for under such conditions it is possible that the electronically driven mode, usually the  $\pi$  mode, may excite oscillation in a second mode. The  $\pi$ -mode oscillation, coupled to the second mode through some symmetry in the resonator system, sets up forced oscillations in the second mode under these conditions. The interaction field pattern of the second mode then appears as a contamination of the  $\pi$ -mode pattern, adversely affecting the electronic interaction with the  $\pi$  mode.

Mode-frequency separation in magnetron-resonator systems has been accomplished by two methods. In one, conductive connections between the anode segments, called straps, are employed. In the other, resonant cavities of two sizes spaced alternately are employed in an unstrapped resonator system.

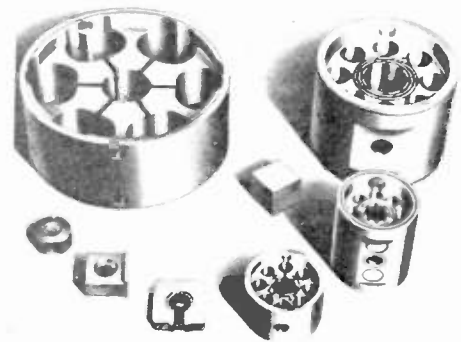

Fig. 20—A series of resonator blocks for magnetron oscillators.

#### Strapping of the Resonator System

The strapping of a magnetron anode structure grew out of a British attempt to lock the oscillation of the system into the  $\pi$  mode by connecting alternate anode segments together with wire straps. Although the number of modes of such a strapped structure is not changed, since its  $N$ -fold symmetry remains, the so-called "mode-locking straps" did succeed in separating the modes and making for easier oscillation in the  $\pi$  mode alone. The frequency separation of the modes is not infinite, however, because the straps are not of negligible length compared to a wavelength and thus have appreciable impedance between points on the structure to which they are connected. In most magnetron anode structures today, straps of some form are employed. How straps appear in position in the resonator block may be seen in Fig. 20 and in the photograph of a cutaway model shown in Fig. 21.

Of very great importance to the operation of a strapped resonator system is the degree of symmetry

in the strapping system. The original British strapping is not symmetrical around the anode. Other types are symmetrical, except for breaks which are usually incorporated at least on one end of the anode. These asymmetries in the strapping provide the most convenient method of incorporating the additional asymmetry needed in the resonator system to orient the

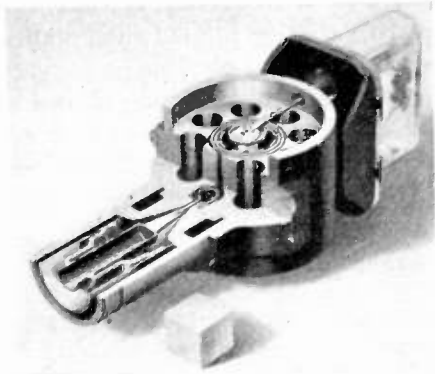

Fig. 21—Photograph of a cutaway model of a magnetron, the 4J21-30, of operating frequency near 1300 megacycles. Note the straps, cathode mount, output loop, and coaxial output circuit. The peak output power of this magnetron is about 750 kilowatts at 27 kilovolts, 45 amperes, and 1400 gauss. A one-inch cube is shown to indicate the scale.

standing-wave patterns of the doublet modes with respect to the output circuit of the magnetron so as to equalize their loading. In addition, the strap asymmetries are arranged so as not to affect the symmetrical distributions of voltage and current in the resonator system for the  $\pi$  mode, but to destroy such symmetry to an appreciable extent for other modes.

#### The "Rising-Sun" Resonator System

The second type of magnetron resonator system in which the mode frequencies may be separated suf-

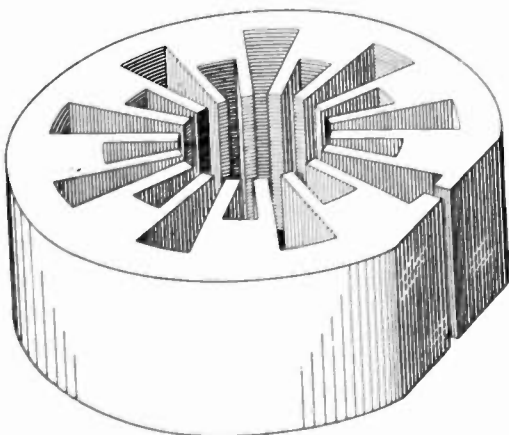

Fig. 22—A so-called "rising-sun"-type resonator system having eighteen resonators. The slit at the "back" of the resonator in the right foreground is to be connected to the output circuit (compare with Fig. 24).

ficiently well to allow "clean" operation in the  $\pi$  mode is an unstrapped structure involving the use of resonant cavities of two sizes so arranged that adjacent cavities

are alternately large and small. This resonator system, called the "rising-sun" system, accomplishes mode-frequency separation by means analogous to the increase in separation of the mode frequencies of a system of two coupled resonators achieved by relative detuning of the individual resonators. Such a resonator system was evolved at the Columbia Radiation Laboratory during a series of experiments with asymmetries in an unstrapped resonator system. It is particularly adaptable to use in magnetrons of short wavelength where straps become very small and extremely difficult to construct. A "rising-sun" resonator system for  $N=18$  is shown in Fig. 22 (compare with Fig. 20).

#### The Output Circuit and Load

In the general physical description of the centimeter-wave magnetron, whose constituent parts are shown in Fig. 5, there remains the discussion of the output circuit. The output circuit is the means of coupling the fields of the magnetron resonator to the load. As such, it must contrive to induce a voltage across a coaxial line or a wave guide to which the load circuit is connected.

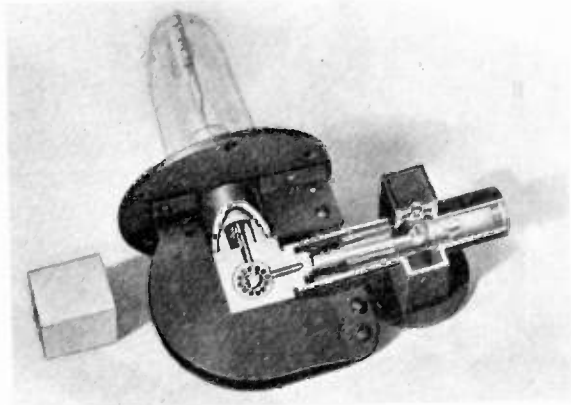

Fig. 23—A photograph of a cutaway model of a 3.2-centimeter magnetron, the 725A. The peak power output of this magnetron is about 55 kilowatts at 13 kilovolts, 12 amperes, and 5650 gauss. The cube shown to give the scale is one inch on a side.

The most common coaxial-line type is illustrated schematically in Fig. 5 and may be seen in the photograph of the cutaway magnetron model of Fig. 21. A variation of the loop and coaxial output in which the loop is placed above the end of the resonator and the coaxial terminated in a junction to wave guide is shown in Fig. 23.

The wave-guide type of output circuit is shown schematically in Fig. 24 and may be seen in a slightly different form in the photograph of a cutaway magnetron model of Fig. 25.

In both types of output circuit the necessary transformer action is now designed into the magnetron structure so that the magnetron may operate at satisfactory loading when connected to a matched output line or wave guide without the use of external transformers. In the coaxial output this is accomplished by adjustment of the loop size and by the use of coaxial

transformer sections inside the vacuum envelope. In the wave-guide output the usual form of transformer is a quarter-wavelength guide section, inside the vacuum envelope, of characteristic impedance equal to the root-mean-square of that of the external guide and the low impedance desired at the magnetron resonator (see Fig. 24).

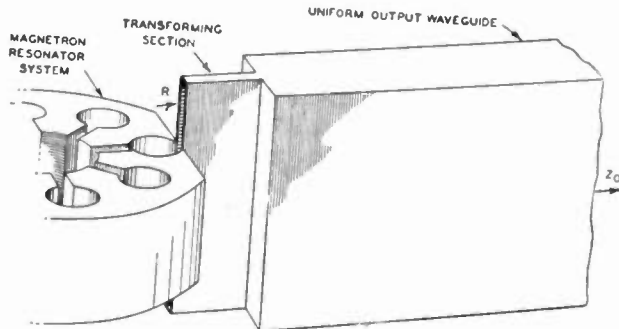

Fig. 24—A schematic diagram of a type of wave-guide output. Other types of resonator systems may be used, and the transforming section may be of dumbbell-shaped cross section rather than of the rectangular cross section shown (compare Fig. 25).

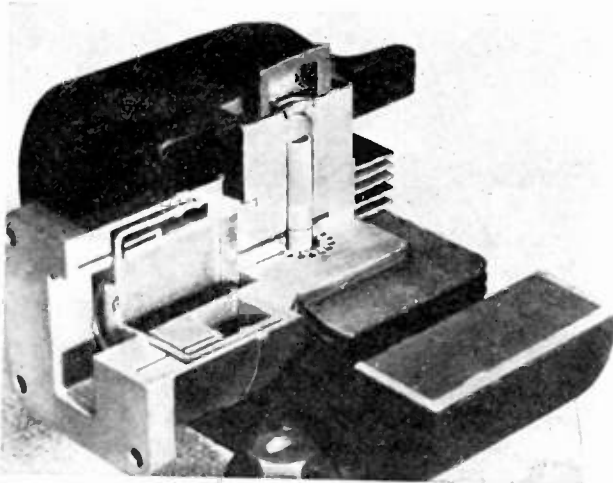

Fig. 25—A photograph of a cutaway model of a "packaged" 3.2-centimeter magnetron, the 4J50. Note the particulars of the wave-guide output and cathode construction. This magnetron may generate 280 kilowatts peak power output at 22 kilovolts, 27 amperes, and 6900 gauss. The scale of the figure may be judged from the fact that the cathode is 0.209 inch in diameter.

### The Rieke Diagram

The Rieke diagram is the third fundamental performance characteristic of the magnetron oscillator (the others are the  $V-B$  and  $V-I$  plots of Figs. 17 and 18). It represents the dependence of output power and operating frequency on load. It is usually plotted as contours of constant output power and operating frequency on a reflection coefficient plane. A typical example for centimeter-wave magnetrons is shown in Fig. 26. The Rieke diagram may be explained in terms of the theory of a simple lumped-constant circuit equivalent to that of the radio-frequency circuit of the magnetron.

### The Pulling Figure

The Rieke diagram completely specifies the dependence upon load of the magnetron output power and frequency of operation. Nevertheless, it is convenient to be able to specify by a single parameter the dependence of operating frequency on load changes. It is customary to specify as the so-called pulling figure  $PF$  the total excursion of frequency,  $\Delta f = \Delta\omega/2\pi$ , resulting from a standard variation in load susceptance, namely, that obtained by the total possible phase variation of a standing wave of 1.5 voltage ratio in the line at the point in question. This is equivalent to traversing the dashed circle on the reflection coefficient plane shown in Fig. 26. The pulling figure of the magnetron is inversely proportional to its external  $Q$ .

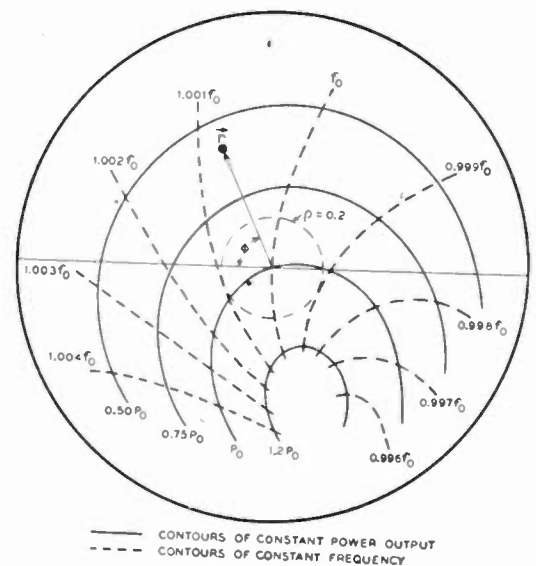

Fig. 26—A typical experimental Rieke diagram for magnetrons in the centimeter wavelength range. The dashed circle represents the locus of all points of constant amplitude,  $\rho$ , of reflection coefficient equal to 0.2. Traversal around this circle indicates a pulling figure of  $0.002 f_0$  megacycles. Present practice is to couple long-wavelength magnetrons more tightly to the load than this and short-wavelength magnetrons less tightly.

### Conclusion

In this paper it has been possible to present only a discussion of the fundamental physical basis of operation of the modern magnetron oscillator. It might be extended, for example, to include treatments of how a good magnetron design may be scaled to other frequencies, voltages, currents, and magnetic fields; how the frequency may be stabilized; what happens when the magnetron operates into a frequency-sensitive load ("long-line effect"); how the oscillator may be tuned; what the nature of the frequency spectrum of a pulsed magnetron is; how oscillations build up; and what special considerations enter into the design of cathodes and magnetic circuits for use in magnetron oscillators. Discussion of these topics may be found elsewhere.<sup>14</sup>



# Selective Demodulation\*

DONALD B. HARRIS†, SENIOR MEMBER, I.R.E.

**Summary**—A method of demodulation is proposed in which the output current of the demodulator is a linear function of the input voltage, while at the same time provision is made for producing the necessary product terms which will result in demodulation. Demodulation is brought about by integrating the product of the instantaneous value of the modulated wave by the instantaneous value of a wave having the same frequency and phase as the carrier. Where this method of demodulation is used it is proposed that two carriers in quadrature on the same frequency may be employed, reducing the bandwidth to that required for single-sideband transmission.

It is suggested that the required linear demodulation characteristics may be obtained through the use of "electron-coupled" demodulators. Theoretical considerations indicate that, when demodulation of this type is employed, selectivity ahead of the demodulator may be dispensed with, the signal-to-noise ratio is improved, greater economy of spectrum space is obtained, the number of tubes required is materially reduced through the use of a common intermediate-frequency amplifier for a number of channels, and any impairment due to the instability of the carrier or oscillator frequency is reduced.

As an example of the possible application of the principles outlined, a hypothetical eight-channel transmission system is described.

## INTRODUCTION

WHEN a modulated wave of the form

$$e = F(t) \cos(\omega_k t + \phi_k) \quad (1)$$

in which  $e$  is the instantaneous voltage,  $F(t)$  is a modulating component,  $f_k = \omega_k/2\pi$  is a carrier frequency, and  $\phi_k$  is the phase angle of the carrier at time  $t = t_0$ , is multiplied by the instantaneous value of the carrier, the expression for the product is

$$\begin{aligned} i &= \gamma e \cos(\omega_k t + \phi_k) = \gamma F(t) \cos(\omega_k t + \phi_k)^2 \\ &= \gamma \frac{F(t)}{2} + \gamma \frac{\cos 2(\omega_k t + \phi_k)}{2} \end{aligned} \quad (2)$$

where  $i$  is the instantaneous output current, and  $\gamma$  is a constant depending upon the characteristics of the device used to bring about the multiplication.<sup>1</sup>

If the result is integrated over at least one carrier cycle the second term becomes zero, and the useful result is

$$I_0 = \gamma \frac{F(t)}{2} \quad (3)$$

The original modulating component is thus restored. While the operations of (1) to (3) usually occur in any analysis of modulation or demodulation and are some-

times incidentally employed in other problems, their general importance, and sometimes even their existence in the analysis, are usually obscured by the difficulties of the modulation problem. It is the purpose of this paper to point out that this relationship constitutes a fundamental principle, through the application of which useful results may be obtained. Transmission systems may be developed in which a number of modulating components may be transmitted on properly spaced and phased carriers, and separated at the receiver without recourse to the usual tuning arrangements. Two carriers of the same frequency but differing in phase may be employed, and their respective modulating components selected in the receiver as desired, to create a dual-channel transmission system. The result of (3) may be employed to produce a spectrum analyzer in which the frequency observed at any given instant is selected solely through controlling the frequency of a beating oscillator. Receivers of the superheterodyne type but without intermediate-frequency amplifiers, in which the output of the mixer is fed directly into the audio or video amplifier, may be designed for the purpose of eliminating difficulties due to image frequencies.

It is not claimed that the material in this paper is completely new. To some extent the analysis follows lines made familiar by other papers on modulation and demodulation, and some of the principles outlined have been applied in practical circuits for many years. In particular, A. V. T. Day and H. Nyquist have independently made suggestions as to the employment of carriers in quadrature.<sup>2-4</sup> The relationships derived are, however, presented in a somewhat novel manner which the author has found helpful in visualizing the general problem of demodulation. Perhaps this publication of the general concepts involved may help others to develop novel applications in practical devices as yet unthought of. The author regrets that circumstances have made it impossible for him to verify his theoretical conclusions experimentally, and hopes that this paper will be regarded primarily as an exposition of general principles.

## GENERALIZATION OF THE PRINCIPLE

The principle may be generalized as follows: Assume that a transmitted wave, the instantaneous voltage value of which is  $e_i$ , is impressed on the input of a circuit element so designed that its output is proportional to the product of  $e_i$  and the instantaneous voltage value  $e_d$  of a demodulating wave applied locally to another terminal of the circuit element. The instantaneous

\* Decimal classification: R134X R148. Original manuscript received by the Institute, February 4, 1946; revised manuscript received, July 18, 1946.

† Formerly, National Defense Research Committee, Division 15, Cambridge, Massachusetts; now, Northwestern Bell Telephone Company, Des Moines, Iowa.

<sup>1</sup> "γ" is selected to represent this constant rather than "K" in order to avoid confusion with the subscript  $k$ , and because it will be shown that a tube constant identified as  $\gamma$  can be utilized to bring about the result of equation (2).

<sup>2</sup> A. V. T. Day, U. S. Patent No. 1,885,009.

<sup>3</sup> H. Nyquist, U. S. Patent No. 1,601,808.

<sup>4</sup> H. Nyquist, Trans. A.I.E.E. (*Elec. Eng.*, February, 1928), vol. 47, p. 624; February, 1928.

useful output current will be

$$i_0 = \frac{dQ}{dt} = \gamma e_i e_d \quad (4)$$

where  $Q$  is the quantity of electricity existing in the circuit at time  $t$  and  $\gamma$  is a constant depending on the characteristics of the circuit element.<sup>5</sup>

Then

$$dQ = \gamma e_i e_d dt \quad (5)$$

and the charge flowing out of the circuit element during the time interval between  $t=0$  and  $t=T$  will be

$$Q = \gamma \int_0^T e_i e_d dt. \quad (6)$$

The average output current during this period is

$$I_0 = \frac{Q}{T} = \frac{\gamma}{T} \int_0^T e_i e_d dt. \quad (7)$$

It is now assumed, for the first case, that the transmitted wave is of the form of (1):

$$e_i = F(t) \cos(\omega_k t + \phi_k). \quad (8)$$

$F(t)$  may take a variety of forms. In the case of carrier-transmitted amplitude modulation it takes the form, for a single modulating frequency:

$$F(t) = E_k [1 + m \cos(\omega_m t + \phi_m)] \quad (9)$$

where  $E_k$  is the amplitude of the carrier,  $m$  is the modulation index, and  $\omega_m$  and  $\phi_m$  are the angular velocity and phase angle, respectively, of the modulating vector. The complete expression for the transmitted wave in this case is

$$e_i = E_k [1 + m \cos(\omega_m t + \phi_m)] \cos(\omega_k t + \phi_k). \quad (10)$$

Where carrier-eliminated transmission is involved,

$$F(t) = m E_k [\cos(\omega_m t + \phi_m)] \quad (11)$$

and the expression for the wave becomes

$$e_i = m E_k [\cos(\omega_m t + \phi_m)] \cos(\omega_k t + \phi_k). \quad (12)$$

If it now be assumed that

$$e_d = \cos(\omega_k t + \phi_k) \quad (13)$$

and that we wish to integrate over one complete cycle of the carrier, the period of which is

$$T_k = \frac{1}{f_k} = \frac{2\pi}{\omega_k} = T, \quad (14)$$

we have, by substitution of (8), (13), and (14), in (7):

$$\begin{aligned} I_0 &= \frac{\gamma \omega_k}{2\pi} \int_0^{2\pi/\omega_k} F(t) \cos(\omega_k t + \phi_k) \cos(\omega_k t + \phi_k) dt \\ &= \frac{\gamma \omega_k}{2\pi} \int_0^{2\pi/\omega_k} \frac{F(t)}{2} dt \\ &\quad + \frac{\gamma \omega_k}{2\pi} \int_0^{2\pi/\omega_k} \frac{F(t)}{2} \cos 2(\omega_k t + \phi_k) dt \\ &= \frac{\gamma \omega_k}{2\pi} \frac{2\pi F(t)}{2\omega_k} = \frac{\gamma F(t)}{2}. \end{aligned} \quad (15)$$

This result is true if the period of  $F(t)$  is so long in comparison with  $T_k$  that  $F(t)$  may be considered to remain constant within the limits of integration.<sup>6</sup>

Rewriting (15) in order to emphasize the salient features of the relationship demonstrated, we have

$$\begin{aligned} I_0 &= \frac{\gamma \omega_k}{2\pi} \int_0^{2\pi/\omega_k} F(t) \cos(\omega_k t + \phi_k) \cos(\omega_k t + \phi_k) dt \\ &= \frac{\gamma F(t)}{2}. \end{aligned} \quad (16)$$

This equation states in effect that when the product of the instantaneous value of a modulated wave and the instantaneous value of a wave having the same frequency and phase as the carrier are integrated over one complete carrier cycle, the integrated output current is a linear function of the original modulation component; complete demodulation is therefore effected by this process.

It is now to be observed that the principle may be further generalized to take into account two carriers on the same frequency but in quadrature. If instead of the single carrier of (8) we have one cosine and one sine carrier, each with its own modulation, the equation of the wave becomes

$$e_i = F_a(t) \cos(\omega_k t + \phi_k) + F_b(t) \sin(\omega_k t + \phi_k). \quad (17)$$

If in the receiving demodulator the product of  $e_i$  and  $e_d = \cos(\omega_k t + \phi_k)$  is integrated, we obtain for the average output current, in accordance with (7):

$$\begin{aligned} I_0 &= \frac{\gamma \omega_k}{2\pi} \int_0^{2\pi/\omega_k} [F_a(t) \cos(\omega_k t + \phi_k) \\ &\quad + F_b(t) \sin(\omega_k t + \phi_k)] \cos(\omega_k t + \phi_k) dt \\ &= \frac{\gamma F_a(t)}{2} + \frac{\gamma \omega_k}{2\pi} \int_0^{2\pi/\omega_k} F_b(t) [1/2 \sin 0 \\ &\quad + 1/2 \sin 2(\omega_k t + \phi_k)] \\ &= \frac{\gamma F_a(t)}{2} + \frac{\gamma \omega_k}{2\pi} \int_0^{2\pi/\omega_k} F_b(t) [0 + 1/2 \sin 2(\omega_k t + \phi_k)] \\ &= \frac{\gamma F_a(t)}{2}. \end{aligned} \quad (18)$$

<sup>5</sup> The exact design of circuit elements of this type is to be considered later. For purposes of the present analysis, it may be assumed that a demodulator of the "balanced" type is used in which the signal is applied 180 degrees out of phase to the grids of a pair of push-pull tubes, while the demodulating carrier is applied in phase to both grids.

<sup>6</sup> It is to be noted that in the case of (15) integration over one-half carrier cycle would have been equally effective in eliminating the undesired alternating component. The limits  $t=0$  and  $t=T_k$  are, however, employed for consistency, as it will later be demonstrated (see (21)) that they are required when the transmitted wave contains two or more frequencies in harmonic relationship.

While, if the demodulating voltage  $e_d$  is  $\sin(\omega_k t + \phi_k)$ , by a similar process not written out in detail we obtain,

$$I_0 = \frac{\gamma\omega_k}{2\pi} \int_0^{2\pi/\omega_k} [F_a(t) \cos(\omega_k t + \phi_k) + F_b(t) \sin(\omega_k t + \phi_k)] \sin(\omega_k t + \phi_k) dt = \frac{\gamma F_b(t)}{2} \quad (19)$$

Either signal may therefore be demodulated at will merely by selecting the proper demodulating voltage,  $\cos(\omega_k t + \phi_k)$  or  $\sin(\omega_k t + \phi_k)$ , as required. Equations (18) and (19) may be applied in practice to effect a dual-channel transmission system, in which a single carrier frequency serves both channels. The benefits of single-sideband transmission may thus be realized without elaborate filtering means.

Also, if more than one modulated carrier frequency is received by the demodulator, as when,

$$e_i = F_{a1}(t) \cos(\omega_{k1} t + \phi_{k1}) + F_{b1}(t) \sin(\omega_{k1} t + \phi_{k1}) + F_{a2}(t) \cos(\omega_{k2} t + \phi_{k2}) + F_{b2}(t) \sin(\omega_{k2} t + \phi_{k2}) \quad (20),$$

the output current integrated over one complete period of carrier  $K_1$ , for the case when the demodulating voltage  $e_d$  is  $\cos(\omega_{k1} t + \phi_{k1})$ , will be

$$I_0 = \frac{\gamma\omega_{k1}}{2\pi} \int_0^{2\pi/\omega_{k1}} [F_a(t) \cos(\omega_{k1} t + \phi_{k1}) + F_{b1}(t) \sin(\omega_{k1} t + \phi_{k1}) + F_{a2}(t) \cos(\omega_{k2} t + \phi_{k2}) + F_{b2}(t) \sin(\omega_{k2} t + \phi_{k2})] \cos(\omega_{k1} t + \phi_{k1}) dt = \frac{\gamma F_{a1}(t)}{2} + \frac{\gamma\omega_{k1}}{2\pi} \int_0^{2\pi/\omega_{k1}} F_{b1}(t) [1/2 \sin 0 + 1/2 \sin(\omega_{k1} t + \omega_{k1} t + \phi_{k1} + \phi_{k1})] dt + \frac{\gamma\omega_{k1}}{2\pi} \int_0^{2\pi/\omega_{k1}} F_{a2}(t) [1/2 \cos(\omega_{k2} t - \omega_{k1} t + \phi_{k2} - \phi_{k1}) + 1/2 \cos(\omega_{k2} t + \omega_{k1} t + \phi_{k2} + \phi_{k1})] dt + \frac{\gamma\omega_{k1}}{2\pi} \int_0^{2\pi/\omega_{k1}} F_{b2}(t) [1/2 \sin(\omega_{k2} t - \omega_{k1} t + \phi_{k2} - \phi_{k1}) + 1/2 \sin(\omega_{k2} t + \omega_{k1} t + \phi_{k2} + \phi_{k1})] dt \quad (21)$$

If  $\omega_{k2} = N\omega_{k1}$ ,  $N$  being an integer, so that an exact multiple of a period of each carrier elapses during the time interval between  $t=0$  and  $t=T_{k1} = 2\pi/\omega_{k1}$ , all integrals are zero, and the expression reduces to

$$I_0 = \frac{\gamma F_{a1}(t)}{2} \quad (22)$$

In this case, it is to be observed that it is essential to integrate over an entire period of the lowest carrier frequency as, if  $N=2$ , the frequency of terms containing  $\cos(\omega_{k2} t - \omega_{k1} t)$  or  $\sin(\omega_{k2} t - \omega_{k1} t)$  will be  $f_k = \omega_{k1}/2\pi$ , which will not integrate to zero over any shorter interval. (See the note related to (15).)

Similarly

$$I_0 = \frac{\gamma\omega_{k1}}{2\pi} \int_0^{2\pi/\omega_{k1}} e_i \sin(\omega_{k1} t + \phi_{k1}) dt = \frac{\gamma F_{b1}(t)}{2} \quad (23)$$

$$I_0 = \frac{\gamma\omega_{k1}}{2\pi} \int_0^{2\pi/\omega_{k1}} e_i \cos(\omega_{k2} t + \phi_{k2}) dt = \frac{\gamma F_{a2}(t)}{2} \quad (24)$$

and

$$I_0 = \frac{\gamma\omega_{k1}}{2\pi} \int_0^{2\pi/\omega_{k1}} e_i \sin(\omega_{k2} t + \phi_{k2}) dt = \frac{\gamma F_{b2}(t)}{2} \quad (25)$$

Equations (22), (23), (24), and (25) show that if a modulated wave contains a number of carriers in harmonic relationship, each frequency having one cosine and one sine carrier, the modulating component of any one of the carriers may be restored in the receiver and all other components eliminated merely by multiplying the instantaneous value of the wave by the particular carrier to be selected, and integrating the result over one cycle of the lowest carrier frequency.

If this result be expressed in the most general possible terms, then

$$I_0 = \frac{\gamma\omega}{2\pi} \int_0^{2\pi/\omega} [\sum F_{an}(t) \cos(n\omega t + \phi_n) + \sum F_{bn}(t) \sin(n\omega t + \phi_n)] \cos(n\omega t + \phi_n) dt = \frac{\gamma F_{an}(t)}{2} \quad (26)$$

and

$$I_0 = \frac{\gamma\omega}{2\pi} \int_0^{2\pi/\omega} [\sum F_{an}(t) \cos(n\omega t + \phi_n) + \sum F_{bn}(t) \sin(n\omega t + \phi_n)] \sin(n\omega t + \phi_n) dt = \frac{\gamma F_{bn}(t)}{2} \quad (27)$$

Here,  $f = \omega/2\pi$  is taken to be the lowest, or fundamental, carrier frequency in the series of which all other carriers are harmonics. The number of the harmonic is indicated by the value of  $n$ , which may be any integer. Subscript  $a$  identifies modulating components that modulate cosine carriers; subscript  $b$ , modulating components that modulate sine carriers.

Equations (26) and (27) are, of course, a statement of Fourier's theorem. In its most general form, therefore, the principle of (1) to (3) proposes the artificial creation, in the transmitter, of a Fourier series in which each cosine or sine function is a carrier, and each coefficient  $F_{an}(t)$  or  $F_{bn}(t)$  is a modulating component. The resulting complex wave containing all components is transmitted to a receiver, and thus carries, in a single envelope, the intermingled intelligence of all channels. By performing in the receiving demodulator an automatic Fourier analysis, that is, by taking successively the product of the instantaneous value of the wave by the particular carrier selected for demodulation, and integrating, the modulation component of that carrier is restored and all other components are eliminated. It is



to be noted that recourse to the usual tuning methods is not taken in the receiver, the only requirement being that the pass band of the demodulator output shall extend from zero to an upper frequency equal to the highest frequency in the modulation spectrum.

#### MODULATORS AND DEMODULATORS

So far reference has been made only to hypothetical "circuit elements" constituted to bring about the results required. It was inferred in the note related to (4) that the requirements might be fulfilled by "balanced" demodulators of conventional design. Actually, of course, some improvement over such demodulators is required in order to perform the operations of (26) and (27) without introducing objectionable cross modulation. If a complex wave of the type defined by (20) were impressed on the input of a conventional balanced demodulator without previously filtering off the unwanted modulated carrier frequencies, interaction between the various carriers and sidebands in the impressed wave due to the nonlinear characteristic of the demodulator would produce spurious modulation products having frequencies within the acceptance band of the demodulator output filter, thereby causing cross talk and spurious responses. It is true that the use of a balanced demodulator will eliminate even-order cross-modulation products; but products of odd order will be unaffected by the balanced arrangement.

In order to eliminate this effect, it is necessary that the instantaneous plate current of the demodulator be a linear function of the impressed grid voltage  $e_i$  while, at the same time, means are provided for producing in the plate circuit terms representing the product of  $e_i$  and  $e_d$ , the demodulating voltage. These requirements are rather satisfactorily met by demodulators in which the demodulation is performed by electron coupling. For example, in the pentagrid mixer, a suitable choice of operating parameters will result in a linear relationship between the signal-grid (grid 1) to plate transconductance  $g_{m1}$ , and the oscillator-grid (grid 3) voltage  $e_d$  as indicated in Fig. 1. Here it is evident that if the characteristic is substantially a straight line in the operating range selected, as shown,

$$g_{m1} = \gamma(e_d - e_0) \quad (28)$$

where  $e_0$  is the voltage value at which an extension of the straight portion of the characteristic intersects the horizontal axis and  $\gamma$  is a constant representing the slope of the curve. This constant, which might be called the "gamma factor" of the tube, is evidently defined by

$$\gamma = \frac{dg_{m1}}{de_d} \quad (29)$$

and is the rate of change of the signal-grid to plate transconductance with change in oscillator-grid voltage.

The relationship expressed by (28) is, of course, strictly true only for a given, constant value of signal-grid voltage. Variations in signal-grid voltage will also

cause  $g_{m1}$  to vary. However, the characteristics of the 6L7 tube are such that, if the amplitude of the voltage applied to the signal grid is kept small, variations in  $g_{m1}$  due to this cause will be negligible. Nesslage, Herold, and Harris have, in fact, suggested that the tube is suited for use as radio-frequency amplifier where a steep control characteristic is desired without sacrificing the benefits of remote-cutoff operation.<sup>7</sup>

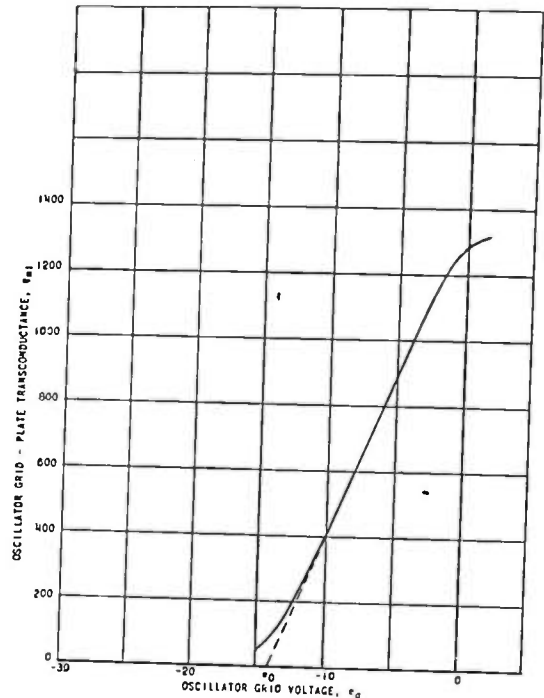

Fig. 1—Signal-grid to plate transconductance  $g_{m1}$  of pentagrid mixer tube 6L7 versus oscillator-grid voltage  $e_d$ .

For small variations of  $e_i$  no more cross modulation should therefore be expected than would be obtained with a remote-cutoff pentode. It is assumed in the following analysis that  $e_i$  will be kept small at all times, and that (28) will accordingly be applicable.

The alternating component of the plate current, due to voltages impressed on the signal grid is, as is well known,

$$i_p = -g_{m1}e_i \frac{r_p}{r_p + R_L} \quad (30)$$

where  $r_p$  and  $R_L$  are the alternating-current plate resistance and the alternating-current load resistance, respectively. The oscillator frequency impressed on the oscillator grid will also be amplified and will appear in the plate circuit, so that the total alternating output current will be

$$i_0 = -(g_{m1}e_i + g_{md}e_d) \frac{r_p}{r_p + R_L} \quad (31)$$

where  $g_{md}$  is the oscillator-grid-plate transconductance.

<sup>7</sup> C. F. Nesslage, E. W. Harold, and W. A. Harris, "A new tube for use in superheterodyne frequency conversion systems," *Proc. I.R.E.*, vol. 24, pp. 207-219; February, 1936.

Now the alternating-current plate resistance of the tube is nominally rated at greater than 1 megohm, and may be expected to remain extremely high for all values of oscillator-grid voltage.<sup>8</sup> Under these conditions,  $R_L$  may be chosen so that it is negligibly small with respect to  $r_p$ , and the factor  $r_p/r_p + R_L$  will approximate unity. Variations in  $r_p$  which may occur during the cycle will therefore have a negligible effect on  $i_0$  and (31) will reduce to

$$i_0 = - (g_{m1}e_i + g_{md}e_d). \tag{32}$$

Substituting the value of  $g_{m1}$  previously derived, we have

$$\begin{aligned} i_0 &= - [\gamma(e_d - e_0)e_i + g_{md}e_d] \\ &= - [\gamma e_d e_i - \gamma e_0 e_i + g_{md}e_d]. \end{aligned} \tag{33}$$

Inspection shows that the first term on the right-hand side of the equation is the product term desired (see (4)), the second term is the amplified input wave, and the third term is the oscillator frequency. All terms are of the first order, and cross modulation will not result between various components of  $e_i$ . It is also noted that the second and third terms represent radio-frequency components which will not pass through the demodulator output filter, so that to all intents and purposes the output of the tube may be represented as

$$i_0 = - \gamma e_i e_d, \tag{34}$$

an equation identical with (4) except for the change in sign brought about by conventional considerations as to the direction of current flow in the plate circuit.

It is therefore suggested that the operations of (26) and (27) may readily be performed practically, and without the creation of undesirable cross modulation, by employing a pentagrid mixer or similar electron-coupled tube, operated in the center of the straight part of the  $g_{m1} - e_d$  curve, in which the input wave

$$\begin{aligned} e_i &= [\sum F_{an}(t) \cos(n\omega t + \phi_n) \\ &+ \sum F_{bn}(t) \sin(n\omega t + \phi_n)] \end{aligned} \tag{35}$$

is impressed on the signal grid (grid 1), and the demodulating wave

$$e_d = \cos(n\omega t + \phi_n) \quad \text{or} \quad e_d = \sin(n\omega t + \phi_n) \tag{36}$$

is impressed on the oscillator grid (grid 3), as indicated in Fig. 2.

It may be of interest to note in passing that the modulation process described in this paper is actually carried out in an indirect manner in conventional nonlinear demodulators. For example, consider the demodulation of a carrier-transmitted wave,

$$e_i = [1 + F(t)]e_k \tag{37}$$

where  $F(t)$  has for brevity been substituted for the more usual  $m \cos(\omega_m t + \phi_m)$  and  $e_k$  for  $E_k \cos(\omega_k t + \phi_k)$ . If this wave is applied to the input of a square-law demodulator, the second-order terms of the alternating component of the output current will be

$$\begin{aligned} i_0 &= k e_i^2 = k \{ [1 + F(t)]e_k \}^2 \\ &= k \{ e_k + F(t)e_k \}^2 \\ &= k \{ e_k^2 + 2F(t)e_k^2 + [F(t)e_k]^2 \} \end{aligned} \tag{38}$$

where  $k$  is a constant depending on the characteristics of the demodulator.

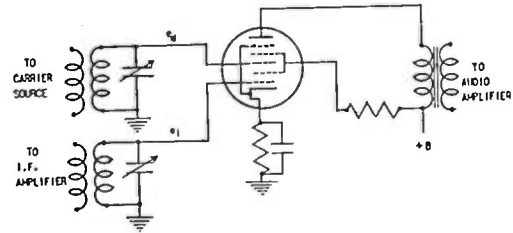

Fig. 2—Linear demodulator employing electron coupling.

It is to be observed that the second term,  $2F(t)e_k^2$ , is identical with the expression under the integral sign in (15), except for the coefficient and the fact that in this case  $F(t)$  is specifically defined as  $m \cos(\omega_m t + \phi_m)$ , while in (15) it may take this meaning or may also be  $[1 + m \cos(\omega_m t + \phi_m)]$ . This term is the only term in the output of a square-law demodulator which leads to useful demodulation products, as the first term produces merely a direct-current component and a component having twice the frequency of the carrier; and the last term contains a large number of cross-modulation products between the various sideband components.

It may therefore be said that (15) merely provides a direct method of carrying out the process which is brought about indirectly, and with the creation of undesirable spurious cross modulation and distortion products, by ordinary nonlinear demodulation techniques.

### PRACTICAL APPLICATIONS

Practical applications of this principle would seem to lie in two fields. First, the creation of a complete series containing a large number of different carrier frequencies would appear to be limited by the radio-frequency pass band of transmitting and receiving equipment. The usefulness of this approach is, therefore, restricted to cases where a limited number of carriers can be employed in a multichannel transmission system, or where the "carrier" frequencies can be made very small, so that a large number of adjacent frequencies can be transmitted in a relatively narrow spectrum. If, for example, the fundamental carrier frequency is taken to be 20 cycles, a total of 500 carriers, each with its own modulation, can be transmitted in a spectrum 10,000 cycles wide. The latter possibility might have application in a facsimile

<sup>8</sup> The author is indebted to R. S. Burnap, Manager, Commercial Engineering, Radio Corporation of America, RCA Victor Division, Harrison, N. J., for this information.

system where each point in the object could be represented by a separate carrier frequency, all carriers being transmitted simultaneously. In such a system the condition qualifying (15), that the period of  $F(t)$  remain large with respect to  $T_k$ , would be valid in spite of the low frequency of the carrier, as  $F(t)$  would be constant.

Second, the presence of both cosine and sine terms in the series offers possibilities in connection with the reduction of the bandwidth of systems operating at conventional radio frequencies.

The following example of an application of the general principle involved is presented by way of clarification and emphasis, and is not necessarily intended to describe a practical workable system possessing advantages with respect to existing systems such that its development and construction would be desirable. It is felt, however, that some of the considerations discussed in connection with this example might be useful in calling attention to general practical approaches which could be employed as a solution of other problems not yet actively being investigated.

### MULTICHANNEL COMMUNICATION SYSTEM

Fig. 3 shows in block form the receiving portion only of a communication system utilizing the implications of (26) and (27). In this system provision is made for eight

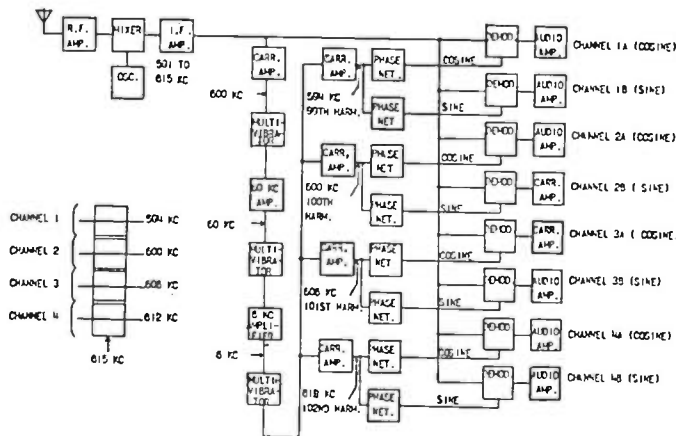

Fig. 3—Multichannel receiver employing selective demodulation.

voice-frequency channels, of which four are operated with cosine carriers, and four with sine carriers. Four carrier frequencies only are provided for the eight channels.

The frequency employed in the radio-frequency section of this receiver may be selected as required, and is accordingly not shown in the figure. It is, however, assumed that the intermediate-frequency amplifier will center at 603 kilocycles, and that the spectrum of the received signal in the intermediate-frequency circuit will be as indicated in Fig. 3. It is seen from this figure that the four carriers have frequencies of 594, 600, 606, and 612 kilocycles, respectively. Double-sideband transmission is used, so that the modulation spectrum

extends 3000 cycles to the side of each carrier, and the acceptance band of the intermediate-frequency amplifier must include frequencies from 591 to 615 kilocycles, a bandwidth of 24 kilocycles. It is assumed that the transmitted wave is of the form of (20), extended to include four carrier frequencies. The carrier may or may not be transmitted, depending upon the degree of cross-talk balance required. It is noted that, since the demodulators are all of the linear type mentioned under the heading "Modulators and Demodulators," demodulation will not result unless the carrier is applied to the oscillator grid, even though the transmitted wave applied to the signal grid contains the carrier. Transmitter design is simplified if the carrier is transmitted, as balanced modulators in the transmitter are not required under these conditions. On the other hand, if a high degree of freedom from cross talk is mandatory it may be necessary to suppress the carrier, as a slight curvature in the signal-grid to plate transconductance characteristic of the demodulator might result in some demodulation independently of the action of the oscillator grid, if the carrier were transmitted.

The received wave, containing the eight modulation envelopes, is impressed in parallel on the signal grids of all the demodulators, a separate demodulator being provided for each channel. Demodulation is effected by applying the appropriate demodulating voltage  $e_d$  to the oscillator grid of each demodulator. This demodulating voltage will, of course, be of the same frequency and phase as the carrier of the particular channel to be demodulated.

Demodulating voltages of the proper frequencies are derived in the following manner:

The output of the intermediate-frequency amplifier is delivered in parallel with the demodulators to a carrier amplifier tuned to the frequency of one of the carriers. This particular carrier must, of course, be transmitted and will be referred to hereafter as the "control carrier." It is not necessary or desirable, however, that a large amount of carrier be provided, and in general it would be expected that the modulation index would be very large. In the figure, the 600-kilocycle carrier has been chosen as the control carrier. It is assumed that all carriers in the transmitter will also have been derived from this same control carrier, in order to maintain a uniform phase standard.

The carrier amplifier is then tuned exactly to 600 kilocycles, by means of crystal tuning if necessary, in order to eliminate the sidebands to the greatest possible extent. The 600-kilocycle output is delivered to a multivibrator operated at the tenth subharmonic, to derive a 60-kilocycle frequency. This wave in turn is impressed on an amplifier sharply tuned to 60 kilocycles for the purpose of further attenuating any sidebands which may have resulted from modulation of the multivibrator.

The output of the 60-kilocycle amplifier is delivered to a second multivibrator, which again reduces the frequency by a factor of 10. The resulting 6-kilocycle wave



passes through a third amplifier tuned sharply to 6 kilocycles. The output of this amplifier should now be entirely free of any sideband components, and should consist of a pure 6-kilocycle wave.

The output of the 6-kilocycle amplifier is now employed to control a third multivibrator at the fundamental frequency of 6 kilocycles. The output of this multivibrator will, therefore, contain harmonics at 6-kilocycle intervals, and if a square wave shape is assumed, the amplitudes of these harmonics will be inversely proportional to the orders of the harmonics. Useful amplitudes may therefore be expected for harmonics as high as the several hundredth.

The 99th harmonic of the final multivibrator stage, having a frequency of 594 kilocycles, is delivered to a carrier amplifier tuned exactly to this frequency, in order to eliminate adjacent harmonics at 600 and 588 kilocycles. The output of the carrier amplifier, which is assumed to be a cosine wave and can be made exactly so by adjusting the "cosine" phasing network, is applied to the oscillator grid of cosine demodulator 1a. The output of this demodulator will, therefore, be the modulation attached to the cosine carrier having a frequency of 594 kilocycles, or in the nomenclature of (20),  $F_{a1}(t)$ . (It is to be noted that strict adherence to the subscript definitions previously established would require that this component be identified as  $F_{a99}(t)$ , but this nomenclature is avoided here because  $F_{a1}(t)$  more satisfactorily associates the modulation with the demodulator involved.)

The output of the 594-kilocycle carrier amplifier is also applied to a "sine" phasing network, which alters the phase 90 degrees. The resulting sine wave is delivered to the oscillator grid of demodulator 1b, so that the output of this demodulator will be the modulation attached to the sine carrier having a frequency of 594 kilocycles, or  $F_{b1}(t)$ .

The 100th harmonic of the final multivibrator stage, having a frequency of 600 kilocycles, is, in a similar manner, selected by a carrier amplifier and applied as a cosine function to demodulator 2a and as a sine function to demodulator 2b, in order to derive modulation components  $F_{a2}(t)$  and  $F_{b2}(t)$ . Similar treatment with respect to the 101st harmonic, 606 kilocycles, and the 102nd harmonic, 612 kilocycles, results in producing at the output of demodulators 3a, 3b, 4a, and 4b, modulation components  $F_{a3}(t)$ ,  $F_{b3}(t)$ ,  $F_{a4}(t)$  and  $F_{b4}(t)$ , respectively.

The demodulators all have acceptance bands extending from 200 to 3000 cycles and cutting off sharply above 3000 cycles in order to eliminate frequencies outside the band. Each is provided with an audio amplifier for the purpose of delivering the audio output to a line or another required termination.

A general appraisal of the merits of this system reveals that a complete eight-channel radio receiver is provided with a total of 30 tubes (double tubes are assumed to be used in the multivibrators), or a ratio of  $3\frac{3}{4}$  tubes per channel. Full advantage of the available

spectrum width is taken, as the eight channels occupy a spectrum 24 kilocycles wide, 3 kilocycles per channel. In part, this spectrum economy is made possible by avoiding the use of input filters and placing the channels immediately adjacent in the spectrum. In part, it is due to the employment of cosine and sine carriers on the same frequency, so that the spectrum is reduced to that required for single-sideband operation. It should be noted that channels may be added to the receiver as required merely by providing an additional demodulator, audio amplifier, and  $\frac{1}{2}$ -carrier amplifier per channel, and broadening the intermediate-frequency stages. For example, 16-channel operation may be arranged with a total of 50 tubes, a ratio of  $3\frac{1}{2}$  tubes per channel. Under these conditions, the bandwidth will be 48 kilocycles. In spite of the wide intermediate-frequency band, the signal-to-noise ratio should be excellent, as only the noise contained in that part of the spectrum occupied by the sidebands being demodulated will appear in the audio output.

Considerable simplification in design is afforded by eliminating filtering ahead of the demodulators. The only filtering employed is in connection with the derivation of the demodulating carriers, and as these carriers contain no modulation components, a simple high- $Q$  tuned circuit is all that is needed to bring about effective filtering, the difficulties of band-pass filter design being avoided. In fact, except for the simple tuned circuits at the demodulator inputs, no band-pass filters are employed in the demodulating section of the receiver, the demodulator output filters being essentially of a low-pass character.

The performance of this system will, of course, depend in practice to a very large extent on the degree of balance that can be maintained. Any variations in phase or balance may produce cross talk or the generation of other spurious products. It appears that cross talk of this type may originate principally from two sources.

First, it is expected that some cross modulation may be produced in the demodulator, due to nonlinearity of the control-grid to plate characteristic. With careful design of the tube it should be possible to limit such cross modulation to a low level, probably 40 decibels below the level of the wanted components. Further attenuation of intelligible cross talk can be brought about by suppressing the carriers, as restoration of the original modulation will not be effected under any conditions unless the carrier is present. If an adequate degree of balance can be maintained in the transmitting balanced modulators under these conditions, the level of the transmitted carrier should not be greater than 30 decibels below the level of the sidebands. It is, therefore, not unreasonable to expect that the level of intelligible cross talk, due to curvature of the demodulator characteristic, should not be higher than 70 decibels below the level of the wanted modulation at the output of the demodulator. Spurious components arising from nonlinearity might be further reduced by employing

a balanced arrangement in the receiving demodulators.

Second, cross talk between the cosine and sine channels on a given frequency will result if exact quadrature is not maintained between the modulated carriers at the transmitter, or if the demodulating carrier does not remain exactly in phase with the modulated carrier at all times. Phase variations in any of these carriers may result from a number of factors, such as selective fading, changes in circuit constants due to temperature variation, and instability of the multivibrators. Of these factors, the last is probably the most important. It is, however, known that it is possible to construct multivibrator systems capable of generating pulses at a pulse repetition frequency of 6000 with a maximum variation in the time position of the pulse not exceeding  $2 \times 10^{-10}$  seconds. At the chosen intermediate frequency of 600 kilocycles, a time interval of this magnitude represents a phase displacement of  $2 \times 10^{-10} \times 6 \times 10^5$  cycles, or about 0 degrees 2.5 minutes. If a phase displacement of this magnitude takes place in the demodulating carrier, the relative amplitude of the undesired modulation having the same carrier frequency will be raised from 0 to  $\sin(\theta^\circ 2.5') = 0.00073$  with respect to the amplitude of the desired modulation, which will remain at 1.00000. The current ratio between the desired and undesired component will be 1370, which represents a difference in level of 63 decibels. It therefore seems reasonable to suppose that, with careful design, the level of undesired modulation components resulting from variations in carrier phase might be kept more than 60 decibels below the level of the desired modulation at the output of the demodulator. It is recognized, of course, that some difficulty might be experienced in practice with the first multivibrator stage, as the initial frequency of 600 kilocycles is somewhat high for reliable multivibrator operation. This difficulty might be surmounted by refinement in the multivibrator design, or by substituting some other type of frequency divider for the first multivibrator stage. It might also be desirable to provide some sort of automatic phase control in order to assure that the multivibrator output will at all times remain in phase with the control carrier. It would appear that a phase control of this type could easily be arranged to operate from any residual direct current in the demodulator output of the "sine" demodulator on the control carrier frequency which might result from phase displacement in the cosine control carrier.

It might, of course, be found desirable to rearrange the frequency and phase allocations indicated in Fig. 3, in order to suit the particular operating conditions required. For example, in two-way service it might be found desirable to reserve all cosine channels for east-to-west operation, allocating the corresponding sine channels to west-to-east operation. Under these conditions, operations in both directions would be on the

same frequencies, and any undesired demodulation products resulting from phase irregularities would appear as side tone or singing rather than as cross talk.

At first glance, it might appear that irregularities in the phase or frequency of the local oscillator of the receiver might produce such a degree of phase unbalance as to render the system inoperative. Consideration of this question confirms, however, that any such irregularities imparted to the modulated carriers will equally affect the control carrier, and hence the demodulating carriers, so that the net effect on the balance of the system will be nil if it be assumed, of course, that the multivibrator system can be designed to keep in step with these irregularities at all times.

Variations in the carrier or local-oscillator frequency will, of course, render separation of the control carrier from the sidebands difficult, as the carrier-amplifier-multivibrator system must be very sharply tuned to produce the required result, and carrier or local-oscillator instability may cause the control carrier to deviate outside the acceptance band of the carrier system. Where extremely high carrier frequencies are involved, it may be necessary to separate the control carrier entirely from the sidebands, placing it several kilocycles distant in the spectrum. The acceptance band of the carrier-amplifier-multivibrator system might then be widened so that deviations of several kilocycles in either carrier or oscillator frequency could be tolerated. It is to be noted that, in a system of this type, expedients of this kind employed to counteract instability will have no effect on the selectivity of the system, as the control carrier and the sidebands deviate together and the selectivity is obtained in the audio system. Difficulties in the design of the intermediate-frequency system may, therefore, be avoided by making the bandwidth of the intermediate-frequency amplifiers much wider than the spectrum of the received signal without impairing the selectivity of the system. It has previously been shown that an increase in intermediate-frequency bandwidth will not increase the signal-to-noise ratio.

In summary, it would appear that, although no system of the type described has been constructed, there are no insuperable obstacles to its successful performance. It is to be expected, of course, that many difficulties not anticipated herein would be encountered if an attempt were made to construct a prototype. Nevertheless, in view of the evident advantages offered, the effort might be justified.

#### ACKNOWLEDGMENT

Acknowledgment is gratefully made to H. W. Albrecht, technical aide to the National Defense Research Committee, Division 15, for his assistance in connection with the design of the circuits for producing and selecting the demodulating carriers of the multichannel transmission system.

# Input Admittance of Cathode-Follower Amplifiers\*

HERBERT J. REICH†, SENIOR MEMBER, I.R.E.

**Summary**—General expressions are derived for the input admittance, conductance, and susceptance of a cathode-follower amplifier, and curves are given that show the effect of frequency and circuit parameters upon the input conductance and the effective input capacitance for typical values of plate resistance, transconductance, and interelectrode capacitances. The analysis shows that a capacitance shunting the load resistance of a cathode-follower amplifier may result in a negative input conductance. If the load capacitance is of the order of magnitude of the interelectrode capacitance or greater, this negative conductance is of the order of  $5 \times 10^{-4}$  mho at frequencies at which  $\omega C_{pk}$  is of the order of  $2 \times 10^{-3}$  mho and above. For typical values of  $C_{pk}$  this value of  $\omega C_{pk}$  corresponds to frequencies of the order of 50 megacycles and above. Negative conductance of this magnitude may readily cause oscillations in the input circuit unless preventive measures are taken. A number of such measures are discussed.

ONE IMPORTANT function of cathode-follower amplifiers is to provide a very high input impedance. For this reason a knowledge of the effect of circuit and tube parameters upon the input admittance of cathode-follower amplifiers is useful. Furthermore, since the input conductance of a cathode-follower stage may be negative and may therefore lead to oscillation in input circuits, it is important to determine the manner in which low values of negative input conductance may be avoided.

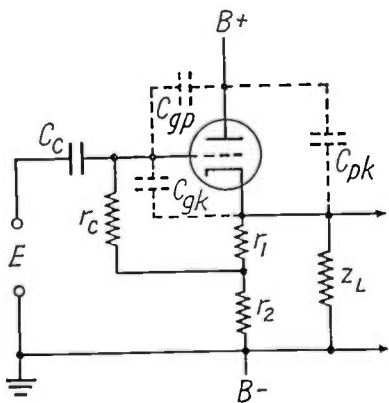

Fig. 1—Cathode-follower amplifier with tapped cathode resistor.

Fig. 1 shows the complete circuit of the most commonly used form of practical cathode-follower stage. The impedance  $z_L$  is the total effective impedance of the external circuit coupled to the output of the stage. The input admittance is intermediate between that obtained when  $r_c$  connects to the cathode, as in Fig. 2, and that obtained when  $r_c$  connects to ground. For the latter connection the admittance is the sum of the conductance  $1/r_c$  and the admittance for infinite  $r_c$ , which may be found from the expression derived for the former

\* Decimal classification: R139.21. Original manuscript received by the Institute, January 8, 1946; revised manuscript received, January 8, 1947.

† Department of Electrical Engineering, Yale University, New Haven, Connecticut.

connection. Because of the much greater complexity of the general formula for the circuit of Fig. 1, the following analysis is based upon the simplified circuit of Fig. 2. In this circuit  $r_1$  is zero. The reactance of the coupling capacitor  $C_c$  is assumed to be negligible throughout the frequency range considered.

Under the assumption that the reactance of  $C_c$  is negligible, application of the equivalent-plate-circuit

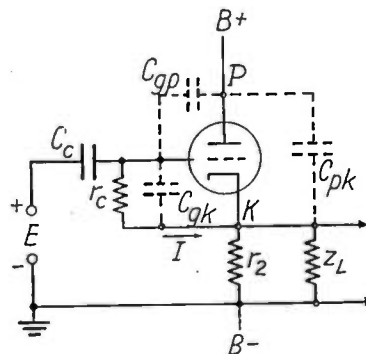

Fig. 2—Cathode-follower amplifier in which the grid resistor is connected to the cathode.

theorem to the circuit of Fig. 2 yields the parallel equivalent plate circuit of Fig. 3 at frequencies below those at which electron-transit time must be considered.<sup>1</sup> In this circuit,  $r_p$  is the alternating-current plate resistance of the tube,  $g_m$  the transconductance, and  $z_b$  the

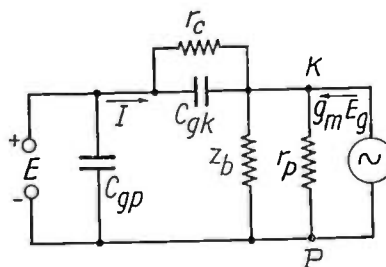

Fig. 3—Equivalent plate circuit for the circuit of Fig. 2 when the reactance of  $C_c$  is negligible.

impedance of the parallel combination of  $r_2$ ,  $z_L$ , and  $C_{pk}$ . The tube factors  $r_p$  and  $g_m$  are assumed to be constant. The total load admittance  $1/z_b$  may be written in the form

$$\frac{1}{z_b} = y_b = g_b + jb_b = g_b + j \left( \omega C_b - \frac{1}{\omega L_b} \right)$$

in which  $C_b$  and  $L_b$  are the capacitance and the inductance of a parallel combination of resistance, capacitance, and inductance equivalent to the actual total load, including  $r_2$  and  $C_{pk}$ .

<sup>1</sup> H. J. Reich, "Equivalent-plate-circuit theorem," Proc. I.R.E., vol. 33, p. 136-138; February, 1945.



Summation of voltages in the circuit of Fig. 3 yields the equation

$$E = I \frac{r_c}{j\omega r_c C_{cb} + 1} + (I + g_m E_o) \frac{1}{y_b + g_p} \quad (1)$$

where  $g_p = 1/r_p$ . It is apparent from Fig. 2 that the alternating grid voltage  $E_o$  is the voltage drop produced by the flow of the current  $I$  through the parallel combination of  $r_c$  and  $C_{cb}$ . Therefore,

$$E_o = I r_c / (j\omega r_c C_{cb} + 1). \quad (2)$$

Solution of (1) and (2) gives the following relation for the input admittance:

$$y_i = g_i + jb_i = j\omega C_{cb} + \frac{I}{E} = j\omega C_{cb} + \frac{y_b + g_p}{1 + \frac{r_c}{j\omega r_c C_{cb} + 1} (y_b + g_p + g_m)} \quad (3)$$

Manipulation of (3) gives the following expressions for the effective input conductance  $g_i$  and the input susceptance  $b_i$ :

$$g_i = (1 + 1) \frac{(g_p + g_b) \left(1 + \frac{r_c s + 1}{1}\right) - \frac{m^2}{r_c} - m s r_c}{1 \left[ m + 1 + \frac{r_c s - 1}{1} \right]^2 - (m - r_c s)^2} \quad (4)$$

$$b_i = \omega \left[ C_{cb} + C_{cb} (1 + 1) \frac{m \left( m + 1 + \frac{r_c s - 1}{1} \right) - \frac{g_p + g_b (s r_c)^2}{1}}{1 \left( m + 1 + \frac{r_c s - 1}{1} \right)^2 - (m - r_c s)^2} \right] \quad (5)$$

where

$$m = \frac{b_b}{\omega C_{cb}} = \frac{C_{cb}}{C_{cb}} - \frac{1}{\omega^2 C_{cb} L_b} \quad (6)$$

$$1 = \omega^2 r_c^2 C_{cb}^2 \quad (7)$$

$$s = g_p + g_b + g_m \quad (8)$$

Examination of (4) shows that the input conductance may be negative if  $m$  is positive, i.e., if the load is capacitive, but is always positive if the load is inductive. Equation (5) shows that the input susceptance is always positive, or capacitive.

Several limiting cases are important:

(a) When  $r_c$  becomes infinite, (4) and (5) reduce to

$$g_i = \frac{g_p + g_b - m g_m}{(m + 1)^2 + \frac{s^2}{\omega^2 C_{cb}^2}} \quad (4a)$$

$$b_i = \omega \left[ C_{cb} + C_{cb} \frac{m(m + 1) + \frac{(g_p + g_b)s}{\omega^2 C_{cb}^2}}{(m + 1)^2 + \frac{s^2}{\omega^2 C_{cb}^2}} \right] \quad (5a)$$

(b) As the frequency is increased,  $g_i$  approaches the limiting value

$$g_i \Big|_{\infty} = \frac{g_p + g_b + m^2 g_c - m g_m}{(m + 1)^2} \quad (9)$$

(c) As the frequency approaches zero,  $g_i$  approaches the value

$$g_i \Big|_0 = g_c \frac{g_p + g_b}{g_m + g_p + g_b + g_c} \quad (10)$$

where  $g_c = 1/r_c$ .

Because sustained oscillation will be set up in an oscillatory circuit shunted by a negative conductance if the magnitude of the negative conductance exceeds the positive conductance of the circuit at resonance, it is important to analyze in some detail the input conductance when the load is capacitive, i.e., when  $m$  is positive. In Figs. 4 and 5 are shown typical curves of the input conductance at infinite frequency as a function of  $m$  for capacitive load. The type 6AG5 tube, connected as a triode and as a pentode and used with low and high

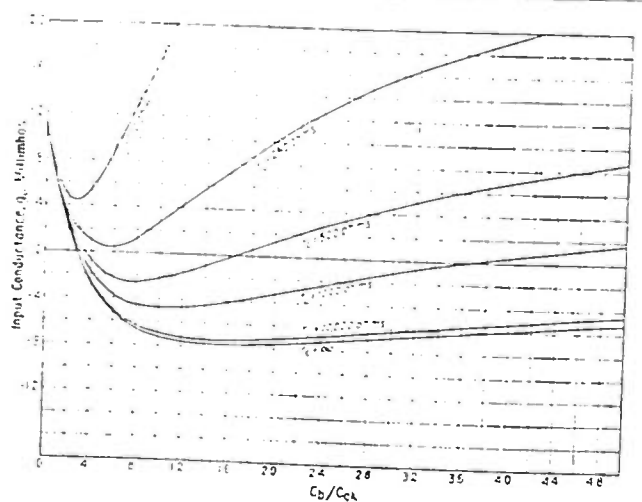

Fig. 4—Limiting value of input conductance  $g_i$  approached at high frequency (transit-time effects neglected). Triode-connected 6AG5;  $g_m = 4 \times 10^{-2}$  mho,  $g_p = 10^{-1}$  mho,  $g_b = 10^{-3}$  mho.

values of load resistance, gives four combinations of tube and circuit parameters typical of those likely to be encountered in practice.

The minima in the curves of Figs. 4 and 5 occur for a value of  $m$  given by the relation

$$m = C_b/C_{gk} = \frac{g_m + 2(g_p + g_b)}{g_m + 2g_c} \quad (11)$$

By substituting (11) into (9) and making  $r_c$  infinite, the maximum negative value of  $g_i$  is found to be

$$\max g_i = -g_m^2/4s = -g_m^2/4(g_m + g_p + g_b) \quad (12)$$

The magnitude of the negative conductance indicated by Figs. 4 and 5 is sufficiently great to make possible sustained oscillation in oscillatory circuits having values of  $Q$  normally encountered. Such oscillations are frequently observed in cathode-follower amplifiers not provided with damping resistance in the grid circuit.<sup>2</sup>

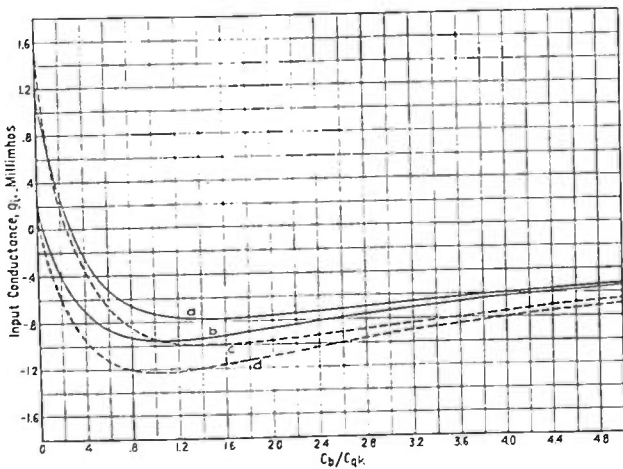

Fig. 5—Limiting value of input conductance  $g_i$  approached at high frequency (transit-time effects neglected).  $r_c = \infty$ .  
 (a) Triode-connected 6AG5;  $g_m = 4 \times 10^{-3}$  mho,  $g_p = 10^{-4}$  mho,  $g_b = 10^{-3}$  mho.  
 (b) Triode-connected 6AG5;  $g_m = 4 \times 10^{-3}$  mho,  $g_p = 10^{-4}$  mho,  $g_b = 10^{-4}$  mho.  
 (c) Pentode-connected 6AG5;  $g_m = 5 \times 10^{-3}$  mho,  $g_p = 1.25 \times 10^{-6}$  mho,  $g_b = 1.25 \times 10^{-3}$  mho.  
 (d) Pentode-connected 6AG5;  $g_m = 5 \times 10^{-3}$  mho,  $g_p = 1.25 \times 10^{-6}$  mho,  $g_b = 10^{-4}$  mho.

Fig. 6, derived by the use of (4) and (4a), shows the manner in which the input conductance varies with the product  $\omega C_{gk}$  for the tube and load-resistance values used in obtaining Fig. 4. The curves shown in Fig. 6 are for a value of  $C_c/C_{gk}$  equal to 2. Change of this ratio over a considerable range does not greatly affect the form of the curves. Changes of tube factors and of load affect the curves principally in the magnitude of the negative conductance. Examination of Fig. 6 and similar curves for other values of tube factors and load resistance shows that negative conductance of appreciable magnitude is obtained for values of  $\omega C_{gk}$  of the order of  $2 \times 10^{-3}$  mho and above. For typical values of  $C_{gk}$  this value of  $\omega C_{gk}$  corresponds to frequencies of the order of 50 megacycles and above.

<sup>2</sup> K. Schlesinger, "Cathode-follower circuits," Proc. I.R.E., vol. 33, pp. 843-855; December, 1945. It is of interest to note that the circuit may also be analyzed as a form of Colpitts oscillator.

From (5) the effective input capacitance is seen to be

$$C_i = C_{gp} + C_{gk}(A+1) \frac{m \left( m+1 + \frac{r_c g_m + 1}{A} \right) + \frac{(g_p + g_b) s r_c^2}{A}}{A \left( m+1 + \frac{r_c s + 1}{A} \right)^2 + (m - r_c s)^2} \quad (13)$$

$$= C_{gp} + C_i'$$

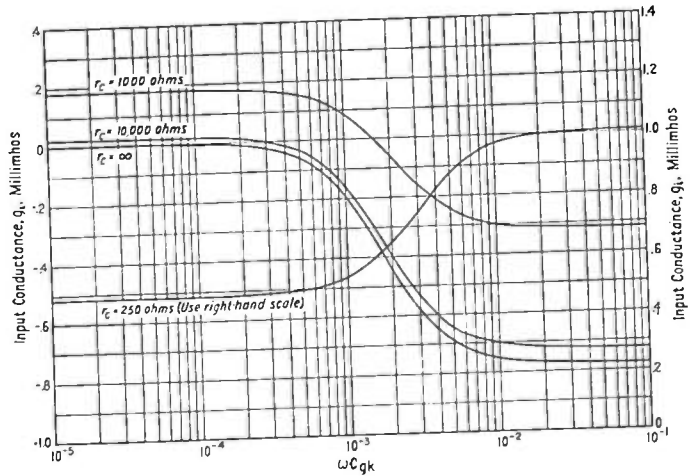

Fig. 6—Input conductance  $g_i$  as a function of  $\omega C_{gk}$  (transit-time effects neglected). Triode-connected 6AG5;  $g_m = 4 \times 10^{-3}$  mho,  $g_p = 10^{-4}$  mho,  $g_b = 10^{-3}$  mho,  $C_b/C_{gk} = 2$ .

Since  $C_{gp}$  is independent of load and frequency, it is sufficient to analyze the expression for  $C_i'$ , which may be written in the form

$$\frac{C_i'}{C_{gk}} = (A+1) \frac{m \left( m+1 + \frac{r_c g_m + 1}{A} \right) + \frac{(g_p + g_b) s r_c^2}{A}}{A \left( m+1 + \frac{r_c s + 1}{A} \right)^2 + (m - r_c s)^2} \quad (14)$$

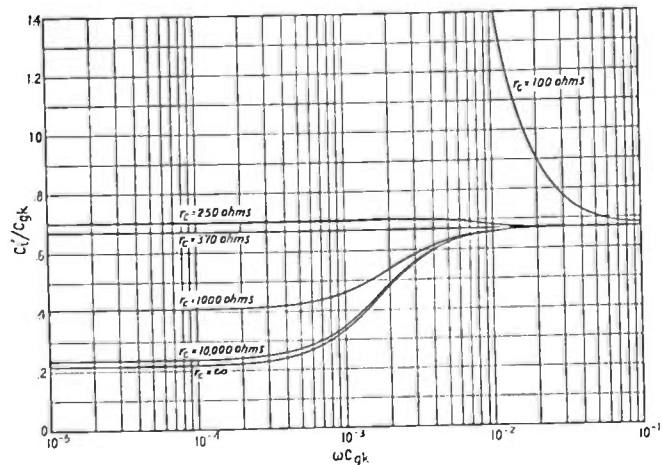

Fig. 7— $C_i'/C_{gk}$  as a function of  $\omega C_{gk}$  (transit-time effects neglected). Triode-connected 6AG5;  $g_m = 4 \times 10^{-3}$  mho,  $g_p = 10^{-4}$  mho,  $g_b = 10^{-3}$  mho,  $C_b/C_{gk} = 2$ .

As  $\omega C_{gk}$  becomes infinite, (14) reduces to

$$\frac{C_i'}{C_{gk}} = \frac{m}{m+1} \quad (15)$$

As  $\omega C_{\sigma k}$  approaches zero, (14) reduces to

$$\frac{C_i'}{C_{\sigma k}} = \frac{m(r_c g_m + 1) + (g_p + g_b)sr_c^2}{(r_c s + 1)^2} \quad (16)$$

Fig. 7 shows curves of  $C_i'/C_{\sigma k}$  for the same tube and circuit parameters as those used for Figs. 4 and 6. Curves for other values of tube factors and load resistance are of the same form, but differ in the value of  $C_i'/C_{\sigma k}$  approached at low values of  $\omega C_{\sigma k}$ . Examination of these curves or of (6) discloses that the effective input capacitance decreases with increase of  $r_c$  and of  $1/g_b$ , which is usually nearly equal to  $r_2$ . At values of  $\omega C_{\sigma k}$  below  $10^{-4}$  mho,  $C_i'$  becomes very small for large values of  $r_c$  and  $r_2$ , and the total effective input capacitance approaches the value  $C_{\sigma p}$ .

The tendency of a cathode-follower stage to oscillate can be prevented either by insuring that the shunt impedance of any oscillatory circuit shunting the input is low or by making the magnitude of the total negative input conductance of the tube small in one of the following ways:

(1) By using tubes of low transconductance (see (12)). This method is in general impractical because high transconductance is desirable in cathode-follower amplifiers for other reasons.

(2) By using a low value of cathode load resistance

(see (12)). This method is feasible in some applications of cathode-follower amplifiers.

(3) By using low capacitance across the cathode load resistor (see Fig. 4). The load capacitance cannot, however, be reduced below the sum of the plate-cathode capacitance and the minimum circuit-wiring capacitance.

(4) By using a sufficiently low value of  $r_c$  so that the positive conductance resulting from  $r_c$  is equal to or nearly equal to the negative conductance resulting from  $C_{\sigma k}$ . The principal objection to this method is that it increases the conductance at low frequencies to an excessively large positive value.

(5) By using resistance in series with the grid. Ordinarily a series resistance of less than 100 ohms is sufficient to prevent oscillation. This value is small enough so that frequency distortion resulting from voltage drop in the series resistance at high frequency is negligible. This method is obviously the most feasible.

Oscillation may also be prevented by insuring that the sum of the tube input susceptance and the susceptance of the input circuit is not zero, i.e., that resonance does not occur, in the frequency range in which the input conductance of the tube is negative. Since Fig. 6 shows that the magnitude of negative input conductance increases with frequency, it is apparent that this can be accomplished only by lowering the resonance frequency of the input circuit.

## An Exponential Transmission Line Employing Straight Conductors\*

WILBUR NORMAN CHRISTIANSEN†

**Summary**—An exponential transmission line is useful for impedance transformations over a wide band of radio frequencies.

It is shown that a four-wire line of the "side-connected" type employing uniform conductors, and in which the rates of taper change only once along the line, may be designed to approximate closely to an exponential line.

Design equations and charts are given which aid in determining the wire sizes, values of taper, and change in taper for building some of these transformers.

### I. INTRODUCTION

IN RECENT years the increasing use in short-wave radio communication of semiaperiodic antennas, principally of the rhombic type, has resulted in attention being given to impedance-transforming devices useful over a large range of radio frequencies.

Wide-band transformers can now be constructed to

\* Decimal classification: R117.17. Original manuscript received by the Institute, October 15, 1945; revised manuscript received, September 20, 1946.

† Research Laboratories, Amalgamated Wireless (Australasia), Ltd., Melbourne, Australia.

achieve any normally required impedance transformation in the useful frequency range of the antennas. These transformers are designed to have a high coefficient of coupling between primary and secondary windings, and this makes difficult their application where high radio-frequency voltages are present. Hence broad-band transformers using closely coupled coils are normally not used with transmitting antennas.

The useful impedance-transforming properties of the exponential horn in acoustics suggested<sup>1</sup> the analogous application of the principle to electrical transmission lines. Various types<sup>2-5</sup> of open-conductor exponential

<sup>1</sup> C. W. Hansell, "Coupling devices for use in high-frequency circuits," Australian Patent 18,994/29, March, 1929.

<sup>2</sup> C. R. Burrows, "The exponential transmission line," *Bell Sys. Tech. Jour.*, vol. 17, pp. 555-573; October, 1938.

<sup>3</sup> M. S. Neiman, "Non-uniform lines with distributed constants," *Izvestiya Electroprom. Slab. Toka*, pp. 14-25; 1938.

<sup>4</sup> H. A. Wheeler, "Transmission lines with exponential taper," *Proc. I.R.E.*, vol. 27, pp. 65-71; January, 1939.

<sup>5</sup> A. R. Volpert, "Lines with non-uniformly distributed parameters," *Elektrsvyaz*, pp. 40-65; 1940.



lines, and cable<sup>6</sup> have been described in the literature, all requiring more or less complicated shaping of the conductors.

The exponential line described in the present paper is of the balanced open-wire type. Its application is principally to the transformation required where a two-wire balanced line branches into a pair of lines. Such branching of feeders will occur, for example, where several rhombic antennas are arranged in an array and are to be fed from a common transmitter.

The object of the development to be described was to produce, for a 300- to 600-ohm transformation, an exponential line which would have convenient physical dimensions, would be easy to construct, and which would not require complicated shaping, or changes in the diameter of conductors.

## II. ELECTRICAL CHARACTERISTICS OF AN EXPONENTIAL LINE

An exponential transmission line has the capacitance and inductance per unit length of line varying in a manner such that

$$Z_{0x} = Z_{00}e^{\delta \cdot x} \quad (1)$$

where  $x$  is the distance from the origin of the point considered,  $Z_{0x}$  is the "nominal characteristic impedance" of the line at a point  $x$  along its length, and  $Z_{00}$  is the nominal characteristic impedance at  $x=0$ , i.e., at the end of the line. (The "nominal characteristic impedance" is equal to the characteristic impedance of a uniform transmission line having the same dimensions as the variable line at the point considered.)

$$\frac{Z_{0l}'}{Z_{00}} = \frac{1 + \sqrt{1 - \nu^2} - (1 - \sqrt{1 - \nu^2}) \cos 2\beta l \sqrt{1 - \nu^2} + \nu \sin 2\beta l \sqrt{1 - \nu^2} - j \{ \nu - \nu \cos 2\beta l \sqrt{1 - \nu^2} - (1 - \sqrt{1 - \nu^2}) \sin 2\beta l \sqrt{1 - \nu^2} \}}{1 + \sqrt{1 - \nu^2} - (1 - \sqrt{1 - \nu^2}) \cos 2\beta l \sqrt{1 - \nu^2} - \nu \sin 2\beta l \sqrt{1 - \nu^2} + j \{ \nu - \nu \cos 2\beta l \sqrt{1 - \nu^2} + (1 - \sqrt{1 - \nu^2}) \sin 2\beta l \sqrt{1 - \nu^2} \}} \cdot e^{-2\gamma l \sqrt{1 - \nu^2}} \quad (6)$$

From (1) it follows that

$$\delta = \log_e \frac{Z_{0l}/Z_{00}}{l} \quad (2)$$

where  $l$  is the physical length of the line and  $Z_{0l}$  refers to the remote end of the line. It has been demonstrated<sup>2-4</sup> that such a line behaves as an impedance-transforming high-pass filter with a cut-off frequency  $f_c$ , given by

$$f_c = \frac{1}{2\pi} \cdot \nu \cdot \frac{\delta}{2} = \frac{\nu \log_e Z_{0l}/Z_{00}}{4\pi l} \quad (3)$$

where  $\nu$  is the phase velocity of wave propagation along the line for very high frequencies, i.e., for frequencies where the change in  $Z_{0x}$  per wavelength is very small. It may be noted that  $\nu$  is assumed to be constant along the length of the exponential line. This implies that the line has low dissipation and unchanging dielectric.

<sup>6</sup> E. Keutner, "Hochfrequenzkabel mit veränderlichem Wellenwiderstand," E.F.D. 62 Folge: pp. 3-9; March, 1943.

For an open-wire line, (3) becomes approximately

$$f_c = \frac{55.0 \log_{10} Z_{0l}/Z_{00}}{l} \text{ megacycles} \quad (4)$$

where the unit of length is the meter. The useful impedance-transforming property of the exponential line appears as follows. If one end of the line is terminated in a load equal to  $Z_{0l}$ , then for frequencies much greater than  $f_c$  the driving-point impedance at the input to the line approximates very closely to  $Z_{00}$ , the nominal characteristic impedance at the input end of the line. As the frequency is decreased towards  $f_c$ , increasing deviations occur in the driving-point impedance from the value of  $Z_{00}$ .

From the analysis of Burrows<sup>2</sup> it may be shown that the frequencies at which these deviations occur are related mainly to the length of the line, while the magnitude of the deviations depends on the rate of line taper. For the line terminated with a resistance equal to  $Z_{0l}$ , it was shown by Burrows that the ratio of the driving point impedance  $Z_{0l}'$ , at the input to the line to the nominal characteristic impedance at that point is

$$\frac{Z_{0l}'}{Z_{00}} = \frac{1 + \sqrt{1 - \nu^2} - j\nu - (1 - \sqrt{1 - \nu^2} - j\nu)e^{-2\gamma l \sqrt{1 - \nu^2}}}{1 + \sqrt{1 - \nu^2} + j\nu - (1 - \sqrt{1 - \nu^2} + j\nu)e^{-2\gamma l \sqrt{1 - \nu^2}}} \quad (5)$$

where  $\nu = f_c/f$  and is less than unity,  $\gamma$  = the propagation constant of the line at frequencies very large compared with  $f_c$ , and for the line considered is approximately equal to  $j\beta$ ,  $\beta$  being the phase-change coefficient, at such high frequencies.

On putting the exponentials into the trigonometric form, we obtain

When  $\nu = 0$ ,  $Z_{0l}'/Z_{00} = 1$ .

When

$$\sin 2\beta l \sqrt{1 - \nu^2} = 0,$$

$$\text{i.e., } 2\beta l \sqrt{1 - \nu^2} = n\pi, \quad n \text{ being an integer,} \quad (7)$$

$Z_{0l}'/Z_{00}$  is equal to unity or  $(1 - j\nu)/(1 + j\nu)$ , depending on whether  $n$  is even or odd. In either case  $|Z_{0l}'/Z_{00}|$  is equal to one.

The magnitude of the input impedance is, therefore, equal to the nominal characteristic impedance of the line at the input for frequencies

$$f = \{(nv/4l)^2 + f_c^2\}^{1/2}. \quad (8)$$

It approaches unity also for all values of  $\beta l$  as  $\nu$  approaches zero, i.e., as  $f$  approaches infinity.

If  $f$  is large compared with  $f_c$ , (8) becomes approximately

$$f = n/4 \cdot \nu/l; \quad (9)$$

i.e., frequencies  $f$  are those for which the line is an integral number of quarter waves in length.

If  $f$  is large compared with  $f_c$ , we may use the approximation  $\sqrt{1-\nu^2}=1$ , and (6) then becomes

$$\frac{Z_0'}{Z_{00}} = \frac{2 + \nu \sin 2\beta l - j\nu(1 - \cos 2\beta l)}{2 - \nu \sin 2\beta l + j\nu(1 - \cos 2\beta l)} \quad (10)$$

and

$$|Z_0'/Z_{00}| = \left\{ \frac{2 + \nu^2(1 - \cos 2\beta l) + 2\nu \sin 2\beta l}{2 + \nu^2(1 - \cos 2\beta l) - 2\nu \sin 2\beta l} \right\}^{1/2} \quad (11)$$

and this has maximum values of approximately  $(1+\nu)$  when

$$2\beta l = \frac{4n+1}{2} \pi,$$

i.e., when

$$f = \frac{4n+1}{8} \frac{v}{l} \quad (12)$$

Similarly, minimum values of approximately  $1/(1+\nu)$  occur when

$$f = \frac{4n-1}{8} \frac{v}{l} \quad (13)$$

The above calculations are for  $\delta$  positive, i.e., the impedance  $Z_0'$  is considered at the low-impedance end of the line. For impedances at the high-impedance end,  $\delta$  is negative, since the line is then convergent. The sign of  $\nu$  is changed in (5), thereby inverting it. Hence the values of  $Z_0'/Z_{00}$  corresponding to the frequencies (12) and (13) are also inverted.

It was shown by Wheeler<sup>4</sup> that if the exponential line is placed between the elements of a half section of a constant- $K$  low-pass filter, and in addition an  $M$ -derived half section is connected at each end of the system, it is possible to keep the impedance (resistance) deviations within 5 per cent of the required value for all frequencies 15 per cent or more above the cut-off frequency.

Where it is desired to limit the length of the exponential line, or where exact matching is required, such terminating sections have useful application. In many cases, however, it is simpler to use a line of such a length that the working frequency is always very high compared with the cut-off frequency of the line so that a purely resistive line termination may be used.

### III. THE DESIGN OF AN OPEN-WIRE EXPONENTIAL LINE FOR A 2-TO-1 IMPEDANCE TRANSFORMATION

#### (a) Previous Designs

The transformation from 600 to 300 ohms with an open-wire exponential line is made difficult by the fact that the construction of a two-wire line with the latter value of characteristic impedance involves the employment of inconvenient physical dimensions for the line, while if a multiple-wire line is used, the same difficulty is experienced at the high-impedance end.

If a two-wire line is designed to provide such a transformation, the ratio of wire separation  $d$  to the radius  $r$  must change from 150/1 to 12/1 over the length of the line. In many applications of such a line the wire separation cannot be reduced below a value of several inches if mechanical instability and the danger of dielectric breakdown are to be avoided. Hence, for  $d/r=12$ , tubing rather than wire must be used in the construction of the line.

Burrows<sup>2</sup> constructed a two-wire exponential transmission line in which conductors with large radii were used at the low-impedance end of the line, the conductor radius being reduced at intervals along the line towards the high-impedance end. By this means the conductor spacing was kept at convenient values throughout the length of the line. Small discontinuities existed at the points where the conductor size was altered, but these were not serious as was shown by the fact that Burrows successfully approached the performance predicted by theory for the exponential line.

Another design for an exponential line for use where one feeder line branches into two was suggested by Neiman.<sup>3</sup> In this line the two 600-ohm-line pairs approach each other from a great distance in such a manner that the resultant four-wire line has an exponential characteristic. The pairs theoretically are required to coalesce to form a single 600-ohm pair at the high-impedance end of the line, but in practice a special two-wire section could be used to overcome this. The shaping of the line is done with tension spacers connecting the two pairs of lines. No change in the size of conductors is required with this line, except possibly for the section at the high-impedance end.

#### (b) Design Employing Straight Conductors

The exponential line to be described here<sup>7</sup> is based on the type of four-wire transmission line in which parallel connections are made between the wires of each adjacent



Fig. 1—Cross sections of a four-wire transmission line.

pair, instead of between diagonal wires as in the more commonly used four-wire transmission line. The arrangement of wires is shown in Fig. 1. If it is assumed that the spacings  $d$  and  $b$  are large compared with the wire radius  $r$ , and that dissipation in the line is negligible, then the characteristic impedance may be calculated from the expression

$$Z_0 = \sqrt{\frac{L}{C}} = \frac{1}{cC} \text{ ohms,} \quad (14)$$

<sup>7</sup> Australian Patent No. 121,850.

$L$  and  $C$  being respectively the inductance (henries) and capacitance (farads) per centimeter length of line, and  $c = 3 \times 10^{10}$  centimeters. The calculation of the capacitance per unit length of line may be done by the method of logarithmic potential to give

$$\frac{1}{C} = 2 \log_e \left( \frac{d\sqrt{b^2 + d^2}}{br} \right) \text{ statfarad per centimeter}$$

$$= 2c^2 \log_e \left( \frac{d\sqrt{b^2 + d^2}}{br} \right) \cdot 10^9 \text{ farad per centimeter. (15)}$$

Therefore,

$$Z_0 = 138 \log_{10} \left( \frac{d\sqrt{b^2 + d^2}}{br} \right). \quad (16)$$

For the production of an exponential line,  $d$  and  $b$  may both vary with the distance  $x$  along the line, while  $r$  preferably is fixed.

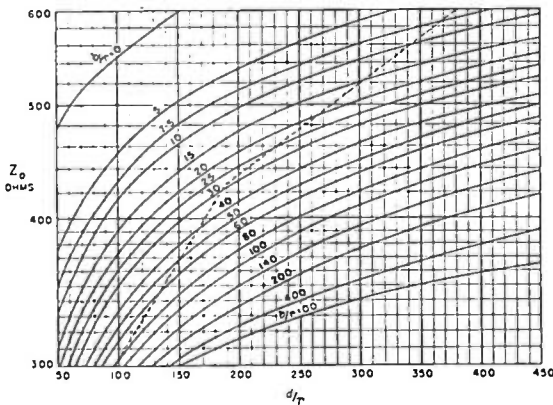

Fig. 2—Characteristic impedance of a four-wire (side-connected) transmission line for various values of conductor spacing.

It is obvious that the construction of an exponential line is greatly simplified if  $b$  and  $d$  can be arranged to vary linearly with  $x$  over appreciable ranges of variation of  $x$ , without causing  $Z_{0x}$  to depart appreciably from the exponential form. To investigate this, use is made of the graphical construction of Fig. 2, in which  $Z_0$  is plotted on a logarithmic scale against  $d/r$  for various values of  $b/r$ . (For the ratio of  $b/r = 5$  it might be suspected that equation (16), which was based on the assumption that  $b$  and  $d$  were both very large compared with  $r$ , would no longer be accurate. However, a field plot for this spacing shows that the error in  $Z_0$  resulting from the use of (16) is only about 1 per cent.)

If it is stipulated that  $d/r$  is to change linearly with the distance  $x$  along the feeder, then a straight line drawn on the graph represents a linear change of  $\log Z_{0x}$  with respect to  $x$ , or  $Z_{0x} = Ae^{Bx}$  ( $A$  and  $B$  being constants), which represents an exponential transmission line.

If, moreover, a straight line can be drawn on Fig. 2 so that the contours representing equal arithmetic intervals of  $b/r$  make equal intercepts on it, then the straight line on the graph represents an exponential

transmission line in which  $b/r$  is related linearly to  $d/r$  and hence to  $x$ . Such a transmission line, therefore, would be constructed wholly of straight conductors.

It is found that a large number of lines can be drawn to fulfill approximately this condition over part of the impedance range of 300 to 600 ohms. Consideration must be given, however, to the use of the values of  $d/r$  and  $b/r$  that are convenient in practice.

The straight lines drawn on Fig. 2 represent a transformation from 300 to 600 ohms done in two sections, the division being made at the point where  $Z_{0x} = \sqrt{Z_{00}Z_{0l}} = 424$  ohms approximately, which is the physical center of the exponential line.

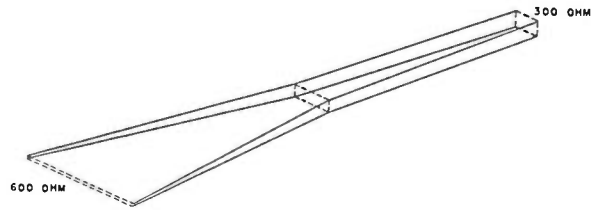

Fig. 3—Outline diagram of the exponential line described.

The configuration of the line is illustrated in Fig. 3. In Table I are shown the values of  $d/r$  and  $b/r$  at the ends and center of the exponential line. To illustrate the physical dimensions of a typical line, spacings are given for a line with conductors of No. 10 American Wire Gauge wire (0.102 inch).

TABLE I

Distance along feeder	$X = x/l$	0	0.5	1.0
Nominal characteristic impedance	$Z_{0x}$	300	424	600
Spacing	$d/r$	95	185	385
Spacing	$b/r$	80	30	6.5
For No. 10 A.W.G. wire	$d$	4.8"	9.4"	19.6"
For No. 10 A.W.G. wire	$b$	4.1"	1.53"	0.33"

In the exponential line represented by the straight lines on Fig. 2,  $b/r$  changes almost linearly. Hence we may approximate it with a feeder line in which  $b/r$  is actually linear, i.e., we may use straight conductors between the center and each end of the line. That the impedance variation along the resultant line follows very closely the exponential form is demonstrated in Fig. 4. The straight line represents an exponential change of impedance along the transmission line, while the points adjacent to the line are those calculated for a line having the form described above. The maximum departure of the impedance level along the "straight-wire" line from the corresponding values for a true exponential line is only one part in a hundred.

The exponential line described above requires to be supported only at the ends and the center. In a practical design, of course, it may be found necessary to use a greater number of supports.



Consider the design of a line to be used for impedance transformation in the range of frequencies from 6 to 20 megacycles. If terminating filter sections of the type indicated by Wheeler<sup>4</sup> are used, then 5 megacycles may be chosen as the cut-off frequency for the line. From (4) we find that  $l = 3.3$  meters, approximately. It should be noted, however, that with such a short length of line the size of conductors would have to be small; otherwise the conductor spacings would become comparable with the length of the line, and the transmission-line equations would no longer apply.

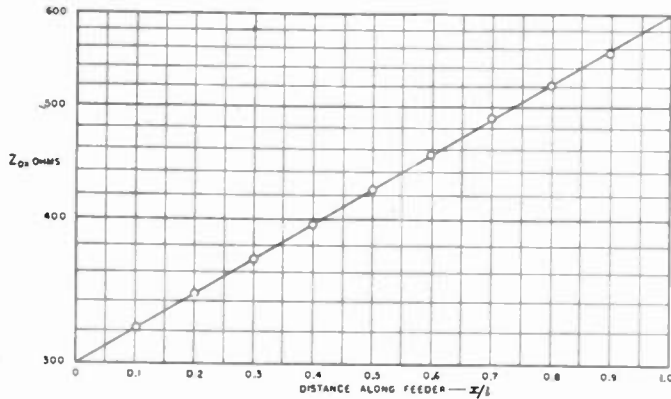

Fig. 4—Variation of nominal characteristic impedance along an ideal exponential line (full line) and "straight-wire exponential line" (small circles).

If it is not desired to use filter sections at the line terminations, then the cut-off frequency must be made considerably lower than the lowest working frequency. Where impedance deviations of 10 per cent from the mean can be tolerated, then from (12) and (13) we see that for the above range of frequencies 0.6 megacycle may be taken as the frequency of cut-off. This gives  $l = 27.6$  meters, approximately.

#### IV. EXPERIMENTAL LINE

A line of the type described above was constructed to allow an experimental check to be made of the system. The length of the line was 40 meters and the conductors used were of No. 12 Standard Wire Gauge (approximately No. 10 Brown and Sharpe) copper wire. Supports were spaced at 22-foot intervals, this being the spacing of poles used in associated uniform transmission lines. The insulated supports (see Fig. 5) were constructed to make possible easy adjustment of the wire spacings  $d$  and  $b$ . (The insulators shown in the photograph were not designed for horizontal mounting, but no better type was available when the line was being built.)

Short lengths of 300- and 600-ohm uniform transmission line were attached to the respective ends of the line.

For this line the cut-off frequency given by (4) is 0.415 megacycle. If the appropriate values for  $l$  and  $f_c$  are substituted in the expressions (9), (12), and (13), then the significant points on a curve of input impedance versus frequency are obtained. The calculated variation

of input impedance of the line with frequency is shown in Fig. 6.

Measurements of input impedance were made at each end of the line, the remote end in each case being terminated with a carbon resistor of appropriate value.

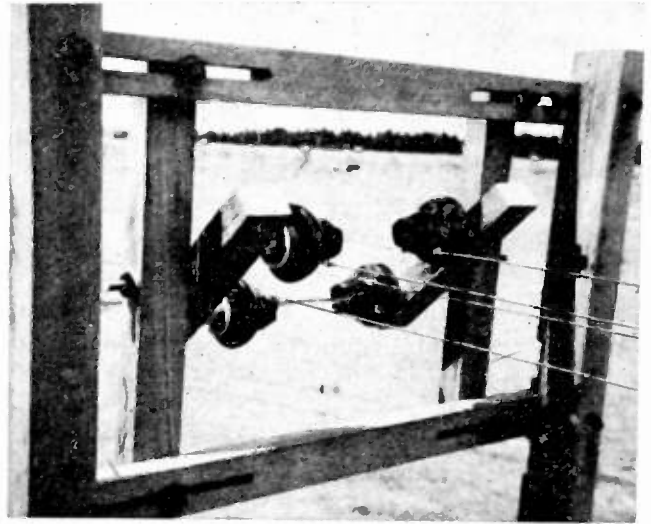

Fig. 5—Typical feeder pole used with an experimental line. Both horizontal and vertical separations of wires are variable.

For the measurements, a portable impedance meter was employed, this unit being composed of a radio-frequency oscillator, balanced amplifier, and tuned output circuit. Across the latter circuit is connected a pair of diodes, the rectified current from which actuates a

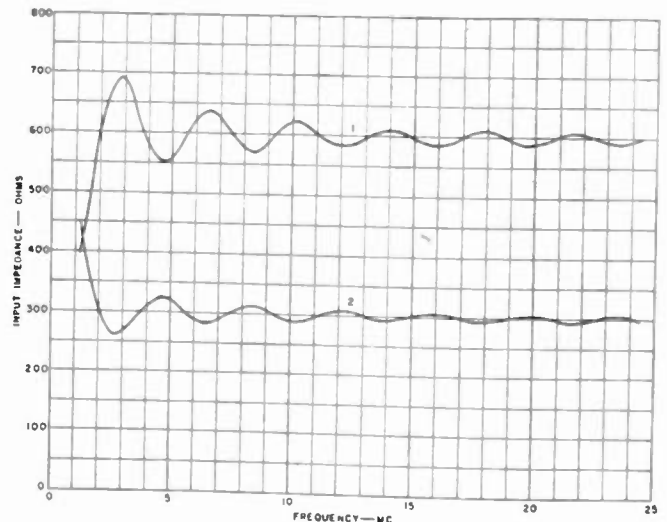

Fig. 6—Theoretical relationship between input impedance and frequency for an exponential line when a resistive termination is used. Length of the line is 40 meters, and the line is designed for a 2-to-1 impedance transformation. Curve 1 is for the high-impedance end of line; curve 2 for the low-impedance end.

meter, as in the ordinary vacuum-tube voltmeter. Across the tuned circuit may also be connected either the load to be measured or one of a number of fixed resistors. Measurements are made by setting the oscillator to the required frequency, tuning the output circuit, and,

with an appropriate fixed resistor (of magnitude greater than the impedance to be measured) connected across the output circuit, adjusting the output from the oscillator until a full-scale deflection is seen on the diode-current meter. The fixed resistor is then replaced by the

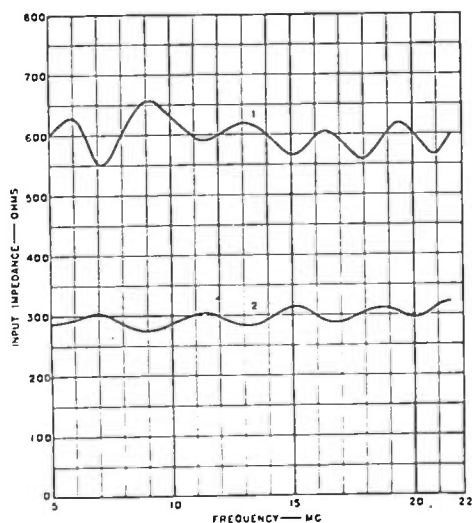

Fig. 7—Measured input impedance of an experimental line. Curve 1 is for the high-impedance end with the line terminated with a resistance of 300 ohms; curve 2 is for the low-impedance end with a termination of 600 ohms.

load to be measured. The reactive component of the latter (in terms of shunt reactance) is calculated from the change in capacitance required to tune the circuit when the external impedance is connected. The equivalent shunt resistance of the load is then read directly from the calibrated scale on the diode-current meter.

In Fig. 7 are shown the measured values of input impedance of the line. The impedances shown are resistive, since in all measurements the reactive component was small enough to be neglected. It is seen that the maximum deviation from the required transformation is 10 per cent. The deviations at the higher frequencies could, doubtless, have been reduced if more detailed attention had been given to the line terminations.

It may be noted in Fig. 7 that the short length of uniform transmission line attached to each end of the exponential line has caused the frequencies of maximum and minimum impedance to be displaced slightly from the positions shown in Fig. 6.

## V. CONCLUSION

It has been shown that a four-wire line may be designed to provide a very close approximation to an exponential line in the range of impedances from 300 to 600 ohms. Experimental tests have confirmed that a satisfactory impedance transformation may be obtained with such a line. The employment of a single size of conductor throughout, the absence of elaborate shaping, and the convenient physical dimensions, are the useful features of the line. It has particular application to the problem of supplying power to multiple rhombic or other aperiodic antennas.

## VI. ACKNOWLEDGMENT

The writer wishes to express his appreciation for the assistance given by the staff of the Rockbank Beam Receiving Station in the construction and testing of the experimental line.

# Correspondence

## Magnetic-Wire Response

The integral contained in equation (17) of Marvin Camras' paper on magnetic-wire record response in the August, 1946, issue of the PROCEEDINGS OF THE I.R.E. AND WAVES AND ELECTRONS can be found analytically.

Basset gives its value as  $\int_0^{\infty} \frac{\cos nx}{\sqrt{x^2+1}} dx = K_0(n)$ , where  $K_0$  is the modified Bessel function of the second kind of order zero.<sup>1</sup>

A table of  $K_0(n)$  versus  $n$  is available in *British Association for the Advancement of Science, Mathematical Tables, vol. VI, Cambridge, 1937*. A graphical solution of the aforementioned integral is thus unnecessary.

EDGAR REICH  
659 Ocean Avenue  
Brooklyn 26  
New York

## Demagnetizing Coefficient

In the issue of August, 1946, there was a paper by Mr. Camras<sup>1</sup> whose equation (17) expressed the demagnetizing coefficient  $D$  in terms of a certain integral, which he evaluated by graphical methods, presumably because he did not recognize it. In fact, however,

$$\int_0^{\infty} \frac{\cos nx}{\sqrt{x^2+1}} dx = K_0(n)$$

where  $K_0$  is the modified Bessel function of the second kind which has been fairly completely tabulated. Evaluation of  $D = \frac{1}{2}n^2K_0(n)$  shows that the author's Fig. 5 obtained by graphical methods is of good accuracy.

R. E. BURGESS  
National Physical Laboratory  
Teddington, Middlesex

<sup>1</sup> M. Camras, "Theoretical response from a magnetic-wire record," *Proc. I.R.E.*, vol. 34, pp. 597-602; August, 1946.

## NOTICE

The new I.R.E. television standard, "Standards on Television: Methods of Testing Television Transmitters—1947," is now available. The price is \$0.75 per copy, including postage to any country.

Orders may be sent to The Institute of Radio Engineers, Inc., 1 East 79 Street, New York 21, N. Y., enclosing remittance and the address to which copies are to be sent.

<sup>1</sup> A. B. Basset, "Hydrodynamics," vol. II, p. 18; Cambridge, 1888.

# Contributors to Proceedings of the I.R.E.



WILBUR NORMAN CHRISTIANSEN

Wilbur Norman Christiansen was born on August 9, 1913, at Melbourne, Victoria, Australia. He received the degree of B.S. from the University of Melbourne in 1934 and M.S. in physics in 1935. In 1935 he joined the staff of the Commonwealth X-Ray and Radium Laboratory and also continued research work in the physics department of the University of Melbourne. From 1937 to the present he has been employed as a development engineer in communication engineering in the Research Laboratories of Amalgamated Wireless (Australasia) Ltd., Sydney, and since 1940 has specialized in problems connected with the overseas communication services of the company.



H. D. Hagstrum was born in 1915 at St. Paul, Minnesota. He received the B.E.E. degree in 1935, the B.A. degree in 1936, the



H. D. HAGSTRUM

M.S. degree in 1939, and the Ph.D. degree in physics in 1940 from the University of Minnesota. From 1936 to 1940 he had a research and teaching assistantship in the physics department at the University of Minnesota.

In 1940 Dr. Hagstrum joined the staff of the Bell Telephone Laboratories. During the war he was engaged in the development of magnetron oscillators for radar use. He is now in the physical research department at Bell Laboratories.



Donald B. Harris (SM'45) was born at Minneapolis, Minnesota, on February 10, 1901. He received the B.A. degree from Yale University in 1922, after completing a physics major. During the school year of 1922 to 1923 he occupied the position of master in physics and mathematics at the Adirondack-Florida School, Onchiota, New York, and Miami, Florida. In 1923 he became associated with the Cutting and Washington Radio Corporation, Minneapolis. He joined the Northwestern Bell Telephone Company in 1924, subsequently occupying various technical and administrative positions. During this period he independently developed a number of electronic devices on which patents were granted or are now pending.

In 1943 Mr. Harris became technical aide of Division 15 of the National Defense Research Committee stationed at Radio Research Laboratory, Harvard University, where he was responsible for the administration of contracts of Division 15 in the Cambridge, Massachusetts, area. He is at present the transmission and protection engineer of the Northwestern Bell Telephone Company, stationed at Des Moines, Iowa.



Herbert J. Reich (A'26-M'41-SM'43) was born on October 25, 1900, at Staten Island, N. Y. He received the M.E. degree from Cornell University in 1924 and the Ph.D. degree in physics in 1928. He was an instructor in machine design at Cornell University during 1924 and 1925; instructor in physics, Cornell University, from 1925 to 1929; assistant professor of electrical engineering, University of Illinois from 1929 to 1936; and associate professor from 1936 to 1939, when he was made a professor. He was on leave at the Radio Research Laboratory at Harvard University from 1944 to 1946, and in 1946 he became professor of electrical engineering at Yale University.



DONALD B. HARRIS



Dr. Reich is the author of "Theory and Applications of Electron Tubes" and "Principles of Electron Tubes, and co-author of "Ultra-High-Frequency Techniques." He is a Fellow of the American Physical Society, and a member of the American Association for the Advancement of Science, the American Institute of Electrical Engineers, the American Society of Engineering Education, Tau Beta Pi, and Sigma Xi.



It is regretted that the captions for the photographs of MILTON D. HARE and STEWART E. MILLER, which appeared on page 380 of the April, 1947, issue of the PROCEEDINGS were transposed.



HERBERT J. REICH



# Institute News and Radio Notes

## Report of the Secretary—1946

The report of the Secretary for the calendar year 1946 is submitted, in accordance with a requirement of the By-Laws. As usual, important statistics are presented to indicate growth, the state of general activities, fiscal condition, and the distribution of members and Sections geographically.

It is now clear that our Institute's growth over the past few years, both as to size and member activities, has continued without any signs of abatement. This expansion, combined with the completion and occupancy of new permanent headquarters, strengthening of the Board of Directors through the adoption of the Regional Representation Plan, and the further rounding out of headquarters staff organization, signalizes the achievement of a significant stability as the technical society that uniquely serves the field of radio communication, electronics, and allied activities throughout the world.

The attention of readers is particularly directed to the increased size of the PROCEEDINGS and to the increased cost of printing (Fig. 1). The maintenance of an enlarged PROCEEDINGS, so necessary to serve the rapidly growing electronic art, poses a problem of major magnitude.

### Membership

At the end of the year 1946, the membership of the Institute, including all grades, was 18,154, a 15 per cent increase over the previous year. Before the war, the annual increase in the number of members was less than 5 per cent; in the first three years of the war it was about 25 per cent. In 1944 and 1945, the figure dropped to 20 per cent, and to 15 per cent in 1946. The membership trend from 1912 to date is shown graphically in Fig. 2.

The distribution of members in the various grades for the years 1945 and 1946 is shown in the accompanying plot, Fig. 3. Actual figures are shown in Table I. Note that the percentage of Associates has dropped and that the percentage of Members and Senior Members has increased. The membership ratio: (Associates)/(higher grades) was 6 to 1 in 1944, 4 to 1 in 1945, and less than 3 to 1 in 1946, a very satisfactory trend.

TABLE I.—MEMBERSHIP DISTRIBUTION BY GRADES

Grade	As of Dec. 31, 1946		As of Dec. 31, 1945	
	Number	Per Cent of Total	Number	Per Cent of Total
Fellow	218	1.2	210	1.2
Senior Member	1,763	9.7	1,288	8.2
Member	2,330	12.8	1,238	7.9
Associate	11,501*	63.0	11,145†	70.6
Student	2,252	12.4	1,898	12.1
Totals	18,154		16,770	

\* Includes 1,701 Voting Associates.

† Includes 2,048 Voting Associates.

Table II shows an analysis for the past five years of the distribution of members at home and abroad. It may be noted that the

foreign membership has increased rapidly since the end of the war.

It is with deep regret that this office records the death of the following members of the Institute during the year 1946:

#### SENIOR MEMBERS

George Edward Cabot (A'16-M'39-SM'43)  
Austin M. Curtis (M'13-SM'43)  
Paul Franklin Johnson (A'23-M'26-SM'43)  
Ralph A. Powers (M'41-SM'43)  
Frank Clifford Stockwell (M'38-SM'43)  
John Wadhams Watson (A'44-SM'45)

#### MEMBERS

A. Nelson Butz, Jr. (A'42-M'45)  
Leonard T. Carlson (A'41-M'46)  
Frank M. Davis (M'44)  
Karl Stiefel (A'39-M'45)

#### ASSOCIATES

Howard I. Bickel (A'43)  
David L. Bigley (A'45)  
Albert Preston Brieden, Jr. (S'43-A'45)  
Truman Preston Brewster (A'44)  
Albert P. Cartier (A'45)  
Stephen Donaldo Custidero (A'45)  
Hershel V. Fitz Charles (A'41)  
Allan Jack Hoenig (S'42-A'45)  
George Hunt (A'41)  
Raymond Hutchens (VA'36)  
George Jacobsen (VA'36)  
Frank Reginald Lambton (A'44)  
Alfred W. Moxon (VA'27)  
Russell Louis Nielsen (S'40-A'41)  
Taintor Parkinson (VA'26)  
Ward Curtiss Priest (VA'26)  
Edward Albert Schlueter (VA'26)  
William James Thomas (A'45)  
Philip S. Walsh (A'42)  
Ralph A. Webster (VA'37)

#### STUDENTS

William Russell Leach (S'44)

### Editorial Department

In 1946 there were published in the PROCEEDINGS 1256 editorial pages, 891 of which were technical. This compares with 944 pages in 1945, with 702 technical pages. Accordingly, total editorial pages increased 41 per cent. There were 122 papers published from 160 authors from different organizations, academic institutions, and the military services, as contrasted with 103 papers in 1945, submitted by 138 authors. In 1946, 47

of our authors were nonmembers of the Institute; in 1945 this number was 33. Advertising in 1945 comprised 976 pages and in 1946, 974 pages. The total number of pages (including covers) published during 1946 was 2240; in 1945, 1912. This averaged 187 pages per issue; in 1945, 157.

After many delays occasioned by shortages, printing difficulties, and other problems, the 1946 YEARBOOK was published in November. This volume consists of 224 pages of editorial material and 188 pages in the advertising section.

Rising prices increased the page-rate cost of the PROCEEDINGS from \$31.00 in 1945 to \$40.00 in 1946, and the rate per copy from \$0.29 to \$0.36. The highs for the year were \$43.00 and \$0.40, respectively. These figures are print costs, and do not include overhead or salaries.

At the end of 1946, the PROCEEDINGS "bank" showed 1072 pages either accepted for publication or in the hands of the readers. This compares with 411 pages at the end of 1945. The Editorial Department, with great hesitancy, found it necessary to return many papers to the authors, asking for condensation, sometimes as much as 60 per cent. This was an absolute necessity in order to present as much useful material from as many authors as possible.

In January, 1946, the journal became known as "PROCEEDINGS OF THE I.R.E. AND WAVES AND ELECTRONS." Separate contents pages and separate pagination, denoted by the letters P and W, were first used. In May, the separate pagination was discontinued, although the three parts of the PROCEEDINGS continued to be indicated as PROCEEDINGS OF THE I.R.E., Institute News and Radio Notes, and WAVES AND ELECTRONS Section. This form continued through December.

By a special arrangement with Iliffe and Sons, and the *Wireless Engineer*, London, England, as well as the Department of Scientific and Industrial Research of the British Government, the Institute, in June, began to publish "Abstracts and References." Reprints of these in an edition printed on one side only are available to members on subscription.

In the early fall copy was sent to the printer for "Standards on Television: Methods of Testing Television Transmitters."

The unfortunate illness of the Editor, Dr. Alfred N. Goldsmith, in the early part of the year, worked severe hardship on the Editorial Department, since without his guiding hand, problems were magnified. Early in

TABLE II.—FIVE-YEAR ANALYSIS OF UNITED STATES AND FOREIGN MEMBERSHIP

	1946	1945	1944	1943	1942
TOTAL	18,154	16,770	13,137	11,070	8,704
United States and Possessions	16,898	14,063	11,596	9,802	7,788
Foreign (including Canada)	2,256	1,726	1,541	1,187	1,000
Per Cent Foreign	12.4	10.0	11.7	10.7	11.0

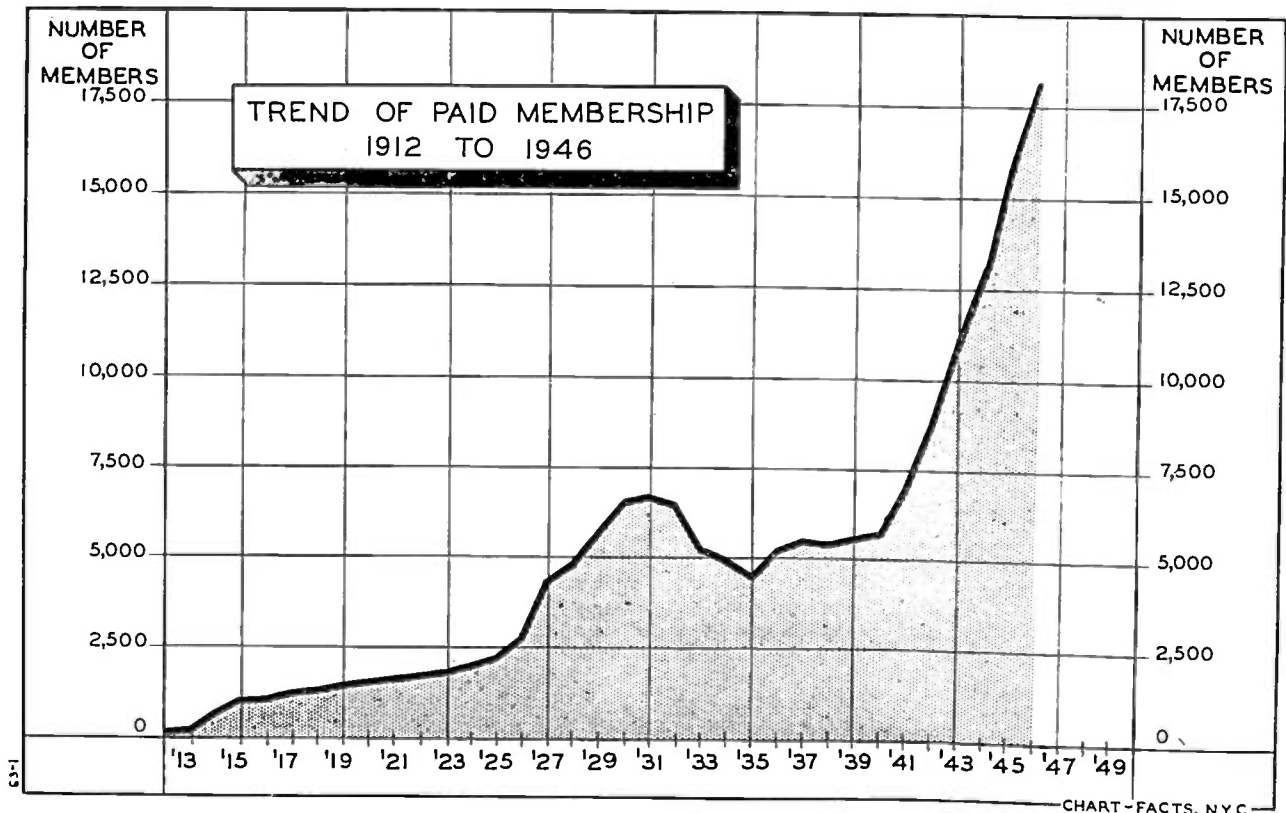
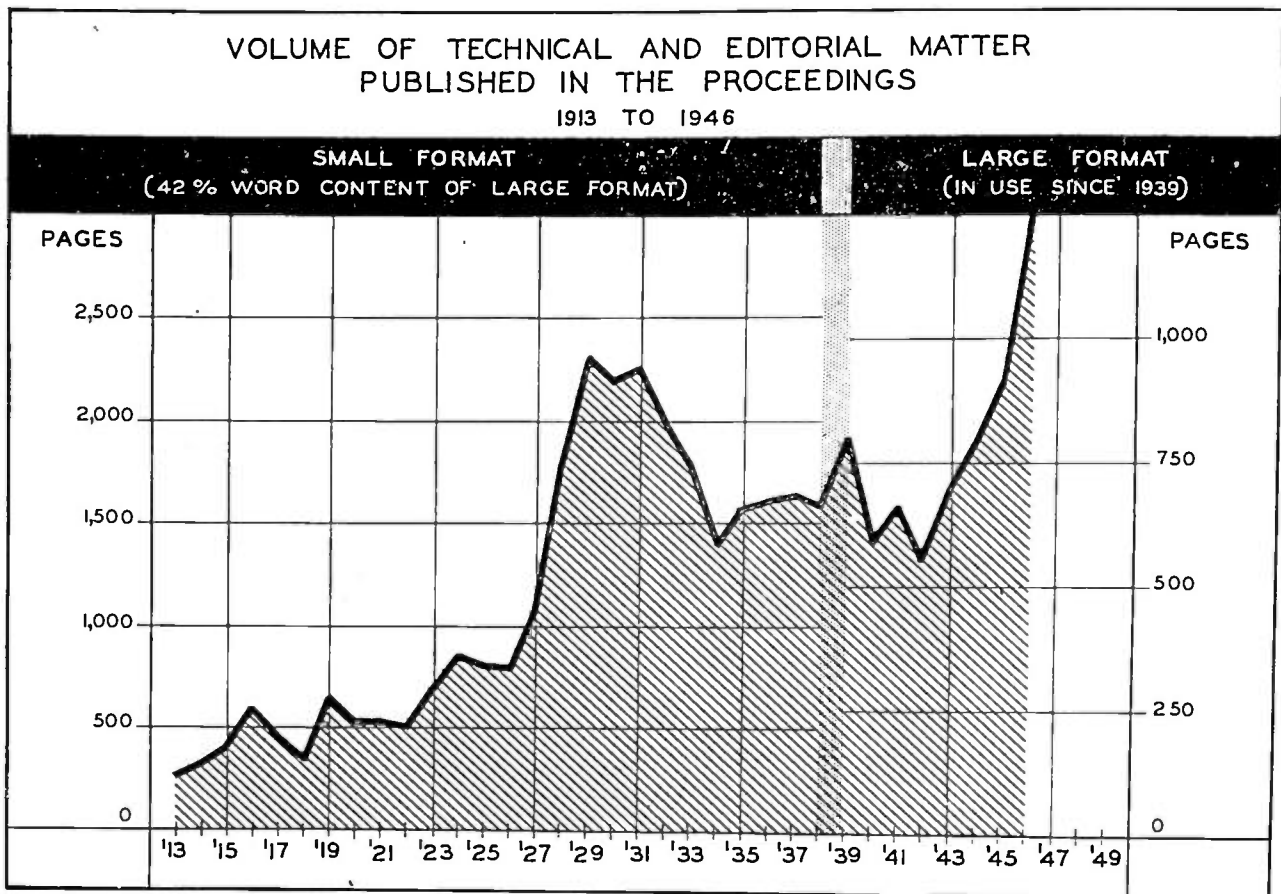

Figs. 1 and 2

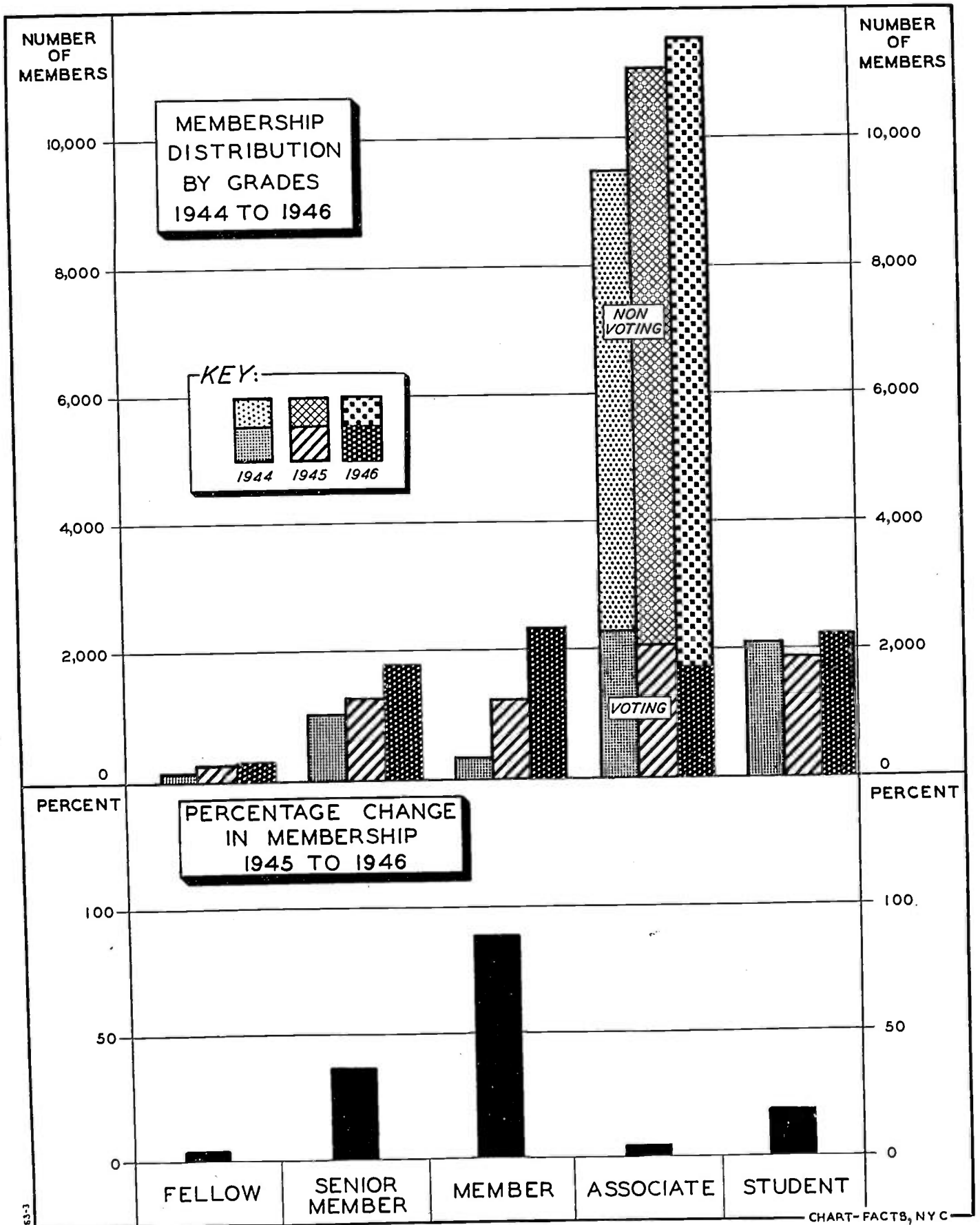

Fig. 3

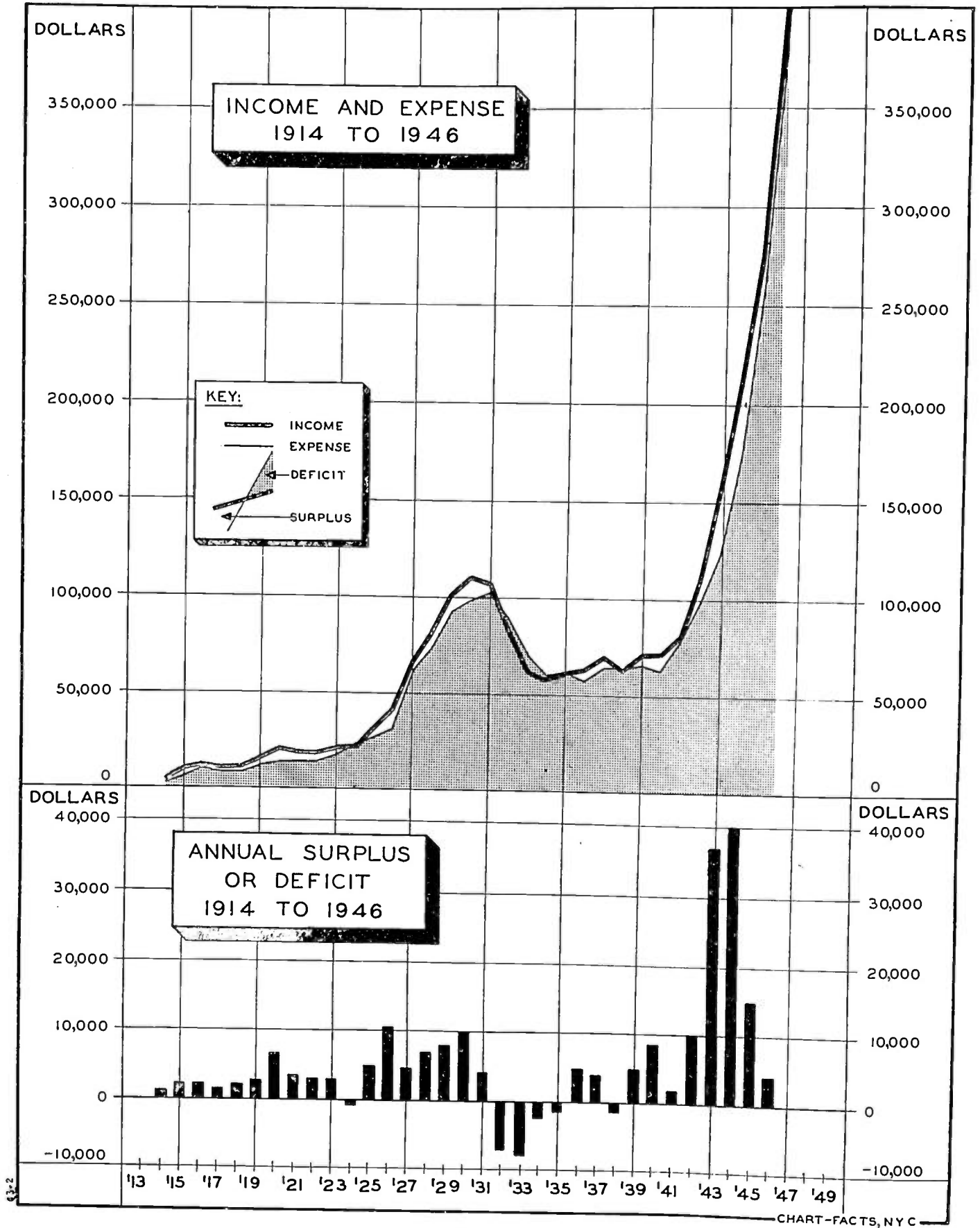

Fig. 4

CHART-FACTS, N.Y.C.



April, Clinton B. DeSoto accepted the position of Technical Editor, made vacant by the resignation of Ray D. Rettenmeyer. At about this same time, Mary L. Potter became Assistant Editor.

The Editorial Department was comfortably housed in a loft building, having the entire fourth floor at 26 West 58 Street, where it had moved in April of 1945 in order to relieve the congestion at Headquarters. In July, it was necessary to move the Department to the second floor of the same building, where only a half floor was available. In November, the Department again moved, to our permanent home at 1 East 79 Street. Attractive and commodious quarters enable efficient and pleasant operation of the Department.

Administratively, in matters involving personnel and fiscal affairs, the Editorial Department has been integrated with Headquarters staff under the direction of the Executive Secretary, George W. Bailey. In matters involving editorial policy, content, format and the like, of all I.R.E. publications, the Editorial Department continues to function under the direction of the Editor, Dr. Alfred N. Goldsmith, with the support and counsel of the Board of Editors, the Papers Review Committee, the Papers Procurement Committee, and the Editorial Administrative Committee.

## Fiscal

A condensed comparison of income and expenses for the years 1945 and 1946 is shown in Table III.

TABLE III.—A CONDENSED COMPARISON OF INCOME AND EXPENSES FOR 1945 AND 1946  
(From Accountant's Report dated Dec. 31, 1946)

	1946	1945
<i>Income</i>		
Membership Dues	\$133,715.04	\$ 95,813.18
Advertising	160,466.41	122,623.89
Subscriptions	25,096.79	20,333.82
Others	62,724.14	37,513.57
<i>Total Income</i>	<u>\$382,022.98</u>	<u>\$276,284.46</u>
<i>Expenses</i>		
Printing PROCEEDINGS	\$120,121.68	\$ 50,307.27
Salaries	108,266.61	79,017.99
Advertising Commissions	45,407.39	32,039.51
Others	104,007.14	99,841.21
<i>Total Expenses</i>	<u>\$377,802.82</u>	<u>\$261,205.97</u>
<i>Net Income</i>	<u>\$ 4,200.16</u>	<u>\$ 15,078.49</u>

## Section Activities

We were glad to welcome five new Sections into the Institute during the past year. They are as follows:

Columbus	(Jan.) 1946
Houston	(Feb.) 1946
Milwaukee	(Feb.) 1946
N.C.-Va.	(June) 1946
Syracuse	(Dec.) 1946

The total number of Sections is now 38. There has been a substantial increase in membership of these Sections, with a few exceptions where there has been a slight decrease. In addition, during the year there

has been formed the following group, unofficially designated as a Sub-Section:

Winnipeg Sub-Section (Toronto)

## Technical Activities

The Winter Technical Meeting of the Institute was held in January, 1946, in the Hotel Astor, in New York City. There were 7020 persons actually registered, and 87 technical papers were presented during the meeting. The unexpected large attendance overtaxed the facilities of the hotel. Provision will be made in 1947 for commodious quarters. An interesting feature of the meeting was the exhibition of products by a large number of manufacturers, many being exhibited for the first time since the veil of wartime secrecy had been lifted.

During the year, the Technical Committees showed increased activity, and preparations are being made for a very active 1946-1947 winter season.

Our commodious new quarters at 1 East 79 Street are ideal for a meeting place for our Technical Committees.

We were reluctant to accept the resignation of Dr. William H. Crew, but realized that in so doing he was accepting a position of large responsibility as Assistant Dean of Rensselaer Polytechnic Institute in Troy, New York.

We are fortunate in having secured the services of Laurence G. Cumming as Technical Secretary. Mr. Cumming was formerly a commander in the Office of Naval Research and took active part in important technical electronic developments during the war. He enjoys a wide acquaintance among radio engineers and scientists.

## The Institute's New Home

In November, 1946, the Institute staff moved into our new home at 1 East 79 Street. The Institute owes a debt of gratitude to its friends and members who generously contributed to the Building Fund, which made the new home possible, and to the Office Quarters Committee, which has so successfully prepared the building for occupancy. All the departments of the Institute are now under one roof with room for expansion. Under such ideal working conditions, the staff is prepared to function smoothly in serving members.

Respectfully submitted,

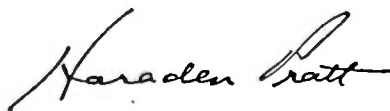

Haraden Pratt, Secretary

April 9, 1947

## A.I.E.E. PACIFIC GENERAL MEETING

An entire division of the 1947 Pacific General Meeting of the American Institute of Electrical Engineers, at Hotel San Diego, San Diego, California, August 26-29, 1947, will be devoted to communications.

## N. E. C. PROCEEDINGS AVAILABLE

Volume 2 of the *Proceedings of the National Electronics Conference* (1946) has been published recently. While they are still available, copies of Volumes 1 and 2 may be obtained from R. E. Beam, Secretary (for 1947), c/o Electrical Engineering Department, Northwestern University, Evanston, Illinois. Price, \$3.00 per copy for Volume 1 and \$3.50 per copy for Volume 2.

❖

## CONNECTICUT VALLEY SECTION ANNUAL MEETING

The Connecticut Valley Section will hold its annual meeting at New London, Connecticut, Saturday, June 7. There will be a symposium on "Frequency Modulation Receivers" by several speakers, each giving a short talk describing his company's developments. The technical session in the morning will be followed by a business meeting and election of officers for the ensuing year. After a luncheon, there will be an inspection trip to the Submarine Base.

❖

## NATIONAL ELECTRONICS CONFERENCE OFFICERS

The National Electronics Conference, Inc., has released a list of the officers who have been elected to serve for the coming year. This corporation, whose purpose is to serve as a national forum on electronic developments and their application, is sponsored jointly by Illinois Institute of Technology, Northwestern University, American Institute of Electrical Engineers, Institute of Radio Engineers, and the University of Illinois, with the Chicago Technical Societies Council a co-operating organization.

Among the new officers of the corporation, the following are members of The Institute of Radio Engineers:

Chairman of the Board of Directors—W. O.

Swinyard (A'37-M'39-SM'43-F'45), Hazeltine Electronics, Inc.

President—A. B. Bronwell (A'39-SM'43), Northwestern University

Executive Vice-President—W. L. Everitt, (A'25-M'29-F'38), University of Illinois

Vice-President in Charge of Program—G. H. Fett (SM'45), University of Illinois

Vice-President in Charge of Publicity—H. S. Renne (A'41-M'45), Radio-Electronic Engineering

Secretary—R. E. Beam (S'37-A'41-SM'44), Northwestern University

Treasurer—A. H. Schulz (A'38-SM'46), Armour Research Foundation

Chairman, Exhibits Committee—O. D. Westerberg (A'45), Commonwealth Edison Co.

Chairman, Hotel Committee—R. J. Donaldson (A'36), Commonwealth Edison Co.

Plans are now being formulated for the 1947 National Electronics Conference, which will be held on November 3, 4, and 5 at the Edgewater Beach Hotel, Chicago. An exceptionally fine program of technical papers will be presented, and numerous exhibits of electronic equipment are being planned.

# Chicago I.R.E. Conference, April 19, 1947

APPROXIMATELY 600 guests registered for the one-day Chicago I.R.E. conference held under the sponsorship of the Chicago Section of The Institute of Radio Engineers at Northwestern University Technological Institute in Evanston, Illinois, on April 19.

The meeting was opened by Alois W. Graf, Chairman of the Chicago Section of the I.R.E. The welcoming address was delivered by Dr. O. W. Eschbach, Dean of the Technological Institute; Dr. W. R. G. Baker, President of I.R.E., delivered the opening address.

The morning was then divided into three concurrent sections:

## RADIO RECEIVERS

*Chairman:* Hugh S. Knowles, Jensen Manufacturing Company, Chicago, Ill.

1. "Compact Electromechanical Filter for the 455 kc. I. F. Channel," R. Adler, Zenith Radio Corporation, Chicago, Ill.

A compact metallic ladder of mechanically resonant elements, linked by compliant members and coupled to electrical circuits by magnetostrictive terminations, transmits uniformly within a 4- to 14-kilocycle band with very rapid attenuation outside. Data for design and performance of this filter in a receiver were given. It is adapted to economical production. A demonstration was included.

2. "A Viscous-Termination Crystal Pickup," T. E. Lynch, Brush Development Company, Cleveland, Ohio.

The characteristics of a perfect phonograph pickup were outlined. Upon the basis of this theoretical unit, a practical unit is derived, including only such

compromises as are required by the state of the art and considerations of a proposed medium price. The pickup thus derived includes a "bimorph" crystal of the new ammonium-phosphate type, rigidly lever-coupled to a sapphire stylus, and all floating freely in a viscous gel.

## ELECTRONICS

*Chairman:* A. B. Bronwell, Northwestern University, Evanston, Ill.

1. "Electronics in Automatic Controls," W. H. Kliever and Gordon Tolkenant, Minneapolis-Honeywell Regulator Company, Minneapolis, Minn.

The elements of a control system were outlined and electronic systems were emphasized. Sensing devices, servomotors, and computers were described in detail.

2. "Comparison and Uses of Photosensitive Devices," H. S. Snyder, Northwestern University, Evanston, Ill.

A general description and introduction to the subject, including a qualitative discussion of photosensitive devices, classification of various types, and notes on uses and limitations.

## ENGINEERING PROFESSION

*Chairman:* A. Crossley, Consulting Engineer, Chicago, Ill.

1. "Patents and the Engineer," Curtis F. Prangley; Moore, Olson and Trexler, Chicago, Ill.

An analysis of the engineer's relation to the patent system and of the keeping of records by engineers to facilitate the

securement and enforcement of patents.

2. "The Engineer in Research," J. E. Hobson, Armour Research Foundation, Chicago, Ill.

A review of the current situation in industrial research, pointing out the reasons for increased emphasis in both industrial and fundamental research today, the opportunities which exist in the industrial research field, and industrial research as a national asset; a discussion of the opportunities for scientific men in research and the requirements for capable research men in industrial research laboratories; suggestions regarding the responsibility of industry to assist in the training and preparation of those men, and one or two definite suggestions for a training program.

A buffet-style luncheon was served in two sections at 12:30 and again at 1:15 in the gymnasium. The afternoon sessions were covered in three panels:

## RADIO RECEIVERS

*Chairman:* Nelson P. Case, The Hallicrafters Company, Chicago, Ill.

1. "Proposed Television Production Test Plans," D. Shankland, Farnsworth Television and Radio Corporation, Ft. Wayne, Ind.

The objectives to be reached in television production testing were outlined and related to the general provisions of the Farnsworth plan. Details of this plan were presented, as well as reasons for rejection of other possible methods.

2. "Precision Master Oscillators," T. A. Hunter, Collins Radio Company, Cedar Rapids, Iowa.

Practical design information was discussed on linear permeability-tuned oscillators with a demonstration of their application in the Collins 75A receiver and 310B and 310C exciter units.

3. "Radio Frequency Performance of Some Receiving Tubes for Television," R. M. Cohen, Radio Corporation of America, Harrison, New Jersey.

Several receiving-type tubes may be used to advantage in television receivers designed to tune all 13 channels. The performance of these tubes in radio-frequency amplifiers, mixers, and local oscillators was discussed. Both push-pull circuits and single-ended circuits were treated. Data were presented for over-all gain, noise, image rejection, and oscillator frequency stability. These data were taken at two respective points in the band: 60 and 200 megacycles.

## COMMUNICATIONS EQUIPMENT

*Chairman:* D. E. Noble, Galvin Manufacturing Corporation, Chicago, Ill.

1. "Mobile Radio Telephone," R. R. O'Connor, Illinois Bell Telephone Company, Chicago, Ill.



CHICAGO I.R.E. SECTION EXECUTIVE COMMITTEE MEMBERS

Rear row, left to right: Karl Kramer, Vice Chairman; Nathan Aram, Historical Data Vice Chairman; Kipling Adams, Membership; Victor J. Andrew, Headquarters Relations Vice Chairman; Ringland Krueger, Membership Chairman; Robert E. Samuelson, Meetings and Papers Chairman; LeRoy Clardy, Procedure Chairman.

Front row, left to right: William Schlesinger, Ways and Means Vice Chairman; Ernie Ross, Program Vice Chairman; Don Haines, Secretary-Treasurer; Harold S. Renne, Publicity Chairman; Harold W. Armstrong, Arrangements Vice Chairman.

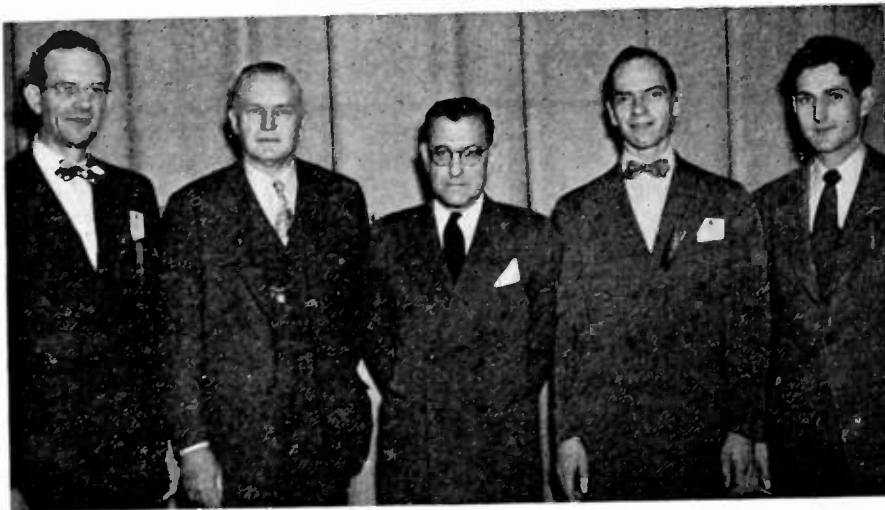

ON STAGE FOR THE OPENING SESSION

Left to right: Alois W. Graf, Chairman, Chicago Section, I.R.E.; Dr. Ovid W. Eschbach, Dean of the Technological Institute, Northwestern University; Dr. W. R. G. Baker, National President, I.R.E.; Robert E. Samuelson, Executive Chairman, Chicago I.R.E. Conference; William Jarzembki, President, Electro Tech Society at Northwestern University.

Three types of mobile common-carrier service are: urban, highway, and marine. Mobile systems were discussed in general, with special emphasis on their connection with telephone lines. Coverage and other results were summarized.

2. "A Variable-Frequency Oscillator with Narrow Band FM," L. A. Mayberry, The Hallicrafters Company, Chicago, Ill.

The design of a low-power variable-frequency exciter unit to be used for amateur radio communications. The device provides three types of output: variable-frequency continuous-wave, crystal-controlled continuous-wave, and the variable-frequency frequency-modulation phone. Particular attention was given to the properties of narrow-band frequency-modulation and to frequency stability.

3. "Personal Plane Radio," D. H. Mitchell, Galvin Manufacturing Corporation, Chicago, Ill.

Radio manufacturers have done an outstanding job of solving the problems of private aircraft radio during the last year. Solution of these problems by economical application of radio techniques common to the broadcast field were discussed. There have been more radios manufactured and made available for the post-war airplane than any other accessory. The engineer's most difficult problem is to convince the private flyer what he needs in aircraft radio and why.

### BROADCAST EQUIPMENT

Chairman: W. E. Phillips, Raytheon Manufacturing Company, Chicago, Ill.

1. "FM Monitor," C. A. Cady, General Radio Company, Cambridge, Massachusetts.

The new frequency-modulation broadcast transmitters require a precision monitor for performance tests. For the past two years development of such a

monitor has been under way in the General Radio Company laboratories. The design problems that were involved and details of their solution were described.

2. "Cascade Phase-Shift Modulation," M. Marks, Raytheon Manufacturing Company, Chicago, Ill.

A new simplified modulator for frequency-modulation broadcast transmitters was described which, by cascading six phase-shift stages, yields substantial improvements in performance, operation, and maintenance.

3. "A System of High-Efficiency Modulation Applied to Television," J. F. Bell, Zenith Radio Corporation, Chicago, Ill.

The general problem of the generation of relatively large amounts of video-modulated radio-frequency power was reviewed, and the need for a high-

efficiency modulating system was shown. The design of such a transmitter was illustrated by description of the Zenith television transmitter, based on the Doherty-Terman system of high-efficiency grid modulation. Approximately 4 kilowatts peak power output is obtained, using four type 4-250A tetrodes in an unconventional grounded-grid version of the Doherty-Terman circuit.

There were 22 manufacturers who had educational exhibits open throughout the day.

Inspection trips of a "typical" lecture room, and electrical and mechanical engineering laboratories, were arranged at twenty-minute intervals and conducted in groups of about twenty-five guests throughout the entire day. These trips were conducted by Northwestern University students, members of the Electro Tech Society.

There were five continuous laboratory demonstrations supervised by students, including an electron microscope, electronic control and servomechanisms, a high-voltage generator, microwave optics, and a laboratory display of circuit analogies.

The Chicago Section of The Institute of Radio Engineers is greatly indebted to Dr. O. W. Eschbach, dean of Northwestern Technological Institute; Dr. John F. Calvert, chairman of the Electrical Engineering Dept., Northwestern Technological Institute; and Dr. Robert E. Beam, adviser for the Student Section A.I.E.E.-I.R.E. at Northwestern University, for their splendid co-operation and active assistance in planning and carrying out this conference.

The Chicago Section wishes to thank the Electro Tech Society (Northwestern University Student Section of the A.I.E.E.-I.R.E.) for its active participation and help in making the conference a success.

The conference was another successful activity of the Chicago Section, and a similar session is planned for next year.



CHICAGO I.R.E. CONFERENCE COMMITTEE MEMBERS

Rear Row, left to right: M. J. Carroll, Chairman, Exhibits; R. E. Samuelson, Executive Chairman of the Conference; R. M. Krueger, Program; H. F. Hafker, Program; J. A. Doremus, Arrangements.

Front row, left to right: E. Ross, Vice-Chairman, Publicity; Kipling Adams, Vice-Chairman of the Conference; W. P. Keller, Publicity; H. S. Renne, Chairman, Publicity; J. A. Rankin, Chairman, Arrangements.

# I.R.E. People

## VLADIMIR K. ZWORYKIN

Vladimir K. Zworykin (M'30-F'38), recently elected vice-president and technical consultant of the RCA Laboratories Division, Radio Corporation of America, was awarded the Howard N. Potts medal by the Franklin Institute for his invention of the iconoscope and kinescope, which are essential to modern commercial television.

Born in Mourom, Russia, in 1889, Dr. Zworykin received his E.E. degree from the Petrograd Institute of Technology in 1912. Continuing there in research work under Professor Boris Rosing, he started his first experiments in television; later he spent two years in X-ray research at the College de France under Professor P. Langevin. In 1920 he came to the United States and joined the research staff of Westinghouse Electric and Manufacturing Company at Pittsburgh, attending at the same time the University of Pittsburgh from which he received his Ph.D. degree in 1926. He became an American citizen in 1924.

Dr. Zworykin joined the Radio Corporation of America in 1930 as director of their Electronic Research Laboratory, where his activities have covered many phases of radio and electronics. For his research work in the



VLADIMIR K. ZWORYKIN

development of the electron microscope, he received the Rumford award of the American Academy of Arts and Sciences in 1941.

In World War II he performed distinguished service as a member of the Scientific Advisory Board to the Commanding General of the United States Army Air Forces, the Ordnance Advisory Committee on

Guided Missiles, and three subcommittees of the National Defense Research Committee, and directed important research work.

Dr. Zworykin received the Morris Liebmann Memorial Prize in 1934 from The Institute of Radio Engineers; the Overseas Premium of the British Institution of Electrical Engineers in 1937; the honorary degree of Doctor of Science from the Brooklyn Polytechnic Institute in 1938; and in 1940 the Modern Pioneers Award of the American Manufacturers Association.

He is the co-author of "Photocells and Their Application," "Television," and "Electron Optics and the Electron Microscope." In January, 1947, he disclosed at a joint meeting of the American Meteorological Society and the Institute of Aeronautical Sciences that he is directing work on an electronic calculator which may make possible accurate weather prediction and control.

Dr. Zworykin is a member of the American Association for the Advancement of Science, the American Physical Society, the American Institute of Electrical Engineers, American Academy of Arts and Sciences, National Academy of Sciences, Franklin Institute, the French Academy of Sciences, and Sigma Xi.



MERRILL A. TRAINER

Merrill A. Trainer (A'35) was recently appointed manager of television equipment sales for the Radio Corporation of America. Prior to his appointment, he was in charge of television terminal-equipment development where he supervised the company's development of airborne-television equipment and television-guided missiles.

Born in Philadelphia on July 25, 1905, Mr. Trainer received the B.S. degree in electrical engineering from the Drexel Institute of Technology in 1927. Upon graduation, he became associated with E. F. W. Alexander in television research at the General Electric Company. Since 1930 he has been on the RCA television engineering staff.

Mr. Trainer is a member of Tau Beta Pi, and has served on several RMA committees.

## ROBERT D. TEASDALE

Robert D. Teasdale (S'45-A'46) has been awarded a Gerard Swope Fellowship for the academic year 1947-48. His problem will involve analytical research on high-frequency wave propagation with particular emphasis on boundary value problems. A graduate of Carnegie Institute of Technology, where he held a George Westinghouse Scholarship, Mr. Swope is instructing and studying for his M.S. at the Illinois Institute of Technology in Chicago. He is an associate member of the American Institute of Electrical Engineers, and a member of Tau Beta Pi, Eta Kappa Nu, Phi Kappa Phi, and Pi Delta Epsilon.



ROBERT D. TEASDALE



OTTO H. SCHMITT

## OTTO H. SCHMITT

Otto H. Schmitt (SM'44) returned to the University of Minnesota on April 1, after a five-year wartime leave of absence with the Airborne Instruments Laboratory. He resumes his position as associate professor in the departments of physics and zoology where a major portion of his efforts will be devoted to research in biophysics. Dr. Schmitt played a leading part in the development of the magnetic airborne detector, a wartime-developed equipment for locating submerged enemy submarines from the air, and in the designing, building, and operating of an aircraft-antenna radiation-pattern-measuring system employing the airplane-modeling method.



## Minutes of Technical Committee Meetings

The following brief abstracts of I.R.E. technical committee minutes are intended to keep the membership informed as to the activities of such groups. Members having views or proposals of interest to the committees, or desiring possibly available information from them, should write directly to the chairman of the particular committee, sending a copy of the letter to Mr. Laurence G. Cumming, Technical Secretary, The Institute of Radio Engineers, 1 East 79 Street, New York 21, N. Y.—*The Editor.*

### ELECTRON TUBE CONFERENCE

Date..... March 3, 1947  
Place..... Hotel Commodore, New York,  
N. Y.

Chairman... G. W. O'Neill

#### Present

G. W. O'Neill, *Chairman*

L. Malter                      I. E. Mouroumtseff  
E. D. McArthur              L. S. Nergaard  
J. A. Morton                  H. J. Reich  
A. L. Samuel

Syracuse University was accepted as the meeting place of the Conference. Mr. McArthur was empowered to organize a local group at Syracuse, which will take care of all necessary arrangements. Professor Reich was asked to replace Mr. McArthur as chairman of the entertainment committee. The technical program of the Conference was discussed and additions made.

### RADIO TRANSMITTERS

Date..... March 3, 1947  
Place..... Hotel Commodore, New York,  
N. Y.

Chairman... E. A. Laport

#### Present

E. A. Laport, *Chairman*

Cledo Brunetti              J. B. Knox  
H. R. Butler                  Robert Serrell  
A. E. Kerwein                I. R. Weir

The subcommittee structure of the Committee was reviewed in the light of the decision of the previous meeting concerning the scope of work of the Committee and it was decided that four subcommittees, already existent, would suffice for the present program. Dr. Brunetti read the list of terms which his group presently has in process of definitions. All but about six terms were accepted for inclusion in the list for Transmitters. In order to divide the work of defining other terms, I. R. Weir, J. E. Young, and Robert Serrell, as subcommittee chairman, will select from the catalog of terms issued in January those which are most properly related to their special activities, and overlaps can be eliminated at the next meeting.

### CIRCUITS

Date..... March 3, 1947  
Place..... Hotel Commodore, New York,  
N. Y.

Chairman... E. A. Guillemin

#### Present

E. A. Guillemin, *Chairman*

H. W. Bode                      D. E. Maxwell  
J. G. Brainerd                  J. M. Miller  
Cledo Brunetti                  Carl Neitzert  
C. R. Burrows                  E. E. Overmier  
W. L. Everitt                  A. F. Pomeroy  
L. A. Kelley                    J. B. Russell, Jr.

W. N. Tuttle

The subcommittee of which Mr. Neitzert is chairman will continue under the new chairmanship of Professor J. B. Russell (Mr. Neitzert dropping out) and with the addition of Messrs. E. H. Perkins, O. J. Zobel, and R. M. Foster as soon as the latter can be added to the membership of the Circuits Committee. Mr. Brunetti pointed out that other committees whose work overlaps that of this one may go ahead with their arrangements unless the Committee announces its desire to pass upon their tentative results. This matter will be looked into by Mr. Brunetti and he will prepare a list of items upon which the Committee will prefer to pass judgment before their final adoption by the Standards Committee. It was also pointed out that the Committee must concern itself with the work of the A.S.A. and that of the Symbols Committee insofar as overlapping items are concerned.

### NAVIGATION AIDS

Date..... March 3, 1947  
Place..... Hotel Commodore, New York,  
N. Y.

Chairman... D. G. Fink

#### Present

D. G. Fink, *Chairman*

H. G. Busignies                  B. E. Montgomery  
L. G. Cumming                  H. K. Morgan  
K. M. Cummings                  G. H. Philips  
C. J. Hirsch                      J. A. Pierce  
D. R. MacQuivey                  P. C. Sandretto  
H. R. Mimno                      Ben Thompson

The Chairman stated that he had written to General Rives and General Arnold requesting representation from the Army Air Force Material Command and from the Air Transport Association, respectively, but thus far had not received replies. He reviewed the Committee's functions and stated that it would reserve the right to make definitions on radio terms, but that those of navigation terms will be passed on to the Radio Technical Committee for Aviation and the Radio Technical Committee for Marine, Institute of Navigation, and Institute of Aeronautical Sciences for comments. The report of the subcommittee was read and detailed comments were made on the work of the various sections. Professors Mimno and Pierce were again nominated to make suitable corrections in the definitions. It was agreed that a classification covering the electronic technique for navigation might constitute a valuable addition, and the acting secretary was asked to attempt these definitions.

### STANDARDS

Date..... March 3, 1947  
Place..... Hotel Commodore, New York,  
N. Y.

Chairman... A. B. Chamberlain

#### Present

A. B. Chamberlain, *Chairman*

R. S. Burnap                      L. C. F. Horle  
I. S. Coggeshall                  E. A. Laport  
M. G. Crosby                      K. C. McIlwain  
L. G. Cumming                      D. E. Noble  
Eginhard Dietze                  E. W. Schafer  
R. F. Guy                          S. A. Schelkunoff

The best method of presenting standards for practical use in the field was discussed. Mr. Laport, Chairman of the Transmitter Committee, strongly recommended a thorough study of the activities of similar technical organizations, aimed toward the reduction of duplicating man-hours in the preparation of Definitions and drafting of Standards for Test Methods. Mr. Laport briefly described his chart, which indicates the relationship of I.R.E.'s Technical Committees to electronic and communication systems. Mr. McIlwain recommended a joint A.I.E.E.-I.R.E. subcommittee for the segregation of definitions common to both organizations. Such a subcommittee has been formed and held its first meeting on the 27th of March, under the chairmanship of Mr. A. B. Chamberlain, the Chairman of the Standards Committee. Mr. Burnap said that the American Standards Association, under the guidance of its Mr. Chester Dawes at Harvard, is increasing its liaison with A.I.E.E., I.R.E., and similar organizations. In contrast to this, Mr. Dietze advised that the American Acoustical Society is now setting up its own standards committee of six or seven members. Mr. Chamberlain advised that suggested revisions to the Standards Committee Manual currently in progress would be made available to all members of the Standards Committee.

### RAILROAD AND VEHICULAR COMMUNICATION

Date..... March 4, 1947  
Place..... Hotel Commodore, New York,  
N. Y.

Chairman... D. E. Noble

#### Present

D. E. Noble, *Chairman*

A. E. Abel                          G. H. Phelps  
G. M. Brown                      F. M. Ryan  
F. T. Budelman                  W. W. Salisbury  
W. A. Harris                      W. J. Young  
W. G. Hawkins                  W. R. Young

In order to clarify the position of the various committees dealing with communication service, Mr. Noble gave a brief description of their respective functions. The main object of the meeting was to formulate definitions and methods of measurement for various transmitter and receiver characteristics. Mr. Noble suggested that the definitions and methods be distributed to individual committee members for concentrated work and presented to the entire committee for approval at the next meeting. Desirable methods of writing the various definitions and test methods were discussed.

## ANTENNAS

Date.....March 4, 1947  
 Place.....Hotel Commodore, New York,  
 N. Y.  
 Chairman...P. S. Carter

*Present*

P. S. Carter, *Chairman*

G. H. Brown	W. E. Kock
L. G. Cumming	D. C. Ports
Sidney Frankel	J. C. Schelleng
R. F. Holz	M. W. Scheldorf
(J. E. Young)	George Sinclair
R. B. Jacques	S. A. Schelkunoff
E. C. Jordan	P. H. Smith
L. C. Van Atta	

Dr. George Sinclair submitted a definition of "Echoing Area." The members were unable to reach agreement concerning this term. A subcommittee of Doctors Van Atta, Schelkunoff, and Kock then worked up a definition under the title "Back Scattering Coefficient" and this was approved. This completes the list of definitions for the present. Since no objections were raised by any members of the Committee, the list will be forwarded to the Standards Committee shortly. The subject of transmission lines was brought up and Dr. Schelkunoff, Chairman of the Wave Propagation Committee, stated that he considered this work to come within the scope of his Committee. Dr. Sinclair submitted a revised edition of "Methods of Testing." Dr. G. H. Brown raised questions concerning the accuracy of the mutual-impedance measuring method suggested. Because of lack of time it was agreed that all comments would be submitted to Dr. Sinclair within a month. At the end of that period, the report will be considered approved and will be submitted to the Standards Committee. It was agreed that no more meetings of this Committee will be held until it has been advised of the action taken by the Standards Committee concerning the work so far completed.

RADIO WAVE PROPAGATION  
AND UTILIZATION

Date.....March 4, 1947  
 Place.....Hotel Commodore, New York,  
 N. Y.  
 Chairman...S. A. Schelkunoff

*Present*

S. A. Schelkunoff, *Chairman*

S. L. Bailey	A. G. Fox
C. R. Burrows	D. E. Kerr
T. J. Carroll	H. O. Peterson
A. E. Cullum	J. A. Pierce
L. G. Cumming	George Sinclair
H. W. Wells	

Dr. Schelkunoff requested the Committee's opinion on how frequently meetings should be held during the period in which definitions are being prepared. It was agreed that meetings of the full Committee would be held only when decisions are to be made. There was extensive discussion of the criteria which should govern the preparation of the definition of terms. It was generally agreed that the present program will be limited to terms concerned primarily with wave propa-

gation; that they should be terms that are useful and commonly employed in more than one sense, or new and not sufficiently well defined in the literature. Controversial terms should be considered particularly. The Committee will recommend to the I.R.E. Standards Committee that the rationalized meter-kilogram-second-coulomb system of units be adopted, and that the Standards Committee take the steps necessary to ensure adoption by the I.R.E. This Committee will prepare and submit for publication in the PROCEEDINGS OF THE I.R.E. a paper explaining the rationalized meter-kilogram-second-coulomb system, and discussing its advantages. Dr. Bailey suggested that testing methods be placed on the schedule for discussion at future meetings, with the purpose of deciding to what extent the Committee should prepare definitions or recommend test procedures.

## MODULATION SYSTEMS

Date.....March 4, 1947  
 Place.....Hotel Commodore, New York,  
 N. Y.  
 Chairman...M. G. Crosby

*Present*

M. G. Crosby, *Chairman*

H. S. Black	C. T. McCoy
F. L. Burroughs	E. M. Ostlund
D. M. Hill	G. R. Town
V. D. Landon	B. Trevor
B. D. Loughlin	J. E. Young

Chairman Crosby exhibited the galley proofs of the report, "Radio Progress During 1946." Suggestions of research problems suitable for submission to the I.R.E. Technical Committee on Research were requested by Mr. C. T. McCoy. A discussion developed concerning the policies, scope, and method of operation of the Research Committee which should be clarified before the other committees can be of much service to it. Considerable discussion centered around methods of reducing the time now required to get new standard definitions into use. Chairman Crosby will discuss this matter with the Standards Committee. The modulation definitions dated January 22, 1947 were discussed in detail. Final forms of definitions 1M1 through 1M21 were agreed upon.

## RADIO RECEIVERS

Date.....March 4, 1947  
 Place.....Hotel Commodore, New York,  
 N. Y.  
 Chairman....W. O. Swinyard

*Present*

W. O. Swinyard, *Chairman*

W. L. Carlson	Garrard Mountjoy
L. F. Curtis	J. M. Pettit
C. J. Franks	A. O. Peterson
A. R. Hodge	F. H. R. Pounsett
C. R. Miner	J. D. Reid
R. F. Shea	

The Chairman reviewed the revised draft of the proposed Standards on Methods of Testing Frequency-Modulated Broadcast Receivers and several points were agreed upon for the first issue of the Standards. Subcommittees were set up to investigate

and report on additional items. A subcommittee under the chairmanship of Mr. R. F. Shea will make the necessary revisions in the 1938 Standards on Testing Broadcast Receivers to bring them in line with current practice and with modern designs of amplitude-modulation sets. Mr. A. R. Hodges was appointed Chairman of a Subcommittee to compile information for the Annual Review from the abstracts which will be in the PROCEEDINGS OF THE I.R.E.

## ELECTROACOUSTICS

Date.....March 5, 1947  
 Place.....Hotel Commodore, New York,  
 N. Y.  
 Chairman...E. Dietze

*Present*

Eginhard Dietze, *Chairman*

F. G. Blake	F. V. Hunt
S. J. Begun	H. S. Knowles
L. G. Cumming	G. M. Nixon
M. J. Di Toro	H. F. Olson
L. C. Holmes	R. A. Schlegel
F. L. Hopper	H. H. Scott
E. S. Seeley	

The Chairman read a program of the committee's work for the next several years. The committee passed the following motion, "Due to the fact that this I.R.E. committee embraces many fields in which other societies are interested, it will submit to the Executive Committee the proposal: in the case of material prepared by this committee, it will submit to other societies and groups which might be interested, the prepared material for their comments, and will delay a maximum of two months before submitting the material to the Standards Committee." A subcommittee was appointed to revise the proposed program as read by the chairman. The following were appointed as members of this subcommittee: Messrs. Dietze, DiToro, Nixon, and Seeley.

## ELECTRON TUBES

Date.....March 5, 1947  
 Place.....Hotel Commodore, New York,  
 N. Y.  
 Chairman...R. S. Burnap

*Present*

R. S. Burnap, *Chairman*

E. L. Chaffee	Louis Malter
K. C. DeWalt	J. A. Morton
W. G. Dow	I. E. Mouromtseff
J. E. Gorham	L. S. Nergaard
J. W. Greer	G. D. O'Neill
D. R. Hull	H. J. Reich
S. B. Ingram	A. L. Samuel
C. M. Wheeler	

The Advanced Developments Subcommittee, realizing that the special needs for which it was organized no longer exist, and that some of the work should be transferred to existing or new groups, resigned. Material prepared to date has been put in shape for further disposition by the Electron Tubes Committee. The Committee decided that the work on microwave tubes should be divided among the existing committees in accordance with the functions of the devices.

## EDUCATION COMMITTEE MEETING

Date.....March 5, 1947  
 Place.....Parlor E, Hotel Commodore,  
 New York, N. Y.  
 Chairman.. A. B. Bronwell

*Present*

A. B. Bronwell, *Chairman*

W. E. Arcand	J. Jenkins
R. E. Beam	R. S. Ould
W. H. Campbell	W. H. Radford
Melville Eastham	J. D. Ryder
G. H. Felt	W. W. Salisbury
A. W. Graf	E. H. Schulz
Alan Hazeltine	F. R. Stansel
Keith Henney	G. R. Town
W. D. Hershberger	W. C. White
G. B. Hoadley	Alexander Wing, Jr.
L. N. Holland	Irving Wolff
E. K. Gannett, <i>Acting Secretary</i>	

Some minor changes were made on the suggested model constitution for Joint-Student Branches as drawn up by this committee in 1946 for its presentation to the Board of Directors.

A traveling lecture series for the benefit of Sections was discussed, with particular attention to the traveling expenses of such lecturers. It was suggested that men in large companies who are constantly traveling on field trips might be made available to the local Sections in the areas they visit, and that such trips might be co-ordinated with Section meetings by I.R.E. Headquarters.

There followed a discussion on the furthering of the scientific training and attitude of engineering students and their professors. Dr. Radford then reported on the availability to schools of some surplus electronic equipment through the United States Office of Education.

## RESEARCH

Date.....March 5, 1947  
 Place.....Hotel Commodore, New York,  
 N. Y.  
 Chairman...F. E. Terman

*Present*

F. E. Terman, *Chairman*

W. L. Barrow	W. L. Everitt
R. M. Bowie	H. T. Friis
L. G. Cumming	L. C. Van Atta
E. W. Engstrom	Julius Weinberger

The Chairman reported that letters had been written: (a) To the Editor of the PROCEEDINGS, suggesting that a procedure be instituted whereby brief notes of new, significant developments could be published promptly, pending the completion of more detailed papers by the authors. A favorable response has been received from Dr. Goldsmith. (b) Suggesting that special efforts be made to secure publication of unusually significant research papers in the radio field. Dr. Goldsmith has referred this to the Papers Procurement Committee. (c) To the Education Committee, on the encouragement of research in engineering colleges. (d) To the Technical Secretary of the I.R.E., the Technical Committees requesting to review the needs for research in their fields. The possibility of developing the historical side of radio was taken up. It was proposed that a suggestion be forwarded to

the I.R.E. Board of Directors recommending that such a project be undertaken by the Institute. The subject of making industry and educational institutions more "research conscious" was again discussed. Current legislation being prepared for a National Science Foundation was discussed, and the advisability of keeping the membership of the Institute informed of its progress approved. It was requested that the Board of Directors define the Institute's policy regarding participation in such legislation. Mr. Weinberger made a brief report on psychological tests designed to evaluate aptitude for research.

## TELEVISION

Date.....March 6, 1947  
 Place.....Hotel Commodore, New York  
 N. Y.  
 Chairman...I. J. Kaar

*Present*

I. J. Kaar, *Chairman*

W. F. Bailey	Leonard Mautner
L. G. Cumming	J. B. Minter
D. G. Fink	Garrard Mountjoy
A. G. Jensen	D. W. Pugsley
R. D. Kell	R. E. Shelby
P. J. Larsen	M. E. Strieby

Mr. Larsen reported on the work of the Subcommittee on Symbols, submitting a completed list of symbols. Mr. Bailey reported on the work of the Subcommittee on Definitions. The work is essentially complete but has not yet been reviewed or co-ordinated with the work of the corresponding RMA committee. The work of the Test Methods Subcommittee was discussed and plans made for addition, review, editing, and submission to the Standards Committee. It was decided that the Tube Committee was to be asked to supply methods of measuring light output of the electro-visual device.

## RADIO TRANSMITTERS

Date.....April 7-8, 1947  
 Place.....I.R.E. Headquarters, New  
 York, N. Y.  
 Chairman.....E. A. Laport

*Present*

E. A. Laport, *Chairman*

H. R. Butler	A. E. Kerwien
Cledo Brunetti	J. B. Knox
L. G. Cumming	I. R. Weir

The Committee preferred, in view of its large catalogue of terms to be defined, that partial releases be made from time to time in looseleaf form by the I.R.E. rather than delayed publication in pamphlet form. Discussion took place concerning the manner of presenting a definition. The entire list of terms to be defined by this Committee, as previously compiled, was reviewed again for the purpose of setting forth in detail the immediate work of the group on terms and definitions. The primary list is the objective of the 1947 work. It is hoped that this can be prepared and ready for printing by the end of 1947, with a steady flow of interim releases for publication. Definitions 1M35 (Limiter), 1M36 (Clipper), and 1M37 (Clipper-limiter) proposed by the Technical Committee on Modulation Systems were referred to in association with certain requirements in

transmitter terminology, and there was a general objection to these definitions in their present form. It is desired that these and certain other related definitions now in process in the Transmitter Committee be reviewed in joint session with the Committee on Modulation Systems before final release by either Committee.

JOINT A.I.E.E.-I.R.E. GROUP FOR  
CO-ORDINATION OF ELECTRONIC  
DEFINITIONS AND TERMS

Date.....March 27, 1947  
 Place.....I.R.E. Headquarters, New  
 York, N. Y.  
 Chairman...A. B. Chamberlain

*Present*

A. B. Chamberlain, *Chairman*

L. G. Cumming	J. C. Schelleng
E. I. Green	J. D. Tebo

The purpose of the meeting was to determine procedures leading to revisions of Electronic Terms sponsored by A.S.A. Sectional Committee C-42. It was agreed that I.R.E. would provide all members present a report of the status of terms and definitions work of each of its nineteen Technical Committees. The various groups and subcommittees of A.S.A. Sectional Committee C-42 were checked for relationship to the I.R.E. definitions and recommendations for further appointments were made. A report on the status of the definitions work of pertinent A.S.A. groups will also be distributed to I.R.E. Technical Committees for comment.

## RMA-I.R.E. CO-ORDINATION

Date.....April 9, 1947  
 Place.....Engineer's Club  
 Chairman...V. M. Graham

*Present*

V. M. Graham, *Chairman*

G. W. Bailey	J. J. Farrell
A. B. Chamberlain	Keith Henney
L. G. Cumming	L. C. F. Horle

The meeting opened with a discussion of the possibility of further co-ordination between RMA and I.R.E. for the purpose of the conservation of man-hour expenditure in creating lists of Definitions and Standards. Mr. Graham presented for consideration, an excerpt from the foreword of RMA's Standards and Engineering Information covering the respective scopes of I.R.E. and RMA in standardization work. Mr. Farrell reviewed the RMA's fundamental work in facsimile. Mr. Horle suggested that I.R.E. Technical Committees have representation at the meetings of the Radio Technical Planning Board. It was agreed that I.R.E. will provide RMA a schedule of its Technical Committees' program of work for next year, when available. After considerable discussion, it was agreed that in the future, RMA will request I.R.E. to provide available definitions and standards prior to initiating work on its own standards. The matter of standardization of disc recording systems was discussed.

(Continued on p. 595)

# Sections

Chairman		Secretary	Chairman		Secretary
P. H. Herdon c/o Dept. in charge of Federal Communication 411 Federal Annex Atlanta, Ga.	ATLANTA	M. S. Alexander 2289 Memorial Dr., S.E. Atlanta, Ga.	L. W. Butler 3019 N. 90 St. Milwaukee 13, Wis.	MILWAUKEE	E. T. Sherwood 9157 N. Tennyson Dr. Milwaukee, Wis.
H. L. Spencer Associated Consultants 18 E. Lexington Baltimore 2, Md.	BALTIMORE	G. P. Houston, 3rd 3000 Manhattan Ave. Baltimore 15, Md.	J. C. R. Punchard Northern Electric Co. 1261 Shearer St. Montreal 22, Que., Can- ada	MONTREAL, QUEBEC	E. S. Watters Canadian Broadcasting Corp. 1440 St. Catherine St., W. Montreal 25, Que., Can- ada
Glenn Browning Browning Laboratories 750 Main St. Winchester, Mass.	BOSTON	A. G. Bousquet General Radio Co. 275 Massachusetts Ave. Cambridge 39, Mass.	J. T. Cimorelli RCA Victor Division 415 S. Fifth St. Harrison, N. J.	NEW YORK	J. R. Ragazzini Columbia University New York 27, N. Y.
I. C. Grant San Martin 379 Buenos Aires, Argentina	BUENOS AIRES	Raymond Hastings San Martin 379 Buenos Aires, Argentina	L. R. Quarles University of Virginia Charlottesville, Va.	NORTH CAROLINA- VIRGINIA	J. T. Orth 4101 Fort Ave. Lynchburg, Va.
H. W. Staderman 264 Loring Ave. Buffalo, N. Y.	BUFFALO-NIAGARA	J. F. Myers Colonial Radio Corp. 1280 Main St. Buffalo 9, N. Y.	K. A. Mackinnon Bos 542 Ottawa, Ont., Canada	OTTAWA, ONTARIO	D. A. G. Waldock National Defense Headquarters New Army Building Ottawa, Ont., Canada
J. A. Green Collins Radio Co. Cedar Rapids, Iowa	CEDAR RAPIDS	Arthur Wulfsburg Collins Radio Co. Cedar Rapids, Iowa	Samuel Gubin 4417 Pine St. Philadelphia 4, Pa.	PHILADELPHIA	A. N. Curtiss RCA Victor Division Bldg. 8-9 Camden, N. J.
A. W. Graf 160 N. La Salle St. Chicago 1, Ill.	CHICAGO	D. G. Haines Hytron Radio and Elec- tronic Corp. 4000 W. North Ave. Chicago 39, Ill.	W. E. Shoupp 911 S. Braddock Ave. Wilksburg, Pa.	PITTSBURGH	C. W. Gilbert 52 Hathaway Ct. Pittsburgh 21, Pa.
J. D. Reid Box 67 Cincinnati 31, Ohio	CINCINNATI June 17	C. K. Gieringer 303 W. Third St. Cincinnati 2, Ohio	Francis McCann 4415 N.E. 81 St. Portland 13, Ore.	PORTLAND	A. E. Richmond Box 441 Portland 7, Ore.
H. C. Williams 2636 Milton Rd. University Heights Cleveland 21, Ohio	CLEVELAND	A. J. Kres 16911 Valleyview Ave. Cleveland 11, Ohio	A. E. Newlon Stromberg-Carlson Co. Rochester 3, N. Y.	ROCHESTER	K. J. Gardner 111 East Ave. Rochester 4, N. Y.
E. M. Boone Ohio State University Columbus, Ohio	COLUMBUS	C. J. Emmons 158 E. Como Ave. Columbus 2, Ohio	S. H. Van Wambeek Washington University St. Louis 5, Mo.	SACRAMENTO	N. J. Zehr 1538 Bradford Ave. St. Louis 14, Mo.
Dale Pollack 352 Pequot Ave. New London, Conn.	CONNECTICUT VALLEY	R. F. Blackburn 62 Salem Rd. Manchester, Conn.	Rawson Bennett U. S. Navy Electronics Laboratory San Diego 52, Calif.	ST. LOUIS	Clyde Tirrell U. S. Navy Electronics Laboratory San Diego 52, Calif.
Robert Broding 2921 Kingston Dallas, Texas	DALLAS-Ft. WORTH	A. S. LeVelle 308 S. Akard St. Dallas 2, Texas	W. J. Barclay 955 N. California Ave. Palo Alto, Calif.	SAN DIEGO July 1	F. R. Brace 955 Jones San Francisco 9, Calif.
J. E. Keto Aircraft Radio Labora- tory Wright Field Dayton, Ohio	DAYTON	Joseph General 411 E. Bruce Ave. Dayton 5, Ohio	J. F. Johnson 2626 Second Ave. Seattle 1, Wash.	SAN FRANCISCO	J. M. Patterson 7200-28 N. W. Seattle 7, Wash.
P. O. Frincke 219 S. Kenwood St. Royal Oak, Mich.	DETROIT June 20	Charles Kocher 17186 Sioux Rd. Detroit 24, Mich.	C. A. Priest 314 Hurlburt Rd. Syracuse, N. Y.	SEATTLE July 10	R. E. Moe General Electric Co. Syracuse, N. Y.
N. J. Reitz Sylvania Electric Prod- ucts, Inc. Emporium, Pa.	EMPORIUM	A. W. Peterson Sylvania Electric Prod- ucts, Inc. Emporium, Pa.	H. S. Dawson Canadian Association of Broadcasters 80 Richmond St., W. Toronto, Ont., Canada	SYRACUSE	C. J. Bridgland Canadian National Tele- graph 347 Bay St. Toronto, Ont., Canada
E. M. Dupree 1702 Main Houston, Texas	HOUSTON	L. G. Cowles Box 425 Bellaire, Texas	M. E. Knox 43-44 Ave., S. Minneapolis, Minn.	TORONTO, ONTARIO	Paul Thompson 4602 S. Nicollet Minneapolis, Minn.
H. I. Metz Civil Aeronautics Ad- ministration 84 Marietta St., NW Atlanta, Ga.	INDIANAPOLIS	M. G. Beier 3930 Guilford Ave. Indianapolis 5, Ind.	L. C. Smeby 820-13 St. N. W. Washington 5, D. C.	TWIN CITIES	T. J. Carroll National Bureau of Standards Washington, D. C.
R. N. White 4800 Jefferson St. Kansas City, Mo.	KANSAS CITY	Mrs. G. L. Curtis 6003 El Monte Mission, Kansas	L. N. Persio Radio Station WRAK Williamsport 1, Pa.	URBANA	R. G. Petts Sylvania Electric Prod- ucts, Inc. 1004 Cherry St. Williamsport, Pa.
J. R. Bach Bach-Simpson Ltd. London, Ont., Canada	LONDON, ONTARIO	G. L. Foster Sparton of Canada, Ltd. London, Ont., Canada		WASHINGTON	
C. W. Mason 141 N. Vermont Ave. Los Angeles 4, Calif.	LOS ANGELES June 17	Bernard Walley RCA Victor Division 420 S. San Pedro St. Los Angeles 13, Calif.		WILLIAMSPORT	



# Sections

## SUBSECTIONS

Chairman		Secretary		Chairman		Secretary	
J. D. Schantz Farnsworth Television and Radio Company 3700 E. Pontiac St. Fort Wayne, Ind.	FORT WAYNE (Chicago Subsection)	S. J. Harris Farnsworth Television and Radio Co. 3702 E. Pontiac Fort Wayne 1, Ind.		C. W. Mueller RCA Laboratories Princeton, N. J.	PRINCETON (Philadelphia Subsection)	A. V. Bedford RCA Laboratories Princeton, N. J.	
T. S. Farley 74 Hyde Park Ave. Hamilton, Ont., Canad	HAMILTON (Toronto Subsection)	E. Ruse 195 Ferguson Ave., S. Hamilton, Ont., Canada		A. R. Kahn Electro-Voice, Inc. Buchanan, Mich.	SOUTH BEND (Chicago Subsection)	A. M. Wiggins Electro-Voice, Inc. Buchanan, Mich.	
K. G. Jansky Bell Telephone Laboratories Box 107 Red Bank, N. J.	MONMOUTH (New York Subsection)	L. E. Hunt Bell Telephone Labora- tories Deal, N. J.		W. A. Cole 323 Broadway Ave. Winnipeg, Manit., Can- ada	WINNIPEG (Toronto Subsection)	C. E. Trembley Canadian Marconi Co. Main Street Winnipeg, Manit., Can- ada	

### Minutes of Technical Committee Meetings

#### SUBCOMMITTEES

##### ELECTRON TUBE CONFERENCE

Date..... April 4, 1947  
Place..... I.R.E. Headquarters, New York, N. Y.  
Chairman..... I. E. Mouromtseff

##### Present

I. E. Mouromtseff, *Chairman*

L. G. Cumming      J. A. Morton  
R. A. Galbraith    L. S. Nergaard  
Louis Malter        G. D. O'Neill  
S. G. Schaffner

The appointments of Mr. Schaffner as Vice Chairman of the Local Arrangements Committee and Professor Galbraith as Treasurer and of Mr. H. W. Parker as a member of the Entertainment Committee were approved. Mr. Schaffner reported that Mr. C. A. Priest had agreed to take charge of the banquet on June 9 following the Conference meeting. Mr. Mouromtseff submitted a list of questions regarding the program which he would like to circulate among the prospective members of the conference. This list will be mailed by Dr. Nergaard together with the invitations.

##### POWER OUTPUT HIGH-VACUUM TUBES

Date..... March 28, 1947  
Place..... I.R.E. Headquarters, New York, N. Y.  
Chairman..... I. E. Mouromtseff

##### Present

I. E. Mouromtseff, *Chairman*

L. G. Cumming      H. E. Mendenhall  
T. A. Elder          E. E. Spitzer  
C. E. Fay            C. M. Wheeler

The matter of additional assignments was considered. The Chairman announced that the subjects of magnetron and transmit-receive (T.R.) tubes had been assigned to this Subcommittee. It was suggested that since the present membership was not composed of many competent to deal with magnetrons, a small group be formed to consider the matter of desirable definitions and methods of test for magnetrons. The proposed

definition for perveance was discussed and agreed upon. Methods of Testing, Section 3, Emission Tests, was approved as revised in consideration of comments received from the parent committee and the Small-Signal (SS) Tube Committee. A new definition for field-free emission current which is required because of new material included in Section 3, was approved. A revised draft of Section 5.3, leakage currents, as submitted by Mr. Mouromtseff, was discussed and some changes made.



#### STUDENT BRANCHES

The Board of Directors, at its April 2, 1947 meeting, approved the petitions that Student Branches be formed at the following universities: University of Alberta, Edmonton, Alberta, Canada; University of Michigan, Ann Arbor, Michigan; University of Syracuse, Syracuse, New York.



#### INTERNATIONAL CONGRESS ITALIAN NATIONAL RESEARCH COUNCIL

The Italian National Council of Research will hold an International Congress in Rome, from September 28 to October 5, 1947, to celebrate the fiftieth anniversary of the discovery of radio by Marconi. It proposes to give a complete picture of the present development of radio studies in the technical and scientific field, and the possibilities foreseen for the future; and to gather radio experts from all over the world, so as to increase the scientific and technical international collaboration in the field of radio communications.

A program of meetings, receptions, and excursions, including visits to scientific Institutes and Italian industries working in the radio communications field, will be offered. The technical and scientific reports and papers presented will be discussed in special meetings and then collected into a volume which, in showing the results of the Congress, will document the development of radio applications up to date.

The Congress is open to all who are interested in radio studies. Participation forms

should reach the General Secretariat of the Congress (Consiglio Nazionale delle Ricerche—P. le delle Scienze Roma) by May 31, 1947; manuscripts of papers, in duplicate, must arrive there before June 30, 1947.



### Note from the Executive Secretary

Fellow-Members:

To some of the I.R.E. members, Headquarters is "just around the corner." These are the members living and working in this section of the country. To others, Headquarters seems a long way off.

But this is a message to all members. It aims to tell you that each of us at Headquarters regards every Section of the Institute and every member of the Institute as being right here. We feel very close to each of the Sections. Their fine accomplishments in the past and their vigorous work at present are well known at Headquarters.

Over and over again, at Board of Directors meetings, at Executive Committee meetings, and in conferences of the Institute staff, the thought has come up and been applauded that the members *are* the Institute, and that the Sections, which represent them, are guiding lights in the navigation of the Institute.

Naturally, an engineering society of over 20,000 members might seem a bit impersonal. But if you knew how each individual member is regarded as "one of the family" here, and how pleased all of us are when matters of personal interest appear in the "I.R.E. News and Radio Notes" Section of the PROCEEDINGS, you would understand that the I.R.E. has managed to retain its youthful spirit and its friendly attitude toward all.

The latch string is always out here at your I.R.E. home.

GEORGE W. BAILEY



## Lawrence R. Quarles

Chairman, North Carolina-Virginia Section

Lawrence R. Quarles was born in Charlottesville, Virginia, on January 26, 1908. He received the degree of Bachelor of Science in engineering in 1929 from the University of Virginia. Following this he spent three years as a research engineer with Westinghouse Research Laboratories at East Pittsburgh, where he worked on various electron-tube circuits for industrial control. He returned to the University of Virginia in 1932 as a Service Fellow in physics and electrical engineering, and was awarded the degree of Doctor of Philosophy (physics) in 1935. He joined the staff of the electrical engineering department as instructor, became an assistant professor in 1939, associate professor in

1942, and professor in 1947. Professor Quarles is currently serving as acting dean of the department of engineering at the University of Virginia.

During the war Professor Quarles was associated as consultant on electronics problems with the Rouss Physical Laboratory, University of Virginia, which was operating under the Office of Scientific Research and Development.

He joined The Institute of Radio Engineers as a Member in 1942, becoming a Senior Member in 1943 when the new grading system was inaugurated. He is also a Member of the American Institute of Electrical Engineers, and a member of Sigma Xi and Tau Beta Pi.

The obligations of the engineer to society, and the necessary concomitant changes in his present somewhat restricted attitude toward sociological, economic, and political matters are discussed in the following guest editorial by a Fellow of the Institute, whose most recent book: "The Engineer in Society," is an expansion of the theme of his editorial.—*The Editor*

## The Industrial Scientist as Citizen

JOHN MILLS

Scientists and engineers are accused of exerting little influence upon the uses which society makes of their technical developments. They produce while others dispose.

Why is it that those who devise the physical mechanisms of our civilization are, as a rule—and the exceptions only prove the rule—so unconcerned and speechless as to the social utilization? They are driven by the creative urges of intellectual curiosity and the instinct of workmanship. Curiosity points the way and craftsmanship follows. But the compelling drive of curiosity becomes canalized. The rigorous training which they undergo, despite some courses in the humanities, soon limits their questions to their chosen fields. They tend to become specialists. They do not explore human relationships, social, economic, and political. In these matters, blocked by their own inhibitions, they tend to accept unquestioningly the current platitudes or the prejudices and doctrines they absorbed as children.

This tendency is pronounced in industry where organization is functional. Much of the power of industrialized science can be ascribed to its co-ordination of highly specialized experts. For any problem outside one expert's field there is, at least nominally, another thoroughly qualified expert. Each has vested interest in his speciality; and when technical advice is needed beyond his range he learns, on a live-and-let-live basis, to rely on co-ranking experts. He accepts their opinions the more completely the further their fields are from his own.

He bows to the authority of experts, and keeps strictly out of preserves that are not his own. Nor does he ask embarrassing questions about matters "which aren't his business." And thus by a natural transition he becomes sterile in matters social, economic, and political. He will damn a Communist, and justly, for following his party line and taking his opinions from Marx or Moscow; but he can remain blissfully unconscious while he is following a company's "policy" line.

He has the brains and the analytical ability to handle the larger questions of social import; but he rarely speaks out and almost never acts. Despite his unique value to society, due to his facility in the scientific method, he pulls his punch and fails to follow through.

Today, in the words of the Biblical paradox, to save his life he must lose it. At any rate, he must divert time and energy from his scientific work to the social problems that vitally concern his future and that of all his fellow men.

This world of ours already has enough products of science to wreck it good and plenty. What it needs is some hair of the dog that bit it: an application to its present problems of the same methods of science as unwittingly provided the mechanisms by which it got where it is. And engineers and scientists must insure that the prescription is filled.

# The Job Ahead\*

CHARLES R. DENNY†

In his position as chairman of the Federal Communications Commission, the writer of the following address has clearly seen and described certain major problems facing the radio engineer and the industry with which he is associated. It is thought that it will accordingly stimulate radio scientists to discover and develop the methods and equipment for which it indicates a major need.—*The Editor.*

WHEN The Institute of Radio Engineers, one of the world's foremost technical bodies, invites a lawyer to speak at its annual banquet, there can be only one reason.

Certainly you are not seeking my views on "betatrons," "cyclotrons," "magnetrons" "resonatrons," or "synchrotrons." I have also been assured by your President that I am not expected to deal with "helical filaments," "resonant cavities," "particle accelerators," "parabolic loci," "Geiger counters," "cloud chambers," or the "electronic digital computer."

No, the reason you have asked me here tonight is the only reason people ever call in a lawyer. You are in trouble. I sense you have a guilty conscience.

You radio engineers are becoming increasingly aware that your profession has moved so far ahead into the unknown, and has accomplished so many seeming miracles, that the public is beginning to look upon you with suspicion. You have come at last to realize that there is a growing danger that men of your profession will be charged with the practicing of black magic.

So, you want a lawyer. I shall be glad to do what I can to help you. Let's begin by reviewing the evidence that has been marshalled against you.

You are now cooking food by radio in seconds as compared to hours. You are sewing raincoats and shower curtains by radio instead of by needle and thread. You are gluing canoes and pianos in minutes instead of days. You are printing newspapers by radio. You are flashing telegrams through the air by facsimile. You are preparing devices which will steer ships at sea and planes in the air. You are building a new frequency-modulation system of static-free broadcasting which transmits the entire range of sound that the human ear can perceive. Not content with sending voice and music into our homes, you are building television stations that will bring important news, sporting events, and programs of great educational and entertainment value into our living rooms. (I am not, however, suggesting that this is such a program.) (I might add that you have made it possible for my wife in Washington to ascertain whether I accepted the suggestion she made this morning that I get a haircut before the dinner tonight.)

By radio, you are locating oil and minerals beneath the surface of the earth and

the bed of the ocean. The brakeman in the caboose of a speeding freight can speak with the engineer, and the engineer can speak with the dispatcher or with the conductor in another train. Busses, trucks, and taxicabs keep in touch with their central office by radio. And recently I rode down 14th Street in Washington with the Chief Engineer of the British Post Office as he talked by telephone with his wife on a farm in Manchester, England. Local and long-distance telephone calls in the United States from moving automobiles have become commonplace.

But to me one of the most awe-inspiring things that you have produced is the radio tube that not only can add, subtract, multiply, and divide but also can solve a series of complex simultaneous equations and retain in its memory as it goes along the answers to the equations which it has solved.

This is but a summary of the evidence against you, and you are involving yourselves deeper and deeper every day. You are experimenting with the use of airplanes circling in the stratosphere to relay signals from place to place and to broadcast frequency-modulation programs and television pictures. And tomorrow morning at this convention you are going to discuss ways and means of bouncing radio waves off the moon, thereby using the moon as a passive repeater for ultra-high-frequency radio transmission. And there is even talk among you of artificial moons.

Your experiments have even gone beyond the present bounds of the radio spectrum. You are sending the voice by infrared waves and television by light waves.

Gentlemen, plainly there is sorcery in your science. My best legal advice to you is to plead guilty. Luckily the punishment these days for such technological black magic is being awarded an honorary degree, a Fellowship, a Medal of Honor, the Morris Liebmann Memorial Prize, or the Browder J. Thompson Memorial award.

However mysterious your methods are, the end product of your work has won you the admiration of the world. Your progress continues at an ever-accelerating rate. The most daring prophecies of yesterday prove too conservative and become today's actuality. Things which today are experiments in your laboratories, or simply ideas in the back of your minds, and even things which you have not yet dreamed of, will, I am confident, in the next ten years be in practical use, contributing importantly to the health, safety, culture, comfort, and well-being of men everywhere. Clearly, we are on the threshold of an immense expansion in the use of radio in our day-to-day lives.

In this expansion, the radio engineer, the radio industry, and the Commission must work together, closely and co-operatively.

Even before the war ended it was evident that in order to be prepared for the expansion which was bound to come there would have to be important changes in the basic plan which allocates bands of frequencies to the various radio services. Developments since 1938, particularly in avia-

tion, have rendered the Cairo allocation plan grossly inadequate. And, as you recall, the Cairo allocation table stopped at 30 megacycles. For the purpose of revising the Cairo plan below 30 megacycles and for formulating a new plan for allocation of frequencies extending from 30 to 30,000 megacycles, the Commission in the fall of 1944 began an extensive general allocation proceeding. In this proceeding we had the full co-operation of the members of your profession. As a result of this proceeding we have developed proposals for the allocation of bands of frequencies throughout the entire useful radio spectrum.

The next step is for us to take our plan to the World Telecommunications Conference which convenes in Atlantic City on May 15, 1947. Sixty-eight nations will be represented at that Conference, and one of the principal tasks before the Conference will be to agree upon a world-wide plan for allocating frequencies to the various radio services. Our proposed plan will be thrown on the table for consideration, along with the proposals of the other nations. And we already know that several nations have prepared over-all frequency-allocation plans which are just as complete and detailed as the United States proposal.

It is anticipated that working out an agreement will take at least three months, but we are confident that a basic workable plan can be achieved. I am sure that what is ultimately adopted will not be the present United States proposal or indeed that of any single nation. It will be a composite plan embodying the best possible way of meeting the requirements of all the nations of the world. Such agreement on a basic plan is, of course, essential not only on the frequencies having long-range propagation characteristics, but also on the very high frequencies, the ultra-high frequencies, and even on the super-high frequencies where the bands are employed for use on ships or aircraft which travel around the globe.

At the same time that we have been working toward a new international allocation table, we have also been undertaking an overall revision in the Commission's rules and standards which govern the operation in the United States of the various radio services. It is our objective that one by one the technical and operating requirements for each of the different individual radio services shall be completely overhauled and brought up to date. In making these revisions we are seeking to do a great deal more than simply codify the existing rules. We are carefully reviewing each rule and each standard for the purpose of insuring that we retain only such requirements as are really essential for the proper functioning of the service in question.

In short, with reference to the established radio services I assure you that the Commission will do everything in its power to smooth the path for their continued growth. But, as we see it, the principal job that lies ahead concerns the birth and development of new radio services. Within the last

\* Decimal classification: R010:R040. Original manuscript received by the Institute, March 18, 1947. Presented, 1947 I.R.E. National Convention, March 5, 1947, New York, N. Y.

† Federal Communications Commission, Washington, D. C.



year several new radio services have been born, including railroad radio, taxicab radio, bus and truck radio, urban mobile radio, and citizens' radio. Also, we have recently announced that we will grant regular five-year licenses for radar equipments which are voluntarily installed on merchant ships.

It will be our objective, as new radio services are perfected, to move them out of the experimental ranks as rapidly as possible and put them on a regular basis. The experimental classification should be reserved for laboratory experiments and for field testing of services which have not yet been proved out. And in this experimental category there must be the widest possible latitude for the full play of the imagination and techniques of the radio engineer. It is our desire to give just as much encouragement to the experiments of the lone inventor working in his cellar as to the organized research programs of the large industrial laboratory.

If the I.R.E. has any suggestions as to what the Commission can do further to encourage experimentation and the development of new services, we should welcome them.

Having invited suggestions from you as to what the Commission can do, I should like to take the liberty of throwing out several ideas that you might be working on.

*Radio Heating*—Radio was born and grew because of man's desire to communicate. But today radio is performing another service—a service growing so rapidly that it soon may boast of a larger investment than radio communications. This is radio heating. It is now being used for such diverse purposes as welding metals, molding plastics, vulcanizing rubber, curing tobacco, fusing glass, drying penicillin, relieving aches and pains, inducing artificial fever, and grilling frankfurters.

With thousands of what are, in effect, powerful transmitters in operation and radiating radio waves, we are all faced with a serious problem. These machines must

either operate on frequencies assigned to them, or some method must be devised for shielding them so that they do not radiate.

The Commission is attempting to solve this problem by setting up graveyards at strategic points in the radio spectrum where all radio heating devices can operate without causing interference to radio communication services. Thus far we have established four such graveyards in the 13-, 27-, 40-, and 2450-megacycle regions. The radio heating people advise us that they need still more frequencies and wider bands. We are endeavoring to provide for them as best we can. But we cannot come anywhere near giving them all they ask for without doing great damage to essential communication services.

Thus, we have here two great industries developing side by side in the radio spectrum. Their problems must be solved so that they can both go forward. On the one hand radio heating devices cannot be permitted to roam the spectrum indiscriminately and cause interference to radio communications. On the other hand provision must be made for the orderly growth of the vast new electronic heating industry. This, gentlemen, is going to be one of the biggest headaches of the next decade. I urge you now to place this problem on the agenda of things to be tackled in your laboratories.

*The High-Frequency Spectrum*—A second big headache may be found in the high-frequency spectrum between 4 and 25 megacycles. These frequencies, which as you know are capable of long-range propagation, are the only means that we have today of linking the continents by radiotelephone, radiotelegraph, and international broadcasts. They also afford the only means for communicating over long distances with planes in the air and ships at sea. There is a growing demand for additional frequencies from each of the services I have mentioned. Our studies in preparation for the World Conference have established that there is no

way that any one of these services can be given additional frequencies without robbing one of the other services.

Thus, the high-frequency spectrum is a potential bottleneck to the expansion of world-wide communications, world-wide aviation, and world-wide shipping.

There are several things that can be done. Certainly we should endeavor to obtain agreement at the World Conference that all nations should make the most efficient utilization of frequencies between 4 and 25 megacycles by employing the best engineering techniques available, including highly directionalized antenna systems.

We should also explore the possibility that channels in this portion of the spectrum can be reassigned so as to provide blocks of frequencies for a given country or region of the world, thus making possible an even better utilization of the available supply.

But I am afraid that even such measures as these will only provide temporary relief in this congested portion of the spectrum. If radio is not to impose a ceiling on the expanding communications and commerce of the world, we must have a means for using the microwaves for communicating between continents. I know that the suggestion that you stretch or bend the microwaves is a big assignment, but I doubt if there is a man in this room tonight who would venture to say that it cannot be done. The answer may lie in planes circling in the stratosphere. The answer may lie in reflections from the moon. The answer may lie in some technique not yet dreamed of. But, as we see it, it is of the greatest importance that an answer to this problem be found.

The people of the United States—indeed, the people of the world—owe much to the men who are in this room tonight for the almost unbelievable progress which has already been made.

We await with keen anticipation the important contributions to a better world which your profession will make in the years that lie ahead.

## A Technical Audit\*

An Address by PRESIDENT W. R. G. BAKER†, FELLOW, I.R.E.

PROBABLY each of us looks at the National Convention of The Institute of Radio Engineers from a different viewpoint. To me it represents the annual audit of the technical phases of the radio and electronics industry. It shows to what extent the 20,000 scientists and engineers comprising The Institute of Radio Engineers have fulfilled their responsibility to the industry and to the public.

Just as an audit exhibits the facts and shows the exact status of a business, so do the exhibits and the technical papers show the progress of a science and the status of an industry in terms of physical accomplishments. Regardless of hopes, ambitions, and desires, an industry can advance no faster

than its engineers and its productive facilities can make available the actual products on which new systems and services must depend. For this reason the National Convention of The Institute of Radio Engineers forces a realistic appraisal of what has been accomplished to date, and what may reasonably be expected in the near future.

It may be well to call your attention to a simple fundamental concerning the art and science of electronics. Back of all the countless developments of electronics and basic to all the applications, regardless of whether industrial or entertainment, is the electron tube in a circuit. This holds true whether we are considering the most simple form of broadcast receiver or the most complex radar equipment. The electron tube, which can detect, identify, amplify, regulate, and control, is the common denominator of the electronics industry.

We all recognize that new services now in the process of commercialization—frequency-modulation broadcasting and television—may well have far-reaching effects on the prosperity of our country and the standard of living of our people. Further than that, new systems and services still in the laboratories and hence not subject to this "audit," show in themselves that this science, art, and industry is so young that its future cannot be realistically projected.

The I.R.E. is the pre-eminent association in the field of electronics. It was organized in 1913. Its growth has been continuous and sound. At present The Institute of Radio Engineers represents 20,000 scientists and engineers engaged in all phases of the research and engineering of the electronics industry.

The future of the Institute is the future of electronics. The future of electronics is beyond man's ability to forecast.

\* Decimal classification: R040. Original manuscript received by the Institute, March 21, 1947. Presented, 1947 I.R.E. National Convention, March 3, 1947, New York, N. Y.

† General Electric Company, Schenectady, N. Y.

# One-Millionth-Second Radiography and Its Applications\*

CHARLES M. SLACK†, AND DONALD C. DICKSON, JR.†, STUDENT, I.R.E.

**Summary**—The making of ultraspeed radiographs using exposure times of the order of one-millionth of a second requires the passage of electron currents approaching 1000 amperes. Such currents are supplied by an electron source utilizing field emission from a cold-cathode electrode which degenerates into a metallic arc in a high vacuum. The recording of such high-speed transients is briefly reviewed. The development of this equipment has been greatly accelerated because of the war. Illustrations showing its applications to various radiographic problems requiring short exposure times which have recently been released by the War Department are included; among these are radiographs taken at Frankford Arsenal and Aberdeen Proving Grounds of exploding shells and bombs, and at Princeton University showing the wounding mechanism of high-velocity fragments.

## INTRODUCTION

ALTHOUGH X rays and "radio" waves are part of the same electromagnetic spectrum, it is not uncommon to find that engineers well versed in "radio" and allied electronic fields do not feel at home when discussing X rays. For this reason it is thought best to review some pertinent basic principles regarding the generation and utilization of X rays.

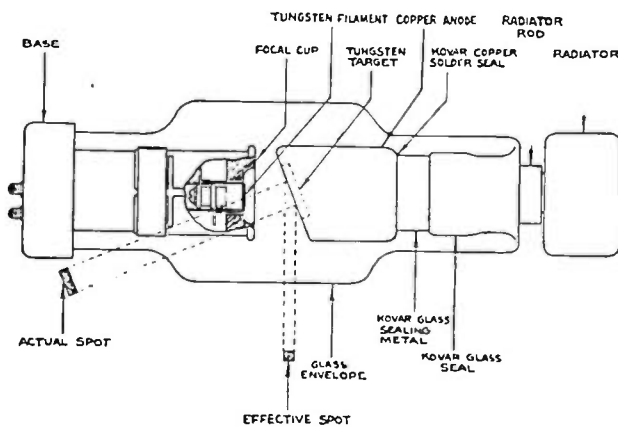

Fig. 1—A typical modern hot-cathode X-ray tube. The electrons are furnished by a hot filament and bombard a tungsten target, generating X rays.

Fig. 1 is a diagram of a rather common type of hot-cathode, radiographic X-ray tube. The tungsten filament supplies electrons which are focused by the focusing cup and accelerated by the voltage drop across the tube to strike the tungsten anode or target approximately in the rectangular area shown. This bombardment of the tungsten by the electrons results in the emission of X rays with approximately equal intensity in all directions from each atom of the bombarded

tungsten. However, the X rays which are directed into the anode are more or less absorbed depending upon the thickness of the anode, so that useful X rays are emitted in all directions to the cathode side of the plane of the anode. Because there is no known practical means of focusing X rays, it follows that all X-ray pictures must be shadowgraphs. For perfect definition in a shadowgraph it would be necessary to have a point source of X rays. It is impossible to obtain a true point source of X rays, so that it is then necessary to determine what maximum source size can be tolerated for a given application. Once a specific maximum bombarding area has been established there remains to be determined the maximum power that can be dissipated in the focal spot for a given time without raising the temperature of the tungsten surface sufficiently to cause excessive melting or vaporization of tungsten. The following formula applies in making this determination:

$$W_m = T_m \times (\pi K C t)^{1/2} / 2 \quad (1)$$

where  $W_m$  is the loading in total energy per unit of focal-spot area which will raise the surface temperature an amount of  $T_m$  degrees centigrade,  $K$  is the thermal conductivity,  $C$  is the heat capacity of the anode material, and  $t$  is the exposure time.

When an X-ray tube is operating with constant accelerating potential, a certain number of milliamperes will be required to take a particular radiograph. It may be found that an exposure of 1-milliamperes second at 300 kilovolts is required to produce a certain desirable film blackening through 1 inch of steel placed 1 meter from the X-ray tube anode. This could be done by using an anode current of 1 milliamperes and an exposure time of 1 second, or a 10-milliamperes anode current and a 1/10-second exposure. Following this reasoning, it is seen that  $10^6$  milliamperes or 1000 amperes would be required at 300 kilovolts to take the same picture in 1-millionth of a second.

Equation (1) indicates that for the same surface temperature of the tungsten this 1-millionth of a second exposure focal-spot area would have to be 1000 times larger than would be required to take the same picture in 1 second. Thus we see that when an X-ray shadowgraph is being taken of a stationary object there must be a sacrifice in definition as the exposure time is shortened. If a problem should require taking a radiograph of an object moving at high velocity it would be necessary to use an exposure time short enough to limit blurring to a small amount, which means that for moving objects a compromise must be made between lack of definition due to blurring and lack of definition due to focal-spot size.

\* Decimal classification: 621.375.623. Original manuscript received by the Institute, May 21, 1946; revised manuscript received, September 3, 1946. Presented, New York Section, New York, N. Y., January 26, 1946.

† Westinghouse Electric Corporation, Bloomfield, N. J.

From Fig. 1 it can be seen that by using the X rays coming from the anode in the direction shown the effective focal-spot size is considerably reduced along one dimension. This is known as the line-focus principle.

#### EARLY ATTEMPTS TO DEVELOP ULTRASPEED RADIOGRAPHY

Steenbeck,<sup>1</sup> and also Kingdon and Tanis,<sup>2</sup> solved the problem of high-speed radiography in the laboratory by utilizing a mercury-pool cathode tube, but the method had the limitations of a single-tube position plus the necessity of maintaining low mercury-vapor pressure by cooling to low temperatures. Oosterkamp<sup>3</sup> succeeded in obtaining rather short exposures by suddenly raising the cathode temperature of an ordinary X-ray tube to near the melting point, but this was a rather dangerous procedure and yielded currents of only about 20 amperes.

#### DEVELOPMENT OF THE FIELD EMISSION ARC TUBE

A few years ago experiments were begun to determine whether or not field-emission currents from a cold metallic cathode could be used to obtain microsecond X-ray exposures.<sup>4</sup> The first efforts were directed towards an investigation of the simple point-to-plane electrode arrangement shown in Fig. 2 (a). It was found that when

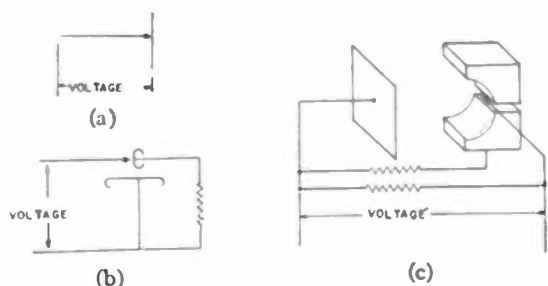

Fig. 2—Successive steps in the development of the special cathode for the high-speed X-ray tube.

- (a) Simple point to plane.
- (b) Stabilized arc with transfer to anode. Point to plane and transfer to second plane.
- (c) Further development of the idea of part (b) with focusing of the electron-stream arrangement of the X-ray tube electrodes. Transfer to anode.

a high positive voltage was suddenly applied to the flat tungsten electrode with respect to the pointed electrode, there was occasionally a very short burst of high-intensity X rays. For a given impressed voltage the operation was very dependent upon the spacing between the electrodes. If the spacing was too great there was no breakdown at all, but with very close spacing vaporized tungsten filled the gap so quickly that a low-voltage tungsten-vapor arc formed and all the

<sup>1</sup> Max Steenbeck, "Über ein Verfahren zur Erzeugung intensiver Röntgenlichtblitze," *Wissenschaftliche Veröffentlichungen aus den Siemens-Werken*, Julius Springer, Berlin, 1938, vol. 17, chap. 4, pp. 363-380.

<sup>2</sup> K. H. Kingdon and H. E. Tanis, Jr., "Experience with a condenser discharge X-ray tube," *Phys. Rev.*, vol. 53, pp. 128-134; January, 1938.

<sup>3</sup> W. J. Oosterkamp, "X-ray photography with extremely short exposure time," *Philips Tech. Rev.*, vol. 5, pp. 22-25; January, 1940.

<sup>4</sup> C. M. Slack and L. F. Ehrke, "Field emission X-ray tube," *Jour. Appl. Phys.*, vol. 12, pp. 165-168; February, 1941.

voltage drop occurred in the circuit external to the tube, so that no X rays resulted.

In order to stabilize the breakdown characteristic, the electrode arrangement of Fig. 2 (b) was experimented with. The intention here was that, with the sudden application of voltage as shown, there would be an initial breakdown between the point cathode and a very closely spaced auxiliary anode. The resistor between the auxiliary anode and the main anode would limit the current through this initial arc, and then the discharge would transfer to the main anode. This principle was found to work very well experimentally and was incorporated into the design of a commercial tube whose electrodes had the configuration shown in Fig. 2 (c). The auxiliary anode has been made concave so as to give some focusing effect on the main electron stream.

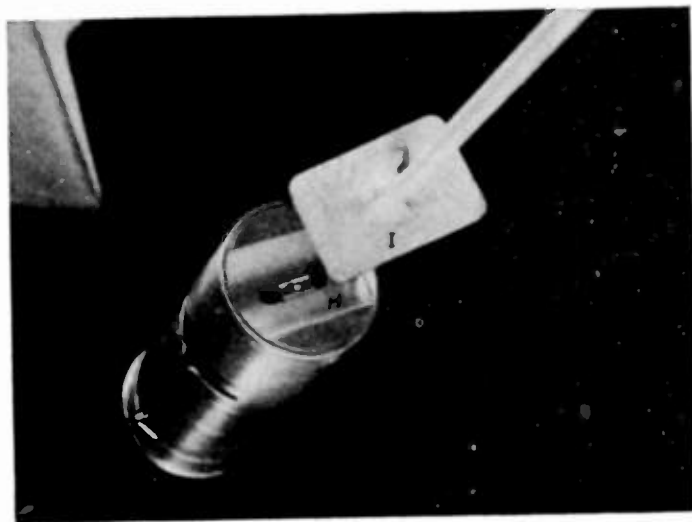

Fig. 3—Photograph of the electrodes of the ultraspeed X-ray tube

Fig. 3 is a photograph of the electrodes in the commercial high-speed X-ray tube. A sharp-edged piece of metal *G* serves as the cold cathode. The entire structure *H* is the auxiliary anode, which is often loosely referred to as the auxiliary or starter cathode because its voltage is so nearly the same as that of the cathode after the low-voltage metallic arc has been formed between it and the cathode *G*. The tungsten anode *I* is about  $\frac{1}{8}$ -inch thick,  $\frac{7}{8}$ -inch wide, and  $1\frac{1}{2}$  inches long, and is the source of the microsecond burst of high-intensity X rays.

Fig. 4 is a photograph of a standard high-speed tube. The main anode connection is the small cap at the bottom, while the cathode lead is brought out at the top. The side-arm connection is to the auxiliary anode, and the close external spacing between this and the cathode lead is possible because of the rapidity with which the starting metallic arc forms, bringing the two leads to nearly the same potential. Excluding the long flexible cathode lead, the tube is about 26 inches in length and 5 inches in diameter at the center.

The slight blackening of the glass bulb around the discharge area is the result of anode tungsten being vaporized and then condensed on the bulb walls. This could be eliminated by using a larger focal spot, but the disadvantage of poorer definition with a larger focal spot outweighs the advantage of longer life. Under normal conditions the life of one of these high-speed X-ray

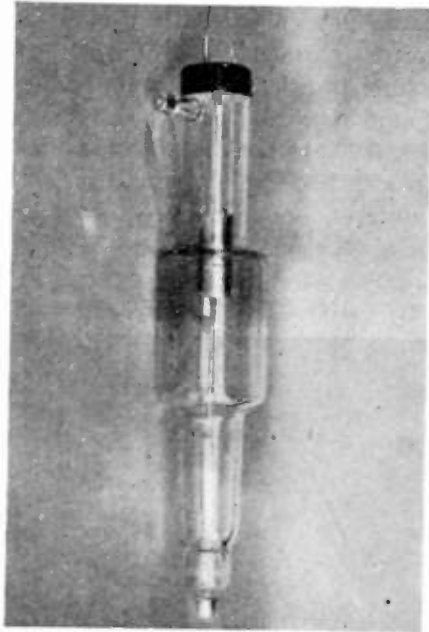

Fig. 4—Photograph of a 300-kilovolt high-speed X-ray tube. Note the small separation of the two cathode electrodes. This is possible because of the extreme rapidity with which the discharge builds up inside the tube, preventing an external arc from forming.

tubes is limited by this bulb deposit. There is some reduction in X-ray output as a result of absorption by the deposit of tungsten, but the worst effect is to alter the electrostatic fields inside the tube so that defocusing of the electron stream occurs, resulting in a large part of the discharge missing the anode. Finally, after the bulb deposit has become sufficiently great, it will "short circuit" the entire discharge away from the cathode-anode region.

#### POWER-SUPPLY AND CONTROL CIRCUIT FOR HIGH-SPEED X-RAY TUBE

The Marx-type surge-generator circuit is ideally suited to supply the millionth-of-a-second burst of energy at high voltage which is necessary to operate the tube. Fig. 5 is a simplified schematic diagram of the surge-generator power supply and the firing-control circuit which are incorporated in the standard commercial unit. The six capacitors to the right of  $C$  are charged in parallel to a maximum of 50 kilovolts. At the same time, with switch  $B$  closed,  $C_4$  is charged to about 1000 volts. When the circuit is broken at  $B$ , as a result perhaps of a bullet breaking a metallized glass fiber, the negative blocking voltage on the grid of thyatron  $T$  begins to decrease at a rate dependent upon the time constant of  $R_2C_5$ . When the thyatron becomes conducting, capacitor  $C_4$  discharges through the primary of an induc-

tion coil  $E$  which causes a high-voltage impulse from the secondary of  $E$  to break down the triggering gap  $L$ . Once

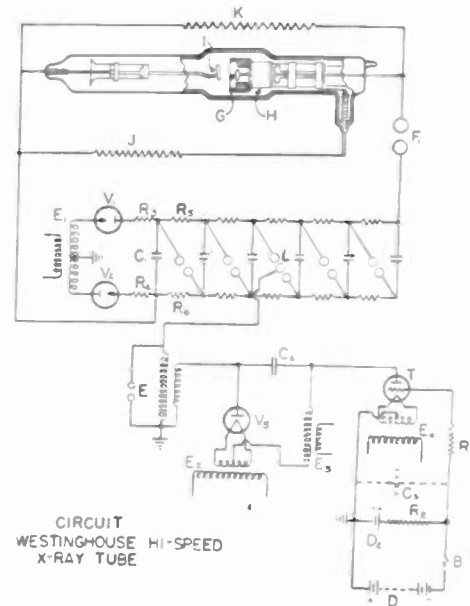

Fig. 5—Schematic circuit diagram of the high-speed tube and surge generator.

this gap is broken down the other sphere gaps in the surge generator follow very quickly, which effectively puts all of the capacitors in series across the X-ray tube. Resistors  $R_5$  and  $R_6$  and the rest of the charging resistors are of sufficiently high resistance so that very

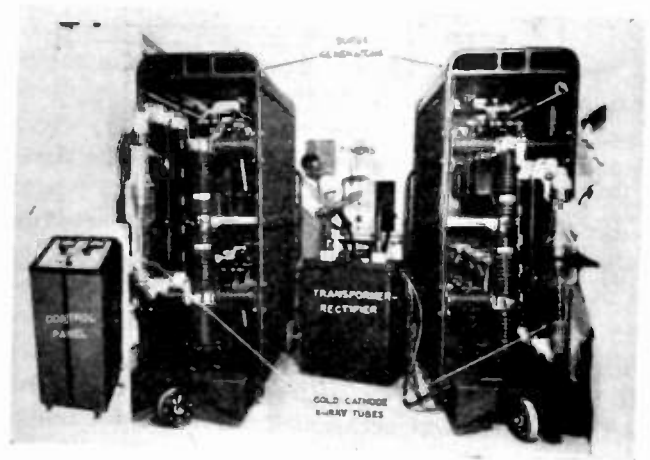

Fig. 6—A typical installation of two surge generators and control installation for ultra-high-speed X-ray equipment. Photograph by Picatinny Arsenal.

little energy is lost in them during the microsecond or so that it is necessary to discharge the capacitors through the X-ray tube. Resistor  $J$ , which stabilizes the starting arc, has a resistance usually of between 5000 and 20,000 ohms, while  $K$  is 100,000 ohms or more and serves only to keep the cathode and anode at the same voltage before the breakdown of gap  $F_1$  results in the application of high voltage to the tube.

An actual installation of this equipment at Picatinny Arsenal is shown in Fig. 6. This is a photograph of two



high-speed radiographic units set up side by side so that simultaneous or sequence pictures might be obtained of the same or of related objects. One charging unit containing the high-voltage transformer, two rectifying tubes, and associated relays and resistors is designed to supply four surge generators simultaneously. The drain on the 60-cycle power line is very small because it is always convenient to spread the 300-watt-second maximum charge on the capacitors of one surge generator over several seconds, and after reaching full charge the power line has only to supply the rectifier filament power and some small losses.

#### APPLICATIONS

The applications of this ultra-high-speed radiographic technique are in general similar to those of the better-known flash photographic techniques, with the important addition that the X-ray method can be used to reveal internal behavior of material opaque to light. Also, the X-ray method is not at all influenced by visible light originating with the object under study.

took place while the charge was still in the barrel. Even after the charge left the barrel, light pictures could not be taken for a time because of the smoke and flame which surrounded the charge for some distance outside of the barrel. Among other things, they also studied the internal action of recoil and ejection mechanisms.

Fig. 7, taken at Frankford Arsenal, shows four stages in the penetration of a steel plate by a high-explosive 20-millimeter shell. For this particular series a different shell and plate were used for each frame and the radiograph was taken at greater and greater times after the initial impact. Successive shell penetrations are so consistent that it was possible to make a moving picture strip by combining many frames similar to those of Fig. 7, but taken with shorter time intervals between them. When seen on a screen the result appears to be a very slow-motion moving picture of a single shell penetrating a steel plate.

Fig. 8 shows radiographs taken at the Aberdeen Proving Center, before static detonation and also 49 microseconds after static detonation of a model bomb.

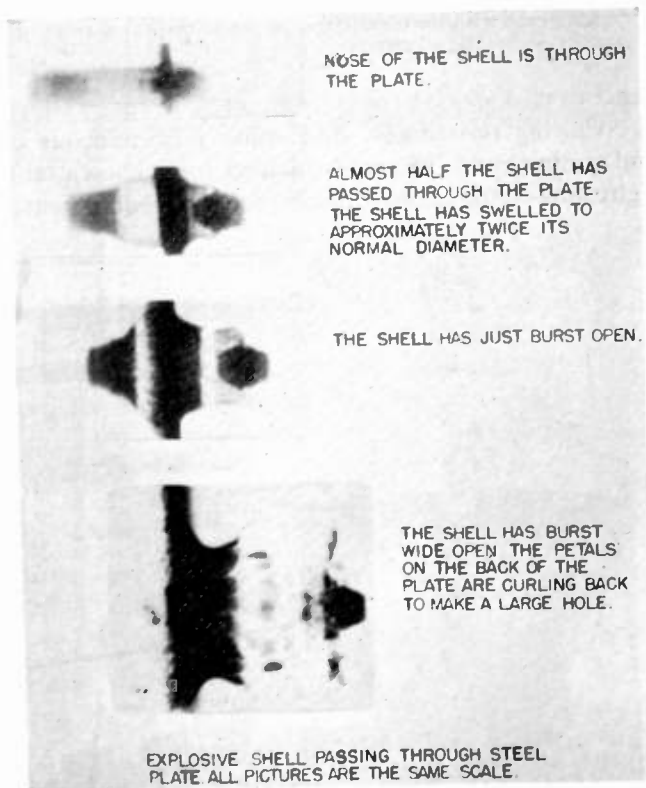

Fig. 7—Series showing the penetration of a steel plate by an explosive 20-millimeter shell. Note the swelling of the shell before the casing splits. Radiographs by Frankford Arsenal.

These characteristics of the high-speed X-ray technique make this equipment uniquely suited to a study of ballistics.

Aside from some laboratory experiments which demonstrated the equipment's possibilities, the first practical application of this technique was made by the Remington Arms Company. They were able to study the progress of a shot-gun charge down a gun barrel and to see the exact manner in which choking action

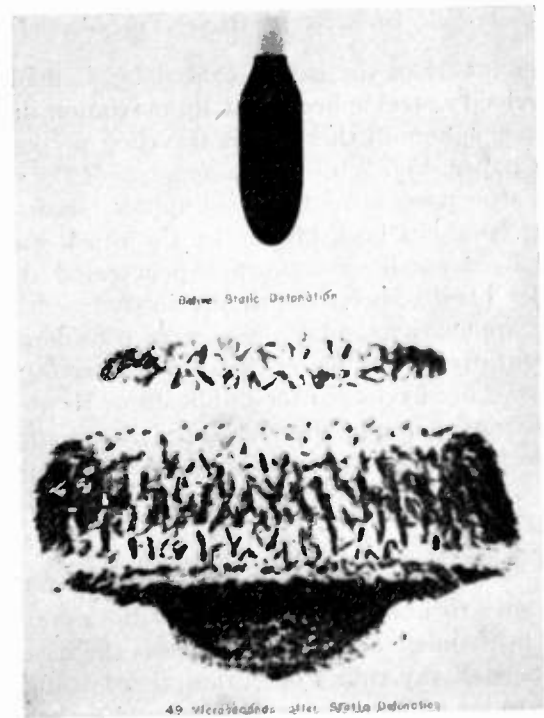

Fig. 8—Radiograph showing the distribution pattern of a model bomb. Radiograph made at the Aberdeen Proving Center.

The same thing has been done with other types of bombs and shells, and, as can be seen, this technique results in very detailed information regarding the distribution of fragments.

It had been observed in both world wars that in some instances battle casualties suffered internal injuries which were very much more severe than external evidence would seem to indicate, and it was thought that this type of wounding was due to very-high-velocity fragments. During World War II, E. N. Harvey directed work at Princeton University on an Office of Scientific Research and Development contract

in which this high-speed X-ray technique was applied to a study of the wounding effect of high-velocity fragments. Fig. 9 (a) is a radiograph of the leg of an anesthetized cat whose blood vessels have been injected with a material fairly opaque to X rays. Fig. 9 (b) is a high-speed radiograph taken approximately at

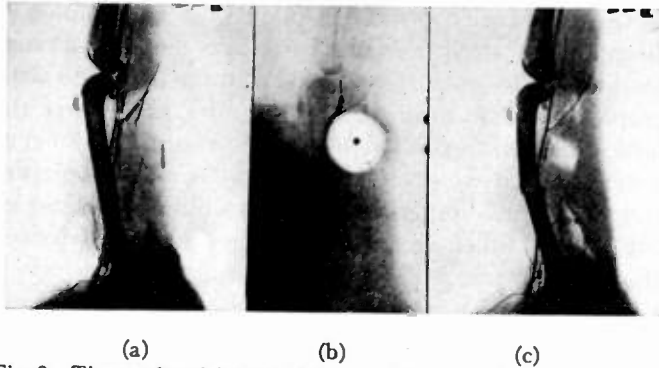

Fig. 9—The results of firing a high-velocity projectile through a cat's leg in which the blood vessels have been injected with a radio-opaque medium. The center radiograph shows the cavity and displacement produced by the passage of the projectile, and the other two radiographs show conditions before and after the shot. Radiographs by Dr. E. Newton Harvey, Princeton University.

the instant when the cavity caused by a small, very-high-velocity steel sphere is at its maximum diameter. The steel sphere in this case is traveling perpendicular to the paper. Fig. 9 (c) is a radiograph of the cat's leg taken after passage of the steel sphere, showing that the leg bone has been broken by the shock wave produced by a small sphere which penetrated the leg a considerable distance from the bone.

The applications cited above were considered to be representative of a few of the more interesting ones that have been released for publication. However, the most extensive use of the high-speed X-ray equipment to date has been in connection with the development of the atomic bomb, but no more may be said on this subject.

#### OSCILLOGRAPHIC ANALYZING EQUIPMENT

In order to understand more fully the exact nature of the field-emission discharge which is the basis of the high-speed X-ray tube's operation, it was thought desirable to set up equipment which would make possible the simultaneous oscillographic recording of the tube anode voltage, anode current, and X-ray intensity, all with respect to time. Preliminary examination indicated that the attainment of this objective would necessitate the solution of several rather independent problems. However, to discuss the various lines of approach which were considered in arriving at the overall objective would require considerable space, so the results to date will be presented and discussed here.

Fig. 10 is a photograph showing two separate, doubly shielded rooms. The shielding of each room consists of solid sheet copper on the inside with galvanized sheet iron on the outside. The room on the left contains an experimental surge generator, part of which can be seen through the doorway, an oil tank in which high-

speed X-ray tubes are placed for operation at up to 600 kilovolts, a 60-kilovolt power supply for the surge

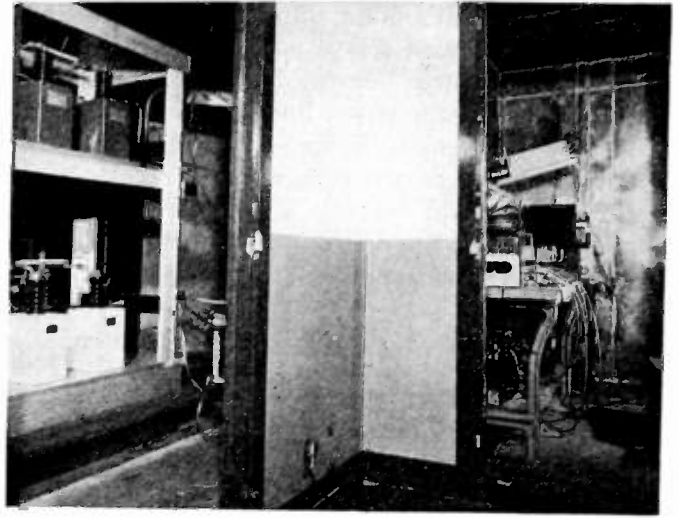

Fig. 10—General view of two double-shielded rooms constructed for oscillographic studies of the functioning of the high-speed X-ray tube and surge generator. The shielding is essential to prevent interference with the functioning of the oscilloscopes by the fields produced by the discharge.

generator, a special triggering unit, current- and voltage-viewing resistances, and some miscellaneous control equipment. The small shielded room shown on the right houses the oscillographic recording equipment.

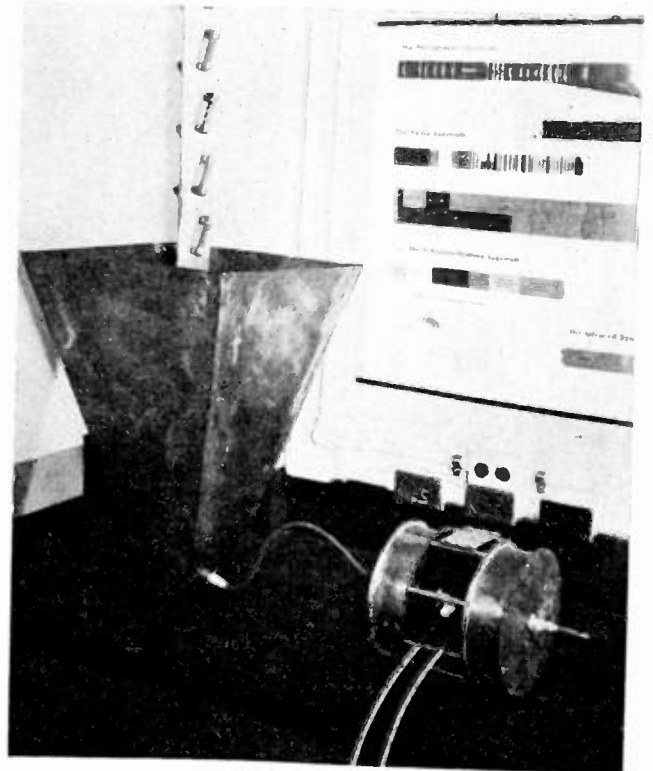

Fig. 11—The voltage-dividing units showing the type of shielding and co-axial wiring necessary to avoid the effect of external disturbances.

Fig. 11 is a photograph of the shielded voltage- and current-viewing resistors removed from the vicinity of the surge generator for clarity. The resistors which

rise out of the inverted copper pyramid are part of the high side of the voltage divider. The low side of the voltage divider is shielded by the cylindrical brass box on the left and is connected to the high side by a short length of coaxial cable. The cylindrical brass box on the right contains the current-viewing resistance. Fig. 12 is

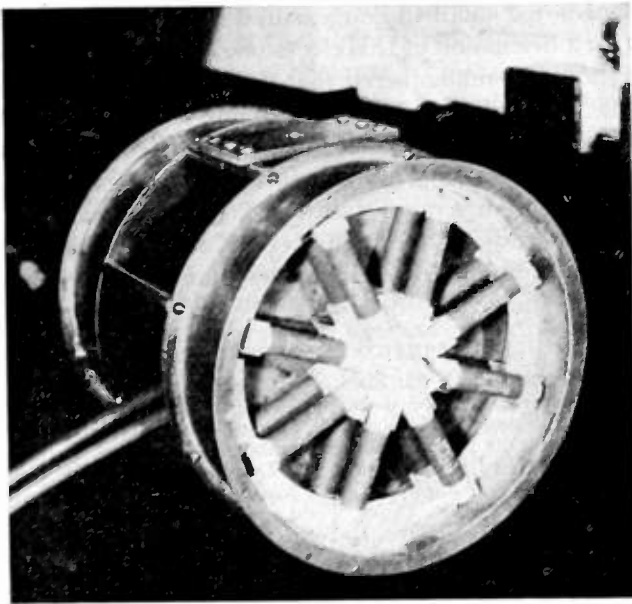

Fig. 12—Inside view of voltage-dividing unit, showing arrangement of Globar resistors.

a close-up photograph showing how sixteen Globar resistors have been arranged in parallel to obtain low inductance and lower current density per resistor than could be obtained with fewer resistors. The two parallel coaxial cables, which can be seen leading out from between the two cylindrical boxes in Fig. 11, go to the vertical deflection plates of two of the synchrosopes.

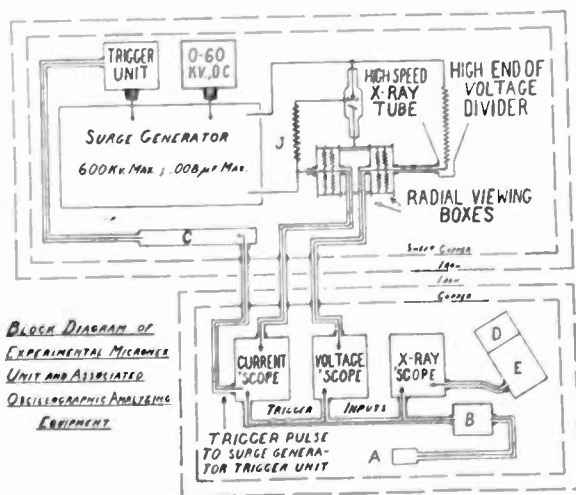

Fig. 13—A block circuit diagram of the experimental surge generator unit and associated oscillographic equipment.

The most unique problem encountered in this work was that of converting instantaneous X-ray intensity to deflection-plate voltage. This was accomplished by use of a fast-acting ionization chamber whose voltage output had to be amplified several hundred times in

order to obtain sufficient deflection voltage for the cathode-ray tube.

Fig. 13 is a block diagram which shows how all of these components are arranged in the two shielded rooms. The procedure for obtaining simultaneous traces of voltage, current, and X-ray intensity is somewhat as follows: The surge-generator capacitors are first charged to the desired voltage. With the cathode-ray beams biased so that no light is visible on the screens and with the three synchrosopes set for single sweep

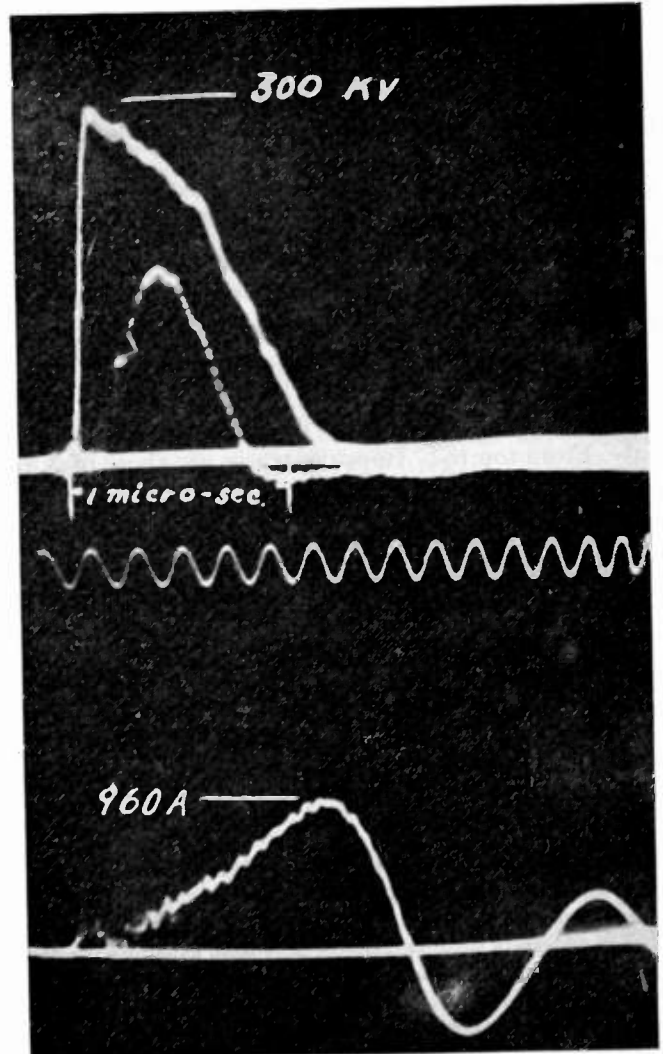

Fig. 14—A typical set of oscillograms. The top curve shows the variation of voltage during the exposure time. The second curve shows the variation in X-ray output, which follows the voltage closely, and the lower curve shows the shape of the current wave.

operation, the camera shutters are opened and the microswitch firing control *A* is pressed. This results in simultaneous voltage trigger pulses being applied to the three synchrosopes from the trigger supply *B*. The trigger output from the current-viewing synchroscope is led by coaxial cable into the large shielded room and through a 10-microsecond delay line to a special triggering unit. This unit utilizes certain radar components to generate a very fast-rising, 30-kilovolt pulse which triggers the main surge generator. The delay line prevents interference feedback to the current synchroscope until after all traces have been

recorded. The resistor  $J$  is the X-ray tube starting resistor, shown also in Fig. 5. The voltages proportional to anode current and anode voltage are led into their respective synchrosopes by coaxial cable which is terminated at the cathode-ray tubes in its characteristic impedance. This termination is not very critical, as the shortest wavelengths involved are considerably longer than the cable lengths. The X rays are picked up through the four layers of shielding by the ionization chamber  $D$ , the voltage output of which is amplified by video amplifier  $E$ , and led by coaxial cable to a final 807 stage in the synchroscope. This reasonably high-gain video amplifier is the main reason for the heavy shielding used, although where peak powers of one hundred or more megawatts are involved considerable shielding is required for the less sensitive synchroscope circuits. By proper manipulation of the output trigger phase control of the current-viewing synchroscope and of two specially installed sweep-starting phase controls in the other two synchrosopes, it is possible to locate each trace in any position desired on the time base.

Fig. 14 shows a typical set of superimposed traces obtained as outlined above. The sine wave has a frequency of 5 megacycles and is used for timing purposes only. From top to bottom the traces are those of X-ray-tube anode voltage, X-ray intensity, and anode current. It can be seen that the X-ray pulse is only about 0.6 millionths of a second in duration and that X-ray

output is effectively zero by the time the voltage has decayed to about 150 kilovolts. The anode current reaches its peak at very low anode voltage, indicating that a metallic arc has been formed in the tube. The anode current begins to oscillate after the metallic arc has been formed and does so sometimes for several cycles. The voltage across the tube during these oscillations is too small to be measured from this trace.

In a discussion of this electronic analyzing equipment it should be remembered that the purpose of the project was to learn certain things about how a high-speed X-ray tube operates, and not to set up the best possible transient recording equipment. The equipment as described here has more than satisfied the original aims as regards studying the high-speed X-ray tube, but there are still a number of refinements that could be made to improve fidelity.

#### ADDITIONAL REFERENCES

- L. F. Ehrke and C. M. Slack, "Ultra-speed radiography," *Photo Technique*, pp. 52-55; January, 1941.
- L. F. Ehrke and C. M. Slack, "Radiography at high speed," *Elec. Eng.*, vol. 60, pp. 432-435; September, 1941.
- C. M. Slack, E. R. Thilo, and C. T. Zavales, "High speed X-rays," *Elec. Ind.*, vol. 3, pp. 104-107; November, 1944.
- C. M. Slack and E. R. Thilo, "Field emission applied to ultra-speed X-ray technique," *Proc. 1st Nat. Elec. Con.*, October, 1944.
- C. M. Slack, L. F. Ehrke, and C. T. Zavales, "Millionth of a second X-ray snapshots," *Westinghouse Eng.*, vol. 5, pp. 99-103; July, 1945.
- C. M. Slack, "One millionth-second radiography," *Jour. Photo. Soc. Amer.*, vol. 11, pp. 302-306; July, 1945.
- C. M. Slack, C. T. Zavales, and E. R. Thilo, "High speed X-rays," *Steel*, vol. 116, pp. 114-117, 120-122, and 150-151; September 3 and September 10, 1945.

## Exact Design and Analysis of Double- and Triple-Tuned Band-Pass Amplifiers\*

MILTON DISHAL†, SENIOR MEMBER, I.R.E.

**Summary**—The purpose of this paper is to present a quick, complete, and exact method of design and analysis of double- and triple-tuned band-pass amplifiers.

The necessary small-percentage pass-band equations are derived giving the relationship between the circuit characteristics and the response characteristics. These circuit characteristics are: the resonant frequency  $f_0$ , coefficient of coupling  $K$ , the circuit  $Q$ , and the input and output capacitances  $C_{in}$  and  $C_{out}$ . The response characteristics are: the percentage bandwidth between peaks  $\Delta f_p/f_0$ , the peak-to-valley response ratio within the pass band  $V_p/V_v$ , the peak-to-"skirt" response ratio  $V_p/V$  at different skirt-to-peak bandwidth ratio points  $\Delta f/\Delta f_p$  outside the pass band, the circuit gain at the peaks, and the phase shift  $\theta$  at any frequency.

These design equations, extended to the case of one to eight cascaded stages, are incorporated in two sets of conveniently used nomographs, one for double-tuned circuits and one for triple-tuned circuits. Specific examples of the use of these nomographs are given.

#### SYMBOLS

$f_0$  = resonant frequency (see Section IV)

$\omega_0$  = resonant radian frequency

\* Decimal classification: R363.12. Original manuscript received by the Institute, December 29, 1945; revised manuscript received, December 4, 1946.

† Federal Telecommunication Laboratories, Nutley, N. J.

$n$  = decrement of a resonant circuit (see Section III)

$Q$  = reciprocal of decrement (see Section III)

$K_c$  = coefficient of capacitive coupling between resonant circuits (see Fig. 3)

$K_L$  = coefficient of inductive coupling between resonant circuits (see Fig. 3)

$K_M$  = coefficient of mutual inductive coupling between resonant circuits (see Fig. 3)

$K = [K_c(\omega/\omega_0) - K_L(\omega_0/\omega)]$

$C, L, M, R$  = capacitance (farads), inductance (henries), mutual inductance (henries), resistance (ohms)

$B$  = susceptance

$G$  = conductance

$F = (f/f_0 - f_0/f) = (\omega/\omega_0 - \omega_0/\omega)$

$\theta$  = phase angle between a resulting voltage and the driving current, or the phase angle between a resulting current and the driving voltage

$\Delta f$  = difference between two frequencies

$V$  = response voltage

$\beta$  = a constant for double-tuned circuits (a function of peak-to-valley ratio)

$N$  = number of cascaded stages



$\gamma$  = a constant for triple-tuned circuits (a function of peak-to-valley ratio)

$\Delta f_p$  = bandwidth between response peaks

$V_p$  = voltage at peaks of the response

$V_v$  = voltage at the valley of the response

$D = n_2/n_1 = Q_1/Q_2$ .

## I. INTRODUCTION

TO AID in the design and analysis of circuits which produce a band-pass response with respect to frequency, there has arisen a large body of literature<sup>1-4</sup> under the two general headings of filter theory and coupled-circuit theory.

However, it would be worth while to have collected in one place a method of design that will quickly and easily give answers to questions of the following type which might arise in the course of a thorough design of, say, a wide-band intermediate-frequency amplifier for receivers:

(a) For a given bandwidth and "flatness" of response, exactly how much more gain can be obtained if we use triple-tuned rather than double-tuned circuits?

(b) Can a certain skirt-selectivity specification be satisfied using only five double-tuned circuits? If so, what must the circuit constants be? What peak-to-valley ratio will there be in the pass band?

(c) How much more gain and how much greater skirt selectivity will be obtained if we accept a relatively poor response in the pass band by allowing a 1.3 peak-to-valley ratio in preference to a good 1.05 peak-to-valley ratio? What must the circuit constants be for both cases?

(d) Will more gain per stage be obtained if all the loading is done in one of the resonant circuits, or should the  $Q$  of all the resonant circuits be made equal?

In this paper, through the medium of two sets of three nomographs each, the writer hopes to provide in one place a ready means of obtaining exact answers (with a minimum of time and calculation) to the above and other questions for the case of double-tuned and triple-tuned band-pass circuits when small-percentage (20 per cent or less) bandwidths are used.

The concepts and constants used are those commonly associated with coupled-circuit theory. Filter-theory constants and concepts are always useful, and when many tuned circuits are coupled together it is practically necessary to use the filter-theory type of design. However, for both double- and triple-tuned circuits, it is possible to obtain exact closed-form solutions for the circuit response (when band-pass percentages are approximately 20 per cent or less); and these solutions are more concisely stated in terms of coupled-circuit constants.

The circuit constants used are the resonant frequency

$f_0$ , the  $Q$  of each resonant circuit used, and the coefficient of coupling  $K$  between resonant circuits. The response constants are the percentage bandwidth between peaks  $\Delta f_p/f_0$ ; the peak-to-valley ratio  $V_p/V_v$  inside the pass band (this fixes the goodness or "flatness" of the pass band); and the skirt bandwidths  $\Delta f/\Delta f_p$  at different skirt-response points  $V_p/V$  (this fixes the sharpness of cutoff or the skirt selectivity outside the pass band), the circuit gain at the peaks, and the phase shift at any frequency.

The results of the double-tuned analysis (i.e., the nomographs and the family of phase-shift curves) will be given next, with examples of their use.

## II. DESIGN AND ANALYSIS OF DOUBLE-TUNED CIRCUITS BY MEANS OF THE NOMOGRAPHS

From (18a), (19a), (21a), (23a), and (25a) of this paper, a set of nomographs have been prepared, and a family of curves have been prepared from the phase-shift equation (26). The use of these nomographs is best explained by a few specific examples.

### Example I

Knowing that the gain per stage is approximately

$$\text{Gain} = G_m/4\pi\Delta f_p\sqrt{C_1C_2}$$

and that  $C_1 \doteq C_2 \doteq 10$  micromicrofarads and  $G_m = 5 \times 10^{-3}$  mho, it is decided that five stages are probably needed to obtain a certain desired gain. A ratio of peak gain to valley gain of 1.10 will be satisfactory. A bandwidth between peaks  $\Delta f_p$  of 2 megacycles is required; and to make the percentage bandwidth approximately 20 per cent or less, a midfrequency  $f_0$  of 30 megacycles is chosen.

What loading resistances should be used to give the proper  $Q$  in the two tuned circuits? What exact gain per stage will be obtained? What must the mutual impedance be to give the proper coefficient of coupling? What will the bandwidth be 6 decibels down from the peaks? What will the bandwidth be 60 decibels down from the peaks?

Starting with Chart A, place a straight edge between point 5 on the "Number of Cascaded Stages ( $N$ )" column and point 1.10 on the " $(V_p/V_v)$ " column. From the " $[Q/(f_0/\Delta f_p)]$ " column, we find that the  $Q$  of each resonant circuit must be

$$Q = 0.69 \frac{f_0}{\Delta f_p} \doteq 10,$$

and from this same column the gain per stage will be

$$\text{Gain} = 0.69 \frac{G_m}{4\pi\Delta f_p\sqrt{C_1C_2}} \doteq 14.$$

Knowing the necessary resonant-circuit  $Q$  and the reactance of the total shunt capacitances in the resonant circuits, the necessary resultant loading resistance is, of course, given simply by  $R = QX_{C_0} = 10 \times 500$  ohms = 5000 ohms.

<sup>1</sup> E. S. Purington, "Single and coupled circuit systems," Proc. I.R.E., vol. 18, pp. 983-1016; June, 1930.

<sup>2</sup> C. B. Aiken, "Two-mesh tuned coupled circuit filters," Proc. I.R.E., vol. 25, pp. 230-272; February, 1937.

<sup>3</sup> F. X. Rettenmeyer, "Radio bibliography—filters," Radio, no. 273, pp. 26-30; October, 1942.

<sup>4</sup> T. E. Shea, "Transmission Networks and Wave Filters," D. Van Nostrand Co., Inc., New York, N. Y., 1929.

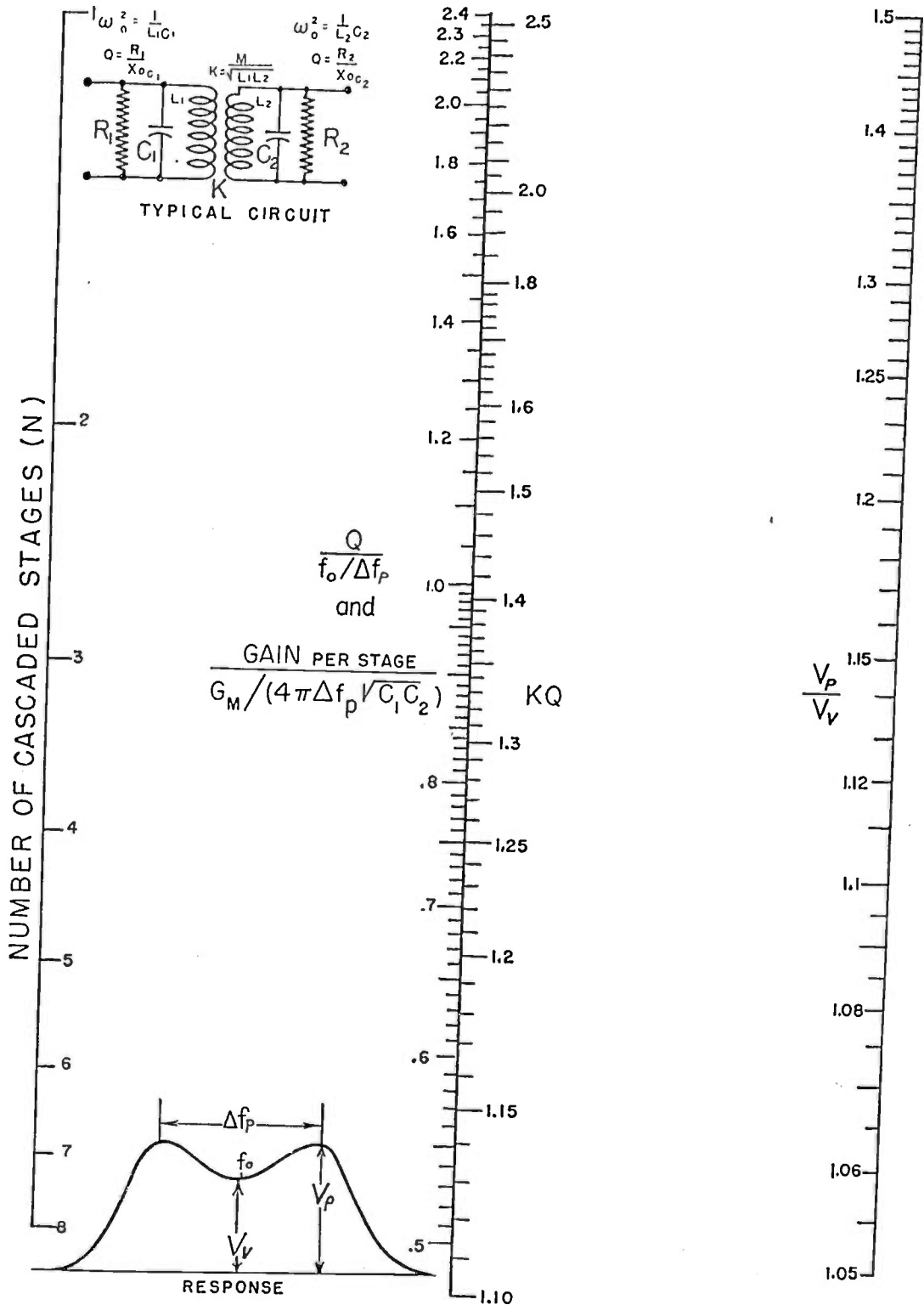

Chart A—Double-tuned band-pass circuit design.

Since the coils used will usually have appreciable loss, they will effectively supply a shunt loading resistance of value  $Q_L X_{0c}$  where  $Q_L$  is the  $Q$  of the inductance and  $X_{0c}$  is the impedance of the shunt capacitance at the resonant frequency.

Thus, the resistance  $R_+$  which must be added in parallel with the above effective resistance, due to a  $Q_L$  of 50, for example, to produce the required resultant  $Q$  is

$$R_+ = \left[ Q / \left( 1 - \frac{Q}{Q_L} \right) \right] X_{0c} \approx 6250 \text{ ohms.}$$

From the "KQ" column of Chart A, the coefficient of coupling must be

$$K = \frac{1.22}{Q} = 0.122.$$

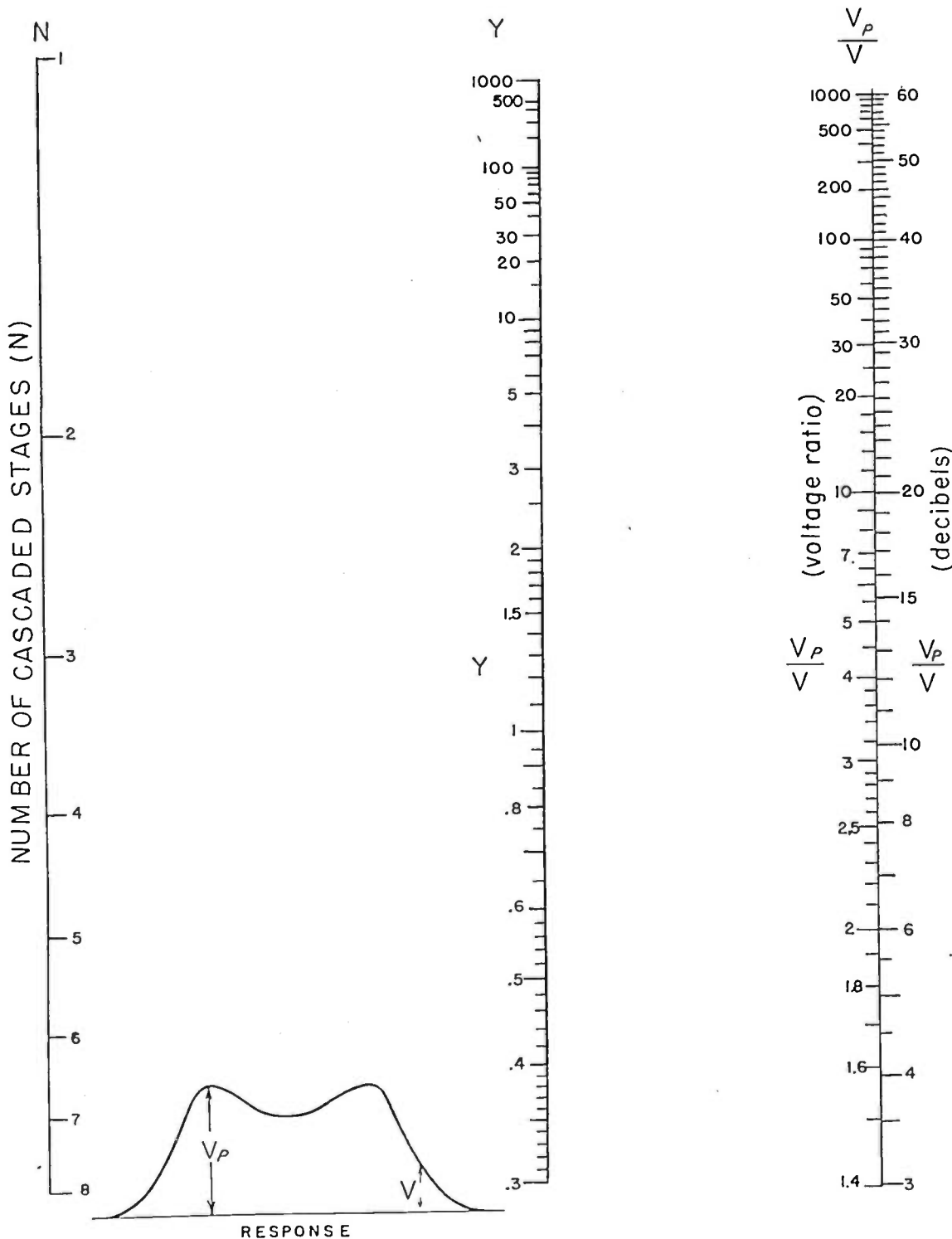

Chart B—Double-tuned band-pass circuit design for factor  $Y$ .

In the type of circuit chosen (see Figs. 1 and 2), the mutual reactance between the two resonant circuits is then found from the simple equation for the coefficient of coupling as given with each type of coupling in Fig. 3.

To consider skirt selectivity, use Charts B and C. On Chart B, place a straight edge between point 5 on the "Number of Cascaded Stages ( $N$ )" column, and 6 decibels (or 2) on the " $(V_p/V)$ " column. Read 0.56 on the middle, or " $Y$ " column. Now, going to Chart C, place the straight edge between 0.69 on the " $[Q/(f_0/\Delta f_p)]$ " column

and 0.56 on the " $Y$ " column and read from the middle column that

$$\Delta f_{6 \text{ decibels}} = 1.95 \Delta f_p = 3.9 \text{ megacycles.}$$

The bandwidth at the 60-decibels-down point is obtained in exactly the same way, i.e., on Chart B, place the straight edge between the point 5 on the "Number of Cascaded Stages ( $N$ )" column and 60 decibels (or 1000) on the " $(V_p/V)$ " column. Read 3.6 on the " $Y$ " column. Going to Chart C, place the straight edge between

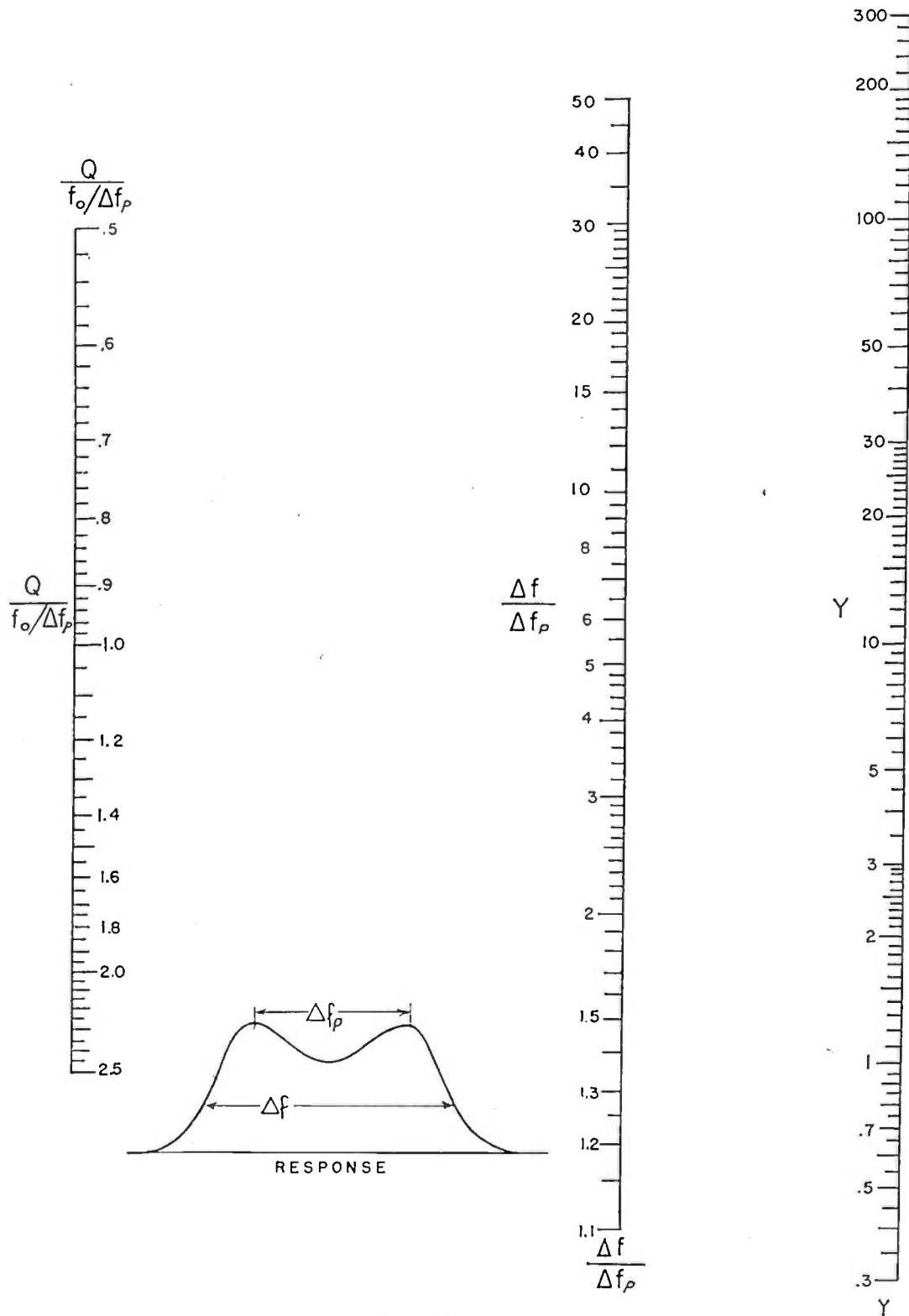

Chart C—Double-tuned band-pass circuit design.

point 0.69 on the “[ $Q/(f_0/\Delta f_p)$ ]” column and 3.6 on the “Y” column. Read from the “[ $\Delta f/\Delta f_p$ ]” column that

$$\Delta f_{60 \text{ decibels}} = 4.4\Delta f_p = 8.8 \text{ megacycles.}$$

Any other points on the response curve are found in the same manner.

*Example II*

Knowing that the approximate gain per stage is

$\text{Gain} = G_m/4\pi\Delta f_p\sqrt{C_1C_2}$ , it is decided that only 3 stages are needed to give a certain desired gain. It is necessary that the skirt selectivity be such that the bandwidth 60 decibels down be only 5 times the bandwidth between the peaks, i.e.,  $\Delta f_{60 \text{ decibels}}/\Delta f_p = 5$ . What must be the  $Q$  of each tuned circuit to obtain this skirt selectivity? What exact gain per stage will be obtained? What coefficient of coupling is required? What peak-to-valley



ratio must be accepted in order to obtain this selectivity?

Starting with Chart B, place a straight edge between point 3 in the "Number of Cascaded Stages ( $N$ )" column and point 60 decibels on the " $(V_p/V_v)$ " column and read 9.6 from the "Y" column. Going to Chart C, place the straight edge between point 5 on the " $(\Delta f/\Delta f_p)$ " column and 9.6 on the "Y" column and read on the " $[Q/(f_0/\Delta f_p)]$ " column that the required  $Q$  is

$$Q = 1.1 \frac{f_0}{\Delta f_p}$$

Now, going to Chart A, place the straight edge between point 3 on the "Number of Cascaded States ( $N$ )" column and 1.1 on the " $[Q/(f_0/\Delta f_p)]$ " column. The exact gain will be

$$\text{Gain} = 1.1 \frac{G_m}{4\pi\Delta f_p \sqrt{C_1 C_2}}$$

and, from the " $KQ$ " column, the required coefficient of coupling is

$$K = \frac{1.48}{Q}$$

From the " $(V_p/V_v)$ " column, the resulting peak-to-valley ratio will be

$$V_p/V_v = 1.27.$$

the resonant frequency as 15 megacycles, what is the response curve?

The product of  $KQ$  is 1.7. Going to Chart A, set the straight edge between 1 on the "Number of Cascaded Stages ( $N$ )" column and 1.7 on the " $KQ$ " column. From the " $(V_p/V_v)$ " column,  $V_p/V_v = 1.15$ . From the " $[Q/(f_0/\Delta f_p)]$ " column, the bandwidth between peaks will be

$$\Delta f_p = 1.38 \frac{f_0}{Q} = 1.04 \text{ megacycles.}$$

To find the width of the skirts at different points, e.g., 10 times or 20 decibels down, go to Chart B. Place the straight edge between 1 on the "Number of Cascaded Stages ( $N$ )" column and 20 decibels on the " $(V_p/V_v)$ " column and read 10 on the "Y" column. Going to Chart C, place the straight edge between 1.38 on the " $[Q/(f_0/\Delta f_p)]$ " column and 10 on the "Y" column and see that

$$\Delta f_{20 \text{ decibels}} = 4.4\Delta f_p = 4.6 \text{ megacycles.}$$

Any other points on the skirts are obtained in the same way.

*Example IV*

To find the phase shift at any point in the pass band, Chart D is used.

It should be noted that  $2(f-f_0)/\Delta f_p$  (which is the abscissa of the graph) is merely a way of writing  $(\Delta f/\Delta f_p)$  to show more clearly that in the phase-shift equation

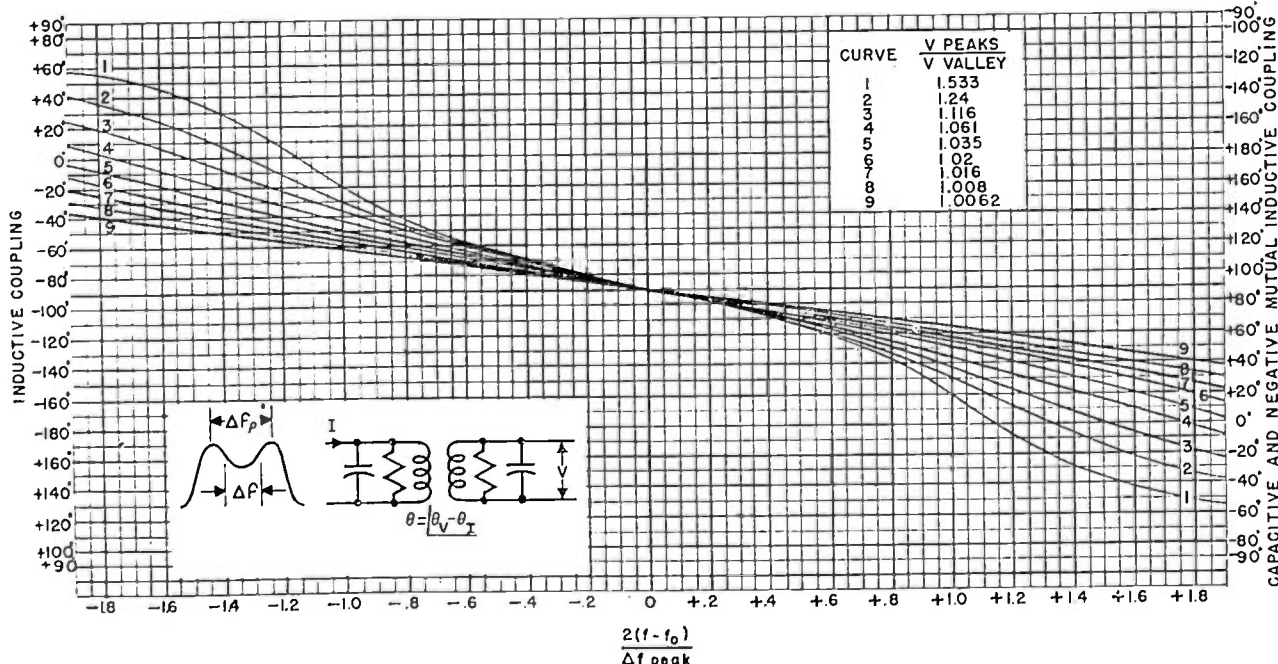

Chart D—Phase shift for a flat-top double-tuned circuit for different peak-to-valley ratios.

*Example III*

The nomographs may be conveniently used for analysis of coupled circuits, as well as for design or synthesis.

Thus, given the  $Q$  of two resonant circuits as 20, the coefficient of coupling  $K$  between them as 0.085, and

(26),  $\Delta f$  defines two frequencies equidistant from the resonant frequency. The abscissa is (+) for frequencies above the resonant frequency and is (-) for frequencies below the resonant frequency. (E.g., at the high-frequency peak  $f=f_{ph}$  and  $2(f-f_0)/\Delta f_p = +1$ , and at the

low-frequency peak  $f=f_{pL}$  and  $2(f-f_0)/\Delta f_p = -1$ .)

Note also that the ordinates give the phase shift *per stage*. If  $N$  cascaded identical stages are used, this phase shift is then multiplied by  $N$ .

Finally, note that the peak-to-valley ratios for each curve are the ratios for a single *stage*.

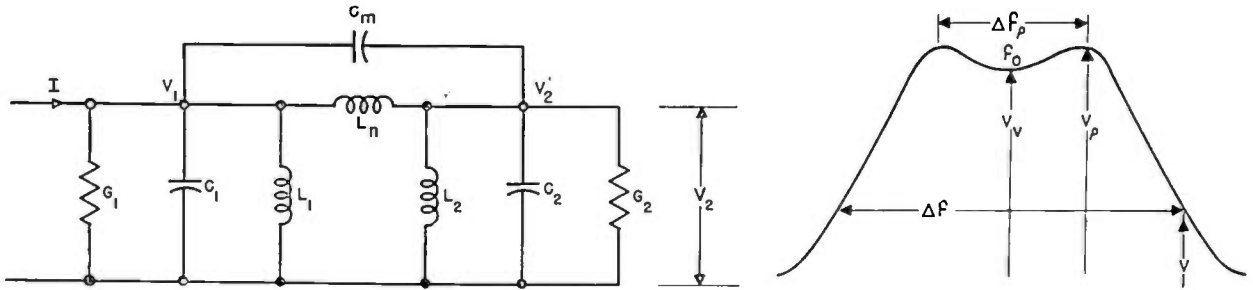

Fig. 1—Basic double-tuned two-node band-pass circuit using both inductive and capacitive coupling and the type of voltage response to be considered.

Thus, if 6 cascaded stages are being used to produce a resultant peak-to-valley ratio of 1.05, each single stage must have a peak-to-valley ratio equal to the 6th root of 1.05, or 1.0083. For this case, curve 8 would therefore give the phase shift versus frequency per stage. This phase shift at each frequency is then multiplied by 6 to give the resultant phase-shift-versus-frequency curve.

### III. CIRCUITS WHICH ARE ANALYZED

The basic circuit analyzed is the two-node network consisting of two resonant circuits coupled together both inductively and capacitively. This circuit and the response investigated are shown in Fig. 1.

By virtue of the exact equivalence of  $\pi$ 's,  $T$ 's, and transformers, the exact analysis of the basic circuit is immediately applicable to ten more circuits. These ten circuits are shown in Fig. 2 and the equations giving the values of the equivalent elements are given in Fig. 3. Lattice, bridged- $T$ , etc., equivalents may also be used.

By virtue of the concept of duality,<sup>5</sup> the analysis of the basic two-node network is immediately applicable to the dual two-mesh network given in Fig. 4, where  $I$ , the equivalent constant-current generator, and  $G$ ,  $C$ , and  $L$ , are substituted respectively for  $E$ ,  $R$ ,  $L$ , and  $C$ . Again, by virtue of the equivalence of  $\pi$ 's,  $T$ 's, and transformers, the analysis also applies to the ten additional circuits given in Fig. 5. Thus, a total of 22 band-pass circuits are effectively analyzed in this paper, plus any lattice, bridged- $T$ , etc., equivalents which the reader may desire to use.

The two-node circuit of Fig. 1 is picked as the circuit to be analyzed, rather than the dual two-mesh circuit of Fig. 4, because vacuum-tube amplifiers are effectively high-impedance generators, and for practically all high-frequency band-pass amplifier applications, high-impedance resonance is desired as obtained by the use of the circuits of Figs. 1 and 2.

If very-small-percentage pass bands are to be pro-

duced, and very slight inequality in the height of the two peaks can be tolerated, then all 22 of the circuits shown in Figs. 1, 2, 4, and 5 can be used as either high- or low-impedance circuits by means of the following reasoning. For the small-percentage band-pass case, it is convenient (and correct) to consider the band-pass char-

acteristic as being produced<sup>1</sup> in the following manner:

(a) Fundamentally, the configuration of only the lossless reactive components produces the band-pass response; the percentage bandwidth being fixed (to a first approximation) by the coefficient of coupling  $K$ . Figs. 1 and 2 and Figs. 4 and 5 give the two-node and the two-mesh reactive networks which can produce a band-pass characteristic. (Consider the shunt resistors of Figs. 1 and 2 to be open-circuited and the series resistors of Figs. 4 and 5 to be short-circuited.)

(b) The peak-to-valley ratio is fixed to a first approximation by the required  $Q$  of the input and output resonant circuits. The correct resonant-circuit  $Q$  can be produced in three ways: (1) by placing a small resistance in series with the resonant circuit,  $Q = X_{oc}/R_s$ ; (2) by placing a large resistance in parallel with the resonant circuit,  $Q = R_p/X_{oc}$ , or (3) by a combination of both series and parallel loading. For this case,

$$Q = \frac{1}{(R_s/X_{oc}) + (X_{oc}/R_p)}$$

(c) The driving force may be applied in two ways: either an infinite-impedance (i.e., zero conductance) constant-current generator may be placed in parallel with either the resonating inductance or the resonating capacitance (never across the mutual reactance); or a zero-impedance constant-voltage generator may be placed in series with either the resonating inductance or resonating capacitance (never in series with the mutual reactance).

In practice, all equivalent generators have finite output impedances associated with them. Thus, the above steps, (b) and (c), are interrelated to the extent that the effect of the output impedance of the generator upon the resonant-circuit  $Q$  must be considered.

(d) The output voltage may be obtained across either the resonating inductance or the resonating capacitance in the output circuit. Of course, we must consider the effect of the resistive component of the load upon the  $Q$  of the output resonant circuit.

<sup>5</sup> Electrical Engineering Staff, Massachusetts Institute of Technology, "Electric Circuits," John Wiley and Sons, New York, N. Y., 1940, pp. 245-246.

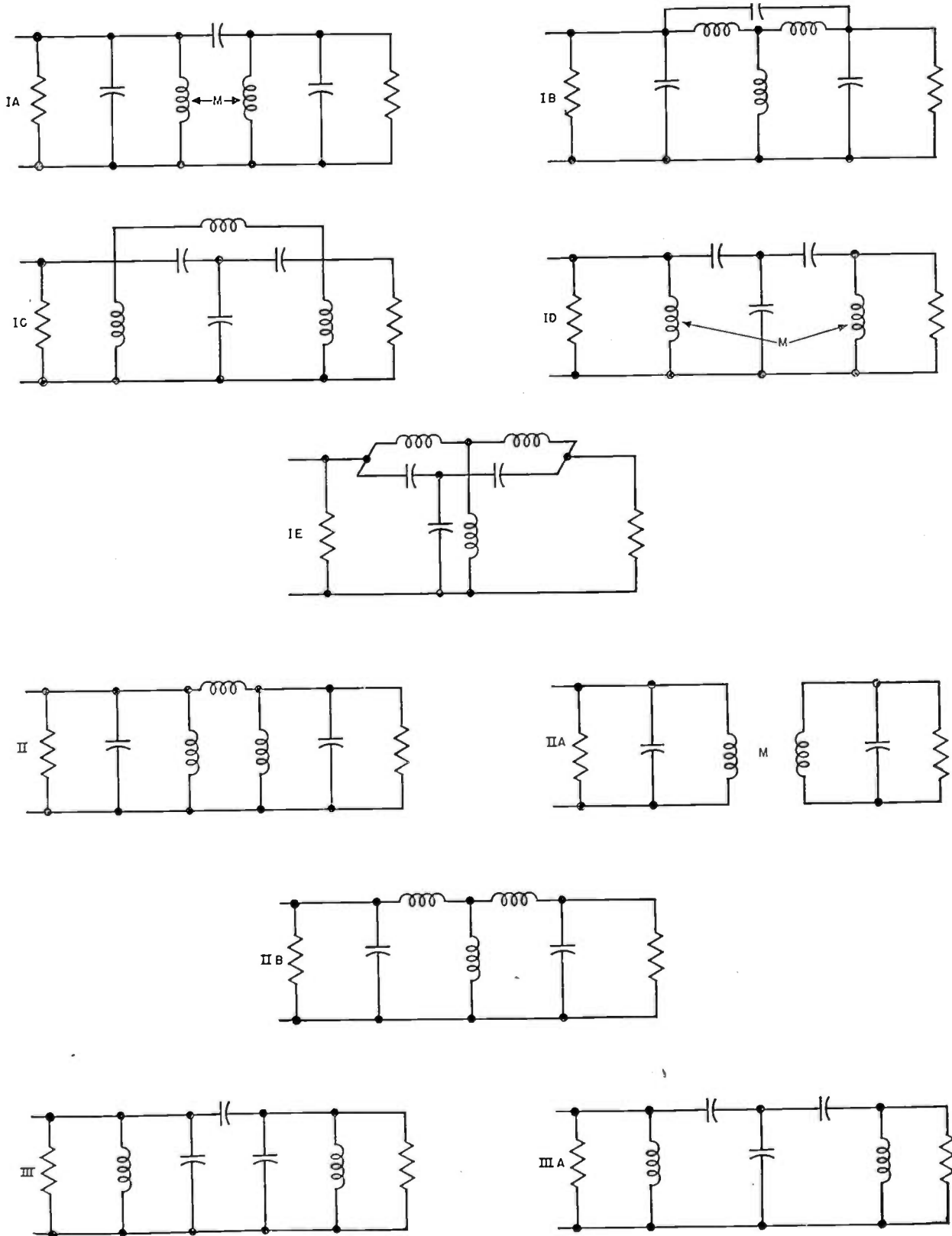

Fig. 2—Ten two-node circuits. The circuit of Fig. 1 is exactly equivalent to these circuits.

IV. ELEMENTS WHICH ARE RESONATED

It is important to know exactly what elements are resonated in the above circuits. The elements which are tuned to resonance in circuit I, Fig. 2, and all the two-node circuits are indicated by the following procedure:

Node 2 is shorted to ground and all the reactive elements remaining are resonated at the desired frequency; then Node 1 is shorted to ground (the short on Node 2 is removed) and all the remaining reactive elements are resonated to the above frequency. Thus, in circuit I,

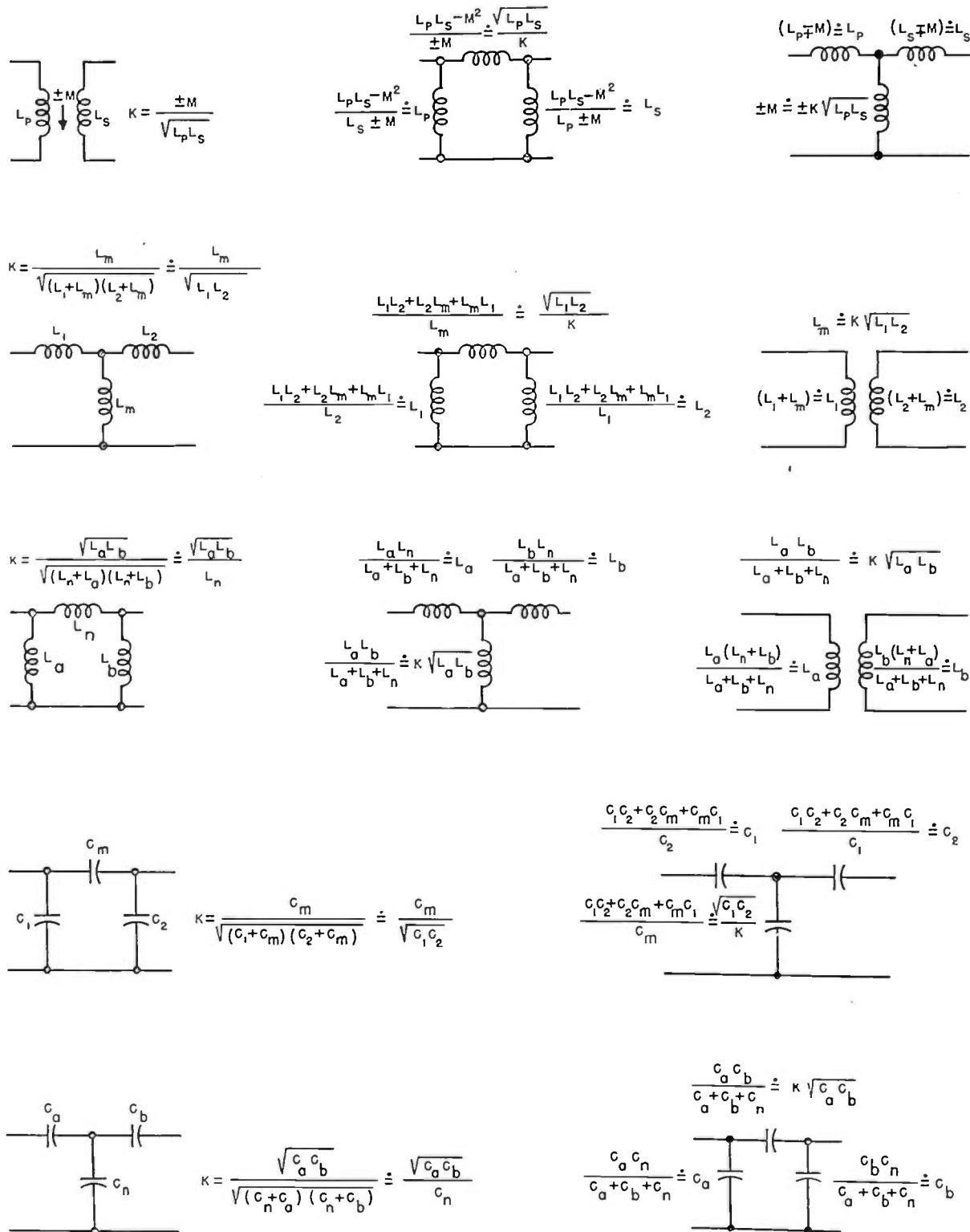

Fig. 3—Coefficient of couplings used in the analysis and the  $\pi$ ,  $T$ , and transformer exact equivalents, and approximations for small couplings.

$C_1$  plus  $C_m$  is resonated with the resultant of  $L_2$  and  $L_n$  in parallel. Thus, for the circuit I in Fig. 2, we have

$$\omega_0^2 = \frac{1}{\left(\frac{L_1 L_n}{L_1 + L_n}\right) (C_1 + C_m)}$$

$$= \frac{1}{\left(\frac{L_2 L_n}{L_2 + L_n}\right) (C_2 + C_m)} \tag{1}$$

This method of defining the resonances also introduces a very practical method of aligning double- or



triple-tuned coupled resonant circuits. *First*, completely detune all but one of the resonant circuits without affecting the mutual impedance. This detuning effectively short-circuits the node to ground for all practical purposes, and may be accomplished simply by placing an additional capacitance across the resonant circuits

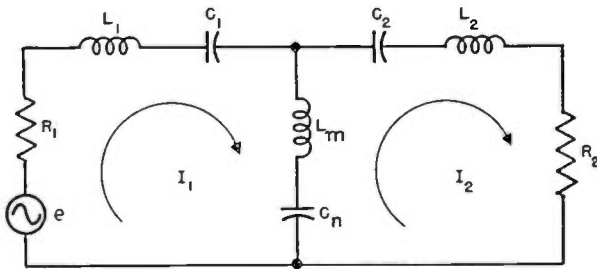

Fig. 4—Basic double-tuned two-mesh band-pass circuit (using both inductive and capacitive coupling) and the type of current response to be considered.

whose value is approximately three or four times that of the capacitance in the circuit. Or, if iron-slug tuning is used, sufficient detuning can usually be accomplished merely by turning the slug to its extreme position. *Second*, feed a signal into the circuit at the desired resonant frequency and tune the remaining one circuit, which is not detuned, for maximum output. This procedure is then repeated until all the circuits have been resonated in the above manner.

Actually, for a certain distribution of the circuit constants, i.e.,  $Q_1 = Q_2$ , there is a more convenient method of alignment which will be mentioned later.

In the dual two-mesh circuits, the elements to be resonated are indicated by the following procedure: Mesh 2 is open-circuited and all the reactances remaining in the circuit are resonated. Then, with Mesh 2 returned to its normal condition, Mesh 1 is open-circuited and all remaining reactive elements are resonated to the same frequency. Thus, for circuit A, Fig. 5, we have:

$$\begin{aligned} \omega_0^2 &= \frac{1}{(L_1 + L_m) \left( \frac{C_1 C_n}{C_1 + C_n} \right)} \\ &= \frac{1}{(L_2 + L_m) \left( \frac{C_2 C_n}{C_2 + C_n} \right)} \end{aligned} \quad (2)$$

## V. EXACT RESPONSE EQUATIONS

The node equations for the circuit shown in Fig. 5 are:

$$\left. \begin{aligned} I &= [G_1 + j(B_{e1} + B_{e_m} - B_{L1} - B_{L_n})]V_1 \\ &\quad - j(B_{e_m} - B_{L_n})V_2 \\ 0 &= -j(B_{e_m} - B_{L_n})V_1 \\ &\quad + [G_2 + j(B_{e2} + B_{e_m} - B_{L2} - B_{L_n})]V_2 \end{aligned} \right\} \quad (3)$$

As mentioned in Section 3, the solution of the above two equations for the response voltage  $V_2$  contains the solution for all the 22 circuits shown in Figs. 1, 2, 4, and 5.

A great simplification is produced in the resulting equations for the circuits if the resonant frequency  $f_0$ , the coefficient of coupling  $K$  between resonant circuits, and the decrement of each resonant circuit  $n$  are introduced into the circuit equations. (The decrement is the reciprocal of the more commonly used  $Q$ .)

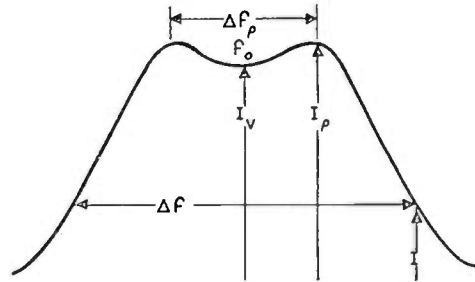

With the introduction of these constants, the equations can be expressed in terms of the three quantities only instead of in terms of the eight  $L$ ,  $C$ , and  $R$  elements making up the circuit. Our mental picture of the circuit action is thus greatly simplified.

By solving (3) for the output voltage  $V_2$  and introducing into the solution the three constants mentioned above, namely,

$$\begin{aligned} \omega_0^2 &= \frac{1}{\left( \frac{L_1 L_n}{L_1 + L_n} \right) (C_1 + C_m)} \\ &= \frac{1}{\left( \frac{L_2 L_n}{L_2 + L_n} \right) (C_2 + C_m)} \end{aligned} \quad (4)$$

$$n_1 = \frac{G_1}{\omega_0 (C_1 + C_m)} \quad (5)$$

$$n_2 = \frac{G_2}{\omega_0 (C_2 + C_m)} \quad (6)$$

$$K_c = \frac{C_m}{\sqrt{(C_1 + C_m)(C_2 + C_m)}} \quad (7)$$

$$K_L = \frac{\sqrt{L_1 L_2}}{\sqrt{(L_1 + L_n)(L_2 + L_n)}} \quad (8)$$

we obtain as the exact solution for the magnitude of the response

$$\begin{aligned} V_2 &= \frac{I}{\omega_0 \sqrt{(C_1 + C_m)(C_2 + C_m)}} \\ &\quad \times \frac{K}{\sqrt{f^4 - 2 \left[ K^2 - \frac{n_1^2 + n_2^2}{2} \right] f^2 + (K^2 + n_1 n_2)^2}} \end{aligned} \quad (9)$$

and the phase of the output voltage with respect to the constant current source is

$$\tan \theta = \frac{\pm [K^2 + n_1 n_2 - f^2]}{\pm [(n_1 + n_2)f]} \quad (10)$$

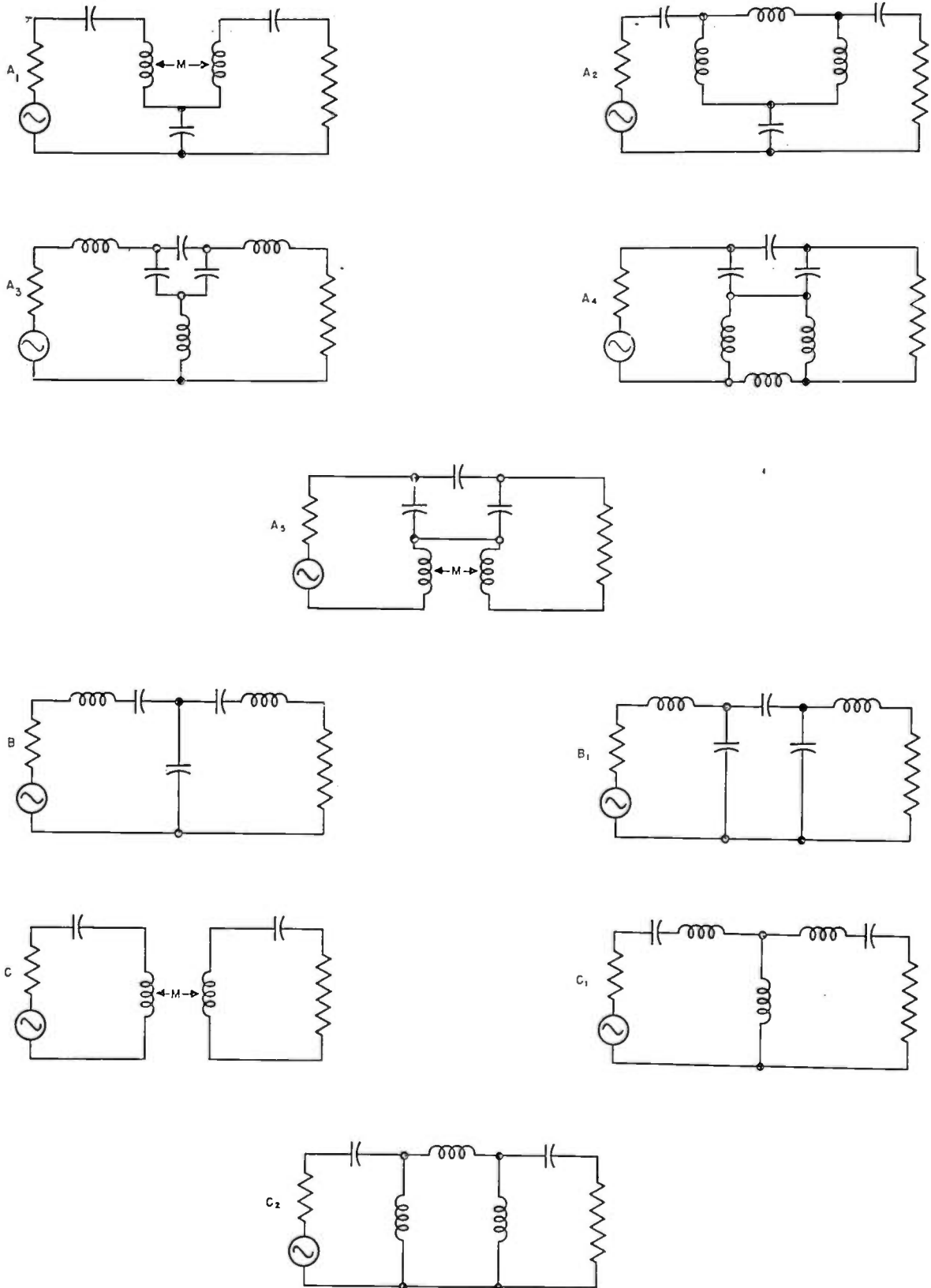

Fig. 5—Ten two-mesh circuits. The circuit of Fig. 4 is exactly equivalent to these circuits.

where

$$K = \left( K_c \frac{\omega}{\omega_0} - K_L \frac{\omega_0}{\omega} \right) \tag{11}$$

$$F = \left( \frac{\omega}{\omega_0} - \frac{\omega_0}{\omega} \right). \tag{12}$$

The sign to be used in the phase-shift equation (10) is the sign of the quantity

$$\left( K_c \frac{\omega}{\omega_0} - K_L \frac{\omega_0}{\omega} \right).$$

Thus, with capacitive coupling predominant, the top signs are used in numerator and denominator, and, with positive inductive coupling predominant, the bottom signs are used.

Examination of the numerator of (9) shows immediately one characteristic of the response. The numerator becomes zero and thus there is a null response at

$$\frac{\omega_{\text{null}}}{\omega_0} = \sqrt{\frac{K_L}{K_c}} \quad (13)$$

With reference to circuit IC of Fig. 2, it should be mentioned that if the winding sense of the inductances is such that the mutual inductive coupling "aids" the capacitive coupling there is no null of response, for then the sign of  $K_L$  in (11) is negative (-) and, therefore, the numerator never becomes zero.

We will now introduce into the above exact equations the approximations that produce the symmetrical and relatively simple small-percentage pass-band analysis.

#### VI. SMALL-PERCENTAGE PASS-BAND RESPONSE SHAPE

Because  $K$  in (9) is a function of frequency, the exact response shape is not symmetrical either geometrically or arithmetically with respect to frequency. If, however, we limit ourselves to small-percentage pass bands where  $\omega/\omega_0$  varies in value over the small range from, say, 0.9 to 1.1, then two important simplifications immediately result in the factors shown in (11) and (12).

Equation (11) becomes independent of frequency:

$$K \doteq (K_c - K_L) \quad (11a)$$

(It must be realized that this approximation cannot be used in the region of the null given by (13).)

Equation (12) becomes

$$F = \left( \frac{\omega}{\omega_0} - \frac{\omega_0}{\omega} \right) = \frac{(\omega + \omega_0)}{2\omega} \times \frac{2(\omega - \omega_0)}{\omega_0} \\ \doteq \frac{2(\omega - \omega_0)}{\omega_0} \doteq \frac{\Delta f}{f_0} \quad (12a)$$

where  $\Delta f$  is the frequency bandwidth between points equidistant from the resonant frequency  $f_0$ .

With the above limitation, (9) shows that, in the small-percentage pass-band case (where (11a) applies) the shape of the amplitude response curve is independent of the type of coupling used. The gain obtained with inductive coupling only is slightly greater than that obtained with capacitive coupling, for, as seen from (9), the capacitances which must be considered in figuring the gain are  $(C_1 + C_m)$  and  $(C_2 + C_m)$  ( $C_m$  is the equivalent high-side capacitances of Fig. 5), and  $C_m$  is zero for inductive coupling only.

The phase shift as given by (10) does differ for the two types of coupling. Since the top signs are used with capacitive coupling and the bottom signs with inductive coupling, we will have positive phase angles with capacitive coupling and negative phase angles with inductive coupling.

The frequency at which the response maximum and minimum occurs is given by differentiating (9) with respect to  $F$  (i.e.,  $\Delta f/f_0$ ) and equating to zero. This results in

$$\left( \frac{\Delta f}{f_0} \right)_{\text{peak}}^2 = K^2 - \frac{n_1^2 + n_2^2}{2} \quad (14)$$

and the location of the minimum is given by  $\Delta f_v/f_0 = 0$ .

The response at the peaks, obtained by substituting (14) in (9), is

$$V_{\text{peaks}} = \frac{I}{\omega_0 \sqrt{(C_1 + C_m)(C_2 + C_m)}} \frac{K}{\sqrt{K^2(n_1 + n_2)^2 + n_1^2 n_2^2 - \left( \frac{n_1^2 + n_2^2}{2} \right)}} \quad (15)$$

The response at the minimum or valley, which is at the resonant frequency, is obtained from (9) by setting  $\Delta f/f_0 = 0$  and is

$$V_v = \frac{I}{\omega_0 \sqrt{(C_1 + C_m)(C_2 + C_m)}} \frac{K}{K^2 + n_1 n_2} \quad (16)$$

The peak-to-valley ratio is, therefore,

$$\left( \frac{V_p}{V_v} \right) = \frac{K^2 + n_1 n_2}{\sqrt{K^2(n_1 + n_2)^2 + n_1^2 n_2^2 - \left( \frac{n_1^2 + n_2^2}{2} \right)^2}} \quad (17)$$

What we desire, in so far as design is concerned, is the values of the decrement  $n$  (or  $Q$ ) and the coefficient of coupling  $K$  required to give a certain peak-to-valley ratio. By combining (14) and (17), we obtain

$$\frac{n_1 + n_2}{2} = \beta \left( \frac{\Delta f_p}{f_0} \right) \quad (18)$$

where

$$\beta = \sqrt{\frac{1}{2} \left[ \frac{(V_p/V_v)_1}{\sqrt{(V_p/V_v)_1^2 - 1}} - 1 \right]} \quad (19)$$

where the subscript 1 is to show that this is the peak-to-valley ratio of one double-tuned stage. Equation (18) is one of the desired design equations and shows that the required average of the decrements of the primary and secondary is fixed only by the peak-to-valley ratio desired and the percentage bandwidth.

The smaller we desire the peak-to-valley ratio to be (thus the flatter the response is in the pass band) the larger  $\beta$  becomes and, therefore, the greater must be the average decrement, i.e., the lower must be the  $Q$ . From (18), we find that  $\beta$  varies between the values of 1.75 to 0.42 as the peak-to-valley ratio varies respectively between the values of 1.01 to 1.50.

Now, making use of (14) and (18), we obtain for the required coefficient of coupling

$$K = \frac{\Delta f_p}{f_0} \sqrt{1 + \beta^2 \frac{2(1 + D^2)}{(1 + D)^2}} \quad (20)$$

where  $\beta$  is given by (22) and  $D$  is the ratio of the primary  $Q$  to the secondary  $Q$ .

$$D = \frac{n_2}{n_1} = \frac{Q_1}{Q_2}$$

Thus, we see that the coefficient of coupling required is fixed mainly by the percentage band pass desired and is also dependent (not to a great extent, however) on the ratio  $D$  of primary  $Q$  to secondary  $Q$ . Equation (20) is the second of our desired design equations.

Dividing equation (20) by equation (18), we obtain

$$\frac{K}{(n_1 + n_2)/2} = \sqrt{\frac{2(1 + D^2)}{(1 + D)^2} + \frac{1}{\beta^2}} \quad (21)$$

This is a very useful equation because it does not involve frequency. It shows that as soon as the peak-to-valley ratio (i.e.,  $\beta$ ) and the  $Q$  ratio are fixed, then the ratio of the coefficient of coupling  $K$  and the average decrement  $(n_1 + n_2)/2$  is also fixed, and conversely, for a given circuit where the  $Q$  ratio and the ratio of the coefficient of coupling and the average decrement is fixed, the peak-to-valley ratio is fixed. It should be understood that the  $Q$  ratio  $D$  has an almost second-order effect; for the quantity  $2(1 + D^2)/(1 + D)^2$  is equal to unity when the  $Q$  ratio is unity, and approaches a maximum value of two when the  $Q$  ratio approaches either zero or infinity.

The next design equation desired is one that will give the output voltage or the gain of the circuit at the peaks of the response. By substituting the design conditions given by equations (18) and (20) in the equation giving the response at the peaks, which is (15), we obtain

$$V_p = \frac{1}{\beta} \times \frac{I}{4\pi\Delta f_p \sqrt{(C_1 + C_m)(C_2 + C_m)}} \times \sqrt{\frac{1 + \frac{2(1 + D^2)}{(1 + D)^2} \beta^2}{1 + \beta^2}} \quad (22)$$

and for the usual case, where the constant-current generator of value  $I$  is a vacuum tube,  $I = G_m E_\theta$ , and we have

$$\text{Gain}_{(\text{per stage})} = \frac{1}{\beta} \times \frac{G_m}{4\pi\Delta f_p \sqrt{(C_1 + C_m)(C_2 + C_m)}} \times \sqrt{\frac{1 + \frac{2(1 + D^2)}{(1 + D)^2} \beta^2}{1 + \beta^2}} \quad (23)$$

Design equation (23) brings out several points of interest with reference to the gain which is obtained with "flat-topped" band-pass circuits. We see that the gain depends directly on the  $G_m$  of the tube used and inversely on the numerical bandwidth desired between peaks  $\Delta f_p$ . The midfrequency has no effect on the gain (as long as the bandwidth  $\Delta f_p$  is a small percentage of the midfrequency  $f_0$ ). The gain is also inversely proportional to the square root of the product of the total capacitance across the input or output circuits that must be resonated. We see also that the gain is inversely

proportional to the factor  $\beta$  which is given by (19) and which is a measure of the flatness of response in the flat-top pass band. The flatter the pass band, the lower the gain obtainable. Finally, the gain depends on the square root of a quantity involving the ratio of primary  $Q$  to secondary  $Q$ .

This square root has only an almost second-order effect on the gain. It is interesting, however, to see the effect of this  $Q$  ratio on the gain. If  $Q_1$  equals  $Q_2$ , the factor under discussion becomes unity. If  $Q_2$  is made infinite and all the loading is done on the primary side, we obtain

$$\sqrt{\frac{1 + 2\beta^2}{1 + \beta^2}}$$

and, if  $Q_1$  is made infinite and all the loading is done on the secondary side, we again obtain

$$\sqrt{\frac{1 + 2\beta^2}{1 + \beta^2}}$$

In most practical designs,  $\beta$  will have a value close to unity; therefore, if all loading is done on one side of the band-pass circuit, approximately 25 per cent more gain per stage will be obtained, as compared to the case where the primary and secondary are equally loaded (i.e.,  $Q_1 = Q_2$ ).

It may be mentioned here that practical considerations dealing with ease of circuit alignment, and "Miller effect" detuning, lead to the conclusion that in many cases it is better to make  $Q_1 = Q_2$  and thus sacrifice the above 25 per cent additional gain per stage. These points will be discussed later.

The next desired design equation is concerned with the shape of the circuit response outside the pass band, i.e., the skirt selectivity. By combining (9), giving the response at any frequency, and (15), giving the response at the peaks, and (18) and (20) giving the required circuit constants, we obtain for the ratio of peak response  $V_p$  to the response  $V$ , at any band-width  $\Delta f$ ,

$$\left(\frac{V_p}{V}\right)_1 = \sqrt{1 + \left[\frac{(\Delta f/\Delta f_p)^2 - 1}{2\beta\sqrt{1 + \beta^2}}\right]^2} \quad (24)$$

and solving (24) for  $\Delta f/\Delta f_p$ , we obtain

$$\frac{\Delta f}{\Delta f_p} = \sqrt{1 \pm 2\beta\sqrt{1 + \beta^2}\sqrt{(V_p/V)_1^2 - 1}} \quad (25)$$

where the subscript 1 is to show that the ratios are the voltage ratios for one double-tuned stage.

This is the last of our desired design equations and we see that the larger  $\beta$  is made (therefore, the flatter the response inside the pass band) the wider are the skirts at any skirt-response point; i.e., skirt selectivity becomes poorer as the pass-band response is improved. It should be noted from (24) or (25) that, for a given peak-to-valley ratio (i.e., a given  $\beta$ ), the shape of the response curve is independent of the ratio of primary  $Q$  to secondary  $Q$ .

The plus or minus sign in (25) should also be noted.



When the plus sign is used, we obtain the skirt bandwidths outside the response peaks, and when the minus sign is used, we obtain the bandwidths inside the peaks of the response curve.

To make analysis as complete as possible, the phase of the response voltage with respect to the driving current should also be given. By combining (10) for the phase shift with design equations (18) and (20), we obtain

$$\tan \theta_{(\text{percentage})} = \frac{\pm [1 + 2\beta^2 - (\Delta f/\Delta f_r)^2]}{\pm [2\beta(\pm \Delta f/\Delta f_r)]} \quad (26)$$

In (26) the top sign is used in front of the numerator and denominator when  $(K_c - K_L)$  is plus, i.e., with a net capacitive coupling. (It should be remembered that these equations should not be applied to the region in the vicinity of the null given by (13).) The plus sign is used inside the bracket in the denominator for the frequencies above the resonant frequency and the minus sign is used for the frequencies below the resonant frequency.

From (26) we can see that, for *inductive* coupling, the phase shift at the midfrequency (i.e.,  $\Delta f = 0$ ) is  $-90$  degrees and at the low-frequency peak, the tan of the phase angle is  $(-/+)\beta$  and at the high-frequency peak, the tan of the phase angle is  $(-/-)\beta$ . Since, in many applications, satisfactory flatness in the pass band is given when  $\beta$  is approximately unity, we see that the phase shift at the low-frequency peak is usually approximately  $-45$  degrees and the high-frequency peak usually has a phase angle of approximately  $-135$  degrees.

With *capacitive* coupling, we see that the phase shift at the midfrequency is  $+90$  degrees; the tan of the phase angle at the low-frequency peak is  $(+/-)\beta$ ; the tan of the phase angle at the high-frequency peak is  $(+/+)\beta$ , and for  $\beta$  equal approximately to unity the phase shift at the low-frequency peak is thus approximately  $+135$  degrees, and at the high-frequency peak it is approximately  $+45$  degrees.

It should be noted that for a given peak-to-valley ratio (i.e., a given  $\beta$ ), the phase shift is independent of the  $Q$  ratio.

## VII. SMALL-PERCENTAGE PASS-BAND DESIGN EQUATIONS WHEN $Q_1 = Q_2$

Design equations having even a small degree of complexity are, in many cases, not used by engineers. However, conveniently used graphical representations of the complex equations will usually be put to use.

In their most usual use, identical band-pass circuits are cascaded to produce intermediate-frequency-amplifier chains. Various applications may necessitate the use of from one to perhaps eight cascaded stages. It would appear worthwhile to develop an exact, quickly used graphical method of designing the cascaded circuits so that they produce a specified response shape.

Since the number of cascaded stages used must be one of the design parameters, consideration of (18), (20), (21), (22), (25), and (26) shows that some form of family-of-curves representation or its equivalent is necessary.

We further note that (20) and (22) are complicated by the relatively second-order effect of the  $Q$  ratio which would necessitate an almost useless family of curves. Because of this complication, we will consider the case where  $Q_1 = Q_2$ , in the graphical method of design; and the equations themselves can be used directly when  $Q_1$  does not equal  $Q_2$ .

There are two important practical reasons why a design using  $Q_1 = Q_2$  should be used whenever possible. The first reason is concerned with the problem of aligning cascaded flat-topped band-pass circuits. The second reason is concerned with the detuning effect caused by the fact that the input and output capacitance of a pentode changes with gain-control setting due to plate-to-grid capacitance feedback (Miller effect), and space-charge effects.

With reference to the alignment of cascaded flat-topped circuits, if  $Q_1$  is made equal to  $Q_2$  the circuits can be aligned just as single-peaked or single-tuned circuits are aligned, i.e., by using a single-frequency signal generator (not a "sweeper"), and tuning for absolute maximum output. With double-peaked circuits, the signal generator is set at the frequency at which the *low* peak of the response is desired and all the circuits are tuned *lower* in frequency for maximum response. (Or the signal generator may be set at the frequency at which it is desired to have the *high*-frequency peak, and all the circuits are then tuned *higher* in frequency for maximum response.) It can be shown that if  $Q_1$  equals  $Q_2$ , equal absolute maxima of response are obtained at the peaks only when both circuits are tuned to the same resonant frequency (as described in Section 3) and, conversely, when both circuits are tuned to the same resonant frequency, absolute maximum (and equal) response is obtained at both peaks (as long as there is no loss in the mutual reactance). It is this fact which is the basis of the method of alignment just described.

When  $Q_1$  does not equal  $Q_2$ , tuning of the circuits to produce an absolute maximum of response at one frequency would necessitate the two circuits being tuned to different resonant frequencies and the two peaks are then of different amplitudes.

With reference to the second reason for making  $Q_1$  equal to  $Q_2$ , it is desirable to have a response curve which is not affected when the gain (i.e., the  $G_m$ ) of the amplifier tubes is changed. Unfortunately, the change in input and output capacitance of a pentode with changing  $G_m$  (due to plate-to-grid capacitance feedback and space-charge effects) detunes the resonant circuits. However, it can be shown that with  $Q_1 = Q_2$  a slight detuning of the resonant circuits will have a practically negligible effect on the *symmetry* of the response curve. Thus, although the response curve as a whole will move slightly as the gain control is changed, the shape of the curve will remain sensibly constant when  $Q_1 = Q_2$ .

When circuits are cascaded, the voltage responses at a given frequency are multiplied together to give the resultant voltage response. When the cascaded circuits are all identical it is obvious that to obtain the resultant

voltage response, the voltage response of one circuit is raised to that power given by the number of cascaded circuits.

We must realize that all the voltage responses in the previous equations apply to only one double-tuned stage. If we are going to cascade  $N$  stages and want a certain resultant peak-to-valley ratio  $V_p/V_v$ , the peak-to-valley ratio of each circuit  $(V_p/V_v)_1$ , must equal  $(V_p/V_v)^{1/N}$ . Likewise, if the resultant skirt-response ratio for  $N$  cascaded stages is to be  $V_p/V_s$ , then the skirt-response ratio for each stage  $(V_p/V_s)_1$  must equal  $(V_p/V_s)^{1/N}$ .

Thus, in (19) and (25), which apply to one stage only, we should make the above substitutions to make them apply to  $N$  cascaded stages.

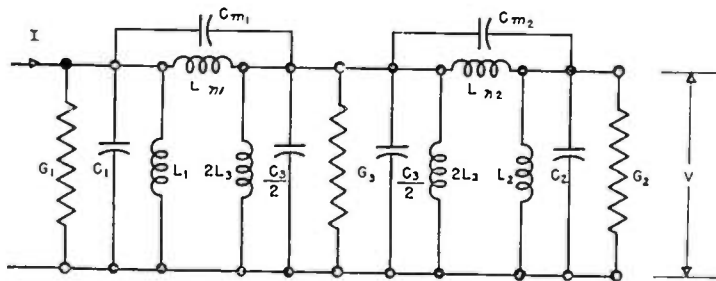
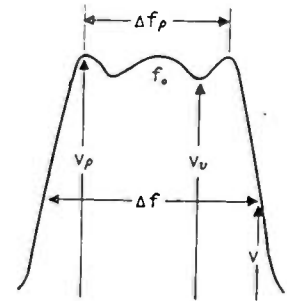

Fig. 6—Basic triple-tuned three-node band-pass circuit using both inductive and capacitive coupling and the type of voltage response to be considered.



larly, the circuit configurations of Figs. 4 and 5 can be used to form three-mesh band-pass circuits.

With respect to the calculation of the two equal coefficients of coupling which appear in the resulting triple-tuned circuit, maximum gain will be obtained if the following procedure is used: the middle resonant circuit formed when two of the node networks of Figs. 1 and 2 are connected in series should be considered to be formed from two identical resonant circuits in parallel (i.e., each one having twice the net inductance and one half the net capacitance). The input resonant circuit is then coupled to one of the above resonant circuits and the output circuit is coupled to the other resonant circuit.

The middle resonant circuit formed when two of the

For the case of  $Q_1=Q_2$ , the design equations then become as follows:

Let

$$\beta = \sqrt{1/2 \left[ \frac{(V_p/V_v)^{1/N}}{\sqrt{(V_p/V_v)^{2/N} - 1}} - 1 \right]} \quad (19a)$$

Then

$$\frac{Q}{f_0/\Delta f_p} = \frac{1}{\beta} \quad (18a)$$

$$KQ = \sqrt{1 + 1/\beta^2} \quad (21a)$$

$$\left( \frac{V_p}{V} \right) = \left\{ 1 + \left[ \frac{(\Delta f/\Delta f_p)^2 - 1}{2\beta\sqrt{1 + \beta^2}} \right]^2 \right\}^{N/2} \quad (24)$$

$$\frac{\text{Gain per stage}}{G_m/4\pi\Delta f_p\sqrt{(C_1 + C_m)(C_2 + C_m)}} = \frac{1}{\beta} \quad (23a)$$

$$\frac{\Delta f}{\Delta f_p} = \sqrt{1 \pm 2\beta\sqrt{1 + \beta^2}\sqrt{(V_p/V)^{2/N} - 1}} \quad (25a)$$

$$\tan \theta_{\text{per stage}} = \frac{\pm [1 + 2\beta^2 - (\Delta f/\Delta f_p)^2]}{\pm [2\beta(\pm \Delta f/\Delta f_p)]} \quad (26)$$

### VIII. FORMATION OF TRIPLE-TUNED BAND-PASS CIRCUITS<sup>6,7</sup>

Any two of the circuit configurations shown in Figs. 1 and 2 may be connected in series to form a triple-tuned three-node band-pass circuit (this also means, of course, that one of the circuits shown can be used twice). Simi-

mesh circuits of Figs. 4 and 5 are connected in series should be considered to be formed from two identical resonant circuits in series (i.e., each one having twice the net capacitance and half the net inductance.) The input resonant circuit is then coupled to one of the above resonant circuits and the output circuit is coupled to the other resonant circuit.

The points made in Sections III and IV of the double-tuned analysis apply also to the triple-tuned case, and, rather than repeat them here, it will be assumed that the reader will again refer to the above sections.

To obtain a flat-topped response with three peaks of equal amplitude in the pass band, all the loading must be removed from the middle tuned circuit which is formed when two double-tuned circuits are thus connected in series. Otherwise, as will be shown later, the outer two peaks of the response will be lower in amplitude than the middle peak.

Unfortunately, it is often impossible to obtain inductances of sufficient  $Q$  for the middle tuned circuit unless extremely large coil forms and shield cans are used. It will be shown that the required  $Q$  for the input and output tuned circuits is of the order of the value of the reciprocal of the percentage bandwidth. Thus, if a bandwidth between peaks of 400 kilocycles is desired with a midfrequency of 20 megacycles, the required  $Q$  of the input and output circuit will be approximately 50. To approach the ideal triple-tuned response curve, the  $Q$  of the middle tuned circuit must be of the order of 10 times (or more) the  $Q$  of the input and output circuits. Thus, a  $Q$  of the order of 500 or more is required in the above

<sup>6</sup> E. A. Guillemin, "Communication Networks," John Wiley and Sons, New York, N. Y., vol. 1, 1931, pp. 335-339. This analysis deals with the rather unfortunate case (in so far as good band-pass response is concerned) of  $Q_1=Q_2=Q_3$ .

<sup>7</sup> M. R. Winkler, "A 3-resonant circuit transformer," *Electronics*, vol. 16, pp. 96-100; January, 1943. Here again the main emphasis is placed on the case of  $Q_1=Q_2=Q_3$ .

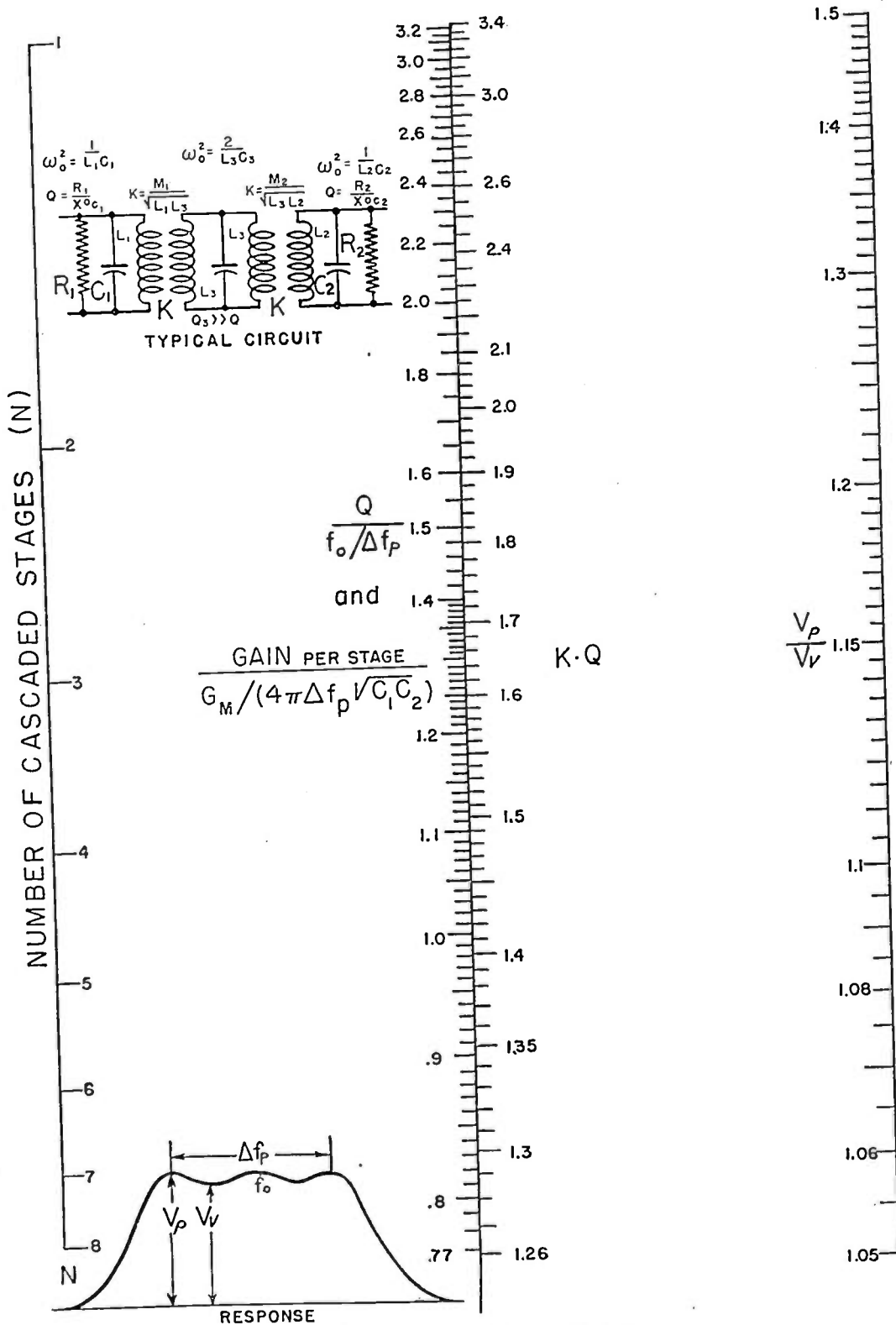

Chart I—Triple-tuned band-pass circuit design.

case. It is difficult to obtain an inductance of this  $Q$ . However, if the midfrequency of the 400-kilocycle pass band were shifted down to 4 megacycles, the required  $Q$  of the input and output circuits would then be about 10, and the necessary middle-circuit  $Q$  would be at least 100. This  $Q$  can be obtained without too much trouble. Thus, if triple-tuned band-pass circuits are to be used, it would be worth while choosing a 10 per cent, or even greater, bandwidth.

As in the double-tuned case, the high-impedance or node circuits will be considered to be used the most, and therefore the specific analysis will be made using three-node circuits having both inductive and capacitive coupling, as shown in Fig. 6. It should be clearly realized, however, that the resulting analysis applies exactly to all of the myriad triple-tuned networks which can be formed from the networks of Figs. 1 and 2 and 4 and 5.

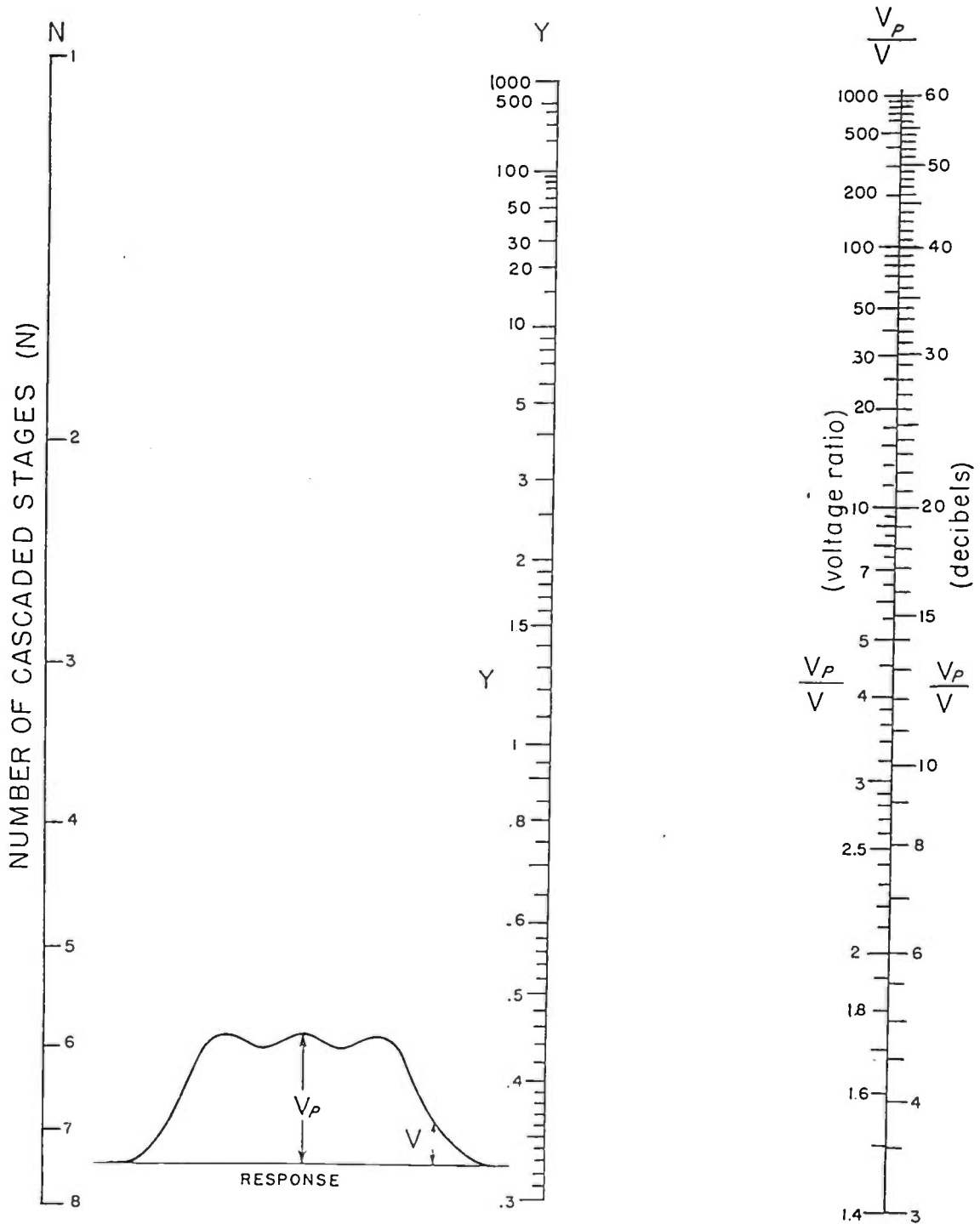

Chart II—Triple-tuned band-pass circuit design for factor  $Y$ .

IX. EXACT TRIPLE-TUNED RESPONSE EQUATION

The node equations which apply to the triple-tuned circuit of Fig. 6 are:

$$\begin{aligned}
 I &= \left\{ G_1 + j \left[ \omega(C_1 + C_{m_1}) - \frac{1}{\omega(L_1 L_{n_1} / L_1 + L_{n_1})} \right] \right\} V_1 - j \left( \omega C_{m_1} - \frac{1}{\omega L_{n_1}} \right) V_2 + 0 \\
 0 &= -j \left( \omega C_{m_1} - \frac{1}{\omega L_{n_1}} \right) V_1 + \left\{ G_3 + j \left[ \omega(C_3 + C_{m_1} + C_{m_3}) - \frac{1}{\omega \left( \frac{L_{n_1} L_3 L_{n_2}}{L_{n_1} L_3 + L_3 L_{n_2} + L_{n_1} L_{n_2}} \right)} \right] \right\} V_2 - j \left( \omega C_{m_2} - \frac{1}{\omega L_{n_2}} \right) V_3 \\
 0 &= 0 - j \left( \omega C_{m_2} - \frac{1}{\omega L_{n_2}} \right) V_2 + \left\{ G_2 + j \left[ \omega(C_2 + C_{m_2}) - \frac{1}{\omega(L_2 L_{n_2} / L_2 + L_{n_2})} \right] \right\} V_3.
 \end{aligned}
 \tag{27}$$



Introducing the resonant frequency (as defined in Section IV) and the coefficient of coupling and the decrement, we obtain from (27) the complete, exact solution for the magnitude and phase of output voltage.

$$\frac{V_3}{I/\omega_0\sqrt{(C_1+C_{m1})(C_2+C_{m2})}}$$

$$= \frac{\frac{1}{2}K^2}{\sqrt{F^6 - [2K^2 - (n_1^2 + n_2^2 + n_3^2)]F^4 + \{K^4 - K^2[n_1^2 + n_3^2 - n_2(n_1 + n_3)] + n_1^2n_2^2 + n_2^2n_3^2 + n_3^2n_1^2\}F^2 + \left[K^2\left(\frac{n_1 + n_3}{2}\right) + n_1n_2n_3\right]^2}} \quad (28)$$

$$\tan \theta = \frac{+F[K^2 + (n_1n_2 + n_2n_3 + n_3n_1) - F^2]}{-\left[K^2\left(\frac{n_1 + n_3}{2}\right) + n_1n_2n_3 - (n_1 + n_2 + n_3)F^2\right]} \quad (29)$$

where, as before,  $F = \left(\frac{\omega}{\omega_0} - \frac{\omega_0}{\omega}\right)$

$$K = \left(K_c \frac{\omega}{\omega_0} - K_L \frac{\omega_0}{\omega}\right).$$

X. SMALL-PERCENTAGE BAND-PASS DESIGN EQUATIONS

Applying the reasoning used in Section V of the double-tuned analysis, we will consider the small-percentage band-pass case, i.e., where  $\omega/\omega_0$  becomes only about 10 per cent greater or less than unity. We thus have the two great simplifications:

$$K \doteq (K_c - K_L) \quad \text{and} \quad \left(\frac{\omega}{\omega_0} - \frac{\omega_0}{\omega}\right) = \frac{\Delta f}{f_0}.$$

Setting the derivative with respect to

$$F \left(\doteq \frac{\Delta f}{f_0}\right)$$

of (28) equal to zero, we obtain for the location of the maxima (plus sign) and minima (minus sign)

$$\frac{\Delta f_{\max}}{f_0} = 0$$

$$\frac{\Delta f_{\min \max}}{f_0} = 2/3 \left[ K^2 - \frac{n_1^2 + n_2^2 + n_3^2}{2} \right] + 1/3 \sqrt{K^4 - K^2[n_1^2 + n_3^2 + n_2(3n_1 + 4n_2 + 3n_3)] + (n_1^4 + n_2^4 + n_3^4) - (n_1^2n_2^2 + n_2^2n_3^2 + n_3^2n_1^2)} \quad (30)$$

We will obtain the design equations for the case where the  $Q$  of the input and output circuits are the same ( $n_1 = n_3 = n$ ) and the middle resonant circuit  $Q$  is much greater than the  $Q$  of the input and output circuits ( $n_2 \ll n$ ).

For this case, the general response (28) becomes the relatively simple equation

$$\frac{V_3}{I/\omega_0\sqrt{(C_1+C_{m1})(C_2+C_{m2})}} = \frac{\frac{1}{2}K^2}{\sqrt{(\Delta f/f_0)^6 - 2(K^2 - n^2)(\Delta f/f_0)^4 + (K^2 - n^2)^2(\Delta f/f_0)^2 + K^4n^2}} \quad (28a)$$

and from (30) the locations of the maxima and minima are given by

$$\left(\frac{\Delta f_{\max}}{f_0}\right)^2 = 0 \quad \text{and} \quad (K^2 - n^2)$$

$$\left(\frac{\Delta f_{\min}}{f_0}\right)^2 = 1/3(K^2 - n^2) = 1/3\left(\frac{\Delta f_{\max}}{f_0}\right)^2 \quad (30a)$$

and the phase-shift equation becomes

$$\tan \theta = \frac{+\left(\frac{\pm \Delta f}{f_0}\right) \left[ K^2 + n^2 - \left(\frac{\Delta f}{f_0}\right)^2 \right]}{-\left[ K^2n - 2n\left(\frac{\Delta f}{f_0}\right)^2 \right]} \quad (29a)$$

Substituting the locations of the maxima (30a) into (28a), gives the response at the peaks, which is

$$V_{\text{peaks}} = \frac{I}{\omega_0\sqrt{(C_1 + C_{m1})(C_2 + C_{m2})}} \times \frac{1}{2n} \quad (31)$$

Substituting the location of the minimum (30a) into (28a) gives the response at the valley

$$V_{\text{valley}} = \frac{I}{\omega_0\sqrt{(C_1 + C_{m1})(C_2 + C_{m2})}} \times \frac{\frac{1}{2}K^2}{\sqrt{4/27(K^2 - n^2)^3 + K^4n^2}} \quad (32)$$

and so the peak-to-valley ratio is

$$\left(\frac{V_p}{V_v}\right)_1 = \frac{\sqrt{4/27(K^2 - n^2)^3 + K^4n^2}}{K^2n} \quad (33)$$

Introducing the location of the outside peaks (30a) into the peak-to-valley ratio (33), we can solve for the decrement which is required to produce a desired peak-to-valley ratio with a given percentage bandwidth between outside peaks. This is our first design equation:

$$\frac{Q}{f_0/\Delta f_p} = \frac{1}{\gamma} \quad (34)$$

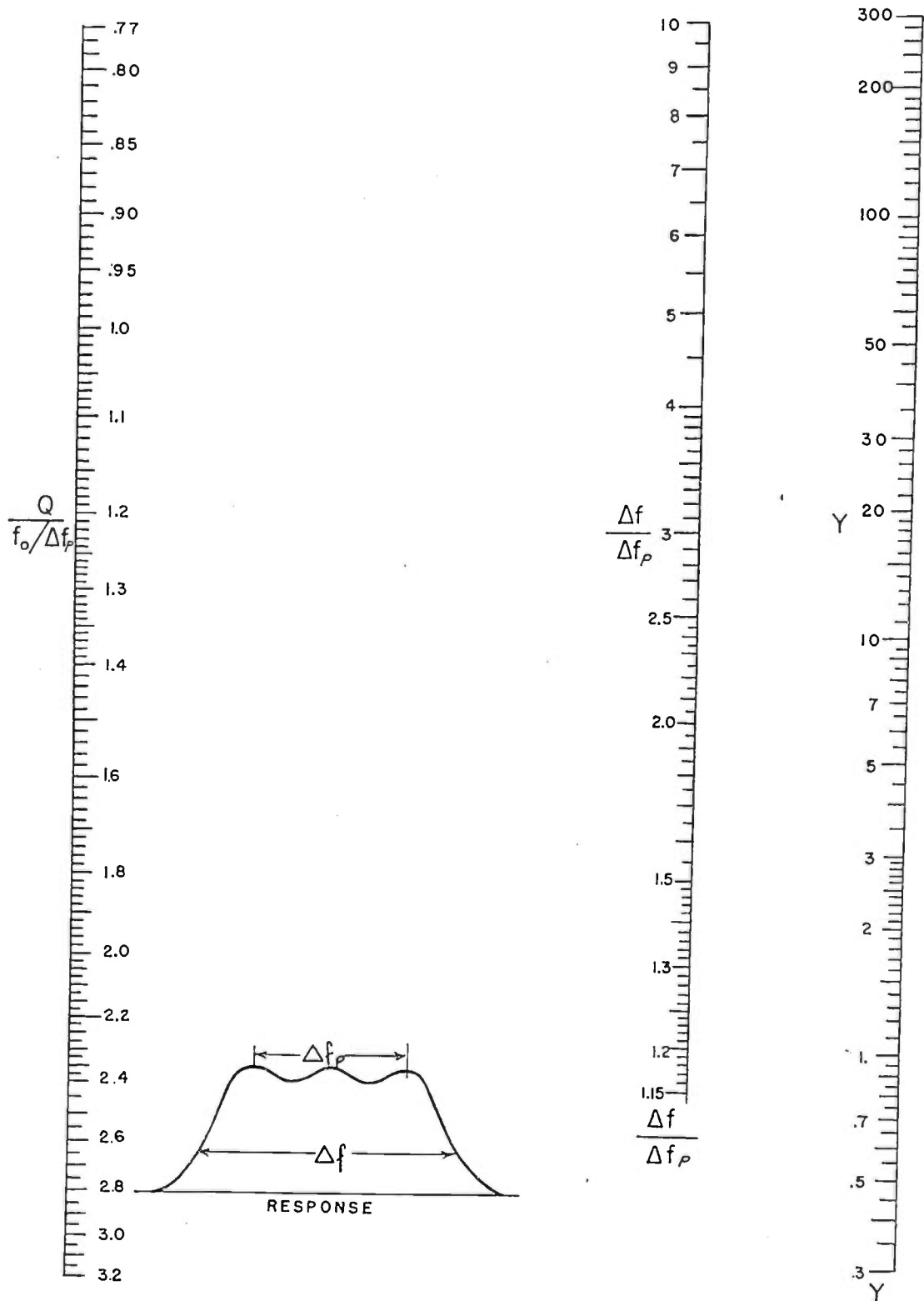

Chart III—Triple-tuned band-pass circuit design.

where

$$\gamma = \frac{\left[ \frac{1 + (V_p/V_r)_1}{\sqrt{(V_p/V_r)_1^2 - 1}} \right]^{1/3} + \left[ \frac{1 - (V_p/V_r)_1}{\sqrt{(V_p/V_r)_1^2 - 1}} \right]^{1/3}}{\sqrt{3}} \quad (35)$$

and, using (30a) we have as the equation giving the coefficient of coupling which is required in order to obtain a given peak-to-valley ratio with a given percentage

bandwidth between peaks

$$\frac{K}{\Delta f_p / f_0} = \sqrt{1 + \gamma^2} \quad (36)$$

where  $\gamma$  is given by (35).

Multiplying (34) by (36), we obtain our second design equation:

$$KQ = \sqrt{1 + (1/\gamma^2)} \quad (37)$$

The next desired design equation is the one giving the skirt selectivity. Substituting the design equations (34) and (36) into the response equation (28a), we obtain the response at any point in terms of the peak-to-valley ratio (represented by  $\gamma$  of (27)) and the percentage bandwidth at the outside peaks. Dividing the result by the response at the peaks given by (24), we obtain the equation giving the skirt-response ratios in terms of the skirt bandwidth.

$$\left(\frac{V_p}{V}\right)_1 = \sqrt{1 + \left\{ \frac{\left(\frac{\Delta f}{\Delta f_p}\right) \left[ \left(\frac{\Delta f}{\Delta f_p}\right)^2 - 1 \right]}{(1 + \gamma^2)\gamma} \right\}^2} \quad (38)$$

Solution of (38) for  $\Delta f/\Delta f_p$  gives

$$\left(\frac{\Delta f}{\Delta f_p}\right) = \frac{[d + \sqrt{d^2 - 4/27}]^{1/3} + [d - \sqrt{d^2 - 4/27}]^{1/3}}{\sqrt[3]{2}} \quad (39)$$

where

$$d = \gamma(1 + \gamma^2)\sqrt{(V_p/V_v)_1^2 - 1}$$

The above equations apply to a single triple-tuned stage. When  $N$  stages are cascaded and a resultant peak-to-valley ratio of  $V_p/V_v$  is desired, then the peak-to-valley ratio of each stage  $(V_p/V_v)_1$  must equal  $(V_p/V_v)^{1/N}$ . Similar reasoning applies to the skirt-response ratio, so that  $(V_p/V)_1 = (V_p/V)^{1/N}$ .

Application of the above reasoning gives the following design equations for  $N$  cascaded triple-tuned circuits, where the input and output resonant circuits in each stage are of equal  $Q$  and the  $Q$  of the middle resonant circuit is much higher than that of the input and output circuits.

Let

$$\gamma = \frac{\left[ \frac{1 + (V_p/V_v)^{1/N}}{\sqrt{(V_p/V_v)^{2/N} - 1}} \right]^{1/3} + \left[ \frac{1 - (V_p/V_v)^{1/N}}{\sqrt{(V_p/V_v)^{2/N} - 1}} \right]^{1/3}}{\sqrt{3}} \quad (35a)$$

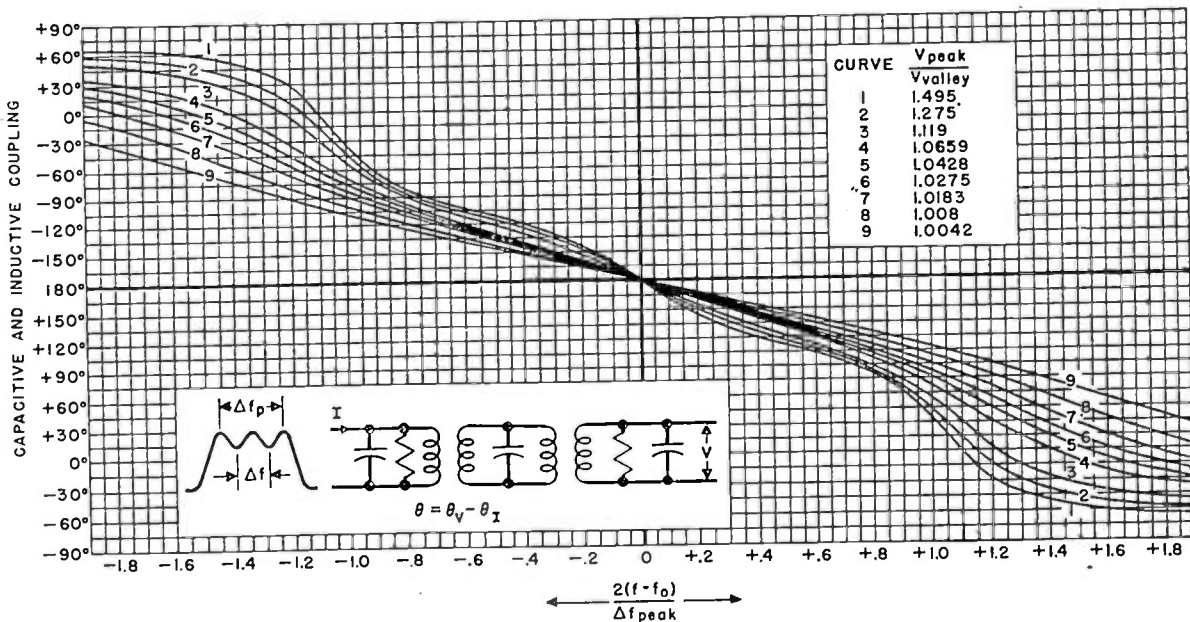

Chart IV—Phase shift for a flat-top triple-tuned circuit ( $Q_1 = Q_3, Q_2 \gg Q_{13}$ ) for different peak-to-valley ratios.

From this equation, we can calculate the skirt bandwidth for different skirt-response points. Then

The next desired equation is the gain equation. Substituting the condition given by (34) into the peak equation (31), we obtain

$$V_2 = \frac{1}{\gamma} \times \frac{I}{4\pi\Delta f_p \sqrt{(C_1 + C_{m1})(C_2 + C_{m2})}} \quad (40)$$

and, finally, if we substitute the design conditions (given by (34) and (36)) in the phase-shift equation (29a), we obtain the phase shift in terms of the peak-to-valley ratio, represented by  $\gamma$ , and the ratio of the bandwidth to the peak bandwidth.

$$\tan \theta = \frac{+\left(\frac{\pm \Delta f}{\Delta f_p}\right) \left[ 2\gamma^2 + 1 - \left(\frac{\Delta f}{\Delta f_p}\right)^2 \right]}{-\gamma \left[ \gamma^2 + 1 - 2\left(\frac{\Delta f}{\Delta f_p}\right)^2 \right]} \quad (41)$$

$$\frac{Q}{f_0/\Delta f_p} = \frac{1}{\gamma}$$

$$KQ = \sqrt{1 + 1/\gamma^2}$$

$$\frac{V_p}{V} = \left[ 1 + \left\{ \frac{\left(\frac{\Delta f}{\Delta f_p}\right) \left[ \left(\frac{\Delta f}{\Delta f_p}\right)^2 - 1 \right]}{(1 + \gamma^2)\gamma} \right\}^2 \right]^{N/2} \quad (38a)$$

$$\frac{\Delta f}{\Delta f_p} = \frac{[d + \sqrt{d^2 - 4/27}]^{1/3} + [d - \sqrt{d^2 - 4/27}]^{1/3}}{\sqrt[3]{2}} \quad (39a)$$

where  $d = \gamma(1 + \gamma^2)\sqrt{(V_p/V)^{2/N} - 1}$

$$\frac{\text{Gain percentage}}{G_m/4\pi\Delta f_p \sqrt{(C_1 + C_{m1})(C_2 + C_{m2})}} = \frac{1}{\gamma} \quad (40a)$$

$$\tan \theta_{\text{per stage}} = \frac{+\left(\pm \frac{\Delta f}{\Delta f_p}\right) \left[ 2\gamma^2 + 1 - \left(\frac{\Delta f}{\Delta f_p}\right)^2 \right]}{-\gamma \left[ \gamma^2 + 1 - 2\left(\frac{\Delta f}{\Delta f_p}\right)^2 \right]} \quad (41a)$$

From (35a), (34), (36), (39a), and (40a), another set of nomographs has been prepared. From the phase-shift equation (41), a family of curves has been prepared.

The procedure for using these nomographs and curves is identical with the procedure given in Section II for the double-tuned nomographs. The reader should refer to the examples given in that section.

#### ACKNOWLEDGMENT

The author wishes to express his appreciation to R. R. Batcher for the construction of the nomographs from the equations in this paper.

The author is also indebted to Jesse LeGrand of the Federal Telecommunications Laboratories, Nutley, New Jersey, for his helpful suggestions as to the format of the nomographs, and to both Mr. LeGrand and Melvin Klein for the many productive discussions we have had about much of the subject matter contained in the paper.

## Contributors to Waves and Electrons Section



CHARLES R. DENNY

Charles R. Denny was born in Baltimore, Maryland, on April 11, 1912. He received the A.B. degree from Amherst College in 1933, and the LL.B. degree from Harvard in 1936. Mr. Denny served as an attorney in the Department of Justice, Washington, D. C., from 1938 to 1941, and in 1942 became special assistant to the Attorney Gen-

eral. He has been associated with the Federal Communications Commission since 1942, when he became assistant general counsel. In March, 1945, he was appointed a member of the Commission and he accepted the post of chairman in December, 1946.

Mr. Denny is a member of Chi Phi.

❖

Milton Dishal (A'41-SM'45) was born on March 20, 1918, in Philadelphia, Pennsylvania. He received the B.S. degree from Temple University in 1939, and the M.A. degree in physics from Temple University in 1941. From 1939 to 1941 Mr. Dishal was a Teaching Fellow in physics at Temple University. In 1941 he entered the employ of the Federal Telecommunications Laboratories, where he is now a senior engineer engaged in the development of radio receivers having special characteristics.

❖

Charles M. Slack was born on December 4, 1901 in Gainesville, Georgia. He received the B.S. degree from the University of Georgia in 1922, the M.A. degree from Columbia University in 1923, and the Ph.D. degree from Columbia University in 1926.

Dr. Slack served as an instructor in physics at Columbia University during 1926 and 1927. He joined the Westinghouse Electric Corporation in 1927 and was made assistant director of research in 1943. Among his other accomplishments, he designed the electronic tube which made it possible for the first time to accurately photograph by X rays the inner structure of golf and tennis balls at the moment of impact.

Dr. Slack is a member of the American Physical Society, The American Institute of Electrical Engineers, American Association for the Advancement of Science, Sigma Xi, and Phi Beta Kappa.

❖

For a photograph and biography of W. R. G. Baker, see the frontispiece on page 3 of the January, 1947, issue of the PROCEEDINGS OF THE I.R.E.



DONALD C. DICKSON

Donald C. Dickson (S'45) was born on December 6, 1923, in Jersey City, New Jersey. He received the B.S. degree in electrical engineering from Newark College of Engineering in 1946. From 1943 to the present Mr. Dickson has been associated with the Research Laboratory of the Westinghouse Electric Corporation in Bloomfield, New Jersey.

❖



MILTON DISHAL



CHARLES M. SLACK



# Abstracts and References

Prepared by the National Physical Laboratory, Teddington, England, Published by Arrangement  
with the Department of Scientific and Industrial Research, England,  
and *Wireless Engineer*, London, England

NOTE: The Institute of Radio Engineers does not have available copies of the publications mentioned in these pages, nor does it have reprints of the articles abstracted. Correspondence regarding these articles and requests for their procurement should be addressed to the individual publications and not to the I.R.E.

Acoustics and Audio Frequencies.....	627
Aerials and Transmission Lines.....	627
Circuits and Circuit Elements.....	630
General Physics.....	631
Geophysical and Extraterrestrial Phenomena.....	632
Locations and Aids to Navigation.....	633
Materials and Subsidiary Techniques.....	633
Mathematics.....	634
Measurements and Test Gear.....	635
Other Applications of Radio and Electronics.....	636
Propagation of Waves.....	637
Reception.....	637
Stations and Communication Systems.....	638
Subsidiary Apparatus.....	638
Television and Phototelegraphy.....	638
Transmission.....	639
Vacuum Tubes and Thermionics.....	639
Miscellaneous.....	640

The number in heavy type at the upper left of each Abstract is its Universal Decimal Classification number and is not to be confused with the Decimal Classification used by the United States National Bureau of Standards. The number in heavy type at the top right is the serial number of the Abstract.

## ACOUSTICS AND AUDIO FREQUENCIES

- 534.232 1304  
A Contribution to the Theory of Acoustic Radiation—C. J. Bouwkamp. (*Philips Res. Rep.*, vol. 1, pp. 251-277; August, 1946.) Study of "the field of radiation produced by a harmonically oscillating membrane with arbitrary amplitude distribution in a closely fitting aperture of an infinite rigid plane."
- 534.321.9.001.8 1305  
Supersonic Applications—T. F. LoGiudice. (*Radio Craft*, vol. 18, pp. 16-17, 67; December, 1946.)
- 534.6:621.395.61 1306  
Application of Regulators to Acoustic Measurements—A. Moles. (*Compt. Rend. Acad. Sci.* (Paris), vol. 224, pp. 101-104; January 13, 1947.) The regulator described consists of a standard microphone, amplifier, and detector. The microphone is electrically corrected to have a sensibly flat response curve. The voltage from the detector is used to control inversely the gain of a variable-micron pentode whose grid receives the signal from the microphone to be tested. The response curve can thus be recorded directly on a rotating drum. A block diagram of the equipment is given.
- 534.861 1307  
The Acoustic Problems of Broadcasting—R. Brailiard. (*Bull. Soc. Franc. Élect.*, vol. 6, pp. 173-180; April, 1946.) In broadcasting, mere intelligibility is not sufficient. Quality reproduction is of great importance, involving detailed study not only of electroacoustics, but also of both physiological and psychological acoustics.
- 621.395.61 1308  
Rapid Method of Determining the Characteristics of a Microphone—A. Moles. (*Radio en France*, no. 4, pp. 30-33; 1945.) A comparison method using a standard electrostatic microphone. The electromotive force from the microphone under test and that from

The Annual Index to these Abstracts and References, covering those published from January, 1946, through December, 1946, may be obtained for 2s. 8d., postage included, from the *Wireless Engineer*, Dorset House, Stamford St., London S. E., England.

the standard are applied, after amplification in a known ratio, to the two sets of plates of a cathode-ray oscilloscope, both microphones being subjected to the same sound field.

- 621.395.616 1309  
The Condenser Microphone—P. G. Bordoni. (*Alla Frequenza*, vol. 15, pp. 167-204; September, 1946. In Italian, with English summary.) A general treatment, with a bibliography of 130 papers and books on the subject.
- 621.395.623.7 1310  
The Acoustic Problems of Electrodynamic Loudspeakers—E. Synek. (*Radio Tech.* (Vienna), vol. 22, pp. 229-232. August-September, 1946.)
- 621.395.623.7 1311  
Report of the Commission on Loudspeakers (Ministry of Industrial Production)—(*Radio en France*, no. 4, pp. 34-37; 1945.) General directions are given for the graphical representation of various measurements on loudspeakers; terms are defined and technical characteristics described.
- 621.395.623.7 1312  
Rational Study of Loudspeakers—A. Clausung. (*Radio en France*, no. 4, pp. 22-27; 1945.) An account of equipment for the routine testing of loudspeakers, giving frequency characteristics, directional characteristics for different frequencies, nonlinear distortion, and impedance as functions of frequency.
- 621.395.623.7.015.3 1313  
Loudspeaker Transient Response—D. E. L. Shorter. (*B.B.C. Quart.*, vol. 1, reprint; October, 1946.) The frequency response curve taken after the interruption of the test note may show marked resonances which are not present in the steady state. Tests were made on four types of cones with delays of 10 to 40 milliseconds and the response was determined by measuring the rate of decay of the sound. Tonal coloration, glitter, and other irritating effects were found to be associated with the additional resonances. See also *Wireless World*, vol. 52, pp. 424-425; December, 1946.
- 621.395.623.8 1314  
Large Electroacoustic Installations—J. Müller-Strobel. (*Schweiz. Bauztg.*, vol. 125, reprint; February 3 and 10, 1945.) A general description of equipment manufactured by the Albiswerk Zurich A.-G. and particularly suitable for railway stations, concert halls, works, etc. A special feature of the system is automatic control of the output volume by means of a voltage derived from a microphone which picks up the noise in the room or hall where the loudspeakers are situated.
- 621.395.623.8 1315  
United Nations Broadcasting and Sound System—(*Tele-Tech*, vol. 6, pp. 90-93, 154; January, 1947.) Technical details of broad-

casting and amplification equipment at Flushington Meadows and Lake Success.

- 621.395.667 1316  
Three-Band Variable Equalizer—L. D. Grignon. (*Electronics*, vol. 20, pp. 112-115; January, 1947.) "Provides gain or attenuation adjustment in one-decibel steps independently in the low-, high-, or mid-frequency bands of the audio spectrum. Applications include recording, rerecording, sound system compensation, and broadcast station equipment." For a fuller account see 1170 of 1946.

## AERIALS AND TRANSMISSION LINES

- 621.392+537.291 1317  
Electronic Amplifier Formed by a Guided Wave in a Medium of High Dielectric Constant—R. Wallauschek. (*Compt. Rend. Acad. Sci.* (Paris), vol. 224, pp. 191-193; January 20, 1947.) A wave of the longitudinal electric type ( $E_0$ ) is propagated in a cylindrical guide in which almost the whole cross section is filled with a dielectric of high permittivity. The phase velocity of the wave is thus much less than that of light. Around the electric axis of the guide is an evacuated cylinder traversed in the direction of propagation of the wave by a beam of electrons of velocity very near the phase velocity of the wave. A solution is obtained of the problem of the interaction of wave and beam in the guide. Formulas are given for the progressive waves. Four possible reflected waves are found. Two of these exist for a small range of beam velocities around the phase velocity of the primitive wave; one has increasing and the other decreasing amplitude. These two waves have a phase velocity less than the velocity of the beam. The other two waves are of constant amplitude, one progressive and the other retrogressive, and their phase velocity is greater than the electron velocity. By combining these four waves, the limiting conditions at the ends of the guide can be satisfied. Cf. 1330 below (Blanc-Lapierre and Lapostolle.)
- 621.392.029.62+621.396.67.029.62 1318  
Wide-Band Aerials and Transmission Lines for 20 to 85 Mc/s—F. E. Lutkin, R. H. J. Cary, and G. N. Harding. (*Jour. I.E.E.* (London), part 111A, vol. 93, no. 3, pp. 552-558; 1946.) Systems covering the frequency bands 20 to 30, 40 to 50, and 50 to 85 megacycles are described which can deal with pulse transmissions of 600 kilowatts peak power. The aerial arrays are built up of full-wave centered dipoles of wire-cage construction, with an input impedance of 600 ohms. Open wire transmission lines are used throughout. Wire-mesh reflectors are used to obtain the horizontal polar diagram required; their effect on dipole impedance is discussed. An exponential transformer is described which simplifies the construction of arrays consisting of four full-wave dipoles, its function being to transform

an impedance of 300 to 600 ohms. Compensating stubs may be used to increase the bandwidth of the wide-band aeriels.

621.392.029.64 1319

Waveguide Data—L. E. Sherbin. (*Electronics*, vol. 20, pp. 122-124; January, 1947.) Curves are given of attenuation and power-carrying capacity as a function of frequency for rectangular copper wave guides of various dimensions operating in the  $TE_{1,0}$  mode. Frequencies from 1600 to 44,000 megacycles are covered.

621.392.029.64 1320

Propagation in Curved Guides—M. Jouguet. (*Compt. Rend. Acad. Sci* (Paris), vol. 224, pp. 107-109; January 13, 1947.) The method of perturbation (2469 of 1946 and 16 of February) is applied to the study of  $H_{0,n}$  and  $E_{0,n}$  waves in a perfectly conducting circular wave guide of radius  $R$  to determine those which reduce to  $E_{m,n}$  and  $H_{m,n}$  waves when  $R$  increases indefinitely. The  $E_1'$  wave behaves normally, but the  $E_1''$  and  $H_0$  waves can only exist in a perfectly conducting curved guide if in combination and with amplitudes in the ratio  $\sqrt{2}:1$ , so that the transported energy is equally divided. The effect of curvature on the phase velocity of this type of wave is not, to the second order, zero. This differs from the corresponding result for a cylindrical guide as long as the curvature is finite. In an actual guide, propagation of an  $H_0$  or  $E_1''$  wave by itself is possible provided that the curvature is sufficiently small and tends towards zero with the resistivity of the wall.

621.392.029.64 1321

Some Applications of the Principle of Variation of Wavelength in Wave Guides by the Internal Movement of Dielectric Sections—G. E. Bacon and J. C. Duckworth. (*Jour. I.E.E.* (London), part IIIA, vol. 93, no. 4, pp. 633-638; 1946.) This principle is used for loading adjustment of centimeter-wave magnetrons working into a complex load, for beam swinging in directive arrays without mechanical movement, and in switching systems.

621.392.029.64 1322

Discussion on "Wave Guides" [I.E.E. Radio-location Convention]—(*Jour. I.E.E.* (London), part IIIA, vol. 93, no. 4, p. 778; 1946.) Points raised include the effect on performance of replacement of damaged parts, and the effect on standing-wave ratio of a small-frequency shift.

621.392.029.64:538.3 1323

Quasi-Stationary Field Theory and Its Application to Diaphragms and Junctions in Transmission Lines and Wave Guides—G. G. Macfarlane. (*Jour. I.E.E.* (London), part IIIA, vol. 93, no. 4, pp. 703-719; 1946.) Calculations are made of the shunt admittance of capacitive and inductive diaphragms in strip transmission lines and rectangular wave guides. By combining quasistationary field theory and Babinet's principle for electromagnetism, a valid result is derived for the case when the diaphragm cross section is comparable with, or greater than, a wavelength.

621.392.029.64:621.317.336.6 1324

Standing Wave Meter—Kallman. (See 1503.)

621.392.029.64:621.318.572 1325

The Rhumbatron Wave-Guide Switch—A. Macleod and J. Ashmead. (*Jour. I.E.E.* (London), part IIIA, vol. 93, no. 4, pp. 700-702; 1946.) The switch operates electrically by tuning and detuning a cavity coupled to the wave guide. High switching speeds are possible and fading is consequently minimized.

621.392.029.64:621.396.615.141.2 1326

Problems and Practice in the Production of Wave-Guide Transmission Systems—L. W.

Brown. (*Jour. I.E.E.* (London), part IIIA, vol. 93, no. 4, pp. 639-646; 1946.) The performance requirements of wave guides are considered in terms of reflections and standing-wave ratios. Careful selection or matching must be adopted, rather than random choice or interchange of sections, when the number of sections exceeds 2 or 3. Particular reference is made to the case of wave guides used with magnetron sources.

621.392.029.64.091 1327

Attenuation Curves for 2:1 Rectangular, Square and Circular Wave Guides—E. O. Willoughby and E. M. Williams. (*Jour. I.E.E.* (London), part IIIA, vol. 93, no. 4, pp. 723-724; 1946.) Graphs are given which show the relationship between frequency and physical size for various values of attenuation in copper wave guides.

621.392.029.64.091 1328

Calculation of Attenuation in Wave Guides—S. Kuhn. (*Jour. I.E.E.* (London), part IIIA, vol. 93, no. 4, pp. 663-678; 1946.) Tables and curves are derived which give the field equations and attenuation constants of rectangular and circular wave guides excited in any mode likely to be met with in practice. Field equations are expressed in terms of field impedances and of the power transmitted by the wave by introducing the concept of "characteristic density" of energy. The attenuation constant caused by wall losses is tabulated for the case of an air-filled copper guide. The attenuation constant and phase constant are also tabulated for the case of an enclosed dielectric of low loss, i.e., for values of  $\tan \delta$  below 0.1.

621.392.1:512.831 1329

Matrix Methods in Transmission-Line and Impedance Calculations—W. H. Watson. (*Jour. I.E.E.* (London), part IIIA, vol. 93, no. 4, pp. 737-746; 1946.) An ordered exposition of methods applicable not only to calculations of the principal wave on a two-conductor transmission line, but also to all plane wave processes capable of representation in terms of transmission lines. Some new results are also indicated.

621.392.2 1330

The Interaction Between a Progressive Wave and a Beam of Electrons of Velocity Near That of the Wave—A. Blanc-Lapierre and P. Lapostolle. (*Compt. Rend. Acad. Sci.* (Paris), vol. 224, pp. 104-105; January 13, 1947.) For an infinite line made up of discrete equal sections, the wave amplitude increases exponentially and the wave velocity is slightly lower than the beam velocity. For an infinite, uniform, continuous line, four waves are possible, only one of them increasing in amplitude. Such a line can be regarded as a model explaining qualitatively the phenomena of interaction in progressive-wave amplifiers.

621.392.43 1331

Impedance Matching by Tapered Transmission Lines—A. W. Gent and P. J. Wallis. (*Jour. I.E.E.* (London), part IIIA, vol. 93, no. 3, pp. 559-563; 1946.) The lines considered are coaxial, the conductors being tapered from one radius to another. Expressions are found for the impedance deviations with change of wavelength at the input of a tapered section when its far end is joined to a coaxial line terminated by its characteristic impedance. The added resistance and reactance are least when the length of the tapered section is approximately an integral multiple of  $\lambda/2$ . If both the outer and inner conductors are tapered, there is an optimum taper which will give unity standing-wave ratio (s.w.r.) for  $\lambda/2$  sections and a standing-wave ratio only slightly different from unity for other lengths. If it is desired to keep the diameter of one conductor the same on both sides of the junction, the best

method is to taper the two conductors in opposite ways for a half wavelength and then in the same way, thus producing either a bulge on the inner conductor or a constriction in the outer conductor. A summary of this paper is given in part IIIA, vol. 93, no. 1, pp. 58-59; 1946.

621.396.611.029.5 1332

Theory of Mode Separation in a Coaxial Oscillator—P. J. Sutro. (*Proc. I.R.E. AND WAVES AND ELECTRONS*, vol. 34, pp. 960-962; December, 1946.) An analysis of the separation of the first and third modes in a coaxial oscillator. It is shown that the difference between the two resonant lengths of one line which give these modes increases with the difference between the products of the terminating interelectrode capacitance and the characteristic impedance for the two lines.

621.396.67 1333

Aerials—K. Fränz. (*Elektrotech. Zeit.*, vol. 65, pp. 229-233; June 15, 1944.) A review of physical principles and developments, with special reference to the directional properties and impedance of various aerial arrays.

621.396.67 1334

The Receiving Dipole Aerial—J. Müller-Strobel and J. Patry. (*Schweiz. Arch. Angew. Wiss. Tech.*, vol. 12, pp. 201-213; July, 1946.) An inclusive account of work previously noted in 795 and 3527 of 1945 and 22 of February.

621.396.67 1335

Slot Aerials and Their Relation to Complementary Wire Aerials (Babinet's Principle)—H. G. Booker. (*Jour. I.E.E.* (London), part IIIA, vol. 93, no. 4, pp. 620-626; 1946.) Babinet's principle of complementary screens is applied to resonant slots in thin plane conducting screens. A  $\lambda/2$  slot, with an input impedance of about 485 ohms, has a polar diagram similar to that of a  $\lambda/2$  dipole but with the directions of vibration of electric and magnetic fields interchanged. Resonant slots may be used to form linear or broadside arrays, to produce polarized waves and for band-pass filters or any similar device used in conjunction with wire aerials. With the aid of Babinet's principle, several other problems can be reduced to problems whose solutions are already known.

621.396.67 1336

Slot Feeders and Slot Aerials—C. E. G. Bailey. (*Jour. I.E.E.* (London), part IIIA, vol. 93, no. 4, pp. 615-619; 1946.) A discussion of the properties of combinations of parallel strips, slots, and gaps formed by cutting narrow strips out of infinite plane conducting sheets. Equivalence and inversion theorems are established for slots and strips and for interconnected slots and wires. These theorems are used to give an approximate solution for the radiation field of a half-wave slot.

621.396.67 1337

The RCA Antennalyzer—An Instrument Useful in the Design of Directional Antenna Systems—G. H. Brown and W. C. Morrison. (*Proc. I.R.E. AND WAVES AND ELECTRONS*, vol. 34, pp. 992-999; December, 1946.) An entirely electrical instrument for deriving the radiation pattern of an aerial array of known configuration, or for determining the characteristics of an aerial array which would give a desired radiation pattern. The application is mainly to broadcast arrays with up to five vertical-tower elements, each element being characterized by four parameters defining its position and the magnitude and phase of its current. These parameters are separately controllable by means of potentiometers. Radiation patterns are presented on a cathode-ray tube in either polar or rectangular co-ordinates.

621.396.67:621.317.336 1338

The Measured Impedance of Cylindrical

Dipoles—D. D. King. (*Jour. Appl. Phys.*, vol. 17, pp. 844-852; October, 1946.) The impedance characteristics of a half-dipole and image plane were measured by a resonance method for low values of the damping; for high damping a standing-wave-ratio method supplemented the resonance data. The results are shown graphically and are in good agreement with those of Brown and Woodward (2207 of 1945).

621.396.67:621.397.5 1339  
Line-of-Sight Aerials [Antennes de Vision]—R. Tabard. (*Télev. Franç.*, nos. 9 and 11, pp. 22-23 and 19, 24; January and March, 1946.) Discusses aerials of the Hertz half-wave and Marconi quarter-wave types and corresponding feeder systems.

621.396.67.029.62(:621.396.96.029.62 1340  
The Use of a Common Aerial for Radar Transmission and Reception of 200 Mc/s—C. J. Banwell. (*Jour. I.E.E.* (London), part IIIA, vol. 93, no. 3, pp. 545-551; 1946.) An account of the development of a common transmitting and receiving aerial system in 1940 for the "chain home for low-flying aircraft" stations then in use for the detection of low-flying aircraft. Bridge systems and switching systems are described, and the diode-switching and spark-gap switching systems discussed in detail. The spark gap finally adopted consisted of tungsten electrodes covered by a glass and ceramic sleeve and enclosed in a glass envelope. The filling was argon, at a pressure of about  $\frac{3}{4}$  atmosphere, with a small quantity of liquid mercury. The breakdown voltage was about 800 volts and the design gave a reasonable life for pulse transmitter powers up to 120 kilowatts with rapid deionization, this being important if short-range echoes were to be obtained. A summary of this paper is given in part IIIA, vol. 93, no. 1, pp. 54-55; 1946.

621.396.67.029.62:621.396.96.029.62 1341  
The Design and Positioning of Aircraft Radar Aerials for Metric Wavelengths—B. Russell. (*Jour. I.E.E.* (London), part IIIA, vol. 93, no. 3, pp. 567-574; 1946.) A discussion of the various problems involved in connection with aircraft aerials for all-round looking, homing and search; and an account of design, positioning technique, and rapid switching arrangements.

621.396.67.029.63/64 1342  
The Use of Spherical Reflectors as Microwave Scanning Aerials—J. Ashmead and A. B. Pippard. (*Jour. I.E.E.* (London), part IIIA, vol. 93, no. 4, pp. 627-632; 1946.) The conditions are discussed under which spherical surfaces can be used for wide-angle scanning while maintaining minimum deterioration in the radiation pattern. A reflector is described which produces a beam width of less than 1 degree at half-power and which can be scanned through 6 degrees at 4 cycles.

621.396.67.029.64:621.315.61 1343  
Dielectric Housings for Centimetre-Wave Antennae—J. B. Birks. (*Jour. I.E.E.* (London), part IIIA, vol. 93, no. 4, pp. 647-657; 1946.) Expressions are derived for the reflection and transmission coefficients of plane waves when incident normally or obliquely on two parallel semireflecting discontinuities. The design and performance of various dielectric housings (radomes) at 10 and 3 centimeters are discussed, with reference to the effect on aerial gain, impedance, polar diagram, and polarization.

621.396.671.011.2 1344  
Radiation Impedance and Aerial Shortening of the Transmitter-Dipole—J. Müller-Strobel. (*Bull. Schweiz. Elektrotech. Ver.*, vol. 37, no. 24, pp. 710-714; 1946, reprint, in

German, with French summary.) The theory of sustained oscillations is applied to a transmitting dipole aerial (a) neglecting and (b) taking account of aerial losses. Formulas suitable for practical calculations have previously been given (3527 of 1945 and 22 of February). These are applied to an aerial supported by a balloon and curves are given for the real and imaginary parts of the radiation impedance. Calculated results, for aerial shortening, taking account of aerial losses, are in good agreement with experimental values.

621.396.671.029.64:621.317.34 1345  
The Influence of Re-Radiation on Measurements of the Power Gain of an Aerial—A. B. Pippard, O. J. Burrell, and E. E. Cromie. (*Jour. I.E.E.* (London), part IIIA, vol. 93, no. 4, pp. 720-722; 1946.) A modification of Purcell's method is given, taking account of reradiation which frequently introduces considerable errors. In the direct method of measuring power gain, reradiation errors are practically negligible.

621.396.676:629.13 1346  
Cavity Aircraft Antennas—H. Kees and F. Gehres. (*Electronics*, vol. 20, pp. 78-79; January, 1947.) Description, with polar diagrams, of a small shunt-excited receiving quarter-wave aerial, fitted inside a cavity, and recessed into the body of an aircraft. The aerial shows good response when used for 75 megacycles marker-beacon reception.

621.396.677 1347  
Elimination of Errors from Crossed-Dipole Direction-Finding Systems—R. A. Smith and C. Holt Smith. (*Jour. I.E.E.* (London), part IIIA, vol. 93, no. 3, pp. 575-587; 1946.) The main sources of error in the early types of 'chain home for low-flying aircraft' apparatus are discussed. The two most serious sources of error are the feeder and reflector systems. In later apparatus, aerials were designed to match the transmission lines, reflector systems to give adequate sense discrimination, reliable operation and minimum errors, and transmission systems to give maximum stability and energy transfer with minimum errors. Difficulties at the receiving end were overcome by the inclusion in each transmission system of a lattice-type phase-shifting network followed by an impedance matching unit. Very careful bonding of the transmission lines was found necessary. Installation and calibration procedures are outlined. A summary of this paper is given in part IIIA, vol. 93, no. 1, pp. 59-60; 1946.

621.396.677 1348  
Theoretical Treatment of Short Yagi Aerials—W. Walkinshaw. (*Jour. I.E.E.* (London), part IIIA, vol. 93, no. 3, pp. 598-614; 1946.) Design data are given for four arrays with driven half-wave dipoles and various arrangements of parasitic radiators. Polar diagrams, power gain, and input resistance curves, as a function of the self-reactance of the radiators, are given for each array system.

621.396.677 1349  
The Gain of an Idealized Yagi Array—D. G. Reid. (*Jour. I.E.E.* (London), part IIIA, vol. 93, no. 3, pp. 564-566; 1946.) An expression is derived for the power gain, compared with a doublet, of an end-fire array having an infinite number of infinitely closely spaced elements, the currents in successive elements being constant in amplitude but progressively and uniformly retarded in phase. Curves show the variation of gain with the over-all length of the array for a number of values of phase velocity. The envelope of these curves enables the maximum gain for a given length of array and the corresponding value of the phase velocity to be found.

621.396.677 1350  
Design of Directive Broad-Band Antennas—R. Baum. (*PROC. I.R.E. AND WAVES AND ELECTRONS*, vol. 34, pp. 956-959; December, 1946.) In the design of an aerial array the ideal polar diagram is usually determined on the assumption that mutual coupling between the various elements is negligible. The presence of mutual coupling causes a distortion of the polar diagram, the nulls being replaced by nonzero minima which may occur in wrong directions. The effects of mutual coupling may be largely compensated by the use of suitably disposed passive elements.

621.396.677 1351  
On Some Problems of the Theory of Highly-Directive Antenna Arrays—S. Tetelbaum. (*Jour. Phys.* (U.S.S.R.), vol. 10, no. 3, pp. 285-292; 1946.) The properties of broadside arrays of elementary dipoles excited in phase are considered for the case in which curvature of the wavefront is important, i.e., when the problem is concerned with the mutual coupling of a single dipole and a broadside array. It is shown that for a plane array, there is an optimum size for maximum transfer between dipole and array. Spherical broadside arrays, in which individual dipoles are centered on the surface of a sphere having the single dipole at its center, are also considered. In this case, a focusing of energy takes place and there are no optimum dimensions. Formulas for radiation resistance are given.

621.396.677:621.392.029.64 1352  
The Design of a Wave-Guide-Fed Array of Slots to give a Specified Radiation Pattern—A. L. Cullen and F. K. Goward. (*Jour. I.E.E.* (London), part IIIA, vol. 93, no. 4, pp. 683-692; 1946.) A method of obtaining any specified aperture distribution from a wave-guide-fed array of slots. The problem of obtaining a specified radiation pattern can then be solved by using the well-known Fourier transformation. Experimental results confirm the theory.

621.396.677:621.392.029.64 1353  
A Wide-Band Linear Array Aerial—L. H. Dawson and N. M. Rust. (*Jour. I.E.E.* (London), part IIIA, vol. 93, no. 4, pp. 693-699; 1946.) This 10-centimeter array consists of half-wave dipole elements spaced  $\lambda/4$  apart in a 3-by 1-inch wave guide, with alternate elements off-set from the center line. With an 8-foot array the beam width is about 2.5 degrees for half power in the horizontal plane, with the largest side lobe 1 per cent of the main beam. When used with a cylindrical parabolic reflector, the array produces a beam width of about 7 degrees in the vertical plane. The beam shape remains almost constant over a 10 per cent frequency shift. The effects of mutual coupling, change of line length, and of characteristic admittance in a feeder loaded by equal small admittances at quarter-wave spacing are discussed.

621.396.677.029.6 1354  
New Parasitic Beam Design—R. G. Rowe. (*Radio News*, vol. 37, no. 1, pp. 40-41, 94; January, 1947.) Constructional details of a four-element, close-spaced aerial array for use on frequencies of 28 megacycles and above, designed so that the length of each half-wave section can be very easily adjusted.

621.396.677.029.62 1355  
Divided Broadside Aerials with Applications to 200-Mc/s Ground Radiolocation Systems—D. Taylor and C. H. Westcott. (*Jour. I.E.E.* (London), part IIIA, vol. 93, no. 3, pp. 588-597; 1946.) A general account of such aerial arrays and their characteristics, with particular reference to their use in 'chain home for low-flying aircraft' and ground-controlled-interception systems. Practical details

of a mobile ground-controlled-interception system are given and also of a fixed ground-controlled-interception station, including a specially designed rotary capacitance switch capable of handling peak powers up to 150 kilowatts.

621.396.677.029.62 1356  
Variable-Elevation Beam-Aerial Systems for  $1\frac{1}{2}$  Metres—G. E. Bacon. (*Jour. I.E.E.* (London), part IIIA, vol. 93, no. 3, pp. 539–544; 1946.) A stack of nine banks of four dipoles each, mounted on a 120-foot tower, is used to produce a beam which is very narrow in the vertical direction but wide horizontally. A special phase-shifting device, located near the center of the stack and inserted in the feed line from the transmitter enables the beam elevation to be varied rapidly. Two such installations are described, the first giving a 3-degree beam and measuring elevation to an accuracy of about  $\pm 0.3$  degree from  $1\frac{1}{4}$  to 15 degrees, and the second a  $1\frac{1}{2}$  degree beam measuring from  $\frac{1}{2}$  to 15 degrees with a maximum error of 0.15 degrees. The beam elevation obtained in practice agreed sufficiently well with the theoretical position for elevation calibration to be unnecessary. A summary of this paper is given in part IIIA, vol. 93, no. 1, pp. 52–53; 1946.

621.396.677.029.64 1357  
A Detailed Experimental Study of the Factors Influencing the Polar Diagram of a Dipole in a Parabolic Mirror—E. G. Brewitt-Taylor. (*Jour. I.E.E.* (London), part IIIA, vol. 93, no. 4, pp. 679–682; 1946.) Details are given of the effect on beam position of variations in wavelength, dipole length and position, length of balancing sheath on the coaxial transmission line, and parasitic reflector position. Results are also given for a dipole designed to give a 'skewed' beam without mechanical displacement.

621.396.677.029.64 1358  
A Dielectric-Lens Aerial for Wide-Angle Beam Scanning—F. G. Friedlander. (*Jour. I.E.E.* (London), part IIIA, vol. 93, no. 4, pp. 658–662; 1946.) The design of an aplanatic dielectric lens suitable for an aerial system of the sectoral horn type is considered. For certain values of the refractive index a plano-convex lens can be found which can be regarded as aplanatic in practice. To avoid distortion when the beam is scanned through a large angle by moving the source, a ray from the focus must meet the corresponding final ray on a circle with center at the focus and radius equal to the focal length.

621.396.677.029.64:621.392.029.64 1359  
Directive Couplers in Wave Guides—M. Surdin. (*Jour. I.E.E.* (London), part IIIA, vol. 93, no. 4, pp. 725–736; 1946.) The directivity and attenuation is calculated by a method due to H. A. Bethe (706 of 1945) for systems such as two parallel or crossed wave guides, using circular holes or linear slots as coupling elements. Broad-band couplers are obtained by multiplication of these coupling elements. The importance of mechanical accuracy, perfect matching, and finite size of coupling elements is discussed.

621.396.677.029.64:621.392.029.64 1360  
Resonant Slots—W. H. Watson. (*Jour. I.E.E.* (London), part IIIA, vol. 93, no. 4, pp. 747–777; 1946.) The coupling of a resonant half-wave slot to a rectangular wave guide is discussed in relation to the feeding of microwave radiators. "The laws of guide coupling are explained in terms of the manner in which impedance is transferred from the position of the slot center in guide 2 into guide 1 at the same position." The coupling of variable reactances to produce a T-section load is discussed. The wave guide feed for a microwave array is analyzed with reference to the band-

width of the system, and performance details are given of a broad-band array of inclined displaced slots. Radiation patterns are given for a 5 per cent frequency change in the S-band.

#### CIRCUITS AND CIRCUIT ELEMENTS

621.3.012.3:515.53 1361  
The Application of Riemann's Number Sphere and Its Projections to A. C. Engineering—F. Steiner. (*Radio Welt*, vol. 1, pp. 23–26; October, 1946.) Stereographic projection of the number sphere leads to a better representation of resistances than that using the Gauss plane; transfer from resistance to conductance merely requires a rotation through 180 degrees. A parallel projection method is developed for obtaining the terminating resistance from measurements of the terminal voltages of two quadripoles in series.

621.314.223:621.392.5.012.8 1362  
General Theory of the Autotransformer—P. Thévenin. (*Radio en France*, no. 2, pp. 37–38; 1947.) The quadripole equivalent of an autotransformer is of T type and appropriate formulas are derived. The T scheme is found particularly suitable for determining short-circuit voltages.

621.316.726.078.3:621.396.62.029.64 1363  
Crystal Control for Stability in V.H.F. Receivers—N. L. Chalfin. (*Tele-Tech*, vol. 6, pp. 71–73; January, 1947.) By using crystal harmonics, no-drift sets can be designed for cheap production.

621.318.572 1364  
Modern Geiger-Muller Counters—A. Graves. (*Electronics*, vol. 20, no. 1, pp. 80–83; January, 1947.) A counting circuit providing an accurate mechanical counter for rates up to 600 per minute and a less accurate electronic integrator for higher counting rates. Various applications are mentioned.

621.319.4:621.793.14 1365  
Metallized Capacitor Dielectrics—J. I. Cornell. (*Tele-Tech*, vol. 6, pp. 98, 157; January, 1947.) A recently developed American product called the 'Solite' capacitor has aluminum electrodes deposited directly on to the paper dielectric by a vaporization process. These capacitors are very small in size, and have long life and a low-power factor.

621.319.4.011.4:537.224 1366  
Calculation of the Edge Correction for Capacitors—Zickner. (*See* 1403.)

621.319.43 1367  
A Note on Variable Capacitors—M. Parodi and F. Raymond. (*Onde Élect.*, vol. 26, no. 237, pp. 477–478; December, 1946.) A formula is derived from which the shape of the moving plates can be calculated for a given capacitance law.

621.39.011 1368  
Application of Complex Functions to Frequency-Transposition Systems—F. H. Stieltjes. (*Tijdschr. ned. Radiogenoot.*, vol. 11, pp. 221–271; November, 1946. In Dutch with English summary.) Campbell's 'cisoidal oscillations' are used to develop a theory of these systems (i.e., modulators, etc.) which is analogous to normal circuit theory; equivalent circuit diagrams are given which show the behavior of such systems at a glance. Practical applications are discussed.

621.39.012 1369  
Functional Schematic Diagrams—S. H. Larick. (*Proc. I.R.E. AND WAVES AND ELECTRONS*, vol. 34, pp. 1005–1007; December, 1946.) Suggestions for clarifying schematic and circuit diagrams. Stress is laid on the importance of correctly representing the functions of circuits rather than the layout of components.

621.392.2:621.314.2 1370  
Design of 500 kc/s Transformers—R. Lee. (*Tele-Tech*, vol. 6, pp. 84–86; January, 1947.) Description of the development of untuned, laminated, iron-cored transformers to cover the frequency range 50 to 515 kilocycles. Constructional technique is briefly indicated and performance curves are given.

621.392.5 1371  
Generalization of the Conception of Rejector Filters—F. Raymond. (*Compt. Rend. Acad. Sci.* (Paris), vol. 217, pp. 680–682; December 27, 1943.) A quadripole with connections between its input and output terminals behaves as a rejector filter for the frequencies transmitted by the quadripole without damping or phase change.

621.392.52:519.27 1372  
The Wiener RMS (Root-Mean-Square) Error Criterion in Filter Design and Prediction—N. Levinson. (*Jour. Math. Phys.*, vol. 25, pp. 261–278; January, 1947.) Methods are given for determining quantitatively the extent to which message and noise can be separated and for the design of a filter to effect this separation. The problem of simultaneous filtering and predicting is considered. The root-mean-square approach used is an approximation to and a simplification of the transcendental case developed by N. Wiener.

621.394/.397.645 1373  
Graphical Solutions for Cathode Followers—H. L. Krauss. (*Electronics*, vol. 20, pp. 116–121; January, 1947.) Design data can be computed given only the conventional family of plate characteristics and the load, which is regarded as a pure resistance.

621.394.645.35:621.317.715 1374  
Contact Modulated Amplifier—Perkin-Elmer Corporation. (*See* 1512.)

621.396.611.1:[531.33/.39 1375  
On the Stability Conditions of Oscillating Systems—Couffignal. (*See* 1497.)

621.396.611.3 1376  
Propagation of Waves in Periodic Systems, taking Account of Certain Boundary Conditions—P. Marié. (*Compt. Rend. Acad. Sci.* (Paris), vol. 222, pp. 1039–1042; April 29, 1946.) An expression is derived, involving electro-spherical polynomials of order  $(n-1)$ , for the attenuation ratio of a series of  $(n+1)$  oscillatory circuits, loosely coupled by mutual inductance, under certain simplifying assumptions. See also 661-of April.

621.396.611.3.015.3 1377  
Transient Regimes in Coupled Resonators—P. Marié. (*Compt. Rend. Acad. Sci.* (Paris), vol. 222, pp. 1096–1098; May 6, 1946.) Continuation of 1376 above. For the general case of  $n$  identical obstacles and where the condition for iterative reflection is satisfied, the intensity of the signal transmitted in the transient regime is represented by an integral Bessel function which can be expanded in a rapidly converging series of Bessel functions. This result is valid for a chain of feebly oscillating coupled circuits terminated by its iterative impedance.

621.396.611.4 1378  
Principles Aiding the Calculation of Electromagnetic Cavities—J. Bernier. (*Compt. Rend. Acad. Sci.* (Paris), vol. 217, pp. 530–532; November 29, 1943.) A continuation of 2155 of 1945. From the principle of similitude it follows that if all the geometric dimensions of a cavity are multiplied by  $m$ , the natural wavelengths, self-inductance, and capacitance will also be multiplied by  $m$ , while the parallel resistance is divided by  $\sqrt{m}$  and the mutual inductance per square centimeter of the coupling loop by  $m$ . The principle of symmetry



enables the modes of vibration of a cavity made up from one with a plane side and its mirror image in that plane side, to be deduced from those of the smaller cavity. The equivalence between two of Maxwell's equations and a principle of minimum energy analogous to the principle of least action enables the natural frequencies and the fundamental fields of a cavity to be studied by the methods of the calculus of variations. In this way the variations in natural frequencies caused by small deformations of the cavity wall can be determined. The principle of orthogonal trajectories can also be applied.

621.396.611.4.029.64 1379  
Resonance Cavities used for Ultra-Short Waves—A. Briot. (*Télev. Franç.*, no. 8, pp. 7-10; December, 1945.) A mathematical treatment, based on Maxwell's equations, of the general case of cavity resonance, with application to the determination of the natural resonance frequencies of cylindrical cavities.

621.396.615 1380  
Complete Theory of Valve Oscillators—D. Guindin. (*Rev. Sci. (Paris)*, vol. 84, pp. 165-168; August, 1946.) The grid and anode currents are assumed to be sinusoidal. An approximate formula for the wavelength is derived mathematically, and agrees better with experimental results than that of classical theory which neglects the grid current.

621.396.615 1381  
A Stabilized Modulated Oscillator—A. E. Hayes, Jr. (*Radio News*, vol. 37, pp. 28-29; January, 1947.) Spurious frequency-modulation in an amplitude-modulated oscillator is eliminated by a secondary circuit producing frequency-modulation which is controlled and switched to oppose it.

621.396.615.14 1382  
Ring Oscillators for U.H.F. Transmission—Gootée. (*See* 1623.)

621.396.615.17:621.317.755 1383  
New Timebase Circuit for Cathode-Ray Oscillographs—(*Elektrotech. Zeit.*, vol. 65, pp. 138-139; April 20, 1944.) An auxiliary shunt circuit with properly chosen time constant, enables the capacitor connected across the time-deflection plates of the cathode-ray oscilloscope to be charged with sensibly uniform current. A modification of the arrangement gives a linear single sweep.

621.396.619.11/.13 1384  
Theory of the Frequency Discriminator—P. Güttinger. (*Bull. Schweiz. Elektrotech. Ver.*, vol. 37, pp. 531-534; September 7, 1946, reprint, in German, with French summary.) A general theory is developed. The conditions for linearity are considered from a new point of view. The main problem investigated is the demodulation of frequency-modulation waves, with particular reference to the transformation of frequency modulation into alternating modulation with the least possible distortion.

621.396.619.23 1385  
Overmodulation without Sideband Splatter—Villard. (*See* 1625.)

621.396.645:621.43.019.8 1386  
Constant-Gain Knock Pickup Amplifier—Krebs and Dallas. (*See* 1551.)

621.396.662.3 1387  
Introduction of the Idea of the Coupling Quadripole—L. Boé. (*Radio en France*, no. 2, pp. 29-31; 1947.) A coupling quadripole is any quadripole with zero open-circuit impedance and infinite short-circuit impedance. It is the basis of nearly all the simplifications possible in systems of quadripoles of the general type.

621.396.662.3 1388  
General Theory of Decimal Attenuators—

P. Thévenin. (*Radio en France*, no. 2, pp. 26-29; 1947.) The decimal attenuator consists of three quadripoles whose input and output terminals are connected in parallel, the quadripoles comprising three identical resistances  $R$ , three identical variable attenuators, and respectively 0, 1, and 2  $T$ -type lines of characteristic impedance  $R$  and reduction 1/10. Theory shows that such an attenuator, connected between a generator and a receiver, will give ratios between generator output voltage and receiver input voltage varying in steps of 1/1000 of a value determined by the receiver impedance, from 1.110 to 0.001. Some applications are discussed.

621.396.69 1389  
Components—M. Chauvierre. (*Radio en France*, no. 2, pp. 4-7; 1947.) A general critical discussion of present design trends in various countries for tubes, circuit components, tuning units, and loudspeakers.

621.396.692.029.3 1390  
Notes on the Construction of Attenuator Resistors—F. Tournery. (*Radio en France*, no. 2, pp. 32-33; 1947.) Economical methods of construction for all audio frequencies are described.

621.396.694.011.3/.4 1391  
Study of Electronic Reactance-Variation Devices—W. Mazel. (*Toute la Radio*, vol. 14, pp. 34-38; January, 1947.) Reactance-tube circuits are described whose behavior for reactance variation depends solely on a proper choice of the values of the resistors and capacitors involved. The operation of such circuits is explained with the aid of graphs and the results obtained with particular circuits are discussed.

#### GENERAL PHYSICS

53.081 1392  
On Unities [units] and Dimensions—H. B. Dorgelo and J. A. Schouten. (*Proc. Acad. Sci. (Amsterdam)*, vol. 49, pp. 123-131 and 282-291; February and March, 1946.) Discussion of the analogy between electric and magnetic quantities, of the relative merits of rationalized and unrationalized Giorgi units and of the expression of quantities dimensionally. Tables are given of units, dimensions, and the field equations using the centimeter-gram second, Gauss and Giorgi systems.

530.145.6 1393  
Physical Interpretation of Wave Mechanics—P. Destouches-Février and J. L. Destouches. (*Compt. Rend. Acad. Sci. (Paris)*, vol. 222, pp. 1087-1089; May 6, 1946.) A discussion of the basic principles of wave mechanics and of its relation to the quantum theory.

530.145.6 1394  
On New Relations between the Densities of Mean Values in Dirac's Electron Theory—G. Petian. (*Rev. Sci. (Paris)*, vol. 83, pp. 303-306; June-December, 1945.)

530.145.65 1395  
An Interpretation of L. de Broglie's Equations for the Photon—R. Murard. Physical Interpretation of L. de Broglie's Equations for the Photon—R. Murard. (*Compt. Rend. Acad. Sci. (Paris)*, vol. 222, pp. 1030-1032 and 1075-1076; April 29, and May 6, 1946.) Relativistic theory of systems of particles shows that the photon can be considered as a system of two Dirac corpuscles whose relative motion round their common center of gravity is evanescent. Regarding the photon as a Dirac corpuscle of positive energy combined with a lacuna in the series of states of negative energy, the relativistic wave mechanics of systems of particles completely justifies L. de Broglie's photon theory.

530.162+ [621.315.6:621.396.822] 1396  
The Response of Biased, Saturated Linear and Quadratic Rectifiers to Random Noise—Middleton. (*See* 1565.)

534.321.9:621.315.58 1397  
The Effect of Ultrasonic Waves on the Conductivity of Salt Solutions—P. E. Fox, K. F. Herzfeld, and G. D. Rock. (*Phys. Rev.*, vol. 70, pp. 329-339; September 1-15, 1946.) The conductivity is increased by an adiabatic compression because of direct pressure influence and temperature increase. Equipment is described for measurements between 200 kilocycles and 1.5 megacycles.

535.14 1398  
The Photoelectric Effect—C. Gutton, (*Télev. Franç.*, no. 11, pp. 9-10; March, 1946.) A short historical account of the experimental laws which led Einstein to his corpuscular theory of light, and then to the development of wave mechanics by L. de Broglie.

535.343.4+621.317.011.5+621.396.11.029.64] :546.171.1 1399  
The Ammonia Spectrum and Line Shapes near 1.25 cm Wave-Length—C. H. Townes. (*Phys. Rev.*, vol. 70, pp. 665-671; November 1-15, 1946.) Results are compared with those of Bleaney and Penrose (2622 of 1946) and of Good (3236 of 1946).

537.12/.13 1400  
Fundamental Particles—R. E. Peierls. (*Nature*, (London), vol. 158, pp. 773-775; November 30, 1946.) A descriptive account of current ideas concerning the nature and properties of the fundamental particles of physics namely the electron, proton, photon, positron, neutron, neutrino, meson, and negative proton.

537.12 1401  
On the Self-Energy of the Electron—G. Racah. (*Phys. Rev.*, vol. 70, pp. 406-409; September 1-15, 1946.) "Some evidence is given that the self-energy of an electron in the hole theory is finite, but coincides with  $mc^2$  only if  $e^2/hc$  satisfies a particular equation."

537.122 1402  
Determination of the Electronic Charge by the Oil-Drop Method—V. D. Hopper. (*Nature*, (London), vol. 158, pp. 786-787; November 30, 1946.) Experiments are described which show that in the oil drop determination of  $e$ , the hole in the condenser plates may distort the electric field appreciably and thus introduce an error. The magnitude of this error in previously measurements is discussed.

537.224:621.319.4.011.4 1403  
Calculation of the Edge Correction for Capacitors—G. Zickner. (*Arch. Elektrotech.*, vol. 38, pp. 1-16; January-February, 1944.) An extension of classical work to a large number of specific conductor systems.

537.291 1404  
On the Back Action [reaction] of the Electromagnetic Field on a Moving Electron—M. Markov. (*Jour. Phys. (U.S.S.R.)*, vol. 10, no. 2, pp. 159-166; 1946.)

537.291 1405  
The Motion of Positive Ions in the Electric Field in a Gas—L. Sena. (*Jour. Phys. (U.S.S.R.)*, vol. 10, no. 2, pp. 179-182; 1946.) A relation between the velocity of drift of ions and the ratio of field strength to gas pressure is established on the assumption that charge exchange of the ions is the predominant process in the interaction between ions and atoms.

537.525.5+621.396.822]:621.385 1406  
Noise and Oscillations in Hot Cathode Arcs—J. D. Cobine and C. J. Gallagher. (*Jour. Frank. Inst.*, vol. 243, pp. 41-54; January,

- 1947.) A summary was abstracted in 3266 of 1946.
- 537.525.6 1407  
Energy Distribution of Electrons in High Frequency Gas Discharges—T. Holstein. (*Phys. Rev.*, vol. 70, pp. 367–384; September 1–15, 1946.) An equation for the energy distribution is obtained and the limitations of its application are defined. Methods of solution and examples are given.
- 537.56:621.385 1408  
Ionization Currents in Non-Uniform Electric Fields—P. L. Morton. (*Phys. Rev.*, vol. 70, pp. 358–366; September 1–15, 1946.) A differential-difference equation for the electron current as a function of the electron energy and distance from the cathode end of a glow discharge is derived and the ionization currents are calculated by a step-by-step method.
- 538.24 1409  
Magnets in Permeable Media and Definition of Magnetic Moment—H. Diesselhorst. (*Elektrotech. Zeit.*, vol. 65, pp. 119–122; April 6, 1944.)
- 538.24 1410  
Induced Magnetization and Magnetic Moments—E. Brylinski. (*Compt. Rend. Acad. Sci.* (Paris), vol. 222, pp. 1035–1037; April 29, 1946.) Consideration of the effects produced in a nonmagnetic material, when a magnetic field is applied, shows that the moment of the couple exerted by a uniform field  $H$  on a plane closed current is the algebraic sum of the moment caused by the field  $H$  and of that due to the field  $4\pi I$  which results from the reaction of the material, the magnetic moment remaining independent of the material. On the assumption that all magnetism is due to moving electric charges in vacuo, it is concluded that the volume integral definition of magnetic moment, which leads to a contradiction, should be abandoned.
- 538.3:517.9 1411  
Applications of the Riesz Potential to the Theory of the Electromagnetic Field and the Meson Field—N. E. Fremberg. (*Proc. Roy. Soc. A*, vol. 188, pp. 18–31; December 31, 1946.) Riesz's method "yields simple deductions of classical results . . . [and] also the results recently obtained by Dirac regarding the proper energy and proper momentum of an electron." Bhabha's analogous theory of the neutral meson field is also treated.
- 538.32 1412  
The Distribution of Currents Induced by a Plane Wave on the Surface of a Conductor—V. Fock. (*Jour. Phys. (U.S.S.R.)*, vol. 10, no. 2, pp. 130–136; 1946.) If the wavelength is small compared with the dimensions and radii of curvature of the conductor, the current distribution near the geometrical shadow can be expressed in terms of an universal function, which is tabulated.
- 538.566 1413  
The Propagation of Electromagnetic Waves in Two or More Successive Media and the Diffraction of These Waves Referred to the Study of Cauchy's Problems—L. Robin. (*Rev. Sci.* (Paris), vol. 84, pp. 7–14; January–May, 1946.) A mathematical paper. Earlier work of Delsarte (*Ann. Sci. Éc. Norm. Supér.*, vol. 53, pp. 223–273; 1936) is confirmed and extended to the case of two homogeneous isotropic media, of given dielectric constant, permeability, and electrical conductivity, separated by a plane interface.  
In general the dielectric constants and the permeabilities alone determine whether Maxwell's equations for this problem have a unique solution or no solution; the conductivities are only involved in certain limiting cases.
- 539.234+621.793.14 1414  
Phenomena of the Production of Thin Metallic Layers by Vaporization—H. Stahl and S. Wagener. (*Zeit. Tech. Phys.*, vol. 24, nos. 10–12, pp. 280–287; 1943.)
- 53 1415  
Reports on Progress in Physics, Vol. 10 (1944–1945) [Book Reviews]—W. B. Mann (Editor). Physical Society, London, 442 pp., 30s. (*Jour. Sci. Instr.*, vol. 23, p. 302; December, 1946.) A list of subjects and authors is given.
- GEOPHYSICAL AND EXTRATERRESTRIAL PHENOMENA**
- 523:621.396.822.029.6 1416  
Disturbances of Extraterrestrial Origin in the Short Wave Band—Steinberg and Denisse. (*See* 1575.)
- 523.5:621.396.812 1417  
On the Detection of Meteors by Radio—L. A. Manning, R. A. Helliwell, O. G. Villard, Jr., and W. E. Evans, Jr. (*Phys. Rev.*, vol. 70, pp. 767–768; November 1–15, 1946.) Observations were made during the meteor shower of October 9, 1946, using a 15-megacycle, 100-kilowatt broadcasting transmitter and also a 29-megacycles continuous-wave transmitter of 0.7 kilowatt. Signal strength bursts and Doppler whistles were observed on both frequencies and the results indicate that both bursts and whistles may be regarded as evidence of the passage of meteors. The use of continuous-wave unmodulated transmissions of relatively low power, with frequency about 30 megacycles has definite advantages for meteor observation.
- 523.74:621.396.821 1418  
Radio Effects Observed During the Period of Solar Activity from 31st Jan. to 14th Feb. 1946—Bureau. (*See* 1564.)
- 523.746 1419  
On Movements and Origin of Sunspots—J. Tuominen. (*Observatory*, vol. 66, pp. 387–391; December, 1946.)
- 523.746:551.510.535:621.396.11 1420  
Effect of Sunspot Cycles on Long Distance Radio Signals—H. T. Stetson. (*Tele-Tech*, vol. 6, pp. 44–49; January, 1947.) A survey of sunspot activity and critical frequencies over the period 1934 to 1946. Absorption in the E layer is an important factor in the prediction of usable frequencies.
- 523.77 1421  
Solar Ultraviolet Spectrum to 88 Kilometers [Above the Earth]—W. A. Baum, F. S. Johnson, J. J. Oberly, C. C. Rockwood, C. V. Strain, and R. Tousey. (*Phys. Rev.*, vol. 70, pp. 781–782; November 1–15, 1946.) The spectrum below 3400 angstroms was photographed by means of a grating spectrograph mounted in the tail fin of a V-2 rocket. The results show a progressive extension of the spectrum into the ultraviolet with increasing height. Detailed analysis of the results is in progress.
- 523.854 1422  
The Magnetic Field of the Galaxy—L. Spitzer, Jr. (*Phys. Rev.*, vol. 70, pp. 777–778; November 1–15, 1946.)
- 537.591+523.165 1423  
An Investigation of the Absorption of Cosmic Rays in a Strong Magnetic Field at 3250 m above Sea Level—A. Alichanov, A. Alichanov, S. Nikitin, and A. Weissenberg. (*Jour. Phys. (U.S.S.R.)*, vol. 10, no. 3, pp. 294–295; 1946.) Continuation of work described in 73 of 1946 (Alichanov and Alichanov). Results indicate that a proportion of the soft component is not composed of electrons; it is suggested that the particles observed may be protons.
- 537.591 1424  
Cosmic-Ray Effects at High Altitudes—C. D. Anderson. (*Phys. Rev.*, vol. 70, p. 788; November 1–15, 1946.) Summary of American Physical Society paper.
- 537.591 1425  
Recent Cloud-Chamber Observations of the Soft Component of Cosmic Rays—W. Hazen. (*Phys. Rev.*, vol. 70, p. 789; November 1–15, 1946.) Summary of American Physical Society paper.
- 537.591 1426  
The Energy Spectrum of Cascade Electrons—I. Tamm and S. Belenky. (*Phys. Rev.*, vol. 70, pp. 660–664; November 1–15, 1946.)
- 537.591 1427  
The Multiple Production of Neutrons by Cosmic Radiation—S. A. Korff and B. Hamermesh. (*Phys. Rev.*, vol. 70, p. 429; September 1–15, 1946.)
- 537.591 1428  
The Mass of the Mesotron as Determined by Cosmic-Ray Measurements—D. J. Hughes. (*Phys. Rep.*, vol. 70, p. 791; November 1–15, 1946.) A review of published results leads to the conclusion "that the spread in mass values exceeds the experimental errors, and that it is extremely likely the mesotron does not possess a unique mass." But see 1429 below. Summary of American Physical Society paper.
- 537.591 1429  
The Mass of Cosmic-Ray Mesotrons—W. B. Fretter. (*Phys. Rev.*, vol. 70, pp. 625–632; November 1–15, 1946.) The range of mesotrons in lead as a function of their momentum was determined by a double cloud-chamber method. The results are consistent with a unique rest mass for mesotrons of 202 times that of an electron. But see 1428 above.
- 537.591 1430  
Mass of Cosmic-Ray Mesotrons—W. B. Fretter and R. B. Brode. (*Phys. Rev.*, vol. 70, p. 791; November 1–15, 1946.) Summary of American Physical Society paper.
- 537.591 1431  
Measurement of Meson Masses by the Method of Elastic Collision. Probable Existence of a Heavy Meson (1000 m $\mu$ ) in the Cosmic Radiation—L. Leprince-Ringuet. (*Phys. Rev.*, vol. 70, pp. 791–792; November 1–15, 1946.) Summary of American Physical Society paper.
- 537.591 1432  
Some Problems in the Study of Cosmic-Ray Mesons—B. Rossi. (*Phys. Rev.*, vol. 70, p. 788; November 1–15, 1946.) Summary of American Physical Society paper.
- 537.591 1433  
Origin of Cosmic-Ray Mesons—M. Schein. (*Phys. Rev.*, vol. 70, pp. 788–789; November 1–15, 1946.) Summary of American Physical Society paper.
- 537.591 1434  
On the Determination of the Energy Spectrum and Sign of Primary Cosmic Radiation—M. S. Vallarta, M. L. Perusquia, and J. De Oyarzabal. (*Phys. Rev.*, vol. 70, pp. 785–786; November 1–15, 1946.) Summary of American Physical Society paper.
- 537.591 1435  
On the Space Correlation of Particles in Cosmic Rays: Part 2—Correlation Between Electrons and Photons—V. Berestetzky. (*Jour. Phys. (U.S.S.R.)*, vol. 10, no. 3, pp. 211–216; 1946.)
- 537.591 1436  
Ionizing Power of Particles of the Hard and Soft Components of the Cosmic Radiation—

- N. Dobrotin. (*Jour. Phys. (U.S.S.R.)*, vol. 10, no. 3, pp. 207-210; 1946.)
- 537.591 1437  
Attempt of an Analysis of Some Cosmic-Ray Phenomena—R. P. Feynman and H. A. Bethe. (*Phys. Rev.*, vol. 70, pp. 786-787; November 1-15, 1946.) Summary of American Physical Society paper.
- 537.591:523.7 1438  
Three Unusual Cosmic-Ray Increases Possibly due to Charged Particles from the Sun—S. E. Forbush. (*Phys. Rev.*, vol. 70, pp. 771-772; November 1-15, 1946.)
- 537.591.15 1439  
Atmospheric Showers and Bursts—D. Skobeltzyn. (*Phys. Rev.*, vol. 70, pp. 441-442; September 1-15, 1946.)
- 537.591.15 1440  
Penetrating (Atmospheric) Showers in Cosmic Rays—V. Veksler, L. Groshev, and L. Lazareva. (*Phys. Rev.*, vol. 70, pp. 440-441; September 1-15, 1946.)
- 537.591.15 1441  
Penetrating Cosmic Ray Showers at 3860 m above Sea Level—L. Bell, N. Birger, and V. Veksler. (*Jour. Phys. (U.S.S.R.)*, vol. 10, no. 2, pp. 198-199; 1946.) Results of observations on the Pamir plateau.
- 537.591.15:539.16.08 1442  
A Cloud-Chamber Investigation of Penetrating Showers—G. D. Rochester. (*Proc. Roy. Soc. A*, vol. 187, pp. 464-479; December 13, 1946.) "Some 20 per cent of penetrating showers are accompanied . . . by what appear to be electron cascades. . . . These showers may be due to electrons or photons produced in processes which become important at very high energies, e.g.,  $>10^{11}eV$ ."
- 537.591.5 1443  
Composition of Cosmic Rays at a Height of 3250 m above Sea Level—A. I. Alikhanoff. (*Bull. Acad. Sci. (U.R.S.S.)*, sér. phys., vol. 9, no. 3, pp. 135-144; 1945. In Russian.)
- 550.38 1444  
On the Question of the Origin of Terrestrial Magnetism—Y. P. Bulashevich. (*Bull. Acad. Sci. (U.R.S.S.)*, sér. géogr. géoph., vol. 8, nos. 2 and 3, pp. 93-95; 1944. In Russian.)
- 551.510.535 1445  
Sporadic E-Region Ionization at Watheroo Magnetic Observatory 1938-1944—H. W. Wells. (PROC. I.R.E. AND WAVES AND ELECTRONS, vol. 34, pp. 950-955; December, 1946.) Continuous recordings of the occurrence of the sporadic E layer have been analyzed to determine diurnal, seasonal, annual, or other regular variations. It is inferred that there is no direct relationship with recurrent solar phenomena or with magnetic disturbances.
- 551.510.535 1446  
The Mechanism of Ionospheric Ionization: Part 2—R. v.d.R. Woolley. (*Proc. Roy. Soc. A*, vol. 187, pp. 403-415; December 13, 1946.) "The available mechanisms for the production of electrons in the three regions of the ionosphere are discussed with special reference to the question whether it is possible to account for the observed electron densities without supposing that the sun emits far more energy in the remote ultraviolet spectrum than would be emitted by a black body at 6000 degrees. The contributions to electron densities made by metastable states of atoms and molecules are examined. It is concluded that the observed electron densities may be accounted for without requiring high solar energy in the ultraviolet if the effective recombination coefficient in the F<sub>2</sub> region is 10<sup>-11</sup>. The F<sub>2</sub> region is supposedly formed by the ionization of atomic oxygen, and the E region by the ionization of molecular oxygen. The electrons forming the F<sub>1</sub> region are supposed to be provided by metastable N<sub>2</sub> or by NO." For part 1 see 416 of March.
- 551.510.535:621.396.11 1447  
The Role of the Ionosphere in the Propagation of Radio Waves—R. Jouaust. (*Bull. Soc. Franç. Elec.*, vol. 6, pp. 348-354; June-July, 1946.) A survey of present knowledge. Regular daily observations on the ionosphere have been carried out at the National Radio Laboratory, Bagnaux, since April, 1946. The program envisaged is the extension of the observations to all the hours of the day and night and the progressive provision of further recording stations in France overseas.
- 551.594 1448  
A New Theory of Atmospheric Electricity—D. S. Kothari and L. S. Lothari. (*Sci. Culture*, vol. 12, pp. 261-263; December, 1946.) A discussion of Frenkel's theory (2186 of 1946) showing that it offers a qualitative explanation of some puzzling phenomena. It may have wider application to dust storms and the electrification of powders injected into gases.
- 551.594:551.574 1449  
Influence of Water Drops on the Ionization and Electrification of Air—J. Frenkel. (*Jour. Phys. (U.S.S.R.)*, vol. 10, no. 2, pp. 151-158; 1946.)
- 614.825:551.594.221 1450  
The Image of Objects Produced by Lightning and Impulse Discharge in Atmosphere—G. Spiwak and J. Kardash. (*Jour. Phys. (U.S.S.R.)*, vol. 10, no. 3, pp. 252-256; 1946.) Laboratory reproduction of the imprinting by lightning of images of nearby objects on struck bodies.
- LOCATION AND AIDS TO NAVIGATION
- 621.396.677 1451  
Various Papers on Directive Aerials—See Aerials section for papers prepared for the Institution of Radio Engineers Radiolocation Convention, 1946.
- 621.396.9:623.454.25 1452  
Radio Proximity-Fuze Development—Hinman and Brunetti. (See 1555.)
- 621.396.932 1453  
Radar Specifications for the Merchant Navy—(*Onde Elec.*, vol. 26, pp. 481-487; December, 1946.) The specifications for navigational radar issued by the Service des Phares Français and by the London conference on radar navigational aids, May and June, 1946, are given, and also that of the London conference for anticollision radar.
- 621.396.932.078+621.396.664 1454  
Radio Controlled Buoys—A. F. Hopkins, Jr., and F. A. B. Smith. (*Electronics*, vol. 20, pp. 84-86; January, 1947.) A simple very-high-frequency remote control selective relay system, originally used for rapid blackout of unattended buoys. Its application is being extended to foghorns and similar navigational aids only required occasionally.
- 621.396.933:621.38.001.8 1455  
Analyzing Present Position of Electronic Aids for Airplanes—G. Shea. (*Tele-Tech*, vol. 6, pp. 34-41, 138; January, 1947.) A discussion of the many "problems encountered in flight together with recommended electronic solutions which have been offered the PICAQ delegates." See also 112 of February and 428 of March.
- 621.396.96 1456  
Identification, Friend or Foe—Radar's Sixth Sense—L. E. Stuart. (*Tele-Tech*, vol. 6, pp. 60-67; January, 1947.) Technical details of the United States Navy's auxiliary system of pulsed transmission and reception for the positive identification of aircraft.
- 621.396.96 1457  
Low-Altitude Radar Bombsight—J. W. Rieke. (*Bell Lab. Rec.*, vol. 25, pp. 13-16; January, 1947.) An account of the AN/APQ-5 equipment and its operation.
- 621.396.96:518.5 1458  
The Ballistic Computer—Juley. (See 1494.)
- MATERIALS AND SUBSIDIARY TECHNIQUES
- 535.37:535.61-15 1459  
Decay in Brightness of Infrared Sensitive Phosphors—R. T. Ellickson and W. L. Parker. (*Phys. Rev.*, vol. 70, pp. 290-299; September 1-15, 1946.)
- 538.221.029.64 1460  
Theory of the Dispersion of Magnetic Permeability in Ferromagnetic Materials at Microwave Frequencies—C. Kittel. (*Phys. Rev.*, vol. 70, pp. 281-290; September 1-15, 1946.) An explanation of the experimental facts is proposed, based on a consideration of the equations of motion of a domain boundary in an applied magnetic field for frequencies such that the skin depth of the magnetic field is smaller than the thickness of the domain. A criticism is given of theories of ferromagnetic resonance.
- 546.287 1461  
Silicone Oils—Part 2: Their Applications—D. F. Wilcock. (*Gen. Elec. Rev.*, vol. 49, pp. 28-33; December, 1946.) For part 1 see 750 of April.
- 546.46.78:548.2 1462  
The Crystal Structure of Magnesium Tungstate—N. J. Dunning and H. D. Megaw. (*Trans. Faraday Soc.*, vol. 42, pp. 705-709; December, 1946.)
- 549.514.51:548.24 1463  
Artificial Electrical Twinning in Quartz Crystals—J. J. Vormer. (*Tijdschr. Ned. Radiogenoot.*, vol. 11, pp. 215-219; November, 1946. In Dutch with English summary.) Electrical twinning can easily be produced below 573 degrees centigrade at well-defined places in AT-CT- and GT-cut quartz plates. Such twinning may occur at points where leads have been soldered to the metal coatings. In some cases this type of twinning can be corrected by suitable heat treatment, but attempts to correct natural electrically-twinned quartz met with little success.
- 620.193.21:669.721 1464  
Magnesium: Corrosion Resistance under Accelerated Atmospheric Conditions—R. R. Rogers, D. A. Tetu, and H. Livingstone. (*Metal Ind.*, vol. 70, pp. 9-10; January 3, 1947.) Magnesium and its alloys offer good resistance to corrosion except in marine atmospheres, in which case protective coatings of paint are desirable.
- 621.3.032.53:533.5 1465  
Glass-to-Metal Seals—G. D. Redston and J. E. Stanworth. (*Jour. Soc. Glass Tech.*, vol. 29, pp. 48-76; April, 1945.) Stress-optical bench photoelastic measurements on standard sandwich seals over a wide temperature range are discussed. Axial stresses for bead seals at room temperature were determined by the method of Hull and Burger.
- 621.3.032.53:533.5 1466  
Glass-to-Metal Seals, with Particular Reference to Current Lead-In Seals in Vacuum Devices—R. W. Douglas. (*Jour. Soc. Glass Tech.*, vol. 29, pp. 92-110; April, 1945.) A procedure for avoiding extreme stresses in manufacture or operation is described.

- 621.3.032.53:533.5 1467  
Sealing Glasses—A. E. Dale and J. E. Stanworth. (*Jour. Soc. Glass Techn.*, vol. 29, pp. 77–91; April, 1945.) A general discussion of the physical properties and chemical compositions of common sealing glasses and their applications. A method of classification is suggested.
- 621.314.63 1468  
Remarks on the Operation and Construction of Barrier Layer Rectifiers—M. Leblanc. (*Bull. Soc. Franç. Élec.*, vol. 6, pp. 444–452; August–September, 1946.) Discussion of various theories proposed to explain the differing properties of metals, semiconductors, and insulators, with particular reference to conductivity. It is concluded that a dry rectifier consists of two crystalline lattices in which the concentration of the electrons is very different, separated by an insulating layer having a thickness of the order of a hundred atomic layers. Electrons crossing this layer obey the laws of wave mechanics. In metals, the free electrons do not obey the classical statistical laws because of their small mass; they form a degenerate gas to which the Sommerfeld-Fermi theory applies. In semiconductors the concentration of free electrons is so low that the electronic gas ceases to be degenerate and classical laws apply. Copper oxide, copper sulphide, and selenium rectifiers are discussed with special reference to the nature and mechanism of the dielectric separating layer.
- 621.314.63 1469  
Applications of Dry Rectifiers—J. M. Girard. (*Bull. Soc. Franç. Élec.*, vol. 6, pp. 522–556; October, 1946.) The principles involved in rectifiers of the barrier-layer type are discussed and an account is given of the characteristics of selenium and copper oxide rectifiers and of their commercial production. Many widely differing applications are described, ranging from apparatus giving many tens of thousands of amperes at low voltage to apparatus giving hundreds of thousands of volts at low currents of the order of tens of milliamperes.
- 621.315.22:669.715 1470  
Cable Sheathing in Aluminium—(*Light Metals*, vol. 9, pp. 474–498; September, 1946.) A critical survey of the possibility of replacing lead by aluminium, based on published German work. See also 1471 below.
- 621.315.22:669.715 1471  
Insulated Cables and Wire in Aluminium—(*Light Metals*, vol. 9, pp. 648–684; December, 1946.) A continuation of 1470 above. A survey of practice in various countries including France and Italy; the possibility of replacing copper by aluminium is considered with particular reference to the methods of cable joining.
- 621.315.61:537.228.1 1472  
The Dielectric Properties of Ferroelectric (Seignette Electric) Crystals and Barium Titanate—V. Ginsburg. (*Jour. Phys. (U.S.S.R.)* vol. 10, pp. 107–115; 1946.) A discussion based on thermodynamical consideration of a phase transition from a nonpyroelectric to a pyroelectric crystal.
- 621.315.61:546.4 1473  
High Dielectric Constant Materials—B. Wul [B. M. Vul]. (*Jour. Phys. (U.S.S.R.)*, vol. 10, no. 2, pp. 95–106; 1946.) Another account in English of the experimental work noted in 3639 of January.
- 621.315.61:547 1474  
Contribution to the Knowledge of Electro-technical Organic Insulating Materials—H. Stäger, B. Frischmuth, and F. Held. (*Schweiz. Arch. Angew. Wiss. Tech.*, vol. 12, pp. 372–390; December, 1946.) Research on the relation between the molecular structure of resinous substances, and the dielectric losses in layered insulating materials is described. The dielectric losses in such materials can be reduced by esterization of the cellulose hydroxyl substances used as binders; this also alters the mechanical properties of the materials. The losses in materials using glass as binder are dependent on the alkali content of the glass. With alkali-free glass the losses are considerably lower than with a cellulose-type binder and the mechanical properties are improved.
- 621.315.61:621.396.67.029.64 1475  
Dielectric Housings for Centimetre-Wave Antennae—Birks. (*See* 1343.)
- 621.315.611.011.5+537.226.3 1476  
The Relation Between the Power Factor and the Temperature Coefficient of the Dielectric Constant of Solid Dielectrics: Part 2—M. Gevers. (*Philips Res. Rep.*, vol. 1, pp. 279–313; August, 1946.) A review of available data given by various authors. The data differ so widely that a relation between the power factor and temperature coefficient cannot be deduced. For part 1 see 125 of February.
- 621.317.33.38:621.392.015.33 1477  
Insulation for High-Voltage Pulse Networks—C. D. Owens. (*Bell Lab. Rec.*, vol. 25, pp. 28–31; January, 1947.) Breakdown tests on various materials, with point-to-point and point-to-plate electrodes, show correlation between arc resistance properties and ability to withstand high-pulse voltages. Mica and glass-bonded mica were found best for arc resistance.
- 621.357.6 1478  
Electroforming: Parts 1–3—E. A. Ollard. (*Metal Ind.*, (London), vol. 70, pp. 6–8, 51–53, and 86–88; January 3, 17, and 31, 1947.) A survey of moulds and moulding materials, conducting surfaces, types of metal, solution formulas, etc., for piece part production by electrodeposition. To be continued.
- 621.775.7 1479  
Metallurgy of Powders; Study of Compressed Kovar—Nguyen Tienchi. (*Compt. Rend. Acad. Sci. (Paris)*, vol. 222, pp. 1046–1047; April 29, 1946.) Kovar ingots were prepared from carefully purified Co, Ni and Fe, with no Mn. Rings from these ingots welded perfectly to a glass having an expansion coefficient of  $5 \times 10^{-6}$ . X-ray photographs show that in the case of the ingot obtained by high-frequency heating, the alloy is well formed, with the same crystalline structure as kovar of American origin. The structure of that obtained by heating to 1050 degrees centigrade for 10 hours is less definite, the diffraction lines being appreciably more diffuse.
- 621.793:666 1480  
Metallizing Glass and Ceramic Materials—A. J. Monack. (*Glass Ind.*, vol. 28, pp. 21–25, 44; January, 1947.) A detailed account of metallizing methods using (a) mechanical films, (b) metallic paints, (c) metal spraying, (d) cathode sputtering or evaporation in vacuo, and (e) chemical reduction.
- 621.793.14+539.234 1481  
Phenomena of the Production of Thin Metallic Layers by Vaporization—Stahl and Wagener. (*See* 1414.)
- 669.018:621.775.7 1482  
Fernico from Metal Powders—E. E. Burger. (*Gen. Elec. Rev.*, vol. 49, pp. 22–24; December, 1946.) Fernico, an alloy of Fe, Ni, and Co, is produced from powdered materials by sintering. Its thermal expansion coefficient is almost the same as that of Corning glass 705AO, permitting seals to be made of almost any size or shape. Its electrical resistance is about 43 microohms per cubic centimeter.
- 669-167 1483  
The Structure and Appearance of Metal Surfaces—J. H. Nelson. (*Metal Treat.*, vol. 13, pp. 279–285; Winter, 1946–1947.)
- 669.3+669.35 1484  
Copper and Copper Alloys: a Survey of Technical Progress During 1946—E. Vocci. (*Metallurgia, Manchr.*, vol. 35, pp. 78–84; December, 1946.) Discusses the production of copper, its up-grading by distillation, the casting and properties of various alloys, corrosion and oxidation, and some aspects of physical metallurgy.
- 669.738:620.193.15 1485  
Comparison of Electroplated Finishes under Humidity (K 110) Test—(*Metallurgia, Manchr.*, vol. 35, pp. 63–64; December, 1946.) Illustrations of results obtained by F. Taylor in work on cadmium plating described in 779 of February.
- 678.1.02 1486  
Colloidal Carbon—W. H. Cadman. (*Jour. Roy. Soc. A.*, vol. 94, pp. 646–663; September 27, 1946.) A description of the methods of manufacture and the properties of carbon-black, with special reference to its use in the rubber industry.
- 679.5 1487  
Polythene—F. A. Freeth. (*Engineering*, (London), vol. 162, pp. 388–389; October 25, 1946.) Abridged English text of a lecture delivered at the Twentieth Congress of the Société de Chimie Industrielle.
- 679.5 1488  
Contribution to the Knowledge of the Softening of Polyvinyl Chloride—H. Stäger and F. Held. (*Schweiz. Arch. Angew. Wiss. Tech.*, vol. 12, pp. 278–288; September, 1946.)
- 679.5:620.193.21 1489  
The Behavior of Thermosetting Plastics Exposed to the Weather—G. O. Grimm. (*Schweiz. Arch. Angew. Wiss. Tech.*, vol. 12, pp. 311–322; October, 1946.) An account of tests, lasting over two years, on rods subjected to bending loads and on a wide range of mouldings exposed in the open. The materials were chiefly of the phenol and urea types, with various fillers. Short tests and weathering tests, with or without mechanical loading, do not give comparable results. Deterioration of materials exposed to the weather is greatly increased by simultaneous mechanical loading.

#### MATHEMATICS

- 51:5+6 1490  
Advanced Instruction in Practical Mathematics—A. Erdélyi and J. Todd. (*Nature* (London), vol. 158, pp. 690–692; November 16, 1946.) A discussion of proposals for the foundation of an Institute for Practical Mathematics with suggestions regarding staff and the functions of such an institution. These should include instruction in advanced mathematical techniques not usually included in university curricula, the provision of short courses for engineers and others, and of postgraduate courses for mathematicians, the promotion of research and the preparation of monographs. See also leader in same issue, pp. 683–684; *Nature*, (London), vol. 157, pp. 571–573; May 4, 1946; and *Nature*, (London), vol. 158, pp. 916–917; December 21, 1946.
- 512.831:621.392.1 1491  
Matrix Methods in Transmission-Line and Impedance Calculations—Watson. (*See* 1329.)
- 517.65 1492  
The Finite Parts of Integrals and the Laplace-Carson Transformation—J. Gilly. (*Rev. Sci. (Paris)*, vol. 83, pp. 259–270; June–December, 1945.)



- 18.5 1493  
Calculations and Electronics—(*Electrician*, vol. 137, pp. 1279–1280; November 8, 1946.) A short account of the various features to be incorporated in the A.C.E. (automatic computing engine) designed by the National Physical Laboratory.
- 518.5:621.396.96 1494  
The Ballistic Computer—J. Juley. (*Bell Lab. Rec.*, vol. 25, pp. 5–9; January, 1947.) For anti-aircraft fire control.
- 518.6:621.317.329:621.385 1495  
Electrostatic Field Plotting—Balachowsky. (*Bull. Soc. Franç. Élec.*, vol. 6, pp. 181–186; April, 1946.) Starting from one electrode, a second equipotential surface is plotted very close to the electrode. Laplace's equation is then used to calculate successive equipotentials until the neighborhood of the second electrode is reached. The shape of this electrode can thus be found for any assigned value of its potential. Practical difficulties of the method are discussed. Similar graphical integration methods may be applied to problems involving the topography equation.
- 519.28:52/59 1496  
Choice of a 'Reality Index' for Suspected Cyclic Variations—W. Gleissberg. (*Nature* (London), vol. 158, pp. 915–916; December 21, 1946.) A discussion of the cyclic variations apparent in some natural phenomena which are not purely periodic in nature. A 'reality index' to indicate the degree of reality of such variations is defined and its use is demonstrated by an example taken from sunspot observations.
- 531.33/.39:621.396.611.1 1497  
On the Stability Conditions of Oscillating Systems—L. Couffignal. (*Rev. Sci.* (Paris), vol. 83, pp. 195–210; May, 1945.)
- MEASUREMENTS AND TEST GEAR
- 620.199:621.315.614.6 1498  
High-Speed Life Test for Capacitor Paper—H. A. Sauer. (*Bell Lab. Rec.*, vol. 25, pp. 17–19; January, 1947.)
- 621.317.083.71 1499  
Remote Indication of Measured Quantities using a Resistance Element and a Crossed-Coil Indicator—J. Lorenz. (*Arch. Tech. Messen*, nos. 112 and 113, pp. T109–110 and T121–122; October and November, 1940.)
- 621.317.323.027.21 1500  
Measurement of H.F. Voltages of the Order of a Microvolt—P. Mourmant. (*Radio en France*, no. 2, pp. 15–19; 1947.) Indirect methods are preferred. Practical difficulties and methods of standardization, and the stability of the heterodyne and measurement receiver are discussed.
- 621.317.33:621.385.3.032.2 1501  
Inter-Electrode Capacitances of Triode Valves and Their Dependence on the Operating Condition—S. C. Mitra and S. R. Khastgir. (*Indian Jour. Phys.*, vol. 20, pp. 81–99; June, 1946.) Interelectrode capacitances are measured by a double-beat method and their variation with filament and anode current for three different anode voltages with no grid bias are studied. Results for eight commercial tubes are given and discussed.
- 621.317.336:621.396.67 1502  
The Measured Impedance of Cylindrical Dipoles—King. (*See* 1338.)
- 621.317.336.6:621.392.029.64 1503  
Standing Wave Meter—H. E. Kallmann. (*Electronics*, vol. 20, pp. 96–99; January, 1947.) A detailed description of an automatic standing-wave detector of moderate accuracy designed for quick adjustments of microwave equipment. Power from a constant source is injected into a U-shaped wave guide. Power reflections caused by mismatch are measured automatically by a device which gives a direct meter indication of standing-wave ratio.
- 621.317.35 1504  
The Cinematic Analyzer—E. Aisberg. (*Radio Craft*, vol. 18, pp. 18–19, 66; December, 1946.) This frequency analyzer comprises a receiver and mixer, a wide band-pass amplifier tuned to 460 kilocycles, a converter stage, an oscillator tuned to 877 kilocycles and frequency-modulated over  $\pm 50$  kilocycles by a vibrating reed wobbler, and a selective amplifier tuned to 417 kilocycles. The output from the latter is applied to the vertical deflection plates of a cathode-ray oscilloscope, the 60-cycle sweep being synchronized with the supply to the wobbler. Applied frequencies between 410 and 510 kilocycles thus appear as peaks on the screen, the height of the peaks indicating the signal amplitude. In addition to this direct application to intermediate-frequency stages, the apparatus can also be used for the study of receiver radio-frequency stages, selectivity curves, and audio-frequency stages.
- 621.317.35 1505  
Wave and Pulse Counter—R. Blitzer. (*Radio Craft*, vol. 18, pp. 25, 49; December, 1946.) The incoming wave is amplified, clipped, and reduced to sharp pulses which are applied to the grid of a thyratron.
- 621.317.372.029.64 1506  
Apparatus for Measurement of Centimetre Waves: Q-Meter and Wattmeter—A. G. Clavier and R. Cabessa. (*Onde Élec.*, vol. 26, pp. 421–429; November, 1946.) In the Q-meter a positive-grid tube, with anode voltage varied periodically (e.g., at 210 cycles), is used to create a variable electromagnetic field; this in turn excites the resonant cavity, the Q of which is to be measured. A crystal detector is used to measure the field in the resonant cavity, the detector current being applied after amplification to the vertical plates of a cathode-ray oscilloscope; the horizontal sweep is derived from the voltage used for modulation. The resonance curve thus obtained enables Q to be found.  $Q = F_0/\Delta F$ , where  $F_0$  is the mean frequency, corresponding to the peak of the resonance curve, and  $\Delta F$  is the width of the curve where the amplitude is half the maximum. A double-beat method can also be used. The apparatus described enables measurements of Q to be made from 2000 to about 50,000 with an accuracy of the order of 10 per cent. It has been used for measuring, at wavelengths of 8 centimeters, the attenuation constants of coaxial cables or of circular guides with  $E_{01}$  or  $H_{11}$  waves. The wattmeter comprises (a) a measurement line of characteristic impedance 90 ohms and of adjustable length, which is inserted between the ultra-high-frequency source and the apparatus to be measured; (b) a bolometer probe carried on a slider movable along the measurement line; and (c) rack-mounted measurement equipment. The length of the line and the position of the bolometer are adjusted to obtain a system of stationary waves, the bolometer being at a current loop. Powers from 50 milliwatts to 150 watts can be measured with the apparatus on wavelengths between 8 and 14 centimeters with an accuracy of about  $\pm 15$  per cent.
- 621.317.38 1507  
Definitions and Measurement of Apparent Power and Energy—A. Iliovici. (*Bull. Soc. Franç. Élec.*, vol. 5, pp. 367–377; December, 1945.) Applicable to polyphase circuits.
- 621.317.7 1508  
Manufacture of Electrical Measuring Instruments in India—B. B. Bhowmik. (*Sci. Culture*, vol. 12, pp. 275–279; December, 1946.) A brief historical survey with suggestions for future developments in the production of jeweled bearings, hair springs, pivots, magnets, etc.
- 621.317.7:621.385 1509  
Portable Precision Valve Tester—F. Haas. (*Toute la Radio*, vol. 14, pp. 59–61; January, 1947.) A description, with circuit diagrams and constructional details, of an instrument for measuring tube slope, cathode insulation, emission, and for testing filament continuity and insulation between electrodes.
- 621.317.7.082.78 1510  
Electronic Magnetometer—J. H. Rubenstein. (*Electronics*, vol. 20, pp. 156–164; January, 1947.) Compact, with sensitive pickup head. Suitable for remote indication of the change of position of a small permanent magnet attached to any moving object.
- 621.317.7.082.78.085.31 1511  
Electronic Position Pickup—D. W. Moore, Jr. (*Electronics*, vol. 20, pp. 100–101; January, 1947.) An earth-inductor compass formed by mounting an armature on a piezoelectric crystal. A small permanent magnet is mounted on the pointer whose position is to be transmitted.
- 621.317.715:621.394.645.35 1512  
Contact Modulated Amplifier—Perkin-Elmer Corporation. (*Rev. Sci. Instr.*, vol. 17, p. 560; December, 1946.) Notice of manufacture of the amplifier described in 2629 of 1946 (Liston, Quinn, Sargeant, and Scott). It is designed to replace sensitive suspension galvanometers; various applications are indicated.
- 621.317.715.085.39 1513  
A Simple Galvanometer Amplifier with Negative Feedback—D. V. Prinz; J. S. Preston. (*Jour. Sci. Instr.*, vol. 23, pp. 301–302; December, 1946.) Comment on 3670 of January, and Preston's reply.
- 621.317.725 1514  
A Very High Impedance R.M.S. Voltmeter for Iron Testing—D. C. Gall and F. C. Widdis. (*Jour. Sci. Instr.*, vol. 23, p. 287; December, 1946.) A tube amplifier, with high-input impedance, which "has no voltage gain but a high power gain, giving in effect a very high impedance to the alternating-current voltmeter which it operates. The ratio of input to output is linear."
- 621.317.727.025 1515  
Alternating Current Potentiometer—S. Holmqvist. (*Ericsson Rev.*, vol. 23, no. 4, pp. 297–307; 1946.) The required alternating-current quantities are transformed thermally into direct voltages, which are measured with direct potentiometers. Circuit diagrams are given for power, current, and voltage measurement.
- 621.317.73 1516  
A Visual Null Indicator for Impedance Bridge Measurements at Radiofrequencies—P. J. Brine and J. W. Whitehead. (*Rev. Sci. Instr.*, vol. 17, pp. 537–539; December, 1946.) Greater accuracy in balance is obtained by applying the detector amplifier output to one pair of plates of a cathode-ray tube, and the modulated output of the radio-frequency oscillator to the other pair. A straight-line trace indicates balance. Using this indicator with a General Radio Type 916A bridge, impedance measurements to an accuracy of 0.2 ohm can be made in the presence of interference levels more than 40 decibels above 1 microvolt.
- 621.317.79:621.397.62 1517  
Television Synchronizing Signal Generating Units: Part I—R. R. Batchler. (*Tele-Tech*, vol. 6, pp. 50–54, 144; January, 1947.) Describes picture and synchronizing test equip-

- ment for studio, laboratory, and receiver-production lines.
- 621.317.794 1518  
The Organic Thermistor Bolometer—C. D. Niven. (*Canad. Jour. Res.*, vol. 24, sec. A, pp. 93-102; November, 1946.) Tests of a bolometer using a cellophane film painted with aquadag show it to be much inferior to the inorganic thermistor developed at the Bell Telephone Laboratories, particularly as regards drift and speed of response.
- 621.396.611.4:538.569.4 1519  
Theory of a Microwave Spectroscope—W. E. Lamb, Jr. (*Phys. Rev.*, vol. 70, pp. 308-317; September 1-15, 1946.) A discussion of (a) the measurement of the exponential decay of the radiation in an untuned echo box between pulses of radio-frequency power, and (b) the steady-state response of a large untuned cavity.
- OTHER APPLICATIONS OF RADIO AND ELECTRONICS
- 518.5 1520  
Calculations and Electronics—(See 1493.)
- 537.533.7 1521  
Imperfections of Shape in Electron-Optical Instruments—F. Bertoin. (*Compt. Rend. Acad. Sci. (Paris)*, vol. 224, pp. 106-107; January 13, 1947.)
- 539.16.08 1522  
Design of a Proportional Counter for Gamma-Rays—B. B. Benson. (*Rev. Sci. Instr.*, vol. 17, pp. 533-536; December, 1946.)
- 539.16.08 1523  
A Universal Radiation Measurement Apparatus, Its Description, Operation and Possible Applications—R. Reiter. (*Zeit. Instrum. Kde*, vol. 64, pp. 105-121; April-June, 1944.) An instrument for use with counters, having a special capacitor arrangement suitable not only for single impulse-counting but for reading the relative values of large radiation quantities from galvanometer deflections. Various applications include the recording of the intensity characteristics of X-rays and of all kinds of corpuscular radiation.
- 550.837:621.39 1524  
The Development of Electrical and Radio Methods of Geophysical Prospecting—V. Fritsch. (*Radio Tech. (Vienna)* vol. 22, pp. 139-146; June-July, 1946.) A review of present-day direct-current audio- and high-frequency methods, with applications to ore, coal, and oil prospecting; water detection; investigation of building sites; and lightning protection.
- 621.317.39:531.768 1525  
Acceleration Measurement by Wireless Methods—G. Loewer. (*Zeit. Instrum. Kde*, vol. 64, pp. 30-46; January-March, 1944.)
- 621.317.7.082.78.085.31 1526  
Electronic Position Pickup—Moore. (See 1511.)
- 621.317.794:535.61-15 1527  
A Fast Superconducting Bolometer—D. H. Andrews, R. M. Milton, and W. DeSorbo. (*Jour. Opt. Soc. Amer.*, vol. 36, pp. 518-524; September, 1946.) For detection of infrared signals. A ribbon of CbN is used at an operating temperature of about 15 degrees Kelvin which can be maintained with the aid of liquid hydrogen and nitrogen for several hours. The primary response time is about  $5 \times 10^{-4}$  seconds at about 3000 cycles while the noise level is  $5 \times 10^{-4}$  microwatts. The apparatus has a secondary response time of  $5 \times 10^{-2}$  seconds at about 140 cycles.
- 621.318.572 1528  
Modern Geiger-Muller Counters—Graves. (See 1364.)
- 621.365 1529  
Electronic Heating—M. Doucerein. (*Bull. Soc. Franç. Élec.*, vol. 6, pp. 498-509; October, 1946.) Describes applications to the heat treatment of wood, rubber, and plastic materials. High-frequency heating should not in all cases be substituted for other methods when these are more economical.
- 621.365.5.029.5 1530  
High Frequency Induction Heating—E. May. (*Machinery (London)*, vol. 70, pp. 45-49 and 109-110; January 9, and 23, 1947.) Abstract of a paper read before the Institution of Production Engineers.
- 621.38:6 1531  
Industrial Electronics—H. A. Thomas. (*Elec. Times*, vol. 111, pp. 104-106; January 23, 1947.) Summary of Institution of Electrical Engineers paper and discussion.
- 621.38.001.8 1532  
The Application of Electronics—W. Wilson. (*Beama Jour.*, vol. 53, p. 440; December, 1946.) Discusses applications in both light and heavy engineering. Abstract of paper in *Machinery Lloyd*, vol. 18, pp. 37-43 and 37-47; October 19, and November 2, 1946.
- 621.38.001.8 1533  
Opinion Meter—(*Electronics*, vol. 20, p. 198; January, 1947.) To integrate the votes of large groups. Each voter sets a hand device connected to the meter, to the degree of positive or negative opinion he holds.
- 621.38.001.8:620.18 1534  
The "Talsurf" Surface Meter—(*Elec. Eng.*, vol. 18, p. 351; November, 1946.) A description of a stylus type of instrument manufactured by Taylor, Taylor, and Hobson for measuring the textures of surfaces. High magnifications of surface irregularities are produced electrically and displayed graphically.
- 621.383.001.8 1535  
Electronic Spectroscopy—G. C. Sziklai and A. C. Schroeder. (*Jour. Appl. Phys.*, vol. 17, pp. 763-767; October, 1946.) Double differentiation of the signal from a photocell, to which a saw-tooth voltage is applied, enables the spectral distribution of the light incident on the cell to be observed on a cathode-ray oscilloscope. The method is directly applicable to color matching.
- 621.383.001.8:614.715 1536  
Photoelectric Dust Meter—G. F. Barnett and A. L. Free. (*Electronics*, vol. 19, pp. 116-119; December, 1946.) A photocell in an illuminated air duct continuously measures the quantity of light reflected by dust particles passing through the system. Applications include testing and rating the efficiency of air-cleaning devices.
- 621.384.6+537.291 1537  
Resonance Acceleration of Charged Particles—E. M. McMillan. (*Phys. Rev.*, vol. 70, p. 800; November 1-15, 1946.) Discussion of phase stability leads to a simple solution of the problem of keeping the particles in step with the accelerating field for a very large number of cycles. Descriptions of the 500 millicoulomb volts synchrotron and the 184-inch synchrocyclotron now under construction at Berkeley will be given later, with a discussion of future possibilities, leading to the eventual attainment of the billion-volt range. Summary of American Physical Society paper.
- 621.384.6 1538  
Electron Radiation in High Energy Accelerators—J. Schwinger. (*Phys. Rev.*, vol. 70, pp. 798-799; November 1-15, 1946.) A discussion of the limitation to the attainment of very-high-energy electrons, in devices such as the betatron and synchrotron, due to the radiative energy loss accompanying the circular motion of the electrons. Summary of American Physical Society paper.
- 621.384.6 1539  
Development of Electron Accelerators—(*Electronics*, vol. 20, pp. 170, 184; January, 1947.) A brief description of the principles of operation of linear accelerators, cyclotrons, synchrotrons, and betatrons. Their limitations are explained. Medical applications are indicated.
- 621.384.6 1540  
Preliminary Studies on the Purdue Microwave Electron Accelerator—R. O. Haxby, E. S. Akeley, A. Ginzburg, R. N. Smith, H. W. Welch, and R. M. Whaley. (*Phys. Rev.*, vol. 70, pp. 797-798; November 1-15, 1946.) Summary of American Physical Society paper.
- 621.384.6 1541  
The Betatron—W. Bosley. (*Jour. Sci. Instr.*, vol. 23, pp. 277-283; December, 1946.) An historical account of its development and some details of particular instruments.
- 621.384.6 1542  
The Theory of the Synchrotron—D. Bohm and L. Foldy. (*Phys. Rev.*, vol. 70, pp. 249-258; September 1-15, 1946.)
- 621.384.6 1543  
Magnetic Fields due to Dee Structures in a Synchrotron—A. F. Clark. (*Phys. Rev.*, vol. 70, p. 444; September 1-15, 1946.) Method of measurement of the out-of-phase fields due to eddy current in the metal dee. Summary of American Physical Society paper.
- 621.385.833+537.533.72 1544  
Properties of Some Electrostatic Lenses—H. Druck and L. Romani. (*Cah. Phys. (Paris)*, no. 24, pp. 15-28; October, 1944, reprint.) The cardinal elements and the spherical and chromatic aberrations of a series of independent electrostatic lenses are determined from their constructional parameters. The term 'independent lens' is used to distinguish such lenses from immersion lenses. Study of the effect of diaphragms or near objects leads to some new results. All the results are obtained from experimental values of the potential measured in an electrolytic bath with sloping base.
- 621.385.833 1545  
Effect Limiting the Possibilities of the Electron Microscope—L. de Broglie. (*Compt. Rend. Acad. Sci. (Paris)*, vol. 222, pp. 1017-1019; April 29, 1946.) Movement of the object due to impacts from the irradiating source may result in reduced image sharpness, particularly when the source uses particles more massive than electrons. This effect is discussed.
- 621.385.833 1546  
Supplementary Bibliography of Electron Microscopy—M. E. Rathbun, M. J. Eastwood, and O. M. Arnold. (*Jour. Appl. Phys.*, vol. 17, pp. 759-762; October, 1946.) References not included in the list of Marton and Sass 1008 of 1946.
- 621.386.1 1547  
X-Ray Generators at 1000 and 2000 kV—J. Saget. (*Bull. Soc. Franç. Élec.*, vol. 6, pp. 476-479; August-September, 1946.)
- 621.386.1:620.179.1 1548  
Application of Recent X-Ray Inspection Equipment—J. J. Buch. (*Machinery (London)*, vol. 69, pp. 663-665; November 21, 1946.)
- 621.386.84 1549  
Radiography and Microradiography by Secondary Electrons—A. Saulnier and J. J. Trillat. (*Rev. Sci. (Paris)*, vol. 83, pp. 211-214; May, 1945.) Penetrating X-rays from a tube operated at 150 kilovolts or more are passed through a sheet of lead 0.2 millimeter

thick and the secondary emission from the lead is used to obtain radiograms of thin objects, such as butterfly wings, onion skin, etc., interposed between the lead and a sheet of photographic paper.

621.39:578.088.7 1550

Electroencephalographic Technique from an Engineer's Point of View—W. G. Egan. (PROC. I.R.E. AND WAVES AND ELECTRONS, vol. 34, pp. 1000-1004; December, 1946.) A general description of equipment and of a new type of electrode. Methods of improving calibration accuracy and recorder performance are suggested.

621.396.645:621.43.019.8 1551

Constant-Gain Knock Pickup Amplifier—R. P. Krebs and T. Dallas. (Electronics, vol. 20, pp. 87-89; January, 1947.) Cathode-follower input, special feedback circuit, and simplified phase-inverter stage provide flat frequency response from 8 to 20,000 cycles with a gain of 160,000 for portrayal of knock patterns of internal combustion engines on a cathode-ray oscilloscope.

621.396.932.078+621.396.664 1552  
Radio Controlled Buoys—Hopkins and Smith. (See 1454.)

621.43 1553

Improved Electronic Engine Indicator—A. H. B. Walker. (Engineering (London), vol. 162, pp. 361-364; October 18, 1946.)

621.791.3:621.365.5 1554

High-Speed Assembly of Radiators by Induction Soldering—(Machinery, vol. 53, pp. 166-167; December, 1946.)

623.454.25:621.396.9 1555

Radio Proximity-Fuze Development—W. S. Hinman, Jr., and C. Brunetti. (PROC. I.R.E. AND WAVES AND ELECTRONS, vol. 34, pp. 976-986; December, 1946.) A description of fuses for smooth-bore projectiles. The oscillating detector, amplifier, power supply unit, and safety arrangements are described in some detail, together with methods of production and testing.

## PROPAGATION OF WAVES

538.566 1556

The Propagation of Electromagnetic Waves in Two or More Successive Media and the Diffraction of These Waves Referred to the Study of Cauchy's Problems—Robin. (See 1413.)

621.396.11:523.746:551.510.535 1557

Effect of Sunspot Cycles on Long Distance Radio Signals—Stetson. (See 1420.)

621.396.11:551.510.535 1558

The Role of the Ionosphere in the Propagation of Radio Waves—Jouaust. (See 1447.)

621.396.41.029.64 1559

Calculation of Multiplex U.H.F. Radio-Telephony Links [100-5000 Mc/s]—H. Chireix. (Bull. Soc. Franç. Élec., vol. 6, pp. 415-424; August-September 1946.) In three parts. The first part discusses the effect of various types of aerial on received power for given power radiated, and the effect of aerial and receiver height using the height-gain formulas of Eckersley (1660 of 1937) and of van der Pol and Bremmer (3245 of 1937, 35 and 3102 of 1938). The second part is a discussion of the noise factor of various systems, single and multiplex, with various types of modulation, with and without relays. The ranges considered are of the order of 50 kilometers i.e., up to approximately optical range. In the third part long-distance communication is discussed for a range of 200 kilometers and the possibility of using various reflector systems as 'passive relays' is considered.

621.396.8.029.62 1560

The World Above 50 Mc—E. P. Tilton. (QST, vol. 31, pp. 50-54, 116; January, 1947.) Reports of amateur transmissions on frequencies of 50 megacycles and above with a special reference to the first transatlantic communication on 50 megacycles using F<sub>2</sub>-layer reflection.

621.396.812.029.56 1561

Short Skip on Five Metres—O. J. Russell. (Short Wave Mag., vol. 4, pp. 670-675; January, 1947.) Analysis of 5-meter propagation data suggests the presence of a short but persistent skip effect of 60 miles, possibly accounted for by a very low ionized layer at a height of 5 to 10 miles.

621.396.812+538.569.4]029.64:551.57 1562

Water Vapor Absorption of Electromagnetic Radiation in the Centimeter Wave-Length Range—G. E. Becker and S. H. Autler. (Phys. Rev., vol. 70, pp. 300-307; September 1-15, 1946.) An experimental investigation of absorption in water vapor in the region of the longest wavelength rotational absorption line, which has been shown to be centered at about 1.34 centimeters wavelength. The basis of the method is the determination of the Q of an 8-foot cubical copper cavity, maintained at 45 degrees centigrade, the air pressure being one atmosphere, and the partial pressure of water vapor being varied between 1 and 55 millimeters Hg. The absorption line is broadened as the water vapor density is increased. The wavelength range 0.7 to 1.7 centimeters was explored. The atmospheric attenuation of 1.34-centimeter waves is given as 0.025 decibel per kilometer for 1 gram of water vapor per cubic meter. A summary was given in 3719 of January.

621.396.812.029.74 1563

Research in England on the Propagation of Ultra-Short Waves—Bras. (Bull. Soc. Franç. Élec., vol. 6, pp. 480-495; August-September, 1946.) A review of the work already abstracted in 512 and 514 to 518 of March.

621.396.821:523.74 1564

Radio Effects Observed During the Period of Solar Activity from 31st Jan. to 14th Feb. 1946—R. Bureau. (Compt. Rend. Acad. Sci. (Paris), vol. 222, pp. 597-599; March 11, 1946.) Atmospherics were recorded on various wavelengths from 24,000 to 150 meters and field strengths of the Geneva station on 48.66 meters as a method of observing chromospheric activity. Sudden fade-outs of the decameter wave signal frequently coincided with sudden increases in intensities of atmospherics on 11,000 meters; 24,000-meter waves were less susceptible to disturbance. Disturbances of long duration on the decameter wavelengths indicate that solar activity is not limited to chromospheric eruptions.

## RECEPTION

621.315.6:621.396.822]+530.162 1565

The Response of Biased, Saturated Linear and Quadratic Rectifiers to Random Noise—D. Middleton. (Jour. Appl. Phys., vol. 17, pp. 778-801; October, 1946.) Rectification of broad-band and semi-broad-band noise gives roughly the same spectral distribution as that of the input, but narrow-band noise causes an infinite number of separate noise bands, centered about harmonics of the central frequency. Clipping of any sort always spreads the spectrum and reduces the output power. The behavior of linear and quadratic rectifiers is qualitatively similar in most cases. The powers in the direct current and continuous portions of the output spectrum are independent of the spectral shape of the incoming noise.

621.396.619.11/.13 1566  
Frequency and Amplitude Modulation—R.

Aschenbrenner. (Radio en France, no. 2, pp. 8-14; 1947.) A theoretical discussion of a method of comparison, with experimental verification. With no signal, background noise is worse in the frequency-modulation receiver. When signals are being received it practically disappears in the frequency-modulation receiver, but remains unchanged in the amplitude-modulation receiver. Reception of music was much better with the frequency-modulation receiver. Slide-band effects are also discussed.

621.396.62 1567

The Radio L.L. Synchrovox 645A Receiver—(Radio en France, no. 2, pp. 23-25; 1947.) Complete technical description with performance characteristics.

621.396.62 1568

Converting the BC-348-Q—P. M. Kersten. (QST, vol. 31, pp. 19-21, 104; January, 1947.) Modifications necessary to make a surplus receiver suitable for amateur use.

621.396.621.54 1569

Method of Plotting Tracking Error—E. B. Menzies. (Electronics, vol. 20, pp. 128-130; January, 1947.) A beat frequency method.

621.396.722(4) "1939/45" 1570

Radio Technique in Europe during the War: Part 2—H. Baumgartner. (Radio Tech. (Vienna), vol. 22, pp. 104-109; June-July, 1946.) An account of the general features of various German, Swedish, and Austrian broadcasting receivers, including small mains sets and portables, and a fuller description with circuit diagram of an Austrian supermidget mains set.

621.396.812:523.5 1571

On The Detection of Meteors by Radio—Manning, Helliwell, Villard, and Evans. (See 1417.)

621.396.822:621.383 1572

Calculated Frequency Spectrum of the Shot Noise from a Photo-Multiplier Tube—Sard. (See 1621.)

621.396.822:621.396.621.53 1573

Noise-Figure Reduction in Mixer Stages—M. J. O. Strutt. (PROC. I.R.E. AND WAVES AND ELECTRONS, vol. 34, pp. 942-950; December, 1946.) An analysis is given of random noise in mixer stages and its effect on proper circuit design and feedback. Conditions for optimum gain in a diode mixer stage are shown to be identical with those for minimum noise. Noise figures for triode and multigrid mixer stages are related to those of a comparable triode amplifier.

621.396.822:[621.396.694+621.396.615.142 1574

Shot Effect and the Receiving Sensitivity of Transit-Time Valves of Different Types—F. Lüdi. (Helv. Phys. Acta, vol. 19, pp. 355-374; September 21, 1946.) The fundamental Schottky equation is extended and applied to calculations of the receiving sensitivity, neglecting the noise of the input resistance and assuming half had received power to be available at that resistance. The calculations show that for all transit-time types of tube the equivalent input resistance, i.e., the tube noise, is much greater than the resistance noise. The results for the different types are summarized and compared with one another and with triode sensitivity. From this it appears that only heterodyne reception is capable of giving a satisfactory sensitivity for microwaves.

621.396.822.029.6:523 1575

Disturbances of Extraterrestrial Origin in the Short Wave Band—J. L. Steinberg and J. Denisse. (Rev. Sci. (Paris), vol. 84, pp. 293-294; September 15, 1946.) Historical survey of galactic and solar noise, from Jansky's observa-

tions in 1932 to the recent work of Reber, Southworth, Appleton, and Hey. Recent theoretical work on noise in tubes and aerials and from interstellar matter is briefly discussed.

621.396.828.1:621.394.141 1576  
Shorting Gate Noise Suppressor [for Morse Reception]—(Tele-Tech, vol. 6, p. 55; January, 1947.) With no signal incoming and set noise after amplification, limiting and rectification, are used to control a tone generator. The excess voltage due to the signal operates a gating circuit which cuts out the tone completely. The result is silence during the signal and a note of constant amplitude during spacing, which can be used for operating printers or automatic equipment. For another account see *Electronics*, vol. 20, p. 150; January, 1947.

#### STATIONS AND COMMUNICATION SYSTEMS

534.861 1577  
The Acoustic Problems of Broadcasting—Brailhard. (See 1307.)

621.395.44.029.62/.64 1578  
A Microwave Relay System—L. E. Thompson. (Proc. I.R.E. AND WAVES AND ELECTRONS, vol. 34, pp. 936-942; December, 1946.) The system is based on double frequency modulation in which the carrier is frequency modulated by a subcarrier, which is frequency of phase modulated by the intelligence. The signal-to-noise ratio and distortion in such a system are discussed and compared with those of a single frequency modulation system. An experimental two-way radio link is described in which double frequency modulation is used with carrier and subcarrier frequencies of about 3000 and 1 megacycle, respectively. The link consists of three sections, each about 30 miles long, and two frequency channels are used for the complete two-way circuit. At each relay station the transmitters in both directions are on the same channel frequency, the two receivers operating on the other channel frequency.

621.395.623.8 1579  
United Nations Broadcasting and Sound System—(See 1315.)

621.396.1 1580  
Planning the Amateur Bands—(Short Wave Mag., vol. 4, pp. 680-681; January, 1947.) A suggested division of each amateur band into continuous wave and telephone zones.

621.396.1 1581  
The Moscow Conference on Telecommunications—Loyen. (Onde Elec., vol. 26, pp. 479-480; December, 1946.) A short review of the objects and recommendations of the conference from September 28, to October 21, 1946. See also 871 of April.

621.396.41.029.64 1582  
Calculation of Multiplex U.H.F. Radio-Telephony Links [100-5000 Mc/s]—Chireix. (See 1559.)

621.396.619 1583  
Modern Modulation Systems—P. Güntinger. (Bull. Schweiz. Elektrotech. Ver., vol. 37, pp. 326-332; June 15, 1946, reprint, in German with French summary.) Systems requiring a wide frequency band, such as frequency modulation or pulse-time modulation, are discussed and various combined systems are tabulated.

621.396.619.11/.13 1584  
Frequency and Amplitude Modulation—Aschenbrenner. (See 1566.)

621.396.619.16 1585  
Pulse Technique—R. Lemas. (Télér. Franç., no. 9, pp. 14-17; January, 1946.) A

general description of various methods.

621.396.65 1586  
Considerations on Multiplex Links by Hertzian Cables [i.e., Radio Links]—J. Mailard. (Onde Elec., vol. 26, pp. 418-420; November, 1946.) A general discussion, from the economic point of view, of the relative merits of modulation and pulse systems for multiplex operation of radio links. It is concluded that pulse systems present definite advantages, since the economy of a multiplex radio link is determined much less by the performance of the link itself (i.e., signal-to-noise ratio, frequency band used) than by the cost of the accessory equipment.

621.396.65.029.64 1587  
The Principal Factors Affecting Radio-Multiplex Telecommunication Systems on Ultra-Short Waves—V. A. Altovskiy. (Onde Elec., vol. 26, pp. 401-417; November, 1946.) A detailed discussion of the problems involved in the design and setting up of multiplex radiotelephony links on wavelengths from 30 to about 1 centimeter including (a) the requirements of the service and criteria of quality, (b) choice of modulation, (c) choice of frequency, and (d) number of relay stations. Design details are given for a 200-channel telephony link to connect Paris and Lyons (about 300 miles), using a 6-centimeter wave and a 20-megacycle frequency-modulation band. Some particulars are also given of actual installations in the United States and France and of the number 10 equipment used during the war in Europe by the British army.

621.396.712 1588  
Status of Broadcasting Overseas—A. Huth. (Tele-Tech, vol. 6, pp. 56-58, 146; January, 1947.) Discusses the effect of the war on the transmitter and receiver situation in countries outside the United States.

621.396.931 1589  
Railroads Plan Greater Use of Radio for Communications—J. Peterson. (Tele-Tech, vol. 6, pp. 78-83, 153; January, 1947.) Discusses existing equipment and future developments.

621.396.931.029.62 1590  
Tests Confirm Efficiency of 72 Mc for Mobile Radio—G. H. Underhill. (Elec. World, vol. 127, pp. 48-51; February 1, 1947.) Field tests in a typical eastern mountainous area indicate that the performance of a 72-megacycle system is much better than would be expected from line-of-sight considerations. The Central Hudson Gas and Electricity Corporation is now installing a 75.66-megacycle system.

621.396.932:621.396.5 1591  
Multi-Channel Radiotelephone for Inland Waterways—G. G. Bradley. (Tele-Tech, vol. 6, pp. 74-77, 149; January, 1947.) The special problems of ship-to-shore radio-telephone communication on the Great Lakes are discussed and equipment recently designed for this service is described.

#### SUBSIDIARY APPARATUS

620.197.122 1592  
Pressure Sealing Zip Fastener—(Jour. Sci. Instr., vol. 22, p. 198; October, 1945.) The fastener is waterproof and prevents the escape of air or gases by means of overlapping rubber lips attached to each side of the line to be sealed.

621.314.6+621.319.4+621.383]:669.018 1593  
Light Alloys in Metal Rectifiers, Photocells, and Condensers—Continuing the series in *Light Metals* mentioned in 1226 of May and back references.  
(xvii) Vol. 9, pp. 9-21; January, 1946. Discusses the manufacture of fixed-paper capacitors, with particular reference to the properties,

handling, and processing of the aluminum foils employed.

(xviii) Vol. 9, pp. 144-151; March, 1946. The manufacture of fixed paper capacitors is further considered, with special reference to the manipulation of the foil and the impregnation of the paper. See also pages 163 to 166 of the same issue.

(xix) Vol. 9, pp. 215-220; April, 1946. Discusses the final stages in the production of fixed capacitors.

(xx) Vol. 9, pp. 231-235; May, 1946. Discusses the materials employed in the sealing and potting of fixed paper capacitors.

(xxi) Vol. 9, pp. 318-325; June, 1946. Practical considerations of the final production stages of capacitor manufacture.

621.314.63 1594  
Applications of Dry Rectifiers—Girard. (See 1469.)

621.316.722.078.3 1595  
Improvement of Various Arrangements for Voltage Stabilization—J. Benoit. (Compt. Rend. Acad. Sci. (Paris), vol. 217, pp. 597-599; December 13, 1943.) A bridge arrangement of resistors and accumulator batteries, with a neon stabilizing tube in one of the arms, is described. This gives much smaller voltage variations than the usual stabilovolt arrangements. Similar improvement is possible for any voltage stabilizer whose internal impedance is not negligible.

621.316.722.078.3:537.525.3 1596  
Characteristics of the Pre-Corona Discharge and Its Use as a Reference Potential in Voltage Stabilizers—S. C. Brown. (Rev. Sci. Instr., vol. 17, pp. 543-549; December, 1946.) Studied particularly in terms of current and voltage characteristics. The use of a diode to give a constant reference potential depends on the high sensitivity of current to changes in voltage. Factors to be considered in design are discussed. A summary was noted in 3578 of January.

621.522.4 1597  
Tests on a Metal Self-Fractionating Oil Diffusion Pump—H. Wachter and J. W. A. van der Scheer. (Zeit. Tech. Phys., vol. 24, nos. 10-12, pp. 287-291; 1943.) An account of tests on an American pump, MF 250, made by Distillation Products, Rochester, New York. The pump is of relatively small dimensions, has a speed of about 250 liters per second and with a rotary backing pump will reach a pressure of  $6 \times 10^{-7}$  tor.

#### TELEVISION AND PHOTOTELEGRAPHY

621.397.262 1598  
Television System with Mixed Amplitude and Frequency Modulation, for the Transmission on a Single Carrier Wave of the Video, Synchronizing and Audio Signals—M. Chauvière. (Radio en France, no. 4, pp. 38-44; 1945.) Successive modulation in amplitude and in frequency of the carrier wave gives two independent channels for video and synchronism signals. Line synchronism corresponds to a frequency variation in one sense with respect to the carrier and image synchronism to a frequency variation in the opposite sense, so that a phase inversion followed by a limiter gives absolute separation of the two synchronizing signals. Application of audio-frequency modulation gives a complete television system on a single carrier wave; such a system has been realized in practice with a transmitter of several watts.

621.397.262 1599  
Television System with Single Carrier Wave and Frequency and Amplitude Modulation—F. Vaglio. (Radio en France, no. 4, pp. 46-47; 1945.) Proposes a television system with simultaneous amplitude and frequency modulation of a single carrier wave.



- 621.397.3.012.3 1600  
Vertical and Horizontal Definition in Television Systems—J. A. Widemann. (*Télév. Franç.*, no. 8, pp. 2-4; December, 1945.) An abac is given from which the two definitions can be found for any system of television, given the number of lines and of images and the cut-off frequency.
- 621.397.331 1601  
Considerations on the Bedford Velocity-Modulation Television System—P. J. Freulon. (*Télév. Franç.*, no. 8, p. 11; December, 1945.) For original paper of Bedford and Puckle see 1934 abstracts, p. 506.
- 621.397.5 1602  
Two Systems of Color Television—D. G. Fink. (*Electronics*, vol. 20, pp. 72-77; January, 1947.) A general discussion on the relative merits of the sequential and simultaneous systems. Both provide good fidelity of color transmission without flicker if bandwidth, frame frequency, etc., are suitably chosen. As simultaneous color transmission can be reproduced in black-and-white by existing receivers, the transition to color television will be easier on this system. For examples of each system see 2051 and 2363 of 1946 and 1240 of May.
- 621.397.5:537.291 1603  
Theory of the Electric Deflexion of Electron Beams—J. Piclit and J. Himpan. (*Elektrotech. Zeit.*, vol. 65, pp. 196-197; May 17, 1944.) Summary of a paper abstracted in 3091 of 1941.
- 621.397.5:621.391.63 1604  
TV [Television] on Modulated Light-Beam—(*Tele-Tech*, vol. 6, pp. 96, 98; January, 1947.) Describes the transmission of video signals over short distances by means of a light-beam carrier system employing a cathode-ray tube as the modulated light source and a multiplier-type photocell receiver.
- 621.397.5:621.396.67 1605  
Line-of-Sight Aerials [Antennes de Vision]—Tabard. (See 1339.)
- 621.397.61 1606  
Television Transmission Centre Paris—H. Delaby. (*Télév. Franç.*, no. 11, pp. 4-8; March, 1946.) A general account of the present Eiffel Tower equipment, with proposed extensions to relay stations.
- 621.396.615.17:621.316.729:621.397.5 1607  
A Simplified Generator for Synchronizing Signals—(*Radio en France*, no. 2, pp. 39-42; 1947.) Circuit and constructional details of simple and comparatively inexpensive equipment.
- 621.397.62 1608  
The Main Types of Faults in a Television Receiver—R. Aschen. (*Télév. Franç.*, nos. 9 and 10, pp. 4-5, 21 and 6; January and February, 1946.)
- 621.397.62 1609  
Large Television Screens and Their Evolution—Hemadinquer. (*Télév. Franç.*, no. 11, pp. 17-18, 27, March, 1946.) Outlines the development of large-surface multicell screens.
- 621.397.62 1610  
Television for Today: Part 7—Video Detector Circuits—M. S. Kiver. (*Radio Craft*, vol. 18, pp. 29, 61; December, 1946.) Discusses full-wave detection circuits, the use of peaking coil filters and polarity.
- 621.397.62 1611  
Pye [Television] Receiver Type B16T—(*Radio en France*, no. 2, pp. 43-48; 1947.) A general description, with circuit details.
- 621.397.62 1612  
Carrier-Difference Reception of Television Sound—R. B. Dome. (*Electronics*, vol. 20, pp. 102-105; January, 1947.) Use of a common intermediate-frequency amplifier for video and sound signals eliminates the effects of local oscillator hum and frequency drift. The over-all intermediate-frequency bandwidth is greater than the carrier difference frequency, and by the use of absorption trap circuits, the sound intermediate-frequency level is kept below the minimum level expected from the picture carrier. The two signals are then separated. A receiver incorporating this system is reliable in performance, and costs are reduced.
- 621.397.62:621.317.79 1613  
Television Synchronizing Signal Generating Units: Part 1—Batcher. (See 1517.)
- TRANSMISSION
- 621.316.726.078.3:621.396.619.13 1614  
Carrier Stabilization in Frequency-Modulated Transmitters—G. Guanella. (*Brown Boveri Mill.*, vol. 33, pp. 193-197; August, 1946.) Several automatic control methods are briefly described, with block diagrams. (a) An alternating voltage of lower frequency is derived by heterodyning with a stable reference frequency and is used for control through a frequency discriminator. (b) Modulation of a stable two-phase voltage by a fraction of the carrier voltage gives a rotating field which is used for retuning. (c) Modulation of a two-phase voltage, with differentiating and heterodyning, gives a control voltage proportional to frequency error. (d) The carrier frequency is compared directly with a suitable harmonic of a reference oscillator.
- 621.394.61 1615  
New 10-kW Transmitter for Telegraphy—E. Guyer and M. Favre. (*Brown Boveri Mill.*, vol. 33, pp. 175-178; August, 1946.) The frequency range is 5.5 to 21 megacycles with stability to one part in  $10^5$ . The transmitter is designed for 3-phase 230/380 volts 50-cycle supply and is capable of 450 words per minute. A modulator attachment permits use for telephony.
- 621.396.61:621.394/.395].61 1616  
Modern 1-kW Transmitter—E. Meili. (*Brown Boveri Mill.*, vol. 33, pp. 172-174; August, 1946.) A description, with illustrations, of a short-wave transmitter for wavelengths of 12.8 to 90 meters and adaptable for either telephony or telegraphy. A Franklin oscillator with quartz control gives frequency stability of  $\pm 2 \times 10^{-6}$ .
- 621.396.61:621.396.619.13 1617  
Engineering a 250 Watt BC Transmitter for F.M.—L. C. Killian and F. Hilton. (*Tele-Tech*, vol. 6, pp. 68-70; January, 1947.) Using the cascade phase shift system.
- 621.396.61.029.54/.58 1618  
The R.A.F. T. 1154 Transmitter—(*Short Wave Mag.*, vol. 4, pp. 499-501; October, 1946.) A brief description of a 100 watt telegraph and telephone aircraft transmitter with three frequency ranges: 200 to 500 kilocycles, 3.0 to 5.5 megacycles, and 5.5 to 10 megacycles.
- 621.396.61.029.58 1619  
A 7 14-Mc/s Transmitter—(*Short Wave Mag.*, vol. 4, pp. 481-483; October, 1946.) General description and performance of a 70-watt amateur transmitter. See also *Short Wave Mag.*, vol. 4, pp. 312-313; July, 1946.
- 621.396.61.029.58 1620  
Five-Band 25-Watt Transmitter—B. Raddell. (*Short Wave Mag.*, vol. 4, pp. 664-669; January, 1947.) A combination of crystal oscillator and power amplifier which can be used either as a low-power transmitter or as an efficient exciter for a high-power radio-frequency amplifier. Data are included for operation on wavebands from 1.7 to 28 megacycles.
- 621.396.61.029.63 1621  
Decimetre-Wave Transmitter Giving 50-W Aerial Power—R. Schweizer. (*Brown Boveri Mill.*, vol. 33, p. 222; August, 1946.) A general description, with photographs but no operational details, of a transmitter, with stabilized anode and heater voltages, suitable for field-strength measurements.
- 621.396.61.029.64 1622  
Projectors of Centimetre Waves—H. Gutton. (*Onde Élec.*, vol. 26, pp. 459-466; December, 1946.) Calculation of the radiation from projectors is based on Huyghens' principle. Three types of projectors are discussed: electro-magnetic horns, reflectors, and dielectric aerials as used by the Germans during the war.
- 621.396.615.14 1623  
Ring Oscillators for U.H.F. Transmission—T. Gootée. (*Radio News*, vol. 37, pp. 48-50, 122; January, 1947.) An even number of 4 or more triodes of the same type are arranged in a ring and tuned by resonant lines to obtain greatly increased power output, 16 triodes giving about 8 times that of a pair in push-pull.
- 621.396.619.13:621.396.712 1624  
New F.M. Broadcast Transmitters—(*Bell Lab. Rec.*, vol. 25, pp. 20-23; January, 1947.) Three transmitters are illustrated and briefly described, rated at 1, 3, and 10 kilowatts, respectively. The last two consist of the 1-kilowatt unit, together with power amplifiers. A frequency synchronization system is employed to control the carrier frequency.
- 621.396.619.23 1625  
Overmodulation without Sideband Splatter—O. G. Villard, Jr. (*Electronics*, vol. 20, pp. 90-95; January, 1947.) Full circuit details of a balanced modulator for incorporation in an amplitude-modulation phone transmitter, to produce modulation in excess of 100 per cent without causing adjacent channel interference.
- VACUUM TUBES AND THERMIONICS
- 537.291+538.691 1626  
The Paths of Ions and Electrons in Non-Uniform Crossed Electric and Magnetic Fields—N. D. Coggeshall. (*Phys. Rev.*, vol. 70, pp. 270-280; September 1-15, 1946.) The force equations for a charged particle moving in such fields can be integrated by a very simple procedure under certain conditions. These conditions are satisfied when motion takes place in a median plane symmetrically situated relative to magnetic pole faces and electrostatic electrodes. Numerical integration can be used when the analytical difficulties are too great, or when the fields are only known empirically. A summary was noted in 3882 of 1945.
- 537.291:621.396.615.142 1627  
Theory of Small Signal Bunching in a Parallel Electron Beam of Rectangular Cross Section—E. Feenberg and D. Feldman. (*Jour. Appl. Phys.*, vol. 17, pp. 1025-1037; December, 1946.) The non-uniform distribution of charge in the bunched beam gives rise to a field which opposes the bunching process so that a kinematic solution may be validly applied only for a limited length of the drift space. An accurate solution of the bunching process requires the integration of the dynamical and field equations which, for 'small-signal' conditions, reduce to a linear homogeneous system. Solutions are obtained which are classified as non-solenoidal or solenoidal according as the motion produces or does not produce a high-frequency charge density within the beam. The physical problem is solved by taking a suitable linear combination of both solutions, a large part of the solution for practical conditions being of the solenoidal type.
- 621.383:621.396.822 1628  
Calculated Frequency Spectrum of the Shot

- Noise from a Photo-Multiplier Tube—R. D. Sard. (*Jour. Appl. Phys.*, vol. 17, pp. 768-777; October, 1946.) A general expression for the power spectrum of the shot noise produced by a secondary-emission multiplier tube is applied to the Radio Corporation of America 931 family. It is deduced that the noise intensity should be constant from zero up to about 100 megacycles, begin to fall off appreciably between 100 and 1000 megacycles, and become very weak at higher frequencies.
- 621.385 1629  
Beam Production in Radial Beam Tubes, Beam Power Tubes, and Other Low Voltage Electronic Devices—A. M. Skellett. (*Rev. Mod. Phys.*, vol. 18, pp. 379-383; July, 1946.) In the magnetic-focus radial-beam tube, the beam is focused entirely by an external magnetic field of between 50 and 250 gauss and in the power tube by the action of the grid wires. Other tubes operating at 300 volts or less include the "magic eye" tuning indicator and the orthicon pickup tube in television systems.
- 621.385:621.317.329:518.6 1630  
Electrostatic Field Plotting—Balachowsky. (See 1495.)
- 621.385:621.317.7 1631  
Portable Precision Valve Tester—Haas. (See 1509.)
- 621.385.1.032.1.011.2 1632  
Impedance of Gasfilled Tubes Traversed by a High-Frequency Discharge—P. Mesnage. (*Compt. Rend. Acad. Sci. (Paris)*, vol. 219, pp. 55-56; July 10, 1944.) Measurements were made with the tubes placed axially in inductance coils tuned to the frequency in use. Two types of discharge were found. In one the resistance is sensibly independent of the exciting field; in the other the resistance is a decreasing function of the field. The imaginary part of the impedance may have either sign and is equivalent to a capacitance for gases and to an inductance, decreasing with increasing field, for metallic vapors.
- 621.385.18.029.64 1633  
Physical Processes in the Recovery of TR Tubes—H. Margenau, F. L. McMillan, Jr., I. H. Dearnley, C. S. Pearsall, and C. C. Montgomery. (*Phys. Rev.*, vol. 70, pp. 349-357; September 1-15, 1946.) Techniques are described for the measurement of the time of elimination of ions on termination of the discharge in TR tubes. The capture of electrons by gas molecules is found to be the principal factor in recovery.
- 621.385.3 1634  
Development of a Water-Cooled Transmitting Triode of 50-kW Anode Dissipation—F. Jenny. (*Brown Boveri Mitt.*, vol. 33, pp. 211-214; August, 1946.) The cathode consists of 12 tungsten wires, arranged for single-, three- or six-phase alternating-current heating. The anode is of special electrolytic copper. Details of evacuation, test procedure and results are described.
- 621.385.3.029.63 1635  
A Medium-Power Triode for 600 Megacycles—S. Frankel, J. J. Glauber, and J. P. Walenstein. (*Proc. I.R.E. and Waves and Electrons*, vol. 34, pp. 986-991; December, 1946.) An account of an air-cooled triode for delivering 25 kilowatts peak pulse power at 600 megacycles and of a water-cooled version for generating continuous waves giving up to 500 kilowatts at the same frequency.
- 621.385.3.032.2:621.317.33 1636  
Inter-Electrode Capacitances of Triode Valves and Their Dependence on the Operating Condition—Mitra and Khastgir. (See 1501.)
- 621.385.38 1637  
The New Thyatron, Sub-Miniature Type RK61 "Raytheon" and Its Applications—(*Radio en France*, no. 2, p. 7; 1947.) Characteristics of a tube about 8 millimeters in diameter and 40 millimeters long.
- 621.385.38:537.525.6 1638  
Initiation of Discharge in Arcs of the Thyatron Type—C. J. Mullin. (*Phys. Rev.*, vol. 70, pp. 401-405; September 1-15, 1946.) From an equation derived for the anode current as a function of time during the initiation of the discharge, estimates of ionization time can be made which are of the correct order of magnitude.
- 621.385.4.029.6 1639  
Resonator May Aid Radio—(*Sci. News Letter*, vol. 51, p. 67; February 1, 1947.) The resonator, used largely during the war for jamming on frequencies between 350 and 600 megacycles will give 140 kilowatts at 450 megacycles. Its special features are briefly described. See also 1732 of 1946, and 3822 of January.
- 621.385.832 1640  
A Cathode-Ray Tube for Viewing Continuous Patterns—J. B. Johnson. (*Jour. Appl. Phys.*, vol. 17, pp. 891-900; November, 1946.) "A cathode-ray tube is described in which the screen of persistent phosphor is laid on a cylindrical portion of the glass. A stationary magnetic field bends the electron beam on to the screen, while rotation of the tube produces the time axis. When the beam is deflected and modulated, a continuous pattern may be viewed on the screen."
- 621.396.615.141.2+621.385.16 1641  
Energy Build-Up in Magnetrons—L. P. Hunter. (*Jour. Appl. Phys.*, vol. 17, pp. 833-843; October, 1946.) An analysis neglecting the mechanism of conversion of the direct-current input into the radio-frequency output power. The magnetron is represented by its equivalent circuit. The law of build-up is derived from energy considerations and the dependence of starting time on load calculated. "The starting time is affected slightly by the initial noise level and becomes infinite below a minimum  $Q$ . For high  $Q$  values the starting time can be varied only by changing the energy stored in the line." A summary was noted in 291 of February.
- 621.396.615.141.2 1642  
Self-Regulating Field Excitation for Magnetrons—H. C. Early and H. W. Welch. (*Electronics*, vol. 20, pp. 184, 188; January, 1947.) Stable magnetron operation is obtained by causing the anode current to excite the magnetic field.
- 621.396.615.141.2 1643  
Background Noise and Audio Frequency Oscillations in Magnetrons—E. Selzer. (*Compt. Rend. Acad. Sci. (Paris)*, vol. 218, pp. 589-591; April 3, 1944.) Background noise is reduced considerably by accurate adjustment of parallelism of the field and the anode axis, but is not completely eliminated. Numerous bands of audio-frequency oscillations have been observed. Displacement of the operating point along the characteristic produces a continuous change of the frequency of these bands which is increased by increase of the applied magnetic field. These results are discussed.
- 621.396.615.141.2 1644  
Construction of Magnetrons of Great Symmetry and with Anodes Not Split. Study of their Static Properties—E. Selzer. (*Compt. Rend. Acad. Sci. (Paris)*, vol. 218, pp. 499-501; March 20, 1944.) Anodes of large diameter, about 9 centimeters, are turned from solid copper and sealed to two glass domes carrying the cathode system. Results of experiments with such magnetrons are discussed.
- 621.396.615.142 1645  
From Transit-Time Effect to Transit-Time Valves: Parts 1 and 2—L. Ratheiser. (*Radio Tech. (Vienna)*, vol. 22, pp. 189-196 and 283-292; August-September, and October, 1946.) Simple explanations are given of transit-time effects and the interaction between electrons and alternating-current fields. The development of modern ultra-high-frequency tubes is traced from Barkhausen-Kurz retarding-field types to velocity-modulation tubes. To be continued.
- 621.396.615.142:537.291 1646  
[Electron] Bunching in Velocity-Modulation Valves—J. Vogt. (*Compt. Rend. Acad. Sci. (Paris)*, vol. 223, pp. 25-27; July 1, 1946.) A general treatment, taking into account electronic fields and showing one case where these fields do not modify the law of bunching obtained by neglecting them.
- 621.396.615.142.2 1647  
Theory of Single-Circuit Clystrons—S. Gvosdover and V. Lopukhin. (*Jour. Phys. (U.S.S.R.)*, vol. 10, no. 3, pp. 275-284; 1946.) The mathematical solution of the interaction of an electron beam and the field of a cavity resonator is given. The amplitude and frequency of the resulting oscillations are determined in terms of the size and shape of the cavity and of the applied potentials. The small effects of the space charge are taken into account. The theory is applied to the single-resonator klystron or monotron.
- 621.396.615.142.2 1648  
Mechanical Klystron for Demonstration—(*Electronics*, vol. 20, pp. 138, 142; January, 1947.) A rocking motion imparted to a water jet causes bunching of the water droplets similar to electron bunching in the klystron.
- 621.396.694.011.3 1649  
Study of Electronic Reactance-Variation Devices—Mazel. (See 1391.)
- 621.396.822:[621.396.694+621.396.615.142 1650  
Shot Effect and the Receiving Sensitivity of Transit-Time Valves of Different Types—Lüdi. (See 1574.)

## MISCELLANEOUS

001.891(94) 1651  
Scientific Research in Australia—(*Engineering (London)*, vol. 163, pp. 5-6, 42-43, 53-54, and 89-90; January 24, 1947.) The nineteenth annual report of the Council for Scientific and Industrial Research, covering a wide range of engineering and allied subjects, including for the first time the work of the Radio-physics Division.

001.98 1652  
The False Preconceived Notion—W. Burridge. (*Brit. Med. Jour.*, no. 4474, p. 516; October 5, 1946.) A letter suggesting that in the assessment of conflicting but apparently equally valid hypotheses, the element to reject is that on which all are in agreement, since this is likely to be the false preconceived notion which has engendered the contradictory conclusions.

016.05 1653  
Word List of Scientific Periodicals—(*Nature (London)*, vol. 158, p. 785; November 30, 1946.) The third edition, to include all scientific and technical periodicals that appeared during the period from 1900 to 1947, is in preparation.

061.6 1654  
The British National Physical Laboratory—H. Buckley. (*Sci. Mon.*, vol. 64, pp. 50-52; January, 1947.) A general account of the organization and functions of the Laboratory. The importance of the association with industry is stressed.



MODEL 106-PA

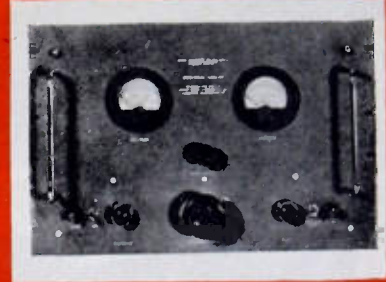

MODEL 206-PA

## Regulated Power Supplies

### MODEL 106-PA

**Characteristics:**

D.C. Voltage Range . . . 200-300V., 140 Ma.  
 A.C. Fil. Power . . . . (2) 6.3V., 5 amps.  
 Ripple Content . . . . . 1/10 of 1%  
 A.C. Input . . . . . 115V., 50/60 cycles  
 Size . . . . . 5" x 19" x 9" deep

Output remains constant within 1%, even though line voltage varies between 95—130 volts. Price \$225 (f. a. b. Cambridge, Mass.)

### MODEL 207-PA

**Characteristics:**

D.C. Voltage Range . . . 0-3500V., 1 amp.  
                                   positive or negative  
                                   grounding  
 A.C. Input . . . . . 220V., 50/60 cycles  
                                   (Variac Control)  
 Overload Relay . . . . . Adj. 0.6—1 amp.  
 Size . . . . . 26 1/8" x 32" x 36" deep

Meters on front panel indicate line voltage, output voltage, and output current.

Power supply is mounted on casters for portability. Access doors provided with interlock safety switches.

### MODEL 206-PA

**Characteristics:**

D.C. Voltage Range . . . 500-700V., 250 Ma.  
                                   700-1000V., 200 Ma.  
 Ripple Content . . . . . .05 of 1%  
 A.C. Input . . . . . 115V., 50/60 cycles  
 Size . . . . . 12 1/4" x 19" x 13" deep

Output is constant from no load to full load of each range within 1%.

Interlocking relay protection at all voltages insures safe operation. Time delay for high voltage circuit applications prevents tube damage. Price \$490 (f. o. b. Cambridge, Mass.)

### MODEL 306-PA

**Characteristics:**

D.C. Voltage Range . . . 300-750V., 30 Ma.  
                                   750-1800V., 30 Ma.  
                                   1800-3600V., 30Ma.  
 Ripple Content . . . . . 300-750V., 0.01%  
                                   750-1800V. } 0.1%  
                                   1800-3600V. }  
 A.C. Input . . . . . 115V., 50/60 cycles  
 Size . . . . . 17 1/2" x 19" x 13" deep

Regulation control is provided for adjustment to perfect load regulation, or to provide over-regulation, if desired.

Safety devices are incorporated to protect operating personnel. Meters indicate line voltage, output voltage, and output current.

## For Every Purpose



MODEL 207-PA



MODEL 306-PA

**HARVEY RADIO LABORATORIES, INC.**

**456 CONCORD AVENUE • CAMBRIDGE 38, MASSACHUSETTS**





BROADCASTERS—

*Simplify*

YOUR PROGRAM SWITCHING

... TO THE MOVEMENT OF A SINGLE KEY:

**E**VEN your most complicated program switching operations are reduced to the simple operation of *one* key—when you use Western Electric's new Relay Type Program Dispatching System. It speeds up the switching involved in serving several destinations with rapidly interchanged studio, line and transcribed programs, auditions and announcements—yet reduces operating errors.

Check these features against your operating requirements:

1. Provides simple, fool-proof method of pre-setting the next scheduled program condition—*leisurely*—while the present program is "on the air."
2. Operation of a single key, instantaneously switches from the program "on the air" to the pre-set condition.
3. This one-key switching operation can be controlled from either the Master Panel or any selected control booth.
4. During light load periods, control of selected lines may be extended to any studio control booth.
5. "On Air" and pre-set circuit conditions—including point of release control—are positively indicated by lamps at all control points.
6. Any or all programs may be interrupted instantly for "flash booth" announcements without upsetting the existing studio circuit conditions.
7. System may be engineered and furnished to meet your *individual* operating requirements—regardless of number of program sources or outgoing lines.

For further details, call your local Graybar Broadcast Representative or write Graybar Electric Co., 420 Lexington Avenue, New York 17, N. Y.



Distributed by  
**Graybar**  
OFFICES IN 92 PRINCIPAL CITIES

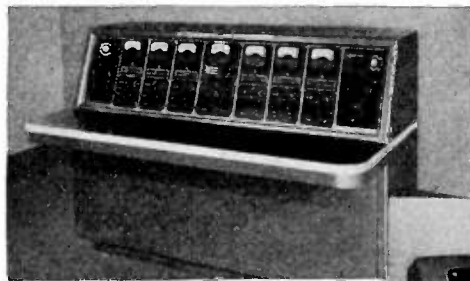

● Six-line Master Control Panel for Western Electric Relay Type Program Dispatching System.

● Below—Flash Booth Indicator Panel (at left) and Control Signal Indicator Panel (at right).

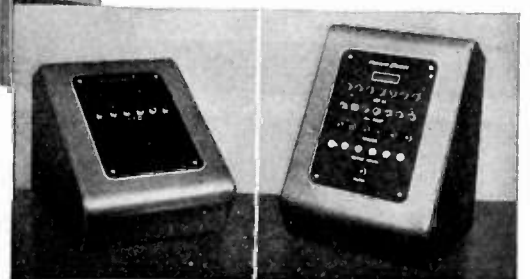

**Western Electric**  
— QUALITY COUNTS —





**ATLANTA**

"Development of a Folded Dipole Turnstile Antenna for Frequency-Modulation Broadcasting," by R. E. Honer, Georgia School of Technology; March 21, 1947.

**BOSTON**

"Transducers for Use with Cathode-Ray Oscillographs," by E. G. Nichols, Allen B. DuMont Laboratories; April 24, 1947.

**BUFFALO-NIAGARA**

"Modern Cathode-Ray Tubes," by W. A. Dickinson, Sylvania Electric Products, Inc.; April 16, 1947.

**CEDAR RAPIDS**

"New Developments in Magnetic Recording," by J. S. Kemp and H. Barnett, Armour Research Foundation; April 15, 1947.

**CHICAGO**

"Applications of High-Frequency Dielectric Heating in the Woodworking Industry," by E. R. Bell, Forest Products Laboratory, United States Department of Agriculture; February 21, 1947.

"Transmission Lines," by C. R. Cox, Andrew Company; February 21, 1947.

"Direct-View Television," by A. Wright, RCA Victor Company; March 21, 1947.

"Projection Television," by E. L. Clark, RCA Victor Company; March 21, 1947.

**CINCINNATI**

"Reduction of Background Noise in Reproduction of Recorded Music," by H. H. Scott, Technology Instrument Corporation; April 15, 1947.

**COLUMBUS**

"Wire and Tape Recording Devices," by T. E. Lynch, Brush Development Company; April 11, 1947.

**DALLAS-Ft. WORTH**

"M1 Carrier Telephone System for Rural Service," by A. D. Colvin, Southwestern Bell Telephone Company; March 27, 1947.

**DAYTON**

"The Remote Control of Aircraft by Means of Radio," by P. Murray, Systems Engineering Laboratory; Wright Field; April 10, 1947.

**HOUSTON**

"Intermediate-Frequency and Detector Systems for Frequency-Modulation Receivers," by C. V. Clarke, Jr., Radio Station KXYZ; April 15, 1947.

**INDIANAPOLIS**

"Very-High-Frequency and Ultra-High-Frequency Antenna Design," by A. G. Kandoian, Federal Telecommunications Laboratories; April 25, 1947.

**LONDON, ONT.**

"Measurements at Ultra-High Frequencies," by W. R. Thurston, General Radio Company; April 8, 1947.

Student Night; April 25, 1947.

**LOS ANGELES**

"An Analysis of Intermodulation Measurements," by W. R. Hewlett, Hewlett-Packard Company; April 15, 1947.

**MONTREAL**

"Ultra-High-Frequency Measurements," by W. R. Thurston, General Radio Company; April 9, 1947.

"Microwave Techniques," by A. D. Watson, McGill University; April 23, 1947.

**OTTAWA**

"Ultra-High-Frequency Measurements," by W. R. Thurston, General Radio Company; April 3, 1947.

"Guided Missiles," by A. E. Wickson, Defense Research Board; April 24, 1947.

Election of Officers; April 24, 1947.

(continued on page 36A)

# ANDREW

## Semi-Flexible COAXIAL CABLE

BETTER ON 3 COUNTS

✓ LOWER loss than plastic 30% to 50% less loss than in plastic cables of same diameter.

✓ GREATER power capacity Insulation does not melt or soften... develops less heat than plastic cables.

✓ LONGER lasting Andrew cables are made entirely of copper and stone, two materials which have unlimited life and which impart the greatest resistance to crushing, corrosion and weathering.

**ANDREW "FIRSTS"** Here's proof of Andrew Leadership in the development of semi-flexible coaxial cables: 1) First to produce  $\frac{3}{8}$  and  $\frac{7}{8}$  inch soft temper cables in 100 foot lengths... 2) First to offer continuous coils of unlimited length with factory splicing... 3) First to offer lines shipped under pressure with all fittings attached.

Such continued leadership enables Andrew to offer better semi-flexible coaxial cables; cables that are better than those made from any other materials.

A complete line of coaxial cables, accessories, and other antenna equipment is produced by Andrew.

## ANDREW CO.

363 E. 75th ST. • CHICAGO 19, ILL.

Pioneer Specialists in the Manufacture of a Complete Line of Antenna Equipment

These are the famous Andrew semi-flexible coaxial cables in  $\frac{3}{8}$  and  $\frac{7}{8}$  inch diameters (shown in actual size). Because of their better construction and design they are used throughout the world by thousands of broadcast, police, government, and military radio stations as the most efficient device for connecting antenna to transmitter or receiver.

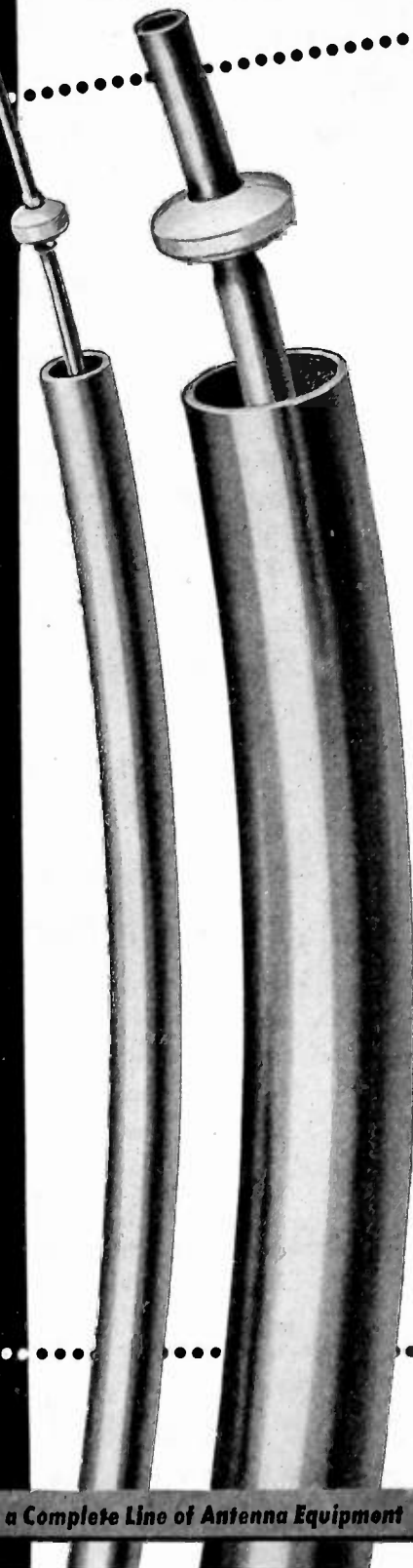



(Continued from page 35A)

#### PHILADELPHIA

"Strotovision," by C. E. Nobles, Westinghouse Electric Corporation; April 3, 1947.

#### PORTLAND

"Electron Microscope, Its Principles and Applications," by N. C. Banca, Scientific Instruments Division, Radio Corporation of America; April 1, 1947.

"Report on I.R.E. National Convention," by T. Ely, Station KEX; April 4, 1947.

"A Method of Measuring the Sound-Absorbing Properties of Acoustic Materials," by E. R. Lind, Graduate Student in Electrical Engineering, Oregon State College; April 12, 1947.

"The Geiger Counter and its Industrial Applications," by S. G. Forbes, Graduate Student in Physics, Oregon State College; April 12, 1947.

"Propagation in the Assigned Frequency-Modulation Bands," by C. R. Matheny, Senior in Electrical Engineering, and C. K. Shanks, Graduate Student in Electrical Engineering, Oregon State College; April 12, 1947.

#### ROCHESTER

"An Infrared Image Tube and Its Applications," by L. E. Flory, Radio Corporation of America Laboratories; April 17, 1947.

#### SACRAMENTO

"Design Problems in Radio Receivers," by L. Bourget, Industrial Electronic Consultant; March 18, 1947.

"Railroad Radio," by B. L. Clark and J. H. Landells, Westinghouse Electric Corporation; April 16, 1947.

#### SAN DIEGO

"The Latest Developments in Mobile Communication Systems," by S. Freedman, United States Navy Electronics Laboratory; April 1, 1947.

"Continuation of Discussion of Audio-Distortion Measurements by the Two-Tone Intermodulation Method," by J. R. McGaughey, United States Navy Electronics Laboratory; April 18, 1947.

#### SYRACUSE

"Analysis of the Operations of the Institute from the Membership and Financial Angles," by W. R. G. Baker, President of The Institute of Radio Engineers; April 3, 1947.

#### TORONTO

"Ultra-High-Frequency Measurements," by W. R. Thurston, General Radio Company; April 7, 1947.

"Ontario Provincial Police Radio System," by J. E. Reid, University of Toronto; April 28, 1947.

#### WASHINGTON

"Theory of Program Guardian Device," by W. M. Jurek, C. C. Langevin Company; April 14, 1947.

#### SUB-SECTIONS

##### FORT WAYNE

"Sea Power in The Pacific," (Sound Film); January 13, 1947.

"Some Aspects of Radar Engineering," by L. F. Millet, Farnsworth Television and Radio Company; February 10, 1947.

"Some New Developments in the Electronics Field," by E. D. Cook, General Electric Company; April 14, 1947.

Installation of Officers; April 14, 1947.

##### HAMILTON

"Industrial Electrochemical Rectifiers," by J. T. Thwaites, Canadian Westinghouse Company; March 10, 1947.

"German Radio and Electrical Equipment," by C. G. Lloyd, Canadian General Electric Company; April 14, 1947.

##### PRINCETON

"Recent Developments in Electromagnetic Recording," by S. J. Begun, Brush Development Company; April 11, 1947.

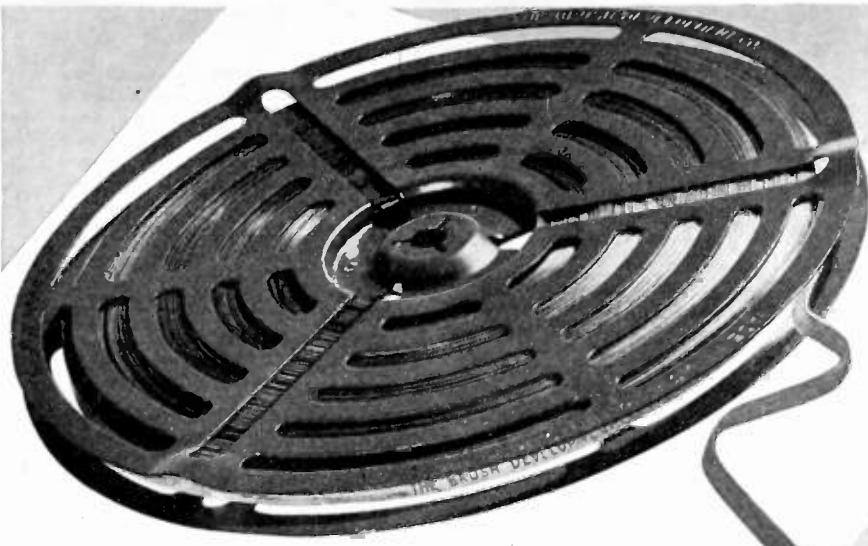

## Offer low-cost Magnetic Recording ...Design for Brush Paper Tape

No matter what type of magnetic recorder you design, the low cost, excellent fidelity and uniformity of Brush Paper Tape make it your best all-round recording medium. With this new development by the pioneer and leader in the field of magnetic recording you can bring magnetic recording to the great mass market of all America! Brush Paper Tape will be furnished you either in bulk in varying widths or 1225 ft. 1/4-inch wide on a metal reel (standard item).

### Look at these advantages of Brush Paper Tape...

- ✓ Easy to handle
- ✓ Extreme low-cost
- ✓ Can be edited... spliced
- ✓ Greater dynamic range
- ✓ Minimum wear on heads
- ✓ Excellent high frequency reproduction at slow speed
- ✓ Permanent... excellent reproduction for several thousand play-backs
- ✓ Easily erased

Other Brush developments in magnetic recording components include Plated Wire and vastly improved Tape and Wire Recording Heads and Cartridges.

Write today for further information

## The Brush Development Co.

3405 Perkins Ave. • Cleveland 14, Ohio

# MEISSNER

**FOR TWENTY-FIVE YEARS  
THE STANDARD OF COIL QUALITY!**

For over a quarter century the name Meissner has stood for the finest in electronic equipment. Founded in 1922 by William O. Meissner, (famous for his outstandingly successful inventions in communications and electronics) this company has long specialized in the development and manufacture of fine coil equipment for every application . . . As a result of this vast background of electronic research and experience, Meissner Coils have become the accepted standard among those who demand high quality performance. Precision-made, designed to the most exacting requirements, these superior components are backed by a twenty-five year reputation for quality and uniformity in manufacture.

A complete line, including Air Core I. Fs.  
Iron Core Plastic I. Fs. and standard I. Fs.

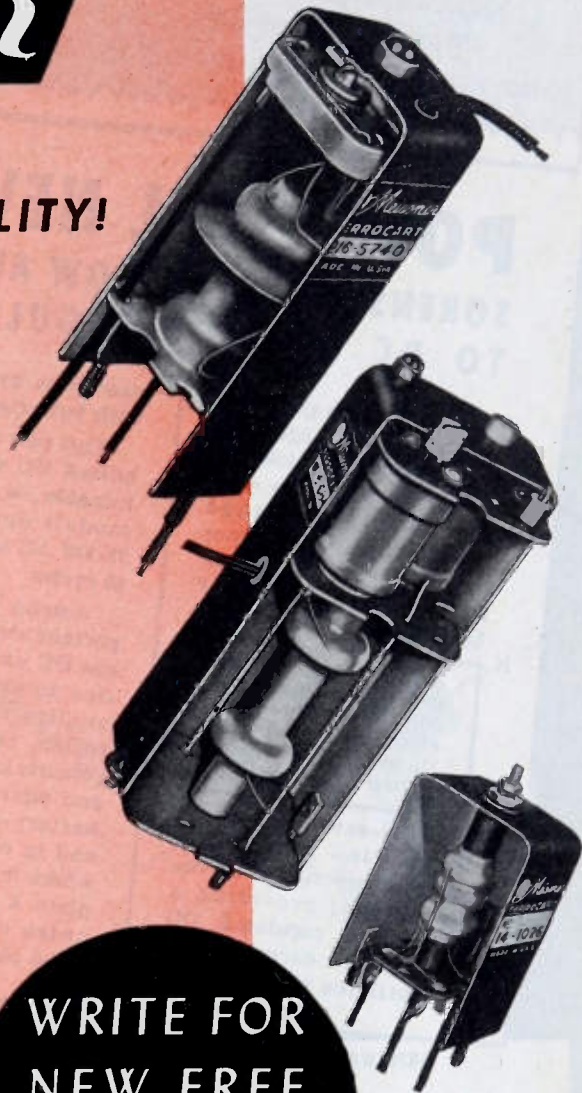

**WRITE FOR  
NEW FREE  
MEISSNER  
CATALOG**

*Meissner*

**ELECTRONIC DISTRIBUTOR AND INDUSTRIAL SALES DEPARTMENT**

**MAGUIRE INDUSTRIES, INCORPORATED**

**936 NORTH MICHIGAN AVENUE • CHICAGO 11, ILLINOIS**

**EXPORT DIVISION • SCHEEL INTERNATIONAL INCORPORATED**

**4237 NORTH LINCOLN AVENUE, CHICAGO 18, ILLINOIS • CABLE ADDRESS HARSHEEL**



# CURRENTLY

SORENSEN & COMPANY, INC.  
Manufacturers of  
VOLTAGE REGULATORS, NOBATRONS & ELECTRONIC APPARATUS

FROM  
SORENSEN  
AT  
STAMFORD



## POWERFUL NEWS! SORENSEN SYSTEM NOW APPLIED TO DC VOLTAGE REGULATION

The Sorensen system of AC electronic voltage regulation provides quick, accurate response to even the smallest voltage change with a minimum wave distortion and a regulation accuracy of  $\frac{1}{2}$  of 1%.

Arrange now to receive your personal copy of the Sorensen electronics journal "Currently", published bi-monthly.

This same electronic regulation system has been incorporated into the Nobatron, providing a source of regulated DC voltage at currents and stabilities that, in the

past, was available only with batteries.

This new source of stabilized DC voltage is obtainable in six standard models operating on a 95-125 AC source of 50 to 60 cycles.

Among the more important uses for Nobatrons are DC ammeter calibration in experimental and quality control laboratories, testing of components in the automotive and aircraft industries in battery-operated relays and in other applications where it is desirable to replace a battery to guarantee continuous regulated power supply.

### GENERAL AC REGULATOR SPECIFICATIONS

Input Voltage Range (-1 model) ..	95-125
(-2 model) ..	190-250
Output Voltage Range (-1 model) ..	110-120
(-2 model) ..	220-240
Load Range .....	25-30,000 V. A.
Regulation Accuracy .....	$\frac{1}{2}$ of 1%
Harmonic Distortion .....	5% Max. (2% in "S" Models)
Input Frequency Range .....	50-70 cycles
Inductive Power Factor Range .....	Down to 0.7 P.F.

For standard voltage regulation, Sorensen Model 500 is a proven leader in its field—compact, accurate and dependable. This model typifies the Sorensen line of AC and Nobatron all-purpose voltage regulators. Let a Sorensen engineer help you with your next voltage regulation problem.

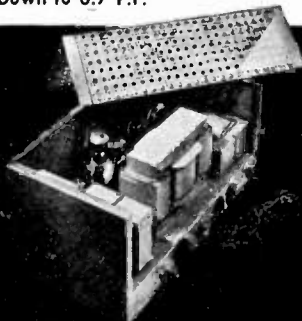

**SORENSEN & COMPANY, INC.**  
375 FAIRFIELD AVENUE • STAMFORD, CONNECTICUT



The following transfers and admissions were approved on May 6, 1947, to be effective June 1, 1947:

#### Transfer to Senior Member

- Ahern, W. R., 618 Sunnycrest Rd., Syracuse 6, N. Y.  
Bailey, R. C., Box 112, Richmond 1, Va.  
Barclay, W. J., 955 N. California Ave., Palo Alto, Cal.  
Brouse, H. L., 1591 Wittekind Terr., Cincinnati, Ohio  
Carlson, R. F., R.F.D. 1, Emporium, Pa.  
Carlson, W. L., RCA Laboratories Division, Princeton, N. J.  
Chipman, R. A., Electrical Engineering Department, McGill University, Montreal, Que., Canada  
Clements, S. E., 3250 Martha Custis Dr., Alexandria, Va.  
Crosby, H. M., 201 Lathrop Rd., Syracuse 9, N. Y.  
Doll, E. B., North American Philips Co., Inc., 145 Palisade St., Dobbs Ferry, N. Y.  
Donley, H. L., 3 Harris Rd., Princeton, N. J.  
Farkas, F. S., Bell Telephone Laboratories, Inc., 463 West St., New York 14, N. Y.  
Graham, H. U., 5012 Allandale Rd., Washington 16, D. C.  
Guest, W. T., 305 S. Irving, Arlington, Va.  
Hammond, R. E., Box 412, Kitchener, Ont., Canada  
Hartz, J. E., 5706 Wyngate Dr., Bethesda 14, Md.  
Jelen, M. J., 15 Fifth Ave., New York 3, N. Y.  
Levy, M. L., 17 N. Chatsworth Ave., Larchmont, N. Y.  
Marks, M., 4620 N. Spaulding Ave., Chicago 25, Ill.  
Mitchell, D. H., 1711 N. Newland Ave., Chicago 35, Ill.  
Post, E. A., 117 N. Stone Ave., LaGrange, Ill.  
Singer, C. H., 1440 Broadway, New York 18, N. Y.  
White, R. W., "Stoneleigh," St. Mellons, Near Cardiff, Wales

#### Admission to Senior Member

- Burke, R. J., 4803 Lackawanna St., Berwyn, Md.  
Clement, A. W., Bell Telephone Laboratories, Inc., 463 West St., New York 14, N. Y.  
Griffing, B. L., 555 St. Paul Ave., Dayton 10, Ohio  
Hallenbeck, F. J., Bell Telephone Laboratories, Inc., 463 West St., New York 14, N. Y.  
Krutner, H., 36 Park St., Brookline, Mass.  
Melton, B. S., Applied Physics Laboratory, The Johns Hopkins University, 8621 Georgia Ave., Silver Spring, Md.  
Resides, W. C., National Broadcasting Co., 30 Rockefeller Plaza, New York 20, N. Y.  
Rives, F. M., 8 Lyndon Rd., Fayetteville, N. Y.  
Warren, C. A., Tuttle Rd., R.F.D. 1, Plainfield, N. J., Watchung, N. J.

#### Transfer to Member

- Blitzer, R., 845 Riverside Dr., New York 32, N. Y.  
Buckbee, J. A., 3702 E. Pontiac St., Ft. Wayne 1, Ind.  
Clark, J. R., Electrical Engineering Bldg., Purdue University, Lafayette, Ind.  
Colby, R. L., Jr., 7823 S. 112 St., Seattle, Wash.  
Dalen, G., AGA, Stockholm-Lidingo, Sweden  
Geils, J. W., 43 Mill Rd., Morris Plains, N. J.  
Hemmes, R. T., 35 Giddings St., Great Barrington, Mass.  
Herider, E. D., 5320 Rock Creek Church Rd., N.E., Washington 11, D. C.  
Klesse, W. R., 61 Chatham St., Chatham, N. J.  
Lieske, E. W., 112-31 St., N. E., Cedar Rapids, Iowa  
Neuenschwander, E. F., 3217 Calumet Dr., Houston 4, Tex.  
Ohmart, P. E., 1932 Auburn Ave., Dayton 6, Ohio  
Rosen, L., 2819-12 St., S. Arlington, Va.

(Continued on page 40A)



# NEW MINIATURE CAPACITORS

for use with Miniature Tubes

Oil-impregnated Paper-dielectric capacitors molded in phenolic

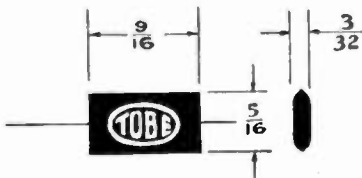

TO MEET REQUIREMENTS for miniature components for use in hearing aids, pocket radio receivers, airborne radio apparatus, and other devices in which economy of space is a primary factor:

Type No.	Capacitance Mfd.	Case Size — Inches			Wire Size	
		Lgth.	Wdth.	Thk.	Dia.	Lgth.
HAC-001	0.001	9/16	5/16	3/32	0.025	1-1/8
HAC-005	0.005					
HAC-01	0.01					
APC-05	0.05	11/16	29/64	7/32	0.032	1-1/8

## SPECIFICATIONS

Impregnation: mineral oil.

Case: molded of mica-filled phenolic; sealed to withstand 90% relative humidity.

Terminal Leads: solid, tinned copper.

Operating Temperature: -55C to +65C; the .001 and .005 Mfd. ratings can be furnished for service up to 85C at slight additional cost.

Working Voltage: 75 volts d-c.

Capacitance Tolerance: +60%, -20%.



**TOBE DEUTSCHMANN Corporation CANTON, MASSACHUSETTS**

# Quiet

## AS A MOUSE



Another Astatic FIRST for improving the clarity and beauty of Phonograph Reproduction

Astatic  
Patents  
Pending

## MODEL "QT" PHONOGRAPH CARTRIDGE

● With surface noise and needle talk VASTLY reduced by the revolutionary type needle mounting and design of this new cartridge, the proverbial mouse would lose his reputation for quietness by comparison. Increased vertical as well as lateral compliance of the replaceable needle used in the "QT" Cartridge has resulted in a great reduction in acoustic noises, which, together with an extremely low order of distortion, insures clearer, cleaner and therefore more enjoyable "quiet talk" phonograph reproduction. The "QT" Cartridge is being extensively used in new equipment installations. Two models are available, "QT-M" with precious metal-tipped stylus and "QT-J" with jewel point.

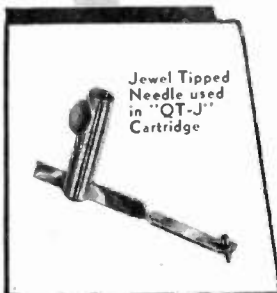
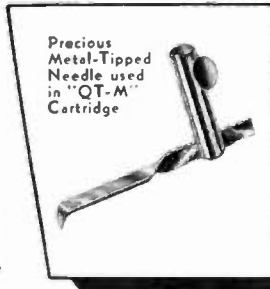

### CHARACTERISTICS

Cartridge Models "QT-M" and "QT-J" have the following specifications: Minimum Needle Pressure, 1-1/4 oz.; output voltage .75, average at 1,000 c. p. s. on Audiotone 78-1 frequency test record; cutoff frequency, 5,000 c. p. s.; terminals, pin type.

THE  
**Astatic**  
CORPORATION  
CONNEAUT, OHIO

IN CANADA: CANADIAN ASTATIC LTD. TORONTO-ONTARIO

Astatic Crystal Devices Manufactured under Brush Development Co. patents.

Copyright Astatic



(Continued from page 38A)

Smith, A. E., R.F.D. 4, Box 790, Louisville, Ky.  
Wilcox, R. L., Jr., 447 Orange St., S. E., Washington 20, D. C.

#### Admission to Member

- Adamson, R. G., Philco Research Division, Broad & Somerset Sts., Philadelphia 32, Pa.  
Axman, E., Electrical Engineering Bldg., State College, Pa.  
Baller, M. D., 3 Sacramento St., Cambridge, Mass.  
Barrett, J. O. G., c/o James Greaves & Co., 11-13 Ridgefield, John Dalton St., Manchester 2, England  
Baylis, F. E., R.F.D. 2, Xenia, Ohio  
Bennetsen, W. J., 6327a Sutherland Ave., St. Louis, Mo.  
Churchill, D. B., Box 88, East Norwich, N. Y.  
Duckett, E. J., 319 Barnes St., Pittsburgh, Pa.  
Fanta, F., Rua Alves Guimaraes, 156, Sao Paulo, Brazil  
Flanders, L. M., Jr., 90 Abbotsford Rd., Brookline, Mass.  
Garrand, L. W., 256 West Broad St., Stamford, Conn.  
Gursky, E. J., Jr., 3221 Connecticut Ave., N. W., Washington 8, D. C.  
Hodgson, A. R., Jr., Paramount Pictures, Times Sq., New York, N. Y.  
Jackson, B. A., One Hawthorne Lane, Valley Stream, L. I., N. Y.  
Jones, G. C., 2208 Lake Ave., Baltimore 13, Md.  
Kather, E. N., Oxbow Rd., South Lincoln, Mass.  
Levi, J. S., 5234 S. Dorchester, Chicago 15, Ill.  
Miller, K. K., 550 Wiltshire Blvd., Dayton 9, Ohio  
Pressman, A., 119-40 Metropolitan Ave., Kew Gardens, L. I., N. Y.  
Redmond, J. J., 10010 Georgia Ave., Silver Spring, Md.  
Robinson, J. C., 180 Lindenwood Court, Emporium, Pa.  
Samson, E. W., 80 Standish Rd., Watertown 72, Mass.  
Sussdorff, R. R., 701—Ninth Ave., Belmar, N. J.  
Timmerman, F., U. S. Navy Electronics Laboratory, San Diego 52, Cal.  
Uttendorfer, E. A., 112 Oak St., W. Hempstead, N. Y.  
Wicker, J. L., Box 543, Officers Mail Room, McClellan Field, Cal.  
Wilson, M. G., 110 Market St., Clearfield, Pa.  
Zeek, R. W., 4341 Nichols Ave., S. W., Washington 20, D. C.

The following admissions to Associate were approved on May 6, 1947, to be effective on June 1, 1947:

- Acosta, T. R., Radio Division 11, Naval Research Laboratory, Washington 2, D. C.  
Allen, W. B., 3795—First Ave., San Diego 3, Cal.  
Andersen, W. M. A., 356 Hillside Ave., Hartford, Conn.  
Arndt, A., 529—22 St., Denver, Colo.  
Attack, H. G., 106 Fairfield Ave., N., Hamilton, Ont., Canada  
Atwood, W. A., Jr., c/o Blandy's Camp, Rockville, Md.  
Barlow, L. C., 120 Breman Ave., East Syracuse, R.F.D. 2, N. Y.  
Benson, C. L., 14-30—160 St., Beechhurst, N. Y.  
Berger, M., Superior Marine Radio Co., 123 Barclay St., New York, N. Y.  
Berube, J. P. G., R.C.A.F. Station, Clinton, Ont., Canada  
Blachere, B., 306 W. 100 St., New York 25, N. Y.  
Bosworth, C. D., 368 Woodstock Ave., Putnam, Conn.  
Brauner, J., 5884 Casper St., Detroit 10, Mich.  
Bregar, J. C., 1111 Martin St., Winston-Salem, N. C.

(Continued on page 42A)

**NOW!** a new standard of performance in cutting heads  
**THE PRESTO 1-D**

► The new Presto 1-D Cutting Head offers: *wide range, low distortion, high sensitivity and stability through a temperature range of 60°-95° F.* The Presto 1-D Cutting Head is a precision instrument made entirely of precisely machined parts, expertly assembled and carefully calibrated. These factors, plus its sound basic engineering design, produce a cutter unequaled in performance by any other mechanically damped magnetic device.

► Note from the light pattern below: The correct location of the cross-over point at 500 cycles, the 6 db per octave slope below this point, and flat response above 500 cycles, which is free from resonant peaks. The range of the cutter is 50-10,000 cycles. The Presto 1-D is damped with "Prestoflex" which is impervious to temperature changes between 60 and 95 degrees Fahrenheit.

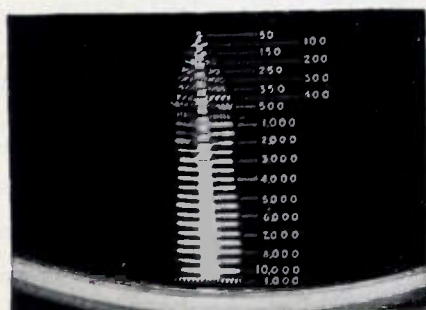
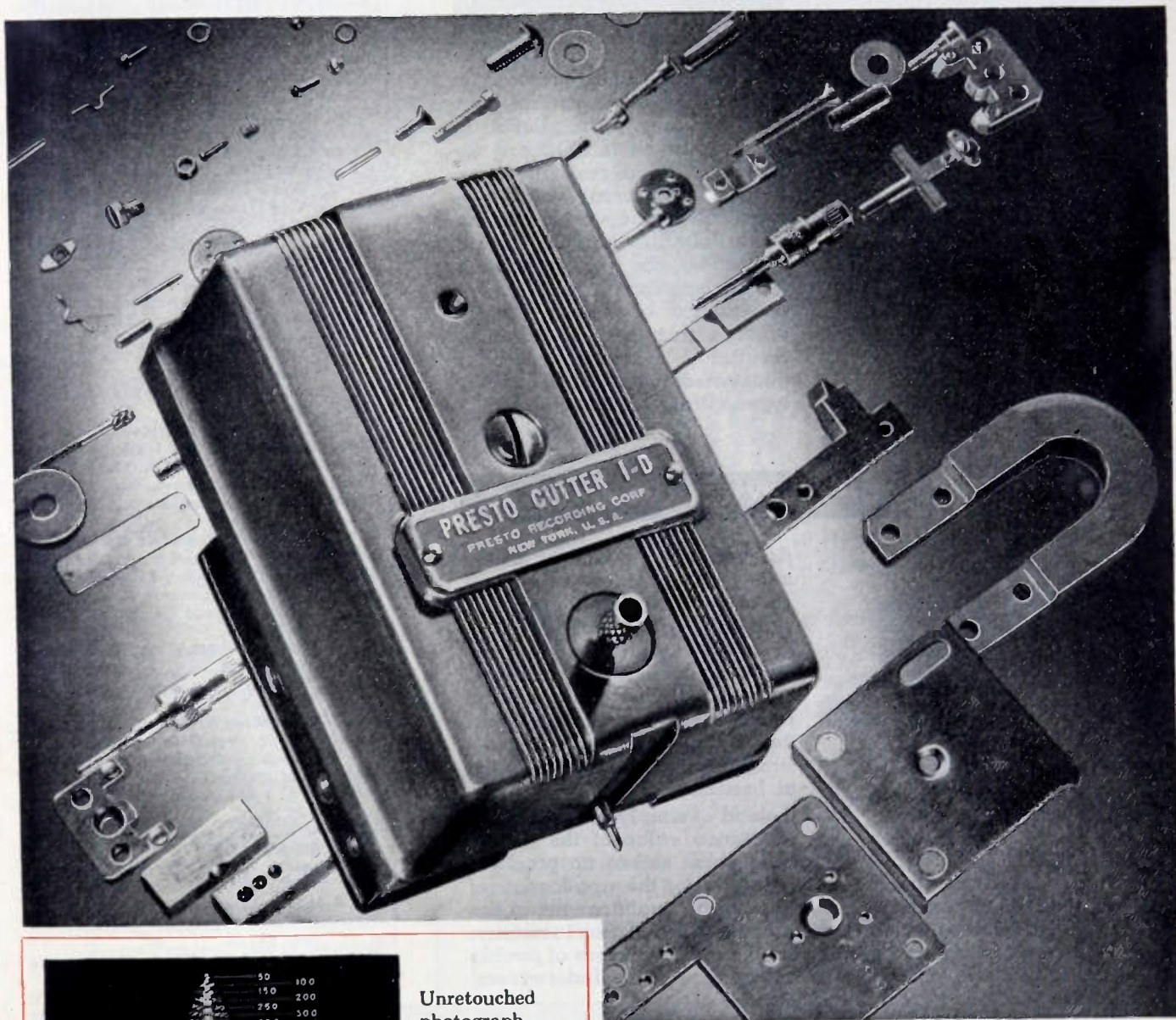

Unretouched photograph showing the light pattern. Notice correct location of the cross-over point at 500 cycles.

**PRESTO**

RECORDING CORPORATION

242 WEST 55TH STREET, NEW YORK 19, N. Y.

Walter P. Downs, Ltd., in Canada



# You Can Get TRUE FACTS ON PERFORMANCE

with these  
**TESTING UNITS**



## ACME VOLTROL

The Acme Voltrol provides a full range stepless control from 0 to 135 volts. Its regulation is accurate to within 4/10 volt adjustment. Unlike resistance regulators, the output voltage is practically independent of the load. Voltrol is the ideal testing instrument for predetermining the performance of any electrical device or product under voltage fluctuation conditions. Available in portable model (illustrated) and panel mounting types. Write for Bulletin 150.

## ACME BREAKDOWN TESTER



An entirely new kind of testing unit that provides for actual checking of circuits at approved standard testing voltages and in addition indicates grounds, shorts or opens. 100% leakage type transformer limits current under short circuit conditions, thereby preventing needless destruction to materials at point of breakdown.

Instead of simply indicating the resistance value of the insulation, which serves no practical

purpose, the Acme Insulation Tester permits the application of high voltages to positively prove the safety qualifications of the electrical device or apparatus under test. The Acme Insulation Breakdown Tester may be adjusted to supply voltages of double the rated voltage plus 1000 in accordance with Underwriters' Laboratories testing recommendations.

## ACME ELECTRIC CORPORATION

44 WATER ST.

CUBA, N. Y.

**Acme**  **Electric**  
TRANSFORMERS



(Continued from page 40A)

- Brewer, H. G., Jr., Haight St., R.F.D. 2, Babylon, N. Y.  
 Brimmer, W. R., 3419 S. 58 St., Cicero 50, Ill.  
 Bristow, F. E., Hqs. Fifth Air Force, Box 118, A.P.O. 710, c/o Postmaster, San Francisco, Cal.  
 Broadus, G. J., 1545 Ninth St., Port Arthur, Tex.  
 Brown, A. L., Naval School, Aviation Electronics, (Officers), Ward Island, Corpus Christi, Tex.  
 Buddecke, C. B., 3515 Tenth St., Port Arthur, Tex.  
 Burditt, W. F., 252 East Main St., Patchogue, L. I., N. Y.  
 Burk, P. O., 7 Cayton Pl., Hampton, Va.  
 Burks, R. C., Tri-State College, Bks. 511-A, Angola, Ind.  
 Cabe, L. E., 2915 Fruit Valley, Vancouver, Wash.  
 Cains, R. J. T., c/o A.N.A., Pty. Ltd., 390 Flinders St., Melbourne, Vic., Australia  
 Cameron, C. E., Quinby, Va.  
 Chander, R., c/o U. Rangaswamy Mudaliar, 40 Laxmana Mudaliar St., Bangalore, S. India  
 Chivers, C. C., General Electric Co., Syracuse, N. Y.  
 Clark, S. M., 1481 Dufferin Pl., Windsor, Ont., Canada  
 Clifford, M. L., 4241 Aldine St., Philadelphia 36, Pa.  
 Collins, E. W. J., Radio Department, c/o Shell Co. of Ecuador, Quito, Ecuador, South America  
 Connor, J. J., 50 Robinson St., Hamilton, Ont., Canada  
 Cory, R. W., Radio Station WWSO, Springfield, Ohio  
 Cowden, D. G., 947 James, Syracuse, N. Y.  
 Darby, R., 1129 W. 64th St., Los Angeles 44, Cal.  
 DeBoard, E. B., 5122 So. 23 St., Omaha 7, Nebr.  
 Diehl, E. P., 159 W. Park Ave., State College, Pa.  
 Doherty, R. E., 386 Common St., Belmont 78, Mass.  
 Drisdale, T. B., 1641 Westheimer, Houston 6, Tex.  
 Duba, L., 5631 S. E. Belmont St., Portland 15, Ore.  
 Duffus, R. A., Jr., Research Laboratory, Stromberg-Carlson Co., Rochester, N. Y.  
 East, W. L., Jr., AA & GM Branch, TAS, Box 598, Ft. Bliss, Tex.  
 Ebert, H. P., 117 Hillside Rd., Skyway Park-Osborn, Ohio  
 Eddy, J., Standard News Association, 63 Park Row, New York 7, N. Y.  
 Egli, J. J., 186 Maple Ave., Red Bank, N. J.  
 Feder, H. W., Sr., Department of Physics, Niagara University, Niagara University, N. Y.  
 Finders, R. M., 70 Wainwright Dr., Dayton 3, Ohio  
 Fisher, H. J., 1 Richards Rd., Port Washington, L. I., N. Y.  
 Flarity, W. H., Naval Research Laboratory, Washington, D. C.  
 Fonda-Bonardi, G., 709 E. 212 St., New York 67, N. Y.  
 Fox, A. M., 1464 Vyse Ave., New York 60, N. Y.  
 Furneaux, W. H., 7 Spruceside Ave., Hamilton, Ont., Canada  
 Gagarin, G. G., 140 West Hamilton St., State College, Pa.  
 Gangberg, F., 137 Shotwell Park, Syracuse 6, N. Y.  
 Girardi, A. H., 9015 Fleetwing Ave., Los Angeles 45, Cal.  
 Gray, D. W., 849 Beacon St., Newton Centre, Mass.  
 Greenberg, A. L., 211 Willis Ave., New York 54, N. Y.  
 Greever, N. J., 6159 University Ave., Chicago, Ill.  
 Haley, J. C., Jr., c/o KRUL, Corvallis, Ore.  
 Hansen, A. K., c/o Canadian Pacific Air Lines Mont Joli, Que., Canada  
 Hefter, M., c/o Meshorer, 14 Sonoma St., Roxbury, Mass.  
 Hill, F. C., 2698 Forrest, Beaumont, Tex.  
 Hird, F. S., Northwestern Bell Telephone Co., Duluth 2, Minn.

(Continued on page 44A)



*Another History-Making Mallory Publication...*



*...the world's first*

## VIBRATOR DATA BOOK

Here's a volume that engineers have long awaited . . . a worthy companion to the famous Mallory Electrical Contact Data Book and Mallory Resistance Welding Data Book . . . a comprehensive manual that tells you everything about vibrator power supply systems that Mallory has learned in sixteen years of building better vibrators and vibrator power supplies.

What are the fundamentals of good vibrator power supply design? What are the pitfalls to avoid when you design new equipment? How can you get maximum service and dependability from the vibrators you use? These and hundreds of other important questions are answered fully in the Mallory Vibrator Data Book—the only work of its kind in the world.

The first edition of this volume is limited. But you can easily reserve your copy by writing *now*—to Mallory direct or to your Mallory distributor. Price per copy is \$1.00. Free to recognized engineers and teachers when requested on your letterhead.

**MORE MALLORY VIBRATORS ARE IN USE TODAY THAN  
ALL OTHER MAKES COMBINED**



### CHECK THIS LIST OF CONTENTS

- Basic Vibrator Structures
- Mallory Standard Vibrator Types
- Selection of Correct Vibrator
- Power Transformer Characteristics
- Typical Vibrator Characteristic Data Sheets
- Power Transformer Design
- General Procedure in Designing Transformers
- Examples of Transformer Design
- Design Considerations for Other Applications
- High Frequency Vibrator Power Supply
- Timing Capacitor Considerations
- Design Practices and Methods of Interference Elimination
- Vibrator Power Supply Circuits
- Vibrator Inspection Procedures

**P. R. MALLORY & CO. Inc.**  
**MALLORY VIBRATORS**  
**AND VIBRATOR POWER SUPPLIES**

**P. R. MALLORY & CO., Inc., INDIANAPOLIS 6, INDIANA**

# NEW DI-FAN RECEIVING ANTENNA



...covers ALL  
television and  
FM frequencies

THE Andrew Co., pioneer specialist in the manufacture of a complete line of antenna equipment, continues its forward pace with the introduction of this new DI-FAN receiving antenna.

The DI-FAN antenna provides excellent reception on all television and FM channels. It thus supersedes ordinary dipole antennas or dipole-reflector arrays which work well over only one or two television channels.

In addition, the following advanced features will recommend the DI-FAN to dealers and receiver manufacturers who want the best possible antenna for use with their FM and TV receivers:

- Impedance of DI-FAN matched to impedance of transmission line, preventing ghost images.
- Designed for use with 300 ohm transmission lines, conforming to RMA standards for FM and TV receivers.
- DI-FAN has a graceful, attractive shape—looks well on any building.
- Light in weight but strong and durable. High strength aluminum alloy elements. Supporting members of heavily plated steel.
- All insulators are high grade glazed steatite.
- Mounting supports available for either chimney or roof installations.

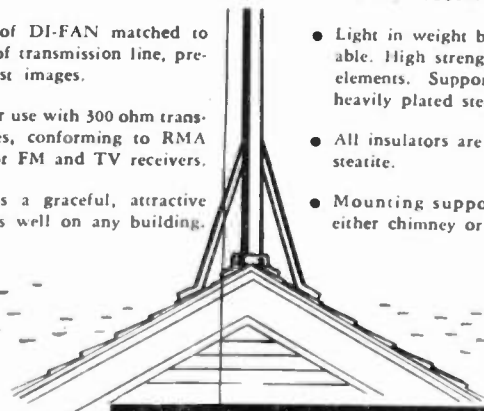

**ANDREW**  
**CO.**

363 E. 75th St.  
Chicago 19, Ill.

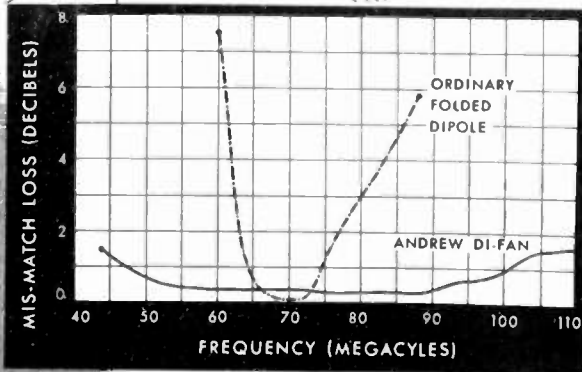

This graph illustrates the superiority of the Andrew DI-FAN over an ordinary folded dipole.



(Continued from page 42A)

- Hock, T. C., c/o H. A. O'Connor & Co., Laddlow Building, Box 252, Singapore, Strait Settlements
- Horton, L. L., 111 N. Ninth Ave., E., Apt. 8, Duluth 5, Minn.
- Howard, J., 985 Briarwood Ave., Bridgeport, Conn.
- Humiston, H. A., 24915 Lakeview Dr., Bay Village, Ohio
- Humphrey, J. G., 1021 King St., Utica 3, N. Y.
- Ives, R. D., 720 N. Ridgeland Ave., Oak Park, Ill.
- Jaeger, M., c/o Sanders, 76-66 Austin St., Forest Hills, L. I., N. Y.
- Jagasia, H. R., Shivandas Chandumal Rd., Wadhmal Udharum Quater, Karachi 1, India
- Jaski, T., 293 Grand, Redwood City, Cal.
- Johnson, J. H., John Volkert Metal Stampings, Inc., 141 Spencer St., Brooklyn 5, N. Y.
- Junkins, C. E., Jr., 171 Homestead Ave., Holyoke, Mass.
- Kahn, S. H., 210 Chamberlain, Raleigh, N. C.
- Kearney, K., 9285 W. Outer Dr., Detroit, Mich.
- Kitches, S., 3953 Drolet St., Montreal, Que., Canada
- Klauser, H. U., 32 Steinwiesstrasse, Zurich 7, Switzerland
- Kosmaczewski, I., 415 W. Park Ave., Angola, Ind.
- Kuczun, C. G., 49 Dunlap St., Salem, Mass.
- Lahn, F. C., 76 Vandergrift Dr., Dayton 3, Ohio
- Landry, N. R., 6079 Louisville St., New Orleans 19, La.
- Laughlin, C. E., 1292 Liberty, Beaumont, Tex.
- Lizzio, J., 131-17-131 St., S. Ozone Park, L. I., N. Y.
- Lodge, L. L., 1392 Bryden Rd., Columbus 5, Ohio
- Lundry, W. R., 91 Woodland Ave., Summit, N. J.
- MacArthur, R. C., 6803 Everall Ave., Baltimore 6, Md.
- MacKenzie, L. G., 7422 Melrose, Hollywood 46, Cal.
- MacKnight, K. I., 1024 New York Bldg., St. Paul 1, Minn.
- Madter, E. W., 71 Carling St., London, Ont., Canada
- Mangus, G., 2025 Brickell Ave., Miami, Fla.
- Manning, D. C., 15732 Sorrento, Detroit 27, Mich.
- Mason, A. F., Jr., 1127 Hays St., San Antonio 2, Tex.
- Martin, J. W., 535 Mill St., Raymond, Wash.
- Mattson, N. H., 1832 Grace St., Chicago 13, Ill.
- Mayfield, S. A., 1809 1/2 Frederica St., Owensboro, Ky.
- Michael, H., 3310 Campbell Dr., New York, N. Y.
- Milan, G., 226 Kirk Ave., Syracuse 5, N. Y.
- Montgomery, D. N., 1800 S. Sixth St., Alhambra, Cal.
- Natarajan, R., c/o Dr. S. Ramakrishnan, 17 Luz Church Rd., Mylapore, Madras, South India
- Navayanaswamy, K., Ambika Ginning Factory and Rice Mills, Lawley Road P. O., Coimbatore, South India
- Nigg, D. J., 911 Harrison St., Syracuse, N. Y.
- O'Brien, D. D., Y.M.C.A., 1600 Louisiana, Houston, Tex.
- Overman, C. I., 6237 Marie St., Cincinnati 24, Ohio
- Ozone, K., 3640 N. Wilton, Chicago 13, Ill.
- Parsons, M. O., 5017 Lovell St., Fort Worth 7, Tex.
- Peterson, W. J., 137 W. Fifth St., Emporium, Pa.
- Prantch, J., 7624 Dresden Ave., Parma, Ohio
- Proft, C. R., Jr., 2621 Seventh St., Port Arthur, Tex.
- Puzio, P. S., 50 Division Ave., Garfield, N. J.
- Ramachandran, P., 191 Margosa Rd., Malleswaram, Bangalore, India
- Rao, Suryanarayana, B. V., Asst. Electrical Engineer, (Wireless), M.S.M. Rly, Madras, South India
- Ramabhadran, S., 177 V Road, Chamaraipet, Bangalore, Bangalore City, South India

(Continued on page 46A)

# For Smaller Portables... Long-Lasting "Eveready" Batteries



No. 950



No. 467

WHEN you design a small portable radio around the new high-energy "Eveready" No. 950 batteries...and the "Eveready" "Mini-Max" No. 467 "B" battery—you can keep the receiver small and compact without sacrificing battery life.

The "Eveready" No. 467 "B" battery, because of its exclusive space-saving flat-cell design, gives longer life in radios than any other "B" battery of equal size. The "Eveready" No. 950 battery, nationally famous before the war, has been redesigned and offers vastly more energy than ever before...without any increase in size or in price. These batteries are available everywhere.

## Some Typical Filament Circuits

Here are four typical circuits that demonstrate how one or more "Eveready" No. 950 flashlight batteries can be connected to heat tube filaments. Many other combinations are, of course, possible and practicable.

For further information on these and other "Eveready" radio batteries, write to National Carbon Company, Inc., for Battery Engineering Bulletin No. 1.

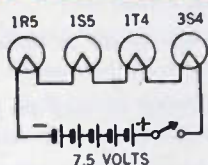

7.5 VOLTS  
5 CELLS  
50 M.A. PER CELL

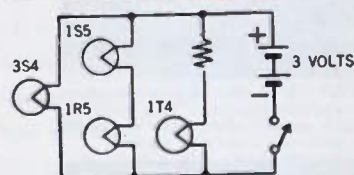

2 CELLS  
150 M.A. PER CELL

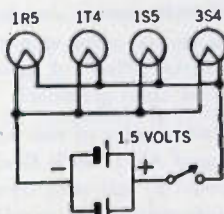

1.5 VOLTS  
2 CELLS  
125 M.A. PER CELL

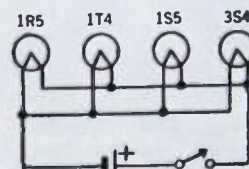

1.5 VOLTS  
1 CELL  
250 M.A. PER CELL



The registered trade-marks "Eveready" and "Mini-Max" distinguish products of National Carbon Company, Inc.

**NATIONAL CARBON COMPANY, INC.**

30 EAST 42nd STREET, NEW YORK 17, N. Y.

Unit of Union Carbide and Carbon Corporation







(Continued from page 44A)

- Ramadas, B., Koraput Dt., Orrissa, Jeypore, India  
 Ramasubramanyam, V., c/o G. Sundaram, J  
 Cathedral Rd., Cathedral Post, Madras,  
 South India  
 Ramaswamy, S. I., Sukashaya Cottage, IV Cross  
 Road, Shankarapuram, Basavanagudi  
 P. O., Bangalore, South India  
 Reagh, R. A., 718 Eighth, South, Lethbridge, Alta.,  
 Canada  
 Reghier, N. J., 2712 Coolidge Ave., Oakland, Cal.  
 Repella, N., A.M.C. Watson Laboratories, Red  
 Bank, N. J.  
 Richardson, S. J., Box 475, Toledo, Wash.  
 Riley, B. R., 3416 Lindale, Dayton 5, Ohio  
 Rodde, L. W., 3554 Wrightwood Ave., Chicago 47,  
 Ill.  
 Rogers, R., 82 Burnham Rd., Morristown, N. J.  
 Rothenberg, H., 24 Steffan Court, Caroline St.,  
 Hillbrow, Johannesburg, South Africa  
 Ruggiero, R. J., Pennsylvania Military College,  
 Chester, Pa.  
 Sandler, B., 3957 Wilshire Blvd., Los Angeles 5, Cal.  
 Schill, R. H., 146 W. Martin Ave., Bellmore, L. I.,  
 N. Y.  
 Schilling, C. R., 574 Butternut St., Middletown,  
 Conn.  
 Schneider, F. H., 222-44th, Newport News, Va.  
 Schubert, W., 352 W. 23 St., New York 11, N. Y.  
 Scott, R. M., 208 S. Glebe Rd., Arlington, Va.  
 Selin, F. R., 24 Tragarete Rd., Port of Spain,  
 Trinidad, British West Indies  
 Sigel, D., 15 Broadway, Bayonne, N. J.  
 Smith, E. C., Route 3, Box 162, Findlay, Ohio  
 Sokasits, F. M., 63 Van Buren St., Passaic, N. J.  
 Speer, J. H., 32 Colln Kelly Dr., Dayton 3, Ohio  
 Srinivasa Modaliar, P. S., 19 Benki Nawab St.,  
 Gollarpet, Bangalore City, Mysore State,  
 South India  
 Stagers, R. D., 2134 Procter St., Port Arthur, Tex.  
 Sterling, J. A., 473 Quebec Ave., Toronto, Ont.,  
 Canada  
 Straughn, W. L., Sr., 1254 Euclid Ave., Beaumont,  
 Tex.  
 Krishna Swamy, M. V., c/o Ramaswamy, Suk-  
 hashaya Cottage Shankarapmam, Basa-  
 vangudi, P. O., Bangalore, Mysore State,  
 South India  
 Thomas, L. P., 139 East Palmer Ave., Collingswood,  
 N. J.  
 Tipton, V. L., Jr., 2410 Grandview Ave., Dayton,  
 Ohio  
 Touger, M. L., 1844 E. 97 St., Cleveland 6, Ohio  
 Towle, M. L., 15 Standish St., Newton Highlands  
 61, Mass.  
 Tuthill, R. M., 1634 Morse Ave., Chicago 26, Ill.  
 Van Ness, C. D., Box 1689, Fort Worth 1, Tex.  
 Visweswaraiiah, H. S., c/o P. S. Narayana Rao,  
 Kirshna Buildings, Avenue Rd., Bangalore,  
 Mysore State, South India  
 Wagner, R. J., Jr., 177 Waverly Pl., New York 14,  
 N. Y.  
 Walcutt, R. P., 6 McClure St., Dayton 3, Ohio  
 Walworth, W. Y., 16 Chauncy St., Cambridge 38,  
 Mass.  
 White, M. A., Box 32, Station F, New York 16,  
 N. Y.  
 Whiting, H. L., 775 Park Ave., New York 21, N. Y.  
 Willenborg, E. J., Box 7614, Philadelphia 1, Pa.  
 Willey, V. E., Box 36, Plainfield, Ind.  
 Williams, I. J. S., 13 Rutherglen Ave., Whitley,  
 Coventry, England  
 Wingert, R. R., 4434 S. California Ave., Chicago,  
 Ill.  
 Wittman, F., 1692 Park Pl., Brooklyn, N. Y.  
 Yachimec, P., 358 Ossington Ave., Toronto, Ont.,  
 Canada  
 Zaepfel, C. G., 47 Frederick Terr., Irvington 11,  
 N. J.  
 Ziellnski, C. A., 473 Hillside Ave., Holyoke, Mass.



Radio equipment used in United Air Lines Mainliners tested at maintenance base.

**For Greater Operating Efficiency**

# UNITED AIR LINES selects



**CREI Radio Engineering Courses  
 for Group Training of its  
 Radio-Electric Personnel**



United Air Lines' new deluxe transport, the four-engined Mainliner 300, speeds at five miles a minute. Features of the planes include electronic automatic pilots.

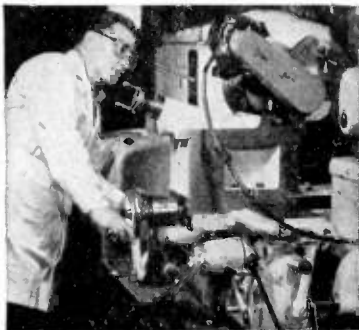

The scheduled air lines of the U. S. offer the safest transportation in the world . . . and radio-electronics lends its certain, guiding hand of assurance. United Air Lines as part of its own program for higher operating efficiency has contracted with Capitol Radio Engineering Institute for further training of RADIO-ELECTRIC PERSONNEL. Through the aid of CREI training, United is—

1. Increasing the technical ability of its technical radio personnel.
2. Enabling its staff to perform duties more efficiently and in less time.
3. Increasing the personal worth of each man to the organization and to himself.

No business is too large, few businesses are too small to profit by the CREI "Employers' Plan" of group training for technical radio personnel.

A plan similar to that now in operation at United Air Lines is flexible and can be patterned to suit your own requirements. For information please write to—

Mr. E. A. Corey

**CAPITOL RADIO  
 ENGINEERING INSTITUTE**  
*An Accredited Technical Institute*

**16th and Park Road, N. W.  
 Washington 10, D. C.**







*Small Size—Big Wattage Capacity*

**... and rated at 70C Ambient Temperature**

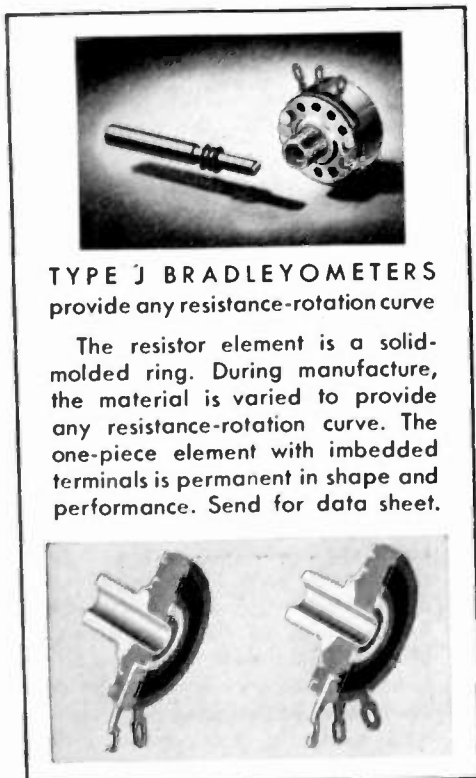

**TYPE J BRADLEYOMETERS** provide any resistance-rotation curve

The resistor element is a solid-molded ring. During manufacture, the material is varied to provide any resistance-rotation curve. The one-piece element with imbedded terminals is permanent in shape and performance. Send for data sheet.

Fixed resistors are usually rated at ambient temperatures of 40C. But Bradleyunit fixed resistors are rated at 70C.

At this high temperature, Bradleyunits . . . in 1/2-watt, 1-watt, and 2-watt ratings . . . operate at full rating for 1000 hours with a resistance change of less than 5 per cent. All three sizes are offered in standard R. M. A. values from 10 ohms to 22 megohms, inclusive.

Bradleyunit resistors require no wax impregnation . . . yet they pass salt water immersion test. The solid molded construction assures high mechanical strength and permanent electrical characteristics. War time uses proved that Bradleyunits withstand wide variations in temperature and humidity. Send for resistor data sheets. Allen-Bradley Co., 114 W. Greenfield Avenue, Milwaukee 4, Wisconsin.

  
**ALLEN-BRADLEY**  
**FIXED & ADJUSTABLE RADIO RESISTORS**  
 QUALITY

These manufacturers have invited PROCEEDINGS readers to write for literature and further technical information. Please mention your I.R.E. affiliation.

(Continued from page 18A)

## UHF Load Resistor

Developed originally for high-frequency low voltage-standing-wave-ratio coaxial loads by Bird Electronic Corporation, 1800 E. 38 St., Cleveland 14, Ohio, the "Terminaline" resistor, Model 69, is equally useful at low and medium radio frequencies. For laboratory and production tests this unit offers a constant resistance of 51.5 ohms through a frequency range of from direct current to well over 1,000 megacycles. Without auxiliary cooling, it will dissipate 300 watts, and when connected to tap-water supply (through hose stems at rear of unit) it will handle one kilowatt. Flow rate of  $\frac{1}{2}$  gallon per minute is satisfactory.

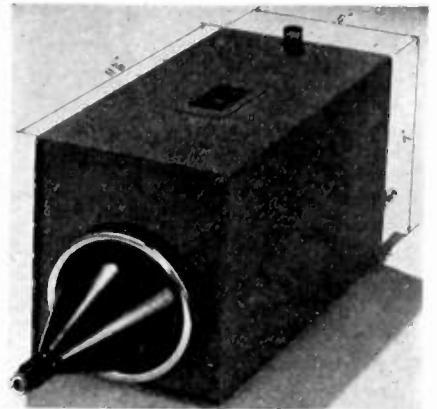

At frequencies below 100 megacycles, the radio-frequency resistance is within 2% of the DC resistance and the reactance component is small. DC resistance is held to  $\pm 5\%$ . The unit can be furnished with a variety of connectors. Principal uses are in transmitter loading and power measurements, and transmission-line testing in conjunction with slotted lines.

## Pocket Oscilloscope

A three-inch oscilloscope capable of measuring direct as well as alternating current has been introduced by Waterman Products Company, Inc., 2445 Emerald Street, Philadelphia 25, Pa. This industrial and television "Pocketscope," Type S-11-A has a three-inch screen, and is extremely portable, weighs only  $8\frac{1}{2}$  pounds, and measures  $11" \times 7" \times 5"$ . Additional features include push-pull amplifiers for horizontal and vertical deflection, intensity modulation amplifier, linear time sweep from three cycles to 50 kilocycles, sensitivity and fidelity of intensity modulation amplifier suitable for television work, antiastigmatic centering controls, trace expansion for detail observation, and attenuators for alternating as well as for direct current.

(Continued on page 60A)

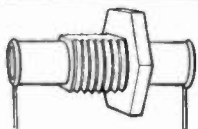
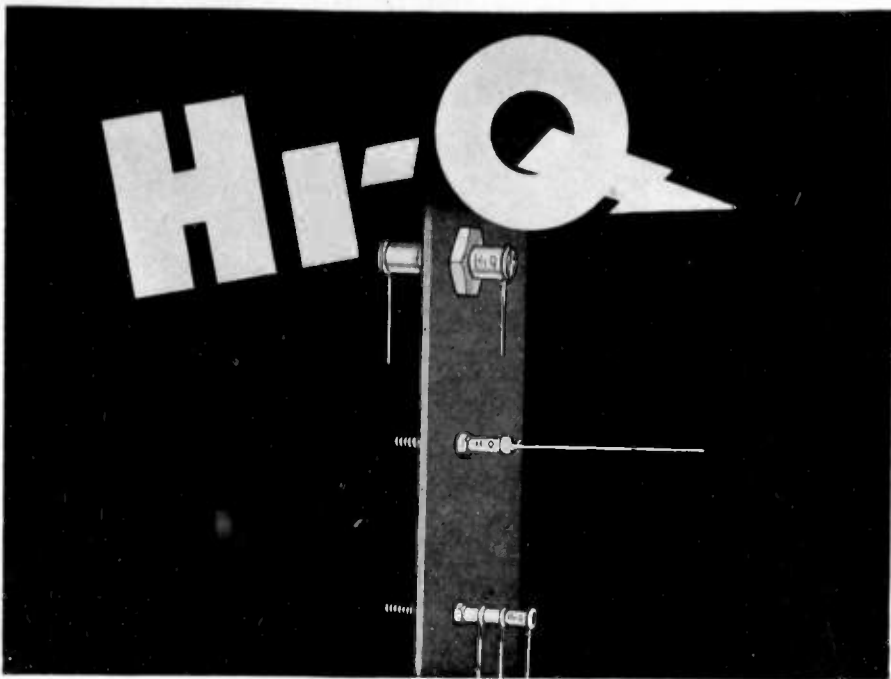

## FEED-THRU AND



## STAND-OFF CERAMIC CAPACITORS

are made to the same high performance standards as conventional CN and CI type Hi-Q capacitors. Engineers who have thoroughly investigated Hi-Q capacitor performance are unanimous in their approval. We invite inquiries for samples to meet the exact needs of your applications.

## OTHER COMPONENTS

### WIRE WOUND RESISTORS



### CERAMIC CAPACITORS



S. I. TYPE  
Durez Coated



C. N. TYPE

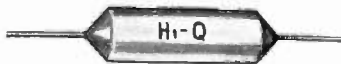

C. I. TYPE

### CHOKE COILS



# Hi-Q

**ELECTRICAL REACTANCE**  
CORPORATION  
FRANKLINVILLE, N. Y.

Accent on

MOTION

The famous Model 80 Even Speed Alliance Phonomotor operating on 110 or 220 volts is made for 40, 50 or 60 cycles, 16 watts input, 78 RPM. It has no gears—runs at an even speed—has a smooth, quiet, positive friction-rim drive. Amply proportioned bearings with large oil reservoirs assure long life. A slip-type fan gives cool operation—avoids any possible injury.

The Alliance Model K Phonomotor, a 25 cycle companion to the Model 80, operates on 110 volts, 25 cycles at 12 watt input. Motor and idler plate on Alliance phonomotors are all shock mounted to the cabinet mounting plate, to minimize vibration.

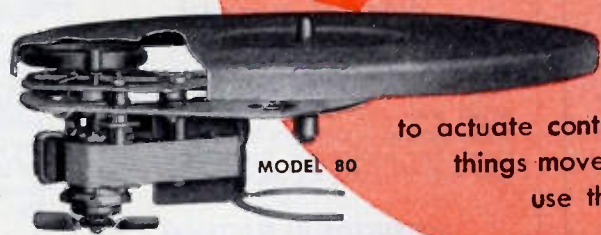

***The trend is to make things move!***

Designs will call for more action—movement! Flexible product performance needs power sources which are compact, light weight! Alliance Powr-Pakt Motors rated from less than 1-400th on up to 1-20th h.p. will fit those "point-of-action" places! Alliance Motors are mass produced at low cost—engineered for small load jobs!

For vital component power links to actuate controls... to make things move... plan to use them!



WHEN YOU DESIGN—KEEP

**alliance**

MOTORS IN MIND

ALLIANCE MANUFACTURING COMPANY • ALLIANCE, OHIO



# WANTED PHYSICISTS ENGINEERS

Engineering laboratory of precision instrument manufacturer has interesting opportunities for graduate engineers with research, design and/or development experience on radio communications systems, electronic & mechanical aeronautical navigation instruments and ultra-high frequency & microwave technique.

WRITE FULL DETAILS  
TO  
EMPLOYMENT SECTION  
**SPERRY  
GYROSCOPE  
COMPANY, INC.**

Marcus Ave. & Lakeville Rd.  
Lake Success, L.I.

## *For Sale* WESTINGHOUSE (DUFUR) OSCILLOGRAPH

Equipment for photographing single electrical transients of very short duration. Includes demountable cathode ray tube with mechanical and molecular pumps, film drum with high speed drive motor, 50 KV power supply, Norinder relay and timing circuits. Range markers down to .2 microseconds. Phenomena of 1 to 20,000 microseconds duration may be recorded. Maximum film drum speed 7,000 RPM. Unused.

Write for further information

BOX 472

THE INSTITUTE OF  
RADIO ENGINEERS  
1 East 79th St., N.Y. 21, N.Y.



The following positions of interest to I.R.E. members have been reported as open. Apply in writing, addressing reply to company mentioned or to Box No. . . .

The Institute reserves the right to refuse any announcement without giving a reason for the refusal.

PROCEEDINGS of the I.R.E.  
1 East 79th St., New York 21, N.Y.

### RADIO ENGINEER

Graduate radio engineer for research and development work on high frequency antennas and transmission line. Firm is a progressive subsidiary corporation of one of the nation's largest radio manufacturers, and is located in the middle west. Salary to be commensurate with qualifications of accepted person. Box 454.

### PATENTS

Patent Department of large industrial corporation requires experienced patent attorneys or agents. At least one with electronic background, for expanding research effort. Minimum supervision. Office in New York suburb, southwest Connecticut. Box 455.

### DEVELOPMENT ENGINEERS

Brooklyn engineering and manufacturing company, established in naval fire control and precision instrument work, requires qualified engineers for servo-mechanism and related development program. Positions require mature, responsible engineers with analytic as well as laboratory background, and 5 years' experience in fundamental development work. Facility in applied mathematics and advanced circuit development requisite. Starting salary commensurate with experience, and subsequent rewards commensurate with accomplishment. Box 456.

### ENGINEERS—PHYSICISTS

Engineers experienced with the operation and maintenance of the SCR-584 radar. Also graduate physicists experienced with optical instruments and electronic timing. Unusually attractive advantages. For application forms write P.O. Box 661, Ventura, California.

### INSTRUCTOR IN ELECTRICAL ENGINEERING

Instructors and professors to teach electrical engineering at prominent university in metropolitan area. Undergraduate and graduate courses in all fields and excellent research facilities. Professors must have advanced degrees. Salaries \$3,000 to \$7,500 depending on qualifications. Write to Box 459 with full details of education and experience.

### PHYSICISTS

Arsenal has positions open for physicists in Civil Service. Salaries from \$2,644 to \$5,905 per annum. Apply to: Frankford Arsenal, Philadelphia 37, Pennsylvania.



### ENGINEERS

The Naval Air Material Center has urgent need for engineers qualified under U. S. Civil Service Commission standards in the fields of radio and radar. Regular work consists of five eight hour days. Employees accrue vacation and sick leave. Permanent employees are also eligible for Civil Service Retirement. Salaries range from \$2,644.80 to \$8,179.00. Write to Naval Air Material Center, Industrial Relations Department, Bldg. 75, U. S. Naval Base Station, Philadelphia 12, Pa., for particulars concerning the filing of applications, types of positions and appointments.

### INSTRUCTOR IN ELECTRICAL ENGINEERING

Electrical graduate with Master's degree and some teaching experience; to teach undergraduate courses in circuits and machinery. Opportunity to do graduate work. Salary \$3,000 for 9 months. Location, midwest. Box 465.

### ASSISTANT PROFESSOR OF ELECTRICAL ENGINEERING

Electrical graduate with Master's degree and several years' teaching experience; to teach AC and DC circuits, AC and DC machinery, and other power courses. Opportunity to do graduate work. Salary \$3,600 for 9 months. Location, midwest. Box 466.

### PHYSICISTS AND ELECTRICAL ENGINEERS

For vacuum tube research. Apply by letter stating qualifications to Director of Research, National Union Radio Corporation, 350 Scotland Road, Orange, New Jersey.

### FACTORY ENGINEER

We have an opening in our factory engineering division for an outstanding man. This position requires experienced background of at least 5 years' engineering work on factory problems relating to receiving tubes manufacture. An engineering degree would be helpful but the primary requirements of the position are the experience and the ability to successfully solve every day problems encountered in the manufacture of receiving tubes. Apply by letter to PERSONNEL DEPT. National Union Radio Corporation, Lansdale, Pa.

### ELECTRICAL ENGINEERING TEACHERS

Instructors, assistant and associate professors to teach electrical engineering at state university in the southeast. Salaries \$2800 to \$4500 for 9 months depending upon qualifications. Write full details of education and experience. Box 467.

### RF-IF—TRANSFORMER ENGINEER

Radio engineer with theoretical and practical knowledge and experience in design of RF-IF transformers. Familiar with modern practice and requirements in FM and television receivers. Excellent opportunity with established growing company. Write giving full details. Box 468.

(Continued on page 52A)



# WANTED: MEN WHO CAN FILL THESE JOBS!



FEDERAL'S NEW PLANT, at Clifton, N. J., is the last word in modern design, modern equipment, and modern methods for precision manufacture of tele-communication and electronic equipment. Remember, too, that Federal is an associate of the International Telephone and Telegraph Corporation—one of the oldest and most securely-founded organizations in the industry. A job with Federal is a job with an assured future!

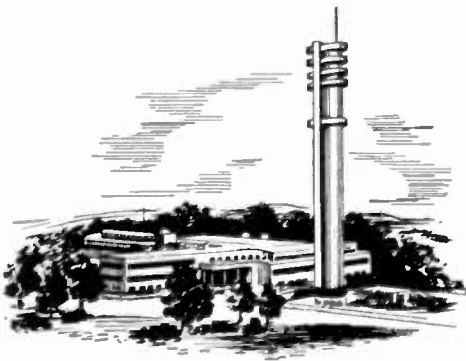

THE FEDERAL TELECOMMUNICATION LABORATORIES, at Nutley, N. J. represent the most modern laboratory and research facilities available anywhere. This, the American unit of IT&T's world-wide research and engineering organization, also represents the most advanced thinking in the field—pioneering that will shape the future of the radio and electronic industries. An affiliation with this organization offers great opportunities for the *right men!*

Federal now has openings for a few top-grade engineers who seek an unusual opportunity

IF YOU ARE an electronic or communication engineer with a really outstanding background—both academic and practical—this may be just the opportunity you've been looking for.

Federal now has a limited number of excellent jobs available for engineers with superior ability—men who want permanent positions with a company known the world over for its far-sighted research and development work in all fields of tele-communications and electronics.

Development engineers with 3 to 15 years experience in high-power and low-power transmitter design; engineers with 3 to 15 years experience in instrument landing of aircraft, mobile transmitters and receivers or wire transmission; telephone engineers with 3 to 15 years experience in circuits and equipment.

If you can meet these qualifications and want a job with an assured future, send complete resume giving educational background, job experience, age and salary requirements, to Federal Telephone and Radio Corporation, Clifton, New Jersey, attention of J. A. Abbott, Personnel Manager. All information will be kept in strict confidence.

## *Federal Telephone and Radio Corporation*

In Canada: — Federal Electric Manufacturing Company, Ltd., Montreal.  
Export Distributors: — International Standard Electric Corp. 67 Broad St., N. Y.



100 Kingsland Road,  
Clifton, New Jersey

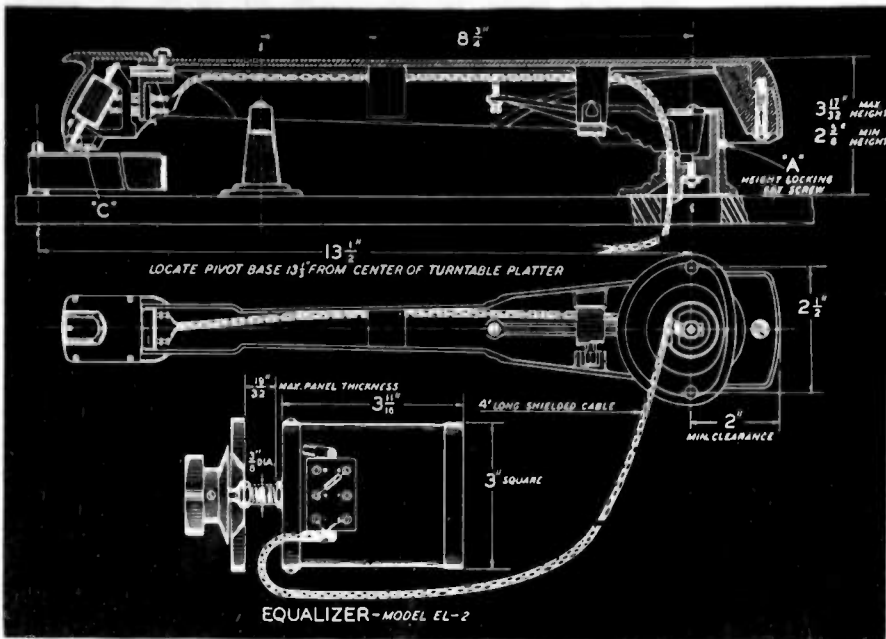

## PARA-FLUX REPRODUCERS WITH NEW MODEL EL-2 EQUALIZER

for realistic reproduction of transcriptions

NOW  
AVAILABLE



Universal  
Reproducer



Lateral Only  
Reproducer



Vertical Only  
Reproducer

The New Model EL-2 EQUALIZER has all components enclosed in one compact housing. This built-in feature replaces the old-style two-piece equalizer, and also eliminates heavy cable. The newly designed Equalizer, in one complete package, embodies double housing which gives double shielding against hum pickup. Combines the switch mechanism as well as impedance matching and correct equalization for following switch positions:

- VERTICAL NO. 1—Linear output from 40 to beyond 11,000 C.P.S.
- VERTICAL NO. 2—Linear output from 40 to 1500 C.P.S. with roll-off to -10 D.B. at 10,000 C.P.S.
- LATERAL NO. 1—Linear output from 40 to beyond 11,000 C.P.S. for N.A.B. pre-emphasis.
- LATERAL NO. 2—Linear response from 40 to beyond 11,000 C.P.S. for orthacoustic pre-emphasis.
- LATERAL NO. 3—Linear from 40 to 3500 C.P.S. with roll-off to -10 D.B. at 10,000 for shellac recording.

Output impedance: 30, 250, and 500/600 ohms.

Equalizer requires only single  $\frac{3}{8}$ " dia. hole for mounting. Accommodates any panel thickness from  $\frac{1}{16}$ " to  $\frac{19}{32}$ ".

The PARA-FLUX REPRODUCER, with interchangeable heads for Vertical, Lateral or Universal, uses only one arm and Equalizer. All possess the same impedance matching to the Equalizer. High output level affords an important advantage in broadcasting as to value of signal level to background noise. Each head is fitted with a selected, hard African diamond stylus, polished and finished to tolerance of 1/10,000 of an inch. Universal and Vertical: 2 mil. radius. Lateral: 2.5 radius. "Hair-line" indicator on head and precise stylus construction make accurate cuing possible and permit "back-tracking" without damage to record or reproducer.

Reproducer is sturdily built, embodies up-to-the-minute features, including convenient finger lift which prevents Reproducer from slipping when lifted off record.

More than 1,000 PARA-FLUX REPRODUCERS are now on the air over FM and AM stations. Also widely used by recording studios, wired program services, sound distribution systems, and for high fidelity home sets.

AVAILABLE THROUGH AUTHORIZED JOBBERS  
Descriptive, illustrated Bulletin PR51, upon request.

**RADIO-MUSIC CORPORATION**  
EAST PORT CHESTER CONN.



(Continued from page 50A)

### ENGINEER

A mid-western manufacturer has an opening for a graduate engineer with a broad background in electronic circuit design and instrumentation. Experience with pulse technique, servo-systems or telemetering procedure is particularly desirable. Unlimited opportunity in a specialized and highly interesting field is offered. A complete résumé should be submitted. Box 469.

### ELECTRONICS ENGINEER

Electronics engineer wanted for responsible position in development of instruments for radiation measurement. Degree and several years' experience plus initiative and ability to follow through are desired. Background in instrumentation, electronics associated with nuclear physics is advantageous. Box 470.

### CHIEF ENGINEER

Chief engineer and works manager wanted by first company to deliver projection television. Heavy experience Ultra High Frequency circuit characteristics and mechanical layout in engineering required. Mechanical layout of radio chassis, production and testing techniques. Resourcefulness, initiative, foresight, sound judgment, willingness to assume responsibility for own decisions. Ability to enforce discipline, to locate and eliminate unnecessary overhead. Salary high—only heavy weights need apply. United States Television Manufacturing Corporation, 3 West 61st Street, New York 23, N.Y.

### ELECTRONICS ENGINEER

A large research and manufacturing company has openings for men with B.S. or M.S. in physics or engineering. Ages between 28 and 35 years. Must have 2 years' experience on the development of electronic measuring instruments; experience in the design of radar circuits or in servo-mechanism techniques. Box 471.

### INSTALLATION—SERVICE PLANNER

Scheduler for television installation work controlling by telephone incoming calls from sets in the field and service men. Some knowledge of electronics. Clear head and steady personality required. Ex-officer preferred. Salary \$50.00 to start, \$60.00 in 60 days if satisfactory. Apply United States Television Mfg. Corporation, 3 West 61st Street, New York 23, N.Y.

### RADIO COMPONENT ENGINEER

Experienced in design of RF and IF components and FM circuits essential. Excellent opportunity for qualified man. Please send a complete résumé. Automatic Manufacturing Corporation, 900 Passaic Ave., East Newark, New Jersey.

# ANNOUNCING the ML-5604

(water cooled type ML-5619)

**Specially designed to meet the severe conditions of RF heating service**

Machlett Laboratories now makes available, for early delivery, two new tubes—the ML-5604 for forced air cooling and the ML-5619 for water cooling—both specifically designed to withstand the rigorous and non-uniform operation inherent in industrial heating applications. In the development of every feature of these tubes, such conditions as widely varied loads, severe vibration, heavy irregular physical shocks and operation by personnel untrained in electronics, have been given full consideration.

- A.** Heavy wall high conductivity copper anode—specially processed.
- B.** One piece high conductivity copper grid and filament support terminals . . . for maximum strength, minimum lead resistance and elimination of electrode distortion.
- C.** Improved filament spring design. Minimizes bowing and increases filament life.
- D.** Chemically cleaned, vacuum fired internal parts for longer life and stable operation.
- E.** Stronger self-supporting grid for uniform electron control.
- F.** Rugged kovar grid and filament seals.
- G.** Rigidly supported grid and filament assemblies. Glass surfaces completely shielded against electron bombardment and radiant filament energy.
- H.** Glass contour provides long leakage path and more efficient cooling.
- I.** Rugged kovar plate seal located in air stream.
- J.** Gold plated contact surfaces. Insure permanent low contact resistance.

These completely new tubes are an outstanding contribution to industrial electronics. They may, of course, also be used for communications purposes. For further information, write Machlett Laboratories, Incorporated, Springdale, Conn.

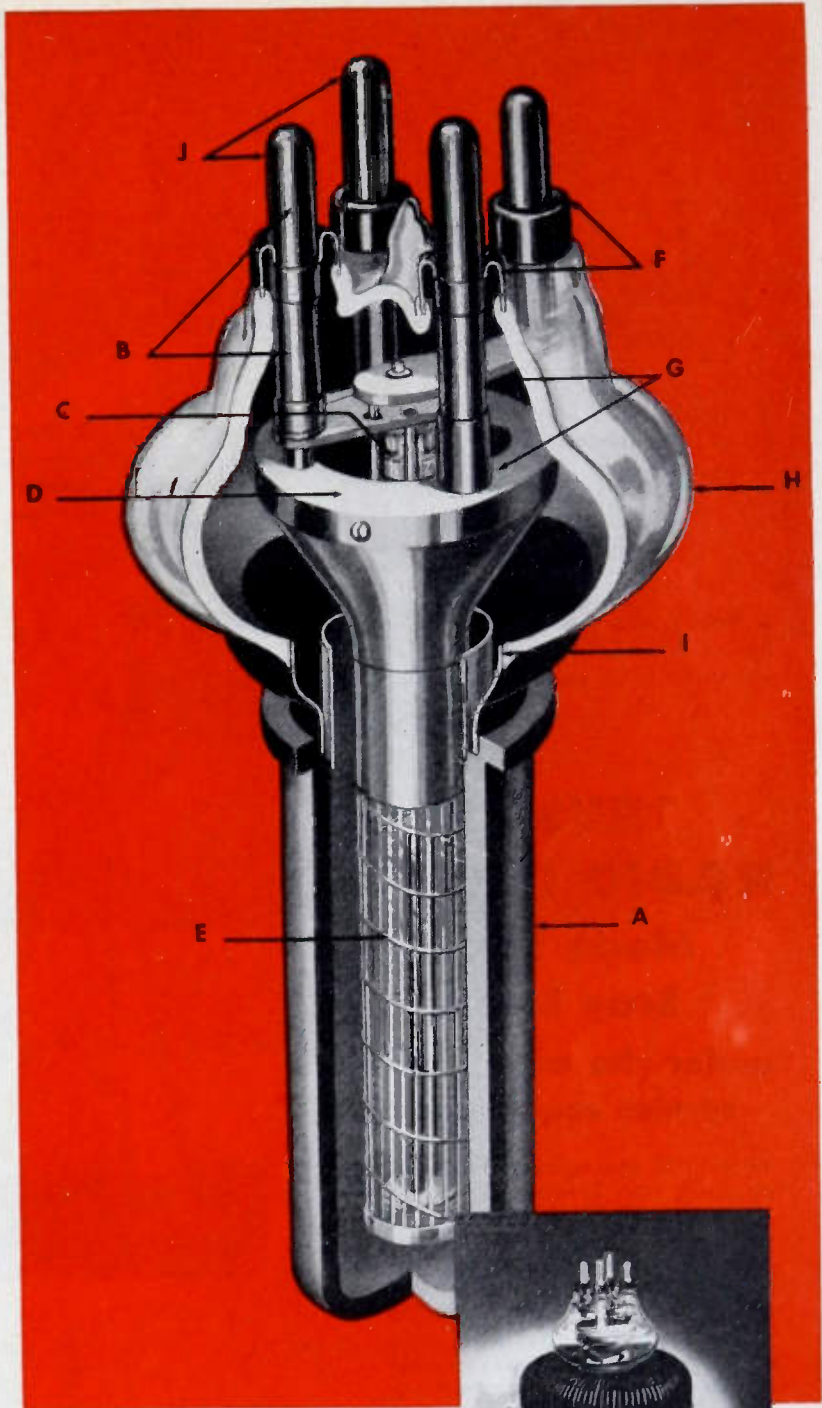

**MACHLETT**

**50 YEARS OF ELECTRON TUBE EXPERIENCE**

### ML-5604 TRIODE R.F. HEATING OSCILLATOR AND POWER AMPLIFIER

Filament . . . . . Tungsten  
Voltage . . . . . 11.0 a.c. Volts  
Current . . . . . 180 Amps.  
Starting: The filament current must never exceed 270 Amps., even momentarily.

AMPLIFICATION FACTOR: 18.5  
DIRECT INTERELECTRODE CAPACITANCES:

Plate to Grid . . . . . 25 mmfd  
Plate to Filament . . . . . 1.25 mmfd  
Grid to Filament . . . . . 30 mmfd

COOLING: Minimum air flow through radiator  
750 c.f.m. @ 1.25" back pressure.  
Minimum air flow of 15 c.f.m. from  
3" nozzle on center of dish.

### OPERATION:

Maximum ratings, Absolute values:  
D.C. Plate Voltage . . . . . 10000 max. Volts  
(Note 1)  
D.C. Grid Voltage . . . . . -2000 max. Volts  
D.C. Plate Current . . . . . 2.75 max. Amps.  
D.C. Grid Current . . . . . .40 max. Amps.  
Plate Input (Note 2) . . . . . 27.5 max. KW  
Plate Dissipation . . . . .  
(Note 3) . . . . . 10 max. KW  
Max. Frequency for full ratings . . . . . 30 mc  
Max. Anode Temperature . . . . . 230° C  
Max. Glass Temperature . . . . . 160° C

(Note 1): For operation below 5 mc, 12,500 max. D.C. plate volts may be used.  
(Note 2): For operation below 5 mc, Plate Input may be 32.5 KW max.  
(Note 3): Plate Dissipation water-cooled (Type ML-5619) 20 KW max.





## Positions Wanted By Armed Forces Veterans

In order to give a reasonably equal opportunity to all applicants, and to avoid overcrowding of the corresponding column, the following rules have been adopted:

The Institute publishes free of charge notices of positions wanted by I.R.E. members who are now in the Service or have received an honorable discharge within a period of one year. Such notices should not have more than five lines. They may be inserted only after a lapse of one month or more following a previous insertion, and the maximum number of insertions is three per year. The Institute necessarily reserves the right to decline any announcement without assignment of reason.

### SALES ENGINEER

B.S.E.E. 1944, Northeastern, Tufts. Tau Beta Pi. Age 24. Married. Navy officer, radar course Bowdoin, M.I.T., sea duty, destroyer; employed one year as electronic research engineer. Presently taking courses in salesmanship, sales management. Desires sales engineering position, preferably New England, Box 62 W.

### ENGINEER

B.S.E.E. 1938. Now studying management engineering; 3 years' Navy electronic officer and radar instructor; 3 years' x-ray field, 1 year electronic design. Desires position in decent climate at sufficient salary to properly raise a family. Prefers managerial duties. Box 63W.

### ENGINEER

B.S.E.E. University of Pittsburgh. Age 25. Married. Officer Signal Corps, installing transmitters, RTTY, and navigational aids for the Air Forces; Two years' experience in electronics research laboratory; Desires position near Pittsburgh, Pa. Box 65W.

### ELECTRICAL ENGINEER

B.E.E. 1945, College of the City of N.Y. Age 21; single; worked several months in radio development. Desires development work in radio or electronics in vicinity of New York City. Box 67W.

### ELECTRONICS ENGINEER

B.S.E.E., Iowa State, M.S.E.E., Purdue. Columbia, Bowdoin and M.I.T. trained Naval electronics officer; Two years' part time commercial broadcasting. Two years' Naval radar radio afloat. One year electronic research. Phi Beta Pi, Theta Kappa Nu. Box 81W.

### INVENTOR—ELECTRICAL ENGINEER

Training in theoretical mechanics and electronics. Diversified experience. Harvard 1929. Desires part time position, research and development, preferably on unusual project requiring best fundamental training and initiative. Location preferred Washington or East coast. Box 82W.

(Continued on page 56A)

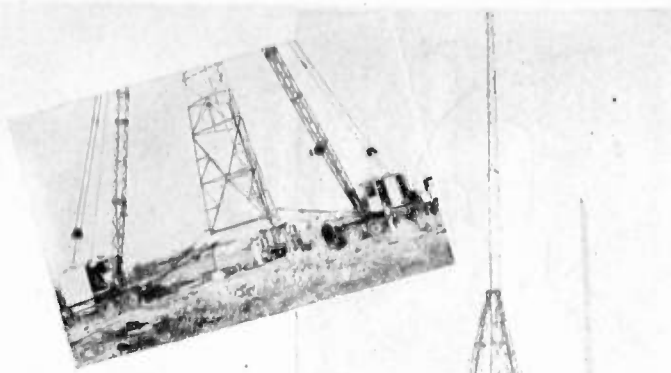

1. WSPR Truscon Tower being lifted from old foundation.

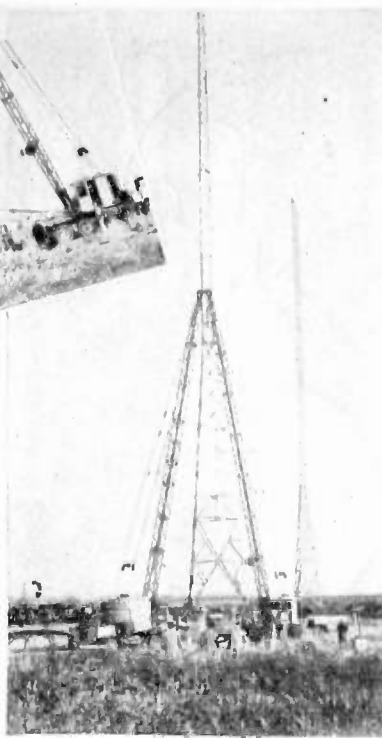

2. WSPR Truscon Tower suspended between cranes and steadied by four guys.

3. WSPR Truscon Tower on ground between old and new base.

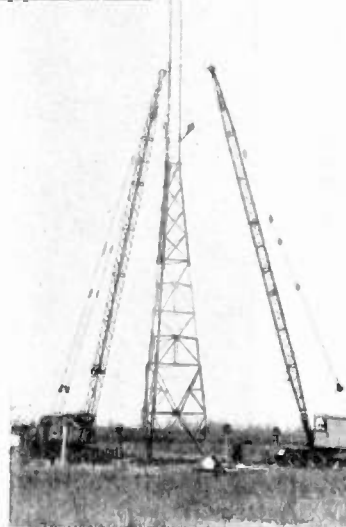

4. WSPR Truscon Tower being set on new piers 50 feet from old location.

## TRUSCON RADIO TOWERS Made Strong Stay Strong under the most difficult service requirements

● WSPR, Springfield, Mass., owns and operates two Truscon Radio Towers. Recently it was necessary to move one of the towers 50 feet to a new foundation. The Truscon tower was left intact . . . even the tower lights were left in position . . . the whole job of moving, as shown by the sequence of photos here, was accomplished in two days . . . and the tower was put back into service immediately.

This is a typical example of Truscon Radio Tower ruggedness—the result of good engineering, good materials and good construction. Truscon can engineer any type of tower you desire . . . guyed or self-supporting, either tapered or uniform cross-section . . . tall or small . . . AM or FM. Truscon engineering consultation is yours without obligation. Write or phone our home office at Youngstown, Ohio, or any of our numerous and conveniently located district sales offices.

**TRUSCON STEEL COMPANY**  
YOUNGSTOWN 1, OHIO  
Subsidiary of Republic Steel Corporation

Manufacturers of a Complete Line of  
Self-Supporting Radio Towers . . .  
Uniform Cross-Section Guyed Radio  
Towers . . . Copper Mesh Ground  
Screen . . . Steel Building Products.



# K-TRAN



**ECONOMICAL**—K-TRANS cost less to purchase—less to use.

**EFFICIENT**—K-TRANS will duplicate or exceed the performance of your present i.f. transformers.

**STABLE**—Permeability tuning, magnetic shielding of windings, silver mica condensers combine to give a stability never before obtainable in a standard commercial i.f. Transformer.

**VERSATILE**—Four models of K-TRAN meet all 455 KC requirements. Also available for 262 K.C., and 10.7 M.C. for F.M. receivers.



MASS PRODUCTION COILS & MICA TRIMMER CONDENSERS

900 PASSAIC AVE.

EAST NEWARK, N. J.

# S.S. WHITE FLEXIBLE SHAFTS

*satisfy every need for*

**SMOOTH,  
SENSITIVE REMOTE CONTROL**

**OVER SHORT DISTANCES**

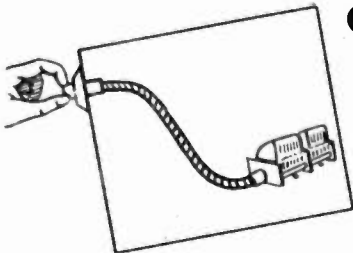

**... OVER LONG DISTANCES**

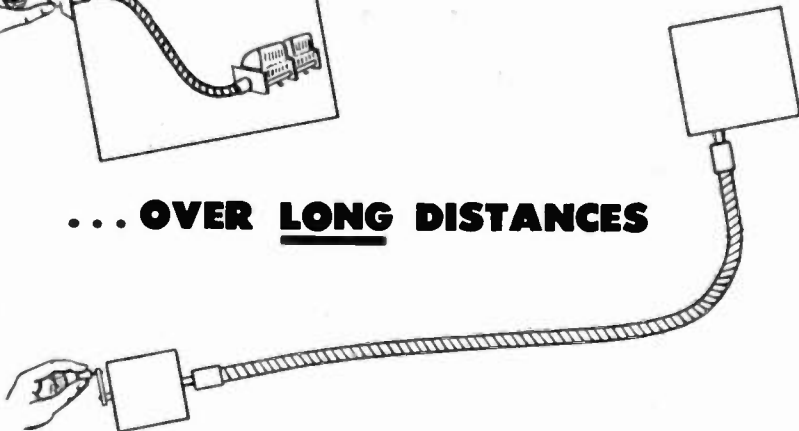

S.S.White remote control type flexible shafts are specially engineered and built for remote control applications. Their torsional deflection under load is very small and is the same for either direction of rotation.

With these S.S.White remote control flexible shafts you can get smooth, easy operation with any required degree of sensitivity over long distances as well as short. For the full story,

**WRITE FOR 260-PAGE HANDBOOK—FREE**

It gives complete facts and technical data about flexible shafts and their application. A copy will be sent free if you write for it direct to us on your business letterhead and mention your position.



## S.S. WHITE

THE S. S. WHITE DENTAL MFG. CO.

## INDUSTRIAL DIVISION

DEPT. G TO EAST 40TH ST., NEW YORK 16, N. Y.

FLEXIBLE SHAFTS • FLEXIBLE SHAFT TOOLS • AIRCRAFT ACCESSORIES  
SMALL CUTTING AND GRINDING TOOLS • SPECIAL FORMULA BUBBLES  
MOLDED RESTORES • PLASTIC SPECIALTIES • CONTRACT PLASTICS MOLDING



*One of America's AAA Industrial Enterprises*

## Positions Wanted

(Continued from page 54A)

### JUNIOR ENGINEER

B.E.E., Cornell University, 1946. Age 21. Single. Desires position in radio, television or electronics. Prefer Detroit area. Box 83W.

### SALES ENGINEER

M.S. in E.E., Boston College, 1940. B.S., Boston College, 1938. Age 30. Two years' teacher, public schools, college physics. Fellowship, Boston College. Desires position in technical sales or application engineering field. Has had experience as research physicist, production engineer, assistant sales engineer. Prefers New England location. Box 85W.

### ENGINEER

B.E.E., Rensselaer, Army officer, Harvard and M.I.T. training, teaching electronics at night, college level, 3 years' experience with LORAN, Countermeasures equipment, and servos, 1 year experience in the coke industry. Desires association with the electronic industry in Boston, Mass. Box 86W.

### JUNIOR ENGINEER

Completing Junior Engineering, two non-electrical courses for B.E.E. degree N.Y.U. Desires work in industrial electronics or sales engineering in metropolitan area. Age 29. Details on request. Box 87W.

### ELECTRONICS ENGINEER

Experienced receiver and transmitter design and production, F.M., A.M.; B.S. London. Age 31. 1934-37, RX designer large British radio firm; 1937-39 Air Ministry production of airborne RX and TX equipment; 1935-45 R.A.F. pilot 3,500 hours, transatlantic Captain; 1945 to date, technical director of large broadcasting station designing FM equipment, and color television. Speak French, well traveled. Desire position Connecticut or New York area. Consider representation or sales engineering. Box 88W.

### JUNIOR ENGINEER

Age 23. Married, 2 children. Experienced in design and all other phases of aids to aeronautical navigation, radio communications and broadcasting, radar, GCA, etc. 1st Class phone license. Now in charge of a CAA communications station. Prefer west coast. Résumé on request. Dan W. Crockett, MTIC, UMIAT Radio, c/o Box 1310, Fairbanks, Alaska.

### INSTRUCTOR

B.S.E.E. '43 Washington University, M.E.E. Cornell due in June. Bowdoin M.I.T. radar school; Experience: some radio industry, some teaching, Navy Elec. Off.; Tau Beta Pi, Sigma Xi, Ham; Married; Midwest preferred. Box 90W.

### RADIO ELECTRONICS ENGINEER

Desires Paris position in September, 1947. Worcester Polytechnic Institute, Sigma Xi; 8½ months Navy Radar Bowdoin, M.I.T., A.M. Harvard. Experience: 2½ years RadLab. M.I.T., 1½ years Airborne Radar Navy, 3 months microwave, 9 months patent work, 3 months Optic Research Lab. Box 103W.

(Continued on page 58A)

**FOR YOUR CONVENIENCE . . .**

**PANEL INSTRUMENTS NOW AVAILABLE**

*Right Off the Shelf!*

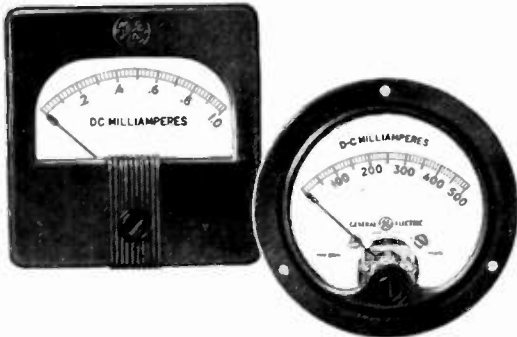

To supply you with instruments at the time you need them, General Electric is accumulating a stock of 3½-inch, round and rectangular panel instruments in all the popular ratings. No waiting for delayed shipments . . . just place your order and they're on the way to you.

#### NEW DISCOUNT BENEFITS

Also, more favorable prices, made possible by new discount benefits, are now available to you when ordering these standard types and ratings.

Included in these stocks of compact, high-quality G-E instruments are ammeters, voltmeters, milliammeters, and microammeters . . . instruments for applications where AVAILABILITY counts.

#### INSTRUMENTS MADE TO ORDER

In addition, General Electric is equipped to solve your individual instrument problems. Requests are welcomed for special, made-to-order instruments to be incorporated in your product where standard models cannot be used. For further information contact your General Electric representative or write to Apparatus Department, General Electric Company, Schenectady 5, N. Y.

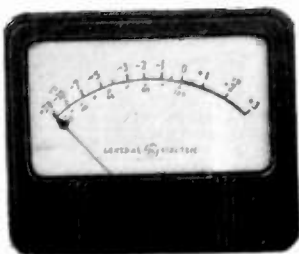

**VU METERS** are now normally stocked in the following styles: non-illuminated, no mask, "A" scale; illuminated, no mask, "A" or "B" scale. Black covers are standard; gray covers can be furnished.

HEADQUARTERS FOR MEASUREMENTS

**GENERAL  ELECTRIC**

002-106



**BUILT TO STAND  
THE GAFF!**

★ Specify "GREENOHMS" if you want the toughest things in power resistors. For Greenohms are those green-colored cement-coated power resistors found in the finest receivers, amplifiers, transmitters and other electronic assemblies.

Greenohms have proved that "they can take it" day after day, year in and year out. Handle heavy overloads without flinching. The exclusive cold-setting cement coating means that wire winding is unimpaired in fabrication. Withstands high temperatures and sudden cooling, on-off operation, without cracking, flaking, peeling. No tougher power resistors are made.



★ Write for DATA . . .

Bulletin 113 sent on request. Contains all necessary engineering data on standard and special Greenohms to meet your particular requirements. Let us quote on your needs.



CLAROSTAT MFG. CO., Inc. • 285-7 N. 6th St., Brooklyn, N. Y.

## Positions Wanted

(Continued from page 56A)

### ENGINEER

B.S. in E.E., Graduate work, Ohio State University, Princeton. Three years' civilian with A.G.F. development and research engineer on H.F. and V.H.F., F.M. and A.M. Mobile communications equipment. One and a half years with A.A.F., microwave R.C.M. development. Desires equivalent position or sales engineer in New York. Box 104W.

### RADIO ENGINEER

B.S.E.E. Age 24. Married. Some graduate work, 2 years' high frequency oscillator and antenna design, development, RCA. Half year radio frequency engineer, CBS. Half year microwave relay advisor, Army Signal Corps. Desires highly responsible position. Box 105W.

### AVIATION RADIO ENGINEER

I am interested in making another long term affiliation in Aviation Radio with a progressive and reputable company who can advantageously use my 18 years of pilot, receiver design and domestic and foreign sales engineering experience. Box 106W.

### JUNIOR ENGINEER

Graduating Michigan in June 1947 with B.S.E.E. Tau Beta Pi, Eta Kappa Nu. 1 year Army experience with receivers, radioteletype, low power transmitters (all up to 30 MC). Speaks French, German and English. HAM, first phone license. Interested in production or development work. Details on request. Box 107W.

### SENIOR ELECTRONIC ENGINEER

Graduate engineer. 20 years' experience, receiver development, sound systems, university teaching, sales promotion, advertising, editing electronics magazine. War experience, Airborne radar, some experience guided missiles. Interested in development or application engineering, liaison, advertising, personnel or editorial position. Box 108W.

### ELECTRONICS ENGINEER

Since 1922 in many phases; 10 years in broadcasting, 5 years a Chief Engineer, 5 years Naval Electronics (Commander). Radiophone first license. Experienced writer, speaker. Personable. Résumé of experience on request. Box 109W.

### RADIO ENGINEER

B.S.E.E. 1943, University of Michigan. 8 years' radio service; 10 years' amateur, Class A; 1st Class radio-phone; 1 year industrial electronics research; Harvard-M.I.T., radar; New London, submarine sonar and radar; 1 year instructing; present manager of manufacturing concern, design, setup, sales and advertising. Box 110.

**MICRODIMENSIONAL  
WIRE & RIBBON  
FOR VACUUM TUBES**

Wires drawn to .0004" diameter.

Ribbon rolled to .0001" thickness.

Special Alloys for individual requirements.

WRITE for list of stock alloys.

**SIGMUND COHN & CO.**  
44 GOLD ST. NEW YORK  
SINCE 190



# WILCOX 2500 WATT

*Transmitter*

*Performance  
Easy Maintenance  
Dependability*

The WILCOX 96C Transmitter is used throughout the world by the Army Air Force Communications System, and by foreign and domestic air-carriers. It has earned the respect of operators and engineers because:

- ✓ 1 **SIMULTANEOUS CHANNEL OPERATION** on several frequencies brings new flexibility and operational ease; increases by 3 times the volume of traffic normally handled.
- ✓ 2 **INSTANTLY REMOVABLE COMPONENTS** make maintenance easy. The transmitter slides from its cabinet like a desk drawer. Plugs, receptacles, and clips make all components easily removable for servicing while adjacent channels continue to operate.
- ✓ 3 **RESEARCH AND ENGINEERING** combined with modern production techniques have produced a transmitter capable of sustained operation through all conditions of temperature, humidity, and weather.

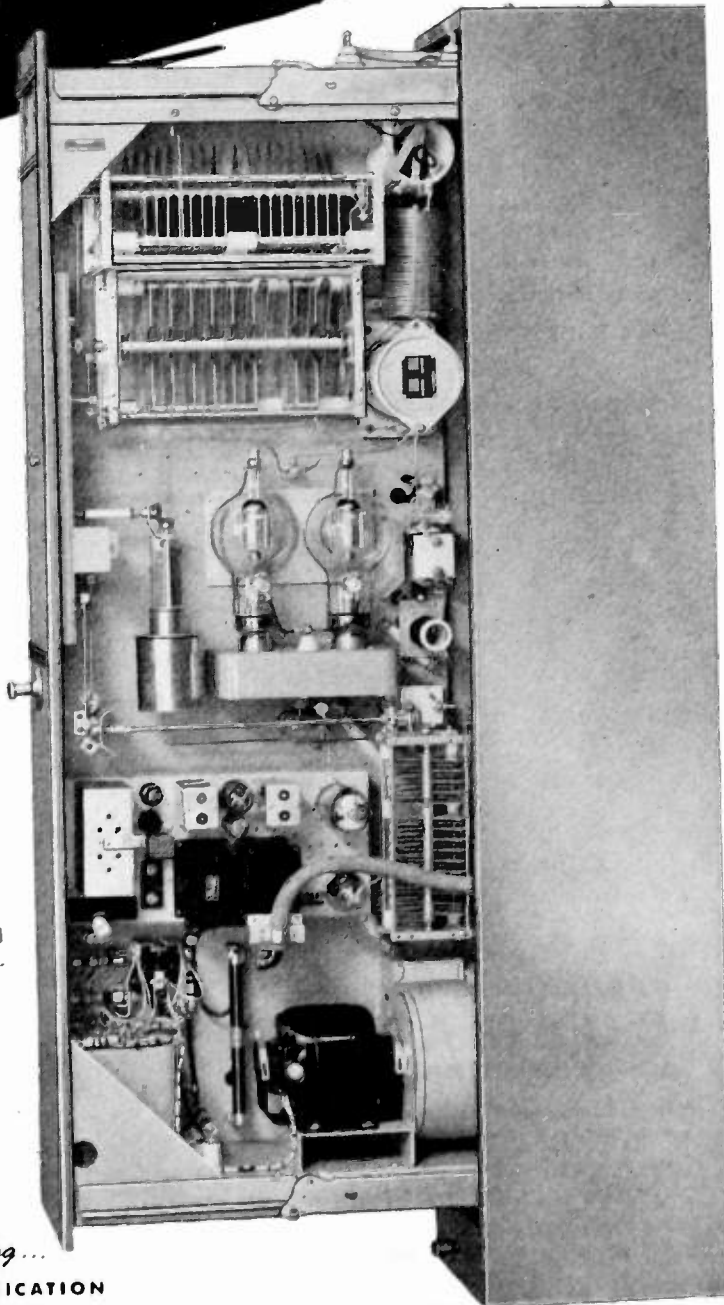

*Write for Free Catalog...*

**DEPENDABLE COMMUNICATION**

**WILCOX ELECTRIC COMPANY, INC.** • Kansas City 1, Missouri

# STANDARD SIGNAL GENERATOR

**MODEL  
65-B**  
**RANGE  
75 KC  
to  
30 MC**



## Individually Calibrated Scale

**OUTPUT:** Continuously variable, .1 microvolt to 2.2 volts.  
**OUTPUT IMPEDANCE:** 5 ohms to .2 volt, rising to 15 ohms at 2.2 volts.  
**MODULATION:** From zero to 100%. 400 cycles, 1000 cycles and provision for external modulation. Built-in, low distortion modulating amplifier.  
**POWER SUPPLY:** 117 volts, 60 cycles, AC.  
**DIMENSIONS:** 11" high, 20" long, 10 1/4" deep, overall.  
**WEIGHT:** Approximately 50 lbs.

Catalog on request

**MANUFACTURERS OF**  
Standard Signal Generators  
Pulse Generators  
FM Signal Generators  
Square Wave Generators  
Vacuum Tube Voltmeters  
UHF Radio Noise & Field Strength Meters  
Capacity Bridges  
Megohm Meters  
Phase Sequence Indicators  
Television and FM Test Equipment

**MEASUREMENTS CORPORATION**  
SOONTON NEW JERSEY

# News—New Products

These manufacturers have invited PROCEEDINGS readers to write for literature and further technical information. Please mention your I.R.E. affiliation.

(Continued from page 48A)

## Sub-Miniature Inductors

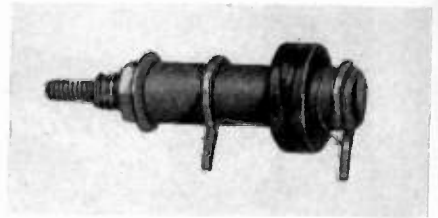

Supplementing the Cambridge Thermionic Corporation, 445 Concord Ave., Cambridge 38, Mass., line of slug-tuned inductors, new sub-miniature inductors have been added. Known as Type LSM, they are particularly useful where a variable inductance is desired and space is limited. Their height when mounted is only 7/8". These units are available in a group of windings which cover normal inductance ranges and special windings may be obtained to meet other specifications.

## UHF Double Triodes

Two new double triodes providing single-ended operation for cascade amplifiers operating at frequencies up to 400 megacycles are being manufactured by the Radio Tube Division of Sylvania Electric Products, Inc., 500 Fifth Avenue, New York 18, N. Y. These high mutual-conductance tubes have independent elements with the exception of heaters permitting an appreciable saving in space and number of tubes required.



Circuit applications include grounded-grid, cathode follower, and push-pull amplifiers and converters in FM and television bands where low equivalent noise resistance, obtained with triode converters, is desirable. Type 7F8 is supplied with a 6.3 volt, 0.300 ampere heater. Similar ratings for Type 14F8 are 12.6 volts and 0.150 ampere. Heaters may be operated from an alternating or direct current source.

(Continued on page 62A)



for experienced  
cooperation  
"call Cleveland"

## applications of COSMALITE\*

A SPIRALLY LAMINATED PAPER BASE PHENOLIC TUBE

For coil forms in all standard broadcast receiving sets, specify #96 Cosmalite.

For permeability tuners, specify SLF Cosmalite.

LOWER COSTS . . . Quick deliveries

Ask about our spirally wound kraft and fish paper Coil Forms and Condenser Tubes.

\*Trade Mark Registered.

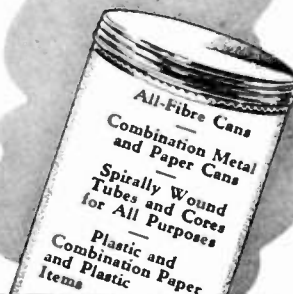

**The CLEVELAND CONTAINER Co.**  
6201 BARBERTON AVENUE CLEVELAND 2, OHIO

PRODUCTION PLANTS also at Plymouth, Wisc., Ogdensburg, N. Y., Chicago, Ill., Detroit, Mich., Jamesburg, N. J.  
PLASTICS DIVISIONS at Plymouth, Wisc., Ogdensburg, N. Y. • ABRASIVE DIVISION at Cleveland, Ohio  
New York Sales Office—1186 Broadway, Room 223

IN CANADA—The Cleveland Container Canada Ltd., Prescott, Ontario



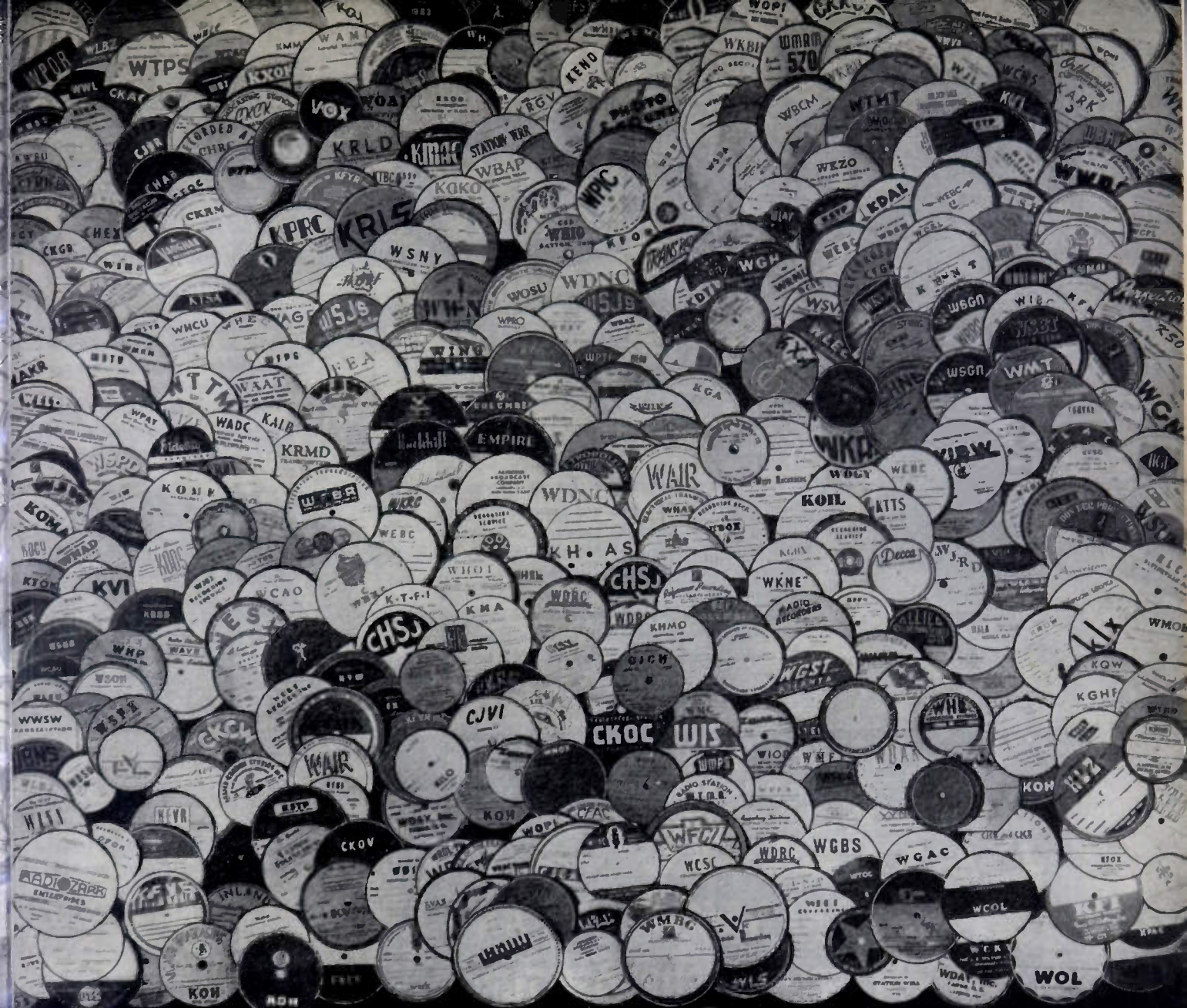

*For Recording Quality*

**EVERYWHERE . . . it's audiodiscs\***

Everywhere, when quality is important, **AUDIODISCS** are referred over all other recording blanks combined.

This universal acceptance by recording engineers in radio, motion pictures, commercial recording studios, and in the production of phonograph records, is the natural result of the consistent high quality of these fine recording discs.

For **AUDIODISCS** are manufactured by a patented precision-machine process which assures uniform results, and **AUDIODISC** recording lacquer is produced in our own plant

from a formula developed by our research engineers. The manufacturing process is thus fully controlled from raw materials to the finished disc.

Praise of **AUDIODISCS** comes from everywhere, not only from all fields of recording, but from every type of climate. In arctic cold or the heat and humidity of the tropics, **AUDIODISCS** are consistently dependable.

There is an **AUDIODISC** designed for every recording need. See your local distributor or write:

**AUDIO DEVICES, INC.,** 444 Madison Avenue, New York 22, N.Y.

Export Department: **Rocke International Corp.,** 13 E. 40th Street, New York 16, N.Y.

*AudiDiscs are manufactured in the U. S. A. under exclusive license from PYRAL, S. A. R. L., Paris.*

\* Reg. U.S. Pat. Off.

*they speak for themselves* **audiodiscs**





## News—New Products

These manufacturers have invited PROCEEDINGS readers to write for literature and further technical information. Please mention your I.R.E. affiliation.

(Continued from page 60A)

### Continuous Length Stampings

Significant savings in assembly and handling time, as well as lower piece cost for springs and small stampings, are made possible by a continuous-strip production method developed by Instrument Specialties Company, Inc., 270 Bergen Blvd., Little Falls, N. J.

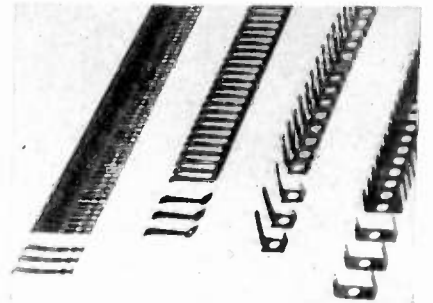

Individual small springs are fabricated of beryllium copper in continuous lengths with sections between parts partially sheared through. Attachment between parts is sufficiently strong to keep lengths intact during inspection, plating, handling, and shipment. Individual pieces snap off easily when ready for assembly. Lengths may be inserted in a dispenser at assembly benches, allowing the operator to break off individual pieces as needed, making a one-handed operation which is simple, rapid, and eliminates time-wasting untangling.

### Antenna Switch

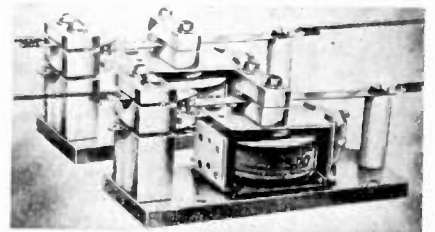

A new type of antenna-switching relay is being manufactured by the Advance Electric & Relay Company, 1260 W. 2nd St., Los Angeles 26, Calif. To facilitate switching of two-wire open lines, twin relays can be spaced the same distance apart as the transmission line. Any spacing down to two inches is possible thus minimizing discontinuities in line spacing and line impedance.

(Continued on page 64A)

PROCEEDINGS OF THE I.R.E. June, 1947



### EDGEWISE-WOUND COPPER STRIP COILS

(Steatite or Glass  
Bonded Mica Insulated)

No size limitations—custom built for specific applications

These large B & W coils are popular for tank circuits, antenna matching networks and similar applications where rugged dependability must be combined with design adaptability to meet individual conditions. Custom built units, based on standard B & W designs are available in either fixed, tapped or continuously variable types and with either fixed link or fixed variable link in any combination. Send details of your application for recommendation and quotation.

**BARKER & WILLIAMSON, Inc.**  
237 Fairfield Ave., Upper Darby, Pa.

**HUGE STOCKS!**

## TRANSMITTING AND SPECIAL PURPOSE TUBES

**WRITE FOR  
NEWARK'S LIST OF TUBES**

Make Newark your source, too, for all needed radio and electronic parts. Brisk, competent service assures quick delivery.

### NEWARK NOW AGENTS OF WAR ASSETS ADMINISTRATION

Newark has been appointed agents of the War Assets Administration for transmitting and special purpose electronic tubes.

### HUGE STOCKS! WIDE SELECTION!

This means that you can now get prompt Newark service on the previously hard-to-get tubes, priced at a fraction of their original cost. Make Newark your headquarters for tubes — whether it's for experimental work or production runs.

ACTING AS AGENTS FOR WAR ASSETS ADMINISTRATION UNDER CONTRACT WAS(p) 7-167

NEW YORK  
Offices & Warehouse  
242 W. 55th St., N.Y. 19

**NEWARK** TELEPHONE  
CIRCLE 6-4060  
**ELECTRIC COMPANY, INC.**

New York City Stores: 115-17 W. 45th St. & 212 Fulton St.

• MAIL AND PHONE ORDERS  
FILLED PROMPTLY

• WRITE: 242-N WEST 55th  
STREET, NEW YORK CITY



# "A HEAD OF THE TIMES"

**All** recessed head screws and bolts have definite advantages over the older, slotted head type but only Reed & Prince recessed heads can be driven in any size from the smallest to the largest—  
**WITH ONE DRIVER!**

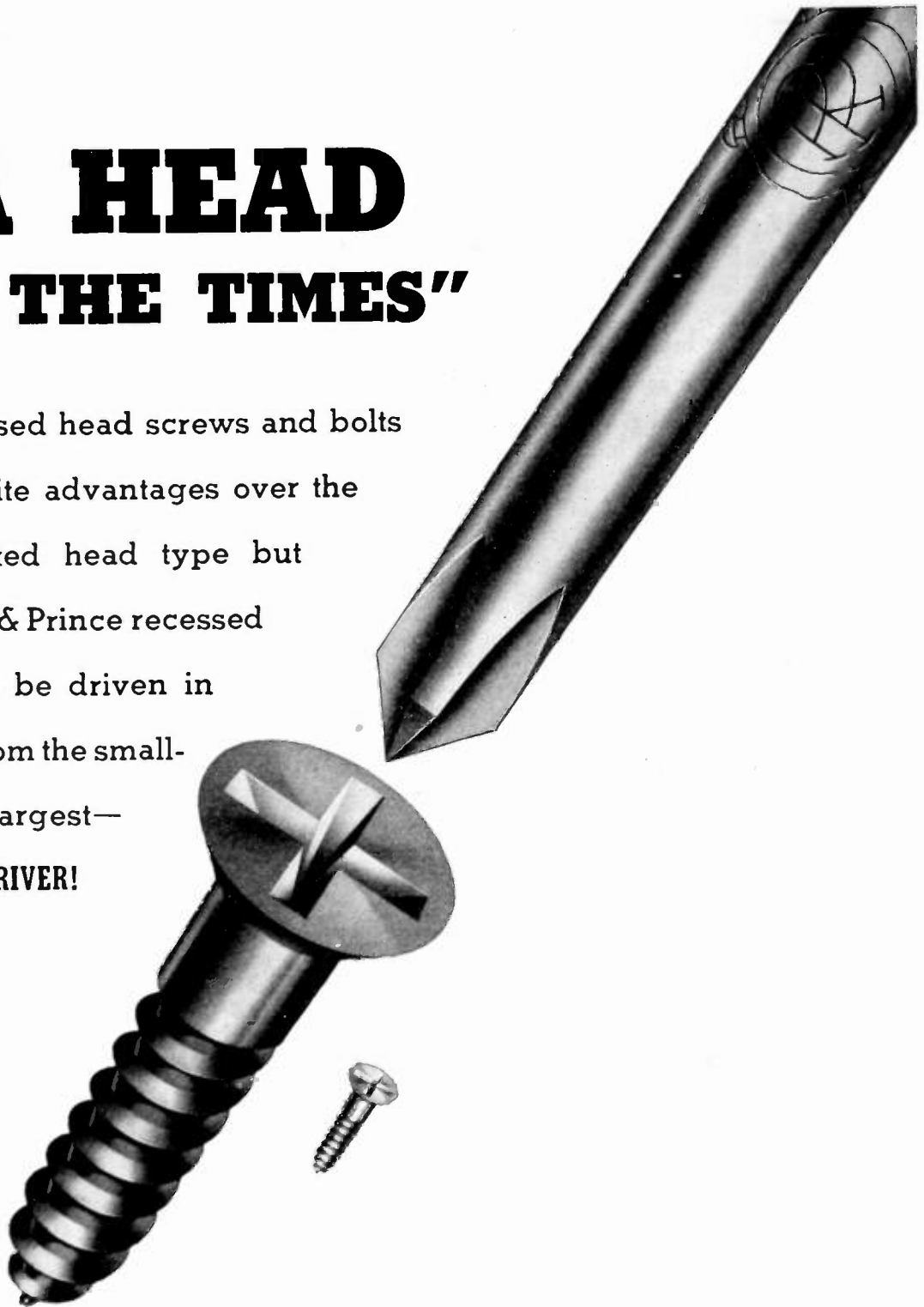

We make Hand Drivers and Bits for power Drivers with long, short and special shafts, but the POINT is always the same! Buy Reed & Prince.

# REED & PRINCE

MANUFACTURING COMPANY

CHICAGO, ILL.

WORCESTER, MASS.

At last—

# THE RADAR ENGINEER'S HANDBOOK

—presenting  
up-to-date data  
on theory and  
practices of radar technology  
—telling how to design equipment  
—describing typical radar systems



Here is a comprehensive, handy reference guide to the practical and engineering aspects of radar. It is specifically designed to acquaint engineers and technical workers in radio and electronics with new techniques, and with special applications of old techniques used in radio detecting and ranging of objects. Completely covering radar theory and practice, this handbook gives you the fundamentals essential to understanding the practical and effective employments of radar apparatus, describes various radar systems developed and used during the war, and explains in technical detail, the design of specific radar equipment.

Just Out

# RADAR ENGINEERING

By DONALD C. FINK

Editor, *Electronics*; Formerly Staff Member, Radiation Laboratory, M.I.T.; and Expert Consultant, Office of the Secretary of War.

644 pages, 471 illustrations, 6x9, \$7.00

This is the first complete book on radar—bringing together in convenient form, full, authoritative data on the many individual developments to date in this field. It enables the engineer to understand quickly and easily the underlying theory of all branches of radar, and to judge critically the use of that theory in the design of radar equipment. It supplies many design formulas which may be applied not only in the fields of radar but in related fields of ultra-high-frequency and super-high frequency communication, in navigation

A partial list of the contents indicating the wide scope of radar theory and practice covered in this handbook.

- Introduction to Radar Concepts
- Radio Frequency Fundamentals
- Transmission Lines
- Waveguides
- Resonant Cavities
- Radiators and Reflectors
- Propagation and Targets
- Introduction to Radar Design
- Basic Radio-frequency Circuits and Structures
- Transmitters and Radiators
- Receivers
- Indicators & Scanners

aid, etc. Theoretical material includes data on pulse generation and transmission, wave-guides, reflection of radio energy, etc. Practical aspects covered deal with components, circuits, and structures used in radar equipment. The various types of equipment described are those employing wide range frequencies of 200, 600, 3,000, and 10,000 megacycles.

See it 10 days FREE

### MAIL THIS COUPON

McGraw-Hill Book Co., 330 W. 42 St., NYC 18

Send me Fink's Radar Engineering for 10 days' examination on approval. In 10 days I will send \$7.00, plus few cents postage, or return book postpaid. (Postage paid on cash orders.)

Name .....

Address .....

City and State .....

Company .....

Position ..... IRE 6-47

(For Canadian price, write: Embassy Book Co., 12 Richmond Street E., Toronto, 1)

## News—New Products

These manufacturers have invited PROCEEDINGS readers to write for literature and further technical information. Please mention your I.R.E. affiliation.

(Continued from page 62A)

### Discharge Capacitors



A new series of discharge capacitors for pulsed-lighting applications, such as speed-flash photography and high-intensity flashing signals, and beacons, has been announced by Solar Manufacturing Corporation, 285 Madison Avenue, New York 17, N. Y. All units are specially designed for energy-storage service with heavy internal leads to carry high discharge current. The manufacturer states that Type QLX series of discharge capacitors have a low inherent inductance, and are of special construction to minimize discharge stresses.

(Continued on page 66A)



KEEP continually POSTED on ELECTRON TUBES

### RCA HB-3 Tube Handbook

Now in 3 Binders—6 Volumes

No other tube handbook provides as much up-to-the-minute technical data on tube types as the RCA HB-3 Handbook, which has been a standard technical reference book for over 15 years. Indexed contents include general data, characteristic curves, socket connections, outline drawings, price lists, preferred-type lists, etc., for the complete line of RCA tubes.

New Sheets Mailed Regularly. The U. S. subscription price of \$10.00 brings you the complete Handbook in three binders, plus supplementary sheets containing new or revised data as issued during the year. Annual service fee thereafter is \$2.00. (These prices apply only in the U. S. and its possessions.)

Subscribe Now. Insure early delivery. Mail your remittance today to: RCA, Commercial Engineering, Section W-52F, Harrison, N. J.



with

# TRIPLETT Meters

5 BASIC MOVEMENTS IN SIZES FOR EVERY NEED



### METER HIGHLIGHTS

- FIVE BASIC MOVEMENTS—Electrodynamometer, moving iron, moving coil, thermocouple and rectifier types.
- RANGES—All standard ranges for every major instrument need.
- SIZES—2", 3", 4", 5", 6" and 7".
- STYLES AND FINISHES—Round, rectangular, square and fan; wide flange, narrow flange, flush, projection or portable. Available in molded or metal case.
- SPECIAL FEATURES TO ORDER—Rear illumination, special dials and other features available on most models.

# Triplett

ELECTRICAL INSTRUMENT CO.

BLUFFTON OHIO

PROCEEDINGS OF THE I.R.E. June, 1947



# UNEXCELLED

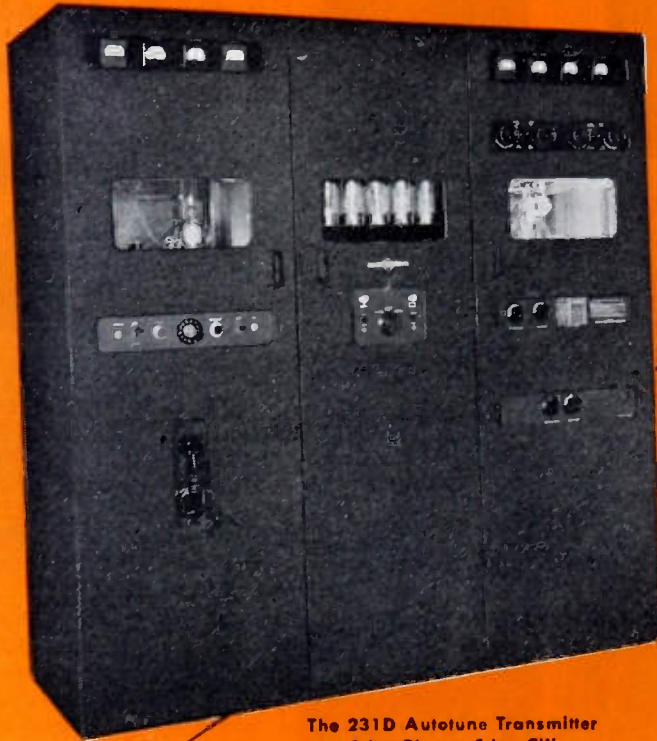

The 231D Autotune Transmitter  
3 kw Phone, 5 kw CW



The 16F Autotune Transmitter  
300 w Phone, 500 w CW



... for reliable communication

**IMMEDIATE DELIVERY**

You need a dependable, well engineered transmitter for point-to-point, ship-to-shore, or ground-to-plane commercial radio communication. The Collins 231D or the Collins 16F is the answer. These transmitters have proved themselves thoroughly reliable and efficient in all climates, and under difficult operating conditions.

Any one of eleven frequencies between 2.0 mc and 18.1 mc is available at the flip of a dial, with all circuits tuned and ready to operate. The widely acclaimed Collins Autotune system is utilized to shift the frequency quickly and accurately.

Compressor circuits are incorporated to raise the average modulation level during voice or MCW transmission. CW transmission is also available, with keying speeds of 60 wpm on MCW and 200 wpm on CW. Both transmitters can be adapted for frequency shift keying.

For dependable, trouble-free radio communication use either the 231D or the 16F. They are built for that purpose. Write today for free illustrated bulletins giving detailed information.

IN RADIO COMMUNICATIONS, IT'S ...



**COLLINS RADIO COMPANY, Cedar Rapids, Iowa**

11 West 42nd Street, New York 18, N. Y.

458 South Spring Street, Los Angeles 13, California



## UNIVERSAL PLATE SUPPLY TRANSFORMERS

Professional  
Series

CUSTOM BUILT—MASS PRODUCED

- "Electroseal" Construction ▶
- High Overload Capacity ▶
- Extreme Compactness ▶
- Complete Reliability ▶
- Unlimited Life ▶
- Fully Guaranteed ▶

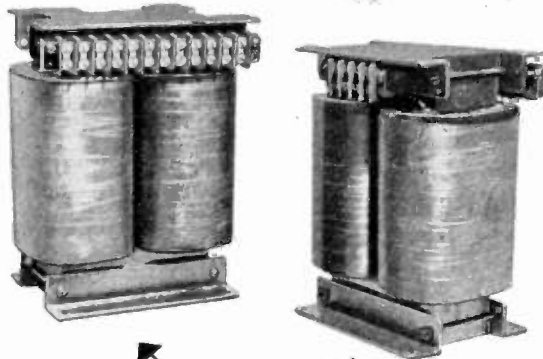

ELECTRO Transformers embody the distinctive "Electroseal" construction and are designed\* to combine maximum performance with reduced weight and size. They are adaptable to a wide variety of uses and offer efficient, economical performance. Quality materials, excellent workmanship and twenty years of research are combined to give you the particular transformer for your specific job.

\* We will be glad to quote to "quantity users" on modifications of our designs to meet special requirements.



**ELECTRO ENGINEERING WORKS**

6021 College Avenue, Oakland 11, California

for every  
photo tube  
application

there is a  
High Sensitivity

**RAULAND  
VISITRON**



There is a Rauland VISITRON available for every phototube application . . . for industrial electronic control devices, sound-on-film, research and development. For high sensitivity, uniformity and dependability, Rauland VISITRONS are the preferred phototubes.

Specify VISITRON . . . and be sure!

Send for valuable Rauland VISITRON Catalog—it's yours for the asking.

**THE RAULAND CORPORATION**  
CHICAGO 41, ILLINOIS

RADIO **Rauland** RADAR  
SOUND · COMMUNICATIONS · TELEVISION



**finch**

first in facsimile  
for broadcasting and point-  
to-point communication!

**FINCH TELECOMMUNICATIONS**

INCORPORATED

SALES OFFICE:  
10 EAST 40th STREET, NEW YORK  
FACTORIES: PASSAIC, N. J.

## News—New Products

These manufacturers have invited PROCEEDINGS readers to write for literature and further technical information. Please mention your I.R.E. affiliation.

(Continued from page 64A)

### High Current Ignitron

A new 400-ampere sealed ignitron for high-power rectifier service has been made available by the Tube Division of General Electric Company's Electronics Department, Syracuse, N. Y. The GL-507, largest sealed ignitron in its class, with an average current rating of 400 amperes, will be primarily used in power rectifiers for mining, electrochemical, transportation, and steel industries.



A mercury-pool tube of permanently-sealed steel construction, the new ignitron has two ignitors, only one of which is used at a time. The tube is over two feet tall and weighs about 100 pounds. According to General Electric tube engineers its design provides the control characteristics of the thyatron, the versatility of the half-wave tube in circuit application work, and the very high emission capacity of the mercury pool.

### Transmission Measuring Set



Completely self-contained and portable a new Type 1A transmission measuring set for rapid measurement of audio frequency gain or loss, has been announced by Tech Laboratories, Inc., 337 Central Avenue, Jersey City 7, N. J. The set combines an accurate vacuum-tube voltmeter, an audio oscillator with four fixed frequencies, and a precision attenuator.

(Continued on page 67A)



**Specify  
MYCALEX**

**LOW LOSS INSULATION**

Where high mechanical and electrical specifications must be met.

**MYCALEX 410**

(MOLDED MYCALEX)

makes a positive seal with metals . . . resists arcing, moisture and high temperatures.

27 years of leadership in solving the most exacting high frequency insulating problems.

**MYCALEX CORPORATION OF AMERICA**

"Owners of 'MYCALEX' Patents"  
Plant and General Offices: Clifton, N.J.  
Executive Offices: 30 Rockefeller Plaza  
New York 20, N.Y.

**IT TAKES MORE THAN QUARTZ  
TO MAKE A CRYSTAL UNIT!**

REEVES-HOFFMAN experience in the design of crystal units and the machinery to cut and lapp crystals is your assurance of precision, dependability, and economy.

REEVES-HOFFMAN production equipment enables you to get extreme precision crystals in quantity, and assures quick delivery.

REEVES-HOFFMAN can make crystal units to fit your circuits, to your specifications.



For specifications of standard Crystal Units write for Catalog RHC-1

**REEVES-HOFFMAN CORPORATION**

SALES OFFICE: 215 EAST 91 STREET, NEW YORK 28, N. Y.  
PLANT: 321 CHERRY STREET, CARLISLE, PA.

**News—New Products**

These manufacturers have invited PROCEEDINGS readers to write for literature and further technical information. Please mention your I.R.E. affiliation.  
(Continued from page 66A)

**Miniature Phototube**

A capsule-size phototube, Type RCA-1P42, manufactured by the Tube Department of the Radio Corporation of America, Camden, N. J., is one of the smallest phototubes ever offered commercially. About the size of a .22 calibre long rifle cartridge it has a maximum diameter of only  $\frac{1}{4}$ " and an overall length just under  $1 \frac{13}{32}$ ". It is activated by light entering through a tiny window at its larger end.

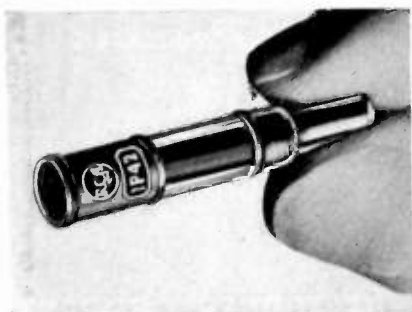

Comparing favorably with larger phototubes in sensitivity, this new tube is expected to find many applications, particularly in devices and machines where the size of former phototubes has been a problem.  
(Continued on page 68A)

**AN IMPORTANT TECH LAB DEVELOPMENT**

**New Type 1250 R. F. SWITCH**

High r. f. current carrying capacity 50 amps. max. intermittent load; 30 amps. steady load. Low loss factor. Sturdy mechanical design . . . Mycalex insulation. Furnished in any number of decks.

Write for Bulletin No. 472

**TECH LABORATORIES, INC.**  
Manufacturers of Precision Electrical Resistance Instruments  
337 CENTRAL AVE. • JERSEY CITY, N. J.

NO. 2  
OF A SERIES

**Carter**  
powers the  
**MOTOROLA 162 MC**  
**F.M. Transmitter**

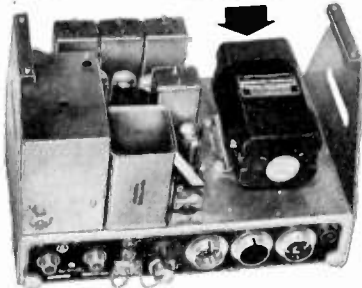

Reliable power assures the reliable operation of the new Motorola FM Mobile 162 megacycle Transmitter... Instantaneous power from the CARTER Genemotor shown on the chassis above. The ONLY Dynamotor that delivers full power in 3/10 second and over 100,000 service-free transmissions. Write for latest catalog.

**Carter Motor Co.**  
*Chicago, Illinois*

2643 N. MAPLEWOOD AVENUE • CABLE: GENEMOTOR

## News—New Products

These manufacturers have invited PROCEEDINGS readers to write for literature and further technical information. Please mention your I.R.E. affiliation.

(Continued from page 67A)

### Sequence Relay

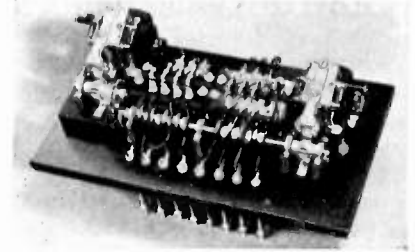

A reversing, separate-circuit ratchet-operated multipole sequence relay has been introduced by Struthers-Dunn, Inc., 146 No. 13 St., Philadelphia 7, Pa. Known as Type 96AFA, it is adaptable to numerous applications involving the addition and subtraction of loads, as in switching-in or switching-out individual units from a bank of capacitors. One operating coil steps the cam shaft forward a step at a time. Similarly, the second operating coil steps the shaft in the reverse direction. Standard ratchets supplied have twelve teeth permitting a total of twelve contacts to be obtained in sequence.

## MICROPHONES BY TURNER



*"The Password  
to  
Sound  
Performance"*

**THE TURNER COMPANY**

909 17TH STREET N. E.  
CEDAR RAPIDS, IOWA



## THERMOSTATIC METAL TYPE DELAY RELAYS

PROVIDE DELAYS RANGING  
FROM 1 TO 120 SECONDS

**FEATURES:**—Compensated for ambient temperature changes from  $-40^{\circ}$  to  $110^{\circ}$  F... Hermetically sealed; not affected by altitude, moisture or other climate changes... Explosion-proof... Octal radio base... Compact, light, rugged, inexpensive... Circuits available: SPST Normally Open; SPST Normally Closed.

PROBLEM? Send for "Special Problem Sheet" and Bulletin.

## AMPERITE REGULATORS

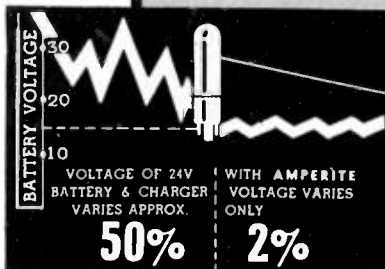

Amperite REGULATORS are the simplest, lightest, cheapest, and most compact method of obtaining current or voltage regulation... For currents of .060 to 8.0 Amps... Hermetically sealed; not affected by altitude, ambient temperature, humidity.

Write for 4-page Illustrated Bulletin.

**AMPERITE CO.**, 561 Broadway, New York 12, N. Y.

In Canada: Atlas Radio Corp., Ltd., 560 King St., W. Toronto

# PROTECTION

*FASTER THAN LIGHTNING*

Littelfuse precision-made fuses give you short circuit action faster than the duration of the average lightning stroke. Ultra high speed protection for delicate instruments and equipment. Lowest amperage fuses commercially produced . . . with ratings as low as one milliamper. Vacuum permits breaking up to 15,000 volts A.C. with up to 500 watts power supply. Send for Catalog No. 9 showing complete line of fuses, mountings and accessories.

**LITTELFUSE**  
*Incorporated*

4773 RAVENSWOOD AVENUE  
CHICAGO 40, U.S.A.

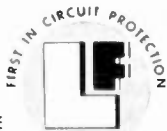

- For Delicate Instruments
- For Television Equipment
- For Bolometer Circuits
- For X-Ray Equipment
- For Radar Power Supplies
- For Cathode Ray Equipment
- For Delicate Thermo-Couples
- For Microammeters
- For Delicate Relays
- For Galvanometers and similar applications

NITE-T-LITE • SWITCH-LITE • IGNITION-FRITZ • NEON INDICATORS  
SWITCHES • CIRCUIT BREAKERS • FUSES, MOUNTINGS AND ACCESSORIES

**PREMAX**

## Antennas

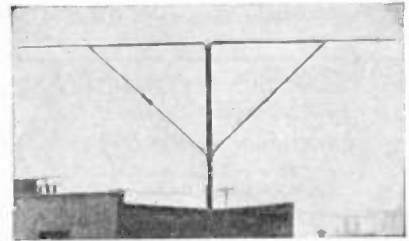

### For FM and Television

Antennas for Television and FM reception which give excellent response on both old and new bands . . . novel design that allows the proper impedance matching to 300 ohm line . . . sturdy mechanical construction that makes them easy to erect . . . simple design with pleasing appearance . . . require less horizontal space than any conventional dipole for the same frequency response.



### For Mobile Units

Telescoping Tubular Antennas varying in height from 6 to 35 feet . . . light-weight yet sturdy enough to resist great shock . . . easily adjustable in height . . . in steel, monel, aluminum and stainless steel. Also the popular "whip" type with special Premax mountings that stand the road-shocks. If your problem is a satisfactory antenna, investigate Premax.

Send at once to your jobber for a copy of the NEW Premax Catalog. It shows the complete line of Vertical Antennas in Steel, Aluminum, Monel and Stainless, as well as Corulite Elements and other elements for arrays. If your jobber can't supply you, write direct, giving us his name.

**Premax Products**

Division of Chisholm-Ryder Co., Inc.  
4713 Highland Ave., Niagara Falls, N.Y.

## FREED *Low Frequency* "Q" INDICATOR

Type No. 1030. Frequency range 20 to 200,000 cycles, "Q" range from .5 to 500. "Q" of inductors measured with up to 50 volts across the coil.

INDISPENSABLE INSTRUMENT FOR MEASUREMENT OF:—

- "Q" and inductance of coils
- "Q" and capacitance of capacitors Dielectric losses and power factor of insulating materials

**FREED TRANSFORMER CO., INC.**

Instruments Division

72 Spring St. New York 12, N.Y.

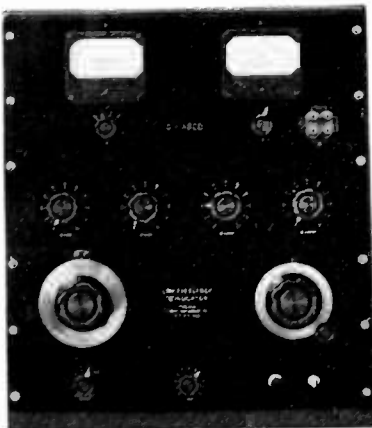

*Worthy of an Engineer's Careful Consideration*

## TYPE 102 - A LINE AMPLIFIER

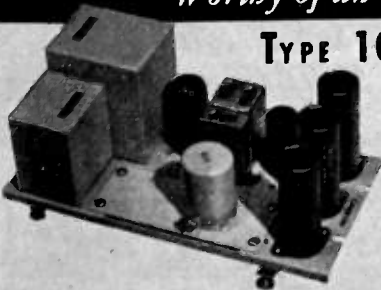

TYPE 102A Amplifier is one of the 102 Series Line Amplifiers of which four different types are available. The "A" is mostly used to drive the line after the master gain control. It is quiet, has excellent frequency characteristic and ample power output with low distortion products.

**The Langevin Company**

INCORPORATED  
SOUND REINFORCEMENT AND REPRODUCTION ENGINEERING  
NEW YORK 37 W. 45 St. 23  
SAN FRANCISCO 1050 Howard St. 3  
LOS ANGELES 1000 N. Seward St. 18

# PROFESSIONAL CARDS

**W. J. BROWN**  
*Electronic & Radio Engineering Consultant*  
 Electronic Industrial Applications, Commercial and Broadcasting Transmitter and Receiver Design, Test Equipment, etc.  
 23 years experience in electronic development  
 P.O. Box 5106, Cleveland, Ohio  
 Telephone, Yellowstone 7771

**EDWARD J. CONTENT**  
*Acoustical Consultant*  
**Functional Studio Design**  
 FM - Television - AM  
 Audio Systems Engineering  
 Roxbury Road Stamford 3-7459  
 Stamford, Conn.

**HERBERT A. ERF**  
*Architectural Acoustics Consultant*  
**STUDIO DESIGN**  
 Standard Broadcast—FM—Television  
 Cleveland 15, Ohio  
 3868 Carnegie Avenue EXpress 1616

**DAVID C. KALBFELL, Ph.D.**  
*Engineer -- Physicist*  
 Complete laboratory facilities  
 Industrial instrumentation and control  
 Broadcast engineering and measurements  
 941 Rosecrans St. Bayview 7303  
 San Diego 6, California

FAirmount 5105 EXpress 7766  
**FRANK MASSA**  
 Electro-Acoustic Consultant  
 3393 Dellwood Road 3868 Carnegie Avenue  
 CLEVELAND, OHIO

**ROBERT E. MCCOY**  
 Consulting Engineer  
 Antennas, Antenna-Coupling Systems, Direction Finders and Beacons.  
 Electronic Circuits for Special Purposes: Measurement, Computation and Control.  
 301-302 Concord Bldg., Portland 4, Oregon

**EUGENE MITTELMANN, E.E., Ph.D.**  
 Consulting Engineer & Physicist  
**HIGH FREQUENCY HEATING INDUSTRIAL ELECTRONICS APPLIED PHYSICS & MATHEMATICS**  
 549 W. Washington Blvd. Chicago 6, Ill.  
 Phone: State 8021

**ARTHUR J. SANIAL**  
 Consulting Engineer  
 Loudspeaker Design; Development; Mfg. Processes. High Quality Audio Systems. Announcing Systems. Test and Measuring Equipment Design.  
 168-14 32 Ave. Flushing, N.Y.  
 FLushing 9-3574

**Paul D. Zottu**  
 Consulting Engineer  
 Industrial Electronics  
 High Frequency Dielectric and Induction Heating Applications, Equipment Selection, Equipment and Component Design, Development, Models.  
 272 Centre St., Newton, Mass. BIG-9240

# INDEX

Section Meetings	35A	Insulation Manufacturers Corporation	71A
Membership	38A	International Resistance Co.	29A
Positions Open	50A	International Tel. & Tel. Corp.	21A, 51A
Positions Wanted	54A	D. C. Kalbfell	70A
News-New Products	18A	Langevin Co.	69A
		Littelfuse, Inc.	69A

## DISPLAY ADVERTISERS

Acme Electric Corporation	42A	Machlett Laboratories, Inc.	53A
Allen-Bradley Company	47A	Maguire Industries, Inc.	37A
Alliance Mfg. Co.	49A	P. R. Mallory & Co., Inc.	43A
American Lava Corp.	17A	Frank Massa	70A
American Phenolic Corp.	15A	Robert E. McCoy	70A
Amperex Electronic Corp.	13A	McGraw-Hill Book Co.	64A
Amperite Corp.	68A	Measurements Corp.	60A
Andrew Co.	35A, 44A	Eugene Mittelman	70A
Arnold Engineering Co.	26A	Mycalex Corp. of America	67A
Astatic Corporation	40A	National Carbon Company, Inc.	45A
Audio Devices, Inc.	61A	National Co., Inc.	20A
Automatic Mfg. Corp.	55A	Newark Electric Co.	62A
Barker & Williamson	62A	Premax Products	69A
Bell Telephone Laboratories	2A & 3A, 34A	Presto Recording Corp.	41A
W. J. Brown	70A	Radio Corporation of America	32A, 64A, 72A
Brush Development Co.	36A	Radio Music Corporation	52A
Capitol Radio Engineering Institute	46A	Rauland Corporation	66A
Carter Motor Co.	68A	Raytheon Mfg. Co.	9A
Centralab	6A, 24A & 25A	Reed & Prince Mfg. Co.	63A
Clarostat Mfg. Co.	58A	Reeves-Hoffman Corp.	67A
Cleveland Container Co.	60A	Revere Copper & Brass, Inc.	22A
Sigmund Cohn & Co.	58A	Arthur J. Sanial	70A
Collins Radio Co.	65A	Sherron Electronics Co.	8A
E. J. Content	70A	Solar Mfg. Corp.	1A
Cornell-Dubilier Electric Co.	Cover III	Sorensen & Company, Inc.	38A
DeMornay-Budd Inc.	19A	Sperry Gyroscope Co., Inc.	50A
Tobe Deutschman Corp.	39A	Sprague Electric Co.	10A
Allen B. DuMont Labs., Inc.	12A	Stackpole Carbon Company	4A
Eitel-McCullough, Inc.	16A	Sylvania Electric Products, Inc.	14A
Electrical Reactance Corp.	48A	Tech Labs	67A
Electro Engineering Works	66A	Triplett Electrical Instrument Co.	64A
Electro Motive Mfg. Co., Inc.	23A	Truscon Steel Company	54A
Herbert A. Erf	70A	Tung-Sol Lamp Works, Inc.	28A
Federal Telephone & Radio Corp.	21A, 51A	Turner Company	68A
Finch Telecommunications, Inc.	66A	United States Instrument Corp.	70A
Freed Transformer Co.	69A	United Transformer Corp.	Cover II
General Electric Company	5A, 27A, 57A	War Assets Administration	30A & 31A
General Radio Co.	Cover IV	Western Electric Company	2A & 3A, 34A
Harvey Radio Laboratories, Inc.	33A	S. S. White Dental Mfg. Co.	56A
Hewlett-Packard Co.	7A	Wilcox Electric Company, Inc.	59A
Hytron Radio & Electronics Corp.	11A	Paul D. Zottu	70A

*For*  
**DESIGN ENGINEERS AND MANUFACTURERS**

**ROTARY SELECTOR SWITCHES**

*A New Catalog*

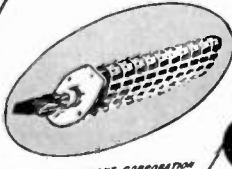

*Just Off the Press*

When you require precision in switches with a number of contact points and with multiple decks, consult this catalog. U.S.I. Switches are designed to operate where performance and dependability are of utmost importance. Other U.S.I. Products: Sound Powered Telephone Instruments and systems.

UNITED STATES INSTRUMENT CORPORATION

**U.S.I. UNITED STATES INSTRUMENT CORPORATION**  
 EAST ORANGE NEW JERSEY





COMPLETE  
IMPREGNATION



FLEXIBILITY



NON-FRAYING



DIELECTRIC STRENGTH



COMPLETENESS  
OF LINE



PUSH-BACK  
QUALITY



UNIFORMITY  
OF PRODUCT

# 7<sup>th</sup> among the Features of **DIEFLEX** VARNISHED

## TUBING PRODUCTS is...

**S**MOOTH inside bore is another big advantage that makes Dieflex varnished tubing or sleeving a superior product for manufacture of all types of electrical products. Smooth bore helps speed assembly and reduce manufacturing costs, just as do the other seven features of this quality insulation. These features, plus long life, make Dieflex attractive both for the product manufacturer and the ultimate user.

The inherent advantages of smooth inside bore, extreme flexibility, thorough impregnation with oleoresinous baking-type varnish, good push-back quality, and other characteristics shown on this page, are reasons for the widespread use of Dieflex varnished tubing products. Get these advantages for your own production. Dieflex is available with either a cotton or glass fiber base to meet every insulating requirement. Decide on Dieflex . . . it's "best for you."

# SMOOTHNESS OF BORE

### DIEFLEX PRODUCTS LIST

#### MADE WITH BRAIDED COTTON SLEEVING BASE

- VTA Grade A-1 Magneto Grade Varnished Tubings
- VTA Grade B-1 Standard Grade Varnished Tubings
- VTA Grades C-1 and C-2 Heavily Coated Saturated Sleeveings
- VTA Grade C-3 Lightly Coated Saturated Sleeveings
- Heavy Wall Varnished Tubings and Saturated Sleeveings

#### MADE WITH BRAIDED GLASS SLEEVING BASE

- VTA Grade A-1 Magneto Grade Varnished Fiberglas Tubings
- VTA Grade C-1 Extra Heavily Saturated Fiberglas Sleeveings
- VTA Grade C-2 Heavily Saturated Fiberglas Sleeveings
- VTA Grade C-3 Lightly Saturated Fiberglas Sleeveings
- Silicone-Treated Fiberglas Varnished Tubings and Saturated Sleeveings

# INSULATION

## MANUFACTURERS CORPORATION

\*CHICAGO 6  
565 W. Washington  
Boulevard  
MILWAUKEE 2  
312 E. Wisconsin Ave.  
\*Local Stocks Available



\*CLEVELAND 14  
1231 Superior  
Ave., N.E.  
DAYTON 2  
1315 Mutual Home  
Building

### IMC Representatives

DETROIT 2—11341 Woodward Ave. • PEORIA 5—1D1 Heinz Court  
MINNEAPOLIS 3—1208 Harmon Place

### Authorized Distributors

#### INSULATION and WIRES INCORPORATED

St. Louis 3, Mo. • Atlanta 3, Ga. • Boston 20, Mass.  
Detroit 2, Mich. • Houston 2, Tex. • New York 7, N. Y.

#### TRI-STATE SUPPLY CORPORATIONS

Los Angeles 13, Cal. • San Francisco 7, Cal. • Seattle 4, Wash.



*RCA Communications' new world-wide automatic tape relay radio system speeds Radiograms.*

## ***New wings for words around the world!***

Radiograms "Via RCA" to and from overseas points now are processed by automatic machines which speed your messages through such gateway cities as New York, London, San Francisco and Manila, without delay.

This advanced technique in international radiotelegraphy is the result of wartime research and development. It gives to private messages the same speed, accuracy and dependability which were attained through its world-wide use by the U. S. Army Communications Service during the war.

"Victrola" T. M. Reg. U. S. Pat. Off.

RCA Laboratories—one of the world's foremost centers of radio and electronic research—is continually pioneering and advancing radio communications in service to the Nation and the public.

When you buy an RCA Victor radio or television receiver, Victrola radiophonograph, or phonograph record, you are getting, thanks to RCA research and engineering, one of the finest products of its kind science has achieved.

*Radio Corporation of America, RCA Building, Radio City, New York 20. Listen to the RCA Victor Show, Sundays, 2:00 P.M., Eastern Daylight Saving Time, over the NBC Network.*



At RCA Communications, "Package Sets" contain an automatic sending and receiving unit for a foreign gateway city. Messages, in tape form, received through these machines, are ready for quick delivery or immediate transmission to any part of the world.



**RADIO CORPORATION of AMERICA**



# your Noise Problems, too can be Solved Better with C-D Quietones



Just because Mom wants to bake a cake is no reason why she shouldn't hear her pet soap opera. And sooner or later she's bound to find out that *some* mixers *don't* cause radio interference. Mixers equipped with C-D Capacitors, for example.

C-D's experience in designing and building noise suppressors is unequalled in the capacitor industry. We are now manufacturing hundreds of types of noise filters for electrical appliances and equipment. It's possible, of course,

that the exact unit for solving *your* noise problem is not included. In that case, our engineers are ready and anxious to design and build the suppressor best suited to your specific requirements—*better, faster, more economically. Consult with them.*

Catalog of standard types will be mailed on request. Cornell-Dubilier Electric Corporation, Dept. M6, South Plainfield, New Jersey. Other large plants in New Bedford, Brookline and Worcester, Mass., and Providence, R. I.

**CORNELL-DUBILIER**  
world's largest manufacturer of  
**CAPACITORS**

MICA • DYKANOL • PAPER • ELECTROLYTIC

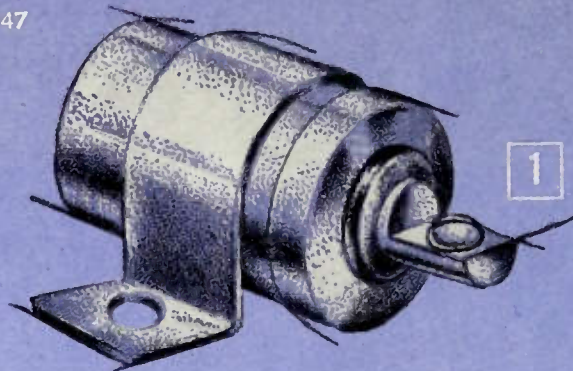

2

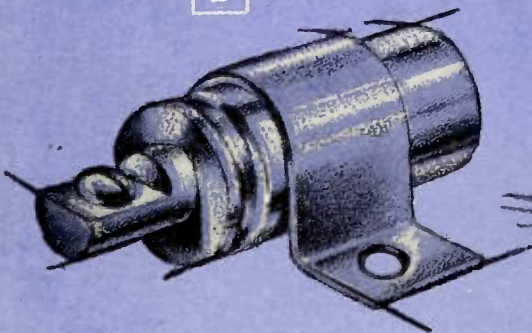

3

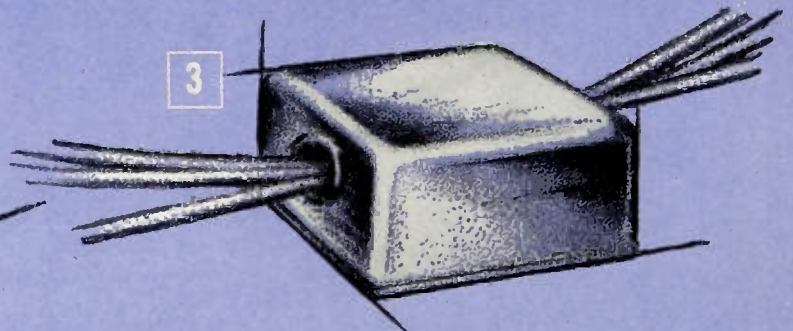

## TYPICAL NOISE SUPPRESSORS

### CAPACITORS #1 AND 2

Two of the Type A-C Filter Capacitors designed for heavy duty service on buses, trucks, etc. for spark and noise suppression. Mechanically rugged, oil filled and impregnated and hermetically sealed.

### CAPACITOR #3

A general purpose filter effectively controls radio noise energy created by fluorescent lamps. This capacitive-inductive type filter is compact and can be quickly installed in a variety of positions. Convenient leads simplify installation.



# FOR PRECISE MEASUREMENT OF INDUCTANCE

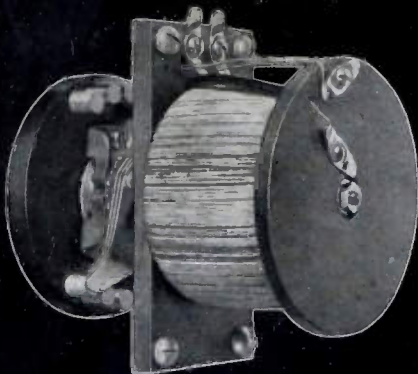
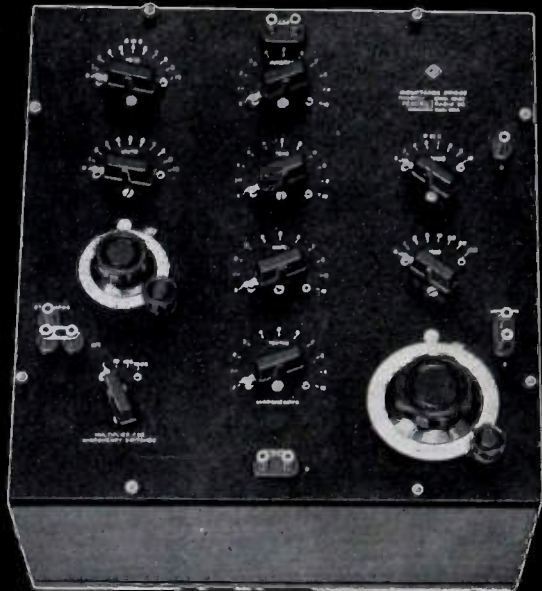
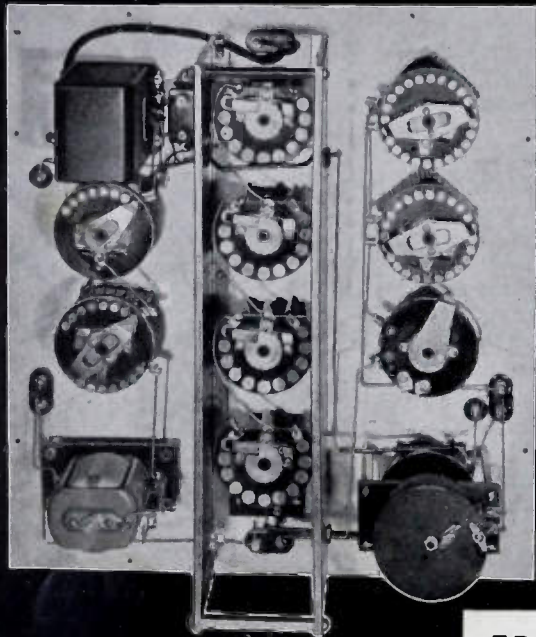

The 1-millihenry toroidally wound standard

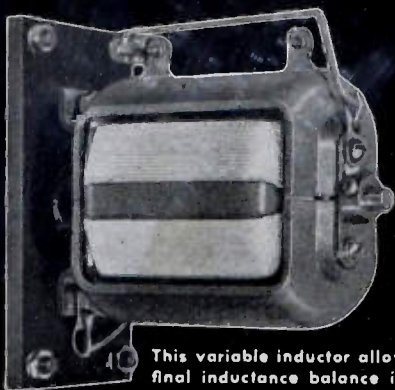

This variable inductor allows a final inductance balance independent of the resistive balance

## FROM 0.1 MICROHENRY TO 1 HENRY

The Type 667-A Inductance Bridge is widely used in the laboratory and in production for precision measurements of the inductance of coils. It employs a standard bridge circuit with a number of unique design features which make it direct-reading, with high accuracy and convenience.

### FEATURES

- **DIRECT READING** from 0.1 microhenry to 1 henry.
- **HIGH ACCURACY** —  $\pm 0.2\%$  or  $\pm 0.1 \mu\text{h}$  over major portion of its range.
- **RANGE** can be extended considerably with external standards.
- **CALIBRATED** for 1 kc use — can be used at frequencies between 60 cycles and 10 kilocycles with less accuracy.
- **VARIABLE RESISTORS** in standard and unknown arms inductance compensated to give constant inductance.
- **ERRORS** from sliding-zero balance have been eliminated.
- **INDUCTANCE BALANCE** independent of resistive balance.
- **STANDARD INDUCTOR** toroidally wound to minimize magnetic pick-up.
- **WITH AUXILIARY VARIABLE CONDENSER** can be converted into a resonance bridge — one of the most precise measuring techniques for determining resistance of inductors at audio frequencies.
- **All four corners** of the bridge available on panel. Bridge elements can be used to form a number of other circuits.

PRICE: Type 667-A Inductance Bridge \$400.00

(Accessories needed are oscillator, amplifier and head telephones)

**NOTE — A few in stock for immediate shipment —**

**ORDER NOW!**



**GENERAL RADIO COMPANY** Cambridge 39, Massachusetts

90 West St., New York 6

920 S. Michigan Ave., Chicago 5

950 N. Highland Ave., Los Angeles 38



# Fixed and Variable INDUCTORS for

BROADCAST AND COMMERCIAL  
TRANSMITTING • ELECTRONIC HEATING  
HIGH CURRENT • HIGH VOLTAGE  
R. F. APPLICATIONS

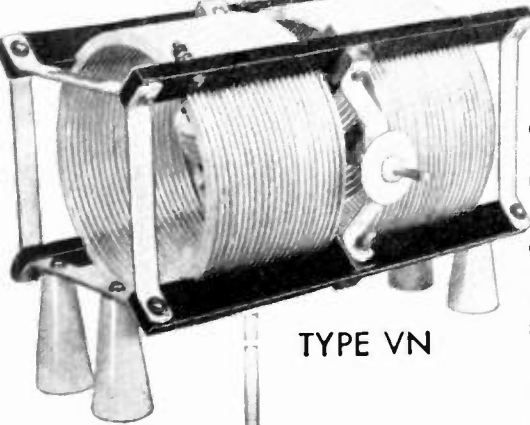
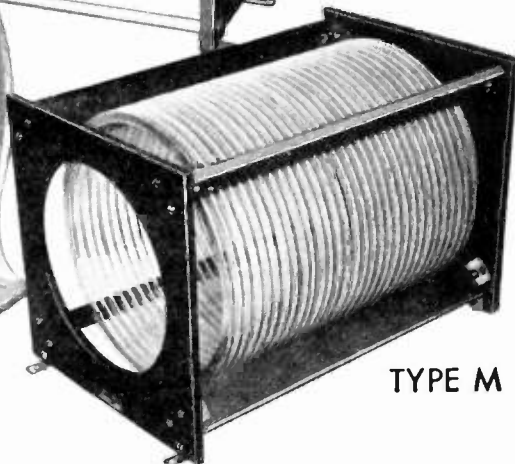
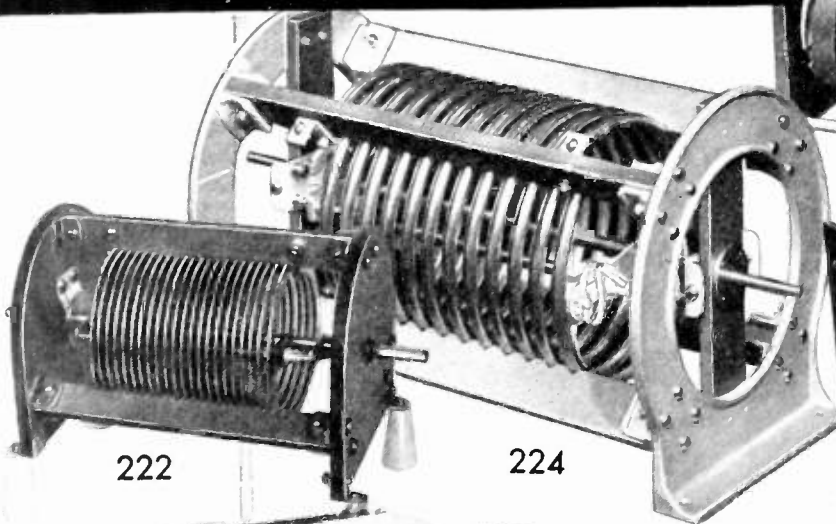
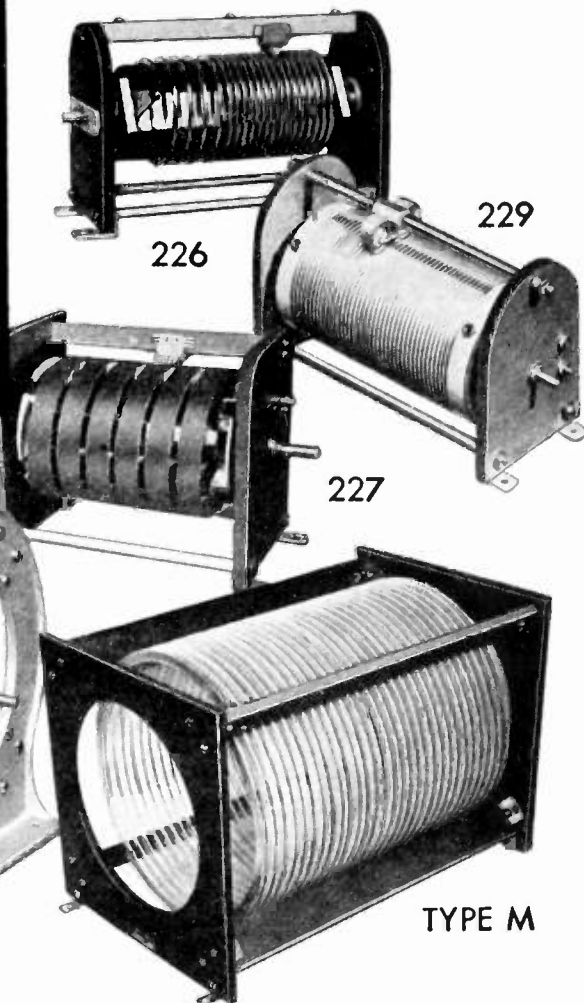

JOHNSON, a pioneer in high voltage, high current inductors for commercial equipment, offers you the benefits of many years of engineering achievement, highly advanced production techniques, and an unequalled choice of types and sizes.

The many variable types assure smooth tuning for low, medium, or high power applications. Types N and M can be supplied with variable coupling rotors, tuning flippers, or as variometers. Faraday shields may be incorporated in the Type M to minimize eddy currents and reduce electrostatic coupling.

The 227 series is engineered to meet the requirements of high current, high frequency, electronic heating and transmitter tank circuits. Dual models feature counter sliding contacts which provide automatic balancing for push-pull circuits.

The 226 series is recommended for high-frequencies and features optional variable pitch winding for wide band coverage. The 224 is wound with 3/8" or 1/2" copper tubing and offers the highest ratings of the types shown.

There is a JOHNSON inductor "your size" for they begin with small wire wound units for low power stages and extend through the big, high power, water cooled types. New data sheets covering the inductors shown have just been completed. We'll be glad to send them for your file or for your immediate requirements.

Write for data  
sheet series W

JOHNSON PRODUCTS INCLUDE

- Transmitting Capacitors • Inductors • Tube Sockets • R. F. Chokes
- Q Antennas • Insulators • Connectors • Plugs and Jacks • Hardware
- Pilot and Dial Lights • Broadcast Components • Directional Antenna Equipment



**JOHNSON** . . . a famous name in Radio

E. F. JOHNSON CO. WASECA, MINNESOTA

These manufacturers have invited PROCEEDINGS readers to write for literature and further technical information. Please mention your I.R.E. affiliation.

(Continued from page 66A)

## New Enterprises

• • • Radio Engineering Company, 8 State Street, New York, N. Y., will specialize in high-quality receiver design.

## Interesting Abstracts

• • • On "Liveness in Broadcasting," a discussion of microphone placement, printed in the January 1947 issue of the *OSCILLATOR*, published by Western Electric Company, 195 Broadway, New York, N. Y.

• • • On "The Art of Machining for Vacuum Tubes" printed in the 1947 Winter issue of *CATHODE PRESS*, published by Machlett Laboratories, Inc., Springfield, Conn.

## HV Coupling Capacitors

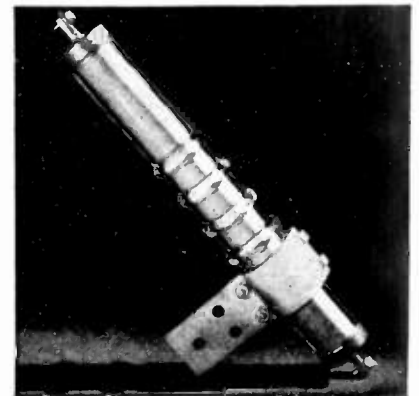

Designed to withstand 10 test impulses of 95 kilovolts, new high-voltage coupling condensers manufactured by the Sprague Electric Company, 189 Beaver St., North Adams, Mass., are expected to be the practical solution to the long-standing problem of coupling telephone equipment to existing 7200-volt alternating current distribution lines. These units have a capacity of 0.002 microfarad and are rated for 8700-volt 60-cycle operation.

## Solderless Coaxial Fittings

Solderless fittings for rigid coaxial transmission lines, available in both bronze and aluminum in all standard sizes, which are gas-tight and have excellent electrical characteristics are being manufactured by Raybould Coupling Company, Meadville, Pa. The manufacturer states that the new couplings will sustain sufficient end-pull to support the line, and their solderless feature simplifies field installations.

(Continued on page 74A)



(Continued from page 66A)

- Rheams, C. J. B., 246 E. Johnson St., Philadelphia, Pa.  
 Rich, P. A., 94 Watchung Ave., Upper Montclair, N. J.  
 Richman, W., 3438—90 St., Jackson Heights, L. I., N. Y.  
 Rife, W. E., 2661 Clime Rd., Columbus 4, Ohio  
 Riley, B. J., Jr., 225 S. Solomon St., New Orleans, La. (Elected April 1, 1947)  
 Roach, J. H., 435 Webster Ave., New Rochelle, N. Y.  
 Robinson, M. U., 203 N. Center St., Hartford, Mich.  
 Roemer, A. K., 2 Lawrence St., East Rockaway, N. Y.  
 Rose, H. E., 192 Shepard Ave., West Englewood, N. J.  
 Rosenzweig, H., 237 Bath Ave., Long Branch, N. J.  
 Roup, R. R., Globe-Union, Inc., Milwaukee 1, Wis.  
 Roush, R. G., 1653 Shadyside Rd., Baltimore, Md.  
 Rubel, S. J., 1872 Monroe Ave., New York 5, N. Y.  
 Rubin, S., 1825 W. Fifth St., Brooklyn 23, N. Y.  
 Russo, J. S., 2027 S. Ninth St., Philadelphia 48, Pa.  
 Sanchez, J. W., 27 Simon, Beverly, Mass.  
 Savigny, J. J., 568a Jarvis St., Toronto 5, Ont., Canada  
 Schafer, H. G., 2911—28 St., N. W., Washington 8, D. C.  
 Schaeperkoetter, L. C., 4148 Grove St., St. Louis 7, Mo.  
 Schatz, H. J., RFD 1, Box 100, State Highway 35, Red Bank, N. J.  
 Schneider, P., 175 Field Place, New York 53, N. Y.  
 Schiffman, J., 2501 N St., S. E., Washington, D. C.  
 Schnakenburg, C. J., 520 Hazel St., Glendale 1, Calif.  
 Schommer, G. R., 119 Lovington Dr., Apt. B, Fairfield, Ohio  
 Schuchman, N., 1375 E. Eighth St., Brooklyn 30, N. Y.  
 Schulz, E. A., 721 Sherwood Dr., Indianapolis 44, Ind.  
 Schwartz, P., 1883 E. 12 St., Brooklyn 29, N. Y.  
 Scroggs, J. R., Central Fire Station, Beaumont, Tex.  
 See, H. P., 8 Pinewood Rd., Plandome, L. I., N. Y.  
 Seidel, H., 2035 E. 13 St., Brooklyn 29, N. Y.  
 Setzer, L. E., 323 Manhattan Ave., Hawthorne, N. Y.  
 Shapiro, A., 857 E. 13 St., Brooklyn 30, N. Y.  
 Sharki, P., 169½ First Ave., Box 88, Manasquan, N. J.  
 Sharp, D. D., 2040—37 St., N. W., Washington 7, D. C.  
 Sharpless, T. K., 629 Walnut Lane, Haverford, Pa.  
 Sheets, M. J., 304 Summers Dr., Alexandria, Va.  
 Shelton, E. J., Jr., 1469 Beacon St., Apt. 7, Brookline 46, Mass.  
 Sidor, E. N., c/o Weldon & Carr, 1605 Connecticut Ave., N. W., Washington, D. C.  
 Sielke, E. L., Box 6000, Torresdale P. O., Philadelphia 14, Pa.  
 Silva, A. A., 71 N. Fifth Ave., Long Branch, N. J.  
 Simon, J. N., 122 S. Smithville Rd., Dayton 3, Ohio  
 Simonds, R. E., 104—30—187 St., Hollis, N. Y.  
 Singer, E. M., 1610 Lincoln Pl., Brooklyn 33, N. Y.  
 Slawek, J. E., 4202 Manayunk Ave., Philadelphia 28, Pa.  
 Smith, B. H., 26 Allen St., Arlington, Mass.  
 Smith, F. C., 209—79 St., Woodcliff, N. J.  
 Smilth, H. E., 913A N. LaBrea, Inglewood, Calif.  
 Snyder, E. P., 22 E. 38 St., New York 16, N. Y.  
 Sokolski, E. A., 300 Riverside Dr., New York 25, N. Y.  
 Southwell, J. D., Central Fire Station, Beaumont, Tex.

(Continued on page 70A)

# ★ CREI Offers To Industry A Planned Program of GROUP TRAINING IN Practical Radio-Electronics Engineering

Here is a proved program of high calibre home-study technical training that will increase the efficiency of your staff engaged in any phase of Radio-Electronics.

The CREI "Employers' Plan" for group training will:

1. Increase the technical abilities of your radio-electronics personnel.
2. Enable them to perform their duties more efficiently and in less time.
3. Increase the value of their services to your organization.

No company time is required for this training... it is accomplished by spare-time home study to meet each individual organization's requirements.

The CREI "Employers' Plan" is useful for the up-grading of technical personnel in manufacturing, AM, FM, and television broadcasting, communications, industrial electronics, including the following:

Engineers	Testers
Engineering Aides	Technicians
Laboratory Assistants	Field Servicemen
Inspectors	Installers
	Maintenance Men

Your request will promptly bring an outline of the plan, as now in use with other organizations, and complete details will follow when your particular needs are known. No obligation or cost, of course. Write to—

## CAPITOL RADIO ENGINEERING INSTITUTE

E. H. Rietzke, President

An Accredited Technical Institute  
 Dept. PR-5, 16th & Park Rd., N. W.

WASHINGTON 10, D. C.



# Be Right with.. OHMITE

## Vitreous Enameled Rheostats

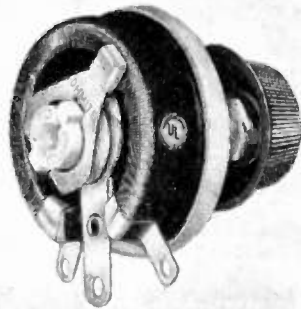

Available in 10 sizes, ranging from 25 to 1000 watts, in a wide range of resistances. Ceramic parts insulate the shaft and mounting. The resistance winding is permanently locked in vitreous enamel. The metal-graphite brush provides unmatched smoothness of action. Engineered and constructed for long, trouble-free life.

## Non-Inductive Resistors

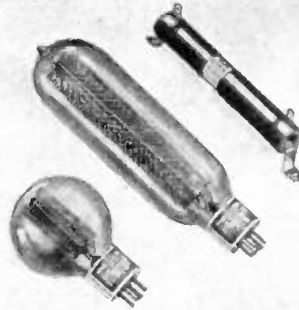

Used as dummy antennas for radio transmitters, load resistors in high frequency circuits, and terminating resistors for radio antennas. Available in vitreous-enamel type wound on a tubular ceramic core and in hermetically sealed-in-glass type mounted on a 4-prong steatite tube base. Sizes from 50 to 250 watts.

## All Ceramic Tap Switches



A popular switch for use with tapped transformers in power supply units. Compact, dependable, and convenient to operate. Available in ratings of 10, 15, 25, 50, and 100 amperes, A.C. Contacts are of the silver-to-silver, non-shorting type. Switch shaft is insulated by a strong ceramic hub. The heavy, one-piece ceramic body is unaffected by arcing.

## Parasitic Suppressor

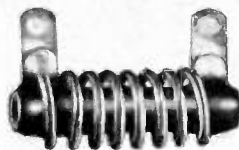

Designed for the suppression of unwanted ultra-high frequency parasitic oscillations due to incidental resonance between tube plate and grid circuits of push-pull and parallel operated transmitting amplifiers. Consists of a 50-ohm vitreous enameled non-inductive resistor which supports a choke of 0.3 microhenries and .003 ohms d-c resistance.

## Radio Frequency Plate Chokes

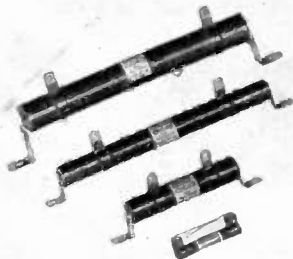

For use in the plate circuits of diathermy oscillators and amateur, aviation, police, and commercial short wave transmitters. Consists of a single layer winding on a steatite core, rigidly held in place, insulated and protected by a moisture-proof coating. Rated at 1 ampere.

## Wire Wound Resistors

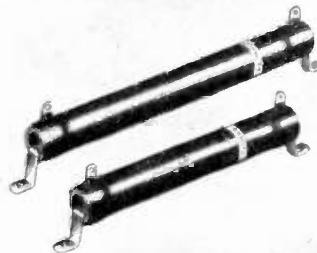

Ohmite offers a complete line of dependable resistors wound on a ceramic tube and protected by vitreous enamel. Ratings from 10 to 200 watts. Available in the fixed type for general use, and in the "Dividohm" type with adjustable lugs for use as a multi-tap resistor or voltage divider.

OHMITE MANUFACTURING CO., 4862 Flournoy St., Chicago 44, U. S. A.

# OHMITE

Write Today for  
Ohmite Catalog No. 18

Provides 16 pages of useful data on the selection and application of rheostats, resistors, tap switches, chokes, attenuators, and other equipment.



RHEOSTATS    RESISTORS    TAP SWITCHES    CHOKES

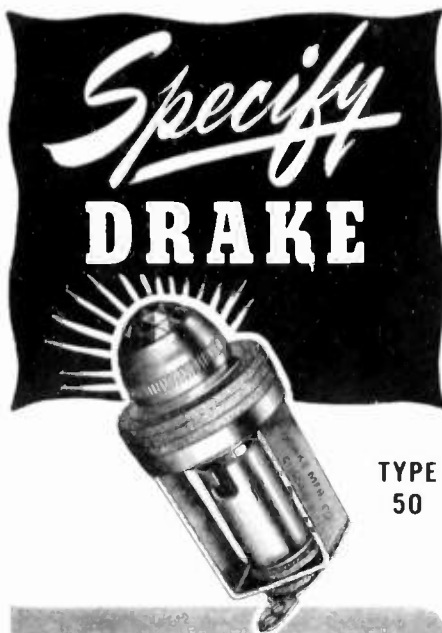

1. Precision Engineered
2. Rugged, Durable, Long-lived
3. Efficient, Dependable Operation
4. Economical

Every conceivable type of Socket and Jewel Light Assembly is available at DRAKE... all measuring up to the same high quality standards. We make over 950 different kinds of Mounting Brackets, to bring lamp filaments into desired positions. Should a new application call for a special design of Assembly or Bracket, our skilled engineers will work with you to design a unit to meet your specific needs. DRAKE quality, dependability and patented features are widely known and appreciated among those who know Socket and Jewel Assemblies best. Very large high speed production facilities assure reasonably prompt deliveries in any quantity. Write or wire for samples and full information.

**ASK FOR OUR NEW CATALOG • NO OBLIGATION!**



**Socket and Jewel  
LIGHT ASSEMBLIES**

**DRAKE  
MANUFACTURING CO.**  
1713 W. HUBBARD ST., CHICAGO 22

## Membership

(Continued from page 68A)

- Spector, M., 26 E. Sixth St., Clifton, N. J.  
 Spencer, R. H., Box 26, University of Connecticut, Storrs, Conn.  
 Sperr, A. E., 14 Saint Luke's Pl., New York 14, N. Y.  
 Spragg, L. A., 14996 Alexander, Detroit 23, Mich.  
 Spillner, H., Jr., 60 Merrit Ave., Dumont, N. J.  
 Stahell, G. D., 411 West Park Ave., Angola, Ind.  
 Stahman, J. R., 3108—30 Ave., S., Minneapolis 6, Minn.  
 Stanley, B. Z., 104-52—116 St., Richmond Hill, N. Y.  
 Stanney, W. J., 4 Avenue H, Alsen Village, Dorchester, Mass.  
 Stanton, L. J., 151 Eighth Ave., New York 11, N. Y.  
 Staples, E. B., 72 Sexton Ave., Westwood, Mass.  
 Staton, M. G., 135 Maple Terr., Merchantville, N. J.  
 Stecca, A. J., 4306 S. Capitol St., Washington 20, D. C.  
 Steck, G. W., 908 Berkeley Ave., Trenton, N. J.  
 Steele, E. R., 30 Trowbridge Ave., Newtonville 60, Mass.  
 Stein, R. S., 941 E. 19 St., Brooklyn 30, N. Y.  
 Stempler, S., 1856 E. 29 St., Brooklyn 29, N. Y.  
 Stokes, B. C., 29 Vanderbilt Ave., Floral Park, L. I., N. Y.  
 Stripp, W. G., 5 Clovelly Rd., Hornsey, London N. 8, England  
 Strom, C. A., Jr., 1910 Oak Dr., West Belmar, N. J.  
 Stubbe, R. R., 548 Weeks St., Palo Alto, Calif.  
 Sullivan, H., 45 Mansfield Ave., Darien, Conn.  
 Sunue, H. E., 8621 Georgia Ave., Silver Spring, Md.  
 Sutter, A. W., 55 W. 42 St., New York 18, N. Y.  
 Svala, C. G., Mariestadv 28, Hammarbyhojden, Sweden  
 Svedlow, J. D., 1546 Selwyn Ave., New York, N. Y.  
 Svensson, R., Petrejusvagen 51, Hammarbyhojden, Sweden  
 Swafford, T. W., Jr., 236 E. Courtland St., Philadelphia 20, Pa.  
 Sweeney, F. C., 335 W. Passaic Ave., Bloomfield, N. J.  
 Taffel, B. R., 24 Waverly Pl., Red Bank, N. J.  
 Tescari, A., Beroldo 2, Milano, Italy  
 Thomas, D. E., Bell Telephone Laboratories, Inc., 180 Varick St., New York, N. Y.  
 Thomson, V. E., 140 Manor Ave., Hempstead, L. I., N. Y.  
 Town, R. A., 15768 Dexter Blvd., Detroit 21, Mich.  
 Trantham, H., Jr., Franklin Institute, Philadelphia, Pa.  
 Trauben, W., 3230 McMichael St., Philadelphia 29, Pa.  
 Triesner, J. E., 693 Penn Ave., Teaneck, N. J.  
 Trotter, W. E., Sylvania Electric Products, Inc., 83—30 Kew Gardens Rd., Kew Gardens, L. I., N. Y.  
 Tucker, W. J., Jr., 18 Pearl St., Mystic, Conn.  
 Tykulsky, A., 1132 Elberon Ave., Elberon, N. J.  
 Tyler, E. M., 28 Locust Ave., Millburn, N. J.  
 Uersepup, P. C., 326 Rutland Ave., Teaneck, N. J.  
 Vandenburg, A. A., 77 Christabel St., Lynbrook, L. I., N. Y.  
 Vorwerk, F. A., 909 Heck St., Asbury Park, N. J.  
 Wade, E. 5069—45 St., Woodside, L. I., N. Y.  
 Walcott, H. R., Jr., RFD 1, Allendale, N. J.  
 Walter, C. W. P., 427 Lincoln Ave., Rutherford, N. J.  
 Ward, B. R., 2720 Grand Concourse, New York 58, N. Y.  
 Warner, R. E., 514 N. E. Seventh St., Abilene, Kan.  
 Washileski, E., 131 Hudson Ave., Red Bank, N. J.  
 Watson, R. E., 5020 Erringer Pl., Philadelphia 44, Pa.  
 Weinstein, A., 3937 S St., S. E., Washington, D. C.  
 Welch, H. W., Jr., Department of Engineering Research, University of Michigan, Ann Arbor, Mich.  
 Weller, E. J., 103 Marlborough Rd., W. Hempstead, N. Y.  
 Wells, M., Box 6087, Cleveland, Ohio

(Continued on page 74A)

## BROWNING INSTRUMENTS

For Precise Communications

### S-4 FREQUENCY METER

Designed especially for mobile transmitters. Reading accuracy to one part in one thousand. Tests frequencies from 1.5 to 100 mc. Telescoping antenna forms convenient handle.



### RJ-12 FM-AM TUNER

Hi-sensitivity tuner for FM-AM reception. Separate RF and IF systems on both bands. Armstrong FM circuit. One antenna serves both FM and AM. Tuning eye shows correct tuning.

### OTHER BROWNING INSTRUMENTS

MJ-9 Frequency Meter and ECO for Homs RH-10 Frequency Calibrator for full, accurate use of WWV signals. Model OL-15 Oscilloscope for laboratory work, production testing or research.

WRITE FOR DESCRIPTIVE LITERATURE



**finch**  
first in facsimile  
for broadcasting and point-  
to-point communication!

**FINCH TELECOMMUNICATIONS  
INCORPORATED**  
SALES OFFICE:  
10 EAST 40th STREET, NEW YORK  
FACTORIES: PASSAIC, N. J.



# MEISSNER

## FOR TWENTY-FIVE YEARS THE STANDARD OF COIL QUALITY

For over a quarter century the name Meissner has stood for the finest in electronic equipment. Founded in 1922 by the late William O. Meissner (famous for his outstandingly successful inventions in communications and electronics) this company has been the source of many new developments in the radio field.

First to build a complete line of jobber coils; first to design and build plastic IFs and to introduce Ferrous IFs, Meissner has long led in the development of fine coil equipment for every application. A pioneer in FM (holding the second license issued in this country) Meissner was also the first to manufacture radio receiver kits. The Meissner Signal Shifter is still the Number 1 requirement for the complete ham shack and the Meissner Analyst has saved thousands of man-hours for servicemen everywhere.

Today Meissner's original policy of aggressive research and development remains unchanged. Strengthened by 25 years of electronic manufacturing experience it is your guarantee of product quality . . . an assurance of perfect performance under all conditions.

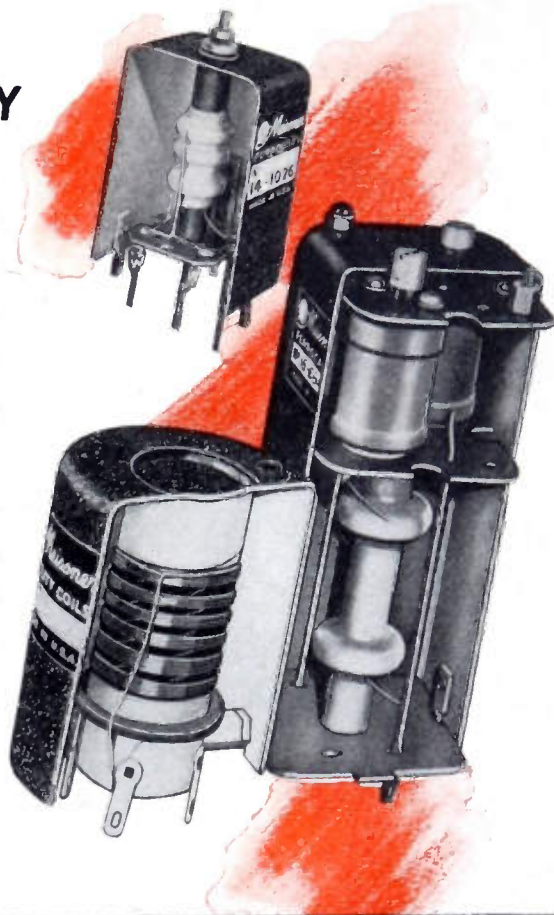

MEISSNER MOUNT CARMEL, ILLINOIS  
ELECTRONIC DISTRIBUTOR AND  
INDUSTRIAL SALES DEPARTMENT

**MAGUIRE INDUSTRIES, INC.**

936 N. MICHIGAN AVENUE  
CHICAGO 11, ILLINOIS

*Meissner*

EXPORT SALES DIVISION, SCHEEL INTERNATIONAL INCORPORATED  
4237-39 N. LINCOLN AVENUE, CHICAGO 18, ILL. CABLE ADDRESS - HARSHEEL



Available in popular sizes and ranges for switch-board and panel requirements; including DC, AC (power frequencies and radio frequencies) rectifier types, and DB meters. Ask your local WESTON representative for full details, or write ... Weston Electrical Instrument Corporation, 589 Frelinghuysen Avenue, Newark 5, New Jersey.

**WESTON**  
*Panel Instruments*



# WHAT'S NEW IN BRITISH RADIO, TELEVISION & ELECTRONICS ?

## These authoritative Journals answer this vital question

THE JOURNAL OF RADIO RESEARCH AND  
PROGRESS FOR ENGINEERS & PHYSICISTS

**WIRELESS ENGINEER** is read by research engineers, designers and students, and is accepted internationally as a source of information for advanced workers; its policy is to publish only original work. The Editorial Advisory Board includes representatives of the National Physical Laboratory, the British Broadcasting Corporation and the Engineering Department of the General Post Office, under the Technical Editorship of Prof. G. W. O. Lowe, D.Sc., M.I.E.E. Regular features include British patent specifications and abstracts and references compiled by the Radio Research Board.

### WIRELESS ENGINEER

PUBLISHED MONTHLY, 32 shillings (\$6.50) A YEAR.

THE JOURNAL FOR MANUFACTURERS AND  
TECHNICIANS OF ALL GRADES

**WIRELESS WORLD** is Britain's leading technical magazine in the general field of radio, television and electronics. Founded over 35 years ago, it has consistently provided a complete and accurate survey of the newest British technique in design and manufacture. Articles of a high standard cover every phase of the radio and allied industries, with reviews of equipment, broadcast receivers and components. Theoretical articles deal with design data and circuits for every application.

### Wireless World

PUBLISHED MONTHLY. 20 shillings (\$4) A YEAR

SUBSCRIPTIONS (by International Money Order) and correspondence should be addressed to:—  
Dorset House, Stamford Street, London, S.E.1, England. Cables: "Iliffepres, Sedist, London."

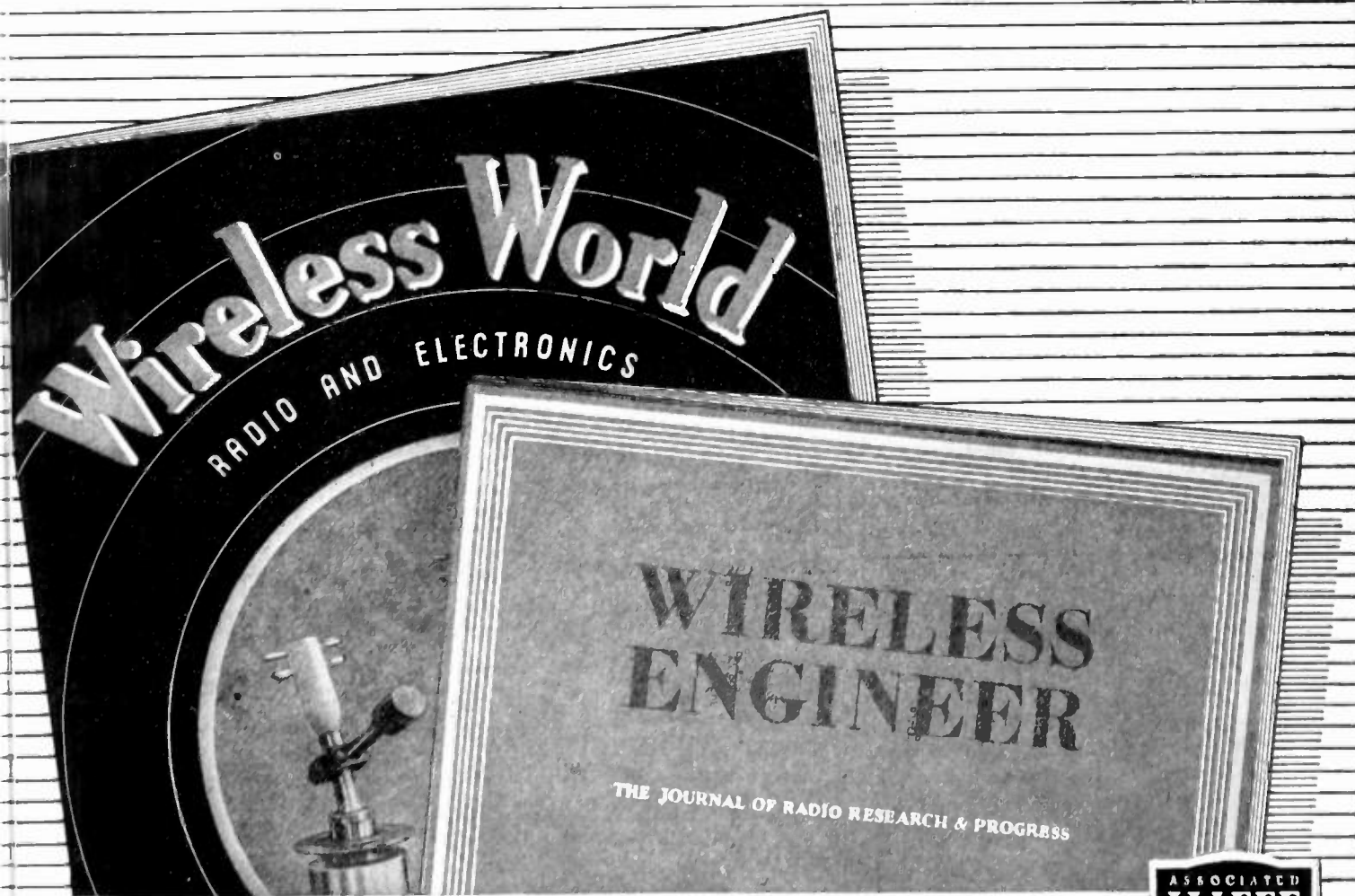

OTHER TECHNICAL BOOKS: "Television Receiving Equipment," by W. T. Cocking, M.I.E.E., editor of "Wireless World," an up-to-date and informative work, 13 shillings (\$2.60); "Basic Mathematics for Radio Students," by F. M. ... B.Sc., D.I.C., A.C.G.I., a particularly helpful new book, 11 shillings (\$2.20); available from the address above.

ASSOCIATED  
**ILIFFE**  
PUBLICATIONS

## PROFESSIONAL CARDS

### W. J. BROWN

*Electronic & Radio Engineering Consultant*  
Electronic Industrial Applications, Commercial and Broadcasting Transmitter and Receiver Design, Test Equipment, etc.  
23 years experience in electronic development  
P.O. Box 5108, Cleveland, Ohio  
Telephone, Yellowstone 7771

### EDWARD J. CONTENT

*Acoustical Consultant*  
*Functional Studio Design*

FM - Television - AM  
Audio Systems Engineering  
Roxbury Road Stamford 3-7459  
Stamford, Conn.

### HERBERT A. ERF

*Architectural Acoustics*  
Consultant

*STUDIO DESIGN*  
Standard Broadcast—FM—Television  
Cleveland 15, Ohio  
3868 Carnegie Avenue Express 1616

### DAVID C. KALBFELL, Ph.D.

*Engineer — Physicist*

Complete laboratory facilities  
Industrial instrumentation and control  
Broadcast engineering and measurements  
941 Rosecrans St. Bayview 7303  
San Diego 6, California

### ROBERT E. McCOY

Consulting Engineer

Antennas, Antenna-Coupling Systems,  
Direction Finders and Beacons.  
Electronic Circuits for Special Purposes:  
Measurement, Computation and Control.

301-302 Concord Bldg., Portland 4, Oregon

FAirmount 5105 Express 7766

FRANK MASSA  
Electro-Acoustic Consultant

3393 Dellwood Road 3868 Carnegie Avenue  
CLEVELAND, OHIO

Paul D. Zottu  
Consulting Engineer  
Industrial Electronics

High Frequency Dielectric and Induction  
Heating Applications, Equipment Selection,  
Equipment and Component Design, Development, Models.

272 Centre St., Newton, Mass. 816-9240

## News—New Products

These manufacturers have invited PROCEEDINGS readers to write for literature and further technical information. Please mention your I.R.E. affiliation.

(Continued from page 68A)

### Plant Expansions

• • • At Waseca, Minn., E. F. Johnson Company, to manufacture a line of Indicator Lights which was recently purchased from the Gothard Manufacturing Company.

• • • At Canonsburg, Pa., by Radio Corporation of America, totaling 115,000 square feet, for the production of phonograph records.

(Continued on page 76A)

## Membership

(Continued from page 70A)

Werzyn, E. A., 7901—35 Ave., Jackson Heights, L. I., N. Y.  
Weyer, E. R., Research Corporation, 405 Lexington Ave., New York 17, N. Y.  
White, R. S., Systems Research Laboratory, Jamestown, R. I.  
Whitehurst, L. M., Box 313, College Park, Md.  
Whitlock, R. S., 515 Hadley Ave., Dayton 9, Ohio  
Whitmyre, R. P., 457 Wendell Terr., Syracuse 3 N. Y.  
Wilkinson, L. A., 24 Luther St., Hatboro, Pa.  
Wilkinson, R. J., 31—33—56 St., Woodside, L. I., N. Y.  
Williams, A. B., 327 E. 47 St., New York 17, N. Y.  
Williams, J. H., 44 Briscoe St., London, Ont., Canada  
Williams, S. B., 366 Clermont Ave., New York 5, N. Y.  
Williams, W. S., 1309 Randolph St., N. W., Washington 11, D. C.  
Wilson, A. L., Sylvania Electric Products, Inc., 83—30 Kew Gardens Rd., Kew Gardens, L. I., N. Y.  
Wilson, E. C., Communications Department, U.S. Naval Air Station, Quonset Point, R. I.  
Wilson, N. B., 5118—25 Rd., N., Arlington, Va.  
Wilson, W. E., 449 Wyoming Ave., Maplewood, N. J.  
Winfree, W. C., 12 and Main Sts., Jacksonville, Fla.  
Winter, N. L., 3831 Macomb St., N. W., Washington, D. C.  
Wood, K. P., 104 Bramshot Ave., London S.E. 7, England  
Wunsch, O. O., 830 Orleans, Beaumont, Tex.  
Zaret, M. E., 3941—48 St., Long Island City 4, N. Y.  
Zindel, G., Tioga & C St., Philadelphia, Pa.  
Zuckerberg, H., 570 Fort Washington Ave., New York 33, N. Y.

The following admissions to Associate were approved on March 2, 1947 to be effective April 1, 1947

Abel-Harry, C. B., 60 Highbury Park, Highbury London, N. 5, England  
Ball, N. T., 8 Leland Ct., Chevy Chase 15, Md.  
Barrack, J., 1011—50 St., Brooklyn 19, N. Y.  
Bawer, L. I., 79—30 Calamus Ave., Elmhurst, L. I., N. Y.  
Blow, A. H., Box 77, Mitchell, Ont., Canada  
Bresson, J., 168 Pembroke St., Brooklyn, N. Y.  
Chambers, W., Box 672, Odessa, Tex.  
Claydon, L. H., 510 Sprague St., Winnipeg, Manitoba, Canada  
Cohn, I. H., 86—07 Eliot Ave., Rego Park, N. Y.  
Cutler, C. R., 627 E. Carroll St., Macomb, Ill.  
Deal, W. R., CESTS, AGF Board No. 1, Fort Bragg, N. C.  
Demere, R. M., Jr., 1420 Southdown Rd., San Mateo, Calif.  
Dobbs, C. I., 5701 S. Hoyne Ave., Chicago, Ill.  
Egger, S. L., 328 S. Mesquite Ave., Box C-2, New Braunfels, Tex.  
Ehlers, D. E., 34—57—72 St., Jackson Heights, L. I., N. Y.  
Embrece, R. R., 6512—31 Ave., S. W., Apt. 785, Seattle 6, Wash.  
Engle, B. E., Apt. 175, Santa Fe Heights, Clovis, N. M.  
Fechter, H. R., Boeing Rep., Army Base, Wendover, Utah  
Fioravanti, J. S., 234 Sixth Ave., Brooklyn 15, N. Y.  
Fisher, E. M., 572 Ridge Rd., Greenbelt, Md.  
Fong, S. G., 403 W. South St., Angola, Ind.  
Friedman, O., 2110 Honeywell Ave., New York 60, N. Y.  
Frohlich, A. J., 13 Crawford St., Eatontown, N. J.  
Gahm, W. L. RFD 1, Cove, Ohio  
Girkin, W. B., 2509 Liberty Pkwy., Dundalk, Baltimore 22, Md.

Gluckman, H. A., 431 Cambridge Y.M.C.A., Cambridge, Mass.  
Goff, R. H., Aberdeen Mission, WSPG, Las Cruces, N. M.  
Goldstein, A. D., c/o Steelman Radio Corp., 742 E. Tremont Ave., New York 57, N. Y.  
Graham, E. A., P. O. Box 428, Clinton, Ont., Canada  
Hale, W. B., 8713 Loch Bend Dr., Townson 4, Md.  
Harris, P. C., 1854 Kipling, Houston, Tex.  
Jackson, S. R., 1830 Bever Ave., S. E. Cedar Rapids, Iowa  
James, T. A. W., 89 Victoria Ave., W., Transcona, Man., Canada  
Kaplan, I., 715 Hopkinson Ave., Brooklyn 12, N. Y.  
Kleinman, J. M., 322 S. 43 St., Louisville, Ky.  
Knox, O. L., 818 E. 43 Pl., Los Angeles, Calif.  
Kuh, M. E., 240 S. Wetherly Dr., Beverly Hills, Calif.  
Kuykendall, J. H., 165 Beech St., Belleville, N. J.  
LeFevre, L. M., c/o USS Blackfin (SS322), F. P. O., San Francisco, Calif.  
Larrabee, C. W., 1563 Dean St., Schenectady, N. Y.  
Lewis, R. M., 208 S. Darling, Angola, Ind.  
Lira, A., Casilla Fl, Vina Del Mar, Chile  
Lockwood, L. W., National Broadcasting Co., 30 Rockefeller Plaza, Rm. 575, New York, N. Y.  
Lovenstein, A. J., 559 W. 158 St., Apt. 61, New York 32, N. Y.  
Mabry, J. H., 8 Charles Lane, San Antonio 2, Tex.  
Markel, A., 210 W. 78 St., New York 24, N. Y.  
McDade, J. G., 521 Sudbrook Ave., Pikesville 8, Md.  
McDonough, V. T., 66—38 Saunders St., Forest Hills, L. I., N. Y.  
McIlwain, McD. S., 4966 Woodland Ave., Cleveland 4, Ohio  
Nelson, H. C., Polytechnic Institute of Brooklyn, Microwave Research Division, 55 Johnson St., Brooklyn, N. Y.  
Pereda, E. F., 2E Southampton Ave., Hampton, Va.  
Petes, J., 9 Danbury St., S. W., Washington, D. C.  
Pond, J. F., 19 Larkin Ave., Toronto 3, Ont., Canada  
Posner, S., 645 Williams Ave., Brooklyn 7, N. Y.  
Post, D. B., 4536 Lake Park Ave., Chicago, Ill.  
Raman, A. A., c/o J. B. Rao, Goods Supdt., Wadi Bunder, Bombay, India  
Reed, C. W., 10113 Hunt Ave., South Gate, Calif.  
Rees, W. M., Jr., 7316 Pittville Ave., Philadelphia, Pa.  
Resnicow, L., 926 Clarkson Ave., Brooklyn, N. Y.  
Rodgers, G. H., 8133 Holy Cross Pl., Los Angeles, Calif.  
Rysuck, J., 141 Forrest Ave., Norfolk 8, Va.  
Schatz, F. W., 253 W. Castle St., Syracuse, N. Y.  
Sellars, E. A., 3364—18 St., N. W., Washington 10, D. C.  
Sherman, J. M., c/o Hobart Manufacturing Co., 448 Huffman Ave., Dayton 3, Ohio  
Shrock, J. B., 2543 Weisser Park Ave., Fort Wayne 5, Ind.  
Sivitz, A., 146 N. Roosevelt Ave., Bexley, Columbus, Ohio  
Smith, P. A., 44 Arden St., New York 34, N. Y.  
Smith, R. M., 458 E. Seventh St., Brooklyn, N. Y.  
Sproson, J., c/o 10, Kings Ave., Talbot Rd., Old Trafford, Manchester 16, England  
Steele, R. H., R & CS, Clinton, Ont., Canada  
Sutton, R. B., c/o Radio Station KPQ, Wenatchee, Wash.  
Swanson, C. D., 251 W. 22 St., New York 11, N. Y.  
Taffet, I., 1075 Grand Concourse, New York 52, N. Y.  
Tarrodaychik, P., 912 S. Cherry St., San Antonio, Tex.  
Thomas, T. F., 4792 Dwight, San Diego 5, Calif.  
Wasley, R. L., 5100 Chowen Ave., S., Minneapolis, Minn.  
Webber, W. B., 3325 S. W. Primrose, Portland, Ore.  
Weiss, G., 260 Fort Washington Ave., New York 32, N. Y.  
Williamson, R. J., Jr., 317 Center St., Vermillion, S. D.  
Wissel, R. A., 2701 North Lehmann Court, Chicago, Ill.  
Young, A. H., Apt. 301, 2322—40 Place, N. W., Washington 7, D. C.



Going places  
(AGAIN)

hallicrafters



Hallicrafters famous radio equipment, sold and distributed around the world before the war and used with superb effectiveness in every theater during the war is once again on the move. Watch for latest details of the Gatti-Hallicrafters mobile radio equipped expedition to the Mountains of the Moon in deepest Africa—a new and exciting test for the ingenuity of hams and the performance of Hallicrafters equipment.

3

GREAT RECEIVERS designed and priced for hams who are going places, too

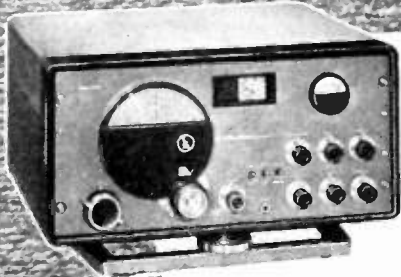

*Model SX-42* Described by hams who have operated it as "the first real postwar receiver." One of the finest CW receivers yet developed. Greatest continuous frequency coverage of any communications receiver—from 540 kc to 110 Mc, in six bands. FM-AM-CW. 15 tubes. Matching speakers available. **\$27500**



*Model S-40A* Function, beauty, unusual radio performance and reasonable price are all combined in this fine receiver. Overall frequency range from 540 kc to 43 Mc, in four bands. Nine tubes. Built-in dynamic speaker. Many circuit refinements never before available in medium price class. **\$8950**



*Model S-38* Overall frequency range from 540 kc to 32 Mc, in four bands. Self contained speaker. Compact and rugged, high performance at a low price. Makes an ideal standby receiver for hams. CW pitch control is adjustable from front panel. Automatic noise limiter. **\$4750**

BUILDERS OF *Skyfone* AVIATION RADIOTELEPHONE

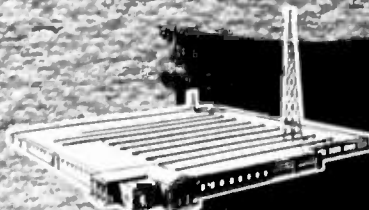

hallicrafters RADIO

THE HALLICRAFTERS CO., MANUFACTURERS OF RADIO AND ELECTRONIC EQUIPMENT, CHICAGO 16, U. S. A.

Sole Hallicrafters Representatives in Canada: Rogers Majestic Limited, Toronto-Montreal

Specify  
**MYCALEX**

LOW LOSS INSULATION

Where high mechanical and electrical specifications must be met.

**MYCALEX 410**

(MOLDED MYCALEX)

makes a positive seal with metals . . . resists arcing, moisture and high temperatures.

27 years of leadership in solving the most exacting high frequency insulating problems.

**MYCALEX CORPORATION OF AMERICA**

"Owners of 'MYCALEX' Patents"  
Plant and General Offices: Clifton, N.J.  
Executive Offices: 30 Rockefeller Plaza  
New York 20, N.Y.

for every  
photo tube  
application

there is a  
High Sensitivity

**RAULAND  
VISITRON**

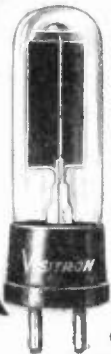

There is a Rauland VISITRON available for every phototube application . . . for industrial electronic control devices, sound-on-film, research and development. For high sensitivity, uniformity and dependability, Rauland VISITRONS are the preferred phototubes.

Specify VISITRON . . . and be sure!  
Send for valuable Rauland VISITRON Catalog—it's yours for the asking.

**THE RAULAND CORPORATION**  
CHICAGO 41, ILLINOIS

RADIO **Rauland** RADAR  
SOUND · COMMUNICATIONS · TELEVISION

**News—New Products**

These manufacturers have invited PROCEEDINGS readers to write for literature and further technical information. Please mention your I.R.E. affiliation.

(Continued from page 74A)

**UHF Signal Generator**

A particularly valuable laboratory standard for determining gain or alignment, obtaining antenna data or measuring standing-wave ratios; for reading single-stage or conversion gain, signal-to-noise ratios, circuit Q, or transmission-line characteristics, within its frequency range of 500 to 1350 megacycles, is being manufactured by the Hewlett-Packard Company, 395 Page Mill Road, Palo Alto, Calif.



This instrument, known as the 610A UHF Signal Generator, is described as unusually stable, and over its frequency range will supply accurately known voltages ranging from 0.1 microvolt to 0.1 volt. The radio frequency may be continuous, amplitude-modulated, pulsed, or square-wave-modulated. Pulse length can be readily controlled between 2 and 50 microseconds, and pulse rate is variable from 60 to 3000 times per second. A simplified direct-reading control is incorporated and operating charts are not necessary.

**Mercury Vapor Rectifiers**

Further completing their line of electron tubes, Eitel-McCullough, Inc., 1018 San Mateo Ave., San Bruno, Calif., announces the availability of Types 866A and 872A mercury vapor rectifiers. These new low-priced rectifiers are directly interchangeable with Types 866A/866 and 872A/872 of other manufacture.

Type 866A/866 operates with 2.5 filament volts, peak inverse voltage as high as 10,000 volts, and a maximum average plate current of 0.25 amperes. The 872A/872 has a five-volt filament and carries a maximum peak inverse voltage rating of 10,000 volts and a maximum average current rating of 1.25 amperes.

**Hand Microphone**

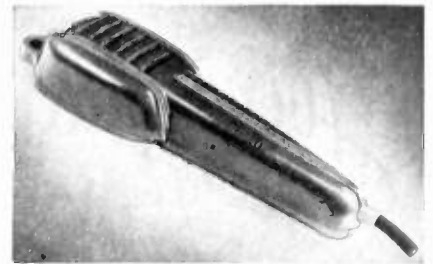

A newly developed hand microphone has been added to the line of microphones manufactured by The Turner Company, 909 17th Street, N.E., Cedar Rapids, Iowa. Designated as Model 20X, it features a "Metalseal" crystal which withstands humidity conditions not tolerated by the ordinary crystal. Factory tests reveal excellent response characteristics for a low-priced unit, which is light in weight and natural to hold.

**Lightweight Towers**

Because of persistent demands from amateur radio operators for a lightweight tower for directional beam antennas, the Fabricated Lightmetals Company, 42 W. 15 Street, New York 11, N. Y., has introduced a new line of reasonably-priced aluminum towers which can be assembled by one man using only a common wrench. Other features of these 10', 20' or 30' self-supporting towers are that they require only small ground space, are excellent for roof-top mounting, and are easily insulated when desired. Maintenance is negligible, it is stated, requiring no painting in normal installations.

**Spot Frequency Generator**

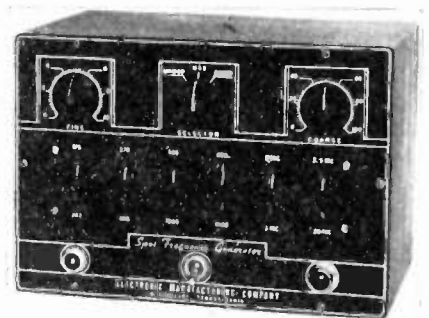

The Electronic Manufacturing Company, 714 Race St., Harrisburg, Pa., announces the production of its Spot Frequency Generator, Model #200. Engineered for use by the average service man, it contains 12 pre-set frequencies chosen to cover adequately 95% of the sets in use. Stability is assured by an electron-coupled circuit and low leakage is effected through use of double shielding. The manufacturer further points out that the unit attenuates to less than one microvolt.

# Compare!

## Here's the Helipot Principle that is Revolutionizing Potentiometer Control in Today's Electronic Circuits

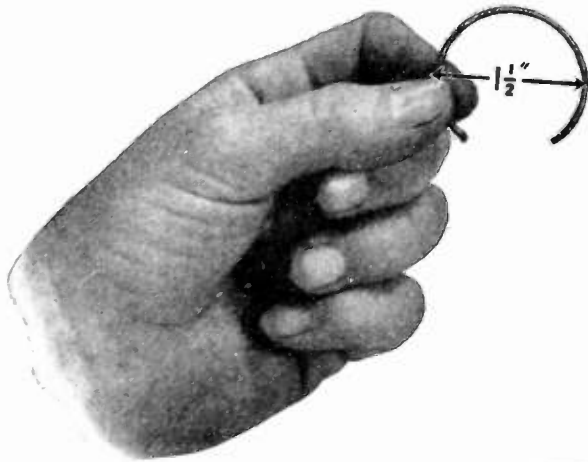

CONVENTIONAL POTENTIOMETERS have a coil diameter of approximately 1 1/2" and provide only 4" (about 300°) of potentiometer slide wire control.



THE BECKMAN HELIPOT has the same coil diameter, yet gives up to 46" (3600°)\* of potentiometer slide wire control—nearly TWELVE times as much!

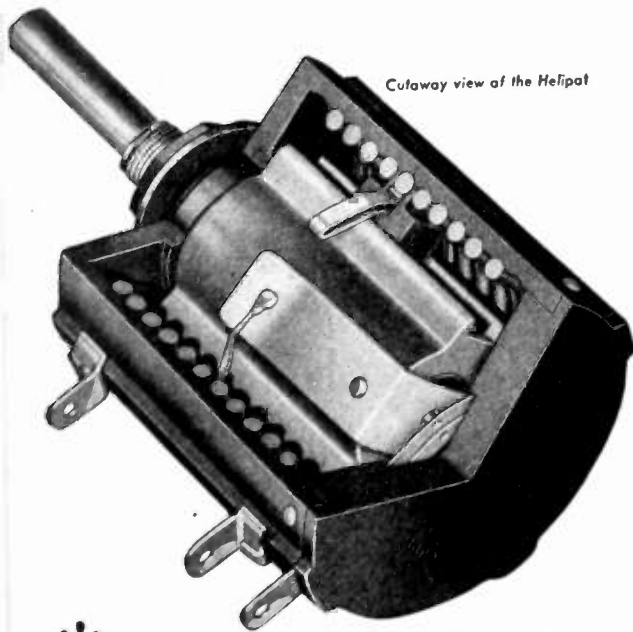

Cutaway view of the Helipot

### Some of the multiple Helipot advantages

**E**XTENSIVELY used on precision electronic equipment during the war, the Helipot is now being widely adopted by manufacturers of quality electronic equipment to increase the accuracy, convenience and utility of their instruments. The Helipot permits much finer adjustment of circuits and greater accuracy in resistance control. It permits simplifying controls and eliminating extra knobs. Its low-torque characteristics (only one inch-ounce starting torque\*, running torque even less) make the Helipot ideal for power-driven operations, Servo mechanisms, etc.

And one of the most important Helipot advantages is its unusually accurate linearity. The Helipot tolerance for deviations from true linearity is normally held to within  $\pm 0.5\%$ , while precision units are available with tolerances held to 0.1%, .05%, and even less—an accuracy heretofore obtainable only in costly and delicate laboratory apparatus.

The Helipot is available in a wide range of types and resistances to meet the requirements of many applications, and its versatile design permits ready adaptation of a variety of special features, as may be called for in meeting new problems of resistance control. Let us study your potentiometer-rheostat problem and make recommendations on the application of Helipot advantages to your equipment. No obligation of course. Write today.

#### \* HELIPOTS ARE AVAILABLE IN 3 STANDARD SIZES:

**TYPE A**—5 watts, incorporating 10 helical turns and a slide wire length of 46 inches, case diameter 1 3/4", is available with resistance values from 25 ohms to 30,000 ohms.

**TYPE B**—10 watts, with 15 helical turns and 140" slide wire, case diameter 3 1/4", is available with resistance values from 100 ohms to 100,000 ohms.

**TYPE C**—2 watts, with 3 helical turns and 13 1/4" slide wire, case diameter 1 3/4", available in resistances from 5 ohms to 10,000 ohms.

The Type B is also available in special sizes of 25 and 40 helical turns, with resistances ranging from 500 ohms to 300,000 ohms, and containing more than 100,000 change-of-resistance steps.

\*Data above is for the standard Type A unit.

Send for the New Helipot Booklet!



THE **Helipot** CORPORATION, 1011 MISSION STREET, SOUTH PASADENA 6, CALIFORNIA

# INDEX AND DISPLAY ADVERTISERS

Section Meetings	35A
Membership	40A
Positions Open	50A
Positions Wanted	54A
News-New Products	18A

General Electric Company	12A
General Radio Co.	Cover IV
Guardian Electric Mfg. Co.	29A
Hallicrafters Company	75A
Hammarlund Mfg. Co.	51A
Helipot Corporation	77A
Hewlett-Packard Co.	27A
Hytron Radio & Electronics Corp.	7A

## DISPLAY ADVERTISERS

Aerovox Corporation	45A
Aircraft Radio Corporation	43A
Alliance Mfg. Co.	21A
American Lava Corp.	41A
Amperex Electronic Corp.	Cover II
Andrew Co.	48A
Arnold Engineering Co.	47A
Astatic Corp.	42A

Illiffe & Sons	73A
Insulation Manufacturers Corp.	79A
International Nickel Co.	33A
International Tel. & Tel. Corp.	15A
E. F. Johnson Co.	67A
D. C. Kalbfell	74A
Karp Metal Products Co., Inc.	11A
Kemet Laboratories Company, Inc.	56A

Barker & Williamson	60A
Bell Telephone Laboratories 2A, 3A, 20A, 34A	
Bendix Aviation Corp. (Radio Div.)	1A, 50A
Bendix Aviation Corp. (Red Bank Div.)	38A
Blaw-Knox Co.	55A
Bliley Electric Company	65A
Boonton Radio Corporation	52A, 60A
W. J. Brown	74A
Browning Laboratories, Inc.	70A
Brush Development Co.	36A
H. H. Buggie & Co.	62A

Lavoie Laboratories	19A
Maguire Industries, Inc.	71A
P. R. Mallory & Co., Inc.	28A
Frank Massa	74A
Robert E. McCoy	74A
Measurements Corp.	44A
Mycalex Corp. of America	76A
National Co., Inc.	14A
Newark Electric Co.	64A
North American Philips Co., Inc.	50A
Ohmite Mfg. Co.	69A

Cambridge Thermionic Corp.	78A
Capitol Radio Engineering Institute	68A
Centralab	59A, 24A, & 25A
Clarostat Mfg. Co.	35A
Cleveland Container Co.	58A
Sigmund Cohn & Co.	62A
Collins Radio Co.	37A
E. J. Content	74A
Cornell-Dubilier Electric Co.	Cover III

Radio Corp. of America 32A, 49A, 52A, 80A	
Rauland Corporation	76A
Raytheon Mfg. Co.	10A
Reeves-Hoffman Corp.	58A
Revere Copper & Brass, Inc.	26A
Selenium Corp. of America	13A
Sherron Electronics Co.	53A
Shure Brothers, Inc.	40A
Sorenson & Company, Inc.	54A
Sprague Electric Company	8A
Stackpole Carbon Company	6A
Superior Electric Co.	63A
Sylvania Electric Products, Inc.	39A

Tobe Deutschmann Corp.	22A
Drake Mfg. Co.	70A
Allen B. DuMont Labs., Inc.	16A, 61A

Triplett Electrical Instrument Co.	66A
Turner Company	9A

Eagle Pencil Co.	23A
Eitel-McCullough, Inc.	4A
Herbert A. Erf	74A
Eric Resistor Corp.	17A
Fairchild Camera & Instrument Corp.	57A
Farnsworth Television & Radio Corp.	50A
Federal Telephone & Radio Corp.	15A
Finch Telecommunications	70A

United Transformer Corp.	5A
Union Carbide & Carbon Corporation	56A
War Assets Administration	30A & 31A
Waterman Products Co., Inc.	64A
Western Electric Company	2A, & 3A, 34A
Weston Electrical Inst. Corp.	72A
S. S. White Dental Mfg. Co.	46A
Paul D. Zottu	74A

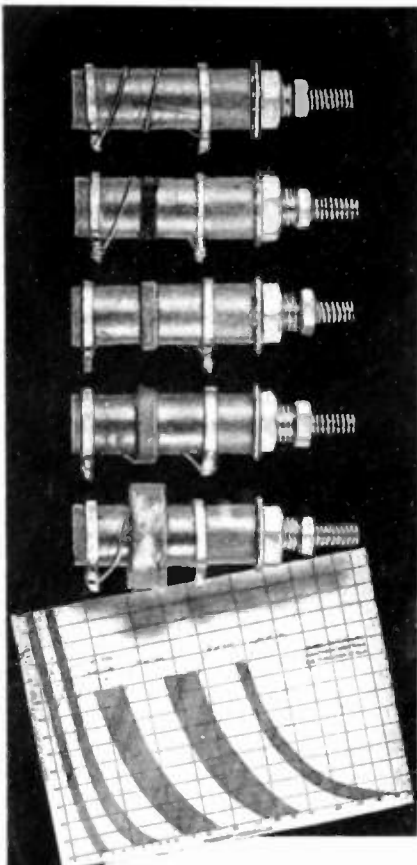

This graph shows frequency ranges covered by each unit. Write us for your full-size copy.

### Five Standard Slug-Tuned LS3 Coils Cover 1/2 to 184 mc

For strip amplifier work, the compact (1 1/4" high when mounted) LS3 Coil is ideal. Also for Filters, Oscillators, Wave-Traps or any purpose where an adjustable inductance is desired.

Five Standard Windings — 1, 5, 10, 30 and 60 megacycle coils cover inductance ranges between 750 and 0.065 microhenries.

CTC LS3 Coils are easy to assemble, one 1/4" hole is all you need. Each unit is durably varnished and supplied with required mounting hardware.

#### SPECIAL COILS

CTC will custom-engineer and produce coils of almost any size and style of winding...to the most particular manufacturer's specifications.



Consult CTC for  
**Three-Way**  
Component Service

Custom Engineering... Standardized Designs...  
Guaranteed Materials and Workmanship  
**CAMBRIDGE THERMIONIC CORPORATION**  
456 Concord Avenue, Cambridge 38, Mass.



The IMC Engineer ...on your staff



but not on your payroll....

OFFERS EXPERIENCED  
ELECTRICAL INSULATION  
ASSISTANCE...

If your problem is increased cost and assembly time, here's a ready answer. Call on your nearest IMC Engineer. He represents a complete line of insulating materials, and he's backed up with a wealth of experience that can help solve your problems. He can be a real help because he represents many manufacturers, and therefore can offer you the right product to best meet your needs. Ask him to...

- 1—Assist you in the selection of the best insulating material for your job.
- 2—Familiarize you with the proper method of application.
- 3—Suggest ways to eliminate waste.
- 4—Help increase your production.

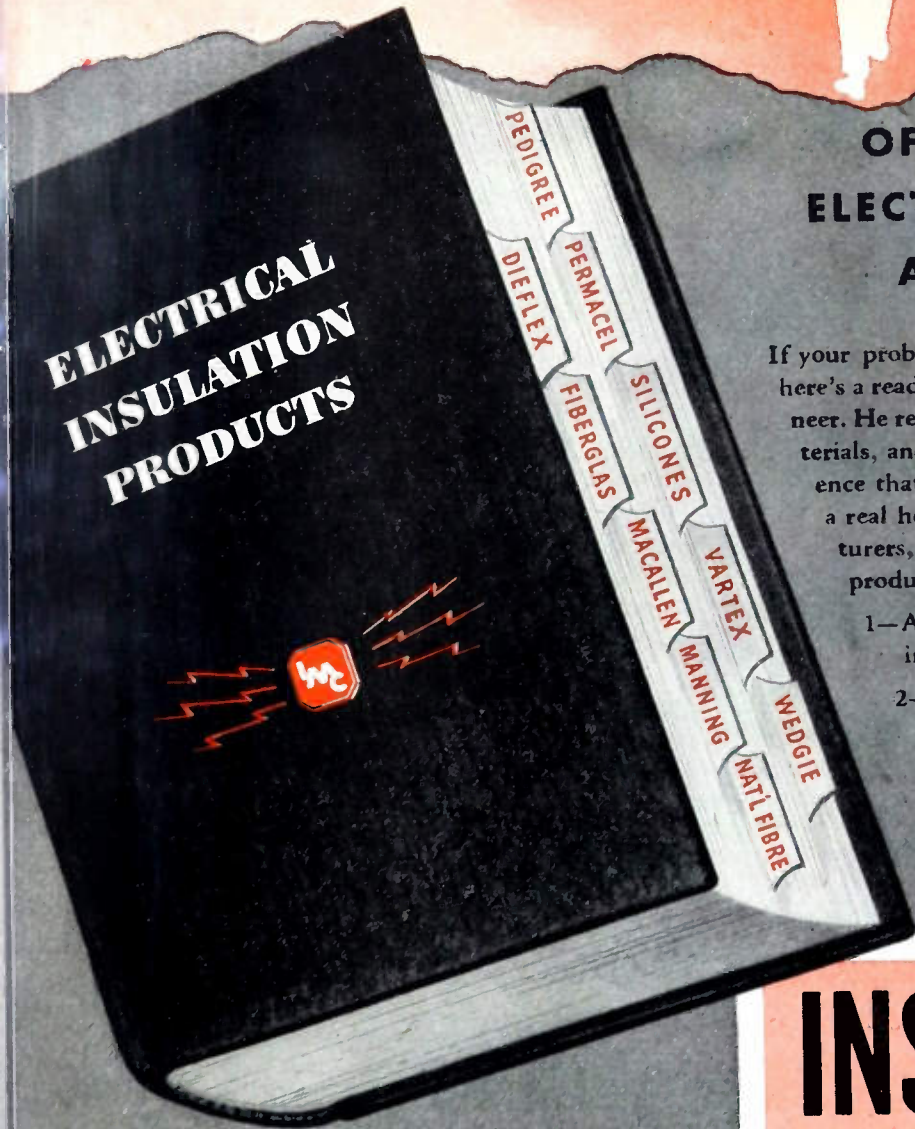

# INSULATION

MANUFACTURERS CORPORATION

\*CHICAGO 6  
565 West Wash-  
ington Blvd.

MILWAUKEE 2  
312 East Wisconsin  
Avenue



\*Local Stocks Available

\*CLEVELAND 14  
1231 Superior  
Ave., N. E.

DAYTON 2  
1315 Mutual Home  
Building.

IMC PRODUCTS: Macallen Mica Products—Vartex Varnished Cloth and Tapes—Varslot Combination Slot Insulation—Varnished Silk and Paper—Fiberglas Electrical Insulation—Manning Insulating Papers and Pressboards—Dow Corning Silicones—Dieflex Varnished Tubings and Saturated Sleeveings of Cotton and Fiberglas—National Hard Fibre and Fishpaper—Phenolite Bakelite—Permacel Adhesive Tapes—Asbestos Woven Tapes and Sleeveings—Cotton Tapes, Webbing, and Sleeveings—Pedigree Insulating Varnishes—Wedgie Brand Wood Wedges.

Representatives in: DETROIT 2: 11341 Woodward Avenue; MINNEAPOLIS 3: 1208 Harmon Place; PEORIA 5: 101 Heinz Court



Television gives you a choice seat at the game.

## Television—a Season Pass to Baseball!

Every home game—day or night—played by the New York Giants, Yankees and Brooklyn Dodgers will be seen over television this season!

Owning a television receiver in the New York area will be like having a season pass for all three ball clubs. And in other cities, preparations for the future telecasting of baseball are being made.

When more than one home game is on the air, baseball fans can switch from one to the other—see the most exciting moments of each through television!

Those who own RCA Victor television receivers will enjoy *brighter, clearer, steadier* pictures through the exclusive RCA Victor Eye-Witness picture synchro-

nizer that “locks” the receiver in tune with the sending station.

To witness baseball or any other event in the ever-growing range of television programs—you’ll want the receiver that bears the most famous name in television today—RCA Victor.

When you buy an RCA Victor television receiver or radio, or Victrola radio-phonograph, or an RCA Victor record or a radio tube, you know you are getting one of the finest products of its kind science has achieved.

“Victrola” T.M. Reg. U.S. Pat. Off.

*Radio Corporation of America, RCA Building, Radio City, New York 20. Listen to the RCA Victor Show, Sundays, 2:00 P.M., Eastern Standard Time over the NBC Network.*



Several television cameras cover the baseball diamond to bring you a close-up of the action wherever it occurs. Here is a supersensitive RCA Image Orthicon television camera used by NBC's New York station WNBT in televising home games of the New York Giants.



**RADIO CORPORATION of AMERICA**



# we've spent 37 years answering one question - *which capacitor?*

A mighty long time to answer one question, you say? Well, not when you've answered it 250,000 times . . . *with a different answer each time!* This is just another way of saying that C-D engineers have designed and built over a quarter-million different types of capacitors to meet manufacturers' specific requirements. And they've saved millions of dollars in manufacturers' assembly costs.

For many applications there is just one capacitor that will do the job right - for other applications several

types may be equally suitable. Whether *your* problem calls for special capacitor design . . . or a standard type unit . . . C-D's specialized experience in the field of capacitors will be able to meet your needs quickly and efficiently.

Consult with our engineers. Catalog of standard types will be mailed at your request. Cornell-Dubilier Electric Corporation, Dept. M5, South Plainfield, New Jersey. Other large plants in New Bedford, Worcester and Brookline, Mass., and Providence, R.I.



**CORNELL-DUBILIER**  
WORLD'S LARGEST MANUFACTURER OF  
**CAPACITORS**

MICA • DYKANOL • PAPER • ELECTROLYTIC CAPACITORS



**CAPACITOR #1** One of the Type MC spark suppressors for use on heavy-duty vehicles. Capacitor unit is hermetically sealed, oil filled and impregnated.

**CAPACITOR #2** This is an oil impregnated paper capacitor for by-pass applications. Available in a wide variety of capacitances and voltage ratings to fit many applications where a sealed unit is desirable.

**CAPACITOR #3** This low capacity, high voltage capacitor unit was designed especially for FM and television applications. Hermetically sealed and provided with glass insulated terminal.

**CAPACITOR #4** A dual capacity unit, with one terminal connected to the case for operation on 220 V.A.C. Ideal for noise suppression, it is constructed for simple installation on flat or round surfaces.



# WAVEMETERS

0.5-150 Mc

55-400 Mc

IN STOCK!



TYPE 566-A — 0.5 to 150 Mc

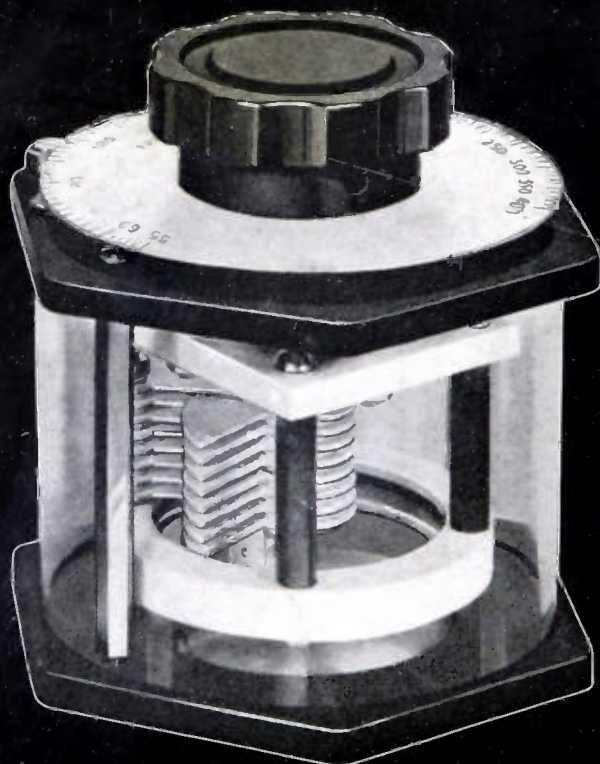

TYPE 758-A — 55 to 400 Mc

● To meet an insistent demand, we have concentrated some of our production facilities on these two popular wavemeters and have managed to accumulate a moderate stock of each.

Both are of the well-known absorption type with accuracies sufficient for a wide variety of routine frequency checks on the ranges of coils, oscillators, receivers, transmitters, etc.

The Type 566-A Wavemeter consists of a variable air condenser, five plug-in coils and an incandescent lamp for resonance indication. The Type 758-A Wavemeter covers its entire frequency range with a single-turn loop the inductance of which is varied simultaneously with the capacitance. An incandescent lamp is used for resonance indication. For low power uses (less than about 2 watts), resonance indication is obtained by the reaction of the wavemeters on the plate or grid currents of the oscillator.

These wavemeters are compact, rugged, inexpensive and direct reading in terms of our primary standard of frequency.

## TYPE 566-A WAVEMETER

**FREQUENCY RANGE:** 0.5 to 150 Mc

**COILS:** Five plug-in type, all supplied. When not in use coils can be plugged into a rack on side of the instrument case

**DIAL CALIBRATION:** Direct reading in frequency

**ACCURACY:**  $\pm 2\%$ , 0.5 to 16 Mc;  $\pm 3\%$ , 16 Mc to 150 Mc

**RESONANCE INDICATOR:** Incandescent lamp

**ACCESSORIES SUPPLIED:** Two spare indicator lamps

**DIMENSIONS:**  $4\frac{3}{4} \times 5\frac{7}{8} \times 5\frac{3}{4}$  inches, over-all

**WEIGHT:** 3 pounds

**PRICE:** Type 566-A WAVEMETER — \$60.00

## TYPE 758-A WAVEMETER

**FREQUENCY RANGE:** 55 to 400 Mc

**COILS:** A single turn loop; inductance and capacitance are varied simultaneously

**DIAL CALIBRATION:** Direct reading in frequency

**ACCURACY:**  $\pm 2\%$

**RESONANCE INDICATOR:** Incandescent lamp

**TEMPERATURE AND HUMIDITY:** Over ranges normally encountered, accuracy is independent of both

**DIMENSIONS:**  $5 \times 5 \times 4\frac{3}{4}$  inches, over-all

**WEIGHT:** 1 pound, 12 ounces

**PRICE:** Type 758-A WAVEMETER — \$35.00

**ORDER NOW — DELIVERY  
PROBABLY FROM STOCK**

# GENERAL RADIO COMPANY

Cambridge 39,  
Massachusetts

90 West St., New York 6

920 S. Michigan Ave., Chicago 5

950 N. Highland Ave., Los Angeles 38