

Proceedings

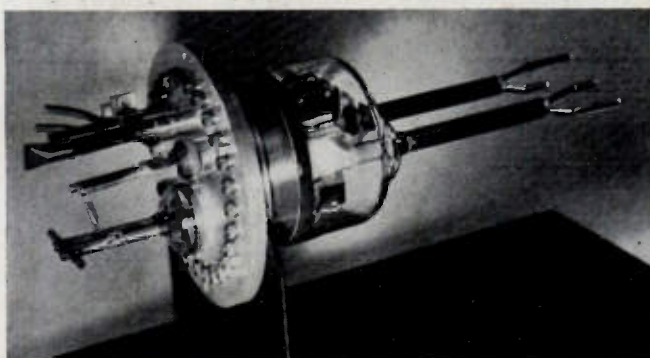

of the I·R·E

A Journal of Communications and Electronic Engineering
(Including the WAVES AND ELECTRONS Section)



New High-Power, Push-Pull Transmitting Tetrode with Total Plate Dissipation of 6000 Watts, for Television Transmission

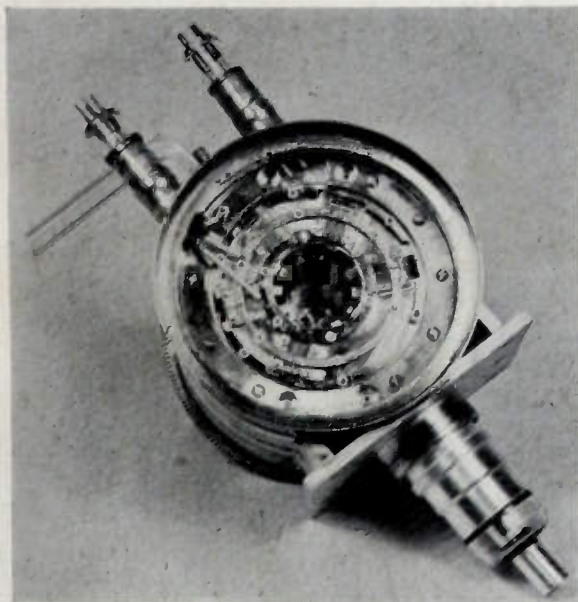

RCA Laboratories
(Submitted by I.R.E. Princeton Subsection)
Frequency-Modulated L-Band Magnetron
COMPLEX STRUCTURE OF MODERN HIGHER-FREQUENCY TUBES

April, 1947

Volume 35

Number 4

PROCEEDINGS OF THE I.R.E.

Design of Centimeter-Wave Radar Receivers

Attenuation of 1.25-Centimeter Radiation Through Rain

Q Circles

The Donutron

Space-Current Division in the Power Tetrode

Waves and Electrons Section

Radio Progress During 1946

Abstracts and References

CHANGES IN CONSTITUTIONS

I am not an advocate for frequent changes in laws and constitutions, but laws and constitutions must go hand in hand with the progress of the human mind. As that becomes more developed, more enlightened, as new discoveries are made, new truths discovered, and manners and opinions change, with the change of circumstances institutions must advance also to keep pace with the times.—Thomas Jefferson

TABLE OF CONTENTS PAGE FOLLOWS PAGE 32A

The Institute of Radio Engineers



LS SERIES

The Ultimate in Quality

UTC Linear Standard Audio Transformers represent the closest approach to the ideal component from the standpoint of uniform frequency response, low wave form distortion, high efficiency, thorough shielding and utmost dependability. Wartime restrictions having been lifted, and UTC production running at full capacity, we now offer these transformers for immediate delivery.



UTC Linear Standard Transformers feature...

- **True Hum Balancing Coil Structure** . . . maximum neutralization of stray fields.
- **Balanced Variable Impedance Line** . . . permits highest fidelity on every tap of a universal unit . . . no line reflections or transverse couplings.
- **Reversible Mounting** . . . permits above chassis or sub-chassis wiring.
- **Alloy Shields** . . . maximum shielding from induction pickup.
- **Multiple Coil, Semi-Toroidal Coil Structure** . . . minimum distributed capacity and leakage reactance.
- **Precision Winding** . . . accuracy of winding .1%, perfect balance of inductance and capacity; exact impedance reflection.
- **Hiper-Allay** . . . a stable, high permeability nickel-iron core material.
- **High Fidelity** . . . UTC Linear Standard Transformers are the only audio units with a guaranteed uniform response of ± 1.5 DB from 20-20,000 cycles.

For Immediate Delivery

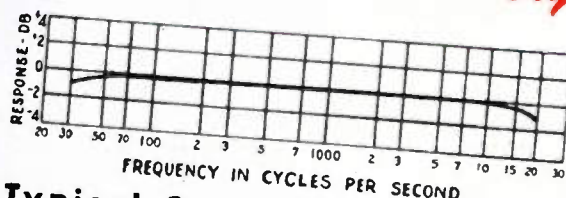

Typical Curve for LS Series

Type No.	Application	Primary Impedance	Secondary Impedance	Max. Level	Relative hum-pickup reduction	Max. unbalanced DC in primary	List Price
LS-10	Low impedance mike, pick-up, or multiple line to grid.	50, 125, 200, 250 333,500 ohms	60,000 ohms in two sections	+15 DB	-74 DB	5 MA	\$25.00
LS-10X	As above	As above	50,000 ohms	+14 DB	-92 DB	5 MA	\$32.00
LS-21	Single plate to push pull grid:	8,000 to 15,000 ohms	135,000 ohms; turn ratio 1.5:1 each side. Split Pri. and Sec.	+14 DB	-74 DB	0 MA	\$24.00
LS-30	Mixing, low impedance mike, pickup, or multiple line to multiple line	50, 125, 200, 250 333, 500 ohms	50, 125, 200, 250, 333, 500 ohms	+17 DB	-74 DB	5 MA	\$25.00
LS-30X	As above	As above	As above	+15 DB	-92 DB	3 MA	\$32.00
LS-50	Single plate to multiple line	8,000 to 15,000 ohms	50, 125, 200, 250, 333, 500 ohms	+17 DB	-74 DB	1 MA	\$24.00
LS-55	Push pull 2A3's, 6ASG's, 300A's, 275A's, 6A3's	5,000 ohms plate to plate and 3,000 ohms plate to plate	500, 333, 250, 200, 125, 50, 30, 20, 15, 10, 7.5, 5, 2.5, 1.2	+36 DB			\$28.00
LS-57	Same as above	5,000 ohms plate to plate and 3,000 ohms plate to plate	30, 20, 15, 10, 7.5, 5, 2.5, 1.2	+36 DB			\$20.00

The above listing includes only a few of the many units of the LS Series. For complete listing — write for catalogue.

United Transformer Corp.

150 VARICK STREET

EXPORT DIVISION: 13 EAST 40th STREET, NEW YORK 16, N. Y.

NEW YORK 13, N. Y.

CABLES: "ARLAB"



STOREHOUSES . . . for BOTTLED LIGHTNING

Check these advantages
of SUPEREX*

Discharge Capacitors

- ✓ RATED FOR DEPENDABILITY
- ✓ EXCELLENT ENERGY-STORAGE TO WEIGHT RATIO
- ✓ BUILT FOR THE APPLICATION
 - Short, heavy, internal leads
 - Low inherent inductance
 - Special construction to minimize discharge stresses
- ✓ RELIABLE HERMETIC SEALS
- ✓ CORROSION-RESISTANT GRAY LACQUER FINISH OVER HEAVY-GAGE TERNEPLATE CONTAINERS

Man-made lightning flashes for high-speed photography, display signs, traffic and marine beacons, airport signals, and a host of other electronic pulsed lighting applications, all have their heart in the discharge of capacitor-stored energy through a flashtube.

Pulsed lighting, capacitor-discharge welding, and all other energy-storage applications where dependability is a must are the fields in which Solar SUPEREX* Discharge Capacitors stand supreme.

You'll find preferred listings, with dimensions, complete rating information and a handy watt-second—microfarad—voltage chart in Bulletin SPD-300. Write for it today.

Solar Manufacturing Corporation
285 Madison Avenue, New York 17, N. Y.

*Trade Mark.

SOLAR CAPACITORS

"Quality Above All"



PROCEEDINGS OF THE I.R.E., April, 1947, Vol. 35, No. 4. Published monthly in two sections by The Institute of Radio Engineers, Inc., at 1 East 79 Street, New York 21, N.Y. Price \$1.50 per copy. Subscriptions: United States and Canada, \$12.00 a year; foreign countries \$13.00 a year. Entered as second class matter, October 26, 1927, at the post office at Menasha, Wisconsin, under the act of March 3, 1879. Acceptance for mailing at a special rate of postage is provided for in the act of February 28, 1925, embodied in Paragraph 4, Section 412, P. L. and R., authorized October 26, 1927.

Table of contents will be found following page 32A

NEW!

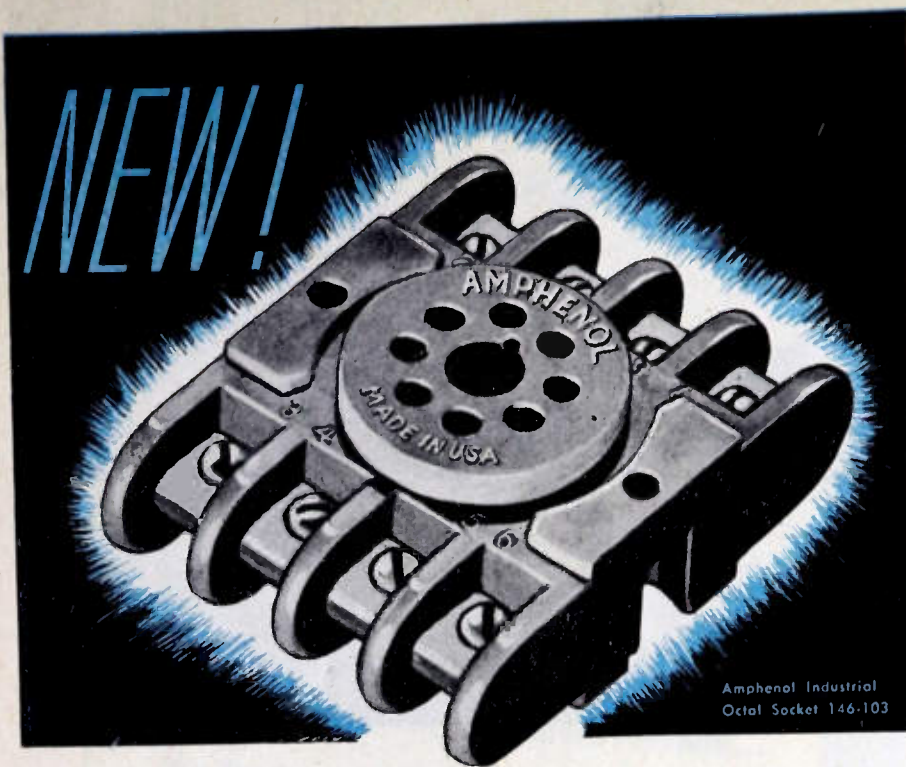

- ★ First to comply with N.E.M.A. and Underwriters' specifications for industrial equipment.
- ★ Rugged insulating barriers prevent flashover and arcing in humid and dusty industrial applications.
- ★ Reversible binding screw terminals simplify wiring and maintenance.
- ★ Cloverleaf contacts . . . four full length lines of contact with each tube pin.

AMPHENOL ELECTRONIC TUBE SOCKETS *designed for* INDUSTRIAL *applications*

Amphenol Electronic Tube Sockets are specially designed for industrial applications. Ruggedly built for utmost dependability and peak performance, they were the first industrial tube sockets to comply with N.E.M.A. and Underwriters' specifications for industrial equipment.

Amphenol sockets are molded of melamine resin or bakelite for strength as well as high arc-resistance and reduced carbon tracking. Utilization of the latest developments in spring bronze has insured the highest degree of contact conductivity and long spring life. Maximum spacing between contacts and chassis is maintained. Heavy insulating barriers prevent flashover between contacts under the adverse conditions found in industrial usage. Screw type terminals provide for quick connect and disconnect, ideal for testing and replacement. No soldering is required.

Amphenol sockets are available in types for practically all industrial electronic tubes. Write today for complete information.



AMERICAN PHENOLIC CORPORATION
1830 SOUTH FIFTY-FOURTH AVENUE
CHICAGO 50, ILLINOIS

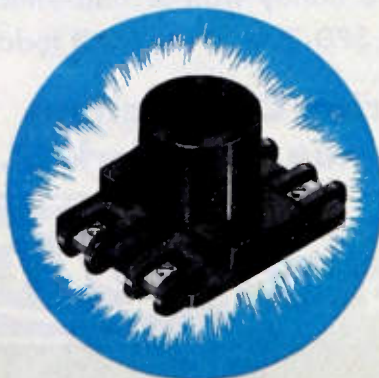
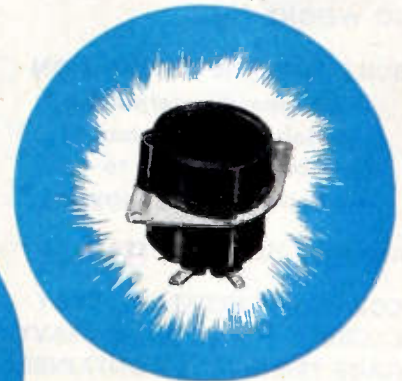

A few of Amphenol's complete line of industrial tube sockets are illustrated



Send for this helpful Data Book on tubes by

Western Electric

In concise, tabular form, this new book gives the essential data on 166 codes of electron tubes designed by Bell Laboratories and made by Western Electric. Planned to help the circuit designer quickly find the tube best suited to his needs, it contains technical characteristics, ratings, dimensions and 89 basing diagrams—all arranged for quick, easy reference. Send the coupon for your copy today!

P-4

Graybar Electric Co.,
420 Lexington Ave., New York 17, N. Y.
Please send me the *General Bulletin on Western Electric electron tubes.*

Name _____

Address _____

City _____ State _____

— QUALITY COUNTS —

Arnold presents:

another step towards a complete line of permanent magnet materials

CAST ALNICO I

CAST ALNICO II

CAST ALNICO III

CAST ALNICO IV

CAST ALNICO V

CAST ALNICO VI

CAST ALNICO XII

SINTERED ALNICO

SINTERED ALNICO

In general SINTERED ALNICO MAGNETS do not compete with, but rather supplement, magnets produced by the cast method to widen the scope of potential permanent magnet applications.

Alnico magnets weighing roughly one ounce or less should be produced by the sintered method.

Heavier magnets of more intricate shapes can be produced. For some applications Sintered magnets are more economical because:

1. Magnetic characteristics are practically the same as Cast Alnico.
2. Sintered Alnico is a fine-grain, homogeneous material which has more uniform flux density, is easier to grind, and provides better surface finish.
3. Sintered Alnico magnets can be produced to closer dimensional tolerances:

SINTERED ALNICO II	CAST ALNICO II
0.000 to 0.125 — + .005	0.000 to 2.00 — ± 1/64
0.126 to 0.625 — + .010	2.0 to 4.0 — ± 1/32
0.626 to 1.250 — + .015	4.0 to 6.0 — ± 3/64
1.251 to 3.000 — + .062	

Grinding can in many applications be eliminated.

4. More intricate shapes, including holes, inserts, etc., are more feasible.
5. Transverse modulus of rupture is several times greater.

All Alnico, and particularly Sintered magnets, have very high values of Coercive Force (which is the capability of resisting demagnetization or loss of magnetism due to stray fields and from heat and vibration).

The curves show roughly the effect of these demagnetization factors on Alnico compared to other alloy steels.

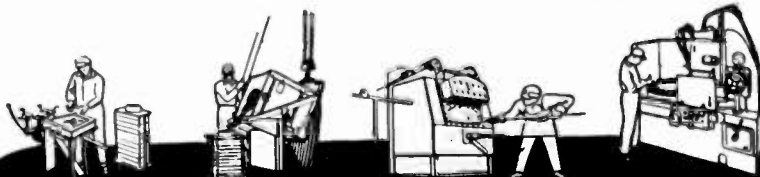
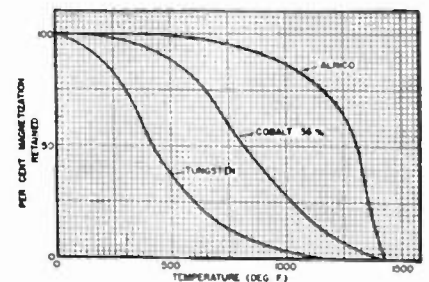
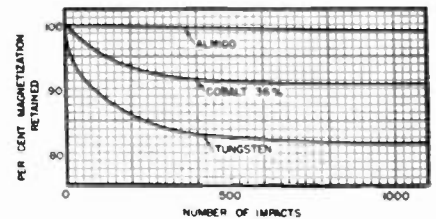
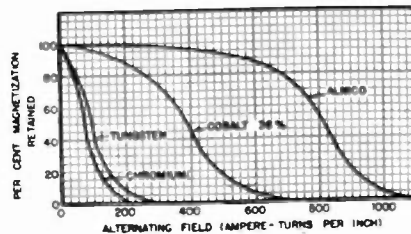

THE ARNOLD ENGINEERING COMPANY

SUBSIDIARY OF ALLEGHENY LUDLUM STEEL CORPORATION
147 EAST ONTARIO STREET, CHICAGO 11, ILLINOIS

Specialists in the manufacture of PERMANENT MAGNET MATERIALS

NOW you can get Sylvania quality in transmitting tubes too!

SYLVANIA INTRODUCES THE TYPE 3D24

BEAM POWER TETRODE WITH ELECTRONIC GRAPHITE ANODE

First of Sylvania's new line of transmitting tubes, the 3D24 is a four-electrode amplifier and oscillator with 45 watt anode dissipation. An outstanding development is the electronic graphite anode, which allows high plate dissipation for small area and maintains constant inter-element relationship and uniform anode characteristics.

The 3D24 may be used at full input up to 125 Mc — maximum permissible frequency will be announced later upon completion of tests.

OTHER FEATURES INCLUDE:

1. Lock-In base. Short leads, no soldered joints.
2. Top cap providing for short path, greater cooling by radiation and convection, resulting in a cooler seal.
3. Thoriated tungsten filament, giving high power output per watt of filament power.
4. Vertical bar grids. #1 grid supplied with two leads for better high frequency performance. #2 grid provided with heat-reflecting shield for greater dissipation, low grid-plate capacity.
5. Low interelectrode capacity. No neutralizing needed with proper circuit arrangement.
6. Hard glass envelope. Permits high power for small size.

The 3D24, a product of the Electronics Division of Sylvania, has interesting potentialities in amateur, police, mobile and marine radio.

MECHANICAL SPECIFICATIONS

Type of cooling	Air—radiation and convection
Mounting position	Vertical, base down or up
Length overall	4.3 inches max.
Seated height	3.769 inches
Diameter	1½ inches
Net weight	1.3 ounces

ELECTRICAL CHARACTERISTICS

Filament Voltage	.63 volts
Filament Current	3.0 amperes
Amplification Factor	50
Direct Interelectrode Capacitances	
Grid-Plate	.02 $\mu\mu\text{f}$ max.
Input	.65 $\mu\mu\text{f}$
Output	.24 $\mu\mu\text{f}$



3D24

TYPICAL OPERATING CONDITIONS

R. F. Power Amplifier and Oscillator—Class C Telephony

Characteristic	C. C. S.	
	C. C. S.	C. C. S.
D. C. Plate Voltage	1500 volts	2000 volts
D. C. Control Grid Voltage	-300 volts	-300 volts
D. C. Screen Grid Voltage	375 volts	375 volts
D. C. Plate Current	90 ma	90 ma
D. C. Control Grid Current	10 ma	10 ma
D. C. Screen Grid Current	22 ma	20 ma
Peak R. F. Grid Input Voltage	400 volts approx.	400 volts approx.
Full Driving Power	4.0 watts approx.	4.0 watts approx.
Plate Power Output	105 watts	140 watts

Direct inquiries to Radio Tube Division, Emporium, Pa.

SYLVANIA ELECTRIC

MAKERS OF ELECTRONIC DEVICES; RADIO TUBES; CATHODE RAY TUBES; FLUORESCENT LAMPS, FIXTURES, WIRING DEVICES; ELECTRIC LIGHT BULBS
PROCEEDINGS OF THE I.R.E. April, 1947

WE MAKE THEM **RUGGED**

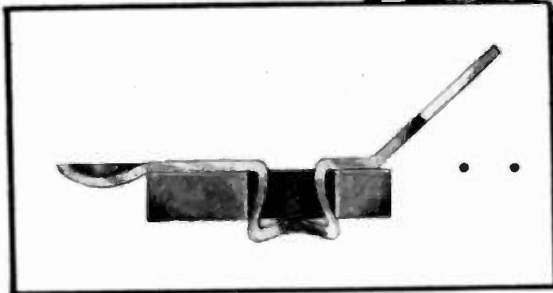
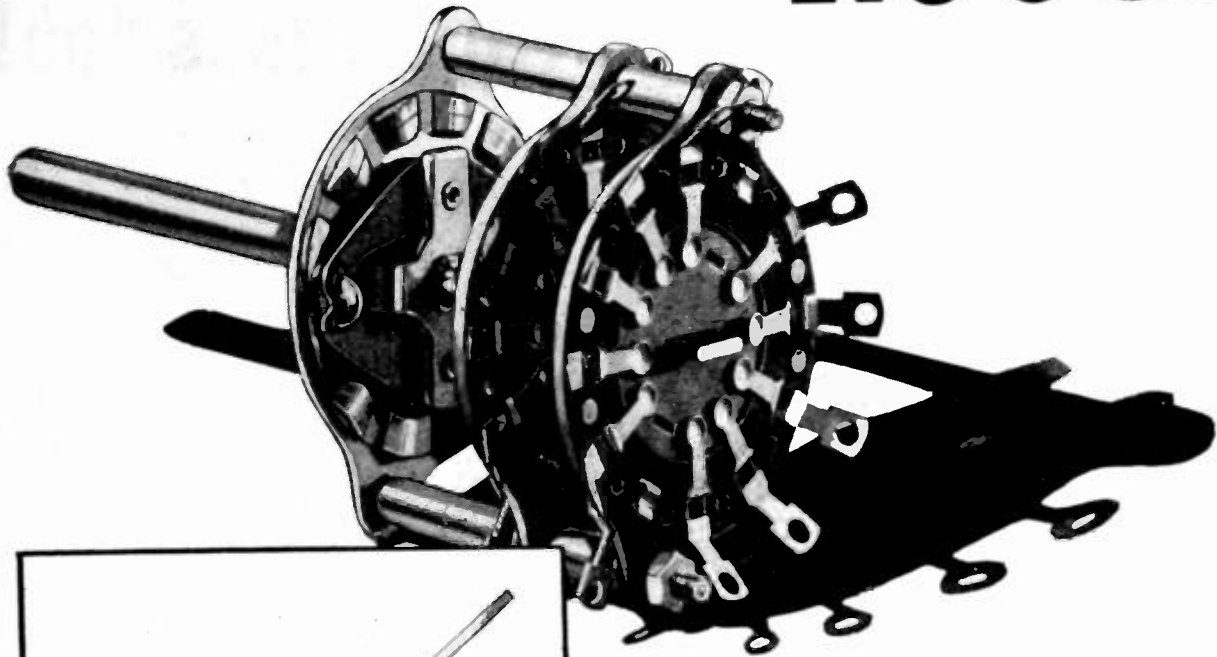

... the terminals
feature two-point fastening!

This Mallory RL Switch, designed for low-power industrial applications, is known throughout the industry for its durability and dependable performance.

Notice how the terminals are fitted right into the stator—firmly held without rivets or staples. No chance of their wobbling loose! The terminals, in turn, are solidly built of spring brass material which is heavily plated with silver. Notice, too, the high lift and flexing ability of the terminals. That's to provide a self-cleaning action, insuring better electrical contact.

Contributing still further to rugged design are the stators of this RL Switch. They're made of heavy phenolic to provide good insulation and to withstand rough usage. Rotor contact slugs are of solid coin silver, common ground rings are of brass, heavily silver-plated: these features combine to assure long life.

The RL Switch offers from 1 to 6 circuits per section with 30 degree indexing—from 1 to 3 circuits per section when 60 degree indexing is used. RL Specification Sheets will give you more of the story. Send for them without obligation. Call on our engineers *any time* for extra help.

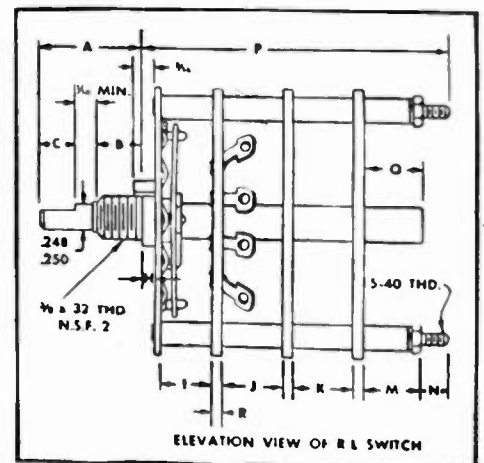

ELEVATION VIEW OF RL SWITCH

ASK FOR RL SPECIFICATION SHEETS

Printed on thin paper to permit blueprinting, these sectional drawings indicate standard and optional dimensions—make it easy for you to order production samples built to meet your requirements. Standard RL switches are obtainable from your nearest Mallory Distributor.

P. R. MALLORY & CO. Inc.

MALLORY SWITCHES

(ELECTRONIC, INDUSTRIAL and APPLIANCE)

P. R. MALLORY & CO., Inc., INDIANAPOLIS 6, INDIANA



**PROUDLY PRESENTS
MODEL 616A
UHF SIGNAL
GENERATOR**



NOW! for the first time

**Fast, direct readings
1800 to 4000 mc**

Here for the first time is an uhf signal generator that combines direct reading scales, simplified controls, and c-w, pulsed, or a limited f-m output with a wide frequency range and a rugged, compact design.

Direct Reading, Direct Control

Carrier frequency in mc may be directly set and read on the large central frequency dial. R-f output from the reflex klystron oscillator is also directly set and directly read, in microvolts or db, on the simplified output dial. No calibration charts or interpolations are necessary. And because the unique coupling device causes oscillator repeller voltage to automatically track frequency changes, no voltage adjustments are necessary during operation. Even the bolometer circuit is automatically compensated for temperature changes.

C-W, F-M, or Pulsed Output

R-f output ranging from 0.1 volt to 0.1 microvolt is available. Output may be continuous or pulsed, or frequency modulated at power supply frequency. Maximum deviation is approximately ± 5 megacycles. Pulse modulation may be supplied from an external source or provided internally. Pulse rate is variable between 40 and 4000 cps, and pulse width ranges from 1 to 10 microseconds. Internal pulsing may be accurately synchronized with either positive or negative external pulses, or external sine

waves. R-f pulse may be delayed 3 to 300 micro-seconds with respect to the external synchronizing pulse. Output trigger pulses are also available. They may be simultaneous with the r-f pulse or delayable from 3 to 300 microseconds with respect to the r-f pulse.

Wide Range, Great Stability

A twist-of-the-wrist precision tunes the -hp- Model 616A to any frequency between 1800 and 4000 mc. Accuracy of calibration is within $\pm 1\%$ and stability is of the order of 0.005% per degree centigrade in ambient temperature. Line voltage changes of $\pm 10\%$ cause frequency changes of less than 0.02%.

Wide Applicability

The -hp- Model 616A UHF Generator is ideal wherever precision ultra-high frequencies are needed for measuring purposes. Some of its many uses include determining of receiver sensitivity, signal-noise or standing-wave ratios, conversion gain, alignment, antenna or transmission line characteristics. The instrument is light and compact, occupying minimum bench space. It is unusually rugged of design for long-term, trouble-free operation. Repairs and replacements, when necessary, are made extremely easy by straight-forward circuit layout and ready accessibility of all components.

The -hp- Model 616A UHF Signal Generator is available for early delivery. Write or wire today for full technical details.

HEWLETT-PACKARD COMPANY

1380D Page Mill Road, Palo Alto, California
Export Agents: FRAZAR AND HANSEN
301 Clay Street, San Francisco 11, California, U.S.A.



- Audio Frequency Oscillators
- Signal Generators
- Vacuum Tube Voltmeters
- Noise and Distortion Analyzers
- Wave Analyzers
- Frequency Meters
- Square Wave Generators
- Frequency Standards
- Attenuators
- Electronic Tachometers

4-750A



ANOTHER EIMAC TETRODE

Designed for

**Industrial
Heating**

**Communications
Airline
Police
Emergency
Broadcast**

**Medical
Diathermy**

Experimental r-f

Here's a new Eimac tetrode—the power step-up you have been asking to have added to the Eimac line.

Capable of 2-kw power output at 4000 plate volts, with less than 15 watts of grid drive, the 4-750A opens a new field of possibilities to designers of electronic equipment. A pair of these tetrodes, driven by low cost, low-power tubes, will supply more than 4-kw output.

A potential workhorse for communications and industrial use, the 4-750A has the ability to deliver its maximum power over a wide range of frequencies. Inherent characteristics include the familiar attributes of Eimac tetrodes—stability, economy, and dependability.

Complete technical data and performance characteristics will soon be available. Write now for your copy.

**EITEL-McCULLOUGH, INC., 1403 San Mateo Avenue
San Bruno, California**

EIMAC 4-750A POWER TETRODE Electrical Characteristics	
Filament: Thoriated tungsten	
Voltage	7.5 volt
Current	20 amp
Direct Interelectrode capacitances (av.)	
Grid-plate	.24 μf
Input	26.85 μf
Output	7.78 μf
Maximum Ratings	
D-C Plate Voltage	6000 max. volts
D-C Plate Current	700 max. ma.
Plate Dissipation	750 max. watts

Follow the Leaders to

Eimac
REG. U. S. PAT. OFF.
TUBES

EXPORT AGENTS: FRAZAR AND HANSEN, 301 CLAY STREET
SAN FRANCISCO 11, CALIFORNIA, U. S. A.

READY NOW

IN ANSWER TO HAMS' DEMANDS



Hams around the world have been National's collaborators in creating the NC-173—ready now after five years of intensive research. Here are some of the advantages this 13-tube superheterodyne receiver offers:

- The NC-173's newly designed adjustable threshold double diode noise limiter—working on both phone and CW—has an extremely high limiting efficiency because of the short recovery time.
- Voltage regulated circuits give the NC-173 high stability and less drift for changes in powerline voltage. The pitch of code characters barely changes—even over extended listening periods.
- The S-meter circuit allows signal strength recordings to be taken on either phone or code.
- Works equally well on coaxial feed-line, single-wire, directional or balanced antenna.
- AC powered. Will also operate on battery for portable or emergency use—110/120 or 220/240 volts, 50/60 cycle. Frequency range .54 to 31 and 48 to 56 MC. (Includes calibrated band spread on 5, 10, 11, 20, 40 and 80 meters).
- Ask your dealer to let you see and hear the new moderate-priced NC-173.

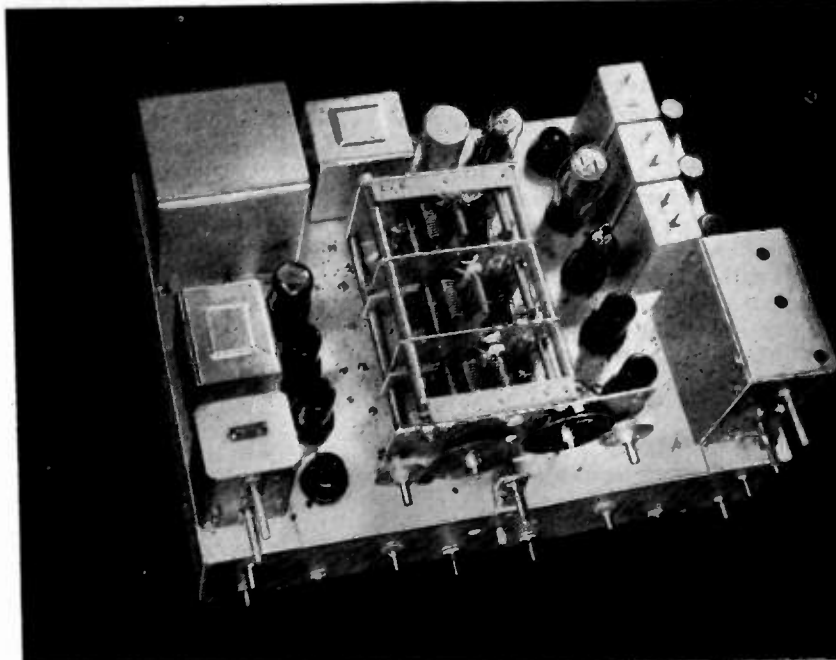

THE NATIONAL NC-173

NATIONAL
COMPANY, INCORPORATED
MALDEN, MASS.

THE MOST DISTINCTIVE NAME IN RADIO COMMUNICATIONS

Does your oscillograph have single or recurrent sweep frequencies as low as 0.2 cycles per second? *IT CAN...*

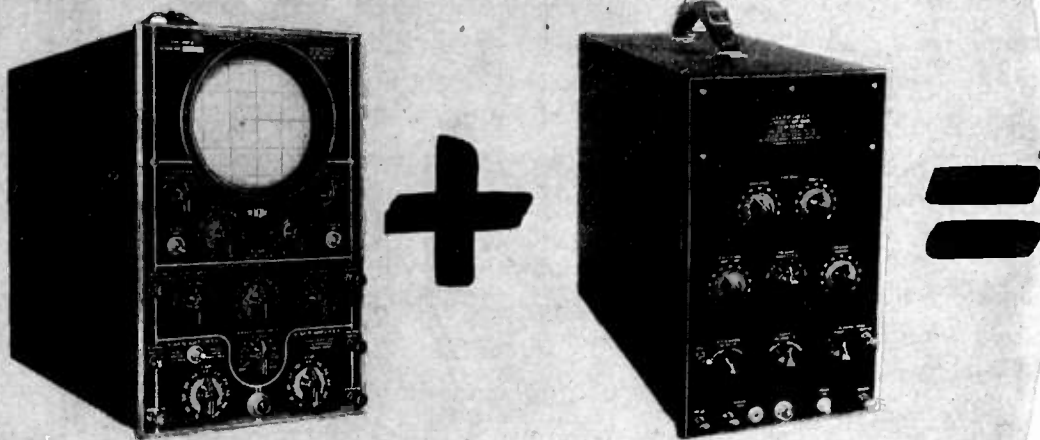

with the **DUMONT** Type 215
LOW-FREQUENCY LINEAR-TIME-BASE GENERATOR

Here's the means for vastly increasing the usefulness of your already useful oscillograph.

This accessory instrument provides a 450 v. d.c. or peak-to-peak undistorted linear-time-base signal voltage of a frequency variable from 0.2 to 125 cycles per second! Special compensating circuit assures linearity.

The single sweep can be initiated either manually or by observed signal. The oscillograph-screen pattern can usually be spread out to three times' full

scale deflection. Return trace blanking signal of either positive or negative phase.

For single sweep, and for low-frequency recurrent-sweep studies, the DuMont Type 215 Low-Frequency Linear-Time-Base Generator used in combination with the DuMont Type 208-B general purpose oscillograph, or equivalent, provides excellent results. Note the typical studies herewith. Definitely "must" equipment.

© ALLEN B. DUMONT LABORATORIES, INC.



ELECTROCARDIOGRAPHY

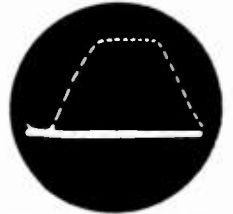

FLASH BULB CHARACTERISTICS

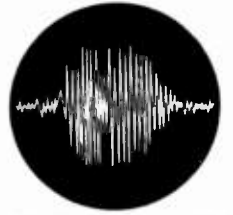

MACHINERY VIBRATION STUDY

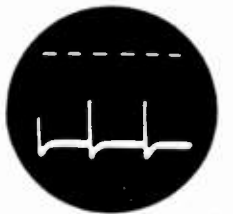

ELECTROENCEPHALOGRAPHY

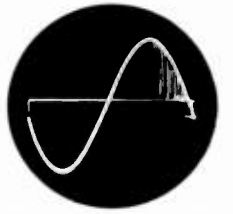

RELAY REBOUND STUDY



DIESEL ENGINE CYLINDER PRESSURE



Descriptive literature on request.

DUMONT Precision Electronics & Television

ALLEN B. DUMONT LABORATORIES, INC., PASSAIC, NEW JERSEY • CABLE ADDRESS: ALBEEDU, PASSAIC, N. J., U. S. A.

Impervious TO ATMOSPHERIC MOISTURE

Proof AGAINST INDUSTRIAL FUMES . . .

Unaffected BY EXTREME HEAT OR COLD

Withstand SEVERE MECHANICAL SHOCKS

. . . in short, constructed to last under the worst of operating conditions.

★ Although essentially fitted for the "tough" applications, Chicago Transformer's *Sealed in Steel* construction is being specified with increasing frequency by engineers who design electronic equipment for only average, or normal, conditions, but who, because of the vital services performed by their products, require an extra margin of dependability.

Their reasoning —

(a) Water vapor, oxygen, and carbon dioxide exist in all atmospheres; chlorine and sulphur compounds in the air of industrial localities.

(b) The action of these agents, intensified by heat and direct current potentials, corrodes copper coil windings, shortens transformer life.

(c) Moisture, even when not excessive in the air, frequently condenses on the inside of partially sealed or unsealed cases and shields as the result of variations in temperature.

Their conclusion —

It is good engineering to specify the transformers that have met with outstanding success the most rigid military tests for sealing against corrosion, have been proven to stay sealed in extremes of heat and cold . . . Chicago Transformers, *Sealed in Steel*.

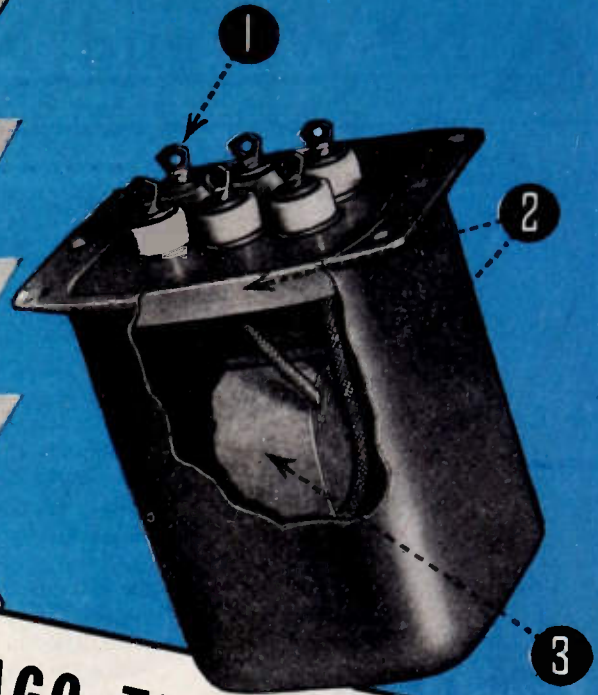

CHICAGO TRANSFORMERS
Sealed in Steel
FOR LASTING DEPENDABILITY

- 1 C.T.'s exclusive Bushing-Gasket Seal at terminals employs tough resilient gaskets to permanently seal all openings and to cushion terminals and bushings against mechanical shock or drastic changes in temperature. (No cracking because of sudden heat transfer from soldering iron to terminals during chassis assembly operation.)
- 2 Seamless, Drawn Steel Case and C.T.'s innovated Deep Seal Base Cover provide a strong, impenetrable housing which, with its compact, modern, and streamlined "good looks," helps sell the equipment in which it appears.
- 3 Coil is impregnated by a process using heat and alternate cycles of vacuum and pressure. By use of vacuum, all moisture is withdrawn from the coil, while pressure and heat thoroughly impregnate it with wax or varnish. Superior to ordinary impregnation processes, this method insures that the transformer is potted without moisture trapped inside.



CHICAGO TRANSFORMER

DIVISION OF ESSEX WIRE CORPORATION

3501 ADDISON STREET • CHICAGO 18, ILLINOIS



April, 1947

Type T-300 Transmitter Tube

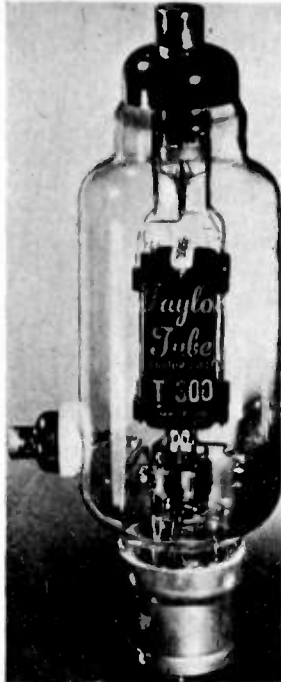

A new transmitting tube in the medium-power field, featuring high peak emission and long life, has been released by **Taylor Tubes Inc.**, 2312 Wabansia Avenue, Chicago 47, Ill. The T-300 may be used for Class B or C operation.

The tube has an overall length of 12" with an envelope diameter of 3½". Its base is the Jumbo 4-pin type. Maximum operating conditions are: plate, 3,000 volts DC; plate current, 275 milliamperes; grid potential, minus 500 volts DC; grid current, 60 milliamperes; plate input, 750 watts; and R.F. grid current, 12 amperes.

High Frequency Cable



A new, improved twisted dual-conductor high-frequency cable specially designed for FM and television receivers to free them from locally induced interference even under the most adverse conditions has been developed by **Federal Telephone and Radio Corp.**, 200 Mount Pleasant Ave., Newark 4, N. J. Known as KT-51, this cable is for use wherever a balanced transmission line is needed. The manufacturer further points out that this new cable has a high degree of stability, low attenuation, and a capacity unbalance maximum of only one per cent.

12A

These manufacturers have invited PROCEEDINGS readers to write for literature and further technical information. Please mention your I.R.E. affiliation.

FM/AM Tuning Tube

A newly designed electron-ray indicator tube, Type 6AL7-GT, which provides visual tuning for frequency or amplitude modulation receivers, has been announced by the Electronics Department, **General Electric Company**, Syracuse, N. Y. Developed to simplify the problem of precise tuning on frequency-modulation receivers, the new tube will produce displaced luminous areas on its face. The "on tune" condition is indicated when the two halves of a pattern which appear on the screen at the end of the tube are aligned. Deviation from the proper tuning condition on either side of resonance will raise or lower an edge of the pattern.

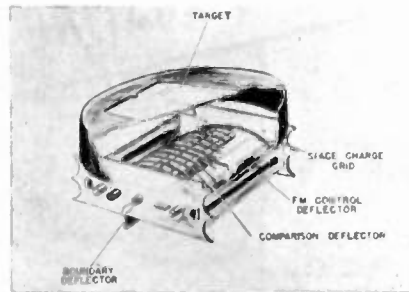

Three deflection electrodes are adjacent to the cathode and the cathode-deflection-electrode-assembly is separated from the target by the space-charge grid. These electrodes can effectively control the position of the electron beam on the target because the velocity of the electron is low in the region between the cathode and space-charge grid.

Quartz Discs

Quartz discs measuring approximately 40 mm. in diameter and 3 mm. thick were recently produced by **North American Philips Co.**, 100 E. 42 St., New York 17, N. Y., which have a frequency of one megacycle and are capable of sustaining a power load of about 2½ kilowatts.

These oscillator plates were developed for use in cavitation, coagulation, and emulsification processes. Both sides of the plates have a chemically-applied silver film by means of which electrical energy is supplied through a multiple-contact rim mounting while the unit is immersed in the liquid to be agitated.

Type OA5 Relay Tube

A new five-element, internally triggered, miniature cold-cathode relay-tube Type OA5 has been announced by the Electronics Division, **Sylvania Electric Products Inc.**, 500 Fifth Ave., New York 18, N.Y. Measuring only 1 5/8" overall and 11/16" in diameter, the tube reduces delay-in-firing from 100 to 1 microsecond; has stable triggering characteristics throughout its life; and is designed for positive-pulse, low-current triggering on trigger grid.



The manufacturer points out that these improved characteristics make it ideal for electronic photoflash and similar applications where manual trip, built-in shutter synchronizing, or photocell switching is used. The tube may be mounted in any position and is supplied with miniature-button seven-pin base.

Terminal Lugs

New insulated midget terminal lugs, designed to cover such applications as tie-points where the potential is exceedingly high at radio frequencies, over a broad humidity range, have been announced by **Cambridge Thermionic Corp.**, 145 Concord Ave., Cambridge 38, Mass. These lugs, furnished in both rivet and stud types are available with either a single or double midget lug, and have a breakdown of approximately 6000 volts alternating-current. The studs are of cadmium-plated brass, and the insulators of phenolic material are securely fitted to lug and stud to avoid loosening under shock and vibration.

(Continued on page 44A)

EVERY DE MORNAY-BUDD WAVE GUIDE is Electrically Tested, Calibrated and Tagged



Crystal Mount DB-453



Rotating Joint DB-446



90° Elbow (H Plane) DB-433



Pressurizing Unit DB-452



Mitered Elbow (H Plane) DB-439



Uni-directional Broad Band Coupler DB-442

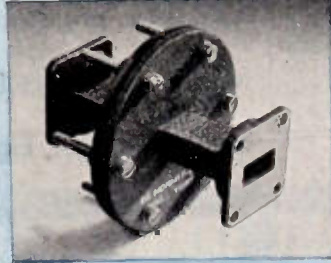

Bulkhead Flange DB-451



Uni-directional Narrow Band Coupler DB-440



90° Twist DB-435

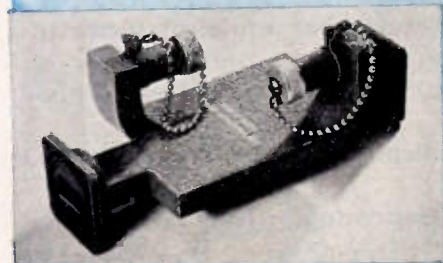

Bi-directional Narrow Band Coupler DB-441

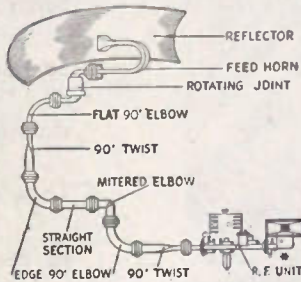

Typical plumbing arrangement illustrating use of De Mornay-Budd components available from standard stocks.



RF Radar Assembly DB-412

When you use any De Mornay-Budd wave guide assembly, you know exactly how each component will function electrically. You avoid possible losses in operating efficiency through impedance mismatches, or breakdown and arcing caused by a high standing wave ratio. (See chart below.)

De Mornay-Budd wave guides are manufactured from special precision tubing, and to the

most stringent mechanical specifications. Rigid inspection and quality control insure optimum performance.

NOTE: Write for complete catalog of De Mornay-Budd Standard Components and Standard Bench Test Equipment. Be sure to have a copy in your reference files. Write for it today.

The curve shows the manner in which the reflected power increases with an increase in the voltage standing wave ratio. The curve is calculated from the following equation:

$$\% \text{ Power Reflected} = \left(\frac{\left(\frac{V_{\max}}{V_{\min}} \right) - 1}{\left(\frac{V_{\max}}{V_{\min}} \right) + 1} \right)^2$$

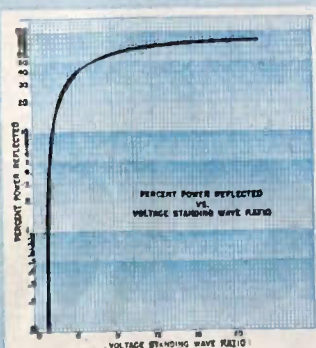

De Mornay-Budd, Inc., 475 Grand Concourse, New York 51, N. Y.

ECONOMICAL SWITCHES

~~LINE~~

~~SLIDE~~

ROTARY ACTION



... for almost any appliance or instrument

Chances are Stackpole has the switch you need—at a price in keeping with your production budget. Eighteen standard types include 1-, 2-, 3- and 4-pole and 3-position switches, with or without detent, spring return, covers and other optional features. Special types and adaptations can be produced economically for large quantity users. They're fully dependable. They add greatly to the sales appeal and efficiency of any electrical product.

STACKPOLE CARBON CO. • St. Marys, Pa.



Write for Catalog RC-6 including Stackpole Switches, Fixed and Variable Resistors and Iron Cores.

STACKPOLE

FIRST QUALITY ELECTRONIC COMPONENTS

"WHEN EQUIPMENT IS STILL IN THE BLUEPRINT STAGE..."



AND VOLTAGE VARIATIONS MAKE YOU RANT AND RAVE



...LET A SOLA 'CV' MAKE THAT VOLTAGE BEHAVE"



Fluctuating Line Voltage



Constant Output Voltage



It may look good on paper . . . and perform superbly under regulated laboratory voltages, BUT . . . when it encounters the *unstable* voltages that are available to your customers, what happens—

- to costly filaments and tubes?
- to precision parts?
- to sensitive, balanced circuits?
- to over-all efficiency?
- to customer good-will?

The operating voltage you specify will never be consistently available unless you make provision for it. That can be done most economically and satisfactorily by including an automatic, self-protecting SOLA Constant Voltage Transformer as a "built-in" component of your equipment.

There are many standard models in SOLA Constant Voltage Transformers that have been specifically

designed for built in use. They are being successfully used today by many manufacturers of electrically energized equipment who have *guaranteed* the availability of constant rated voltage. May we make a recommendation for your equipment?

SOLA *Constant Voltage* TRANSFORMERS

Transformers for: Constant Voltage • Cold Cathode Lighting • Mercury Lamps • Series Lighting • Fluorescent Lighting • X-Ray Equipment • Luminous Tube Signs • Oil Burner Ignition • Radio • Power • Controls • Signal Systems • etc. SOLA ELECTRIC COMPANY, 2525 Clybourn Avenue, Chicago 14, Illinois

Manufactured in Canada under license by FERRANTI ELECTRIC LIMITED, Toronto

SINCE
1895

THORDARSON

THE OLDEST MANUFACTURER OF QUALITY
TRANSFORMER EQUIPMENT IN THE UNITED STATES

For well over fifty years Thordarson has been turning out the finest in amateur and industrial transformer equipment. Founded in 1895 by Chester Thordarson, designer of the first amateur transmitting transformer, this company has pioneered many new developments, including the superior coil and core materials now used in its entire line. Describing quality transformers for every ham requirement, the Thordarson catalog is still regarded as the "bible" of the radio amateur.

In the industrial field, Thordarson was first to design and build transformers for specific applications. To this day, when there is a question of correct transformer design, Thordarson is usually consulted first. Thordarson Amplifiers, a logical outgrowth of this vast transformer manufacturing experience, are regarded by experts as the finest in present-day sound equipment.

In the future, as in the past, Thordarson Transformers and Amplifiers will continue to be manufactured to the same high standards which have distinguished their production from the beginning. When you specify Thordarson you will always be sure of obtaining a product which is as perfect as a half century of electronic manufacturing experience can make it.

THORDARSON CHICAGO, ILLINOIS

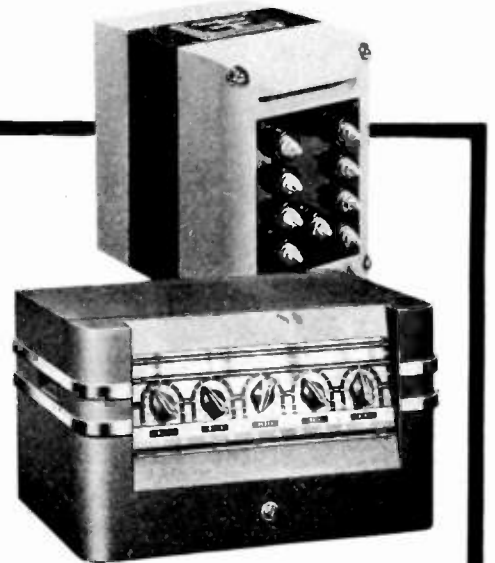

Thordarson Transformers and Amplifiers are designed for every electronic application

THORDARSON

ELECTRONIC DISTRIBUTOR AND INDUSTRIAL SALES DEPARTMENT
MAGUIRE INDUSTRIES, INC. 936 NORTH MICHIGAN AVENUE
CHICAGO 11, ILLINOIS

EXPORT SALES DIVISION • SCHEEL INTERNATIONAL INCORPORATED
4237-39 N. LINCOLN AVENUE, CHICAGO 18, ILL. CABLE ADDRESS HARSHEEL

ALSiMAG INSULATION

TRADE MARK

FOR ELECTRONIC HEATING DEVICES

LOW LOSS FACTOR . . . HIGH DIELECTRIC STRENGTH AND RESISTIVITY

Electronic heating devices require the best insulation. That is why you find ALSiMag custom made technical ceramic insulation at the critical points in practically all the leading makes of dielectric

and induction heating equipment. ALSiMag is also widely employed in work holders, fixtures, gang run devices, locators, spacers and jigs to hold products during electronic heating.

AMERICAN LAVA CORPORATION
 CHATTANOOGA 5, TENNESSEE
 46th YEAR OF CERAMIC LEADERSHIP

SALES OFFICES: ST LOUIS, Mo., 1123 Washington Ave., Tel: Garfield 4959 • NEWARK, N. J., 671 Broad St., Tel: Mitchell 2-8159
 CAMBRIDGE, Mass., 38-B Brattle St., Tel: Kirkland 4498 • CHICAGO, 9 S. Clinton St., Tel: Central 1721 • SAN FRANCISCO, 163 Second St., Tel: Douglas 2464 • LOS ANGELES, 324 N. San Pedro St., Tel: Mutual 9076 • PHILADELPHIA, 1649 N. Broad Street

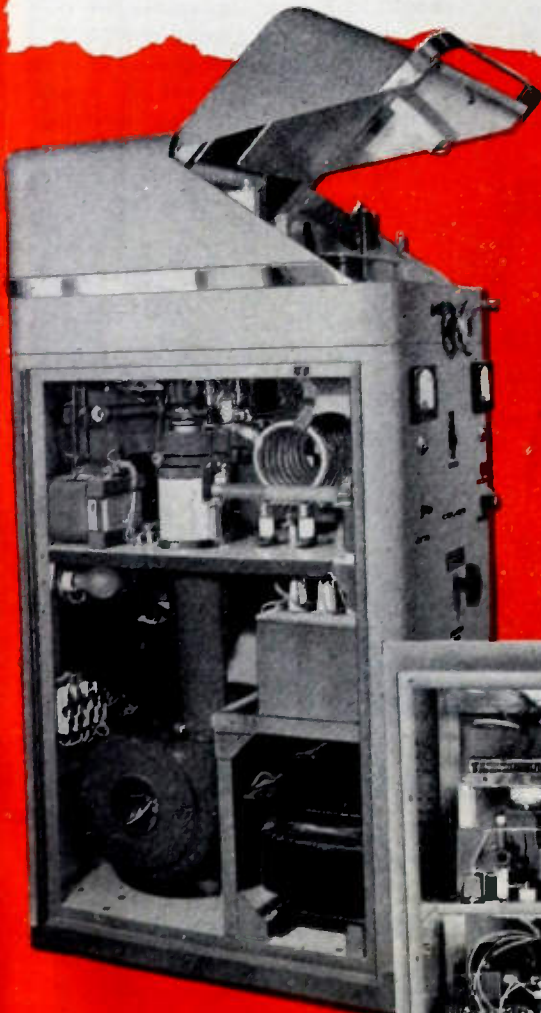

Right side view (Panel removed)
 5 KW Thematron Heatmaster

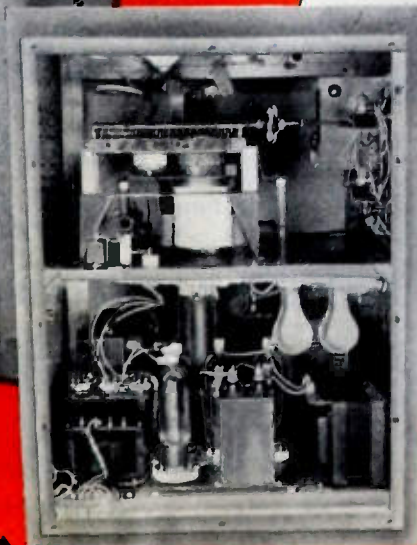

Left side view (Panel removed)
 25 KW Thematron Heatmaster Jr.

WHY
 THERMATRON
 USES ALSiMAG
 INSULATION

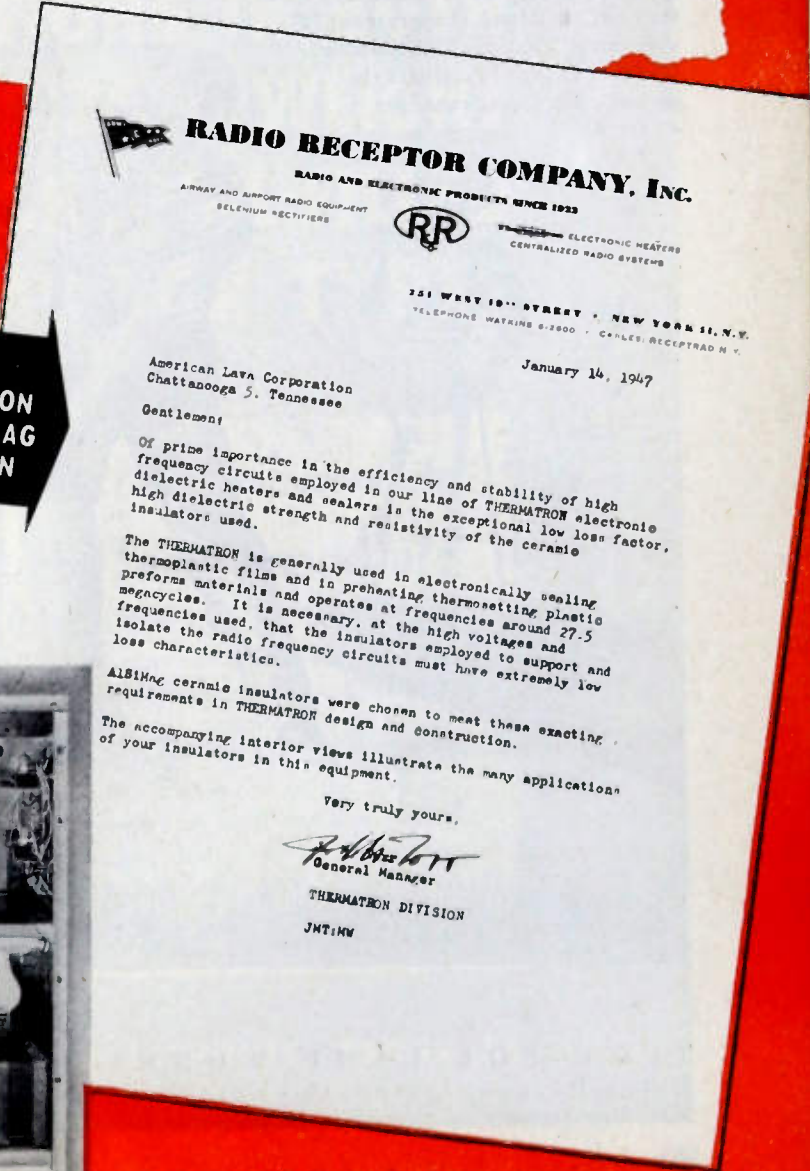

Photo courtesy Radio Receptor Co., Inc.
 251 West 19th Street, New York 11, N. Y.



TUNG-SOL
6X4 MINIATURE
POWER RECTIFIER

... Impromptu Discussions about Miniature Tubes



"Those TUNG-SOL people have come out with another new one . . . their 6X4 power rectifier in miniature. It is electrically equivalent to the big 6X5GT but has all the many advantages of a miniature. While this 6X4 was planned for mobile service, it is so good that you can use it for a lot of other applications.

"You expect a rectifier to do its job under a wide range of operating conditions. The TUNG-SOL 6X4 certainly does. In full-wave condenser input service at full load, it operates at 72% efficiency. That can't be matched by other types of rectifiers that do not offer the advantages of the 6X4.

It provides 335 volts output at 70 milliamperes with 325 volts AC applied to each plate. Where regulation is a factor, use of the choke input circuit results in about 10% variation in output voltage over a 10 to 1 range of output current.

"How is it under extreme temperature variations? The 6X4 is always ready to 'start' in the coldest weather. Its use is seldom restricted by high ambient temperatures.

Conduction cooling through the tube socket will usually be enough even in compact 'boxed-in' equipment. The 6X4 respects Ohms law in the desert or in the 'Arctic. Its ruggedness is proof against both continual vibration and wide variations in heater supply voltages. With a tremendous reserve in emission, it makes little difference if its source of AC power is a vibrator or the Grand Coulee dam.

"Too bad, Joe, you dubbed your shot. I just wanted to tell you that you should look into miniatures for that new stuff you are getting out. TUNG-SOL Engineers will be glad to tell you which miniature to use and advise you as to circuits. You know they are not in the radio set business so you can talk to them freely. Why don't you write 'em?"



TUNG-SOL

vibration-tested

ELECTRON TUBES

TUNG-SOL LAMP WORKS INC., NEWARK 4, NEW JERSEY
Sales Offices: Atlanta • Chicago • Dallas • Denver • Detroit • Los Angeles • New York
Also Manufacturers of Miniature Incandescent Lamps, All-Glass Sealed Beam Headlight Lamps and Current Intermittors

SPRAGUE VITAMIN Q DIELECTRIC

(TRADEMARK REG, U. S. PAT. OFF.)

HAS PERMITTED
SUBSTANTIAL RE-
DUCTIONS IN BOTH
THE SIZE AND WEIGHT
OF MANY OIL-FILLED
CAPACITOR TYPES



TYPICAL! Greatly Increased Life for Fluorescent Lamp Capacitors

The application of Vitamin Q dielectric to Sprague Fluorescent Lamp Ballast Capacitors has established new, higher standards of performance under all conditions of use. Standard $3\frac{1}{2}$ mfd. 330 volt capacitors in 2" round containers were tested competitively for 750 hours at 575v. A-C at 85°C. in still air. Not one of the Sprague Capacitors failed. All competing units by three other manufacturers failed within four hours. Write for Sprague Technical Data Bulletin No. 3200.

SPRAGUE ELECTRIC COMPANY, North Adams, Mass.

PIONEERS OF ELECTRIC AND ELECTRONIC PROGRESS

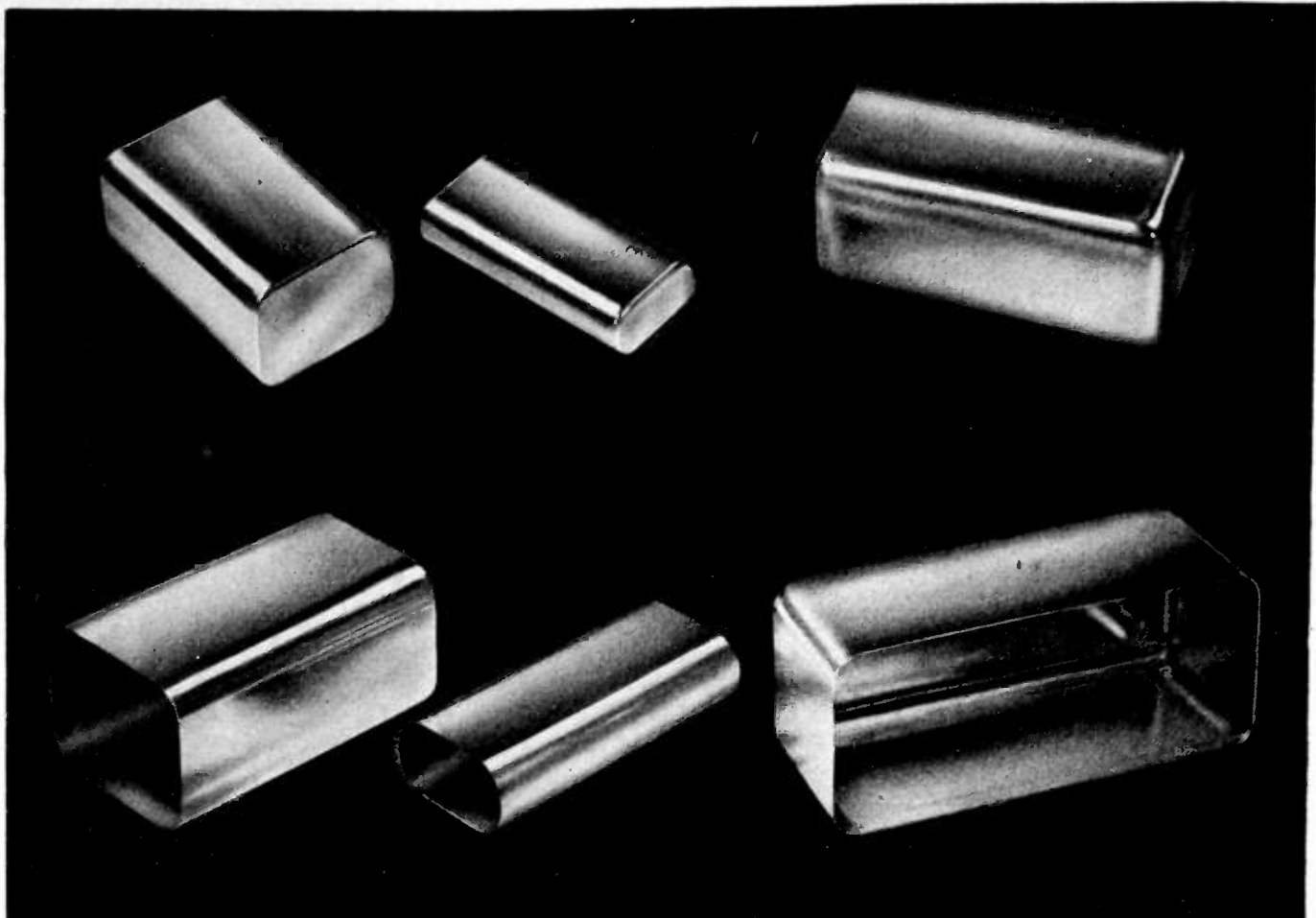

REVERE SHEET AND STRIP FOR DRAWN PARTS

FOR all products to be made by drawing, stamping and similar sheet metal operations, Revere sheet and strip of copper or brass offer maximum ease of fabrication. Not only are these metals naturally ductile, but they benefit further from the metallurgical skill which Revere has gained in 145 years of experience.

In composition, mechanical properties, grain size, dimensions and finish, you will find Revere metals highly uniform. They enable you to set up economical production methods and adhere to them. They can help you produce better products at faster production rates, with less scrap and fewer rejects.

Revere copper, brass and bronze lend themselves readily to the widest variety of finishing operations—polishing, lacquering, electro-plating. With these superior materials it is easy to

make radio shields and similar products beautiful as well as serviceable.

That is why wise buyers place their orders with Revere for such mill products as—*Copper and Copper Alloys*: Sheet and Plate, Roll and Strip, Rod and Bar, Tube and Pipe, Extruded Shapes, Forgings—*Aluminum Alloys*: Tubing, Extruded Shapes, Forgings—*Magnesium Alloys*: Sheet and Plate, Rod and Bar, Tubing, Extruded Shapes, Forgings—*Steel*: Electric Welded Steel Tube. We solicit your orders for these materials.

REVERE

COPPER AND BRASS INCORPORATED

Founded by Paul Revere in 1801

230 Park Avenue, New York 17, New York

Mills: Baltimore, Md.; Chicago, Ill.; Detroit, Mich.;

New Bedford, Mass.; Rome, N. Y.

Sales Offices in Principal Cities, Distributors Everywhere



**THESE AND
A HUNDRED OTHERS**

**COMMUNICATION
INDUSTRIAL
RECTIFICATION
ELECTRO-MEDICAL
EXPERIMENTAL
SPECIAL PURPOSE**

**ONE SOURCE FOR ALL TYPES
AMPEREX**

For a quarter century AMPEREX has been identified with creative research, laboratory approach, precision manufacture and helpful service in its chosen field—power tubes. As tube specialists deeply concerned with all modern developments, Amperex engineers are in a position to give detached counsel and information.

WRITE, AMPEREX APPLICATION ENGINEERING DEPARTMENT,
AMPEREX ELECTRONIC CORPORATION
25 WASHINGTON STREET, BROOKLYN 1, NEW YORK
IN CANADA AND NEWFOUNDLAND: ROGERS MAJESTIC LIMITED
11-19 BRENTCLIFFE RD., LEASIDE, TORONTO 12, ONTARIO, CANADA

Now available from Tobe...

Electrolytic MOTOR-STARTING CAPACITORS



Suitable for use in starting circuits of a-c motors within their nominal voltage rating and at all temperatures from -76°F to $+185^{\circ}\text{F}$.

These units are supplied without insulating tube or other hardware. Requests for hardware should be accompanied by drawings of parts required.

110 VOLTS -- A-C			110 VOLTS -- A-C		
Capacitance	Case		Capacitance	Case	
Min. - Max.			Min. - Max.		
20 - 24	A		216 - 240	B	
27 - 30	A		243 - 270	B	
32 - 36	A		270 - 300	B	
43 - 48	A		324 - 360	C	
54 - 60	A		378 - 420	C	
64 - 71	A				
70 - 78	A		220 VOLTS -- A-C		
76 - 84	A		20 - 24	A	
86 - 96	A		26 - 30	A	
97 - 107	A		32 - 36	C	
108 - 120	A		38 - 42	C	
124 - 138	A		43 - 48	C	
145 - 161	A		53 - 60	C	
162 - 180	B				
189 - 210	B				

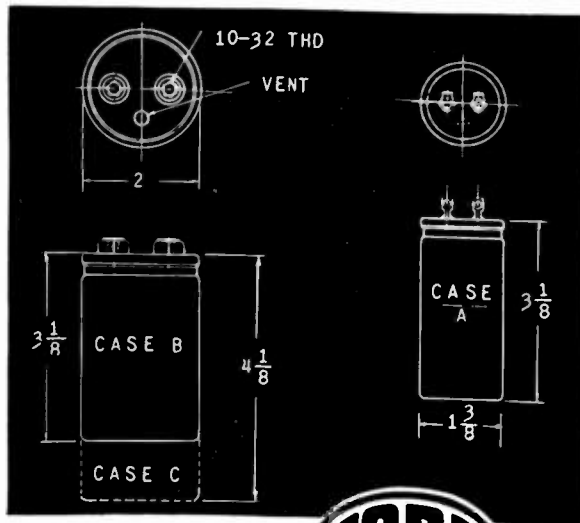

TOBE DEUTSCHMANN Corporation CANTON, MASSACHUSETTS

NEW VHF NAVIGATION

SYSTEM PROVED*

*** First Demonstrations at Indianapolis
Successful in Fog and Snow Storm**

On January 4-5, and again from January 20-23, a new VHF airborne receiving and indicating system, giving ADF type presentation, was successfully demonstrated in conjunction with the CAA's Omnidirectional Range at Indianapolis. The radio and instrumentation equipment was designed and built to specifications of Aeronautical Radio Inc. by the Collins Radio Company.

In full cooperation with commercial aviation in its untiring efforts to establish improved air navigation facilities, the Collins 51R system was speeded to completion by intensive engineering effort, and is the *first* of its type to be demonstrated. ARINC's Radio Equipment Committee and commercial airline engineers witnessed the earlier demonstration in the Collins flight research plane, a Beechcraft 18S. Fog and low-hanging clouds precluded any but instrument flying and provided ideal conditions for proving the effectiveness of the system.

The second demonstration was at the request of the Air Transport Association's Air Navigation Traffic Control Research Group for ATA members. The equipment was installed in ATA's experimental plane, a DC-3.

The Collins 51R Navigation System includes

a 280 channel receiver covering 108 mc to 136 mc in 100 kc steps and provides facilities for the following:

- a. Localizers, tone type (90/150 cycles), including flag alarm.
- b. Localizer, phase type, including flag alarm.
- c. Omnidirectional ranges, indicating on cross pointer meter, course chosen by manual course selector. Includes operation of ambiguity indicator and flag alarm.
- d. Omnidirectional ranges which, when automatically combined with magnetic heading information, provide automatic direction finding type of presentation in the cockpit.

The receiver utilizes the exclusive Collins Drift Cancelled Oscillator (DCO) circuit which provides extremely high stability and rejection of spurious signals. Two or more receivers can be operated with a single antenna.

These successful demonstrations are historic because they mark the first major step in the development of a complete, fully integrated system which will permit guided and controlled flight in any direction, on any track, to any point within the coverage of the basic radio facilities.

IN RADIO COMMUNICATIONS, IT'S . . .



COLLINS RADIO COMPANY, Cedar Rapids, Iowa

11 W. 42nd Street, New York 18, N. Y.

458 South Spring Street, Los Angeles 13, Calif.

Centralab reports to



I As revolutionary as the multi-purpose tube—that's what electronic engineers are saying about Centralab's new *Couplate*. Now available for the first time, the *Couplate* is a complete interstage coupling circuit which combines into one unit the plate load resistor, the

grid resistor, the plate by-pass capacitor and the coupling capacitor. For today's manufacturers, the *Couplate* saves up to five soldered connections, increases labor efficiency 50%, assures fast, precision wiring on interstage couplings.

FRONT

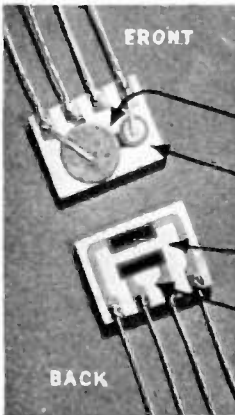

BACK

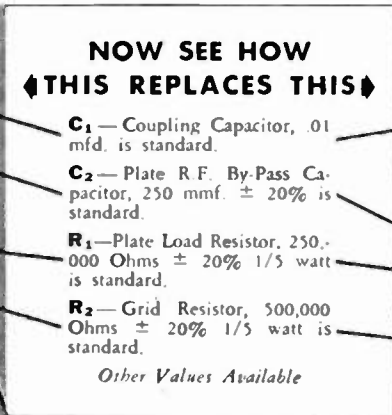

**NOW SEE HOW
THIS REPLACES THIS**

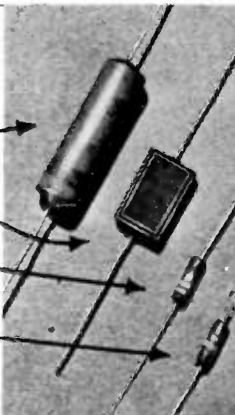

- C₁**—Coupling Capacitor, 01 mfd. is standard.
- C₂**—Plate R.F. By-Pass Capacitor, 250 mmf. \pm 20% is standard.
- R₁**—Plate Load Resistor, 250,000 Ohms \pm 20% 1/5 watt is standard.
- R₂**—Grid Resistor, 500,000 Ohms \pm 20% 1/5 watt is standard.

Other Values Available

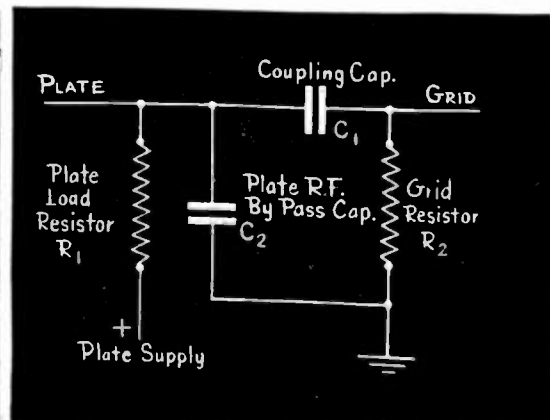

2 Integral Ceramic Construction: Each *Couplate* is an integral assembly of "Hi-KAP" capacitors and resistors closely bonded to a steatite ceramic plate and mutually connected by means of metallic silver paths "printed" on the base plate. Think of what that means in terms of time and labor saving...

3 Only four soldered connections are now required by the *Couplate* instead of the usual eight or nine (see above). That means fewer errors, lower costs!

Electronic Industry

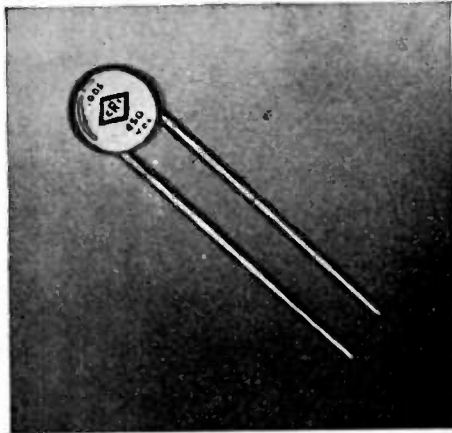

Look at "HI-KAP" Performance, Ratings, Convenience of Design!

Diameter (Max. O. D.)	$\frac{5}{8}$ "
Thickness (Maximum)	$\frac{5}{32}$ "
W. V. D. C.	450
Guaranteed Min. Capac.	.005
Flash Test V. D. C.	900
Weight (Average)	1 gm. .035 oz.

Other capacity values available. Inquire now!

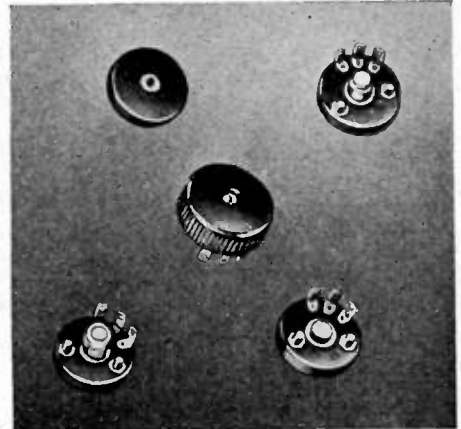

4 In addition—Centralab has just announced a sensational new quality line of miniature ceramic disc capacitors impervious to moisture...

5 Hi-KAP's permanent Ceramic-X stability assures utmost reliability in small physical size and low mass weight. Write for Bulletin 933.

6 Here's Centralab's newest control for miniature receivers, amplifiers. No bigger than a dime, high quality performance is assured.

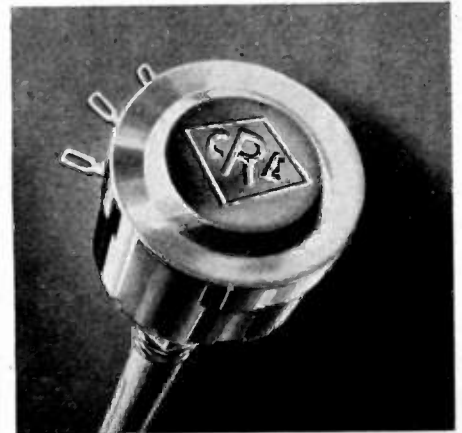
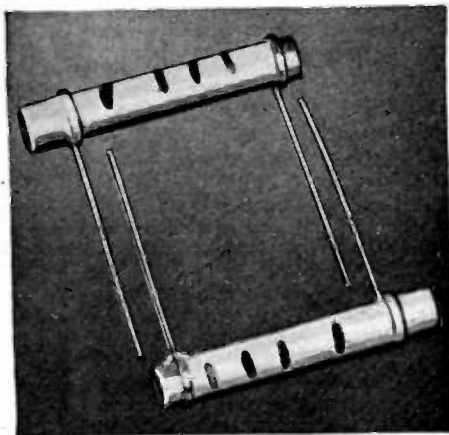

7 More news! The recognized dependability and high quality of ceramic bypass and coupling capacitors is now available at a new low price...

8 Made from Centralab's original Ceramic-X—result of our continuing research in high dielectric constant ceramics. Write for Bulletin 943.

9 When you see this CRL monogram on electronic components, you're assured of tested performance, quality and dependability. Look for it!

Look to Centralab in 1947! First in component research that means lower costs for the electronic industry. If you're planning new equipment let Centralab's sales and engineering service work with you. Get in touch with Centralab!

Centralab

DIVISION OF GLOBE-UNION INC., MILWAUKEE, WIS.

More and More 250 Watt Stations

are being powered by Raytheon



Here's the AM Transmitter that small-station owners are turning to... for its dependable, simpler circuits... its advanced design ... its modern, "dress-up" beauty!

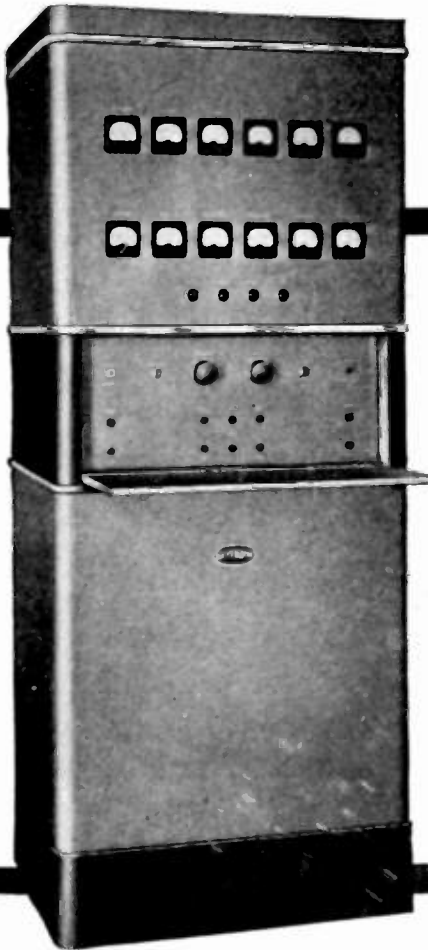

HERE'S WHAT THE SMALL STATION NEEDS!

... Study these RAYTHEON features before you choose any transmitter, for replacement or new installation.

1. **Simplified, More Efficient Circuits**—A high level modulation system eliminates necessity of complicated and critical adjustment of linear amplifiers and minimizes harmonic distortion.
2. **Increased Operating Efficiency**—The use of the most modern improved components which are operated at well below their maximum capacity together with simplified circuit design greatly increases overall operating efficiency.
3. **Greater Dependability**—Due to the use of Triode type tubes, feedback failure will not cause a complete breakdown and the signal quality will still be good. Cooled by natural convective air currents, it is not subject to damage or fire caused by a blower failure.
4. **Simple, Speedy and Accurate Tuning**—All operational controls are centralized on the front panel; every circuit is completely metered

and instantly checked. A clutch-equipped low-speed motor makes micrometer adjustment of the two tuned stages very easy.

5. **No Buffer Stage Tuning**—The use of a Video type amplifier in the buffer stage eliminates this complicated tuning.
6. **Silent Operation**—Natural air cooling means no blower noise, permits microphones in same room with transmitter.
7. **Low Audio Distortion**—Triode type tubes used in the audio stages have inherently lower distortion level. Specially designed audio transformers reduce audio distortion still further.
8. **Easy Servicing**—Vertical chassis, symmetrical mechanical layout and complete accessibility through double rear doors and hinged side panels make the RA-250 a favorite.
9. **Easily Meets All F.C.C. Requirements**—All electrical characteristics are well within the F.C.C. requirements. Noise level is -60 db below 100% modulation. Frequency response ± 1 db from 30 to 10,000 cycles per second.

ANNOUNCED only a few short months ago, the Raytheon 250 Watt AM transmitter has already won its way into the forefront of small station broadcasting. Presented as a transmitter of unsurpassed design, unsurpassed styling and unsurpassed engineering excellence, it has proved its claims on all three points. Visitors exclaim over its strik-

ing, modern beauty ... beauty that gives a "show-place" air to any station. Station owners are delighted with its dependable performance ... its silent operation ... and the high fidelity signal it puts on the air.



Excellence in Electronics

Before you select a 250 Watt transmitter, be sure you possess *all* the facts. Write or wire for our specification bulletin.

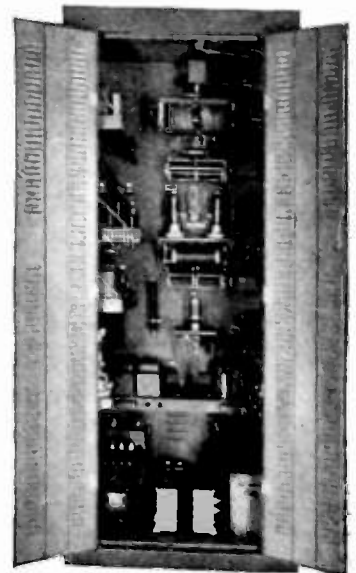

RAYTHEON MANUFACTURING COMPANY

Broadcast Equipment Division, 7475 No. Rogers Ave., Chicago 26, Illinois

DEVOTED TO RESEARCH AND MANUFACTURE FOR THE BROADCASTING INDUSTRY

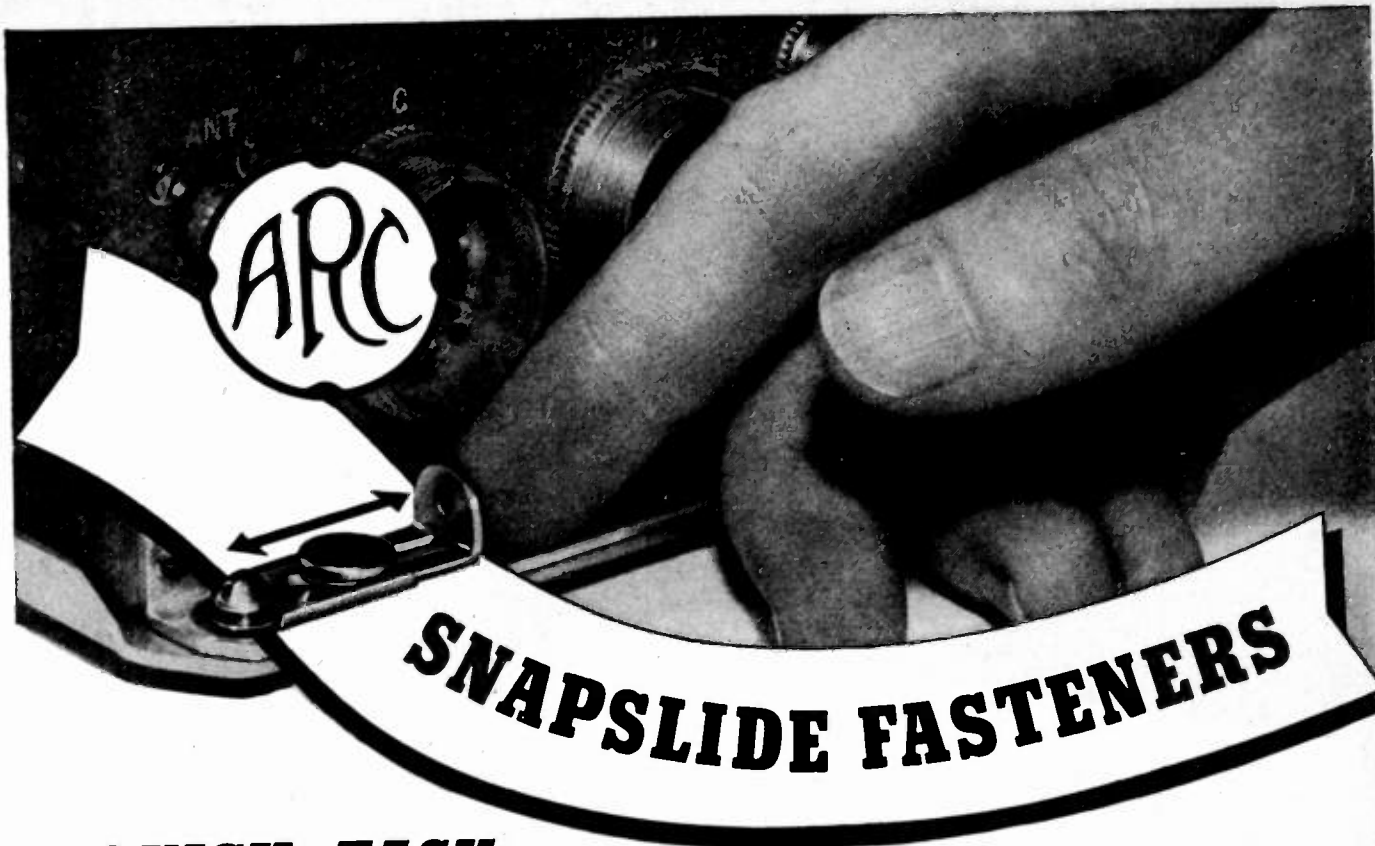

**QUICK, EASY,
ENTIRELY VISIBLE,
NO TOOLS NEEDED**

These Snapslide Fasteners were originated by A. R. C. to provide positive means of attachment and yet to allow instant disengagement. Note how the two spring jaws of the Snapslide lock around the Stud and insure complete security. Both large and small Snapslide Fasteners are available, with Buttons and Studs for various applications and different thicknesses of material.

VARIETY OF USES

Large Snapslides, approximately $\frac{7}{16}$ " wide by 1" long, are suitable for attaching radio sets or such units as dynamotors, converters, etc. to shock absorbers or directly to mounting plates.

Small Snapslides, approximately $\frac{1}{4}$ " wide by $\frac{1}{2}$ " long, are used to hold down tube covers, fuse covers, and similar light-weight parts.

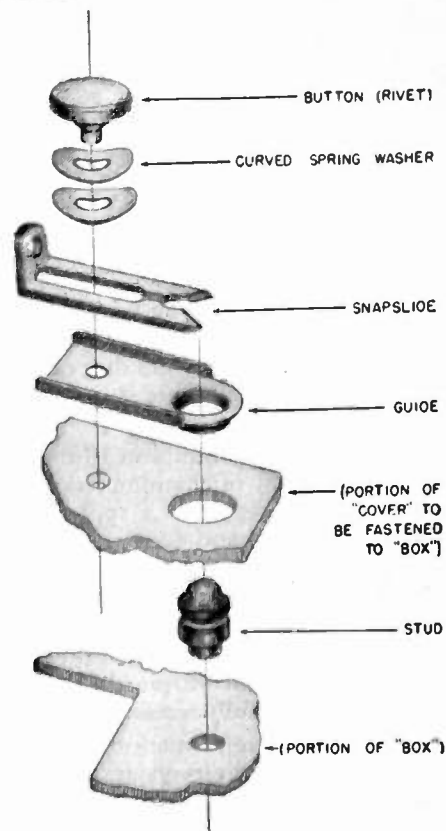

A. R. C.
Aircraft Radio Corporation
 Designers and Manufacturers of Radio and Electronic Equipment Since 1928
 Boonton, N. J.





**Here's a new way
to read meters
...in the dark!**

How often have you wished for a meter you could see *clearly*—the whole scale of it, wherever you were using it—in the dark, under low lights, or even in the kind of glare that causes reflections on the glass—a really illuminated meter? Well, here it is—the result of a new Simpson patented method of illumination.

On these new Simpson Illuminated Meters (voltmeters, ammeters, milliammeters, and microammeters), every fraction of the dial face is flooded with light—there isn't a spot of shadow. And this isn't a dull glimmer of light. It's a full and even radiance.

An ingeniously shaped Lucite cone carries the light from a recessed bulb in the back of the instrument through the front edge that surrounds the entire dial. This makes possible the use of the standard Simpson metal dial. Unlike translucent dials, it cannot fade or discolor so that reading becomes difficult. It cannot warp or buckle, causing the pointer to stick, or distorting readings. The bulb recess is neoprene sealed.

Behind the refinement of this superior illumination lies the basic reason for preferring Simpson instruments—their in-built accuracy. That high quality which is the indispensable component of every Simpson instrument makes sure that the accuracy will *stay* there, year after year.

SIMPSON ELECTRIC COMPANY
5200-5218 W. Kinzie Street, Chicago 44, Illinois
In Canada, Bach-Simpson, Ltd., London, Ont.

Simpson

INSTRUMENTS THAT STAY ACCURATE



OPEN FACE



SHROUD STYLE

2" Round Case. Flange diameter, 2-3/4"; depth overall, 2-5/16"; body diameter, 2-11/64"; scale length, 1-7/8".

3" Round Case. Flange diameter, 3-1/2"; depth overall, 2-1/4"; body diameter, 2-3/4"; scale length, 2-9/16".



3" Rectangular Case. Width, 3"; height, 3-1/8". Mounts in round hole. Body diameter, 2-3/4".

2" Rectangular Case. 2-3/8" square. Mounts in round hole. Body diameter, 2-3/16".

NEW 5516 INSTANT-HEATING VHF BEAM PENTODE

18
WATTS

USEFUL POWER OUTPUT
FOR MOBILE F-M
WITHOUT NEUTRALIZATION

165
MC



IT WAS NOT EASY . . . Compact though it is, the new 5516 is a far cry from the cathode-type tubes previously used in mobile vhf equipment. Design and production headaches for instant-heating vhf beam pentodes increase in geometric progression with the operating frequency. A glance at 5516 constructional advantages discloses unusual measures taken to solve such problems. Yes, the 5516 of necessity costs more, but it does a *real* job at 165 mc.

WHAT THE 5516 DOES FOR YOU . . . 5516 useful power outputs at 165 mc of 18 watts f-m, 12 watts a-m (more at lower frequencies) are not theoretical but are based on actual tested transmitter designs. Low internal tube drop gives high output at low plate potential, with simplified power supply requirements. Instant-heating filament permits tremendous savings in battery drain — mobile or aircraft. One 2E30 doubler or tripler drives a 5516 in plate-modulated class C to full output at 165 mc. Ratings — designed for mobile use — are CCS and equally suitable for the fixed station. Also the 5516 requires no neutralization in properly designed circuits. Write today for complete data sheet.

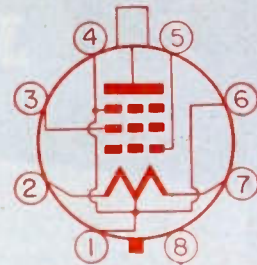

BASING — BOTTOM VIEW

Pin	Connection	Pin	Connection
1	Fil. center tap & beam plates	5	Control grid
2	Filament	6	Same as pin 1
3	Screen grid	7	Filament
4	Same as pin 1	8	No connection
			Cap Plate

HYTRON TYPE 5516 INSTANT-HEATING VHF BEAM PENTODE

GENERAL CHARACTERISTICS

Filament	oxide-coated, center-tapped
Potential (a-c or d-c)	6.0 ± 10% volts
Current	0.7 ampere
Grid-plate capacitance	0.12 max μmf
Input capacitance	8.5 μmf
Output capacitance	6.5 μmf
Maximum overall length	3-21/32 inches
Maximum diameter	1-7/16 inches
Base	low-loss, medium-shell, 8-pin octal

ABSOLUTE MAXIMUM CCS RATINGS

	80 mc	135 mc	165 mc	Mod.*	Unmod.	
D-c plate potential	475	395	355	600	500	v
	30	26.5	23.5	45	40	w
	75	250	10	90	250	ma
D-c plate current						
D-c screen potential				250	250	v
Plate dissipation				10	15	w

USEFUL POWER OUTPUT (CCS) — TYPICAL OPERATION#

Service	Up to: 165	135	80	mc
Class C unmod. or f-m	18	24	30	w
Class C plate-modulated	12	16	20	w

* Carrier condition with max modulation percentage of 100. # Useful power output to load equals plate power output less circuit and direct radiation losses.

5516

CONSTRUCTIONAL ADVANTAGES *

- Zirconium-coated plate, gold-plated control grid, carbonized screen grid enable maximum possible vhf ratings, despite compact size.
- Special, rugged filament suspension avoids short circuits and burn-outs in rigorous mobile applications.
- Three separate base-pin connections to filament center tap provide for lowest possible cathode lead inductance.
- Dishpan stem and compact structure give short, heavy leads with low inductance and capacitance.

SPECIALISTS IN RADIO RECEIVING TUBES SINCE 1921

HYTRON

RADIO AND ELECTRONICS CORP.

MAIN OFFICE: SALEM, MASSACHUSETTS



MANUFACTURERS

WHOLESALERS

JOBBERS

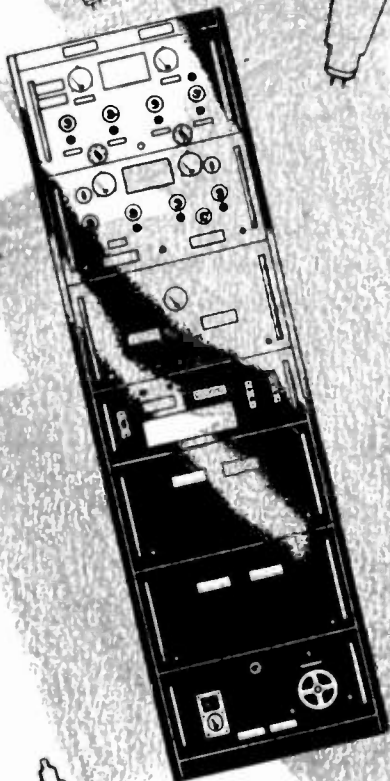

**MANUFACTURERS
WHOLESALERS
JOBBERS . . .**

to obtain this desirable material get in touch with your WAA approved Distributor!

Much of the huge inventory of electronic tubes and equipment, declared surplus by the armed forces, has been allocated to approved distributors for disposal.

The names and addresses of our distributors are listed here. They are equipped to serve your needs and will know what is immediately available.

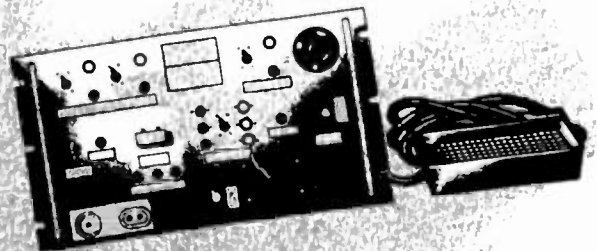
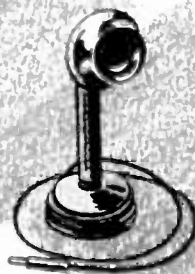

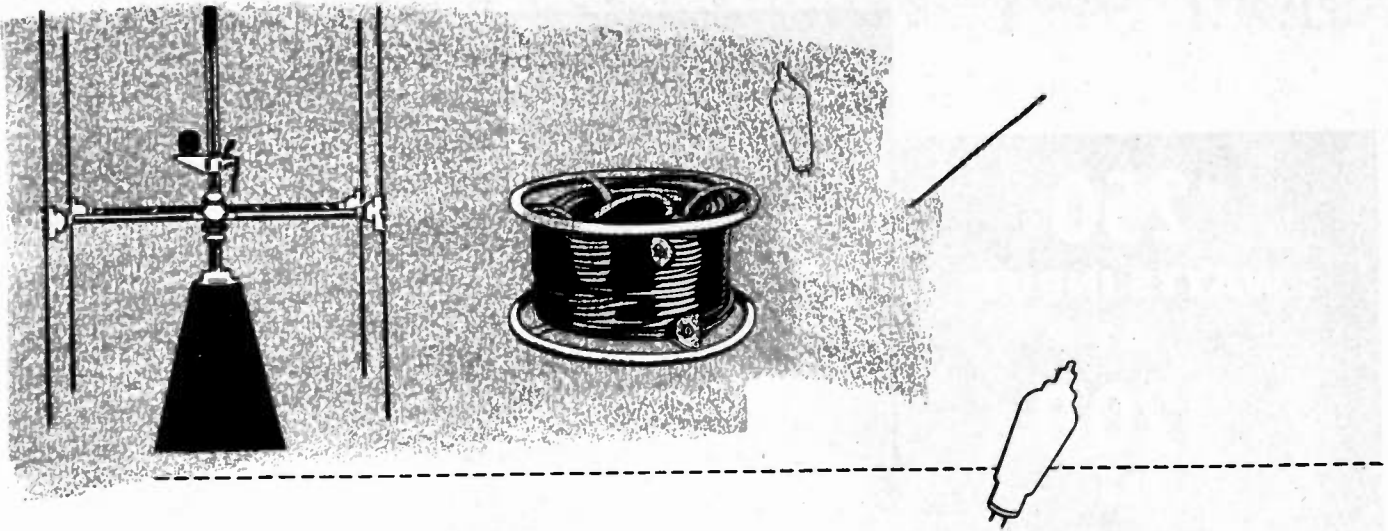

**THESE ARE THE APPROVED DISTRIBUTORS APPOINTED
BY THE WAR ASSETS ADMINISTRATION TO SERVE YOU:**

American Condenser Co.
4410 Ravenswood Avenue
Chicago 11, Illinois

Automatic Radio Mfg. Co., Inc.
122 Brookline Avenue
Boston 15, Massachusetts

Belmont Radio Corporation
3633 So. Racine Avenue
Chicago 9, Illinois

Communication Measurements Laboratory
120 Greenwich Street
New York 6, New York

Cole Instrument Co.
1320 So. Grand Ave.
Los Angeles, California

Electronic Corporation of America
353 West 48th Street
New York 19, New York

Electra-Voice, Inc.
Carroll & Cecil Streets
Buchanan, Michigan

Emerson Radio & Phonograph Corporation
76 Ninth Avenue
New York 11, New York

Essex Wire Corporation
1601 Wall Street
Ft. Wayne 6, Indiana

General Electric Company
Building 267-1 River Road
Schenectady 5, New York

Raytheon Manufacturing Company
60 East 42nd Street
New York 17, N. Y.

Smith-Meeker Engineering Company
125 Barclay Street
New York 7, New York

Southern Electronic Company
512 St. Charles Street
New Orleans 12, Louisiana

Standard Arcturus Corporation
99 Sussex Avenue
Newark, New Jersey

Sylvania Electric Products, Inc.
Emporium, Pennsylvania

Technical Apparatus Company
165 Washington Street
Boston 8, Massachusetts

Tobe Deutschmann Corporation
863 Washington Street
Canton, Massachusetts

Tung-Sol Lamp Works, Inc.
95 Eighth Avenue
Newark 4, New Jersey

General Electronics Inc.
1819 Broadway
New York 23, New York

Hammarlund Mfg. Company, Inc.
460 West 34th Street
New York 1, New York

Hoffman Radio Corporation
3761 South Hill Street
Los Angeles 7, California

Hytron Radio & Electronics Corporation
76 LaFayette Street
Salem, Massachusetts

E. F. Johnson Company
206 Second Avenue, S. W.
Waseca, Minnesota

Majestic Radio & Television Corporation
125 West Ohio Street
Chicago 10, Illinois

National Union Radio Corporation
57 State Street
Newark 2, New Jersey

Navigation Instrument Co., Inc.
2007 Capitol Avenue
Houston 3, Texas

Newark Electric Co., Inc.
242 West 55th Street
New York 19, New York

Radio Parts Distributing Company
128 W. Olney Road
Norfolk 10, Virginia

ELECTRONICS DIVISION

WAR ASSETS ADMINISTRATION



Offices located at: Atlanta • Birmingham • Boston • Charlotte • Chicago • Cincinnati • Cleveland • Dallas
Denver • Detroit • Fort Worth • Helena • Houston • Jacksonville • Kansas City, Mo. • Little Rock • Los
Angeles • Louisville • Minneapolis • Nashville • New Orleans • New York • Omaha • Philadelphia • Port-
land, Ore. • Richmond • St. Louis • Salt Lake City • San Antonio • San Francisco • Seattle • Spokane • Tulsa

1000*

**250
WATTS INPUT*
AT
1200
Mc.**

**...with the new
RCA-5588
grounded-grid
power triode**

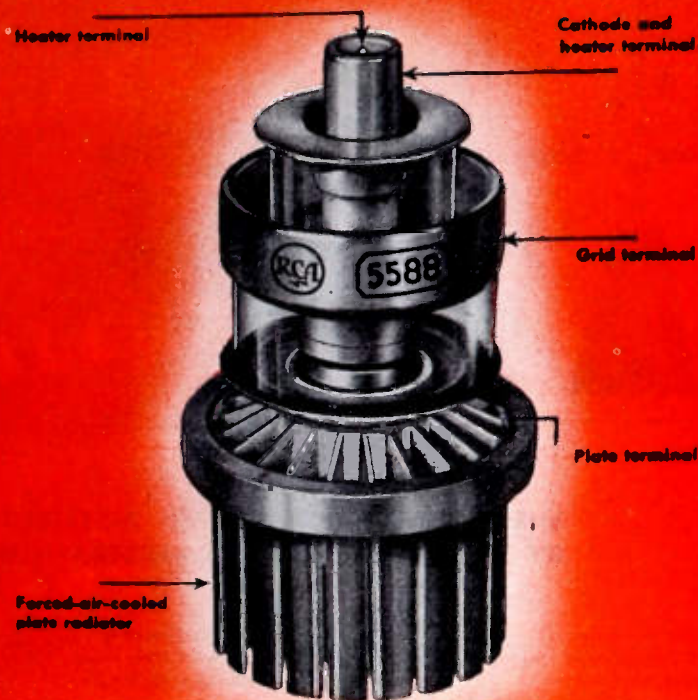

(ACTUAL SIZE)

RATINGS AND CHARACTERISTICS

Amplification factor	23	
Direct interelectrode capacitances:		
Grid-plate	6.5	mmf
Grid-cathode	13	mmf
Plate-cathode	0.32 max.	mmf
Over-all length	3-5/16" ± 3/32"	
Greatest diameter	1.75" ± 0.010"	

As R-F Power Amplifier and Oscillator—
Class C telegraphy, CCS

Key-down conditions per tube
without amplitude modulation

Maximum CCS Ratings, absolute values:

D-C plate voltage	1000 volts
D-C grid voltage	-200 volts
D-C plate current	300 ma.
D-C grid current	100 ma.
Plate input	250 watts
Plate dissipation	200 watts

Here it is . . . a u-h-f tube tiny enough to fit snugly into the palm of your hand, yet big enough to handle a plate dissipation up to 200 watts. It will operate with full plate voltage and plate input at frequencies as high as 1200 Mc . . . and at reduced ratings at higher frequencies.

RCA-5588 is designed with a unique coaxial electrode structure that permits use of a large, heavy-duty cathode to meet the high emission requirements of u-h-f power applications. The tube is particularly well-suited for use in radially spaced, coaxial-cylinder circuits. In these circuits, it can be inserted directly into one end of its circuit cylinder . . . a feature that effectively isolates plate from cathode for optimum grounded-grid service and provides high circuit efficiency for u-h-f service.

Other outstanding features of the 5588 are its large-area, low-inductance electrode terminals . . . silver-plated to reduce r-f losses, its efficient forced-air-cooled plate radiator, and its terminal arrangement that enables you to install the tube quickly without circuit disassembly.

Here is a triode with a power and frequency rating worth considering for those special u-h-f applications. RCA application engineers will be glad to co-operate with you in adapting this or any other RCA tube to meet your equipment needs. For their specialized help, as well as for complete information on the 5588, write RCA, Commercial Engineering, Section R-52D, Harrison, N. J.

* Class C telegraphy, CCS



RCA LABORATORIES
PRINCETON, N. J.

**THE FOUNTAINHEAD OF MODERN
TUBE DEVELOPMENT IS RCA**



TUBE DEPARTMENT

RADIO CORPORATION of AMERICA

HARRISON, N. J.

PROCEEDINGS OF THE I.R.E.

(Including the WAVES AND ELECTRONS Section)

Published Monthly by

The Institute of Radio Engineers, Inc.

VOLUME 35

April, 1947

NUMBER 4

BOARD DIRECTORS, 1947

Walter R. G. Baker
President

Noel Ashbridge
Vice-President

Raymond F. Guy
Treasurer

Haraden Pratt
Secretary

Alfred N. Goldsmith
Editor

William L. Everitt
Senior Past President

Frederick B. Llewellyn
Junior Past President

1945-1947

Stuart L. Bailey
Keith Henney
B. E. Shackelford

1946-1948

Virgil M. Graham
Frederick R. Lack
Donald B. Sinclair

1947-1949

Murray G. Crosby
Raymond A. Heising
William C. White

1947

J. E. Brown
Jack R. Popple
David Smith

Harold R. Zeamans
General Counsel

George W. Bailey
Executive Secretary

Laurence G. Cumming
Technical Secretary

BOARD OF EDITORS

Alfred N. Goldsmith
Chairman

PAPERS REVIEW COMMITTEE

Murray G. Crosby
Chairman

PAPERS PROCUREMENT COMMITTEE

Dorman D. Israel
General Chairman

Edward T. Dickey
Vice General Chairman

PROCEEDINGS OF THE I.R.E.

First Board of Directors Meeting in the New Institute Headquarters.....	338
The Engineer and Science Legislation..... Robert W. King	339
2769. Considerations in the Design of Centimeter-Wave Radar Receivers..... Stewart E. Miller	340
2770. Attenuation of 1.25-Centimeter Radiation Through Rain..... Lloyd J. Anderson, John P. Day, Clemens H. Freres, and Alfred P. D. Stokes	351
2771. Q Circles—A Means of Analysis of Resonant Microwave System..... William Altar	355
2772. A Tunable Squirrel-Cage Magnetron—The Donutron..... F. H. Crawford and Milton D. Hare	361
2773. Space-Current Division in the Power Tetrode..... Clifford M. Wallis	369
Correspondence:	
2499. "Acoustic Preferences of Listeners"..... Lawrence V. Wells	378
2499. "Tonal-Range and Sound-Intensity Preferences of Broadcast Listeners"..... Ted Powell	378
2670. "Contributions to Wave-Guide Theory"..... John W. Miles	378
Contributors to PROCEEDINGS OF THE I.R.E.....	379

INSTITUTE NEWS AND RADIO NOTES SECTION

Constitutional Revision.....	381
I.R.E. Awards.....	382
New England Radio Engineering Meeting.....	386
Sections.....	388
Spring Technical Conference Cincinnati Section I.R.E.....	389
I.R.E. People.....	390

Books:

2774. "Electrical Transmission in Steady State", by Paul J. Selgin... Reviewed by C. E. Kilgour	395
2775. "The Electronic Control Handbook", by Ralph R. Batcher and William Moulie... Reviewed by W. D. Cockrell	395
2776. "Principles of Radar (Second Edition)", by Radar School of M.I.T... Reviewed by E. K. Stodola	395

WAVES AND ELECTRONS SECTION

Donald W. R. McKinley, Chairman, Ottawa Section—1947.....	397
Active Participation versus Passive Activity..... David J. Knowles	398
2781. Radio Progress During 1946.....	399
2782. Abstracts and References.....	426
Section Meetings..... 35A	Positions Open..... 50A
Membership..... 35A	Positions Wanted..... 56A
Advertising Index.....	70A

EDITORIAL DEPARTMENT

Alfred N. Goldsmith
Editor

Helen M. Stote
Publications Manager

Clinton B. DeSoto
Technical Editor

Mary L. Potter
Assistant Editor

William C. Copp
Advertising Manager

Lillian Petranek
Assistant Advertising Manager

Responsibility for the contents of papers published in the PROCEEDING OF THE I.R.E. rests upon the authors. Statements made in papers are not binding on the Institute or its members.

Changes of address (with advance notice of fifteen days) and communications regarding subscriptions and payments should be mailed to the Secretary of the Institute, at 450 Ahnaip St., Menasha, Wisconsin, or 1 East 79 Street, New York 21, N. Y. All rights of republication, including translation into foreign languages, are reserved by the Institute. Abstracts of papers, with mention of their source, may be printed. Requests for republication privileges should be addressed to The Institute of Radio Engineers.





Board of Directors 1946



First Board of Directors Meeting in the New Institute Headquarters

Seated around the table from left to right are George W. Bailey, *executive secretary, 1945-1947*; Frederick R. Lack, Hubert M. Turner, *president, 1944*; Raymond F. Guy, *treasurer, 1947*; Donald B. Sinclair, Raymond A. Heising, *treasurer, 1943-1945*; Edmond M. Deloraine, *vice-president, 1946*; Frederick B. Llewellyn, *president, 1946*; Haraden Pratt, *president, 1938, treasurer, 1941-1942, secretary, 1943-1947*; William C. White, *treasurer, 1946*; Alfred N. Goldsmith, *secretary, 1918-1927, president, 1928, editor, 1913-1947*; Stuart L. Bailey, William L. Everitt, *president, 1945*; Keith Henney, George T. Royden, and Murray G. Crosby, *director-elect, 1947*.

The new Headquarters Building of The Institute of Radio Engineers, at 79th Street and Fifth Avenue, New York, N. Y., has been sufficiently completed to enable the normal activities of the Institute to be carried out in this adequate location. On December 4, 1946, the Board of Directors met for the first time in the new building.

It was generally agreed that the quarters were commodious, attractive, and so arranged as to permit the effective functioning of the various departments of the Institute now housed in the building.

A second meeting of the Board of Directors was held in the Board Room on January 8, 1947. The great volume of business successfully handled by the Board on each of these occasions sufficiently attested to the congeniality of the surroundings and the analytic and co-operative attitude of the Board members. Comprehensive agenda were in each instance disposed of during the corresponding sessions.

Scientific research and engineering development have engaged in ever-increasing measure of public attention and corresponding political activity. The contributions made by scientists and engineers during World War II, culminating in the radar techniques and the release of atomic-nuclear energy, have been particularly effective in this regard. Such developments have served to persuade certain legislators and also some members of the scientific community that the Federal Government should subsidize research on a large scale, and with certain types of governmental organization and control, and with a measure of public ownership of the products or applications of such governmentally sponsored research. Some of the less obvious implications and perils of such a plan are described in the following guest editorial by a prominent American research worker and engineer, who is himself the editor of the *Bell System Technical Journal*. The subject matter of this editorial fully merits thoughtful analysis by the readers of the PROCEEDINGS.—*The Editor*

The Engineer and Science Legislation

ROBERT W. KING

As the social repercussions of technology increase in number and grow in significance, the engineer may be expected to widen his outlook to encompass the full consequences of his handiwork. This augurs well for the continuing value of his social contributions, especially when regard is had to his experience in subjecting difficult and involved problems to co-operative attack.

With this in mind no apology need introduce a reference to a particularly timely socioscientific problem. Some will recall the efforts made during the life of the seventy-ninth Congress to enact legislation that would have created a National Science Foundation. Although the efforts failed, the underlying question has lost nothing in importance, and discussion of it will shortly be resumed, perhaps on an extended scale.

The essence of the problem is to assure the rapid advance of scientific knowledge and, as contributory to this, the training of an adequate number of American scientific workers. None is more concerned in its wise solution than the engineer, and I believe that the engineering profession should be prepared to urge wide recognition of this fact. In discharging his responsibility for adapting science to the national economy and enabling it to serve society, every extension of scientific knowledge assists; but the effectiveness of the engineer's efforts is also influenced by many economic conditions, as a consequence of which he is vitally concerned with any political implications which attach to a Science Foundation.

Now, anybody having a legislative origin and empowered to disburse funds wholly or chiefly from the national treasury will, almost of necessity, involve far-reaching and yet intangible political implications. For example, among many advocates of one or other of the recent bills proposing State-aid to science, the doctrine had already been born that inventions and patents growing out of the new knowledge acquired through federal appropriations automatically should become the property of the government. The line of reasoning leading to this conclusion is simple and direct,—*what the State has paid for should belong to the State*. Here, in a sense, is a doctrine the very antithesis of free enterprise; and what might in time be its effect, if given a legislative leverage to work upon, is too serious to be ignored.

In a legislatively created Science Foundation there is also a standing inducement for the politician to meddle with science. While it is not possible to demonstrate and measure the amount of political tinkering that lies hidden in any particular enactment, we are living in an era of intellectual instability with a world tide running in the socialistic direction. Many countries already exhibit a union of science and government, while even in England (not to mention the United States) there is increasing clamor that State planners map the programs of scientific research.

Here, again, the supporting argument is simple and superficially attractive. No scientific statement is absolutely valid and therefore every proposition of science ultimately represents an arbitrary act of faith. Arbitrariness, or "judgment," also governs the directions that research shall take, and since society may have important stakes in the outcome (including matters of national defense), it is held questionable whether such decisions should be permitted private individuals. They increasingly should be reserved for the authorities legally constituted to guard the public weal.

Should we in the United States come, commonly, to accept this argument, then a serious threat to the freedom of American science might well be in the making.

The traditional American way of supporting science has been through private contributions—a method which we know from experience involves no danger of political infringement—but, without examination, many have assumed that this way is henceforth closed. Surely, so radical a proposition should not be accepted without full discussion. There is no primary source of funds for science other than private incomes. The recent bills would have established the federal-tax collector as an intermediary between those who earn and can supply the funds and the scientific bodies that would disburse them. And, because the mere act of collection would be simplified and stabilized by interposition of the tax collector, there were some who saw this as the main problem and were willing to overlook the attendant risks. But a simple analysis reveals incomes—corporate and personal—of such a total that, if given appropriate credit under the income-tax law for science donation, they would re-establish ample support.

Engineers will serve both their profession and the cause of science if they will follow the forthcoming discussions, thinking through and clearly defining the issues therein involved. Whether energetic attempts are made in the next session of Congress to revive the recent legislative program, or whether Congress will clearly be so economy-minded as to make an appeal to legislation unprofitable, leadership is wanted for the proposition that, under American institutions, support of science can and should arise voluntarily as a manifestation of social enlightenment.

Considerations in the Design of Centimeter-Wave Radar Receivers*

STEWART E. MILLER†, MEMBER, I.R.E.

Summary—A review of the radar duplexer and receiver, as developed during the war, is presented. Attention is devoted to the principles of operation and typical circuit arrangements employed in the duplexer, the crystal converter, the local-oscillator injection circuits, the intermediate-frequency amplifier, and the automatic-tuning unit. Emphasis is placed on methods found advantageous in the 1-centimeter and 3-centimeter wavelength regions. The interrelation between the various receiver components in determining the over-all receiver noise figure is shown analytically, and typical performance numbers are given.

INTRODUCTION

THIS review of the centimeter-wave radar receiver will assume that the reader is familiar with the general principles of operation of a radar.

DISCUSSION OF THE RECEIVER'S FUNCTION

Fig. 1 shows, in block form, the major functions performed in the radar receiver. For descriptive purposes, the magnetron will be chosen as a starting point. The

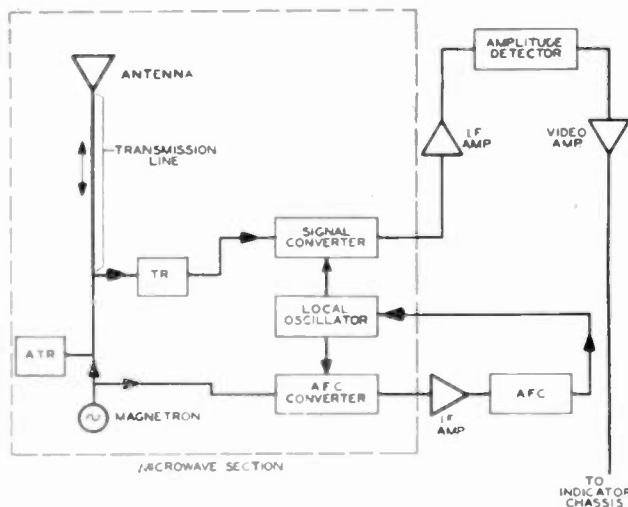

Fig. 1—Radar transmitter-receiver.

energy from the magnetron goes by way of several junction points and by way of a transmission line to the antenna. From the antenna, the transmitted pulse goes out into space, strikes the various targets, and the reflected energy returns to the same antenna, back over the same transmission line, to the junction points previously mentioned. It is desired, of course, that the received signal be directed to its amplifying system (through the box marked TR) instead of back along the

path which the transmitter energy traversed on its way to the antenna. Note that a single antenna and transmission line is used for both the transmitted and received energy, each of which is contained in the same frequency band. This is made possible by two conditions. The first condition is that transmission and reception do not occur simultaneously. Every transmitting interval of 1 microsecond is followed by a receiving interval of around 1000 microseconds. The second condition, making possible use of a common transmitting system, is that there is a tremendous difference in power levels between the transmitted and received signals. This makes it possible to use gaseous discharge tubes for switching. Suffice it to say for now that the major portion of the transmitted signal does travel directly to the antenna, and the major portion of the received signal does return through the box marked TR to the signal converter. In the converter, the signal is mixed with some local-oscillator energy, and converted to an intermediate frequency where it can be amplified with relative ease. The intermediate-frequency amplifier is followed by an amplitude detector and video amplifier. In many respects the latter elements are quite conventional.

As yet there has been no mention of the elements of the loop in the lower section of Fig. 1. The function of this loop is to automatically tune the receiver so as to amplify the echoes with a maximum of sensitivity. The question may arise as to why a manual tuning adjustment is not satisfactory. In some cases it is. In other cases the individual operating the radar does not have time, or is not sufficiently trained, to make it feasible for him to tune in the signal manually. In still other cases the frequency stability of the magnetron and local oscillator is not sufficient to guarantee peak receiver sensitivity for a reasonable period, even though a manual tuning adjustment is made. The reasons for frequency drifts will be given at a later point, but it may now be stated that the advantages of automatic receiver tuning have been attractive enough to outweigh the penalties in terms of cost, size, and weight of added equipment. The exact manner of accomplishing automatic receiver tuning varies considerably with the various types of local oscillators, and the details will be deferred to a later point.

CENTIMETER-WAVE CIRCUITS

Attention will now be directed in turn toward each of the components of the radar receiver. First, consideration will be given to the centimeter-wave portion of the circuit.

* Decimal classification: R537.13. Original manuscript received by the Institute, April 9, 1946; revised manuscript received, June 20, 1946. Presented, joint American Institute of Electrical Engineers-Institute of Radio Engineers lecture series on radar, New York, N. Y. December 7, 1945, and Newark, N. J., January 3, 1946.

† Bell Telephone Laboratories, Inc., New York, N. Y.

Because of the distributed nature of circuits used in the centimeter-wave region, the transmission lines used to "interconnect" the various elements of the receiver are in fact part of the circuit. It is appropriate, therefore, to consider briefly the transmission line from the viewpoint of the circuit designer. The choice of coaxial lines or wave guides for centimeter-wave transmission is a balance between three factors: (1) loss, (2) power-handling capability, and (3) physical convenience. Coaxial lines are more flexible and more convenient in size than wave guides, and for these reasons coaxial lines may at times be used in place of wave guides despite poorer loss and power-handling characteristics. This discussion will be concerned with receivers designed for use in the 10,000- to 30,000-megacycle region, where waveguide transmission lines have been almost universally used. Receivers designed for 3000 megacycles and lower have usually employed coaxial transmission lines, because of the unreasonable bulk of wave guides at such frequencies and because the loss and power characteristics of coaxial lines are tolerable below 3000 megacycles.

DUPLEXER

Previous discussions have identified the duplexer as a switching system which makes possible the use of a single transmission line and antenna for sending and receiving. The upper half of Fig. 2 shows the system which might be required if no duplexer were available.

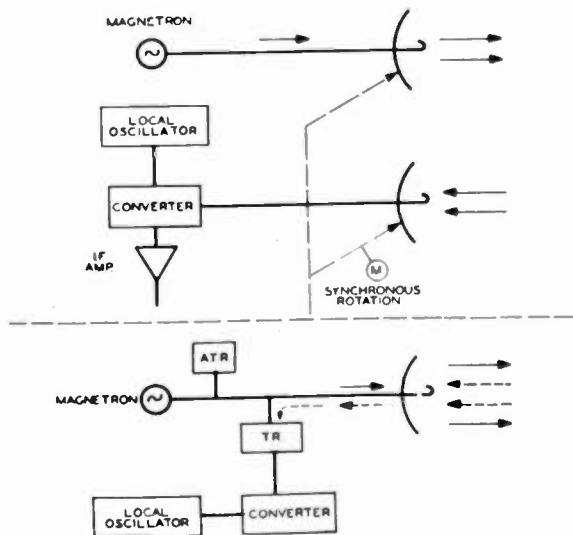

Fig. 2—Transmitter-receiver systems without duplexers and with duplexers.

The magnetron would be associated with one transmission line and antenna; the receiver would be associated with another transmission line and antenna. The motion of the two reflectors would have to be mechanically synchronized so the two electrical beams would always point in the same direction. It is quite apparent that such a system would be bulky and mechanically more complex than the system using a duplexer, as shown in the lower half of Fig. 2. In order to achieve this simplification of the mechanical structure, the electrical circuit

is made more complex. The electrical complexity of the duplexer is justified by two significant radar system improvements: (1) the size and weight of an entire transmission line and antenna are eliminated, and (2) the duplexer makes available to the armed services many types of systems which would prove impractical if it were necessary to synchronize two antenna beams in the complicated scanning cycles employed.

The principal elements of the duplexer are two switches, one which disconnects the receiver during the transmitting interval of time (marked TR in Fig. 2), and one which disconnects the transmitter during the receiving interval of time (marked ATR in Fig. 2). It is also required that these switches allow the transmitted power to pass without appreciable loss to the antenna. Historically, the switch used to disconnect the receiver came first, and was named the TR for transmit-receive. When the transmitter-disconnect switch appeared, it proved to be electrically similar to the TR. Because of similarity to the TR electrically and physically, the transmitter-disconnect switch became known as the RT, the anti-TR, or simply the ATR. These terms, TR and ATR, are widely accepted and will be used in this article.

In order to understand the operation of the duplexer, consider first the wave-guide circuit shown in Fig. 3. If power is sent in entry *A* as shown, approximately half of it will flow down each of the two remaining arms, *B* and *C*, provided that these branches are terminated in their characteristic impedances. If, however, a short-

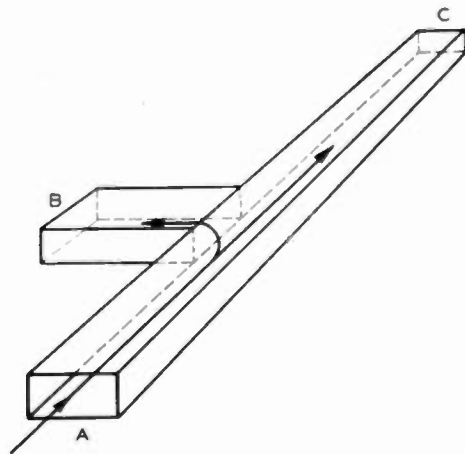

Fig. 3—Shunt wave-guide tee.

circuiting plane is placed in the *B* arm at the proper distance from the junction point, all of the power tending to enter line *B* will be reflected, and essentially all of the power entering at *A* can be made to flow straight through to *C*. Similarly, if the short-circuiting plane is placed in branch *C* at the proper distance from the junction, all of the power can be made to flow from *A* to *B*. This is the switching principle on which the radar duplexer operates. The short-circuiting planes referred to above are, in fact, virtual reflecting surfaces switched in

and out during the various parts of the transmit-receive cycle by gaseous discharge tubes. We will next consider one of these switches, the TR.

The top sketch of Fig. 4 represents a resonant cavity of the type used in the TR box. The metal posts projecting from the ends of the metal cylinder form a capacitive reactance across the cylinder and tune the structure to resonance. The electric vector has a large value directly across the gap, and this fact is used in forming the switch. The chamber within the resonator

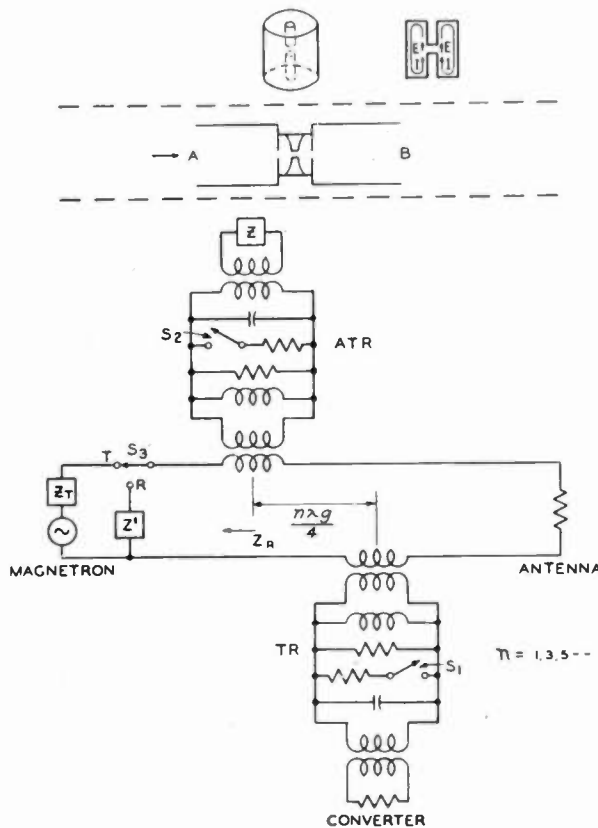

Fig. 4—Duplexer details.

is filled with a mixture of hydrogen and water vapor, which will ionize and form a gaseous discharge when the voltage vector across the gap exceeds a critical value. The presence or absence of this gaseous discharge makes it possible to carry out the receiver disconnect function. To do so the TR box may be placed in series with a wave-guide line and coupled to it by means of small holes, or irises, on each side of the resonant cavity, as shown in the second sketch of Fig. 4. If the cavity is tuned to resonance at the frequency to be used, and a small signal is sent into entry *A*, the signal will pass through the TR with only minor attenuation. The impedance seen looking in at entry *A* with Z_0 terminating line *B* can be made Z_0 , the characteristic impedance of the line.

If a much greater amount of power is sent in at *A* the gaseous discharge will form and place a very low impedance across the cavity. The result is a very large

reflection coefficient at that point, and very little of the power entering at *A* will reach *B*.

The TR just described and the wave-guide tee of Fig. 4 are the principal building blocks of the duplexing system. The operation of the duplexer will now be described with reference to the equivalent circuit shown in the lower half of Fig. 4. The various elements in this sketch may be identified as follows: The antenna is represented by the resistance load at the right; the magnetron is represented during the transmitting interval by an impedance Z_T in series with a voltage source, and by a different passive impedance Z' during the receiving interval of time; the magnetron and antenna are joined by a transmission line, and their locations may be thought of as at points *A* and *C* of Fig. 3.

Two branch lines are shown in Fig. 4, one for the receiver and one for the transmitter-disconnect switch, the ATR. The signal converter is shown as a resistance terminating the receiver branch, and the associated chain of elements is used to represent the TR box. The input and output irises of the TR resonant cavity have a transforming action, and are shown in the equivalent circuit as ideal transformers. The resonant cavity is shown as a parallel *LRC* combination. The possibility of forming a gaseous discharge across the gap is represented by the switch in series with a resistance, the latter being the resistance of the arc.

Consider only the TR and converter line for a moment and assume that the TR cavity has been tuned to the frequency of operation. Then, a signal insufficient in magnitude to break down the gas across the TR gap will pass through the TR box and on to the converter with loss occasioned only by the resistive shunting across the high side of the ideal transformers. If, however, enough power is available in the TR box to break down the gas across the gap, a very low resistance is shunted across the high-impedance side of the ideal transformer, which in turn presents a still lower resistance across the input terminals to the receiving branch. This is the action which permits the transmitted power to pass by the receiving branch without appreciable attenuation.

Looking now at the ATR branch in Fig. 4, it may be seen that the form of this equivalent circuit is very similar to that of the TR branch. Indeed, a TR gas-discharge tube and cavity can be used as the transmitter-disconnect switch. The ATR branch is represented by input and output ideal transformers, with a resonant circuit and switching gap between them. The impedance Z at the output terminals of the ATR is not a match to the wave-guide line as it was in the case of the TR, and in order to see why this is desirable a few more observations about the functions of the TR and the ATR are in order.

During the transmitting interval all the generator power should reach the antenna. This is accomplished for the ATR in the same way as described for the TR, namely, the low resistance of the gaseous-discharge arc

across the high-impedance side of the ideal transformers becomes a still lower resistance across the input terminals to the ATR branch, causing negligible absorption of the power from the main line. During the receiving interval, the available antenna power should flow to the signal converter, at the bottom of the diagram. Hence, it is desirable to present a wave-guide match at the input terminals of the TR side branch. Another ideal condition is for the left-hand section of the diagram to present a series short-circuit at the plane of the TR junction, where there already exists a wave-guide match in the form of the transferred impedance of the converter. This would produce the desired result of absorbing all the power from the antenna in the signal converter line. Making the left-hand side of the diagram look like a short-circuit at the plane of the TR box has recently been accomplished by means of the ATR branch.

If the impedance Z at the output terminals of the ATR is chosen properly, the small-signal impedance at the input to the ATR branch may be made very large. Having established this condition, the total series impedance Z_R at the plane of the ATR will be very high regardless of the impedance in the remainder of the transmission line to the left of the ATR. (This discussion ignores resonance of the ATR branch with the magnetron branch.) By placing the ATR branch an odd-quarter wavelength from the TR plane, the series impedance of the magnetron-ATR branch will be low at the TR junction and most of the received power will flow into the receiver branch.

For simplicity, this discussion has been based on using a TR cavity and TR tube in the ATR position. This method of design has been used in order to meet rush wartime schedules, but a better design results if a special ATR tube is used. The special tube makes possible elimination of the impedance element Z at the top of the ATR branch, and elimination of the need for tuning the resonant ATR cavity for transmitter frequency changes of ± 1 per cent to ± 3 per cent.

The discussion just completed has also been based on the series equivalent circuit shown in Fig. 4. It is also possible to arrange the branching lines so as to be effectively in shunt with the magnetron-to-antenna line, or one branch may be in shunt and the other in series with the main line. These are circuit-design choices, but the over-all duplexer operation remains essentially unchanged.

It has been mentioned that the TR and ATR gas tubes are required to handle the transmitter power without appreciable loss, and this requirement has not proved difficult. In a typical case the power lost in the gaseous discharge of a TR tube will be only a few per cent of the transmitter power.

Other requirements on the TR tube, however, have not been met so easily. As discussed in the following section, a comparatively delicate silicon crystal is used as the frequency converter. Such a crystal may be impaired in its loss and noise characteristics if the power

sent into it is not kept below the order of 100 milliwatts. It is, therefore, required that the power flowing into the converter during the transmitting interval be less than 100 milliwatts when the power flowing down the main transmission line is of the order of 50 kilowatts. This means that more than a 60-decibel loss through the TR box is required during the transmit interval. A minimum of TR loss (about 1.25 decibels in practice) is obviously desirable during the receive interval. Obtaining the stated performance has required considerable effort, principally directed along the lines of reducing the TR cavity losses including those within the tube.

In studying the TR leakage power it was found that, when the magnetron is turned on after a period of inactivity, the leakage power soars to large values for a few pulses before settling down to its normal value. The reason for the initial large surges is thought to be a lack of ions present in the gas to facilitate the forming of the arc across the TR gap. In order to relieve this "turn-on" effect, as it is called, two things have been done in the TR design: (1) a small quantity of a radioactive salt has been placed within the TR tube to provide a few ions; and (2) an auxiliary electrode, known as the keep-alive electrode, has been placed near the gap. In most systems a continuous direct-current bias is maintained on this electrode to maintain a small current flow in the gas, and hence, to maintain a supply of ions for rapid formation of the arc when the transmitter is turned on.

Fig. 5 shows the wave form of the magnetron output, and the wave form of the TR leakage during the corresponding interval of time. The spike is caused by the finite time required for formation of the arc. The height of the spike has not been determined because of the extremely high frequencies contained in it. Its duration is thought to be of the order of 0.01 or 0.02 microsecond,

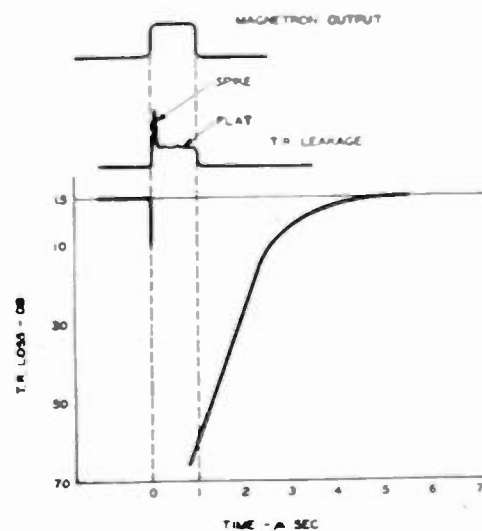

Fig. 5—Transmitter-receiver characteristics.

regardless of the duration of the pulse, and the flat lasts for the duration of the magnetron pulse. The peak power in the spike is thought to be principally responsible for

burning out crystals when such burnout occurs as the result of TR leakage.

The curve at the lower part of Fig. 5 illustrates the loss versus time characteristic of the TR box. After the magnetron pulse is ended, it is desirable that the receiver return to normal sensitivity in the shortest time possible, since the minimum range at which the radar will detect targets is determined by this recovery characteristic. Hence, the ideal TR box would return to its normal or low-level loss condition in zero time at the end of the transmitted pulse. This is not possible, of course, because time is required for deionization of the gaseous discharge. As Fig. 5 indicates, the TR loss in a very good radar may be 6 decibels greater than normal at 2 or 3 microseconds after the end of the transmitted pulse. As the TR tube ages, this recovery-time curve extends farther to the right, thus disabling the receiver for a longer time after the transmitted pulse. The TR recovery time is a major contributor to over-all receiver recovery, and is probably the most fundamental limitation on the minimum range of the radar set as a whole.¹

CRYSTAL CONVERTER

In starting the discussion of the converter circuit, it is pertinent to explain why the crystal is used in place of a vacuum-tube converter. Simply stated, the reason is that the crystal delivers superior performance. At frequencies below 3000 megacycles, vacuum-tube converters have been used with a definite advantage over the crystal in ruggedness. A vacuum tube can be subjected to extreme overload conditions, occasionally, without permanent damage, whereas a crystal's performance is more critically dependent on its entire history. It takes but one momentary overload beyond some permissible value, and the crystal is permanently damaged. Because the crystal is a relatively delicate element, considerable care in design, equipment layout, and the providing of instruction material was required to make field use of crystals successful. To show that such effort was justified, one needs merely to point out that a job was done which could not have been done by any other means. Crystals have been made in quantity production with conversion losses of the order of 7 decibels, and excess noise increments of the order of 2 decibels, both at frequencies of the order of 30,000 megacycles. It will probably be some time before such performance is duplicated or surpassed by vacuum-tube converters.

In circuit use the crystal is employed as a diode type of converter. The signal and local-oscillator powers are fed in on a pair of microwave terminals, the rectifying action in the crystal produces the usual set of sum and difference frequencies, and the appropriate difference-frequency energy is taken out at a pair of intermediate-frequency terminals.

Fig. 6 illustrates one method of feeding microwave

¹ A. L. Samuel, J. W. Clark, and W. W. Mumford, "The gas-discharge transmit-receive switch," *Bell Sys. Tech. Jour.*, vol. 25, pp. 48-101; January, 1946.

power into the crystal and taking the intermediate-frequency power out of it. First it is necessary to get both the signal and local-oscillator powers into one wave-guide line, and that process will be discussed as a separate item. Assume, for the present, that both of

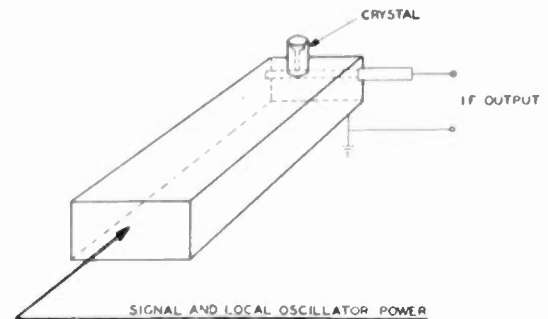

Fig. 6—Converter circuit.

these powers are in one wave guide; then, it is necessary to match the radio-frequency crystal impedance to the wave guide. To accomplish this, a coaxial-to-wave guide transformer may be used, since at least one type of crystal (1N26) is mounted at the end of a coaxial line. The transformation may be accomplished by extending the center conductor of the coaxial line into the wave guide, parallel to the E vector, at approximately a quarter wavelength from a short-circuiting plane which ends the wave guide. The horizontal rod in Fig. 6 is perpendicular to the E vector and does not appreciably affect the coaxial-to-wave-guide transformer. However, this rod does form a support for the end of the matching probe which is an extension of the crystal's center conductor, and also provides a convenient means for bringing out the intermediate-frequency power.

The above discussion is a simplified picture of the crystal converter. The principal electrical characteristics are: (1) conversion loss, (2) noise increment, and (3) intermediate-frequency impedance, the latter being a very important quantity in the intermediate-frequency-amplifier design. The conversion loss is the ratio of the intermediate-frequency (converted signal) power output of the crystal to the radio-frequency signal power input to the crystal; typical values run between 7 and 9 decibels in the 3000- to 30,000-megacycle range. The noise increment is the ratio of the actual crystal noise output to thermal noise, and typical values run between 1 decibel and 3 decibels. The intermediate-frequency impedance of the crystal is the impedance of the crystal as a source of intermediate-frequency signal for the intermediate-frequency amplifier which follows it. Typical values run between 200 and 500 ohms.

LOCAL-OSCILLATOR INJECTION

The last centimeter-wave circuit problem is that of placing the local-oscillator energy and the received-signal energy in a single wave guide, so that they both may be matched into the crystal converter simultaneously.

The requirements of this circuit problem may be listed as follows: (1) About 1 milliwatt of local-oscillator power is required at the crystal for optimum conversion efficiency. Most reflex oscillators, which are used to provide the local-oscillator energy, will generate more than 20 milliwatts of power. (2) The local oscillator must operate into a satisfactory impedance, so that stable operation will result. Most reflex oscillators are designed to work into a matched wave guide or coaxial line. (3) Essentially all of the received-signal power available at the output of the TR should be matched into the converter. A loss of 0.5 decibel of signal energy into the source of local-oscillator power is considered excessive.

Implied in the last requirement is that the local-oscillator power must be combined with the signal power after the latter has left the TR. This is common practice because the bandwidth of the TR is insufficient to pass both the signal and local-oscillator frequencies with a maximum of efficiency.

Fig. 7 illustrates a method of local-oscillator injection developed in the period preceding 1942. The output of the oscillator is brought out of the tube on a coaxial line at the end of which the center conductor extends beyond the outer conductor for a short distance, forming a small

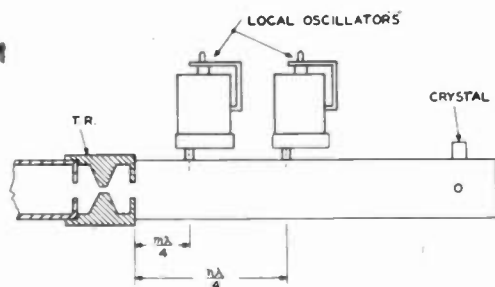

Fig. 7—Local-oscillator injection using probe coupling.

antenna. The end of this antenna is projected into the wave guide parallel to the E vector, and located an odd quarter of a wavelength from the face of the TR, which is a low-impedance point at the local-oscillator frequency. Energy leaving the antenna toward the left is reflected by the low impedance and combines with the energy leaving the antenna toward the right. In this way the required 1 milliwatt of power is directed from the local oscillator to the crystal. The third local-oscillator injection requirement listed above is also met; namely, that very little signal power should be lost in the radio-frequency branch leading to the local oscillator.

However, the arrangement of Fig. 7 is not ideal. If the TR is not tuned properly, the impedance at the TR output iris may not be low and the net power flow from local oscillator to converter will be reduced. It is apparent that, all other things being constant, tuning the TR will affect the magnitude of power flow from local oscillator to converter, and that is not a desirable characteristic. Moreover, the oscillator is very loosely coupled to

the load, since the tube will produce over 20 milliwatts of power and only a milliwatt is being extracted under the condition sketched. This loose coupling is a reactive mismatch to the oscillator's output coaxial line, and it is possible for the tube to see a particular type of impedance mismatch which would take it over into an unstable operating region. This possibility can be avoided in a number of ways. The reason for the second local oscillator in Fig. 7 will be given at a later point.

Fig. 8 illustrates a method of coupling the local oscillator to the converter using a directional coupler. The local oscillator is tightly coupled to the side wave guide, so as to deliver all of its 20 milliwatts. This allows the oscillator to operate into a well-matched line, because most of the 20 milliwatts is absorbed in a termination at the end of the side wave guide. Two or more coupling irises allow power to pass from the local-oscillator line to the TR-converter line, as indicated by the solid arrows of Fig. 8. In this way the required 1 milliwatt is directed to the converter. One advantage of this circuit is that the tuning of the TR does not affect the transfer of power from the local oscillator to the converter. This is true (to a first approximation) because the directive feature of the coupling irises prevents local-oscillator power from traveling in the direction shown by the dotted arrow of Fig. 8.

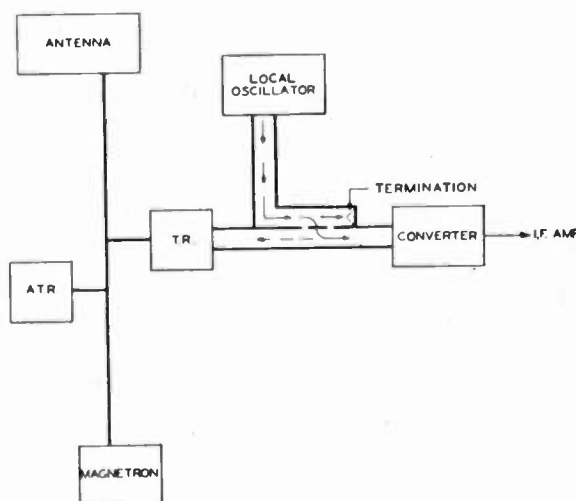

Fig. 8—Local-oscillator injection using the directional coupler.

A recently developed method of feeding the local-oscillator signal to the converter makes use of the $E-H$ tee, shown in Fig. 9. Assume that crystal converters are used to terminate branches B and C , that signals from the TR box are directed into entry A , and that local-oscillator power is directed into entry D . If all branches are terminated to match the wave-guide impedance, the signal power P_s and the local-oscillator power P_{LO} will divide as shown in Fig. 9. The local-oscillator power will not flow down the signal-entry line A , and the signal power will not flow down the local-oscillator line D . Thus, TR tuning does not directly affect the transfer of

local-oscillator power to the converter, and very little signal energy is lost in the local-oscillator mixing method. These advantages alone are important. In addition, no local-oscillator power is lost in the process of coupling to the converter. If 1 milliwatt is required in each converter, 2 milliwatts of local-oscillator power at entry *D* will provide it. The other injection methods previously examined effectively wasted oscillator power in exchange for isolation from the signal path, i.e., to prevent signals from being lost in the local-oscillator branch.

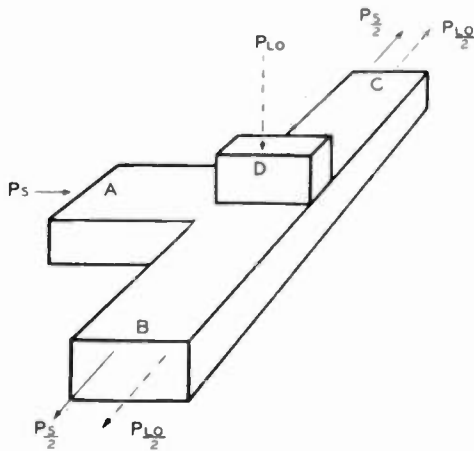

Fig. 9—E-H tee.

Of course, the signal power in the latter case is contained in the outputs of two crystal converters, one at *B* and one at *C*. It is necessary, therefore, to use a balanced intermediate-frequency input circuit to add the two components and recover the entire signal in an unbalanced path. Aside from requiring care in its design, the balanced intermediate-frequency input circuit has not been found to be a severe problem. Another characteristic of this method of local-oscillator feed is highly significant, but its discussion will be deferred to the section on noise figure.

NOISE FIGURES

This discussion of noise in the radar receiver will require an understanding of *noise figure*, as defined by H. T. Friis.² There are three principal sources of noise in the radar receiver, intermediate-frequency-tube noise, crystal-converter noise, and local-oscillator noise. Intermediate-frequency tube noise will be covered at a later point. Very little is known about the reasons for crystal noise, and no attempt will be made here to explain it. However, a word might be said about local-oscillator noise.

Fig. 10 shows the spectral distribution of the power at the crystal converter. There is a continuous band of thermal and converter noise represented by the hori-

zontal dotted line, a vertical line representing the local-oscillator carrier, and an additional hump of noise generated in the local oscillator. The height and width of the local-oscillator noise hump are functions of the electronic design of the tube and the *Q* of the radio-frequency circuit. Because of limitations on the local-oscillator design, noise from the local oscillator is accepted as an existing thing, and thought is given to methods of

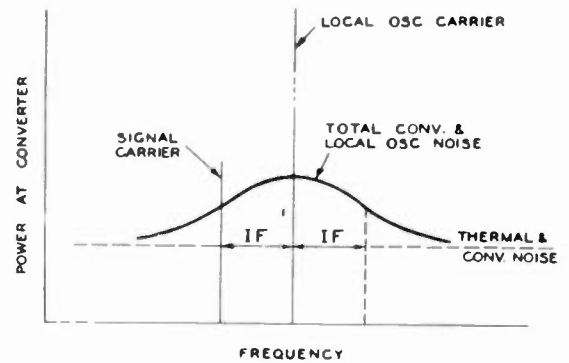

Fig. 10—Spectrum of power at converter.

working around it. One method of eliminating the local-oscillator noise involves the choice of intermediate frequency, and may be understood from an examination of Fig. 10. The receiver noise output due to local-oscillator noise is the result of beating the local-oscillator carrier against some of the sideband noise components from the local oscillator. The oscillator noise components involved in this process are removed from the carrier by the intermediate frequency, as shown by the vertical lines. At frequencies farther from the local-oscillator carrier, the oscillator-noise sidebands become smaller, and hence using a higher intermediate frequency in the receiver reduces its susceptibility to the noise of a given local oscillator. This cannot be carried on indefinitely, however, for the noise figure of the intermediate-frequency amplifier becomes poorer as the intermediate frequency is increased. It is necessary to strike a balance between the reduced local-oscillator noise effect and the increased intermediate-frequency noise effect.

A more modern method is to use the balanced converter for local-oscillator noise elimination. An explanation of how the balanced converter circuit reduces local-oscillator noise will be made with reference to Fig. 9. Consider the transmission of local-oscillator noise and carrier from entry *D* to two crystals at points *B* and *C*. Because these two signals travel along the same path relative to each other all the way to either *B* or *C*, the intermediate-frequency outputs of the two crystals will have the same phase angle. This is true because the intermediate-frequency phase depends only on the relative phase of the two radio-frequency signals reaching a given crystal. Assume for the moment that the losses of the two crystals are equal. Then the intermediate-frequency output of each of the two crystals is equal in magnitude and phase angle. If a phase reversal (through

² H. T. Friis, "Noise figures of radio receivers," *Proc. I.R.E.*, vol. 32, pp. 419-422; July, 1944.

inductive coupling) is included on the output of one of the crystals in the balanced intermediate-frequency input circuit which follows the converters, the intermediate-frequency output signals of the two crystals may be made to cancel each other. Thus, for carrier and noise originating at the local oscillator the intermediate-frequency output can be balanced to zero.

Consider now the transmission of a signal from the TR entering the *E-H* tee at *A*, and the carrier from the local oscillator entering at *D*. The transmission of the signal will result in the *same* radio-frequency polarity at the two crystals at any one moment; the transmission of the local-oscillator carrier will result in the *opposite* radio-frequency polarity at the two crystals (relative to each other), due to a phase reversal in the *E-H* tee junction. Therefore, the intermediate-frequency outputs of the two crystals will be 180 degrees out of phase, and the action of the balanced intermediate-frequency circuit (including a phase reversal for one of the crystals) yields an adding of the signal components.

To repeat now, two signals of the proper frequency to produce intermediate frequency entering the same line of the *E-H* tee can be made to cancel out in the intermediate-frequency circuit which follows, whereas if one of the signals enters one line and the other signal enters the other line of the *E-H* tee, the intermediate-frequency signals will add. This is a very important characteristic of the balanced converter, for it permits balancing out local-oscillator noise which, under certain conditions, can materially degrade the sensitivity of the radar receiver.

Attention will now be directed toward the mechanism by which the various noise-figure contributors add to determine the over-all receiver noise figure. As shown at the top of Fig. 11 the contributors to the receiver noise figure are the intermediate-frequency amplifier, the converter, the local oscillator, the duplexer, and the transmission line (if the latter has measurable loss). Before deriving the relation between these various factors, it is appropriate to emphasize the importance of the decibels which describe the performance of these elements. Given a radar which is just capable of detecting a target at 100 miles, then by improving the receiver noise figure by 3.2 decibels it will be possible to detect the same target at 120 miles. Thus, the performance of the elements shown in the top of Fig. 11 is described by significant decibels, for their performance is significant in determining radar performance. To take another example, a decibel of added duplexer loss cannot be compensated for by an added decibel of intermediate-frequency gain, for the latter does not (in general) improve the receiver noise figure.

In building up an expression for receiver noise figure repeated use is made of the formula for the noise figure of two networks in tandem, as given by Friis. For example, NF_1 is defined in the first line of Fig. 11 as the noise figure of the intermediate-frequency-amplifier-converter combination. Repeated application of this

idea leads to (5) of Fig. 11 for the noise figure of the entire radar receiver. The duplexer and transmission line usually have no extraneous noise sources in them, and the final expression has been simplified accordingly. All of the symbols of Fig. 11 refer to power numerics.

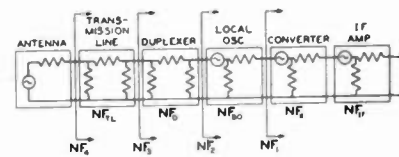

$$NF_1 = NF_2 \left(\frac{NF_3 - 1}{G_2} \right) \quad ; \quad \text{But } NF_2 = \frac{N_0}{G_2}$$

$$\therefore NF_1 = \frac{1}{G_2} (N_0 + NF_3 - 1) \quad \dots \dots \dots (1)$$

$$NF_2 = NF_3 \left(\frac{NF_4 - 1}{G_3} \right) \quad ; \quad \text{But } G_3 \approx 1$$

$$\therefore NF_2 = NF_3 + NF_4 - 1 \quad \dots \dots \dots (2)$$

$$NF_3 = NF_4 \left(\frac{NF_5 - 1}{G_4} \right) \quad ; \quad \text{But } NF_4 = \frac{N_0}{G_4} \quad \text{And } N_0 = 1$$

$$\therefore NF_3 = \frac{1}{G_4} NF_5 \quad \dots \dots \dots (3)$$

$$NF_4 = \frac{1}{G_4} NF_5 \quad \dots \dots \dots (4)$$

$$\text{or } NF_1 = \frac{1}{G_1 G_2} \left[NF_5 - 1 + \frac{1}{G_2} (N_0 + NF_5 - 1) \right] \quad \dots \dots \dots (5)$$

Fig. 11—Receiver noise-figure derivation.

Typical noise figures of the elements of the radar receiver are tabulated in Table I. Using a crystal loss of 7.25 decibels, a crystal output-noise ratio of 2.3 decibels (based on a 10-megacycle bandwidth centered on 60 megacycles), there results a noise figure for the combination of 13.1 decibels. The local-oscillator noise, not balanced out by the balanced detector, increases the noise figure to 13.4 decibels under the conditions listed. (If a single crystal mixer had been assumed, local-oscillator noise would have brought NF_1 up to about

TABLE I
TYPICAL NOISE FIGURES FOR
CONVERTER—INTERMEDIATE-FREQUENCY COMBINATION

	Decibels	Times
Crystal loss	7.25	5.3
Crystal noise	2.3	1.7
Intermediate-frequency noise figure ($\beta = 10$ megacycles) ($f_0 = 60$ megacycles)	5.0	3.16
$NF_1 = 5.3(1.7 + 3.16 - 1) = 20.5$ times or 13.1 decibels.		
$NFB_0 = 14$ decibels or 25 times		
Reduced by balanced detector to		
$NFB_0' = 4$ decibels or 2.5 times		
$NF_1 = (2.5 + 20.5 - 1) = 22$ times or 13.4 decibels		
Duplexer loss = 1.8 decibels		
Noise figure = 13.4 + 1.8 = 15.2 decibels or 33 times.		

16 decibels.) Adding in 1.8 decibels of duplexer loss brings the over-all noise figure up to 15.2 decibels. This noise figure by no means represents the best receiver that has been built, but taking a mean of the various components used at the various radar operating frequencies, would come out quite close to the numbers given. (Local-oscillator noise is as serious as shown in Table I only at frequencies of the order of 30,000 megacycles.)

INTERMEDIATE-FREQUENCY AMPLIFIER

There remain to be discussed two more principal elements of the radar receiver, the intermediate-frequency amplifier and the automatic-frequency-control circuit. Both of these units use tubes and general design principles which are not unlike those employed before the war. Consequently, decidedly less emphasis is being given to this material, compared to the emphasis given to the centimeter-wave elements.

The function of the intermediate-frequency amplifier is to amplify the output of the crystal to such a level that a video amplifier can carry the remainder of the amplification job without running into microphonics. The output of the crystal is as small as 5 to 10 microvolts, and the desired second-detector output is usually 0.5 to 1.0 volt. The resultant over-all gain requirement is about 100 decibels from the grid of the first intermediate-frequency amplifier to the output of the second detector, and in addition it is necessary to have reserve gain for the aging of tubes. The intermediate-frequency bandwidth must be adequate to pass the pulse width used in the particular radar, with margin for frequency drifts in the transmitter and receiver. A typical intermediate-frequency bandwidth might be taken as 2 to 4 megacycles for pulse widths of 1 to $\frac{1}{2}$ microsecond. In order to meet its bandwidth and gain requirements, a typical intermediate-frequency amplifier will employ from 5 to 10 stages of straight amplification.

Choice of the intermediate frequency itself is an interesting problem involving many factors. Other aspects of the intermediate-frequency-amplifier design problem include (1) choice of an interstage network, (2) choice of gain-control method, and (3) design of the intermediate-frequency input circuit for optimum noise figure. These topics are discussed at length in another paper,³ and will not be taken up here.

AUTOMATIC-FREQUENCY-CONTROL UNIT

The last major element in the radar receiver is the AFC, or automatic-frequency-control unit. It is the function of the automatic frequency control to maintain the frequency of the signal at the output of the converter in the center of the intermediate-frequency pass band, the tuning condition for best reception of weak signals. Frequency drifts in either the magnetron or local oscillator will tend to cause the converted signal to drift out of the intermediate-frequency pass band. Hence, the automatic-frequency-control system will, in general, perform two functions: (1) it will stabilize the local oscillator against any tendency toward frequency drifts within itself; and (2) it will introduce a local-oscillator-frequency change of the same magnitude and direction as any frequency change in the magnetron output.

³ Andrew L. Hopper and Stewart E. Miller, "Considerations in the design of a radar intermediate-frequency amplifier," to be published in the PROCEEDINGS OF THE I.R.E.

Let us consider the nature of the frequency changes the automatic frequency control has to overcome. The frequency changes which the local oscillator tends to make may be either slow or fast. A typical thermal coefficient of local-oscillator frequency may be taken as 0.25 megacycle per degree centigrade, and over the service temperature range of -55 to $+55$ degrees centigrade this drift would amount to about 27 megacycles. Fluctuations in power-supply voltages might cause variations of around 3 megacycles per 1 per cent voltage change on the reflector, and perhaps half of that for variations in anode voltage.

Frequency changes on the part of the magnetron may also be either slow or fast. The thermal effect may be of the order of 0.1 or 0.2 megacycle per degree centigrade, and over the service range this might amount to 10 or 20 megacycles. In addition, the frequency of the magnetron depends upon the radio-frequency load impedance presented to the tube, since the magnetron is inherently a self-excited oscillator. The magnetron frequency change accompanying a load reflection coefficient of 0.2, changed through all possible phase angles, is of the order of 10 or 15 megacycles. The way such a frequency change will turn up in the radar system operation depends on how the antenna impedance changes in the various parts of the antenna scanning cycle. In some systems, the antenna impedance changes very rapidly, causing correspondingly rapid changes in magnetron frequency. This presents a very difficult problem for the automatic frequency control. In the ordinary search radar, where the antenna may revolve at 20 revolutions per minute, the magnetron frequency changes usually will be quite slow, and the automatic frequency control will have little difficulty in following.

In short, it may be said that a minimum of 40 megacycles total automatic-frequency-control range is desirable. When it is recalled that the bandwidth of the receiver is 2 to 4 megacycles, this 40 megacycles looks very large. The speed with which such frequency corrections are required depends on the particular radar system, and may range from a fraction of a megacycle, per second, to about 1000 megacycles, per second.

The signal used by the automatic frequency control as an input is a small portion of the magnetron output. The received echoes are not reliable sources of automatic-frequency-control signal, and are not used. The nature of the magnetron output pulse, and therefore of the automatic-frequency-control input pulse, is another factor which varies widely depending on the particular system design. The pulse width may run from $\frac{1}{2}$ to 5 microseconds, and the pulse-repetition frequency may run from 250 to over 5000 pulses per second. In practice, this wide range of input signals requires that the circuit constants of the automatic frequency control be chosen for the particular system in question.

No one design is considered satisfactory for all the input signal conditions mentioned, although it is not uncommon for an automatic frequency control to be required to operate on a pulse-width range of 4 to 1 and a pulse-rate range of 3 to 1.

Two circuit arrangements for obtaining the automatic-frequency-control input signal are shown in Fig. 12. One path for the automatic-frequency-control input signal is shown by the dotted lines on the left half of the sketch. A portion of the magnetron output is taken directly from the line leading to the antenna, through a

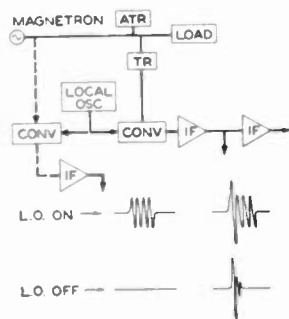

Fig. 12—Automatic-frequency-control signal sources.

linear loss of about 65 decibels. More loss may be located in the line leading to the converter, where the signal is mixed with a portion of the output from the same local oscillator which feeds the signal converter on the right-hand side of this sketch. A separate intermediate-frequency amplifier then amplifies the automatic-frequency-control converter output.

An alternate way of deriving the automatic-frequency-control input signal is to take a portion of the intermediate-frequency output from the signal channel directly after the preamplifier.

The difference between these two signals may be seen in the wave forms sketched at the lower portion of Fig. 12. The dotted circuit is designed for operation only during the transmitting interval; hence, that circuit may be arranged so that the separate automatic-frequency-control crystal converter is operating at the best signal level during the transmitted pulse. Under these conditions, it is possible to have the converter output essentially ideal. That is, when the local oscillator is tuned to the correct frequency to produce a signal in the intermediate-frequency pass band, the converter will have an output signal which is an accurate reproduction of the magnetron output. When the local oscillator is turned off or tuned to a frequency far removed from the correct one, no detectable converter output will be present in the band of frequencies passed by the intermediate-frequency amplifier. This is shown by the straight line representing no intermediate-frequency output with the local oscillator off.

In the signal channel, however, the conversion circuit is designed for best reception of weak echoes. The

level of the magnetron signal is determined by the leakage from the TR box, and is far too great for optimum conversion in the crystal converter. The signal crystal is decidedly overloaded during the transmitted pulse. Furthermore, the output of the TR box contains a spike of energy which, as mentioned previously, is caused by the finite time required for the gap in the TR tube to break down. Hence, in this path, even with the local oscillator turned off, there is enough high-frequency energy in the wave front of the pulse reaching the signal crystal so that simple rectification of that envelope produces appreciable energy at the crystal output in the band of frequencies passed by the intermediate-frequency amplifier. This is represented by the sketch on the lower right. Such energy is the result of simple rectification of the TR leakage, and is not involved with a conversion process. (Therefore, the magnitude will be less at an intermediate frequency of 60 megacycles than at an intermediate frequency of 30 megacycles.) It is apparent that the energy represented here tells the automatic-frequency-control circuit nothing about the correctness of local-oscillator tuning. Therefore, it should be eliminated by a blanking process in the intermediate-frequency preamplifier.

A comparison between the two methods of getting an automatic-frequency-control input signal shows that the separate converter method requires more equipment but provides a clean signal directly. The single converter system is simpler, but necessitates blanking out a portion of the converter output in order to provide the automatic frequency control with a clean signal. Both methods have been found satisfactory in production.

The remainder of the automatic-frequency-control circuit is concerned with converting the automatic-frequency-control output voltage into a local-oscillator frequency change. After a brief examination of the local oscillator's characteristics which are suitable for applying frequency changes, it will be apparent what kind of voltage the automatic frequency control must provide in order to complete the loop.

Referring to Fig. 13, the left-hand portion of the top sketch shows, schematically, a reflex klystron of the type commonly used as a local oscillator. It is characteristic of such tubes that the frequency of oscillation depends on the direct-current reflector voltage. The nature of this frequency variation is shown at the right. Over a 40-megacycle interval the frequency will vary more or less linearly with applied voltage change at about 2 megacycles per volt, in a typical case. Thus, if the center of this range is chosen as the mean operating point, frequency corrections may be made by providing the local-oscillator reflector with a direct-current voltage incrementally above or below the mean value, depending on the desired polarity of frequency correction.

The bottom half of Fig. 13 shows another means of changing the local-oscillator frequency—in this case a

means involving thermal changes. The spacing between the grids at the gap of the reflex oscillator tunes the resonant cavity and, therefore, determines the frequency of oscillation. The manner of controlling the

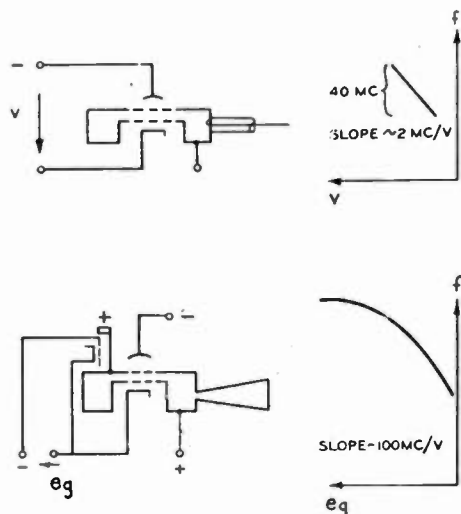

Fig. 13—Local-oscillator frequency control.

local-oscillator frequency may be traced as follows: The grid-to-cathode voltage E_g controls the electron stream between the cathode and anode of an auxiliary triode. The anode of this triode is a strut whose length is a function of its temperature, which in turn is a function of the triode current flow. Because the strut is anchored at one end, its change in length causes the klystron gap capacitance to change, in turn resulting in a change of frequency of oscillation. (Tubes manufactured using this general idea employed a different strut mechanism than the one described.) A sketch of the frequency versus grid-voltage curve is shown at the right. Large changes of frequency may be obtained in this way, at a rate of about 100 megacycles per volt.

One significant difference between the two methods of changing local-oscillator frequency should be pointed out. The direct-current voltage on the reflector, as shown at the top of Fig. 13, acts directly on the electron stream in the oscillator. Thus, for an assumed discontinuous change in reflector voltage, there will result an almost discontinuous change in oscillator frequency; saying this another way, there will be essentially zero lag between the reflector voltage and the oscillator frequency, so the reflector voltage at any instant may be taken as an indication of the frequency. In the auxiliary triode method of controlling frequency, shown in the lower half of Fig. 13, a discontinuous change in the voltage E_g will not result in a discontinuous change of frequency because of the thermal time constant in the strut mechanism. The frequency of operation of this tube depends not on the instantaneous value of E_g but rather on the integrated value of the triode current flow for some interval of time preceding.

Knowing how the automatic-frequency-control input

signal is derived, and the kind of voltage required at the local oscillator to make the frequency correction, the circuit which goes between is rather straightforward.

The upper half of Fig. 14 shows a circuit for use with reflector automatic frequency control. The intermediate-frequency pulses from the automatic-frequency-control intermediate-frequency amplifier are passed through a discriminator detector, whose output may be

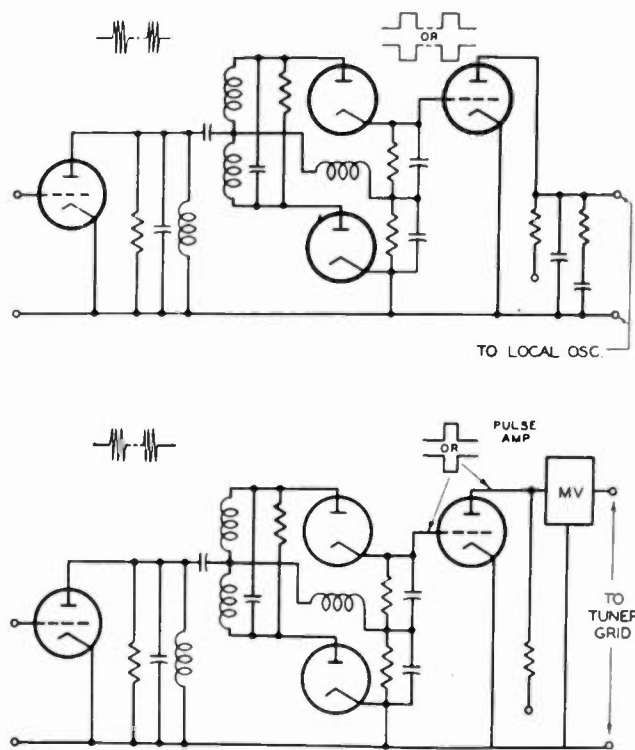

Fig. 14—Automatic-frequency-control circuits.

a positive or negative pulse depending on whether the input pulse's carrier frequency is above or below the crossover frequency of the discriminator. The crossover frequency, or lock point of the automatic frequency control, is set to coincide with the center of the signal intermediate-frequency pass band. The positive or negative discriminator output pulses are integrated and applied to the reflector of the local oscillator as a direct-current voltage. Previous discussion has indicated how the reflector voltage changes the local-oscillator frequency, which in turn changes the carrier frequency of the intermediate-frequency pulses used as automatic-frequency-control input. Aside from integration of the pulses, this circuit is similar to the automatic tuning circuits of low-frequency receivers.

The sketch on the lower half of Fig. 14 shows a circuit used in conjunction with a local oscillator having a thermal tuning mechanism in the form of an auxiliary triode (lower half of Fig. 13). The first portion of the circuit is again a discriminator detector which produces output pulses of positive or negative polarity, depending on the direction of tuning error. These pulses are

amplified and used to place a direct-coupled multivibrator in one stable condition if the pulses are positive, or into another stable condition if the pulses are negative. If a train of positive pulses is presented as an input to the multivibrator, the first one positions the multivibrator with one tube conducting, and nothing further will happen until a negative pulse arrives at the multivibrator input. The first negative pulse turns the multivibrator over, and succeeding negative pulses have no further effect. The resulting operation may be described in conjunction with Fig. 15.

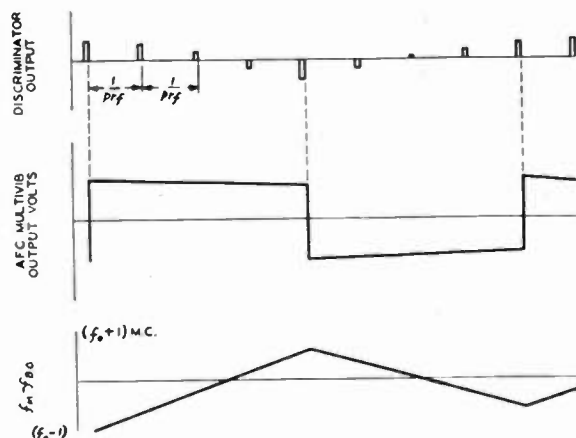

Fig. 15—Automatic-frequency-control operation.

The chain of events sketched in Fig. 15 starts with the condition that the intermediate-frequency signal is

below the desired lock frequency. This produces a positive discriminator output, which in turn positions the multivibrator in the positive output position. A long time constant prevents decay of the automatic-frequency-control output voltage in the time interval under consideration. Hence, a flat-topped wave is impressed on the auxiliary triode grid in the thermally tuned local oscillator. This drives the oscillator frequency upward at a rate determined by the time constant of the thermal elements in the oscillator tuning section. When the intermediate frequency has become greater than the desired frequency by an amount sufficient to produce a measurable negative discriminator output, the discriminator pulse will reverse the position of the multivibrator. This will drive the local-oscillator frequency downward, and the process will repeat itself. The type of automatic frequency control just described is always hunting for the correct tune point, and although this condition might seem undesirable, the arrangement has been successful in practice. The frequency range over which the hunting takes place can be maintained less than ± 1 megacycle, which is seldom very serious.

In conclusion, a brief comment may be made on the circuits following the intermediate-frequency amplifier, and preceding the indicator. These circuits, the second detector and video amplifiers, are conventional and follow television practice except for details. Consequently, no discussion of that portion of the receiver is required here.

Attenuation of 1.25-Centimeter Radiation Through Rain*

LLOYD J. ANDERSON†, JOHN P. DAY†, CLEMENS H. FRERES†, ASSOCIATE, I.R.E., AND ALFRED P. D. STOKES†

Summary—The attenuation of 1.25-centimeter radiation by rain was determined experimentally. The experimental setup consisted of an optical path of 6400 feet with nine equally spaced rain gauges. The techniques used made it possible to utilize both uniform and nonuniform rainfall rates. Drop-size measurements were also made but no conclusions could be drawn because of the wide scatter in the drop-size distributions obtained. If the maximum distance over which communication can normally be established is 100 miles, light to moderate rain will reduce the range to about 10 miles. The radiated power must be increased by 10^{20} in order to re-establish communication over the 100-mile path.

I. INTRODUCTION

SEVERAL attempts have been made to measure the attenuation of 1.25-centimeter radiation by rain. Each has been characterized by insufficient rainfall

data to take into account the fluctuations in rainfall intensity which occur in both time and space. These fluctuations are particularly evident in high-intensity rainfall, and necessitate closely spaced rain gauges along the attenuation path and an accurate system for time correlation of all the gauges with the attenuation data.

In this experiment, nine rain gauges were used over a path of 6400 feet. Readings were taken over 30-second intervals, and time correlations to ± 2 seconds were obtained by a field telephone network.

It was apparent that the attenuation measurements should be made in an area of maximum precipitation. Furthermore, the experiment demanded periods of varying rates of rainfall with frequent "clearing" for calibration purposes. Tropical, orographic rain seemed to offer the greatest probability of fulfilling these conditions.

A site near Hilo, Hawaii, satisfied these requirements, having a yearly fall in excess of 250 inches. The path

* Decimal classification: R247XR113.501. Original manuscript received by the Institute, July 26, 1946; revised manuscript received, October 9, 1946.

† United States Navy Electronics Laboratory, San Diego 52, California.

was located on a lava flow, parallel to the mean trade-wind vector; i.e., due east-west. The lava was covered with saw grass and low brush. The terrain had a gentle slope from the receiver at 2500 feet mean sea level to the transmitter at 2800 feet mean sea level.

Orographic lifting of the unstable, moist, tropical air caused frequent two- to three-day periods of precipitation having a wide range in intensity. On one occasion intensities as high as 125 millimeters per hour were observed. The light winds associated with orographic precipitation allowed an essentially vertical trajectory of the rain drops. Therefore, representative sampling of the rain falling through the propagation path was accomplished by placing the gauges directly in line between the transmitter and the receiver.

II. RAINFALL-INTENSITY EQUIPMENT

Two methods of determining the rate of precipitation were employed. Five Friez tipping-bucket automatic-recording rain gauges were evenly distributed along the path. Their impulses were recorded on a single Esterline-Angus five-pen recorder at the receiver station. In



Fig. 1—Layout of experimental path and apparatus.

addition, four rain shelters employing the "funnel-and-graduate" technique were installed between the automatic gauges, as shown in Fig. 1. Although the rainfall intensity varied widely both with time and in space, as in the two runs shown in Fig. 2, well-co-ordinated meas-

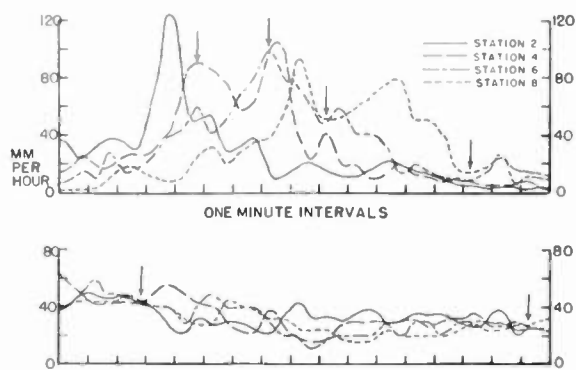

Fig. 2—Rainfall-intensity variation.

uring techniques having sufficient coverage detected periods when the rate of fall along the path was uniform. Since such periods of uniformity seldom lasted longer than sixty seconds, precise control and timing were vital. Accordingly, the rain shelters were provided with field phones for conveying instructions and signals for taking simultaneous graduate readings and for exposing drop-size blotters. During operations, signals for

graduate readings were given every thirty seconds and blotters were exposed on an average of every five minutes.

III. DROP-SIZE EQUIPMENT

The size of the rain drops was measured by the blotter method. Ordinary office blotters of 38 square inches area were lightly dusted with powdered potassium permanganate and exposed to the rain for a long enough time to collect about 100 drops. Upon contact with the blotter, each drop dissolved a small amount of permanganate and made a purple spot whose diameter was a function of the volume of the drop. It was found that the spot size increased for the first few minutes after contact, but that a maximum diameter was reached within five minutes. After a few minutes the permanganate was reduced to manganese dioxide, leaving a permanent brown spot of characteristic size.

Calibration was made by putting various-sized drops on small pieces of the blotter paper. The paper was weighed before and after the drops were added. With the measured difference in the weight, drop diameters were then calculated on the assumption of spherical drops.

Another set of so-called "splatter" points was obtained by bombarding the blotters from a height of 12 feet with a set of calibrated droppers. From this height even the 4-millimeter drops were calculated to have reached terminal velocity, and hence this curve was representative of field conditions. The calibration points by both methods lay on two smooth curves with an average deviation of ± 0.05 millimeter, and hence considerable confidence was felt in the drop sizes measured in the field.

IV. RADIO EQUIPMENT

The simple equipment used for the attenuation measurements is shown in Fig. 3. After an initial warm-up period, it required little attention. Satisfactory measure-

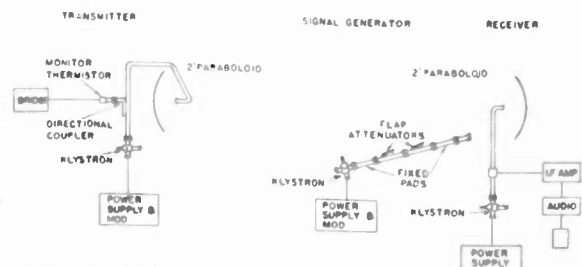

Fig. 3—Block diagram of attenuation-measurement apparatus.

ments required a comprehensive check of the "clear-weather" values before and after any one rainfall.

The transmitter was housed in a small elevated shack. The antenna and guide were protected from the rain by a back-sloping shutter flap.

A klystron tube, modulated at 800 cycles, was used as the transmitter. The peak power output was approximately 50 milliwatts. Wave-guide feed was employed on a 24-inch paraboloid antenna (beam width 1.7 degrees).

A thermistor with a directional coupler was used as a power monitor.

A 24-inch paraboloid fed the receiver, which consisted of a superheterodyne with a klystron local oscillator driving a 30-megacycle intermediate-frequency amplifier with 6-megacycle bandwidth. The second-detector output fed an audio amplifier and recorder.

A klystron signal generator with two flap attenuators was used to calibrate the receiver. Fixed pads were used on either side of the flap attenuators to provide a flat line. The characteristics of the flap attenuators were checked every few hours with a thermistor. Each flap was calibrated and used over a 12-decibel range. Ability to duplicate setting was approximately ± 0.2 decibel. A small nozzle was used to direct the output of the signal generator upon the receiving paraboloid. Calibrations were made before, during, and after rainfalls, and were within ± 1.0 decibel over the five- to six-hour measuring periods.

V. ANALYSIS: ATTENUATION DATA

The primary attenuation data shown by the solid dots of Fig. 4 are for periods when the rainfall at all nine

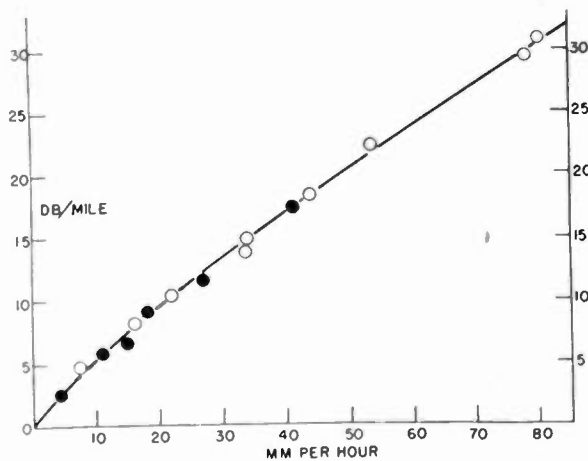

Fig. 4—Attenuation curve of 1.25-centimeter radiation in rain.

stations was essentially uniform. Six such periods of uniform fall along the path were selected, covering the important range of 0 to 41 millimeters per hour.

Fig. 5 is a rainfall-intensity profile of the highest uniform fall recorded. By Humphrey's Classification of Rain,¹ the intensities covered by the primary curve are more than adequate for normal rates of precipitation encountered in nature.

Using the primary attenuation curve, it was possible to extend the curve for extremely high rates of fall (cloudbursts) in the following manner: Fig. 6 is a rainfall-intensity profile for an interval of nonuniform rainfall distribution. The area under the curve was divided into

four sections, as shown. Three sections cover the portions of the path where the intensity was below 45 millimeters

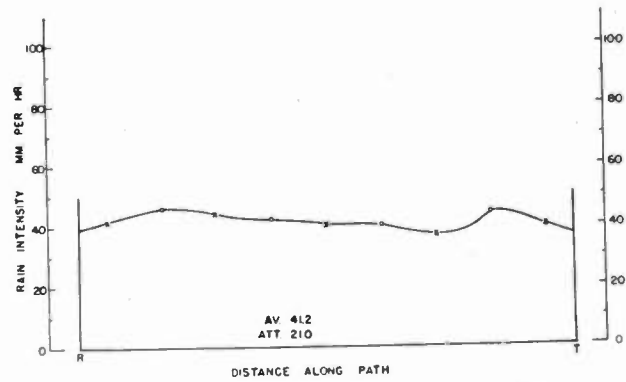

Fig. 5—Intensity profile during nonuniform precipitation.

per hour. Hence, with the primary attenuation curve, it is possible to assign the contribution that each of the three sections makes to the total observed attenuation (assuming that the attenuation in decibels is linear with distance).

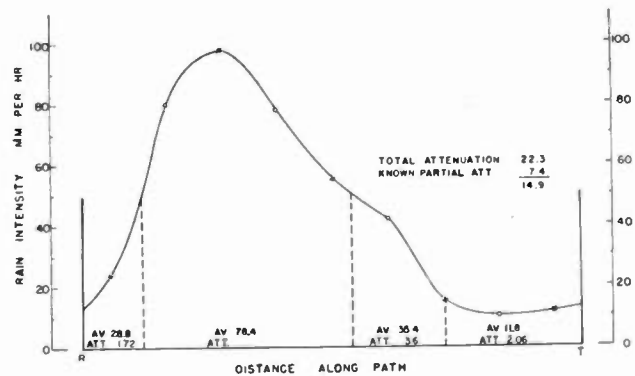

Fig. 6—Intensity profile during uniform precipitation.

After subtracting the part of the attenuation already known, the high-intensity central portion is left to account for the residual attenuation. Dividing the residual attenuation by the fraction of a mile covered by this part of the path gives a point at 78 millimeters per hour, which is the average intensity through the interval. As a check on the method, similar nonuniform profiles were used for values below 41 millimeters per hour, as shown by the open circles in Fig. 4. It will be seen that the open circles agree quite well with the solid circles, and hence considerable confidence in the high-intensity points is justified.

In plotting the points, the size of the circles indicates the limit of the estimated experimental error.

VI. ANALYSIS: DROP-SIZE DATA

In all, some 95 blotters were exposed during attenuation runs. An average of 100 drops were collected and counted on each blotter.

The data were worked up by dividing the size range into steps of about $\frac{1}{4}$ millimeter in diameter. The number of drops in each size was determined and a cumulative

¹ W. J. Humphrey, "Physics of the Air," McGraw-Hill Book Co., New York, N. Y., 1940. 1 millimeter per hour: light rain; 4 millimeters per hour: moderate rain; 15 millimeters per hour: heavy rain; 48 millimeters per hour: excessive rain.

percentage curve plotted for each blotter. In this type of plot the percentage contributions of each successive size grade are added to the previous grades, and an S-shaped curve results. The median diameter is taken as the intercept on the 50 per cent line. Hence, the median diameter is the diameter for which half the drops are larger and half are smaller.

Fig. 7 is a plot of this median diameter data versus the precipitation rate at the time and place the blotter was exposed. It will be noted that there is a large scatter in the points, showing no well-defined relationship, although a trend toward larger drops at higher intensities is apparent.

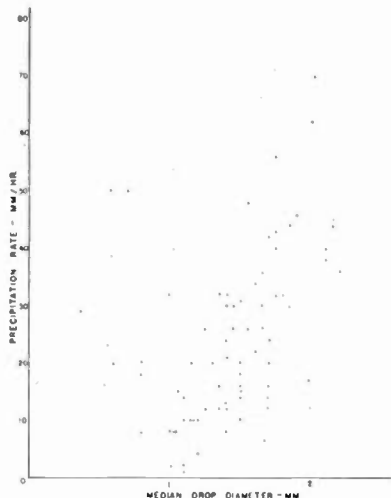

Fig. 7—Median drop versus intensity.

A large scatter was also noted in drop sizes on individual blotters. This is attributed to the comparatively short distance of fall of the drops. Condensation probably took place not more than 1000 feet above the path, and hence the drops did not have sufficient time to assume size distributions corresponding to the precipitation rate.

VII. DISCUSSION

In a recent paper by Robertson and King,² it is noted that the maximum attenuation occurred as much as one minute after the maximum precipitation. They attributed this discrepancy to three possible causes: (1) attenuation measurements were instantaneous and rainfall measurements were averaged over a one-minute period; (2) nonuniform rainfall along the path; (3) effect of drop size.

Although the measurements presented in this paper suffered from the same factors, the effect of these factors has been reduced.

First, attenuation values used were averages over 30-second intervals, and rainfall values were also averages

² S. D. Robertson and A. P. King, "The effect of rain upon the propagation of waves in the 1- and 3-centimeter regions," *Proc. I.R.E.*, vol. 34, pp. 178P-180P; April, 1946.

over simultaneous 30-second intervals. Fig. 2 illustrates the necessity for reducing the time intervals to as short a period as possible in order to follow the rapid time variations of rainfall.

Second, since nine rain gauges were used in the 6400-foot path, each gauge covered only 700 feet of the path. This close spacing of the gauges made possible the plotting of instantaneous (30-second interval) rainfall profiles, Figs. 5 and 6, covering the full length of the path. With this type of representation, nonuniform rainfall can also be utilized as shown above.

Third, drop-size measurements were made, and although they indicated a wide distribution of drop sizes, it would seem that this heterogeneity would eliminate any clear-cut drop-size effects.

Robertson and King also noted a scatter in their low rainfall attenuation values. This they attributed to the inaccuracy of their funnel-and-graduate rainfall method at low intensities and to inaccuracy of the radio data at low attenuation.

In the present measurements, the funnel and graduate method was adapted to varying rainfall rates by varying the size of graduate used. In this way readings could be made to ± 1 millimeter per hour at intensities up to 50 millimeters per hour. The automatic rain gauges were probably less accurate, since impulses were recorded for every 0.01 inch of rain that fell. Thus, in a rain of 5 millimeters per hour, impulses were spaced at 3-minute intervals.

At low attenuations it was not necessary to measure extremely low values, since the path was five times as long as that used by Robertson and King.

VIII. CONCLUSIONS

The average attenuation of 1.25-centimeter radiation due to rainfall is 0.37 decibel per mile per millimeter per hour.³ This figure changes slowly with the rainfall encountered, being about 0.50 at low intensities and 0.35 at high intensities.

It is interesting to apply the measured attenuation curve to a communication circuit. From Fig. 4, a moderate (5 millimeters per hour) rain gives an attenuation of about 2 decibels per mile. This would indicate that, with rainfall of this magnitude over a 100-mile circuit, the radiated power would have to be increased by 200 decibels (10^{20}) to provide the same power received in clear weather. Conversely, if communication can normally be established over a 100-mile circuit, a moderate rainfall will reduce the communication range to 10 miles. The rainstorm need extend only 10 miles from the transmitter to accomplish this reduction.

³ Theoretical calculations made by J. W. Ryde of the attenuation rate (The Institution of Electrical Engineers Radiolocation Convention, London, March 1946) yields an average of 0.25 decibel per mile per millimeter per hour. The discrepancy between theory and experiment has not been satisfactorily resolved to date.

Q Circles—A Means of Analysis of Resonant Microwave Systems*

WILLIAM ALTAR†

Summary—A new circle diagram is presented for systems having an isolated single resonant mode, in addition to frequency-insensitive structures of arbitrary complexities, and ending in an outgoing wave guide or other transmission line. The diagram is obtained from standing-wave measurements in the outgoing line performed at three or more frequencies near resonance. The diagram permits the mapping, in the complex plane of load impedances or reflection coefficients, of such contour lines as loaded-resonator Q , frequency pulling, and the circuit efficiency when the resonator is electronically excited. The proof of these relations, as given in Part II (to be published in a subsequent issue), rests on field theory and establishes in effect the use of general circuit methods in the realm of microwave applications.

Part I

1. STATEMENT OF PROBLEM

THE ACCURATE determination of the circuit properties of systems at microwave frequencies poses new problems with regard both to techniques of measurement and the rigorous evaluation of the measured data. The need for a practical modus operandi for the latter was brought home to this writer in connection with performance tests on resonant-cavity magnetrons. It became apparent in the testing that the variations encountered from one tube to the next could be traced in part to varying circuit properties of the built-in matching transformer which connects the magnetron proper to the outgoing wave guide and the load. Consequently, it would be profitable to segregate the analysis into two parts, respectively concerned with the electronic mechanism of converting direct-current into radio-frequency power, and with the circuit properties of the magnetron plus matching transformer.

In the circuit problem one wants to derive relations for the impedance which specified loads in the wave guide will present at the magnetron cavity. This impedance determines the degree of frequency pulling and the loaded-cavity Q , important operating parameters for the conversion mechanism. Once the functional relation between these parameters and the conversion process has been ascertained, one is in a position to alter the design of the matching transformer and to predict the modified load chart of tube performance on the basis solely of the measured circuit properties of the individual tube.

Now the point is that the circuit properties can be determined by "cold" measurements, i.e., with an auxiliary test generator and before the magnetron is evacu-

ated. Thus, the matching section and its effect on the resonator Q can be subjected to easy adjustments at an early stage of manufacture.

The new circle diagram of a resonant system, for which the name " Q circle" is proposed, permits the accurate analysis at wavelengths of a few centimeters, where the conventional Q determination from the half-power band width of a resonance curve would fail. Presumably, a similar procedure can be used with klystrons and other resonant-cavity oscillator tubes. More important, perhaps, the case discussed here is just one typical example demonstrating the rigorous applicability of circuit concepts and theorems to microwave systems in general.

The justification for thus extending the scope of conventional circuits methods necessitates some considerations of fundamental import, and which are not directly related to the problem at hand, showing that the matching transformer may be considered essentially a four-terminal network and the resonant cavity as an RLC circuit. When these statements have been verified as corollaries of the electromagnetic field theory (see Section 3, Part II) one has in effect reduced the problem to one of mere circuit theory, the solution for which is offered in Section 4.

Thus one steers a middle course between two unsatisfactory extremes; one, the unnecessarily complicated step of solving the field equations for a system of given conductor geometry, and the other an over-simplified presentation of the system in terms of a postulated equivalent circuit. While one could with some intuitive skill set up a simple circuit of lumped elements to simulate the highly interlinking microwave fields, such a representation must for all its heuristic merits be lacking in rigor. A detailed representation of such fields by a rigorously equivalent circuit would be so complex as to offer no advantage over the rigorous field solution.

Yet the complexity of the field is no obstacle to that formulation of circuit theory which avoids explicit reference to specific circuits; just as the general theory of four-terminal networks is not limited or even affected by the complexity of the network. The restricting assumptions needed to derive transducer theory as a corollary of field theory are exclusively concerned with the conductor geometry at and near the terminal points, but not with the internal configurations and properties of the system. The real criterion of the validity of circuit theory at any frequency is the presence of one single mode of propagation at each terminal point, to the exclusion of all others. This is in complete analogy to conditions existing at power or voice frequencies where

* Decimal classification: R119.3. Original manuscript received by the Institute April 29, 1946; revised manuscript received, August 8, 1946. This method was first developed in the early spring of 1943 and, under then-existing security restrictions, received only limited discussion at that time.

† Westinghouse Electric Corporation, East Pittsburgh, Pennsylvania.

circuit theory is commonly used; there the conductor spacing is electrically small, so as to exclude all modes of propagation except the principal mode (conductor surface equals equipotential surface at each line section).

The diagram is derived in the complex plane of reflection coefficients instead of the more conventional impedance plane. The impedance concept, in the absence of well-defined paths for the currents and terminal points for the voltages, loses much of its usefulness and may indeed be discarded without sacrificing any of the useful content of circuit theorems. Like the reflection coefficient, to which it bears a simple relation, the impedance concept is tied to a specific mode of propagation whose interaction with a given load it describes. But in this respect it is not superior to the reflection coefficient itself. The latter, a complex alternating-current vector r whose definition includes the position of the standing wave, is equally descriptive of a load. Vector diagrams in the complex r plane surpass in simplicity and directness of interpretation all similar diagrams using mathematically equivalent co-ordinates (Fig. 1).

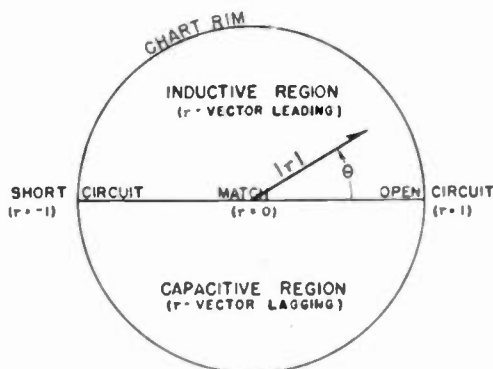

Fig. 1

The complex r plane is essentially identical with the so-called Smith chart^{1,2} commonly used for plotting standing-wave measurements, but for the present application we can dispense with the mapping of resistance and reactance contours as usually given in that chart.

Measurements of the reflection coefficient are made by means of a standing-wave detector between generator and load (Fig. 2(a)). This instrument measures the square of the electric field amplitudes in a transmission line by means of an electrostatic probe, from which the reflection coefficient is determined in accordance with rule *b*. given at the end of Section 1.

The specific circuit problem at hand also has certain novel features. Since magnetrons are accessible to radio-frequency measurements from the outgoing end only, cold tests must be performed looking back, as it were (i.e., in the direction opposite to the normal operation

of the magnetron), and a method for evaluating these data must be given.

Let the element jX in Fig. 2(a) schematically represent the resonant cavity (better: the single operating mode) minus its loss, while the matching transformer is representable as a transducer $M.T.$, the circuit properties of which do not vary with frequency. Included in $M.T.$ is the resistance R in series with jX , representing

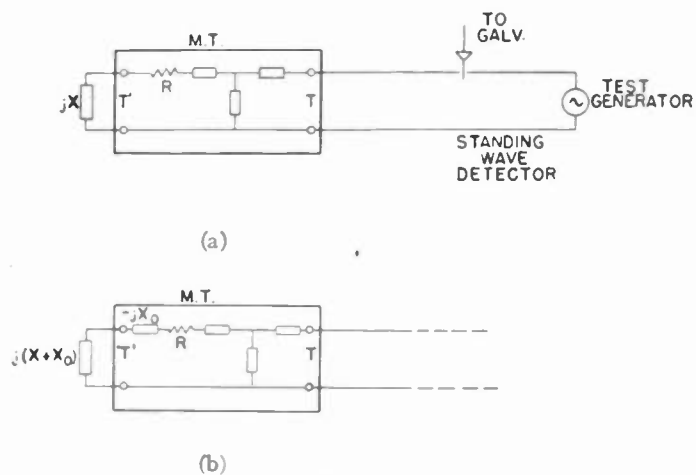

Fig. 2

cavity loss, and $M.T.$ may in addition have losses of its own. As the frequency varies, the resonant element goes through a sequence of imaginary impedance values

$$jX = jaZ_0 \quad \alpha = \frac{f}{f_0} - \frac{f_0}{f} \quad Z_0 = \sqrt{\frac{L}{C}} \quad (1)$$

like an LC circuit at series resonance. This reactance at terminals T' presents a "looking-in" value at terminals T , where it is measured by means of the standing-wave detector.

Three or more such r measurements taken at specified frequencies at the terminals T and looking to the left render the information which is needed for computing the impedance, or the reflection coefficient r' , which an arbitrary load at terminals T will present to the magnetron proper, i.e., at terminals T' and looking to the right. In theoretical parlance, we are exploiting a relation which exists between the two network transformations respectively associated with the two directions of propagation of a given transducer $M.T.$

The resonance frequency f_0 of the element jX can be made identical with that of the system for matched load by disposing of a certain arbitrariness with regard to the exact location of terminals T' . Since, at resonance, the total mesh reactance including that presented by the load at terminals T' must reduce to zero, the resonance frequency of the mesh is a function of the load. As a matter of expediency the circuit may be redrawn as in Fig. 2(b), inserting two equal reactive impedances of opposite sign, jX_0 and $(-jX_0)$, in series with the resonant element but separated from each other by the terminal point T' . If X_0 is chosen to be equal to the

¹ P. H. Smith, "Transmission line calculator," *Electronics*, vol. 12, p. 29-31; January, 1939.

² P. S. Carter, "Charts for transmission line measurements and computations," *RCA Rev.*, vol. 3, p. 355-368; January, 1939.

reactive part of the impedance seen at terminals T' when T is matched (Fig. 2(a)), the modified arrangement of Fig. 1(b) will have the desired property that the resonant frequency of the matched system is identical with f_0 as used in (1).

The frequency parameter α can be approximated

$$4 \frac{(f - f_0)}{(f + f_0)},$$

hence, f itself may be used as the linear parameter. Strictly, even α is a linear parameter only if the cutoff wavelength of the outgoing wave guide or transmission line were infinite; though this correction is too small to matter where the bandwidth is small.

For similar reasons, our assumption that the matching transformer be independent of frequency is not a very stringent condition, given the high Q values of existing oscillator tank circuits.

It was thought best to close this section with a brief compilation of the definitions and rules underlying our use of the Smith chart.

a. In the chart, loads at a chosen guide reference plane are represented by their reflection coefficients r . At any specified transmission-line section, r is an alternating-current vector equal to the complex ratio of the electric field associated with the reflected wave to that associated with the incident wave at the specified plane.

In the chart, these vectors are plotted from the center ($r=0$ for match). Open and short circuit at the reference plane are represented by the points, or vectors, $r=1$ and, respectively, $r=-1$ (Fig. 1).

b. A standing-wave pattern of given power-standing-wave ratio (SWR) is represented in the chart by an r vector in accordance with the relations

$$r = |r| e^{j\theta} \quad |r| = \frac{\sqrt{\text{SWR}} - 1}{\sqrt{\text{SWR}} + 1} \quad \theta = \frac{4\pi x}{\lambda_0}$$

The distance x from the reference point to the nearest maximum is counted positive toward the generator and represented by the angle θ , which is zero at the open-circuit point and increases in the counterclockwise sense.

The fractional-wavelength scale printed on the published¹ Smith Chart has the reference zero at the short-circuit point and increases clockwise toward the generator. It refers to the position of the reference plane relative to the nearest minimum, while our angle θ measures the position of the maximum relative to the reference plane.

c. A short section of open transmission line or other capacitive load has its nearest maximum on the load side and its chart point is displaced in a clockwise sense relative to open circuit ($r=+1$). At the reference point the reflected wave is then lagging because phase equality exists between the two waves at the maximum, which is farther from the generator than the reference plane.

There, the reflected wave is ahead and the incident wave behind the respective phases at the reference plane. It follows that the r vector lags for capacitive loads (lower half of the chart) and leads for inductive loads (upper half). This is in agreement with customary sign conventions for impedances, and with the formula (e.g., for a small self-inductance):

$$r = \frac{Z - Z_0}{Z + Z_0} = \frac{j\omega L - 1}{j\omega L + 1} = -1 + 2j\omega L + \dots$$

d. To refer a given chart diagram to a new reference plane, all r vectors must be rotated through angles proportional to the displacement, and in the clockwise sense if the new reference plane is nearer the generator. A full revolution in the chart corresponds to a displacement by a half wave.

e. For increasing frequencies, load points in the chart always travel in the clockwise sense because the change increases the electrical length of the line, and thus works in the same sense as shifting the reference plane toward the generator. Since a Q circle is a plot of the conjugates of chart points, the sequence of points on the Q circle is opposite, i.e., clockwise, for decreasing frequencies.

f. The contour lines of resistance and reactance crowd toward the open-circuit point ($r=1$) for large R or X values. The contour lines of conductance and susceptance crowd toward the short-circuit point ($r=-1$) for large Y values. Except for a rotation through 180 degrees the two systems of contour lines are identical.

2. EVALUATION OF Q -CIRCLE DATA— AN ILLUSTRATIVE EXAMPLE

In order not to burden with general derivations and proofs those readers whose primary interest is in the practical use of Q circles, it was thought preferable to precede the theoretical discussion of Part II with a condensed outline of the procedure. The data chosen are typical of a resonant-cavity magnetron with magnetic coupling. More modern tubes with guide output have Q circles almost tangent to the chart rim, indicating a simpler equivalent circuit.

The three standing-wave measurements listed in Table I, obtained at three equidistant frequencies, are a representative set taken from a total of six to ten similar data covering the resonant-frequency region.

TABLE I

Point	Frequency in megacycles	Minimum position, fractional wavelength	Standing-wave ratio		Conjugate of the complex reflection coefficient
			Power	Amplitude	
A	8605	0.155	18.4	4.30	0.622/0.095 $\times 4\pi$
B	8597	0.254	10.6	3.26	0.530/-0.004 $\times 4\pi$
C	8589	0.324	12.25	3.50	0.555/-0.074 $\times 4\pi$

Of these, only the first three columns represent measured data, while the rest are computed.

The standing-wave detector is in the outgoing wave guide and looks at the magnetron through its matching

section, which, in this particular case, is a coaxial-to-guide transformer. The zero of the position scale serves as the guide reference plane, and the readings increase toward the test generator. Let it be required to determine the frequency pulling (shift of tuning frequency) and the loaded Q of the operating mode as functions of the load. The mode is single, at about 3.50 centimeters. The loads are again referred to the zero of the probe position scale used in Table I. Let it further be required to map contour lines of circuit efficiency in the load chart. By circuit efficiency—as contrasted with electronic conversion efficiency—is meant that fraction of the generated radio-frequency power which emerges through the guide.

a. Matched Load

In the complex r plane the Q circle is defined as the locus for varying frequency, not of the reflection coefficient but its conjugate complex value. It may be drawn from three of its points, A , B , and C , as shown in Fig. 3. Chart points measured at other frequencies must lie on this circle, their exact positions to be determined by means of a linear frequency scale which we now proceed to draw. First, to locate the so-called off-resonance point 0 (Fig. 3), line t_1 is drawn tangent to the circle at B and extended to I , its point of intersection with the line passing through A and C . Next, draw the second tangent t_2 from I to the circle, the contact point determining the off-resonance point 0 . This is the limiting point toward which the point on the

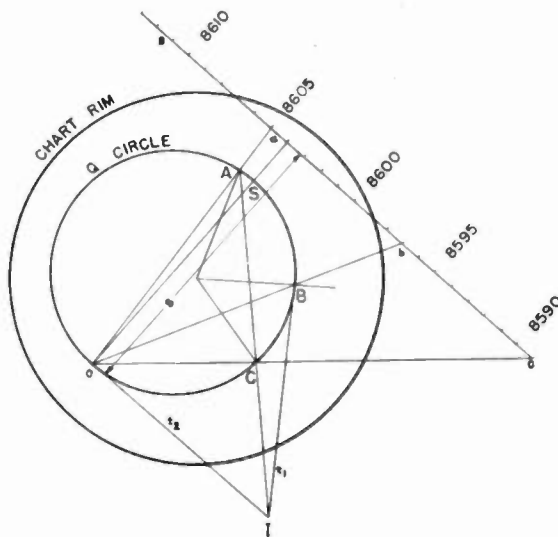

Fig. 3

circle for the mode under consideration converges as the frequency is raised or lowered beyond limit. To set up the linear scale, one draws line g parallel to t_2 at a suitable distance s from 0 . A pencil of rays through 0 will then establish a projective relationship between points $a, b, c \dots$ on g and points $A, B, C \dots$ on the circle. Spacings between $a, b, c \dots$ are proportional to

the differences in frequency (more exactly in α) at which the corresponding points $A, B, C \dots$ were measured. One verifies, by way of checking the accuracy of point 0 , that the points a, b , and c are equally spaced, the intervals $a-b=b-c$ corresponding to equal frequency intervals of 8.0 megacycles. This gives us a scale factor by means of which the position on the Q circle may be interpolated for any stated frequency, and vice versa. In particular, for the point S diametrically opposite to 0 on the Q circle, linear interpolation gives a frequency of 8604.0 megacycles, later shown to be the resonance frequency of the system when terminated in a matched load.

By checking measured points other than A, B , and C against the frequency scale, one verifies its linearity as a check for the absence of undesired modes near the operating frequency of the system.

If A, B , and C happen to be about equally spaced on the circle, the given procedure for finding 0 becomes impractical and is better replaced by the following. One draws two lines tangent to the circle at points A and C , and joins their point of intersection to point B by a straight line. This line then intersects the circle again at 0 .

To find the loaded Q of the system when terminated in a matched load, we read from the frequency scale that interval $2\Delta f$ which is represented by a scale spacing $2s$. It will be seen that the point on the circle traverses half the circumference as the frequency is varied from $f_0 + \Delta f$ to $f_0 - \Delta f$. This is the half-power bandwidth as one would measure it were it possible to take a standard resonance curve by means of instruments directly inserted into the resonant mesh, while the wave guide would be terminated in a matched load. In the numerical example, the half-power width comes out 27.2 megacycles, giving a value

$$Q_{\text{match}} = \frac{f_0}{2\Delta f} = \frac{8604}{27.2} = 315. \quad (2)$$

For the matched load the circuit efficiency e will be shown to be numerically equal to the radius of the Q circle. Since the chart rim has unit radius, we find from Fig. 3:

$$e_{\text{match}} = \frac{\text{power into matched load}}{\text{total radio-frequency power generated}} = 66 \text{ per cent.} \quad (3)$$

We may define a transmission Q for the system:

$$Q_{t, \text{ match}} = \frac{\text{reactive system power}}{\text{power into matched load}} = \frac{Q_{\text{match}}}{e_{\text{match}}} = 476 \quad (4)$$

and similarly a dissipation Q

$$Q_d, \text{ match} = \frac{\text{reactive system power}}{\text{power dissipation in system}} = \frac{Q_{\text{match}}}{1 - e_{\text{match}}} = 920. \quad (5)$$

While a strict separation between cavity loss and loss in the matching section must not be expected from the few data taken, it is possible to quote upper limits for the cavity loss and for the efficiency of transmission of the matching section. Clearly, if we could reduce to zero all cavity losses, an increased radius of the Q circle would result, yet the off-resonance point O would not be affected since the cavity loss is zero, anyway, at frequencies for off resonance. Consequently, the efficiency with which the matching section transmits power into a matched load cannot exceed the numerical value of the radius of the biggest circle through O which lies entirely within the chart rim. Hence, the ratio

$$e' = \frac{\text{power into matched load}}{\text{power into matching section}} \leq \frac{1 + |r_0|}{2} = 85 \text{ per cent,} \quad (6)$$

corresponding to an insertion loss of the matching section not less than 16.2 per cent. A corresponding lower limit results for the circuit efficiency of the cavity alone:

$$e'' = \frac{\text{power into matching section}}{\text{total radio-frequency power generated}} \leq \frac{0.66}{0.86} = 77 \text{ per cent.} \quad (7)$$

By comparing these values with empirical expectations one can often locate such hidden sources of excessive loss as faulty soldering, etc.

b. Contours of Q and of Frequency in the Load Chart

The basic geometrical element for contour mapping is the inverted Q circle (Fig. 4). It is related to the Q circle through transformation by reciprocal radii, with the chart rim serving as the unit circle. It can be constructed from three of its points; for instance, from the inversions $\bar{A}, \bar{B}, \bar{C}$ of points A, B, C . Point \bar{O} may be found by inverting the off-resonance point O , or alternatively from point $\bar{A}, \bar{B}, \bar{C}$ to which it is related by the same construction which served to locate O from A, B, C .

The case depicted in Fig. 4, where the inverted Q circle surrounds the chart rim, is the usual but not the only possible case. Our formulations should not exclude the possibility that the chart center lies outside the Q circle, and the chart rim, consequently, lies outside the inverted Q circle. A formulation embracing both cases assigns an algebraic sign to the radius of the inverted Q circle and to all other Q contours, being positive if the chart rim lies inside the circle in question and negative otherwise.

All Q contours are circles tangent at \bar{O} to each other and to the inverted Q circle. The latter, being the contour for infinite loaded Q , must lie outside the accessible

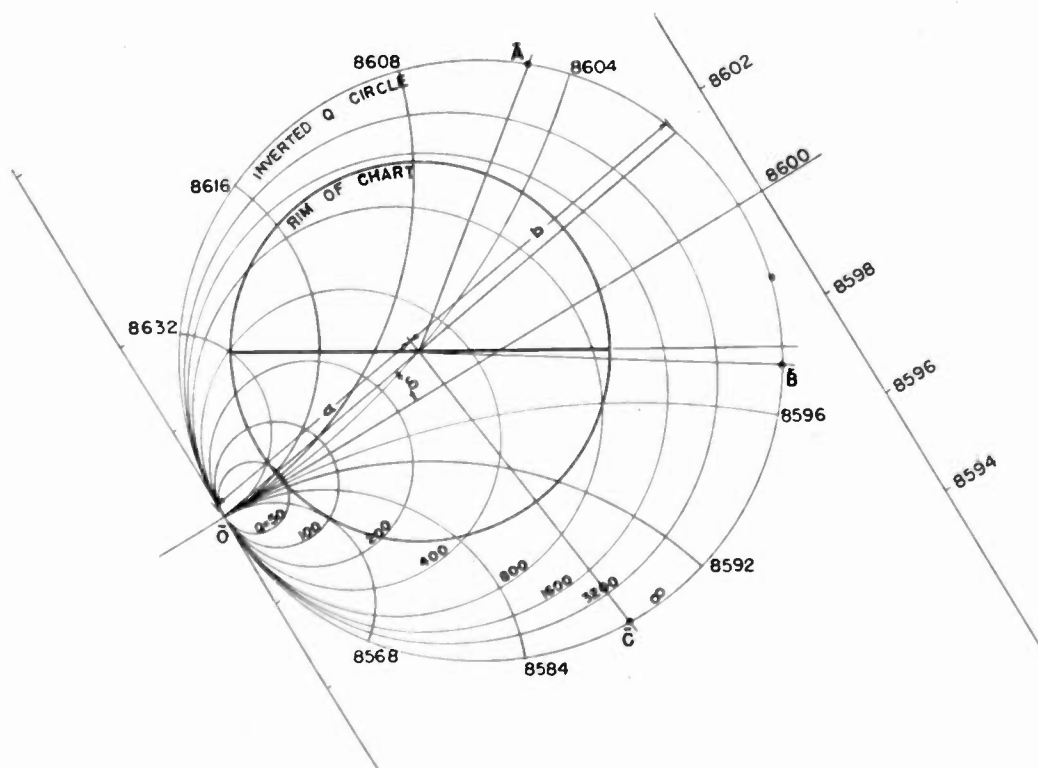

Fig. 4

On this basis one arrives at estimates for the component Q values of the cavity alone:

$$\begin{aligned} \text{cavity transmission } Q &= \frac{Q_{\text{match}}}{e''} \leq 315/0.77 = 410 \\ \text{cavity dissipation } Q &= \frac{Q_{\text{match}}}{1 - e'} \geq 315/0.231 = 1370. \end{aligned}$$

load range as demarked by the chart rim. The frequency contours also are a family of circles, tangent to each other at \bar{O} and orthogonal to the Q contours (Fig. 4).

The centers of the Q contours lie on the diameter through \bar{O} , and the radii are:

$$R'(Q) = \frac{R_0 Q}{Q + Q'} \tag{8}$$

$$R''(f) = \frac{17.00}{f - 8600} = \left[\frac{R_0 f'}{2Q'(f - f')} \right] \tag{10b}$$

where R_0 is the radius of the inverted Q circle and Q' is the Q value associated with its center:

$$Q' = \frac{b}{a} Q_{\text{match}} = \frac{1.75}{1.36} 315 = 406. \tag{9}$$

The chord of the inverted Q circle, passing through $\bar{0}$ and through the chart center, is divided by the latter into segments $a=1.36$ and $b=1.75$, as seen from Fig. 4. If the inverted Q circle has negative curvature, the negative sign applies to segment b . The circles of constant frequency have their centers on the line which at $\bar{0}$ is tangent to the inverted Q circle, and their radii are

$$R''(\alpha) = \frac{R_0}{Q'(\alpha - \alpha')} \tag{10}$$

where α' is the value associated with the contour through the center of the inverted Q circles:

$$\alpha' = \frac{2R_0 \sin \delta}{bQ_{\text{match}}} = 0.92 \cong 10^{-3} \tag{11}$$

corresponding to a frequency which is $(1/2 \times 0.92 \times 10^{-3} \times 8604) = 4.0$ megacycles below that for matched

The completed load chart (Fig. 4) gives the Q value and tuning frequency for any specified load. In particular, one verifies the previously computed values $Q=315$ and $f=8604$ for the center of the chart.

The frequency contours meet the inverted Q circle at points which are the inverted images of the points on the Q circle measured at the respective frequencies. An additional check may be derived from a linear frequency scale which exists for the inverted Q circle, and which may be found in a manner analogous to that of the Q circle, except that the value Q' must be taken in place of Q_{match} .

The contour lines of circuit efficiency are a family of circles, as shown in Fig. 5. Two of these are known; namely, the chart rim for $e=0$, and the inverted Q circle for $e=\infty$. Others may be constructed using the geometrical rule that they must be orthogonal to a certain circle C which we now proceed to determine.

A straight line g (Fig. 5) is drawn through the centers of both the chart rim and the inverted Q circle, intersecting the latter at points G and G' . Next, draw a circle C' of arbitrary radius and passing through G, G' , which intersects the chart rim in the points H, H' . The center M of circle C is then found as the point of inter-

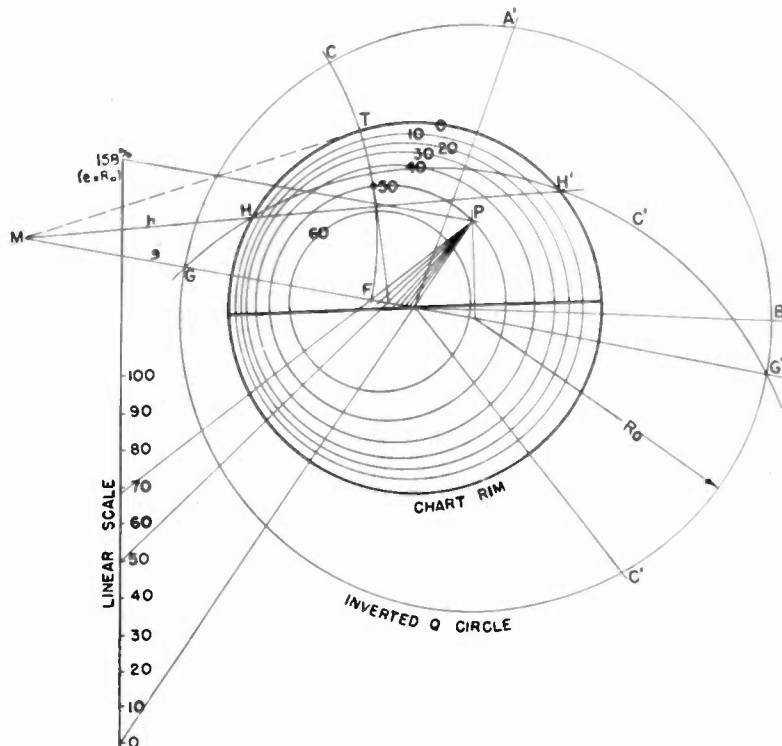

Fig. 5

load. In other words, the diameter at $\bar{0}$ is the contour line for a frequency of 8600 megacycles, and other circles have radii given by

section of line h through H, H' and line g . To find the radius \overline{MT} of circle C , a tangent to point T on the chart rim is laid from point M .

The circle C with center M and which passes through T is orthogonal to all e circles, so that it becomes a simple problem in geometry to find their radii once the centers on line g have been located. To find the center for a specified e value, a linear e scale may be laid out by selecting a point P and joining it to the center of the inverted Q circle by a straight line parallel to the proposed e scale. The scale zero lies on the ray which joins P to the center of the chart. Another ray through P , parallel to line g , meets the scale at the scale point $e=1.58$ (numerically equal to the radius R_0). From these two scale points, the point $e=100$ per cent and others are found by linear interpolation. From Fig. 5, one reads the maximum efficiency of which the system is capable to be 68 per cent when the load point is at F .

The radius of an e contour equals the length of the tangent drawn from the given center to the circle C , as indicated in the Fig. 5, for the 50 per cent contour line.

c. Circuit Efficiency of the System for Arbitrary Loads

The amounts of total power generated and of power emerging at the wave guide may be computed with the help of two simple and singularly appropriate relations, which link them to the geometrical concept of "power" of a point P with respect to a circle. Let a and b be

the segments into which the chord of a circle is separated by one of its points, P . The product $a \cdot b$ of these lengths, a function only of the position of P and the circle but not of the chord chosen, is called the "power" of point P relative to the circle. It can be shown that the net, or active, power emerging through a wave guide when the outgoing wave is of unit amplitude is numerically equal to the "power" of the load point with respect to the chart rim. The total radio-frequency power generated, on the other hand, will be proved in Part II to be $1/R_0$ times the "power" of the load point in the receiver chart, with respect to the inverted Q circle in that chart. By combining these two statements, one finds the circuit efficiency of the system

$$e = R_0 \frac{\text{"power" of load point relative to chart rim}}{\text{"power" of load point relative to inverted } Q \text{ circle}} \quad (12)$$

for any load. For instance, if the load is matched the load point is the chart center, and (12) reduces to

$$e_{\text{match}} = \frac{R_0}{ab} = \frac{1.58}{1.36 \times 1.75} = 66 \text{ per cent} \quad (13)$$

which, in agreement with a previous determination, is equal to the radius of the Q circle.

A Tunable Squirrel-Cage Magnetron—The Donutron*

F. H. CRAWFORD† AND MILTON D. HARE‡

Summary—The donutron is an all-metal squirrel-cage magnetron. It is a multisegment magnetron with a single resonant structure. It is tuned by the relative axial displacement of alternate anode segments, through flexure of one wall of the cavity in which the anode structure is supported. During the testing of some sixty models, the operating efficiency and the output power have been increased to 40 to 50 per cent and around 50 watts, respectively (6- to 12-centimeter range). The best model to date tunes over a 1.5 to 1 ratio with power flat to 3 decibels. A single value of voltage and magnetic field is

adequate for the entire tuning range. Of the various modes of operation, two are important, a long-wave tunable cavity mode and a short-wave resonant re-entrant-line mode. The former can be entirely suppressed and the latter enhanced by a special phase-reversing anode. In the line mode the highest output powers have been observed. In cold tests, modes around 4 centimeters as well as indication of even shorter resonance wavelengths have been found. A wide range of design parameters has been studied. Rieke diagrams have been taken for the best tubes.

I. GENERAL DESCRIPTION

THE donutron is a magnetron consisting essentially of a set of interleaving fingers arranged in the form of a cylinder to form a multisection squirrel-cage anode (see Fig. 1). Alternate fingers are attached to rings which in turn are soldered to the side walls of a cylindrical metal cavity. A uniform magnetic field is maintained parallel to the anode axis in the usual

fashion. One of the walls of the cavity is a thin diaphragm allowing the separation d between the ends of the fingers and the bottoms of the slots to be varied

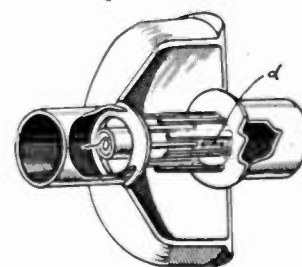

Fig. 1—Cutaway diagram of donutron, showing interleaving of fingers and variable tuning setting d .

* Decimal classification: R339.2. Original manuscript received by the Institute, March 29, 1946; revised manuscript received, October 19, 1946. This paper is based on work done for the Office of Scientific Research and Development, under Contract No. OEMsr-411 with the President and Fellows of Harvard College.

† Formerly, Radio Research Laboratory, Harvard University, Cambridge, Massachusetts; now, Williams College, Williamstown, Massachusetts.

‡ Formerly, Radio Research Laboratory, Harvard University, Cambridge, Massachusetts; now, Union College, Lincoln, Nebraska.

by pulling the two anode halves apart. This alters the capacitance and, in some modes of operation, the

inductance, and thus tunes the system.¹ Various devices have been employed to increase the tuning range, such as small radial tabs on the finger ends and continuous circumferential rings attached in each case only to the fingers belonging to a given anode half. The cathode consists of a heavy nickel tube with heavy end cylinders or "hats" for cooling. A sintered nickel mesh filled with emitting oxides fills the space between the end cylinders. It is important that the emitting surface be of the same general length as the fingers. Heating is indirect.

The N -fingered donutron, while behaving in operation as a magnetron with an N -pole anode, differs from the conventional multicavity magnetron in the replacement of the N identical mutually coupled oscillators by a single resonant structure. Thus, although the donutron has several modes of operation, they are widely separated in frequency in marked contrast with the narrowly spaced $(2N-1)$ resonant modes of the multicavity structure.

Approximately sixty tubes have been constructed, a majority of which have been tested as oscillators. During this time power developed has increased from less than 1 watt to 50 or 60 watts (in continuous-wave operation) and efficiencies have been raised to around 50 per cent.

II. COLD TESTS AND MODES OF OPERATION

For the purpose of investigating the cold resonance, tuning behavior, and anode field patterns of this tube, special cold-test equipment was built up.

This is indicated schematically in Fig. 2, and consists essentially of a local oscillator which supplies 100 per cent square-wave amplitude-modulated radio-frequency power through 9 feet of lossy cable to the magnetron. The lossy cable introduces an attenuation of about 10 decibels and prevents interaction between the

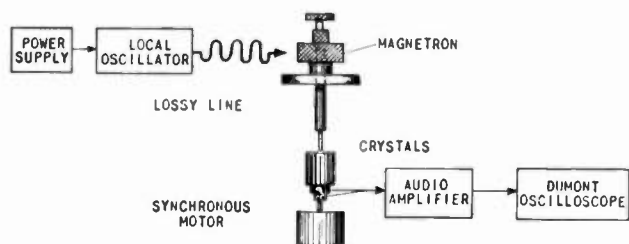

Fig. 2—Schematic diagram of arrangement for cold tests.

magnetron and the oscillator. At wavelengths below 5 centimeters it was necessary to use another local oscillator of power too low to permit use of the lossy cable, and results accordingly were less reliable in this region. The magnetron was used essentially as the finished tube complete with tuning mechanism, but without the cathode assembly and output loop, which were later attached in a hydrogen bottle. For the cold tests a special adjustable loop was clamped in the output

¹ R. Kompfner, describing work done at Birmingham University in 1942, used this adjustment for tuning the cold tube to a desired wavelength. His work has not been published.

opening, while the whole tube was fixed on the probe table in such a way that a rotatable radial probe mounted in a dummy cathode could be inserted in the normal cathode position. The probe was connected by a coaxial transmission line containing a line stretcher to two wavemeter crystals arranged so as to provide half-wave rectification of the radio-frequency power. The probe-line-stretcher-crystal assembly was rotated continuously by an 1800-revolution-per-minute synchronous motor, while the audio output of the crystals was taken off through silver-graphite brushes running on coin-silver slip rings. The audio amplifier was tuned

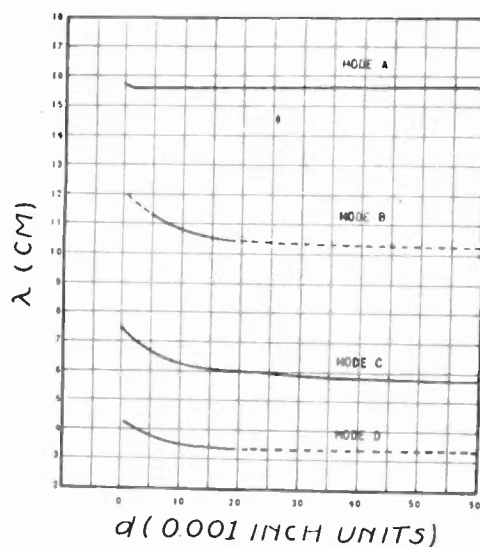

Fig. 3—Resonant modes of the donutron and their tuning behavior (cold tests on tube No. 39 with 16 fingers).

to the approximately 2000-cycle-per-second frequency of the square-wave modulation, while its output led to a DuMont oscilloscope whose sweep was synchronized with the 60-cycle-per-second line frequency. This tied the oscilloscope sweep to the angular position of the rotating probe. In practice, the oscillator was set at the desired wavelength and the probe-line stretcher tuned for maximum output, while the magnetron was tuned over its entire range. At each resonance a photograph of the oscilloscope pattern was taken and the magnetron-tuner setting recorded. The oscilloscope pictures show the square of the radial electric field strength at the cathode as a function of the azimuthal angle. By means of a special adjustment the probe could be moved at will along the axis of the tube. The cold tuning curves result from plotting the wavelength of the resonant responses versus the tuner settings. The probe patterns are the chief data on which our knowledge of the nature of the oscillations in the tube depends.

In a general way, the cold-test data indicate four principal types of oscillation in the donutron structure. Fig. 3, for example, indicates the resonant wavelengths for these types for plain-finger anodes as a function of the tuning setting, i.e., the separation d (Figs. 1 and 5) of the ends of the fingers from the bottoms of the slots,

in thousandths of an inch. Beginning with the mode of longest wavelength we have, at the top, mode A, which tunes only very slightly over the whole range of adjustment. The rotating-probe pattern (Fig. 4(a)) indicates the presence of a cavity oscillation, in which the fingers attached to one side of the cavity are of opposite polarity to that of the fingers attached to the other side. Here the number of maxima $= (N/2) = 8$ indicates a π mode, i.e., a mode in which neighboring segments are 180 degrees out of phase (the loop maximum falling between and partially obscuring the second and third maxima counting from the left is to be ignored). In this mode the anode structure behaves much as a simple capacitor shunted across the cavity. Since this mode tunes only slightly and in operation never produced very much power, it has not been studied with any care.

patterns are functions of the axial position of the probe itself, and in Fig. 4 (C₁)(C₂) and (C₃) are typical patterns taken with the radial probe at the middle, near one end, and beyond the end of the finger system respectively. The third of these patterns, after correcting for the square, response characteristic of the rectifier, indicates a radio-frequency field near the cathode which is a simple $\sin \theta$ function. The field under the center of the fingers has $\sin \theta$ as an envelope with the fluctuations due to alternating charge on the fingers superposed. The patterns of mode C in general are reasonably well represented by an expression of the form $\sin \theta \cdot \sin (N/2)\theta$, where N is the number of fingers. Actually, at the major minima of the curves (where $\sin \theta$ is small) it is difficult to locate the small pips, and usually 7 rather than 8 are found per half wave (for $N=16$). In any event, the significant thing is the $\sin \theta$ variation. This indicates definitely that in this mode we have a single standing wave around the circumference of the anode, and hence that the anode structure itself and not the cavity is the resonant element. This was verified in operation by the observation that, when the cavity radius was increased by up to 25 per cent and the cavity height by 50 per cent, the wavelength of the C mode at identical settings changed by only a millimeter or so. This was of great importance, and led to the discovery that the operating wavelength for mode C could be computed simply from the anode size and the number and length of fingers alone.

In mode-C operation we have a single standing wave around the anode, while the cavity presumably is being forced to oscillate as a $\frac{1}{4}$ -wave radial line with a short at the external circumference and with a single pair of circumferential or θ nodes superposed.

A typical probe pattern for mode D is shown in Fig. 4(d). It is apparent that here, also, we have a single wavelength around the anode, and that the cavity must be forced to oscillate in some new mode, perhaps a $\frac{3}{4}$ -wave radial one. The patterns all have fewer pips than for mode C, though the exact interpretation is not clear. Mode D has been observed in operation at the Sylvania Electric Products Company in Salem, although not at the Radio Research Laboratory. It would merit further investigation in the future.

III. MODE B—THE PRINCIPAL TUNABLE-CAVITY MODE

Mode B gives a probe pattern (Figs. 3 and 4(b)) very similar to mode A, and hence, as before, indicates a capacitance-shunted cavity oscillation with π -mode magnetron operation. Mode-B operation with efficiencies around 35 per cent has been obtained, although the power output is limited, as the anode current is raised, by a sudden jump to mode C.

In mode C we have another mode of operation with a good tuning range, and in this mode the greatest powers and efficiencies have been obtained. Here the probe

This mode was actually the mode in which the donutron was expected to operate when it was first designed, and for many purposes this mode may be very satisfactory. Tuning ranges of 1.3 to 1 or so can be reached with plain fingers, and the addition of finger nails or rings extends this to 1.7 to 1 or higher. Because of the mode jump from mode B to mode C as the anode current is increased, high powers have not been observed, though at 10 watts output efficiencies of 35 per cent have been obtained. This mode would undoubtedly be worth extensive investigation, although for the following reasons it was decided to concentrate on mode C.

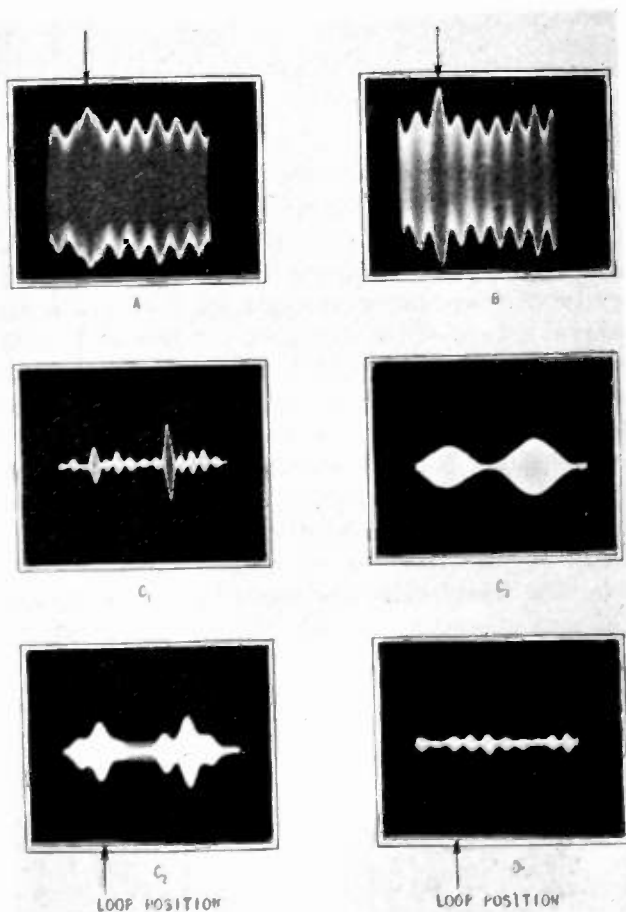

Fig. 4—Rotating-probe patterns on the oscilloscope (tube No. 39)

1. All tubes seemed to oscillate well in the C mode, even when the B mode was weak and irregular.
2. The low current for the mode change B to C offered prospects of better power outputs over wider anode-current ranges.
3. Several devices to suppress mode C in favor of mode B were tried without success. The phase-reversing anode to be described below was found actually to suppress mode-B and enhance mode-C operation.
4. Since the wavelength of mode C is roughly $\frac{1}{2}$ to $\frac{1}{3}$ of that of mode B, size and power considerations obviously favored the shorter-wave mode.

IV. MODE C—THE PRINCIPAL TUNABLE-LINE MODE

The existence of a standing wave around the anode structure at once suggested that mode C was a re-entrant-line mode of some kind or other. On searching for such a re-entrant line, the possibility arose of treating the zigzag path between the finger systems (see Fig. 5) as the line in question. If we imagine the anode halves

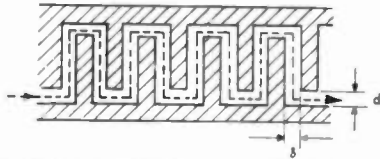

Fig. 5—The zigzag path between the anode fingers regarded as a re-entrant transmission line.

to be so adjusted that the gap at the ends of the fingers is equal to the side gaps between the fingers (i.e., with $d = \delta$), we see that the length of the midpath (dotted line Fig. 5) is $2\pi r_a + Nl$ where r_a is the internal anode diameter, N the number of fingers, and l their length. This would be expected to be the approximate wave-

length for such a line if it were straightened out. Actually it must be thought of as a folded line where the capacitance per unit length is probably only slightly altered, while the inductance per unit length is considerably reduced. This should increase the phase velocity and increase the wavelength in the line compared with the air wavelength. In practice, this increase is by a factor of almost exactly two—leading, therefore, to the very useful, but entirely empirical, equation

$$\text{(mode C)} \quad \lambda_{\text{air}} = \frac{2\pi r_a + Nl}{2} \quad (1)$$

Actually, with fingers of appreciable radial thickness it is slightly better to use r_a' , the radius to the midpoint of the anode structure, rather than r_a , the internal anode radius. Hence,

$$\text{(mode C)} \quad \lambda_{\text{air}} = \pi r_a' + nl \quad (2)$$

for an electronic mode of order $n = N/2$, i.e., the mode corresponding most closely to the π mode in an ordinary magnetron of N segments. Equation (2) of course takes no account of tuning and applies only to the wavelength for a setting which makes $d = \delta$. The formula was tried out on all the data on squirrel-cage magnetrons which could be found as well as on Radio Research Laboratory tubes where the wavelength for $d = \delta$ was actually observable from the tuning curve. A few of the results are given in Table I. Under the columns headed W and l are given, respectively, the finger width, and the finger thickness measured in a radial direction. It should be emphasized that the wavelength for a given tuning setting depends, among other things, upon the anode current, the size and separation of the end hats, etc., and these quantities are not noted particularly in the table. The wavelength was found to be, as we should

TABLE I

(All dimensions are in inches, λ in centimeters)

Here N = finger number, W = finger width, l = finger thickness radially measured, r_a' = anode radius to midpoint of finger, l = finger length, D_a = internal anode radius, d = tuning separation, and λ = wavelength. For d and δ , see Fig. 5.

Tube	N	W	l	r_a'	l	l/D_a	d	λ Calc. Eq. (2)	λ Obs.	Remarks
Raytheon (glass)	16	—	—	0.127	0.200	0.9	—	5.1	5.2	$d \neq \delta$
Salem Sylvania	20	—	—	0.112	0.208	1.0	—	6.2	6.8	$d \neq \delta$
Flushing SD849	16	—	—	0.197	0.250	0.7	—	6.7	6.0	$d \neq \delta$
Flushing SD848	20	—	—	0.197	0.250	0.7	—	7.9	7.0	$d \neq \delta$
RRL Donutron No. 6	16	0.030	0.030	0.197	0.250	0.7	0.042	6.6	6.6	$d = \delta$ for all Radio Research Laboratory tube wavelengths.
RRL Donutron No. 13	24	0.030	0.030	0.197	0.230	0.6	0.018	8.6	8.4	
RRL Donutron No. 23	32	0.018	0.030	0.197	0.230	0.6	0.018	10.9	10.3	
RRL Donutron No. 28	16	0.030	0.030	0.197	0.184	0.5	0.042	5.3	5.4	
RRL Donutron No. 37 ¹	16	0.030	0.63	0.214	0.230	0.6	(0.048)	6.4	6.5	
RRL Donutron No. 38	16	0.030	0.125	0.245	0.288	0.8	0.060	8.1	8.0	
RRL Donutron No. 45 ²	(20)	0.030	0.60	0.214	0.288	0.8	0.022	9.0	9.1	$\lambda = 8.5$ at $I_a = 100$ ma.
RRL Donutron No. 47 ³	(20)	0.030	0.60	0.214	0.169	0.46	0.022	6.0	5.5	Cold resonance only.

¹ Here cathode was shorted at long-wavelength end of range; hence, exact d value is uncertain.

² No. 45 and No. 47 are phase-reversing models, and hence, although the finger spacing is that for $N = 22$, the zigzag path must be taken as though N were 20.

³ No. 47 failed before hot operation was achieved; hence the cold resonance alone is given.

expect, independent of radial finger thickness t (over a 4 to 1 range), and of the finger width W (over a 2 to 1 range). Equation (2) is usable over a range of the ratio l/D_a of approximately 0.5 to 1.0, or perhaps higher. In the case of the Radio Research Laboratory donutrons, the observations agree with the predictions of (2) within about ± 3 per cent. This relation is therefore of the greatest value in designing tubes to fit certain frequency and voltage restrictions.

V. THE PHASE-REVERSING ANODE

On examination of the field patterns and finger charges to be expected in the magnetron with a field variation of the form $\sin \theta \times \sin (N/2) \theta$ around the cathode, an important fact emerges. Thus, whether $N/2$ be even or odd, at each node of $\sin \theta$ (the nodes of the standing wave around the anode) we should have two adjacent fingers of the same sign. This is illustrated in Fig. 6 for the case of $N/2=6$, where the

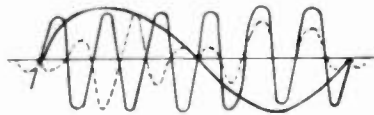

Fig. 6—Field distribution about the anode in mode-C operation (dotted curve is product of two sign functions in solid line).

dotted curve is the product function $\sin \theta \times \sin 6\theta$. This suggests that, in such a case, electrons will contribute more to useful oscillations if in their motion around the interaction space they undergo a phase slippage of 90 degrees at the nodes of $\sin \theta$ lest they be drawn back to the cathode, thus wasting useful energy. It was found that with the designs having the "phase-reversing anodes" the necessity for this phase slippage is eliminated to a considerable degree, and thus the efficiency of operation becomes greater. The

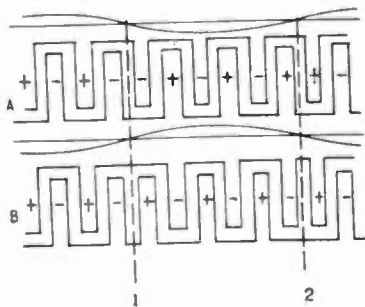

Fig. 7—The ordinary anode structure (A) and the phase-reversing structure (B). Dotted lines 1 and 2 are drawn through voltage nodes.

phase-reversing anode is best understood by referring to Figs. 7, and 8. Figure 7A illustrates two interleaving anode halves developed on a plane with the two nodal lines and the consequent sign of charge of all fingers. Here the two fingers nearest the nodal lines are in each case of identical sign. If we remove all the fingers between the node lines 1 and 2 in Fig. 7A and

attach them to opposite anode halves, we have the situation in Fig. 7B where the sign sequence is now preserved all around the anode. Consequently, the electrons see a sign sequence similar to that in the π mode of an ordinary multisegment magnetron. Since the radio-frequency fields are low near the nodal points, there will be very little loss if the two neighboring fingers at a node are left as a single wide finger. Furthermore, if we make N the number of fingers, counting the wide finger double, equal to twice an odd number, the two broad fingers must be attached to one anode half. This is illustrated in Fig. 8 for the case of $N=18$, where the shaded rectangular outlines correspond to fingers attached to one side and the open circles to

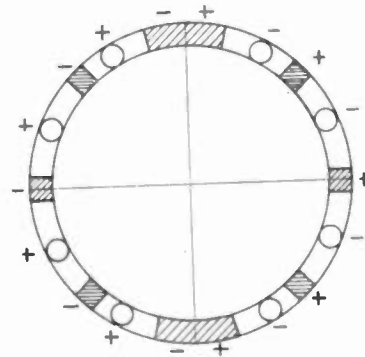

Fig. 8—Wide-finger phase-reversing anode for $N=18$. Here the shaded fingers are attached to one anode half and the unshaded ones to the other. The + and - sequence is similar to that of a magnetron operating in a simple π mode.

those attached to the other side. The obvious symmetry of this scheme is of considerable advantage in hand milling of the anode halves. The use of N equal to twice an even number is to be preferred when hobbing is used, since then the two anode halves are identical and only a single hob need be ground. We have used both $N=18$ and $N=22$, and our results indicate a decided advantage of the phase-reversing anode over the plain ones used up to that time.

VI. TUNING IN MODE-C OPERATION

In general the tuning range observed in mode-C operation decreases as both the length l and the number N of the fingers are increased. A typical tuning curve for a tube with micrometer tuning screw and spring-loaded diaphragm is given in Fig. 16.

It was first thought that the use of finger tabs (on the ends of the fingers) would increase the tuning range to almost any value desired. This is true in general (tuning ranges up to 2 to 1 were observed), but as soon as the fingers were pushed in close to the long-wavelength end of the range a number of closely spaced or "millimeter" modes was observed. This trouble seems to be largely removed when exact alignment of the anode halves is achieved and a precise tuning mechanism is used (see Fig. 14, for example, where a considerably greater range of tuning would be available with a longer screw motion).

VII. FIELD PATTERN IN MODE-C OPERATION

Although we may regard the resonant re-entrant line as the folded or zigzag line described above, it is very instructive to look at the anode structure from another point of view. Thus we may equally well regard the two end rings from which the fingers project as being the re-entrant line. In this case, the fingers simply provide capacitive loading for the line, with the main radio-frequency currents flowing in the rings themselves. Only enough current flows into a finger to charge it to a value which depends upon the point of attachment to the line. In this case, the wavelength in the line is less than the air wavelength, which is very roughly twice the anode circumference. It is, of course, probable that the two methods of regarding the anode structure, i.e., the zigzag line and the ring line, are equivalent, although the latter is somewhat more useful from a purely qualitative standpoint. Thus, if we imagine two rings such as the above with out-of-phase radio-frequency currents in each, we should expect magnetic fields which form closed lines around the rings themselves. Since, however, the rings are soldered to the walls of the cavity, the magnetic lines emerging from the anode-cathode space are unable to encircle the rings and must instead pass around through the free space in the cavity and back between the teeth into the anode-cathode space (see Fig. 9). The magnetic lines thus form closed curves which lie roughly in planes perpendicular to the tube axis rather than being in radial

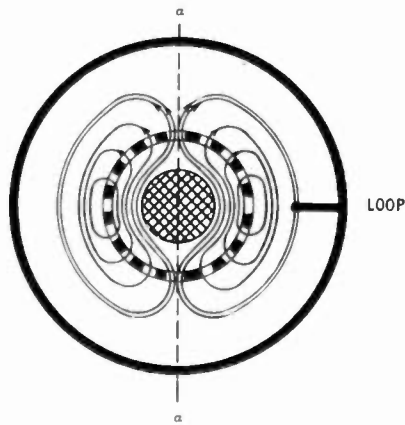

Fig. 9—Cross section of donutron perpendicular to the cathode axis, showing the probable magnetic-field pattern in black mode-C operation. The black mode is thus directly coupled to the output loop.

planes through this axis. Since the greatest magnetic fields will arise where the radio-frequency currents are a maximum, we shall have the greatest number of lines emerging between the pair of teeth between which the voltage nodes of the standing-wave pattern lie. Experimentally, it was possible to verify this by moving the stationary probe in a dummy cathode along under each finger in turn. It was found that, with a given position of coupling-in loop, zero pickup was observed between two diametrically opposite pairs of fingers. The median

radial plane between these pairs of fingers was always very nearly perpendicular to the coupling loop.

In cold-test study we should expect only one such mode (except when the two degenerate modes are very close together in frequency) with what we can most conveniently call its nodal line (*a-a* in Fig. 9) perpendicular to the coupling loop. When, however, the tube is being excited by the electron stream, we should expect the excitation of two such patterns having nodal lines at right angles to one another and probably 90 degrees out of phase in time. In the case of complete

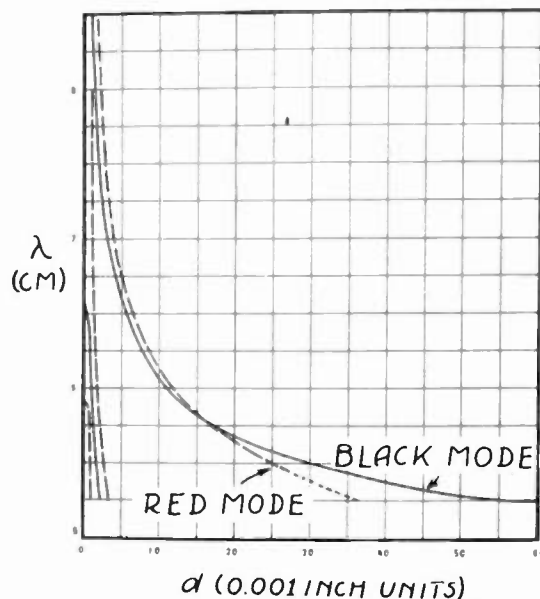

Fig. 10—Tuning of the near-degenerate pair of modes (the black, solid curve; and red, dotted curve) in mode-C operation (tube No. 47).

symmetry and exact mechanical alignment of the anode structure, these two modes would, of course, be degenerate, though the degeneracy would be removed presumably by even the presence of the coupling loop itself, not to speak of unavoidable mechanical imperfections. It has been possible with a precision tuning mechanism and the rotating probe to obtain patterns for both of these modes and to trace their individual tuning curves over the whole tuning range. In the case of a well-made and well-aligned tube, the two modes differ by a millimeter or less in wavelength and the tuning curve of one mode actually crosses the other (see Fig. 10). Since only one of these modes is directly coupled to the loop, the mode at 90 degrees to this must be coupled to and hence excited by the loop, in cold excitation, only by intermode coupling. To avoid confusion we call the mode *directly* coupled to the loop (Fig. 9) the black mode and the other the red mode. Then, since the red mode is so lightly loaded, we should expect it to build up to large amplitude, and hence the probe pattern for it to be of greater amplitude than that of the black mode. This is illustrated in the oscilloscope photographs shown in Fig. 11. These were made on

tube No. 47, which has a phase-reversing anode. Because of the presence of the diametrically opposed wide fingers at right angles to the loop, the black and red modes are separated more in wavelength than in the case of the simple-fingered anode. In Fig. 11 the

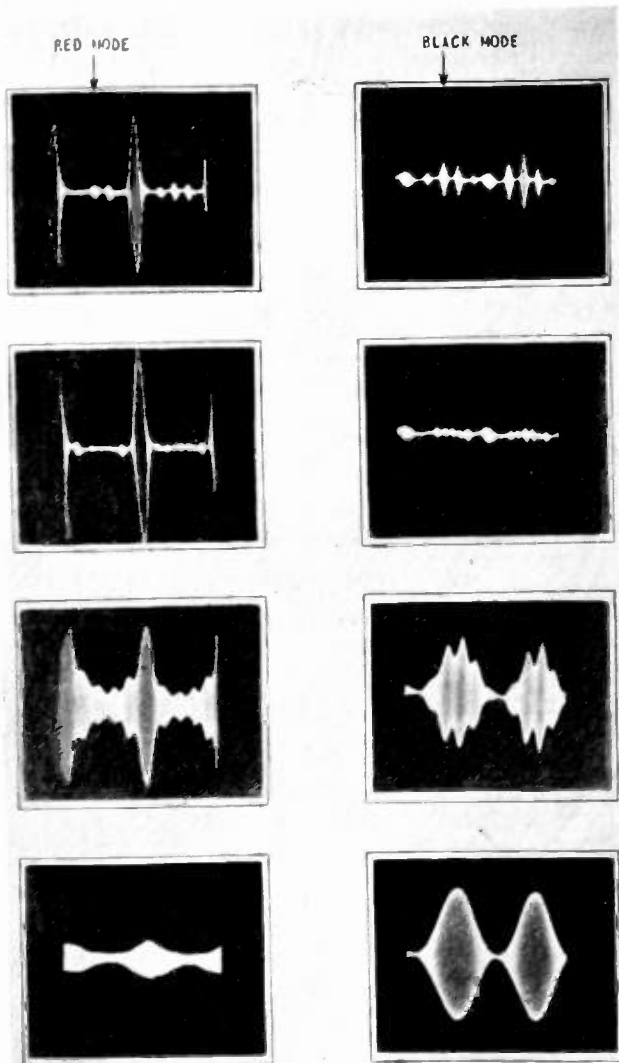

Fig. 11—Oscilloscope patterns of rotating-probe tests in mode-C operation. The left-hand column gives typical patterns for the red mode, while the right-hand column applies to the black mode. In each case the probe is being moved from a position near the middle of the fingers towards one end as one moves down the columns. The arrows represent the position of the coupling loop. A certain amount of the red mode is present in the first two black-mode pictures.

rotating probe is moved from a position near the middle of the fingers (top photograph) to a point well within the ring at one end (bottom photograph). The loop position is seen to be in line with a maximum for the black mode (right column) and in between two major maxima for the red mode (left column). The presence of a certain amount of the red mode is also seen in the top two photographs in the black-mode column.

VIII. OVERLAP MODEL OF PHASE-REVERSING ANODE

The presence of the nearly degenerate pair of modes, the red and the black, presents, of course, an undesir-

able situation for getting as much power as possible coupled out into the line. When the magnetic field and anode voltage are adjusted to the optimum values for the desired black mode, the red mode will, of course, be excited and cause the extraction of more or less energy from the electron cloud and its conversion into heat in the anode. In the perfectly symmetrical plain-fingered anodes this should be more serious than in the phase-reversing anode.

A general method for preventing the excitation of an unwanted mode in any magnetron is to *detune* the unwanted mode from the neighborhood of the wanted one. In the case of the squirrel-cage magnetron there are several ways in which this may be done. Since the two modes have their voltage nodes at different points on the line and in fact 90 degrees apart, any change in the shunt capacity across the line at the voltage loop of one mode will fall near a voltage node for the other mode. It will thus change the frequency of the first mode and leave the second almost unchanged. In our case we may most readily increase or decrease the capacitance at the node of the black mode, i.e., at the broad phase-reversing fingers. Direct decrease of the capacitance at this point would entail cutting off the ends of the broad fingers by a sizable amount, and it was feared that this might seriously distort the uniformity of the direct-current electric field in the interaction space. Hence, it was decided to increase the capacitance at these points. This is readily done by adding wide fingers to the outside of that half of the anode which does not bear the phase-reversing fingers. This is illustrated in Fig. 12, where A

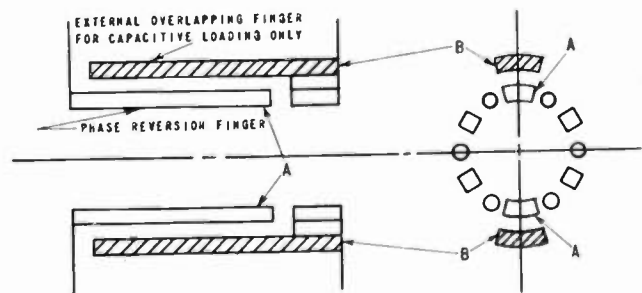

Fig. 12—Longitudinal and transverse cross sections of the "overlap phase-reversing" anode.

indicates the phase-reversing fingers and B the overlap fingers. They are so spaced as to produce considerable addition of capacitance across the line at this point and accordingly to shift the wavelength of the red mode to higher values. Fig. 13 shows the result on cold test and indicates the wide separation of the red and black modes which can actually be obtained by this method. When used as an oscillator this design gave very satisfactory operation (see Fig. 16 for tube No. 57).

A relative reduction in capacitance at the voltage nodes of the black mode was brought about by constructing a phase-reversing anode with finger tabs on all the fingers but the wide ones. The result was to shift the red C curve *below* the black C curve (Fig. 14).

IX. MODE D AND HIGHER-FREQUENCY MODES

As indicated in Fig. 3, a definite mode, mode D, was observed in the neighborhood of 4 centimeters for a tube

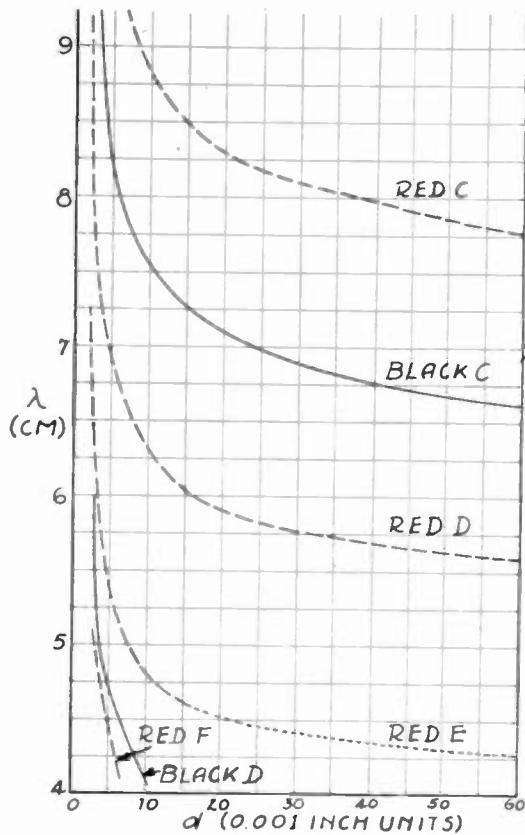

Fig. 13—Cold-test tuning curves of the overlap phase-reversing anode. Note the wide separation of red and black modes compared with the plain models (Fig. 10). Resonances were actually followed up as high as 11 centimeters.

whose C mode was around 6 to 7 centimeters. By constructing a tube in the overlap model it was possible to increase the wavelengths of all the red (indirectly coupled) modes to such an extent that the sequence could be followed as far as red F before reaching the wavelength region where the power from the local cold-test oscillator became too low for ease of observation. The results are shown in Fig. 13, and open up some interesting possibilities for future work.

X. RIEKE DIAGRAMS

The behavior of the donutron as determined by the loading conditions presented to it by the output line can best be shown on a standard Smith chart, as has been shown by F. F. Rieke in an unpublished work. This is a polar plot in which the absolute value of the reflection coefficient $|K|$ of the load is plotted radially, while the distance l of the standing-wave minimum nearest the tube from, say, the tube flange furnishes the angular co-ordinate according to the relation $\theta = (2l/\lambda) \times 720$ degrees. The position of the standing-wave minimum is shifted by moving a pair of standard quarter-wave metal slugs along the coaxial line, while the value of $|K|$ is altered by changing the separation of the slugs. The measured values of power and fre-

quency are entered at the values of θ and $|K|$ for which data were taken and constant power and frequency contours sketched in.

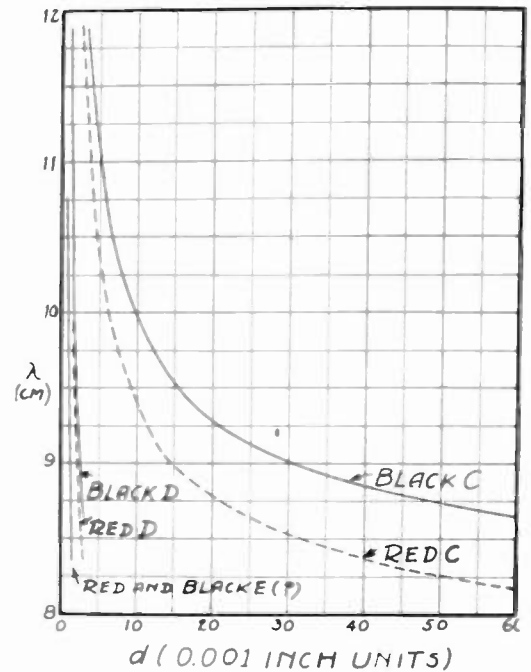

Fig. 14—Cold-test tuning curves for phase-reversing anode with finger tabs on all fingers (except the wide ones at the voltage nodes).

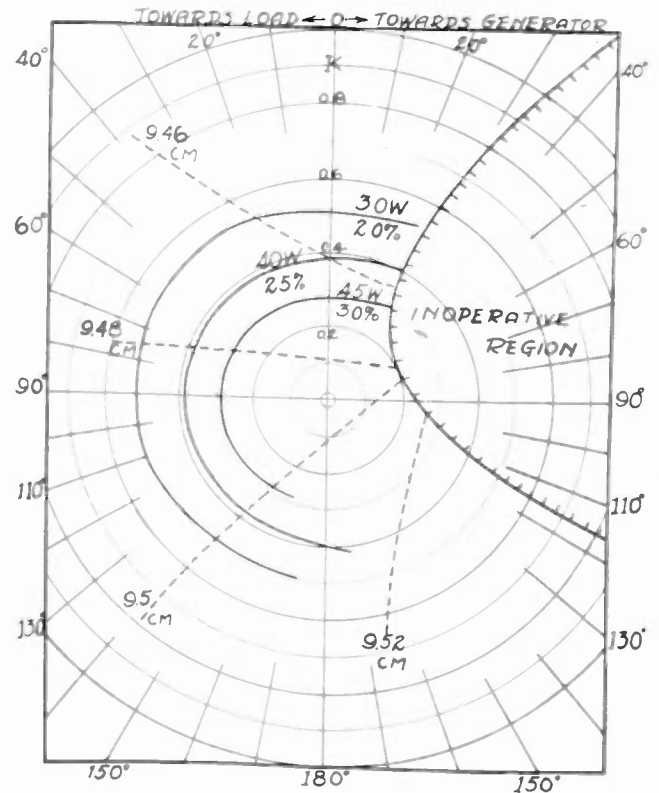

Fig. 15—Rieke diagram for tube No. 57. This tube is a phase-reversing overlap model and, although tube failure occurred before data near the matched-line conditions could be obtained, it would probably give the power center near the center of the diagram.

A typical such curve is given in Fig. 15 where, although the cathode failed before the data near the

power center could be taken, it is fairly clear that the maximum output power should correspond fairly closely to the center of the diagram—where the tube is matched to its load.

XI. CONCLUSION

In general, the donutron represents a considerable departure from the conventional multicavity continuous-wave magnetrons. The best models of the nearly sixty tubes which have been built to date give roughly 50 watts at 40 to 50 per cent efficiency and tuning ranges of 1.50 to 1 or more. The total weight without the magnet is only about 10 ounces, and the construc-

tion is much simpler and less expensive than for conventional strapped multicavity magnetrons of such large N value. The usual troubles due to mode jumping are almost entirely eliminated by this design, and a single value of anode voltage is satisfactory for the whole tuning range. The power output is satisfactorily constant over the entire tuning range in most models (see Fig. 16, which illustrates the near flatness of the power curve for tube No. 57 over the tuning range of 8.8 to 12.1 centimeters). The mode separation between the normally degenerate pair in mode-C operation is readily controlled by simple changes in the finger structure. The higher-voltage modes, such as the D, E, etc., should be examined more extensively. The use of large anodes with more than two pairs of phase-reversing fingers offers possibilities in the way of multiple standing waves in physically large anodes at centimeter or smaller wavelengths. The *direct* scaling to smaller wavelengths, as well as the extension of the tuning range, all invite further work.

ACKNOWLEDGMENT

The authors wish to express their indebtedness to the whole group whose efforts have made this development possible. These include Marshall Pease and Walter G. Wadey, who have been responsible for the design, construction, and use of the cold-test apparatus; Phillip Jastram and Robert Artman, who have carried out most of the tests on hot tubes; Alfred Keck and Virginia Leonard, who have constructed the experimental tubes; and Frances Grow, who has done the exacting machine work on the anode structure. We owe our thanks to J. M. Longyear of the Radiation Laboratory at the Massachusetts Institute of Technology, who made the cathodes used in these tubes. In addition, we owe much to the frequent discussions and helpful advice of W. G. Dow and Gunnar Hok of this laboratory, and of Donald Benedict and Henry McCarthy of the Sylvania Electric Products Company.

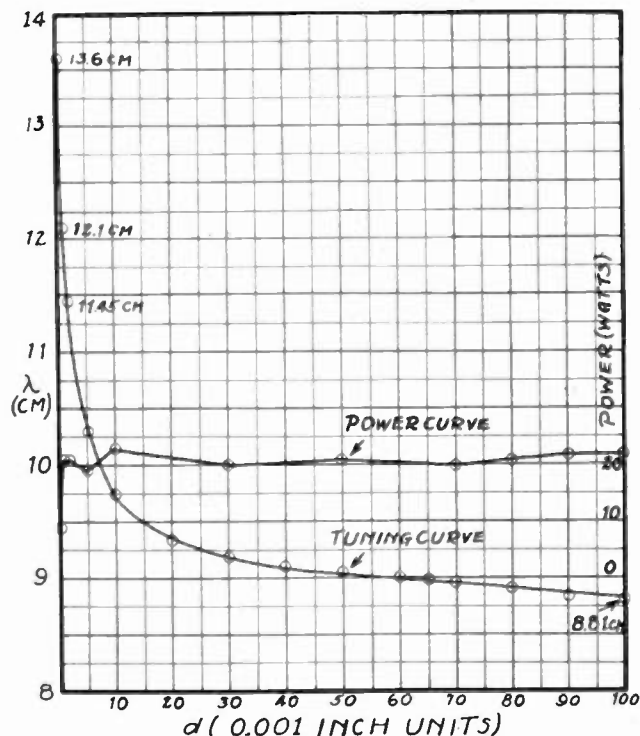

Fig. 16—Tuning curve and power-output curve (at low current) of tube No. 57 (see Fig. 15). The relative flatness of the power curve is to be noted.

Space-Current Division in the Power Tetrode*

CLIFFORD M. WALLIS†, SENIOR MEMBER, I.R.E.

Summary—In the conventional power tetrode, when operating within the normal range of electrode voltages, changes in plate potential do not appreciably affect the total space current or its division at the grid plane. Furthermore, changes in grid potential, although affecting to a large degree the magnitude of the space current reaching the screen plane, do not alter materially the division of this current between screen and plate. Making use of these facts, and taking into account the effect of initial velocities of emission and contact potential, each electrode current can be expressed in terms

of the $3/2$ power of an equivalent voltage and an empirical function. These empirical functions can be plotted on a log-log chart in a manner that allows the complete static curve data to be easily determined for any grid, screen, and plate voltage within the normal operating range.

Methods of determining experimentally the empirical functions at low power levels are described. A sample log-log chart and an explanation of its use are presented.

INTRODUCTION

THE EXPERIMENTAL determination of the electrode currents of a high-vacuum tube in the region of high positive control-grid voltages is not readily accomplished except by the use of special

* Decimal classification: R131×R334. Original manuscript received by the Institute, March 21, 1946; revised manuscript received, August 19, 1946.

† Department of Electrical Engineering, University of Missouri, Columbia, Missouri.

test equipment and techniques.¹⁻³ A number of analytical studies have been made to determine the theoretical relationships that govern the flow of space current in the triode and its division between the two receiving electrodes. In the multigrid tube the problem is much more difficult to treat in an analytical manner. The total space current in the tetrode, for example, is more or less a function of the three receiving-electrode potentials, and its division at the grid and screen planes also depends on these potentials. In addition, secondary-emission and the space-charge effects that occur within certain voltage ranges preclude the formulation of analytical expressions for the electrode currents which are sufficiently simple and comprehensive for practical use. At best the problem can be solved only in an empirical manner.

In the case of the triode, early investigators^{4,5} recognized that, to the first-degree approximation, the division of the space current between grid and plate for positive grid voltages is a function only of the ratio of these electrode voltages. This fact was verified by Myers,⁶ and by Everett and Spangenberg.⁷ In a later paper Spangenberg⁸ derived equations for the electrode currents and the division factor based on a study of the electron paths for a given electrode geometry. However, the effects of initial velocities of electron emission and contact potentials were not considered.

In a recent paper dealing with the static characteristics of the triode, Chaffee⁹ discussed the effect of initial electron velocity and demonstrated that, in expressing the current density at any point, a small constant voltage added to each electrode potential serves as an approximate correction for initial velocity. He showed that the effect of space charge between grid and plate, which is evident at high grid and low plate potentials, can be taken into account by an empirical term which is a function of the grid- and plate-voltage ratio alone. Expressions for the total space current, grid current, and plate current were each derived in terms of the 3/2 power of the equivalent diode voltage and an empirical function. A method of plotting the three empirical functions on a log-log chart

was shown which allows the complete static characteristic of the triode to be represented for a wide range of grid and plate potentials. One great advantage of this method is that the experimental data, from which the three empirical functions are determined, may be obtained at low power level by conventional methods of measurements.

It is the purpose of this paper to present a method of applying the above scheme to the power tetrode and to show that the same empirical relationships formulated for the triode may be used in modified form to express the electrode currents in the tetrode.

THEORETICAL DISCUSSION

As previously mentioned, Chaffee⁹ has shown that a small voltage designated as V_i may be used as an approximate correction for the effect of initial electron velocity. Therefore, V_i added to the potential V of any point in the interelectrode space would be the space potential necessary to give the same current density at that point if the actual cathode were replaced by one that emitted electrons with zero velocity. From the Child's Law equation for the current density, expressed in terms of $(V+V_i)$, the following theorem and its corollary are shown to be valid: Within the limitations set by the above approximation, the current density at every point varies as $(V+V_i)^{3/2}$, provided $(V+V_i)$ everywhere is altered proportionately. If the potential $(V+V_i)$ everywhere in space surrounding all electrodes in a multielectrode tube is changed by some constant factor (λ), each electrode current is altered by $\lambda^{3/2}$.

Consider now the tetrode tube. Assuming that the potential of the space just outside the cathode surface is the datum region of V , then to make $(V+V_i)$ at all points vary by the same ratio, namely λ , the measured grid, screen, and plate potentials, designated respectively as e_g , e_s , and e_p , must change in a manner such that

$$e_g' + \phi_c - \phi_g + V_i = \lambda(e_g + \phi_c - \phi_g + V_i) \quad (1a)$$

$$e_s' + \phi_c - \phi_s + V_i = \lambda(e_s + \phi_c - \phi_s + V_i) \quad (1b)$$

$$e_p' + \phi_c - \phi_p + V_i = \lambda(e_p + \phi_c - \phi_p + V_i) \quad (1c)$$

where the ϕ 's represent the electron affinities of the electrode materials and e_g' , e_s' , and e_p' are the measured electrode potentials corresponding to the condition that $V' + V_i = \lambda(V + V_i)$. If we denote $(\phi_g - \phi_c - V_i)$ by Δe_g , $(\phi_s - \phi_c - V_i)$ by Δe_s , and $(\phi_p - \phi_c - V_i)$ by Δe_p , then, strictly speaking, to fulfill the above requirement, $(e_g - \Delta e_g)$, $(e_p - \Delta e_p)$, and $(e_g - \Delta e_g)$ must each be changed so that their ratios remain constant.

Current Division at Grid Plane

In the conventional screen-grid tetrode the screen shields the cathode from the plate to such a degree that, over wide ranges of plate voltage, changes in the plate voltage have negligible effect on the off-cathode gradient, and hence on the total space current of the

¹ H. N. Kozanowski and I. E. Mouromtseff, "Vacuum-tube characteristics in the positive-grid region by an oscillographic method," *Proc. I.R.E.*, vol. 21, pp. 1082-1096; August, 1933.

² E. I. Chaffee, "Power tube characteristics," *Electronics*, vol. 11, pp. 34-42; June, 1938.

³ O. W. Livingston, "Oscillographic methods of measuring positive-grid characteristics," *Proc. I.R.E.*, vol. 28, pp. 267-268; June, 1940.

⁴ F. Tank, "Zur kenntnis der vorgänge in elektrodenröhren," *Jahr. der Drahtlosen Tel. und Tel.*, vol. 20, pp. 82-87; August, 1928.

⁵ H. Lange, "Die stromverteilung in dreielektrodenröhren und ihre bedeutung für die messung der voltspannungen," *Zeit. für Hochfrequenz.*, vol. 31, pp. 1-18; June, 1928.

⁶ D. H. Myers, "Division of primary electron current between grid and anode of a triode," *Proc. Phys. Soc.*, vol. 49, part 3, pp. 264-278; May 1, 1937.

⁷ W. L. Everett and K. Spangenberg, "Grid-current flow as a factor in the design of vacuum-tube power amplifiers," *Proc. I.R.E.*, vol. 26, pp. 612-639; May, 1938.

⁸ K. Spangenberg, "Current division in plane-electrode triodes," *Proc. I.R.E.*, vol. 28, pp. 226-236; May, 1940.

⁹ E. I. Chaffee, "The characteristic curves of the triode," *Proc. I.R.E.*, vol. 30, pp. 383-395; August, 1942.

tube. Experimental results on a number of power tubes also indicate that the division of the space current at the grid plane is affected but slightly by changes in the plate voltage. Refer, for example, to the graphs shown in Fig. 1, which are plotted from test data taken on a conventional type of power tetrode. Over the region where secondary emission effects are not present, the curves of (i_g/i_0) versus e_p show little change in the division ratio as the plate potential is varied over an extended range. Of course, with a high value of e_p and a low value of e_s , secondary emission effects cause some increase in the division ratio. However, this occurs only at values of plate voltage well below the normal operating range.

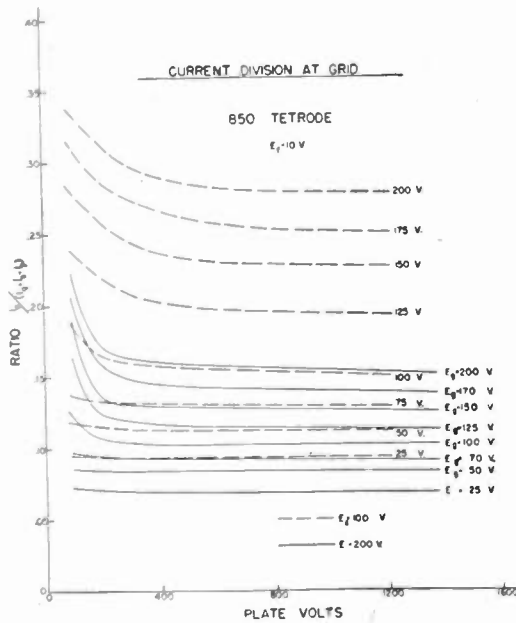

Fig. 1—Division ratio (i_g/i_0) versus e_p , 850 tetrode.

In general, experimental data on a number of tubes indicate that, for fixed grid and screen voltages, the space potential and current density at any point in the space between cathode and grid and in the region around the grid plane are not materially altered by changes in plate voltage. Therefore, one may say, with close approximation, that to change $(V+V_1)$ at every point in the cathode-grid region by some factor (λ) only the conditions stipulated in (1a) and (1b) need be fulfilled. Hence, only $(e_g - \Delta e_g)$ and $(e_s - \Delta e_s)$ must be changed so that their ratio remains constant. This ratio is designated as L_g .

$$L_g = \frac{e_g - \Delta e_g}{e_s - \Delta e_s} = \frac{e_{g0}}{e_{s0}} \quad (2)$$

In view of the theorems previously cited it is evident that for a constant value of L_g , the grid current (i_g) and the combined screen and plate current (i_{sp}) must each vary as the $3/2$ power of a voltage measured from an origin that is displaced from the measured potential origin by the voltage increments Δe_g and Δe_s .

The curves in the $e_s - e_g$ plane for constant total space current (i_0) are similar to the constant i_p curves of the triode in the $e_p - e_g$ plane, in that they are parallel and straight over a wide range of electrode voltages (see Fig. 2). Within this region, assuming the above approxima-

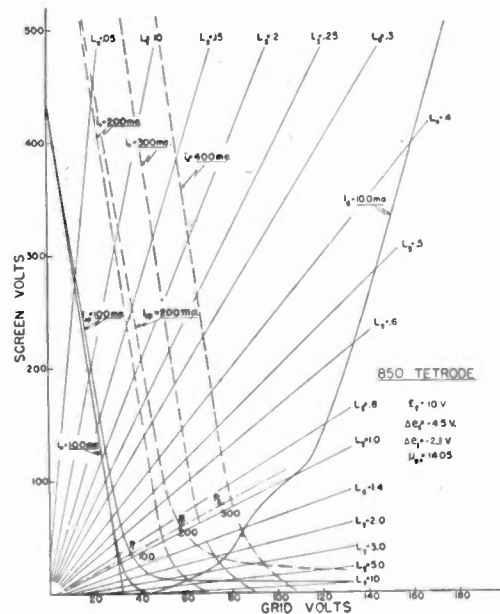

Fig. 2—Curves for constant values of i_0 and i_{sp} with grid voltage and screen voltage as co-ordinates, 850 tetrode.

tion to be valid, the equation for i_0 may be written as

$$i_0 = B \left[e_{g0} + \frac{e_{s0}}{\mu_{gs}} \right]^{3/2} = B \left[\frac{e_{s0}}{\mu_{gs}} \right]^{3/2} [1 + \mu_{gs} L_g]^{3/2} \quad (3)$$

where B is the perveance of the tube, and $\mu_{gs} = \partial e_s / \partial e_g$, with i_0 constant.

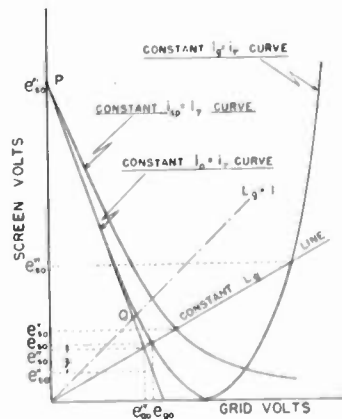

Fig. 3—Sample curves for constant i_0 , i_{sp} , and i_g , showing method of determining $F(L_g)$ and $F_p(L_g)$.

At very low values of screen potential the curves in the $e_s - e_g$ plane depart from the straight-line form because of the accumulation of space charge between

the grid and screen. This departure from linearity may be treated as an empirical function of the ratio term L_g . Referring to Fig. 3, where a constant i_0 curve is illustrated, let e_{s0}'' be the screen potential for a grid potential e_{g0} that would give i_0 if the linearity were preserved. Then

$$i_0 = B \left[e_{g0} + \frac{e_{s0}''}{\mu_{gs}} \right]^{3/2}$$

Letting $z = (e_{s0} - e_{s0}'')$, the above equation can be expressed in the following form:

$$i_0 = B \left[\frac{e_{s0}}{\mu_{gs}} \right]^{3/2} [1 + \mu_{gs} L_g]^{3/2} F(L_g) \quad (4)$$

where

$$F(L_g) = \left[1 - \frac{z/e_{s0}}{1 + \mu_{gs} L_g} \right]^{3/2}$$

From Fig. 3 it may be shown that $F(L_g)$ may also be expressed as

$$F(L_g) = \left[\frac{e_{s0}^{1V}}{e_{s0}} \right]^{3/2} \quad (5)$$

which is somewhat more convenient to use.

The current that passes on beyond the grid plane is $(i_s + i_p) = i_{sp}$. Assuming the plate potential does not influence the current division at the grid, the currents i_0 and i_{sp} can be expressed likewise as functions of e_{s0} and L_g . Hence,

$$i_{sp} = B \left[\frac{e_{s0}}{\mu_{gs}} \right]^{3/2} [1 + \mu_{gs} L_g]^{3/2} F_{sp}(L_g) \quad (6)$$

and

$$i_0 = B \left[\frac{e_{s0}}{\mu_{gs}} \right]^{3/2} [1 + \mu_{gs} L_g]^{3/2} F_0(L_g) \quad (7)$$

where

$$F_0(L_g) = F(L_g) - F_{sp}(L_g).$$

The validity of the 3/2 power relationship expressed in (4), (6), and (7) appears to be well substantiated by the test results on a number of tetrodes.

As used in (6) and (7), the functions $F_{sp}(L_g)$ and $F_0(L_g)$ are the current-division factors whose sum is $F(L_g)$. For any value of L_g their values are found from the constant i_{sp} and constant i_0 curves (also illustrated in Fig. 3) in conjunction with the extended linear portion of the constant i_0 curve. These three curves are obtained experimentally at the same current magnitude. Since i_0 , i_{sp} , and i_0 each vary as the 3/2 power of e_{s0} along any constant L_g line, and since $F(L_g)$ has been determined as in (5), it follows that

$$F_{sp}(L_g) = \left[\frac{e_{s0}^{1V}}{e_{s0}^V} \right]^{3/2} \quad (9)$$

and

$$F_0(L_g) = \left[\frac{e_{s0}^{1V}}{e_{s0}^{VI}} \right]^{3/2} \quad (10)$$

where e_{s0}^V and e_{s0}^{VI} are the screen potentials marking the intersections of the constant i_{sp} and i_0 curves, respectively, with the L_g line.

The tests necessary to obtain the data from which these functions are calculated are described in Appendix A. The displacement voltages Δe_g and Δe_s are calculated by means of (20) and (21).

Current Division at the Screen

Tests on a number of tetrodes having different electrode shapes show that the division of the space current (i_{sp}) at the screen plane is remarkably independent of the grid potential over the normal operating range of the plate potential. The graphs of i_p/i_{sp} versus e_g for

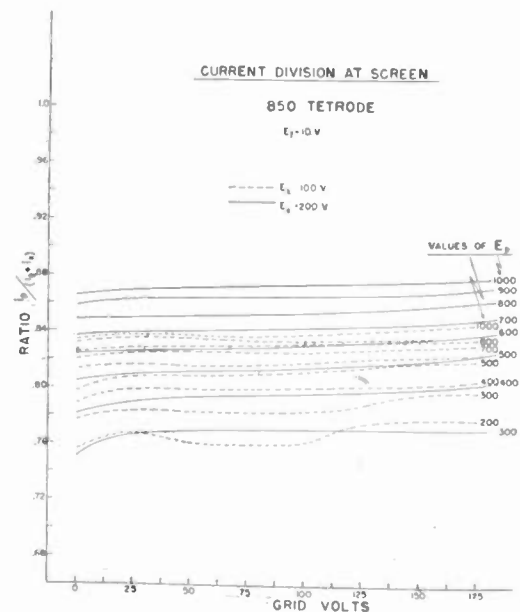

Fig. 4—Division ratio i_p/i_{sp} versus e_g , 850 tetrode.

the 850 tetrode, shown in Fig. 4, are a good illustration of this point. Although the grid potential is a major factor in determining the magnitude of the combined screen and plate current, a change in its value produces practically equal percentage changes in either electrode current.

For a tetrode with a fixed grid voltage, the static curves in the $e_p - e_s$ plane for constant i_{sp} are also essentially straight and parallel over a wide range of plate and screen potentials, as shown in Fig. 5. Within this

region, for any fixed value of grid potential an equation for i_{sp} could be written in the form

$$i_{sp} = C \left[e_{s0} + \frac{e_{p0}}{\mu_{sp}} \right]^n$$

where μ_{sp} is the slope of the constant i_{sp} curves. As these are nearly vertical to the screen-voltage axis, the value of μ_{sp} is extremely large.

Suppose now that the control grid of the tetrode were removed. To give the same current (i_{sp}) in the triode thus created, with the same division ratio at the screen plane, both the screen and plate voltages would have to

of the voltage measured from an origin displaced from the e_{s0}, e_{p0} origin by the voltages $\Delta e_s'$ and $\Delta e_p'$.

Both $\Delta e_s'$ and $\Delta e_p'$ are directly proportional to e_{p0} as demonstrated by their graphs for the 850 tetrode, shown in Fig. 6. Although considerable time has been spent in trying to determine the theoretical relationship between these displacement voltages and e_{p0} , no concise expressions have been obtained. However, in the case of $\Delta e_s'$ it can be shown that, to the first degree of approximation, $\Delta e_s' = \mu_{s0} e_{p0}$. Values of $\Delta e_s'$ calculated from this relationship agree reasonably well with the experimental values of $\Delta e_s'$ plotted in Fig. 6.

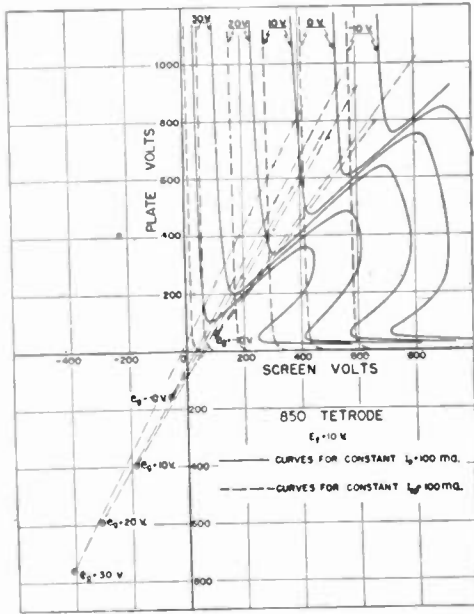

Fig. 5—Curves for constant values of i_o and i_{sp} at fixed values of e_g with screen voltage and plate voltage as co-ordinates for 850 tetrode.

be changed to certain new values which we will designate as e_{s0}' and e_{p0}' . The new equation expressing i_{sp} for this condition is

$$i_{sp} = C \left[\frac{e_{p0}'}{\mu_{sp}} \right]^{n'} \left[1 + \frac{\mu_{sp}}{L_p'} \right]^{n'} \quad (11)$$

where $L_p' = e_{p0}'/e_{s0}'$. If L_p' is constant, then, as a triode, i_{sp} must vary as the 3/2 power of e_{p0}' according to the theorem previously cited. Therefore, n' must be equal to 3/2, and we have

$$i_{sp} = C \left[\frac{e_{p0}'}{\mu_{sp}} \right]^{3/2} \left[1 + \frac{\mu_{sp}}{L_p'} \right]^{3/2} \quad (12)$$

The voltages e_{s0}' and e_{p0}' are the equivalent triode voltages that screen and plate must have in the absence of the grid to produce the same i_{sp} that exists in the tetrode when its electrode potentials are e_{g0}, e_{s0} , and e_{p0} . If we let $e_{s0}' = (e_{s0} - \Delta e_s')$ and $e_{p0}' = (e_{p0} - \Delta e_p')$, then (12) states that, for a fixed value of e_{g0} , along any line of constant L_p' the current i_{sp} varies as the 3/2 power

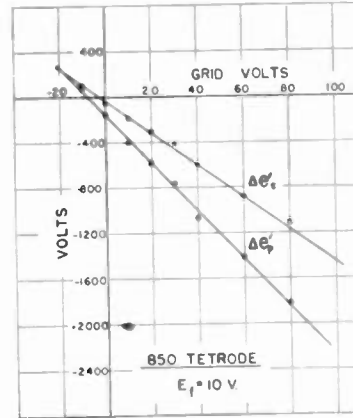

Fig. 6—Experimental values of $\Delta e_s'$ and $\Delta e_p'$ versus e_g , 850 tetrode.

The voltages $\Delta e_s'$ and $\Delta e_p'$ are similar in nature to the increment voltages Δe_s and Δe_p , used in determining the current division at the grid plane, since they locate the potential origin from which the 3/2 law is applicable.

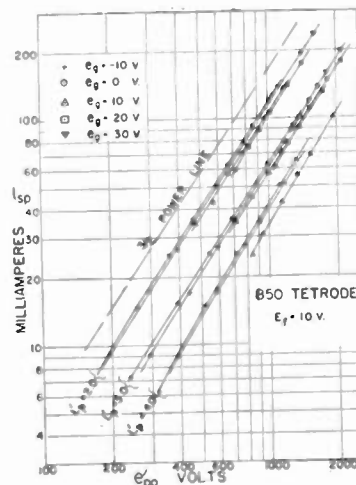

Fig. 7—Experimental values of i_{sp} versus e_{p0}' for constant values of L_p' , 850 tetrode.

Experimental values of i_{sp} plotted as a function of e_{p0}' on log-log scales for various fixed values of e_{g0} and L_p' are presented in Fig. 7. It may be noted that

the graphs are reasonably straight and have a slope of 3/2 over a wide range of e_{p0}' values.

A constant i_{sp} curve is illustrated in Fig. 8. At low values of plate voltage the curve deviates from the

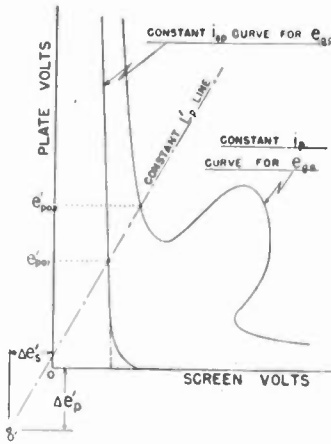

Fig. 8—Sample curves for constant i_{sp} and i_p showing method of determining $F_p(L_p')$.

linear form due to the space-charge effects previously discussed. This departure from a straight line may be treated as a function of L_p' in a manner similar to that used in analyzing the current division at the grid plane. By so doing, the more general form of (12) becomes

$$i_{sp} = C \left[\frac{e_{p0}'}{\mu_{sp}} \right]^{3/2} \left[1 + \frac{\mu_{sp}}{L_p'} \right]^{3/2} F(L_p'). \quad (13)$$

However, this deviation from linearity occurs at plate voltage well below the screen voltage, and considerably below the normal operating range (see Fig. 5). Therefore, for all practical purposes $F(L_p')$ may be assumed to be unity and (12) used to express i_{sp} .

Since i_p and i_s are also functions only of e_{p0}' and L_p' similar expressions for these quantities can be written as

$$i_p = C \left[\frac{e_{p0}'}{\mu_{sp}} \right]^{3/2} \left[1 + \frac{\mu_{sp}}{L_p'} \right]^{3/2} F_p(L_p') \quad (14)$$

and

$$i_s = C \left[\frac{e_{p0}'}{\mu_{sp}} \right]^{3/2} \left[1 + \frac{\mu_{sp}}{L_p'} \right]^{3/2} F_s(L_p'). \quad (15)$$

The plate-current division function $F_p(L_p')$ is determined from the constant i_{sp} curve and the constant i_p curve, both having been obtained for the same current magnitude, and at the same grid voltage. The latter curve is also illustrated in Fig. 8. Since i_{sp} , i_p , and i_s vary as the 3/2 power of e_{p0}' along any line of constant L_p' , it follows that

$$F_p(L_p') = \left[\frac{e_{p01}'}{e_{p02}'} \right]^{3/2} \quad (16)$$

where e_{p01}' and e_{p02}' are the plate potentials, measured from O' , marking the intersection of the constant L_p' line with the constant i_{sp} and i_p curves, respectively. The values of $F_s(L_p')$ are readily obtained from the relationship

$$F_s(L_p') = 1 - F_p(L_p'). \quad (17)$$

The peculiar pattern of the constant i_p curves is due to secondary emission from plate to screen. In this region the 3/2-power relationship between i_p and e_{p0}' and between i_s and e_{p0}' is not valid, of course.

The experimental method of obtaining the $\Delta e_s'$ and $\Delta e_p'$ voltages, and the $F_p(L_p')$ functions for various values of e_{g0} is outlined in Appendix B.

Log-Log Chart for Tetrodes

The various functions $F(L_g)$, $F_s(L_g)$, $F_{sp}(L_g)$, and $F_p(L_p')$ may be plotted on a chart using logarithmic scales in a manner that will give the complete static characteristics of the tetrode for any combination of electrode voltages within their normal operating range. A sample chart is illustrated in part in Fig. 9. Values of screen voltage (e_{s0}) are read along the abscissa. At the left is an ordinate scale for current and at the right an ordinate scale for $(1 + \mu_{gs} L_g)$. L_g is also marked along the latter scale, corresponding to $\mu_{gs} = 5.0$. In this chart the "reference current" (i_r), having the same ordinate as $L_g = 0$, is chosen as 100 milliamperes. This is a convenient value for a 100-watt power tube.

Equation (5) written in logarithmic form is

$$\log \left[\frac{i_0 \mu_{gs}^{3/2}}{B} \right] = \frac{3}{2} \log e_{s0} + \frac{3}{2} \log [1 + \mu_{gs} L_g] + \log F(L_g). \quad (18)$$

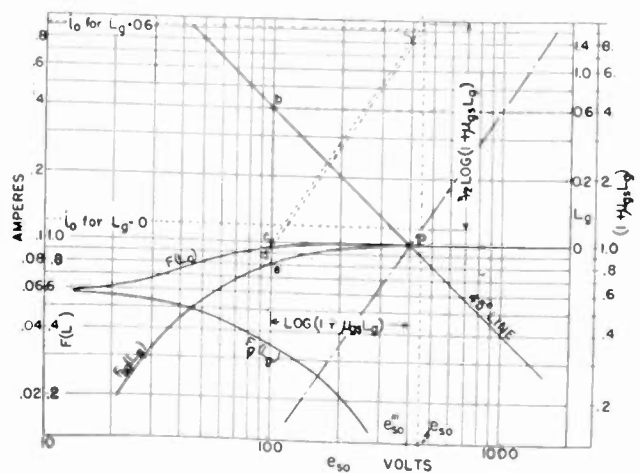

Fig. 9—Sample log-log chart to show construction and use of $F(L_g)$ functions.

Suppose for the moment that the constant i_0 curves, the one for $i_0 = i_r$, being shown in Fig. 3, were all straight lines, thereby making $F(L_g)$ equal to unity and $\log F(L_g)$

equal to zero. The plot of $(1 + \mu_{os}L_o)$ versus e_{o0} for a constant total space-current of i_r would then be the 45-degree line drawn on the chart of Fig. 9. This line intersects the $L_o = 0$ ordinate at the point P corresponding to the intersection of the constant $i_o = i_r$ curve with the screen-voltage axis at the potential e_{o0}' in Fig. 3. The line marked "3/2 power line" in Fig. 9, and whose slope is 3/2, is the plot of (18) when $L_o = 0$ and $F(L_o) = 1$.

For any value of L_o greater than zero, $F(L_o)$, $F_{sp}(L_o)$, and $F_p(L_o)$ will have values less than unity. By use of the special $F(L)$ scale on the lower left-hand side of the chart, these functions are plotted against L_o . This is done by projecting values of L_o from the right-hand scale over to the 45-degree line and then downward. The functions are then plotted on the $F(L)$ scales against their values of L_o as abscissa.

Equation (18) indicates that the total space current for any value of L_o can be obtained by adding to any ordinate of the 3/2 power line a constant length corresponding to $3/2 \log [1 + \mu_{os}L_o]$ and subtracting a length equivalent to $\log [1/F(L_o)]$. The manner in which this is accomplished is illustrated by the dotted lines for an assumed value of $L_o = 0.6$ and $e_{o0} = 450$ volts. The projection from point (d) determines i_o since the vertical distance between points (c) and (d) corresponds to $\log [1/F(L_o)]$.

The same procedure and arguments are valid in determining the current i_{sp} and i_p . For example, i_o is found by projecting from point (b) downward to the $F_o(L_o)$ curve, and then upward with a 3/2 slope to the e_{o0} abscissa line.

is illustrated. Comparing (12) and (14), it may be seen that the plate current can be expressed as

$$i_p = i_{sp} \cdot F_p(L_p')$$

Using the expression for i_{sp} given in (6),

$$i_p = B \left[\frac{e_{o0}}{\mu_{os}} \right]^{3/2} [1 + \mu_{os}L_o]^{3/2} F_{sp}(L_o) \cdot F_p(L_p'). \quad (19)$$

Therefore, on the log-log chart the value of i_p may be found by subtracting from the i_{sp} point on the left-hand current scale a vertical distance equivalent to $\log [1/F_p(L_p')]$. In order to do this graphically the $F(L')$ function is plotted on the chart shown in Fig. 10, using the $(1 + \mu_{os}L_o)$ scale on the right. The $F_p(L_p')$ function may be plotted in exactly the same manner as the other functions are plotted—the $F_{sp}(L_o)$ function, for example—so that any vertical distance between this curve and the i_r line is equal to $\log [1/F_p(L_p')]$. However, since there is a $F_p(L_p')$ curve for each value of grid voltage, some confusion between these and the other function curves would result if all were graphed in this manner. A more convenient place for the $F_p(L_p')$ curves is along the 45-degree line, where each is plotted in such a way that, for a given L_p' , the horizontal distance between the $F_p(L_p')$ curve and the 45-degree line is equal to $2/3 \log [1/F_p(L_p')]$.

The procedure used to plot these curves is illustrated by the dashed lines for an assumed value of $L_p' = 1.7$. The point (f) is first located by projecting the value of L_p' over to some point (o) on the 45-degree line and thence downward to the calculated value of $F_p(L_p')$ on the lower left $F(L)$ scale. The vertical distance $\bar{g}f$ is equal then to $\log [1/F_p(L_p')]$. A line of 3/2 slope through point (f) , intersecting the (i_r) line at point (h) , gives a horizontal distance $\bar{g}h$ or $\bar{a}l$ that is equal to $2/3 \log [1/F_p(L_p')]$. Point (l) is a point on the $F(L_p')$ curve for this particular value of L_p' . Other points on the curve are located in a similar manner.

Using the illustrative $F_p(L_p')$ curve, the plate current for the arbitrarily selected values of L_p' and e_{o0} is also indicated by the dashed lines in Fig. 10. Assuming that i_{sp} has been found by the method previously outlined and that the projection line of 3/2 slope is drawn from point (e) , the point (k) is located as shown in the figure. It should be noted that point (k) is displaced vertically downward from this line by a distance equal to $\log [1/F_p(L_p')]$. Hence a line of 3/2 slope through (k) and intersecting the e_{o0} abscissa line determines the plate current for the assumed conditions. The screen current is readily found by subtracting i_p from i_{sp} . A complete log-log chart for a sample power tetrode is shown in Fig. 11.

Log-log charts similar to the one shown are useful in several ways. First, the chart presents in a compact form the static-characteristic data of the tube. Computed from test data which may be obtained by

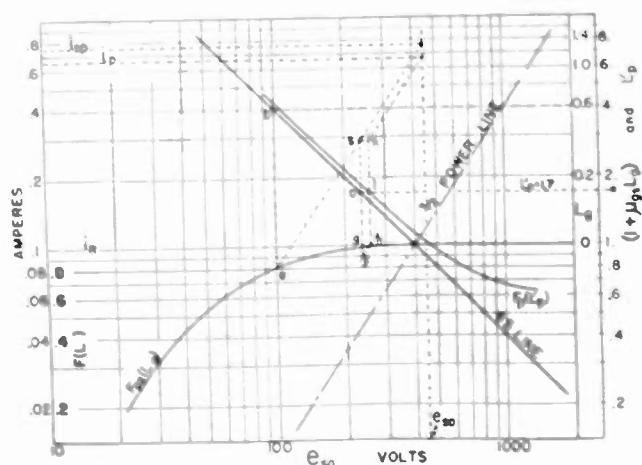

Fig. 10—Sample log-log chart to show construction and use of $F_p(L_p')$ functions.

To explain the method of handling the $F_p(L_p')$ function on the log-log chart, the chart of Fig. 9 is repeated in Fig. 10 with only the $F_{sp}(L_o)$ curve drawn. The graphical solution of i_{sp} , in accordance with (6) for arbitrarily chosen values of $L_o = 0.6$ and $e_{o0} = 450$ volts,

conventional methods of measurement, it furnishes a means of extrapolation whereby one may determine the electrode currents at high values of electrode potentials. Second, a comparison of the operating characteristics of tubes of the same power rating may

The question of accuracy of the chart is of primary importance. A fair estimate of this point may be gained from Figs. 12 and 13, where a few sample curves are compared. In these figures the solid lines are graphs of current values determined from log-log charts, whereas the dashed-line curves are plotted from experimental readings. Space does not permit the inclusion of additional illustrative data to answer this question more fully. However, for the several tubes on which complete results were obtained, the chart values do not deviate

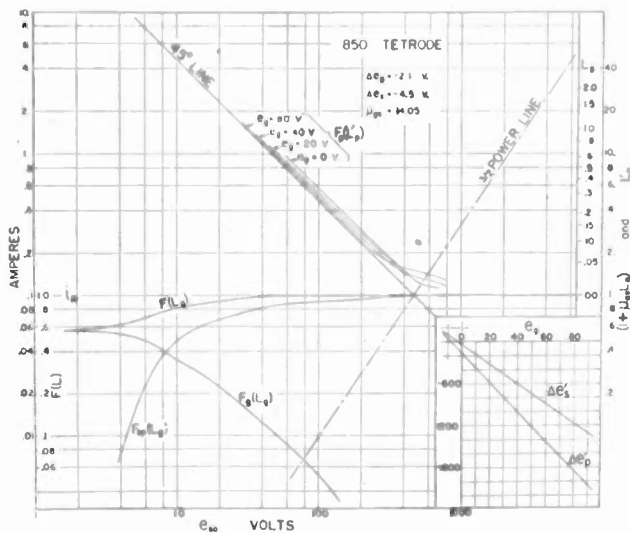

Fig. 11—Complete log-log chart for 850 tetrode.

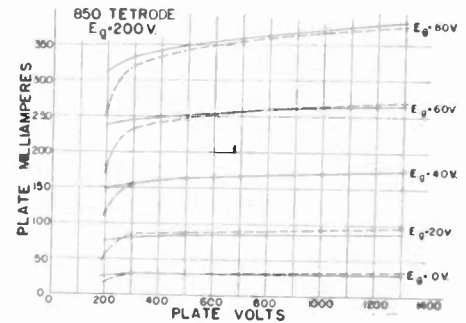

Fig. 13—Graphs of i_p versus e_p for 850 tetrode. Solid lines are chart values; dashed lines are test values.

easily be made. For example, the evaluation of the permeance term "B" is useful in making such comparisons. This can be determined from the chart as follows: Since the "3/2 power line" gives i_p for $L_0 = 0$ and any value of e_{s0} , the intersection of this line with the abscissa line for $e_{s0} = 100\mu_0$, gives a value of i_0 equal numerically to 1000 B.

Another point of comparison that can be made from the log-log chart is in the study of the space current division at the grid and screen of the tube. For any value of L_0 , the ratio of the grid to total space-current can be determined. Also for any value of L_p' the ratio of

in any case more than 10 per cent from the measured values, and in most cases the difference is less than 5 per cent. It should be emphasized, however, that the log-log chart does not give correct results for the tetrode in the region of secondary emission from plate to screen. But since the tube is not normally operated to produce plate voltage swings into this region, this is not a serious limitation on the use of the chart.

CONCLUSION

Although the experimental data presented in this paper are confined to that obtained on one sample tube, complete data on three different types of tubes were determined to check the theoretical deductions. In addition, to further verify the soundness of certain of the assumptions made in the analysis, tests on other tubes were also performed. Each one of the three types on which most of the experimental work was done has a different electrode conformation. The electrodes of one simulate the parallel-plane type, the second has cylindrical electrodes, and those of the third are more or less rectangular in shape. All are rated as 100-watt tubes. Measurements of the electrode currents at high electrode voltages were made by the method described by Chalfee.²

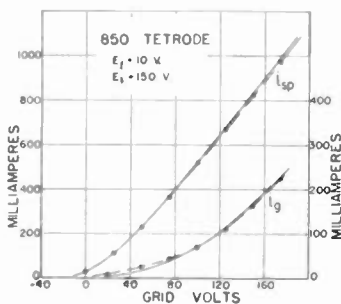

Fig. 12—Graphs of i_p and i_g versus e_0 for 850 tetrode. Solid lines are chart values; dashed lines are test values.

the screen-to-plate current may be found. In general, tubes for which the $F_0(L_0)$ and $F_{sp}(L_0)$ curves are relatively close together will have relatively high grid current and hence high grid losses. Tubes for which the $F_p(L_p')$ curves are close to the 45-degree line will have low screen currents and consequently low screen losses.

ACKNOWLEDGMENT

Grateful acknowledgment by the author is made to E. L. Chalfee, director of the Cruft Research Laboratory, Harvard University, for the use of certain test equipment and for his helpful suggestions during the experimental phase of the investigation.

APPENDIX A

Experimental Determination of Δe_s , and Δe_o and $F(L_o)$ Functions

It is advantageous first to procure the data for the curves in the $e_s - e_o$ plane for constant values of i_o , i_p , and i_{sp} . When doing this the plate voltage may be adjusted to a value within its normal range, or, for convenience, the screen and plate may be tied together. Usually several curves for other constant values of i_o are obtained to procure a good average value of μ_{os} .

The following procedure should be used to determine the displacement voltage Δe_o and Δe_s . The measured grid and screen potentials are adjusted to approximate equality to minimize secondary emission effects, and are also adjusted to give a convenient magnitude of i_{sp} . Both i_{sp} and i_o are measured. The measured values of e_s and e_o may be plotted as a point on the constant current curves sheet. Such a point is shown, for example, as P_1 in Fig. 2. A second point P_2 is then found at which the ratio i_{o2}/i_{sp2} is the same as at P_1 . To increase the accuracy, a third and fourth point may be located in a similar manner. These points should lie on a straight line that passes through the origin of e_{o0} and e_{s0} according to the theorem that the ratio of the two currents is constant if the ratio e_{o0}/e_{s0} is held constant. Since both currents vary as the $3/2$ power of either e_{s0} or e_{o0} along this line, then

$$\frac{i_{sp2}}{i_{sp1}} = \left[\frac{e_{s2} - \Delta e_s}{e_{s1} - \Delta e_s} \right]^{3/2}$$

or

$$\frac{i_{sp2}}{i_{sp1}} = \left[\frac{e_{o2} - \Delta e_o}{e_{o1} - \Delta e_o} \right]^{3/2}$$

from which

$$\Delta e_o = \frac{e_{o1} \left[\frac{i_{sp2}}{i_{sp1}} \right]^{2/3} - e_{o2}}{\left[\frac{i_{sp2}}{i_{sp1}} \right]^{2/3} - 1} \quad (20)$$

$$\Delta e_s = \frac{e_{s1} \left[\frac{i_{sp2}}{i_{sp1}} \right]^{2/3} - e_{s2}}{\left[\frac{i_{sp2}}{i_{sp1}} \right]^{2/3} - 1} \quad (21)$$

By determining three or more points, several calculations of Δe_o and Δe_s can be made and their values averaged. These experimental points are shown in Fig. 2 to illustrate the degree of accuracy with which they fall in a straight line. Table I gives the values of Δe_o and Δe_s calculated from these points.

The displaced origin having been located in the above manner, L_o lines are drawn, and from these and the constant-current curves the functions $F(L_o)$, $F_{sp}(L_o)$, and $F_o(L_o)$ are determined by (5), (9), and (10).

Secondary emission is a troublesome factor over certain ranges of the grid and screen potential. To minimize

TABLE I

	Points	Δe_o	Δe_s	Average
850 Tube	P_1 and P_2	-4.5 volts	-1.8 volts	$\Delta e_o = -4.5$ volts
850 Tube	P_1 and P_3	-4.5 volts	-2.0 volts	$\Delta e_o = -2.1$ volts
850 Tube	P_2 and P_2	-4.6 volts	-2.4 volts	

this, a constant-grid-current curve for $i_o = i_r/10$ in conjunction with $i_o = i_r$ line may be used to determine $F_o(L_o)$. When this is done, the values of $F_o(L_o)$ are obtained by dividing the $3/2$ power of the voltage ratios by 10.

APPENDIX B

Experimental Determination of $\Delta e_s'$, $\Delta e_p'$ and $F(L_p')$ Functions

The curves in the $e_p - e_s$ plane for constant values of i_{sp} and i_p at a fixed grid potential should be obtained before one attempts to determine $\Delta e_s'$ and $\Delta e_p'$. These curves may be taken at any equal current magnitude, provided it is one that places the curves well away from the plate-voltage axis. Curves for as many grid voltages as desired are taken. Such experimental curves are shown in Fig. 5.

The procedure used to determine the displacement voltages $\Delta e_s'$ and $\Delta e_p'$ is identical to that used in finding Δe_o and Δe_s , except that added precaution is necessary to avoid secondary emission from either screen or plate. To do this, the points where the current ratio (i_p/i_s) is made equal should be located in a region where the plate voltage is not greater than twice, and not less than the screen voltage. Usually it is desirable to obtain readings for three or more points. Referring to Fig. 5, it may be seen that the region where secondary emission from the plate starts is easily discerned, as the constant i_p curves break quite suddenly.

The above figure shows the points of constant (i_p/i_s) used to determine the displaced origin. These lie on a straight line, which substantiates the theory that (i_p/i_s) is constant along any line of constant L_p' . Denoting by e_{p01}' , e_{s01}' , e_{p02}' , and e_{s02}' , the voltage co-ordinates of any two points on the line, and i_{p1} and i_{p2} as the plate currents at these points, the displacement voltages are calculated by the equations

$$\Delta e_p' = \frac{e_{p01}' [i_{p2}/i_{p1}]^{2/3} - e_{p02}'}{[i_{p2}/i_{p1}]^{2/3} - 1} \quad (22)$$

$$\Delta e_s' = \frac{e_{s01}' [i_{p2}/i_{p1}]^{2/3} - e_{s02}'}{[i_{p2}/i_{p1}]^{2/3} - 1} \quad (23)$$

After the displaced origin for a particular grid voltage is located, L_p' lines are drawn from it and values of $F_p(L_p')$ for assumed values of (L_p') are calculated by (16).

Correspondence

Acoustic Preferences of Listeners

The engineering profession has shown decided reticence in conducting experiments directed at determining the acoustic preferences of listeners. Such experiments are admittedly difficult to make, and this fact has deterred many workers. Too many engineers have felt that listener preference was of no concern and that the parameters of an ideal reproducing system were obvious. If the public disagreed, its aesthetic deficiency was deplored. Listener preferences and engineers' concepts of what they should be have been rather divergent for too long. I wish to congratulate Messrs. Eisenberg and Chinn for conducting experiments of this kind.¹

It seems to me that one matter of concept has not been adequately appraised. A reproducing system can function in either of two ways: to create the illusion (1) of taking the listener to the performance, or (2) of bringing the performance to the listener. The former may be the most desirable, and is probably capable of reproducing "sound like the original." However, it requires the listener to wear headphones, and for complete realism a binaural system must be provided. Loudspeaker reproduction falls in the latter class. A single-channel system naturally sacrifices the illusion of perspective, but further compromises are also in order. Few people care for full orchestral volume in their living rooms and this forces consideration of the equal-loudness contours. Listening to a single sound source with both ears at a different volume, with the added effects of the local acoustics, cannot possibly "sound like the original." We should realize that the system is one particular form of synthesis, and optimum performance will require consideration of factors peculiar to that system. The engineer should strive to discover and understand those factors. There is a perfection to seek within the confines of the system, even though it cannot be absolute. We can be assured of one thing: the general public is quite unbiased in its judgment.

Experiment to determine how much usage or habit is a factor influencing preferences should not be neglected. Its importance was quite evident to those working directly with the public during the transition from horn- to cone-type loudspeakers. At first the cone sounded "fine for music" but the horn was judged "better for voice" because it was "plainer." After a week or two some customers felt that something had gone wrong with their horn speakers, particularly if the dealer had removed it during the test interval so that direct comparisons had not taken place. What had really happened, of course, was that listening preferences had evolved with usage. I feel that data which do not include this factor will have rather limited value.

We should not expect too much of the transmission system in making the reproduc-

tion more pleasing than the original sound. When this can be done there is a basic fault at the source, and a major effort should be made to remedy it there. It is a justifiable interim technique but a questionable long-range objective. I recently heard one of the world's greatest pianists overload a concert grand piano by some 10 or 15 decibels. If the timbre had remained unchanged at the higher levels I would have enjoyed the concert more, but I doubt that any transmission system could have helped. On the other hand, I have more than once wished I could inflict a tone control on the brass section while attending an original performance. Such aesthetic preferences are primary concerns of people other than the engineer of the reproducing system. He may be able to help at times, but the primary responsibility belongs elsewhere.

LAWRENCE V. WELLS
Wilcox-Gay Corporation
Charlotte, Michigan

Tonal-Range and Sound-Intensity Preferences of Broadcast Listeners

As for audience tastes and reactions, it must be remembered that this is a variable factor and one to a large extent determined by past conditioning. The "it" girl of the gay '20's looks odd today, and the "high-fidelity" radio receiver of fifteen years ago might sound like a tinny phonograph now. Hearing accustomed to a mediocre radio receiver or sound system, with a cutoff at about 7000 cycles, will react with a feeling of "tinniness" and "harshness" to a wide-band system which passes 10- to 15-kilocycle signals.

The terms "high-fidelity" and "distortionless" are loosely used, and actually have no real meaning since fidelity standards are so hopelessly inadequate. The radio sets of twenty years ago were also billed as "clear as a crystal," "high-fidelity," "distortionless," "program sounds as if in the next room," etc., but they sound anything like that today.

The field of audio distortion, like lens distortion in optics, is a highly complex field. Audio systems may simultaneously generate some half-dozen types of distortion when subjected to complex signals—harmonic, intermodulation, frequency discrimination, phase shift, frequency modulation, frequency shift, and transient distortion. More adequate distortion-rating standards will have to be set up before audio systems can be rated as "high-fidelity."

Audio systems are sometimes called "distortionless." Just as there is no such thing as a distortionless lens system, there is no such thing as a distortionless audio system. A system rated as such might actually develop up to 10 per cent frequency-modulation distortion in the transducer units, transformers, and capacitors, up to 10 or 15 per cent over-all intermodulation distortion; and considerable transient and nonlinear phase-shift distortion.

Mr. Chinn and Mr. Eisenberg¹ evidently rated their system at a fraction of 1 per cent distortion with the old single-sine-wave-frequency method, which is wholly inadequate. If they subject their system to complex-signal tests, such as triple-odd-order-frequency sine-wave intermodulation tests; to square and triangular waves; to pulse signals; and to frequency-modulation distortion tests, they may find one answer as to why their audiences reacted with a sense of "harshness" to their wide-band (but not necessarily distortionless) audio system.

TED POWELL
Engineering Development Section
A. B. DuMont Laboratories
Clifton, New Jersey

Contributions to Wave-Guide Theory

Discussion with friends makes it evident that my paper¹ did not emphasize sufficiently the important part played by Dr. Julian Schwinger in the development of the concepts exhibited therein. Inasmuch as several articles on the same subject have appeared in various journals (and many more are doubtless scheduled to appear), further comment seems appropriate.

The concept of an equivalent transmission line for a wave guide appears to have been first utilized by Schelkunoff, at least in this country. The general idea of impedance representation of discontinuities appears to have been used by workers in many laboratories as early as 1942. In 1943 the author worked on wave-guide discontinuities using methods suggested by the work of Hahn² and by Smythe³ (who had extended Condon's work⁴ in a set of notes used in a graduate course at the California Institute of Technology) and solved all of the problems treated in the paper.¹ Judging from publication dates, Schelkunoff^{5,6} at Bell laboratories and Whinnery and Jamieson^{7,8} at General Electric were using the same methods on the same problems. Smythe had also suggested the use of static approaches such as conformal mapping in these problems, and such methods were evidently appreciated by Whinnery at General Electric and by workers at the Massachusetts Institute of Technology.

In the early part of 1944, the author had the good fortune to pursue the study of dis-

¹ J. W. Miles, "The equivalent circuit for a plane discontinuity in a cylindrical wave guide." *Proc. I.R.E.*, vol. 34, pp. 728-742; October, 1946.

² W. C. Hahn, "A new method for the calculation of cavity resonators." *Jour. Appl. Phys.*, vol. 12, pp. 62-68; January, 1941.

³ W. R. Smythe, "Notes for graduate course physics 101c." Calif. Inst. of Tech., Pasadena, Calif., 1943.

⁴ E. V. Condon, "Microwave theory," *Rev. Mod. Ph.*, October, 1942.

⁵ S. A. Schelkunoff, "Impedance of a transverse wire in a rectangular wave guide," *Quart. App. Math.*, vol. 1, April, 1943.

⁶ S. A. Schelkunoff, "Impedance concepts in wave guides," *Quart. App. Math.*, vol. 2, April, 1944.

⁷ J. R. Whinnery and H. W. Jamieson, "Equivalent circuits for discontinuities in transmission lines," *Proc. I.R.E.*, vol. 32, pp. 98-114; February, 1944.

⁸ J. R. Whinnery and H. W. Jamieson, "Coaxial-line discontinuities," *Proc. I.R.E.*, vol. 32, pp. 695-709, November, 1944.

¹ H. A. Chinn and P. Eisenberg, "Tonal-range and sound-intensity preferences of broadcast listeners," *Proc. I.R.E.*, vol. 33, pp. 571-580; September, 1945. Discussion: vol. 34, pp. 757-761; October, 1946.

continuities at the Massachusetts Institute of Technology Radiation Laboratory. There, a group composed of Drs. Julian Schwinger, Frank Carlson, Robert Whitmer, A. E. Heins, David Saxon, Paul Marcus, and others were all working on theoretical problems in wave guides, using, for the most part, methods developed by Schwinger. Among the contributions which appear to be solely due to Schwinger were:

(a) The variational method of solution for the electric field in the aperture.

(b) The realization that, in the general case of a plane discontinuity, two linearly independent fields were necessary, with the result that even a plane discontinuity generally requires a four-terminal network for its representation.

The author generalized the method used

by Schwinger *et al.* by placing it in dyadic form, developing independently the method in terms of the current flowing in the plane of the discontinuity (Schwinger was evidently well aware of this possibility, and Marcus had developed it independently by an inversion of the integral equation for the aperture field), and developing the possibility of a pi representation (of which Schwinger was also aware).

In addition to Schwinger's methods, Bethe's small-hole theory⁹ was then in general use at the Massachusetts Institute of Technology.

Other methods suggested by the British (in as-yet-classified documents) were also in

⁹H. A. Bethe, "Theory of diffraction by small holes," *Phys. Rev.*, vol. 66, pp. 163-182, October 1, 1944.

use, including certain rather powerful static approaches and an electrodynamic analogue to Babinet's principle in optics.

It is inevitable that, due to the necessities imposed by military security, the exact origin of many research contributions during the past five years will remain obscure, but it was certainly not the author's intent to attempt to take any of the credit for Schwinger's invaluable contributions to wave-guide theory. No one who had had the good fortune to work with him can express aught but regret that Schwinger has not seen fit to publish his brilliant work in this field.

JOHN W. MILES
Department of Engineering
University of California
Los Angeles, California

Contributors to the Proceedings of the I.R.E.



WILLIAM ALTAR

William Altar obtained his Ph.D. degree in physics and mathematics at the University of Vienna in 1923, and studied electrical engineering at the Technical University. After a few years as an industrial research engineer, he went to King's College, London, where he did research work on wave propagation.

Coming to the United States in 1929, he became assistant professor of physics at Pennsylvania State College, where he stayed until 1935. This was followed by a two-year fellowship in chemical physics at Fricks Chemical Laboratory, Princeton. He then sailed for Istanbul, Turkey, where for two years he taught electrical engineering at Roberts College.

After teaching electrical engineering at Case School from 1940 to 1942, he joined the Westinghouse Research Laboratories as an engineer on microwaves. He has been associated with the radar development program from Pearl Harbor to the capitulation of Japan.

A member of the A.I.E.E., Dr. Altar has written many papers on theoretical physics, chemical physics, electrical power transmission, and radio.

Lloyd J. Anderson was born on December 18, 1917, at Salt Lake City, Utah. He attended the University of California in Los Angeles from 1935 to 1939, where he received the A.B. degree in chemistry. He did physical chemical work at Scripps Institute of Oceanography of the University of California at La Jolla. He received the M.A. degree in oceanography from the University of California in 1942. Since that time, Mr. Anderson has been a physicist at the United States Navy Electronics Laboratory in San Diego. He is a member of the American Chemical Society.



LLOYD J. ANDERSON

F. H. Crawford was born at Dickinson, North Dakota, on July 5, 1900. He was graduated from the University of North Dakota with the B.S. degree in 1920, and thereafter spent three years as a Rhodes scholar in Oxford, England. Returning to this country, he spent 1923 and 1924 doing graduate work and teaching physics at Northwestern University. He then proceeded to Harvard, where he received his Ph.D. degree in 1928. He was instructor of physics from 1928 to 1930 and assistant professor of physics and chairman of the Board

of Tutors in Natural Science during 1930 to 1936 at Harvard. He was visiting professor of physics at Williams College in 1936 and 1937, and was made Thomas T. Read professor of physics there in 1937. His special subjects are molecular spectroscopy and thermodynamics. In July, 1943, he went on leave of absence to the Radio Research Laboratory, and served until the end of the war as special research associate in the field of magnetrons.

Dr. Crawford is a Fellow of the American Physical Society, the American Optical Society, and the American Academy of Arts and Sciences.

John P. Day was born on January 17, 1919, at David City, Nebraska. In 1940 he received the B.S. degree in physics from the California Institute of Technology; he also studied physics in the graduate school during 1940 and 1941. From 1941 to 1943 he was engaged in aircraft radar development at the Naval Research Laboratories. Since 1943 he has been employed in the Research Department of the United States Navy Electronics Laboratory in San Diego, California.



F. H. CRAWFORD



JOHN P. DAY



Clemens H. Freres (A'46) was born on March 5, 1917, in Racine, Wisconsin. He received the B.S. degree in electrical engineering from the University of Wisconsin in 1942. He has been employed since 1942 at the United States Navy Electronics Laboratory in San Diego, California.



Milton D. Hare was born at Moncton, New Brunswick, Canada, on May 9, 1914. He received the A.B. degree from Pacific Union College in 1937, and in 1939 the A.M. degree from Stanford University. From 1937 to 1941 Mr. Hare was a member of the physics faculty of Pacific Union College. In 1941 he joined the staff of Atlantic Union College and served as professor of physics and mathematics until the summer of 1943. From then until the close of the war he was engaged in vacuum-tube development work at Radio Research Laboratory, Harvard University.

In the fall of 1945, Mr. Hare joined the Bell and Howell Laboratories, Chicago, Illinois. Since September, 1946, he has been head of the department of physics, Union College, Lincoln, Nebraska. He is a member of the American Physical Society.



Stewart E. Miller (M'46) was born at Milwaukee, Wisconsin, in 1918. He attended the University of Wisconsin for three years, and was there elected to Tau Beta Pi and



CLEMENS H. FRERES

Eta Kappa Nu. At the beginning of the senior college year he transferred to Massachusetts Institute of Technology and studied communications engineering under a joint Massachusetts Institute of Technology-Bell System co-operative plan. Studying under a Tau Beta Pi fellowship during the graduate year, he received the B.S. and M.S. degrees in electrical engineering in 1941, and was elected an associate member of Sigma Xi. Joining the technical staff of the Bell Telephone Laboratories, Inc., as a member of



MILTON D. HARE

the system, development department, he became engaged in repeater development for the coaxial-cable carrier system. During the war he was engaged in the design and development of centimeter-wave transmitter-receivers for the United States Army and Navy. When the war ended he became engaged in the development of transmission systems for coast-to-coast relaying of telephone and television.



STEWART E. MILLER



Alfred P. D. Stokes was born on July 28, 1919 at Washington, D. C. He attended Antioch College from 1937 to 1939, and received the B.S. in structural engineering from Catholic University in 1943. He studied aerological engineering at the Postgraduate School of the United States Naval Academy and was assigned to the Navy Electronics Laboratory as aerological officer in propagation research, where he is now employed.



ALFRED P. D. STOKES



Clifford M. Wallis (M'42-SM'43) was born on March 7, 1904, in Waitsfield, Vermont. He received the B.S. degree in electrical engineering from the University of Vermont in 1926. During the following two years he was associated with the General Electric Company in Lynn, Massachusetts. He received the M.S. degree from Massachusetts Institute of Technology in 1928, and the D.Sc. degree from Harvard University in 1941. Dr. Wallis has been connected with the University of Missouri since 1928, and is now professor of electrical engineering at that institution. He has published several papers on the theoretical analysis of single-phase rectifier circuits.

During the summer of 1941 he served as visiting professor of communication engineering at Harvard University, where he assisted in the initiation of the pre-radar school. From March, 1944, until September, 1945, he was connected with the Harvard Underwater Sound Laboratory as research associate. He continued his association with the development of underwater sonic devices during the summer of 1946 as a member of the staff of the United States Navy Underwater Sound Laboratory at New London, Connecticut.

Dr. Wallis is a member of Tau Beta Pi, Sigma Xi, and the American Institute of Electrical Engineers.



CLIFFORD M. WALLIS

Institute News and Radio Notes

Constitutional Revision

DURING the past few years, it has been necessary on a number of occasions for your Board of Directors and the Institute's Membership to consider changes in the basic document, our Constitution. The number of proposed changes submitted by the Board to the members in this period has caused an expense and burden on the Institute's office and has caused complaint by numerous members. Each proposed change in our operations which required an amendment of the Constitution was delayed on an average of eight months after decision in its favor by the Board. It has been suggested that changing conditions should be estimated sufficiently far in advance so that changes in the Constitution would become necessary only at very infrequent intervals.

Changing conditions, combined with the very rapid growth of our Institute, have made this very desirable goal impossible. This is true not only of the handling of the affairs of our Institute but is the experience of many other institutions and, in fact, the experience of many individuals throughout the world today.

It appears that there will be no moratorium on changes necessary to be made in our operating procedures to keep them abreast of conditions. It is therefore proposed to place somewhat greater responsibility and corresponding freedom of management in the hands of the Board of Directors in order that changes in operation may be made more expeditiously and economically and without continued demands upon the membership. Among general factors back of this situation are

- (a) Our increasing membership with the development of large groups of members at scattered points throughout the country. Our membership was approximately 5000 in 1935 and is now approaching 20,000.
- (b) The increasing number and variety of problems in which the Institute along with other engineering bodies is actively interested.
- (c) The increased cost of all operations.
- (d) The increased headquarters and committee activities. These activities are being developed through experience and cannot be planned very completely in advance.
- (e) Continuing attempts to speed up and make more efficient the work of the Institute.

As of January 1, 1948, the new Regional Plan goes into effect whereby the Board of Directors is selected more directly by the membership and is made more responsive to the wishes of the membership. According to the plan adopted in 1946, there will be eight Regional Directors and a reduced number of Directors-at-Large and Appointed Directors.

It is felt that with this new type of representation of membership on the Board, the Board will as a regular matter have a much better picture of the needs and wishes of the membership, and the membership, because of such representation, will be in a position to make its wishes effective with the Board. Under these conditions, it will be necessary for the Board to be able to move more rapidly than in the past and thus more effectively. It is also felt that greater latitude in operations can and should be left with the Board since the membership will be more fully and accurately represented.

A complete study of the Constitution was authorized by your Board of Directors and carried out by the Constitution and Laws Committee in order that changes in line with the above point of view might be submitted to the membership. Based on this study, the Board has had prepared a revised Constitution which will be submitted to the members in the near future.

The Board and the Constitution and Laws Committee have spent more than one year in the basic discussions and in the determination

of details of the revised Constitution. All portions of it have been repeatedly considered with the greatest of care. The Board has approved the proposed changes and strongly recommends them to the membership as necessary and desirable for the continuing progress of your Institute. Large portions of the old Constitution have been retained in the new draft as they have been found to work satisfactorily. Many of the detailed provisions have been eliminated and are being rewritten as part of the By-laws which are subject to Board determination.

The principal changes proposed are indicated below. The ballot which will in due course be furnished all voting members will list these more in detail.

1. A change in Article II provides for the new grade of "Special Member" which is proposed in order to enable us to bring into our ranks the support of those active in radio and electronic development but whose main experience has been more in the field of management than of engineering practice. Such members would have all of the privileges of the Institute except the right to hold the offices of President and Vice-President. This grade may be considered in the honorary class since it is proposed to be conferred only by invitation of the Board of Directors.
2. The detailed requirements at present in Article II for the various grades of membership are removed from the Constitution and transferred to the Bylaws although the basic requirements for the various grades are retained in the Constitution. This is to allow some latitude in the instructions to the Admissions Committee without changing the basic concept underlying the plan of membership.
3. In Article III, the methods of handling admissions, transfers, and expulsions are removed and transferred to the Bylaws.
4. The material in Article IV which, at present, lists the entrance fees and dues of the various grades of members, is eliminated from the Constitution and transferred to the Bylaws in order that the Institute's finances may be kept on a sound basis during these times of changing conditions. The Regional Directors will be relied upon to reflect at all times the position of the membership of the regions with respect to fees, dues, and other financial matters. The Board as such has no wishes in the matter but exists to put into effect those services which the membership desires and for which it wishes to pay.
5. In Article VII, the number of names required for a nomination by petition is changed from 35 to 100. This change is recommended in view of the greatly increased membership of the Institute and is in accord with sound procedure.
6. In Article X, the number of names required for an amendment by petition is changed from 35 to 100. The reason for this proposed change is the same as that given in 5.
7. Also in Article X, the percentage of valid votes cast necessary for the passing of an amendment is changed from 75 to 67 per cent. It is felt that if two thirds of the members voting on a proposed change are in favor of it, the amendment should pass and not be held up by the opposition of one fourth of the voters.

Regular ballots containing details of all proposed changes are being prepared and will be mailed to you by the end of April. Your earnest consideration is requested for the proposed changes. Please bear in mind that the activities of the Institute have become so enlarged and proceed under such pressure that your Board of Directors needs all of your help in providing the most efficient operation for your service that it is possible to build.

B. E. SHACKELFORD, *Chairman*
Constitution and Laws Committee

I.R.E. Awards



Morris Liebmann Memorial Prize—1947
JOHN R. PIERCE

"For his development of a traveling-wave amplifier tube having both high gain and very great bandwidth."



Browder J. Thompson Memorial Award
1946
CHARLES L. DOLPH

"For the best article published in the PROCEEDINGS OF THE I.R.E. during 1946 by a person under thirty years of age."



Morris Liebmann Memorial Prize—1946
ALBERT T. ROSE

"For his contributions to the art of converting optical images to electrical signals, particularly the image orthicon."



GEORGE P. ADAIR

"For his technical direction of matters relating to allocation of radio frequencies."



GEORGE L. BEERS

"For his numerous advances in circuits and systems leading to improved radio broadcasting, particularly in the receiver field."



BENJAMIN DE F. BAGLY

"For his contributions as a teacher in the field of radio communications and his service in the co-ordination of communications security."



Fellow Award—1947
GEORGE P. ADAIR



LLOYD V. BERKNER

"For his investigations of ionospheric phenomena and his contributions to air-borne-radar development."



Ashley and Crippen
Fellow Award—1947
BENJAMIN DE F. BAGLY



Fellow Award—1947
GEORGE L. BEERS



Harris and Ewing
Fellow Award—1947
LLOYD V. BERKNER

I.R.E. Awards



Fellow Award—1947
ROBERT S. BURNAP

"For his many technical and administrative contributions to the welfare of the Institute and radio field as an active chairman or member of numerous technical committees."



DONALD G. FINK

"In recognition of his espousal of high standards of technical publishing and for his wartime contributions in the field of electronic aids to navigation."



FRED V. HUNT

"For his work as a scientist, teacher, and administrator and his contributions to acoustics."



Fellow Award—1947
FRED V. HUNT



Fellow Award—1947
EDWARD L. BOWLES

"For his activities in making possible the maximum practical use of advanced radio equipment in military operations and for his work in the educational field."



Fellow Award—1947
DONALD G. FINK



Fellow Award—1947
WILLIAM W. HANSEN



Fellow Award—1947
ROBERT F. FIELD

"Who, as an engineer and physicist, improved methods and standards in alternating-current measurements."



WILLIAM W. HANSEN

"In recognition of his many contributions to the theory of tubes, networks, circuits, and antennas."



DAVID R. HULL

"For his contributions in developing a program utilizing electronic advances in military equipment and tactics."



Fellow Award—1947
DAVID R. HULL

I.R.E. Awards



Fellow Award—1947

KARL G. JANSKY

"For his researches in the realm of cosmic and circuit noise affecting radio communication."



JAMES W. McRAE

"For outstanding work in the planning of research and development programs in radar and countermeasures and for his researches in radio transmitting methods."



DANIEL EARL NOBLE

"In recognition of his contributions to the design and application of very-high-frequency voice-communication systems for police and other emergency services."



Fellow Award—1947
DANIEL EARL NOBLE



Fellow Award—1947

CHARLES V. LITTON

"For his contributions to theory and practice in the field of high-vacuum techniques, including processes and precision devices for the production of electron tubes."



Fellow Award—1947

JAMES W. McRAE



Fellow Award—1947
PEDRO J. NOIZEUX



Fellow Award—1947

RAY D. KELL

"For his extensive contributions, over many years, to television for both civilian and military use."



ILIA E. MOURONTSEFF

"In recognition of his contributions to vacuum-tube development, particularly transmitting tubes."



PEDRO J. NOIZEUX

"For his leadership in development of radio communication services."



Fellow Award—1947
ILIA E. MOURONTSEFF

I.R.E. Awards



Fellow Award—1947
JOHN A. PIERCE

"For his contributions to the development of loran, a radio aid to navigation."



CONAN A. PRIEST

"For his contributions as an engineer, executive, and organizer in the field of radio transmitter development and design."



EDWARD N. WENDELL

"For his contributions to the development and production of radio systems for navigating and landing airplanes by instrument."



Fellow Award—1947
EDWARD N. WENDELL



Fellow Award—1947
FRANK H. R. POUNSETT

"In recognition of his contributions to the engineering development and production design of radar apparatus in Canada."



Fellow Award—1947
CONAN A. PRIEST



Fellow Award—1947
WINFIELD W. SALISBURY



Fellow Award—1947
ROBERT M. PAGE

"In recognition of his pioneering achievements in solving some of the early problems of basic importance to radar."



WINFIELD W. SALISBURY

"For his contributions to the generation of high-power continuous-wave energy at ultra-high frequencies."



ROBERT WATSON-WATT

"For his early contributions to radio and for his pioneering work in radar."



British Information Services Photo
Fellow Award—1947
ROBERT WATSON-WATT

New England Radio Engineering Meeting

CAMBRIDGE, MASSACHUSETTS, SATURDAY, MAY 17, 1947

The newly created North Atlantic Region of The Institute of Radio Engineers, made up of the Connecticut Valley Section and the Boston Section, will sponsor an all-day radio engineering meeting at the Hotel Continental in Cambridge, Massachusetts on Saturday, May 17, 1947. This date is a postponement of an earlier date previously announced.

This Regional All New England Meeting is a new venture in co-operation among New England electronic specialists. It is designed to establish new and valuable associations between them and the rich background of industries, educational institutions, and research centers situated in the compact, highly developed New England area. Numbered among the radio engineers of this region are many of the country's outstanding electronic specialists and this meeting brings into focus New England men and their contributions to the art.

Scheduled for the day's meeting are six technical papers to be presented for the first time on communications, microwaves, frequency modulation, and measure-

ments. None of these papers will be given concurrently. A large space in the Hotel Continental will be devoted to a number of exhibits of radio and electronic products manufactured only in this region. New England manufacturers make a wide variety of electronic apparatus and the exhibit offers an excellent opportunity for New England engineers to acquaint themselves with these items and with their neighbors, the people who make them.

As part of the social amenities, a luncheon is planned at noon, with a banquet scheduled for the evening with excellent entertainment technically and socially adapted to the humor and tastes of engineers and their families. Speechmaking at the Banquet will be held to a minimum. As part of the streamlined program, Mr. George W. Bailey, Executive Secretary of the Institute of Radio Engineers, will bring greetings from National Headquarters.

Brief outlines of the papers to be presented at the technical sessions are given below.

1. LOW-DRAG AIRCRAFT ANTENNAS FOR FREQUENCIES FROM 2 TO 18 MEGACYCLES

JOHN V. N. GRANGER

(Graduate Student, Harvard University, Cambridge, Massachusetts)

The difficulties involved in the design of efficient radiators for high-speed aircraft are discussed and deficiencies of conventional structures explained. Comparisons of the effects of polarization for long-distance communication are given. Novel radiators, involving the use of the airplane wings as a dipole are described and the mechanical and electrical performance confirmed with experimental data.

2. THE COMMERCIAL DESIGN OF GEIGER-MUELLER COUNTER TUBES

HERBERT METTEN

(Sylvania Electric Products, Inc., Boston, Massachusetts)

The subject of Geiger-Mueller tubes will be introduced with a brief historical survey of conventional methods for detection of radioactivity, including Geiger-Mueller tubes, followed by a simplified description of the mechanism involved in the detecting action of Geiger-Mueller tubes. There will be a description of the effect of various gas fills on tube characteristics, with a comparison of self-quench and external-quench gas fills from the standpoint of tube life, stability, operating voltage, and recovery time. The problem of windows for beta-ray counters will be considered. A discussion of production methods and problems will include such subjects as



W. H. Beal

CRUFT LABORATORY, HARVARD UNIVERSITY

types of cathode, purity of fill, use of high-vacuum techniques, sealing of windows, and methods of finishing (basing and devices for mounting and protection). The presentation of some typical characteristics of Geiger-Mueller tubes, together with demonstrations of the tubes in actual use, will conclude the talk.

3. RECENT DEVELOPMENTS IN FREQUENCY STABILIZATION OF MICROWAVE OSCILLATORS

WILLIAM G. TULLER, FRANK P. ZAFFARANO, AND WILLIAM C. GALLOWAY

(Massachusetts Institute of Technology, Cambridge, Massachusetts)

Mr. Tuller will review the methods of stabilizing microwave transmitters which show the relative merits of the three generally used systems. The reference-cavity stabilization scheme of Pound is then considered in some detail, and recent developments in this circuit are considered. Among these are the development of a system operable over a wide frequency band and capable of modulation with good linearity. Inherent limits of this system in modulation-frequency response, stability, and distortion are given.

4. A VERY-HIGH-FREQUENCY BRIDGE FOR IMPEDANCE MEASUREMENTS AT FREQUENCIES BETWEEN 20 AND 140 MEGACYCLES

R. A. SODERMAN
(General Radio Company,
Cambridge, Massachusetts)

A bridge has been developed for impedance measurements on circuits having either distributed or lumped parameters. The resistive and reactive components of the unknown are measured in terms of incremental capacitances. The resistance range is 0 to 200 ohms over the frequency range, and the reactance range is 0 to ± 200 ohms at 100

megacycles and is inversely proportional to frequency. Coaxial, two-terminal, or ground-plane measurements may be made. The circuit and errors will be discussed and typical measurements presented.

5. DESIGN PROBLEMS OF FREQUENCY-MODULATION RECEIVERS

ALDO MICCIOLI
(Associate, Dale Pollack, New London, Connecticut)

The problems affecting the design of frequency-modulation receivers are discussed,

including the relative merits of variable-inductor and variable-capacitor tuning. Stability and switching problems are considered, and a solution for a typical receiver presented, with provision for an amplitude-modulation band oscillator. The relative merits of triode and pentagrid converters and the problem of oscillator injection are considered. Coil design, radio-frequency gain, bandwidth, and stability of intermediate-frequency amplifiers are discussed. The problems of proper limiter and discriminator design are considered, and the over-all performance of a typical receiver described.

6. WARTIME DEVELOPMENTS IN WAVE-GUIDE THEORY

JULIAN S. SCHWINGER
(Harvard University, Cambridge, Massachusetts)

This paper will treat rigorous and approximate mathematical approaches to the solution of problems of radiation from wave guides and the effects of structures within wave guides, with particular attention to general methods of solving for equivalent-circuit parameters.

REGISTRATION

All members of The Institute of Radio Engineers in the Boston and Connecticut Valley Sections (except students) will receive a registration form by mail, which must be returned with the proper fees by May 5, 1947. Students in this area may apply to their I.R.E. representative in their schools for free registration and will find information concerning the meeting and who their representatives are, posted on school bulletin boards.

Registration fees for New England Radio Engineering Meeting:

- Members of I.R.E. (all grades except students) \$ 1.00
- Nonmembers of I.R.E. 2.00
- All students (through school representatives) free

Advanced registration is essential, since all facilities are limited. It is suggested that persons who do not receive registration forms by mail communicate by personal letter to Mr. H. H. Dawes, New England Radio Engineering Meeting, 275 Massachusetts Avenue, Cambridge 39, Massachusetts.

The following schedule of prices will apply:

- Single luncheon ticket \$ 1.75
- Single banquet ticket 3.75

For members of I.R.E.

- Complete coverage including one luncheon ticket, two banquet tickets, and one registration 10.00

For nonmembers of I.R.E.

- Complete coverage including one luncheon ticket, two banquet tickets and one registration 11.00

Hotel Continental, Cambridge, Massachusetts, prices:

- Single room, bath 3.85
- Double room, bath 6.60

Registration with the New England Meeting does not guarantee hotel room. Direct contact with the hotel should be made.

Remember the date, May 17! For Advanced Registration or Other Information, Communicate with H. H. Dawes or the General Chairman

GENERAL CHAIRMAN, L. E. Packard, Technology Instruments Corporation, Waltham, Massachusetts
ARRANGEMENTS CHAIRMAN: H. H. Dawes, New England Radio Engineering Meeting, 275 Massachusetts Avenue, Cambridge 39, Massachusetts

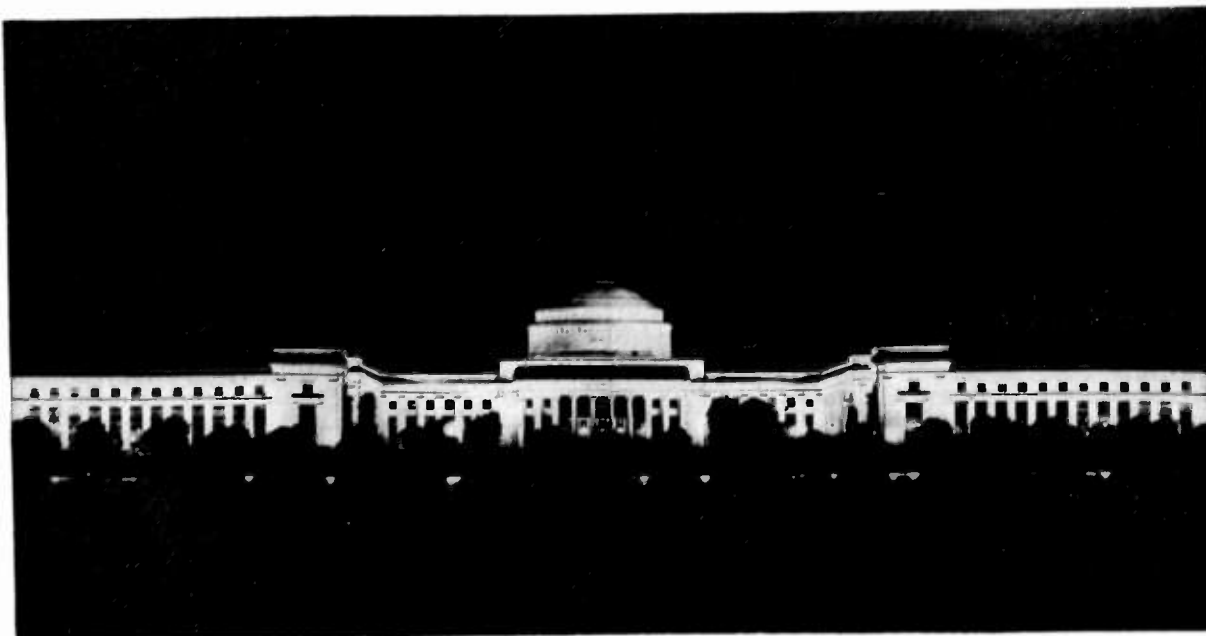

M.I.T. Photo Service

Sections

Chairman		Secretary	Chairman		Secretary
	ATLANTA April 18	M. S. Alexander 2289 Memorial Dr., S.E. Atlanta, Ga.	L. W. Butler 3019 N. 90 St. Milwaukee 13, Wis.	MILWAUKEE	E. T. Sherwood 9157 N. Tennyson Dr. Milwaukee, Wis.
H. L. Spencer Associated Consultants 18 E. Lexington Baltimore 2, Md.	BALTIMORE	G. P. Houston, 3rd 3000 Manhattan Ave. Baltimore 15, Md.	J. C. R. Punchard Northern Electric Co. 1261 Shearer St. Montreal 22, Que., Canada	MONTREAL, QUEBEC May 14	E. S. Watters Canadian Broadcasting Corp. 1440 St. Catherine St., W. Montreal 25, Que., Canada
Glenn Browning Browning Laboratories 750 Main St. Winchester, Mass.	BOSTON April 24	A. G. Bousquet General Radio Co. 275 Massachusetts Ave. Cambridge 39, Mass.	J. T. Cimorelli RCA Victor Division 415 S. Fifth St. Harrison, N. J.	NEW YORK May 7	J. R. Ragazzini Columbia University New York 27, N. Y.
I. C. Grant San Martin 379 Buenos Aires, Argentina	BUENOS AIRES	Raymond Hastings San Martin 379 Buenos Aires, Argentina	L. R. Quarles University of Virginia Charlottesville, Va.	NORTH CAROLINA-VIRGINIA	J. T. Orth 4101 Fort Ave. Lynchburg, Va.
H. W. Staderman 264 Loring Ave. Buffalo, N. Y.	BUFFALO-NIAGARA April 16	J. F. Myers Colonial Radio Corp. 1280 Main St. Buffalo 9, N. Y.	D. W. R. McKinley 211 Cobourg St. Ottawa, Canada	OTTAWA, ONTARIO April 17	W. A. Caton 132 Faraday St. Ottawa, Canada
J. A. Green Collins Radio Co. Cedar Rapids, Iowa	CEDAR RAPIDS	Arthur Wulfsburg Collins Radio Co. Cedar Rapids, Iowa	Samuel Gubin 4417 Pine St. Philadelphia 4, Pa.	PHILADELPHIA May 1	A. N. Curtiss RCA Victor Division Bldg. 8-9 Camden, N. J.
A. W. Graf 160 N. La Salle St. Chicago 1, Ill.	CHICAGO April 18	D. G. Haines Hytron Radio and Electronic Corp. 4000 W. North Ave. Chicago 39, Ill.	W. E. Shoupp 911 S. Braddock Ave. Wilksburg, Pa.	PITTSBURGH May 12	C. W. Gilbert 52 Hathaway Ct. Pittsburgh 21, Pa.
J. D. Reid Box 67 Cincinnati 31, Ohio	CINCINNATI April 15	C. K. Gieringer 303 W. Third St. Cincinnati 2, Ohio	Francis McCann 4415 N.E. 81 St. Portland 13, Ore.	PORTLAND	A. E. Richmond Box 441 Portland 7, Ore.
H. C. Williams 2636 Milton Rd. University Heights Cleveland 21, Ohio	CLEVELAND April 24	A. J. Kres 16911 Valleyview Ave. Cleveland 11, Ohio	A. E. Newlon Stromberg-Carlson Co. Rochester 3, N. Y.	ROCHESTER April 17	K. J. Gardner 111 East Ave. Rochester 4, N. Y.
E. M. Boone Ohio State University Columbus, Ohio	COLUMBUS May 9	C. J. Emmons 158 E. Como Ave. Columbus 2, Ohio	S. H. Van Wambeek Washington University St. Louis 5, Mo.	SACRAMENTO ST. LOUIS	N. J. Zehr 1538 Bradford Ave. St. Louis 14, Mo.
Dale Pollack 352 Pequot Ave. New London, Conn.	CONNECTICUT VALLEY April 17	R. F. Blackburn 62 Salem Rd. Manchester, Conn.	Rawson Bennett U. S. Navy Electronics Laboratory San Diego 52, Calif.	SAN DIEGO May 6	Clyde Tirrell U. S. Navy Electronics Laboratory San Diego 52, Calif.
Robert Broding 2921 Kingston Dallas, Texas	DALLAS-Ft. WORTH	A. S. LeVelle 308 S. Akard St. Dallas 2, Texas		SAN FRANCISCO	F. R. Brace 955 Jones San Francisco 9, Calif.
J. E. Keto Aircraft Radio Laboratory Wright Field Dayton, Ohio	DAYTON April 17	Joseph General 411 E. Bruce Ave. Dayton 5, Ohio	J. F. Johnson 2626 Second Ave. Seattle 1, Wash.	SEATTLE May 8	J. M. Patterson 7200-28 N. W. Seattle 7, Wash.
P. O. Frincke 219 S. Kenwood St. Royal Oak, Mich.	DETROIT April 18	Charles Kocher 17186 Sioux Rd. Detroit 24, Mich.	C. A. Priest 314 Hurlburt Rd. Syracuse, N. Y.	SYRACUSE	R. E. Moe General Electric Co. Syracuse, N. Y.
N. J. Reitz Sylvania Electric Products, Inc. Emporium, Pa.	EMPORIUM	A. W. Peterson Sylvania Electric Products, Inc. Emporium, Pa.	H. S. Dawson Canadian Association of Broadcasters 80 Richmond St., W. Toronto, Ont., Canada	TORONTO, ONTARIO	C. J. Bridgland Canadian National Telegraph 347 Bay St. Toronto, Ont., Canada
E. M. Dupree 1702 Main Houston, Texas	HOUSTON	L. G. Cowles Box 425 Bellaire, Texas	M. E. Knox 43-44 Ave., S. Minneapolis, Minn.	TWIN CITIES	Paul Thompson 4602 S. Nicollet Minneapolis, Minn.
H. I. Metz Civil Aeronautics Authority Experiment Station Indianapolis, Ind.	INDIANAPOLIS	M. G. Beier 3930 Guilford Ave. Indianapolis 5, Ind.	L. C. Smeby 820-13 St. N. W. Washington 5, D. C.	URBANA WASHINGTON May 12	T. J. Carroll National Bureau of Standards Washington, D. C.
R. N. White 4800 Jefferson St. Kansas City, Mo.	KANSAS CITY	Mrs. G. L. Curtis 6003 El Monte Mission, Kansas	W. C. Freeman, Jr. 2018 Reed St. Williamsport 39, Pa.	WILLIAMSPORT May 7	S. R. Bennett Sylvania Electric Products, Inc. Plant No. 1 Williamsport, Pa.
J. R. Bach Bach-Simpson Ltd. London, Ont., Canada	LONDON, ONTARIO	G. L. Foster Sparton of Canada, Ltd. London, Ont., Canada			
C. W. Mason 141 N. Vermont Ave. Los Angeles 4, Calif.	LOS ANGELES April 15	Bernard Walley RCA Victor Division 420 S. San Pedro St. Los Angeles 13, Calif.			

Sections

SUBSECTIONS

Chairman	Secretary	Chairman	Secretary
R. B. Jones City Signal Service 319 E. Main St. Fort Wayne 2, Ind.	FORT WAYNE (Chicago Subsection) S. J. Harris Farnsworth Television and Radio Co. 3702 E. Pontiac Fort Wayne 1, Ind.	C. W. Mueller RCA Laboratories Princeton, N. J.	PRINCETON (Philadelphia Subsection) A. V. Bedford RCA Laboratories Princeton, N. J.
T. S. Farley 74 Hyde Park Ave. Hamilton, Ont., Canad	HAMILTON (Toronto Subsection) E. Ruse 195 Ferguson Ave., S. Hamilton, Ont., Canada	A. R. Kahn Electro-Voice, Inc. Buchanan, Mich.	SOUTH BEND (Chicago Subsection) April 17 A. M. Wiggins Electro-Voice, Inc. Buchanan, Mich.
K. G. Jansky Bell Telephone Laboratories Box 107 Red Bank, N. J.	MONMOUTH (New York Subsection) L. E. Hunt Bell Telephone Labora- tories Box 107 Deal, N. J.	W. A. Cole 323 Broadway Ave. Winnipeg, Manit., Can- ada	WINNIPEG (Toronto Subsection) C. E. Trembley Canadian Marconi Co. Main Street Winnipeg, Manit., Can- ada

SPRING TECHNICAL CONFERENCE CINCINNATI SECTION I.R.E.

The Cincinnati Section of The Institute of Radio Engineers will hold a Spring Technical Conference on May 3, 1947, at the Engineering Society Building in that city, according to a notice issued by John D. Reid, chairman of the Section and by Lewis M. Clement, chairman of the Papers Committee, and Harold L. Brouse, member of the Papers Committee. The papers to be presented in the morning session of the Conference are as follows:

- "Antennas for Television Reception," by Andrew Alford, Consulting Engineer
 - "A New Approach to Television Input Circuits," by Paul F. G. Holst, Crosley Division, Aviation Corporation
 - "Intermediate-Frequency Television Amplifier Design," by Stuart Seeley, Radio Corporation of America
 - "Television Receiver Synchronizing Circuits," by Robert W. Sanders, Farnsworth Television and Radio Corporation
- The papers to be delivered in the afternoon session include:
- Part I—"Cathode-Ray-Tube Screens in Contact with Metal," by C. S. Szegho, The Rauland Corporation
 - Part II—"Reflective and Refractive Optics for Projection Television Receivers," by George K. Schnable, The Rauland Corporation
 - "Interconnecting Facilities for Television Broadcasting," by W. E. Bloecker, American Telephone and Telegraph Co.
 - "The Future of Color in Television," by Donald G. Fink, McGraw-Hill Publishing Co.

The morning session will be under the chairmanship of R. J. Rockwell, and the afternoon session under the chairmanship of W. C. Osterbrook. During the entire Conference, the Cincinnati television transmitter of the Crosley Broadcasting Corporation will be in operation. A group of exhibits of television components and test equipment will also be shown during the Conference in an auditorium adjacent to the main-meeting auditorium.

CHICAGO SECTION MEETING

At a recent meeting of the Chicago Section, Grote Reber (A'33-SM'44) of Stewart Warner Corporation gave an address on "Cosmic Static," describing how a highly directional antenna is used to scan the sky, the output feeding into a tuned radio-frequency receiver with a hissing noise. Many measurements have been made at 160 megacycles, and are now under way at 480 megacycles. Mr. Reber reported that static apparently originating from the sun is greatly enhanced at times of great sunspot activity. Various theories have been advanced as to the cause of this static, but none has satisfactorily explained all the observed phenomena. Radiation has been detected from the Andromeda Nebula, which is 5×10^{18} miles away (800,000 light years). This may well be a long-distance record for radio reception.

Joseph Heller (SM'45) of the Panoramic Radio Corporation spoke on "The Panalyzer as an Engineering Tool." He pointed out that many engineering problems are being solved by this device which has been used extensively as an aid to communications. Various factors limiting the frequency resolution obtainable were discussed; excessive sharpening of the intermediate frequency to permit higher resolution is likely to result in spurious responses masking the desired pattern. A very wide range of amplitude discrimination (about 10%) is possible by the use of an amplifier with a logarithmic response.



SYRACUSE SECTION

The Board of Directors, at its December 4, 1946, meeting, accepted the recommendation of the Executive Committee that the petition of Syracuse members for the establishment of a Syracuse Section be approved.

CEDAR RAPIDS SECTION

The Cedar Rapids Section of the Institute, continuing its vigorously active career, has introduced some procedures at least one of which is believed to be novel. These procedures may be of interest to other Sections.

Prior to the meeting of the National Sections Committee in New York on March 3, 1947, the Cedar Rapids Section asked its members to submit any ideas or suggestions which might be deemed appropriate for discussion at the New York meeting. It would always be well if Section representatives came to meetings of the Sections Committee as carriers of the viewpoint of the membership of their Section and with all available proposals emanating from the membership of that Section.

The Cedar Rapids Section has also appointed a specific person as a membership-campaign representative. All members of the Section were urged to have any eligible non-member of whom they know communicate with the Section representative in question.

To facilitate large attendance of members of the Cedar Rapids Section at the Winter Technical Meeting of the Institute in New York, the Section made arrangements with the railroad companies to provide special cars for the use of its membership to and from the convention. Thus the members could be assured not only of a comfortable trip but of the company of their fellow members during the journey. This procedure was believed to be a convenience to the members and an inducement for the attendance of a larger delegation than would otherwise have been the case.

STUDENT BRANCHES

The Board of Directors, at its February 5, 1947, meeting, approved the petitions that Student Branches be founded at the City College of the City of New York and at the College of Engineering of New York University.

I.R.E. People



HAROLD O. WYCKOFF



ALLEN H. SHOOLEY



MAXWELL K. GOLDSTEIN

Army and Navy Awards

Bronze Star Medal

Harold O. Wyckoff (A'43) has been awarded the Bronze Star Medal by the War Department. As Assistant Chief of the Operational Research Section of the Ninth Air Force, part of the larger 'Operation Analysis' of the Army Air Forces, he "analyzed and made studies of bombing in coordination with ground attacks that proved of great value in the employment of fighter bombers. His successful efforts in all fields of research were an important contribution to the aerial offensive." Dr. Wyckoff received his doctorate in physics from the University of Washington in 1940 and in the same year joined the staff of the National Bureau of Standards where he is now associate physicist in the X-ray section. He has done extensive work in the field of Cerenkov radiation and X-ray protection and measurements. He is a member of the Physical Society and the Washington Philosophical Society.

Distinguished Civilian Service Awards

Allen H. Shooley (A'35) has been awarded the Distinguished Civilian Service Award from the Secretary of the Navy, "for distinguished service in fundamental research in the field of measurement of basic physical quantities and particularly for his development of the precision-time-measuring equipment which became the basis for all precision-ranging circuits used in fire-control radar by the Army and Navy." Mr. Shooley received his bachelor's degree in electrical engineering from Iowa State College and his Master's from Purdue University. While with the Radio Corporation of America, from 1936 to 1940, he designed and built miniature radio tubes. He joined the Naval Research Laboratory in 1940 and has since been continuously identified with fire-control

and missile-control radar. Mr. Shooley is a member of Sigma Xi and an associate member of the Franklin Institute and the United States Naval Institute.

Maxwell K. Goldstein (A'30-SM'46) has been awarded the Distinguished Civilian Service Award by the Secretary of the Navy, "for distinguished contributions to the Naval Service in developing high-frequency direction finding as a vital weapon for combating the German submarine menace during the crucial Battle of the Atlantic." Dr. Goldstein received his doctorate in engineering in 1933 from Johns Hopkins University and was subsequently engaged in the development of automatic remote indicating systems for anti-aircraft gun control apparatus and radio navigation aids. In 1939 he joined the Naval Research Laboratory and for a number of years was in charge of its radio direction-finder work; he is now head of the Avigation Section. He is a member of Sigma Xi.

A. E. Abel (A'31-AM'45), chief engineer

of Bendix Radio, has received highest civilian honors from the United States War Department for outstanding achievement in the development of radar during World War II. Commendation was made specifically for service "in a position of trust and responsibility for outstanding assistance in development, research and production of radio set SCR-598." The SCR-598 is part of a gun-laying radar equipment which made possible accurate and speedy aiming of large guns in sea warfare and harbor defense. One of the civilian applications of this radar is for precise harbor traffic control.

Certificate of Appreciation

Dorman D. Israel (A'23-M'30-F'42), vice-president in charge of engineering and production of Emerson Radio and Phonograph Corporation, New York City, was awarded the War Department Certificate of Appreciation for outstanding contribution to the war effort in the research, development, and production of VT fuzes during World War II.

Born in Newport, Kentucky, Mr. Israel received his degree in electrical engineering from the University of Cincinnati. He has been chief development engineer of Crosley Radio Corporation and chief engineer of Grigsby-Grunow Corporation. In August, 1946, he became president and a director of Radio Speakers, both Emerson subsidiaries.

Mr. Israel has long been active in The Institute of Radio Engineers. He was chairman of the Cincinnati Section in 1931, has been for a number of years General Chairman of the Papers Procurement Committee, and is a member of the RMA Co-ordinating Committee, the 1947 Convention Committee, and the Awards Committee. He is also chairman of the receiver section of the engineering department of Radio Manufacturers Association.



DORMAN D. ISRAEL

I.R.E. People



RUSSELL B. RENNAKER

RUSSELL B. RENNAKER

Russell B. Rennaker (M'46) has joined the Collins Radio Company, Cedar Rapids, Iowa, and been placed in charge of the Broadcast Sales Division. Mr. Rennaker has been associated with Federal Telephone and Radio Corporation, Columbia Broadcasting Service as engineering supervisor, and has served as national president of the Association of Broadcast Technicians. During the war, he was connected with the work of the Office of Strategic Service for two years. Mr. Rennaker has held an amateur radio operator's license since 1916.



HARRY SUSSMAN

Harry Sussman (S'33-A'33-SM'44) has been appointed chief engineer of the Espey Manufacturing Company, Inc., of New York City. Mr. Sussman has been engaged in radio design and development work since 1932, when he was a laboratory assistant with Emerson Radio and Phonograph Corporation. He received his B.E.E. degree from Brooklyn Polytechnic Institute in 1933, and has since been associated with Lear Developments, RCA Victor, and Hazeltine Electronics Corporation.



HARRY SUSSMAN

H. I. ROMNES

H. I. Romnes (SM'45) has left the Bell Telephone System where he was engaged in engineering and research work, to become a radio engineer of the American Telephone and Telegraph Company. As radio engineer, he heads the radio section of the engineering division, succeeding Francis M. Ryan (J'14-A'17-M'26-F'40), who previously had been named radio co-ordinator.

Mr. Romnes was graduated from the University of Wisconsin with a degree in electrical engineering, and joined the Bell Telephone Laboratories in 1928. After work on toll-signaling and -transmission systems, repeaters, and associated equipment at the Laboratories, he was transferred in 1935 to the toll-transmission group in the parent company. Prior to his recent appointment he was in charge of that group under Frank A. Cowan (M'30-SM'43), transmission engineer.

Active in the American Institute of Electrical Engineers, Mr. Romnes has been secretary of its committee on communications for over a year.



VALDEMAR POULSEN GOLD MEDAL

At the December 4, 1946, meeting of the Board of Directors President Llewellyn read



E. F. W. ALEXANDERSON

a letter from Suker Englund, dated November 22, 1946, which contained the information that "The Academy of Technical Sciences has awarded Dr. E. F. W. Alexanderson (A'13-M'13-F'15) the Valdemar Poulsen Gold Medal to be handed over to Dr. Alexanderson on the 23rd of November, the birthday of Valdemar Poulsen." Mr. Englund also stated that because of the War and the Occupation of Denmark, it had not been possible to award this Medal since 1939, but the Academy was awarding two Gold Medals this year, the second one being presented to Sir Robert Watson-Watt following the recommendation of the Institution of Electrical Engineers, London.



H. I. ROMNES



H. H. FRIEND

H. H. Friend (A'26-M'38-AM'43) has been appointed assistant to the president of the Arnold Engineering Company, Chicago, a subsidiary of the Allegheny Ludlum Steel Corporation. Mr. Friend was formerly associated with the Curtiss Wright Corporation where he went in 1943 from the Bendix Aviation Corporation.



BENNETT S. ELLEFSON

Bennett S. Ellefson (A'38-M'44), director of the central engineering laboratories of Sylvania Electric Products, Inc., has been in Germany serving as a scientific consultant for the Technical Industrial Investigating Division of the United States Department of Commerce. His schedule included visits to German synthetic-mica plants and laboratories for an investigation of wartime developments as well as investigation of several laboratories and plants producing fluorescing chemical compounds for cathode-ray tubes. Dr. Ellefson's investigations will be documented for public information by the Department of Commerce.



BENNETT S. ELLEFSON

I.R.E. People



EMIL F. HEMBROOKE

EMIL F. HEMBROOKE

Emil F. Hembrooke (A'27) was recently elected a vice-president of the Muzak Corporation.

Mr. Hembrooke served for fifteen years with Western Electric Company and Electric Research Products, Inc., a subsidiary of Western Electric, where he became chief research engineer on engineering and equipment for wire broadcast systems. From 1941 to 1943 he was chief engineer for the Muzak Corporation, and since 1945 has been director of equipment and engineering.



THOMAS B. MOSELEY

Thomas B. Moseley (A'42-M'46) recently was appointed a broadcast sales engineer of the Collins Radio Company for the Southwest Area. Mr. Moseley formerly was associated with the Weldon Engineering Company of Del Rio, Texas, and held the position of chief radio engineer, Signal Office, Headquarters Eighth Service Command during World War II. More recently, he was



THOMAS B. MOSELEY

secretary-treasurer and chief engineer for the International Electronics Corporation of Dallas, Texas.



ROBERT W. LARSON

Robert W. Larson (SM'44) has been appointed administrative assistant to the director of the General Electric Research Laboratory at Schenectady. Born in Jamestown, N. Y., Mr. Larson was graduated from Rensselaer Polytechnic Institute in 1922 with the degree of Electrical Engineer. He joined the staff of the General Electric Research Laboratory, working on high-power vacuum tubes, and later became assistant engineer in the Tube Division of the Electronics Department. From 1943 to 194 he was chief technical aide and deputy chief of Division 15, National Defense Research Committee, which was responsible for such activities as the jamming of German and Japanese radar during the war. In 1944 he resigned upon taking a position as assistant to the manager of the engineering department in the Lancaster, Pennsylvania, plant of the Radio Corporation of America, and was named consultant to the Division.



JOHN H. MILLER

John H. Miller (A'19-M'25-SM'43) has been appointed vice-president and chief engineer of Weston Electrical Instrument Corporation, Newark, N. J. He succeeds W. N. Goodwin, Jr. (A'15-M'29-SM'43) who, although retired, has been retained as an engineering consultant.

After receiving his degree in electrical engineering from the University of Illinois in 1915, Mr. Miller joined the Westinghouse Electric and Manufacturing Company as an apprentice, later becoming an engineer on watt-hour meters. In 1918 he was commissioned in the Signal Corps, working on special radio developments for aircraft. After the war he went to the Jewell Electrical Instrument Company of Chicago as chief engineer and later became vice-president. When the Jewell Company merged with Weston in 1931, Mr. Miller became assistant chief engineer of the latter, and also spent some time with the company's English affiliate. In 1937 he took charge of the commercial engineering division which he continued to manage until he was appointed chief engineer in 1944.

Mr. Miller, along with two other engineers, formed the Chicago Section of The Institute of Radio Engineers and served several years as chairman and secretary of the group. He was on the board of the Western Society of Engineers for several years, is a Fellow of the Radio Club of America and the American Institute of Electrical Engineers.



HARRY S. DAWSON

HARRY S. DAWSON

Harry S. Dawson (A'35-SM'45), chairman of the Toronto Section of the Institute of Radio Engineers, has been appointed manager of the Canadian Association of Broadcasters. He also continues as the Association's engineering consultant. A Cornell graduate in electrical engineering, Dr. Dawson has been connected with Rogers Radio Tubes, Ltd., Station CFRB in Toronto, and Research Enterprises Limited. He joined the Canadian Association of Broadcasters as chief engineer in 1945.



JOHN J. GLAUBER

John J. Glauber (A'27-SM'45) has been appointed chief engineer in charge of engineering and development of radio transmitting tubes for the United Electronics Company, Newark, N. J. Mr. Glauber was formerly with Federal Telecommunications Laboratories of New York, in charge of design and development of ultra-high-frequency high-power pulse tubes for radio applications during the war.



JOHN J. GLAUBER

I.R.E. People



WILLIAM F. COTTER

WILLIAM F. COTTER

William F. Cotter (A'27-SM'44) was recently appointed chief engineer for the Scott Radio Laboratories, Inc., succeeding Marvin Hobbs (A'35-M'41-SM'43) who will engage in consulting engineering on radio broadcast equipment.

Mr. Cotter served in the United States Naval Reserve from 1917 to 1919, at which time he became associated with a consulting engineer in New York as radio engineer. From 1922 to 1925 he was employed by the Federal Telephone and Telegraph Company of Buffalo as engineer-in-charge of the radio development laboratory. During this time he was responsible for the establishment of the pioneer broadcast station WGR. For ten years Mr. Cotter was associated with the American Bosch Magneto Company as chief engineer. In 1935 he joined the Stromberg-Carlson Company as chief radio engineer, and later became radio consulting engineer.

Mr. Cotter has served The Institute of Radio Engineers on membership and admissions committees; and the American Institute of Electrical Engineers as vice-chairman of the Springfield Section, chairman of the Rochester Section, and vice-chairman of District 1, membership committee.

A member of the Rochester Engineering Society, Mr. Cotter is presently serving as a member of The Institute of Radio Engineers committee on radio receivers; member-at-large, membership committee, of the American Institute of Electrical Engineers; member of the Radio Manufacturers Association, committee on export radio receivers; and a member of Panel 5 of the Radio Technical Planning Board.

EMIL REISMAN

Emil Reisman (A'46) has been appointed chief engineer of Resistance Products Company, Harrisburg, Pennsylvania. He was formerly with International Resistance Company as development engineer on various types of resistors. During the war he served on several committees engaged in drawing up the American War Standards.

LOUIS GERARD PACENT

Louis Gerard Pacent (A'12-M'15-F'27), president of the Pacent Engineering Corporation, has received the War Department Certificate of Appreciation in recognition of his engineering services to the Signal Corps with the following citation: "For valuable assistance to the Signal Corps by developing and adopting manufacturing techniques which involved mass production of communication equipment, and the fact that these laboratories were able to accomplish vital phases of their mission to provide many types of advanced designs of new equipment for our fighting forces was in large measure due to your important contributions. The Signal Corps Engineering Laboratories express their appreciation for your outstanding service directed toward the successful conduct of the war."

Mr. Pacent is a Fellow of the Society of Motion Picture Engineers; Fellow and a past president of the Radio Club of America; Fellow of the American Institute of Electrical Engineers, and a member of their Board of Examiners and committee on communication; and member of the Acoustical Society of America.



A. R. HOPKINS

RCA APPOINTMENTS

Recent appointments in the engineering products department of the Radio Corporation of America include those of A. R. Hopkins (A'27-M'32-SM'43) as manager of communications and electronic equipment sales, C. M. Lewis (A'45) as sales manager of the Chicago region, and H. V. Sommerville (A'46) as sales manager of the Cleveland region.

Mr. Hopkins received the electrical engineering degree from The Ohio State University. He became associated with RCA in 1929. From 1937 to 1942 he was in charge of RCA broadcast equipment sales, and then became engineering products manager for the Chicago region.



JAMES F. JOHNSON

JAMES F. JOHNSON

James F. Johnson (A'40-M'42-SM'44), vice-chairman of the Seattle Section of The Institute of Radio Engineers, has been given charge of Eitel-McCullough, Inc., tube sales for The Dave M. Lee Company of Seattle, recently appointed northwestern regional sales representative. Mr. Johnson was manager of the communications group in the Radiation Laboratory at Massachusetts Institute of Technology during the war.



G. EMERSON PRAY

G. Emerson Pray (M'41-SM'43), senior engineer and a director of Tuck Electronic Corporation, was recently elected president of that company as well as a director and vice-president of Electronic Apparatus, Inc.



KENNETH A. NORTON

The appointment of Kenneth A. Norton (A'29-M'38-SM'43-F'43) as chief of the recently established frequency-utilization research section of the Central Radio Propagation Laboratory at the National Bureau of Standards was announced by E. U. Condon (M'42-SM'43), director of the Bureau. Mr. Norton rejoins the Bureau's staff from the War Department where he served the Chief Signal Officer as a consultant on radio wave propagation, and as assistant director of the Operational Research Group headed by W. L. Everitt (A'25-M'29-F'38). He also served with the Eighth Air Force in England as a radio and tactical countermeasures analyst.

Mr. Norton has contributed extensively to scientific journals in the field of radio wave propagation and its application to the allocation of radio frequencies. He is a Fellow of the American Physical Society and the American Society for the Advancement of Science, and a member of the American Institute of Electrical Engineers, American Mathematical Society, the Institute of Mathematical Statistics, and the American Statistical Society.

POPOV MEDAL

The Popov Gold Medal is awarded annually by the Presidium of the Academy of Sciences of the USSR to a scientist of any nationality for outstanding scientific research or invention in the field of radio. The first presentation was made in 1946 for work completed between 1933 and 1945, and subsequent awards will be given for works completed between competitions.

Manuscripts submitted for the competition should reach the Radio-Physics and Radio-Engineering Council of the Academy of Sciences of the USSR at Tretia Misuskaia 3, Moscow, not later than February 1 of the year for which the Medal is awarded, and must be marked "Popov Medal Competition." The Council will judge the material and submit the names of candidates to the Presidium by April 7, and the Medal will be awarded on May 7 ("Radio Day") of each year.

Entries may be made by scientific, bodies, research institutions, establishments for higher education, governmental bodies, public bodies, or individuals, and may be awarded for works that already have been published. They may be submitted in any language, in the form of three typed or printed copies. An organization should append its estimate of the scientific value of the work and its significance to the development of radio, a short biography of the candidate, and a list of his major scientific papers and inventions.

An award will be made only if the Council considers that a worthy entry is among those submitted.

❖

PLANNING COMMITTEE

At the February 5, 1947, meeting of the Board of Directors, the following were appointed to serve as members of a Planning Committee to survey activities of the Institute in the light of present and possible services to its members, and to plan a suitable course of future action: R. A. Heising, *chairman*; Alfred N. Goldsmith, B. E. Shackelford, D. B. Sinclair, Keith Henney, and S. L. Bailey.

❖

PATENTS IN THE PUBLIC DOMAIN

The United States Patent Office has issued a list of 'Dedicated Patents' (that is, patents dedicated to the people of the United States). It has also issued in November, 1946, 'Supplement No. 1 to Dedicated Patents' and will issue in January and June thereafter, additional supplements. Copies of the original listings and of the supplements may be secured through the United States Patent Office, Department of Commerce, Washington, D. C. Copies of the list of patents, or photostatic copies of the listed applications, may be obtained on terms given on the front inside cover of Supplement No. 1 mentioned above.



RALPH S. BEAL

RALPH R. BEAL

Ralph R. Beal (A'15-SM'45), vice-president in charge of engineering of RCA Communications, Inc., died on January 24, 1947. Mr. Beal was a pioneer in radio, television, and electronics. As a field engineer in the early days of radiotelegraph communication, he participated in the first investigations into high-power point-to-point radio transmission and contributed toward the development of the art into a dependable means of world-wide international communication.

Born in Maude, Kansas, in 1887, Mr. Beal received his technical training at Leland Stanford University. Graduated in 1912, he joined the Federal Telegraph Company in San Francisco, and subsequently supervised the installation of continuous-wave equipment in Navy radio stations in Panama, Hawaii, the Philippines, and Bordeaux, France. Later, he made engineering investigations in the Orient, related to establishing direct overseas radio communications between the United States and China.

Mr. Beal joined the Radio Corporation of America as its Pacific Division engineer in 1926, undertaking the application of modern equipment linking the RCA West Coast radiotelegraph services by direct overseas circuits to the principal countries of the Orient.

In 1934 he was transferred to New York as research supervisor of RCA. Three years later he was made research director and given the responsibility of co-ordinating research and advanced engineering development activities of the company and its subsidiaries. Among major developments to which he contributed during this period were the application of radio-electronics to the electron microscope, television, theater television, radar, radio relays, and the opening of the microwave section of the radio spectrum. When RCA formed a committee in 1935 to study television broadcasting, Mr. Beal was made chairman, a post which he held for nine years. He became vice-president of RCA Communications, Inc., in charge of engineering, on April 6, 1945.

Mr. Beal was a Fellow of the Society of Motion Picture Engineers and a member of the Microwave Committee of the Office of Scientific Research and Development.

ARMY SIGNAL ASSOCIATION

J. E. Brown was the Representative of the I.R.E. at the meeting of the Army Signal Association held in Chicago, January 17, 1947.

❖

CANADIAN COUNCIL

Virgil M. Graham was appointed to act as a liaison representative between the Canadian Council and the Board of Directors, at the February 5, 1947, meeting of the Board.

❖

AMERICAN DOCUMENTATION INSTITUTE

A meeting of the American Documentation Institute at which Dr. J. H. Dellinger represented the I.R.E., was held on January 30, 1947, to elect as members, the nominees of the nominating agencies.

❖

M.I.T. INDUSTRIAL FELLOWSHIPS IN ELECTRONICS

A number of Graduate and Advanced Research Fellowships are offered by the Massachusetts Institute of Technology for study and research in the field of electronics.

Applicants for Graduate Student Fellowships must satisfy the requirements for admission to the Graduate School on recommendation of the Department of Physics or the Department of Electrical Engineering. Recipients will work for advanced academic degrees in one of these spheres, the area of specialization falling within the field of electronics.

A few Advanced Research Fellowships will be awarded to candidates possessing graduate academic degrees or equivalent research experience who, without enrolling as graduate students, wish to pursue advanced studies and research in the field of electronics at M.I.T.

Graduate Student Fellows will receive between \$1200 and \$1500 according to their experience and qualifications, plus a credit to meet the tuition fee. Advanced Research Fellowships will range from \$2000 to \$3000.

Application for an Industrial Fellowship in Electronics should be made through the Director, Research Laboratory of Electronics, at least four months prior to the intended date of entrance.

❖

APPOINTMENTS COMMITTEE REPORT

On January 8, 1947, President Baker, as chairman of the Appointments Committee, presented the report of the committee which had been mailed to the 1946 Board Members. The following appointments were then made: Secretary, Haraden Pratt; Treasurer, R. F. Guy; Editor, Alfred N. Goldsmith; Appointed Directors—1947, J. E. Brown, F. R. Lack, J. R. Poppele, David Smith, W. C. White.

Books

Electrical Transmission in Steady State, by Paul J. Selgin

Published (1946) by McGraw-Hill Book Co., Inc., 330 W. 42 St., New York 18, N. Y. 416 pages+7-page index+ix pages+3-page bibliography. 104 illustrations. $5\frac{1}{2} \times 8\frac{3}{4}$ inches. Price, \$5.00.

Growing out of a set of notes prepared for lecture courses offered at the Polytechnic Institute of Brooklyn under the sponsorship of the War Training Program, this book "aims primarily at broadening... the foundations for a superstructure of technological knowledge which the reader... may have acquired through the exercise of his profession."

It is assumed that the reader is at least as well prepared as a senior in college, for to quote further from the preface: "A book such as this must be built upon a solid mathematical framework and cannot be 'light reading.' When unfamiliar branches of mathematics must be called upon, these should be adequately introduced.... It is to be hoped for example, that the reader may become familiar with the fundamentals of complex-function theory through its frequent applications to network- and impedance-transformation theory...."

The author considers transmission by means of circuits and lines only and so is not concerned with the theory of wave guides, antennas, or radiation. The analogies in the performance of lines and networks are stressed throughout the treatment of transmission constants, distortion, and reflection. Impedance transformation by networks and lines is expounded making use of conformal maps for Z and Y transformations. The quarter-wave transformer and tuned lines and stubs are handled in considerable detail, with discussions of the multisection transformer, generalized selectivity, and the exponential line. These latter are given as examples of the more-advanced type of problem which may be handled by the methods presented.

There is included a chapter on electromagnetic theory and static fields and one on Maxwell's equations as applied to circuit elements. Two chapters are devoted to coupled circuits and one each to network theory as applied to the vacuum-tube and high-frequency amplifiers. The bibliography lists a number of books on related subjects which are divided into eleven categories to which reference is made throughout the text.

In no sense a handbook for ready reference, this volume contains a wealth of basic theory which may well serve as a text for the engineering desiring to reinforce his background of fundamentals.

C. E. KILGOUR
Crosley Division
The Aviation Corporation
Cincinnati 25, Ohio

Reprints and Preprints

The following reprints are available:

"Radar," by Edwin G. Schneider. Published in the August, 1945, issue of the PROCEEDINGS OF THE I.R.E. AND WAVES AND ELECTRONS. Price, \$5.50.

"The Presentation of Technical Developments Before Professional Societies," by William L. Everitt. Published in the July, 1945, issue of the PROCEEDINGS OF THE I.R.E. Obtainable on request without charge.

"Preparation and Publication of I.R.E. Papers," by Helen M. Stote. Published in the January, 1946, issue of the PROCEEDINGS OF THE I.R.E. AND WAVES AND ELECTRONS. Obtainable on request without charge.

Please address your inquiries to
The Institute of Radio Engineers, Inc.
1 East 79 Street
New York 21, New York

The Electronic Control Handbook, by Ralph R. Batcher and William Moulic

Published (1946) by Caldwell-Clements, Inc., 480 Lexington Ave., New York 17, N. Y. 335 pages+6-page index+3-page bibliography+vii pages. 297 illustrations. $6 \times 9\frac{1}{4}$ inches. Price, \$4.50.

The writers of this handbook have proceeded on the theory that electronic control means a lot more than a few circuits with tubes in them. While the circuit sections have not been slighted, a large part of the book is devoted to the theory of control systems, means of converting physical characteristics to electrical signals, and electrical power to mechanical motion. To the radio engineer who wishes to enter the electronic-control field, this material should be of much more practical value than too many descriptions of specific control circuits.

Since this volume is intended to supplement the "Electronic Engineering Handbook" by the same authors, no space is taken up with fundamental tube theory. This omission will be appreciated by the reader who finds many electronic handbooks padded with much material of interest only to the tube designer.

The book has been planned in a painstaking effort to cover the whole control field, rather than overemphasize some specialty. By concentrating on basic circuits rather than complete systems, the authors have produced a book that should not quickly become obsolete. It is written with an understanding of electronic control and instrumentation problems as well as the required knowledge of electronic circuits. There may be some criticism that some circuit descriptions are too brief—a criticism which will always be applied to handbooks—but generous references and bibliographies provide leads for more detailed study on most subjects.

On the whole, the book succeeds well in its objective, and is about as comprehensive and practical a reference as has appeared in this field.

W. D. COCKRELL
General Electric Company
Schenectady, N. Y.

Principles of Radar (Second Edition), by Members of the Staff of the Radar School, Massachusetts Institute of Technology

Published (1946) by McGraw-Hill Book Co., Inc., 330 W. 42 St., New York 18, N. Y. 881 pages+6-page index. 568 illustrations. $6\frac{1}{2} \times 9\frac{1}{4}$ inches. Price, \$5.00.

This book is a revised edition of a book used during the war in the training of groups of Army and Navy officers at the M.I.T. Radar School. As such the book will undoubtedly be familiar to many readers of the PROCEEDINGS. The first edition which was originally issued as a confidential document has now been released from military-security classification, but is not generally available. The book was originally intended to give the student officers detailed grounding in the general technical principles of pulse-echo radar systems and the theory of operation of the various components of such systems. This new edition does not materially depart from this original intent, but some of the material of only transient military value has been deleted and other material of general interest added.

A chapter discussing the general considerations in pulse-echo radar systems and the terminology used in connection with them introduces the more detailed chapters of the book which deal with radar transmitting, modulating, receiving, timing, and indicating equipment. Chapters are also included on radar antennas and propagation, radio-frequency transmission lines, wave guides, transmit-receive switching devices, and the servomechanisms extensively used in transferring data and controls from one part of the system to another.

For the most part the detailed discussions of the principles of components are specific and on a quantitative basis, but generally not given in extensive mathematical detail. This treatment makes the book easily readable, and at the same time provides the reader with satisfactorily accurate concepts.

Although this book was published in 1946, a few items of past and present interest in the radar field have been omitted. In some cases this may have been due to uncertainty as to military-security classification, but some subjects, such as stagger-tuned intermediate-frequency amplifiers, which were mentioned in the now unclassified first edition, have been omitted. However, the book does cover the field of pulse-echo radar in a very comprehensive and readable fashion, and, as the only book of its kind available at present, it should be very useful not only to workers in the radar field, but to anyone wishing to obtain a sound and detailed introduction to the technical aspects of radar, and particularly to anyone interested in reviewing the many special techniques of wartime radar for possible applications to other fields.

E. K. STODOLA
Signal Corps Engineering Laboratories
Evans Signal Laboratory
Belmar, N. J.

Minutes of Technical Committee Meetings

ANTENNAS

Date November 4, 1946
 Place National Bureau of Standards,
 Washington, D. C.
 Chairman P. S. Carter

Present

P. S. Carter, *Chairman*
 Harry Diamond W. E. Kock
 J. E. Eaton D. C. Ports
 Byron Goodman M. W. Scheldorf
 (George Grammar) George Sinclair
 R. B. Jacques L. C. Van Atta
 J. W. Wright

The first item on the agenda was the discussion of microwave definitions. The entire committee was asked to think over the problem of defining an antenna radiation pattern which will cover both transmitting and receiving cases under one definition. Relative pattern is also to be defined. "Methods of Testing Antennas" was next reviewed. It was decided that a number of changes should be made in the material before it is presented at the next meeting. One of the problems is that of whether to use the *m-k-s* system of units throughout. This problem will be taken up with the Committee on Standards and a ruling obtained. Definitions of the following terms might prove useful: Relative Pattern; Cross Talk; Cross Coupling; Figures of Merit; Antenna Coupling.

ANTENNAS

Date December 2, 1946
 Place National Bureau of Standards,
 Washington, D. C.
 Chairman P. S. Carter

Present

P. S. Carter, *Chairman*
 Harry Diamond D. C. Ports
 J. E. Eaton P. H. Smith
 R. T. Holtz M. W. Scheldorf

The entire meeting was devoted to the consideration of revised definitions of microwave antenna terms, with the result that about 70 per cent of the definitions were approved, while the remainder were either dropped or deferred for future consideration.

RADIO RECEIVERS

Date November 13, 1946
 Place Hotel Sheraton, Rochester,
 New York
 Chairman W. O. Swinyard

Present

W. O. Swinyard, *Chairman*
 G. L. Beers C. R. Miner
 W. F. Cotter J. M. Pettit
 Mr. Fox F. H. R. Pounsett
 J. K. Johnson R. F. Shea

The first matter discussed was the method to be used in gathering the data to be forwarded to the chairman for editing into the report for the Annual Review. It was generally agreed that only items which comprised contributions to the art should be

Publication Delays

With the lifting of secrecy regulations at the end of the war, much important material on advances in communications and electronics made during recent years became available. The authors of papers on these subjects and the organizations in which such progress has been made naturally feel that these developments should receive early publication. The Institute of Radio Engineers thoroughly agrees with this point of view and in anticipation of just such a condition, the Board of Directors set aside a substantial postwar publication fund. It was believed that this would enable the Institute to publish with reasonable promptitude all postwar papers in its field which were submitted for the PROCEEDINGS.

Unfortunately, postwar conditions have prevented the consummation of this plan. Rising printing and paper costs have absorbed the fund and made even further demands on the limited income of the Institute. Further, the flood of valuable postwar papers has far exceeded predictions and many more papers of importance are anticipated. Even with a critical policy on acceptance of papers and the requirement of condensation of material wherever possible, our situation is one of great difficulty.

Vigorous efforts have been and are still being made to secure additional funds which will enable the Institute somewhat to clear up its backlog of papers. The size of the PROCEEDINGS has been gradually increased during the last few years, and a further expansion is in progress. We hope that we shall be able to go much farther later in the year, and meanwhile ask your patience during necessary delays. Any concrete suggestions as to ways and means of raising added funds for publication will be appreciated.—
The Editor

DELAYS MAY OCCUR— PLEASE WAIT!

It is intended that the PROCEEDINGS OF THE I.R.E. shall reach its readers approximately at the middle of the month of issue. However, present-day printing and transportation conditions are exceptionally difficult. Shortages of labor and materials give rise to corresponding delays. Accordingly, we request the patience of our PROCEEDINGS readers. We suggest further that, in cases of delay in delivery, no query be sent to the Institute unless the issue is at least several weeks late. If numerous premature statements of nondelivery of the PROCEEDINGS were received, the Institute's policy of immediately acknowledging all queries or complaints would lead to severe congestion of correspondence in the office of the Institute.

included. The committee assigned to some of its members the task of summarizing and reporting on sixteen of the leading technical publications. The Chairman will review the complete list of publications and make additional assignments where required. The next item on the agenda was a discussion of "Methods of Testing Frequency-Modulation Broadcast Receivers (between 88 and 108 megacycles)," particularly with regard to the request of the I.R.E. Standards Committee that there be considered certain changes in this report. Discussion made it evident to the committee that in some instances, the art has not yet reached the point where firm standards on test methods can be recommended.

SUBCOMMITTEES

POWER-OUTPUT HIGH-VACUUM TUBES

Date November 22, 1946
 Place McGraw-Hill Building, New
 York, N. Y.
 Chairman I. E. Mouromtseff

Present

I. E. Mouromtseff, *Chairman*
 T. A. Elder L. J. Nergaard
 C. E. Fay E. E. Spitzer
 R. W. Grantham C. M. Wheeler
 H. W. Mendenhall A. K. Wing, Jr.

Dr. Mouromtseff undertook the preparation of the material for the Annual Review. A final definition for "perveance" was agreed upon. "Methods of Testing, Section 3, Emission Tests" will include as Section 31 the material on determination of Richardson field-free emission by means of the Schottky-line intercept as suggested by Dr. Nergaard. This will require the rewriting of Section 3 by Mr. Fay and submission to Dr. Nergaard for comment. A list of definitions compiled by the Small High-Vacuum Tube subcommittee was reviewed, but action not completed.

SMALL HIGH-VACUUM TUBES

Date December 6, 1946
 Place McGraw-Hill Building,
 New York, N. Y.
 Chairman Alan C. Rockwood
 Acting Secretary L. B. Curtis

Present

Alan C. Rockwood, *Chairman*
 E. M. Boone E. H. Hurlburt
 L. B. Curtis E. R. Jervis
 J. T. Fetch J. A. Morton
 G. D. O'Neill

The morning session was devoted to the correction of the October 11 Committee meeting minutes, amendments to Methods of Testing and Definitions. The Chairman announced with regret the resignation of A. C. Bousquet. Harold Ellithorn of the physics laboratory of Notre Dame University and E. R. Jervis of the Tung-Sol Lamp Works in Newark have accepted membership on the Committee.

The afternoon session was spent in editing the explanatory section on Methods of Measuring Vacuum-Tube Admittances.



Donald W. R. McKinley

CHAIRMAN, OTTAWA SECTION, 1947

Donald W. R. McKinley was born in Shanghai, China, on September 22, 1912. At the University of Toronto he obtained the degrees of Bachelor of Arts in mathematics and physics in 1934, Master of Arts in 1935, and Doctor of Philosophy in experimental physics in 1938. After some field work in geophysics he went to the National Research Council, Ottawa, in 1939, to take charge of the Standard Frequency Laboratory, and later worked on the development of an airborne cathode-ray direction finder.

In August, 1940, he went to England for six months as radio and radar liaison officer for the N.R.C. On his return, he became head of the Air Force Section of the Radio Branch, which handled the design and development of radar equipment for the Royal Canadian Air Force, including the small-scale production of microwave-early-warning and microwave-height-finder equipments. In 1942, he was given a commission in the Royal Canadian Air Force, but he was immediately put on the Reserve List and instructed to continue on military research in a civilian capacity. From December, 1943, to March, 1944, he investigated the tropicalization and operational problems connected with service radio and radar equipment—visiting Australia, New Guinea, Ceylon, and India. During 1944–1945 he was chairman

of a Canadian interservice committee to co-ordinate work on the tropicalization of military equipment, and was also chairman of the Troposphere Subcommittee of the Canadian Radio Wave Propagation Committee.

From the latter part of 1944 to the present he has been in charge of the N.R.C. development work in the field of radio aids to aerial navigation, and is a member of the Commonwealth and Empire Conferences on Radio for Civil Aviation, an observer-member of the Radio Technical Commission for Aeronautics, and a technical adviser at the Radiotechnical Division of the Provisional International Civil Aviation Organization.

Dr. McKinley is a member of the associate Committee on Aeronautical Research, and the Canadian Radio Technical Planning Board. His amateur-radio activities have dated from 1928, and included membership in the Canadian Amateur Radio Operators' Association, the American Radio Relay League, and the Radio Society of Great Britain. He joined The Institute of Radio Engineers in 1939 as an Associate and transferred to Senior Member in 1946. He is now chairman of the Ottawa Section of the I.R.E. and a member of the Canadian Council of the I.R.E. In the King's Honours List, July, 1946, he was made an Officer of the British Empire.

Engineers who become members of a society representing their field assume certain tacit, but none the less real obligations. Among these is to contribute to the upbuilding of their field through constructive participation in the affairs of their society. A forceful presentation of this aspect of engineering activities is contained in the following guest editorial from the Secretary-Treasurer of the Emporium, Pennsylvania Section of the Institute.—*The Editor*

Active Participation versus Passive Activity

DAVID J. KNOWLES

A large number of the editorials which have appeared in the PROCEEDINGS in the last two years, dealt with responsibilities. The subjects covered include the responsibility of the engineer to society, to the Institute, to our government, to other scientists, and the converse of these. This follows a trend not only in the thinking of the engineering brotherhood, but also in the thinking of all men in a world where we are beginning to realize that to reach our goal of an ideal world, we must recognize and accept our responsibilities. Probably the basic responsibility is that of the individual to society and vice versa; or from the engineering standpoint, the responsibility of the engineer to other individuals for the results of his developments.

The engineer now realizes that his products and ideas can be perverted to any cause no matter what chaos and destruction result therefrom; and he can no longer ignore the uses to which his work is put. He must accept the responsibility not only for the creation of his ideas, but also for their administration.

Activity in the Institute and its Sections becomes, therefore, not only desirable, but also necessary. By activity is meant the active participation in Institute and Section affairs as opposed to the passive activity of merely being a member and paying dues. These are necessary things, but attendance at Section meetings if at all possible; the voluntary action of serving on committees, contribution to the publications, or even the participation in the discussion of a paper all lead to a strengthening of our organization. If we are to have organizational activity we must have individual activity.

We function through the representation of our organization. To be efficient our organization should be the voice of *all* radio and electronic engineers. To attract new members and thus strengthen its voice, the Institute must be alive no matter how conservative and dignified its policies and individual activity is the key to this. True majority rule must be maintained as well as wise leadership and activity is again the key. If our "engineering conscience" is to guide us, our voice must be the voice of the majority of the members and the individual must actively express himself to his officers. If asked to serve as an officer or on a committee, the opportunity should not be passed by. Such experience is valuable to the Institute and the profession, since individuals so experienced help formulate policy to a greater extent than passive members. This activity also points out men of the caliber for national leadership.

Briefly, from the radio engineer's standpoint, the best way of accepting his responsibilities is a problem to be solved. The activity and participation of the individual in Institute affairs no matter how small is a large factor in the solution of the problem.

Radio Progress During 1946

Introduction

THE YEAR 1946 marked the substantial reconversion of the radio manufacturing industry from a wartime to a peacetime basis. Substantial progress was also made in restoring and expanding international communication services which had been discontinued or converted to wartime uses at the outbreak of the war.

As was the case during the year 1945, a large number of the papers published during 1946 described developments carried on in connection with the solution of military problems. However, there developed a marked tendency to describe the application of these developments to peacetime purposes. In the case of electron tubes, the new developments were mostly in the fields of television and systems employing frequency modulation. In the case of transmitters and receivers, the new developments were largely in the field of low-power systems operating in the very-high-frequency or the ultra-high-frequency range for communication with mobile units, or for point-to-point relay operation. Very little development was described during the year with reference to the field of standard broadcasting.

During 1946 many papers of interest were presented at the Winter Technical Meeting of the Institute in New York in January, at the Fourth I.R.E. Electron Tube Conference at Yale University in June, at the National Electronics Conference in Chicago in October, and at the Rochester Fall Meeting held jointly by the Institute and the Radio Manufacturers Association in Rochester, N. Y., in November. Many of these papers, however, were not published during the period covered by this review.

The "Bibliography of Scientific and Industrial Reports," published by the United States Department of Commerce, contained abstracts of reports of publications describing various enemy and United States Government wartime communication developments. These abstracts had to do with the theoretical and practical aspects of radar, communication equipment, secrecy systems, jamming devices, and countermeasures systems. This publication is issued weekly by the Department of Commerce, Office of Technical Services, and is sold by the Superintendent of Documents, Government Printing Office, Washington 25, D. C., on a subscription basis, \$10 for one year. Abstracts are given, together

with the prices of microfilm or photostat copies, of the complete reports.

Radio Transmitters and Modulation Systems

During this period, the literature began to reflect some of the work of the war era which had previously been withheld from publication. The scope of radio transmitters has been greatly extended in frequency, power, and applications. In some new systems, such as radar and radio relaying, the transmitter portion is less distinguishable as a separate entity than in the older systems, so that the literature deals with the transmitter as an incidental part of a whole system. The same is true to some extent with regard to frequency-modulation and television broadcasting, underwater sound, most mobile communication systems, and navigational aids.

The literature which appeared during 1946 featured primarily the new techniques which had been developed, and little was written about the evolution in the design of the more "conventional" transmitters for communication, navigation, and broadcasting. The activity in the general engineering of "conventional" radio transmitters was but slightly represented in the published literature; commercial advertisements, however, reflected a marked and vigorous development and served as a barometer of progress.

Radio transmitters of greatly diversified types had come into use during the war in connection with walkie-talkies, handy-talkies, radar, proximity fuzes, beacons, guided missiles, loran, and innumerable other applications. There had also been a great deal of engineering devoted to special transmitters for wave-propagation studies.

- (1) C. J. Marshall and L. Katz, "Television equipment for guided missiles," *Proc. I.R.E.*, vol. 34, pp. 375-401; June, 1946.
- (2) R. D. Kell and G. C. Sziklai, "Miniature airborne television equipment," *RCA Rev.*, vol. 7, pp. 338-357; September, 1946.
- (3) Daniel E. Noble, "Details of the SCR-300 FM walkie-talkie," *Electronics*, vol. 18, pp. 204, 209, 212, 216; June, 1945.
- (4) F. Rockett, "Proximity fuze," *Electronics*, vol. 18, pp. 110-111; November, 1945.
- (5) W. S. Hinman, Jr. and Cleo Brunetti, "Radio proximity fuze design," *Jour. Res., Nat. Bur. Stand.*, vol. 37, p. 113; July, 1946.
- (6) J. G. Nordahl, "Tank radio set," *Bell Lab. Rec.*, vol. 23, pp. 1-5; January, 1945.
- (7) T. W. Wigton, "Railroad radio communication on the VHF'S," *Radio*, vol. 29, pp. 35-39; August, 1945.

The war period saw a revival of very-low-frequency and low-frequency communications, especially in the auroral zones where high-frequency conditions are often unfavorable. Many new transmitter designs were

* Decimal classification: R090.1. Original manuscript received by the Institute, January 20, 1947; revised manuscript received, January 27, 1947. This report is based on material from the 1946 Annual Review Committee of The Institute of Radio Engineers, as co-ordinated and edited by the Chairman.

manufactured in great numbers and placed in service in point-to-point, marine coastal, and aviation and marine navigation systems. The use of low-frequency airways aids continued while very-high frequencies were being installed. Future long-range navigation trends indicate an increasingly important role for low frequencies and new developments in high-power low-frequency transmitters are indicated. A very-low-frequency transmitting station of 1000 kilowatts output was used by the Germans for long-distance communication with submarines.

Broadcasting

There has been a steady upward trend in the number of broadcasting stations, and the transmitter power is increasing year after year in all bands, from that used for European low-frequency broadcasting up through the band used for frequency-modulation broadcasting in the United States. A new International Broadcasting

TABLE 1

RADIO BROADCAST STATIONS FOR WHICH LICENSES AND CONSTRUCTION PERMITS ISSUED BY THE FEDERAL COMMUNICATIONS COMMISSION WERE OUTSTANDING ON DECEMBER 31, 1946

Class of Broadcast Station	Number of Licenses and Construction Permits
Standard	1520
Commercial high-frequency (frequency modulation)	473
Conditional grants	211
Experimental high-frequency	1
Commercial television	51
Experimental television	67
International	38
Facsimile	3
Noncommercial educational	28
Developmental	37

Union in Europe was organized to deal with frequency-assignment matters in that region. Applications to the Federal Communications Commission in the United States for licenses for broadcasting stations were at an all-time high. Similar activity existed in almost all of the nations of the Western hemisphere. Short-wave broadcasting was expanded enormously throughout the world, with many new countries participating and the power employed increasing. There were many 50-, 100- and 200-kilowatt transmitters in use, and powers up to 500 kilowatts are indicated in the near future. Growth of frequency-modulation broadcasting was indicated by the fact that more than 900 applications were pending at one time before the Federal Communications Commission. Some applicants proposed to use transmitter powers as high as 50 kilowatts. These facts, revealed by the news rather than the technical literature, showed the impetus behind transmitter engineering and the reasons for present and future record manufacturing activities. New economic conditions and new power tubes were dominant factors in progress in transmitter design.

- (8) H. Romander, "Engineering details of OWI 200 kw units," *Elec. Ind.*, vol. 4, pp. 100-103, 158, 162; October, 1945.
- (9) "The Programme of Work of la Radio-diffusion Francaise," *M. A. Genie Civ.*, vol. 123, p. 52; February 15, 1946.
- (10) N. J. Oman, "A new exciter unit for frequency modulated transmitters," *RCA Rev.*, vol. 7, pp. 118-130; March, 1946.

During recent years an important evolution of low- and medium-power transmitters has been evidenced by increasing applications of transmitters employing multiple radio-frequency sections, each tuned for a single working frequency and arranged for simultaneous operation on two or more frequencies selectable by remote control. Multichannel transmitters of this type are popular for airways-ground and point-to-point communications, and all the leading manufacturers now offer equipment of this type.

The use of single-sideband equipment for high-frequency point-to-point public telephony has grown to large proportions in recent years. Many such services to world points were by a combination of radio and land-line relay, and this was supplemented in some cases by direct radio circuits. Many new terminal points were also added to the world radiotelephone system. The efficiency of this system in power, in circuit stability, and in spectrum conservation has resulted in its general adoption throughout the world.

During the war, teleprinter operation on single sideband was used in a system known as two-tone voice-frequency telegraph, wherein one audio tone was used for the marking signal and another for the spacing signal. This form of frequency multiplexing permitted as many as six telegraph channels on one sideband, or twelve in the case of twin-channel single sideband. Under disturbed propagation conditions, the same number of tones could be used for a smaller number of teleprinter channels by marking and spacing with multiple tones.

Frequency-Shift Keying

The advent of frequency-shift keying in high-frequency communication occurred during the war and was being used increasingly. Frequency-shift exciters were produced for commercial use with existing high-frequency telegraph transmitters. In this system of communication, the radio transmitter is unusual only in the application of the keying signals to the frequency-shift exciter, which replaces the conventional master oscillator. The advantages of the system are realized by the receiving technique, as in frequency-modulation systems generally. Frequency-shift facsimile and radiophoto transmission were also developed.

- (11) C. F. P. Rose, "A 60-kilowatt high-frequency transoceanic radiotelephone amplifier," *Proc. I.R.E.*, vol. 33, pp. 657-662; October, 1945.
- (12) H. O. Peterson, J. B. Atwood, H. E. Goldstine, G. E. Hansell, and R. E. Shock, "Observations and comparisons on radio telegraph signaling by frequency shift and on-off keying," *RCA Rev.*, vol. 7, pp. 11-31; March, 1946.

- (13) F. Vinton Long, "AACS radioteletype weather transmission system," *Communications*, vol. 26, pp. 16, 18, 20, 52-55; September, 1946.
- (14) T. A. Jones and K. W. Pfeleger, "Performance characteristics of various carrier telegraph methods," *Bell. Sys. Tech. Jour.*, vol. 25, pp. 483-531; July, 1946.

During the year, radiotelephone service was inaugurated between radio stations at fixed points and automotive vehicles. In certain cities in the United States this was being done as an extension of the land-line telephone service. Frequency-modulation equipment on very-high frequencies was used and two-way operation was obtained by a "press-to-talk" telephone instrument in the vehicle.

Experience with grounded-grid operation of power amplifiers continued favorably as new tubes of characteristics suitable for this mode of operation at higher and higher frequencies became available. Grounded-grid operation was quite general in most new high-frequency and very-high-frequency power amplifiers when triodes were used. However, tetrode amplifiers were widely used at powers for which suitable tetrodes were available.

Class-B high-level modulation of a class-C power amplifier was the dominant system of amplitude-modulating radio transmitters throughout the world. Only occasional exceptions were noted. The Doherty system of high-efficiency linear amplification continued in use in some degree. Other systems of high-efficiency linear amplification have been occasionally disclosed. These, together with the many systems suggested during the 1930's, when special effort was directed to this subject, have found almost no commercial adoption.

Feedback techniques for audio amplifiers and modulation systems were the subject of further study and improvement. One important contribution to modulator feedback circuits was the cathode follower, which replaced the former modulator-driver two-winding transformer which was troublesome because of its phase-frequency characteristics.

- (15) S. T. Fisher, "A new method of amplifying with high efficiency a carrier wave modulated in amplitude by a voice wave," *Proc. I.R.E.*, vol. 34, pp. 3P-14P; January, 1946.
- (16) H. W. Bode, "Network Analysis and Feedback Amplifier Design," D. Van Nostrand Company, Inc., New York, N. Y.; 1945.

During the war, a broadcast transmitter of 2500 kilowatts output was placed in operation. Its location and purpose are not revealed. Others of 500 kilowatts and 800 kilowatts were also commissioned but have not yet been described.

Radio transmitters of many specialized kinds were developed for navigational applications. Some of the transmitters employed pulse techniques and some continuous waves. The frequencies employed run through the entire present-day radio spectrum.

Pulse Techniques

During the war, pulse techniques were developed for

applications from low frequencies (low-frequency loran and sonar) through to the microwaves (radar, etc.) and in powers from milliwatts to megawatts. Pulse generation was solely a transmitter function in all pulse systems, and pulse transmitters became a whole new field of radio transmitter technology. Already the literature contains important papers on this subject. Even though the birth of pulse transmitters occurred years ago in ionosphere explorations, its recent evolution has placed it definitely in the realm of new technology.

- (17) D. D. Grieg, "Pulse-time modulation radio relay system," *Electronics*, vol. 19, pp. 95-96 (Abstract); March, 1946.
- (18) R. E. Lacy, "Multichannel microwave radio relay equipments for the Army," *Electronics*, vol. 19, pp. 96-108 (Abstract); March, 1946.

One type of pulse transmitter, which was described during the year, consisted essentially of a stable frequency source, which set the pulse rate, a clipper-differentiator-clipper chain which shaped the pulse and determined its duration, and subsequent power amplifiers which raised the power level to that desired for the application. Another form was that in which pulsing was accomplished in the modulating circuits and applied as a pulse of plate potential to a self-oscillator. In the latter, the pulse rate was sometimes set by spark discharge and the pulse characteristics set by a pulse-shaping network such as a Guillemin line. The power level was determined by the plate potential applied during the pulse. This technique differed almost completely from that of conventional transmitters. The simplest form of pulse transmitter was the blocking oscillator.

References to published papers dealing with radar are given in the section of this review entitled, "Navigation Aids."

Relay Systems

Pulse methods were applied successfully to radio relaying at frequencies where it was practical to employ pulses of short duration with their resulting wide bandwidths. Military field equipment developed during the war made available multichannel telephone and telegraph operation over links and relay circuits by time-division multiplex modulation, assigning to successive pulses a sample of the status of the signal in each successive channel. Modulation in these equipments was by the pulse-time or pulse-position method.

Radio relaying by continuous-wave methods was also exploited successfully, employing frequency modulation, either single or double. On account of the low power used, the radio transmitter equipment resembled closely the receiver and other portions of the equipment and sometimes used identical tubes, thus substantially merging these normally opposite fields of radio engineering.

- (19) John J. Kelleher, "Pulse-modulated radio relay equipment," *Electronics*, vol. 19, pp. 124-129; May, 1946.
- (20) D. D. Grieg and A. M. Levine, "Pulse-time modulated multiplex radio relay system—terminal equipment," *Elec. Commun.*, vol. 23, pp. 159-178; June, 1946.

- (21) D. D. Grieg, "Multiplex broadcasting," *Elec. Commun.*, vol. 23, pp. 19-26; March, 1946.
- (22) William R. Greer, "Pulse modulating system," *Electronics*, vol. 19, pp. 126-131; September, 1946.
- (23) James F. Gordon, "A new angular-velocity-modulation system employing pulse technique," *Proc. I.R.E.*, vol. 34, pp. 328-334; June, 1946.
- (24) C. R. Burrows and A. Decino, "Ultra-short-wave multiplex," *Proc. I.R.E.*, vol. 33, pp. 84-94; February, 1945.
- (25) N. F. Schlaack and A. C. Dickieson, "Cape Charles-Norfolk ultra-short-wave multiplex system," *Proc. I.R.E.*, vol. 33, pp. 78-83; February, 1945.
- (26) W. S. Marks, Jr., O. D. Perkins, and W. R. Clark, "Radio-relay communication systems in the United States Army," *Proc. I.R.E.*, vol. 33, pp. 502-522; August, 1945.
- (27) F. J. Bingley, "VHF multiple-relay television network," *Electronics*, vol. 18, pp. 102-108; October, 1945.
- (28) C. W. Hansell, "Radio-relay systems development by the Radio Corporation of America," *Proc. I.R.E.*, vol. 33, pp. 156-168; March, 1945.
- (29) "Multi-channel pulse modulation," *Wireless World*, vol. 52, pp. 187-192; June, 1946.
- (30) "Army No. 10 set," *Wireless World*, vol. 36, pp. 282-285; September, 1946.
- (31) H. Chireix, "Determination of noise power and signal-noise ratio for the case of simplex or multiplex radio transmission on ultra short-waves by (a) amplitude or duration-modulated pulses; (b) frequency modulated pulses," *Ann. Radioelec.*, vol. 1, pp. 55-64; July, 1945.

A radio-relay system for commercial telegraph service linking New York and Philadelphia was placed in operation in July, 1946. Progress was made in the installation of three additional systems to connect New York, Washington, and Pittsburgh. These circuits are to operate in the 4000-megacycle range with a signaling bandwidth of 150 kilocycles. They can accommodate as many as 512 duplexed teleprinter circuits.

- (32) J. Z. Millar, "A preview of the Western Union system of radio beam telegraphy," *Jour. Frank. Inst.*, vol. 241, pp. 397-413; June, 1946; and vol. 242, pp. 23-40; July, 1946.
- (33) F. B. Bramhall, "Radio relays for telegraphy," *Elec. Eng.*, vol. 65, pp. 516-520; November, 1946.
- (34) C. W. Hansell, "Development of radio relay systems," *RCA Rev.*, vol. 7, pp. 367-384; September, 1946.
- (35) G. G. Gerlach, "A microwave communication system," *RCA Rev.*, vol. 7, pp. 576-600; December, 1946.

During 1946, a system of ultra-high-frequency broadcasting was proposed for eight simultaneous programs transmitted by means of time-division multiplexing of pulses by pulse-position modulation.

- (36) D. D. Grieg and A. G. Kandoian, "Pulse-time multiplex broadcasting of the ultra-high-frequencies," *Proc. National Electronics Conference*, 1946.

Transmitter Circuit Design

Transmitter design principles have evolved, during very recent years, from lumped L and C circuits to distributed circuits of the transmission-line type and then into enclosed spaces such as wave guides and cavities. As the frequency of transmission increased, more and more of the transmitter was built into the tube. Ultra-high-frequency and super-high-frequency tubes exemplify the evolution of tube and tuned circuit built into one.

For references to work on cavity resonators, see the section of this review entitled, "Radio Wave Propagation."

A vacuum-contained push-pull triode transmitter was described in which the resonating grid and plate circuits were in the evacuated space and formed integral parts of the grid and plate structures. The tube was used with a tuned filament line. It could oscillate in a narrow frequency band between 200 and 700 megacycles per second. Its output was 200 to 300 kilowatts peak pulsed power and it could also be used for continuous waves.

- (37) H. A. Zahl, J. E. Gorham, and G. F. Rouse, "A vacuum-contained push-pull triode transmitter," *Proc. I.R.E.*, vol. 34, pp. 66W-69W; February, 1946.

Telegraph Switching Systems

During the war, reperforator switching systems were installed in the central offices of the telegraph company in several large cities in the United States, replacing the former manual methods of relaying messages. Announcement was made of a program for extending semi-automatic message relaying on a country-wide basis utilizing microwave radio and carrier-current transmission. It is planned to divide the United States into state-wide or larger areas, each served by a single central office. Such offices, operating on a semiautomatic basis, would have circuits to all telegraphic points within their respective state areas. Area central offices would then be interconnected by trunk route systems. Both the inter- and intra-area circuits are expected to make liberal use of radio-relay circuits.

Over-all goals of this system reorganization are fewer central-office handlings per message, reduced central-office transit time, and improved accuracy through the elimination of manual repetitions.

- (38) F. E. D'Humy and H. L. Browne, "Recent developments in telegraph switching," *Trans. A.I.E.E. (Elec. Eng.)*, February, 1940, vol. 59, pp. 71-77; February, 1940.
- (39) F. E. D'Humy and P. J. Howe, "American telegraphy after 100 years," *Trans. A.I.E.E. (Elec. Eng.)*, December, 1944, vol. 63, pp. 1014-1032; December, 1944.
- (40) R. E. Hanford, "United Air Lines reperforator switching systems," *Elec. Commun.*, vol. 22, no. 4, pp. 203-211; 1945.

Transmitter Techniques

Among other published papers relating to radio transmitter techniques were the following:

- (41) J. R. Pierce, "Reflex oscillators," *Proc. I.R.E.*, vol. 33, pp. 112-118; February, 1945.
- (42) R. J. Kircher, "A coil-neutralized vacuum-tube amplifier at very-high frequencies," *Proc. I.R.E.*, vol. 33, pp. 838-843; December, 1945.
- (43) Werner Muller, "Transitron oscillator for high stability," *Elec. Ind.*, vol. 4, pp. 110-112, 134, 136, 138; December, 1945.
- (44) J. S. Jackson, "Analysis of parasitic oscillations in radio transmitters," *Radio News*, vol. 35, pp. 68, 70, 86, 88; February, 1946.
- (45) J. R. Brinkley, "A method of increasing the range of VHF communication systems by multi-carrier amplitude modulation," *Jour. I.E.E. (London)*, vol. 93, part III, pp. 159-166; disc. pp. 167-176; May, 1946.
- (46) J. F. Gordon, "A new angular-velocity-modulation system employing pulse techniques," *Proc. I.R.E.*, vol. 34, pp. 328-334; June, 1946.
- (47) N. Young, "Television transmitter for black-and-white and color television," *Proc. National Electronics Conference*, 1946.
- (48) W. R. Rambo, "Frequency modulation of high-frequency power oscillators," *Proc. National Electronics Conference*, 1946.

- (49) Robert Samuelson, "Microwave generators," *Proc. National Electronics Conference*, 1946.
- (50) J. B. Fisk, H. D. Hagstrum, and P. L. Hartman, "The magnetron as a generator of centimeter waves," *Bell Sys. Tech. Jour.*, vol. 25, pp. 167-348; April, 1946.
- (51) E. I. Green, H. J. Fisher, and J. G. Ferguson, "Techniques and facilities for microwave radar testing," *Bell Sys. Tech. Jour.*, vol. 25, pp. 435-482; July, 1946.

Frequency Modulation

During 1946 the developments in frequency modulation progressed as rapidly as the reconversion process would permit. Many new models of frequency-modulation broadcast transmitters were announced. Frequency-modulation receivers did not begin to appear on the market until the latter part of the year, at which time a few of the larger, more expensive, console type were released. Applications for frequency-modulation broadcasting licenses were being filed at a rapid rate and in some areas the available frequency spectrum was saturated. In April, the Federal Communications Commission authorized "interim operation" in which frequency-modulation broadcast stations were allowed to operate with low power and temporary antenna systems on either the old 43- to 50-megacycle band or the new 88 to 108-megacycle band "pending the availability of full equipment." At the end of the year a few stations were still operating on the low-frequency band. In November the Commission authorized, on an optional basis, the radiation of circular or elliptical polarization, but retained the standard of horizontal polarization where only one polarization was radiated.

One method of generating frequency modulation was described in which a special tube was devised to produce phase modulation by beam deflection in a cathode-ray type of tube. The beam was deflected in a manner such that the phase modulation was given the proper compensation to convert it to frequency modulation.

- (52) Robert Adler, "Phasitron modulator," *FM and Television*, vol. 5, pp. 30-31, 68; December, 1945.
- (53) F. M. Bailey and H. P. Thomas, "Phasitron FM transmitter," *Electronics*, vol. 19, pp. 108-112; October, 1946.

Another modulator was described in which phase modulation was generated from pulse-time modulation by means of a mechanically saturated nonlinear coil.

- (54) L. R. Wrathall, "Frequency-modulation by nonlinear coils," *Bell Lab. Rec.*, vol. 24, pp. 102-105; March, 1946.

Other frequency-modulation transmitters were described which employed modifications of reactance-tube frequency modulation involving somewhat different methods of producing the frequency variations and effecting automatic frequency control.

- (55) J. R. Boykin, "FM frequency control system," *Radio*, vol. 30, pp. 20-22, 62-63; February, 1946.
- (56) M. Silver, "Federal FM broadcast transmitter," *FM and Television*, vol. 6, pp. 34-36; February, 1946.

A new type of frequency-modulation detector was described which had the property of insensitivity to amplitude modulation, so that the limiter preceding the

detector was made unnecessary. The circuit involved a locked-in oscillator and comprised only a single tube and discriminator circuit. Further description was given of the ratio type of detector, which has the same property of insensitivity to amplitude modulation.

- (57) William E. Bradley, "Single-stage FM detector," *Electronics*, vol. 19, pp. 88-91; October, 1946.
- (58) S. W. Seeley, "New ratio detector simplifies FM receiver design," *Broadcast News*, no. 42, pp. 46-47; January, 1946.

A frequency-modulation signal generator was described employing a master-oscillator-amplifier circuit instead of the usual heterodyne system. The spurious responses attendant to the heterodyne system were therefore eliminated. Modulation calibration was held constant by means of a circuit design in which the degree of frequency deviation was independent of output frequency.

- (59) Donald M. Hill and Murray G. Crosby, "Design of FM signal generator," *Electronics*, vol. 19, pp. 96-101; November, 1946.

Further consideration of fundamental frequency-modulation theory was offered by various workers in the field. Studies were also made of frequency-modulation propagation.

- (60) B. van der Pol, "The fundamental principles of frequency-modulation," *Jour. I.E.E. (London)*, vol. 93, part III, pp. 153-158; May, 1946.
- (61) J. Ernest Smith, "Theoretical signal-to-noise ratios," *Electronics*, vol. 19, pp. 150-152, 154; June, 1946.
- (62) W. J. Frantz, "The transmission of a frequency-modulated wave through a network," *Proc. I.R.E.*, vol. 34, pp. 114P-125P; March, 1946.
- (63) P. Guttinger, "The mutual effect of two frequency-modulated waves in limiters," *Brown Boveri Rev.*, vol. 31, pp. 296-297; September, 1944.
- (64) P. Guttinger, "Effect of frequency and phase distortions on frequency-modulated waves" (in German), *Assoc. Suisse Elect. Bull.*, vol. 36, pp. 261-269; May 2, 1945.
- (65) M. S. Corrington, "Frequency-modulation distortion caused by multipath transmission," *Proc. I.R.E.*, vol. 33, pp. 878-891; December, 1945.
- (66) S. T. Meyers, "Nonlinearity in frequency-modulation radio systems due to multipath propagation," *Proc. I.R.E.*, vol. 34, p. 256; May, 1946.

Applications of frequency modulation to telegraphy were described in which improvements in transmission and operating efficiency were reported.

- (67) H. O. Peterson, John B. Atwood, H. E. Goldstine, Grant E. Hansell, and Robert E. Schock, "Observations and comparisons on radio telegraph signaling by frequency shift and on-off keying," *RCA Rev.*, vol. 7, pp. 11-31; March, 1946.
- (68) Chris Buff, "Frequency shift keying technique," *Radio*, vol. 30, pp. 14-17, 30; August, 1946.

Narrow-band frequency modulation was investigated for amateur uses.

- (69) J. Babkes, "Narrow-band FM for amateur use," *CQ*, vol. 2, pp. 7-8, 61-63; March, 1946.
- (70) J. C. Geist, "Simplified f.m.," *QST*, vol. 29, pp. 29-30, 90; December, 1945.
- (71) Geo. W. Shuart, "Narrow-band f.m. with crystal control," *QST*, vol. 30, pp. 27-29; November, 1946.

Clipping Limiter

Instruments and observations were described in which a clipping limiter was applied to the input of a voice-

modulated transmitter. Improvements in signal-to-noise ratio were obtained during conditions of high noise or interference level.

- (72) W. W. Smith, "Premodulation speech clipping and filtering," *QST*, vol. 30, pp. 46-50; February, 1946.
- (73) John W. Smith and N. H. Hale, "Speech clippers for more effective modulation," *Communications*, vol. 26, pp. 20-22, 24-25; October, 1946.
- (74) K. D. Kryter and others, "The combined effects of clipping and peaks of speech waves in an ATB transmitter and limiting static peaks in the ARB receiver," *Bibliography of Scientific and Industrial Reports*, vol. 2, p. 95, PB19806, June 12, 1946.
- (75) J. C. R. Licklider and E. B. Newman, "Field tests of premodulation clipping in the transmitter of a type 19 wireless set," *Bibliography of Scientific and Industrial Reports*, vol. 2, p. 95, PB19809, July 12, 1946.
- (76) J. C. R. Licklider and others, "A premodulation clipper unit voice-communication transmitters," *Bibliography of Scientific and Industrial Reports*, vol. 2, p. 95, PB19807, July 12, 1946.

Navigation Aids

The year 1946 marked the release of information on radio navigational systems developed in secrecy during the war years. The availability of these military systems for civilian use, together with the great need for improved techniques in handling congested air and marine traffic, resulted in a high degree of technical activity. To follow this activity, and to assist in the formulation of definitions and standards, the Institute formed a Technical Committee on Navigation Aids.

This committee, in preliminary studies, divided navigation aids into three types: radial systems, hyperbolic systems, and directional systems. In the radial systems (radar, shoran, transponder beacons, etc.) the position of the navigator is measured by timing the traverse of a radio wave along two or more radii centered on fixed points of known position. In the hyperbolic systems (loran, gee, decca, etc.) the position is determined by noting the difference in time of arrival from transmissions at three or more fixed points of known position. The directional systems (Adcock, loop direction finder, and low-frequency and very-high-frequency radio-range beacons) indicate position from the direction of arrival of the wave front to or from two or more stations of known position. These systems, singly or in combination, provide facilities for (1) long-range navigation, (2) approach (air) or pilotage (marine), and (3) instrument landing (air) or docking (marine).

Radar Systems

The release of information on radar has resulted in the extensive bibliography given below. This is divided for convenience into general references, ground-based radar, airborne radar, and marine radar.

Historical

- (77) C. D. Tuska, "Historical notes on the determination of distance by timed radio waves," *Jour. Frank. Inst.* vol. 237, pp. 1-20; January, 1944; pp. 83-102; February, 1944.
- (78) S. Cripps, "The pioneers of radio location," *Elec. Eng.* vol. 17, pp. 680-686; September, 1945.
- (79) L. A. DuBridge, "History and activities of the Radiation

- Laboratory of the Massachusetts Institute of Technology," *Rev. Sci. Instr.*, vol. 17, pp. 1-5; January, 1946.
- (80) "Navy releases Sonar story," *Electronics*, vol. 19, pp. 284, 286, 288, 290, 292, 294; May, 1946.
- (81) R. B. Colton, "Radar in the United States Army. History of early development at Signal Corps Laboratories, Fort Monmouth, N. J.," *PROC. I.R.E.*, vol. 33, pp. 740-753; November, 1945.
- (82) E. G. Bowen, "The historical development of radar," *Proc. I.R.E.* (Australia), vol. 7, pp. 3-7; March, 1946.
- (83) R. L. Smith-Rose, "Radio location," *Wireless World*, vol. 51, pp. 34-37; February, 1945; pp. 66-70; March, 1945.
- (84) "Radar stories are released by U. S. and Great Britain," *Electronics*, vol. 16, pp. 274, 278, 280, 282; June, 1943.
- (85) "German views on British radar," *Electronic Eng.* vol. 17, p. 686; September, 1945.

General Information

- (86) D. G. Fink, "The radar equation," *Electronics*, vol. 18, pp. 92-94; April, 1945.
- (87) E. V. Appleton, "The scientific principles of radio location," *Jour. I.E.E.*, (London), vol. 92, part I, pp. 340-353; September, 1945.
- (88) R. L. Smith-Rose, "Radiolocation or radar," *R.S.G.B. Bull.* vol. 21, pp. 119-125; February, 1946.
- (89) L. A. DuBridge, "The future of radar," (Abstract) *Electronics*, vol. 19, pp. 254, 256; January, 1946; and (Abstract) *Elec. Ind.*, vol. 4, pp. 77, 80, December, 1945.
- (90) L. N. Ridenour, "Radar in war and peace," *Elec. Eng.*, vol. 65, pp. 202-207; May, 1946.
- (91) Clinton B. DeSoto, "Radar techniques," *QST*, vol. 29, pp. 20-23, April, 1945; pp. 46-49, May, 1945; pp. 44-49, June, 1945; pp. 47-52, 86, 88, 90; August, 1945.
- (92) G. R. Bozzoli, "An introduction to radiolocation," *Trans. S. Afr. Inst. Elec. Eng.*, vol. 35, pp. 77-83; July, 1944.
- (93) H. Stoelzel, "Radar technique," *Schweiz Bauzgt.*, vol. 126, pp. 249-252; December 1, 1945 (in German).
- (94) E. G. Schneider, "Radar," *PROC. I.R.E.*, vol. 34, pp. 528-578; August, 1946.
- (95) D. A. Quarles, "Radar systems considerations," *Trans. A.I.E.E. (Elec. Eng.)*, April, 1964) vol. 65, pp. 209-215; April, 1946.
- (96) "Achievements of radar," *Wireless World*, vol. 51, pp. 269-270; September, 1945.
- (97) "Radar—a report on science at war," *Jour. Appl. Phys.*, vol. 16, pp. 491-493; September, 1945.
- (98) D. G. Fink, "Radar warfare," *Electronics*, vol. 18, pp. 92-97; October, 1945.
- (99) "Fundamentals of radar," *Wireless World*, vol. 51, pp. 299-303; October, 1945.
- (100) "Radar secrets given to public by U. S. and British governments," *Telegr. and Teleph. Age.*, vol. 63, pp. 6, 8, 10, 34; September, 1945.
- (101) F. S. Goucher, J. R. Haynes, W. A. Depp, and E. J. Ryder, "Spark gap switches for radar," *Bell Sys. Tech. Jour.*, vol. 25, pp. 563-602; October, 1946.
- (102) E. Peterson, "Coil pulsers for radar," *Bell Sys. Tech. Jour.*, vol. 25, pp. 603-615; October, 1946.

Ground-Based Equipment

- (103) D. G. Fink, "Radar specifications," *Electronics*, vol. 18, pp. 116-119; November, 1945.
- (104) D. G. Fink, "The SCR-268 radar," *Electronics*, vol. 18, pp. 100-109; September, 1945.
- (105) D. G. Fink, "SCR-545 radar," *Electronics*, vol. 19, p. 198; January, 1946; Correction to "Radar specifications" quoted above.
- (106) D. G. Fink, "The SCR-584 radar," *Electronics*, vol. 18, pp. 104-109; November, 1945; vol. 18, pp. 104-109; December, 1945; vol. 19, pp. 110-117; February, 1946.
- (107) H. A. Straus, L. J. Rueger, C. A. Wert, S. J. Reisman, M. Taylor, R. J. Davis, and J. H. Taylor, "Fire-control radar MPG-1," *Electronics*, vol. 18, pp. 92-97; December, 1945; vol. 19, pp. 110-117; January, 1946; vol. 19, pp. 140-147; March, 1946.
- (108) W. A. Cole, "Trans-Canada air lines radar installation," *Eng. Jour. Montreal*, vol. 29, pp. 228-233; April, 1946.
- (109) W. C. Hendricks, "Light weight radar for early warning," *Communications*, vol. 26, p. 54; January, 1946.
- (110) P. A. Marchant and K. M. Heron, "Post Office equipment for radar," *P.O.E.E. Jour.*, vol. 38, pp. 117-120; January, 1946.
- (111) H. A. Zahl and J. W. Marchetti, "Radar on 50 centimeters," *Electronics*, vol. 19, pp. 98-104; January, 1946; vol. 19, pp. 98-103; February, 1946.

Ground-Based Radar Applications

- (112) E. G. Bowen, "The military application of radar," *Proc. I.R.E.* (Australia), vol. 7, pp. 4-9; May, 1946.
- (113) R. A. Smith, "Radar for civil aviation," *Nature*, vol. 157, pp. 151-153; February 9, 1946.
- (114) J. H. DeWitt, Jr., "Technical and tactical features of radar," *Jour. Frank. Inst.*, vol. 241, pp. 97-123; February, 1946.
- (115) H. G. Foster, "Radar in A.A. defense," *Electronic Eng.*, vol. 18, pp. 2-8; January, 1946.
- (116) C. W. Watson, "Ground-controlled approach for aircraft," *Electronics*, vol. 18, pp. 112-115, November, 1945.
- (117) R. L. Rod, "Radio and radar aids to aerial navigation," *Radio*, vol. 30, pp. 35-39, 60; January, 1946.
- (118) A. C. Clarke, "Astronomical radar," *Wireless World*, vol. 52, pp. 321-323; October, 1946.
- (119) J. Mofenson, "Radar echoes from the moon," *Electronics*, vol. 19, pp. 92-98; April, 1946.
- (120) "IFF," *Radio Craft*, vol. 17, p. 332; February, 1946.
- (121) "Wartime uses of radar," *Elect. Times*, vol. 108, pp. 232-237; August 23, 1945.
- (122) W. C. Hendricks, "Lightweight radar for early warning," *Communications*, vol. 26, p. 54; January, 1946.
- (123) H. A. Zahl and J. W. Marchetti, "Radar on 50 centimeters," *Electronics*, vol. 19, pp. 98-103; February, 1946.

Radar Convention Reports

- (124) O. P. Ferrell, "London radiolocation convention," *Radio*, vol. 30, pp. 26, 28, 47, 48; May, 1946.
- (125) "Radiolocation convention," *Engineering*, vol. 161, pp. 306-308; March 29, 1946; pp. 319-320; April 5, 1946; p. 367; April 19, 1946; pp. 389-390; April 26, 1946.

Radar Books

- (126) O. E. Dunlap, Jr., "Radar; What Radar Is and How It Works," Harper and Brothers, New York, N. Y. 1946.
- (127) R. W. Hallows, "Radar; Radiolocation Simply Explained," Chapman and Hall, London, 1946.
- (128) John F. Rider and G. C. Baxter Rowe, "Radar; What It Is," John F. Rider Publisher, Inc., New York, N. Y. 1946.
- (129) M.I.T. Radar School Staff, "Principles of Radar," McGraw-Hill Book Co., New York, N. Y. 1946.

Airborne Radar

- (130) E. B. Macmillan, H. Leaderman, and T. J. Suen, "Design of radar antenna housing," *Aero Digest*, vol. 52, pp. 89-90, 121, 123; March, 1946.
- (131) L. LeKashman, "Flight and traffic control aids," *Aero Digest*, vol. 53, pp. 42-43; September, 1946.
- (132) "Radar trainer for fighter pilots," *Aero Digest*, vol. 51, p. 114; December 15, 1945.
- (133) H. F. Langdon, "Navigating by altimeter," *Air Transport*, vol. 4, pp. 53-54, 56; May, 1946; pp. 47, 49; July, 1946.
- (134) M. Mickel, "General use of radar by airlines, considered still 2-3 years away," *Aviation News*, vol. 5, p. 27; March 18, 1946.
- (135) "Radar measures the airlines," *Canadian Aviation*, vol. 19, pp. 26-27, 56; February, 1946.
- (136) R. C. Jensen and R. A. Arnett, "Airborne radar for navigation and obstacle detection," *Trans. A.I.E.E. (Elec. Eng.)*, May, 1945), vol. 65, pp. 307-313; May, 1946.
- (137) Stuart W. Seeley, "Shoran precision radar," *Trans. A.I.E.E. (Elec. Eng.)*, April, 1946), vol. 65, pp. 232-240; April, 1946.
- (138) R. I. Wilkinson, "Short survey of Japanese radar," *Elec. Eng.*, vol. 65, pp. 370-377; August-September, 1946; pp. 455-463; October, 1946.
- (139) D. G. Fink, "Fm radar altimeter," *Electronics*, vol. 19, pp. 130-134; April, 1946.
- (140) A. Goldman, "Pulse-type radio altimeter," *Electronics*, vol. 19, pp. 116-119; June, 1946.
- (141) P. J. Herbst, I. Wolff, D. Ewing, and L. F. Jones, "The teloran proposal," *Electronics*, vol. 19, pp. 124-127; February, 1946.
- (142) J. V. Holdam, S. McGrath, and A. D. Cole, "Radar for blind bombing," *Electronics*, vol. 19, pp. 138-143; May, 1946; pp. 142-149; June, 1946.
- (143) D. G. Fink, "Radar countermeasures," *Electronics*, vol. 19, pp. 92-97; January, 1946.
- (144) F. J. Larsen, "Ultrasonic trainer circuits," *Electronics*, vol. 19, pp. 126-129; June, 1946.
- (145) "Artificial radar target," *Electronics*, vol. 19, pp. 214, 216; February, 1946.

- (146) G. T. Montgomery, "All weather flying," *Electronics*, vol. 19, pp. 84-87; September, 1946.
- (147) C. B. Barnes, "Radar for carrier-based planes," *Electronics*, vol. 19, pp. 100-105; October, 1946.
- (148) L. R. Quarles and W. M. Breazeale, "Factors affecting the range of radar sets," *Trans. A.I.E.E. (Elec. Eng.)*, August-September, 1946), vol. 65, pp. 546-548; August-September, 1946.
- (149) "Trans-Canada airlines radar installation," *Engineering Jour.*, vol. 29, pp. 228-233; April, 1946.
- (150) L. V. Berkner, "Naval airborne radar," *Proc. I.R.E.*, vol. 34, pp. 671-706; September, 1946.
- (151) L. J. Haworth, "Radar indicators," *Radio News*, *Radio Electronic Eng.*, vol. 6, pp. 3-6, 28-29; June, 1946.
- (152) "Shoran for world mapping," *Radio News*, vol. 36, pp. 112-113; August, 1946.
- (153) V. Zeluff, "Aircraft radar," *Scientific American*, vol. 174, pp. 204-206; May, 1946.
- (154) "Fundamentals of radar," *Wireless World*, vol. 52, pp. 23-26; January, 1946.
- (155) R. C. Jensen and R. A. Arnett, "Airborne radar for navigation and obstacle detection," *Trans. A.I.E.E. (Elec. Eng.)*, May, 1946), vol. 65, pp. 307-313; May, 1946.
- (156) J. V. Holdam, S. McGrath, and A. D. Cole, "Radar for blind bombing," *Electronics*, vol. 19, pp. 138-143; May, 1946; pp. 142-149; June, 1946.
- (157) W. L. Webb, "Commercial application of radar," *Bendix Radio Eng.*, vol. 2, pp. 39-40; January, 1946.
- (158) Robert L. Rod, "Radio and radar aids to aerial navigation," *Radio*, vol. 30, pp. 35-38, 60; January, 1946.
- (159) Thomas Grover and E. C. Kluender, "The electronic navigator," *Communications*, vol. 26, pp. 30, 36-39; August, 1946.
- (160) Donald F. Folland, "Use of microwaves for instrument landing," *Radio*, vol. 30, pp. 18-22, 47; March, 1946; and pp. 23-25, 55; April, 1946.
- (161) "Microwave instrument blind landing system," *Elec. Ind.*, vol. 5, pp. 60-64, 136; February, 1946.

Marine Radar

- (162) "Electronic marine navigator—first commercial radar product," *Product Eng.*, vol. 17, pp. 69-71; January, 1946.
- (163) I. F. Byrnes, "Merchant marine radar," *RCA Rev.*, vol. 7, pp. 54-66; March, 1946.
- (164) "Radar in navigation," *Jour. Frank. Inst.*, vol. 241, pp. 311-312; April, 1946.
- (165) "Demonstration of a marine Metropolitan Vickers radar set," *Engineer*, vol. 181, pp. 583-584; June 28, 1946.
- (166) "Electronic navigator on Lakes steamer pierces darkness and fog," *Marine Eng.*, vol. 51, p. 152; August, 1946.
- (167) "Marine radar equipment," *Engineer*, vol. 181, p. 527; June 7, 1946.
- (168) "Private radar installation," *Mech. Eng.*, vol. 68, p. 560; June, 1946.
- (169) "Radio aids to marine navigation," *Engineer*, vol. 181, pp. 426-427; May 10, 1946.
- (170) "Radar on the 'Queen Elizabeth'," *Electrician*, vol. 137, p. 600; August 30, 1946.
- (171) "Radar on the bridge," *Science Illustrated*, vol. 1, pp. 88-91; June, 1946.
- (172) "Radar marine navigation," *Westinghouse Eng.*, vol. 6, pp. 98-102; July, 1946.
- (173) "Electronic navigational aids—loran—radar—racon. Basic description of electronic aids as applied for commercial use," United States Coast Guard, 1945.
- (174) "Electronic navigational aids. Advisory minimum specification for navigational radars—Supplement No. 1—CG-157-1," United States Coast Guard, August 1, 1946.
- (175) "Radar navigator for commercial shipping," *Electronics*, vol. 18, p. 154; October, 1945.
- (176) "Ship-search radar for troopships," *Electronics*, vol. 18, pp. 260, 264; December, 1945.
- (177) L. H. Lynn and O. H. Winn, "Marine radar for peacetime use," *Trans. A.I.E.E. (Elec. Eng.)*, May, 1946), vol. 65, pp. 271-290; May, 1946.
- (178) W. C. Tinus and W. H. C. Higgins, "Early fire-control radars for Naval vessels," *Bell Sys. Tech. Jour.*, vol. 25, pp. 1-47; January, 1946.

Hyperbolic Systems

Hyperbolic systems were employed extensively during the war and have continued in peacetime use. The

following bibliography contains the principal papers describing general principles and the loran, gee, and decca systems.

- (179) B. W. Sitterly, "Elements of loran," MIT Rad. Lab. Report No. 499, March, 1944. Also available as Nav. Ships 900,027, Bureau of Ships; April, 1944.
- (180) "Loran handbook for shipboard operators," Bureau of Ships (Ships 278); July, 1944.
- (181) "Loran handbook for aircraft," Air Forces Manual No. 37, Training Aids Division, Office of Assistant Chief of Air Staff, Training; September, 1944.
- (182) "Loran transmitting station manual," Nav. Ships 900,060A, Bureau of Ships; March, 1945.
- (183) L. S. Harley, "Gee, A new method of radio navigation," *Electronic Eng.*, vol. 17, pp. 713-716; October, 1945.
- (184) D. G. Fink, "The loran system," *Electronics*, vol. 18, pp. 94-99; November, 1945; pp. 110-115; December, 1945; vol. 19, pp. 109-115; March, 1946.
- (185) Alexander A. McKenzie, "Loran—the latest in navigational aids," *QST*, vol. 29, pp. 12-16; December, 1945; vol. 30, pp. 54-57; January, 1946; pp. 62-65, 124; February, 1946.
- (186) R. W. Kenyon, "Principles of loran in position location," *Elec. Ind.*, vol. 4, pp. 106-107, 138, 140; December, 1945.
- (187) "The decca navigator; continuous-wave navigation system," *Wireless World*, vol. 52, pp. 93-95; March, 1946.
- (188) M. G. Scroggie, "The decca navigator," *Communications*, vol. 26, pp. 21-24; March, 1946.
- (189) David Davidson, "Loran indicator circuit operation," *Elec. Ind.*, vol. 5, pp. 84-93, 126, 128, 130, 132; March, 1946.
- (190) J. A. Pierce, "An introduction to loran," *Proc. I.R.E.*, vol. 34, pp. 216-234; May, 1946.
- (191) J. A. Pierce, "2-mc sky-wave transmission, as applied to loran," *Electronics*, vol. 19, pp. 146-153; May, 1946.
- (192) "The Decca navigator," *Electronic Eng.*, vol. 18, pp. 166-171; June, 1946.
- (193) J. A. Pierce, "An introduction to hyperbolic navigation with particular reference to loran," (Abstract), *Jour. I.E.E. (London)* vol. 93, part III, pp. 243-245; July, 1946.
- (194) M. G. Scroggie, "Decca navigator stations," *Wireless World*, vol. 52, pp. 260-262; August, 1946.

Directive Systems

Since directive navigation systems were in wide use before the war, the wartime advances were not as spectacular as those in the radar and the hyperbolic fields. However, substantial contributions to the knowledge of wave-front errors and propagation effects were made during the war years, and many new devices based on wave-front direction were developed. The following bibliography covers directive systems:

- (195) Peter Caporale, "The CAA instrument landing system," *Electronics*, vol. 18, pp. 116-124; February, 1945 and pp. 128-135; March, 1945.
- (196) P. J. Herbst, I. Wolff, D. Ewing, and L. F. Jones, "The Teleran proposal," *Electronics*, vol. 19, pp. 124-127; February, 1946.
- (197) Sydney Pickles, "Army air force portable instrument landing system," *Elec. Commun.*, vol. 22, no. 4, pp. 262-294; 1945.
- (198) D. G. C. Luck, "An omnidirectional radio-range system," *RCA Rev.*, vol. 7, pp. 94-117; March, 1946.
- (199) Andrew Alford, Armig G. Kandoian, Frank J. Lundburg, and Chester B. Watts, Jr., "An ultra-high-frequency radio range with sector identification and simultaneous voice," *Proc. I.R.E.*, vol. 34, pp. 9W-17W; January, 1946.
- (200) A. Scott, "New four band ADF," *Air Transport*, vol. 4, pp. 67-68, 71; April, 1946.
- (201) H. Busignies, P. R. Adams, and R. I. Colin, "Aerial navigation and traffic control with Navaglobe, Navar, Navaglide and Navascreen," *Elec. Commun.*, vol. 23, pp. 113-143; June, 1946.
- (202) J. F. Manildi, "Elimination of direct-reading compass errors by proper aircraft design," *Aeronautical Eng. Rev.*, vol. 5, pp. 3-10; May, 1946.
- (203) "Microwave instrument blind landing system," *Elec. Ind.*, vol. 5, pp. 60-64, 136; February, 1946.
- (204) M. Reison, "Direction finder," U. S. Patent No. 2,377,902.
- (205) F. Penin, "Mutual perturbations of two loop direction finders," *L'Onde Elec.*, p. 1010; March, 1946.

Government and Industry Activity

Aside from revelations of wartime devices, the principal advance of the year was agreement among industry and government organizations on a program of standardization for immediate use of various facilities. The need for international standardization of navigational aids, particularly for air transport, gave rise to intensive consideration of the merits of different systems by the Provisional International Civil Aviation Organization (PICA0). Demonstrations of various systems in England, in the United States, and in Canada resulted in an agreement, reached at Montreal near the end of 1946, on the following program:

Instrument landing: localizer, glide-path, and marker beacons, similar to the CAA or SCS51 (U. S. Army) system. Radar-guided approach (GCA system) may be used as a supplementary aid.

Short-distance navigation: very-high-frequency (VHF) omnidirectional radio range in conjunction with radar transponder beacons. Supplementary gee coverage in Europe.

Long-range navigation: continuation of existing low-frequency radio range beacons, beacons for use with direction finders, and standard loran; installation of low-frequency (LF) loran facilities on 180 kilocycles.

The way was left open for development and use of other systems, such as teleran, navar, lanac, pressure-pattern flight, radar altimeters, etc.

- (206) F. M. Holz, "PICA0 radio group selects CAA's ILS for standard use," *American Aviation*, vol. 10, p. 23; December 15, 1946.
- (207) "Instrument landing system now available to airlines," *American Aviation*, vol. 10, p. 54; July 1, 1946.
- (208) "GCA to be put under three months CAA test at Indianapolis base," *American Aviation*, vol. 9, p. 42; April 1, 1946.
- (209) "CAA's blind landing system put into use; GCA work continues," *CAA Jour.*, vol. 7, p. 72; June 15, 1946.
- (210) "CAA speeds work on vhf radio aids for private flying," *CAA Jour.* vol. 7, p. 29; March 15, 1946.
- (211) "PICA0 technicians viewing U. S. radio navigation aids," *CAA Jour.*, vol. 7, pp. 125-126; October 15, 1946.
- (212) "CAA promises gradual change to vhf facilities," *Electronics*, vol. 19, pp. 318-319, 321, 323; April, 1946.
- (213) Horace F. Amrine, "Radio aids to navigation," *The Department of State Bulletin*, vol. xv, pp. 1130-1133; December 22, 1946.
- (214) "Report of Electronic Subdivision Advisory Group on Air Navigation—Air Material Command," Engineering Division, Wright Field, Dayton, Ohio; June, 1946.
- (215) Third Commonwealth and Empire Conference on radio for civil aviation, CERCA (43) 21 (H.M. Stationery Office, London) 126 pp.; 1945.
- (216) P.I.C.A.O. Technical Papers on Equipment and Systems demonstrated at R.A.F. Transport Command, Telecommunications Research Establishment and Royal Aircraft Establishment; September 9-25, 1946, (3 volumes). Issued jointly by above establishments or available through Provisional International Civil Aviation Organization, Dominion Square Building, Montreal, Canada.

At the close of 1946, the Civil Aeronautics Administration of the United States had 58 instrument-landing systems in operation. The Chicago-New York and the Las Vegas-Denver airways were equipped with 2-course very-high-frequency radio ranges and an experimental airway system of very-high-frequency omnidirectional

ranges was in operation between Chicago and New York. The Civil Aeronautics Administration was planning the installation of about 600 additional omnidirectional ranges and 150 instrument-landing systems.

Radio Receivers

Wartime Developments

In contrast to the older technique of multichannel radio communication and broadcasting by means of frequency separation, the alternative of time sharing has come to the front in the form of a system called pulse-time or pulse-position modulation. This system had extensive field use during the war, and its potential importance for the future calls attention to the special receiver circuits required, particularly those following the second detector.

Reference should be made to published papers listed in the sections of this review entitled, "Radio Transmitters," and "Navigation Aids."

The development of wide-band receivers for radar and other purposes brought forth new approaches to the design of intermediate-frequency amplifiers. Among these, the stagger-tuned amplifier seems especially significant.

- (217) H. Wallman, "Stagger-tuned wide-band amplifiers," *Electronics*, pp. 92-108 (Abstract); March, 1946.
 (218) M. J. Larsen and L. L. Merrill, "Capacitance-coupled I-F amplifiers," *Electronics*, pp. 92-108 (Abstract); March, 1946.

The wartime activity in radar countermeasures created a line of wide-tuning-range search receivers in the very-high-frequency (VHF), ultra-high-frequency (UHF), and super-high-frequency (SHF) regions, combining wide pass bands with an attempt at reducing the spurious responses encountered in superheterodyne receivers when radio-frequency preselection is difficult to incorporate.

- (219) W. B. Lewis, "Radar receivers," *Jour. I.E.E. (London)*, pp. 272-279; October, 1946.
 (220) G. E. Hulstede, J. M. Pettit, H. E. Overacker, K. R. Spangenberg, and R. R. Buss, "Very-high-frequency receivers," *Electronics*, pp. 92-108 (Abstract); March, 1946.
 (221) L. H. Lynn and O. H. Winn, "Marine radar for peacetime use," *Trans. A.I.E.E. (Elec. Eng., May, 1946)*, vol. 65, pp. 271-273; May, 1946.
 (222) G. T. Ford, "Characteristics of vacuum tubes for radar intermediate frequency amplifiers," *Bell Sys. Tech. Jour.*, vol. 25, pp. 385-407; July, 1946.
 (223) A. L. Samuel, J. W. Clark, and W. W. Mumford, "The gas-discharge transmit-receive switch," *Bell Sys. Tech. Jour.*, vol. 25, pp. 48-101; January, 1946.

On January 24, 1946, engineers of the Signal Corps Engineering Laboratories succeeded in receiving radar echoes from the moon. The receiver employed in this work was of unusual interest. It was a quadruple, conversion superheterodyne, converting a carrier of 111.5 megacycles down to 180 cycles. The final intermediate-frequency amplifier had a 5-cycle pass band. A low-noise, grounded-grid radio-frequency preamplifier was

used, providing a 30-decibel gain with a noise figure of 3.5 decibels.

- (224) Jack Mofenson, "Radar echoes from the moon," *Electronics*, vol. 19, pp. 92-98; April 1946.
 (225) A. C. Omberg, "Earth-moon radio circuits," *Bendix Radio Eng.*, vol. 2, pp. 1-3, 22; April, 1946.
 (226) Arthur C. Clarke, "Astronomical radar," *Wireless World*, vol. 52, pp. 321-323; October, 1946.

The Bikini atom-bomb tests made in July, 1946, required the development of many types of electronic circuits which were used in recording results of the explosion. Some of the circuits may be of considerable interest to receiver design engineers.

- (227) D. G. Fink and C. L. Engleman, "Electronics at Bikini," *Electronics*, vol. 19, pp. 84-89; November, 1946.

The use of printed circuits in proximity fuzes was announced in the early part of the year. This is a process in which an electrical circuit is printed or stenciled with a silver paste on a steatite ceramic and then fired at a high temperature to bond it firmly, making possible an extremely compact assembly. Several papers appeared shortly thereafter dealing with this subject and with possible commercial applications of printed circuits.

- (228) "Printed circuit wiring," *Elec. Ind.*, vol. 5, pp. 90-91, 120, 122; April, 1946.
 (229) Cleo Brunetti and A. S. Khouri, "Printed electronic circuits," *Electronics*, vol. 19, pp. 104-108; April, 1946.

New Components

Some of the new components which came into prominence during the year were polystyrene-dielectric capacitors, subminiature tubes (under 0.4 inch diameter), new types of insulating materials, tube sockets with built-in capacitors, selenium rectifiers, germanium-crystal rectifiers, and dual-frequency intermediate-frequency transformers for 455 kilocycles and 10.7 megacycles.

A paper was presented at the Rochester Fall Meeting of the Institute describing a new type of paper capacitors of a very compact size, the size reduction being due to the use of metalized paper. A homogeneous aluminum film of negligible thickness deposited on the dielectric replaces the conventional foil and permits operation at higher dielectric stresses without fear of permanent short-circuit because of the self-healing characteristics of the film.

At least one manufacturer developed a pocket radio of remarkable compactness. This set employs subminiature tubes and several new components especially developed for this application.

Selenium rectifiers were being used toward the close of the year to replace rectifier tubes in small sets.

A complete line of miniature tubes was put on the market beginning late in 1945. Tubes of this type found ready application and were widely used in frequency-modulation receiver circuits toward the end of the year.

The use of vacuum tubes for frequency converters and detectors was being displaced in certain fields. In the microwave region of the spectrum the silicon crystal

was reported as being superior even to the best of tubes, while for high-level detection at lower frequencies the germanium crystal was proving to be an efficient competitor. The copper-oxide rectifier was reported in one instance as possessing advantages as a detector, while in the case of a sonar receiver operating in the 13- to 37-kilocycle region a varistor second detector was used.

- (230) C. F. Edwards, "Microwave converters"; H. C. Torrey, "Crystal rectifiers in superheterodyne receivers"; P. H. Miller, "Noise spectrum in crystal mixers"; *Electronics*, pp. 92-108 (Abstracts); March, 1946.
- (231) J. R. Weeks, "Polystyrene capacitors," *Bell Lab. Rec.*, vol. 24, pp. 111-115; March, 1946.
- (232) F. Rockett, "Circuits for sub-miniature tubes," *Electronics*, vol. 19, pp. 154-156; May, 1946.
- (233) Albert H. Postle, "Radio insulating materials," *Radio*, vol. 29, pp. 33-36, 59-60; December, 1945.
- (234) Geoffrey Herbert, "Dry-contact rectifiers for radio application," *Radio*, vol. 29, pp. 29-32, 60-61; December, 1945.
- (235) H. K. Henisch, "Metal rectifier developments—possible application of titanium dioxide," *Elec. Eng.*, vol. 18, pp. 313-315; October, 1946.
- (236) Julian Loebenstein, "Selenium rectifiers," *Communications*, vol. 26, pp. 26-28; November, 1946.
- (237) E. D. Wilson, "Principles and applications of semiconductor rectifiers," *Elec. Mfg.*, vol. 38, pp. 126-129, 188-190; December, 1946.
- (238) H. A. Ross, "The theory and design of intermediate-frequency transformers for frequency-modulated signals," *A.W.A. Tech. Rev.*, vol. 6, pp. 447-471; March, 1946.
- (239) Robert T. Thompson, "Two-frequency 1-F transformers," *Electronics*, vol. 19, pp. 142, 146, 151, 154, 158; September, 1946.
- (240) "Belmont's new pocket radio," *Radio Maintenance*, p. 16; August, 1946.

General résumés of war developments in silicon-tungsten, germanium-tungsten, and similar crystal contact rectifiers appeared. Electrical characteristics and ratings were included.

- (241) E. C. Cornelius, "Germanium crystal diodes," *Electronics*, vol. 19, pp. 118-123; February, 1946.
- (242) W. E. Stephens, "Crystal rectifiers," *Electronics*, vol. 19, pp. 112-119; July, 1946.
- (243) E. C. Cornelius, "Silicon crystals for uhf detection circuits," *Electronics*, vol. 4, pp. 74-76, 134, 136, 138; November, 1945.

Frequency-Modulation Receiver Developments

Early in the year the Radio Manufacturers Association proposed two new standards of specific interest to designers of frequency-modulation receivers: (1) an intermediate frequency of 10.7 megacycles, and (2) an antenna-to-set transmission-line impedance of 300 ohms.

The change in radio-frequency allocation by the Federal Communications Commission for frequency-modulation broadcasting stations from 40 to 50 megacycles to the higher band, 88 to 108 megacycles, which was made in January, 1946, was generally accepted as final throughout the industry. Although several manufacturers put out receivers incorporating both bands, most of them did not include the 40- to 50-megacycle band in new receivers.

In contrast to what could probably have been considered standard prewar practice for multiband receivers, most of the multiband receivers made in 1946 did not include complete short-wave coverage up to 18 or 20 megacycles. The trend seemed to be toward receivers employing one of the following combinations:

- (1) standard broadcast, (2) standard broadcast and 88- to 108-megacycle frequency modulation, (3) standard broadcast, one or two band-spread short-wave ranges, and 88- to 108-megacycle frequency modulation, or (4) standard broadcast, one or two band-spread short-wave ranges, 40- to 50-megacycle frequency modulation and 88- to 108-megacycle frequency modulation.

- (244) D. H. Hughes, "The design of band-spread tuned circuits for broadcast receivers," *Jour. I.E.E.* (London), vol. 93, part III, pp. 87-96; March, 1946.

The ratio detector which was announced in October, 1945, continued throughout 1946 to be a development of considerable promise and interest, particularly with respect to its application to low- and medium-priced receivers. During the year several new and interesting ideas pertaining to the design of frequency-modulation tuning systems and detectors were advanced.

At the National Electronics Conference, held in Chicago October 3-5, 1946, several papers were presented on the subject of the design of frequency-modulation receivers.

- (245) Z. Benin, "A permeability-tuned 100-megacycle amplifier of specialized design."
- (246) G. Wallin and D. W. Dymond, "Very-high-frequency tuner design."
- (247) C. R. Miner, "Front-end design of frequency-modulation receivers."
- (248) Z. Benin, "Modern home receiver design," *Electronics*, vol. 19, pp. 94-98; August, 1946.
- (249) William E. Bradley, "Single-stage F-M detector," *Electronics*, vol. 19, pp. 88-91; October, 1946.
- (250) J. R. Tillman, "Linear frequency discriminator," *Wireless Eng.*, vol. 23, pp. 281-286; October, 1946.
- (251) Norman L. Chalfin, "Crystal control for FM receivers," *Radio News*, Radio Electronic Eng. Dept., vol. 6 (Engineering Section), pp. 12-14, 34; March, 1946.
- (252) R. M. Cohen, R. C. Fortin, and C. M. Morris, "Miniature tubes for F-M conversion,"; D. B. Smith, "Impulse noise in F-M receivers"; S. W. Seeley, "Discriminators for F-M receivers," *Electronics*, pp. 92-108 (Abstracts); March, 1946.
- (253) David B. Smith and William E. Bradley, "The theory of impulse noise in ideal frequency-modulation receivers," *PROC. I.R.E.*, vol. 34, pp. 743-751; October, 1946.

The problem of the design of intermediate-frequency amplifiers for frequency-modulation receivers was discussed in several articles.

- (254) David W. Martin, "High gain 1-F amplifier for FM," *Bendix Radio Eng.*, vol. 2, pp. 19-22; April, 1946.
- (255) D. L. Jaffe, "Intermediate frequency amplifier stability factors," *Radio*, vol. 30, pp. 26-27, 54-55; April, 1946.

Converters were designed for use with prewar frequency-modulation receivers to make possible reception in the 88- to 108-megacycle band. These ranged from a simple crystal diode in the antenna lead to rather complicated devices of specialized design.

- (256) H. A. Audet, "Tubeless converter for new F-M band," *Electronics*, vol. 19, pp. 140, 142; October, 1946.
- (257) Harvey Kees, "A simple F-M converter," *Radio News*, vol. 35, pp. 31, 127-129; May, 1946.
- (258) J. E. Young and W. A. Harris, "Twelve-channel F-M converter," *Electronics*, vol. 19, pp. 110-111; December, 1946.

The trend during the year 1946 in the design of frequency-modulation receivers, as in the case of

amplitude-modulation receivers of past years, was to produce designs to meet a price and not primarily to provide high-quality entertainment. The emphasis from a manufacturer's standpoint seemed to be to provide receiving means for a new service. Receivers were thus produced which would provide no better reception of frequency-modulation signals than the 5-tube a.c.-d.c. set does of amplitude-modulation signals.

General

The difficulties encountered in the procurement of gang capacitors led to a wide use of permeability tuners in broadcast receivers. It appeared, however, that this trend might not continue except in the case of auto radios and that in all probability capacitor-tuned sets would return to their former high degree of popularity with the returning availability of gang capacitors.

Some work was done during the year on low-impedance loops for broadcast receivers and several manufacturers put sets on the market which incorporated this feature.

- (259) W. S. Bachman, "Loop-antenna coupling-transformer design," *Proc. I.R.E.*, vol. 33, pp. 865-867; December, 1945.
- (260) W. J. Polydoroff, "Inductive tuned loop circuits," *Radio*, vol. 30, pp. 21-22; April, 1946.
- (261) W. J. Polydoroff, "Inductively tuned loop circuits," *Radio*, vol. 30, pp. 20-22; May, 1946.
- (262) A. W. Simon, "Tracking permeability-tuned circuits," *Electronics*, vol. 19, p. 138; September, 1946.

The extreme scarcity of magnet wire during the year brought about the almost universal use of Alnico-5 permanent-magnet speakers in receivers.

Phonograph pickups, wire recorders, and record-scratch-suppression circuits were subjects of considerable interest to receiver design engineers.

A dynamic noise suppressor, in which the high and low cutoff frequencies of a band-pass filter were independently and rapidly adjusted through electronic control circuits by characteristics of the desired signal, was applied to the reduction of scratch and rumble noises in phonograph record reproduction. The device takes advantage of the threshold characteristics of the ear. The maximum frequency range transmitted at the attained noise reduction of approximately 20 decibels was substantially wider than that of a fixed filter yielding the same result.

- (263) H. H. Scott, "Dynamic suppression of phonograph record noise," *Electronics*, vol. 19, pp. 92-95; December, 1946.
- (264) Harold E. Haynes, "An integrating meter for measurement of fluctuating voltages," *Jour. Soc. Mot. Pic. Eng.*, vol. 46, pp. 128-133; February, 1946.
- (265) T. H. Long, "A new wire recorder head design," *Trans. A.I.E.E. (Elec. Eng.)*, April, 1946, vol. 65, pp. 216-220; April, 1946.
- (266) W. S. Bachman, "Phonograph reproducer design," *Trans. A.I.E.E. (Elec. Eng.)*, March, 1946, vol. 65, pp. 159-162; March, 1946.
- (267) "A new moving-coil pickup," *Electronic Eng.*, vol. 18, pp. 224-226; July, 1946.
- (268) D. W. Pugsley, "Wire recording," *Elec. Eng.*, vol. 65, pp. 316-321; July, 1946.
- (269) Marvin Camras, "Theoretical response from a magnetic-wire record," *Proc. I.R.E.*, vol. 34, pp. 597-602; August, 1946.
- (270) W. F. Leidel, Jr. and N. E. Payne, "Tuned-ribbon pickup," *Elec. Ind.*, vol. 5, pp. 67-69, 100-101; October, 1946.

- (271) John D. Goodell, "The reproduction of disc recordings," *Radio News*, Radio Electronic Eng. Dept., vol. 7, pp. 5-7, 27-29; October, 1946.
- (272) Kenneth J. Germeshausen and R. S. John, "Phonograph pickup using strain gage," *Elec. Ind.*, vol. 5, pp. 78-79, 118, 120; November, 1946.

General research in various basic fields of receiver design continued. New work was reported on formulas for capacitor tracking in superheterodyne receivers, on progressive universal windings, on the selectivity obtainable with superregenerative detectors, and on theoretical signal-to-noise ratios obtainable with various types of modulation. One proposal was presented for a superheterodyne without a continuously operating local oscillator.

- (273) J. Marshall, "Superhet tracking formulas," *Electronics*, vol. 19, pp. 202, 206, 210, 212, 214; October, 1946.
- (274) J. E. Smith, "Theoretical signal-to-noise ratios," *Electronics*, vol. 19, pp. 150-152, 154; June, 1946.
- (275) R. W. Woods, "Oscillatorless superheterodyne," *Electronics*, vol. 19, pp. 224, 226, 228, 230, 232, 236; February, 1946.
- (276) H. L. Grisdale and R. B. Armstrong, "Tendencies in the design of the communication type of receivers," *Jour. I.E.E. (London)*, vol. 93, part III, pp. 365-384; September, 1946.
- (277) Jack R. Ford and N. I. Korman, "Stability and frequency pulling of loaded unstabilized oscillators," *Proc. I.R.E.*, vol. 34, pp. 794-799; October, 1946.
- (278) A. W. Simon, "Calculating the inductance of universal-wound coils," *Radio*, vol. 30, pp. 18-19, 30-31; September, 1946.
- (279) A. W. Simon, "On the theory of the progressive universal winding," *Proc. I.R.E.*, vol. 33, pp. 868-71; December, 1945.
- (280) E. W. Herold, "Superheterodyne frequency conversion using phase-reversal modulation," *Proc. I.R.E.*, vol. 34, pp. 184P-198P; April, 1946.
- (281) John A. Kirk, "Super-regenerative 2 meter receiver," *Radio News*, vol. 36, pp. 30-31, 104, 106, 108; October, 1946.
- (282) "Cathode ray," "Super-regenerative receivers," *Wireless World*, vol. 52, pp. 182-186; June, 1946.
- (283) F. R. W. Strafford, "The super-regenerative detector: an analytical and experimental investigation," *Jour. I.E.E. (London)*, vol. 93, part III, pp. 23-28; January, 1946.
- (284) Allan Easton, "Superregenerative detector selectivity," *Electronics*, vol. 19, pp. 154-157; March, 1946.

Noise-limiting circuits received considerable attention during the year. One noise-limiter circuit was discussed at the September meeting of the Chicago Section of the I.R.E. by G. J. Andresen. This system effectively removes noise pulses by reducing their amplitude to very nearly the instantaneous level of the audio wave. This differs from the common limiter which clips the pulses at the level of the average maximum of the audio wave.

- (285) Frederick Delanoy, "Design and application of squelch circuits," *Radio*, vol. 30, pp. 11-13, 29-30; September, 1946.
- (286) George Grammar, "Noise limiting in C.W. reception," *QST*, vol. 30, pp. 13-17, 118, 122; May, 1946.
- (287) C. C. Eaglesfield, "Motor-car ignition interference," *Wireless Eng.*, vol. 23, pp. 265-272; October, 1946.
- (288) Emerick Toth, "Noise and output limiters," *Electronics*, vol. 19, pp. 114-119; November, 1946; pp. 120-125; December, 1946.

Industry Statistics

On October 30, 1946, the radio and parts manufacturing industry in the United States was decontrolled by the Office of Price Administration. During the period of OPA control, the Census Bureau collected monthly statistics on radio set production. An analysis of Census Bureau data up to September provides a basis for estimating set production for the year 1946. The

estimated 1946 monthly production figures shown below were computed from Census Bureau data to and including September, 1946. The monthly averages based on a full year were then computed by averaging these figures and the monthly figures extrapolated from curves for the January to September production.

TABLE II
PRODUCTION OF RADIO RECEIVERS

Type	1941 Monthly Average	Actual 1946 Monthly Average (Jan.-Sept.)	Estimated 1946 Monthly Average (Jan.-Dec.)	Per cent of 1941 Monthly Average	Estimated Total Production 1946
Table models (including compact)	480,250	774,140	779,000	162	9,350,000
Console models	63,333	10,413	12,000	19	143,000
Battery receivers (except auto)	206,583	141,077	161,000	78	1,936,000
Automobile receivers	188,083	111,567	131,000	70	1,566,000
Radio-phonograph combinations	81,583	138,590	179,000	220	2,148,000
Total	1,019,832	1,110,938	1,262,000	124	15,143,000

The highest production of radio receivers during any prewar year was in 1941. OPA data show that 210 manufacturers received price approvals up to September 5, 1946. The Federal Communications Commission has estimated that there are 66,000,000 amplitude-modulation and 500,000 frequency-modulation receiving sets in the United States. Of the 500,000 frequency-modulation sets, approximately 400,000 were made before the war.

Antennas

The growing importance of frequency-modulation (FM) broadcasting and the recent change in frequency assignments have led to the development of new types of broadcast antennas in the range from 88 to 108 megacycles, as well as improvements in older types. Early in the year there was described a slotted tubular antenna which has the characteristic of a horizontal loop and which, from its appearance as mounted on a pole, has sometimes been called a "rocket antenna." A somewhat similar antenna, known as the "pylon antenna," was developed by one manufacturer.

- (289) Andrew Alford, "Antenna for FM station WGHF," *Communications*, vol. 26, pp. 22-23; February, 1946 (Abstract).
 (290) C. R. Jones, "Slotted tubular antenna for 88 to 108 mc," *Communications*, vol. 26, pp. 36-39; July, 1946.

Similarly descriptive is the name of the "clover-leaf" antenna, in which the radiating unit is a cluster of four curved elements, these units being stacked by mounting on a vertical coaxial feed-line the outer conductor of which is in fact a slender structural steel tower of standard design.

- (291) P. H. Smith, "The clover-leaf FM antenna," *Communications*, vol. 26, pp. 58, 60, 68; April, 1946.

Another new array of coaxially fed horizontal loops was described by:

- (292) A. G. Kandoian, "FM broadcast loops," *Communications*, vol. 26, pp. 38, 40; April, 1946.

This is an adaptation of a type described earlier in the year.

- (293) A. G. Kandoian, "Three new antenna types and their applications," *PROC. I.R.E.*, vol. 34, pp. 70W-75W; February, 1946. *PROC. I.R.E. AND WAVES AND ELECTRONS*, vol. 1, p. 70-W; February, 1946.

The above reference also includes a description of an improved turnstile antenna by R. F. Holtz, and a discussion of feeding loops by M. W. Scheldorf. The problem of feeding frequency-modulation antennas was also treated in:

- (294) W. Pritchett, "Feeding combined FM and AM antenna arrays," *Elec. Ind.*, vol. 5, pp. 72-74; April, 1946.
 (295) A. G. Kandoian, "Coaxial feed FM loop antennas," *Elec. Ind.*, vol. 5, pp. 74-76, 122, 124, 126; May, 1946.

Practical forms for antennas suitable for use on trains were shown in:

- (296) E. G. Hills, "Vhf antennas for trains," *Electronics*, vol. 19, pp. 134-136; November, 1946.

Microwave Antennas

The impressive advance in microwave antennas which was made during the war is suggested by a multitude of detailed references in papers in various fields, but is not as yet measured by a large literature of a type to satisfy the specialist. While this delay is understandable, its existence makes the present report rather fragmentary.

One notable fact which is apparent is that the antenna designer has become an optician, with a stock of tools which includes spherical and cylindrical optics, reflectors and lenses, point sources and line sources, special optical systems, and so forth. Another is the importance of good mechanical engineering in the design of such difficult devices as scanning antennas. It has been up to the antenna designer to unite these fields with the transmission line and wave-guide arts, in the process adding many new tricks of his own, of structure and measurement as well as of principle.

A popular account of some work in the microwave field is given in the following reference:

- (297) E. M. Purcell, "Microwave radar antennas," *Radio News*, Radio Electronic Department, vol. 6, pp. 3-6, 29; May, 1946.

A metal-plate lens was reported in which a refractive index less than unity is obtained by employing the principle that in wave guides the phase velocity exceeds that of free space. The lens is used instead of reflectors for purposes of collimation.

- (298) W. E. Kock, "Metal lens antennas," *PROC. I.R.E.*, vol. 34, pp. 828-836; November, 1946.

Close co-operation between the designers of antenna and airplane has been necessary in the matter of housing microwave equipment in a plane without doing violence to the performance of the one or the other.

- (299) E. B. McMillan, H. Leaderman, and T. J. Suen, "Design of radar antenna housings," *Aero Digest*, vol. 52, pp. 89-90, 121, 123; March, 1946; vol. 53, pp. 80-81, 102; August, 1946.

R. E. Burgess discussed the use of a ferromagnetic core to increase the pickup of loop receiving antennas. By way of illustration, he cited data on a loop used in German aircraft during the war.

- (300) R. E. Burgess, "Iron-cored loop receiving aerial," *Wireless Eng.*, vol. 23, pp. 172-178; June, 1946.

L. L. Libby analyzed the balanced shielded loop in terms of familiar transmission-line concepts which enable the approximate prediction of resonance frequencies and impedance characteristics.

- (301) L. L. Libby, "Special aspects of balanced shielded loops," *Proc. I.R.E.*, vol. 34, pp. 641-646; September, 1946.

Radiation from loops was discussed in a paper by E. B. Moullin.

- (302) E. B. Moullin, "Radiation from large circular loops," *Jour. I.E.E. (London)*, vol. 93, part III, pp. 345-351; August, 1946.

A method of optimizing the relation between width of the main beam of an array and the power in side lobes, was published.

- (303) C. L. Dolph, "A current distribution for broadside arrays which optimizes the relationship between beam width and side-lobe level," *Proc. I.R.E.*, vol. 34, pp. 335-348; June, 1946.

There have been other papers on theoretical subjects which are of value, but which do not lend themselves to adequate description in an account of this kind.

- (304) R. E. Burgess, "Fluctuation noise in a receiving aerial," *Proc. Phys. Soc. (London)*, vol. 58, pp. 313-321; May 1, 1946.

Noise Reduction

A very considerable investigation on precipitation static and means for reducing it was reported.

- (305) R. Gunn, W. C. Hall, and D. G. Kinzer, "The precipitation-static interference problem and methods for its investigation," *Proc. I.R.E.*, vol. 34, pp. 156P-161P; April, 1946.
- (306) R. C. Waddel, R. C. Drutowski, and W. N. Blatt, "Aircraft instrumentation for precipitation-static research," *Proc. I.R.E.*, vol. 34, pp. 161P-166P; April, 1946.
- (307) R. G. Stimmel, E. H. Rogers, F. E. Waterfall, and R. Gunn, "Electrification of aircraft flying in precipitation areas," *Proc. I.R.E.*, vol. 34, pp. 167P-177P; April, 1946.
- (308) G. D. Kinzer and J. W. McGee, "Investigations of methods for reducing precipitation-static radio interference," *Proc. I.R.E.*, vol. 34, pp. 234-240; May, 1946.
- (309) R. Gunn and J. P. Parker, "The high-voltage characteristics of aircraft in flight," *Proc. I.R.E.*, vol. 34, pp. 241-247; May, 1946.
- (310) M. Newman and A. O. Kemppainen, "High-voltage installation of the precipitation-static project," *Proc. I.R.E.*, vol. 34, pp. 247-254; May, 1946.

A sensitive microwave radiometer for measuring the temperature of radiation resistance was described.

- (311) R. H. Dicke, "The measurement of thermal radiation at microwave frequencies," *Rev. of Sci. Instr.*, vol. 17, pp. 268-275; July, 1946.

Antenna Testing

In the field of antenna testing, a description of a method and tools for calculating the radiation patterns of directional antenna systems consisting of two or three elements was given by:

- (312) Homer A. Ray, Jr., "A practical calculator for directional antenna systems," *Proc. I.R.E.*, vol. 34, pp. 398-902; November, 1946.

G. H. Brown and W. G. Morrison described an entirely electronic instrument for plotting on the face of a cathode-ray tube the radiation pattern of directional antenna systems using as many as six radiators. The radiation pattern may be observed while independent changes are being made in current ratio, phase angle, azimuth position, and distance from a reference point.

- (313) George H. Brown and Wendell C. Morrison, "The RCA Antennalyzer—an instrument useful in the design of directional antenna systems," *Proc. I.R.E.*, vol. 34, pp. 992-999; December, 1946.

It was pointed out that expression of free-space transmission in terms of the effective areas of the two directional antennas leads to a beautifully simple transmission formula.

- (314) H. T. Friis, "A note on a simple transmission formula," *Proc. I.R.E.*, vol. 34, pp. 254-256; May, 1946.

Other papers of interest from the point of view of antenna testing were:

- (315) F. J. Gaffney, "Microwave measurements and test equipments," *Proc. I.R.E.*, vol. 34, pp. 775-793; October, 1946.
- (316) R. J. Clayton, J. E. Houldin, H. R. L. Lamont, and W. E. Willshaw, "Radio measurements in the decimeter and centimeter wavebands," *Jour. I.E.E. (London)*, vol. 93, part III, pp. 97-117; March, 1946.

Electron Tubes

Small High-Vacuum Tubes

A new tube, the cyclophon, was described. This tube is used for multiplex relay work at ultra-high frequencies and contains a rotating electron beam which impinges upon a system of electrodes arranged in a circle.

- (317) D. D. Grieg and A. M. Levine, "Pulse-time-modulated multiplex radio relay system—terminal equipment," *Elec. Commun.*, vol. 23, pp. 159-178; June, 1946.

A number of improvements in existing tubes were reported. These include an ionization gauge and a coil-neutralized amplifier operating at very-high frequencies. Disk-sealed tubes have been studied as power amplifiers in the frequency range of 200 to 3000 megacycles.

- (318) R. J. Kircher, "A coil-neutralized vacuum-tube amplifier at very-high frequencies," *Proc. I.R.E.*, vol. 33, pp. 838-843; December, 1945.
- (319) Charles M. Fogel, "An ionization gauge of simple construction," *Proc. I.R.E.*, vol. 34, pp. 302-305; May, 1946.
- (320) E. A. Veazie, "The 6AR6 Tube," *Bell Lab. Rec.*, vol. 24, pp. 264-265; July, 1946.

Intense interest was shown in a thorough study of activated cathodes, especially of the oxide-coated type. Several special sessions were given to this subject during this year by the American Physical Society and some other organizations in which such cathodes were discussed. Also, several papers deal with the same problem in American and French publications.

- (321) John P. Blewett, "Oxide coated cathode literature, 1940-1945," *Jour. Appl. Phys.*, vol. 17, pp. 643-647; August, 1946.

- (322) Edward A. Coomes, "The pulsed properties of oxide cathodes," *Jour. Appl. Phys.*, vol. 17, pp. 647-654; August, 1946.
- (323) A. Eisenstein, "A study of oxide cathodes by x-ray diffraction methods," *Jour. Appl. Phys.*, vol. 17, pp. 434-443; June; pp. 654-663; August, 1946.
- (324) A. Fineman and A. Eisenstein, "Studies of the interface of oxide coated cathodes," *Jour. Appl. Phys.*, vol. 17, pp. 663-668; August, 1946.
- (325) Ch. Beguenet, "L'émision des cathodes tungsten-césium et tungsten-thorium," *Le Vide*, no. 1, pp. 13-21; no. 2, pp. 54-61; 1946.
- (326) Robert Champeiz, "La mesure du courant de saturation des cathodes oxydes," *Le Vide*, no. 3, pp. 79-89; 1946.
- (327) Martin A. Pomerantz, "Magnetron cathodes," *Proc. I.R.E.*, vol. 34, pp. 903-910; November, 1946.
- (343) Radio Manufacturers Association Electron Tube Releases: 2E31, 2E32, 2E41, 2E42, 2G21, 2G22, 1C8, 1V5, 1W5, 1Q6.
- (344) Marcus A. Acheson, "Proximity-fuze tubes," presented at Rochester Fall Meeting, Rochester, New York, November, 1945. (Abstract, *Electronics*, vol. 19, pp. 228, 230, 232, 234, 236; January, 1946.)
- (345) Frank Rockett, "Proximity fuze," *Electronics*, vol. 18, pp. 110-111; November, 1945.
- (346) Harner Selvidge, "Proximity fuzes for artillery," *Electronics*, vol. 19, pp. 104-109; February, 1946.
- (347) Ralph G. Peters, "The radio proximity fuze," *Communications*, vol. 27, pp. 45-47, 92-94; October, 1945.
- (348) "Navy proximity fuze," *Elec. Ind.*, vol. 4, pp. 104-105, 132, 134; November, 1945.

A number of papers were published based upon studies of the characteristics of vacuum tubes. These have included space-charge effects, noise factor, and physical limitations in electron ballistics.

- (328) L. Brillouin, "Influence of space charge on the bunching of electron beams," *Phys. Rev.*, vol. 70, pp. 187-196; August, 1946.
- (329) N. R. Campbell, V. J. Francis, and E. G. James, "Noise factor of valve amplifiers," *Wireless Eng.*, vol. 23, pp. 74-83; March, 1946; and pp. 116-121; April, 1946.
- (330) S. Rodda, "Beam tetrode characteristics," *Wireless Eng.*, vol. 23, pp. 140-145; May, 1946.
- (331) S. Rodda, "Space charge and electron deflections in beam tetrode theory," *Electronic Eng.*, vol. 17, pp. 541-545; June; pp. 589-592; July; pp. 649-650, 652; August, 1945.
- (332) J. R. Pierce, "Physical limitations in electron ballistics," *Bell Sys. Tech. Jour.*, vol. 24, pp. 305-321; July-October, 1945.
- (333) A. L. Samuel, "Electron ballistics in high-frequency fields," *Bell Sys. Tech. Jour.*, vol. 24, pp. 322-352; July-October, 1945.

Problems in mechanical construction and design of electron tubes were discussed in several papers.

- (334) L. L. Winter and H. G. MacPherson, "Effect of surface finish and wall thickness on the operating temperature of graphite radio-tube anodes," *Proc. I.R.E.*, vol. 33, pp. 834-837; December, 1945.
- (335) George A. Espersen, "Fine wires in the electron-tube industry," *Proc. I.R.E.*, vol. 34, pp. 116W-120W; March, 1946.
- (336) Report No. 30, "Telefunken metal-ceramic radio valve," His Majesty's Stationery Office; U. S. Department of Commerce, Office of Technical Service; 1946.
- (337) Albert W. Hull, "Stresses in cylindrical glass-metal seals with glass inside," *Jour. Appl. Phys.*, vol. 17, pp. 685-687; August, 1946.
- (338) W. J. Scott, "Glass-to-metal seal design," *Electronic Eng.*, vol. 17, pp. 764-767; November, 1945.

Both magnetron and reflex oscillators were discussed at some length in the literature of 1946.

- (339) "Multi-cavity magnetron," *Bell Lab. Rec.*, vol. 24, pp. 219-223; June, 1946.
- (340) Edward L. Ginzton and Arthur E. Harrison, "Reflex-klystron oscillators," *Proc. I.R.E.*, vol. 34, pp. 97P-113P; March, 1946.
- (341) R. L. Sproull and E. G. Linder, "Resonant-cavity measurements," *Proc. I.R.E.*, vol. 34, pp. 305-312; May, 1946.

A paper was published describing the development of a gas-discharge transmit-receive switch which had become an accepted part of radar equipment:

- (342) A. L. Samuel, J. W. Clark, and W. W. Mumford, "The gas-discharge transmit-receive switch," *Bell Sys. Tech. Jour.*, vol. 25, pp. 48-101; January, 1946.

The first radio-frequency and converter tubes for general use in a size under 0.4-inch diameter and 1 9/16-inch length were announced during the year. Additional structural information on such subminiature tubes for proximity-fuze use has been released.

A radically different beam deflection tube (Radio Manufacturers Association type 6AL7GT) was described which converts a three-phase crystal-controlled voltage to a phase-modulated voltage with magnetic modulation at an audio frequency.

- (349) "Phasitron converts from AM to FM directly," *Elec. Ind.*, vol. 5, pp. 78-79; January, 1946.

There appeared analyses of the "transitron" circuit, both as applied to audio-frequency amplification and to oscillator circuits.

- (350) Werner Muller, "Transitron oscillator for high stability," *Elec. Ind.*, vol. 4, pp. 110-112, 134, 136, 138; December, 1945.
- (351) Robert Adler, "Reentrant pentode AF amplifier," *Electronics*, vol. 19, pp. 123-125; June, 1946.

There has been a brief mention (with photographs) of Japanese receiving magnetrons for local 10- and 3-centimeter oscillators.

- (352) Marvin Hobbs, "Japanese magnetrons," *Electronics*, vol. 19, pp. 114-115; May, 1946.

Large High-Vacuum Tubes

In the field of microwave tubes a comprehensive analysis of multicavity magnetron operation was the subject of quite a number of technical lectures and of several papers.

- (353) J. B. Fisk, H. D. Hagstrom, and P. L. Hartman, "The magnetron as a generator of centimeter waves," *Bell Sys. Tech. Jour.*, vol. 25, pp. 167-348; April, 1946.
- (354) D. G. Fink, "Cavity magnetrons," *Electronics*, vol. 19, pp. 126-131; January, 1946.
- (355) G. D. O'Neill, "Separate cavity tunable magnetron," *Elec. Ind.*, vol. 5, pp. 48-50, 122-123; June, 1946.
- (356) H. G. Shea, "Rising sun pulsed and CW magnetrons," *Elec. Ind.*, vol. 5, pp. 46-50; August, 1946.

A novel tube of outstanding interest in the microwave field was discussed during the I.R.E. Electron Tube Conference at Yale University; also, it was the subject of several technical lectures. This was the "traveling-wave" amplifier tube. Originated in England, it was thoroughly studied and developed in this country. Basically it represents a concentric transmission line with a wire spiral for the outer and an electron beam for the inner conductor. Interaction between the waves traveling through the spiral and the beam results in a considerable radio-frequency power gain. The main advantage of this novel amplifier is the unusually wide band of frequencies handled by the tube, a band 800 megacycles wide in the vicinity of 4000 megacycles.

- (357) F. Rockett, "Wideband microwave amplifier tube," *Electronics*, vol. 19, pp. 90-92; November, 1946.

In the field of velocity-modulation tubes there was described a reflex klystron with a much larger than normal output, because of the intensification of the modulated beam by abundant secondary emission from the target which is in this case positively biased (with respect to the cavity resonator). It was possible to obtain from 10 to 20 watts output at 3000 megacycles instead of less than 1 watt from the same tube with the electron-repelling (negative) target. A similar tube was obviously independently developed during the war, in Germany.

- (358) C. C. Wang, "Velocity-modulation oscillators with secondary-emission characteristics," presented in the I.R.E. Symposium, "Wartime developments," April 6, 1946, New York
 (359) L. Mayer, "Ueber Versuche mit Geschwindigkeitsteuerten Laufzeitelektronenrohren mit dichtmodulierten Sekundärelektronenstrom und nur einem Hohlraumresonator," *Zeit. Für Hochfrequenz und Akustik*; 1942.

Several patents on a combination of a klystron with a few stages of electron-multiplier arrangement were granted to various engineers in this country, France, and England.

Crystal-controlled cascade klystrons intended for better frequency control (up to one part in a million) were described in several papers.

- (360) A. E. Harrison, "Microwave frequency stability," presented at the National Electronic Conference, Chicago; October, 1946.
 (361) E. C. Levinthal, "Cascade amplifier klystron," presented at the I.R.E. Winter Technical Meeting, New York; January, 1946.

A German version of klystron with water-cooling, giving output at 8.6 to 9.3 centimeters was mentioned. It was used by the Germans for jamming purposes.

- (362) "Germany's UHF tubes," *Electronic Ind.*, vol. 5, pp. 81-82, 122; February, 1946.
 (363) A. G. Clavier and V. Altovsky, "Simultaneous use of centimeter waves and frequency modulation," *Elec. Commun.*, vol. 22, pp. 326-338; December, 1945.

In the foreign literature a new version of the Barkhausen-Kurz generator with the floating anode was discussed. The advantages claimed were higher output, higher efficiency, and wider range of operating voltages.

- (364) N. P. Otpuschenikoff, "Static charge on the anode and its role in the mechanism of the excitation of oscillation in the 'Bremsfeld' scheme with a free anode," *Jour. Tech. Phys.* (in Russian), vol. 14, No. 1, pp. 110-112; 1946.
 (365) N. P. Otpuschenikoff, "Anode current and excitability in the Barkhausen-Kurz scheme," *Jour. Tech. Phys.* (in Russian), vol. 14, pp. 113-119; 1946.

Among very-high-frequency television and frequency-modulation developments, beam tetrodes, double beam tetrodes, and grounded-grid triodes predominated. Not many papers were published on this subject, however. Large tube manufacturers, now and then, advertised the commercial availability of such tubes with 0.5 to 10 kilowatts output for the 100-megacycle band; also, tubes were announced for operation at 500 megacycles and even at higher frequencies with a few hundred watts output. For higher outputs in the region of 500 to 1000 megacycles, tubes of the "resnatron" type were suggested and discussed at several meetings.

- (366) A. van Weel, "An experimental transmitter for ultra-short-wave radio-telephony with frequency modulation," *Philips Tech. Rev.*, vol. 8, pp. 121-128; April, 1946.
 (367) S. Frankel, J. J. Glauber, and J. Wallenstein, "A medium-power triode for frequencies around 600 megacycles," presented, I.R.E. Winter Technical Meeting, New York, N.Y.; January, 1946.
 (368) H. W. Jamison and J. R. Whinnery, "Power amplifiers with disk-seal tubes," *PROC. I.R.E.*, vol. 34, pp. 483-489; July, 1946.
 (369) G. T. Ford, "A miniature tube for broad band I-F amplifiers," I.R.E. Symposium, New York; April, 1946.
 (370) "Electron tubes," *Gen. Elec. Rev.*, vol. 49, p. 57; January, 1946.
 (371) W. G. Dow, J. N. Dyer, W. W. Salisbury, and E. A. Yunker, "Generation of continuous-wave power of very-high frequencies," presented, I.R.E. Winter Technical Meeting; January, 1946.
 (372) W. W. Salisbury, "The resnatron," *Electronics*, vol. 19, pp. 92-97; February, 1946.
 (373) F. W. Boggs, "Principles of operation of resnatron," I.R.E. Symposium, New York; April, 1946.

In the microwave frequency range, a system of broadcasting which transmitted a single frequency with time-pulse modulation was proposed as being more efficient than the ordinary multichannel arrangements. In order to realize it, a special beam-switching tube, the "cyclophon," was developed consisting substantially of a cathode-ray tube with the electron beam swinging across an array of anodes or "dynodes" employing abundant secondary emission.

- (374) J. J. Glauber, D. D. Grieg, and S. Maskovitz, "The cyclophon," National Electronics Conference, Chicago; October, 1946.

As outgrowths of war developments several interesting pulse-triodes were described.

- (375) H. A. Zahl, J. E. Gorham, and G. F. Rouse, "A vacuum-contained push-pull triode transmitter," *PROC. I.R.E.*, vol. 34, pp. 66W-69W; February, 1946.
 (376) R. R. Law, D. G. Burnside, R. P. Stone, and W. B. Whalley, "Development of pulse triodes and circuit to give one megawatt at 600 megacycles," *RCA Rev.*, vol. 7, pp. 253-264; June, 1946.
 (377) J. J. Glauber, "Radar vacuum-tube developments," *Elec. Commun.*, vol. 23, pp. 306-319; September, 1946.

A rather novel and interesting type of high-frequency oscillator for low frequencies was described in Russian technical literature. This is a mercury-arc tube with a dielectric disk located between the anode and cathode. The disk has a central aperture constricting the arc. Within certain limits of vacuum (about 2μ Hg) and of current density, the tube, named by the author a "Stenotron," produces continuous oscillations of a frequency which is not governed by the LC product of the associated circuit but depends on tube constants only. Up to 1 kilowatt output was obtained with frequencies up to 100,000 cycles per second. A somewhat similar tube is described in a U. S. patent.

- (378) T. A. Souëtin, "Stenotron—ionic tube generator," *Electrichesvo* (in Russian), pp. 44-48; May, 1946.
 (379) Clarence W. Hansell, "Mercury arc oscillator," U. S. Patent No. 2,184,740; December 26, 1939.

Several papers were published to assist the electron-tube engineer in his design work.

- (380) Chai Yeh, "The effect of grid-support wires on focusing cathode emission," *PROC. I.R.E.*, vol. 34; pp. 444-447; July, 1946.
 (381) G. Liebman, "The calculation of amplifier valve characteristics," *Jour. I.E.E.* (London), vol. 93, part III, pp. 138-152; May, 1946.

(382) J. L. H. Jonker and B. D. H. Tellegen, "The current to a positive grid in electron tubes," *Philips Res. Reports*, vol. 1, pp. 13-32; October, 1945.

In the broad field of electronics a general interest in electron and ion accelerators of all types can be noted. Velocities of the order of magnitude of several hundred millions and billions of electron volts seemed to be the ultimate aim. The three existing types—the cyclotron, the Van der Graaff generator, and the betatron—and also two novel designs, the synchrotron and a sectioned microwave wave-guide accelerator, were the subject of a special session during the September meeting of the American Physical Society in New York.

X-Ray Tubes

A general review of the field was given in a paper on the present voltage classes and principal constructional features of modern X-ray tubes. A bibliography was included.

(383) Z. J. Atlee, "Industrial X-Ray tubes," *Electronics*, vol. 18, pp. 136-140; November, 1945.

In this family belongs also a sectional X-ray tube for two million or more volts. The essential part of this tube construction is the high-voltage cylindrical envelope 6 to 8 feet long, consisting of short Kovar rings (3 per inch) about 1 foot in diameter separated by glass insulation sealed to the rings.

(384) R. R. Machlett, "An accelerator column for two to six million volts," presented at the National Electronics Conference, Chicago, October, 1946.

Cathode-Ray Tubes and Television Tubes

During the early part of 1946 the development of cathode-ray and camera tubes for television was accelerated, and production was started on a small scale. The Joint Electron Tube Engineering Council Cathode-Ray-Tube Committee was active in the standardization of items affecting interchangeability of cathode-ray tube types, such as preferred tube and picture sizes, bulb sizes, type of base, anode contacts, fluorescent screen color, and important electrical characteristics. The latter part of the year brought acceleration in cathode-ray tube production and in the marketing of television receivers and camera and test equipment.

The image orthicon, developed during the war and representing a major step forward in the field of television camera tubes, was improved and continued in production. This tube was used in television field cameras during the fall for the pickup of football games with pictures much improved over those transmitted from orthicon cameras before the war. The advantages and use of the image orthicon in television equipment developed for the services during the war were described, as was the development of a miniature image orthicon for the military services.

(385) A. Rose, P. K. Weimer, and H. B. Law, "The image orthicon—a sensitive television pickup tube," *Proc. I.R.E.*, vol. 34, pp. 424-432; July, 1946.

(386) R. E. Shelby and H. P. See, "Field television," *RCA Rev.*, vol. 7, pp. 77-93; March, 1946.

(387) R. D. Kell and G. C. Szilkai, "Image orthicon camera," *RCA Rev.*, vol. 7, pp. 67-76; March, 1946.

(388) R. E. Shelby, F. J. Somers, and L. R. Moffett, "Naval airborne television reconnaissance system," *RCA Rev.*, vol. 7, pp. 303-337; September, 1946.

(389) P. K. Weimer, H. B. Law, and S. V. Forgue, "Mimo—miniature image orthicon," *RCA Rev.*, vol. 7, pp. 358-366; September, 1946.

The infrared image tube used in the "Snooperscope" and "Sniperscope" proved to be of major importance in military operations during the war.

(390) G. A. Morton and L. E. Flory, "Infrared image tube," *Electronics*, vol. 19, pp. 112-114; September, 1946.

(391) G. A. Morton and L. E. Flory, "An infrared image tube and its military applications," *RCA Rev.*, vol. 7, pp. 385-413; September, 1946.

The development of cathode-ray tubes for television during the year 1946 resulted in several important improvements. The metal-backed luminescent screen provided increased light output, improved contrast, and ion-spot protection, resulting in a major improvement in projection kinescopes.

(392) D. W. Epstein and L. Pensak, "Improved cathode-ray tubes with metal-backed luminescent screens," *RCA Rev.*, vol. 7, pp. 5-10; March, 1946.

A tilted-electron-lens ion trap was developed which was readily adaptable to different types of electron guns and simple to manufacture and use. Its use would completely eliminate the ion-spot blemish from the fluorescent screen in cathode-ray tubes. Wider use of all-sulphide P4 white screens resulted in improved contrast and better control of the color uniformity. Preferred tubes sizes of 7-, 10-, 15-, and 20-inch diameter with picture diagonals of 6, 9, 13½, and 18 inches were standardized by the Joint Electron Tube Engineering Council.

The new pressed-face bulbs with uniform long face radii provided essentially flat pictures with bulbs that could be readily processed in manufacture. An improved anode contact, the recessed small-cavity cap, was developed and is being standardized along with the war-time-developed recessed small-ball cap for cathode-ray tubes. A new 12-pin type base was developed and standardized for new picture tubes. It had the advantages of the high-voltage insulation and the large locating lug of the dihedral war-program base, but had a smaller-size shell to fit the 1 7/16-inch neck.

A résumé of electron guns for television was published, and several other papers appeared on subjects related to cathode-ray tubes for television.

(393) G. A. Morton, "Electron guns for television applications," *Rev. Mod. Phys.*, vol. 18, pp. 362-378; July, 1946.

(394) M. Cawein, "Television resolution as a function of line structures," *Proc. I.R.E.*, vol. 33, pp. 855-864; December, 1945.

(395) G. Liebmann and H. Moss, "The image formation in cathode-ray tubes and the relation of fluorescent spot size and final anode voltage," *Proc. I.R.E.*, vol. 34, pp. 580-586; August, 1946.

(396) G. Liebmann, "Origin of ion burn in cathode-ray tubes," *Nature*, vol. 157, p. 228; February 23, 1946.

(397) G. Liebmann, "Ion burn in cathode-ray tubes," *Electronic Eng.*, vol. 18, pp. 289-290; September, 1946.

(398) D. Gabor, "A zonally corrected electron lens," *Nature*, vol. 158, p. 198; August 10, 1946.

Improved cathode-ray-oscillograph tubes for industrial applications were announced in the 2-, 3-, and 5-inch sizes. They featured high deflection sensitivity, small spot size, improved contrast, and higher trace brightness than those available during the war. A new multiband 5-inch tube was described. Tubes were developed with the P11, ZnS-type short-persistence screen having increased photographic sensitivity and visual efficiency over the older P5, CaWO₄-type short-persistence phosphor. The P7 and P14 long-persistence-phosphor screens developed during the war show promise of important industrial applications.

- (399) I. E. Lempert and R. Feldt, "The 5RP multiband tube: an intensifier-type cathode-ray tube for high-voltage operation." *PROC. I.R.E.*, vol. 34, pp. 432-440; July, 1946.
- (400) H. W. Leverenz, "Luminescence and tenebrescence as applied in radar," *RCA Rev.*, vol. 7, pp. 199-239; June, 1946.

The field of electron microscopy and electron diffraction has continued to expand. The following papers are representative of the many developments and applications.

- (401) C. L. Simard, C. J. Burton, and R. B. Barnes, "High dispersion electron diffraction by primary magnification," *Jour. Appl. Phys.*, vol. 16, pp. 832-836; December, 1945.
- (402) J. Hillier and R. F. Baker, "On the improvement of resolution in electron diffraction cameras," *Jour. Appl. Phys.*, vol. 17, pp. 12-22; January, 1946.
- (403) J. H. L. Watson, "Fiberless sample mounting for the electron microscope," *Jour. Appl. Phys.*, vol. 17, pp. 121-127; February, 1946.
- (404) R. D. Heidenreich, L. Sturkey, and H. L. Woods, "Investigation of secondary phases in alloys by electron diffraction and the electron microscope," *Jour. Appl. Phys.*, vol. 17, pp. 127-136; February, 1946.
- (405) James Hillier, "Further improvement in the resolving power of the electron microscope," *Jour. Appl. Phys.*, vol. 17, pp. 307-309; April, 1946.
- (406) A. M. Cravath, A. E. Smith, J. R. Vinograd, and J. N. Wilson, "Preparation of electron microscope specimens for determination of particle size distribution in aqueous suspensions," *Jour. Appl. Phys.*, vol. 17, pp. 309-310; April, 1946.
- (407) P. Grivet and H. Bruck, "Le microscope électronique électrostatique," *Ann. de Radioélectricité*, vol. 1, no. 4/5, pp. 293-310; 1946.
- (408) V. K. Zworykin, G. A. Morton, E. G. Ramberg, J. Hillier, and A. W. Vance, "Electron Optics and the Electron Microscope," John Wiley and Sons, New York, N. Y., 1945.
- (409) E. F. Burton and Walter H. Kohl, "The Electron Microscope." Reinhold, New York, N. Y., 1942.

Concentrated Arc Lamp

A concentrated arc lamp, developed during the war for certain military applications, became available for general use during the year. The source of light is a small incandescent spot which forms on a refractory oxide cathode permanently sealed into a glass bulb filled with an inert gas. The light emitted can be modulated over the audio-frequency range by modulating the lamp current itself. It was reported that the approach to a point source made the arc lamp useful for narrow-beam and high-intensity projection applications, such as optical testing, lensless projection and enlargement, photography, etc.

- (410) W. D. Buckingham and C. R. Deibert, "The concentrated arc lamp," *Jour. Opt. Soc. Amer.*, vol. 36, pp. 245-250; May, 1946.

Phototubes

The conference on infrared devices at the Cleveland meeting of the Optical Society of America, March 7-9, 1946, disclosed renewed interest in photoconductive cells. Improvements on the World War I Case Thalofide cell have resulted in a practicable cell, more rugged, stable, and sensitive than the original. A lead-sulfide photoconductive cell has also been developed which promises to be useful out as far as 3.6 microns.

- (411) R. J. Cashman, "New photoconductive cells," *Jour. Opt. Soc. Amer.*, vol. 36, pp. 356; June, 1946. (Abstract.)
- (412) A. von Hippel, F. G. Chesley, H. S. Denmark, P. B. Ulin, and E. S. Rittner, "Thallous sulfide photoconductive cells; I, experimental investigation," *Jour. Chem. Phys.*, vol. 14, pp. 355-369; June, 1946.
- (413) A. von Hippel and E. S. Rittner, "Thallous sulfide photoconductive cells; II, theoretical discussion." *Jour. Chem. Phys.*, vol. 14, pp. 370-378; June, 1946.

At the ultraviolet end of the spectrum, application has been made of a photoelectric Geiger counter tube. Using a special glass and a copper cathode, such a device becomes remarkably sensitive and shows promise of becoming important in fire control.

- (414) P. B. Weisz, "Electronic fire and flame detector," *Electronics*, vol. 19, pp. 106-109; July, 1946

In contrast to its use during the war as an electronic noise source because of its extraordinary gain, the multiplier phototube again received attention in the detection of small light values because of its value in avoiding coupling-resistor and amplifier tube noise. Such applications included astronomical photometry, Raman spectrography, and exposure control in photofluorography. It was suggested that the use of a fluorescent screen with the photomultiplier tube to make radioactive measurements would have many possible applications to nuclear research.

- (415) R. W. Engstrom, "Photomultiplier tube characteristics," Paper No. 44, New York meeting of the Opt. Soc. of Amer.; October 3-5, 1946.
- (416) G. E. Korn, "Application of the multiplier phototube to astronomical photoelectric photometry," *Astrophys. Jour.*, vol. 103, pp. 306-331; May, 1946.
- (417) J. L. Saunderson, V. J. Caldecourt, and E. W. Peterson, "A photoelectric instrument for direct spectrochemical analysis," *Jour. Opt. Soc. Amer.*, vol. 35, pp. 681-697; November, 1945.
- (418) D. H. Rank and R. V. Wiegand, "A photoelectric Raman spectrograph for quantitative analysis," *Jour. Opt. Soc. Amer.*, vol. 36, pp. 325-334; June, 1946.
- (419) R. H. Morgan, "The automatic control of exposure in photofluorography," U. S. Public Health Reports, vol. 58, pp. 1533-1541; October, 1943.
- (420) M. Blau and B. Dreyfus, "The multiplier phototube in radioactive measurements," *Rev. Sci. Instr.*, vol. 16, pp. 245-248; September, 1945.

Radio Wave Propagation

Most of the papers on radio wave propagation published in 1946 were of experimental rather than theoretical interest, as is shown by the following references. These are grouped under five main subjects, and in each field the titles of the papers indicate the main lines of development during the year. A few papers which may prove of general theoretical interest are listed in the final section of the bibliography and, throughout, some

papers published in foreign countries prior to 1946 have been included since they have only recently become available in the United States. There are probably many others not recorded in this report.

Ionosphere

As a result of studies of the ionosphere, much detailed information about the effect of solar phenomena on radio propagation was made available, with corresponding refinement in the choice of optimum frequencies for long-distance short-wave transmission.

- (421) C. W. Allen, "Variation of the sun's ultra-violet radiation as revealed by ionospheric and geomagnetic observations," *Terr. Mag. and Atmos. Elec.*, vol. 51, pp. 1-18; March, 1946.
- (422) Ya. L. Al'pert, "On the results of radio observations during the solar eclipse of July 9, 1945," *Compt. Rend. Acad. Sci. (U.S.S.R.)*, vol. 49, pp. 254-258; November 10, 1945.
- (423) E. V. Appleton, "Two anomalies in the ionosphere," *Nature*, vol. 157, p. 691; May 25, 1946.
- (424) C. J. Bakker, "Radio investigations of the ionosphere," *Philips Tech. Rev.*, vol. 8, pp. 111-120; April, 1946.
- (425) T. W. Bennington, "The new sunspot cycle," *Wireless World*, vol. 52, pp. 83-85; March, 1946.
- (426) T. W. Bennington, "Ionosphere storm effects in the E-layer," *Nature*, vol. 157, pp. 477-478; April 13, 1946.
- (427) T. W. Bennington, "Short-wave forecasting" (using ionosphere charts for choosing frequencies), *Wireless World*, vol. 52, pp. 246-250; August, 1946 and pp. 292-295; September, 1946.
- (428) R. E. Burgess, "Fluctuation noise in a receiving aerial," *Proc. Phys. Soc. (London)*, vol. 58, pp. 313-321; May 1, 1946.
- (429) O. Burkard, "On the question of short-wave propagation," *Funktech. Mh.*, no. 5, pp. 65-66; May, 1945.
- (430) J. W. Cox, "Geophysics of the ionosphere," *Nature*, vol. 158, pp. 189-190; August 10, 1946.
- (431) R. H. Dicke and R. Beringer, "Microwave radiation from the sun and moon," *Astrophys. Jour.*, vol. 103, pp. 375-376; May, 1946.
- (432) V. C. A. Ferraro, "On diffusion in the ionosphere," *Terr. Mag. and Atmos. Elec.*, vol. 51, pp. 427-431; September, 1946.
- (433) O. P. Ferrell, "Irregularities in radio transmission," *Radio*, vol. 29, pp. 27-28, 61; December, 1945; vol. 30, pp. 23-24; February, 1946.
- (434) E. Gherzi, "Ionospheric reflections and weather forecasting for Eastern China," *Bull. Amer. Meteor. Soc.*, vol. 27, pp. 114-116; March, 1946.
- (435) L. Harang, "Scattering of radio waves from great virtual distances," *Terr. Mag. and Atmos. Elec.*, vol. 50, pp. 287-296; December, 1945.
- (436) L. Harang, "Radio-echo observations at Tromsø during the solar eclipse on July 9, 1945," *Terr. Mag. and Atmos. Elec.*, vol. 50, pp. 307-310; December, 1945.
- (437) J. C. Jaeger, "Note on diffusion in the ionosphere," *Proc. Phys. Soc. (London)*, vol. 57, pp. 519-523; November 1, 1945.
- (438) K. O. Kiepenheuer, "Origin of solar radiation in the 1-6 meter radio wave-length band," *Nature*, vol. 158, p. 340; September 7, 1946.
- (439) P. G. Ledig, M. W. Jones, A. A. Giesecke, and E. J. Chernosky "Effects on the ionosphere at Huancayo, Peru, of the solar eclipse, January 25, 1944," *Terr. Mag. and Atmos. Elec.*, vol. 51, pp. 411-418; September, 1946.
- (440) M. Ryle and D. D. Vonberg, "Solar radiation on 175 Mc/s.," *Nature*, vol. 158, pp. 339-340; September 7, 1946.
- (441) M. N. Saha and B. K. Banerjee, "Wave-treatment of propagation of electromagnetic waves in the ionosphere," *Indian Jour. Phys.*, vol. 19, pp. 159-166; October, 1945.
- (442) A. H. Shapley, "Application of solar and geomagnetic data to short-term forecasts of ionospheric conditions," *Terr. Mag. and Atmos. Elec.*, vol. 51, pp. 247-266; June, 1946.
- (443) N. Smith and R. Silberstein, "Radio propagation work at the National Bureau of Standards," *QST*, vol. 30, pp. 45-50; May, 1946.
- (444) R. L. Smith-Rose, "The solar eclipse of 1945 and radio-wave propagation," *Nature*, vol. 157, pp. 40-42; January 12, 1946.
- (445) R. L. Smith-Rose, "The influence of an eclipse of the sun on the ionosphere," *Brit. Jour. I.R.E.*, vol. 6, pp. 82-97; June, 1946.
- (446) H. W. Wells and A. H. Shapley, "Eclipse effects in F₂ layer of the ionosphere," *Terr. Mag. and Atmos. Elec.*, vol. 51, pp. 401-409; September, 1946.
- The influence of atmospheric conditions on propagation in the troposphere was studied, and data on the properties of the soil at different frequencies were accumulated. Some theoretical studies were made also in the domain of ground-wave propagation, but these include no radically new departures from earlier theory.
- (447) R. J. Clayton, J. E. Houldin, H. R. L. Lamont, and W. E. Willshaw, "Radio measurements in the decimeter and centimeter wavebands," *Jour. I.E.E. (London)*, vol. 93, part III, pp. 97-125; March, 1946.
- (448) V. A. Fock, "Diffraction of radio waves around the earth's surface," *Jour. Ex. Th. Phys. (U.S.S.R.) (in Russian)*, vol. 15, no. 9, pp. 479-496; 1945; *Jour. Phys. (U.S.S.R.) (in English)*, vol. 9, no. 4, pp. 255-266; 1945.
- (449) L. H. Ford and R. Oliver, "An experimental investigation of the reflection and absorption of radiation of 9-cm. wavelength," *Proc. Phys. Soc. (London)*, vol. 58, pp. 265-280; May, 1946.
- (450) J. Frenkel, "Influence of water drops on the ionization and electrification of air," *Jour. Phys. (U.S.S.R.)*, vol. 10, No. 2, pp. 151-158; 1946.
- (451) R. Frost, "Turbulence and diffusion in the lower atmosphere," *Proc. Roy. Soc. (London)*, vol. 186, pp. 20-35; June 4, 1946.
- (452) B. Gutenberg, "Physical properties of the atmosphere up to 100 km.," *Jour. Meteor.*, vol. 3, pp. 27-30; June, 1946.
- (453) M. Leontovich and V. Fock, "Solution of the problem of propagation of electromagnetic waves along the earth's surface by the method of the parabolic equation," *Jour. Phys. (U.S.S.R.)*, vol. 10, no. 1, pp. 13-24; 1946.
- (454) L. I. Mandelstam and N. D. Papalexi, "On a modification of the interference method of investigating the propagation of radio waves," *Compt. Rend. Acad. Sci. U.R.S.S.*, vol. 26, pp. 775-779; 1940.
- (455) J. S. McPetrie and J. A. Saxton, "The electrical properties of soil at wave-lengths of 5 metres and 2 metres," *Jour. I.E.E. (London)*, vol. 92, part III, pp. 256-258; December, 1945.
- (456) G. Millington, "Curved earth geometrical optics," *Marconi Rev.*, vol. 9, pp. 1-12; January, March, 1946.
- (457) G. E. Mueller, "Propagation of 6-millimeter waves," *Proc. I.R.E.*, vol. 34, pp. 181P-183P; April, 1946.
- (458) K. F. Niessen, "On the approximate absorption formula of the earth for vertical dipoles," *Physica*, vol. 9, pp. 915-922; November, 1942. (In German.)
- (459) K. F. Niessen, "The ratio between the horizontal and the vertical electric field of a vertical antenna of infinitesimal length situated above a plane earth," *Philips Res. Rep.*, vol. 1, pp. 51-62; October, 1945.
- (460) H. Ott, "The saddle-point method in the vicinity of a pole with applications to wave-optics and acoustics," *Ann. Phys. (Leipzig)*, vol. 43, nos. 6, 7, pp. 393-403; 1943.
- (461) R. Penndorf, "The constitution of the stratosphere," *Meteor. Zeit.*, vol. 58, pp. 103-105; 1946; *Bull. Amer. Meteor. Soc.*, vol. 27, pp. 343-345; June, 1946.
- (462) J. A. Pierce, "2-Mc. sky-wave transmission," *Electronics*, vol. 19, pp. 146-153; May, 1946.
- (463) M. I. Ponomarev, "Application of the 'phase-integral' method to the problem of radio wave propagation along the earth's surface," *Bull. de l'Acad. des Sci. de l'URSS, Serie Physique*, vol. 10, no. 2, pp. 189-195; 1946.
- (464) M. G. Rabuteau, "The evolution of the technique of long-distance telecommunications," *Onde Elec.*, vols. 20-25, no. 225, pp. 140-154; December, 1945.
- (465) S. D. Robertson and A. P. King, "The effect of rain upon the propagation of waves in the 1- and 3-centimeter regions," *Proc. I.R.E.*, vol. 34, pp. 178P-180P; April, 1946.
- (466) P. A. Sheppard, "Radio meteorology: influence of the atmosphere on the propagation of ultra-short radio waves," *Nature*, vol. 157, pp. 860-862; June 29, 1946.
- (467) B. A. Vvedenski, "On the effect of refraction in the troposphere on the propagation of ultra-short radio waves in a diffraction zone," *Bull. de l'Acad. des Sci. de l'URSS, Serie Physique*, vol. 6, nos. 1, 2, pp. 41-55; 1942.
- (468) H. P. Williams, "Vertical vs. horizontal polarization," *Jour. Television Soc.*, vol. 4, pp. 171-177; September, 1945.
- (469) "Propagation of electromagnetic waves in mountains, valleys, fjords, etc.," *Jour. des Telecommun.*, vol. 12, pp. 57-62; 1945.

Wave Guides

From the theoretical point of view probably the most interesting work was that on wave guides, particularly

the papers on bent guides and on radiation from the open end of a guide. In this field, attention was also directed to the actual method of excitation of different types of waves in a wave guide.

- (470) J. T. Allanson, R. Cooper, and T. G. Cowling, "The theory and experimental behaviour of right-angled junctions in rectangular-section wave guides," *Jour. I.E.E.* (London), vol. 93, part III, pp. 177-187; May, 1946.
- (471) W. Altar, F. B. Marshall, and L. P. Hunter, "Probe error in standing-wave detectors," *Proc. I.R.E.*, vol. 34, pp. 33P-44P; January, 1946.
- (472) A. R. Anderson and A. M. Winchell, "Flexible wave guides," *Electronics*, vol. 19, pp. 104-109; August, 1946.
- (473) A. Berkman and D. Mash, "The influence of slotted screens on the structure of the field in a wave guide," *Bull. de l'Acad. des Sci. de l'URSS, Serie Physique*, vol. 9, nos. 10, 11, pp. 1139-1144; 1945.
- (474) H. Buchholz, "Radiation from the open end of a circular guide with an attached plane screen," *Arch. Elektrotech.*, vol. 37, pp. 22-32, 87-104, 145-170; 1943.
- (475) M. Cotte, "Propagation of a disturbance in a wave guide," *Compt. Rend.* (Paris), vol. 221, pp. 538-540; November 5, 1945.
- (476) G. F. Hull, Jr., "Experiments with UHF wave guides," *Amer. Jour. Phys.*, vol. 13, pp. 384-389; December, 1945.
- (477) M. Jouguet, "On the propagation of electromagnetic waves in curved hollow guides," *Compt. Rend.* (Paris), vol. 222, pp. 440-442, 537-538; February 18 and March 4, 1946.
- (478) T. Kahan, "End conditions in wave guides," *Compt. Rend.* (Paris), vol. 222, pp. 535-537; March 4, 1946.
- (479) J. Kemp, "Anomalous attenuation in wave guides," *Wireless Eng.*, vol. 23, pp. 211-216; August, 1946.
- (480) G. V. Kisungo, "Contribution to the theory of wave-guide excitation," *Bull. de l'Acad. des Sci. de l'URSS, Serie Physique*, vol. 10, no. 2, pp. 217-224; 1946.
- (481) N. Malov, "On the calculation of the radiation field of a wave guide," *Jour. Ex. Th. Phys.* (U.S.S.R.), vol. 14, no. 6, pp. 224-225; 1944. (In Russian.)
- (482) N. Malov, "Electromagnetic waves in conical wave guides," *Jour. Ex. Th. Phys.* (U.S.S.R.), vol. 15, no. 7, pp. 389-391; 1945. (In Russian.)
- (483) L. Mandelstam, "Some questions connected with the excitation and the propagation of electromagnetic waves in tubes," *Jour. Ex. Th. Phys.* (U.S.S.R.), vol. 15, no. 9, pp. 461-470; 1945. (In Russian.)
- (484) T. Moreno, "Engineering approach to wave guides," *Electronics*, vol. 19, pp. 99-103; May, 1946.
- (485) T. Moreno, "Wave-guide transmission systems," *Electronics*, vol. 19, pp. 136-141; June, 1946.
- (486) E. N. Phillips, "Minimum attenuation in wave guides," *Electronics*, vol. 19, pp. 137-139; January, 1946.
- (487) G. M. Roe, "Normal modes in the theory of wave guides," *Phys. Rev.*, vol. 69, p. 255; March 1-15, 1946. (Abstract.)
- (488) G. Williams and H. C. Bolton, "The use of the impedance concept as applied to wave guides," *Phil. Mag.*, vol. 36, pp. 862-873; December, 1945.

Transmission Lines

The uses to which transmission lines may be put continue to multiply, and some papers dealing with the properties of composite lines were published.

- (489) A. R. Anderson, "Cylindrical shielding and its measurement at radio frequencies," *Proc. I.R.E.*, vol. 34, pp. 312-322; May, 1946.
- (490) A. K. Aulie, "On adjustment of generator and load impedance," *Elektrotech. Tidsskr.*, vol. 59, pp. 97-101; March, 1946.
- (491) J. L. Clark, "Some novel expressions for the propagation constant of a uniform line," *Bell Sys. Tech. Jour.*, vol. 25, pp. 156-157; January, 1946.
- (492) S. Colombo and M. Parodi, "Application of Heaviside's transposition theorem to the study of the current and voltage in a uniform line," *Rev. Gén. Élect.*, vol. 54, pp. 309-312; October, 1945.
- (493) C. R. Cox, "Design data for beaded coaxial lines," *Electronics*, vol. 19, pp. 130-135; May, 1946.
- (494) D. R. Crosby and C. H. Pennypacker, "Radio-frequency resistors as uniform transmission lines," *Proc. I.R.E.*, vol. 34, pp. 62P-66P; February, 1946.
- (495) H. DeMilleville, "Quadrupole nomograms. Their application to transmission lines," *Rev. Gén. Élect.*, vol. 54, pp. 22-24; January, 1945.

- (496) E. Feenberg, "The relation between nodal positions and standing wave ratio in a composite transmission system," *Jour. Appl. Phys.*, vol. 17, pp. 530-532; June, 1946.
- (497) G. Fuchs, "New method for measuring the impedance differences of concentric pairs," *Rev. Gén. Élect.*, vol. 55, pp. 109-117; March, 1946.
- (498) G. Glinski, "The solution of transmission line problems in the case of attenuating transmission line," *Trans. A.I.E.E. (Elec. Eng.)*, February, 1946), vol. 65, pp. 46-49; February, 1946.
- (499) G. Glinski, "Discontinuity effects," *Elect. Ind.*, vol. 5, pp. 97-98; February, 1946.
- (500) G. W. O. Howe, "Aerial resistance and cable impedance," *Wireless Eng.*, vol. 23, pp. 65-66; March, 1946.
- (501) B. Kramer and F. Stolte, "Measurements of velocity of propagation in cable," *Electronics*, vol. 19, pp. 128-129; July, 1946.
- (502) J. Lamb, "The experimental behaviour of the coaxial line stub," *Jour. I.E.E.* (London), vol. 93, part III, pp. 188-190; May, 1946.
- (503) J. Lefevre, "General graphical method for determining operating conditions of polyphase transmission lines," *Rev. Gén. Élect.*, vol. 54, pp. 345-348; November, 1945.
- (504) W. W. Lewis, "Coordination of insulation and spacing of transmission line conductors," *Trans. A.I.E.E. (Elec. Eng.)*, October, 1946), vol. 65, pp. 690-694; October, 1946.
- (505) I. F. MacDiarmid and H. J. Orchard, "Propagation characteristics of a uniform line," *Wireless Eng.*, vol. 23, pp. 168-171; June, 1946.
- (506) L. Mautner, "Simplified input impedance chart for lossless transmission lines," *Communications*, vol. 26, pp. 44-45, 63; May, 1946.
- (507) H. Parodi and M. Parodi, "Contribution to the theory of electric transmission lines," *Rev. Gén. Élect.*, vol. 53, pp. 227-231; October, 1944.
- (508) M. Parodi, "Propagation along a line having only distributed resistance and capacitance, which are functions of position and satisfy certain relations," *Compt. Rend.* (Paris), vol. 221, pp. 257-259; September, 1945.
- (509) M. Parodi and F. Raymond, "Propagation on an arbitrary symmetric polyphase transmission line," *Compt. Rend.* (Paris), vol. 220, pp. 522-523; April 9, 1945.
- (510) R. H. Paul, "Transmission problems," *Electrician*, vol. 136, pp. 1097-1099; April 26, 1946 and pp. 1165-1167; May 3, 1946.
- (511) L. R. Quarles, "Transmission lines as resonant circuits," *Communications*, vol. 26, pp. 22, 24-25, 51-52; May, 1946.
- (512) L. R. Quarles, "Transmission lines as filters," *Communications*, vol. 26, pp. 34, 35, 44-45, 48; June, 1946.
- (513) L. R. Quarles, "Transmission lines as impedance transformers," *Communications*, vol. 26, pp. 20, 22, 24, 26, 38; July, 1946.
- (514) F. Raymond, "On the equations of propagation on an arbitrary line," *Compt. Rend.* (Paris), vol. 220, pp. 497-500; April 4, 1945.
- (515) H. Scherenzel, "Ideal lines and lines with losses represented by circle diagrams," *Elektrotech. Zeit.*, vol. 65, pp. 329-332; October 12, 1944.
- (516) J. P. Shanklin, "Vectorial treatment of transmission lines," *Electronics*, vol. 18, pp. 162-166; December, 1945.
- (517) P. J. Sutro, "Characteristic impedance of balanced lines," *Electronics*, vol. 19, p. 150; July, 1946.
- (518) C. T. Tai, "Shunt and series sections of transmission line for impedance matching," *Jour. Appl. Phys.*, vol. 17, pp. 44-50; January, 1946.
- (519) E. O. Willoughby, "Some applications of field plotting," *Jour. I.E.E.* (London), vol. 93, part III, pp. 275-293; July, 1946.

Cavity Resonators

New uses of cavity resonators were also described and theoretical studies of perturbation effects in cavities were described.

- (520) I. G. Wilson, C. W. Schramm, and J. P. Kinzer, "High Q resonant cavities for microwave testing," *Bell Sys. Tech. Jour.*, vol. 25, pp. 408-434; July, 1946.
- (521) L. Essen, "Cavity resonator wavemeters. Simple types of wide frequency range," *Wireless Eng.*, vol. 23, pp. 126-132; May, 1946.
- (522) P. Grivet, "New methods for calculating the properties of electromagnetic resonators," *Compt. Rend.* (Paris), vol. 218, pp. 71-73; January 10, 1944.
- (523) P. Grivet, "On the resonant wavelengths of certain electromagnetic resonators," *Compt. Rend.* (Paris), vol. 218, pp. 183-185; January 31, 1944.

- (524) A. M. Gurewitsch, "Cavity oscillator circuits," *Electronics*, vol. 19, pp. 135-137; February, 1946.
- (525) F. Horner, T. A. Taylor, R. Dunsmuir, J. Lamb, and W. Jackson, "Resonance methods of dielectric measurement at centimetre wavelengths," *Jour. I.E.E.* (London), vol. 93, part III, pp. 53-68; January, 1946.
- (526) T. Kahan, "Semi-transparent oscillating electromagnetic cavities," *Compt. Rend.* (Paris), vol. 220, pp. 496-497; April 4, 1945.
- (527) T. Kahan, "The perturbation method applied to the study of electromagnetic cavity resonators," *Compt. Rend.* (Paris), vol. 221, pp. 536-538; November 5, 1945.
- (528) T. Kahan, "Effect of an electron beam on the resonant frequencies of an electromagnetic cavity," *Compt. Rend.* (Paris), vol. 221, pp. 616-618; November 19, 1945.
- (529) T. Kahan, "Calculation of the perturbed resonant frequency of an electromagnetic cavity (deformation of the boundary)," *Compt. Rend.* (Paris), vol. 221, pp. 694-696; December 3, 1945.
- (530) T. Kahan, "Boltzmann's law of slow transformation and the theory of electromagnetic cavities," *Compt. Rend.* (Paris), vol. 222, pp. 70-71; January 2, 1946.
- (531) R. A. Kirkman and M. Kline, "The transverse electric modes in coaxial cavities," *Proc. I.R.E.*, vol. 34, pp. 14P-17P; January, 1946.
- (532) L. Mandelstam, "Emission through an aperture in a resonator," *Jour. Ex. Th. Phys.* (U.S.S.R.) (In Russian), vol. 15, no. 9, pp. 471-474; 1945.
- (533) H. Motz, "Calculation of the electromagnetic field, frequency and circuit parameters of high-frequency resonator cavities," *Jour. I.E.E.* (London), vol. 93, part III, pp. 335-343; September, 1946.
- (534) P. Nicholas, "Characteristic oscillations of solid conductors and electromagnetic cavities," *Ann. de Radioelect.*, vol. 1, pp. 181-190; January, 1946.
- (535) J. T. Randall, "The cavity magnetron," *Proc. Phys. Soc.* (London), vol. 58, pp. 247-252; May, 1946.
- (536) O. E. H. Rydbeck, "On the forced electromagnetic oscillations in spherical resonators," *Ark. Mat. Astr. Fys.*, vol. 32A, no. 3, paper 11, 18 pp.; 1945.
- (537) R. L. Sproull and E. G. Linder, "Resonant-cavity measurements," *Proc. I.R.E.*, vol. 34, pp. 305-312; May, 1946.
- (538) C. G. A. von Lindern and G. de Vries, "Flat cavities as electrical resonators," *Phillips Tech. Rev.*, vol. 8, pp. 149-160; May, 1946.
- (539) R. Warnecke and J. Bernier, "Electronic generator of electromagnetic waves (in a cavity resonator)," *Compt. Rend.* (Paris), vol. 218, pp. 73-75; January 10, 1944.
- (550) J. W. Miles, "The analysis of plane discontinuities in cylindrical tubes," *Jour. Acous. Soc. Amer.*, vol. 17, pp. 259-284; January, 1946.
- (551) J. Ortusi, "Study on the diffraction and reflection of guided waves," *Ann. de Radioelect.*, vol. 1, pp. 87-133; October, 1945.
- (552) C. L. Pekeris, "Perturbation theory of the normal modes for an exponential M-curve in nonstandard propagation of microwaves," *Jour. Appl. Phys.*, vol. 17, pp. 678-684; August, 1946.
- (553) H. Poritsky and M. H. Blewett, "A method of solution of field problems by means of overlapping regions," *Quart. Appl. Math.*, vol. 3, pp. 336-347; January, 1946.
- (554) J. C. Slater, "Physics and the wave equation," *Bull. Amer. Math. Soc.*, vol. 52, pp. 392-400; May, 1946.
- (555) S. T. Meyers, "Nonlinearity in frequency-modulation radio systems due to multipath propagation," *Proc. I.R.E.*, vol. 34, pp. 256-265; May, 1946.
- (556) G. E. Mueller, "Propagation of 6-millimeter waves," *Proc. I.R.E.*, vol. 34, pp. 181P-183P; April, 1946.

Television

The year 1946 was marked by strenuous efforts on the part of the manufacturing industry to make television available to the public. Production difficulties and shortages of material and labor were experienced throughout the radio industry, and in the first three quarters of the year very few shipments were made. In the last quarter, however, the industry was successfully resolving the difficulties, and production of television sets was increasing strongly.

Wartime use of radio location and navigation devices resulted in the training of large numbers of men in pulse techniques. It appears that the stimulation of interest created thereby will be very beneficial to television. Many papers and articles appearing during the year (and reported elsewhere in this review) have shown the great varieties of pulse-type equipments which were used. Specific and direct applications of television in wartime were in the field of guided missiles.

- (557) "Tele-guided missiles," *Elec. Ind.*, vol. 5, pp. 62-65, 114, 116, 118; May, 1946.
- (558) C. J. Marshall and L. Katz, "Television equipment for guided missiles," *Proc. I.R.E.*, vol. 34, pp. 375-401; June, 1946.

Because of the very great interest in the technical aspects of television, it was found desirable to devote an appreciable portion of the I.R.E. Winter Technical Meeting in January, 1946, to the discussion of television developments.

- (559) "I.R.E. Winter Technical Meeting, January, 1946," *Proc. I.R.E.*, vol. 34, pp. 80W-93W; February, 1946.

Before the war considerable progress had been made by the industry in preparing equipment standards as a basis for design, but advances in the electronic art during the war period were so great that in most cases entirely new designs were called for. Potential broadcasters had in most cases indicated their desires by filing applications for Construction Permits with the Federal Communications Commission, and by placing equipment reservations with manufacturers. The larger radio equipment items such as transmitters were being promised for shipment during the first half of 1947 and the more elaborate studio equipments appeared to be potentially available during the first quarter of 1947.

General

Other papers of special interest in the general field of wave phenomena which became available during the year included the following:

- (540) H. Arzelies, "Specular reflection," *Ann. Phys.* (Paris), vol. 1, pp. 5-69; January-February, 1946.
- (541) E. T. Copson, "An integral equation method of solving plane diffraction problems," *Proc. Roy. Soc. A* (London), vol. 186, pp. 100-118; June, 4, 1946.
- (542) H. B. Dwight, "Geometric mean distances for rectangular conductors," *Trans. A.I.E.E. (Elec. Eng.)*, August-September, 1946, vol. 65, pp. 536-538; August-September, 1946.
- (543) Ya. Feld, "The boundary problem of electrodynamics and integral equations of certain diffraction problems," *Jour. Ex. Th. Phys.* (U.S.S.R.), vol. 14, no. 9, pp. 330-341; 1944.
- (544) V. Fock, "The distribution of currents induced by a plane wave on the surface of a conductor," *Jour. Phys.* (U.S.S.R.), vol. 10, no. 2, pp. 130-136; 1946.
- (545) G. A. Grinberg, "New method of solving some boundary problems in equations in mathematical physics, where separation of variables is permissible," *Bull. de l'Acad. des Sci. de l'URSS, Ser. Phys.*, vol. 10, no. 2, pp. 127-168; 1946.
- (546) R. D. Hill, "Potential distributions of equal coaxial cylinders," *Jour. Sci. Instr.*, vol. 22, pp. 221-222; November, 1945.
- (547) F. Lüdi, "On the theory of magnetic field generators for microwaves," *Helv. Phys. Acta* (In German.), vol. 19, pp. 1-20; February 20, 1946.
- (548) N. N. Malov, "On the question of the diffraction of electromagnetic waves by a cylinder," *Jour. Ex. Th. Phys.* (U.S.S.R.) (In Russian), vol. 15, no. 12, pp. 759-764; 1945.
- (549) N. N. Malov, "A 'black body' for radio waves," *Jour. Ex. Th. Phys.* (U.S.S.R.) (In Russian), vol. 16, no. 6, pp. 495-498; 1946.

As a forerunner to television network operation, considerable progress was made in both the radio-relaying and cable type of service. By the radio method, transmissions from New York to Philadelphia and New York to Schenectady were continued, and progress was made in installations of microwave circuits from New York to Boston and New York to Schenectady. In the cable category many additional miles of coaxial cable were laid and television programs originating in New York were transmitted via cable to television broadcasting stations in Washington on regular schedules. Special programs originating in Washington were also transmitted via cable to television broadcasting stations in New York.

(560) Laurance G. Woodford, Keith S. McHugh, and Oliver E. Buckley, "The Bell System's progress in television networks," *Bell Tel. Mag.*, vol. 25, pp. 147-158; Autumn, 1946.

In preparing for effective broadcasting on television, studio techniques and operating requirements were studied.

(561) D. C. Birkinshaw and D. R. Campbell, "Studio technique in television," *Jour. I.E.E.* (London), vol. 92-93, part III, pp. 165-181; September, 1945.

(562) R. E. Farnham, "An appraisal of illuminants for television studio lighting," *Jour. Soc. Mot. Pict. Eng.*, vol. 46, pp. 431-440; June, 1946.

(563) F. T. Bowditch, M. R. Null, and R. J. Zevesky, "Carbon arcs for motion picture and television studio lighting," *Jour. Soc. Mot. Pic. Eng.*, vol. 46, pp. 441-453; June, 1946.

Every part of the home installation of a television receiving system received attention. The usual antenna for a single installation was generally some form of a dipole, designed to cover as much as possible of a frequency band broad enough to cover all frequency-modulation and television broadcasting channels and in some cases provided with directors or reflectors to improve signal pickup. Advertising literature in the various technical periodicals gave the important electrical characteristics of the antennas offered. Considerable thought was given to the problem of providing television signal pickup for apartment house installations, and at least one manufacturer offered a complete system.

The standardization of receiver transmission lines to 300 ohms surge impedance was beneficial in simplifying the problems of both the manufacturer and the user. Good materials for the construction of these lines were available.

(564) "Report of conference on radio-frequency cables," *Trans. A.I.E.E. (Elec. Eng., December, 1945)*, vol. 64, pp. 911-941; December Supplement, 1945.

A great deal of commercial engineering analysis was put into the problem of determining whether television-receiver input systems should tune to all thirteen channels or only to eight, the maximum number which might be assigned in any particular metropolitan area. The preponderance of favor seemed to be toward a receiver which, as delivered, will tune to all thirteen channels. One method of tuning to all thirteen channels made use

of small rotary-coil variable inductors. Other methods involved the mounting of the thirteen separate tuned input systems on a tap switch.

(565) Paul Ware, "Inductive tuning system for FM-television receivers," *Proc. Radio Club Amer.*, vol. 23, pp. 9-16; May, 1946.

Phosphor development during and after the war provided picture-tube screens of high efficiency and accurately controllable color.

(566) I. Krushel, "Phosphors and their behavior in television," *Elec. Ind.*, vol. 4, pp. 100-105, 132, 134; December, 1945; and vol. 5, pp. 92-95, 142, 144, 146, 148, 150; January, 1946.

Man-made electrical interference, including diathermy, electronic heating, ignition, and receiver oscillator radiation, continued as potential threats to satisfactory television service. Some analyses of the problem appeared.

(567) T. T. Goldsmith, "Television interference-engineering problems," *Elec. Ind.*, vol. 5, pp. 60-61, 108; July, 1946; and pp. 73-75, 96; August, 1946.

The effects of local oscillator radiation were discussed.

(568) E. W. Herold, "Local oscillator radiation and its effect on television picture contrast," *RCA Rev.*, vol. 7, pp. 32-53; March, 1946.

The Federal Communications Commission in the United States initiated steps toward the control of interference-producing sources.

(569) Public notice in the Matter of "Promulgation of rules and regulations governing medical diathermy equipment and industrial heating equipment," Federal Communications Commission, Docket No. 7858, Nos. 97876 and 97877, September 20, 1946.

Announcement was made of a new method for handling the audio channel in television receivers. Provided that certain recommended modulation-depth and phase-modulation limits are maintained in the transmitters, this method would effect some receiver circuit simplification and provide a solution to the local-oscillator drift problem.

(570) R. B. Dome, "Television sound channels," presented, Rochester Fall Meeting, Rochester, N. Y., November 12, 1946. (Abstract, *Communications*, vol. 26, pp. 22, 24; December, 1946.)

In the color-television field, opinion was divided into two basic groups. One group held that the sequential color system had been perfected to the point where it was ready for commercialization as soon as the Federal Communications Commission gave approval to the use of ultra-high frequencies for this purpose. The other group, favoring a simultaneous color system, held that, although not perfected, the simultaneous system showed sufficient promise to warrant delaying commercialization of a color system until further experimentation was completed.

(571) "Color television—is it ready to adopt?," *Elec. Ind.*, vol. 5, pp. 88, 118, 120; April, 1946.

(572) D. G. Fink, "Where color television stands," *Electronics*, vol. 19, pp. 104-107; May, 1946.

(573) "Interim Report, UHF color television (November, 1946)," RTPB Panel 6, RMA Television Systems Committee; RTPB 6-2143-A, November 25, 1946.

(574) "All-electronic color television," *Electronics*, vol. 19, pp. 140, 142; December, 1946.

Studies of the technical requirements for television transmission were continued.

- (575) R. E. Graham and F. W. Reynolds, "A simple optical method for the synthesis and evaluation of television images," *Proc. I.R.E.*, vol. 34, pp. 18W-30W; January, 1946.

Piezoelectric Crystals

The following summary is based on papers published since the last annual report, together with a few earlier ones that have only recently become available. Considerably more progress has been made than the summary would indicate, but the results are not yet released for publication.

Two noteworthy books dealing with piezoelectric phenomena have appeared in recent months. One is a general treatise dealing not only with the piezoelectric properties of crystals but with the crystallographic, dielectric, and elastic properties as well. The treatment includes both theory and experimental results. The other is a compilation of certain papers mentioned in previous annual reviews, together with new material, dealing with the various quartz cuts and their properties, techniques of orientation, preparation, mounting, testing, etc.

- (576) W. G. Cady, "Piezoelectricity, an Introduction to the Theory and Applications of Electromechanical Phenomena in Crystals," McGraw-Hill Book Co., New York and London, 1946. Pp. 806, with illustrations and tables.
- (577) R. H. Heising, "Quartz Crystals for Electrical Circuits," D. Van Nostrand Co., New York, N. Y., 1946. Pp. 563 with illustrations and tables.

Quartz Crystals

The perennial problem of maintaining the supply of quartz crystals, and of understanding and gaining the mastery over the physical properties of quartz, has received considerable attention.

- (578) Elizabeth J. Armstrong, "X-ray studies of surface layers of crystals," *Bell Sys. Tech. Jour.*, vol. 25, pp. 136-155; January, 1946.
- (579) W. L. Bond, "Computation of interfacial angles, interzonal angles, and clinographic projection by matrix methods," *Amer. Mineralogist*, vol. 31, pp. 31-42; 1946.
- (580) F. Connor, "Quartz crystals in war and peace," *Domestic Commerce*, vol. 33, pp. 24-26; September, 1945; and *Jour. Chem. Education*, vol. 22, pp. 546-547; November, 1945.
- (581) D. D'Eustachio, "Surface layers on quartz and topaz," *Phys. Rev.*, vol. 70, pp. 522-528; October, 1946.
- (582) C. Frondel, "Elastic deficiency and color of natural smoky quartz," *Phys. Rev.*, vol. 69, pp. 543-544; May 1 and 15, 1946. (Let. to ed.)
- (583) J. Henderson, "Quartz crystal in New Zealand," *New Zealand Jour. Sci. Tech. B*, vol. 25, pp. 162-169; January, 1944.
- (584) R. S. Rivlin, "Optical methods for determining the orientation of quartz crystals," *Jour. Sci. Instr.*, vol. 22, p. 221; November, 1945.
- (585) R. S. Rivlin and H. P. Rooksby, "A simple X-ray spectrometer," *Jour. Sci. Instr.*, vol. 23, pp. 148-150; July, 1946.
- (586) N. Wooster and W. A. Wooster, "Preparation of synthetic quartz," *Nature (London)*, vol. 157, p. 297; March 9, 1946.
- (587) W. A. Wooster and N. Wooster, "Control of electrical twinning in quartz," *Nature (London)*, vol. 157, pp. 405-406; March 30, 1946.
- (588) L. A. Thomas, "Terminology of interpenetrating twins in α -quartz," *Nature (London)*, vol. 155, p. 424; April 7, 1945.
- (589) S. Tolansky, "The topography of crystal faces. I. The topography of a (100) face of left-handed quartz crystal," *Proc. Roy. Soc. A*, vol. 184, pp. 41-51; July 23, 1945.

Other Crystals

Although in many important applications Rochelle salt, for various practical reasons, is being replaced by other crystals, it is still to some extent the object of scientific study. Progress has been made recently in correlating, over a wide range of temperature, the thermal expansion of Rochelle salt with its crystal structure as revealed by X-rays, with special reference to the anomalies at the Curie points and the part played by hydrogen bonds.

The chief rivals of Rochelle salt at present are the primary phosphates of potassium (KH_2PO_4 or "KDP") and of ammonium ($\text{NH}_4\text{H}_2\text{PO}_4$ or "ADP"). A determination of the thermal expansion, and of the dielectric, elastic, and piezoelectric constants over a wide range of temperatures has been made by Mason. He gives also a theoretical discussion of his results. The phosphates of potassium KH_2PO_4 and KD_2PO_4 have been investigated by De Quervain, by means of X-rays. He pays particular attention to the effects at the Curie points and the domain structure.

Bärtschi and his associates have investigated the effect on the dielectric and elastic properties of $\text{NH}_4\text{H}_2\text{PO}_4$ caused by replacing some of the NH_4 groups with thallium. Matthias and Merz found that the replacing of some of the K ions in KH_2PO_4 with alkali metals lowered the Curie point, while thallium raised it. The Tl substitution also increased the stiffness, raised the temperature at which the temperature coefficient of frequency vanished, and made d_{14} greater, d_{36} smaller.

- (590) P. Bärtschi, B. Matthias, W. Merz, and P. Scherrer, "Displacement of the critical point in the NH_4 -rotation-transformation," *Helv. Phys. Acta*, vol. 18, no. 4, pp. 238-240; 1945.
- (591) M. de Quervain, "X-ray investigations with potassium phosphate at low temperatures," *Helv. Phys. Acta.*, vol. 17 no. 7, pp. 509-552; 1944.
- (592) W. P. Mason, "The elastic, piezoelectric and dielectric constants of potassium dihydrogen phosphate, and ammonium dihydrogen phosphate," *Phys. Rev.*, vol. 69, pp. 173-194; March 1 and 15, 1946.
- (593) W. P. Mason, "Elastic, piezoelectric and dielectric properties of sodium chlorate and sodium bromate," *Phys. Rev.*, vol. 70, pp. 529-537; October 1 and 15, 1946.
- (594) W. P. Mason, "Properties of monoclinic crystals," *Phys. Rev.*, vol. 70, pp. 705-728; November 1 and 15, 1946.
- (595) B. Matthias and W. Merz, "Effect of foreign ions on seignettelectric properties," *Helv. Phys. Acta.*, vol. 19, no. 4, pp. 227-229; 1946.
- (596) A. R. Ubbelohde and I. Woodward, "Structure and thermal properties of crystals. VI, The role of hydrogen bonds in Rochelle Salt," *Proc. Roy. Soc. A.*, vol. 185, pp. 448-465; April 5, 1946.

Growing Crystals

Among the papers describing methods of growing artificial crystals may be mentioned the following:

- (597) R. M. Barrer, "Preparation of synthetic quartz," *Nature (London)*, vol. 157, p. 734; June 1, 1946.
- (598) A. N. Holden, "Apparatus for growing single crystals from solution," *Phys. Rev.*, vol. 68, p. 283; December 1 and 15, 1945. (Abstract.)

In this connection may be mentioned an investigation in which crystals were grown containing two parts of a

d-Glucose and one of the chloride, bromide, or iodide of sodium. Resonators from these crystals all had temperature coefficients of frequency of the order of $180(10^{-6})$ per degree centigrade. Values of the piezoelectric constants are not given.

- (599) B. Matthias and W. Merz, "Piezoelectricity of the sugar-sodium halides," *Helv. Phys. Acta*, vol. 19, no. 4, pp. 229-230; 1946.

Vibrational Theory

Progress continues to be made in vibrational theory. Ekstein has extended his theory, mentioned in last year's annual report, and has applied it to the thickness vibrations of quartz plates and their reaction on the driving circuit. Swann has published a dynamical treatment of a vibrating crystal carrying a mechanical load at either boundary.

- (600) H. Ekstein, "Forced vibrations of piezoelectric crystals," *Phys. Rev.*, vol. 70, pp. 76-84; July 1 and 15, 1946.
 (601) W. F. G. Swann, "General dynamical considerations applied to piezoelectric oscillations of a crystal in an electrical circuit," *Jour. Frank. Inst.*, vol. 242, pp. 167-195; September, 1946.

Piezo Oscillators

In the study of piezo oscillators, Biggs and Wells have suggested several methods for measuring antiresonant impedance. Butler describes some new oscillating circuits, all employing series resonance; although they provide lower stability of frequency than the Meacham oscillator, they are claimed to have more power. Grasel describes a crystal-controlled generator for aligning aircraft-beacon receivers.

- (602) A. J. Biggs and G. M. Wells, "The measurement of the activity of quartz oscillator crystals," *Jour. I.E.E. (London)*, vol. 93, part III, pp. 29-36; January, 1946.
 (603) F. Butler, "Series-resonant crystal oscillators," *Wireless Eng.*, vol. 23, pp. 157-160; June, 1946.
 (604) W. C. Grasel, "A crystal-controlled 75-mc signal generator," *Communications*, vol. 25, pp. 46, 48, 51; June, 1945.

Use of Crystals in Ultrasonics

The investigation of ultrasonic phenomena, which began soon after World War I, has recently received fresh impetus, largely through the application of the pulse techniques that were developed for radar. Several papers in this field have appeared during the past year. In most of this work a piezoelectric crystal, usually quartz, was used both as a transmitter of ultrasonic radiation and as a detector. A noteworthy application of ultrasonic beams from crystals is the "supersonic reflectoscope" for locating hidden flaws in metals, measuring the thickness of metal parts, etc. Both compressional and shear waves can be used. The latter are generated by a Y-cut quartz plate; the waves are polarized, the vibration direction being parallel to the X axis of the quartz.

- (605) W. S. Erwin, "Supersonic measurement of metal thickness," *Iron Age*, vol. 154, pp. 59-61, November 9, 1944; *Steel*, vol. 116, pp. 131, 188, 190, 192; March, 1946.
 (606) F. A. Firestone, "The supersonic reflectoscope for interior inspection," *Metal Progress*, vol. 48, pp. 505-512; September, 1945.

- (607) F. A. Firestone and J. R. Frederick, "Refinements in supersonic reflectoscopy; polarized sound," *Jour. Acous. Soc. Amer.*, vol. 18, pp. 200-211; July, 1946.

Miscellaneous Applications

Although no strikingly new applications of piezoelectric crystals have been revealed, there has been some activity in improved designs of crystal filters, including the use of "duplex crystals" (two quartz plates bonded together to vibrate flexurally at frequencies as low as 1 kilocycle). Jaffe has offered suggestions for expressing the figures of merit of crystal transducers when serving as voltage-generating devices and as emitters of ultrasonic waves. Mason has used a torsionally vibrating crystal in measurements of the viscosity of gases.

- (608) W. Bantle, B. Matthias, and P. Scherrer, "Specially-wide-band filters using artificial crystals," *Schweiz. Arch. angew. Wiss. Tech.*, vol. 11, pp. 161-164; June, 1945.
 (609) H. Jaffe, "The order of magnitude of piezoelectric effects," *Phys. Rev.*, vol. 68, p. 282; December 1 and 15, 1945. (Abstract.)
 (610) C. E. Lane, "Duplex crystals," *Bell Lab. Rec.*, vol. 24, pp. 59-62; February, 1946.
 (611) F. J. Lehany and K. G. Dean, "An unbalanced narrow-band crystal filter," *A.W.A. Tech. Rev. (Australia)*, vol. 6, no. 7, pp. 369-380; 1945.
 (612) W. P. Mason, "Variations of the viscosity of polyatomic gases with frequency," *Phys. Rev.*, vol. 70, p. 110; July 1 and 15, 1946. (Abstract.)
 (613) E. S. Willis, "A new crystal channel filter for broadband carrier systems," *Trans. A.I.E.E. (Elec. Eng.)*, March, 1946, vol. 65, pp. 134-138; March, 1946.

There is at present a trend toward the adoption of the meter-kilogram-second system of units for piezoelectric quantities, and also toward certain changes in definitions and symbols for crystallographic and elastic terminology. Some specific recommendations on these matters have already been agreed upon by the Institute's Committee on Piezoelectric Crystals, to be made public in a forthcoming report.

Electroacoustics

During the first postwar year many investigators returned to peacetime subjects. This is indicated by the papers published on room acoustics and related subjects, on the construction of acoustic laboratories, on musical tones, methods of measuring acoustic materials, on the visual representation of speech, etc.

Papers illustrative of the design of acoustic rooms were:

- (614) L. L. Beranek and H. P. Sleeper, Jr., "The design and construction of anechoic sound chambers," *Jour. Acous. Soc. Amer.*, vol. 18, pp. 140-150; July, 1946.
 (615) R. H. Bolt, "Note on normal frequency statistics for rectangular rooms," *Jour. Acous. Soc. Amer.*, vol. 18, pp. 130-133; July, 1946.
 (616) W. S. Gorton, "Demountable soundproof rooms," *Jour. Acous. Soc. Amer.*, vol. 17, pp. 236-239; January, 1946.
 (617) D. P. Løye and R. L. Morgan, "A small acoustical tube for measuring absorption of acoustical materials in auditoriums," *Jour. Acous. Soc. Amer.*, vol. 17, pp. 326-328; April, 1946.
 (618) F. Massa, "Sound-pressure measurement standard," *Electronics*, vol. 19, pp. 218, 220, 222, 224, 226, 228; May, 1946.

Interesting was the use of wedges to increase the absorbing surface beyond that provided by the walls, and

also the use of nonuniform distribution of the sound-absorbing material to obtain desired effects.

- (619) Herman Feshbach and Cyril M. Harris, "Effect of nonuniform wall distributions of absorbing material on the acoustics of rooms," *Jour. Acous. Soc. Amer.*, vol. 18, pp. 472-487; October, 1946.
- (620) C. M. Harris, "The effect of position on the acoustical absorption by a patch of material in a room," *Jour. Acous. Soc. Amer.*, vol. 17, pp. 242-244; January, 1946.
- (621) V. O. Knudsen, "Propagation of sound in the atmosphere—attenuation and fluctuations," *Jour. Acous. Soc. Amer.*, vol. 18, pp. 90-96; July, 1946.
- (622) K. C. Morrical, "Irregular room surfaces in studios," (Abstract.) *Communications*, vol. 26, pp. 35-36; April, 1946.

Reports on some of the theoretical work on acoustics done during the year may be found in the following articles:

- (623) P. G. Bergmann, "The wave equation in a medium with a variable index of refraction," *Jour. Acous. Soc. Amer.*, vol. 17, pp. 329-333; April, 1946.
- (624) R. K. Cook and P. Chrzanowski, "Absorption and scattering by sound-absorbent cylinders," *Jour. Acous. Soc. Amer.*, vol. 17, pp. 315-325; April, 1946; *Jour. Res. Nat. Bur. Stand.*, vol. 36, pp. 393-410; April, 1946.
- (625) H. Fletcher, "The pitch, loudness and quality of musical tones," *Amer. Jour. Phys.*, vol. 14, pp. 215-225; July-August, 1946.
- (626) E. W. Stewart, "Dispersion of the velocity and anomalous absorption of sound in hydrogen," *Phys. Rev.*, vol. 69, pp. 632-640; June 1 and 15, 1946.

A subject that was considered during the war and is now being generally applied in acoustic calibrations is the principle of reciprocity.

- (627) A. L. Di Mattia and F. M. Wiener, "On the absolute pressure calibration of condenser microphones by the reciprocity method," *Jour. Acous. Soc. Amer.*, vol. 18, pp. 341-343; October, 1946.
- (628) Edwin M. McMillan, "Violation of the reciprocity theorem in linear passive electromechanical systems," *Jour. Acous. Soc. Amer.*, vol. 18, pp. 344-347; October, 1946.

Work done on visual representation of speech was published:

- (629) R. K. Potter, "Introduction to technical discussions of sound portrayal," *Jour. Acous. Soc. Amer.*, vol. 18, pp. 1-3; July, 1946.
- (630) H. Dudley and O. O. Gruenz, Jr., "Visible speech translators with external phosphors," *Jour. Acous. Soc. Amer.*, vol. 18, pp. 62-73; July, 1946.
- (631) W. Koenig, H. K. Dunn, and L. Y. Lacy, "Sound spectrograph," *Jour. Acous. Soc. Amer.*, vol. 18, pp. 19-49; July, 1946.
- (632) G. A. Kopp and H. C. Green, "Basic phonetic principles of visible speech," *Jour. Acous. Soc. Amer.*, vol. 18, pp. 74-89; July, 1946.
- (633) J. C. Steinberg and N. R. French, "The portrayal of visible speech," *Jour. Acous. Soc. Amer.*, vol. 18, pp. 4-18; July, 1946.

The end of the war also brought about the release of the results of various war projects which were previously unavailable for publication. A number of papers appeared on the subjects of underwater sound, echo-ranging sonar, the acoustic properties of liquids and metals, ultrasonics and supersonics, aircraft acoustical problems, etc.

Illustrative of the material published on underwater sound are the following papers:

- (634) J. W. M. Du Mond, E. R. Cohen, W. K. H. Panofsky, and E. Deeds, "A determination of the wave forms and laws of propagation and dissipation of ballistic shock waves," *Jour. Acous. Soc. Amer.*, vol. 18, pp. 97-118; July, 1946.

- (635) R. J. Evans, "Echo ranging sonar," *Electronics*, vol. 19, pp. 88-93; August, 1946.
- (636) F. E. Fox and G. D. Rock, "Compressional viscosity and sound absorption in water at different temperatures," *Phys. Rev.*, vol. 70, pp. 68-73; July 1 and 15, 1946.
- (637) R. S. Lanier and C. R. Sawyer, "Sonar for submarines," *Electronics*, vol. 19, pp. 99-103; April, 1946.
- (638) Donald P. Loye and Don. A. Proudfoot, "Underwater noise due to marine life," *Jour. Acous. Soc. Amer.*, vol. 18, pp. 446-449; October, 1946.
- (639) R. Clark Jones, "Fifty horsepower siren," *Jour. Acous. Soc. Amer.*, vol. 18, pp. 371-386; October, 1946.
- (640) M. F. M. Osborne and S. D. Hart, "Transmission reflection and guiding of an exponential pulse by a steel plate in water," *Jour. Acous. Soc. Amer.*, vol. 18, pp. 170-184; July, 1946.
- (641) C. L. Pekeris, "Theory of propagation of sound in a half-space of variable sound velocity under conditions of formation of a shadow zone," *Jour. Acous. Soc. Amer.*, vol. 18, pp. 295-315; October, 1946.
- (642) I. Rudnick, "Acoustic transmission through a fluid lamina," *Jour. Acous. Soc. Amer.*, vol. 17, pp. 245-253; January, 1946.
- (643) B. K. Sahay, "A new aspect of ultrasonics," *Jour. Acous. Soc. Amer.*, vol. 17, pp. 285-286; January, 1946.
- (644) G. B. Shaw, "Echo depth sounder for shallow water," *Electronics*, vol. 19, pp. 88-92; September, 1946.

The work done in the field of ultrasonics is illustrated by these articles:

- (645) F. A. Firestone and J. R. Frederick, "Refinements in supersonic reflectoscopy. Polarized sound," *Jour. Acous. Soc. Amer.*, vol. 18, pp. 200-211; July, 1946.
- (646) J. Quinn, "The absorption of ultrasonic waves in benzene," *Jour. Acous. Soc. Amer.*, vol. 18, pp. 185-189; July, 1946.

Studies of the acoustic properties of the jungle were made to assist in the war effort:

- (647) Carl F. Eyring, "Jungle acoustics," *Jour. Acous. Soc. Amer.*, vol. 18, pp. 257-270; October, 1946.
- (648) John S. Saby and Howard A. Thorpe, "Ultrasonic ambient noise in tropical jungles," *Jour. Acous. Soc. Amer.*, vol. 18, pp. 271-273; October, 1946.

Acoustic methods were applied to problems connected with aircraft and the atmosphere:

- (649) G. W. Gilman, H. B. Coxhead, and F. H. Willis, "Reflection of sound signals in the troposphere," *Jour. Acous. Soc. Amer.*, vol. 18, pp. 274-283; October, 1946.
- (650) K. R. Jackman, "Aircraft acoustical problems and possible solutions," *Aviation*, vol. 45, pp. 75-79, July, 1946; pp. 83-89, August, 1946, pp. 71-78, September, 1946.
- (651) J. Weichbrod, "Problems of high altitude communication," *Jour. Acous. Soc. Amer.*, vol. 18, pp. 161-166; July, 1946.

The matter of aiding those with defective hearing has been a matter of concern. The design of better, and especially more compact, hearing aids and methods of testing and selecting hearing aids were the subjects of a number of papers, as follows:

- (652) H. Montague, "Hearing aids for deaf children," *Volta Rev.*, vol. 48, pp. 9-13, 60; January, 1946.
- (653) O. A. Whildin, "Hearing aid service for children," *Volta Rev.*, vol. 48, pp. 23-26; January, 1946.
- (654) T. H. Turney, "Testing of deaf aids," *Jour. Sci. Inst.*, vol. 23, pp. 58-59; March, 1946.
- (655) H. Daves and others, "The selection of hearing aids," *Laryngoscope*, vol. 56, pp. 85-115; March, 1946.
- (656) E. H. Greibach, "Laboratory method for objective testing of bone receivers and throat microphones," *Trans. A.I.E.E. (Elec. Eng., April, 1946)*, vol. 65; April, 1946.

Great activity has taken place in the field of sound recording and reproduction. The principal methods studied were film, phonograph, and magnetic recording. New and improved types of sound pickups and

reproducers were worked on. Means for improving the quality of reproduction and the reduction of interfering noise were discussed, as well as refinements in the mechanical design of apparatus.

The optical method for measuring groove modulation has provided a useful tool:

- (657) B. B. Bauer, "Measurement of recording characteristics by means of light patterns," *Jour. Acous. Soc. Amer.*, vol. 18, pp. 387-394, 395; October, 1946.

Magnetic recording is another development which has interesting possibilities:

- (658) S. J. Begun, "Magnetic recording," (Abstract), *Communications*, vol. 26, pp. 31, 33; April, 1946.
 (659) M. Camras, "Theoretical response from a magnetic-wire record," *PROC. I.R.E.*, vol. 34, pp. 597-602; August, 1946.
 (660) T. H. Long and G. D. McMullen, "A B-H curve tracer for magnetic-recording wire," *Elec. Eng., Trans.*, vol. 65, pp. 146-149; March, 1946.

But film and disk processes also received further consideration:

- (661) A. M. Glover and A. R. Moore, "A phototube for dye image sound track," *Jour. Soc. Mot. Pict. Eng.*, vol. 46, pp. 379-386; May, 1946.
 (662) H. B. Lee, "Stereophon sound recording system," *Jour. Acous. Soc. Amer.*, vol. 17, pp. 356-357; April, 1946.
 (663) H. P. Kalmus, "Pickup with low mechanical impedance," *Electronics*, vol. 19, pp. 140-145; January, 1946.

Further progress was made in the design of loudspeakers and microphones, their use and calibration. Articles on this subject covering broadcasting, theater and radio receiving, as well as wartime applications, are indicated by the following:

- (664) J. F. Marshall, "The Navy type PAM-1 portable announcing system," *Engrs. Notebook*, vol. 2, pp. 6-7; January, 1946.
 (665) F. L. Hopper and R. C. Moody, "Wave propagation and outdoor field tests of a loudspeaker system," *Jour. Soc. Mot. Pict. Eng.*, vol. 46, pp. 115-123; February, 1946.
 (666) J. B. Lansing, "New permanent magnet public address loudspeaker," *Jour. Soc. Mot. Pict. Eng.*, vol. 46, pp. 212-219; March, 1946.
 (667) P. Hickson, "Marine loudspeaking gear," *Wireless World*, vol. 52, pp. 254-255; August, 1946.
 (668) H. F. Olson, "Gradient microphones," *Jour. Acous. Soc. Amer.*, vol. 17, pp. 192-198; January, 1946.
 (669) H. E. Ellithorn and A. M. Wiggins, "Antinoise characteristics of differential microphones," *PROC. I.R.E.*, vol. 34, pp. 84P-89P; February, 1946.
 (670) J. B. Ledbetter, "Broadcast microphones," *Radio News*, Radio-Electronic Dept., vol. 6, pp. 10-13, 20-21; June, 1946.
 (671) J. E. White, "Motional impedance analysis applied to a dynamic microphone," *Jour. Acous. Soc. Amer.*, vol. 18, pp. 155-160; July, 1946.

Railroad and Vehicular Communication

The most significant uses of radiotelephone apparatus in land-mobile applications was in the 152- to 162-megacycle band. Many field tests and the operation of new systems demonstrated urban coverage in this band to be superior to the coverage achieved in the 30- to 40-megacycle range. The superior performance of the higher-frequency band was attributed to:

- (1) The lower level of noise found at the higher frequencies.
- (2) The filling in of possible dead spots by the multiple reflections of the higher-frequency waves.
- (3) The absence of skywave interference in the 152- to 162-megacycle band.

Tests were made of rural coverage in the three mobile-service bands, 30 to 44, 72 to 76, and 152 to 162 megacycles. The first reports showed comparable performance where primary coverage only was considered and where the effects of ignition noise and sky-wave interference were neglected. The 30- to 44-megacycle band provided the greatest range of the three bands where secondary coverage was included in the test. Additional test data must be available before general conclusions can be reached, but the trend of the information indicated that effective rural coverage might be obtained with equipment operating in the higher-frequency bands.

Equipment design moved along conventional lines, with emphasis upon low standby drain for mobile equipment and upon stability and sensitivity. Specialized mounting methods were explored with a view to developing railroad equipment which would withstand severe shock. Power-gain antennas were developed for the land stations in the 152- to 162-megacycle band. Selective calling systems of several types were put into use to provide for the individual calling of mobile units.

Telephone companies inaugurated field trials of a new service whereby vehicles could be furnished with radiotelephone service as an extension of the wire-line telephone system. The National Association of Motor Bus Operators began the installation of a pilot system for the investigation of the use of radiotelephone equipment for bus dispatching and safety control. Several railroads installed experimental radio systems. Many taxicab companies installed radio equipment for use in taxi dispatching. The American Trucking Association announced that it planned to investigate the use of radiotelephone dispatching in the trucking service. Power companies, pipe lines, construction companies, fire departments, forestry divisions, road maintenance departments, and police planned to extend their use of mobile radio equipment.

- (672) W. E. Peek, "Two-way radio blazes its way into transit 1946 future," *Mass Transportation*, vol. 41, p. 287; October, 1945.
 (673) "Calling all buses," *Bus Transportation*, vol. 24, p. 67; November, 1945; also, vol. 25, p. 45; February, 1946.
 (674) "Engines with ears; fm radio offers simpler execution of train orders," *National Safety News*, vol. 52, p. 40; November, 1945.
 (675) H. H. Hasselbacher, "Modern railroad communication," *Commercial and Financial Chronicle*, vol. 162, p. 3016; December 20, 1945.
 (676) P. B. Tanner, "Very-high-frequency space radio for train communication," *Commercial and Financial Chronicle*, vol. 162, p. 3142; December 27, 1945.
 (677) "Recorder for train communication," *Railway Age*, vol. 119, p. 1050; December 29, 1945.
 (678) "Rules for train telephone service; FCC proposes rules and regulations for governing use of radio," *Railway Age*, vol. 119; pp. 863-865; November 24, 1945.
 (679) "Highway radio control of truck traffic," *Electronics*, vol. 18, pp. 248, 250; December, 1945.
 (680) "Two-way vehicular telephone service planned by A. T. and T.," *Product Engineering*, vol. 16, p. 859; December, 1945.

- (681) R. A. Clark, Jr., "Railroad radio communications," *Communications*, vol. 25, pp. 62-66; December, 1945.
- (682) J. H. Dunn, "Railroad telegraph and telephone saw big change in 1945," *Railway Age*, vol. 120, pp. 114-118; January 5, 1946.
- (683) J. H. Dunn, "Train communication squared away in 1945," *Railway Age*, vol. 120, pp. 62-66; January 5, 1946.
- (684) "Communication test employs film recorder," *Railway Mech. Eng.*, vol. 120, p. 41; January, 1946.
- (685) E. A. Dahl, "2660-mc. train communication system," *Electronics*, vol. 19, pp. 118-122; January, 1946.
- (686) "Highway radiophone service," *FM and Television*, vol. 6, pp. 45, 72; January, 1946.
- (687) "Agencies agree on train radio control," *Railway Age*, vol. 120, p. 295; February 2, 1946.
- (688) "Mobile radio for the police force," *Engineer*, vol. 181, p. 174; February 22, 1946.
- (689) "Radio laboratory on the rails," *Diesel Power*, vol. 25, pp. 185-186; February, 1946.
- (690) "Railroad communications systems," *Diesel Power*, vol. 24, pp. 212-213; February, 1946.
- (691) "Erie railroad tests two-way communications equipment," *Telegraph and Telephone Age*, vol. 64, p. 5; February, 1946.
- (692) "Waycar fourteen fifty-two calling Diesel thirty-two," *Diesel Power*, vol. 24, pp. 204-206; February, 1946.
- (693) "Mobile service for intercity highways," *Bell. Lab. Rec.*, vol. 24, p. 62; February, 1946.
- (694) "Multicarrier communication system: diversity transmission for mobile working," *Wireless World*, vol. 52, pp. 59-61; February, 1946.
- (695) M. B. Sleeper, "Selective calling in New York on 157 mc.," *FM and Television*, vol. 6, pp. 46-49; February, 1946.
- (696) H. L. Landau, "Mobile 2 to 18 mc. radioteletype for long-range operation," *Communications*, vol. 26, pp. 36-37, 54-55, 74; February, 1946.
- (697) "New reading communications system embodies war advances in radar," *Telegraph and Telephone Age*, vol. 64, pp. 6-7; February, 1946.
- (698) "Radio for trucks," *Shipping Management*, pp. 18-19; February, 1946.
- (699) "Yard radio tests on the Reading," *Railway Age*, vol. 120, pp. 509-511; March 9, 1946.
- (700) "Motor alternator for train communication," *Railway Age*, vol. 120, p. 677; March 30, 1946.
- (701) J. J. Kennedy, "Power supply for communication equipment," *Railway Mech. Eng.*, vol. 120, pp. 149-150; March, 1946.
- (702) L. J. Prendergast, "Train communication finding its place," *Railway Mech. Eng.*, vol. 120, pp. 142-145; March, 1946.
- (703) W. B. Chilson, "Radio co-ordinates highway work," *Better Roads*, vol. 16, pp. 29-31; March, 1946.
- (704) J. P. Woodward and W. R. McMillan, "Experience with emergency fm radio communication," *Edison Elec. Inst. Bull.*, vol. 14, pp. 83-84; March, 1946.
- (705) J. E. Hubel, "New radio dispatching system," *Radio News*, vol. 35, pp. 68-70; March, 1946.
- (706) A. C. Nygren and W. G. Clinton, "161 mc satellite system for rail yards," *FM and Television*, vol. 6, pp. 38-43; April, 1946.
- (707) Baltimore and Ohio radio installation," *Railway Mech. Eng.*, vol. 120, pp. 213-215; April, 1946.
- (708) "Mobile radio service," *Elec. Ind.*, vol. 5, pp. 84-85; April, 1946.
- (709) "Detroit, Toledo and Ironton tests radio in Detroit," *Railway Age*, vol. 120, pp. 916-917; May 4, 1946.
- (710) "Bus radio central," *Business Week*, pp. 42, 44, 46; May 18, 1946.
- (711) "Seaboard tests train radio warning signal," *Railway Mech. Eng.*, vol. 120, pp. 278; May, 1946.
- (712) J. R. Brinkley, "A method of increasing the range of v.h.f. communications systems by multicarrier amplitude modulation," *Jour. I.E.E.* (London), vol. 93, part III, pp. 159-176; May, 1946 (pp. 167-176 discussion).
- (713) W. B. Tyrrell, "Farnsworth demonstrates railroad radio," *Diesel Power*, vol. 24, pp. 592-595, 615; May, 1946.
- (714) H. C. Towers, "Railway communications," *Electrician*, vol. 136, pp. 1585-1588; June 14, 1946.
- (715) "VHF communication equipment," *Wireless World*, vol. 52, pp. 180-181; June, 1946.
- (716) J. K. Kulansky, "Selective calling system," *Electronics*, vol. 1, pp. 96-99; June, 1946.
- (717) H. B. Martin, "Frequency modulation mobile radiotelephone services," *RCA Rev.*, vol. 7, pp. 240-252; June, 1946.
- (718) J. Courtney, "Railroad radio—from FCC to ICC," *Electronics*, vol. 19, pp. 92-94; June, 1946.
- (719) "The editors listen in," *Diesel Power*, vol. 24, pp. 712-714; June, 1946.
- (720) "Facsimiles by radio transmission," *Railway Age*, vol. 20, pp. 1275-1276; June 29, 1946.
- (721) "St. Louis is scene of commercial radio service to mobile 'phones," *Manufacturers Record*, vol. 115, pp. 46-47, June, 1946.
- (722) "Bus radio progress," *Business Week*, p. 32, July 27, 1946.
- (723) "KKSX calling; Key System, Oakland, Calif., using frequency modulated, two-way radio," *Bus Transportation*, vol. 25, p. 45; July, 1946.
- (724) "Facsimile to moving train via vhf," *Electronics*, vol. 19, pp. 168, 170, 172, 174, 176, 178; July, 1946.
- (725) "Radio in the public service; mobile equipment for police and fire use," *Electrician*, vol. 137, p. 318; August 2, 1946.
- (726) "Radio in railroad tunnels," *Railway Age*, vol. 121, p. 373; August 31, 1946.
- (727) "Northern Pacific tests radio train communication," *Railway Signaling*, vol. 39, pp. 533-536; August, 1946.
- (728) "G. H. Phelps, "Radio communication in switch yard operations," *Iron and Steel Eng.*, vol. 23, pp. 68-74; August, 1946.
- (729) "Rolling through Michigan; Pere Marquettes attract much attention," *Railway Age*, vol. 121, pp. 401-402; September 7, 1946.
- (730) "Burlington shows two-way yard radio," *Railway Age*, vol. 121, p. 523; September 28, 1946.
- (731) "Northern Pacific tests radio on freight trains," *Railway Mech. Eng.*, vol. 120, pp. 484-486; September, 1946.
- (732) "Mobile two-way fm in cabs," *Electronics*, vol. 19, pp. 182, 184; September, 1946.
- (733) "F.C.C. rules governing railroad radio," *FM and Television*, vol. 5, pp. 34-35, 78-79; December, 1945.
- (734) Arnold C. Nygren, "Progress report on railroad FM," *FM and Television*, vol. 5, pp. 23-29; December, 1945.
- (735) Ralph G. Peters, "Railroad radiotelephone tests on the Nickel Plate Road," *Communications*, vol. 26, pp. 14-16, 30-31, 34; November, 1946.
- (736) E. G. Hills, "VHF antenna for trains," *Electronics*, vol. 19, pp. 134-136; November, 1946.
- (737) William S. Halstead, "Railroad FM satellite system," *Communications*, vol. 26, pp. 17-21, 54-55; May, 1946.
- (738) "Mobile two-way FM in cabs," *Electronics*, vol. 19, pp. 182-184; September, 1946.
- (739) J. P. Woodward and W. R. McMillan, "Experience with emergency FM radio communications," *Edison Elec. Inst. Bull.*, vol. 14, pp. 83-84; March, 1946.

Circuits

In the field of analysis and synthesis of circuit networks there were comparatively few papers published in 1946 deserving of special mention.

In connection with the design of delay lines, two papers were significant. One of these presented a new and useful mathematical approach pertinent to lines having a uniform ladder or quasi-ladder structure. The other discussed a design procedure yielding satisfactory delay lines of simple solenoidal structure.

(740) M. J. E. Golay, "The ideal low-pass filter in the form of a dispersionless lag line," *Proc. I.R.E.*, vol. 34, pp. 138P-144P; March, 1946.

(741) H. E. Kallmann, "Equalized delay lines," *Proc. I.R.E.*, vol. 34, pp. 646-657; September, 1946.

The ordinary image-parameter theory of two-terminal-pair networks is ill adapted to deal with the problem of optimizing for maximum power transfer, except in the restricted case of purely resistive image impedances. A paper was published which extended the image-parameter theory so as to permit the consideration of conjugate matching and illustrated the results with several appropriate examples:

(742) S. Roberts, "Conjugate-image impedances," *Proc. I.R.E.*, vol. 34, pp. 198P-204P; April, 1946.

A discussion of the use of Tschelyscheff polynomials to produce optimum-response characteristics in the

synthesis of filter networks has been available in the technical literature for some time (for example, in the paper by S. Darlington entitled, "Synthesis of Reactance 4-Poles," *Jour. of Math. and Phys.*, vol. 18, pp. 257-353; September, 1939). However, the value of these methods is apparently just beginning to be appreciated. Several papers were published during the year which discussed such methods in a way which may be of interest to those who previously have been unfamiliar with them.

- (743) P. I. Richards, "Universal optimum-response curves for arbitrarily coupled resonators," *PROC. I.R.E.*, vol. 34, pp. 624-629; September, 1946.
- (744) K. R. Spangenberg, "The universal characteristics of triple-resonant-circuit band-pass filters," *PROC. I.R.E.*, vol. 34, pp. 629-634; September, 1946.
- (745) R. Baum, "Design of broadband I.F. amplifiers," *Jour. Appl. Phys.*, vol. 17, pp. 519-529; June, 1946; and pp. 721-730; September, 1946.

In the field of servomechanisms the effects of nonlinear behavior received attention. A method of analysis offering some promise was discussed and applied in the following paper:

- (746) B. V. Bulgakov, "On the method of van der Pol and its application to nonlinear control problems," *Jour. Frank. Inst.*, vol. 241, pp. 31-54; January, 1946

Facsimile

During 1946 there was a marked renewal of interest in the possibility of a broadcast facsimile home newspaper service. This field was opened up by a ruling by the Federal Communications Commission that frequency-modulation broadcasting stations might transmit facsimile programs when not being used for sound programs. Thus a high-quality transmission medium with good coverage was provided, whereas before the war the standard-band stations were only available after midnight and were particularly subject to troublesome fading in the marginal areas. There has also been a renewal of interest in facsimile methods for specialized communication services designed for police and forestry departments, railroads, etc. The need for industry standards has been recognized and preliminary agreements reached in RMA Committees.

- (747) D. Schulman, "Facsimile synchronizing methods," *Electronics*, vol. 19, pp. 131-133; March, 1946.
- (748) "Facsimile to moving train via VHF," *Electronics*, vol. 19, pp. 168, 170, 172, 174, 176, 178; July, 1946.
- (749) "Mail by microwave," *Sci. News Let.*, vol. 50, p. 198; September 28, 1946.
- (750) S. Feldman, "Possibilities of home facsimile," *Radio News*, vol. 36, pp. 49, 112, 114; November, 1946.
- (751) Milton Alden, "Will newspapers sell their presses," *FM and Television*, vol. 6, pp. 32-33; October, 1946.
- (752) T. Whiteside, "Ticker on every breakfast table," *New Republic*, vol. 115, pp. 293-294; September 9, 1946.

Facsimile equipment was used in conjunction with frequency-modulation radio in reporting the movement of ships in and out of New York harbor. Field trials were begun of a radio-facsimile method of expediting the delivery of telegrams. Telegrams were sent via radio

from a centrally located office to a radio-equipped car cruising in a delivery area. In the car telegrams were recorded automatically at the rate of one per minute while deliveries were being made.

- (753) "How word comes from Sandy Hook," *New York Times*, June 13, 1946.
- (754) "Report on Boston conference on distribution," *New York Times*, October 16, 1946.
- (755) "Photo-electrix telefax sends facsimile," *San Francisco Call-Bulletin*, November 20, 1946.

Acknowledgment

As in previous years, this summary for 1946 covers generally, for the subjects dealt with, developments described in publications issued up to about the first of November. The material has been prepared by members of the 1946 Annual Review Committee of the Institute, with editing and co-ordinating by the Chairman. The members of the Annual Review Committee are:

E. A. Laport	Radio Transmitters
P. S. Carter	Antennas
W. O. Swinyard	Radio Receivers
R. S. Burnap	Electron Tubes
S. A. Schelkunoff	Radio Wave Propagation and Utilization
M. G. Crosby	Modulation Systems
C. G. Fick	Television
W. G. Cady	Piezoelectric Crystals
Eginhard Dietze	Electroacoustics
D. E. Noble	Railroad and Vehicular Communications
D. G. Fink	Navigation Aids
E. A. Guillemin	Circuits
R. F. Guy	Standards
E. W. Schafer	Symbols
C. J. Young	Facsimile
H. C. Gillespie	Industrial Electronics
F. E. Terman	Research
I. S. Coggeshall	
B. S. Ellefson	
Keith Henney	
W. B. Lodge	
L. E. Whittemore	Chairman

The chairmen of the above committees wish to acknowledge the assistance given them in many cases by individual members of the committees. Special acknowledgment is due J. C. Schelleng for the preparation of material on Antennas, Marion C. Gray for the preparation of material on Radio Wave Propagation and Utilization, and to the several chairmen of subcommittees of the Committee on Electron Tubes for the preparation of material in their respective fields: Alan C. Rockwood, Small High-Vacuum Tubes; I. E. Mouromtseff, Large High-Vacuum Tubes; L. B. Headrick, Cathode-Ray Tubes and Television Tubes; and Alan M. Glover, Phototubes.

- (681) R. A. Clark, Jr., "Railroad radio communications," *Communications*, vol. 25, pp. 62-66; December, 1945.
- (682) J. H. Dunn, "Railroad telegraph and telephone saw big change in 1945," *Railway Age*, vol. 120, pp. 114-118; January 5, 1946.
- (683) J. H. Dunn, "Train communication squared away in 1945," *Railway Age*, vol. 120, pp. 62-66; January 5, 1946.
- (684) "Communication test employs film recorder," *Railway Mech. Eng.*, vol. 120, p. 41; January, 1946.
- (685) E. A. Dahl, "2660-mc. train communication system," *Electronics*, vol. 19, pp. 118-122; January, 1946.
- (686) "Highway radiophone service," *FM and Television*, vol. 6, pp. 45, 72; January, 1946.
- (687) "Agencies agree on train radio control," *Railway Age*, vol. 120, p. 295; February 2, 1946.
- (688) "Mobile radio for the police force," *Engineer*, vol. 181, p. 174; February 22, 1946.
- (689) "Radio laboratory on the rails," *Diesel Power*, vol. 25, pp. 185-186; February, 1946.
- (690) "Railroad communications systems," *Diesel Power*, vol. 24, pp. 212-213; February, 1946.
- (691) "Erie railroad tests two-way communications equipment," *Telegraph and Telephone Age*, vol. 64, p. 5; February, 1946.
- (692) "Waycar fourteen fifty-two calling Diesel thirty-two," *Diesel Power*, vol. 24, pp. 204-206; February, 1946.
- (693) "Mobile service for intercity highways," *Bell. Lab. Rec.*, vol. 24, p. 62; February, 1946.
- (694) "Multicarrier communication system: diversity transmission for mobile working," *Wireless World*, vol. 52, pp. 59-61; February, 1946.
- (695) M. B. Sleeper, "Selective calling in New York on 157 mc.," *FM and Television*, vol. 6, pp. 46-49; February, 1946.
- (696) H. L. Landau, "Mobile 2 to 18 mc. radioteletype for long-range operation," *Communications*, vol. 26, pp. 36-37, 54-55, 74; February, 1946.
- (697) "New reading communications system embodies war advances in radar," *Telegraph and Telephone Age*, vol. 64, pp. 6-7; February, 1946.
- (698) "Radio for trucks," *Shipping Management*, pp. 18-19; February, 1946.
- (699) "Yard radio tests on the Reading," *Railway Age*, vol. 120, pp. 509-511; March 9, 1946.
- (700) "Motor alternator for train communication," *Railway Age*, vol. 120, p. 677; March 30, 1946.
- (701) J. J. Kennedy, "Power supply for communication equipment," *Railway Mech. Eng.*, vol. 120, pp. 149-150; March, 1946.
- (702) L. J. Prendergast, "Train communication finding its place," *Railway Mech. Eng.*, vol. 120, pp. 142-145; March, 1946.
- (703) W. B. Chilson, "Radio co-ordinates highway work," *Better Roads*, vol. 16, pp. 29-31; March, 1946.
- (704) J. P. Woodward and W. R. McMillan, "Experience with emergency fm radio communication," *Edison Elec. Inst. Bull.*, vol. 14, pp. 83-84; March, 1946.
- (705) J. E. Hubel, "New radio dispatching system," *Radio News*, vol. 35, pp. 68-70; March, 1946.
- (706) A. C. Nygren and W. G. Clinton, "161 mc satellite system for rail yards," *FM and Television*, vol. 6, pp. 38-43; April, 1946.
- (707) Baltimore and Ohio radio installation," *Railway Mech. Eng.*, vol. 120, pp. 213-215; April, 1946.
- (708) "Mobile radio service," *Elec. Ind.*, vol. 5, pp. 84-85; April, 1946.
- (709) "Detroit, Toledo and Ironton tests radio in Detroit," *Railway Age*, vol. 120, pp. 916-917; May 4, 1946.
- (710) "Bus radio central," *Business Week*, pp. 42, 44, 46; May 18, 1946.
- (711) "Seaboard tests train radio warning signal," *Railway Mech. Eng.*, vol. 120, pp. 278; May, 1946.
- (712) J. R. Brinkley, "A method of increasing the range of v.h.f. communications systems by multicarrier amplitude modulation," *Jour. I.E.E.* (London), vol. 93, part III, pp. 159-176; May, 1946 (pp. 167-176 discussion).
- (713) W. B. Tyrrell, "Farnsworth demonstrates railroad radio," *Diesel Power*, vol. 24, pp. 592-595, 615; May, 1946.
- (714) H. C. Towers, "Railway communications," *Electrician*, vol. 136, pp. 1585-1588; June 14, 1946.
- (715) "VHF communication equipment," *Wireless World*, vol. 52, pp. 180-181; June, 1946.
- (716) J. K. Kulansky, "Selective calling system," *Electronics*, vol. 1, pp. 96-99; June, 1946.
- (717) H. B. Martin, "Frequency modulation mobile radiotelephone services," *RCA Rev.*, vol. 7, pp. 240-252; June, 1946.
- (718) J. Courtney, "Railroad radio—from FCC to ICC," *Electronics*, vol. 19, pp. 92-94; June, 1946.
- (719) "The editors listen in," *Diesel Power*, vol. 24, pp. 712-714; June, 1946.
- (720) "Facsimiles by radio transmission," *Railway Age*, vol. 20, pp. 1275-1276; June 29, 1946.
- (721) "St. Louis is scene of commercial radio service to mobile 'phones," *Manufacturers Record*, vol. 115, pp. 46-47, June, 1946.
- (722) "Bus radio progress," *Business Week*, p. 32, July 27, 1946.
- (723) "KKSX calling; Key System, Oakland, Calif., using frequency modulated, two-way radio," *Bus Transportation*, vol. 25, p. 45; July, 1946.
- (724) "Facsimile to moving train via vhf," *Electronics*, vol. 19, pp. 168, 170, 172, 174, 176, 178; July, 1946.
- (725) "Radio in the public service; mobile equipment for police and fire use," *Electrician*, vol. 137, p. 318; August 2, 1946.
- (726) "Radio in railroad tunnels," *Railway Age*, vol. 121, p. 373; August 31, 1946.
- (727) "Northern Pacific tests radio train communication," *Railway Signaling*, vol. 39, pp. 533-536; August, 1946.
- (728) "G. H. Phelps, "Radio communication in switch yard operations," *Iron and Steel Eng.*, vol. 23, pp. 68-74; August, 1946.
- (729) "Rolling through Michigan; Pere Marquette attracts much attention," *Railway Age*, vol. 121, pp. 401-402; September 7, 1946.
- (730) "Burlington shows two-way yard radio," *Railway Age*, vol. 121, p. 523; September 28, 1946.
- (731) "Northern Pacific tests radio on freight trains," *Railway Mech. Eng.*, vol. 120, pp. 484-486; September, 1946.
- (732) "Mobile two-way fm in cabs," *Electronics*, vol. 19, pp. 182, 184; September, 1946.
- (733) "F.C.C. rules governing railroad radio," *FM and Television*, vol. 5, pp. 34-35, 78-79; December, 1945.
- (734) Arnold C. Nygren, "Progress report on railroad FM," *FM and Television*, vol. 5, pp. 23-29; December, 1945.
- (735) Ralph G. Peters, "Railroad radiotelephone tests on the Nickel Plate Road," *Communications*, vol. 26, pp. 14-16, 30-31, 34; November, 1946.
- (736) E. G. Hills, "VHF antenna for trains," *Electronics*, vol. 19, pp. 134-136; November, 1946.
- (737) William S. Halstead, "Railroad FM satellite system," *Communications*, vol. 26, pp. 17-21, 54-55; May, 1946.
- (738) "Mobile two-way FM in cabs," *Electronics*, vol. 19, pp. 182-184; September, 1946.
- (739) J. P. Woodward and W. R. McMillan, "Experience with emergency FM radio communications," *Edison Elec. Inst. Bull.*, vol. 14, pp. 83-84; March, 1946.

Circuits

In the field of analysis and synthesis of circuit networks there were comparatively few papers published in 1946 deserving of special mention.

In connection with the design of delay lines, two papers were significant. One of these presented a new and useful mathematical approach pertinent to lines having a uniform ladder or quasi-ladder structure. The other discussed a design procedure yielding satisfactory delay lines of simple solenoidal structure.

- (740) M. J. E. Golay, "The ideal low-pass filter in the form of a dispersionless lag line," *Proc. I.R.E.*, vol. 34, pp. 138P-144P; March, 1946.
- (741) H. E. Kallmann, "Equalized delay lines," *Proc. I.R.E.*, vol. 34, pp. 646-657; September, 1946.

The ordinary image-parameter theory of two-terminal-pair networks is ill adapted to deal with the problem of optimizing for maximum power transfer, except in the restricted case of purely resistive image impedances. A paper was published which extended the image-parameter theory so as to permit the consideration of conjugate matching and illustrated the results with several appropriate examples:

- (742) S. Roberts, "Conjugate-image impedances," *Proc. I.R.E.*, vol. 34, pp. 198P-204P; April, 1946.

A discussion of the use of Tschelyscheff polynomials to produce optimum-response characteristics in the

synthesis of filter networks has been available in the technical literature for some time (for example, in the paper by S. Darlington entitled, "Synthesis of Reactance 4-Poles," *Jour. of Math. and Phys.*, vol. 18, pp. 257-353; September, 1939). However, the value of these methods is apparently just beginning to be appreciated. Several papers were published during the year which discussed such methods in a way which may be of interest to those who previously have been unfamiliar with them.

- (743) P. I. Richards, "Universal optimum-response curves for arbitrarily coupled resonators," *PROC. I.R.E.*, vol. 34, pp. 624-629; September, 1946.
- (744) K. R. Spangenberg, "The universal characteristics of triple-resonant-circuit band-pass filters," *PROC. I.R.E.*, vol. 34, pp. 629-634; September, 1946.
- (745) R. Baum, "Design of broadband I.F. amplifiers," *Jour. Appl. Phys.*, vol. 17, pp. 519-529; June, 1946; and pp. 721-730; September, 1946.

In the field of servomechanisms the effects of nonlinear behavior received attention. A method of analysis offering some promise was discussed and applied in the following paper:

- (746) B. V. Bulgakov, "On the method of van der Pol and its application to nonlinear control problems," *Jour. Frank. Inst.*, vol. 241, pp. 31-54; January, 1946

Facsimile

During 1946 there was a marked renewal of interest in the possibility of a broadcast facsimile home newspaper service. This field was opened up by a ruling by the Federal Communications Commission that frequency-modulation broadcasting stations might transmit facsimile programs when not being used for sound programs. Thus a high-quality transmission medium with good coverage was provided, whereas before the war the standard-band stations were only available after midnight and were particularly subject to troublesome fading in the marginal areas. There has also been a renewal of interest in facsimile methods for specialized communication services designed for police and forestry departments, railroads, etc. The need for industry standards has been recognized and preliminary agreements reached in RMA Committees.

- (747) D. Schulman, "Facsimile synchronizing methods," *Electronics*, vol. 19, pp. 131-133; March, 1946.
- (748) "Facsimile to moving train via VHF," *Electronics*, vol. 19, pp. 168, 170, 172, 174, 176, 178; July, 1946.
- (749) "Mail by microwave," *Sci. News Let.*, vol. 50, p. 198; September 28, 1946.
- (750) S. Feldman, "Possibilities of home facsimile," *Radio News*, vol. 36, pp. 49, 112, 114; November, 1946.
- (751) Milton Alden, "Will newspapers sell their presses," *FM and Television*, vol. 6, pp. 32-33; October, 1946.
- (752) T. Whiteside, "Ticker on every breakfast table," *New Republic*, vol. 115, pp. 293-294; September 9, 1946.

Facsimile equipment was used in conjunction with frequency-modulation radio in reporting the movement of ships in and out of New York harbor. Field trials were begun of a radio-facsimile method of expediting the delivery of telegrams. Telegrams were sent via radio

from a centrally located office to a radio-equipped car cruising in a delivery area. In the car telegrams were recorded automatically at the rate of one per minute while deliveries were being made.

- (753) "How word comes from Sandy Hook," *New York Times*, June 13, 1946.
- (754) "Report on Boston conference on distribution," *New York Times*, October 16, 1946.
- (755) "Photo-electrix telefax sends facsimile," *San Francisco Call-Bulletin*, November 20, 1946.

Acknowledgment

As in previous years, this summary for 1946 covers generally, for the subjects dealt with, developments described in publications issued up to about the first of November. The material has been prepared by members of the 1946 Annual Review Committee of the Institute, with editing and co-ordinating by the Chairman. The members of the Annual Review Committee are:

E. A. Laport	Radio Transmitters
P. S. Carter	Antennas
W. O. Swinyard	Radio Receivers
R. S. Burnap	Electron Tubes
S. A. Schelkunoff	Radio Wave Propagation and Utilization
M. G. Crosby	Modulation Systems
C. G. Fick	Television
W. G. Cady	Piezoelectric Crystals
Eginhard Dietze	Electroacoustics
D. E. Noble	Railroad and Vehicular Communications
D. G. Fink	Navigation Aids
E. A. Guillemin	Circuits
R. F. Guy	Standards
E. W. Schafer	Symbols
C. J. Young	Facsimile
H. C. Gillespie	Industrial Electronics
F. E. Terman	Research
I. S. Coggeshall	
B. S. Ellefson	
Keith Henney	
W. B. Lodge	
L. E. Whittemore	Chairman

The chairmen of the above committees wish to acknowledge the assistance given them in many cases by individual members of the committees. Special acknowledgment is due J. C. Schelleng for the preparation of material on Antennas, Marion C. Gray for the preparation of material on Radio Wave Propagation and Utilization, and to the several chairmen of subcommittees of the Committee on Electron Tubes for the preparation of material in their respective fields: Alan C. Rockwood, Small High-Vacuum Tubes; I. E. Mouromtseff, Large High-Vacuum Tubes; L. B. Headrick, Cathode-Ray Tubes and Television Tubes; and Alan M. Glover, Phototubes.

Abstracts and References

Prepared by the National Physical Laboratory, Teddington, England, Published by Arrangement with the Department of Scientific and Industrial Research, England, and *Wireless Engineer*, London, England

NOTE: The Institute of Radio Engineers does not have available copies of the publications mentioned in these pages, nor does it have reprints of the articles abstracted. Correspondence regarding these articles and requests for their procurement should be addressed to the individual publications and not to the I.R.E.

Acoustics and Audio Frequencies.....	426
Aerials and Transmission Lines.....	426
Circuits and Circuit Elements.....	427
General Physics.....	429
Geophysical and Extraterrestrial Phenomena.....	430
Locations and Aids to Navigation.....	431
Materials and Subsidiary Techniques.....	431
Mathematics.....	433
Measurements and Test Gear.....	433
Other Applications of Radio and Electronics.....	434
Propagation of Waves.....	435
Reception.....	436
Stations and Communication Systems.....	436
Subsidiary Apparatus.....	437
Television and Phototelegraphy.....	437
Transmission.....	438
Vacuum Tubes and Thermionics.....	439
Miscellaneous.....	440

The number in heavy type at the upper left of each Abstract is its Universal Decimal Classification number and is not to be confused with the Decimal Classification used by the United States National Bureau of Standards. The number in heavy type at the top right is the serial number of the Abstract.

ACOUSTICS AND AUDIO FREQUENCIES

534.222.1+538.566.2.....	611
Propagation of Radiation in a Medium with Random Inhomogeneities—Bergmann. (See 847.)	
534.32:621.396.722.....	612
Tonal-Range and Sound-Intensity Preferences of Broadcast Listeners—H. A. Chinn and P. Eisenberg. (PROC. I.R.E. AND WAVES AND ELECTRONS, vol. 34, pp. 757-761; October, 1946.) Discussion of 3567 of January.	
534.43:621.395.613.32.....	613
Phonograph Pickup Using Strain Gage—K. J. Gerimeshausen and R. S. John. (Elec. Ind., vol. 5, pp. 78-79, 120; November, 1946.) This uses the change in resistance of a carbon layer, which is elongated or compressed by the moving stylus. It is a simple, rugged device giving good performance.	
534.75.....	614
The Threshold of Audition for Short Periods of Stimulation—J. W. Hughes. (Proc. Roy. Soc. B, vol. 133, pp. 486-490; December 3, 1946.) The threshold of audition rises as the period of stimulation is decreased. The relationship between these two quantities is similar to that found for other sensory mechanisms.	
534.851.001.4.....	615
Disc Recording—H. A. Chinn. (Elec. Ind., vol. 5, pp. 64, 66; November, 1946.) Stresses the need for standard groove shape and for far wider co-operation between the makers of records and of reproducers.	
534.851.6.....	616
Recording Stylus—I. L. Capps. (Elec. Ind., vol. 5, pp. 65, 67, 110; November, 1946.) Discusses the effect of stylus contour, cutting edge, and burnishing facet in lacquer disk recording.	
621.395.623.73:534.415.....	617
Stroboscopic Study of Loud-Speaker Membranes—J. Fasal. (Toute la Radio, vol. 13, pp.	

The Annual Index to these Abstracts and References, covering those published from January, 1946, through December, 1946, may be obtained for 2s. 8d., postage included, from the *Wireless Engineer*, Dorset House, Stamford St., London S. E., England.

178-181; July-August, 1946.) An account of basic principles of the stroboscope and their special application to the study of the vibrations of loudspeaker membranes.

621.395.625:621.395.645.....	618
40-Watt Beam-Power Amplifier for Disc Recording—J. K. Hilliard. (Communications, vol. 26, pp. 22-24; November, 1946.) The response of the input is pre-equalized so that the highest frequencies recorded are emphasized greatly, and the amplifier is designed to maintain rated output up to these frequencies.	
621.395.625.3.....	619
Signal and Noise Levels in Magnetic Tape Recording—D. E. Wooldridge (Trans. A.I.E.E. E. (Elec. Eng., June Supplement, 1946), vol. 65, p. 495; June Supplement, 1946.) Discussion of 2804 of 1946.	

621.395.625.3.....	620
A New Wire Recorder Head Design—T. H. Long. (Trans. A.I.E.E. (Elec. Eng., June Supplement, 1946) vol. 65, pp. 495-497; June Supplement, 1946.) Discussion of 2127 of 1946.	
621.395.667.....	621
Wide Range Tone Control—J. M. Hill. (Wireless World, vol. 52, pp. 422-423; December, 1946.) Description and diagram of a circuit suitable for tone correction at low-volume levels.	

621.396.615.029.3.....	622
Low Cost Audio Oscillator—R. W. Ehrlich. (Radio News, vol. 36, pp. 50-51, 110; November, 1946.) Resistance-tuned, 100 to 25,000 cycles.	

621.396.645.36.029.3.....	623
Class-B Audio-Frequency Amplifiers—F. Butler. (Wireless Eng., vol. 24, pp. 14-19; January, 1947.) The distortion introduced by the variable grid input impedance into a conventionally connected class-B amplifier is considered. By earthing the grid and injecting at the cathode, a very low but comparatively constant input impedance is achieved. Although considerable excitation power is required, "a large proportion of this appears as useful output." The design of a practical push-pull amplifier using cathode injection is outlined.	

AERIALS AND TRANSMISSION LINES

621.314.214.....	624
A Tuned-Line Matching Transformer—T. A. Gadwa. (QST, vol. 31, pp. 36-38; January, 1947.) Matching of an open-wire line to a close-spaced beam aerial, or other low impedance, is effected by means of an adjustable capacitor in combination with short parallel lines for the inductance elements. Adjustment procedure is described.	
621.315.1.015.3+621.316.98.....	625
Study of Transient Voltages on Lines	

Struck by Lightning Protection by Lightning Arresters—G. Bodier. (Rev. Gén. Elec., vol. 55, pp. 199-215; May, 1946.)

621.315.2:621.317.372.....	626
End Leakage in Cable Power-Factor Measurement—Rosen. (See 795.)	
621.315.2.015.532.....	627
Detecting Corona in Cables—W. J. King. (Bell Lab. Rec., vol. 24, pp. 413-415; November, 1946.) As it forms, usually in air pockets between the conductor and its shield, corona produces an electrical disturbance which can be detected and amplified by the test equipment. Tests at reduced pressure are included for cables to be used at high altitudes in aircraft.	

621.315.21.....	628
Propagation along a Cable having Resistance and Capacitance only, these Parameters being Functions of Position and Satisfying Certain Relations—M. Parodi. (Compt. Rend. Sci. (Paris), vol. 221, pp. 257-259; September 3, 1945.) An expression is derived, by means of the Laplace transformation, for the voltage distribution along the line, from which the current can be calculated. A similar method is applicable to a line having only inductance and capacitance.	

621.315[.211.2+.22.....	629
Mineral-Insulated Metal-Sheathed Conductors—F. W. Tomlinson and H. M. Wright. (Jour. I.E.E. (London), part I, vol. 93, pp. 561-562; November, 1946.) Summary of 12 of February.	

621.319.7:621.392.....	630
Some Applications of Field Plotting—E. O. Willoughby. (Jour. I.E.E. (London), part I, vol. 93, pp. 543-545; November, 1946.) Summary of 2814 of 1946.	

621.392+621.316.35.011.3.....	631
Formulas for the Inductance of Coaxial Buses Comprised of Square Tubular Conductors—H. P. Messenger and T. J. Higgins. (Trans. A.I.E.E. (Elec. Eng., June Supplement, 1946), vol. 65, p. 501; June Supplement, 1946.) Discussion of 2815 of 1946.	

621.392:621.317.784.....	632
A Wide-Band Wattmeter for Wave Guide—Early. (See 813.)	

621.392:621.397.62.....	633
The Choice of Transmission Lines for Connecting Television Receiving Aerials to Receivers—F. R. W. Strafford. (Tech. Bull. Radio Component Mfrs' Fed., vol. 1, pp. 3-5; November, 1946.) Various possible types of transmission line are considered: the twin unscreened feeder with a pair of 'Fahnstock' terminal plugs is likely to be the most satisfactory for simple domestic-television aerial installations.	

621.392.012.8.....	634
The Equivalent Circuit for a Plane Discon-	

tinuity in a Cylindrical Wave Guide—J. W. Miles. (PROC. I.R.E. AND WAVES AND ELECTRONS, vol. 34, pp. 728-742; October, 1946.) Equivalent circuits representing a plane discontinuity consisting of a junction between two waveguides of arbitrary cross section are given and the values of the equivalent impedances enumerated.

It is shown that in general the equivalent circuit takes the form of a T network, but that in many cases it reduces to an ideal transformer plus a shunt element. For discontinuities such as slots in guide walls it is shown that an equivalent π network is a better representation.

The theory is applied to a transverse wire, capacitive and inductive windows, and capacitive and inductive cross sections in a rectangular guide and approximate expressions for the impedances are deduced.

621.392.21 635

Propagation along any Line whose Parameters, Functions of Space, Satisfy at All Points a Condition Analogous to that of Non-Distortion—M. Parodi. (Rev. Gén. Élec., vol. 55, pp. 414-415; October, 1946.) Extends the results of 550 of 1946 (Colombo and Parodi).

621.396.67 636

A Folded Unipole Antenna for Emergency Communications—J. S. Brown. (Communications, vol. 26, pp. 18-20; November, 1946.) A quarter-wave system using vertical polarization, and having broad-band impedance characteristics with omnidirectional horizontal radiation pattern. Graphs are given for standing-wave ratio and aerial impedance over the frequency range 30 to 44 megacycles.

621.396.67:621.396.712 637

Postwar Broadcast Antenna Installation—D. W. Jeffries. (Communications, vol. 26, pp. 11-13, 34; November, 1946.) Description of the construction and erection of a $\lambda/4$ self-supporting steel radiator for 1450 kilocycles using a 48-foot-by-48-foot square-mesh mat with 90 radial wires each $\lambda/4$ long. Arrangements are described for obstruction lighting and for audio-frequency monitoring using germanium crystal rectifiers.

621.396.67.029.56/58 638

A Unique Five-Band Antenna System—J. A. McCullough. (QST, vol. 30, pp. 29-31, 136; December, 1946.) Describes a novel means of using combinations of the supporting tower and four parallel dipoles (rotary) to cover all bands from 3.5 to 28 megacycles.

621.396.67.029.58 639

10-Meter Vertical Coaxial Antenna—C. V. Hays. (Radio News, vol. 36, pp. 88, 92; November, 1946.) Constructional details.

621.396.67.029.58 640

A Simple Rotatable Antenna for Two Bands—R. J. Long. (QST, vol. 31, pp. 22-24; January, 1947.) A two-element array for 14 and 28 megacycles.

621.396.67.029.64:621.396.931 641

V.H.F. Antenna for Trains—E. G. Hills. (Electronics, vol. 19, pp. 134-136; November, 1946.) A top loaded, folded, vertically polarized, monopole aerial (for 160 megacycles) concentrates radiation close to the ground in an omnidirectional pattern. The aerial is only five inches high, mechanically rugged, and has an input impedance of 50 ohms. Design techniques are described.

621.396.671:621.396.822 642

Study of the Thermal Equilibrium of Wireless Aerials—G. Lehmann. (Ann. Telecommun., vol. 1, pp. 91-98; May-June, 1946.) The black-body radiation law is used to determine the intensity of the radio-frequency noise field in a uniform temperature enclosure. The noise electromotive force induced in a dipole corresponds to the value given by applying

Nyquist's formula to the radiation resistance. The identity of the polar diagrams of any aerial for reception and for transmission is established. In practice extraterrestrial noise (from the galaxy and the sun) leads to relatively high-aerial-noise temperatures at meter wavelengths. The relations between the aperture, the beamwidth, and the gain of a directive aerial are deduced. The paper was first published in September, 1942, in *Cahiers de Physique*. See also 2122 of 1941 and 2699 of 1946 (Burgess).

621.396.677 643

A High-Gain Two-Meter Rotary Beam—J. A. Kmosko. (QST, vol. 30, pp. 45-47; November, 1946.) A six-element broadside parasitic array with coaxial feed, which has a forward gain of 12 decibels, a front-to-back ratio of 36 decibels and a beamwidth of ± 10 degrees for half power.

621.396.677 644

Directional Patterns of Rhombic Antennae—W. N. Christiansen. (A. W. A. Tech. Rev., vol. 7, pp. 33-51; September, 1946.) "Spatial directional patterns of typical rhombic antennae are given. It is shown that a design which involves the application of the simple 'alignment' relation at the geometric mean of the frequency range is much superior at the higher frequencies to one in which a wider aperture has been used to obtain higher output at this mean frequency.

"A comparison with the pattern of a large tuned array shows the inferiority of a single rhombic antenna. Many of the prominent minor lobes seen in the directional pattern of the latter may be suppressed by the use of several rhombics in the form of an array. Various simple designs are discussed and it is shown possible, particularly when the rhombics are arranged in an interlaced 'end-fire' array, to produce over the whole working range of the rhombic a directional pattern which compares well with that of a large tuned array at its designed frequency."

621.396.677.2 645

Five are Better than Three. Some Experiences With a Five-Element Rotary—W. W. Basden. (QST, vol. 30, pp. 32, 138; December, 1946.) The five-element 28-megacycle beam at WSCXS is different from the usual three-element beam in that director elements have been added 0.1 wavelength above and below the normal director. Delta match feed was used and the line is tapped on the radiator 13 inches each side of the center.

621.396.679.4 646

Dipole with Unbalanced Feeder—D. A. Bell. (Wireless Eng., vol. 24, pp. 3-5; January, 1947.) A short account of the effect of pickup on the concentric downlead from a directly connected dipole receiving aerial. The equivalent circuit of such an aerial arrangement is discussed and the function of a quarter-wave balancing sleeve is considered. An example is given showing the distortion of the polar diagram of an array produced by feeder-lead pickup.

621.396.931/.933]22.029.62 647

Radio Direction Finding at 1.67-Meter Wavelengths—Yuan. (See 732.)

CIRCUITS AND CIRCUIT ELEMENTS

621.314.26 648

Mechanism of Frequency Changing—L. Chrétien. (Toute la Radio, vol. 13, pp. 76-78 and 104-106; March-April and May, 1946.) Criticizes existing theories of the behavior of frequency-changing circuits and puts forward a new theory based on the stroboscopic effect.

621.315.59+621.316.89 649

Properties and Uses of Thermistors—Thermally Sensitive Resistors—Becker, Green, and Pearson. (See 765.)

621.317.432 650

Energy Dissipated by Eddy Currents in a Thin Ferromagnetic Disk Normal to the Field—G. Ribaud. (Compt. Rend. Acad. Sci. (Paris), vol. 222, pp. 726-727; March 25, 1946.) Formulas have previously been given (3811 of 1944) for the energy dissipated by eddy currents in a thin nonmagnetic disk. The difference in the case of a magnetic material results essentially from magnetic charges on the faces of the disk which produce a uniform demagnetizing field, which is added to that due to the eddy currents. The ratio of the energy dissipated in a magnetic disk to that in a nonmagnetic disk of the same resistivity, has a maximum value of $r/4\epsilon$ when $\mu=r^2/\epsilon^2$, μ being the permeability, ϵ the skin thickness and r the distance from the axis. The energy-dissipation formulas given are only valid when the thickness of the disk is more than 2 or 3 times the skin thickness.

621.318.423.012.3 651

Mutual Inductance of Concentric Coils—T. C. Blow. (Electronics, vol. 19, p. 138; November, 1946.) A nomogram for calculating mutual inductance between two concentric single-layer air-core solenoids with greater length than diameter.

621.318.7 652

Tchebycheff Polynomials and the Theory of Electric Filters—A. Colombani. (Compt. Rend. Acad. Sci. (Paris), vol. 222, pp. 1278-1280; May 27, 1946.) The successive intensities in a filter of n cells are shown to depend on polynomials which satisfy Tchebycheff's equation. The particular solution applicable to the filter enables a simple formula for the intensities to be derived.

621.319.4 653

Modern Capacitors—R. Besson. (Toute la Radio, vol. 13, pp. 139-142; June, 1946.) Discusses the temperature, loss, and other characteristics of electrolytic capacitors, capacitors with paper dielectric, and those using silvered mica or ceramic material.

621.319.4:621.315.614.6 654

Paper Capacitors Containing Chlorinated Impregnants—Mechanism of Stabilization—L. Egerton and D. A. McLean. (Bell Sys. Tech. Jour., vol. 25, pp. 652-653; October, 1946.) Barrier films are formed on the electrodes which reduce the catalytic decomposition of the chlorinated impregnant of the electrode metal, prevent attack of the electrodes by liberated hydrogen chloride, and hinder electrolytic action. Abstracted from *Indus. and Eng. Chem.*, May, 1946. For part 3 of this article, see 655 below.

621.319.4:615.315.614.6 655

Paper Capacitors Containing Chlorinated Impregnants: Part 3—Effects of Sulfur—D. A. McLean, L. Egerton, and C. C. Houtz. (*Indus. and Eng. Chem.*, vol. 38, pp. 1110-1116; November, 1946.) Sulphur is an effective stabilizer with both tin and aluminum electrodes, and improves the power factors especially with thin foil electrodes. Previous findings confirmed by the tests are: the importance of all parts of the capacitor, the superiorities of kraft paper over linen, and the widely different behaviors of capacitors with different electrode metals. For an earlier part in this series, see 654 above.

621.392 656

Analysis of Linear Sweet Generator—E. L. Langbergh. (Electronics, vol. 19, pp. 194, 198; November, 1946.) A theoretical analysis of a time base circuit consisting of a capacitor which charges in series with a tube having negative-current feedback. The degree of nonlinearity depends on tube characteristics and on the charging rate of the capacitor. Details of a practical laboratory circuit are given using a high μ pentode as the charging tube and a gas-filled triode as the discharging device.

- 621.392 657
The Transfer Impedance of Recurrent II and T Networks—J. R. Rudd. (*A. W. A. Tech. Rev.*, vol. 7, pp. 79–87; September, 1946.) The transfer impedances are derived for chains of up to six sections of symmetrical II and T networks terminated in equal resistances. Where the product of the impedance values of the arms of the II and T sections is equal to the square of the terminating resistance, the circuits have identical transfer impedances.
- 621.392:621.385.832 658
Design of Cathode-Ray Tube Circuits—W. Knoop. (*QST*, vol. 30, pp. 45–50, 160; December, 1946.) The operation of a cathode-ray tube, and methods of using it in designing power supply and control circuits are explained.
- 621.392:621.396.615 659
The Design of Parallel-T Networks for R-C Oscillators—L. E. V. Lynch and D. S. Robertson. (*A. W. A. Tech. Rev.*, vol. 7, pp. 7–25; September, 1946.) "... the theory of unbalanced parallel-T networks is developed and the application to resistance-capacitance oscillators is discussed. Curves are given to facilitate the design of such oscillators, together with a typical oscillator circuit showing a new method of applying automatic gain control to the associated amplifier."
- 621.392.5 660
Theory of the 'Enclosed' (encadré) Linear Quadripole—P. Grassot. (*Rev. Gén. Élec.*, vol. 55, pp. 443–448; November, 1946.) The term 'quadripôle encadré' is used for a quadripole interposed between a source and a dipole receiver. General considerations are applied to a discussion of the case of a nondissipative enclosed quadripole consisting of pure resistances, leading to the formulation of three theorems. Examples are given of their application. The results may also be applied to telephone transformers, tuned transformers, filters, lines, etc.
- 621.392.52 661
Rigorous Formula for the Attenuation Constant of a Filter—P. Marié. (*Compt. Rend. Acad. Sci. (Paris)*, vol. 222, pp. 869–870; April 8, 1946.) A rigorous formula is derived for the attenuation ratio produced by a filter made up of $(n-1)$ quadripoles, of iterative impedances Z_0 and Z_n , when the filter is terminated by an impedance Z_n and the source presents an internal impedance Z_0 .
- 621.392.52.015.33 662
Transient Response of Filters—E. T. Emms. (*Wireless Eng.*, vol. 24, pp. 27–28; January, 1947.) Comment on 48 of February (Eaglesfield) and 1188 of 1946 (Tucker). It is shown "that if the wave $\cos \omega t \cdot 1$ is put into a band-pass network then the envelope of the output wave is exactly the same as the output wave obtained when unit step is placed into the low-pass analogue."
- 621.394/.397.645 663
Cathode Follower of Very-Low-Output Resistance—(*Electronics*, vol. 19, pp. 206, 210; November, 1946.) Abstract of a report by C. M. Hammack of the Radiation Laboratory of the Massachusetts Institute of Technology. A two-stage cathode follower is described having the normal cathode-load resistance of the first stage replaced by a second tube. The output conductance is shown to be increased by a factor μ over the conventional circuit. The response to pulses is also greatly improved.
- 621.395.667 664
Design of Constant Impedance Equalizers—A. W. J. Edwards. (*Wireless Eng.*, vol. 24, pp. 8–14; January, 1947.) "Some useful properties of inverse networks (as used in line equalization) are deduced and applied to the development of simple practical design procedures involving no calculations when suitable test equipment is available."
- 621.396.61.015.33 665
Calculation of the Minimum Pass Band of a Pulse Transmission System—J. Laplume. (*Ann. Radióelect.*, vol. 1, pp. 327–332; April–July, 1946.) The rate of rise of the output potential from a transmission system when a Heaviside pulse is applied to the input may be increased by improving the high-frequency response of the system. The output then has an oscillatory form.
- Transmission systems which distort the applied pulses in the same way have sensibly identical response curves and it is therefore possible to define mathematically an output-signal type and deduce the response curve which produces this signal from the input pulse. The pass band of such a system is worked out in terms of two characteristics of the output pulse, namely, amplitude of the first oscillation and a quantity measured from the steeply rising part of the potential-time curve of the pulse.
- 621.396.611 666
Increment Features on Variable Oscillators—A. R. A. Rendall. (*Electronic Eng.*, vol. 18, p. 350; November, 1946.) The frequency of an oscillator can be expressed in the form $f_0 = \frac{1}{2\pi RC}$. By connecting in series with the main variable capacitor C a fixed capacitor C_1 , the new frequency will be $f_1 = (C+C_1)/2\pi RC_1$, so that the increment of frequency is $1/2\pi RC_1$, which is independent of C .
- 621.396.611 667
Stability and Frequency Pullings of Loaded Unstabilized Oscillators—J. R. Ford and N. I. Korman. (*Proc. I.R.E. and Waves and Electrons*, vol. 34, pp. 794–799; October, 1946.) "Conditions are established under which the frequency of a loaded unstabilized oscillator will not jump discontinuously as the load susceptance is changed. Frequency-pulling equations and stability criteria are established for an oscillator coupled to a resistive load through a pair of coupled resonant circuits."
- 621.396.611:621.396.615.18 668
The Inductance-Capacitance Oscillator as a Frequency Divider—Norrman. (*See 817.*)
- 621.396.611.1+531.12 669
Calculation of the Natural Frequencies of Nonlinear Systems—H. Jounin. (*Compt. Rend. Acad. Sci. (Paris)*, vol. 222, pp. 1203–1205; May 20, 1946.) The method of approximation for quasilinear systems proposed by Kryloff and Bogolouboff in their "Introduction to Non-linear Mechanics," is applied to the case of a certain class of isochronous oscillators to obtain a simple formula.
- 621.396.611.1 670
Constant Current Circuits—O. T. Fundingsland and G. J. Wheeler. (*Electronics*, vol. 19, pp. 130–133; November, 1946.) "Exponential circuits can be made to carry more nearly constant current for longer times if corrective networks are used. Design equations and actions of these circuits are derived, and their advantages in magnetron pulse circuits are illustrated by a numerical example."
- 621.396.611.3.015.33 671
Transient Response of V.F. [Video Frequency] Couplings—W. E. Thomson. (*Wireless Eng.*, vol. 24, pp. 20–27; January, 1947.) "Formulas and curves are given for the response to the Heaviside unit function of a single [frequency-compensated] resistance-capacitance coupled stage. ... The analysis of the low-frequency response deals mainly with the compensation of grid coupling by anode decoupling. ... For high-frequency compensation the case in which a reactance is inserted in series with the load resistor is analyzed, critical damping being assumed."
- 621.396.615.11 672
A Resistance-Capacitance Beat-Frequency
- Oscillator—D. S. Robertson and L. C. Nye. (*A. W. A. Tech. Rev.*, vol. 7, pp. 27–31; September, 1946.) Accuracies of ± 2 cycles from 20 to 200 cycles and of 1 per cent from 200 to 5000 cycles, and high stability with respect to temperature and supply-voltage variations are claimed. The unit is light and suitable for use in aircraft, and may be operated from a 120- or 240-volt, 50- to 800-cycle supply.
- 621.396.615.142 673
Reflex Oscillators—J. R. Pierce. (*Electronic Eng.*, vol. 18, pp. 345–346; November, 1946.) Summary of paper noted in 3530 of 1945.
- 621.396.615.17:621.396.96 674
Coil Pulsers for Radar—E. Peterson. (*Bell Sys. Tech. Jour.*, vol. 25, pp. 603–615; October, 1946.) A method of generating regularly spaced, sharply peaked pulses of high power for modulating high-frequency generators by making use of the variation of reactance with current of a molybdenum permalloy-cored coil. Pulse widths were obtained from 0.2 to over 1 microsecond, peak powers from 100 to 1000 kilowatts, and pulsing rates from 400 to 3600 pulses per second.
- The principles of operation of a low-power coil pulser working from an alternating-current input and of a high-power apparatus for direct-current operation are described.
- 621.396.619.23 675
A 15-Watt Modulator for Low-Power Work—B. H. Geyer, Jr. (*QST*, vol. 31, pp. 28, 104; January, 1947.) Uses a cathode-follower type of driver with resistance coupling.
- 621.396.62.029.64 676
Components of U.H.F. Field [Strength] Meters—Karplus. (*See 819.*)
- 621.396.645 677
Oscillation Conditions in Single Tuned Amplifiers—W. R. Faust and H. M. Beck. (*Jour. Appl. Phys.*, vol. 17, pp. 749–756; September, 1946.) The gain of a tuned amplifier of n similar stages is calculated. A certain minimum grid-to-plate capacitance is required to cause oscillation. There also exists a region of stable gain, zero to $2^{1/n}$ (approximately) within which no oscillation will occur however large the grid-to-plate capacitance.
- 621.396.645 678
Design of Broad Band I.F. Amplifier: Part 2—R. F. Baum. (*Jour. Appl. Phys.*, vol. 17, pp. 721–730; September, 1946.) The mathematical analysis for broad-band amplifiers of the stagger-tuned type is given. The resonant frequencies of the tuned circuits are assumed to be arranged in pairs so that the geometric mean of each pair is the midband frequency, and the two circuits of each pair have equal Q . An exact solution is possible for either a monotonic or oscillatory response but the latter is shown to be preferable because for a given response characteristic (i.e., a given gain tolerance within the pass band and given minimum attenuation outside it) the oscillatory type requires fewer stages. For part 1, see 3223 of 1946.
- 621.396.645.35 679
A D.C. Amplifier Using a Modulated Carrier System—R. A. Lampitt. (*Electronic Eng.*, vol. 18, pp. 347–350; November, 1946.) Many of the difficulties which occur with a standard direct-current amplifier are overcome by using the signal to be amplified for modulation of a 20-kilocycle amplifier in a linear mode. Any additional amplification may then be carried out by an ordinary alternating-current amplifier at 20 kilocycles. The alternating-current output is rectified so that the resulting direct-current component is a replica of the original input. The amplifier described has an over-all gain of 100,000.

621.396.692.012.3 680
Parallel Standard Resistors—A. K. W. (Wireless World, vol. 52, p. 396; December, 1946.) A table is given for finding the value of parallel combinations of standard resistors.

621.397.645 681
Video Amplifier H.F. Response: Part 3—(Wireless World, vol. 52, pp. 413-414; December, 1946.) For parts 1 and 2 see 61 and 62 of February. The circuits there described are combined to form a single coupling having two correcting inductances; this considerably improves performance.

621.398 682
Continuously Variable Radio Remote Control—D. W. Moore, Jr. (Electronics, vol. 19, pp. 110-113; November, 1946.) "Phase-shifting properties of a resonant circuit provide automatic self-adjustment of a radio control system. Guided missiles, aircraft, satellite transmitters, and telemetering systems can be radio controlled by the stepless positioning provided."

621.3.011.3 683
Introduction au calcul des inductances [Book Review]—M. Romanowski. Gauthier-Villars, Paris, 114 pp. (Rev. Gén. Élec., vol. 55, p. 172; May, 1946.) The calculation falls into two stages: (1) application of Maxwell's equations and of the energy laws of linear circuits; and (2) integration leading to energy formulas for the whole conductor. The second stage is more particularly concerned in this case. Mathematical difficulties preclude exact solutions except in the simplest cases.

621.319.4:621.396.69(02) 684
Capacitors—Their Use in Electronic Circuits [Book Review]—M. Brotherton. D. Van Nostrand Co., Inc., New York, N. Y., 1946, 170 pp., \$3.00. (Gen. Elec. Rev., vol. 49, pp. 66-67; November, 1946.)

GENERAL PHYSICS

530.13:530.12 685
Comments on "A Relativistic Misconception"—M. E. Deutsch: V. P. Barton: A. J. O'Leary (Science, vol. 104, pp. 400-401; October 25, 1946.) The original article was abstracted in 388 of March (Eddy).

530.145 686
New Developments in Relativistic Quantum Theory—C. Møller. (Nature (London), vol. 158, pp. 403-406; September 21, 1946.)

530.145:538.3 687
Quantum Mechanics of Fields: Part 3—Electromagnetic Field and Electron Field in Interaction—M. Born and H. W. Peng. (Proc. Roy. Soc. Edinb. A, vol. 62, part 2, pp. 127-137; 1944 to 1946.) For parts 1 and 2, see 236 of 1945.

534.1+535.13] Huyghens 688
On Huyghens' Principle—Rocard. (See 845.)

535.1 689
Waves of Ordinary Light are Propagated as if the Luminous Vector were Divergent; Consequences for Physical Optics—A. Foix. (Compt. Rend. Acad. Sci. (Paris), vol. 222, pp. 180-181; January 14, 1946.)

535.13 690
Mechanical Explanation of Maxwell's Equations—D. Riabouchinsky. (Compt. Rend. Acad. Sci. (Paris), vol. 221, pp. 391-394; October 8, 1945.) Treatment of Maxwell's equations establishes a univocal and reciprocal correspondence between all the elements of gas-dynamic and electromagnetic fields.

535.13 691
Dynamics of the Ether—D. Riabouchinsky. (Compt. Rend. Acad. Sci. (Paris), vol. 221, pp.

432-434; October 15, 1945.) A system of equations is derived for fluid motion analogous to Maxwell's equations. Continuation of 690 above.

535.312 692
Optical Properties of Thin Metallic [Non-magnetic] Laminae—F. Scandone and L. Ballerini. (Nuovo Cim., vol. 3, pp. 81-115; April 1, 1946.) (In Italian with English summary.) Drude's method involving a complex refractive index is applied to derive the classical Fresnel relations and explicit formulas for the intensity and phase relations of the reflected and transmitted energy are obtained.

535.333:[546.212+546.212.02] 693
Water Spectrum Near One-Centimeter Wave-Length—C. H. Townes and F. R. Merritt. (Phys. Rev., vol. 70, pp. 558-559; October 1-15, 1946.) The spectral lines of H₂O and of mixtures of H₂O and D₂O have been measured at pressures near 0.1 millimeter of mercury using an oscillator whose frequency can be swept across the lines. The frequencies, intensities, and widths of the lines agree with previous measurements at atmospheric pressure within experimental error.

535.736.1+771.53+621.397.611.2 694
A Unified Approach to the Performance of Photographic Film, Television Pickup Tubes, and the Human Eye—Rose. (See 918.)

536.73 695
Derivation, Interpretation, and Application of the Second Law of Thermodynamics—P. G. Nutting. (Science, vol. 104, pp. 317-318; October 4, 1946.) The second law is "here derived as a by-product of Gibbs's masterful general treatment, but apparently neither Gibbs nor any of his followers ever noted it."

537+538].081.5 696
Simplification of the Dimensional Equations of Electric and Magnetic Quantities—M. Tarbouriech. (Rev. Gén. Élec., vol. 55, pp. 151-155; April, 1946.) Tables are given showing the further simplification of the dimensional system of Brylinski (4023 of 1944) (a) when Q is replaced by IT and LT_{-1} by V in the equations involving I , L , and T , and (b) when the quantities involved are R , I , T , and L . The advantages of the latter system are enumerated.

537.291 697
Graphical Determination of Electron Trajectories in a Given Electric Field—R. Musson-Genon. (Compt. Rend. Acad. Sci. (Paris), vol. 222, pp. 858-860; April 8, 1946.) The determination of planar electron trajectories, when the potential is known, is affected generally by a graphical construction analogous to Huyghens' method in optics. The accuracy normally achieved by this method is discussed, and a method of correction indicated which increases it.

537.311.33 698
Relation Between the Constant A and the Thermal Activation Energy ϵ in the Conductivity Law of Semiconductors—G. Busch. (Helv. Phys. Acta, vol. 19, pp. 189-198; May 31, 1946.) Wilson's theory of excess semiconductors is extended assuming that the location of the electron distribution centers in the energy scheme is not given by a discrete value ΔB of the thermal activation energy ϵ , but by a region of finite breadth. For the conductivity σ two temperature regions exist in which $\log \sigma$ is a linear function of the reciprocal of the absolute temperature, the two slopes being different. Application of the theory of lattice defects in crystals to the semiconductor problem shows the empirical relation $\log A = \alpha + \beta\epsilon$ between the constant A and the thermal activation energy ϵ to be exactly valid.

537.52 699
On the Mechanism of the Progress of a

Discharge—A. Zingerman and N. Nikolaevskaya. (Zh. Eksp. Teor. Fiz., vol. 16, no. 6, pp. 499-502; 1946.) (In Russian.) Photographs were taken of incomplete discharges between two spheres separated by distances of several hundred millimeters. Impulse voltages up to 3 megavolts were applied to the spheres. It appears from these photographs that the discharge channel is not formed by the movement from the cathode to the anode of a single 'electron avalanche' but consists of several merging streams. The speed of the growth of the 'electron avalanche' is discussed and two typical photographs are shown.

537.523.4 700
Phenomena of Voltage Recovery in V.H.F. Sparks—S. Tszner. (Compt. Rend. Acad. Sci. (Paris), vol. 221, pp. 373-375; October 1, 1945.) The phenomena are explained on the assumption that thermionic emission from the electrodes can be neglected in practice.

537.533.74 701
Reaction of Radiation on Electron Scattering and Heitler's Theory of Radiation Damping—H. A. Bethe and J. R. Oppenheimer. (Phys. Rev., vol. 70, pp. 451-459; October 1-15, 1946.)

537.565 702
The Mobility and Diffusion of Ions—E. Montel. (Compt. Rend. Acad. Sci. (Paris), vol. 222, pp. 873-875; April 8, 1946.) If I is the current varying with period T represented by identical ions, of mobility k , introduced into a plane capacitor at the level of one of the plates, i the current collected by the other plate when a constant potential drop $V=ha$ is maintained between the armatures, a being their distance apart, then neglecting diffusion and supposing the space density is small enough to produce no deformation of the field, i has a zero minimum value every time the wavelength khT/m of the harmonic of order m is contained an integral number of times in a . When account is taken of ionic diffusion it is shown that the effect on the position of these minima is completely negligible and so cannot influence values of k determined from them.

538.23+538.541 703
Simple Relation Between the Energies Dissipated by Hysteresis and Eddy Currents in a Solid of Revolution—G. Ribaud. (Compt. Rend. Acad. Sci. (Paris), vol. 222, pp. 788-789; April 1, 1946.) Calculations of the energy dissipation are made for different solids of revolution, assuming that the frequency is high enough for the skin thickness to be small and the field weak enough for the permeability to be considered constant. In all cases it is found that the ratio of hysteresis loss to that due to eddy currents is the same and equal to $1/\pi$ of the area of the B , H cycle for $H=1$.

538.3 704
The Interpretation of Maxwell's Equations—L. Bouthillon. (Compt. Rend. Acad. Sci. (Paris), vol. 222, pp. 871-873; April 8, 1946.) It is shown that Maxwell's equations can be written in the form:

$$\begin{aligned} -(\nabla \bar{D}) &= \frac{4\pi}{a_e} \bar{j} + \frac{\partial \bar{H}}{\partial t}, & (\nabla \bar{B}) &= \frac{4\pi}{a_m} \bar{i} + \frac{\partial \bar{E}}{\partial t}, \\ (\nabla \bar{E}) &= \frac{4\pi}{k_e} \rho_e, & (\nabla \bar{H}) &= \frac{4\pi}{k_m} \mu_e. \end{aligned}$$

Thus each term in the equations on the left has its counterpart in those on the right. — \bar{B} , the magnetic induction, corresponds to \bar{D} , the electric induction, and vice versa; \bar{H} , the intensity of the magnetic field, to \bar{E} , the intensity of the electric field; \bar{j} the intensity of the magnetic current, to \bar{i} , that of the electric current, and μ_e , the magnetic charge, to ρ_e , the electric charge. Written in this way, Maxwell's equations have maximum symmetry.

- 538.566.2+534.222.1 705
 Propagation of Radiation in a Medium with Random Inhomogeneities—Bergmann. (*See* 847.)
- 538.691:513.738 706
 Geometrical Characterizations of Some Families of Dynamic Trajectories—L. A. MacColl. (*Bell Sys. Tech. Jour.*, vol. 25, p. 653; October, 1946.) A solution of the problem of "obtaining a set of geometrical properties which shall completely characterize the 5-parameter family of trajectories of an electrified particle moving in an arbitrary static magnetic field." Abstracted from *Amer. Math. Soc. Trans.*, July, 1946.
- 539.133 707
 A New Method of Measuring the Electric Dipole Moment and Moment of Inertia of Diatomic Polar Molecules—H. K. Hughes. (*Phys. Rev.*, vol. 70, pp. 570-571; October 1-15, 1946.) Preliminary results of experiments on the behavior of molecules subjected simultaneously to a steady homogeneous electric field and an oscillating electric field mutually at right angles.
- 539.15 708
 Nuclear Magnetic Resonance and Spin Lattice Equilibrium—B. V. Rollin. (*Nature* (London), vol. 158, pp. 669-670; November 9, 1946.) Measurement of radio-frequency absorption of a material in a magnetic field gives the time for establishment of thermal equilibrium between the spin system and the lattice. Measurable absorptions have been observed so far only with substances containing protons or fluorine nuclei.
- 539.152.1 709
 The Principles of Nuclear Physics—L. Bloch. (*Rev. Gén. Élec.*, vol. 55, pp. 31-35; January, 1946.)
- 539.168.08 710
 An Arrangement with Small Solid Angle for Measurement of Beta Rays—L. F. Curtiss and B. W. Brown. (*Jour. Res. Nat., Bur. Stard.*, vol. 37, pp. 91-94; August, 1946.)
- 539.23 711
 [Optical] Anti-Reflexion and High-Reflexion Films—S. Weintraub. (*Nature* (London), vol. 158, p. 422; September 21, 1946.) Describes some of the properties of single-layer films of high refractive index and optical thickness $\frac{1}{4}$ of the mean wavelength of the incident light, and of multilayer films of alternately low and high-refractive index.
- 541.133 712
 On the Conductivity of Strong Electrolytes—S. G. Chaudhury. (*Jour. Phys. Chem.*, vol. 50, pp. 477-485; November, 1946.) An equation relating conductivity and concentration, derived by Onsager and modified by Shedlovsky, neglects "the effect of the change in the concentrations of ions near the electrode surface (during the time the current is on) from those in the bulk on the conductivities or mobilities of ions." This effect is considered and an equation for the conductivity deduced.
- 541.135 713
 Research on the Mechanism of Electrolysis. Study of the Energy Transfer Coefficients—M. Bonnemay. (*Compt. Rend. Acad. Sci.* (Paris), vol. 222, pp. 793-795; April 1, 1946.)
- 546.3316+546.171.116]-16:621.3.02 714
 Persistent Currents in Frozen Metal-Ammonia Solutions—J. W. Hodgins. (*Phys. Rev.*, vol. 70, p. 568; October 1-15, 1946.) Persistent currents up to 0.1 ampere lasting for as much as 30 seconds have been detected in frozen rings of sodium solutions in liquid ammonia. Currents were detected by means of a search coil and ballistic galvanometer. The presence of persistent currents appeared to depend critically on the temperature cycle involved.
- 621.385.1.016.4.029.5 715
 Production of High-Frequency Energy by an Ionized Gas—P. C. Thonemann and R. B. King. (*Nature* (London), vol. 158, p. 414; September 21, 1946.) By coupling a coaxial line into a discharge tube near the anode and suitably adjusting an external bar magnet, an output corresponding to 3 millivolts could be obtained at the output of a 1000-megacycle superheterodyne receiver of a 4-megacycle bandwidth. No input was observed in the cathode region or in the absence of the magnet.
- GEOPHYSICAL AND EXTRATERRESTRIAL PHENOMENA**
- 523.72.029.62 716
 Temperature Radiation from the Quiet Sun in the Radio Spectrum—D. F. Martyn. (*Nature* (London), vol. 158, pp. 632-633; November 2, 1946.) The undisturbed sun can be considered as a radiator having maximum effective temperature of the order of 10^6 degrees Kelvin at about $\lambda=1m$. For $\lambda<1m$ the radiation emanates from the cooler chromosphere, while for $\lambda>1m$ the corona tends to behave as a reflector. The temperatures observed are consistent with Edlén's estimate of 10^6 degrees for the coronal temperature. It is predicted that for $\lambda>1m$ there should be a progressive reduction of brightness as the limb is approached, but at wavelengths below 60 centimeters there should be a limb brightening (Fig. 2). The effect of the solar magnetic field is illustrated in Fig. 1 where the estimated effective temperature wavelength distribution for both ordinary and extraordinary radiation is shown.
- 523.72.029.62 717
 Observation of Million Degree Thermal Radiation from the Sun at a Wavelength of 1.5 Metres—J. L. Pawsey. (*Nature* (London), vol. 158, pp. 633-634; November 2, 1946.) Daily measurements of solar noise over a period of 6 months on the wavelength of 1.5 meters confirm Martyn's predictions of thermal radiation at temperatures of the order of 10^6 degrees Kelvin (see 716). Histograms of the results show a sharp cutoff at a lower limit corresponding to 0.6 to 1.2×10^6 degrees; the skewness of the curve at high intensities may be explained by variable additional radiation associated with sunspots.
- 537.591 718
 Momentum Spectrum of Mesons at Sea-Level—J. G. Wilson. (*Nature* (London), vol. 158, pp. 414-415; September 21, 1946.)
- 537.591 719
 Observation of Protons of Great Energy in the Penetrating Part of Cosmic Radiation—L. Leprince-Ringuet, M. Lhéritier and R. Richard-Foy. (*Compt. Rend. Acad. Sci.* (Paris), vol. 221, pp. 406-407; October 8, 1945.)
- 537.591:[546.621+546.815 720
 A Comparison of the Stopping Power of Lead and Aluminum for Cosmic-Ray Mesotrons—E. Fein. (*Phys. Rev.*, vol. 70, p. 567; October 15, 1946.)
- 537.591:550.385 721
 Changes in Cosmic Ray Intensity Associated with Magnetic Storms—H. Alfvén. (*Nature* (London), vol. 158, pp. 618-619; November 2, 1946.) These may be due to changes in the earth's electrostatic potential caused by differences in potential between the two sides of the ion stream emitted by the sun at the time of a storm. This potential difference may amount to 50 megavolts and is due to motion of the ion stream in the sun's magnetic field.
- 537.591.1 722
 Observation of Remarkable Particles Other than Protons in the Penetrating Part of Cosmic Radiation—L. Leprince-Ringuet, M. Lhéritier, and R. Richard-Foy. (*Compt. Rend. Acad. Sci.* (Paris), vol. 221, pp. 465-467; October 22, 1945.) Trajectories observed in a large Wilson chamber differ from those due to protons or mesons. A particle intermediate between the two would explain satisfactorily the observed results, which are compatible with the emission of a neutral meson.
- 538.71.087 723
 Monitor for Magnetic Storms—A. Dauvillier. (*Compt. Rend. Acad. Sci.* (Paris), vol. 222, pp. 1380-1381; June 12, 1946.) Describes apparatus installed at the Pic du Midi observatory to give audible warning of large variations of the horizontal component of the earth's magnetic field.
- 550.38(44) "00/04" 724
 Intensity of the Terrestrial Magnetic Field in France in the Gallo-Roman Period—É. Thellier and O. Thellier. (*Compt. Rend. Acad. Sci.* (Paris), vol. 222, pp. 905-907; April 8, 1946.) Measurements on samples from the Fréjus amphitheater and the Cluny thermal baths have given mean values of 0.66 and 0.71 gauss, respectively, for the earth's field in ancient times. These results are discussed.
- 550.385 "1946.03.28" 725
 Exceptional Magnetic Disturbance of 28th March 1946—G. Gibault. (*Compt. Rend. Acad. Sci.* (Paris), vol. 222, pp. 907-908; April 8, 1946.)
- 551.510.535 726
 High-Power Radio Soundings of the Ionosphere—P. Lejay and R. Chezlemas. (*Compt. Rend. Acad. Sci.* (Paris), vol. 222, pp. 1363-1366; June 12, 1946.) A report of results obtained, every two hours in the daytime, since April, 1946, at the National Laboratory of Radioelectricity, Bagneux (Seine). Rectangular pulses, of duration 20 microseconds, were transmitted 50 times per second from each of two self-oscillators giving about 20 kilowatts aerial power, one covering 3.5 to 6.5 megacycles and the other 6.5 to 11.5 megacycles, the sweep being completed in about 15 minutes. The photographic records show that the critical frequencies for reflection from the P₂ layer are considerably higher than those expected on theoretical grounds and than those observed elsewhere. The mean values for April were about 2 megacycles higher than those predicted by American forecasts. Slow changes were noted, low values for the critical frequencies on April 7 and 14 being followed by high values on April 9 and April 16 to 17, respectively. Low values correspond in general to greater equivalent heights.
- 551.510.535 727
 Nocturnal Variations of the Heights of the Layers of Maximum Ionization of Regions E and F—S. N. Ghosh. (*Sci. Culture*, vol. 12, pp. 201-202; October, 1946.) The height of the layer of maximum electron density in the E layer remains fairly constant during the night while the corresponding height for the F layer increases. This fact is explained theoretically as being due to the different laws of disappearance of free electrons in the two regions.
- 551.510.535:550.38 728
 Geomagnetic Control of Region F₂ of the Ionosphere—S. K. Mitra. (*Nature* (London), vol. 158, pp. 668-669; November 9, 1946.) Discussion of Appleton's recent note (2898 of 1946). The geomagnetic effects may arise from bombardment of the upper atmosphere by charged particles, but it is more likely that the particles are of terrestrial origin and ionized by solar ultraviolet rays. This hypothesis is consistent with Appleton's experimental data and with the geomagnetic control of the intensity of night-sky radiation.
- 551.510.535:550.384.4 729
 Geomagnetic Time Variations and Their Relation to Ionospheric Conditions—S. K.

Chakrabarty. (*Curr. Sci.*, vol. 15, pp. 246-247; September, 1946.) The quiet day solar diurnal variation S_q of the geomagnetic field is believed to originate in the earth's outer atmosphere or the ionosphere. S_q -curves of San Juan, Alibag, and Huancayo are given. For low-latitude stations variations of S_q appear to depend on geomagnetic parameters, although for high-latitude stations they depend more on geographical co-ordinates.

These results can be explained if the atmospheric conductivity K is supposed to vary with geomagnetic latitude, particularly for low latitudes, and if K is not dependent on the sun's zenith distance as has previously been assumed. The probable source of the S_q current system is the F_2 layer.

551.515.42 730

On the Development of Microcyclones Below Thunder Clouds—S. Mull and Y. P. Rao. (*Sci. Culture*, vol. 12, pp. 106-108; August, 1946.) An expression is derived for the pressure fall below a thunder cloud. This explains the existence of small kinks in the isobars, before the development of a major thunderstorm.

LOCATION AND AIDS TO NAVIGATION

621.396.9:523.2:621.396.1 731

Astronomical Radar—In 106 of February, please cancel the words 'using a parabolic aerial array.'

621.396.931/.933].22.029.62 732

Radio Direction Finding at 1.67-Meter Wavelengths—L. C. L. Yuan. (*PROC. I.R.E. AND WAVES AND ELECTRONS*, vol. 34, pp. 752-756; October, 1946.) Describes 1.67-meter tests on various aerial systems for measuring both the elevation and bearing of an incident wave. Measurements were made at ranges from 7 to 30 miles. With the aerial system 1.5 wavelengths above ground, and with a dry surface free from reflecting objects, the results agree with the optical direction for the incident wave to within $\frac{1}{2}$ degree in bearing, and to within $\pm \frac{1}{2}$ degree in elevation. With wet ground the error in the elevation may be as great as $3\frac{1}{2}$ degrees. A mathematical analysis of the reception by the two aerial systems used is given.

621.396.932.1 733

New Techniques in Modern Marine Navigation—R. Leprêtre. (*Rev. Gén. Élec.*, vol. 55, pp. 419-426; November, 1946.) A general account of the application of radar to marine navigation and a more detailed account of the operation of the Decca system.

621.396.933 734

The Radio Equipment used by the Pilot of an Aircraft and the Corresponding Ground Installations—Gaillard. (*See* 887.)

621.396.933 735

An Introduction to Hyperbolic Navigation with Particular Reference to Loran—J. A. Pierce. (*Jour. I.E.E.* (London), part I, vol. 93, pp. 546-547; November, 1946.) A longer abstract of the same paper was noted in 3287 of 1946.

621.396.933.1 736

Simple Radio Approach System—R. Beson. (*Toute la Radio*, vol. 13, pp. 84-85; March-April, 1946.) A coil is carried by the aircraft in a plane perpendicular to the axis of the fuselage, with a vertical aerial just behind the coil and a suitable receiver whose output feeds a bridge-type rectifier associated with a center-zero voltmeter. A motor driven commutator reverses the coil connections every $1/12$ second and at the same time reverses the voltmeter connections. With the aircraft on its proper course the voltmeter needle points to zero, deviations being indicated by movement of the needle to either side.

621.396.96+621.396.932 737

SJ Radar for Submarines—C. L. Van Inwagen. (*Bell Lab. Rec.*, vol. 24, pp. 402-406; November, 1946.) A 3000-megacycle radar for location of ship target by submarines, with plan-position indicator and A-scope displays. It can also be used as an aid to navigation.

621.396.96 738

Scanning Equipment for Ground Radar—D. Taylor and W. H. Penley. (*Engineering* (London), vol. 162, pp. 337-338; October 11, 1946.) The motions of two aerial systems may be synchronized by using (a) two identical three-phase induction motors with stators in parallel and wound rotors in parallel; (b) three selsyns as a differential mechanism to operate an oil pump and oil motor; and (c) two selsyns operating a Ward-Leonard control unit through a thermionic-tube torque amplifier. The last method gave the smoothest control and with 1-horse power motors two arrays were synchronized within ± 1 degree. A dipole-rocking mechanism is described in which the dipole is at the end of a pivoted arm which is rocked by means of a special arrangement of two crankshafts using weights to provide mechanical balance.

621.396.96 739

Radio v. U-Boat—G. M. Bennett. (*Wireless World*, vol. 52, pp. 408-411; December, 1946.) An account of the development of radio detection devices used by Allied aircraft and ships in the Battle of the Atlantic, and the countermeasures adopted by the enemy.

621.396.96:001.4 740

What is Radar?—"Cathode Ray." (*Wireless World*, vol. 52, pp. 415-416; December, 1946.) A discussion of the various definitions that have been given of radar, pointing out the techniques covered by each definition.

621.396.96 741

The Battle of the Atlantic [Book Notice]—Central Office of Information (London), 104 pp., 1s. (*Govt. Publ.* (London), p. 3; October, 1946.) The official account of the fight against the U-Boats, 1939 to 1945.

MATERIALS AND SUBSIDIARY TECHNIQUES

533.5 742

What Is a Vacuum?—H. Piraux. (*Toute la Radio*, vol. 13, pp. 189-193; July-August, 1946.) A review of methods of obtaining and measuring high vacuums.

535.377 743

The Thermoluminescence and Conductivity of Phosphors—R. C. Herman and C. F. Meyer. (*Jour. Appl. Phys.*, vol. 17, pp. 743-748; September, 1946.) Phosphors, such as zinc sulphide, irradiated by ultraviolet at low temperatures can be made to glow by raising the temperature, the electrical conductivity rising at the same time. A theoretical discussion of these phenomena is given.

537.13:621.385.1.032.216 744

Some Cases of Interaction Between Positive Ions and Metallic Surfaces—N. Morgulis. (*Zh. Eksp. Teor. Fiz.*, vol. 16, no. 6, pp. 489-494; 1946.) (In Russian.) An experimental attempt to determine the contact potential differences of thoriated tungsten by observing the displacement of the ion-current characteristics for different thorium coatings, and different conditions of thermal ionization did not produce satisfactory results.

In experimental investigations of this kind the neutralization of the ions on the surface is often slowed down, but the electric field prevents the ions from leaving the surface. This phenomenon is discussed for the case of a pure tungsten filament in caesium vapor, and conditions of equilibrium are established.

537.311.33:546.281.26 745

Electric Conductivity of Silicon Carbide—G. Busch. (*Helv. Phys. Acta*, vol. 19, pp. 167-188; May 31, 1946.) Conductivity measurements on single crystals of silicon carbide for current densities between 10^{-6} amperes per square centimeter and about 1 ampere per square centimeter show Ohm's law to be valid. Curves are given showing the variation of conductivity with temperature from 80 degrees Kelvin to 1400 degrees Kelvin.

537.533.8 746

Secondary Emission from Germanium, Boron, and Silicon—L. R. Koller and J. S. Burgess. (*Phys. Rev.*, vol. 70, p. 571; October 1-15, 1946.) The experiments were carried out in an electron gun tube evacuated to between 10^{-6} and 10^{-7} millimeters of mercury. The germanium and silicon were heated to dull red heat and the boron to 425 degrees centigrade before making measurements. Results are shown graphically.

538.221 747

Anomalous High-Frequency Resistance of Ferromagnetic Metals—J. H. E. Griffiths. (*Nature* (London), vol. 158, pp. 670-671; November 9, 1946.) At wavelength of 1 to 3 centimeters the product $\mu\rho$ of the permeability and resistivity of ferromagnetic films shows a large increase at a certain value of external steady magnetic field H . If H^1 is the magnetic field inside the metal, the product $H^1\lambda$ tends to be constant and is of the order of $2\pi mc/e$ ($=10.7 \times 10^3$ gauss per centimeter). This suggests that resonant absorption by magnetic dipoles is taking place.

538.221 748

Magnetic Dispersion of Iron Oxides at Centimeter Wavelengths—J. B. Birks. (*Nature* (London), vol. 158, pp. 671-672; November 9, 1946.) Measurements were made of the characteristic impedance and propagation constant of a coaxial line (at wavelength of 9 and 6 centimeters) and of a wave guide (at wavelength of 3 centimeters) filled with mixtures of ferrous-ferric or gamma-ferric oxide and paraffin wax. The complex permeability of each oxide was deduced; its magnitude decreases rapidly with the wavelength and a large absorption occurs.

538.221 749

Magnetic Properties of Feebly Magnetic Sesquioxide of Iron—J. Roquet. (*Compt. Rend. Acad. Sci.* (Paris), vol. 222, pp. 727-729; March 25, 1946.)

546.287 750

Silicone Oils: Part 1—Their Properties—D. F. Wilcock. (*Gen. Elec. Rev.*, vol. 49, pp. 14-18; November, 1946.) Description of chemical constitution, viscosity in relation to temperature, pour point, evaporation, miscibility, combustion, and some chemical properties.

546.841.78:621.385.032.21:539.16.08 751

A Geiger Counter for Determination of Thorium Content of Thoriated-Tungsten Wire—R. E. Aitchison. (*A. W. A. Tech. Rev.*, vol. 7, pp. 1-5; September, 1946.)

548.0:537:546.331.2 752

Elastic, Piezoelectric, and Dielectric Properties of Sodium Chlorate and Sodium Bromate—W. P. Mason. (*Phys. Rev.*, vol. 70, pp. 529-537; October 1-15, 1946.) Determination over a wide temperature range by measuring the properties for three oriented cuts. Values of piezoelectric constant and Poisson's ratio obtained differ considerably from those of previous workers.

548.4 753

Imperfections in the Structure of Large Metal Crystals, Revealed by Micrography and by X Rays—P. Lacombe and L. Beaujard. (*Compt. Rend. Acad. Sci.* (Paris), vol. 221, pp. 414-416; October 8, 1945.)

- 549.514.51+549.614]:548.4 754
Surface Layers on Quartz and Topaz—D. D'Eustachio. (*Phys. Rev.*, vol. 70, pp. 522-528; October 1-15, 1946.) An investigation by X-ray photography of the nature of the surface layers of single crystals of quartz and topaz.
- 621.314.632 755
Phenomena of Aging of Copper Oxide Rectifiers—R. Douçot. (*Rev. Gén. Élect.*, vol. 55, pp. 448-451; November, 1946.) Results of an experimental study are given graphically. Aging is rapid in the days immediately following manufacture and can be accelerated by special treatment. The direct-current characteristic has a point of maximum stability at about 0.3 volt. This is of importance in carrier-current telephony, where the rectifier is used at a particular point of its characteristic.
- 621.315.33 756
The Inside of Electrical Machines [Manufacture and Insulation of Copper Wire and Strip]—R. H. Robinson. (*Electrician*, vol. 137, pp. 787-791; September 20, 1946.) An account of the drawing and covering of copper wire with a short discussion of the dielectric strength of various coverings.
- 621.315.61:537.533.73 757
Study of Insulating Materials by Electron Diffraction—J. Devaux. (*Ann. Radioélec.* vol. 1, pp. 324-326; April-July, 1946.) Charge which accumulates on the specimen can be dispelled by playing on it a secondary beam of electrons of low velocity. This is due to ionization by the slow electrons of the residual gas in the discharge tube. The value of using both X-ray and electron diffraction methods in the study of crystals is outlined.
- 621.315.61:679.5 758
New Electrical Materials: Part 2—A. E. L. Jervis. (*Electrician*, vol. 137, pp. 793-797; September 20, 1946.) Continuation of 2931 of 1946. Notes on silicones and their use in ceramics, resins, greases, and enamels. An extensive bibliography is appended.
- 621.315.612 759
High Dielectric Constant Ceramics—A. von Hippel, R. G. Breckenridge, F. G. Chesley, and L. Tisza. (*Ind. and Eng. Chem.*, vol. 38, pp. 1097-1109; November, 1946.) Dielectric measurements over a wide range of frequencies, temperatures, and voltages, and thermal expansion and X-ray studies, were undertaken for titanium dioxide and the alkaline earth titanates, including some mixtures and solid solutions of the barium and strontium compounds. Barium titanate and the barium-strontium titanate solid solutions exhibit peculiar dielectric behavior which is connected with a lattice transition from pseudocubic to cubic.
- 621.315.614.72.011.5 760
Dielectric Strength Measurements on Varnished Cambric—A. Rufolo and H. K. Graves. (*Bull. Amer. Soc. Test. Mat.*, no. 142, pp. 34-37; October, 1946.) A study of the effect of humidity, electrodes, and breakdown media on dielectric strength.
- 621.315.615:679.5 761
Dielectric Constants of Dimethyl Siloxane Polymers—E. B. Baker, A. J. Barry, and M. J. Hunter. (*Ind. and Eng. Chem.*, vol. 38, pp. 1117-1120; November, 1946.) The dielectric constants of these silicones were measured as functions of temperature. The results, together with density temperature and optical data, were used to calculate the dipole moments, the infra-red dispersion and the dipole, atomic, and electronic polarizations by means of the Onsager-Kirkwood theory.
- 621.315.616:679.5 762
Plastic Compositions for Dielectric Applications—W. C. Goggin and R. F. Boyer. (*Ind. and Eng. Chem.*, vol. 38, pp. 1090-1096; November, 1946.) Plastics are described for use as casting and laminating resins and for sealing components. For radar housings polystyrene fibers were used. A sandwich method using hard outer surfaces filled with polystyrene foam gave low loss at very high frequencies. The housings for proximity fuzes and the materials used in cables present special problems. The characteristics of an experimental plastic having rigidity and ideal electrical properties are given.
- 621.315.616.029.5:679.5 763
Polystyrene Plastics as High-Frequency Dielectrics—A. von Hippel and L. G. Wesson. (*Ind. and Eng. Chem.*, vol. 38, pp. 1121-1129; November, 1946.) The dielectric loss in styrene monomer is analyzed. Polymerization conditions are investigated and a high quality polystyrene is modified by cross-linking, copolymerization, and hydrogen substitution. Special filters allow adjustment of the dielectric constant and the thermal expansion (for sealing to metal surfaces).
- 621.315.616.9.015.5 764
The Electric Strength of Paraffins and Some High Polymers—A. E. W. Austen and H. Pelzer. (*Jour. I.E.E.* (London), part 1, vol. 93, pp. 525-532; November, 1946.) Attempts to measure the electric strength of paraffins were unsuccessful, except for material oriented by pressing. A value of 6.5×10^6 volts per centimeter was obtained for polythene, with little change from room temperature to -190 degrees centigrade. The strength of polyvinyl chloride-acetate increased from 6.5×10^6 volts per centimeter at room temperature to 12×10^6 volts per centimeter at -190 degrees centigrade.
- 621.316.89+621.315.59 765
Properties and Uses of Thermistors—Thermally Sensitive Resistors—J. A. Becker, C. B. Green, and G. L. Pearson. (*Trans. A.I.E.E.* (*Elec. Eng.*, November, 1946) vol. 65, pp. 711-725; November, 1946.) A detailed discussion of the conduction mechanism in semiconductors, and the criteria for usefulness of circuit elements made from them. Methods of preparation, and numerous applications of thermistors using their high temperature coefficient of resistivity are given.
- 621.316.89.029.63 766
Thermistors at High Frequencies—J. Walker. (*Wireless Eng.*, vol. 24, pp. 28-29; January, 1947.) Measurements made on the resistance of a directly heated high-resistance thermistor at 400 megacycles per second are in agreement with values calculated from a knowledge of the direct-current resistance.
- 621.318.32:621.317.44 767
New Method for the Study of Ferromagnetic Materials in Weak A. C. Fields. Application to Some Alloys—Épelboim. (*See* 797.)
- 621.357.8:537.533.73 768
Diffraction of Electrons at Monocrystalline Surfaces of Electrolytically Polished Copper—P. Renaud and H. Frisby. (*Comp. Rend. Acad. Sci.* (Paris), vol. 222, pp. 1429-1430; June 17, 1946.) For the metallurgical or electrochemical study of metals it is very desirable to use well-defined and reproducible surfaces which, as far as possible, correspond to the true crystal lattice. Polished copper surfaces were prepared electrolytically. The bath must be protected from dust particles and it is desirable to calcine the anode and cathode before use. Excellent diffraction photographs were obtained with such surfaces after treatment with boiling water. The diagrams correspond to Cu_2O and suggest that the electrons penetrate a large number of layers; they cannot be explained in terms of diffraction by a few layers of atoms only. The electrolytically polished copper surfaces are attacked when cold by distilled water.
- 621.357.8:548.73 769
X-Ray Study of the Surface Hardening of Single Crystals of Aluminium and of Iron by Mechanical Polishing—J. Bénard and P. Lacombe. (*Comp. Rend. Acad. Sci.* (Paris), vol. 222, pp. 182-183; January 14, 1946.) To determine the depth of the structural modification due to polishing with emery, electrolytic polishing of the successive layers was used and a study made of the changes in the X-ray reflection diagrams. Beyond a certain depth (5 to 10 microns for no. 2 emery) the original pattern of Laue spots and continuous Debye-Scherrer rings changed, the rings becoming sectors only and disappearing altogether, leaving only the Laue spots, at a depth of the order of 60 microns. The results for aluminium were similar, but the depth of modification was considerably less than for iron.
- 621.362 770
Characteristics of Thermocouples—Weller. (*See* 815.)
- 621.385.832.087.5 771
A New Film for Photographing the Television Monitor Tube—White and Boyer. (*See* 907.)
- 621.791.76:621.3.011.2 772
Measurement and Effect of Contact Resistance in Spot Welding—R. A. Wyant. (*Trans. A.I.E.E.* (*Elec. Eng.*, June Supplement, 1946) vol. 65, p. 513; June Supplement, 1946. Discussion of 1890 of 1946.)
- 621.798:679.5 773
Polythene Plastics for Packaging—Visking Corporation. (*Materials and Methods*, vol. 24, pp. 1188-1189; November, 1946.)
- 621.9.038 774
Dies from Diamonds and Their Use: a Triumph of Technical Precision—C. C. Paterson. (*Not. Proc. Roy. Inst.*, vol. 33, no. 150, pp. 14-21; 1946.)
- 666.1.031.13 775
Physical Basis of the Electrical Fusion of Glass—I. Psychès. (*Rev. Gén. Élect.*, vol. 55, pp. 143-150; April, 1946.) The difficulties encountered in the fusion of glass by the passage through it of electric currents are due to the wide variation of resistance with temperature, low-heat conductivity, and high viscosity. These are discussed from a practical standpoint.
- 666.115:[532.13+536.4 776
Viscosity and the Extraordinary Heat Effects in Glass—A. Q. Tool. (*Jour. Res. Nat. Bur. Stand.*, vol. 37, pp. 73-90; August, 1946.)
- 666.29.041 777
Automatic Glazing Machine—R. Rulison. (*Bell Lab. Rec.*, vol. 24, pp. 400-401; November, 1946.) The rods to be glazed are mounted on a slowly rotating shaft placed inside an electrically heated furnace.
- 669.738 778
Cadmium Plate and Passivated Cadmium-Plate Coatings—E. E. Halls. (*Metallurgia* (Manchester), vol. 34, pp. 295-297; October, 1946.)
- 669.738 779
Cadmium Plate and Passivated Cadmium-Plate Coatings—F. Taylor; E. E. Halls. (*Metallurgia* (Manchester), vol. 35, pp. 28-31; November, 1946.) Comment on 778 above, and Halls' reply.
- 678 780
Comparison of Natural and Synthetic Hard Rubbers—G. G. Winspear, D. B. Herrmann, F. S. Malm, and A. R. Kemp. (*Bell Syst. Tech. Jour.*, vol. 25, p. 654; October, 1946.) Abstracted from *Ind. and Eng. Chem.*, July, 1946.

621.31 781
Electrical Contacts. [Book Review]—L. B. Hunt. Johnson and Matthey, London, 1946, 122 pp., 10s. 6d. (*Nature* (London), vol. 158, p. 647; November 9, 1946.) A book of reference for the electrical engineer, written in collaboration with others. The subject is dealt with under three headings: design and selection of contacts, properties of contact materials, and contact engineering.

666.1(02) 782
Techniques of Glass Manipulation in Scientific Research [Book Review]—J. D. Heldman. Prentice-Hall, New York, N. Y., 1946, 132 pp., \$2.50. (*Jour. Phys. Chem.*, vol. 50, p. 489; November, 1946.)

MATHEMATICS

517.432.1 783
On the Operator Formulae of the Symbolic Calculus—P. Humbert. (*Comp. Rend. Acad. Sci.* (Paris), vol. 221, pp. 398-399; October 8, 1945.) Distinguishes three classes of operational formulas, of which the third has been very little studied. Examples are given.

517.512.2 784
Fourier Analysis of Frequency-Modulated Oscillations with Saw-Tooth Variation of the Instantaneous Frequency—J. Rybner. (*Akad. Tekn. Videnskab., Lydtekn. Lab.*, Publ. No. 2; Reprint from *Matemat. Tidskr. Afd. B*, 1946. In Danish with English summary.) The oscillation is $a = A \sin(\omega t + f \cdot \delta \omega t^2)$ where t lies between $\pm 1/2f$. The carrier-frequency components can be expressed in terms of Fresnel integrals. The sideband components cannot be expressed in terms of fully tabulated functions, but values are given for the first four terms for a range of about 1 to 10 of modulation index.

517.942.9 785
The Numerical Solution of Laplace's Equation in Composite Rectangular Areas—M. M. Frocht. (*Jour. Appl. Phys.*, vol. 17, pp. 730-742; September, 1946.)

517.948.32 786
The Principal Methods of Solving Numerically the Integral Equations of Fredholm and Volterra—J. Bernier. (*Ann. Radioélect.*, vol. 1, pp. 311-318; April-July, 1946.) These equations occur in numerous boundary-condition problems.

518.5 787
The Automatic Sequence Controlled Calculator: Part 3—H. H. Aiken and G. M. Hopper. (*Elec. Eng.*, vol. 65, pp. 522-528; November, 1946.) For parts 1 and 2 see 461 of March.

518.5 788
A Punched-Card Technique for Computing Means, Standard Deviations, and the Product-Moment Correlation Coefficient, and for Listing Scattergrams—N. R. Bartlett. (*Science*, vol. 104, pp. 374-375; October 18, 1946.)

51(075.8) 789
Higher Mathematics for Students of Chemistry and Physics, with Special Reference to Practical Work [Book Review]—J. W. Mellor. Dover Publications, New York, N. Y., 1946, 641 pp., \$4.50. (*Gen. Elect. Rev.*, vol. 49, p. 67; November, 1946.) The purpose is "to give a working knowledge of higher mathematics to students of physical and general chemistry." A special feature is the large number of examples based on actual measurements published in current scientific articles.

MEASUREMENTS AND TEST GEAR

621.316.89.029.63 790
Thermistors at High Frequencies—Walker. (See 766.)

621.317.32:537.533.73 791
Measurement of High D.C. Voltages by Electron Diffraction—J. J. Trillat. (*Rev. Gén.*

Élect., vol. 55, pp. 307-310; August, 1946.) By means of electrons with uniform velocity measurements are made of the radial distances of spots or rings in the diffraction diagrams of thin sheets of silver, aluminium, or gold of known thickness. An accuracy approaching 1 per cent is possible.

621.317.32.087 792
Simultaneous Recording of Current, Voltage and Short-Period Voltage Fluctuations—E. Schwabe. (*Arch. Tech. Messen.*, p. T49; May, 1940.) A triple recorder using current and voltage transformers and, for recording the voltage fluctuations, a lamp and photocell with compensation for normal voltage.

621.317.334 793
Adaptation of the Method of Maxwell-Wien to the Precise Comparison of Inductance Standards—R. Hérou and M. Romanowski. (*Comp. Rend. Acad. Sci.* (Paris), vol. 222, pp. 789-791; April 1, 1946.) If P and Q are the resistances of two opposite arms of a Maxwell-Wien bridge, a fixed capacitor being connected in parallel with the third arm and inductances L_1, L_2 inserted successively in the fourth arm, the bridge arms all being approximately equal and earth capacitances and residual inductances compensated, then $L_2/L_1 = P_2Q_2/P_1Q_1$. P and Q should be of the type used for high precision measurements, variable in 1Ω steps. Final balance is achieved by means of a resistor of 100Ω , shunted by a variable capacitor, in series with the inductance. Tests carried out with frequencies of 1000 and 100 cycles show that with such an arrangement inductance comparisons can be effected with an accuracy of about 1 in 10^5 and this may be increased when the apparatus details are perfected.

621.317.35:578.088.7 794
A New Electronic [Infrasonic Frequency] Analyzer.—G. R. Baldock and W. Grey Walter. (*Electronic Eng.*, vol. 18, pp. 339-344; November, 1946.) The apparatus consists of a number of selective circuits which respond to frequencies between 1.5 and 30 cycles. These circuits are resistance-capacitance phase-shift positive feedback amplifiers with gains adjusted to values below that at which oscillation occurs. An epoch of an aperiodic wave form may be analyzed by means of a switch which selects each of the selective circuits. An additional circuit, called an averager, records the analysis of the record over periods of one to two minutes. The analyzer records the mean relative amplitudes throughout the period, but it will not distinguish between a large signal present for a short time and a smaller one present for a long time. Its main use is for vibration studies and bioelectric effects.

621.317.372:621.315.2 795
End Leakage in Cable Power-Factor Measurement—A. Rosen. (*Jour. I.E.E.* (London), part I, vol. 93, p. 549; November, 1946.) Summary of 176 of February.

621.317.42 796
A B-H Curve Tracer for Magnetic-Recording Wire—T. H. Long and G. D. McMullen. (*Trans. A.I.E.E.* (Elec. Eng., June Supplement, 1946), vol. 65, pp. 494-495; June Supplement, 1946.) Discussion of 2247 of 1946.

621.317.44:621.318.32 797
New Method for the Study of Ferromagnetic Materials in Weak A.C. Fields. Application to Some Alloys—I. Épelboim. (*Rev. Gén. Élect.*, vol. 55, pp. 271-281, 310-324; July-August, 1946.) Theory and operational details are given of a bridge method. A specially designed demountable coil attachment permits accurate and reproducible results. The nickel alloys anhyster D , mumetal and permalloy were studied after each had been subjected to two different heat treatments resulting in widely differing magnetic characteristics. In the case of the 76 per cent nickel alloys, the

existence of a superstructure in annealed permalloy and of anisotropy of the copper in tempered inumetal, may account for the observed differences. Measurements were made at frequencies from 50 to 10,000 cycles. The effective resistance to eddy currents was found to be less than the direct-current resistance and the ratio of permeability to effective resistance was constant over a wide frequency range. Rayleigh's law is shown to be valid whatever the difference between the crystalline energy and that of the internal strains in a ferromagnetic material. The empirical law proposed by Sixtus is found inaccurate. The anomalous behavior of the permeability characteristic as a function of the field can be explained by the effect of harmonics.

621.317.7+681.2].085.34 798
A Scanning Device for All Types of Luminescent-Spot Measuring Apparatus—F. Perrier. (*Compt. Rend. Acad. Sci.* (Paris), vol. 222, pp. 868-869; April 8, 1946.) The beam reflected from a rotating mirror is given a motion at right angles to its usual path by interposing a suitable screen between the mirror and the source, the deflection law being determined by the shape of the screen. Where one variable is the time, the screen may be semicylindrical, pierced with a helical slot, and suspended from a torsion pendulum. This produces a sinusoidal sweep. Alternatively, a motor-driven disk has its edge cut to the shape of identical portions of Archimedean spirals. This gives a saw-tooth linear sweep.

621.317.7.029.64 799
Microwave Test and Measuring Equipment—W. T. Jones. (*Electronic Ind.*, vol. 5, pp. 48-54, 136; November, 1946.) A review of the various types of instruments and methods developed for the measurement at ultra-high-frequency of (a) frequency, using cavity and coaxial line type meters, (b) spectrum distribution, (c) power, using diodes, crystals, thermocouples, calorimeters or bolometers, (d) attenuation, and (e) standing-wave ratios, by insertion of a slotted section of transmission line between generator and load, with a pickup probe moved along the line and a meter to indicate the relative field strength at points under examination.

621.317.7.029.64 800
Microwave Measurements and Test Equipment—F. J. Gaffney. (*Proc. I.R.E. and Waves and Electrons*, vol. 34, pp. 775-793; October, 1946.) A general summary is given of the methods of measuring such quantities as standing-wave ratios, impedance, power, attenuation, and frequency. The electrical and mechanical considerations in the design of microwave measurement apparatus and the accuracies at present obtainable are discussed. The application of the methods to the measurement of the performance of radar systems is outlined.

621.317.71/.72].082.742 801
Moving-Coil Current and Voltage Multi-Range Meters—J. Bubert. (*Arch. Tech. Messen.*, p. T68; June, 1940.) Design considerations.

621.317.714+621.317.725 802
Frequency Compensated A.C. Ammeters and Voltmeters—J. M. Whittenton and C. A. Wilkinson. (*Trans. A.I.E.E.* (Elec. Eng., November, 1946), vol. 65, pp. 761-764; November, 1946.) Impedance changes can cause frequency errors in moving iron voltmeters, while eddy currents can cause them in both ammeters and voltmeters. By suitable choice of materials, eddy currents can be made negligible. Errors due to impedance changes can be corrected by shunting about 75 per cent of the series resistance with a capacitor.

621.317].72+.784 803
A Precision A.D./D.C. Comparator for Power and Voltage Measurements—G. F.

Slotted and H. D. Hawkes. (*Jour. I.E.E.* (London), part 1, vol. 93, pp. 549-550; November, 1946.) Summary of 183 of February.

621.317.73 804

Reactance Comparator—(*Electronics*, vol. 19, pp. 142-150; November, 1946.) The tuning of a circuit containing the test reactor is varied by a vibrating reed capacitor. A thyatron controlled stroboscope lamp illuminates a pointer attached to the reed when the natural frequency of the test reactor equals that of the oscillator under test.

621.317.73:518.3 805

Capacity Nomogram for Use with Avometer Type D—R. Terlecki and J. W. Whitehead. (*Electronic Eng.*, vol. 18, p. 336; November, 1946.) The unknown capacitance is connected in series with the 230-volt alternating-current mains and the Avometer, set to the 300-volt alternating-current range. The nomogram shown can then be used for measuring capacitances from 200 to 100,000 picofarads.

621.317.733 806

An Equal-Ratio Impedance Bridge—L. G. Alexander. (*A.W.A. Tech. Rev.*, vol. 7, pp. 59-77; September, 1946.) A detailed description of a bridge which has an accuracy of 1 per cent, or better, in measuring impedances at frequencies up to 3 megacycles.

621.317.733:518.4 807

Universal Chart for Unbalanced Bridge—R. C. Paine. (*Elec. Ind.*, vol. 5, pp. 72-74, 110; November, 1946.) Gives graphical methods for determining the detector voltages of unbalanced bridges and derives a universal chart.

621.317.75:621.396.619:621.397.61 808

Test Oscilloscope for Television Stations—A. H. Broly and W. R. Brock. (*Electronics*, vol. 19, pp. 120-122; November, 1946.) For measurement of transmitter modulation. The radio-frequency signal is picked up from the transmitter feeder and is fed through a tuned transformer directly to the Y deflection plates of a cathode-ray tube; a time base for the X deflection operates at half the time frequency.

621.317.755:621.3.001.4 809

Routine Testing by Cathode-Ray Oscilloscope—F. Haas. (*Toute la Radio*, vol. 13, pp. 161-163; June, 1946.) Full circuit details are given for apparatus which gives a vertical trace on a cathode-ray oscilloscope corresponding to a particular frequency. For routine testing of capacitors or inductances, connections are made to an oscillator so that the trace on the cathode-ray oscilloscope is displaced from the central position by an amount proportional to the percentage error. The method is readily adaptable to routine testing of lengths, thicknesses, angles, etc.

621.317.757 810

A Non-Reactive (Déphasçuse) Valve and a New Method of Harmonic Analysis—A. Colombani. (*Comp. Rend. Acad. Sci.* (Paris), vol. 221, pp. 399-401; October 8, 1945.) Across the anode resistance of a pentode is connected, through 1-microfarad capacitors, a bridge of two fixed resistors, one variable resistor *R* and a variable capacitor *C*. The voltage across one diagonal of the bridge can be varied both in magnitude and phase with respect to that across the other diagonal by suitably altering *R* and *C*. By coupling this circuit to a variable frequency oscillator, together with the source to be analyzed, it is possible to measure the frequencies, amplitudes, and phase differences of the harmonics with reference to the fundamental.

621.317.76.029.64 811

U.H.F. Signal Generator [Mark SX-12]—(*Elec. Ind.*, vol. 5, pp. 76-77; November, 1946.) A set of five interchangeable klystrons supplies microwave energy at any frequency from 2600

to 10,300 megacycles and can be matched to any load by means of a tunable double-stub transformer. It delivers at least 200 milliwatts and up to 750 milliwatts in certain frequency ranges. The stable output can be modulated either in frequency or in amplitude. A built-in generator gives undistorted square-waves up to 100 volts (peak) in the range 350 to 3500 cycles, and may be externally synchronized. The electronically regulated power supply of the klystron delivers up to 1250 volts with better than ± 0.2 -volt regulation, and less than 0.2-volt peak-to-peak ripple.

621.317.761 812

Precision Frequency Meter—P. Bernard. (*Toute la Radio*, vol. 13, pp. 121-124; May, 1946.) An account of a rack-mounted equipment of controlled multivibrators, selectors, mixers, and filters designed originally for the precision measurement of quartz-crystal frequencies by unskilled workmen. The unknown frequency is caused to beat successively with standard decade frequencies and can be read directly from the settings of the various selectors. An absolute precision to within 1 cycle is obtainable.

621.317.784:621.392 813

A Wide-Band Wattmeter for Wave Guide—H. C. Early. (*Proc. I.R.E. AND WAVES AND ELECTRONS*, vol. 34, pp. 803-807; October, 1946.) Used to measure the power transmitted by a wave guide or coaxial transmission line the wattmeter consists of a special section of $1\frac{1}{2}$ inches by 3 inches wave guide containing a tapered ridge, with a directional coupler assembly connected to two lengths of cable, each with thermojunction at the end and a low-resistance microammeter. The cable lengths are so chosen that the variation of attenuation with frequency compensates for the variation of voltage pickup in the coupler loop, giving a substantially constant calibration over the range 8 to 12 centimeters.

621.317.784.029.64 814

Microwave Wattmeter—(*Electronics*, vol. 19, pp. 164, 169; November, 1946.) The current flowing into a matched terminated transmission line is measured by a thermocouple. At low frequencies (20 megacycles) the terminating resistance decides the input impedance, while at high frequencies (1500 megacycles) the line has sufficient loss for the characteristic impedance to be the deciding factor.

621.362 815

Characteristics of Thermocouples—C. T. Weller. (*Gen. Elect. Rev.*, vol. 49, pp. 50-53; November, 1946.) Standard calibration points, operating ranges, and limits of departure from the average curve are tabulated for the five principal types of thermocouple, namely copper-copric, iron-copric, chromel-copric, chromel-alumel, and platinum—platinum with 10 per cent rhodium. The voltage is also shown graphically as a function of temperature difference between the two ends for these types of thermocouple, and is tabulated for copper-copric thermocouples.

621.385:621.317.7 816

Simple Valve Tester—R. E. Hartkopf. (*Wireless World*, vol. 52, pp. 386-390; December, 1946.) For measurement of insulation, mutual conductance, and emission.

621.396.611:621.396.615.18 817

The Inductance-Capacitance Oscillator as a Frequency Divider—E. Norrman. (*Proc. I.R.E. AND WAVES AND ELECTRONS*, vol. 34, pp. 799-803; October, 1946.) The basic circuit and the effects of changes in the values of the circuit components on the range of frequency control are discussed. Details are given of a four-stage frequency divider, with an output of 90 cycles, controlled by an 81-kilocycle quartz crystal oscillator. The method of tuning the successive oscillator stages is described.

621.396.615.14.029.54/:62 818

Design of F.M. Signal Generator—D. M. Hill and M. G. Crosby. (*Electronics*, vol. 19, pp. 96-101; November, 1946.) The means of obtaining constant frequency deviation with a reactance modulator are discussed for both heterodyne and the constant-deviation variable oscillator systems. In the latter, which is shown to be the more efficient, a modulation input potentiometer is ganged with the tuning dial. A satisfactory design is one in which the reactance-modulated oscillator operates from 27 to 54 megacycles, and is balanced by a doubler stage and a second doubler output stage, providing frequency coverage from 54 to 216 megacycles. Maximum stability and simplicity are achieved since oscillator and modulator operate at a low frequency and radio-frequency switching is simple. By means of a converter, the range of 100 kilocycles to 25 megacycles can also be covered.

621.396.62.029.64 819

Components of U.H.F. Field [Strength] Meters—E. Karplus. (*Electronics*, vol. 19, pp. 124-129; November, 1946.) A description of the characteristics of the various units concerned. (a) The tuning limitations of butterfly circuits, which are described in detail in 3260 of 1945 (Karplus), are discussed in terms of circuit dimensions. Where low losses are more important than wide tuning range, cylinder, or coaxial butterfly circuits are preferable. These are fully described in 1797 of 1946 (Gross). (b) A tunable resonator with a five-to-one frequency range is described, which uses a short, fixed wave guide and a long flexible conductor which is pushed through the guide as required to produce resonance. (c) For a cartridge-type crystal detector the correction for frequency is examined, and necessary precautions in use are mentioned. (d) The output from a signal generator may be checked by measuring either the input to the attenuator or the output at a known attenuator setting. (e) A regulated power supply can be obtained by using a controlled saturable reactor in the power input circuit.

OTHER APPLICATIONS OF RADIO AND ELECTRONICS

539.16.08:546.841.78:621.385.032.21 820

A Geiger Counter for Determination of Thorium Contents of Thoriated-Tungsten Wire—R. E. Aitchison. (*A.W.A. Tech. Rev.*, vol. 7, pp. 1-5; September, 1946.)

621.314.12:621.3.07 821

Industrial Applications of the Amplidyne—F. Penin. (*Rev. Gén. Élect.*, vol. 55, pp. 266-270; July, 1946.) Essentially consisting of two generators in series, the amplidyne gives power amplification of the order of 10,000, with a low time constant, so that a power of a few microwatts from a radar receiving aerial can be applied through an electronic amplifier to operate apparatus requiring hundreds of kilowatts. Industrial applications are described, such as the control of high-frequency alternators for induction furnaces, or of the voltage of a direct-current generator, with limitation of the current.

621.315.332.7.001.4 822

Process Testing of Film Continuity on Formex Fine Wire—B. Mulvey. (*Gen. Elect. Rev.*, vol. 49, pp. 46-48; November, 1946.) An apparatus consisting essentially of mercury electrodes, an electronic relay, and a recorder is used to count the number of breaks in enamel film covering fine wire as soon as the wire is made. Constructional and operating details are given.

621.317.35:578.088.7 823

A New Electronic [Infrasonic Frequency] Analyser—Baldock and Grey Walter. (*See 794.*)

- 621.317.39:531.7 824
Recent Electrical Devices for the Measurement of Forces, Acceleration, and Displacements—H. Gondet. (*Rev. Gén. Élect.*, vol. 55, pp. 123-135; April, 1946.) Many practical inventions are described, based on the properties of piezoelectric crystals, magnetostriction, variation of magnetic fields, capacitance, resistance, and inductance changes. Devices using a photoelectric cell are also described. An indication is given of the accuracy to be expected.
- 621.317.39:633.1 825
Determination of the Moisture Content of Cereals by Measurement of Specific Inductive Capacity—L. G. Groves and J. King. (*Jour. Soc. Chem. Ind.* (London), vol. 65, pp. 320-324; October, 1946.)
- 621.317.725:621.385:536.52 826
Flame Radiation Measuring Instrument—E. M. Yard. (*Electronics*, vol. 19, pp. 102-104; November, 1946.) A highly stable bridge-type battery-operated tube, voltmeter connected to a radiation pyrometer, for checking performance of open-hearth steel furnaces.
- 621.318.572:531.76 827
High Speed Counter—(*Electronics*, vol. 19, pp. 190, 192; November, 1946.) The apparatus, now being produced in quantity, can be used to measure velocities and accelerations for intervals up to 1 second in steps of 1 microsecond.
- 621.365 828
High-Frequency Heating—M.J.A. (*Toute la Radio*, vol. 13, pp. 168-173; July-August, 1946.) Practical methods and applications.
- 621.365.5 829
Duplex Operation of Induction Heaters—W. C. Rudd. (*Electronics*, vol. 19, pp. 93-95; November, 1946.) Multiple connection of identical units, for either two-phase or three-phase input, can provide twice the power of either unit operating alone.
- 621.383:535.24 830
Logarithmic Photometer—M. H. Sweet. (*Electronics*, vol. 19, pp. 105-109; November, 1946.) A method for obtaining logarithmic response to light intensity from a photocell.
- 621.383:535.33.071 831
Observation of Spectral Lines with Electron Multiplier Tubes—J. D. Craggs and W. Hopwood. (*Nature* (London), vol. 158, p. 618; November 2, 1946.)
- 621.384 832
A New Method for Displacing the Electron Beam in a Synchrotron—J. S. Clark, I. A. Getting, and J. E. Thomas, Jr. (*Phys. Rev.*, vol. 70, pp. 562-563; October 1-15, 1946.) Auxiliary coils are provided to induce radial oscillations of the beam, which can be swept across the target in a time of the order of 2 microseconds.
- 621.384.6 833
The Betatron—A. Ghosh. (*Sci. Culture*, vol. 12, pp. 75-85; August, 1946.)
- 621.384.6 834
Experimental 8 MeV Synchrotron for Electron Acceleration—F. K. Goward and D. E. Barnes. (*Nature* (London), vol. 158, p. 413; September 21, 1946.) Results obtained indicate that the synchrotron gives much greater energy and x-ray yield than the betatron without increase in magnet size.
- 621.385.833 835
Determination of the First Order Elements of Symmetrical Electrostatic Lenses—P. Chanson, A. Ertaud, and C. Magnan. (*Compt. Rend. Acad. Sci.* (Paris), vol. 221, pp. 233-235; August 20, 1945.)
- 621.386+537.531]:535.34 836
Absorption Measurements for Broad Beams of 1- and 2-Million-Volt X-rays—G. Singer, C. B. Braestrup, and H. O. Wyckoff. (*Jour. Res. Nat. Bur. Stand.* vol. 37, pp. 147-150; August, 1946.)
- 621.396:539.172.4 837
Electronics at Bikini—D. G. Fink and C. L. Engleman. (*Electronics*, vol. 19, pp. 84-89; November, 1946.) A description, with photographs of the equipment used at the atomic bomb tests for recording the geophysical phenomena and for examining the effects of blast and radiation on radio equipment.
- 621.396.029.64:643.33 838
Radarange for Cooking—(*Electronics*, vol. 19, pp. 178, 180; November, 1946.) Microwave cooking using a magnetron and a horn aerial to direct radio-frequency energy into food. See also *Elec. Eng.*, vol. 65, p. 591; December, 1946.
- 621.398 839
Continuously Variable Radio Remote Control—(See 682.)
- 621.398:621.6.031 840
Carrier Supervisory Control of Pumping Station Over Power Cable—W. A. Derr, W. A. Keller, and H. A. W. Hedke. (*Trans. A.I.E.E.* (*Elec. Eng.* November, 1946) vol. 65, pp. 699-710; 1946.)
- 629.123.]:621.3.013.8 841
The Magnetic Field of a Ship and Its Neutralization by Coil Degaussing—W. C. Potts. (*Jour. I.E.E.* (London), part 1, vol. 93, pp. 488-495; November, 1946.) Discussion, pp. 522-524.
- 629.123.]:621.3.013.8 842
The Electrical Engineering Aspect of Degaussing—I. S. Fraser, A. A. Read, and B. E. Vieyra. (*Jour. I.E.E.* (London), part 1, vol. 93, pp. 496-507; November, 1946.) Discussion, pp. 522-524.
- 629.123.]:621.3.013.8 843
Processes Applied to a Ship to Alter Its State of Magnetization—S. H. Ayliffe. (*Jour. I.E.E.* (London), part 1, vol. 93, pp. 508-517; November, 1946.) Discussion, pp. 522-524.
- 629.123.]:621.3.013.8 844
The Correction of Ships' Magnetic Compasses for the Effects of Degaussing—H. C. Wassell and D. A. Turner. (*Jour. I.E.E.* (London), part 1, vol. 93, pp. 518-522; November, 1946.) Discussion, pp. 522-524.
- PROPAGATION OF WAVES
- 534.1+535.13] Huyghen 845
On Huyghens' Principle—Y. Rocard. (*Onde Élect.*, vol. 26, pp. 288-298; July, 1946.) A presentation intended to be mathematically rigid and physically useful. The derivation of Kirchhoff's formula from Green's theorem is given and the formula is applied to the simple case of acoustical radiation from a monochromatic point source. The application to electromagnetic waves is considered and the radiation from an elementary area dS situated in a normal plane wave is discussed in detail and the diffracted energy calculated. The case of larger obstacles is considered; in particular Darboud's method is applied to a doublet at the focus of a parabolic mirror.
- 538.566:551.4 846
The Diffraction of Radio Waves Around the Surface of the Earth—V. A. Fock. (Published as a monograph by the Academy of Sciences of the U.S.S.R., Moscow, 1946. 80 pp. In Russian.) A theoretical treatment of the propagation of radio waves round the curved surface of the earth for distances short enough for ionospheric influences to be negligible. The finite conductivity of the earth is taken into account.
- Formulae appropriate to the region where the transmitter and the observation point are intervisible, and also to the diffraction zone are derived, and particular attention is paid to the evaluation of the field in the region of the 'cut-off' point.
- The work is in agreement with the earlier considerations of Weyl and van der Pol, but represents an extension of their analyses, particularly in so far as it permits the determination of the field produced by ultra-short waves just inside the diffraction zone.
- 538.566.2+534.222.1 847
Propagation of Radiation in a Medium with Random Inhomogeneities—P. G. Bergmann. (*Phys. Rev.*, vol. 70, pp. 486-492; October 1-15, 1946.) An analysis is given of the propagation of radiation through a medium whose index of refraction varies from point to point or from time to time in a random manner. The methods of geometrical optics are used to correlate statistically the variations in optical path length and received signal level with the properties of the inhomogeneities. The dependence of signal fluctuation on range may be predicted without a detailed knowledge of the statistical properties of the medium. The results obtained may be applied to the propagation of either electromagnetic or sound waves of high frequency in the atmosphere.
- 551.510.535 848
High-Power Radio Soundings of the Ionosphere—Lejay and Chezlemas. (See 726.)
- 621.396.11 849
Propagation of Electromagnetic Waves in a Medium with Nonuniform Electrical Characteristics and with a Magnetic Field [Thesis]—C. T. F. van der Wyck. Drukkerij Waltman (A. J. Mulder), Delft, 1946. In Dutch, with long English summary. Theoretical analysis of the propagation of plane, cylindrical, and spherical waves, in a medium with an exponential variation of electrical characteristics in a vertical direction, under the influence of a uniform magnetic field.
- 621.396.81.029.64:629.13 850
Effect of Aircraft on Fading—J. W. Whitehead. (*Wireless Eng.*, vol. 24, p. 29; January, 1947.) The type of fading to be expected in very-high-frequency ground-based communication systems due to reflection from an aircraft is briefly discussed and illustrations are given.
- 621.396.812.029.4/:539.172.4 851
A Note on "The Possible Effect of the Atomic Bomb Test at Bikini on Radio Reception," at about 3.05 a.m. (I.S.T.) on 25th July 1946—S. P. Chakravarti. (*Curr. Sci.*, vol. 15, pp. 226-227; August, 1946.) The results of some observations taken at Bangalore in the direction of Bikini during the test. Reception of atmospherics on a wavelength of 20,000 meters was increased; the field of strength of an American station on a wavelength of 25.3 meters decreased considerably.
- 621.396.812.029.64 852
Propagation of Microwaves—A. de Gouvenain. (*Tout la Radio*, vol. 13, pp. 50-52; February, 1946.) A survey of general propagation characteristics, taking account of refraction, with application to ultra-short-wave link calculations.
- 621.396.812.3:551.510.535 853
Space-Diversity Reception and Fading of Short-Wave Signals—S. S. Banerjee and G. C. Mukerjee. (*Nature* (London), vol. 158, pp. 413-414; September 21, 1946.) An account of observations on the fading of signals of 16 to 41-meter wavelength over a 700-kilometer path. Occasionally the nature of the fading changes from random fluctuations to smooth and quasiperiodic variations, according as the signals suffer single or multiple reflection in the ionosphere.

621.396.96:523.53"1946.10.09" 854

Radar Observations during Meteor Showers 9 October 1946—R. Bateman, A. G. McNish, and V. C. Pineo. (*Science*, vol. 104, pp. 434-435; November 8, 1946.) A peak pulse power of about 100 kilowatts on 107 megacycles was used in tests carried out at the Sterling (Virginia) Laboratory of the National Bureau of Standards. Observations were both visual and photographic. On October 9, 1946, the rate of occurrence of radar echoes rose from about 8 per hour to 7:30 P.M., 75 degrees west mean time, to a peak of over 60 per hour between 10:30 and 11:30 P.M., the predicted time for the maximum intensity of the Draconid shower being 10:00 P.M. Cloud prevented visual observations.

RECEPTION

621.396.62 855

High Fidelity Receiver—J. C. Hoadley. (*Radio News*, vol. 36, pp. 46-48; November, 1946.) Construction details. Straight radio-frequency amplification; infinite impedance detector.

621.396.62:621.317.79 856

A Signal Tracer—F. Haas. (*Toute la Radio*, vol. 13, pp. 56-58; February, 1946.) A practical instrument for fault finding in receivers, which enables the signal to be followed from the aerial socket to the loudspeaker.

621.396.62:621.396.619.13].0.15.33 857

The Theory of Impulse Noise in Ideal Frequency-Modulation Receivers—D. B. Smith and W. E. Bradley. (*PROC. I.R.E. AND WAVES AND ELECTRONS*, vol. 34, pp. 743-751; October, 1946.) An analysis is given of the effect of impulsive noise on an ideal frequency-modulation receiver. It is shown that the amplitude and wave form of the generated noise are substantially independent of the amplitude and wave form of the initiating noise. One from of generated noise is determined largely by the characteristics of the audio amplifier and results from a perturbation of the phase of the detector signal, while another and more objectionable form is produced by the de-emphasis circuit when the phase of the detector signal is caused to slip one revolution.

"An operational formula for the ideal detection process is given from which both the steady-state and transient solutions of the detection process may be derived."

621.396.62.029.52/.62 858

Special-Purpose Receivers for the Range 50 kc/s to 50 Mc/s—B. Sandel. (*A.W.A. Tech. Rev.*, vol. 7, pp. 89-93; September, 1946.) A brief description of two directly-calibrated receivers, covering respectively the ranges 50 kilocycles to 5 megacycles in six bands, and 5 to 50 megacycles in eight bands. They were used for testing signal generators.

621.396.621 859

Murphy A104—(*Wireless World*, vol. 52, pp. 394-395; December, 1946.) Test report on table model receiver for alternating-current mains.

621.396.621 860

New Communication Receiver—(*Wireless World*, vol. 52, p. 425; December, 1946.) A brief description of equipment B40/B41 made by Murphy Radio for the Admiralty, consisting of two receivers covering the ranges 640 kilocycles to 30.6 megacycles and 14.7 to 720 kilocycles.

621.396.621.029.5 861

Some Considerations in the Design of Communication Receivers—I. F. Simpson. (*Electronic Eng.*, vol. 18, pp. 332-336; November, 1946.) Desirable qualities of self-contained and semiportable receivers in the frequency range of 130 kilocycles to 30 megacycles are considered, and the compromises which have been necessary in their development. An ac-

curately calibrated oscillator, stable to within ± 6 kilocycles at 30 megacycles is the most important requirement. Sensitivity, automatic-volume control, noise, selectivity, ease of handling, flexibility, spurious response, and signal strength indication are also discussed.

621.396.621.029.54 862

A Home-Made Midget Receiver—L. G. Woollett. (*Electronic Eng.*, vol. 18, p. 352; November, 1946.) Employs an internal frame aerial, uses ordinary battery-type tubes, and is internally powered. Frequency range is 588 to 1230 kilocycles, and dimensions are $4\frac{1}{2}$ inches \times 4 inches \times $3\frac{3}{4}$ inches.

621.397.82 863

Television Sound Rejection—Cocking. (*See* 922.)

621.396.822 864

Noise Factor: Part 1—L. A. Moxon. (*Wireless World*, vol. 52, pp. 391-393; December, 1946.) A discussion and definition of noise factor. It is defined as the number of times by which the available signal power must exceed KTB , where K is Boltzmann's constant, T the absolute temperature, and B the 'energy band width,' in order to give unity ratio of available signal-to-noise power at the input to the detector.

621.396.822:621.396.671 865

Study of the Thermal Equilibrium of Wireless Aerials—Lehmann. (*See* 642.)

621.396.828 866

Noise Limiters—H. B. Dent. (*Wireless World*, vol. 52, pp. 397-398; December, 1946.) The Dickert shunt-type noise limiter and improvements of its are described. The noise is automatically limited to the strength of the carrier instead of to a predetermined level. Circuit diagrams are given.

621.396.+621.396.665 867

Noise and Output Limiters: Part 1—E. Toth. (*Electronics*, vol. 19, pp. 114-119; November, 1946.) A comprehensive survey, with circuit diagrams, of eleven limiting circuits for amplitude-modulation communication receivers, including simple diode circuits, balanced detectors, self-adjusting circuits, and degenerative arrangements. Analysis of operation and advantages and disadvantages are stated for each type of circuit.

STATIONS AND COMMUNICATION SYSTEMS

621.315.66 868

New "Microwave Tower"—(*Jour. Appl. Phys.* vol. 17, p. 757; September, 1946.)

621.395:654.05 869

Intensity Fluctuations in Telephone Traffic—C. Palm. (*Ericsson Technics*, no. 44, pp. 3-189; 1943. In German.) Three principal sections: (1) Telephone traffic considered as a stochastic (i.e., pertaining to conjecture) process. (2) Intensity fluctuations as a starting point for the treatment of telephone traffic problems. (3) Measurement methods and results.

621.396(675)"1939/1945" 870

Telecommunications in the Belgian Congo during the War—A. Huynen. (*Bull. Sci. Ass. Inst. Electrochn. Montefiore*, vol. 59, pp. 247-262; April-May, 1946.) From October, 1940, short-wave transmissions from the Congo station at Leopoldville were well received in Belgium, as the Germans were unable to jam them to any extent. For retransmission of the B.B.C. news bulletins in French, a receiver was tuned to each of the B.B.C. frequencies, thus giving a choice at any time for retransmission under the best possible conditions. When the Germans jammed the B.B.C. frequency in use, simple switching arrangements gave an instantaneous change to one not being jammed.

621.396.1 871

Moscow [Telecommunications Conference]—A. L. B. (*QST*, vol. 31, pp. 25-27; January, 1947.) Account of the discussions on amateur frequency allocations.

621.396.1.029.62/.63 872

A Plan for [Improved Frequency Allocation] in the Ten-Meter Band—K. B. W. (*QST*, vol. 30, pp. 26-27, 130; December, 1946.)

621.396.324 873

High-Flying Teletype—R. A. Vanderlippe. (*Bell Lab. Rec.*, vol. 24, pp. 396-399; November, 1946.) A lightweight teletype printer with an associated converter-control unit which makes it practicable to send teletype messages to and from aircraft in flight.

621.396.619[.13+.16] 874

Frequency Modulation: Pulse Modulation—C. Dreyfus-Pascal. (*Toute la Radio*, vol. 13, pp. 126-128; May, 1946.) A short account of a frequency-modulation system of the Federal Telephone and Radio Corporation which enables 24 programs to be transmitted on the same carrier wave, together with a synchronization signal. The system uses an electronic commutator with 24 elementary pentodes, each of which is linked with a particular studio. The electronic beam rotates at 24,000 cycles and the carrier frequency used is 1300 megacycles. See also 239 of February.

621.396.619.16 875

Pulse Time Modulation Circuits—(*Electronics*, vol. 19, pp. 140, 142; November, 1946.) A preliminary description of this Federal Telecommunication Laboratories equipment was given in 2803 of 1945 (Deloraine and Labin). The transmitter will take eight audio channels with fidelity over the audio-frequency range 50 to 9000 cycles. Its output is approximately 800 to 1000 watts (peak) and 40 to 50 watts (average). This is fed to a vertically stacked omnidirectional loop aerial having a gain of 9 decibels over a dipole. The directive receiving aerial has a parabolic reflector, with a gain of 17 decibels.

621.396.65 876

Radio Relays for Telegraphy—F. B. Bramhall. (*Elec. Eng.*, vol. 65, pp. 516-520; November, 1946.) Relay towers 20 to 50 miles apart will be used in a Western Union triangular radio network, New York-Washington-Pittsburgh, operating at 4000 megacycles with an 'audio' width of 150 kilocycles divided into 1080 teleprinter operating circuits. The absence of noise in this band and the heavy traffic makes the project economical.

621.396.7.029.58 877

World List of Short-Wave Transmitters—(*Toute la Radio*, vol. 13, pp. 118-119; May, 1946.) A list of the frequencies, call signs, and locations of transmitters with frequencies from 2.5 to 26.55 megacycles.

621.396.712 878

Co-operative Two-Station Antenna System—L. McManus. (*Electronics*, vol. 19, pp. 154, 164; November, 1946.) A system of phrasing units and filters permits the simultaneous use of two towers as radiators and driven reflectors for two broadcasting transmitters at Sherbrooke, Quebec.

621.396.712:621.316.9 879

Protecting Against Carrier Failure—H. G. Towilson. (*Elec. Ind.*, vol. 5, pp. 68-71; 116; November, 1946.) "Practical methods of insuring against interruptions and loss of broadcasting time due to lightning and other causes."

621.396.712.3 880

New Station Techniques—(*Electronics*, vol. 19, pp. 169, 176; November, 1946.) A summary of recent developments in B.B.C. studio organization, and of the results of extensive

frequency-modulation field trials, abstracted from the new journal, *B.B.C. Quart.*

- 621.396.72 881
Army Broadcasting—P. B. T. (*Wireless World*, vol. 52, p. 414; December, 1946.) Location and frequencies of stations used for broadcasting to the British and American Forces.
- 621.396.81.029.64:629.13 882
Effect of Aircraft on Fading—Whitehead (See 850.)
- 621.396.931 883
Two-Way Radio for Power Line Crews—(*Electronics*, vol. 19, p. 123; November, 1946.) Photographs of a frequency-modulation transmitter and a mobile receiver.
- 621.396.931 884
Inductive System for Train Communication—P. N. Bossart. (*Telegr. Teleph. Age*, vol. 64, pp. 8–10, 30, 16–19; November, December, 1946.) For communication between vehicles of the same or different trains, or between vehicles and wayside stations. At frequencies below 10 kilocycles the reliable range is of the order of a mile if only the rails are used, but can be increased up to 30 or 40 miles if adjacent line wires are available. Carrier frequencies up to 100 kilocycles preferably with frequency-modulation, are used. Break-in schemes, power requirements, receiver sensitivities, squelch systems and channel widths are discussed. A 'carrytone' portable telephone can be provided to enable individuals not necessarily in any vehicle, to communicate within the system.
- 621.396.931 885
Railroad Radiotelephone Tests on the Nickel Plate Road—R. G. Peters. (*Communications*, vol. 26, pp. 14–16, 34; November, 1946.) See also 884 and 886.
- 621.396.931.029.62 886
Two-Way V.H.F. Radio in Potomac Yard Improves Control of R.R. Operations—(*Telegr. Teleph. Age*, vol. 64, pp. 5–6; December, 1946.) Description of tests of a comprehensive very-high-frequency two-way radiotelephone installation as a means of improving managerial control in the operation of large railway yards. The frequency-modulation system included a central station transmitter and receiver, five remote control units located at key points, a mobile transmitter and receiver on each of two steam locomotives, and remote control units on their forward platforms and in their cabs. See also 885.
- 621.396.933 887
The Radio Equipment Used by the Pilot of an Aircraft and the Corresponding Ground Installations—S. Gaillard. (*Ann. Radioélect.*, vol. 1, pp. 333–342; April–July, 1946.) A description of airborne and ground apparatus developed by the Société Indépendante de T.S.F. for the communication of landing and take-off instructions between the airport controller and the pilot. The airborne transmitter (frequency band of 2800 to 6700 kilocycles) works on telegraphy or telephony with 20-watt aerial power; the receiver requires 10 microvolt input for 350 milliwatts output with a signal-to-noise ratio of not less than 26 decibels. The ground apparatus is similar but is designed for alternating-current mains power supply.
 An airborne beacon receiver (200 to 428 kilocycles) is also described.
- 621.396.97.029.62 888
Against V.H.F. Broadcasting—"Radio-phare." (*Wireless World*, vol. 52, p. 412; December, 1946.) The objection to broadcasting on frequencies as high as 90 megacycles with a service range of only 50 miles is that broadcasting, if limited to such frequencies, would tend to lose its international character.
- SUBSIDIARY APPARATUS**
- 531.35:621.396.619.13:621-526 889
A Low Frequency Mechanical Modulator—B. B. Underhill. (*Rev. Sci. Instr.*, vol. 17, pp. 280–281; July, 1946.) A medium-speed motor drives a flywheel through a continuously variable reduction gear. The motion of the flywheel is converted to s.h.m. by a scotch yoke-rack and pinion assembly to which a linear potentiometer is directly coupled.
- 621-526 890
Linear Servo Theory—R. E. Graham. (*Bell Sys. Tech. Jour.*, vol. 25, pp. 616–651; October, 1946.) "This paper discusses a typical analogy between electrical and mechanical systems and describes, in frequency-response language, the behavior of such common servo components as motors, synchro circuits, potentiometers, and tachometers. The elementary concepts of frequency analysis are reviewed briefly, and the familiar Nyquist stability criterion is applied to a typical motor-drive servo system. The factors to be considered in choosing stability margins are listed: system variability, noise enhancement, and transient response. The basic gain-phase interrelations shown by Bode are summarized, and some of their design implications discussed. In addition to the classical methods, simple approximate methods for calculating dynamic response of servo systems are presented and illustrated."
- 621-526 891
Electrical Analogy Methods Applied to Servo-mechanism Problems—G. D. McCann, S. W. Herwald, and H. S. Kirschbaum. (*Trans. A.I.E.E. (Elec. Eng.)*, June Supplement, 1946), vol. 65, p. 515; June Supplement, 1946.) Discussion of 1362 of 1946.
- 621.314 892
Operation of a Vibrator. Vibrator Applications—C. Dreyfus-Pascal. (*Toute la Radio*, vol. 13, pp. 86–88, 89–91; March–April, 1946.) A review of the principles of operation, including electromechanical rectification, and circuit diagrams for various practical applications.
- 621.314.2.04 893
Transformer Theory—P. Bricout. (*Compt. Rend. Acad. Sci. (Paris)*, vol. 221, pp. 21–22; July 2, 1945.) Theory is given which enables all necessary calculations to be made for transformer design, given the primary and secondary voltages, maximum power, the output, and the hysteresis cycle for the laminations on full load.
- 621.314.63.001.8 894
Some Applications of Dry Rectifiers—J. Girard. (*Rev. Gén. Élect.*, vol. 55, pp. 192–198; May, 1946.) An account of the application of dry rectifiers to obtain high voltages with low or very low currents, moderate voltages with moderate currents, and low voltages with high currents. Examples are given of equipment for central telephone exchanges. Selenium rectifiers have recently been designed to give 60,000 amperes at 6 volts, and currents as high as 150,000 amperes are envisaged.
- 621.314.634 895
Selenium Rectifiers—J. Loebenstein. (*Communications*, vol. 26, pp. 26–28; November, 1946.) Details of design, construction, and characteristics. Applications in single and 3-phase circuits are described.
- 621.316.98 896
Selective Attraction of Lightning: Role of Electrical Resistances—S. Szpor. (*Rev. Gén. Élect.*, vol. 55, pp. 25–31; January, 1946.) Quantitative study of the part played by the electrical resistance of projecting points in attracting lightning shows that it rarely has any effect.
- 621.317.755.087.5 897
An Automatic Oscillograph with a Memory—A. M. Zarem. (*Trans. A.I.E.E. (Elec. Eng.)*
- June Supplement, 1946), vol. 65, p. 514; June Supplement, 1946.) Discussion of 2339 of 1946.
- 621.318.5 898
A High-Voltage Vacuum-Sealed Relay—K. R. Vale. (*A.W.A. Tech. Rev.*, vol. 7, pp. 95–101; September, 1946.) The relay was designed to be used with aircraft transmitter aeriels at voltages up to 15 kilovolts (peak) and at a keying speed of 25 words per minute.
- 621.318.572:621.396.96 899
Spark Gap Switches for Radar—F. S. Goucher, J. R. Haynes, W. A. Depp and E. J. Ryder. (*Bell Syst. Tech. Jour.*, vol. 25, pp. 563–602; October, 1946.) An account of wartime development work on rotary and fixed switches for use in radar modulators.
 The irregular breakdown of rotary spark gaps used with modulator switching voltages of less than 20 kilovolts was overcome by irradiating the gap, prior to breakdown, with corona produced by a sharp point on the cathode.
 Investigations into the most suitable gas atmosphere, electrode material, and gap design for use in sealed-off fixed gaps are fully described with particular reference to the methods adopted for reducing the effects of sputtering of the electrode metals on the gap spacing and insulation.
 Operating characteristics for various types of production gaps are given.
- 621.325.53:535.61-15 900
Modulated Arc Lamp—(*Electronics*, vol. 19, pp. 150, 154; November, 1946.) A caesium vapor lamp for modulated infrared ray communication in convoy and troop landing operations.
- 621.352.4 901
Water Activated Cell—(*Elec. Ind.*, vol. 5, p. 75; November, 1946.) A primary battery for emergency services using silver chloride as depolarizer and thin magnesium sheet separated by highly absorbent paper. It is both light and small, has indefinite shelf life in its sealed container and is activated by immersion in either fresh or sea water.
- 621.396.615.17 902
A Linear Sweep Generator—W. H. Haywood. (*Radio News*, vol. 36, pp. 78, 84; November, 1946.) Saw-tooth generator, 1 to 10⁶ cycles.
- 621.396.622.71 903
An Unusual Rectifier Circuit—E. E. Comstock. (*QST*, vol. 30, pp. 56–57; November, 1946.) A combination of the conventional bi-phase center tap rectifier circuit with an inverted form of the same circuit makes four different output voltages available.
- 621.396.68:621.385.832 904
R.F. H.T. Power Supplies for Cathode-Ray Tubes—R. D. Boadle. (*A.W.A. Tech. Rev.*, vol. 7, pp. 53–57; September, 1946.) Description of a 2-kilovolt unit for an electrostatic cathode-ray tube, and a 4-kilovolt unit for a magnetically deflected and focused tube. The high-voltage circuits are enclosed in oil-filled brass or copper tanks, with solder-seal glass insulators.
- 669:621.38/39 905
Specialised Metallurgical Products in Industry—(*Electronic Eng.*, vol. 18, pp. 328–331; November, 1946.) An illustrated description of products now available, including cathode tubing, metal films on glass, silvered mica capacitor packs, and specialized contacts.
- 621.327.4 906
Electric Discharge Lamps [Book Review]—H. Cotton. Chapman and Hall, London, 36s. (*Engineering*, (London), vol. 162, p. 339; October 11, 1946.)
- TELEVISION AND PHOTOTELEGRAPHY**
- 621.385.832.087.5 907
A New Film for Photographing the Television Monitor Tube—C. F. White and M. R.

- Boyer. (*Jour. Soc. Mot. Pict. Eng.*, vol. 47, pp. 152-164; August, 1946.) "A film which is specially adapted for photographing images on the P-4 monitor tube surface has been prepared. Optical sensitization is adjusted to yield peaks of sensitivity with the blue to yellow spectral region corresponding to the emission of the P-4 screen. Resolving power of the film has been found of controlling importance when used in 16-millimeter size and this factor has affected the choice of emulsion for this purpose. The film may be employed either as a negative or reversed."
- 621.385.832.088 908
C.R. Tube Quality Test—P. L. F. Jones. (*Electronic Eng.*, vol. 18, p. 353; November, 1946.) Apparatus which injects into a television receiver a complete wave form consisting of dots of approximately element duration separated from the next in the line scan direction by an equal space.
- 621.396.97:535.88 909
Pre-Television—P. Toulon. (*Toute la Radio*, vol. 13, pp. 194-195; July-August, 1946.) An apparatus resembling an epidiascope may be used with rolls of paper film giving broadcast program pictures, the rolls being circulated each week for the following week's programs. Changing of the pictures may be effected by special signals.
- 621.397.5 910
Fundamentals of Television—(*Cah. Toute la Radio*, no. 5, pp. 16-19; July, 1946.) The basic features of television transmitting and receiving apparatus are described. Interlacing is illustrated by an inset paragraph with interlaced text.
- 621.397.5 911
Colour Television—J. Vergennes. (*Cah. Toute la Radio*, no. 5, pp. 22-25; July, 1946.) Fundamental problems are discussed and a short account is given of the main features of the C.B.S. system using a set of color screens rotated mechanically, and of Baird's special 3-color tube.
- 621.397.5:778.5 912
The Relation of Television to Motion Pictures—A. B. Du Mont. (*Jour. Soc. Mot. Pict. Eng.*, vol. 47, pp. 238-247; September, 1946.) A broad discussion of the applications of film recording in the television field, on the basis of the equivalence "... film recordings are to television what the transcribed program is to broadcasting"; and of ways in which the two industries could collaborate.
- 621.397.5:778.5 913
Television Reproduction from Negative Films—E. Meschter. (*Jour. Soc. Mot. Pict. Engrs.*, vol. 47, pp. 165-181; August, 1946.) "The expected reproduction characteristics are examined for the cases where film is included as one step of the television process. Features of performance to be expected from both negatives and prints as image sources are predicted from average characteristics of elements of the television system. A dynamic test procedure for the investigation of the over-all reproduction curve involving film and television is described. Actual tests confirm the theoretical prediction that a negative film with a rising shoulder characteristic may provide superior television images."
- 621.397.6 914
Projection Television—(*Electronics*, vol. 19, pp. 212-216; November, 1946.) A description of (a) a German lens system for projecting and enlarging phosphorescent images (U.S. Patent 2,229,302), and (b) a system using transmission screens of zinc blende as optical polarizing gates controlled by a scanning electron beam (U. S. Patents 2,277,008 and 2,297,443).
- 621.397.6 915
High-Definition Television Equipment—R. R. Cahen. (*Cah. Toute la Radio*, no. 5, pp. 14-15; July, 1946.) The special features and general layout of an 829-line television equipment with an amplifier pass band of 15 megacycles; the equipment includes telecinema apparatus with an iconoscope.
- 621.397.61:621.317.75:621.396.619 916
Test Oscilloscope for Television Stations—Brolly and Brock. (See 808.)
- 621.397.611:621.383 917
Theory of the Iconoscope—R. Barthélemy. (*Compt. Rend. Acad. Sci.*, (Paris), vol. 221, pp. 245-247; August 27, 1945.) Summarizes the results of a year's work with the object of reconciling theory and practice. It appears that the simultaneous existence of a state of equilibrium and an appreciable potential drop between the front and back of the moving beam can only be caused by the action of space-charge.
- 621.397.611.2+771.53+535.736.1 918
A Unified Approach to the Performance of Photographic Film, Television Pickup Tubes, and the Human Eye—A. Rose. (*Jour. Soc. Mot. Pict. Eng.*, vol. 47, pp. 273-294; October, 1946.) "The picture pickup devices—film, television pickup tube, and eye—are subject ultimately to the same limitations in performance imposed by the discrete nature of light flux. The literature built up around each of these devices does not reflect a similar unity of terminology. The present paper is exploratory and attempts a unified treatment of the three devices in terms of an ideal device." In this ideal device scene brightness is proportional to the square of the signal-to-noise ratio and inversely proportional to the picture element area and to quantum efficiency.
- 621.397.62 919
Pye Television Model B16T—(*Wireless World*, vol. 52, pp. 403-407; December, 1946.) Test report and full circuit diagram.
- 621.397.62:621.392 920
The Choice of Transmission Lines for Connecting Television Receiving Aerials to Receivers—Strafford. (See 633).
- 621.397.645 921
Video Amplifier H.F. Response: Part 3—(See 681.)
- 621.397.82 922
Television Sound Rejection—W. T. Cocking. (*Wireless World*, vol. 52, pp. 417-421; December, 1946.) The various forms of rejector and acceptor circuits used in avoiding interference between the sound and vision channels are fully analyzed and their effect on the main intertube coupling is discussed.
- 621.397.82 923
Television Fading—G. T. Clack. (*Electronic Eng.*, vol. 18, p. 353; November, 1946.) Suggestions to reduce the effects of fading in television receivers due to reflections from aircraft by introducing alternating-current coupling to the cathode-ray tube.
- 621.397.5 924
Television Simplified [Book Review]—M. S. Kiver. D. Van Nostrand Co., Inc., New York, N. Y., 1946, 369 pp., \$4.75. (Proc. I.R.E. AND WAVES AND ELECTRONS, vol. 34, p. 772; October, 1946.)
- TRANSMISSION
- 621.385+621.396.694 925
The VT-127-A in Amateur Transmitters—G. L. Davies. (*QST*, vol. 30, pp. 33-37, 132; November, 1946.) Operating data and constructional details for using these tubes in a 144-megacycle transmitter both as the doubler tube and in push-pull as the final amplifier.
- Operation at audio and low frequencies is also suggested.
- 621.396.61+538.561 926
Electric Signals with Rectangular Frequency Spectrum—P. Boughon and P. Jacquinet. (*Compt. Rend. Acad. Sci.* (Paris), vol. 222, pp. 1476-1478; June 24, 1946.) An experimental and theoretical study of the production of oscillations having a uniform distribution of energy over the band ΔN , and negligible energy outside this band. The theoretical form of such oscillations is
$$f(t) = E_0 \cos 2\pi \text{Not} \{(\sin \pi \Delta N t / \pi \Delta N t)\}$$
where N_0 is the mid frequency. A modulation voltage proportional to $(\sin \pi \Delta N t) / \pi \Delta N t$ was obtained by rotation of a disk in front of a photoelectric cell with a window, so that the height of the window uncovered varied as $a + (\sin \pi \Delta N t) / \pi \Delta N t$. The voltage from the cell was applied to a symmetrical modulator, balanced so as to eliminate the constant term a . The bandwidth could be varied at will by altering the speed of the disk.
- 621.396.61 927
New Transmitter for Amateur Radio—W. Bruene and N. Hale. (*Radio News*, vol. 36, pp. 39, 111; November, 1946.) A general account of the Collins 30-kilocycle transmitter.
- 621.396.61.029.5 928
200 Watt All-Band Transmitter—H. D. Hooton. (*Radio News*, vol. 36, pp. 40-43, 134; November, 1946.) An easily constructed unit, with either crystal or variable-frequency-oscillator control for the 10-, 20-, 40-, and 80-meter bands.
- 621.396.61.029.56/.58 929
Single Control in the Bandswitching Transmitter—J. H. Harms. (*QST*, vol. 30, pp. 19-25, 128; December, 1946.) "A 3.5 to 30 megacycle exciter with broad-band driver circuits... well within the electrical and mechanical capabilities of the ordinary amateur."
- 621.396.61.029.56/.58 930
What About the BC-375-E?—R. M. S. (*QST*, vol. 30, pp. 38-42, 148; December, 1946.) A U. S. Army aircraft transmitter, using a MOPA circuit, producing 45 to 75-watt output over a frequency range including the 3.5- and 7-megacycle amateur bands. Considerable modifications for satisfactory amateur use would be necessary.
- 621.396.619.13/.14 931
A New Phase-Modulation Circuit for Narrow-Band F.M. Transmission—J. J. Babkes. (*QST*, vol. 31, pp. 11-15; January, 1947.) The circuit described uses crystals in the 3625 to 3712-kilocycle range and, after eight-fold multiplication, will produce a frequency swing of 10 to 12 kilocycles at 29 megacycles. The power output is about 3.5 watts.
- 621.396.619.13 932
Narrow-Band F. M. with Crystal Control—G. W. Shuart. (*QST*, vol. 30, pp. 27-29; November, 1946.) Design and construction of a reactance modulator with crystal controlled oscillator, forming a narrow band frequency-modulation system. With a 3.5-megacycle AT-cut crystal there is a total frequency swing of 3200 cycles at 28 megacycles.
- 621.396.619.2:534.78 933
Let's Not Overmodulate—It isn't Necessary!—J. W. Smith and N. H. Hale. (*QST*, vol. 30, pp. 23-26; November, 1946.) Describes the use of speech clipping and filtering for more effective communication.
- 621.396.828.018.3 934
Keeping Your Harmonics at Home—G. Grammer. (*QST*, vol. 30, pp. 13-19; November, 1946.) "A discussion of the factors in harmonic generation and radiation."

VACUUM TUBES AND THERMIONICS

- 621.38 935
Flicker Effect—A. Blanc-Lapierre. (*Compt. Rend. Acad. Sci.*, (Paris) vol. 221, pp. 375-377; October 1, 1945.) Schottky attributes the effect to random modifications of the emissive property of the cathode due to fluctuations in the number of atoms adsorbed at its surface, but Surdin (3586 of 1939) has shown that the effect can also be explained by fluctuations of the number of free electrons in the metal, so that it is related to the Bernamont effect. The two points of view lead to equivalent mathematical hypotheses.
- 621.385:537.291 936
Deflected Beam Valves for Ultra High Frequencies—M. R. Gavin and G. W. Warren. (*G.E.C. Jour.*, vol. 14, pp. 97-104; August, 1946.) The theory of transverse control of an electron beam is investigated, at frequencies where the electron transit times are comparable with the period of the alternating field. A general expression is derived for the high-frequency sensitivity of deflection control tubes and from considerations of energy of the electrons the input resistance is deduced. In both these respects, deflection control tubes compare favorably with grid control tubes, but high shot-noise level makes them inferior to modern high-frequency triodes as amplifiers of very small signals. A brief description is given of tubes designed for frequencies up to 750 megacycles.
- 621.385:621.396.645.029.5 937
Characteristics of Vacuum Tubes for Radar Intermediate Frequency Amplifiers—G. T. Ford. (*Bell. Syst. Tech. Jour.*, vol. 25, pp. 385-407; July, 1946.) The important factors are merit bandwidth, noise figure, input conductance, constancy of capacitances, power consumption and physical size. The effect of tube geometry on transconductance and electrode capacitances is considered in detail for an idealized plane structure. The close spacing used ensures that any limitations due to input conductance is due to lead inductance rather than to transit time effects. The cathode emission and the tube geometry of the Western Electric 6AK5 (described in detail) are such that a noise figure of 2.8 may be obtained at 60 megacycles with a bandwidth of 10 megacycles.
- 621.385.029.63/.64 938
Wideband Microwave Amplifier Tube—F.R. (*Electronics*, vol. 19, pp. 90-92; November, 1946.) For another account, see 585 of March.
- 621.385.032.24 939
Certain Electrostatic Properties of Grid Electrodes—V. S. Lukoshkoff. (*Bull. Acad. Sci. (U.R.S.S.) sér. phys.*, vol. 8, no. 5, pp. 243-247; 1944. In Russian.) A conception of an ideal grid with an infinitely fine mesh is introduced, and a general theory applicable to grids of all shapes and structures in conjunction with neighboring electrodes developed. The electrostatic field is regarded as made up of two fields, the 'far' field determined by the shape of the grid and of the neighboring electrodes, and the 'near' field similar in its structure to that of the grid. Using these conceptions, and referring to his previous work (3394 of 1936), the author considers the triode to which all other multi-electrode types can be reduced. In all classical theories of the triode it is assumed that the field at the cathode is the same as it would be were the grid replaced by a whole electrode of the same shape and having a potential U_0 related to the grid potential U_g in accordance with formula (1). Thus the triode is reduced in effect to a diode in order to determine the cathode field. The main problem of this analysis becomes the question whether such a reduction can be used with any type of triode. It is concluded that such a reduction is justifiable only under the following two conditions: (a) the

shape of the grid should be co-ordinated with that of the other two electrodes, and (b) the structure and shape of the grid should also be co-ordinated. Further possible developments of the analysis are also given.

An abstract in English was noted in 2397 of 1946.

- 621.385.1+621.396.694 940
Analysis of Intermittent Discharges in Valves—J. Moussiégt. (*Compt. Rend. Acad. Sci.*, (Paris), vol. 222, pp. 1280-1282; May 27, 1946.) An explanation of the intermittent nature of the discharge in a tube, across which is connected a capacitance above a certain minimum value, is based on the fact that a portion of the voltage versus current characteristic has a negative slope.
- 621.385.1 941
Current Maximum in Intermittent Functioning of Discharge Tubes—J. Moussiégt. (*Compt. Rend. Acad. Sci.*, (Paris), vol. 222, pp. 1479-1480; June 24, 1946.) A systematic study of a commercial neon tube containing some argon. A linear relation is shown to exist between the reciprocals of the current maximum and the parallel capacitance. See also 940 above.
- 621.385.1.032.216 942
Oxide Coated Cathode Literature, 1940-1945—J. P. Blewett. (*Jour. Appl. Phys.*, vol. 17, pp. 643-647; August, 1946.) A brief survey with an annotated bibliography.
- 621.385.1.032.216 943
The Pulsed Properties of Oxide Cathodes—E. A. Coomes. (*Jour. Appl. Phys.*, vol. 17, pp. 647-654; August, 1946.) A survey of experimental results. Large electron currents are available in microsecond pulses. Sparking, which may be either current limited or voltage limited, and pulse temperature rise depend on cathode materials and life; pulse temperature rise also indicates the nature of cathode resistance. Pulsed data also provide evidence for a layer structure of the oxide cathode.
- 621.385.1.032.216:537.13 944
Some Cases of Interaction Between Positive Ions and Metallic Surfaces—Morgulis (See 744.)
- 621.385.1.032.216:621.386.1 945
A Study of Oxide Cathodes by X-Ray Diffraction Methods: Part 2—Oxide Coating Composition—A. Eisenstein. (*Jour. Appl. Phys.*, vol. 17, pp. 654-663; August, 1946.) An investigation of the time changes occurring in oxide cathode coating composition. Lattice constant measurements are used to detect changes in the bulk of the coating and a new method of diffraction pattern analysis gives variation of composition with depth below the surface. The effect on the thermionic emission of changes in BaO-SrO composition, which depends on the base metal used, is discussed. For part 1, see 3811 of January; see also 943 above and 946 below.
- 621.385.1.032.216:621.386.1 946
Studies of the Interface of Oxide Coated Cathodes—A. Fineman and A. Eisenstein. (*Jour. Appl. Phys.*, vol. 17, pp. 663-668; August, 1946.) X-ray diffraction patterns show the existence of a crystalline 'interface' compound between the base metal and the oxide coating of the cathode. This 'interface' has an anomalous resistance to microsecond pulse currents, whose value, measured with imbedded probes, is shown as a function of peak current for various operating temperatures. See also 945 above.
- 621.385.16 947
The Donutron—F. H. Crawford and M. D. Hare. (*Electronics*, vol. 19, pp. 200, 204; November, 1946.) Abstract with drawings of an unpublished report by F. H. Crawford and

M. D. Hare of Harvard University on a tunable squirrel cage magnetron having an output of 50 watts at 45 per cent efficiency operating in the re-entrant line mode over a frequency range of 1 to 1.5 at a single anode voltage.

- 621.385.16 948
The Internal Mechanism of the Magnetron—J. Vogé. (*Onde Élect.*, vol. 26, pp. 345-354 and 374-386; August-October, 1946.) The steady-state conditions in a nonoscillating magnetron are first considered: the importance of taking into account the initial velocity of the electrons is stressed. For voltages up to a value somewhat exceeding the critical potential, cardioid and spiral trajectories are possible. Reasons are advanced suggesting that the latter type occurs in practice. At higher potentials the cardioid type alone is obtained.
- The processes involved in an oscillating magnetron are considered in part 2. Formulas are obtained for the frequencies of the possible modes of oscillation, in terms of the magnetic field and number of anode segments. The internal impedance of the magnetron is also calculated. Finally, theory and experiment are compared.
- 621.385.3:621.396.694.012.8 949
Theory of the Equivalent Diode—G. B. Walker. (*Wireless Eng.*, vol. 24, pp. 5-7; January, 1947.) A new method, based on electrostatic considerations, is suggested whereby the equivalent diode can be uniquely determined whatever the emission velocity may be.
- 621.385.38 950
The Parallel Operation of Gasfilled Triodes—G. Windred. (*Electronic Eng.*, vol. 18, pp. 337-338, 357; November, 1946.) By operating thyratrons in parallel, increased anode currents may be obtained. In some cases two small tubes can be more economical than one larger one. Failure of one tube may cause overloading of the other. A tube replacement technique if suggested whereby a faulty tube may be replaced without interrupting the operation of the circuit. Possible methods of ensuring the simultaneous striking of both tubes are discussed.
- 621.385.38 951
Extending Thyatron Life—(*Electronics*, vol. 19, pp. 210, 212; November, 1946.) Abstract of a report by H. W. Gerlicher of Evans Signal Laboratory. The loss of hydrogen due to absorption by nickel parts of the tube is made good by placing within the envelope a heated capsule of titanium hydride powder.
- 621.385.4/.5 952
Tetrode versus Pentode—L. Chrétien. (*Toute la Radio*, vol. 12, pp. 2-4, 8; December, 1945.) The characteristics of both tubes are reviewed, and it is concluded that the tetrode gives better performance for power amplification. Push-pull arrangement of tetrodes is advocated, in order to eliminate harmonics of even order.
- 621.385.41 953
Spontaneous Fluctuations in a Double-Cathode Valve—D. K. C. MacDonald. (*Wireless Eng.*, vol. 24, p. 30; January, 1947.) At low temperatures (1900 to 2000 degrees Kelvin) the ratio β of the 'fluctuation temperature' to the true temperature approximates to unity. The rapid rise of β at higher temperatures is difficult to explain in terms of positive ion emission.
- 621.385.82.029.3:621.395.61 954
High Power Thermionic Cell Using Positive Ion Emission and Operating in a Gaseous Medium—S. Klein. (*Compt. Rend. Acad. Sci.*, (Paris), vol. 222, pp. 1282-1284; May 27, 1946.) Another account of the cell described in 593 of March.

- 621.396.615.142 955
Lens Effect of Alternating Fields in Velocity Modulated Valves—P. Guénard. (*Ann. Radioélect.*, vol. 1, pp. 319–323; April–July, 1946.) In a velocity-modulated tube, the electric field across the gap in the modulating electrode (buncher) produces a 'lens' effect, so that an incident parallel beam of electrons is not only bunched (the normal velocity modulation effect) but becomes alternately convergent and divergent. The effect is computed for the case of small applied fields.
- 621.396.615.142.2 956
The Theory of the Monotron—S. Gvozdover and V. Lopukhin. (*Zh. Eksp. Teor. Fiz.*, vol. 16, no. 6, pp. 528–536; 1946. In Russian, with English summary.) Resonant frequencies, the amplitude of stationary vibrations, the efficiency, and the minimum current required for excitation are determined for the monotron. The monotron is a single-circuit klystron whose operation is based on the fact that negative impedance can be produced by passing an electron discharge between two parallel planes. The original theory of J. J. Müller (406 and 1010 of 1942) and F. B. Llewellyn (3155 of 1939) is elaborated.
- 621.396.69:389.6 957
Why New Valves?—F. C. Connelly. (*Murphy News*, vol. 21, Supplement, pp. 8–10; December, 1946.) A description of the new B8A standard type of tube base and comparison with former types.
- 621.396.69:389.6 958
Valve Standardization—(See 980.)
- MISCELLANEOUS**
- 001.3 959
The Cultural Understanding and Appreciation of the Scientific Approach—R. H. Ojemann. (*Science*, vol. 104, pp. 335–338; October 11, 1946.) Information is presented which appears to show that the vast majority of the population grow up with little real understanding of scientific principles and methods, or of the function of research in a democratic society. Causes of this situation are suggested; adequate support for research projects is unlikely unless it can be remedied.
- 001.4 960
 μ is Overworked—"Cathode Ray." (*Wireless World*, vol. 52, pp. 364–365; November, 1946.) Many examples are quoted of different and inconsistent uses of μ . It is suggested that ' μ ' for 'micro-' should be used with discretion especially in magnetic formulas, and that ' $\mu\mu$ ' should be replaced by 'p' ('pico-').
- 001.89 961
Recommendations of the Royal Society Empire Scientific Conference—(*Sci. Culture*, vol. 12, pp. 117–124; September, 1946.) For another account, see 3828 of January.
- 001.891 962
Research and the Smaller Firm in Britain—(*Nature*, (London), vol. 158, pp. 638–639; November 2, 1946.) Report of conference arranged by the Manchester Joint Research Council. Small firms were anxious to develop their own lines of research.
- 029:62 963
Documentation in Engineering—M. Doucet. (*Tech. Wet. Tijdschr.*, vol. 15, pp. 27–31; April–May, 1946.) A central reference service should be founded to provide research workers and practical engineers with all available information on any particular subject. Collaboration with existing institutions is emphasized.
- 029:778.142 964
Document Copying on Microfilm—(*Nature* (London), vol. 158, p. 579; October 26, 1946.) The importance of photographic copying is stressed, and attention is called to a new document-recording camera and microfilm reader made by W. Watson and Sons. See also 2409 of 1946 (Moholy).
- 5+6] "1939/45" 965
The Scientist in War Time—E. V. Appleton. (*Proc. Inst. Mech. Eng.*, vol. 154, no. 3, pp. 303–316; 1946.) The thirty-second Thomas Hawksley lecture. For another account, see 2420 of 1946.
- 519.283 966
Statistical Methods in Quality Control: Part 11—Statistical Tests of Significant Differences—A.I.E.E. Subcommittee on Educational Activities. (*Elect. Eng.*, vol. 65, pp. 466–468; October, 1946.) Discusses the statistical interpretation of limited experimental tests. For previous parts, see 2422 and 2423 of 1946 and back references.
- 531.715.1:531.717.1:539.23 967
Measurement of Thickness of Thin Films—A. F. Gunn and R. A. Scott. (*Nature* (London) vol. 158, p. 621, November 2, 1946.) The film is applied over a portion of a sheet-glass plate so that it has an abrupt edge, and the whole surface is coated with a thin layer of silver; this is placed in contact with a similarly silvered glass plate. Interference fringes are formed by multiple reflection.
- 533.45:629.13.052 968
Barometric Measurement of Height in Aviation—K. Ramsayer. (*Arch. Tech. Messen.*, pp. T61–62; June, 1940.) A brief account of aneroid barometers for height measurement in aircraft, with a detailed tabular analysis of causes of error.
- 538+531].081:621.39.012.8 969
Electrical and Mechanical Analogies—E. B. Ferrell. (*Bell. Lab. Rec.*, vol. 24, pp. 372–373; October, 1946.) A list is drawn up of quantities which play analogous parts in electrical, mechanical, and rotational problems respectively. The method of analysis by analogy has been successfully used to solve problems concerning recording and loudspeaking systems, relays, and servomechanisms.
- 538.3:001.5 970
The Use of Analogies—G.W.O.H. (*Wireless Eng.*, vol. 24, pp. 1–3; January, 1947.) A defense of the use of analogies in teaching the theory of electromagnetism. "The obvious way of explaining new and intangible concepts is by means of familiar and tangible concepts."
- 621.3.016.25 971
The Sign of Reactive Power—A.I.E.E. Standards Committee. (*Elect. Eng.*, vol. 65, pp. 512–516; November, 1946.) Some examples are quoted to support the contention that inductive reactive power should be considered positive.
- 621.365 972
Electronic Heating Conference—(*Electronics*, vol. 19, pp. 184, 190; November, 1946.) Held at San Francisco. The main subjects discussed were baking of foundry cores, and radio-frequency sterilization of food.
- 621.386.86 973
Invisible Industrial Hazard—S. R. Warren, Jr. (*Elec. Eng.*, vol. 65, pp. 499–507; November, 1946.) Excessive exposure to X-rays and gamma-rays can cause bodily harm months or even years later. As these rays are invisible, the urgent necessity is emphasized of warning workers of the danger, and providing adequate protection.
- 621.396 974
The Radio Work of Joseph Bethenod—L. Bouthillon. (*Ann. Radioélect.*, vol. 1, pp. 279–292; April–July, 1946.) A lecture given to the Société des Radioélectriciens to commemorate the work of Joseph Bethenod, a former president of the society.
- 621.396.001.6 975
Research and Development in Radio Technology—R. A. Collacott. (*Electronic Eng.*, vol. 18, pp. 287–288; September, 1946.)
- 621.396/397].6.004.67 976
Civic Radio Service—(*Elect. Rev.* (London), vol. 139, p. 944; December 6, 1946.) Fulham Electricity Department will sell and service radio and television equipment, "a decision which has been followed by a number of other municipal undertakings."
- 621.396.615.14. 977
The New Technique of Ultra-Short Waves—A.-V.-J. Martin. (*Toute la Radio*, vol. 13, pp. 153–156; June, 1946.) The evolution is traced from the Barkhausen-Kurz oscillator up to cavity magnetrons, klystrons, and rhumbatrons.
- 621.396.69:389.6 978
Some Aspects of Standardisation in Radio—T. R. W. Bushby. (*Proc. I.R.E.* (Australia), vol. 7, pp. 15–20; October, 1946.) National and international organizations concerned with standardization are specified. The advantages are stressed of using only sizes of components belonging to a preferred numbers series, and of specifying the standard deviation and the number of observations as well as the mean value when testing batches of similar components. The correct use of technical terms is important.
- 621.396.69:389.6 979
Commercial Standardisation—(*Tech. Bull. Radio Component Mfrs'. Fed.*, vol. 1, pp. 5–6; August, 1946.) A survey of the constitution and activities of the technical panels of the Federation, giving details of the draft recommendations for standardization of certain components.
- 621.396.69:389.6 980
Valve Standardization—(*Wireless World*, vol. 52, p. 375; November, 1946.) Although discussion is still proceeding on standard tube types, tentative agreement has been reached that most tubes will have a new small eight-pin base (type B8A) with a central spigot and a locating boss. For large-bulb tubes, a base of type B8B will be used. Any further changes will be of a minor character. See also *Electronic Eng.*, vol. 18, p. 327, November, 1946.
- 621.396.69:389.6 981
Why New Valves?—Connelly (See 957.)
- 621.396.96:001.4 982
What Is Radar?—"Cathode Ray." (See 740.)
- 5+6]:41.3=00 983
Dictionary of Science and Technology [Book Review]—M. Newmark. Pitman, London, 386 pp., 30s. (*Jour. Sci. Inst.*, vol. 23, p. 219; September, 1946.) Intended for use in the fields of chemistry, physics, and engineering. The French, German, and Spanish languages are covered.
- 51 984
The Mathematical Discoveries of Newton [Book Review]—H. W. Turnbull. Blackie, London, 1945, 68 pp., 5s. (*Beama Jour.*, vol. 53, p. 330; September, 1946.)

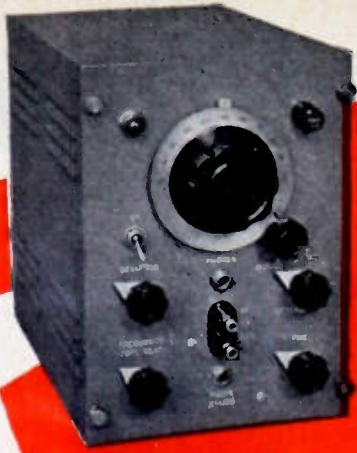

Visual Alignment means *Accurate* Alignment

Alignment with a Visual Alignment Signal Generator (VISALGEN) eliminates guess-work and time consuming plotting.

- **WHAT**
The *Visalgen* Does
Aligns intermediate and radio frequency amplifiers in FM and AM Communication and Broadcast Receivers, as well as Broadband receivers of all types.
- **WHY**
The *Visalgen* Is Useful
Saves time, instantaneously you see the entire frequency response curve. Indispensable for FM discriminator and overcoupled circuit alignment.
- **HOW**
The *Visalgen* Operates
Gives a wide band FM output synchronized with a linear sweep, so that the overall frequency response of the circuit under test is seen on an oscilloscope screen.
- **WHERE**
The *Visalgen* May Be Used
The Visalgen, available in two models: the 205TS (500 KC to 20 MC) and the 204TS (20 KC to 500 KC) is useful in Development Laboratories, Production Testing or on the service bench. In short, wherever fast accurate alignment is necessary.

A matching oscilloscope is also available in a separate cabinet or installed with either VISALGEN in a single cabinet.

IMMEDIATE DELIVERY —

HARVEY
OF CAMBRIDGE

WRITE FOR FURTHER INFORMATION

HARVEY RADIO LABORATORIES, INC.
456 CONCORD AVENUE • CAMBRIDGE 38, MASSACHUSETTS

Hit of I.R.E. Convention



Western Electric 10 KW TRANSVIEW design FM Transmitter



Western Electric's new 10 kw FM transmitter is still the talk of broadcasters who saw it at the recent I.R.E. Convention.

Its sleek, business-like appearance, with full length glass doors and an unobstructed view of all tubes, caught their eye—but they were even more impressed by its technical characteristics and operating advantages.

Particularly, they liked its *low intermodulation* and *low harmonic distortion*, its *Synchronizer* for precise frequency control, and its *Arc-*

Back Indicator, a new circuit for quick and accurate location of a faulty mercury vapor rectifier tube.

Western Electric's complete line of TRANSVIEW design FM transmitters will range from 250 watts to 50 kw. For full information, call your local Graybar Broadcast Representative or write to Graybar Electric Co., 420 Lexington Avenue, New York 17, N. Y.

— **QUALITY COUNTS** —

SECTION MEETINGS

ATLANTA

"High-Frequency Heating," by E. S. Lammers, Westinghouse Electric Corporation; January 24, 1947.

BUFFALO-NIAGARA

"A Few Special Developments," by E. D. Cook, General Electric Company; February 19, 1947.

DAYTON

"Theory, Operation and Application of Cathode-Ray Oscillographs," by E. G. Nichols, Allen B. Dumont Laboratories; February 13, 1947.

LONDON ONTARIO

"Electronics in the Navy," by H. G. Burchell, United States Navy; January 10, 1947.

"Radio Parts Manufacturing in Europe," by J. R. Longstaffe, J. R. Longstaffe Company; February 17, 1947.

LOS ANGELES

"Navigational Marine Radar," by W. U. Dent, Westinghouse Electric Corporation; February 18, 1947.

MONTREAL

"Air Navigation and Traffic Control," by H. K. Morgan, Bendix Radio, Division of Bendix Aviation Corporation; February 5, 1947.

NORTH CAROLINA-VIRGINIA

"Teleran-Air Navigation and Traffic Control by Means of Television and Radar," by D. H. Ewing, Radio Corporation of America; January 24, 1947.

OTTAWA

"Some Practical Considerations on Communications in the 30-Megacycle to 10,000-Megacycle Regions," by J. B. Knox, Radio Corporation of America Victor Company; February 20, 1947.

PHILADELPHIA

"The Philadelphia Urban Mobile Radiotelephone System," by A. P. Godsho, Bell Telephone Company; February 5, 1947.

SAN DIEGO

"Electronics In Our Modern World," by L. E. Reukema, University of California; February 10, 1947.

TORONTO

"FM Broadcasting in Canada," by J. A. Ouimet, Canadian Broadcasting Corporation; February 4, 1947.

"The Differential Analyzer," by F. C. Carter, University of Toronto; February 24, 1947.

"Wide-Band Video Amplifiers," by R. H. Duncan, University of Toronto; February 24, 1947.

"Atomic Power," by B. Stoicheff, University of Toronto; February 24, 1947.

WASHINGTON

"Coaxial Cable Network and Application to Television Transmission," by V. B. Bagnall, American Telephone and Telegraph Company; February 10, 1947.

MEMBERSHIP

The following transfers and admissions were approved March 2, 1947 to be effective as of April 1 1947:

Transfer to Senior Member

Albert, A. L., 2855 Jackson St., Corvallis, Ore.
Bertram, S., 703-30 Ave., Apt. H., Seattle 22, Wash.

(Continued on page 38A)

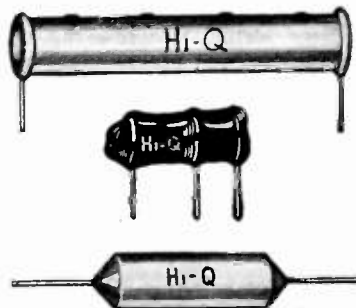
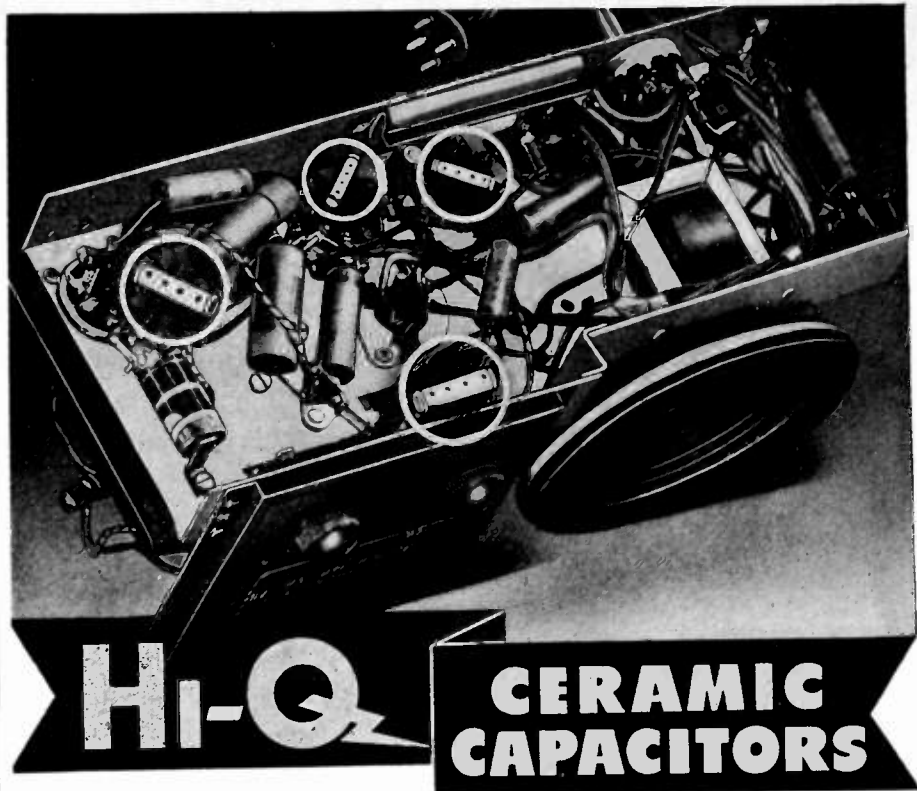

General purpose capacitors adequately meet the requirements of small AC-DC sets. Their reliable performance and long life make them especially desirable in applications where other types of more expensive units must be replaced. In addition HI-Q general purpose capacitors avoid aging and comparable reduced performance.

We shall be glad to submit samples for your examination.

OTHER HI-Q COMPONENTS

WIRE WOUND RESISTORS



FEED-THRU & STAND-OFF CAPACITORS

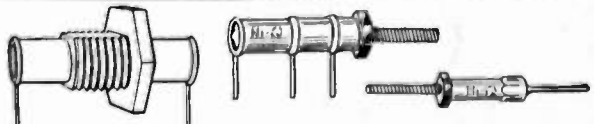

CHOKE COILS



HI-Q ELECTRICAL REACTANCE CORPORATION

FRANKLINVILLE, N. Y.

THIS TIME BOTH DAVID AND GOLIATH HAD TO WIN

In almost any business, how to handle both large and small orders with equal dispatch is a problem. At least that's the way it was in our industry (resistors) until January 1, 1946. On that day—after months of observation, we introduced the IRC Industrial Service Plan. Minimum orders for nearly all IRC Standard Resistors can now be obtained from the well-stocked shelves of local independent electronic parts distributors. No time lost when you need experimental or maintenance quantities in a hurry. No production runs held up by small orders at the factory. Consuming manufacturer, distributor and ultimate user all benefit.



* An unpretentious booklet containing the essence of the IRC Industrial Service Plan is available upon request.

IRC

Wherever the Circuit says Ω

Power Resistors on Short Delivery Cycle

Whatever your needs in power resistors there's an IRC resistor to do the job... readily available for immediate delivery. Four types of power wire wound resistors... each particularly suited to certain circuit or design applications... all unexcelled in essential electrical and mechanical characteristics... provide proven solutions to voltage dropping problems where power dissipation is necessary. Write for complete information regarding specifications, characteristics and delivery, stating products in which you are interested. International Resistance Company, 401 N. Broad Street, Philadelphia 8, Pennsylvania.
In Canada: International Resistance Company, Ltd., Toronto, Licensee.

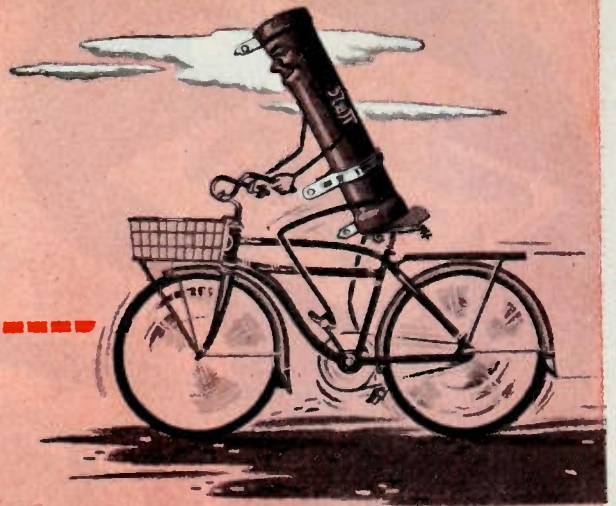

PWW Resistors

For exacting heavy-duty applications. Tubular power wire wounds of extreme mechanical strength. Available in two coatings for high temperature or high humidity conditions. Fixed, adjustable and non-inductive types in full range of sizes, ohmic values and terminals.



FRW Resistors

For voltage dropping in limited space applications. Flat power wire wounds of lightweight construction. Designed for vertical or horizontal mounting singly or in stacks. Mounting brackets serve as conductors of internal heat. Fixed adjustable and non-inductive types in full range of sizes and ohmic values.

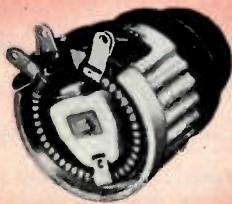

PR Rheostats

All metal construction permits operation at full load with as little as 25% of winding in use, with only slight increase in temperature rise. Available in 25 and 50 watt ratings. Type PR-25: diameter 1 7/8", depth behind panel 2 1/2", standard resistance values 1 to 5,000 ohms. Type PR-50: diameter 2 3/8", depth behind panel 1 3/8", standard resistance values 0.5 to 10,000 ohms (higher values on special orders).

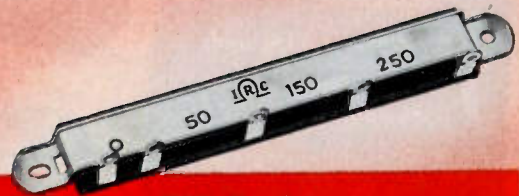

MW Resistors

For applications where low temperature rise, space and weight are vital factors. Encased in special phenolic compound for complete protection. Unique design of mounting bracket aids rapid heat dissipation. Multi-section feature permits exceptional flexibility for voltage dividing applications.

$$I = \frac{E}{IIRC}$$

INTERNATIONAL RESISTANCE COMPANY



Power Resistors • Precisions • Insulated Composition Resistors • Low Wattage Wire Wounds • Rheostats • Controls • Voltmeter Multipliers • Voltage Dividers • HF and High Voltage Resistors



Andrew Co.
begins its
second
decade of
service
to the
industry



- Transmission lines for AM-FM-TV
- Directional antenna equipment
- Antenna tuning units
- Tower lighting equipment
- Consulting engineering service

ANDREW

WRITE FOR
COMPLETE CATALOG

ANDREW CO.
363 EAST 75th STREET • CHICAGO 19

*Pioneer Specialists
in the Manufacture
of a Complete Line of
Antenna Equipment*

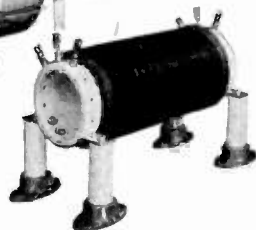
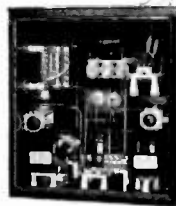
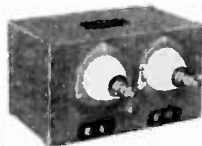
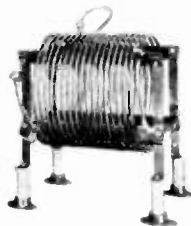
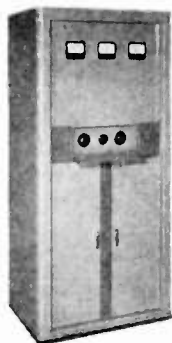
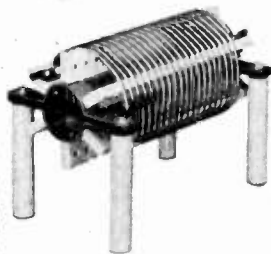
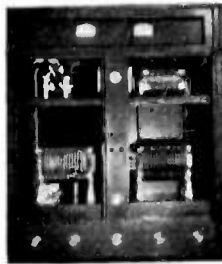

(Continued from page 35A)

- Brown, A. S., R.F.D. 1, Box 621, Red Bank, N. J.
Carter, R. H. A., Inglehope, Harcourt Rd., West Malvern, Worcs, England
Conrad, R. S., 3728 C Ave., N.E., Cedar Rapids, Iowa
Courtenay, J. A., Southern Bell Tel. & Tel. Co., New Orleans 12, La.
Eckert, C. C., 169 Valleyview Dr., Dayton 5, Ohio
Fetsch, J. T., Naval Research Laboratories, Electronics Section, Bellevue, D. C.
Harmon, W. S., 4025 McClung Dr., Los Angeles 43, Calif.
Herndon, P. H., Jr., 411 Federal Annex, Atlanta 3, Ga.
Johnson, E. M., 161 Hickory Grove Dr., E., Larchmont, N. Y.
Johnson, H. D., Sylvania Electric Products, Inc., Emporium, Pa.
Loucks, I. H., 115 Kingsley Ave., Bethesda, Washington 14, D. C.
Marx, F. L., American Broadcasting Co., Inc., 30 Rockefeller Plaza, New York 20, N. Y.
Muffy, G., R.F.D. 1, Verona, Pa.
Tatum, F. W., 85 Bronx River Rd., Yonkers 4, N. Y.
Triplett, W. R., 3840-44 Ave., S.W., Seattle 6, Wash.
Varela, A. A., 5 Woodmont Rd., Alexandria, Va.
Welsh, R. R., 427 Euclid Ave., Haddonfield, N. J.
Wertli, A. J., 4 St. Ursustrasse, Baden, Aargau, Switzerland
Wilcox, J. F., Transmitter Division, General Electric Co., Thompson Rd. Plant, Syracuse, N. Y.

Admission to Senior Member

- Ballard, B. G., National Research Council, Ottawa, Ont., Canada
Della-Corte, J. P., 108-25-67 Dr., Forest Hills, N. Y.
Lewis, W. A., 3300 Federal St., Chicago 16, Ill.
Spriggs, A. J., 524 Knollwood Dr., S.E., Cedar Rapids, Iowa
Thayer, G. N., Bell Telephone Laboratories, Inc., 463 West St., New York 14, N. Y.
Wilde, A. J., R.F.D. 3, Waynesville, Ohio

Transfer to Member

- Andrew, W. M., 3660 Southern Ave., S.E., Washington 20, D. C.
Atchley, D. W., Jr., 59 Hillcrest Rd., Belmont 78, Mass.
Bitner, H. W., 349 East Bald Eagle St., Lock Haven, Pa.
Campbell, C. M., Jr., 202 Highland Ave., Syracuse 3, N. Y.
Foster, J. W., 2922 Center Point Rd., N.E., Cedar Rapids, Iowa
Goldenberg, H. E., 6009 Central St., Kansas City, Mo.
Hastings, R., Misiones 48, Buenos Aires, Argentina
Heartz, L. C., 120 Royal Rd., Bangor, Me.
Keck, M. W., 2231 Oak Grove Pl., Toledo 12, Ohio
Longfellow, B. S., 928 Second St., Alexandria, Va.
Martin, N. A., Box 701, Dixon, Calif.
McGregor, R. B., 2100 Confederate Pl., Louisville 8, Ky.
Ricciotti, S., 941 N. Union St., Shawnee, Okla.
Spiegel, L., P. O. Box 46, Belleville, Ill.
Wentink, T., Jr., R. F. D. 4, Box 568, New Brunswick, N. J.
Wolfskill, R. F., 321 East Gregory Blvd., Kansas City 5, Mo.

Admission to Member

- Battison, J. H., KMBC, Kansas City 6, Mo.
Berens, G. E., 60 W. Peach Orchard Rd., Dayton 9, Ohio
Bolau, R. S., 15 Farlow Rd., Newton 58, Mass.
Carson, C. J., 407 Sixth St., S.W., Cedar Rapids, Iowa

(Continued on page 40A)

no matter how

we tell it

IT'S NEWS

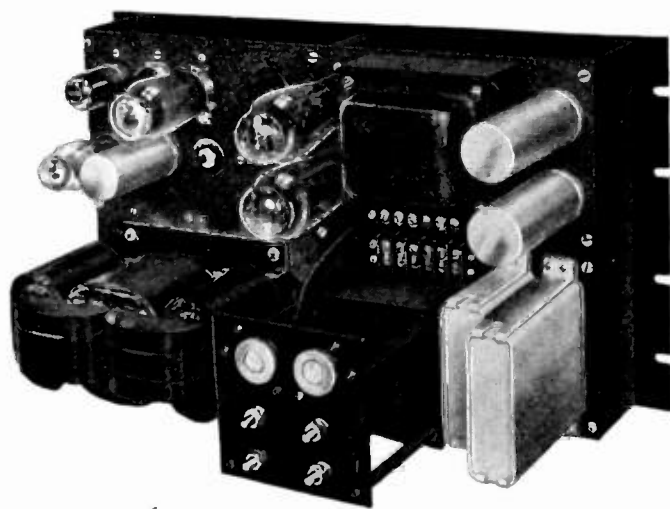

The **STABILINE** *Electronic* Voltage Regulator

Instantaneous in action with a maximum waveform distortion of 3 percent — this new completely-electronic voltage regulator maintains a stable output . . . within $\pm .1$ volt of nominal for line variations from 95 to 135 volts; within $\pm .15$ volt of nominal for any load current change or load power factor change from lagging .5 to leading .9.

Rated—Input: 95-135 volts, 1 phase, 60 cycles. Output: settable between 110-120 volts, 1 KVA. Let us supply you with complete technical and performance data.

WRITE-PHONE-WIRE -OR MAIL THIS COUPON TODAY

STABILINE *Electronic*
VOLTAGE
REGULATOR

THE Superior Electric

COMPANY
83 LAUREL STREET
BRISTOL, CONNECTICUT

The SUPERIOR ELECTRIC Company
BRISTOL, CONNECTICUT

RE

Gentlemen:
Please forward complete engineering and performance data on the new STABILINE electronic voltage regulator.

Company.....

Address.....

City..... State.....

Name..... Position.....



QUIET...



(Pat. Applied For)



Jewel Tip



Precious Metal Tip

No other word could so vividly ... so adequately ... describe the superb reproducing quality of Astatic's excitingly new, greatly improved "QT" Phono Pickup Cartridge. Now in production, this finer cartridge is being used extensively for new applications as well as modern home replacements.

NEW TYPE "QT" CARTRIDGE

Highly acclaimed for its clear, clean, "quiet-talk" reproduction, the "QT" Cartridge is ideally suited for use with home record players. The unusual design of this cartridge with a needle allowing appreciably more vertical compliance has VASTLY reduced surface noise and needle talk for more enjoyable reproduction.

Made in Two Models The "QT" Cartridge is available with either precious metal tipped needle, Model QT-M, or with jewel tip, Model QT-J. Both needles are REPLACEABLE, easily inserted or removed. MATCHED to the cartridge, they are the only needles that can be used with it, thus assuring that the quality of reproduction will remain constant regardless of needle replacement.

LITERATURE IS AVAILABLE



©Astatic



(Continued from page 38A)

- Couillard, L. W., 125—38 St., N.E., Cedar Rapids, Iowa
- Fox, M., 8809 S. Kenwood Ave., Chicago 19, Ill.
- Haas, C. H., KFSG, 1100 Glendale Blvd., Los Angeles 26, Calif.
- Hilsabeck, D. M., 39 Shopping Court, Dayton 3, Ohio
- James, R. L., 2051 Kensington Dr., Dayton 6, Ohio
- Jelks, E. B., Southern Bell Tel. & Tel. Company, Savannah 1, Ga.
- Johnson, R. L., 5 South Maple Ave., East Orange, N. J.
- Jones, D. M., Navy Department, Bureau of Ships, Washington, D. C.
- Kaufman, M. G., 143 Ivanhoe St., S.W., Washington 20, D. C.
- Kelcher, A. E., Jr., 419 Sterling Pl., Ridgewood, N. J.
- Korb, A. W., 30 Ottawa Ave., Grandville, Mich.
- Mansfield, R., 8049 S. Maryland Ave., Chicago, Ill.
- Matzinger, J. R., 1927—31 St., N.W., Canton, Ohio
- Mayer, C. H., Apt. 2-A, 155 Ivanhoe St., S.W., Washington 20, D. C.
- Saunders, A. C. W., 63 Ramshead Rd., Medford 55, Mass.
- Shall, H. N., 8228 Holmes Rd., Kansas City 5, Mo.
- Stine, P. T., 157 Irvington St., S.W., Washington 20, D. C.
- Whitehouse, M. H. L., Holmwood Pl., Four Elms, Edenbridge, Kent, England
- Willard, F. R., Electrical Engineering Department, North Carolina State College, Raleigh, N. C.

Transfer to Associate

- Blatt, F. J., 3576 Alaska Ave., Cincinnati 29, Ohio
- Brownman, H. L., 1235 Grand Concourse, New York 52, N. Y.
- Dean, N. J., Box 14, School of Engineering, Columbia University, New York 27, N. Y.
- Howland, B., c/o W. H. Smith, 2114—14 St., S.E., Washington 20, D. C.
- Hurley, R. B., 705 Hamilton St., Schenectady 7, N. Y.
- Morin, J. A. R., 16 Lafayette Rd., Ipswich, Mass.
- Rothschild, L. I., Jr., 125 Kendall Blvd., Oaklyn, N. J.
- Schmitt, L. D., 4136 N. Sacramento Ave., Chicago 18, Ill.
- Siegel, B. L., 2161 Barnes Ave., New York 60, N. Y.
- Smoke, F., 686 Highbury Ave., London, Ontario, Canada
- Squitieri, A. M., 22 Lincoln Place, Brooklyn 17, N. Y.
- Taylor, H. M., Jr., 509 E. 2 St., North Morristown, Tenn.

Admission to Associate

- Adams, A. B., P. O. Box 1587, West Palm Beach, Fla.
- Anderson, K. W., 3811 Mt. Vernon, Ft. Worth, Tex.
- Bahr, R. J., General Electric Co., Thompson Rd., Syracuse, N. Y.
- Blakelock, A. O., 200 East Genesee, Fayetteville, N. Y.
- Bogart, R. M., 52 Concord Ave., Cambridge 38, Mass.
- Brennand, R., 90 Seaforth Gardens, Hook Surbiton, Surrey, England
- Brown, J. H., Johns Hopkins University, 8621 Georgia Ave., Silver Spring, Md.
- Bruce, R., Jr., 516 Lillian St., Fort Wayne 7, Ind.
- Buck, R. F., 23 Morton St., Bloomfield, N. J.
- Bush, T. K., 3105 Lafayette, Fort Wayne 5, Ind.
- Caha, V., 30 Soborska, Prague 19, Czechoslovakia
- Clutter, E. C., 33—13 Ave., Columbus 10, Ohio
- Coan, J. O., Jr., 2711 Forest Dr., Winston-Salem 5, N. C.

(Continued on page 42A)

BIGGEST NEWS IN AM!

It's Federal's New Triodes for 50 KW Transmitters —
with **THORIATED TUNGSTEN FILAMENTS!**

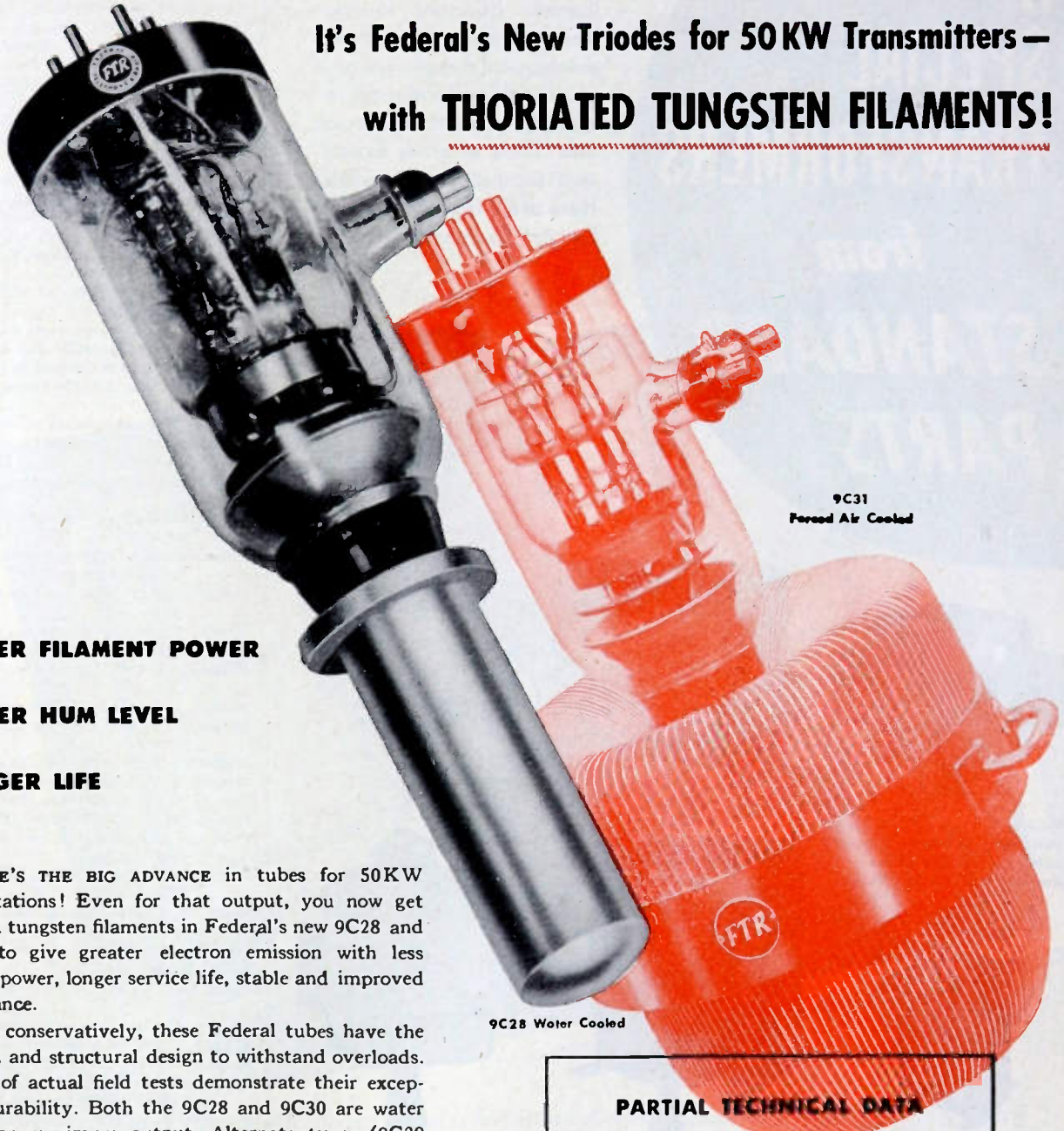

- LOWER FILAMENT POWER
- LOWER HUM LEVEL
- LONGER LIFE

HERE'S THE BIG ADVANCE in tubes for 50KW stations! Even for that output, you now get thoriated tungsten filaments in Federal's new 9C28 and 9C30 — to give greater electron emission with less filament power, longer service life, stable and improved performance.

Rated conservatively, these Federal tubes have the electrical and structural design to withstand overloads. Months of actual field tests demonstrate their exceptional durability. Both the 9C28 and 9C30 are water cooled for maximum output. Alternate types (9C29 and 9C31), with air cooling, are also available. In a pair of either type you'll find new operating economy and low tube costs.

Federal's 38 years of tube engineering and manufacture show up once more in this latest "first". No wonder Federal tubes have consistently set the standards for performance in AM broadcast service. We'll be glad to send you more data on these tubes. Write department K 437.

9C28 Water Cooled

9C31
Forced Air Cooled

PARTIAL TECHNICAL DATA

	9C28	9C30
Filament voltage	15 v.	15 v.
Filament current	135 amp.	135 amp.
<i>Maximum Ratings</i>		
Plate Voltage	12,000 v.	15,000 v.
Plate Current	10 amp.	8 amp.
Plate Input	100 kw.	120 kw.
Plate Dissipation	40 kw.	40 kw.

Federal Telephone and Radio Corporation

In Canada: — Federal Electric Manufacturing Company, Ltd., Montreal.
Export Distributors: — International Standard Electric Corp. 67 Broad St., N. Y.



100 Kingsland Road,
Clifton, New Jersey

HOW TO BUY SPECIAL TRANSFORMERS from STANDARD PARTS

The special physical design or special electrical characteristic transformers you may need can probably be engineered from Acme Electric standard laminations and parts to the exact mechanical dimensions and electrical performance required. No need for special dies, tools or other expensive production materials. Here are a few of the Acme Electric designs available.



Mounting type 100.
Available in ratings
from 3 to 40 VA.



Mounting type 110.
Available in ratings
from 35 to 2500 VA.

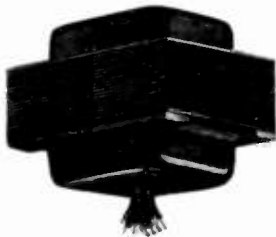

Mounting type 130, 2 hole
horizontal mounting lead
holes on bottom or side of
shell. Ratings 15 to 100 VA.



Mounting type 121.
Available in ratings
from 35 to 2500 VA.
Taps to suit your
needs.



Mounting type 131 with
end bells. Leads out bot-
tom or side. Ratings 35
to 500 VA.



Mounting type 150. 4 hole
horizontal mounting. Lead
holes on bottom or side of
shell. Primary tap changer
on top. Ratings 35 to
500 VA.

Write for Specification Transformer Bulletin 168.

ACME ELECTRIC CORPORATION
44 WATER STREET + + + CUBA, N. Y.

Acme  **Electric**



(Continued from page 40A)

- Curry, H. D., 3844 Charles St., Omaha, Nebr.
Deskachar, P. R., 99 Livingstone, Brooklyn 2, N. Y.
Diehl, R. T., 89 Hicks St., Brooklyn 2, N. Y.
Eastlund, L. C., 2730 S. E. Taylor, Portland, Ore.
Einsohn, I. A., 1524 Nelson Ave., New York 52, N. Y.
Elwell, H. G., Jr., 254 W. Third Ave., Roselle, N. Y.
Featherstone, R. P., 4235 Pleasant Ave., Minneapolis 9, Minn.
Gardner, D. A., 352 West 23 St., New York 11, N. Y.
Green, A., 394 Prospect St., Nutley 10, N. J.
Hall, G. O., 1654 Massachusetts Ave., Cambridge 38, Mass.
Hammond, M. L., 9 Marinus St., Rochelle Park, N. J.
Haynes, W. A., Jr., 4606—43 St., N. W., Washington 16, D. C.
Horn, H. T., 3118—22 Ave., S., Seattle 44, Wash.
Ing, G. W., 135 Ostrom Dr., San Antonio 2, Tex.
Ingerson, F. A., 129 Oakland St., Syracuse, N. Y.
Kain, G. H., Apt. 1-A, 175 East 62 St., New York 21, N. Y.
Kappauf, E. F., 48 Hemlock St., Brooklyn 8, N. Y.
Kubala, A. M., P. O. Box 544, West Los Angeles 25, Calif.
Lahey, J. L., 10436 Dickens Ave., Melrose Park 2, Ill.
Layton, B., 106 Fort Washington Ave., New York 32, N. Y.
L'Hommedieu, A. P., Westinghouse Corp., 40 Wall St., New York 5, N. Y.
McPherson, R. W., 1081 Sheridan Ave., New York, N. Y.
Masnik, M., Jr., 95-38—115 St., Richmond Hill, L. I., New York 19, N. Y.
Meigs, V. C., 4262 Victoria Ave., Los Angeles 43, Calif.
Mitchell, J. W., 421 N. Ditman, Los Angeles, Calif.
Morgan, R. B., Unit 1, Sandia Base, Albuquerque, N. M.
Murdoch, J. P., 68 West 71 St., New York 23, N. Y.
Murphy, R. P., 3 Waldron Ave., Nyack, N. Y.
Page, G. W., 51 Carroll Ave., Takoma Park, Md.
Pepe, G., 47 C. so Buenos Ayres, Milano, Italy
Peterman, A. F., Rm. 704, 2051 W. Grand Blvd., Detroit 8, Mich.
Pitts, W. J., 72 Ferguson Ave., Gidea Park, Essex, England
Pleotz, G. P., 420 Memorial Dr., Cambridge 39, Mass.
Popovich, B., Apt. 400-B, 186 W. Chippewa, Buffalo 1, N. Y.
Puskarich, L. B., Box 231, Foster Rd., McKeesport, Pa.
Reiss, A., 624 Montgomery St., Brooklyn 25, N. Y.
Riley, B. J., Jr., 225 S. Solomon, New Orleans, La.
Rankin, J. G., 901 Oswego St., Liverpool, N. Y.
Rosenberg, M., Radio Corporation of America Laboratories, Princeton, N. J.
Rountree, W. R., 4126—49, San Diego 5, Calif.
Schaefer, J. H., 3621 Rushland Ave., Toledo, Ohio
Schoenfuss, A. F., Roanoke Ave., Oakland, N. J.
Sharman, H. M., 552 Page St., San Francisco, Calif.
Singleton, H. E., International Tel. and Tel. Co., Patent Dept., 67 Broad St., New York 4, N. Y.
Swanson, E. E., 6902 Fourth St., N. W., Washington, D. C.
Taffet, W., 2 West 192 St., New York 58, N. Y.
Tompson, E. C., Rm. 1516, 40 East 34 St., New York, N. Y.
Tompson, E. C., Rm. 1516, 40 East 34 St., New York, N. Y.
Troetschel, W. O., Box FAETU, Naval Air Station, Whidbey Island, Wash.
Vezina, A. J., 723 Middle St., Fall River, Mass.
Woolen, C. E., Jr., 3415 Guilford Terrace, Baltimore 18, Md.
Wright, E. E., 248 Broad St., Red Bank, N. J.
Zink, H. F., Owens Illinois Glass Co., 1510 Westwood, Toledo, Ohio

SERVEL

...one of the distinguished names in refrigeration, finds Reed & Prince recessed head screws meet the requirements of speed, accuracy and finish on their production line.

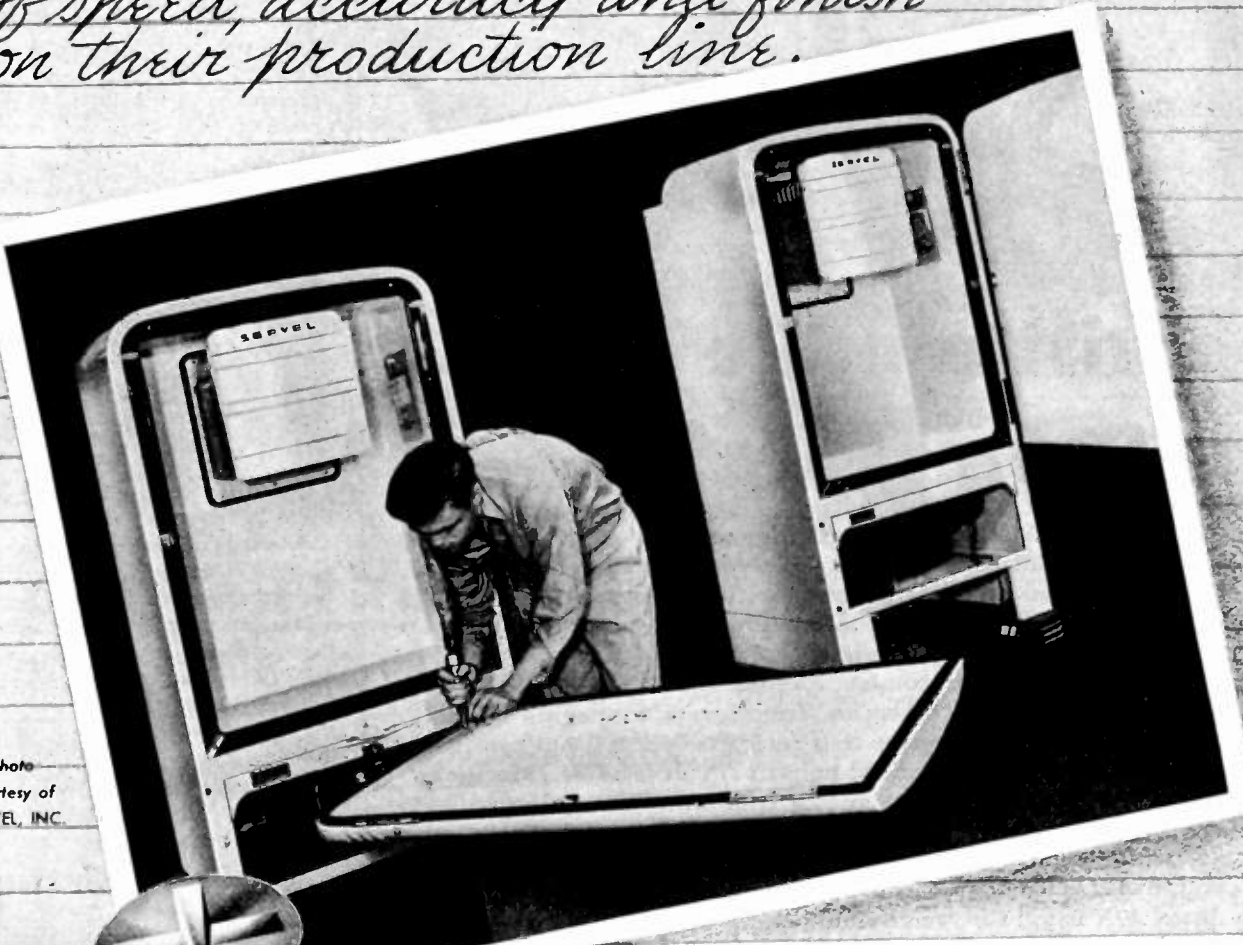

Photo
courtesy of
SERVEL, INC.



All Recessed Head screws have definite advantages over the older, slotted head type but ONLY REED & PRINCE Recessed Heads can be driven in any size — from the smallest to the largest — with ONE driver!

REED & PRINCE

MANUFACTURING
WORCESTER, MASS.

COMPANY
CHICAGO, ILL.

Announcing...THE NEW TURNER MODEL 20X HAND MICROPHONE



**a little mike
with a BIG future**

We're mighty proud of this new addition to the line of Microphones by Turner. Small in size yet *big in performance* it inherits those qualities of sound engineering and careful workmanship that have made the name Turner a symbol for precision and dependability.

The New Model 20X is designed to appeal to owners of home recorders and amateur communications equipment. It has innumerable applications in offices and factories and for paging and call system work. Sound pressure tests reveal remarkable performance characteristics for a low priced unit. Its circuit features a Metalseal crystal which withstands humidity conditions not tolerated by the ordinary crystal. Response to voice and music is smooth and flat within ± 5 db from 40-7000 c. p. s. Level is 54db below 1 volt/dyne/sq. cm. Finished in lustrous brown baked enamel, the Model 20X is light in weight and natural to hold. It may be hung on a hook. Furnished complete with 7 ft. attached shielded cable.

WRITE FOR BULLETIN

THE TURNER COMPANY

909 17th Street N. E. • Cedar Rapids, Iowa

Microphones **BY TURNER**

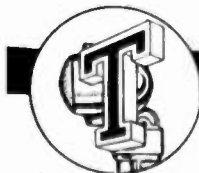

"THE PASSWORD TO SOUND PERFORMANCE"

LICENSED UNDER U. S. PATENTS OF THE AMERICAN TELEPHONE AND TELEGRAPH COMPANY, AND WESTERN ELECTRIC COMPANY, INCORPORATED. CRYSTALS LICENSED UNDER PATENTS OF THE BRUSH DEVELOPMENT COMPANY.

News—New Products

These manufacturers have invited PROCEEDINGS readers to write for literature and further technical information. Please mention your I.R.E. affiliation.

(Continued from page 12A)

Field Intensity Meter

Clarke Instrument Corp., 910 King Street, Silver Spring, Md., announces its model 106 VHF Field Intensity Meter for use in the television and FM bands from 50 to 220 megacycles. The instrument is direct reading in terms of microvolts per meter without the use of charts, curves, or calculations over a range of 5 microvolts to 10 volts. The receiver employs a stage of amplification at the signal frequency and features single-control tuning with provisions for separate fine adjustment of the antenna and mixer input tuning controls without disturbing the gang tuning.

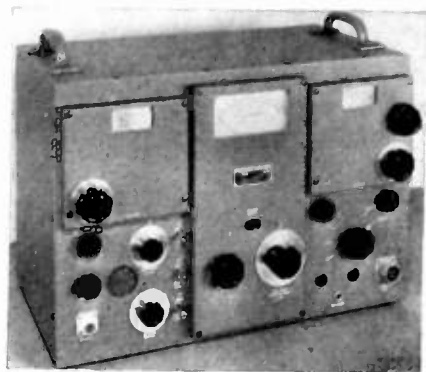

A built-in calibrating oscillator provides a source of standard signal for calibrating the instrument. Circuit arrangement provides a direct-reading feature even though the equipment is used with an antenna other than the standard dipole. The manufacturer points out that the selectivity of the instrument is adequate for measurements on adjacent channels 200 kilocycles apart, a feature particularly necessary for interference studies in the FM bands.

Variable Inductance

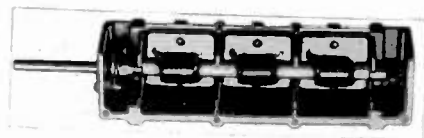

A new patented unit providing infinitely variable-inductance tuning for all television, frequency modulation, and other stations from 44 to 216 megacycles within the range of the receiver, has been announced by P. R. Mallory & Co., Inc., 3029 E. Washington St., Indianapolis 6, Ind. This entire band is covered in 3600° rotation (10 turns) of the shaft, which may be rotated by hand or motor driven. It is stated that a conventional receiver input system employing this "inductuner" requires but a few adjustments for proper alignment in production.

(Continued on page 46A)

PROCEEDINGS OF THE I.R.E. April, 1947



A-C CAPACITORS



Line Capacitors & Fluorescent Lamps

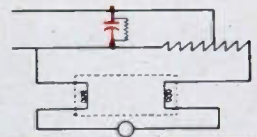

Low Starting Torque Motors

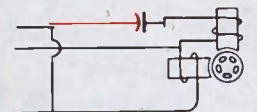

High Power Factor Luminous Tube Transformers

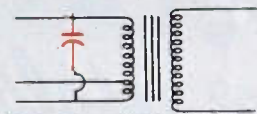

High Starting Torque Motors

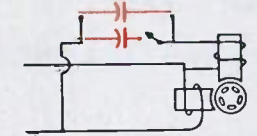

THEIR STRENGTH

— ADDS "STAYING POWER"

TO YOUR PRODUCTS

Capacitors needn't be the weak link in your product—they can have just as much "staying power" as any other component in your equipment.

G-E capacitors have long life. One reason for this is that they are Pyranol* impregnated. Practically all moisture, air, and gas have been withdrawn from the capacitor before the Pyranol treatment takes place. The use of Pyranol also means that these capacitors can operate at high temperatures—up to 75 C (167 F) case temperature. This eliminates one of the main causes of capacitor breakdown.

Casings, available in all standard shapes, are double-rolled, or roll-crimped and soldered, sealing the capacitor hermetically. Plastic bushings, of high dielectric strength, bring out the hot-tin dipped soldered terminals.

If you are building a quality product, here's a quality a-c capacitor that you'll never have to worry about. They're available in a broad range of voltage ratings and capacities. Write for the latest Bulletin GEA-2027C. Apparatus Dept., General Electric, Schenectady 5, N. Y.

*Reg. U. S. Pat. Off.

Why Manufacturers Like G-E Capacitors

1. Their price is right.
2. You can get fast shipments.
3. The range of ratings is broad.
4. Designed for small size and light weight in all ratings.
5. Their quality is unexcelled.

GENERAL ELECTRIC

407-111-6700

Another New

WELL-DESIGNED

WELL-BUILT

WELL-PERFORMING

TRUSCON RADIO TOWER

● More and more the landscape is becoming dotted with Truscon Radio Towers serving the AM and FM needs of the broadcasting industry.

One of the newest is WBNY, Buffalo, N. Y.,— a Truscon Self-Supporting Radio Tower with FM antenna. Height of tower is 358 feet . . . height of FM antenna is 62 feet . . . total overall height is 420 feet.

Truscon can engineer any type of tower you desire . . . guyed or self-supporting, either tapered or uniform cross-section . . . tall or small . . . AM or FM. Truscon engineering consultation is yours without obligation. Write or phone our home office at Youngstown, Ohio, or any of our numerous and conveniently located district sales offices.

● Close-up view of WBNY Truscon Radio Tower showing construction detail.

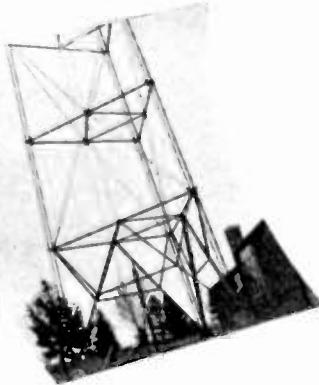
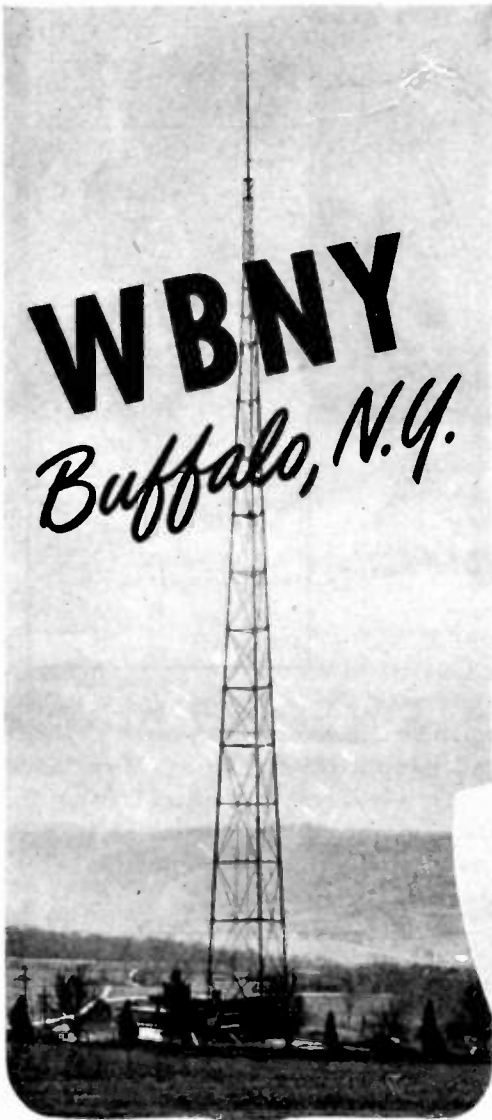

TRUSCON STEEL COMPANY
YOUNGSTOWN 1, OHIO
Subsidiary of Republic Steel Corporation

Manufacturers of a Complete Line of
Self-Supporting Radio Towers . . .
Uniform Cross-Section Guyed Radio
Towers . . . Copper Mesh Ground
Screen . . . Steel Building Products.

News—New Products

These manufacturers have invited PROCEEDINGS readers to write for literature and further technical information. Please mention your I.R.E. affiliation.

(Continued from page 44A)

Vacuum Capacitor

A new vacuum capacitor, Type VC-50, rated at 30,000 volts maximum peak voltage and having a capacitance of 50 micro-microfarads $\pm 2\%$, has been announced by **Amperex Electronic Corporation**, 25 Washington St., Brooklyn, N. Y. Maximum root-mean-square current ratings of 65 amperes at 10 megacycles, and 40 amperes at 60 megacycles are based on a maximum-glass-to-metal seal temperature of 150°C. Internal losses are largely ohmic and decrease as the frequency decreases.

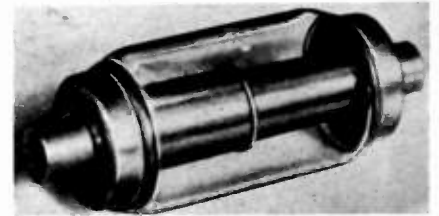

Voltage, which increases as the frequency decreases, reaches the maximum allowable peak voltage rating of 30 kilovolts at 10 megacycles. The condenser may be used at lower frequencies provided the peak voltage rating is observed. Maximum over-all dimensions of the condenser are: length—6.6 inches, diameter—2.5 inches.

New Oscilloscope



A new cathode ray oscilloscope featuring portability and low cost has been announced by **Sylvania Electric Products, Inc.**, 500 Fifth Ave., New York 18, N. Y. This new unit, Type 131 weighing only 18 pounds, has a single frequency range from 15 to 40,000 cycles and is provided with a five-range selection control and a fine-frequency adjustment. Visual study of wave form is provided by a 3" cathode ray tube designed for 650-volt deflection-plate operation.

(Continued on page 48A)

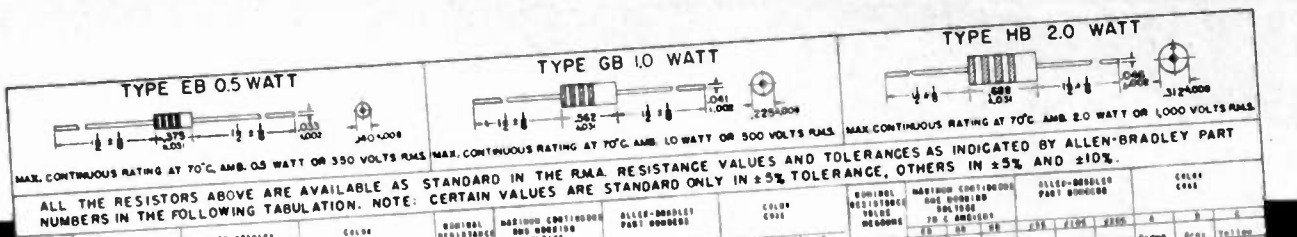

MAX. CONTINUOUS RATING AT 70°C. AMB. 0.5 WATT OR 350 VOLTS RMS. MAX. CONTINUOUS RATING AT 70°C. AMB. 1.0 WATT OR 500 VOLTS RMS. MAX. CONTINUOUS RATING AT 70°C. AMB. 2.0 WATT OR 1000 VOLTS RMS.

ALL THE RESISTORS ABOVE ARE AVAILABLE AS STANDARD IN THE RMA RESISTANCE VALUES AND TOLERANCES AS INDICATED BY ALLEN-BRADLEY PART NUMBERS IN THE FOLLOWING TABULATION. NOTE: CERTAIN VALUES ARE STANDARD ONLY IN ±5% TOLERANCE, OTHERS IN ±1% AND ±10%.

RMA VALUE	RMA TOL.	ALLEN-BRADLEY PART NUMBERS			RMA VALUE	RMA TOL.	ALLEN-BRADLEY PART NUMBERS			RMA VALUE	RMA TOL.	ALLEN-BRADLEY PART NUMBERS		
		EB	GB	HB			EB	GB	HB			EB	GB	HB
10	±1%	1000	1000	1000	100	±1%	1000	1000	1000	10	±1%	1000	1000	1000

FIGURE	COLOR	COLOR CODE
0	BLACK	
1	BROWN	
2	RED	
3	ORANGE	
4	YELLOW	
5	GREEN	
6	BLUE	
7	VIOLET	
8	GRAY	
9	WHITE	
TOL.	COLOR	
±5%	GOLD	
±10%	SILVER	
±20%	NONE	

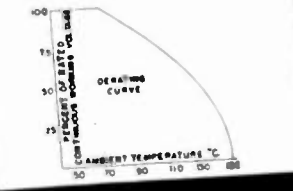
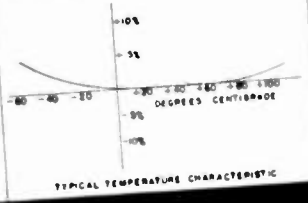

**ALLEN-BRADLEY
SOLID MOLDED
FIXED
RESISTORS**

Here's a Handy Reference Chart for selecting your fixed resistors

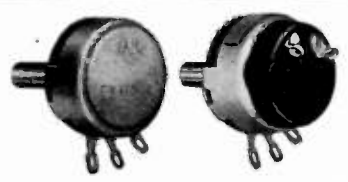

TYPE J BRADLEYOMETERS
Continuously Adjustable Resistors
with 2 watt rating and high
safety factor

The resistor material is molded with insulation, terminals, face plate, and bushing into a one-piece unit. It is not a film or paint type resistor. During manufacture, the resistor material is varied throughout its length to provide the desired resistance-rotation curve. Once molded, the curve does not change. Heat, cold, or moisture cannot affect the dependability of the Type J Bradleyometer.



This Bradleyunit resistor chart is a valuable source of resistor information. It lists over 450 resistors, in accordance with RMA standards, part numbers for various tolerances, voltage, and wattage ratings. Temperature characteristics and derating curves are also included, as well as dimension diagrams for the ½ watt, 1 watt, and 2 watt Bradleyunits. We shall be glad to send you a copy to fit your 8½x11 ring binder.

Bradleyunits will sustain an overload of ten times rating for several minutes without failing. Wax impregnation is unnecessary to pass salt water immersion tests. The leads, tempered near the resistor to prevent sharp bends, are easily soldered. The honeycomb shipping cartons keep the leads straight and speed up assembly operations.

Allen-Bradley Co.,
114 W. Greenfield Ave., Milwaukee 4, Wis.



ALLEN-BRADLEY FIXED & ADJUSTABLE RADIO RESISTORS

QUALITY

The New NOBATRON™

stabilized dc low voltages
at high currents WITHOUT BATTERIES

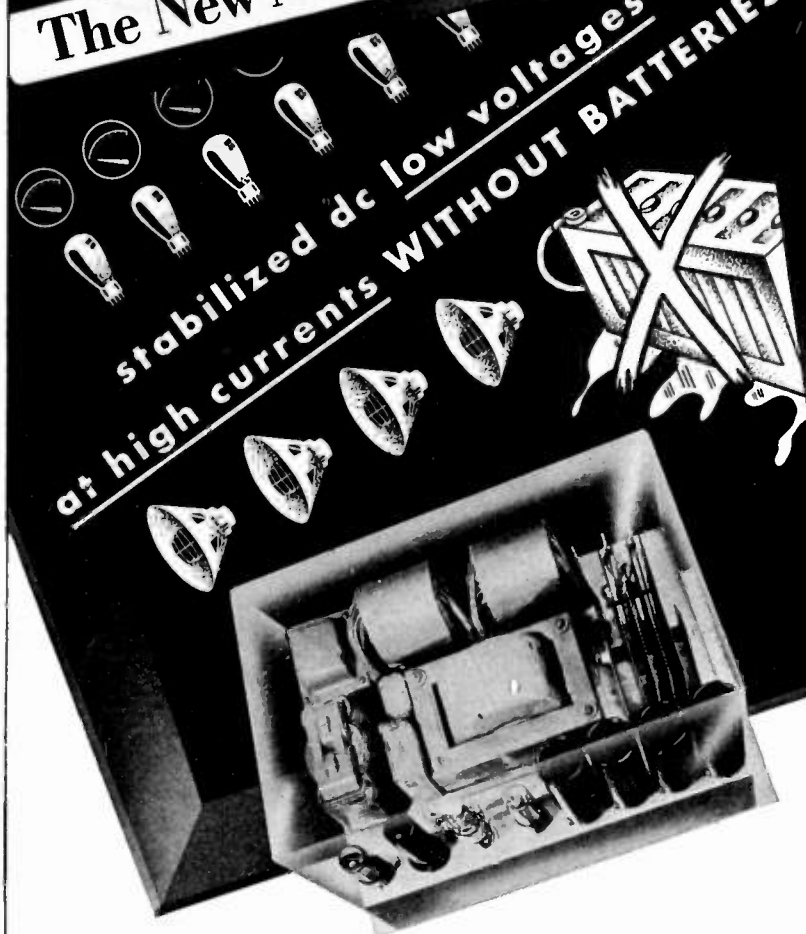

- The Sorensen NOBATRON provides a new source of DC voltages regulated at currents previously available only with batteries.
- Six standard NOBATRON models operate on a 95-125 volt AC source of 50 to 60 cycles and provide currents of 5, 10, and 15 amperes at output voltages of 6, 12, or 28.
- Ideally suited for critical applications where constant DC voltages and high currents are required, the NOBATRON maintains a regulation accuracy of $\frac{1}{2}$ of 1%, RMS of 1% and has a recovery time of $\frac{1}{5}$ of a second.

● Investigate the many advantages of Sorensen regulators applied to your unit. Write today for your copy of the new complete Sorensen catalog, S-P. It is filled with schematic drawings, performance curves, photos, and contains in detail, "Principles of Operations."



SORENSEN & COMPANY, INC.
STAMFORD, CONNECTICUT

A LINE OF STANDARD REGULATORS FOR LOAD RANGES UP TO 30 KVA.
SPECIAL UNITS DESIGNED TO FIT YOUR UNUSUAL APPLICATIONS.

News—New Products

These manufacturers have invited PROCEEDINGS readers to write for literature and further technical information. Please mention your I.R.E. affiliation.

(Continued from page 46A)

Tube Life Tester

A new grid-pulse life-test unit has recently been designed by Chatham Electronics, 475 Washington St., Newark 2, N. J., which is suitable for life testing receiver-type tubes under pulsed operating conditions. This apparatus consists basically of four units; a control panel, power unit, pulse modulator, and tube test rack.

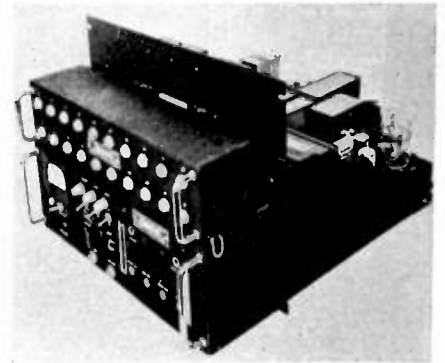

The power unit is designed to provide all potentials normally required for receiver-type-tube testing. The modulator has been designed to deliver a positive pulse, adjustable from 50 to 350 volts, at rates of from 500 to 2500 times per second, at from 1 to 25 micro-seconds duration.

The tube rack plugs into the unit directly over the control panel and provides ample space for mounting ten tubes. Twenty connectors are mounted on the front of this rack to allow individual monitoring of the grid and plate current of the tubes under test. Suitable connections are provided for monitoring the modulator pulse amplitude and repetition rate.

Dipole Antenna

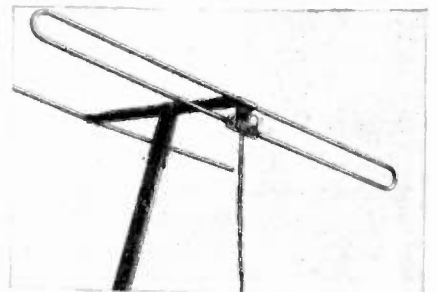

A readily assembled dipole antenna utilizing aluminum tubing for the dipoles, bakelite for the spreaders, and steel tubing for the supporting members, is being manufactured by the Technical Appliance Corp., 41-06 De Long St., Flushing, L. I., N. Y. The downlead is a ribbon transmission line comprising two stranded conductors insulated by a wide band of polystyrene assuring relatively low loss.

(Continued on page 52A)

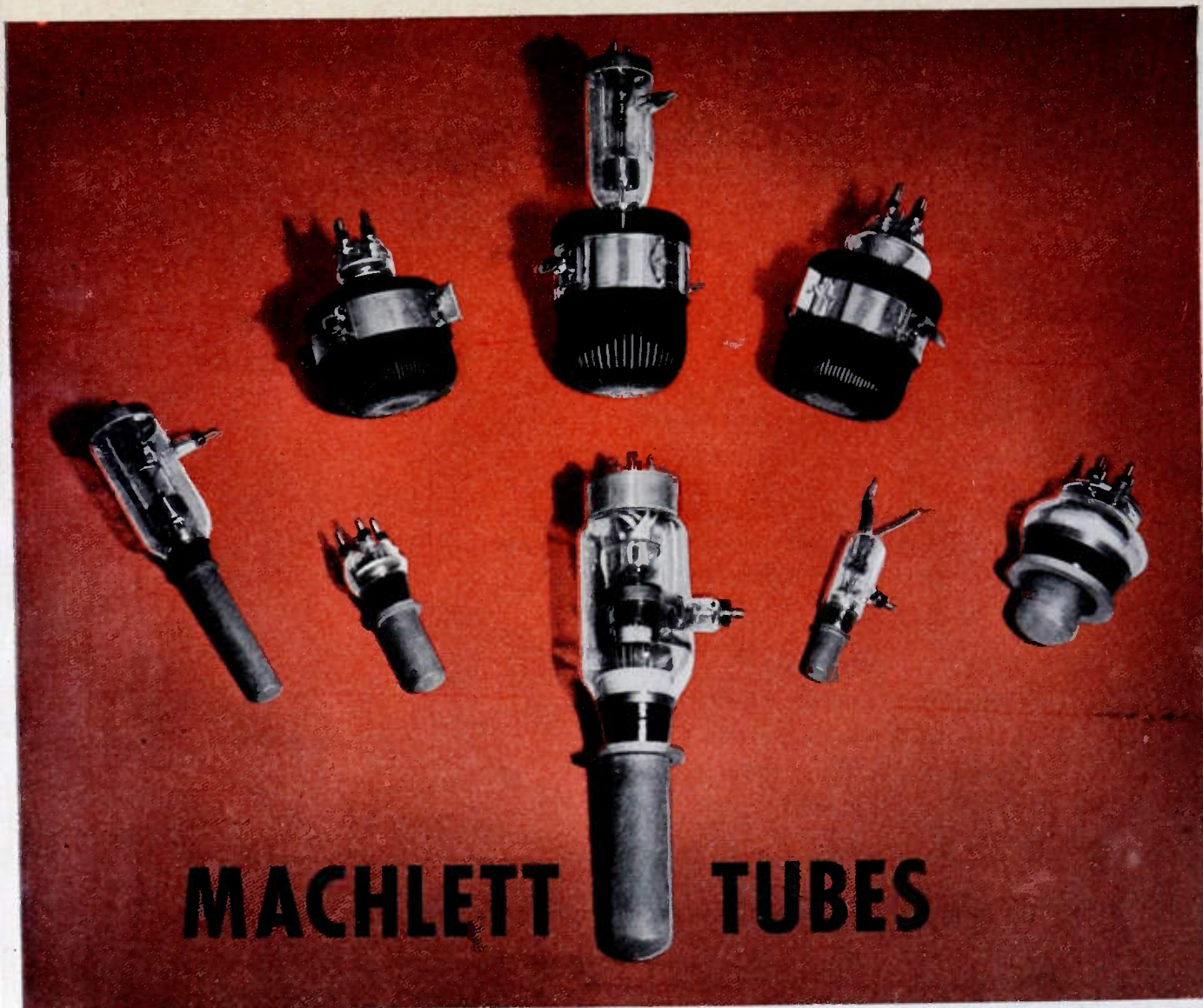

DESIGNED AND PROCESSED FOR LONG LIFE IN R-F HEATING EQUIPMENT

EVER since the first external anode tubes were made, the primary considerations in design, construction and processing were those directed to meeting the requirements of broadcast and communication applications. In those early years, there was little need—and later, little opportunity—to adequately provide for the special and more rigorous requirements of industrial service.

Machlett Laboratories, specialist for half a century in servicing the special electron tube needs of the equipment manufacturer, has long recognized the

necessity for special construction and processing of tubes for industrial use and has been guided by this in every step in the design and manufacture of its water and forced-air cooled tubes for induction and dielectric heating applications. For this reason, Machlett external anode tubes are more rugged, more completely outgassed and have inherently more factors of safety to cope with unusual operating conditions. For longer life and better performance use Machlett electron tubes because they are especially built to fill your needs.

The complete story of what Machlett Laboratories have done and are doing to furnish better tubes to industrial equipment manufacturers and users will be sent upon request. Machlett Laboratories, Inc., Springdale, Conn.

MACHLETT

APPLIES TO RADIO AND INDUSTRIAL USES
ITS **50** YEARS OF ELECTRON TUBE EXPERIENCE



A number of attractive positions are open to qualified development and design engineers in many product lines of which a few are:

- Theater Sound and Projection Equipment
- | | |
|---|--------------------------------|
| Broadcast Transmitters | Industrial Electronics |
| Scientific Instruments | Television Transmitters |
| Communication Equipment | Commercial Sound Equipment |
| Test and Measuring Equipment | Government Radiation Equipment |
| Aviation Communication and Navigation Equipment | |

Write to
National Recruiting Office
RCA Victor Division
Camden New Jersey



The following positions of interest to I.R.E. members have been reported as open. Apply in writing, addressing reply to company mentioned or to Box No. . . .

The Institute reserves the right to refuse any announcement without giving a reason for the refusal.

PROCEEDINGS of the I.R.E.
 1 East 79th St., New York 21, N.Y.

FM ENGINEER

FM Engineer with College degree, with or without some pre-war experience in FM who can head up FM development group and be responsible for their work. Box 463.

Engineers

Communication—Mechanical—Sales
CHIEF MECHANICAL ENGINEER
 —Thorough knowledge of small metal parts design, preferably on radio components. To be in charge of all mechanical design. Splendid opportunity, permanent position for an aggressive and responsible engineer.

COMMUNICATIONS ENGINEERS
 —Well versed in mathematics and all phases of R.F. circuits for development projects. Experience in VHF Microwave technique desirable. Applicants must possess initiative and be able to think analytically.

SALES ENGINEER—For factory sales office. Must be familiar with broadcast transmitter and industrial electronic circuits and components. B.S. degree and "Ham" license not mandatory but desirable. Little traveling.

Interesting and varied work in a clean factory.
 For more information regarding the above write to:

Mr. Lloyd W. Olander
 Chief Engineer
 E. F. Johnson Company
 Waseca, Minnesota

PHYSICISTS

Arsenal has positions open for physicists in Civil Service. Salaries from \$2644 to \$5905, per annum. Apply to: Frankfort Arsenal Philadelphia 37, Pa.

ENGINEERS

The Naval Air Material Center has urgent need for engineers qualified under U. S. Civil Service Commission standards in the fields of radio and radar. Regular work consists of five eight hour days. Employees accrue vacation and sick leave. Permanent employees are also eligible for Civil Service Retirement. Salaries range from \$2644.80 to \$8179. Write to Naval Air Material Center, Industrial Relations Department, Bldg. 75, U. S. Naval Base Station, Philadelphia 12, Pa. for particulars concerning the filing of applications, types of positions and appointments.

DEVELOPMENT ENGINEERS

Guided Missiles

An experienced development and research engineer is needed to head new
(Continued on page 52A)

Engineers

Broadcast Radio receiver Project Engineers, Television receiver Project Engineers and Mechanical Engineers experienced in broadcast receiver engineering methods. Excellent opportunity for advancement in a growing engineering department.

Reply giving full details to

Personnel Manager
BENDIX RADIO
 Division of Bendix
 Aviation Corporation
 Baltimore 4, Maryland

**WANTED
 PHYSICISTS
 ENGINEERS**

Engineering laboratory of precision instrument manufacturer has interesting opportunities for graduate engineers with research, design and/or development experience on radio communications systems, electronic & mechanical aeronautical navigation instruments and ultra-high frequency & microwave technique.

WRITE FULL DETAILS
 TO
EMPLOYMENT SECTION
SPERRY
GYROSCOPE
COMPANY, INC.

Marcus Ave. & Lakeville Rd.
 Lake Success, L.I.

USE STANDARD PARTS — SAVE TIME AND MONEY



K-TRANS

will duplicate the performance of any I. F. Transformer you are using and

COST LESS

Both to buy and to handle in your lines

AUTOMATIC MICA TRIMMERS

are the standard trimmers of the industry



MASS PRODUCTION COILS & MICA TRIMMER CONDENSERS

900 PASSAIC AVE.

EAST NEWARK, N. J.

ELECTRONIC ENGINEERS

Seniors and Juniors

Wanted by

The Federal Telephone & Radio Corp.

well versed in all phases of transmitter design; only Graduate Engineers with either engineering degree or equivalent training in this type of work will be considered.

Good Salary—Steady Positions

Excellent opportunities for advancement. Give complete background, experience, education & employment history. Address letter to Personnel Manager.

FEDERAL TELEPHONE & RADIO CORP.
NEWARK 1, N. J.



first in facsimile
for broadcasting and point-to-point communication!

FINCH TELECOMMUNICATIONS

INCORPORATED

SALES OFFICE:

10 EAST 40th STREET, NEW YORK

FACTORIES: PASSAIC, N. J.



(Continued from page 50A)

development group in Electronics Department. Design and development of radar and electronics controls, servomechanisms, and special devices for pilotless aircraft. Broad experience and Doctor's degree or equivalent required.

Positions also open for graduate engineers and physicists with electronic and mathematical-physics backgrounds.

Salaries \$5,000-\$8,000, commensurate with ability. Call or write F. Melograno, Pilotless Plane Division, Fairchild Engine and Airplane Corporation, Farmingdale, Long Island, New York.

RADIO ENGINEER

Experience in design of microwave components required by Research Department of Galvin Manufacturing Corporation, 4545 W. Augusta Boulevard, Chicago, Illinois. Write attention of D. E. Noble.

ENGINEERS AND TECHNICIANS

Engineers and Technicians familiar with the operation of the SCR-584 radar. Unusual opportunity. Salary commensurate with education and experience. California location. Box 457.

ELECTRICAL ENGINEERS WITH TEACHING BACKGROUND

A Prominent Manhattan Educational Institution is now preparing a series of courses which are on a post high school level, and will have immediate need for instructors with the following background: Electrical engineering degree or better, teaching experience with several years of practical experience. Applicants should be able to teach various courses in electronics on an engineering level. Box 458.

PHYSICISTS AND ENGINEERS

Wanted by field service laboratory several physicists and engineers, experienced in the fields of Wave Propagation, Astrophysics, and Electronics Engineering. Salaries range from \$3400 to \$5900. The Laboratory is located on the Chesapeake Bay in Maryland. Write fully indicating interest and giving experience and salary requirements. Box 460.

TELEVISION DESIGN ENGINEER

A graduate Electrical Engineer, whose experience has been mainly in the development and engineering field of Television Transmitters and associate equipment. Write giving full details. Box 461.

RADIO ENGINEER

Western educational institution has opening for experienced engineer (graduate) thoroughly familiar with all phases of radio-electronics. Capacity to assume responsibility with minimum supervision. Top salary for high calibre man. Submit complete personal history. Replies held confidential. Box 462.

SERVICE ENGINEERS

Men who would like to utilize their spare time repairing tower music systems, sound distribution systems and sound reinforcement systems within your state border. Traveling expenses and service charges paid by us. Write to: Schulme-

(Continued on page 54A)

News—New Products

These manufacturers have invited PROCEEDINGS readers to write for literature and further technical information. Please mention your I.R.E. affiliation.

(Continued from page 48A)

Vacuum Tube Test Set

A vacuum-tube bridge-characteristic test set designed to reduce operator fatigue, and eliminate personal errors frequently resulting from circuit arrangement, has been announced by **Sylvania Electric Products Inc.**, 500 Fifth Avenue, New York 18, N. Y. The console unit includes bridge and auxiliary switch gear mounted on the control shelf; electronically-regulated power channels; bridge signal source; amplifier; meters; and other accessories to measure mutual conductance, plate resistance, amplification factor, and all static characteristics.

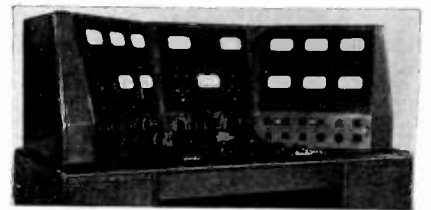

All meters except those for gas and heater cathode current, are located on sloping panels. All current meters have circuit jacks for external calibration. Operating from a 1500-watt, 220 volt, three-phase source, the unit will provide all necessary alternating and direct current voltages and currents. A reverse-polarity switch is provided for heater supply which can also be used as a second auxiliary.

Frequency Meter

A direct reading frequency meter, Type 838, designed to measure frequencies in the audio and supersonic spectrum, has been announced by **The Daven Company**, 191 Central Ave., Newark 4, N. J. Seven overlapping ranges are available for frequency determination between 20 to 100,000 cycles per second.



The indication is substantially independent of variations in input voltage between 0.5 and 150 volts root-mean-square, and the manufacturer states that the accuracy on all ranges is $\pm 2\%$ of the top frequency on the range in use. Where a continuous graphic frequency record is required, a jack has been provided for connection to an external recording milliammeter. The unit is designed for standard rack mounting or can be supplied in a case for bench use.

(Continued on page 62A)

NOW! a new standard of performance in cutting heads

THE PRESTO 1-D

▶ The new Presto 1-D Cutting Head offers: *wide range, low distortion, high sensitivity and stability through a temperature range of 60°-95° F.* The Presto 1-D Cutting Head is a precision instrument made entirely of precisely machined parts, expertly assembled and carefully calibrated. These factors, plus its sound basic engineering design, produce a cutter unequalled in performance by any other mechanically damped magnetic device.

▶ Note from the light pattern below: The correct location of the cross-over point at 500 cycles, the 6 db per octave slope below this point, and flat response above 500 cycles, which is free from resonant peaks. The range of the cutter is 50-10,000 cycles. The Presto 1-D is damped with "Prestoflex" which is impervious to temperature changes between 60 and 95 degrees Fahrenheit.

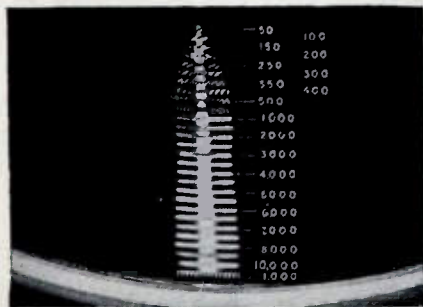

Unretouched photograph showing the light pattern. Notice correct location of the cross-over point at 500 cycles.

PRESTO

RECORDING CORPORATION
242 WEST 55TH STREET, NEW YORK 19, N. Y.
Walter P. Downs, Ltd., In Canada

Outstanding developments produced by pioneer and leader in this field

Brush Plated Wire

- ✓ Constant plating thickness assures uniform signal
- ✓ Correct balance of magnetic properties assures good frequency response and high level
- ✓ Excellent surface finish assures low noise and minimum wear
- ✓ Corrosion resistant
- ✓ Easy to handle—ductile—can be knotted

Brush Paper Tape

- ✓ Easy to Handle
- ✓ Extremely low-cost
- ✓ Can be edited . . . spliced
- ✓ Greater dynamic range
- ✓ Minimum wear on heads
- ✓ Excellent high frequency reproduction at slow speed
- ✓ Permanent—excellent reproduction for several thousand play-backs

**New Brush Magnetic
Recording tape and wire offer
LOWER COST . . . UNIFORMITY
. . . EXCELLENT FIDELITY**

Vastly improved tape and wire recording heads and cartridges

Another important improvement made by Brush has been the development of very simply constructed, low-cost erasing, recording and reproducing heads. Of principal interest are their excellent electrical characteristics, extreme simplicity of design to avoid trouble, and the "hum-bucking" characteristics which reduce the effect of extraneous magnetic fields. When required, the head cartridge alone (pole piece and coil unit) may be supplied for incorporation into manufacturers' own head structure.

These latest developments in magnetic recording equipment can now be obtained for radio combinations and other uses. Brush engineers are ready to assist you in your particular use of magnetic recording components.



The new
Brush wire
recording head

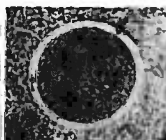

Cross section
of Brush
plated wire



Hysteresis
loop of Brush
plated wire



The new
Brush tape
recording head

THE BRUSH DEVELOPMENT CO. 3405 Perkins Ave.
Cleveland 14, Ohio

Write today for further information



(Continued from page 52A)

rich Electronics, Inc., Sellersville, Pennsylvania, Attention: H. B. Smith.

PRODUCTION ENGINEER

Experienced in glass machinery products and technique. Also fluorescent chemicals and coating application to glass. Excellent opportunity. Write, giving full details in first letter. Box 453.

PATENTS

Patent Department of large industrial corporation requires experienced patent attorneys or agents. At least one with electronic background, for expanding research effort. Minimum supervision. Office in New York suburb, Southwest Connecticut. Box 455.

SENIOR ENGINEERS

Several capable men needed for:

1. Advanced electronic circuit and systems development.
2. Servo-mechanisms, hydraulic, pneumatic, electric.
3. Gyromechanisms and other instrumentation.
4. Microwave techniques, plumbing, antennas, radomes, etc.
5. Magnetic circuit design (good all round electrical background).
6. General mechanical component design, airborne radar.

Qualifications: Several years commercial experience in one or more of above, good educational background.

Positions Offer: Permanence, top salaries, and opportunities for increased responsibility for men who can produce.

Work: Large guided missile program. All phases—study, research, development, product design for production.

Organization: Progressive, stable, under engineering management.

Applications: Handled, of course, in confidence. Give enough information in your first letter to warrant interview. Apply to Personnel Department, Raytheon Manufacturing Company, Foundry Avenue, Waltham 54, Mass.

ELECTRICAL AND ELECTRONIC ENGINEERS

You are invited to investigate opportunities in electronics and electrical engineering at this laboratory. We are organized as a department in a large college located in a Middle Atlantic state, and are engaged in research and development. Members of our research staff are appointed with academic rank. Some are teaching, although this is not a condition of employment. Box 449.

TELEVISION ENGINEER

Wanted by well-known manufacturer of television radio receivers. To be service manager for New York area. Write fully, giving experience and salary requirements. Box 450.

MATHEMATICIAN

With knowledge of electrical and mechanical means of solving equations, to work on computer development with New York City concern. Additional knowledge of Servo systems desirable. Box 452.

(Continued on page 56A)

NOW AVAILABLE!

Centralab's medium-duty power switches for special industrial and electronic uses!

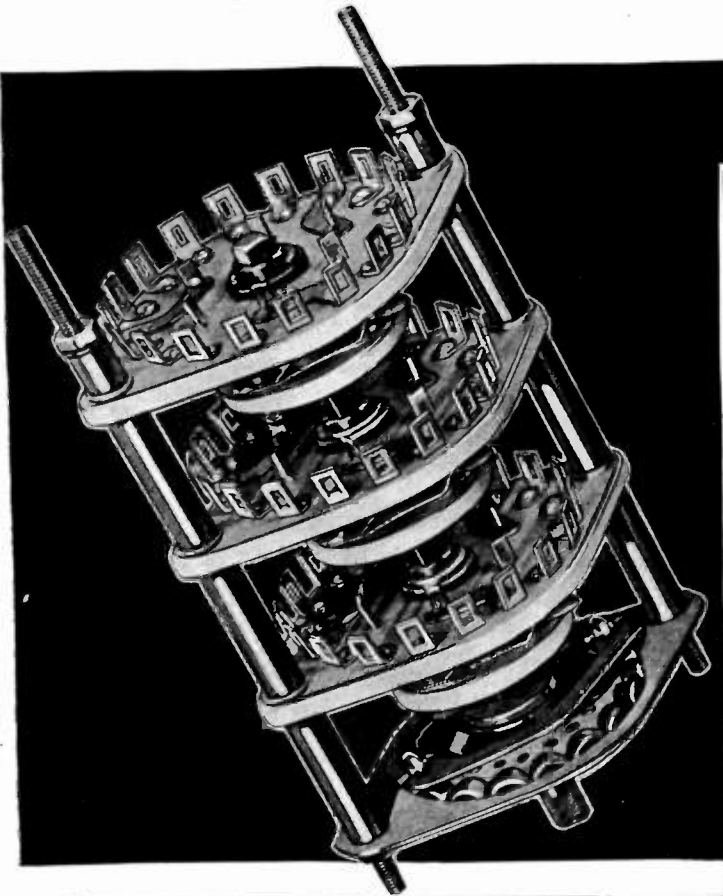

Efficient performance up to 20 megacycles — specially designed for transmitters, power supply converters, X-ray equipment etc.

HERE THEY ARE — Centralab's famous medium-duty power switches — now ready for a broad new range of industrial and electronic uses!

Look at some of the exclusive features which these sturdy switches offer you: 1) for accurate positioning, square operating shaft snugly fits staked sleeve in steatite rotors. 2) for peak performance, solid silver contacts are individually aligned and adjusted. 3) for flexibility, units can be assembled with shorting or non-shorting contacts. Switching combinations are 1 pole, 17 positions—and 3 poles, 5 positions per section. 20° double roller indexing.

Tests prove that these power switches have a minimum life operation of 25,000 cycles without failure. Switches have single hole bushing mounting, and tie rod extensions at front and rear serve as locating keys and added mounting support. Furnished with cadmium plated, steel and brass parts. Units in non-corrosive metals also available.

RATINGS: 7½ amperes at 60 cycles, 115 volts A.C. Minimum voltage breakdown between critical points is 3,000 volts RMS, 60 cycles. See how these fine Centralab switches can fit your industrial and electronic needs. Write today for Centralab's complete switch bulletin number 722!

Positive Action — Solid Silver Contacts

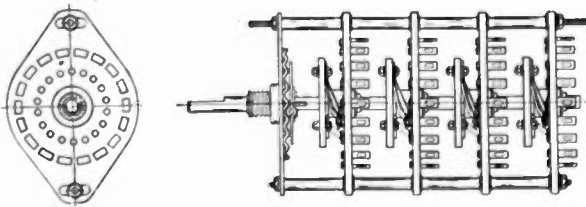

Ceramic Trimmers
Bulletin 630



Ceramics
Bulletin 720



Variable Resistors
Bulletin 697

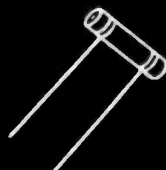

Ceramic Capacitors
Bulletin 630



Selector Switches
Bulletin 722

Centralab
Division of GLOBE-UNION INC., Milwaukee

BRACH

ESTABLISHED 1906



ANTENNA SYSTEMS

for **USERS**

of **PRIVATE BRANDS**



We manufacture the following, under private labels and trademarks:

AUTOMOBILE ANTENNAS . . . every variety, including types that can be raised and lowered from inside the car.

RESIDENTIAL ANTENNAS . . . AM and FM, for homes, stores and multi-family buildings. Complete lines of noise-reducing systems incorporating latest patented developments of coupling transformers.

FM, AM and TELEVISION . . . Dipoles with or without reflectors, folded dipoles, turnstile, radiating types and other combinations for roof, sidewall and other mountings.

MARINE ANTENNAS . . . Collapsible and transmitting types for every purpose.

For **POLICE** and other mobile units . . . roof-top antennas for ultra-high frequencies.

WE INVITE INQUIRIES AND CONSULTATIONS.

L. S. BRACH MFG. CORP.

200 CENTRAL AVENUE NEWARK, 4 N. J.



WORLD'S OLDEST AND LARGEST MANUFACTURERS OF RADIO ANTENNAS AND ACCESSORIES

LABORATORY TEST EQUIPMENT

by **FREED**

Send for
Descriptive
Literature

No. 1030 Direct Reading Low Frequency "Q" Indicator "Q" .5 to 500 Frequencies from 50-50,000 Cycles

No. 1020 Direct Reading Megohmmeter up to 1,000,000 megohms. Self Contained A.C. Operated

No. 1050 60 Cycle Filter

No. 1010 Comparison and Limit Bridge. Self Contained. A.C. Operated

No. 1040 Wide Range Vacuum Tube Voltmeter

FREED TRANSFORMER COMPANY, INC., 72-78 Spring Street, N.Y.C.

POSITIONS OPEN

(Continued from page 54A)

DEVELOPMENT ENGINEERS

Brooklyn engineering and manufacturing company, established in naval fire control and precision instrument work, requires qualified engineers for servomechanism and related development program. Positions require mature, responsible engineers with analytic as well as laboratory background, and 5 years' experience in fundamental development work. Facility in applied mathematics and advanced circuit development requisite. Starting salary commensurate with experience, and subsequent rewards commensurate with accomplishment. Box 456.

RADIO ENGINEER

Graduate radio engineer for research and development work on high frequency antennas and transmission line. Firm is a progressive subsidiary corporation of one of the nation's largest radio manufacturers, and is located in the Middle West. Salary to be commensurate with qualifications of accepted person. Box 454.

RECEIVER MECHANICAL DESIGN ENGINEER

Well known eastern manufacturer of broadcast and television receivers will employ one thoroughly experienced and highly competent man to head up their mechanical design staff. Only those who are easily qualified for above will be considered. This position will be filled without delay so your application must be received promptly. It will be held in confidence. Box 464.

★ ★ ★ ★



Positions Wanted By Armed Forces Veterans

In order to give a reasonably equal opportunity to all applicants, and to avoid overcrowding of the corresponding column, the following rules have been adopted:

The Institute publishes free of charge notices of positions wanted by I.R.E. members who are now in the Service or have received an honorable discharge within a period of one year. Such notices should not have more than five lines. They may be inserted only after a lapse of one month or more following a previous insertion, and the maximum number of insertions is three per year. The Institute necessarily reserves the right to decline any announcement without assignment of reason.

ELECTRONICS ENGINEER

B.S.E.E., Iowa State. M.S.E.E. Purdue. Columbia, Bowdoin and M.I.T. trained Naval Electronics Officer. Two years part time commercial broadcasting. Two years Naval radar radio afloat. One year electronic research. Phi Beta Kappa. Theta Kappa Nu. Box 81 W.

(Continued on page 58A)

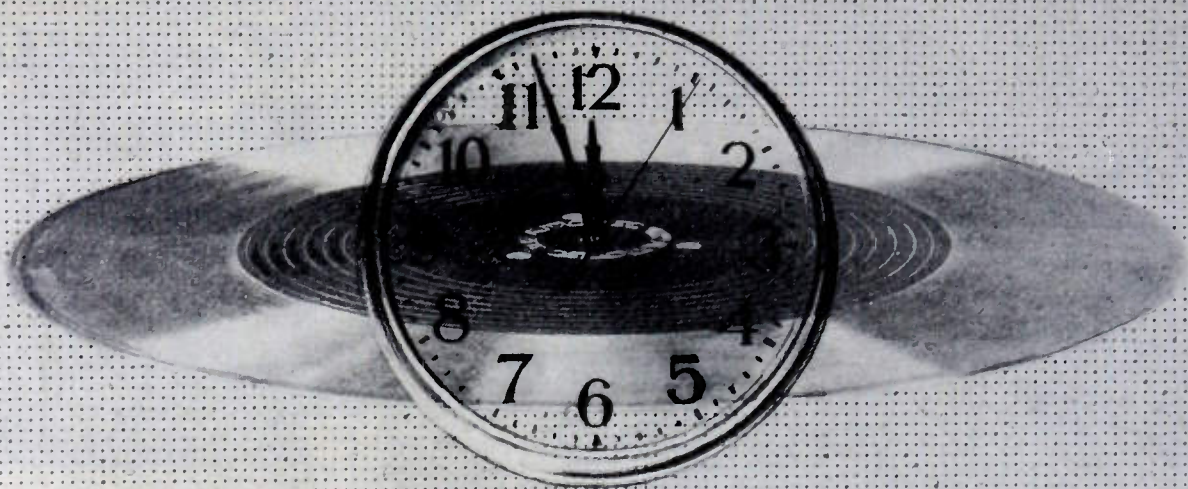

ON THE AIR

... with **audiodiscs**

The clock on the studio wall and the important warning signal below it are two ever-present reminders on which radio broadcasting depends.

Today, approximately half the time this warning signal appears in the broadcasting stations throughout the country, the studio clock is measuring the time of transcribed programs. This large proportion of broadcast time devoted to recorded programs is a significant tribute to the advancement in the quality of sound

recording and reproduction.

In this spectacular trend of broadcasting, AUDIO-DISCS have played a basic role. These recording discs are the ones most extensively used for instantaneous recording, for the original sound recording in making pressings and for the Master discs used in the electroplating process.

If it's worth recording—it's worthy of an AUDIO-DISC. See your local AUDIODISC distributor or write:

AUDIO DEVICES, INC., 444 Madison Avenue, New York 22, N.Y.

Export Department: Rocke International Corp., 13 E. 40th Street, New York 16, N.Y.

Audi discs are manufactured in the U. S. A. under exclusive license from PYRAL, S. A. R. L., Paris.

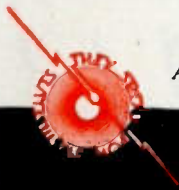

they speak for themselves **audiodiscs**

READY
for immediate delivery

Langevin

Broadcast Audio Facilities

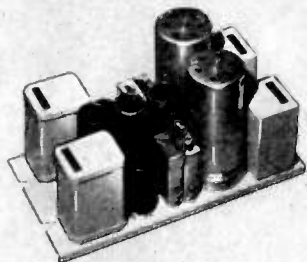

...featuring the Langevin Type 111-A, Dual Preliminary Amplifier; gain 47 DB; output level +16 DBM; input impedance 30/250/600 ohms; output impedance 600 ohms. This amplifier can be used also as a booster . . .

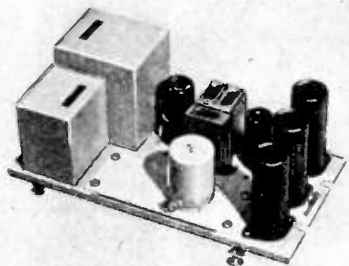

...in addition, the Langevin Type 102-A Program Amplifier is available from stock; gain 55 DB; output level +28 DBM; input impedance 30/250/600 ohms; output impedance 600 ohms. This unit has provisions for decreasing the gain to 45 or 35 DB . . .

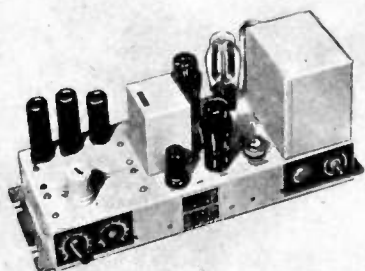

...in order to provide for the broadcaster's monitoring facilities, Langevin is ready to ship the Type 108-A Amplifier; gain 43 or 63 DB; output level +43 DBM (20 watts); input impedance 600/25,000 ohms; output impedance 8/500 ohms . . .

...also available for immediate shipment are the Langevin Type 201-B Rectifier and Type 114-A AC, DC Monitor Amplifier, a 4 watt unit.

THE Langevin CO.

INCORPORATED

SOUND REINFORCEMENT and REPRODUCTION ENGINEERING

NEW YORK, 37 W. 65 ST., 23
SAN FRANCISCO LOS ANGELES

Positions Wanted

(Continued from page 56A)

JUNIOR ENGINEER

B.E.E., Cornell University, 1946. Age 21. Single. Desires position in radio, television or electronics. Prefer Detroit area Box 83 W.

ENGINEER—FOREIGN SERVICE

B.S. Harvard University. Captain in the U. S. Army Signal Corps as a radar officer; hold both 2nd Class Radiotelegraph and 1st Class Radiotelephone operators licenses, as well as Class "A" amateur; 26 years old; speaks Spanish and French fluently besides a little German and Chinese; VERY willing to work in foreign country, especially South America. Box 84 W.

SALES ENGINEER

M.S. in E.E., Boston College, 1940. B.S., Boston College, 1938. Age 30. Two years teacher, public schools, college physics. Fellowship, Boston College. Desires position in technical sales or application engineering field. Has had experience as research physicist, production engineer, assistant sales engineer. Prefers New England location. Box 85 W.

ENGINEER

B.E.E., Rensselaer, Army officer, Harvard and M.I.T. training, teaching electronics at night, college level, 3 years experience with LORAN, Countermeasures equipment, and servos, 1 year experience in the coke industry. Desires association with the electronic industry in Boston, Mass. Box 86 W.

JUNIOR ENGINEER

Completing Junior Engineering, two non-electrical courses for B.E.E. degree N.Y.U. Desires work in Industrial Electronics or Sales Engineering in metropolitan area. Age 29. Details on request. Box 87 W.

ELECTRONICS ENGINEER

Experienced receiver and transmitter design and production, F.M., A.M.; B.S. London. Age 31. 1934-37, RX designer large British radio firm; 1937-39 Air Ministry production of airborne RX and TX equipment; 1935-45 R.A.F. pilot, 3500 hours, transatlantic Captain; 1945 to date, Technical Director large Broadcasting Station designing FM equipment, and color television, Speak French, well traveled. Desire position Connecticut or New York area. Consider representation or sales engineering. Box 88 W.

ELECTRONIC ENGINEER

B.S.E.E. 1943. Now studying for M.S. Harvard, expect degree June 1947. Age 25. Single. Two years industrial research; Harvard-M.I.T. trained electronic-radar officer; 1 year experience with radar, sonar, radio and loran aboard ships; 1½ years Naval Research Laboratory research and development of new radar system. Desires position involving electronic design and development. Location East Coast, preferably Philadelphia-New York area. Box 89 W.

(Continued on page 60A)

PREMAX

Corulite Elements

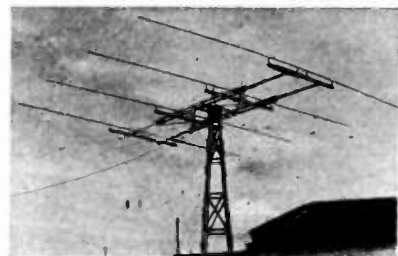

The Ideal Element to Use in Building Horizontal Arrays

Premax Corulite Elements are designed to meet the need for lightweight but sturdy elements for use in horizontal arrays and similar applications. They are exceptionally light in weight and their special design provides the necessary strength and rigidity so essential in horizontal types of installation—and at an extremely low cost.

Available in one, two, three and four section units, fully telescoping one within the other and adjustable between 4' and 17' lengths. They meet all requirements for the various 5 to 20 meter arrays in general use and are ideal for combinations in the commercial, FM, television and amateur bands.

Send at once to your jobber for a copy of the NEW Premax Catalog. It shows the complete line of Vertical Antennas in Steel, Aluminum, Monel and Stainless, as well as Corulite Elements and other elements for arrays. If your jobber can't supply you, write direct, giving us his name.

Premax Products

Division of Chisholm-Ryder Co., Inc.

4713 Highland Ave., Niagara Falls, N.Y.

PROCEEDINGS OF THE I.R.E. April, 1947

Simultaneous **CHANNEL OPERATION** WITH **WILCOX 99A Transmitter**

SIMULTANEOUS TRANSMISSION

Simultaneous Transmission on several frequencies brings new flexibility and operational ease. Three operators can use the transmitter at one time, thus increasing by 3 times the volume of traffic normally handled.

EASY MAINTENANCE

Every major component is instantly removable by means of plugs and receptacles, providing complete accessibility and easy maintenance.

COMPACT CONSTRUCTION

Housed in a single steel cabinet, the rectifier, modulator, remote control equipment, and 4 transmitting channels combine to make the most compact multi-frequency transmitter in the 400-watt field.

Write for Free Catalog...
TOMORROW'S TRANSMITTER TODAY

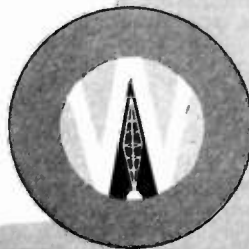
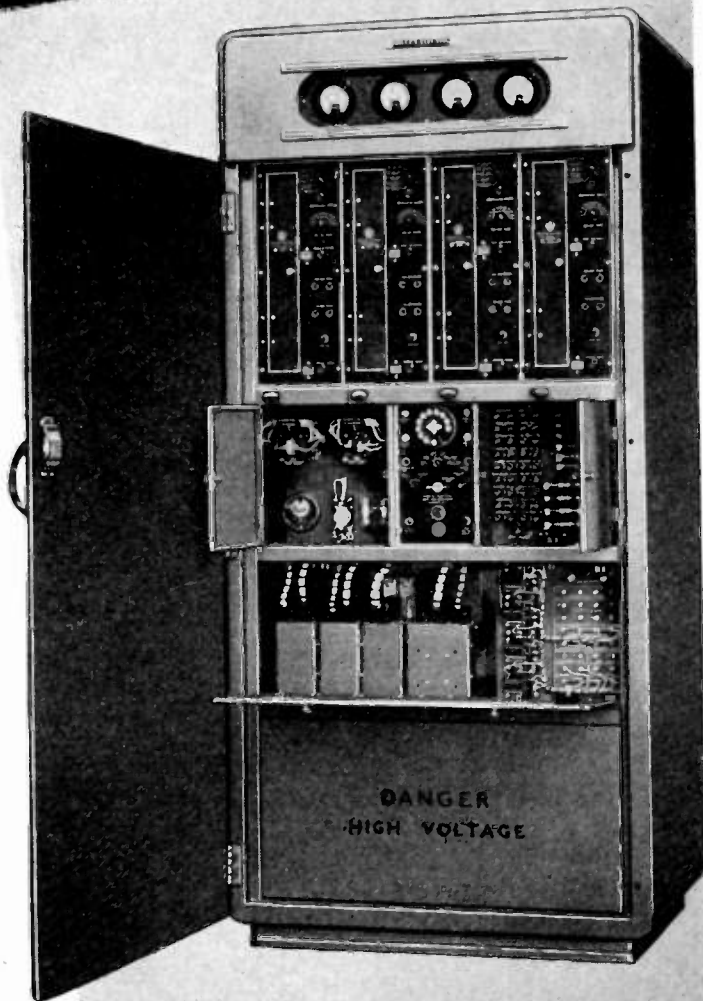

WILCOX ELECTRIC
COMPANY, INC.
Kansas City 1, Missouri

MICRODIMENSIONAL
WIRE & RIBBON
FOR VACUUM TUBES

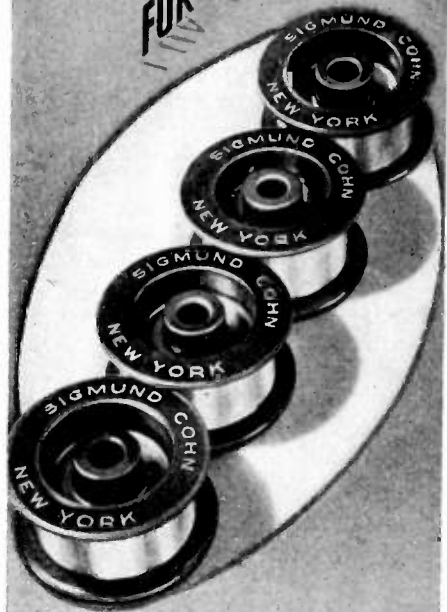

WOLLASTON PROCESS WIRE

drawn as small as .000010";

Made to your specifications
 for diameter and resistance

WRITE for list of products,

SIGMUND COHN & CO.
 45 GOLD ST., NEW YORK
 N.Y.

Positions Wanted

(Continued from page 58A)

INSTRUCTOR

B.S.E.E. '43 Washington U., M.E.E. Cornell due in June; Bowdoin, M.I.T. Radar School; Experience, some radio industry, some teaching, Navy Elec. Off.; Tau Beta Pi, Sigma Xi, Ham; married. Midwest preferred. Box 90 W.

JUNIOR ENGINEER

Age 23, married, two children. Experienced in design and all other phases of aids to aeronautical navigation, radio communications and broadcasting, radar, GCA, etc. 1st Class phone license. Now in charge of a CAA communications station. Prefer West Coast. Résumé on request. Dan W. Crockett, MTIC, UMIAT Radio, c/o Box 1310, Fairbanks, Alaska.

ENGINEER

B.E.E. by February 1947. Senior work in E.E. completed. Requires two non-electrical subjects for degree now taking in evening school. Age 27. Desires start in electronics field. Army meteorologist. Box 47 W.

COMMUNICATIONS ENGINEER

B.S. Engineering, Physics. Toronto. Age 26. Three years Naval officer in charge of operating and maintaining all radar equipment aboard cruiser. One year field engineering commercial frequency modulation radio. Seeks opportunity for original work in electronics, U. S. or Canada. Box 49 W.

ENGINEER

B.S.E.E. Age 33; married. M.I.T.-Harvard trained electronics-radar officer, Signal Corps, desires position of sales engineer or development of radar and allied fields. Sales, administrative, and manufacturing experience. Box 50 W.

ENGINEER

B.S.E.E. Purdue University and Massachusetts Institute of Technology electronics officer. Age 28; married. Experience with naval radar, sonar, and Ioran while serving three years afloat. Civilian experience in transformer design and with utility. Desires permanent position in Midwest. Box 52 W.

ELECTRONICS TECHNICIAN

Three years teaching, total experience, 13 years. Desires opportunity in research laboratory, teaching, frequency-modulation or television radio station work, theatre sound maintenance, or commercial sound work. Box 53 W.

ELECTRONICS ENGINEER

B.E.E. 1944, Northeastern, Tufts. Age 24. Annapolis Reserve Midshipmen School. Navy officer radar course at Bowdoin and M.I.T., sea duty on destroyer. Employed nearly one year by Army Air Forces as electronic engineer. Member Tau Beta Pi. Box 62 W.

ENGINEER

B.S.E.E. 1938. Now studying management engineering. 3 years Navy electronic officer and radar instructor. 3 years X-ray field, 1 year electronic design. Desires position in decent climate at sufficient salary to properly raise a family. Prefers managerial duties. Box 63 W.

(Continued on page 62A)



CONSTANT-IMPEDANCE Controls

★ The Clarostat Series CIB Attenuator (shown) was developed to meet the need for a constant-impedance attenuator capable of handling considerable power with low insertion loss. Provides linear attenuation with ample power-handling capacity.

Recommended as output level control for power amplifiers, or as input attenuator for individual loudspeakers in P-A system.

Dissipates 10 watts at any setting. Linear up to 30 db. in 10 steps, beginning with absolute zero and progressing in 3 db. steps up to 24, and then 30, followed by infinity.

Available in several ohmage to meet all requirements. Fibre-glass resistance elements. Single-hole mounting. Only 2 3/4" long by 2" diameter.

★ **DATA on request . . .**

Write for Bulletin 111 on Series CIB Attenuator. If interested in L-pads and T-pads, ask for Bulletin 102, as well.



CLAROSTAT MFG. CO., Inc. · 285-7 N. 6th St., Brooklyn, N. Y.

NEW

SMALLER, LIGHTER

"EVEREADY"

"A-B" BATTERY

for more compact portables!



Will outlast any other battery pack of its size!



SPECIFICATIONS:

Voltage:
"A"-9, tapped at 7 1/2.
"B"-90.

Size:
9 7/32" x 2 23/32" x 4 5/16".

Net weight:
4 lbs. 15 ozs.

Now the "Eveready" combination "A-B" 90-volt battery pack is available in even a smaller size... for the more compact, lighter portables. This pack provides plenty of power—it will last longer than any other "A-B" pack of comparable size.

This longer life is the result of the exclusive flat-cell principle found only in "Eveready" "Mini-Max" batteries.

It will pay you, in designing your new portables, to take advantage of this powerful, lighter-weight, smaller "Eveready" battery pack. For more details, consult National Carbon Company, Inc.

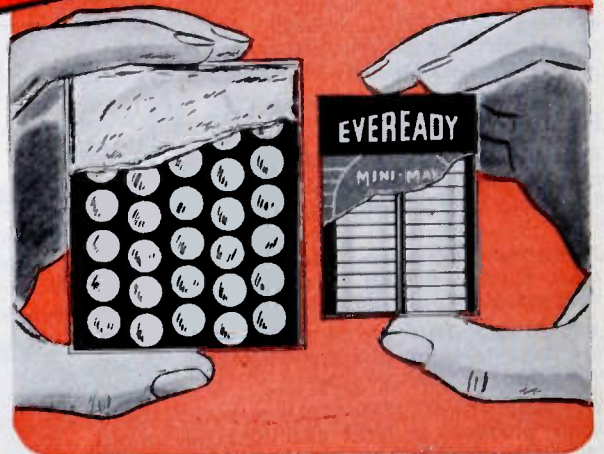

• Ordinary battery (left) is made of round cells and wasted space! "Eveready" battery (right) is made of flat cells—no space between them wasted by air, pitch, or cardboard!



The registered trade-marks "Eveready" and "Mini-Max" distinguish products of

NATIONAL CARBON COMPANY, INC.

30 EAST 42nd STREET, NEW YORK 17, N. Y.

Unit of Union Carbide and Carbon Corporation



Here's a NEW Line of AC and DC Panel Instruments

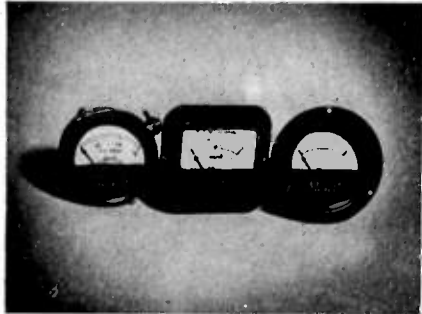

TYPES:

Ammeters, AC and DC
Milliammeters, AC and DC
Voltmeters, AC and DC
Resistance Meters

ACCURACY:

AC meters are double-vane, repulsion type; DC meters are polarized-vane, solenoid type. Accuracy, well within 5%.

CASE STYLES:

Three basic styles, all requiring 2-7/64" hole; round or rectangular; mounted by flange, ring or clamp. Certain DC models available with zero adjuster. Interchangeable with popular type of instrument formerly available.

FEATURES:

Rugged Construction: Metal cases, molded inner unit with coil frames and insulators integral for maximum rigidity.

Attractive Appearance: Neatly styled cases finished in dull telephone black with concealed coils and full-view scales.

All-Metal Dials: Made the same way as for much higher priced instruments, to withstand age and moisture.

Reasonably Priced: Standard models are being produced in large quantities for industrial users, making possible a complete line at moderate prices.

For ranges, specifications, and mounting dimensions, send for Bulletin F-64. Shurite Meters, 67 Hamilton Street, New Haven 8, Connecticut.

Shurite

ELECTRICAL MEASURING INSTRUMENTS

Positions Wanted

(Continued from page 60A)

JUNIOR ENGINEER

B.E.E. 1945. Age 21; single. Six months experience with Army Air Forces on very-high-frequency transceiver design at Wright Field, Ohio. Interested in communications research (very-high-frequency or all other frequency ranges). Available December 1946. Location N.Y., N.J., Conn. New York City preferable. Box 64 W.

ENGINEER

B.S.E.E. University of Pittsburgh. Age 25; married. Officer Signal Corps, installing transmitters, RTTY, and navigational aids for the Air Forces. Two years experience in electronics research laboratory. Desires position near Pittsburgh, Pa. Box 65 W.

ELECTRICAL ENGINEER

B.E.E. 1945. College of the City of New York. Age 21; single. Worked several months in radio development. Desires development work in radio or electronics in vicinity of New York City. Box 67 W.

INVENTOR—ELECTRICAL ENGINEER

Training in theoretical mechanics and electronics. Diversified experience. Harvard 1929. Desires part time position, research and development, preferably on unusual project requiring best fundamental training and initiative. Location preferred Washington on East coast. Box 82 W.

News—New Products

These manufacturers have invited PROCEEDINGS readers to write for literature and further technical information. Please mention your I.R.E. affiliation.

(Continued from page 52A)

New Microphones

Two modern, high quality, low-priced general-purpose dynamic and crystal microphones are announced by **Electro-Voice, Inc.**, Carroll Street, Buchanan, Mich. It is stated that the frequency response is substantially flat from 50 to 8000 cycles and the polar pattern is non-directional at low frequencies, becoming directional at higher frequencies. Both known as Model 610, the dynamic unit has an output level of minus 53 db at various impedances, and the crystal unit has a high-impedance output level of minus 48 db.



(Continued on page 63A)

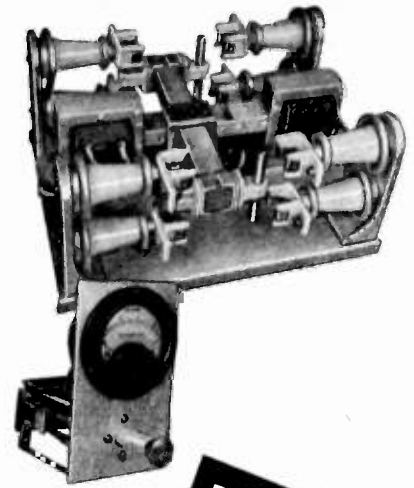

R. F. CONTACTORS
and
M. B. B. SWITCHES

JOHNSON R. F. Contactors were designed for switching high voltage, high current, R. F. circuits. Contacts are sectionalized to provide large contact area, and through wiping action, are self cleaning. No holding current is required to operate, and either DPDT or SPDT types are available.

Optional auxiliary switches operate low current control circuits, pilot lights, high current control circuits, or provide sequence operation of contactors.

Electrical Rating	Type JR	Type JS
Solenoid Voltage	230/115V	230/115V
Contacts - Continuous		
Max. R. F. current	50 amps.	30 amps.
Voltage Breakdown	20,000V. peak	14,000V. peak
Dimensions		
Width	9 1/2"	6"
Length	12"	9"
Height	5"	4 1/4"

With *Make - Before - Break Switches meters may be inserted and removed from antenna or similar high voltage circuits without opening the circuit. They're designed with excellent R. F. insulation for high voltage breakdown and current carrying capacity.

Data Sheets and Prices Available on Request to Dept. WD.

FOR BROADCAST STATIONS
COMPLETE DIRECTIONAL ANTENNA SYSTEMS ★ HIGH VOLTAGE COMPONENTS ★ CO-AXIAL TRANSMISSION LINE ★ F-M ISO-COUPLER ★ OPEN WIRE TRANSMISSION LINE SUPPORTS.

JOHNSON
a famous name in Radio



E. F. Johnson Co. Waseca, Minn.

News—New Products

These manufacturers have invited PROCEEDINGS readers to write for literature and further technical information. Please mention your I.R.E. affiliation.
(Continued from page 62A)

Antenna Tuning Units

Two new antenna tuning units are being introduced by the **Raytheon Manufacturing Company**, 7517 N. Clark St., Chicago 26, Ill. They are the RT-1000, which is suitable for AM broadcast stations of from 250 to 1000 watts power, and the RT-5, which is suitable for AM stations of from 5 to 10 kilowatts power. Both units are similar in all respects except the power which they can handle.

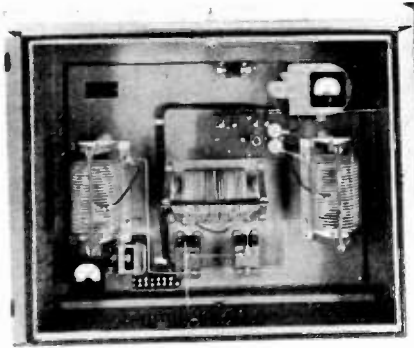

These two antenna tuning units provide a convenient means for matching antennas of widely diverse characteristics to either concentric or open-wire transmission lines, and, it was pointed out, they possess appreciable harmonic reduction properties. The circuit consists primarily of a single "T" section low-pass filter network which can be easily adjusted for the proper matching of the resistance of the antenna to the resistance of the transmission line.

Audio Voltmeter

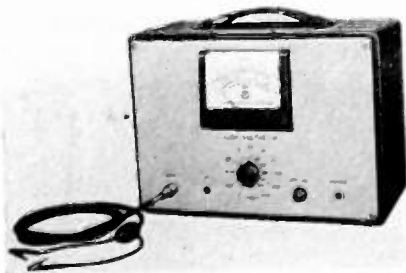

Consisting of a precision attenuator, a three-stage high-gain stabilized amplifier, a balanced diode rectifier, a special direct current microammeter, and a regulated power supply, a new audio voltmeter, Type WV-73A, has been announced by the **Radio Corporation of America**, Camden, N. J. The unusual sensitivity of this unit makes it possible to measure the electrical conductivity of switches, circuit breakers, relays, buses and grounds, in addition to transmission losses in lines and circuits, and the response of special filters and compensators.

(Continued on page 64A)

Symbol of Quality

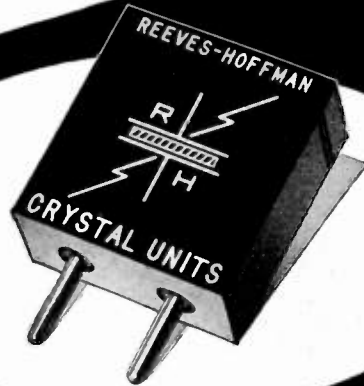

Write for
Crystal Units
Catalog RHC-1



REEVES-HOFFMAN CORPORATION

SALES OFFICE: 215 EAST 91 STREET, NEW YORK 28, N. Y.
PLANT: 321 CHERRY STREET, CARLISLE, PA.



THERMOSTATIC-METAL TYPE DELAY RELAYS

PROVIDE DELAYS RANGING
FROM 1 TO 120 SECONDS

FEATURES:—Compensated for ambient temperature changes from —40° to 110° F . . . Hermetically sealed; not affected by altitude, moisture or other climate changes . . . Explosion-proof . . . Octal radio base . . . Compact, light, rugged, inexpensive . . . Circuits available: SPST Normally Open; SPST Normally Closed.

PROBLEM? Send for "Special Problem Sheet" and Bulletin.

AMPERITE REGULATORS

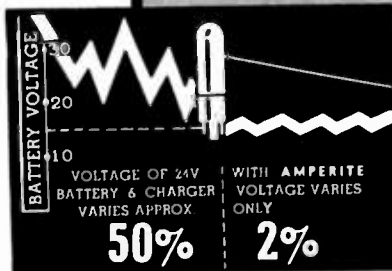

Amperite REGULATORS are the simplest, lightest, cheapest, and most compact method of obtaining current or voltage regulation . . . For currents of .060 to 8.0 Amps . . . Hermetically sealed; not affected by altitude, ambient temperature, humidity.

Write for 4-page Illustrated Bulletin.

AMPERITE CO., 561 Broadway, New York 12, N. Y.

In Canada: Atlas Radio Corp., Ltd., 560 King St., W. Toronto

News—New Products

These manufacturers have invited PROCEEDINGS readers to write for literature and further technical information. Please mention your I.R.E. affiliation.

(Continued from page 63A)

Condenser-Resistor Bridge

A portable condenser-resistor bridge Type YCW-1, capable of measuring a wide range of capacity, resistance and other electrical characteristics of condensers, has been announced by the Specialty Division of General Electric Company's Electronics Department, Syracuse, N. Y. Designed primarily for production testing and radio servicing and featuring push-button switching, the instrument will also measure the turn-ratio of transformers.

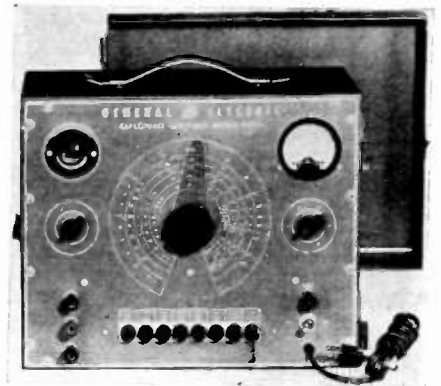

This unit will measure capacity from 0.000005 to 200 microfarads in three convenient ranges, and resistance from 5 ohms to 20 megohms in two ranges. Using a Wein-bridge principal with standards of $\pm 1\%$ for capacitance and $\pm 2\%$ for resistance, bridge balance is indicated by an electronic visual-indicator tube.

Twin Power Supply

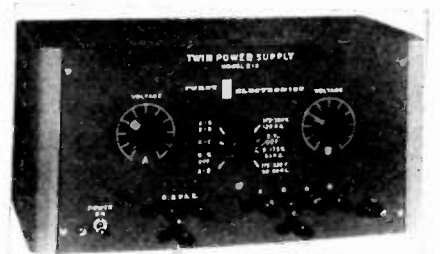

A new power supply featuring two independent adjustable output voltages which remain constant regardless of variations of line voltage and the load connected to each output, is being manufactured by Furst Electronics, 800 W. North Ave., Chicago 22, Ill. A selector switch permits the operation of these two electronically-regulated outputs, either singly, in series, or in parallel. A wide range of direct and alternating current, and voltage outputs are available in this Model 210 unit.

(Continued on page 67A)

for experienced cooperation call Cleveland

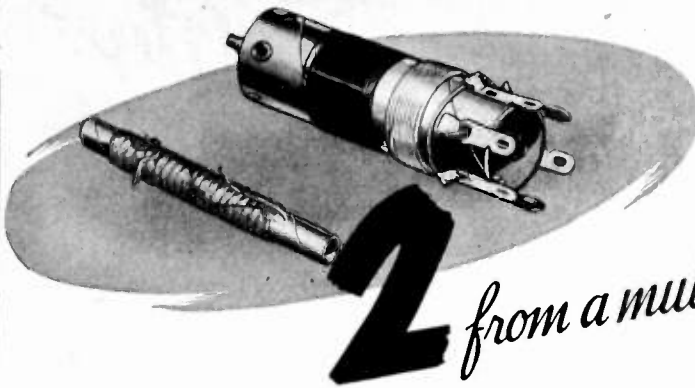

applications of COSMALITE*

a spirally laminated paper base Phenolic Tube

No. 96 Cosmolite for coil forms in all standard broadcast receiving sets.

SLF Cosmolite for permeability tuners.

Advantages include lower costs and quicker deliveries

Ask also about our spirally wound kraft and fish paper Coil Forms and Condenser Tubes

* Trade Mark Registered

All-Fibre Cans
—
Combination Metal and Paper Cans
Spirally Wound Tubes and Cores for All Purposes
—
Plastic and Combination Paper and Plastic Items

The **CLEVELAND CONTAINER Co.**
6201 BARBERTON AVENUE CLEVELAND 2, OHIO

PRODUCTION PLANTS also at Plymouth, Wisc., Ogdensburg, N. Y., Chicago, Ill., Detroit, Mich., Jamesburg, N. J.
PLASTICS DIVISIONS at Plymouth, Wisc., Ogdensburg, N. Y. • ABRASIVE DIVISION at Cleveland, Ohio
New York Sales Office—1186 Broadway, Room 223
IN CANADA—The Cleveland Container Canada Ltd., Prescott, Ontario

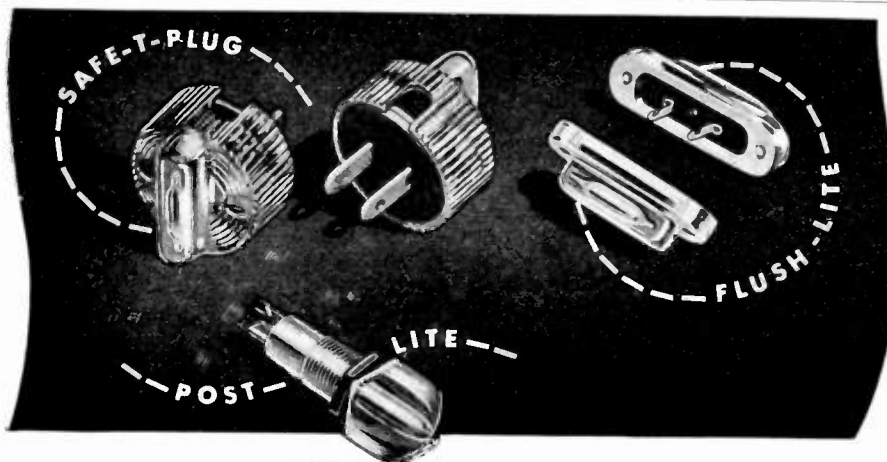

YOU CAN SEE IT'S ON

WITH LITTELFUSE NEON INDI-GLOWS!

Littelfuse neon-glow Flush-Lites and Post-Lites assure quick orientation in the dark, locate instruments, switches, etc., on radar, television, communication and aircraft panels. As on-off indicators on radios, electric stoves and other electrical appliances they are approved by Underwriters' Laboratories, and last 15,000 hours or more.

Neon-glow Safe-T-Plugs, built like standard plugs for use on non-thermostatically controlled electrically heated appliances, glow when the appliance is on, and are required by Underwriters' Laboratories and most insurance companies to reduce fire hazard.

For details request Littelfuse Catalog No. 9.

LITTELFUSE  *Incorporated*

4791 N. RAVENSWOOD AVE.

CHICAGO 40, U. S. A.

NITE-T-LITE • SWITCH-LITE • IGNITION-FRITZ • NEON INDICATORS • SWITCHES • CIRCUIT BREAKERS • FUSES, MOUNTINGS AND ACCESSORIES

AT **SHERRON** YOUR ELECTRONICS PROJECT

STARTS HERE — IN
THE LABORATORY →

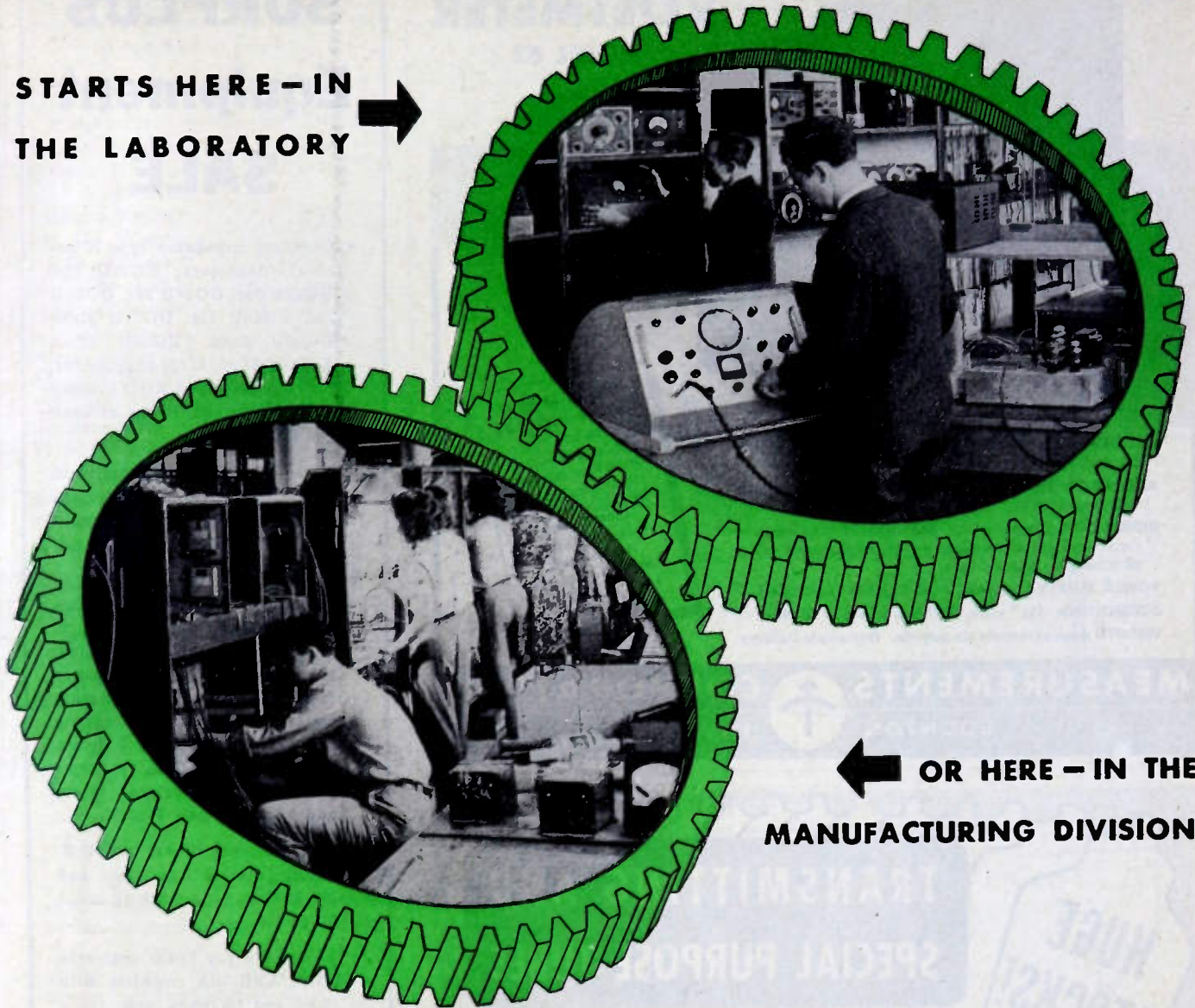

← OR HERE — IN THE
MANUFACTURING DIVISION

EITHER WAY . . . SHERRON CAN SERVE YOU ALL THE WAY . . .

Sherron is set to mesh gears with your production program at any level . . . research, design, development and — or manufacturing.

Our laboratory, particularly, is a highly developed facet of our service. The premises that assure manufacturing practicability are established here. The equipment used in this laboratory is the last word in electronic

research apparatus . . . and every laboratory worker is a thoroughly seasoned physicist, alert to the most advanced techniques.

The same complete operation, which has allied Sherron with some of the foremost electronics manufacturers, is available to a few additional manufacturers . . . Write for particulars of our definitive service to electronics manufacturers.



SHERRON ELECTRONICS CO.

Division of Sherron Metallic Corporation

1201 FLUSHING AVENUE • BROOKLYN 6, NEW YORK

VACUUM TUBE VOLTMETER

MODEL 62

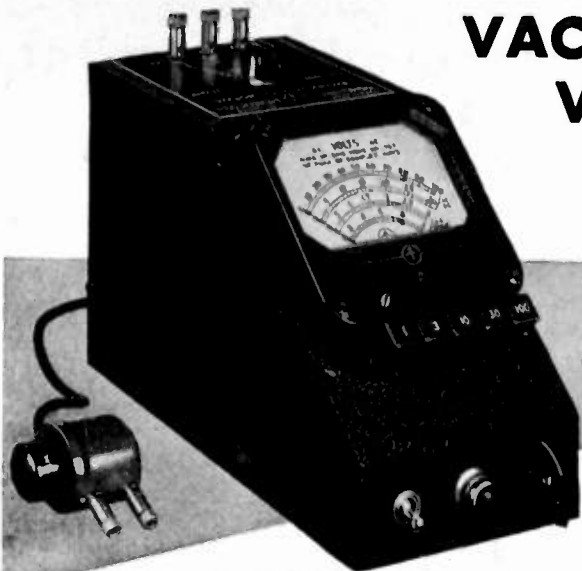

SPECIFICATIONS:

RANGE: Push button selection of five ranges—1, 3, 10, 30 and 100 volts a.c. or d.c.

ACCURACY: 2% of full scale. Useable from 50 cycles to 150 megacycles.

INDICATION: Linear for d.c. and calibrated to indicate r.m.s. values of a sine-wave or 71% of the peak value of a complex wave on a.c.

POWER SUPPLY: 115 volts, 40-60 cycles—no batteries.

DIMENSIONS: 4¾" wide, 6" high, and 8½" deep.

WEIGHT: Approximately six pounds. Immediate Delivery

MANUFACTURERS OF
Standard Signal Generators
Pulse Generators
FM Signal Generators
Square Wave Generators
Vacuum Tube Voltmeters
UHF Radio Noise & Field
Strength Meters
Capacity Bridges
Megohm Meters
Phase Sequence Indicators
Television and FM Test
Equipment

MEASUREMENTS CORPORATION
BOONTON NEW JERSEY

TRANSMITTING AND SPECIAL PURPOSE TUBES

**HUGE
STOCKS!**

**WRITE FOR
NEWARK'S LIST OF TUBES**

Make Newark your source, too, for all needed radio and electronic parts. Brisk, competent service assures quick delivery.

NEWARK NOW AGENTS OF WAR ASSETS ADMINISTRATION

Newark has been appointed agents of the War Assets Administration for transmitting and special purpose electronic tubes.

HUGE STOCKS! WIDE SELECTION!

This means that you can now get prompt Newark service on the previously hard-to-get tubes, priced at a fraction of their original cost. Make Newark your headquarters for tubes — whether it's for experimental work or production runs.

ACTING AS AGENTS FOR WAR ASSETS ADMINISTRATION UNDER CONTRACT WAS(p) 7-167

NEW YORK
Offices & Warehouse
242 W. 55th St., N.Y. 19

NEWARK
ELECTRIC COMPANY, INC.

TELEPHONE
Circle 6-4060

New York City Stores: 115-17 W. 45th St. & 212 Fulton St.

• MAIL AND PHONE ORDERS
FILLED PROMPTLY

• WRITE: 242-N WEST 55th
STREET, NEW YORK CITY

SURPLUS Equipment SALE

- Constant impedance type N coaxial connectors: UG21U 75¢, UG22U 75¢, UG24U 75¢, UG25U 75¢, UG58U 75¢, UG27U \$1.00, UG29U \$1.00, UG30U \$1.00, UG83U \$1.00, M359 adapter 50¢, ½ft.-2ft. length of RG11U cable with PL259 connectors at each end \$1.00.
- Fixed attenuator, TPS-51PB-20. 20db attenuation, 50 ohm impedance, with type N connectors at each end \$3.50.
- Microwave Generator TS155A/UP, range 2700-2900 megacycles, pulse modulated 120-2000 pps, variable pulse width and delay, thermistor bridge, r.f. power meter for internal and external metering, and direct reading calibrated attenuator. 9 tubes, 25" w., 15¼" d., 12½" h., complete with connectors, cables and adapters, new \$160.00.
- Measurements Model 78B R.F. signal generator, 15-25 mc and 150-230 mc, good working order \$45.00.
- 3" cathode ray radar indicator ID-93/APG-13A complete with 3BP1 and 10 tubes, new, 115 v 400 cps \$25.00.
- Radar receiver A N/APR-5A, 1000-6000 megacycles, 15 tubes, 115 volts, 60 cps, compact, brand new \$150.00.
- Silver button micas, 15 and 500 mmfd, 500 vdc, 10¢. Silver button mica feed thru capacitors, threaded, 500 mmfd 15¢.
- Oil filled capacitor, 1 mfd. 15000 WVDC, GE Pyranol 14F263 \$25.00.
- 2mfd, 4000 WVDC, GE Pyranol 23F47 \$5.00.

ELECTRO-IMPULSE LABORATORIES

P.O. Box 250 Red Bank
New Jersey

News—New Products

These manufacturers have invited PROCEEDINGS readers to write for literature and further technical information. Please mention your I.R.E. affiliation.

(Continued from page 64A)

Television Rectifier

A high-voltage rectifier tube, Type 1Y2, designed for anode supply on direct-view or projection-type television tubes, has been developed by Chatham Electronics, 475 Washington St., Newark 2, N. J. The peak inverse voltage rating is 50 kilovolts. Two tubes deliver 50 kilovolts, direct current, in a voltage-doubler circuit, or 25 kilovolts, direct current, when used singly. Filament voltage is not critical—it may fluctuate between 1.0 and 1.65 volts. The filament is sufficiently rugged for 60 cycle operation and requires low filament power making it equally adaptable to an RF filament supply, it was pointed out. Inter-electrode capacitance and absence of back emission prevents undue loading of the oscillatory circuit in RF applications.

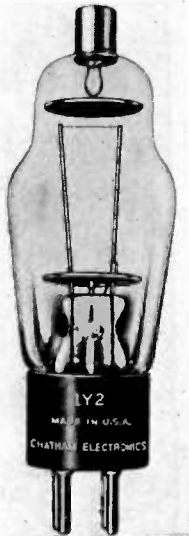

Constant Speed DC Motor

An improved model of a constant speed direct current motor has been developed by the Amglo Corporation, 4234 Lincoln Ave., Chicago 18, Ill. The new motor utilizes the principle of polarized magnetic drive of a vibrating reed, the nucleus of speed control with direct-current power, which provides immediate self-starting.

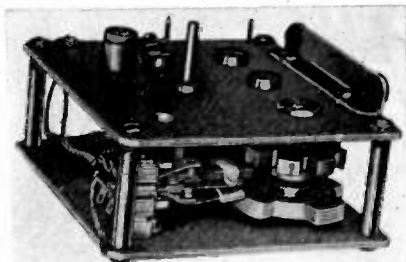

This improved unit when tested under actual working conditions consumed only from 0.06 to 1.0 watt from either battery or direct current line sources. Shaft speeds were geared from one revolution each 24 hours to 100 revolutions per minute, providing clock-like accuracy previously possible with only alternating-current units. The new motor is small enough to be held in the palm of the hand and is designed to operate at one of several voltages between 3 and 110 volts direct current.

(Continued on page 68A)

3 COMMON PROBLEMS

IN RADIO AND ELECTRONIC EQUIPMENT DESIGN



ONE SIMPLE ANSWER

1. REMOTE CONTROL—Where equipment contains variable elements which must be regulated from remote points, S.S. White remote control flexible shafts satisfy every need for easy installation and smooth, sensitive, dependable operation over distances up to 50 feet or more.

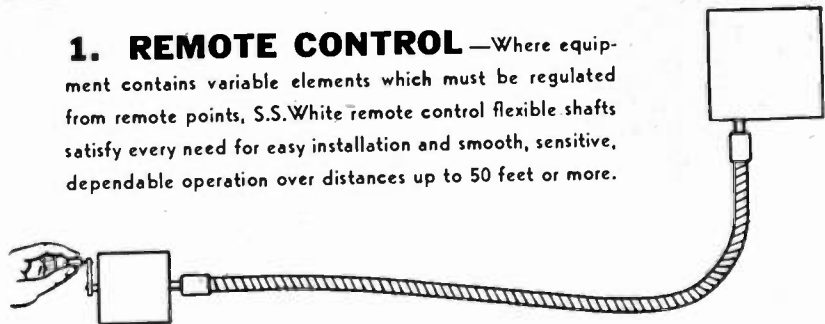

2. POWER DRIVE—Where equipment includes instruments or other mechanisms requiring rotary power drive, S.S. White power drive flexible shafts meet every need for positive, reliable, trouble-free operation between practically any two points, regardless of curves obstacles or distance.

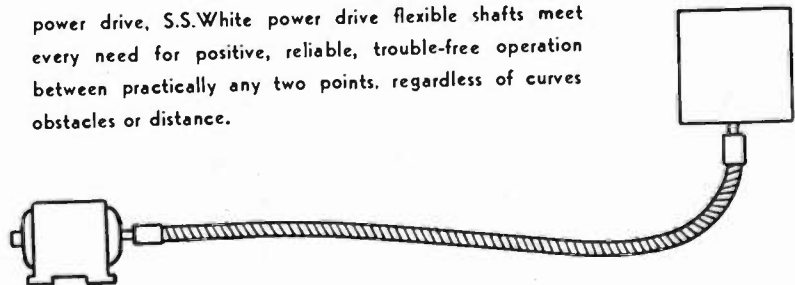

3. COUPLING—Short lengths of S.S. White flexible shafting used inside equipment to couple variables to their controls, give full freedom in placing both the elements and the dials for space saving, easy assembly and wiring, and convenient operation and servicing.

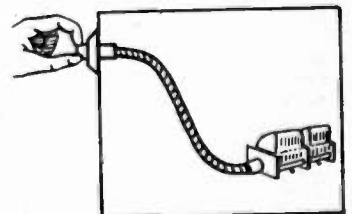

WRITE FOR FLEXIBLE SHAFT HANDBOOK

The 260-page flexible shaft handbook gives the full story of flexible shafts and their application. A copy is yours—free—if you request it on your business letterhead and mention your position.

S.S. WHITE INDUSTRIAL DIVISION
THE S. S. WHITE DENTAL MFG. CO. DEPT. G 10 EAST 40th ST., NEW YORK 16, N. Y.



FLEXIBLE SHAFTS • FLEXIBLE SHAFT TOOLS • AIRCRAFT ACCESSORIES
SMALL CUTTING AND GRINDING TOOLS • SPECIAL FORMULA RUBBERS
MOLDED RESISTORS • PLASTIC SPECIALTIES • CONTRACT PLASTICS MOLDING

One of America's AAAA Industrial Enterprises

a discussion of
electronics in action

ELECTRONICS for INDUSTRY

By **WALDEMAR I. BENDZ**

Westinghouse Electric Corporation, Boston,
Mass.

Assisted by **CHARLES A. SCARLOTT**, Editor,
"Westinghouse Engineer"



This new book clearly and concisely explains the principles of industrial electronics, describing the various types of electronic tubes, their functioning and the basic circuits in which these are used in many industrial devices. Electronics is discussed from the physical point of view. Numerous diagrams, rather than the usual mathematical explanations, help clarify the discussions. Photographs and brief explanations throughout the text show the tasks performed by many electronic devices in industry. Presupposing an understanding of the fundamentals of electric circuits, **ELECTRONICS FOR INDUSTRY** does not concern itself with detailed proof of theories. However, numerous footnotes refer the reader to other sources for the study of theory and specific design. Each chapter concludes with a summary of the important points discussed, plus a carefully prepared reference list for further detailed study of each subject.

Subjects discussed are—

- MEET THE ELECTRON
- ELECTRON ESCAPE FROM SOLIDS—EMISSION
- ELECTRICITY FROM LIGHT
- ELECTRICITY INTO LIGHT
- TWO-ELEMENT TUBES
- THREE-ELEMENT PIOTRONS
- MULTIGRID PIOTRONS
- THYRATRONS
- FROM ALTERNATING TO DIRECT CURRENT
- MERCURY-POOL TUBES
- AMPLIFICATION
- PRINCIPLES OF OSCILLATION
- MODULATION AND DETECTION OF CARRIER WAVES
- HEATING BY HIGH FREQUENCY
- BASIC CIRCUITS OF ELECTRONIC CONTROL
- INDUSTRIAL APPLICATION OF ELECTRONIC CONTROL
- ELECTRONIC REGULATORS

March 1947 501 Pages \$5.00

ON APPROVAL COUPON

JOHN WILEY & SONS, INC.
440 Fourth Avenue, New York 16, N.Y. IRE-4-47
Please send me a copy of Bendz' **ELECTRONICS FOR INDUSTRY** on ten days' approval. If I desire to keep the book, I will remit \$5.00 plus postage; otherwise, I will return the book postpaid.

Name
Address
City State

(Approval offer not valid outside U. S.)

News—New Products

These manufacturers have invited PROCEEDINGS readers to write for literature and further technical information. Please mention your I.R.E. affiliation.

(Continued from page 67A)

Cable Tester

Operating on the same core-loss principle as the "cyclograph" but eliminating those features not required for testing wire rope, a new cable tester has been announced by the Allen B. DuMont Laboratories, Inc., 2 Main Avenue, Passaic, N. J. In addition to the instantaneous reading on the oscillograph screen as the cable passes through the test coil, provision is made for recording a permanent record.

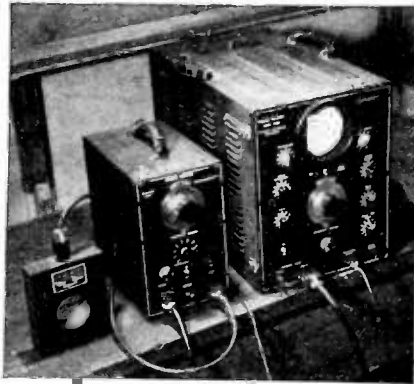

By proper choice of test frequency and adjustment of instrument circuits, the meter response can be made linear with respect to increases in stress in the wire rope over a limited range. A 110-volt relay is also provided which can be set to operate at any desired level to operate a warning signal to indicate if the properties of the rope change more than an allowable amount.

Very-High Mu Triode

A new very-high-Mu Triode, Type NU-2C53, with an application factor of 500 at plate-voltage ratings of from 1 to 8 kilovolts has been released by the National Union Radio Corp., 57 State St., Newark 2, N. J. At lower plate voltages between 250 and 400 volts, it is possible to obtain single-stage amplification of from 250 to 300 times. These characteristics are achieved in the small receiving-tube size structure which makes it adaptable in instrument, test equipment, pulse amplifier, and regulated power-supply design where space economy is an important factor.



(Continued on page 69A)

Specify

MYCALEX

LOW LOSS INSULATION

Where high mechanical and electrical specifications must be met.

MYCALEX 410

(MOLDED MYCALEX)

makes a positive seal with metals
... resists arcing, moisture and high temperatures.

27 years of leadership
in solving the most
exacting high frequency
insulating problems.

MYCALEX CORPORATION OF AMERICA

"Owners of 'MYCALEX' Patents"
Plant and General Offices: Clifton, N.J.
Executive Offices: 30 Rockefeller Plaza
New York 20, N.Y.

for every
photo tube
application

there is a
High Sensitivity

**RAULAND
VISITRON**



There is a Rauland VISITRON available for every phototube application ... for industrial electronic control devices, sound-on-film, research and development. For high sensitivity, uniformity and dependability, Rauland VISITRONS are the preferred phototubes.

Specify VISITRON ... and be sure!
Send for valuable Rauland VISITRON Catalog—it's yours for the asking.

THE RAULAND CORPORATION
CHICAGO 41, ILLINOIS

RADIO **Rauland** RADAR
SOUND · COMMUNICATIONS · TELEVISION

News—New Products

These manufacturers have invited PROCEEDINGS readers to write for literature and further technical information. Please mention your I.R.E. affiliation.

(Continued from page 68A)

Modulation Meter



A new modulation meter operating without vacuum tubes and requiring neither batteries nor line power has been announced by Sylvania Electric Products Inc., 500 Fifth Avenue, New York 18, N. Y. It is designed primarily for use in the amateur phone bands between 3.5 and 54 megacycles. This new meter, Type X-7018, provides a compact light-weight instrument for determination of the modulation percentage of either a sine-wave-modulated or a voice-modulated carrier, as well as giving an indication of carrier shift.

Tube and Battery Tester

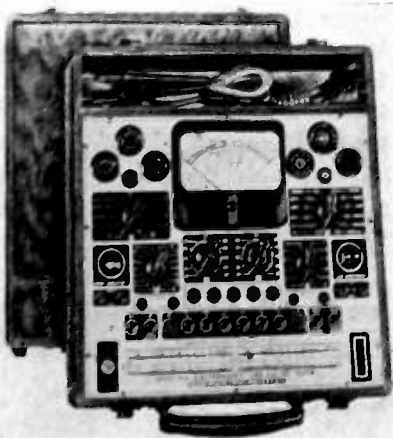

Precision Apparatus Co., Inc., 92-27 Horace Harding Blvd., Elmhurst, L. I., N. Y., announce their 954-P electronic tube-battery and set tester which is a portable combination mutual-conductance type vacuum-tube tester, radio battery tester and 37-range alternating and direct current multi-range set tester, with ranges to 6000 volts AC and DC utilizing a 20,000 ohms-per-volt meter.

CATHODE FOLLOWER

BASIC PATENTS

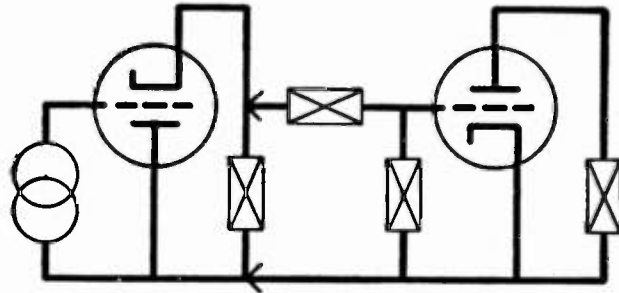

● NOTICE TO MANUFACTURERS

Licenses are now available for the use of Cathode Follower circuits in all types of electronic and communication apparatus

●
Inquiries
Are Invited
●

REMCO ELECTRONIC, INC.

Formerly Revelation Patents Holding Co.

33 WEST 60TH ST., NEW YORK 23, NEW YORK

New . . . Improved ATTENUATORS by TECH LABS

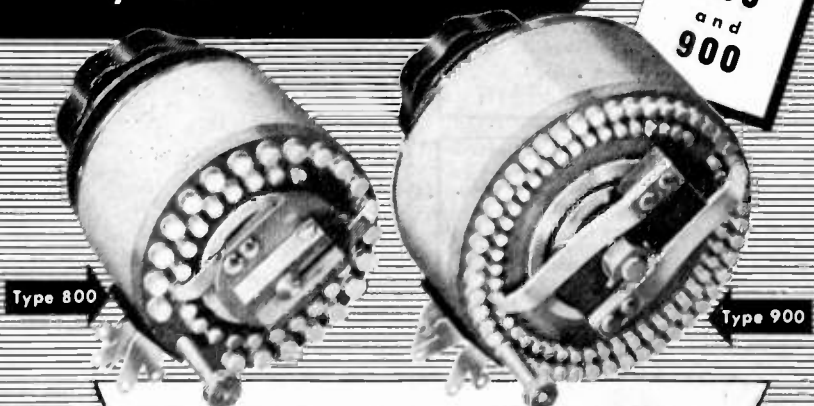

"New Times—New Modes", says old proverb. These new attenuators were born to meet new war-created demands. They represent a new medium frame size: Type 800 (2 1/4" dia.) and a larger size: Type 900 (3" dia.). The Type 800 is supplied as potentiometer, rheostat, ladder and T-pad up to 20 steps. The larger size Type 900 is similarly furnished with up to 45 steps. Write for new bulletin.



Manufacturers of Precision Electrical Resistance Instruments

337 CENTRAL AVE. • JERSEY CITY 7, N. J.

PROFESSIONAL CARDS

W. J. BROWN
Electronic & Radio Engineering Consultant
 Electronic Industrial Applications, Commercial and Broadcasting Transmitter and Receiver Design, Test Equipment, etc.
 23 years experience in electronic development
 P.O. Box 5106, Cleveland, Ohio
 Telephone, Yellowstone 7771

EDWARD J. CONTENT
Acoustical Consultant
Functional Studio Design
 FM - Television - AM
 Audio Systems Engineering
 Roxbury Road Stamford 3-7459
 Stamford, Conn.

HERBERT A. ERF
Architectural Acoustics Consultant
STUDIO DESIGN
 Standard Broadcast—FM—Television
 Cleveland 15, Ohio
 3868 Carnegie Avenue Express 1616

DAVID C. KALBFELL, Ph.D.
Engineer — Physicist
 Complete laboratory facilities
 Industrial instrumentation and control
 Broadcast engineering and measurements
 941 Rosecrans St. Bayview 7303
 San Diego 6, California

ROBERT E. McCOY
Consulting Engineer
Electrical Design and Theory
DC to UHF
 301-302 Concord Bldg., Portland 4, Oregon

JAMES R. WALKER, B.S.E.E., M.S.
 Consultant on Industrial Electronic Applications and Electrical Devices for Physical Measurements
 Complete Lab. Facilities
 856 Pallister, Detroit, Mich.
 Phone MA 1243

Paul D. Zottu
 Consulting Engineer
 Industrial Electronics
 High Frequency Dielectric and Induction Heating Applications, Equipment Selection, Equipment and Component Design, Development, Models.
 272 Centre St., Newton, Mass. BIG-9240

INDEX AND DISPLAY ADVERTISERS

Section Meetings	35A
Membership	35A
Positions Open	50A
Positions Wanted	56A
News—New Products	12A

International Resistance Co.	36A, 37A
International Tel. & Tel. Corp.	41A, 52A

E. F. Johnson Co.	62A
D. C. Kalbfell	70A

Langevin Co.	58A
Littelfuse, Inc.	64A

DISPLAY ADVERTISERS

Acme Electric Corporation	42A
Aircraft Radio Corporation	27A
Allen-Bradley Company	47A
American Lava Corp.	17A
American Phenolic Corp.	2A
Amperex Electronic Corp.	21A
Amperite Corp.	63A

Andrew Co.	38A
Arnold Engineering Co.	4A
Astatic Corporation	40A
Audio Devices, Inc.	57A
Automatic Mfg. Corp.	51A

Bell Telephone Laboratories	3A 34A
Bendix Aviation Corp. (Radio Div.) ..	50A
L. S. Brach Mfg. Co.	56A
W. J. Brown	70A
Brush Development Co.	54A

Centralab	24A, 25A, 55A
Chicago Transformer	11A
Clarostat Mfg. Co.	60A
Cleveland Container Co.	64A
Sigmund Cohn & Co.	60A
Collins Radio Co.	23A
Edward J. Content	70A
Cornell-Dubilier Electric Corp.	Cover III

DeMornay-Budd, Inc.	13A
Tobe Deutschmann Corp.	22A
Allen B. DuMont Labs., Inc.	10A

Eitel-McCullough, Inc.	8A
Electrical Reactance Corp.	35A
Electro Impulse Laboratories	66A
Herbert A. Erf	70A

Federal Telephone & Radio Corp.	41A, 52A
Finch Telecommunications, Inc.	52A
Freed Transformer Co.	56A

General Electric Company	45A
General Radio Co.	Cover IV

Harvey Radio Laboratories, Inc.	33A
Hewlett-Packard Co.	7A
Hytron Radio & Electronics Corp.	29A

Insulation Manufacturers Corporation ..	71A
---	-----

E. F. Johnson Co.	62A
D. C. Kalbfell	70A

Langevin Co.	58A
Littelfuse, Inc.	64A

Machlett Laboratories, Inc.	49A
Maguire Industries, Inc.	16A
P. R. Mallory & Co., Inc.	6A
Robert E. McCoy	70A
Measurements Corp.	66A
Mycalex Corp. of America	68A

National Carbon Company, Inc.	61A
National Co., Inc.	9A
Newark Electric Co.	66A

Premax Products	58A
Presto Recording Corp.	53A

Radio Corporation of America	32A, 50A, 72A
Rauland Corporation	68A
Raytheon Mfg. Co.	26A
Reed & Prince Mfg. Co.	43A
Reeves-Hoffman Corp.	63A
Remco Electronic, Inc.	69A
Revere Copper & Brass, Inc.	20A

Sherron Electronics Co.	65A
Shurite Meters, Inc.	62A
Simpson Electric Co.	28A
Sola Electric Company	15A
Solar Manufacturing Corp.	1A
Sorensen & Company, Inc.	48A
Sprague Electric Co.	19A
Stackpole Carbon Company	14A
Superior Electric Co.	39A
Sylvania Electric Products, Inc.	5A

Tech Labs	69A
Truscon Steel Company	46A
Tung-Sol Lamp Works, Inc.	18A
Turner Company	44A

United Transformer Corp.	Cover II
-------------------------------	----------

James R. Walker	70A
War Assets Administration	30A & 31A
Western Electric Company	3A, 34A
S. S. White Dental Mfg. Co.	67A
Wilcox Electric Company, Inc.	59A
John Wiley & Sons, Inc.	68A

Paul D. Zottu	70A
---------------------	-----



6th among the Superior Features of **DIEFLEX** Varnished Tubing Products... is Good

PUSH-BACK QUALITY



COMPLETE
IMPREGNATION



FLEXIBILITY



DIELECTRIC
STRENGTH



COMPLETENESS
OF LINE



NON-FRAYING



SMOOTH
INSIDE BORE



UNIFORMITY
OF PRODUCT



An important factor in both cost and high production of electrical devices is ease of assembly. Dieflex varnished tubings and saturated sleeveings are non-fraying products with unusually good push-back characteristics. It is easy to solder and join connections and to splice with Dieflex due to these push-back and non-fraying qualities.

The physical properties of Dieflex Varnished Tubing Products are unusually good because of the specially formulated oleoresinous impregnating type baking varnish used. Both cotton and glass fiber types offer advantages in assembly time saved and increased product life. Be sure of getting the best . . . specify "Dieflex."

DIEFLEX PRODUCTS LIST

MADE WITH BRAIDED COTTON SLEEVEING BASE

VTA Grade A-1 Magneto Grade Varnished Tubings—VTA Grade B-1 Standard Grade Varnished Tubings—VTA Grades C-1 and C-2 Heavily Coated Saturated Sleeveings—VTA Grade C-3 Lightly Coated Saturated Sleeveings—Heavy Wall Varnished Tubings and Saturated Sleeveings.

MADE WITH BRAIDED GLASS SLEEVEING BASE

VTA Grade A-1 Magneto Grade Varnished Fiberglas Tubings—VTA Grade C-1 Extra Heavily Saturated Fiberglas Sleeveings—VTA Grade C-2 Heavily Saturated Fiberglas Sleeveings—VTA Grade C-3 Lightly Saturated Fiberglas Sleeveings—Silicone-Treated Fiberglas Varnished Tubings and Saturated Sleeveings.

INSULATION

MANUFACTURERS CORPORATION

CHICAGO 6
565 W. WASHINGTON BLVD.

MILWAUKEE 2 — 312 East Wisconsin Ave.

Representatives in: DETROIT 2 — 11341 Woodward Ave.

MINNEAPOLIS 3 — 1208 Harmon Place • PEORIA 5 — 101 Heinz Court



CLEVELAND 14
1231 SUPERIOR AVE., N. E.

DAYTON 2 — 1315 Mutual Home Bldg.



Frequency-Modulation radio reception is virtually free from natural static—even thunderstorms do not interrupt.

FM Radio—another world in listening pleasure!

It's as though the orchestra were right in the room with you—and the room suspended in the silence of space. When you listen to music over RCA Victor FM, *you hear FM at its finest.*

Natural static interference ordinarily caused by thunderstorms does not mar FM radio reception. You are in a different, new world of utter quiet where you hear only the lifelike music. Moreover, you enjoy the same perfect reception day or night.

The vast experience, research and skills at RCA Laboratories, such as aided in the development of RCA Victor

FM, are constantly applied to all RCA products, so that each one is always at the top of its field.

And when you buy anything bearing the RCA or RCA Victor name—whether it's a radio (standard, or FM, or both), a television receiver, Victrola radio-phonograph, a phonograph record or a radio tube, you know you are getting one of the finest of its kind that science has yet achieved.

Radio Corporation of America, RCA Building, Radio City, New York 20 . . . Listen to The RCA Victor Show, Sundays, 2:00 P.M., Eastern Time, over NBC. "Victrola" T.M. Reg. U. S. Pat. Off.



With the new RCA Victor AM-FM sets you'll hear FM radio—and standard AM radio too, at their finest. Ask your RCA Victor dealer for a demonstration of the fine new Crestwood series of Victrola AM-FM radio-phonographs.



RADIO CORPORATION of AMERICA

profit engineering with C-D Capacitors



Perhaps you're starting from scratch with a completely new product. Maybe you're sprucing up an old one. Or possibly you'd like to tighten assembly costs—bring your soaring break-even point back to earth. Regardless of what your specific problem may be, if capacitors play a part in your plans, C-D engineers can do a job of profit engineering for you.

Unequaled specialization has enabled us to design and build over 250,000

different types of capacitors. Typical of this experience are the capacitors shown below—designed by C-D engineers to meet the specific production and profit problems of manufacturers like yourself.

CATALOG OF STANDARD TYPES AVAILABLE ON REQUEST

Cornell-Dubilier Electric Corporation,
Dept. M4, South Plainfield, New Jersey.
Other large plants in New Bedford,
Worcester and Brookline, Mass., and
Providence, R. I.

MICA • DYKANOL • PAPER • ELECTROLYTIC

CORNELL-DUBILIER
world's largest manufacturer of
CAPACITORS

1910



1947

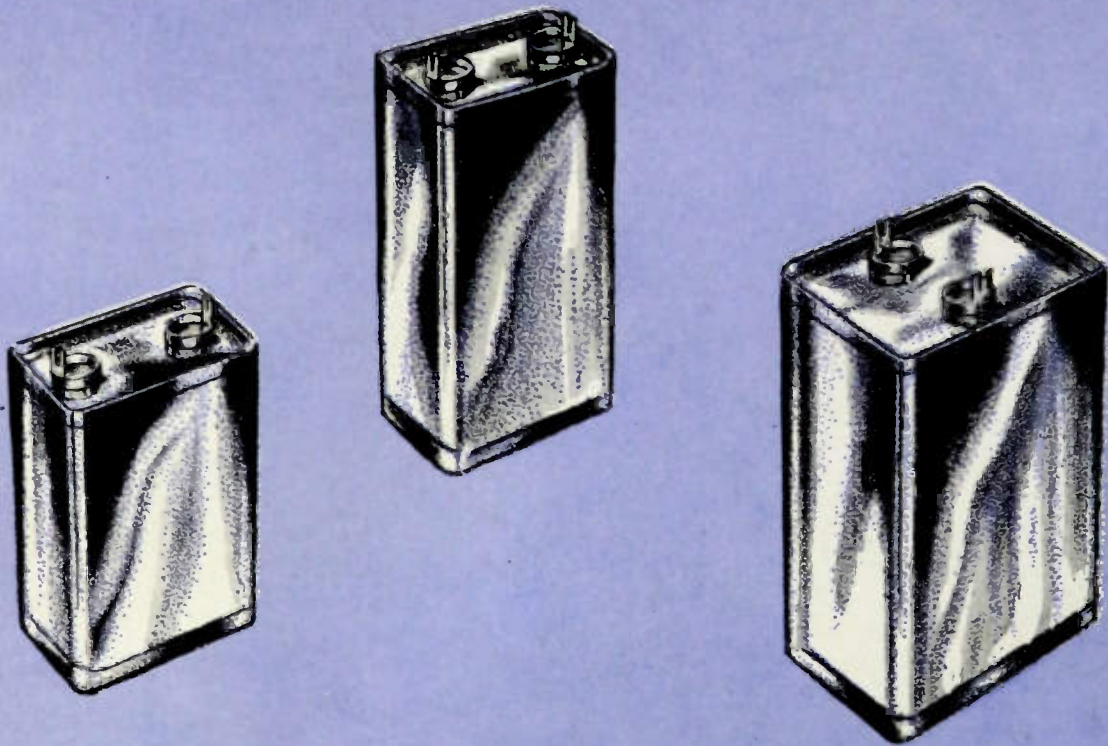

TYPICAL C-D MADE-TO-ORDER CAPACITORS

DESIGNATED AS THE TYPE HKG SERIES, these hermetically-sealed capacitors are available in a wide range of capacities at 2,000 and 2,500 V.D.C. Ruggedly constructed, they embody the research experience of over 37 years devoted exclusively to capacitors.

METERS—by

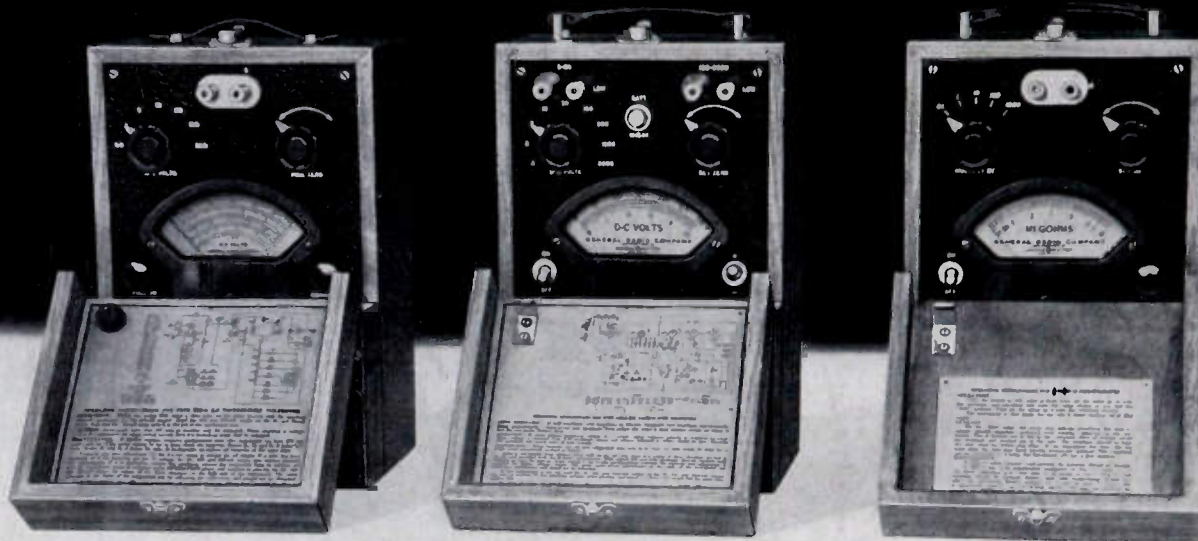

TYPE 727-A VACUUM-TUBE VOLTMETER

This general-purpose, battery-operated v-t voltmeter is for use at frequencies up to about 100 megacycles.

RANGE—0.05 volt to 300 volts ac, in seven ranges (0.3, 1, 3, 10, 30, 100, 300 volts, full scale)

ACCURACY—With sinusoidal voltages applied, the accuracy is $\pm 3\%$ of full scale on the 0.3-volt range and $\pm 2\%$ of full scale on all other ranges. Periodic checking of the full-scale sensitivity will give corrections to be made to eliminate effects of aging on the higher voltage ranges.

WAVEFORM ERROR—On lowest ranges the instrument approximates a true square-law device. It is calibrated to read the r-m-s value of a sinusoidal voltage. On the higher voltage ranges it is essentially a peak-reading instrument calibrated to read 0.707 of the peak values and on distorted waveforms the percentage deviation from r-m-s values may be as large as the percentage of harmonics present.

FREQUENCY ERROR—Less than 1% between 20 cycles and 30 Mc. At 65 Mc the error is about $\pm 5\%$ and at 100 Mc about $\pm 10\%$.

INPUT IMPEDANCE—The input capacitance is about 16 micromicrofarads. Parallel input resistance (at low frequencies) is about 5 megohms on the lower ranges and about 3 megohms on the upper.

PRICE: \$125*

TYPE 728-A D-C VACUUM-TUBE VOLTMETER

This battery-operated v-t voltmeter is designed for measuring d-c voltages in low-power circuits where no appreciable power can be taken by the meter.

RANGE—0.05 to 3000 volts in seven ranges (3, 10, 30, 100, 300, 1000, 3000 volts, full scale)

ACCURACY—Within $\pm 3\%$ of full scale on all ranges. If the full-scale sensitivity is checked occasionally the effect of aging, on the higher voltage ranges, can be eliminated.

INPUT RESISTANCE—1000 megohms on the ranges above 100 volts; greater than 5000 megohms on the lower

TERMINALS—Two sets of input terminals are provided; one for measurements at the 0 to 30 volts end of the range and the other for higher voltages.

POLARITY—A reversing switch on the panel permits measurements with either the positive or the negative of the source grounded to the panel of the instrument.

EFFECT OF A-C—A superimposed a-c voltage of as high as 200 volts has negligible effect on meter indication.

PRICE: \$125*

TYPE 729-A MEGOhmmETER

This battery-operated megohmmeter is particularly useful where portability is required. It is well suited to field measurements of leakage resistance of cables and insulation.

RANGE—2000 ohms to 50,000 megohms in five overlapping ranges

SCALE—Standard direct-reading ohmmeter calibration is used; center scale values are .1, 1, 10, 100 and 1000 megohms

ACCURACY—Within $\pm 5\%$ of the indicated value between 30,000 ohms and 3 megohms when the central decade of the scale is used; otherwise the error is increased because of the compressed scale.

TEMPERATURE AND HUMIDITY—Effects of these are negligible over normal range of room conditions (65 to 95 deg. F.; 0 to 95% relative humidity)

VOLTAGE ON UNKNOWN—Voltage applied to the unknown does not exceed 22½ volts and varies with meter indication.

PRICE: \$95*

*Plus 10% temporary price increase, due to greatly increased costs

THESE three accurate, highly stable and portable meters are all battery-operated and completely self-contained. They are housed in identical walnut cabinets 11 inches by 6½ inches by 5½ inches in size. Their accuracy is sufficient for a wide variety of measurements both in the laboratory and in the field.

Other G-R meters include a portable a-c operated vacuum-tube voltmeter for audio and radio frequency measurements up to several hundred megacycles, a crystal galvanometer direct-reading in voltage between 30 and 1,000 megacycles, an a-c operated megohmmeter with a range of 2,000 ohms to 50,000 megohms, a counting rate meter for measuring random emanations from radio-active materials, three models of output-power meters, and an audio-frequency microvoltmeter with an output voltage range of 0.1 microvolt to 1 volt.

G-R meters are carefully designed, correctly engineered, ruggedly constructed and accurately calibrated to insure many years of useful life.

WRITE FOR COMPLETE INFORMATION

GENERAL RADIO COMPANY

Cambridge 39,
Massachusetts

90 West St., New York 6

920 S. Michigan Ave., Chicago 5

950 N. Highland Ave., Los Angeles 38