

PROCEEDINGS OF THE I-R-E



AND



WAVES AND ELECTRONS

October, 1946

Volume 34

Number 10

PROCEEDINGS
OF THE I.R.E.

Equivalent Circuit for Plane Discontinuity in Wave Guide

Impulse Noise in F-M Receivers

Direction Finding at 1.67 Meters

Waves and Electrons
Section

Microwave Measurements

Oscillator Stability and Frequency Pulling

L-C Oscillator as Frequency Divider

Wide-Band Wattmeter for Wave Guide

Abstracts and References

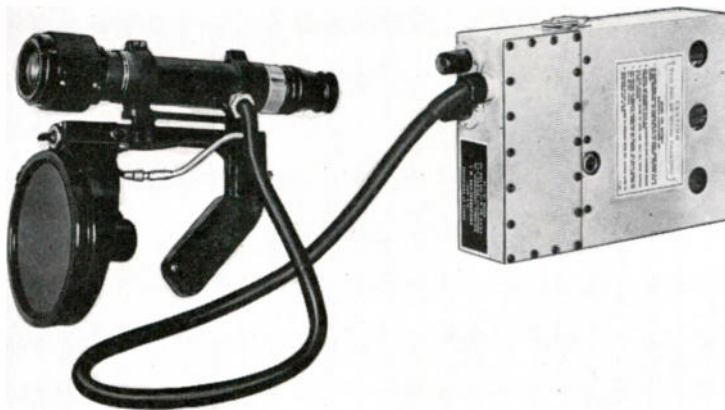

Electronic Laboratories, Inc., of Indianapolis

THE GAP NARROWS IN THE ELECTROMAGNETIC-WAVE SPECTRUM

Infrared Beam Projectors Illuminate Night Scene; Photoelectrically Produced Electrons Excite Fluorescent Screen to Produce Visible Image, then Magnified Optically. Above: Rifle for Repelling Night Infiltrations by Enemy. Below: Beam Projector and Viewer as Separate Unit—A Device of Possible Peacetime Application.

The Institute of Radio Engineers



FOR HIGH Q

In tuned circuits, filters, etc., the Q (efficiency factor) of the coils employed is a paramount performance factor. Having specialized in this field for many years, UTC has developed a number of standardized types of coils ideally suited to filter applications.



VI-C INDUCTOR

The UTC VI-C Inductor is an exclusive item of tremendous value in filter construction. This inductor is tunable over a range of +100% -50% from the nominal value, permitting precise circuit tuning using commercial tolerance capacitors. Standard units are available in nominal inductances from 10 Mhys. to 10 Hys. These units weigh 5 ounces, measure 1 1/4" x 1-7/16" x 1-7/16"



HQA REACTOR

These reactors are designed for audio frequency operation with high Q and excellent stability. For a typical coil, (.14 Hy.), inductance varies less than 1% from .1 to 25 volts. Q is 120 at 5,000 cycles. Hum pickup is low (toroidal structure), 70 Mv. per gauss at 60 cycles. Variation in inductance less than 1/3% from -60° C. to +85° C. Hermetically sealed in drawn case 1-13/16" diameter x 1-3/16" high. Weight 5 ounces. Available in inductance values from 5 Mhys. to 2 Hys.



HQB REACTOR

The HQB reactors are similar to the HQA series, but provide higher Q. For a typical coil, (.45 Hy.), inductance varies less than 1% with applied voltage from .1 to 50 volts. Hum pickup twice that of HQA. Variation of inductance less than 1/3% from -50° C. to +85° C. Q is 200 at 4000 cycles. Hermetically sealed in steel case 1 3/8" x 2 3/8" x 2 1/2" high. Weight 14 ounces. Available in any inductance value from 5 Mhys. to 12 Hys.

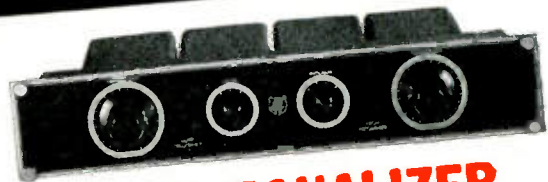

3 AX EQUALIZER

The Universal equalizer for broadcast and recording service. Provides up to 25 DB adjustable equalization at 25, 50, or 100 cycles for low end, and at 4000, 6000, 8000 or 10,000 cycles at high end. Calibrated controls read directly in DB equalization and frequency setting. The insertion loss effected is compensated for through special compensating pads so that insertion loss is constant regardless of setting. Rapid change in tone color can be obtained with negligible change in volume.

Descriptive circulars are available for each of the above products

United Transformer Corp.
150 VARICK STREET NEW YORK 13, N. Y.

EXPORT DIVISION: 13 EAST 40th STREET, NEW YORK 16, N. Y., CABLES: "ARLAB"

Now Available!

MICROWAVE TEST AND MEASUREMENT EQUIPMENT BY



A.R.C. 24,000 Mc. wavemeter and attenuator, built to highest precision standards through unique split-plate method of construction.

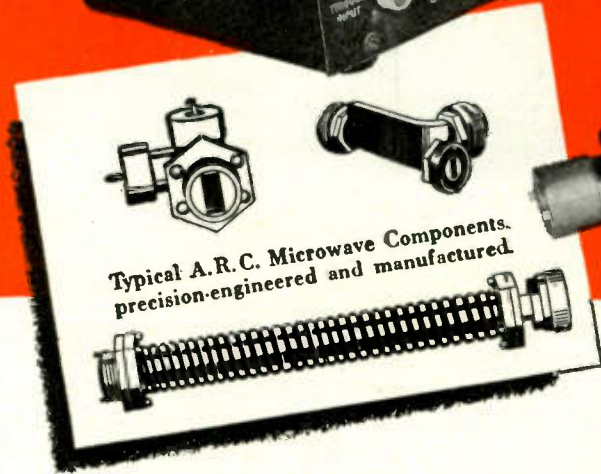
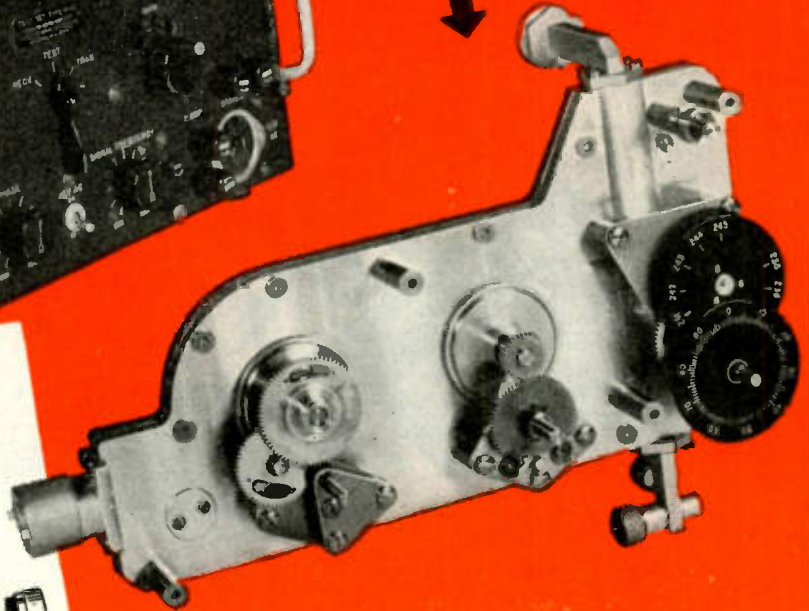

Recently released from Army-Navy classification, this equipment, formerly known as the TS-223/AP, is now being produced by Aircraft Radio Corporation as the A.R.C. Test Set, Type H-10.

This highly specialized test equipment is used primarily for the measurement of radar receiver sensitivity, frequency and band width; and transmitter power and frequency, in the

24,000 Mc. band. Other field or laboratory measurements possible with this equipment include testing of type 2K50 r-f oscillator tubes and measurement of radar receiver recovery time.

The heart of the A.R.C. Test Set, the 24,000 Mc. wavemeter and attenuator, is available separately, if desired.

For full information on A.R.C. microwave accessories and component parts, write

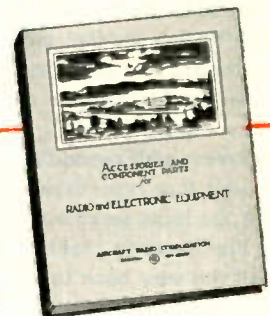

NOW AVAILABLE: free, illustrated catalog of A.R.C. Radio and Electronic Component Parts and Accessories



AIRCRAFT RADIO CORPORATION

708 Main Street

BOONTON, NEW JERSEY



PROCEEDINGS OF THE I.R.E. AND WAVES AND ELECTRONS, October, 1946, Vol. 34, No. 10. Published monthly in two sections by The Institute of Radio Engineers, Inc., at 330 West 42nd Street, New York 18, N.Y. Price \$1.00 per copy. Subscriptions: United States and Canada, \$10.00 a year; foreign countries \$11.00 a year. Entered as second class matter, October 26, 1927, at the post office at Menasha, Wisconsin, under the act of March 3, 1879. Acceptance for mailing at a special rate of postage is provided for in the act of February 28, 1925, embodied in Paragraph 4, Section 412, P. L. and R., authorized October 26, 1927.

Table of contents will be found following page 32A

AEROVOX CAPACITORS
 are backed by
QUALITY CONTROL
 ...eliminating defects at
 the source



• When that Aerovox sales engineer takes your order, he releases the chain reaction of **QUALITY CONTROL**.

First, he has studied your particular application. From long and specialized experience, he knows circuits, constants, components. He is backed by an engineering staff second to none. So he sells only that type capacitor that can render the most service at least cost.

At the Aerovox plant that order reacts all the way back to raw materials.

Aerovox maintains a complete process average of all its vendors. Incoming materials are critically inspected. For example: over 12,000 chemical tests are made each month!

Then there are quality control checks at every step in production. Defective materials or workmanship just can't get by. Defective units are simply not produced.

Finally, the Aerovox Quality Control Department plots daily test data to de-

termine that the process is in control at all times. When any part of the process is out of control, production stops; the situation is investigated and corrected. Thus, the possibility of any defectives screening through is lessened more than ever before. You have utmost assurance that these capacitors are thoroughly dependable.

Yes indeed, Aerovox **QUALITY CONTROL** is your gain quite as well as ours.

• Let us apply **QUALITY CONTROL** to your capacitance problems and needs!



FOR RADIO-ELECTRONIC AND INDUSTRIAL APPLICATIONS

AEROVOX CORPORATION, NEW BEDFORD, MASS., U.S.A.

SALES OFFICES IN ALL PRINCIPAL CITIES • Export: 13 E. 40th St., New York 16, N. Y.

Cable: 'ARLAB' • In Canada: AEROVOX CANADA LTD., HAMILTON, ONT.

INSTANT ACTION



When you want it
where you want it with

alliance MOTORS

The Model 80 Phonomotor has been the outstanding favorite of manufacturers and jobbers who want a power source that's smooth, quiet, and time-tested. This is the No. 1 motor for driving turntables and record changers!

Other Alliance Powr-Pakt Motors will open and close valves, switches, operate toys and motion displays, actuate parts in business and vending machines, and can be used as component power sources in electronic control systems.



Modern design calls for "tailored power"

Alliance motors are rated as low as 1/400th h.p. on up to 1/20th h.p. They are small, compact and some weigh less than one pound. They furnish economical driving energy to meet the special demands of small loads. Some are uni-directional—others are reversible—some are for continuous duty—others for intermittent operation.

Alliance Powr-Pakt motors are mass produced, precision made and low in cost. They can help you get *instant action*—when you want it—and where you want it! Write today.

WHEN YOU DESIGN—KEEP

alliance

MOTORS IN MIND

ALLIANCE MANUFACTURING COMPANY • ALLIANCE, OHIO



Solar Proudly Presents

A NEW
Capacitor Dielectric

S O L A R M A N U F A C T U R I N G
GENERAL OFFICES: 285 MADISON AVENUE, NEW YORK 17, N. Y.
PAPER, MICA AND ELECTROLYTIC CAPACITORS FOR

SUPEREX by Solar

SUPEREX*, Solar's superb new oil-impregnant for paper dielectric capacitors, is the result of a long-time program of research and development. Its entry into mass production under rigid standards of quality control marks another Solar contribution to the electrical industry.

SUPEREX gives to the electrical industry a capacitor dielectric material with the following outstanding properties:

1. Low Power Factor
2. Long Life
3. High Flash Point
4. Non-Inflammability
5. Non-Corrosiveness
6. Stabilized for Operation at High Temperatures, 85°C for DC, 75°C for AC
7. High Insulation Resistance
8. High Dielectric Constant

NOW available to the electrical and electronic manufacturing industries after months of heavy pilot plant production and test by leading capacitor users in the United States, SUPEREX stands forth today as the ideal capacitor impregnant for most applications. Tests by those who have already used SUPEREX capacitors have won this new material unqualified approval.

*Trade Mark

SUPEREX assures outstanding performance in motor phase-splitting capacitors, energy storage capacitors, all light and heavy-duty capacitors used in communication and industrial electronic equipment, and in capacitors for power factor correction.

SOLAR has now completed a new plant for mass production of SUPEREX capacitors. This ultra-modern plant with the latest developments in high-vacuum processing equipment, is supplying daily increasing quantities of SUPEREX capacitors to those who need the utmost in capacitor performance and reliability.

SOLAR will be glad to tell you how you can utilize the advantages of SUPEREX capacitors in your applications. A letter today will bring you the benefit of Solar's authoritative experience in solving capacitor problems.

P. S. Do you read The Solar System for regular news on developments in the capacitor field?

If not, drop us a note to place your name on the mailing list

without charge.



Ⓢ 1844

C O R P O R A T I O N

PLANTS AT CHICAGO, ILL.; NORTH BERGEN AND BAYONNE, N. J.

THE ELECTRICAL AND ELECTRONIC INDUSTRIES

Why

this team sets the

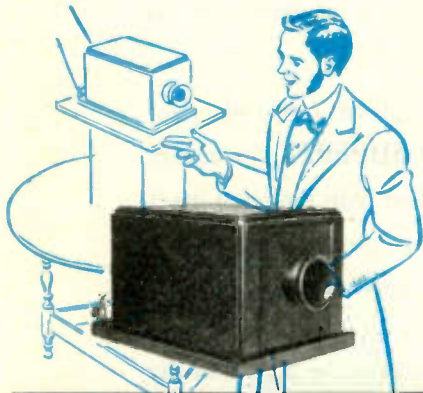

1877: Grand-daddy of all microphones was Alexander Graham Bell's box telephone, into which Thomas A. Watson shouted and sang in the first intercity demonstrations of the infant art of telephony.



1920: Telephone scientists developed the first successful commercial mike—the double carbon button air-damped type. Used first in public address systems, it later became the early symbol of broadcasting.

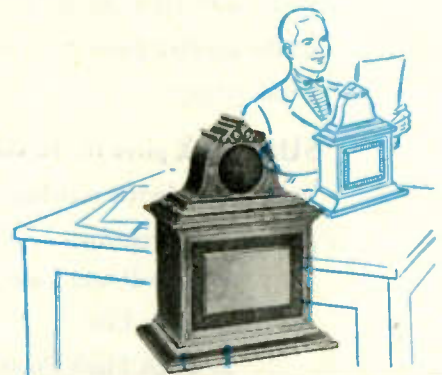

1921: The condenser microphone, designed by Bell Laboratories for sound measurement in 1916, entered the public address and broadcasting fields. It provided a wide frequency range and reduced distortion.



1937: The Western Electric "Machine Gun" mike does for sound pick-up what the telephoto lens does for photography. Sharply directional, this microphone makes sound "close-ups" of unusually long range.



1938: Cardioid directional microphone, with ribbon and dynamic elements, was the first mike ever to combine 3 pick-up patterns in one instrument. The later 639B, with 6 patterns, is also one of the finest all-purpose mikes ever made.

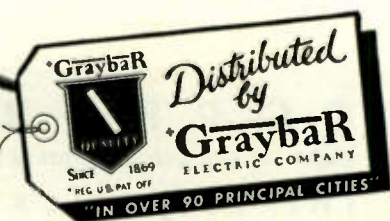

pace in Microphone Development



1931: Bell Telephone Laboratories developed the Western Electric moving coil or dynamic microphone. The first of its kind, it was rugged, noiseless, compact, and needed no polarizing energy. Many are still in use.



1935: The first non-directional mike—the famous Western Electric 8-Ball, designed by Bell Laboratories. Small, spherical, it provided top quality single mike pick-up of speech or music from every direction.



1936: Directional with slide-on baffle, non-directional without it, the Western Electric Salt Shaker gave highest quality pick-up at new low cost. Widely used in studios and remotes as well as in high quality sound distribution.



1946: No larger in diameter than a quarter, the 640 Double-A condenser mike (shown with associated amplifier) is ideal for single mike high fidelity pick-ups. It was originally designed as a laboratory test instrument.

What is a microphone? Fundamentally it's a device which converts sound into electrical energy—just what Bell's original telephone did for the first time away back in the seventies.

Today's Western Electric mikes—the Salt Shaker, Cardioid and 640 Double-A—are a far cry from the first crude, close-talking telephone transmitter. But they're its direct descendants.

Year after year, Bell Telephone scientists—through continuing research—have developed finer and finer telephones and microphones.

Year after year, Western Electric has manufactured these instruments, building quality into each one.

Together these teammates have been responsible for almost every important advance in microphone development.

Whether you want a single mike, a complete broadcasting station, or radio telephone equipment for use on land, at sea or in the air, here's the point to remember:

If Bell Telephone Laboratories designed it and Western Electric made it, you can be sure there's nothing finer.



BELL TELEPHONE LABORATORIES

World's largest organization devoted exclusively to research and development in all phases of electrical communications.

Western Electric

Manufacturing unit of the Bell System and the nation's largest producer of communications equipment.

THE LOGICAL CHOICE...

Eimac 4-250A Tetrode

ELECTRICAL CHARACTERISTICS—EIMAC 4-250A

Filament: Thoriated Tungsten	5.0 volts
Voltage	14.5 amps
Current	250 watts
Plate Dissipation (Maximum)	
Direct Interelectrode Capacitances: (Average)	
Grid-Plate (Without shielding)	0.12 μ ufd
base grounded	12.7 μ ufd
Input	4.5 μ ufd
Output	

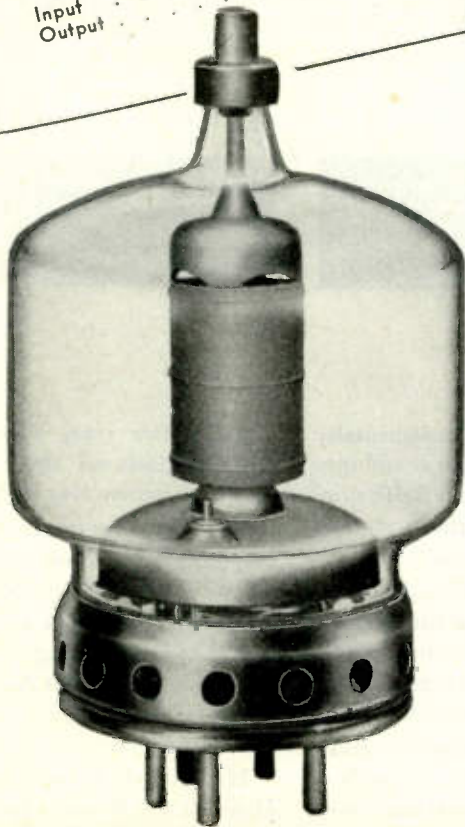

Proven performance is the reason why the EIMAC 4-250A tetrode is the logical choice when a dependable power-amplifier tube is needed. Below are listed characteristics and design features of the EIMAC 4-250A which explain why this tetrode is *picked for power*.

HIGH POWER—LOW DRIVE:

At frequencies up to 70 Mc. the EIMAC 4-250A develops a power output of 750 watts with a drive of less than 6 watts.

LOW PLATE—GRID CAPACITANCE:

Extremely low plate to grid capacitance, only 0.12 μ ufd, permits operating without neutralization in many cases—simplifies neutralization in others.

OPERATIONAL STABILITY:

The unique arrangement of low inductance leads, plus especially treated grids insures exceptionally stable operation.

COMPACT—RUGGED:

Approximately $3\frac{1}{2} \times 6\frac{1}{2}$ inches in size, the 4-250A has been constructed to withstand abnormal abuse—and give extra long life.

The 4-250A is just one of a host of EIMAC tubes designed for long-life and trouble-free operation. Investigate the possibilities of their use in your transmitters today. Contact your nearest EIMAC representative, or write direct for full technical information.

EITEL-McCULLOUGH, INC., 1265E San Mateo Ave., San Bruno, Calif.
Export Agents: Frazar and Hansen, 301 Clay St., San Francisco 11, Calif., U.S.A.

CALL IN AN EIMAC REPRESENTATIVE FOR INFORMATION

ROYAL J. HIGGINS (W9AIO), 600 So. Michigan Ave., Room 818, Chicago 5, Ill., Phone: Harrison 5948.

VERNER O. JENSEN, Verner O. Jensen Company, 2616 Second Ave., Seattle 1, Wash., Phone: Elliott 6871.

M. B. PATTERSON (W5CI), Patterson & Co., 1124 Irwin-Keaster Bldg., Dallas 1, Tex., Phone: Central 5764.

ADOLPH SCHWARTZ (W2CN), 220 Broadway, Room 2210, New York 7, N. Y., Phone: Cortland 7-0911.

HERB BECKER (W6QD), 1406 So. Grand Avenue, Los Angeles 15, California, Telephone: Richmond 6191.

TIM COAKLEY (W1KKP), 11 Beacon Street, Boston 8, Massachusetts, Telephone: Capitol 0050.

RONALD G. BOWEN, 1886 South Humboldt Street, Denver 10, Colorado, Telephone: Spruce 9368.

JAMES MILLAR ASSOCIATES, J. E. Joyner, Jr. (W4YO) 1000 Peachtree Street, N.E., Atlanta, Georgia.

Follow the Leaders to

Eimac
REG. U. S. PAT. OFF.
TUBES

THE COUNTERSIGN
OF DEPENDABILITY IN ANY
ELECTRONIC EQUIPMENT

For Performance and Dependability

Another endorsement of

EIMAC 4-250A TETRODES

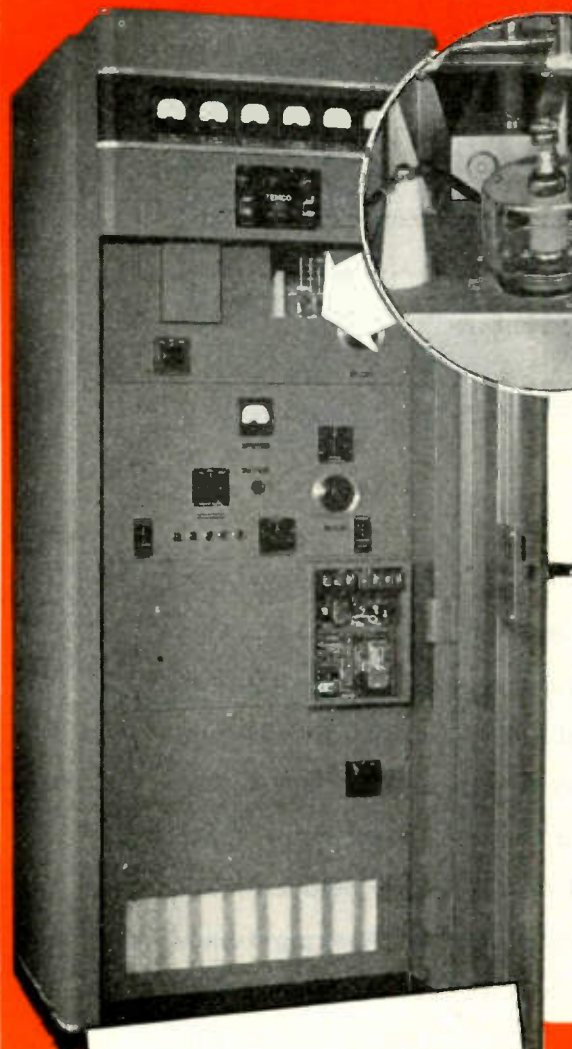

TEMCO 1000-GA

The Transmitter Equipment Manufacturing Company's 1000-GA is a radio telephone and telegraph manually-controlled transmitter for operation on 5 frequency bands. It is rated at 1. KW input for phone and CW, on 5 crystal-controlled frequencies from 3.5 to 29.7 megacycles

In the power amplifier of the 1000-GA transmitter, TEMCO employs two EIMAC 4-250A tetrodes to obtain a kilowatt input on CW and high level modulated radio telephone. The characteristics of this tube make it the obvious choice for this assignment.

The low driving power requirements of the EIMAC 4-250A permitted TEMCO engineers to build an exciter stage combining new simplicity with greater ease in servicing. Also contributing to circuit simplicity is the low plate-grid capacitance of these tetrodes (0.12 *uufd*) which means that neutralization is ordinarily unnecessary at frequencies up to 40 Mc.

TEMCO is one of a number of large electronic equipment manufacturers using EIMAC tubes. No matter what your power requirement, there's a dependable, long-lasting EIMAC tube for the job.

Follow the Leaders to

Eimac
REG. U. S. PAT. OFF.
TUBES

EITEL-McCULLOUGH, INC., 1265 E San Mateo Ave., San Bruno, Calif.
Export Agents: Frazar and Honsen, 301 Clay St., San Francisco 11, Calif., U. S. A.

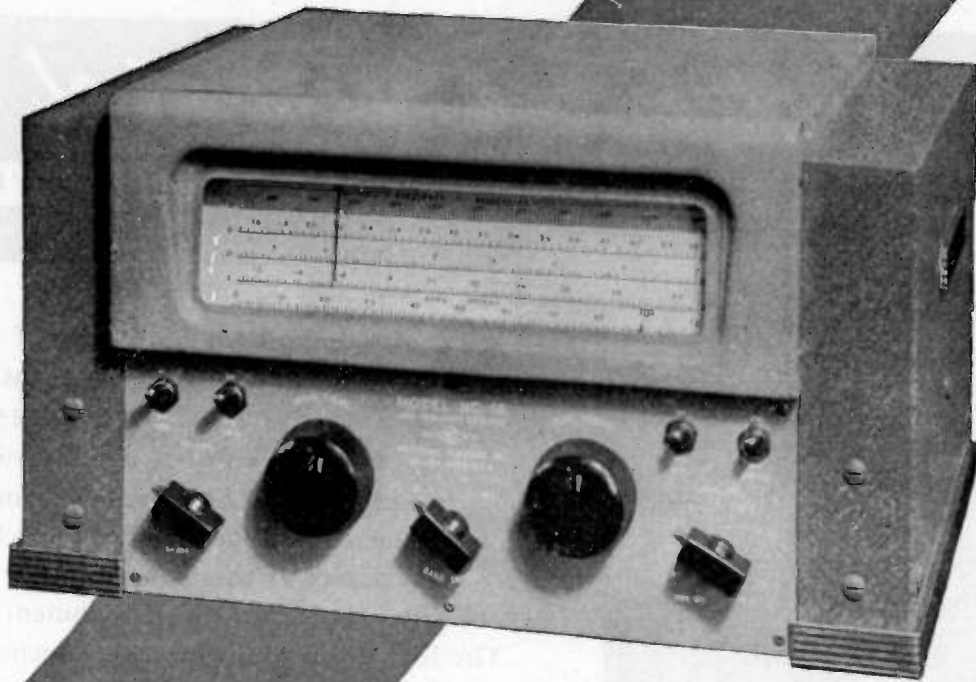

NC-46

Clean modern styling combines with advanced electrical design to make the NC-46 an outstanding choice for the amateur. Workmanship is of traditional National quality in spite of moderate price. Features of the NC-46 include a series valve noise limiter with automatic threshold control, CW oscillator, separate RF and AF gain controls, and amplified and delayed AVC. Four coil ranges cover from 550 Kc. to 30 Mc. A straight-line-frequency condenser is used in combination with a separate bandspread condenser. Look over an NC-46 at your dealer's, study it inside and out. It's a lot of receiver for your money.

NATIONAL COMPANY, INC.



MALDEN, MASSACHUSETTS



VITAL DEVELOPMENTS IN NEW 889R-A

these bring impressive improvements in:

1 — MECHANICAL STRENGTH

2 — HIGH FREQUENCY OPERATION AT PEAK VOLTAGE LEVELS

REPORT....

Summary of Developments

Both filament and grid structures are mounted from one piece, oxygen free, high conductivity copper supports (A) making possible the use of heavy shoulder sections (B). The older, outmoded structure necessitated both the internal brazing of thimble and the external brazing of a small reinforcing disk. Complete elimination of the brazing procedure eliminates not only a weaker mechanical area but also its detrimental effects on the copper and the glass seal. A strong conical form (C) replaces the less desirable cylindrical form at the seals (D). The anode and grid shields (E) have been relocated and redesigned.

Summary of Tests

Distortion: Equal forces were applied to the old and new structures (Fig. 1). The old structure was heavily distorted; the new structure showed no change. Force on the new structure was increased in the endeavor to distort it, but the glass dish invariably failed first (Fig. 2).

Thermal Fatigue: At the end of 200 cycles no apparent fatigue fail-

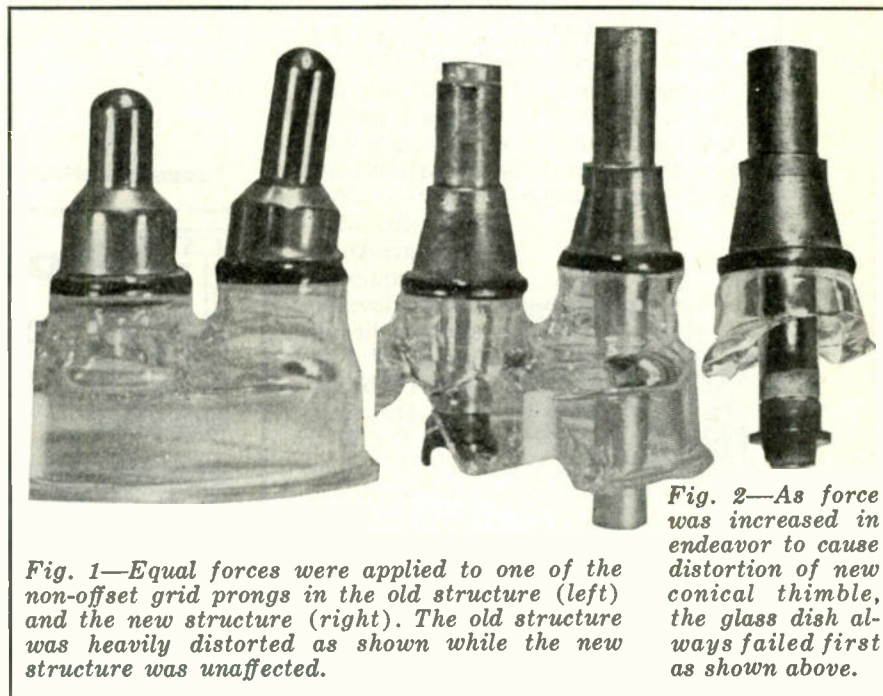

Fig. 1—Equal forces were applied to one of the non-offset grid prongs in the old structure (left) and the new structure (right). The old structure was heavily distorted as shown while the new structure was unaffected.

Fig. 2—As force was increased in endeavor to cause distortion of new conical thimble, the glass dish always failed first as shown above.

ure was discernible, thus assuring freedom from grid-filament shorts caused by stresses on the terminals.

Copper Seals: Copper seals were chosen for this tube because the pure metal is non-magnetic, has very low rf resistance and high conductivity. The seals were not heated by rf during operation. Terminals ran much cooler.

Electric Field: Relocation and redesigning of the anode and grid shields reduced the high concentration of the electric field in the glass envelope. Glass heating and resultant punctures were traced to this concentration in the out-moded design.

Conclusion: The redesigning has resulted in an impressive increase in mechanical strength and improvement in high frequency operation at peak voltage levels.

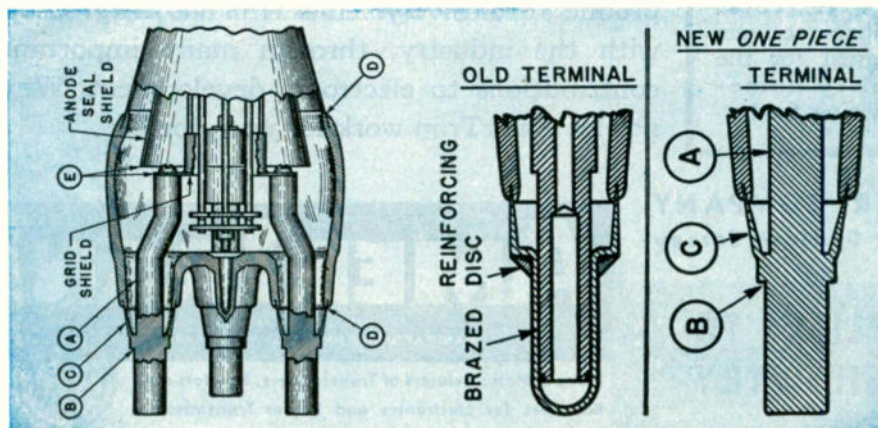

WRITE FOR technical rating and data sheets.

**AMPEREX
ELECTRONIC
CORPORATION**



25 WASHINGTON STREET, BROOKLYN 1, N. Y.
In Canada and Newfoundland: Rogers Majestic Limited
622 Fleet Street West, Toronto 2B, Canada

AMERTRAN TRANSFORMERS

ARE *designed into* THE SPECIFICATIONS
OF PROGRESSIVE ELECTRONIC MANUFACTURERS

Federal BROADCAST TRANSMITTERS

● AmerTran Transformers and Reactors have been specified for Federal Transmitters over a period of many years. WABC's 50,000 watt station, OWI's 200,000 watt Tokyo Broadcast Pacific stations, CBS short wave and many other important Federal

installations are AmerTran-equipped. Latest development is the new series of Federal AM broadcast transmitters, 5 KW to 50 KW, AmerTran-equipped, now in process of manufacture.

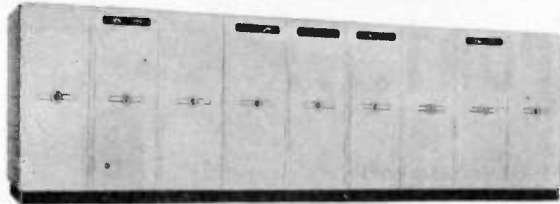

PRESS WIRELESS COMMERCIAL AND GOVERNMENT TRANSMITTERS

● Internationally known Press Wireless, Inc. depend upon AmerTran Transformers and Reactors in their world wide communications network. Press

Wireless Manufacturing Corporation Engineers design AmerTrans into their streamlined transmitters for commercial and government use.



DUMONT

"20-20 teleVISION"
for
home entertainment

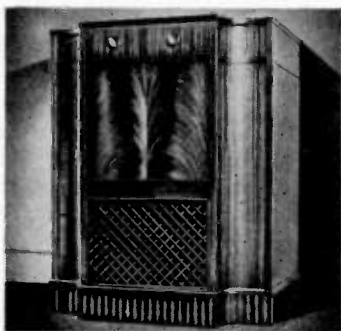

Allen B. Du Mont Laboratories, Inc., authorities in modern television, use AmerTran Transformers in their de luxe receivers designed for the quality home-television field.

AMERTRAN engineers have "grown up" with the electronics industry. The entire AmerTran organization is streamlined for efficient design and manufacture of transformers and allied products exclusively. AmerTran has *progressed* with the industry, through many important contributions to electronic development. Why not let AmerTran work for you, too?

AMERICAN TRANSFORMER COMPANY
178 Emmet Street • Newark 5, New Jersey

TRANSFORMER SUPPLIERS TO
THE ELECTRONICS INDUSTRY

AMERTRAN

REG. U. S. PAT. OFF.
MANUFACTURING SINCE 1901 AT NEWARK, N. J.

Pioneer Manufacturers of Transformers, Reactors and
Rectifiers for Electronics and Power Transmission



MAKING TUBES IS EASY...



If
**YOU KNOW
HOW!**

↑ Hytron commercial engineer makes precision measurements of 50L6GT performance in many typical radio receivers. He then compiles weighted averages of tube characteristics selected to be correlated for functional testing.

Out of the commercial engineer's investigations grows this functional production tester. Combined functional and standardized tests are quicker. Operator can be even more accurate, and you are assured of more uniform performance. →

FUNCTIONAL TESTING..

You may have discovered that a tube rigidly inspected by standardized testing procedures (JAN, RMA, IRE) still may not perform satisfactorily in your equipment. Ordinary control of basic characteristics may not be enough. Functional dynamic tests—selected and correlated to simulate performance in typical equipment applications—may have to be added.

Simple analogy explains why. Testing of fundamental tube characteristics is like inspection of individual components of multi-ganged tuned circuits. When the tuner is assembled or the tube connected into a circuit, coils and condensers or tube characteristics may not combine properly. Individual variations within tolerances may be in opposition. Operational tests are the only positive checks.

Hytron commercial engineers, therefore, developed functional testers like the illustrated 50L6GT production test kit

Another **HYTRON EXTRA!**

—essentially a customary equipment circuit. Whether or not a part of the standardized tests, 50L6GT characteristics related to power sensitivity and output are simultaneously checked for smooth dynamic interaction. This comprehensive functional test automatically includes additional minor tests—pertinent but usually omitted from production testing. Hum itself is also measured, because no basic characteristic test controls it adequately.

Functional testing is another Hytron extra. Based on painstakingly acquired know-how, it is often the best and easiest way to assure you of uniform, reliable tube performance in your equipment.

SPECIALISTS IN RADIO RECEIVING TUBES SINCE 1921



HYTRON

RADIO AND ELECTRONICS CORP.

MAIN OFFICE: SALEM, MASSACHUSETTS





. . . Impromptu Discussions about Miniature Tubes

Sure audio voltage amplifiers are available in miniatures



. . . TUNG-SOL Miniatures 1S5, 6AQ6, 6AT6 and 12AT6.

Those AT6's are used for about everything . . . automobile or household receivers, television, aircraft, marine equipment, public address systems and industrial instruments. They give top-notch performance, they are rugged and they are small . . . everything you are looking for in a tube.

With voltage gains ranging between 37 at 100 volts supply to 47 at 300 volts, they are ideally suited to the economical "grid

current biased" circuit resulting in remarkable uniformity from tube to tube. The AT6's are designed to provide distortionless output voltage adequate to drive the power stages to full output with but a few tenths of a volt input signal. And don't forget the two diodes which permit high efficiency detection in the same tube. Low capacity coupling to the triode grid and low electronic

coupling between the two diodes both add to this tube's versatility.

You can use AT6's with either the diodes or the triode not connected in the circuit. With sufficiently high plate supply voltage, they are adaptable to d.c. amplification of the diode output providing a useful circuit for field strength meters and a lot of other industrial applications.

Why don't you talk to the TUNG-SOL service engineers about their miniatures. You can, without tipping your hand. You know they don't build sets.



TUNG-SOL
vibration-tested
ELECTRON TUBES

TUNG-SOL LAMP WORKS INC., NEWARK 4, NEW JERSEY
Sales Offices: Atlanta • Chicago • Dallas • Denver • Detroit • Los Angeles • New York
Also Manufacturers of Miniature Incandescent Lamps, All-Glass Sealed Beam Headlight Lamps and Current Intermittors

AT LAST—A COMPLETE COMMUNICATION SYSTEM IN ONE "PACKAGE"

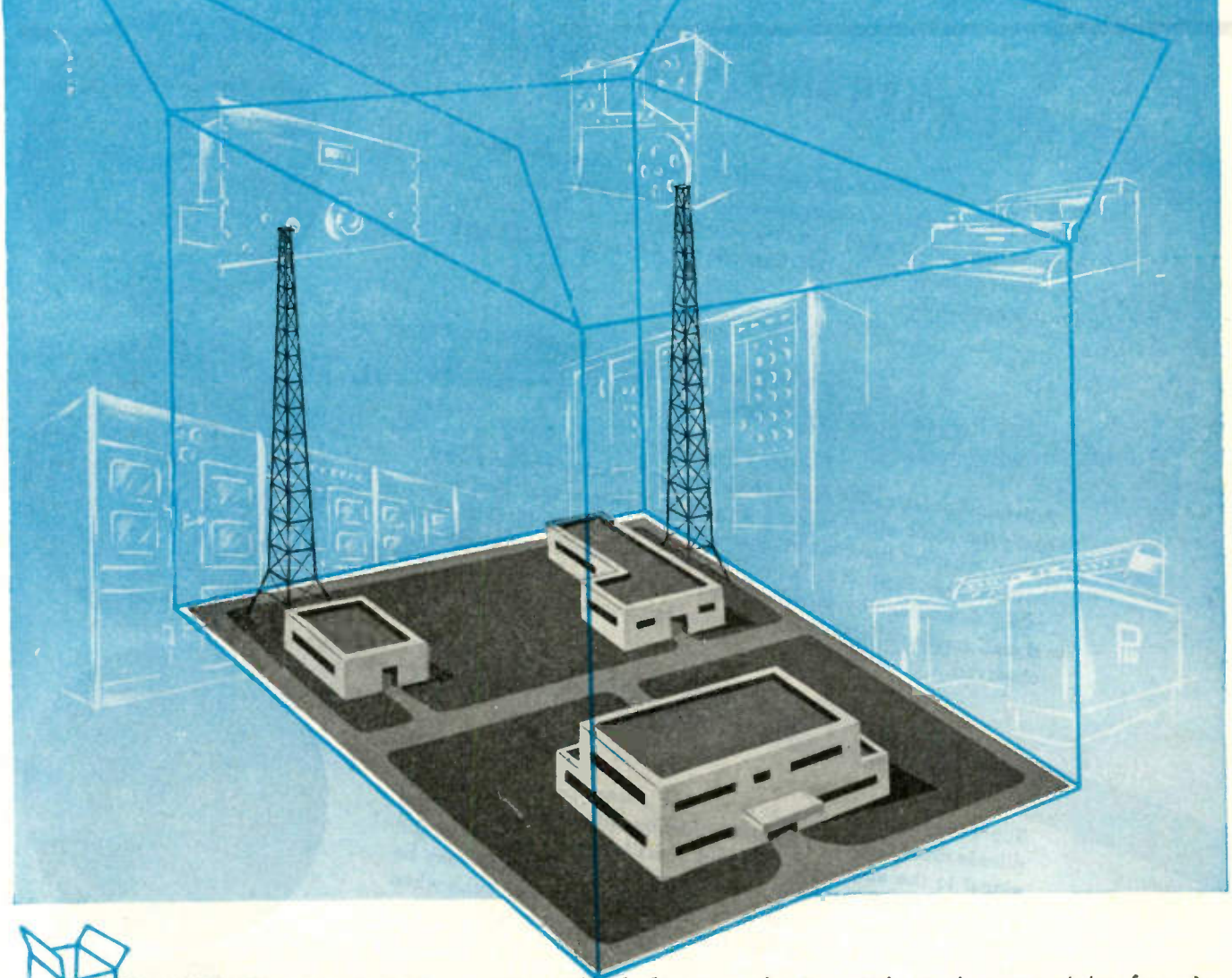

PRESS WIRELESS has conceived and developed a "packaged" line of communications systems — transmitting and receiving — from antenna tower to operating console. Each system is complete and individually packaged. Each "packaged" system includes modern radio-telegraph, radio-telephone, frequency shift and radio-photo-transmitters; dual diversity and general coverage radio receivers, radio-photo-receivers, high speed tape recorders, optical tape scanners—plus associated terminal equipment. Together, these units

provide a highly flexible group of complete communication systems from which you may select the basic "packaged" units to meet the requirements of your proposed installation—or you may modernize your existing facilities by the addition of this equipment.

For nearly two decades PW engineers have designed new radio transmitters and complete telecommunications systems to meet the requirements of our own and other world-wide radio press circuits. PW pioneered in simultaneous voice and tele-

graph or photo transmission from the same transmitter, made important contributions to the technique of radio photo transmission and reception. PW was among the first to apply the principle of "frequency shift" to communication circuits—a method which permits operation of circuits at higher speeds with far greater efficiency. Today PW is prepared to advise and assist you with your next communication requirement.

Address inquiries to Press Wireless Mfg. Corp., Executive Offices, 1475 Broadway, New York 18.



PRESS WIRELESS

First in "Packaged" Communications Equipment

**DU MONT
CATHODE-
RAY**

Oscillography

PLAYS AN IMPORTANT ROLE IN INDUSTRY

FENCE-CHARGING EQUIPMENT

In designing or testing devices for supplying short electrical shock pulses to a fence conductor, it is essential to know the maximum voltage, shape and duration of each pulse, as well as the repetition rate. The Type 247 Cathode-ray Oscillograph is ideal for this application.

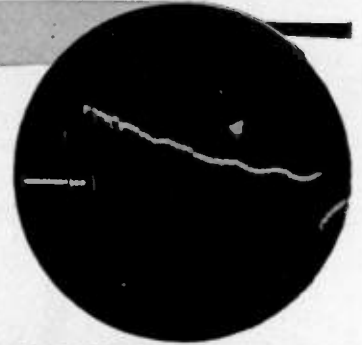

POWER EQUIPMENT

A detailed examination of the closing action of relay contacts may easily be made when using a Type 247 Oscillograph. This will reveal whether the contact closing is positive or subject to rebound. The duration of the entire bouncing period can be accurately determined by superimposing time markers on the applied signal, and the effects of corrective adjustments may be instantly observed.

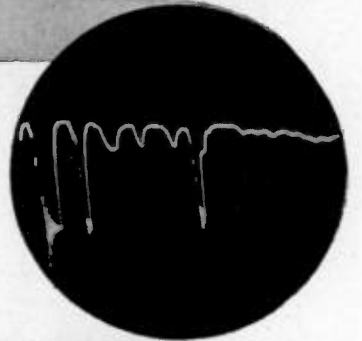

AUDIO AND VIDEO AMPLIFIERS

There is no quicker way to determine phase, frequency and amplitude distortion in an amplifier than by applying a square-wave signal to the amplifier input and visually observing the output waveform. Both the input and output signal waveforms may be viewed simultaneously on the Type 5SP Cathode-ray Tube when driven by two Type 208-B, 241, 247 or 248 Oscillographs, or most combinations of these types.



ACOUSTICS

By using a Type 208-B combined with a Type 215 Sweep Generator or by using a Type 247 Cathode-ray Oscillograph when conducting a reverberation test, accurate information may be obtained as to the damping time of sound waves. It is also possible to plot any "dead spots". If remedial measures for either condition are necessary, the effects of the corrections can be seen instantly.

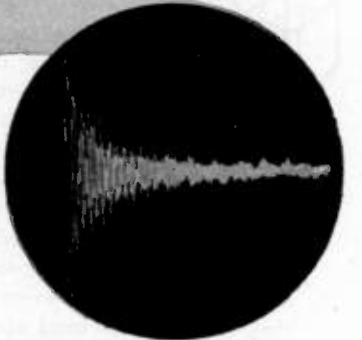

**DU MONT CATHODE-RAY
EQUIPMENT MAY BE
THE LOGICAL ANSWER
TO YOUR PROBLEM!**

© ALLEN B. DU MONT LABORATORIES, INC.

DUMONT

Precision Electronics & Television

ALLEN B. DUMONT LABORATORIES, INC., PASSAIC, NEW JERSEY • CABLE ADDRESS: ALBEEDU, PASSAIC, N. J., U. S. A.



TESTING ONE-HALF MILLION DRY CELLS

AT ONCE!



At right: A technician tests an "Eveready" "A-B" battery pack.

JUST think of it—540,000 dry cells in process of testing at all times! This is the record of the Battery Testing Laboratory of National Carbon Company, Inc.—the world's most complete laboratory for testing dry cells.

Under temperature and humidity conditions that have remained constant day and night, summer and winter, for twenty-one years, a great variety of tests are conducted. Here, over the years, "Eveready" battery technicians have accumulated data and knowledge that have enabled them to build longer life and more reliable service into "Eveready" radio batteries.

Some of the equipment used:

Fourteen program machines, each having a capacity for 72 different timing programs.

Thirty-one recorders with total capacity for complete recording of the operation of 202 timing programs.

2,480 switchboard jacks, each one serving three separate test positions.

Nine ovens with automatic temperature control. Many have a capacity of 36 cu. ft.

Four refrigerators, the largest being 34 cu. ft., with automatic temperature control.

NATIONAL CARBON COMPANY, INC.

30 EAST 42nd STREET, NEW YORK 17, N. Y.

Unit of Union Carbide and Carbon Corporation



EVEREADY
TRADE-MARKS
MINI-MAX

The registered trade-marks "Eveready" and "Mini-Max" distinguish products of National Carbon Company, Inc.

IF IT'S 1000 WATTS YOU WANT

... STUDY THIS NEW, ADVANCED

RAYTHEON AM TRANSMITTER

"It's a beauty,"
says the visitor . . .

"It's a star performer,"
says the station engineer . . .

"It's an excellent investment,"
says the station-owner.

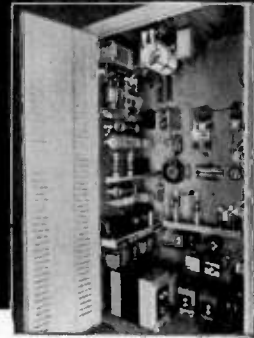

HERE'S WHAT RAYTHEON OFFERS

Study these RAYTHEON features before you choose any transmitter, for replacement or new installation.

- 1 Simplified, More Efficient Circuits**—A high level modulation system eliminates necessity of complicated and critical adjustment of linear amplifiers and minimizes harmonic distortion. Tube cost low, power consumption considerably lower.
- 2 Greater Dependability**—Modern components, operated at well below their maximum ratings, and simplified circuit design reduce failures to minimum. Designed to withstand overloads—fully resistant to excessive temperatures, high humidity. Performance not impaired by ordinary line voltage fluctuation.
- 3 High Fidelity Signal**—Modern triode type tubes used in all audio stages have an inherently lower distortion level. Specially designed audio transformers reduce distortion still further. The feedback circuit also improves signal quality but is not essential in this simplified circuit.
- 4 Push-Pull Final Amplifier**—A Push-Pull R F final amplifier materially decreases harmonic distortion. Parasitic oscillation in this stage is eliminated and suppressors are not needed.
- 5 Easy to Operate**—Only two stages, the R F Drive Amplifier and Power Amplifier, have to be tuned. A Video type amplifier eliminates complicated tuning of the Buffer stage.
- 6 Fast, Accurate Tuning**—All operational controls are centralized on the front panel; every circuit is completely metered and instantly checked. Low speed motor tuning gives positive micrometer adjustment of the two tuned stages.
- 7 Easy to Service**—Vertical chassis construction and symmetrical mechanical layout make servicing easy. Hinged side panels give access to all cabling and meters. Full height double rear doors give maximum access to wiring and components.
- 8 Easily Meets All F.C.C. Requirements**—Flat frequency response from 30 to 10,000 cycles per second. Noise level —60 db below 100% modulation. Less than 2½% RMS for 95% modulation.

AGAIN RAYTHEON presents an item of broadcast equipment that scores a hit with all who see it. Following on the heels of Raytheon's highly successful 250 Watt design, this new 1000 Watt AM transmitter provides the same excellent performance, the same inherent superiorities for higher-powered stations . . . and at surprisingly low cost.

It's an outstanding design . . . perfected after months of careful engineering. Simpler circuits give the all-important *dependability* that Raytheon transmitters are becoming widely noted for. Exceptional signal quality is achieved through triode type tubes and audio transformers better than were ever before available. Its striking modern beauty catches the eye of visitors—makes it a show-piece.

This Raytheon transmitter commands attention of 1000 Watt station owners and engineers. Before *you* decide on a transmitter, write or wire for our fully illustrated specification bulletin. *Prompt deliveries can be made.*

RAYTHEON MANUFACTURING COMPANY

Broadcast Equipment Division

7517 No. Clark Street, Chicago 26, Illinois

DEVOTED TO RESEARCH AND MANUFACTURE FOR THE BROADCASTING INDUSTRY



Excellence in Electronics



+40 db



New

-hp- 450A AMPLIFIER

A Stable, Wide-band, General Purpose Laboratory Instrument

This versatile -hp- Amplifier is ideal for general laboratory use. It provides unusual stability at 40 or 20 db gain, and new freedom from spurious responses. Low phase shift is assured by a straightforward, resistance-coupled amplifier design, together with inverse feedback. Frequency response is flat within 1/2 db between 10 and 1,000,000 cycles. Varying tube voltages or aging tubes have no appreciable effect on the gain or other characteristics. The amplifier is fully operated from a 115 volt 60 cycle power supply.

When used in conjunction with the -hp- 400A Vacuum Tube Voltmeter, this amplifier increases the voltmeter's sensitivity by 100 times (300 microvolts full scale) at 40 db. At 20 db gain, sensitivity is multiplied 10 times (3 millivolts full scale). And since the 450A is designed for use with the 400A, both have identical base sizes to permit stacking and short leads.

This rugged, compact amplifier is ready now for early shipment. Your inquiry or order will be given prompt attention.

SPECIFICATIONS

- GAIN:**
40 db (100X) or 20 db (10X)
(Panel Selector Switch)
- FREQUENCY RESPONSE:**
at 40 db gain:
within $\pm 1/2$ db between 10 and 1,000,000 cps
within ± 1 db between 5 and 2,000,000 cps
at 20 db gain:
within $\pm 1/2$ db between 5 and 1,000,000 cps
within ± 1 db between 2 and 1,200,000 cps
- INPUT IMPEDANCE:** 1 megohm shunted by approximately 15 uufd
- OUTPUT:** 10 Volts maximum to 3,000 ohms or higher resistive load
- INTERNAL IMPEDANCE:** Less than 150 ohms over entire range
- POWER SUPPLY:** 115 volts 50/60 cycles 40 watts
- MOUNTING:** Metal Case, leather carrying handle
- SIZE:** 7 1/2" wide, 5 1/4" high, 9 1/2" deep
Net weight 10 lbs.
Shipping weight 18 lbs.
- PRICE:** \$125.00 FOB Palo Alto, California



INCREASES SENSITIVITY OF -hp- 400A 100 TIMES!



HEWLETT-PACKARD COMPANY

1278A Page Mill Road, Palo Alto, California, U. S. A.

NOW...

SPRAGUE brings you a
2 MIL. METER MULTIPLIER
that gives you a...

50%

REDUCTION IN RESISTANCE VALUE!

Conventional multipliers wound with ordinary enamelled wire cannot operate safely at much more than the one MA called for in government specifications. Sprague Precision Meter Multipliers, however, can be used at *twice their normal current rating*, with only a slight decrease in long time stability. Plus or minus 1% resistance tolerance should be specified.

This cutting of resistance value in *half*, with approximate halving in meter multiplier cost, results from use of wire that is insulated before winding, with a 1000° C. heat-proof ce-

ramic end wound on special high-temperature plastic forms. *Larger wire sizes* are used through reduction of resistance values.

It all adds up to a net saving of as much as 50% in multiplier cost . . . because it allows exactly half the resistance value and, in some cases, half the number of multipliers, to be used for a given application. Sprague engineers will be glad to make recommendations for your specific application.

Write for the new Sprague Resistor Catalog No. 100E.

SPRAGUE ELECTRIC COMPANY, Resistor Division, North Adams, Mass.

SPRAGUE * KOOLOHMS

POWER TYPES • BOBBIN TYPES • METER MULTIPLIERS • MEGOMAX, ETC.

*Reg. U. S. Pat. Off.

**change pitch and direction almost
instantaneously with the improved
Presto 8-D Recorder**

The Improved Presto 8-D Recorder is equipped with a reversing device for the feed screw. Result: Six feed pitches, inside-out and outside-in, using only one feed screw. This feed screw need never be removed from the recorder. Thus, changes in pitch and direction are accomplished within a matter of seconds.

The Presto 8-D Recorder is the easiest and most convenient machine to operate because of the arrangement of its controls and the cantilever overhead which saves lost motion in operation. Its unusually heavy construction assures high fidelity masters and instantaneous recordings.

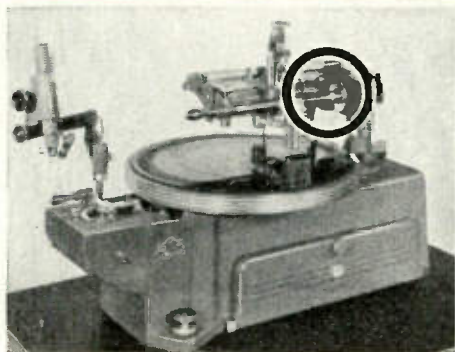
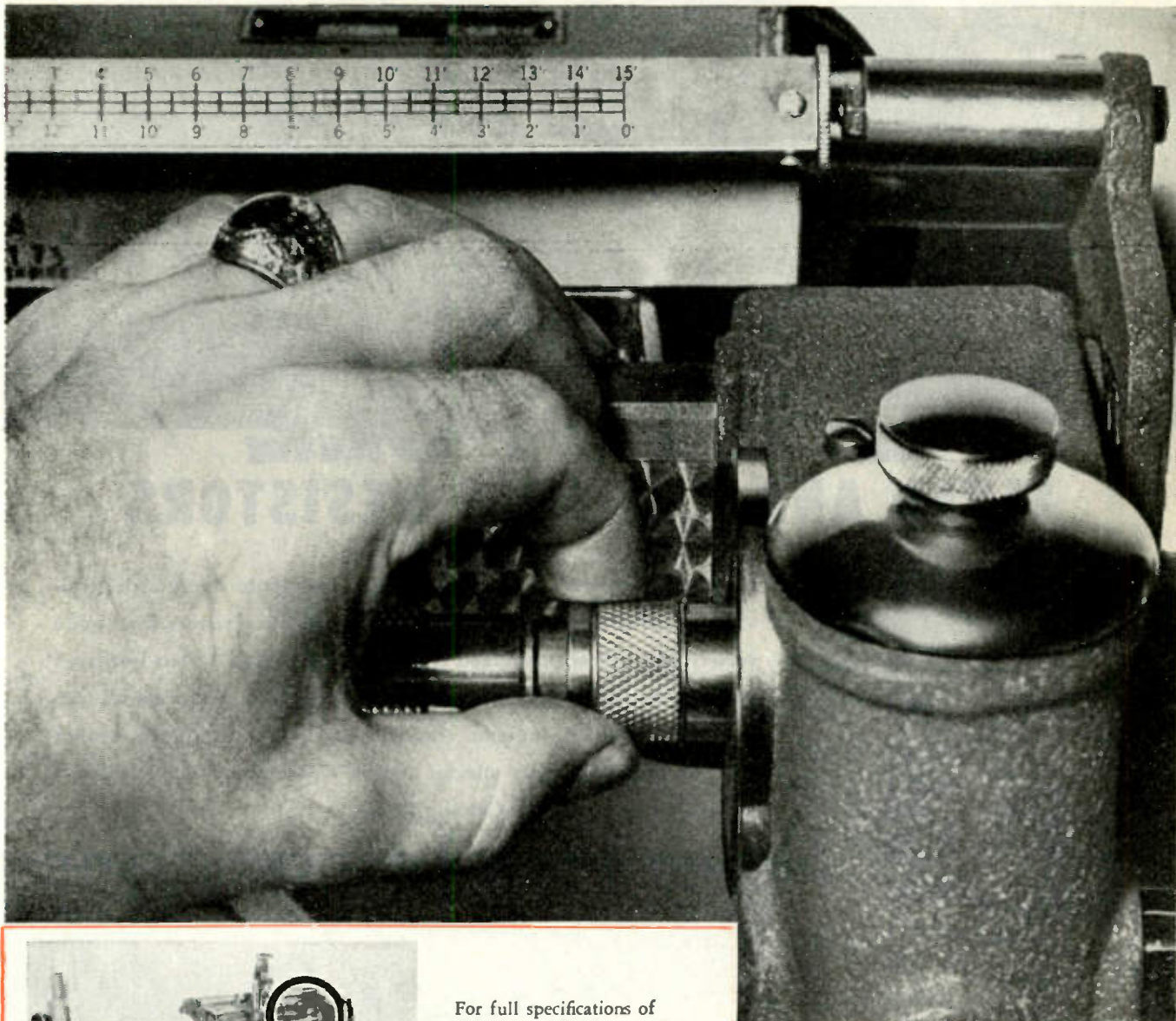

For full specifications of the Presto 8-D please write Presto Recording Corporation, 242 West 55th Street, New York 19, N. Y. To insure future delivery within a reasonable time, we suggest you place your order now for immediate listing.

PRESTO

RECORDING CORPORATION
242 West 55th Street, New York 19, N. Y.
Walter P. Downs, Ltd., in Canada

World's Largest Manufacturer of Instantaneous Sound Recording Equipment



STACKPOLE

FIXED AND VARIABLE RESISTORS

One of the nation's largest producers, Stackpole offers a dependable source of supply for both fixed and variable resistors for a wide variety of applications. Fixed types include 1/2- and 1-watt insulated units in smallest sizes consistent with modern performance demands. Variables include standard-size units, midgets, sealed designs and numerous special types. Write today for Stackpole Electronic Components Catalog RC6.



DEPENDABLE LOW-COST SWITCHES

Line, Slide, Rotary Action Types
Ideal for radios, rcys and all electrical equipment where high-grade but inexpensive switching is required. Available in standard types to meet almost any requirement. Write for Catalog RC6.

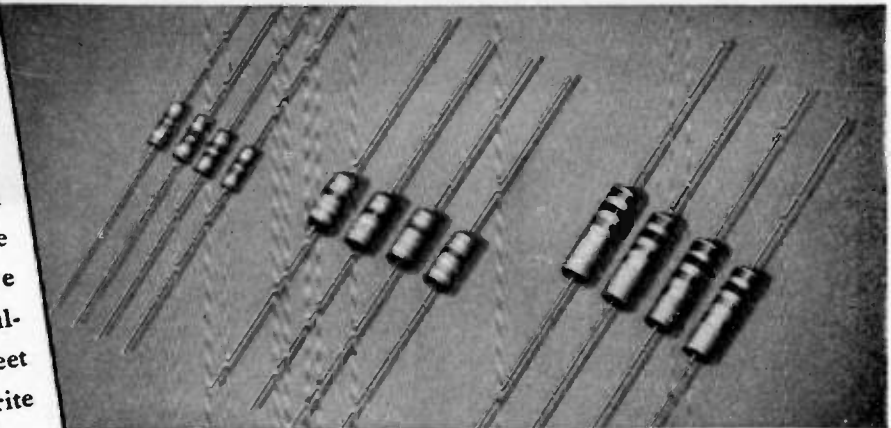

STACKPOLE CARBON COMPANY
(Electronic Components Division)
ST. MARY'S, PA.



■ Seal up a stream of electrons in a vacuum tube...and you have a space-defying genie that vitalizes industry...and can save countless lives!

■ As far back as 1930 the Sperry Gyroscope Company put electronics to work...introducing electronic control for the Sperry Gyro-Compass.

■ From then on electronics was employed whenever it could extend the usefulness and performance of Sperry products—as in automatic pilots, gun fire control devices, navigation instruments, both aeronautical and marine. And in 1939, came the Klystron, “heart-beat” of Radar.

■ In war, Radar tracked out enemy plane, sub and ship positions, saving numberless lives by advance warning of hostile attack. And today, in peace, Radar brings new safety to mankind...plotting aerial and marine operations with pin-point accuracy, through pea-soup weather and over vast distances.

■ Sperry pioneered in helping develop these and many other services for mankind. But “pioneering” isn’t enough. And that’s why Sperry research and practical applications of electronics go endlessly on...in that search for something better which we call *product improvement*.



Sperry Gyroscope Company, Inc.

EXECUTIVE OFFICES: GREAT NECK, NEW YORK • DIVISION OF THE SPERRY CORPORATION
 LOS ANGELES • SAN FRANCISCO • SEATTLE • NEW ORLEANS • CLEVELAND • HONOLULU
Aircraft: Gyropilots • Gyrosyn Compasses • Attitude Gyros • Directional Gyros • Gyro-Horizons • Detonation Indicators • Automatic Radio Direction Finders • Instrument Landing Systems • Traffic Control Systems • **Marine:** Gyro-Compasses • Gyro-Pilots • Gyro-Magnetic Compasses • Incandescent Searchlights • Steering Systems • Radar • Loran
Industrial: Railroad Radio • Microwave Relays • Microline Test Equipment • Klystron Tubes • Strobodome • Knockometer

RAYTHEON

announces

TWO NEW RELIABLE "WORK HORSES"

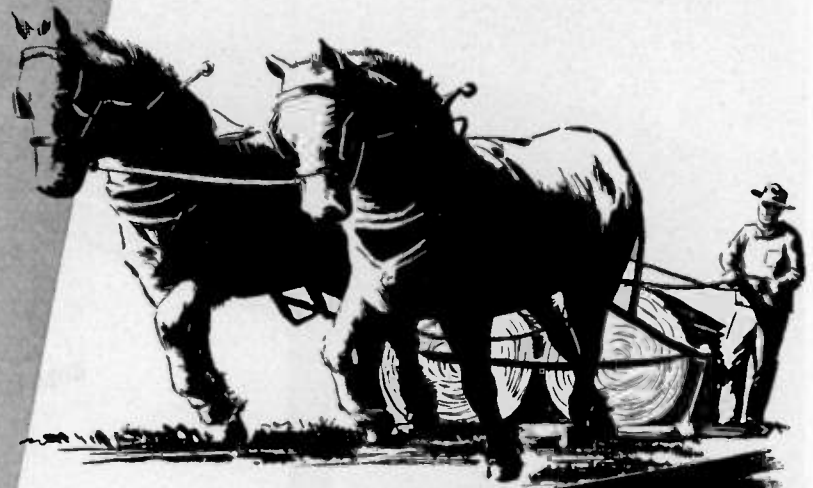

to carry the Bulk Load of R-F and I-F Amplification for the Radio Receiver Industry

Announcement of Raytheon types 6BD6 and 12BD6 makes available two new miniature cathode-type R-F amplifier tubes designed to perform the specific tasks done by the bulkier or obsolescent series of types such as the 6D6, 6U7G, 6K7, 6SK7, 12SK7GT, etc. Equivalent to types 6SK7 and 12SK7, the miniature types 6BD6 and 12BD6 employ characteristics which have been carefully tailored for almost twenty years by tube designers in cooperation with receiver designers to exhibit advantages not so well offered by "high Gm" types. These new types offer:



6BD6



12BD6

1. A very desirable and practical remote cut-off characteristic.
2. Acceptable zero-bias operation without cathode resistors.
3. A proper characteristic for operation with or without series screen-dropping resistor.
4. Production of maximum economically useable stable stage gain (regardless of Gm) at radio and intermediate frequencies.
5. A proper balance of Gm, Rp, and Cgp to permit operation at maximum gain without cost of "throttling back" to insure stability.
6. A tube design yielding high uniformity and minimum rejections in tube and receiver manufacture.
7. Utilization of conventional standard I-F transformers embodying all the experience and minutiae of cost-reducing and production-expediting detail resulting from years of collective engineering effort.
8. Savings on engineering and production costs.
9. A small size version of the world's most popular cathode-type amplifier tubes.
10. Raytheon dependable quality.

DESCRIPTIVE DATA

BULB: Glass T-5 1/2 BASE: Miniature Button 7-Pin
 6BD6 12BD6
 Heater Voltage: 6.3 12.6 volts
 Heater Current: 0.3 0.15 ampere
 Interelectrode Capacitances (with shield):
 Grid to Plate: .004 uuf max.
 Input: 4.3 uuf
 Output: 5.0 uuf

CHARACTERISTICS

Operating Conditions:		
Eb	Ec2	Ec1
100 volts	100 volts	-1.0 volt
250 volts	100 volts	-3.0 volts
250 volts	100 volts	-35 volts



Excellence in Electronics

RAYTHEON MANUFACTURING COMPANY

RADIO RECEIVING TUBE DIVISION

Newton, Mass. • Chicago • Los Angeles

Gm umhos	Rp megohms	Ib m.a.	Ic2 m.e.
2350	0.12	13	5
2000	0.7	9	3
10 (approx.)			



CORNERSTONE

of your new FM
transmitter circuit



**TYPE GL-5D24
POWER TETRODE**

GENERAL ELECTRIC'S TYPE GL-5D24—modern, compact, efficient—is the basic power tube for new FM transmitters you are designing and building. Output is sufficiently large for the tube to handle the final stage of low-power transmitters, while serving as a driver in higher-power circuits.

AMPLIFIER, OSCILLATOR, OR CLASS B MODULATOR—all three jobs are part of the GL-5D24's performance. The tube's suitability for FM use is emphasized by the high frequency characteristic, ranging up to 85 mc at max ratings and well beyond that figure at somewhat lower ratings.

SHORT INTERNAL LEADS bring lead inductance down to a point where neutralization usually is not required—or if it is, the circuit easily

can be neutralized by tuning out the screen lead inductance.

EXTREMELY LOW DRIVING POWER gives economy of operation that appeals to transmitter users. Strong, well-braced design and construction mean longer life in hard service. Among important special features is the zirconium-coated plate, which both radiates heat well, and helps to maintain a high degree of vacuum by serving as a "getter".

SEE YOUR NEAREST G-E OFFICE for price and other information about this up-to-the-minute, cost-saving h-f power tube. Or write to *Electronics Department, General Electric Company, Schenectady 5, N. Y.*

ELECTRICAL CHARACTERISTICS

Filament voltage	5 v
Filament current	14.1 amp
Avg interelectrode capacitances:	
grid-plate	0.06 mmfd
input	12.7 mmfd
output	4.5 mmfd
Frequency at max ratings	85 mc
Type of cooling	forced-air

MAX CLASS C RATINGS (CCS)

Plate voltage	3,500 v
current	350 ma
input	600 w
dissipation	200 w
Screen voltage	600 v

GENERAL  **ELECTRIC**

161-E13-8880

FIRST AND GREATEST NAME IN ELECTRONICS

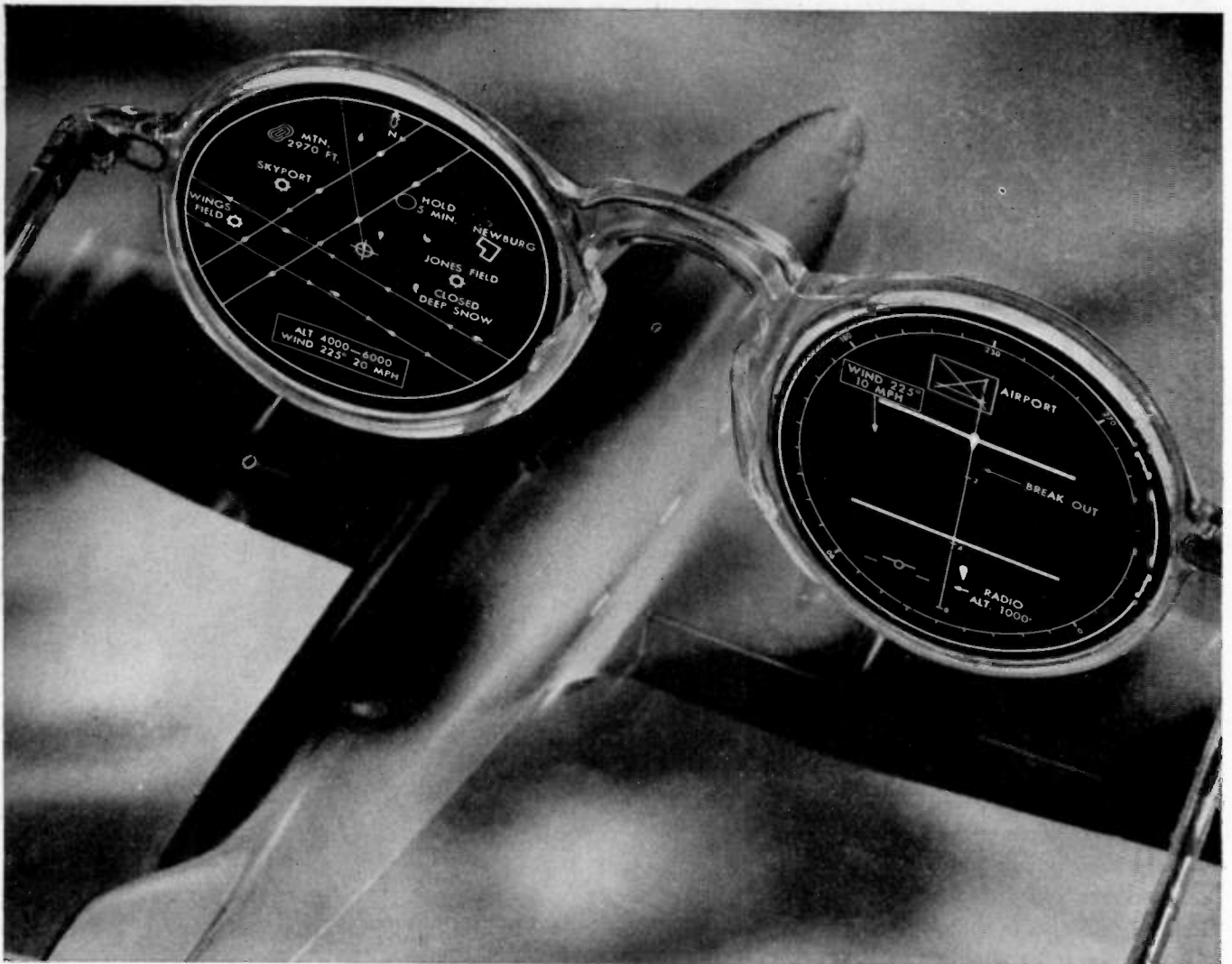

Teleran pictures—air traffic control by radar plus television.

Teleran—"radio eyes" for blind flying!

It's a television "information please" between airplane and airport—with the pilot's questions given split-second answers on a television screen mounted in the cockpit.

Teleran (a contraction of *TELE*vision—*Radar Air Navigation*) collects all of the necessary information on the ground by radar, and then instantly transmits a television picture of the assembled data to the pilot aloft in the airplane.

On his receiver the pilot sees a picture showing the position of his airplane and the position of all other aircraft near his altitude, superimposed upon a terrain map complete with route markings, weather conditions and unmistakable visual instruc-

tions. The complex problem of air traffic control is well handled by Teleran.

Teleran—another achievement of RCA—is being developed with Army Air Forces co-operation by RCA Laboratories and RCA Victor, endless sources of history-making developments in radio and electronics. They are also your assurance that any product bearing the RCA or RCA Victor monogram, is one of the finest instruments of its kind science has yet achieved.

Radio Corporation of America, RCA Building, Radio City, New York 20 . . . Listen to The RCA Victor Show, Sundays, 2:00 P. M., Eastern Standard Time, over the NBC Network.

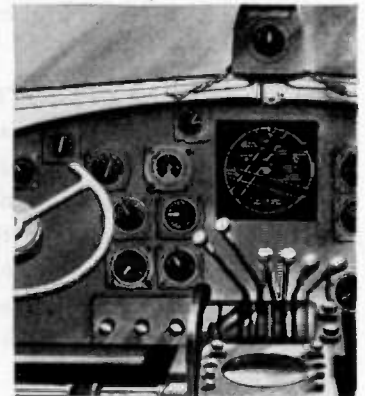

Instrument Panel of the Future. The Teleran indicator, mounted in a cockpit, simplifies the pilot's job by showing his position relative to the airport and to other planes in the vicinity. It promises to become one of the most useful developments in the history of aviation.



RADIO CORPORATION of AMERICA



Amphenol AND RADIO AMATEURS HAVE ALWAYS WORKED TOGETHER

Radio amateurs are the most versatile technical experimenters known—and so are Amphenol engineers. Amateurs have pioneered the greatest share of electronic developments since the dawn of radio—and Amphenol has pioneered in the development of components used by hams.

Amateurs have an appreciation of the electrical engineering problems in the production of components to give the best performance. They agree that Twin-Lead, pioneered by Amphenol, is one of the most important and useful new products in the field of electronics.



AMERICAN PHENOLIC CORPORATION
CHICAGO 50, ILLINOIS
In Canada • Amphenol Limited • Toronto, Ontario

COAXIAL CABLES AND CONNECTORS • INDUSTRIAL CONNECTORS, FITTINGS AND CONDUIT • ANTENNAS • RF COMPONENTS • PLASTICS FOR ELECTRONICS

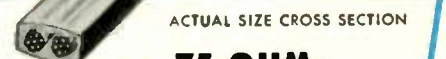

ACTUAL SIZE CROSS SECTION

75 OHM TRANSMITTING TWIN-LEAD

Amateurs asked for it—now here it is! It's the new heavy duty 75 ohm Amphenol Twin-Lead transmission line. Conservatively rated at 1000 watts for 30 mc or lower frequency. Available—now—at your distributor's.

Attenuation	Megacycles	75 ohm DB per 100 ft.
}	3.5	0.29
	7.0	0.49
	14.0	0.82
	28.0	1.40

Receiving Twin-Lead is available in 75 ohm, 150 ohm and 300 ohm impedances. Get a copy of Amphenol's new Twin-Lead bulletin from your dealer.

Other Amphenol products of interest to amateurs available at your dealer's:

Radio Tube Sockets. Industrial, standard, miniature and sub-miniature—plugs and accessories. Octal angle sockets for cathode ray applications.

Connectors. All types, with fittings—from 1 to 50 contacts.

Cables, Coax and Twinax (also connectors). Microphone cables (also connectors).

Plastics for Electronics. Plastic sheets, rods and tubes. Flexible tubing and spaghetti. Coil Dope. Molded coil forms, stand-off insulators, knobs and dial pieces.

Antennas. UHF dipoles and arrays.

Tubes are ... CHARACTERS!



AMATEUR

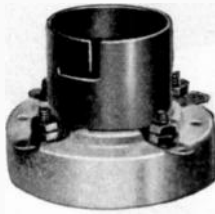

123-209



BROADCAST



124-212

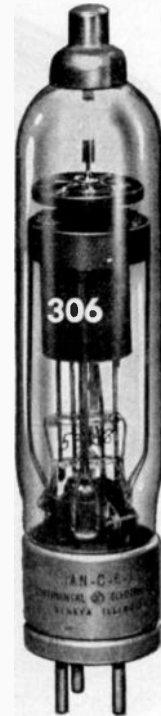

**INDUSTRIAL
ELECTRONIC**

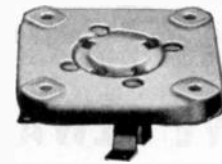

122-244

Handle them with Johnson Sockets

SOCKET--	BASE OR TYPICAL TUBE
123-209	Med 4
123-210	Pin Bayonet
123-211	Standard Jumbo
123-216	4 Pin Giant 5 Pin Bayonet
124-212	833 A
124-213	152TL
124-214	1500th
124-215	204A
120-267	9000 series
120-277B	Miniature
121-235	Acorn
121-245	
121-265	
122-101	
122-217	829
122-244	Small 7 Pin Super Jumbo (Industrial No. 412 Base
122-225	5 Pin
122-226	6 Pin
122-227	7 Pin Med.
122-228	Octal
122-234	RK72
122-237	7 Pin Large
122-224	4 Pin
122-247	826
122-248	826
122-275	Giant 5 Pin
124-220	899R

There are many types in the tube family. Like humans they differ in appearance and performance. Each makes individual demands on its socket. A JOHNSON socket accommodates the 4-250A where provision for adequate heat dissipation is a major requirement. JOHNSON designed the first ceramic socket for miniature tubes where the socket must hold the small pins firmly and still accommodate minor variations without fracturing the envelope.

JOHNSON has achieved unusual prominence through skill in engineering both ceramics and metal to meet these demands. Experienced electronic engineers recognize and provide for tube and circuit requirements. Confidence, cooperation and assistance on the part of tube manufacturers explain the more complete line, and why JOHNSON is the only manufacturer producing some types.

When you need sockets look to JOHNSON. The price is usually no more, frequently less.

For more information write Dept. W

JOHNSON

a famous name in Radio



E. F. JOHNSON CO. WASECA, MINN.

... a spring service you'll like

long experience...
in applying the right spring
to assure top performance

...for your product



IN your effort to make a better product you naturally try to leave nothing to chance. We'd like to suggest that you don't leave the springs for your product to chance either. Take advantage of Accurate's long experience . . . be sure . . . by letting us help you choose the proper type and size spring, made from the material best suited to your conditions. Many, many times, proper spring selection has paid dividends by improving product performance and preventing product failure.

Accurate's business is to furnish precision springs and wire forms for a wide variety of products. In addition to our ability to help you with spring engineering, we have the expert personnel and modern equipment necessary to give you fast service and fine workmanship.

Send for a copy of the Accurate Handbook on Springs.

ACCURATE SPRING MFG. COMPANY

3835 W. Lake Street, Chicago 24, Illinois



COMPLETE AUDIO FACILITIES WITH

Only 2 Types of AMPLIFIERS VACUUM TUBES

... AND ALL PLUG-IN

The Langevin Types 116-A and 117-A Plug-in Amplifiers were developed in collaboration with the General Engineering Department of the Columbia Broadcasting System.

We believe these amplifiers fulfill the desire of many broadcast engineers to simplify their audio facilities. With only these two types of amplifiers even the largest system can be fabricated. Further—in the interest of simplicity—only two types of tubes are required in the operation of both these units (the accompanying power supply uses a selenium rectifier). A replaced amplifier can be serviced when convenient at a test bench, with the aid of a simple service unit designed for that purpose.

Many lessons learned during the War have been incorporated in these amplifiers: They are simple, compact, rugged and of high quality; they are replaceable in a matter of seconds WITHOUT THE USE OF TOOLS; they are designed for easy servicing. And they can be either rack or console mounted; fittings are available. These units are connected into the circuit by means of a plug especially designed for them by Cannon—employing gold plated contacts and a shielded TWIN-AX input connection.

A COMPLETE SYSTEM USING THESE AMPLIFIERS WILL BE BETTER IN ALL RESPECTS THAN THE F.C.C. RECOMMENDATIONS FOR FM.

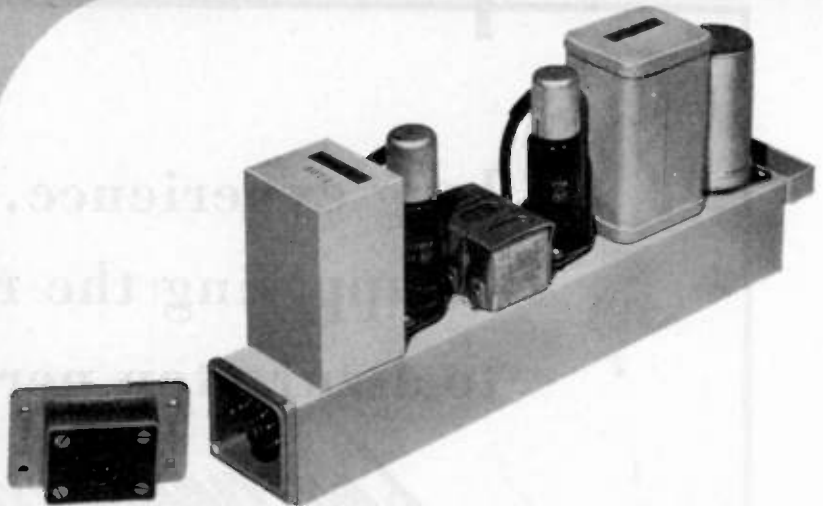

The Type 116-A has been designed for use as a microphone preliminary and as a booster amplifier—gain 36 db. Operates from source impedance of 150/600 ohms and into load impedance of 150/600 ohms, in accordance with RMA proposed standards.

Push buttons permit reading plate current. Overall dimensions, including plug receptacle, 13½" long, 2" wide and 5½" high.

Complete specifications upon request.



The Type 117-A has been designed as a program or monitor amplifier—gain 55 db. Operates from source impedance of 150/600 ohms and into load impedance of 150/600 ohms, in accordance with RMA proposed standards.

Push buttons permit reading plate current. Overall dimensions, including plug receptacle, 11" long, 3¼" wide and 5½" high.

Complete specifications upon request.

The Langevin Company

INCORPORATED

SOUND REINFORCEMENT AND REPRODUCTION ENGINEERING

NEW YORK, 37 W. 65 St., 23 • SAN FRANCISCO, 1050 Howard St., 3 • LOS ANGELES, 1000 H. Seward St., 38



INFORMATION PLEASE!

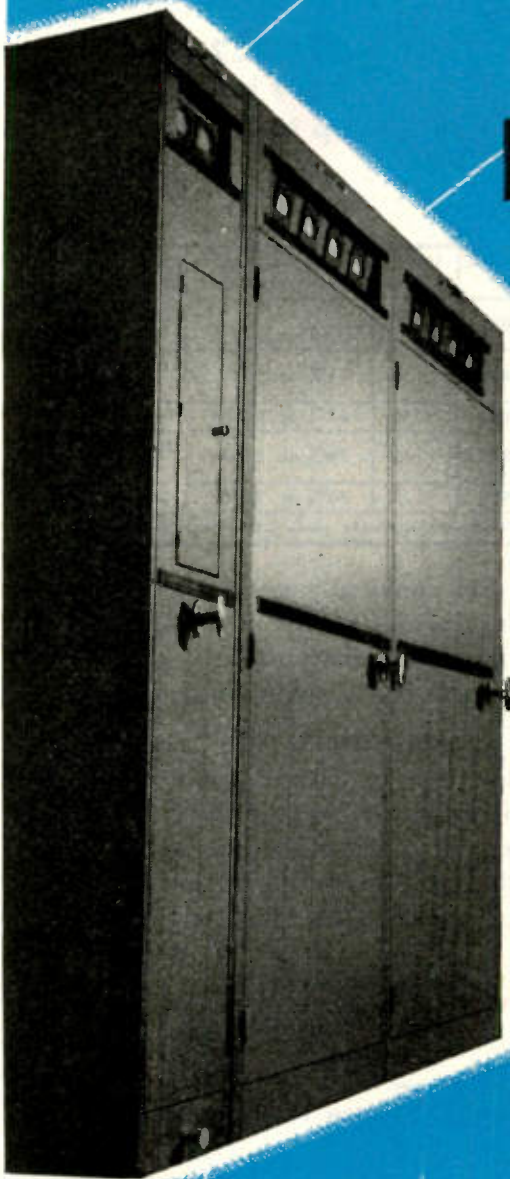

Radio communication is as vital to the airways as rails are to the railroads. For high performance, dependability, and easy maintenance, WILCOX radio equipment has earned the confidence of airline personnel throughout the world. Solve your communication problems with Wilcox.

Check the Wilcox 2500 Watt 96C Transmitter For:

- 1. PERFORMANCE**—Transmitter units combine with modulator and rectifier to give either simultaneous transmission on a number of frequencies, or the selection of an individual frequency best suited to the immediate communication problem. Complete remote control.
- 2. DEPENDABILITY**—Research, engineering, and testing combined with highest quality materials result in a rugged product capable of sustained operation through all conditions of temperature, humidity, and weather.
- 3. MAINTENANCE**—All controls and components are completely accessible. Plugs and receptacles or clips make every major section readily removable. Fuses, power and telephone line terminals are located on convenient panels.
- 4. SAFETY**—The disconnect switch at base of transmitter cuts off all voltage and grounds components so unit can be serviced without affecting operation of adjacent channels.

A request on your letterhead will bring complete information

Wilcox Electric Company, Inc.
KANSAS CITY, MISSOURI



RCA "Metal-Header" Power Tubes for Industrial and Communication Service



RCA-9C22
100 kw input
up to 5 Mc



RCA-9C25
40 kw input
up to 30 Mc



RCA-7C24
5 kw input
up to 110 Mc

Improved construction offers greater over-all performance in grounded-grid or grounded-cathode circuits.

RCA's family of "metal-header" power triodes incorporates constructional features that provide increased ruggedness and stability, superior shielding of electrodes, and a greater degree of operating economy.

The flanged-header grid terminal and the external plate provide greater heat dissipation and unusually low lead inductance. When used in a grounded-grid circuit, with a large circular connector, the flanged-header grid terminal effectively isolates the filament from the plate. As a result, neutralization is seldom necessary in grounded-grid service.

The types listed may also be used to advantage in conventional grounded-cathode circuits.

Tube Type	Max. Power Input*	100% Input to	Reduced Input for Higher Freq.	Cooling Methods	Ampl. Factor
7C24	5 KW	110 Mc	Forced Air	25
9C25	40 KW	30 Mc	61% at 100 Mc	Forced Air	32
9C27	40 KW	30 Mc	61% at 100 Mc	Water	32
9C22	100 KW	5 Mc	70% at 25 Mc	Forced Air	38
9C21	150 KW	15 Mc	70% at 25 Mc	Water	38

*Grounded-cathode, class C telegraphy.

All types have unusually good high-frequency characteristics. In addition, RCA 7C24, 9C25, and 9C27 have high-efficiency thoriated-tungsten filaments that offer substantial savings in filament power.

Technical bulletins on these RCA "metal-header" tubes are available on request. RCA tube application engineers will be pleased to co-operate with you in adapting these or other RCA tube types to your equipment designs. Just write RCA, Commercial Engineering, Section D-18J, Harrison, N. J.



RCA Laboratories, Princeton, N. J.
THE FOUNTAINHEAD OF MODERN TUBE DEVELOPMENT IS RCA



TUBE DEPARTMENT
RADIO CORPORATION of AMERICA
HARRISON, N. J.

PROCEEDINGS OF THE I.R.E.

AND

WAVES AND ELECTRONS

Published Monthly by

The Institute of Radio Engineers, Inc.

BOARD OF DIRECTORS, 1946

Frederick B. Llewellyn
President

Edmond M. Deloraine
Vice-President

William C. White
Treasurer

Haraden Pratt
Secretary

Alfred N. Goldsmith
Editor

Hubert M. Turner
Senior Past President

William L. Everitt
Junior Past President
1944-1946

Raymond F. Guy
Lawrence C. F. Horle
1945-1947

Stuart L. Bailey
Keith Henney
Benjamin E. Shackelford
1946-1948

Walter R. G. Baker
Virgil M. Graham
Donald B. Sinclair
1946

Ralph A. Hackbusch
Frederick R. Lack
George T. Royden
William O. Swinyard
Wilbur L. Webb
Edward M. Webster

Harold R. Zeamans
General Counsel

George W. Bailey
Executive Secretary

BOARD OF EDITORS

Alfred N. Goldsmith
Chairman

PAPERS REVIEW COMMITTEE

Murray G. Crosby
Chairman

PAPERS PROCUREMENT COMMITTEE

Dorman D. Israel
General Chairman
Edward T. Dickey
Vice General Chairman

VOLUME 34

October, 1946

NUMBER 10

PROCEEDINGS OF THE I.R.E.

Instincts and Reason.....	Raymond F. Guy	726
Wilbur L. Webb, Board of Directors, 1946.....		727
The Equivalent Circuit for a Plane Discontinuity in a Cylindrical Wave Guide.....	John W. Miles	728
The Theory of Impulse Noise in Ideal Frequency-Modulation Receivers.....	David B. Smith and William E. Bradley	743
Radio Direction Finding at 1.67-Meter Wavelengths.....	Luke Chia-Liu Yuan	752
Discussion on "Tonal-Range and Sound-Intensity Preferences of Broadcast Listeners" by Howard A. Chinn and Philip Eisenberg.....	Edward Massell, Walter van B. Roberts, C. C. Eaglesfield, Bryan Groom, Philip Eisenberg, and Howard A. Chinn	757
Contributors to the PROCEEDINGS OF THE I.R.E.....		762

INSTITUTE NEWS AND RADIO NOTES

Institute News and Radio Notes.....	763
Rochester Fall Meeting.....	763
I.R.E. People.....	764
Institute Committees—1946.....	766
Technical Committees, 1946-1947.....	767
Institute Representatives on Other Bodies—1946.....	768
Institute Representatives in Colleges—1946.....	769
Sections.....	770

Books:

"Design of Crystal Vibrating Systems," by William J. Fry, John M. Taylor, and Bertha W. Hennis. Reviewed by Karl S. Van Dyke.....	770
"Electron and Nuclear Counters, Theory and Use," by Serge A. Korff..... Reviewed by John R. Ragazzini.....	771
"Electronic Equipment and Accessories," by R. C. Walker..... Reviewed by G. L. Beers.....	771
"Television Simplified," by Milton S. Kiver..... Reviewed by Albert F. Murray.....	772
I.R.E. Publication Problems and Author Co-operation.....	772

WAVES AND ELECTRONS

SECTION

A Gap in Engineering Education.....	A. V. Loughren	773
H. S. Dawson, Chairman, Toronto Section, 1946.....		774
Microwave Measurements and Test Equipments.....	F. J. Gaffney	775
Stability and Frequency Pulling of Loaded Unstabilized Oscillators.....	Jack R. Ford and N. I. Korman	794
The Inductance-Capacitance Oscillator as a Frequency Divider.....	Ernst Norrman	799
A Wide-Band Wattmeter for Wave Guide.....	H. C. Early	803
Contributors to Waves and Electrons Section.....		807
Abstracts and References.....		808
Section Meetings.....	35A Positions Wanted.....	44A
Membership.....	35A Positions Open.....	50A
Advertising Index.....		74A

EDITORIAL DEPARTMENT

Alfred N. Goldsmith
Editor

Helen M. Stote
Publications Manager

Clinton B. DeSoto
Technical Editor

Mary L. Potter
Assistant Editor

William C. Copp
Advertising Manager

Lillian Petranek
Assistant Advertising Manager

Responsibility for the contents of papers published in the PROCEEDINGS OF THE I.R.E. AND WAVES AND ELECTRONS rests upon the authors. Statements made in papers are not binding on the Institute or its members.

Changes of address (with advance notice of fifteen days) and communications regarding subscriptions and payments should be mailed to the Secretary of the Institute, at 450 Ahnaip St., Menasha, Wisconsin, or 330 West 42nd Street, New York 18, N. Y. All rights of republication, including translation into foreign languages, are reserved by the Institute. Abstracts of papers, with mention of their source, may be printed. Requests for republication privileges should be addressed to The Institute of Radio Engineers.



One of the fundamental problems of present-day civilization is the speedy adaptation of the thoughts and behavior of men to an environment teeming both with instrumentalities for the large-scale betterment of mankind or, alternatively, with implements for his utter destruction. A presentation of this situation and of the possible function of the engineer in aiding to resolve some of the grave difficulties confronting mankind is presented below by a prominent broadcast engineer and pioneer who is also a Director of the Institute and its Chairman of its Standards Committee and of its Constitution and Laws Committee.—*The Editor.*

Instincts and Reason

RAYMOND F. GUY

Acts motivated by instinct may be in conflict with those motivated by objective thought.

Man's ability to think objectively of himself and his surroundings is a crowning gift which sets him apart from all other creatures. We are not yet privileged to understand the wonderful mechanism of our minds which enables us to store countless facts and impressions for instant selective recall, which enables us to rationalize and create, and forecast on the passing stages in our minds vast and complex events of the distant future.

We are part of a wondrous creation which we call nature. Nature abounds in secrets, the clues to which have been dangling tantalizing before our unseeing eyes through the ages. We learned slowly until recently, according to our distorted conception of time.

In the short span of thirty generations the inquisitive minds of men have learned that the earth is not flat but a drifting speck in a vast cosmos, the origin of which baffles us and the boundaries of which may be vaguely visualized only by resort to a mathematical expression. Within an infinitesimal span of time our processes of thought and nationalization have compounded a storehouse of knowledge which delves ever deeper into the mechanisms and laws of nature, the basic composition of matter, and the metabolism of life.

In less than a century, transportation has progressed from the beast of burden to the jet-propelled aircraft of the stratosphere. Communication has progressed from the crudest forms to our modern miracle of radio. Medicine and surgery have advanced tremendously in eliminating our diseases. And scientific achievement has been crowned by the release of the energy locked in the atom.

But despite his progress, man remains a creature of instincts which are his inheritance from a primal ancestry. Controlled and rationalized thought is a process apart from instinct. Our basic combative instincts were created and nurtured through countless generations of individual hardship, violence, and struggle against nature and predatory creatures. They aided survival. But with modern technology they threaten it.

Man is a gregarious animal whose first instincts impel him to seek security for himself and his family and, secondarily, his tribe. He can be proud of the technology which is the fruit of his rationalized thinking. But he has

little cause to rejoice in his collective ability to submerge these primitive instincts and substitute for them rationalized thought and action consistent with his changing technology and society. In the exercise of his combativeness the tribe has in essence become the nation and the locale has become the world.

Our inherited instincts seemingly cannot adjust themselves in pace with our technology. Mass expression of the instinct of self-preservation is mass conflict. With constantly improving new tools of communication, transportation, and controlled destruction, mass conflicts have become ever more destructive of life and the fruits of man's labor. The crowning achievement of science, the release of the energy locked in the atom, looses forces beyond comprehension. Its greatly accelerated accomplishment was dictated by the exigencies of mass conflict. Its first application was as a weapon which dwarfed all other instruments of cataclysmic destruction. And new and more ghastly weapons and weapon carriers are being laboriously and expensively prepared. Distance provides diminishing security.

We can judge the future only by the past. Based strictly upon past performance, the human race seems headed helplessly down a path to be marked by occasional mass conflicts of mounting frightfulness, until some inevitable climax brings it to a halt.

Must we drift thus, the victims instead of the masters of our creations?

At the conclusion of a second world convulsion of battle and wholesale destruction within the span of only two generations, are we over a period of years to drift into another? Or can human society soon demonstrate advances in sociology consistent with those in technology?

Those now living are mankind's link between his past and his future. The things we do may decide the fate of generations still unborn. The need is great to break the precedent and eliminate the curse of savage and impoverishing mass suicide. The law of the jungle is no longer applicable to civilized society as we know it.

Men of the professions are trained to think and act objectively and their success is measured by this faculty. Is there not something constructive we can do beyond deploping the dismal prospect of a world society which periodically sacrifices the best of its population and resources and continually burdens itself with an economy struggling to pay for past wars and prepare for new ones?



Wilbur L. Webb

Board of Directors—1946

Wilbur L. Webb was born July 17, 1906, in Stanberry, Missouri. He received the B.S.E.E. degree from the State College of Washington in 1929. In that year he became affiliated with the General Electric Company as a test engineer, and from 1929 to 1930 served in the Army Air Forces as a flying cadet. From 1930 to 1935 Mr. Webb was a radio engineer for Bell Telephone Laboratories, working on the design and development of aircraft and marine radio receivers and direction finders. He was associated with Lear Developments, Inc., New York City, as chief engineer in aircraft radio equipment from 1935 to 1936; also in 1936, he

joined the Bendix Radio Division of Bendix Aviation Corporation where he has served in progressively important positions. As a project engineer from 1936 to 1937, Mr. Webb was concerned with radio compasses, aircraft receivers, and special direction finders, and, as Section chief from 1937 to 1938, he worked with radio receivers and direction finders. From 1938 to 1945 he was chief engineer, and since 1945 has been director of engineering and research.

In 1935 Mr. Webb became an Associate Member of The Institute of Radio Engineers and transferred to Senior Member grade in 1944.

The Equivalent Circuit for a Plane Discontinuity in a Cylindrical Wave Guide*

JOHN W. MILES†

Summary—Impedance concepts in wave guides have been discussed rigorously and have been applied to the analysis of a plane discontinuity in the form of a junction between two guides of arbitrary cross sections separated by an infinitely thin diaphragm having arbitrary openings. The problem is described by a four-terminal network whose elements are given by the solution of an infinite number of simultaneous equations, any finite number of which may be solved to give a uniformly converging approximation to the true solution. In any specific application, it is merely necessary to substitute the characteristic eigenfunctions and eigenvalues in these equations without repeating their formulation.

In many cases the analysis gives a lower bound to the true impedance, and in the case of a simple obstacle (no change of cross section) an alternative analysis is developed to yield an upper bound.

The general equivalent circuit is represented as a T network, but it is shown that there is one important category of problems where this T section reduces to an ideal transformer plus a shunt element, which in turn may be reduced to a pure shunt element. The formulation of a pi network is discussed.

The theory is applied to a transverse wire, capacitive and inductive windows, and capacitive and inductive changes of cross section in a rectangular guide, and approximate expressions for their impedances are deduced. A rather extensive treatment of the capacitive window is given in order to demonstrate the potentialities of the method, and the true answer is bounded by approximations, differing (for a typical case) by less than 0.006 per cent.

NOMENCLATURE

a	= amplitude of incident wave
b	= amplitude of reflected wave
c	= velocity of light
j	$= (-1)^{1/2}$
\underline{k}	= unit vector in z direction
m, n, p, q, r, s	= free indexes
t	= time
u, v	= co-ordinates in the plane transverse to axis of cylinder
z	= longitudinal co-ordinate
A, B, C	= arbitrary constants
\underline{E}	= vector electric field
\underline{H}	= vector magnetic field (more properly, magnetomotive force $= \underline{B}/\mu$)
I	= transmission-line current
\bar{I}, \bar{J}	= obstacle current
P	= power
S	= surface or cross section
TE	= transverse electric (H) mode
TM	= transverse magnetic (E) mode
Y	= field admittance
Z	= equivalent-circuit impedance
β	= phase constant
δ_{mn}^m	= kronecker delta = 1 if $m = n$, = 0 if $m \neq n$

\bar{E} = normalized field

ϵ = dielectric constant (m-k-s units)

$\zeta = (\epsilon/\mu)^{1/2}$ = characteristic admittance

$\eta = (\mu/\epsilon)^{1/2}$ = characteristic impedance

λ = free-space wavelength

λ_g = wavelength in wave guide

μ = permeability (m-k-s units)

σ = aperture area

τ = obstacle area

ϕ = transverse solution to vector wave equation

ψ = arbitrary phase parameter

ω = circular frequency = $2\pi \times$ frequency

$()^*$ = complex conjugate of $()$

INTRODUCTION

IN RECENT years there have been a number of papers published¹⁻⁷ both in this country and abroad, on the subject of the impedance concepts in wave guides and, in particular, on the impedances of certain types of discontinuities in these guides. The purpose of the present paper is to establish the equivalent circuit of a plane discontinuity in a cylindrical wave guide of arbitrary cross section after first establishing precisely the impedance concepts on which the equivalent circuit is based. The analysis will be illustrated by several important practical applications.

The plane discontinuity takes the form of an infinitely thin diaphragm having arbitrary openings and separating two cylindrical guides, 1 and 2, of arbitrary cross sections S_1 and S_2 , occupying the regions of negative and positive z , respectively, where the z axis is parallel to the axis of the cylinders. The guides 1 and 2 are described by the orthogonal co-ordinates (u_1, v_1, z) and (u_2, v_2, z) , respectively. Although it is not necessary that the co-ordinates (u_1, v_1) and (u_2, v_2) be the same, the common co-ordinates (u, v) will be assumed in the plane $z=0$, where, in the interests of convenience, the discontinuity is located.

¹ S. A. Schelkunoff, "Impedance of a transverse wire in a rectangular wave guide," *Quart. App. Math.*, vol. 1; April, 1943.

² S. A. Schelkunoff, "Impedance concepts in wave guides," *Quart. App. Math.*, vol. 2; April, 1944.

³ W. Dällenbach, "Darf Man von Wellenwiderstand Einer Ebenen Welle Oder Einer Rohrleitung Sprechen?," *Hochfrequenz-Technik und Electroakustik*, Band 61, Heft 6; June, 1943.

⁴ J. R. Whinnery and H. W. Jamieson, "Equivalent circuits for discontinuities in transmission lines," *Proc. I.R.E.*, vol. 32, pp. 98-114; February, 1944.

⁵ Simon Ramo and J. R. Whinnery, "Fields and Waves in Modern Radio," John Wiley and Sons, New York, N. Y., 1944.

⁶ J. C. Slater, "Microwave Transmission," McGraw-Hill Book Company, New York, N. Y., 1942.

⁷ S. A. Schelkunoff, "Electromagnetic Waves," D. Van Nostrand Company, Inc., New York, N. Y., 1943.

* Decimal classification: R118.2. Original manuscript received by the Institute, October 29, 1945; revised manuscript received, February 5, 1946.

† University of California, Los Angeles, California.

We shall assume that only one mode, hereafter termed the dominant mode, propagates on each side of the discontinuity; although it is in no way necessary that the dominant modes be the same in guides 1 and 2, it is required that no other propagated modes be excited by the discontinuity, either due to the geometry (e.g. symmetry in a circular guide may prevent the TE_{11} mode from being excited), or due to the fact that the guide in question supports only one propagated mode. The extension of the treatment to problems where more than one mode propagates, or where the discontinuity has a finite longitudinal dimension, should be clear from the patterns of the following analysis.

THE FIELDS

Starting from Maxwell's equations, it can be shown that the electric fields satisfy the vector wave equation.^{5,8} In addition, since the co-ordinate is fixed in direction, the longitudinal (E_z) and transverse electric fields satisfy separate scalar and vector wave equations, respectively. In the subsequent analysis we shall deal only with the transverse fields, and all field vectors imply transverse fields unless explicitly specified to the contrary. Separating out the z dependence and assuming harmonic time variation ($e^{i\omega t}$, which factor is suppressed throughout the analysis), the electric field may then be written

$$\bar{E}(u, v, z) = \sum_{m,n} C_{mn} \bar{\phi}_{mn}(u, v) e^{\mp i\beta_{mn} z} \quad (1)$$

$$\nabla^2 \bar{\phi}_{mn} + \mu_{mn}^2 \bar{\phi}_{mn} = 0 \quad (2)$$

$$\bar{\phi}_{mn} \times \bar{n} = 0 \text{ at guide walls} \quad (3)$$

$$\beta_{mn}^2 = \beta^2 - \mu_{mn}^2 \quad (4)$$

where β_{mn} is the phase constant for the m nth mode and β is the phase constant in free space. The choice of the negative or positive sign in (1) corresponds to a wave traveling in the positive or negative z direction, respectively.

The properties of the solutions to (2) in a cylindrical guide have been discussed extensively in standard texts.^{5,7,8} It suffices here to mention that there are two classes, the TE_{mn} (or H_{mn}) and TM_{mn} (or E_{mn}) modes, and, as is clear from (4), only a finite number of these modes have real values of β_{mn} for fixed β (i.e., fixed frequency). In the following, it is assumed that only one of the modes present in a given problem is propagated ("dominant" mode), and it will be designated by the subscript zero, regardless of the actual values of m and n which also characterize it. Solutions to (2) to (4) are listed in Appendix I.

THE FIELD ADMITTANCES

An extensive discussion of the concepts introduced in this section is given in the literature,⁹ and the following is intended only as a brief recapitulation.

⁵ J. A. Stratton, "Electromagnetic Theory," McGraw-Hill Book Company, New York, N. Y., 1941.

⁸ See chapter 8 of footnote reference 5.

Maxwell's curl equations for the *total* fields will be written in a form analogous to that of the standard "telegraph" or transmission-line equations; namely,

$$\nabla \times \bar{H} = j\beta\zeta \bar{E} \quad (5)$$

$$\nabla \times \bar{E} = -j\beta\eta \bar{H} \quad (6)$$

where $\zeta = \eta^{-1}$ is the "characteristic admittance" of the dielectric medium. It follows from (1), (5), and (6), remembering that the TE and TM modes have no longitudinal (z) electric and magnetic components, respectively, that the transverse magnetic field may be obtained from the transverse electric field as follows:

$$\bar{H}_{(u,v,z)} = \pm Y_{mn} [\bar{k} \times \bar{E}(u, v, z)] \quad (7)^{10}$$

$$Y_{(TE_{mn})} = \left(\frac{\beta_{mn}}{\beta} \right) \zeta = \left[1 - \left(\frac{\mu_{mn}}{\beta} \right)^2 \right]^{1/2} \zeta \quad (8)$$

$$Y_{(TM_{mn})} = \left(\frac{\beta}{\beta_{mn}} \right) \zeta = \left[1 - \left(\frac{\mu_{mn}}{\beta} \right)^2 \right]^{-1/2} \zeta. \quad (9)$$

The quantities Y_{mn} are designated herein as the "field admittances" of their respective modes. For propagated modes the β_{mn} , and hence the Y_{mn} , are real, but for nonpropagated modes the β_{mn} must be taken as negative imaginary (in order to insure attenuation away from the source), and the field admittances become negative imaginary (inductive) or positive imaginary (capacitive) for nonpropagated TE or TM modes, respectively.

Although the longitudinal fields are not required for the calculation of the equivalent circuit, they may be calculated by substituting the transverse fields in (5) and (6).

THE TRANSMISSION-LINE ANALOGY

We shall now demonstrate that the transverse fields of each mode may be represented by the voltage and current on a transmission line having the phase constant of the mode in question and having a characteristic admittance which is an arbitrary multiple of the field admittance for that mode. To do this we define the transmission-line voltage $\bar{V}_{mn}(z)$ and the transmission-line current $I_{mn}(z)$ by writing

$$\bar{E}_{mn}(u, v, z) = AV_{mn}(z) \bar{\phi}_{mn}(u, v) \quad (10)$$

$$\bar{H}_{mn}(u, v, z) = \pm BI_{mn}(z) \bar{k} \times \bar{\phi}_{mn}(u, v). \quad (11)$$

The constants A and B are, for the present, arbitrary. The \pm sign in (11), corresponding to the \mp sign in (1), insures a current flow in the direction of the propagated wave. Comparison with (1) reveals that the phase constant of our equivalent transmission line is indeed the field phase constant; moreover, an electric short circuit ($\bar{E}=0$) in a plane of constant z causes the voltage at that point to vanish, corresponding to a short-circuited transmission line, while a magnetic short

¹⁰ The top and bottom signs, here and elsewhere, correspond to the \pm signs in (1).

circuit ($\bar{H}=0$) causes the current to vanish, corresponding to an open-circuited transmission line.

If we substitute (7) in (10) and (11) we obtain

$$I_{mn}(z) = \left(\frac{A}{B}\right) Y_{mn} V_{mn}(z) \quad (12)$$

so that the characteristic admittance of the equivalent transmission line is A/B times the field admittance for the mode under consideration; we remark that so far the only restriction on A and B is that they be independent of the co-ordinates (u, v, z). Thus we may describe the propagation of the fields of any individual mode by a transmission line which is arbitrary up to the constants A and B . We emphasize that a separate line is required for each mode, but if one is not interested in the behavior of the fields in the immediate vicinity of sources the transmission line for any nonpropagated mode may be regarded as a lumped susceptance located at the source of the mode in question, a justifiable assumption only if we view the source from a distance sufficiently removed to insure the attenuation of the nonpropagated mode; in the subsequent treatment we shall make our analysis on this basis.

Although it is not required for the propagation analogy, it is convenient to require the complex (with respect to time) power transferred across any plane of constant z to be the same in both the guide and transmission line; namely,

$$P_{mn}(z) = \frac{1}{2} \int_S \bar{E}_{mn} \times \bar{H}_{mn}^* dS = \frac{1}{2} V_{mn}(z) I_{mn}^*(z). \quad (13)$$

Substituting (10) and (11) in (13) we obtain the condition

$$AB \int_S |\bar{\phi}_{mn}|^2 dS = 1 \quad (14)$$

so that the product AB is determined by the normalization of the eigenfunctions. We shall choose the convenient normalization

$$\int_S \bar{\phi}_{mn} \cdot \bar{\phi}_{pq} dS = \delta_p^m \delta_q^n \quad (15)$$

i.e., the integral of (15) vanishes unless the two modes are identical, in which case the integral is unity. The orthogonality of the solutions to (2) is proved in the Appendix II, as no published proof of the orthogonality of the solutions to the vector wave equation is known to the author.

Having fixed the product AB , we are still at liberty to fix the ratio (A/B) and the definition of the characteristic admittance in (12) is fixed only up to this ratio. While it is convenient to take this ratio as unity (as is done in the subsequent analysis), it is by no means necessary, and, inasmuch as it will be found that all physically measurable quantities (e.g., reflection coefficients) depend only on the ratios of admittances, it is physically impossible to determine the ratio (A/B)

absolutely. Hence, the true characteristic impedance of a wave guide remains undetermined, but all impedances may be expressed relative to an arbitrarily chosen characteristic impedance. This latter point has not been sufficiently appreciated in a great deal of the literature dealing with impedance concepts in wave propagation. Nevertheless, it should be added that there are certain special cases, such as the principal modes on two-conductor transmission lines, where unique voltages and currents may be directly measured. In such cases A and B would be naturally chosen to give a characteristic impedance in agreement with that established by "low-frequency" distributed-constant analyses for the transmission line in question; i.e., in such a way as to make the fictitious or equivalent transmission line identical with the physical model.

THE FIELDS NEAR A PLANE DISCONTINUITY

Turning to the specific problem at hand, the determination of the equivalent circuit of a plane discontinuity, we divide the area common to S_1 and S_2 in the plane $z=0$ into the two areas σ and τ , where σ is the aperture consisting of one or more windows, and τ is the remaining area which we term the obstacle. The superscripts 1 and 2 will be used to denote quantities in guides 1 and 2, and, where there is a choice of signs, the top and bottom sign will be associated with 1 and 2, respectively. If we imagine dominant modes of amplitudes $a^{1,2}$ incident on the discontinuity ($z=0$), designate the amplitudes of the reflected modes as $b^{1,2}$, denote the transverse electric field in the plane $z=0$ as $\bar{E}(u, v)$, and remember that the functions $\bar{\phi}_{mn}(u, v)$ form a complete orthonormal set, we may express the transverse electric fields in the guides as

$$\begin{aligned} \bar{E}^{1,2}(u, v, z) = & [a^{1,2} e^{\mp i\beta_0^{1,2} z} + b^{1,2} e^{\pm i\beta_0^{1,2} z}] \bar{\phi}_0^{1,2}(u, v) \\ & + \sum_{m,n} e^{\pm i\beta_{mn}^{1,2} z} \bar{\phi}_{mn}^{1,2}(u, v) \\ & \cdot \int_{\sigma} \bar{\phi}_{mn}^{1,2}(u', v') \cdot \bar{E}(u', v') dS' \quad (16) \end{aligned}$$

$$b^{1,2} = -a^{1,2} + \int_{\sigma} \bar{\phi}_0^{1,2}(u', v') \cdot \bar{E}(u', v') dS'. \quad (17)$$

It is important to observe that the integrals are taken only over the aperture in order to satisfy implicitly the boundary conditions imposed on the electric field by the metal surface, that the summations do not contain the dominant modes, and that the co-ordinates u and v are not necessarily the same in guides 1 and 2 (although assumed common in the plane $z=0$). It should also be remarked that the representation for the electric field given by (16) in the plane $z=0$ is continuous in the open region σ but may be discontinuous on the boundaries of σ , since it vanishes on the obstacle τ but can be infinite at sharp edges; this anomaly has been observed by Bethe and Sommerfeld,^{11,12} and it

¹¹ H. A. Bethe, "Theory of diffraction by small holes," *Phys. Rev.* vol. 66; October, 1944.

¹² A. Sommerfeld, *Math. Ann.*, Bd. XLVII, S.317, 1896; also *Zeit. für Math. und Phys.*, Bd. XLVI, S.11, 1901.

can be shown that all such singularities are always integrable (it is herein considered physically obvious).

Substituting (16) in (7), the magnetic fields are given by

$$\begin{aligned} \bar{H}^{1,2}(u, v, z) = & \pm Y_0^{1,2} [a^{1,2} e^{\mp j\beta_0^{1,2} z} \\ & - b^{1,2} e^{\pm j\beta_0^{1,2} z}] \bar{k}_z \times \bar{\phi}_0^{1,2}(u, v) \\ & \mp \sum_{m,n} Y_{mn}^{1,2} e^{\pm j\beta_{mn}^{1,2} z} \bar{k} \times \bar{\phi}_{mn}^{1,2}(u, v) \\ & \cdot \int_{\sigma} \bar{\phi}_{mn}^{1,2}(u', v') \cdot \bar{E}(u', v') dS'. \end{aligned} \quad (18)$$

The continuity of the magnetic field between regions 1 and 2 is not guaranteed by the continuity of the electric field (already established in the formulation of (16)); from (18) the equation of continuity across the aperture is

$$\begin{aligned} Y_0^1(a^1 - b^1)\bar{\phi}_0^1(u, v) + Y_0^2(a^2 - b^2)\bar{\phi}_0^2(u, v) \\ = \int_{\sigma} \bar{E}(u', v') \cdot \bar{G}(u', v', u, v) dS' \end{aligned} \quad (19)$$

$$\bar{G}(u', v', u, v) = \sum_{m,n} \sum_{p=1,2} Y_{mn}^p \bar{\phi}_{mn}^p(u', v') \bar{\phi}_{mn}^p(u, v). \quad (20)$$

The equation (19) constitutes a "vector-integral" equation for the determination of the aperture field $\bar{E}(u, v)$. The "kernel" is a dyadic in the sense that its scalar product with a vector is a vector and symmetric in the sense that this scalar product is commutative. \bar{G} may also be designated as the "Green's function" of the boundary-value problem. It should be observed that (19) is valid only in the aperture σ , the magnetic field being discontinuous across the obstacle τ due to the current flowing there.

Although (16), (18), and (20) represent a complete solution for the transverse fields, the solution will be effected in terms of equivalent-circuit concepts.

THE EQUIVALENT CIRCUIT

Following (10) and (11), we define, as measures of the transverse electric fields corresponding to the dominant modes, the equivalent transmission-line voltages

$$V_0^{1,2}(z) = [a^{1,2} e^{\mp j\beta_0^{1,2} z} + b^{1,2} e^{\pm j\beta_0^{1,2} z}] \quad (21)$$

and, as measures of the corresponding magnetic fields, the equivalent transmission-line currents

$$I_0^{1,2}(z) = Y_0^{1,2} [a^{1,2} e^{\mp j\beta_0^{1,2} z} - b^{1,2} e^{\pm j\beta_0^{1,2} z}]. \quad (22)$$

Both of the currents are specified positive when flowing towards the junction $z=0$.

In order to describe the effect of the higher-order modes (at a sufficient distance from the discontinuity), we imagine the voltages and currents of (21) and (22) to be interrelated by a four-terminal network whose constants must be determined in such a way as to represent completely the effect of the higher-mode fields on the dominant-mode fields. The polarities and direc-

tions of flow are shown in Fig. 1. The voltages and currents may be chosen in any two reference planes, and, in principle (since our transmission lines 1 and 2 completely represent the situation in the guides), they do not have to bound or be adjacent to the discontinuity; however, it is obvious, in the case of our plane obstacle, that convenience dictates the plane $z=0$ as a single, common reference plane for both sets of voltages and currents. The voltages and currents, as hereafter written, will therefore be implicitly measured in this reference plane, unless specifically exhibited as functions of z .

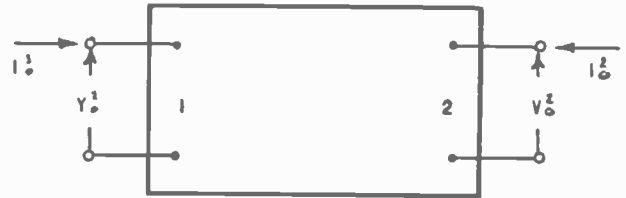

Fig. 1—General four-terminal network.

Due to the linearity of Maxwell's equations, the (linear) measures of the fields must be linearly related; hence, we define the parameters (or equivalent circuit-impedance elements) by the relations¹⁸

$$V_0^1 = Z_{11}I_0^1 + Z_{12}I_0^2 \quad (23a)$$

$$V_0^2 = Z_{21}I_0^1 + Z_{22}I_0^2. \quad (23b)$$

Equations (23) are recognized as the familiar circuit equations of a four-terminal network, where positive signs are associated with the mutual-impedance elements (Z_{12} and Z_{21}) because of our unconventional choice of polarities and directions of current flows (which were dictated by the convenience of symmetry in the final results). While reciprocity ($Z_{12} = Z_{21}$) may be directly inferred from conservation of energy, it will be explicitly demonstrated in the subsequent analysis, and the equivalent circuit becomes the T network shown in Fig. 2. Although most reflection problems are more expediently solved directly in terms of impedances, the reflection and transmission coefficients are derived in Appendix III.

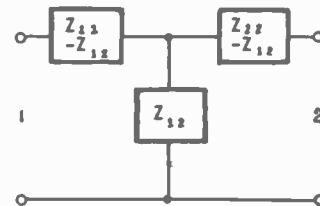

Fig. 2—T network.

In order to evaluate the impedance elements of (23), we insert the currents of (22) in the integral equation (19) to obtain

¹⁸ The impedance elements Z_{ij} should not be confused with the field impedances; accordingly, only field admittances (Y_{mn}) will be used.

$$I_0^1 \bar{\phi}_0^1(u, v) + I_0^2 \bar{\phi}_0^2(u, v) = \int_{\sigma} \bar{E}(u', v') \cdot \bar{G}(u', v', u, v) dS'. \quad (24)$$

In order to eliminate the currents from (24) we again appeal to the linearity of Maxwell's equations and assert that the transverse field in the aperture must be a linear combination of two fields proportional to the amplitudes of the exciting (dominant-mode) fields;¹⁴ thus, since the currents I_0^1 and I_0^2 are proportional to the amplitudes in question, we may write for the transverse electric field in the aperture,

$$\bar{E}(u, v) = I_0^1 \bar{E}^1(u, v) + I_0^2 \bar{E}^2(u, v). \quad (25)$$

Substituting (25) in (17) and evaluating $V_0^{1,2}(0)$ from (21) we obtain

$$V_0^{1,2} = I_0^1 \int_{\sigma} \bar{E}^1(u, v) \cdot \bar{\phi}_0^{1,2}(u, v) dS + I_0^2 \int_{\sigma} \bar{E}^2(u, v) \cdot \bar{\phi}_0^{1,2}(u, v) dS \quad (26)$$

which, on comparison with (23), yields

$$Z_{ij} = \int_{\sigma} \bar{\phi}_0^i(u, v) \cdot \bar{E}^j(u, v) dS. \quad (27)$$

In (27) et seq. the indices i and j may take the values 1 and 2. If we substitute (25) in (24) and equate coefficients of I_0^1 and I_0^2 (by virtue of their linear independence) we obtain the determining equations

$$\bar{\phi}_0^i(u, v) = \int_{\sigma} \bar{E}^i(u', v') \cdot \bar{G}(u', v', u, v) dS'. \quad (28)$$

The scalar components of (28) are integral equations of the first kind¹⁵ for the determination of the components of \bar{E}^1 and \bar{E}^2 , and (28) may be regarded as a "vector integral equation of the first kind," just as in the case of (19).

To solve (28) we follow (analogously) the standard technique of expanding the field $\bar{E}_i(u, v)$ in a complete set of orthonormal functions $\bar{\psi}_{rs}(u, v)$ which are solutions to (2) and (3) in a guide of cross section σ , thus satisfying the boundary condition imposed on the tangential electric field. Hence we write

$$\bar{E}^i(u, v) = \sum_{r,s} A_{rs}^i \bar{\psi}_{rs}(u, v) \quad (29)$$

where r and s cover the complete set. In addition, we define the coefficients

$$C_{rs}^i = \int_{\sigma} \bar{\phi}_0^i(u, v) \cdot \bar{\psi}_{rs}(u, v) dS \quad (30)$$

$$D_{rr's'}^i = \int_{\sigma} \bar{\psi}_{rs}(u, v) \cdot \bar{G}(u, v, u', v') \cdot \bar{\psi}_{r's'}(u', v') dS' dS \quad (31)$$

remembering that \bar{G} is symmetric. Substituting (29) in (28), reversing the order of integration and summation, taking the scalar product of both sides of the equation by $\bar{\psi}_{r's'}(u', v') dS'$, and integrating over σ , we obtain

$$\sum_{r',s'} D_{rr's'} A_{r's'}^i = C_{rs}^i. \quad (32)$$

Since (32) holds for all r and s it represents an infinite set of simultaneous equations for the determination of the set A_{rs}^i . To obtain the impedance elements we substitute (29) in (27), whence

$$Z_{ij} = \sum_{r,s} C_{rs}^i A_{rs}^j. \quad (33)$$

An attack which is both more elegant and more powerful for many important special cases has been used by Dr. Julian Schwinger on the scalar counterparts of (27) and (28). Following Schwinger, in order to eliminate the dependence of the impedance elements on the field amplitudes, we multiply both sides of (28) by $\bar{E}^j(u, v) dS$, integrate over σ , divide both sides of the resulting equation by the square of (27), and obtain

$$\frac{1}{Z_{ij}} = \frac{\int_{\sigma} \int_{\sigma} \bar{E}^i(u, v) \cdot \bar{G}(u, v, u', v') \cdot \bar{E}^j(u', v') dS' dS}{\int_{\sigma} \bar{E}^i(u, v) \cdot \bar{\phi}_0^i(u, v) dS \int_{\sigma} \bar{E}^j(u', v') \cdot \bar{\phi}_0^j(u', v') dS'}. \quad (34)$$

Inasmuch as the Green's function is symmetrical, reciprocity is immediately evident from (34); i.e., $Z_{12} = Z_{21}$. It can be shown that (34) is stationary with respect to first-order variations about the true field, and, for the special case where only one set (TE or TM) modes is excited (so that the field admittances are all capacitive or all inductive) and $i=j$, the magnitude of $1/Z_{ij}$ is an absolute minimum for the true field; this is proved in Appendix IV. Several important practical cases are included in this latter category.

A convenient approximation in the foregoing analysis is to assume the linear relation

$$\bar{E}^2(u, v) = N \bar{E}^1(u, v). \quad (35)$$

Substituting (35) in (27), we obtain (remembering that reciprocity exists)

$$Z_{12} = NZ_{11} = \frac{1}{N} Z_{22} \quad (36)$$

$$N = \left[\int_{\sigma} \bar{\phi}_0^2(u, v) \cdot \bar{E}^1(u, v) dS \right] \cdot \left[\int_{\sigma} \bar{\phi}_0^1(u', v') \cdot \bar{E}^1(u', v') dS' \right]^{-1}. \quad (37)$$

Substituting (36) in (33), we obtain

$$V_0^1 = Z_{11} [I_0^1 + NI_0^2] = \frac{1}{N} V_0^2. \quad (38)$$

Hence the equivalent circuit reduces to a shunt element

¹⁴ This suggestion was made by Dr. Julian Schwinger.

¹⁵ E. T. Whittaker and G. N. Watson, "Modern Analysis," Macmillan Company, New York, N. Y., 1943, chap. 11.

plus a transformer as shown in Fig. 3. Physically the approximation of (35) assumes that the transverse fields, and therefore the voltages measuring them, on the two sides of the aperture are linearly related, with the natural result that a simple transformer is introduced in the equivalent circuit. In practice, it is con-

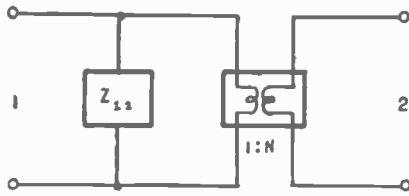

Fig. 3—Approximate equivalent circuit.

venient to redefine the characteristic impedance in one of the guides to make $N=1$, thus reducing the equivalent circuit to a pure shunt element. This corresponds to the choice of $A=B^{-1}$ in (12) such that $(A_2/A_1)=N$, where N is defined as in (37).

A category of problems for which (35) to (38) are rigorously correct is obtained if there exists the relation

$$\bar{\phi}_0^2(u, v) \equiv N\phi_0^1(u, v) \tag{39}$$

as is easily shown by substitution in (27) and (28); moreover, it follows directly from the linearity of Maxwell's equations that a linear relation between the exciting fields necessarily implies a linear relation between the excited fields. It also follows from (28) that (39) is a necessary, as well as a sufficient, condition for the validity of (35), (36), (37), and (38).

It is obvious that any discontinuity consisting of a thin obstacle with no change of cross section falls in this category with N automatically equal to unity. There are, in addition, problems involving changes of cross section which satisfy (39), the most important being those involving a change of the dimension in a rectangular wave guide (TE_{10} dominant mode) which is parallel to the electric field and changes of cross section in coaxial lines.

It should be clear that the justification of the approximation of (35) is measured by the degree of validity of (39). In particular, it may be observed that Schelkunoff,² in attempting to demonstrate the validity of the equivalent circuit of Fig. 3 for all plane discontinuities, implicitly assumes the relation (39) to be valid. Of course it should be added that this approximation is often sufficient in practice, and, in any event, it is certainly superior to those earlier approximations which neglected the shunt element entirely and simply gave the transformer as an equivalent circuit.

THE PI EQUIVALENT CIRCUIT

Although qualitative reasoning is fairly conclusive in favor of a T equivalent circuit for plane discontinuities, it is interesting to investigate the possibility of a Pi network. This can be done by setting up a pi circuit having pillar arms of admittances $(Y_{11}-Y_{12})$ and $(Y_{22}-Y_{12})$ and an archtrave of Y_{12} , writing the junction

(or node) equations for I_0^1 and I_0^2 (in contrast to the mesh equations (23)), and expressing the aperture field as a linear combination of two fields \bar{E}^1 and \bar{E}^2 (analogous to (25)) proportional to the voltages V_0^1 and V_0^2 . If the expression for the field is then substituted in (17) and (21) two constraints, which must be imposed on \bar{E}_1 and \bar{E}_2 , are obtained. If the junction equations, together with the aperture-field expression, are then substituted in (24), expressions for the admittance elements in terms of \bar{E}_1 and \bar{E}_2 and integral equations for \bar{E}_1 and \bar{E}_2 can be obtained, whence the solutions can be effected as in (29), (30), (31), (32), and (33). Unfortunately, the aforementioned constraints on \bar{E}_1 and \bar{E}_2 make the solution awkward.

The superiority of the T network over the pi network is due to the characteristics of the discontinuity under consideration, as is evidenced by the fact that a simple shunt element (plus a transformer) is a good approximation to the actual equivalent circuit. For other types of discontinuities, such as slots in the guide walls, which might be well approximated by simple series elements, the pi representation would prove superior.

THICKNESS CORRECTION

In practice, it is often true that the thickness of an obstacle has an effect which is sufficiently important to change results markedly from those predicted on the assumption of "infinitely thin" obstacles, as treated above. An approximation to the thickness correction, which is generally sufficient in practice, may be obtained simply by considering the aperture as a short section of wave guide separating the two interfaces of the discontinuity and treating only the dominant mode in this section. On the basis of the foregoing theory, using the equivalent circuit for a length of transmission line,¹⁶ the circuit shown in Fig. 4 is obtained. Z_{11} , Z_{12} , and Z_{22} are calculated on the assumption of an

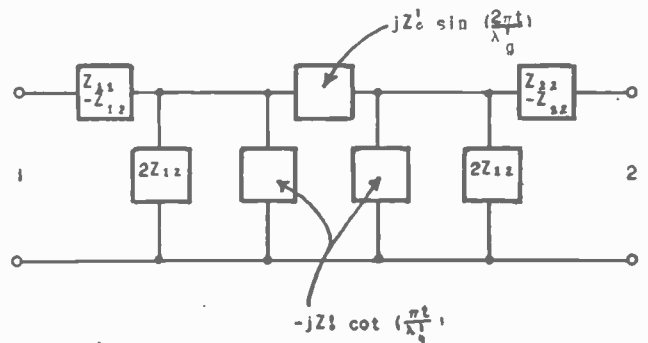

Fig. 4—Equivalent circuit for thick obstacle.

"infinitely thin" obstacle; t is the thickness of the obstacle, Z_0' is the characteristic impedance of a guide having the cross section of the aperture, probably expressed relative to the characteristic impedance of one of the guides, and λ_g' is the guide wavelength in the aperture; both Z_0' and λ_g' may be imaginary, but are taken for the mode having the lowest cutoff frequency.

¹⁶ W. L. Everitt, "Communication Engineering," McGraw-Hill Book Company, New York, N. Y., 1939.

THE FIELDS AS FUNCTIONS OF CURRENT
IN THE OBSTACLE

The principal reason for expressing the fields in the vicinity of a plane discontinuity as functions of the electric field in the plane of the discontinuity is the simplicity of the boundary condition imposed on the electric field by the obstacle. It is, however, feasible to express the fields as functions of the current flowing on the surface of the obstacle, the physical motivation being that the total field must be simply the incident field plus a scattered field which may be attributed to the current flowing in the obstacle. In the case of a general discontinuity involving a change of cross section this mode of treatment is not particularly expedient, since the fields on the two sides of the discontinuity must be expressed by integrals whose regions are not completely common to one another. On the other hand, there are certain advantages to this type of representation when the discontinuity assumes the form of an obstacle in an otherwise continuous guide, particularly since it is amenable to extension in those cases where the obstacle is not infinitely thin and even where it is not perfectly conducting (or is dielectric).

While it is possible to formally invert the integral equation (28), valid over the region σ , to an integral equation valid over the region τ and identify the kernel of the latter equation as the obstacle current, it is preferable from a physical standpoint to develop the equation from the concepts of the previous paragraph. From the definition of $\bar{\phi}_{mn}(u, v)$, the transverse components of the scattered magnetic fields may be written¹⁷

$$\begin{aligned} \bar{H}^{1,2}(u, v, z) = & \sum_{m,n} e^{\pm i\beta_{mn}z} \bar{k} \times \bar{\phi}_{mn}(u, v) \\ & \cdot \int_{S(z=\mp\Delta)} \bar{H}(u', v', \mp\Delta) \\ & \cdot \bar{k} \times \bar{\phi}_{mn}(u', v') dS' \end{aligned} \quad (40)$$

where the integrals are carried out just to the left or right ($z = \mp\Delta$) of the obstacle. If the obstacle is regarded as a current sheet of surface current densities $\bar{I}^{1,2}(u, v)$ (on the two sides), the boundary condition on the field of (40) becomes

$$\bar{H}^{1,2}(u, v, \mp\Delta) = \pm \bar{k} \times \bar{I}^{1,2}(u, v). \quad (41)$$

Following (16), (17), (18), (19), and (20) and remembering that $\bar{I}(u, v)$ vanishes in σ , the total magnetic field, consisting of incident field plus scattered field, may be written

$$\begin{aligned} \bar{H}^{1,2}(u, v, z) = & \pm [a^{1,2}e^{\mp i\beta_0z} - b^{1,2}e^{\pm i\beta_0z}] \bar{k} \times \bar{\phi}_0(u, v) \\ & \pm \sum_{m,n} e^{\pm i\beta_{mn}z} \bar{k} \times \bar{\phi}_{mn}(u, v) \\ & \cdot \int_{\tau} \bar{I}^{1,2}(u', v') \cdot \bar{\phi}_{mn}(u', v') dS' \end{aligned} \quad (42)$$

¹⁷ The superscripts 1 and 2 have been dropped from β_{mn} and $\bar{\phi}_{mn}$, since the guides are the same on both sides of the discontinuity.

$$b^{1,2} = a^{1,2} - \int_{\tau(\mp\Delta)} \bar{I}^{1,2}(u', v') \cdot \bar{\phi}_0(u', v') dS'. \quad (43)$$

Applying (7) to (42) yields the transverse electric field, and invoking the boundary condition that this field vanish on the obstacle τ we obtain the integral equation (valid only on τ)

$$\begin{aligned} Z_0(a^{1,2} + b^{1,2})\bar{\phi}_0(u, v) \\ = 2 \int_{\tau(\mp\Delta)} \bar{I}^{1,2}(u', v') \cdot \bar{G}(u', v', u, v) dS' \end{aligned} \quad (44)$$

$$\bar{G}(u', v', u, v) = \frac{1}{2} \sum_{m,n} \frac{\bar{\phi}_{mn}(u', v') \bar{\phi}_{mn}(u, v)}{Y_{mn}}. \quad (45)$$

Following (21) and (22), the transmission-line voltages and currents in the reference plane $z=0$ are given by

$$V_0^{1,2} = Z_0(a^{1,2} + b^{1,2}) \quad (46)$$

$$I_0^{1,2} = (a^{1,2} - b^{1,2}). \quad (47)$$

Now the electric fields must be equal over σ , and since both vanish over the same region τ it follows that

$$V_0^1 = V_0^2 = V_0 \quad (48)$$

and, if we then define the normalized current

$$\bar{J}(u, v) = \lim_{\Delta \rightarrow 0} \frac{\bar{I}^1(u, v) + \bar{I}^2(u, v)}{V_0} \quad (49)$$

(44) becomes

$$\bar{\phi}_0(u, v) = \int_{\tau} \bar{J}(u', v') \cdot \bar{G}(u', v', u, v) dS \quad (50)$$

while, if we define the shunt impedance element

$$Z = \frac{V_0}{I_0^1 + I_0^2} \quad (51)$$

(43) yields

$$\frac{1}{Z} = \int_{\tau} \bar{J}(u, v) \cdot \bar{\phi}_0(u, v) dS. \quad (52)$$

As in the case of (27), (28), and (34), (50), and (52) may be combined to yield

$$Z = \frac{\int_{\tau} \int_{\tau} \bar{J}(u', v') \cdot \bar{G}(u', v', u, v) \cdot \bar{J}(u, v) dS' dS}{[\int_{\tau} \bar{J}(u, v) \cdot \bar{\phi}_0(u, v) dS]^2}. \quad (53)$$

It has already been mentioned that (34) is a minimal expression for $1/Z_{11}$ if only one set (*TE* or *TM*) of modes is excited, and (53), being of the same form as (34), is therefore a minimal expression for Z under the same conditions. Accordingly, if a problem of a simple obstacle (i.e., involving no change of cross section), wherein only one set of modes is excited, is solved approximately by the two methods, (34) (or (27)) will yield a lower bound to the true value of Z_{11} , while (53) (or (52)) will yield an upper bound. In speaking of upper and lower bounds, it should be remembered that \bar{G} in (22) is positive and negative imaginary for *TM*

and TE modes, respectively, and conversely for \bar{G} of (45), and the terms maximum and minimum are applied to the absolute value of the impedance elements.

The solution of (50) and (52) may be effected exactly as in the case of (27) and (28), but the choice of a set of functions in which to expand the current \bar{J} is not as clear-cut as in the case of the electric field \bar{E} . At the walls of the guide the normal component of the magnetic field, and therefore the tangential current, must vanish, while at the boundaries between σ and τ it is clear that the normal component of the current must vanish, and these facts may be utilized in selecting an appropriate set of functions.

In applications, one of the foregoing two approaches will give a more rapidly converging solution, depending on the specific problem. In general, it might be felt that the solution requiring integrations over the smaller area would be more accurate, but it is difficult to establish any dogmatic rules.

In applying the analysis of the foregoing sections to specific problems, one should search for any simplifications which are due to the special geometry involved. In particular, one should always investigate the possibility of solving the integral equations exactly or by neglecting the frequency dependence of the higher-mode field admittances, the latter approximation reducing the dynamic problem to a static problem, whence solutions to Laplace's equation may be utilized. In view of the complications involved in the exact solution of Sommerfeld's problem,¹² there appears to be little hope of solving exactly any integral equation arising in the more complicated wave-guide problems. On the other hand, the reduction to a static problem is singularly propitious in the case of certain problems involving rectangular boundaries such that conformal mapping may be used.

Finally, it should be emphasized that all of the foregoing impedances are calculated on the assumption that the characteristic impedances of the guides are defined as in (22) and (46) in conjunction with (8) and (9).

TREATMENT OF PLANE OBSTACLES

In order to illustrate the theory developed above, several types of plane discontinuities in wave guides will be considered. Although the general solution of (29), (30), (31), (32), and (33) may be applied to any problem in the category under discussion, various methods of obtaining solutions to (34) or (53) will be utilized in order to demonstrate the versatility of the formulation used therein.

The simplest problems are those involving no change of cross section, and several such problems of practical interest will be treated first. The equivalent circuit for such a discontinuity, as indicated earlier, is a pure shunt element, corresponding to $i=j=1$ in (34) or (53), and its impedance will be designated simply by Z .

Emphasis will be laid on rectangular guides, since they are most important in practice and most easily treated in theory.

It should be re-emphasized that the characteristic impedance or admittance to be defined for each of the problems treated is entirely arbitrary, but that the value of any equivalent circuit-element impedance relative to the arbitrarily defined characteristic impedance is independent of the actual value of the characteristic impedance. Following the discussion (10), (11), (12), (13), (14), and (15) et. seq., the constants A and B in (12) will be taken as unity, so that the characteristic impedance in any particular case, unless specifically stated otherwise, will be given by (8) or (9) for the dominant mode in question.

THE TRANSVERSE WIRE

As a first example, the problem of a vertical short-circuiting wire will be treated. This problem has been solved by Schelkunoff¹ through two approaches, both different than the following.

The dominant and exciting mode is the TE_{10} mode, and the wire of radius R is located at $x=a_0$, parallel to the exciting electric field, as shown in Fig. 5. It is assumed that R is small compared to a_0 and λ . Inasmuch as the exciting field has no E_x or E_z components, no such components are required to satisfy the boundary

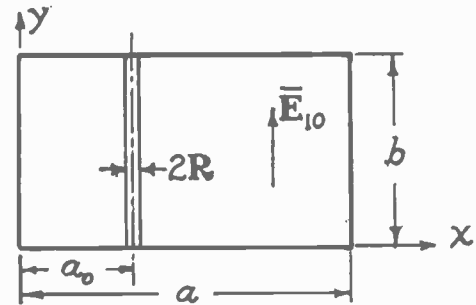

Fig. 5—Transverse wire.

conditions, and the necessary solutions are given by Appendix I (1) and I (4) where $n=0$, and the field admittances are given by substituting μ_{m0} in (8). Substituting these results in (53) and carrying out the integrations with respect to y , the impedance of the wire is given by

$$Z = \frac{1}{2} \sum_2^{\infty} \eta \left[1 - \left(\frac{m\lambda}{2a} \right)^2 \right]^{-1/2} \left(\frac{I_m}{I_1} \right)^2 \quad (54)$$

$$I_m = \int_{a_0-R}^{a_0+R} J(x) \sin \left(\frac{m\pi x}{a} \right) dx. \quad (55)$$

For a wire of small radius (and only such a wire may be considered as a "plane" obstacle) it may be assumed that $J(x)$ is constant over the wire and hence cancels out in (54). Then, if the order of summation and integration be reversed, the summation is effected by approximating $[1 - (m\lambda/2a)^2]^{-1/2}$ by $j(2a/m\lambda)$, the result, after neglecting terms of order $(R/a)^2$ and setting $Z=jX$, is

$$\left(\frac{X}{Z_0} \right) = \left(\frac{a}{2\lambda_0} \right) \left\{ \csc^2 \left(\frac{\pi a_0}{a} \right) \log \left[\frac{2ae}{\pi R} \sin \left(\frac{\pi a_0}{a} \right) \right] - 2 \right\} \quad (56)$$

$$Z_0 = \left(\frac{\lambda_g}{\lambda}\right) \eta = Y_0^{-1}, \quad (57)$$

$$\lambda_g = \lambda \left[1 - \left(\frac{\lambda}{2a}\right)^2\right]^{-1/2}$$

where Z_0 and λ_g are, respectively, the field impedance and guide wavelength for the dominant mode.

It should be remarked that, although the true solution to (54) makes X a minimum with respect to variations of $J(x)$, (56) is not necessarily larger than the true answer, since an approximation to the field admittances has been introduced. This latter approximation may be improved by replacing $[1 - (m\lambda/2a)^2]^{-1/2}$ by $\{[1 - (m\lambda/2a)^2]^{1/2} - (2a/m\lambda)\}$ in (54), carrying out the integrations, and adding the result to (56), as has been done by Schelkunoff.¹

THE INDUCTIVE WINDOW

As a second illustration of the theory, utilizing the variational principle, the problem of the "inductive window" is considered. The geometry is shown in Fig. 6, where the dominant mode is again the TE_{10} mode. The arguments of the preceding section may be repeated as regards the modes excited, and the eigenfunctions, eigenvalues, and field admittances are again given by (103), (106), and (8).

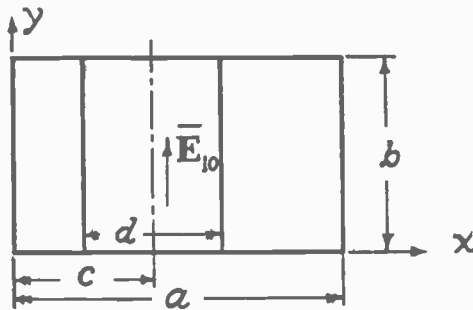

Fig. 6—Inductive window.

Insofar as the aperture is a singly connected region, the impedance of the discontinuity is more easily formulated by (34). Carrying out the y integrations, the result is

$$\frac{1}{Z} = 2\zeta \sum_2^{\infty} \left[1 - \left(\frac{m\lambda}{2a}\right)^2\right]^{1/2} \left(\frac{I_m}{I_1}\right)^2 \quad (58)$$

$$I_m = \int_{c-d/2}^{c+d/2} \mathcal{E}(x) \sin\left(\frac{m\pi x}{a}\right) dx \quad (59)$$

where $\mathcal{E}(x)$ is the normalized aperture field.

While (58) may be evaluated by expanding $\mathcal{E}(x)$, as in (29), it is sufficiently accurate for most cases to neglect $(2a/m\lambda)^2$ compared to 1 and sum the series as in the preceding case; thus¹⁸

¹⁸ No attempt is made herein to establish results with complete mathematical rigor; such operations as summing an apparently divergent series may be physically justified by introducing a small but finite exponential attenuation.

$$\sum_1^{\infty} m \sin(m\theta) \sin(m\theta')$$

$$= \frac{\partial^2}{\partial\theta\partial\theta'} \sum_1^{\infty} \frac{\cos(m\theta) \cos(m\theta')}{m}$$

$$= -\frac{1}{2} \frac{\sin\theta \sin\theta'}{(\cos\theta - \cos\theta')^2} \quad (60)$$

In order to obtain a $(0-\pi)$ range of integration, it is expedient to introduce the change of variable.

$$\cos\left(\frac{\pi x}{a}\right) = \alpha \cos\theta + \beta$$

$$\alpha = \sin\left(\frac{\pi c}{a}\right) \sin\left(\frac{\pi d}{2a}\right),$$

$$\beta = \cos\left(\frac{\pi c}{a}\right) \cos\left(\frac{\pi d}{2a}\right). \quad (61)$$

Taking the sign of the radical in (58) to give an inductive reactance (corresponding to attenuated TE modes), neglecting $(2a/m\lambda)^2$ compared to unity, substituting (60) and (61), and re-expanding the result, (58) yields

$$B = -\zeta \left(\frac{\lambda}{a}\right) \left[\frac{1}{\alpha^2} \sum_1^{\infty} \frac{m (\int_0^{\pi} \mathcal{E}(\theta) \sin m\theta d\theta)^2}{(\int_0^{\pi} \mathcal{E}(\theta) \sin \theta d\theta)^2} - 1 \right]. \quad (62)$$

In order to evaluate (62), it may be recalled that the magnitude of the general expression (34) was asserted to be a minimum for the case where only one set (TE or TM) of modes was excited and where $i=j$; accordingly, since the summation in (62) obeys these conditions (despite the approximation in neglecting $(2a/m\lambda)^2$ compared to unity), it must be a minimum. If $\mathcal{E}(\theta)$ is expanded in a Fourier series in θ it is evident that the summation is a minimum for $\mathcal{E}(\theta) = C \sin\theta$, inasmuch as each of the terms in the summation is positive definite. (The magnitude of C is, of course, immaterial.) Hence the solution to (62) is, after integrating and substituting α from (61),

$$\left(\frac{B}{Y_0}\right) = -\left(\frac{\lambda_g}{a}\right) \left[\csc^2\left(\frac{\pi c}{a}\right) \csc^2\left(\frac{\pi d}{2a}\right) - 1 \right] \quad (63)$$

where Y_0 is the characteristic admittance for the TE_{10} mode and is given by (57). (63) may be corrected as in the case of the previous problem. For the symmetrical case, $c=a/2$, (63) reduces to

$$\left(\frac{B}{Y_0}\right) = -\left(\frac{\lambda_g}{a}\right) \cot^2\left(\frac{\pi d}{2a}\right) \quad (64)$$

while for the asymmetrical case, $c=d/2$, (63) reduces to

$$\left(\frac{B}{Y_0}\right) = -\left(\frac{\lambda_g}{a}\right) \cot^2\left(\frac{\pi d}{2a}\right) \left[1 + \csc^2\left(\frac{\pi d}{2a}\right)\right]. \quad (65)$$

It may be observed that the asymmetrical window has a considerably greater susceptance than the symmetrical window of the same opening.

THE CAPACITATIVE WINDOW

Another important obstacle in practice is the capacitive window in a rectangular guide, shown in Fig. 7. An approximate solution has been indicated, somewhat abstractly, by Schelkunoff.⁷

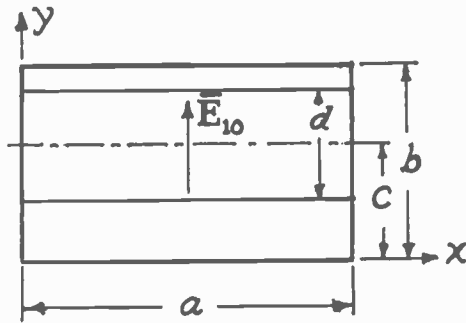

Fig. 7—Capacitive window.

Assuming a TE_{10} incident mode, it is seen that TM modes (having longitudinal electric field components) will be necessary to satisfy the boundary conditions. In order to avoid the complications inherent in having both TE and TM modes present, it is convenient to use a different set of solutions than those of I(1) and I(2). Inasmuch as the exciting field (TE_{10} mode) has no x component of the electric field, and there is no discontinuity in the x direction, the scattered field required to satisfy the boundary conditions will have no such component. The set of solutions to (2), (3), and (15) in a rectangular guide for the problem may therefore be taken as

$$\phi_{1n} = \bar{j} \left[\frac{2(2 - \delta_n^0)}{ab} \right]^{1/2} \sin\left(\frac{\pi x}{a}\right) \cos\left(\frac{n\pi y}{b}\right) \quad (66)$$

$$Y_{1n} = Y_0 \left[1 - \frac{(n/b)^2}{(2/\lambda)^2 - (1/a)^2} \right]^{-1/2} \\ = Y_0 [1 - (n\lambda g/2b)^2]^{-1/2} \quad (67)$$

where ϕ_{10} may be recognized as the TE_{10} (dominant) mode, Y_0 is the characteristic admittance for that mode, as defined in (57), and λ_g is the guide wavelength for the TE mode, as defined by (57).

In substituting (66) in (34), it is convenient to observe that

$$\mathcal{E}(x, y) = \mathcal{E}(y) \sin\left(\frac{\pi x}{a}\right) \quad (68)$$

and carry out the integrations with respect to x . The result is

$$\left(\frac{Z_0}{Z}\right) = \left(\frac{Y}{Y_0}\right) = 4 \sum_1^\infty \left(\frac{Y_{1n}}{Y_0}\right) \left(\frac{I_n}{I_0}\right)^2 \quad (69)$$

$$I_n = \int_{c-d/2}^{c+d/2} \mathcal{E}(y) \cos\left(\frac{n\pi y}{b}\right) dy. \quad (70)$$

It may be observed that (69) is independent of guide width a except as it occurs in combination with $(2/\lambda)$ in (67), from which it may be immediately inferred that the solution to the problem for the rectangular guide of finite width is directly deductible from the problem

for the plane parallel plate guide (a infinite) if λ in the latter problem is replaced¹⁹ by λ_g . The correspondence may be furthered by observing that, after integrating out the x dependence of (66), the TE_{10} mode in the rectangular guide corresponds to the principal mode (number E_s or H_s) in the plane parallel-plate case, while the higher modes in the former case correspond to the TM modes in the latter case. From the latter fact it may be inferred that (69) is capacitive, although this may also be demonstrated by picking the sign of the radical (for $n > 0$) corresponding to attenuation of the higher modes given by (66).

In order to solve (69), it may be observed that

$$\sum_1^\infty \frac{1}{n} \cos\left(\frac{n\pi y}{b}\right) \cos\left(\frac{n\pi y'}{b}\right) \\ = -\frac{1}{2} \log 2 \left| \cos\left(\frac{\pi y}{b}\right) - \cos\left(\frac{\pi y'}{b}\right) \right| \quad (71)$$

after which the solution may be carried out exactly as in the case of (58) if $(2b/n\lambda g)^2$ is neglected compared to unity. The result obtained in this manner is

$$\left(\frac{B^0}{Y_0}\right) = 4 \left(\frac{b}{\lambda_g}\right) \log \left[\csc\left(\frac{\pi c}{a}\right) \csc\left(\frac{\pi d}{2a}\right) \right] \quad (72)$$

where B^0 denotes the "static" approximation to B .

It may be observed that neglecting $(2b/n\lambda)^2$ compared to unity is equivalent to replacing the corresponding solutions to the wave equation by solutions to Laplace's equation, so that the results should be obtainable by standard approaches. Thus, the problem at hand may be solved by conformal mapping. To accomplish this it is merely necessary to solve the static problem of finding the *extra* capacitance per unit width of the plane parallel plates which is due to the window plates, multiply this capacitance by ω to obtain B , and divide by the characteristic admittance of a plane parallel-plate transmission line,^{4,5} i.e., (ζ/b) . The result is (72). In this approach, the characteristic admittance is quite definite, being defined as in ordinary distributed parameter line theory (as contrasted to field theory), corresponding to the usual definition of capacitance.

Another approach to the problem at hand is to solve the integral equation associated with (69), and this approach is particularly advantageous in allowing "dynamic" corrections to be made to the "static" approximation. This integral equation may be obtained in the general case of (34) by multiplying both sides of the equation by the denominator of the right hand side, differentiating with respect to either dS' or dS , and cancelling $\bar{E}^i(u', v')$ or $\bar{E}^i(u, v)$, respectively. In the case of (69) this yields

$$I_0 \left(\frac{Y}{Y_0}\right) = 4 \sum_1^\infty \left(\frac{Y_{1n}}{Y_0}\right) I_n \cos\left(\frac{n\pi y}{b}\right) \quad (73)$$

¹⁹ This observation is due to Julian Schwinger, although the relation between the two problems has been observed by other workers, and it was first suggested to the author by W. R. Smythe.

which is an integral equation of the first kind¹⁵ for $\mathcal{E}(y)$. Substituting (70), neglecting $(2b/n\lambda g)^2$ compared to unity, and substituting (71), (73) becomes

$$\begin{aligned} \left(\frac{B^0}{Y_0}\right) \int_{c-d/2}^{c+d/2} \mathcal{E}(y') dy' \\ = -4 \left(\frac{b}{\lambda_0}\right) \int_{c-d/2}^{c+d/2} \log 2 \left| \cos\left(\frac{\pi y'}{b}\right) \right. \\ \left. - \cos\left(\frac{\pi y'}{b}\right) \right| \mathcal{E}(y') dy'. \end{aligned} \quad (74)$$

Introducing the change of variable (61) (substituting b for a , therein), splitting off the $\log \alpha$, and re-expanding the $\log 2 |\cos \theta - \cos \theta'|$ (74) becomes

$$\begin{aligned} \left[\left(\frac{B^0}{Y_0}\right) + 4 \left(\frac{b}{\lambda_0}\right) \log \alpha \right] \int_0^\pi u(\theta') d\theta' \\ = 8 \left(\frac{b}{\lambda_0}\right) \int_0^\pi u(\theta') \sum_1^\infty \frac{\cos n\theta \cos n\theta'}{n} d\theta' \end{aligned} \quad (75)$$

$$u(\theta) = \mathcal{E}(\alpha \cos \theta + \beta) \sin \theta [1 - (\alpha \cos \theta + \beta)^2]^{-1/2}. \quad (76)$$

Expanding $u(\theta)$ in the Fourier series

$$u(\theta) = \sum_0^\infty a_m \cos m\theta \quad (77)$$

and integrating with respect to θ' in (75), the result is

$$\left[\left(\frac{B^0}{Y_0}\right) + 4 \left(\frac{b}{\lambda_0}\right) \log \alpha \right] a_0 = 4 \left(\frac{b}{\lambda_0}\right) \sum_1^\infty a_m \frac{\cos m\theta}{m} \quad (78)$$

whence the only nontrivial solution to (75), yielded by the requirement that both sides of (78) vanish identically, is

$$\begin{aligned} \left(\frac{B^0}{Y_0}\right) = 4 \left(\frac{b}{\lambda_0}\right) \log (1/\alpha) \\ u(\theta) = a_0 \end{aligned} \quad (79)$$

or

$$\mathcal{E}(y) = a_0 \sin\left(\frac{\pi y}{b}\right) \left[1 - \left(\frac{\cos\left(\frac{\pi y}{b}\right) - \beta}{\alpha} \right)^2 \right]^{-1/2}. \quad (80)$$

(79) is equivalent to (72) when α is substituted from (61).

The simplest manner in which to correct (79) for the neglect of $(2b/n\lambda_0)^2$ compared to unity is to write

$$\left(\frac{B}{Y_0}\right) = \left(\frac{B^0}{Y_0}\right) + 8 \left(\frac{b}{\lambda_0}\right) \sum_1^\infty \frac{\Delta_n}{n} \left(\frac{I_n}{I_0}\right)^2 \quad (81)$$

$$\Delta_n = \{ [1 - (2b/n\lambda_0)^2]^{-1/2} - 1 \} \quad (82)$$

where B^0 is given by (79), and the I_n are to be evaluated by substituting (80) in (70). The result thus obtained is

$$\left(\frac{B}{Y_0}\right) = \left(\frac{B^0}{Y_0}\right) + 4 \left(\frac{b}{\lambda_0}\right) \{ 2\beta^2 \Delta_1 + 2(1 - \alpha^2 - 2\beta^2)^2 \Delta_2 \}$$

$$\begin{aligned} + \frac{1}{\pi} \sum_{n=3}^\infty \Delta_n \left[\sum_{r=0}^{((n+1)/2)} (-)^r 2^{(n/2-r-1)} \frac{n\Gamma(n-r)}{\Gamma(r+1)} \right. \\ \cdot \sum_{s=0}^{(n-2r)} 2^{s/2} \alpha^{(n-2r-s)} \beta^s \left(\frac{n-2r-s}{2} \right)^{-1} \\ \left. \cdot \Gamma^{-2} \left(\frac{n-2r-s}{2} \right) \right]^2 \}. \end{aligned} \quad (83)$$

The result given by (83) is the variational solution to (24) obtained by substituting the "static" field (i.e., the the solution to Laplace's equation obeying the boundary conditions of the problem) in (70) and, as such, forms an upper bound to the true answer, as asserted in discussing (34). It is naturally to be expected that a more accurate result will be obtained if the field used is a closer solution to the wave equation, taking into account frequency effects. Such a solution may be obtained by including terms from the series of (81) in the formulation of the integral equation for $\mathcal{E}(y)$; thus, retaining the first term, (74) must be modified to read

$$\begin{aligned} \left(\frac{B^1}{Y_0}\right) \int_{c-d/2}^{c+d/2} \mathcal{E}(y') dy' \\ - \frac{4\Delta_1}{\pi} \int_{c-d/2}^{c+d/2} \mathcal{E}(y') \cos\left(\frac{\pi y'}{b}\right) dy' \cos\left(\frac{\pi y}{b}\right) \\ = -4 \left(\frac{b}{\lambda_0}\right) \int_{c-d/2}^{c+d/2} \log 2 \left| \cos\left(\frac{\pi y'}{b}\right) \right. \\ \left. - \cos\left(\frac{\pi y'}{b}\right) \right| \mathcal{E}(y') dy'. \end{aligned} \quad (84)$$

Proceeding exactly as in the case of (74), the solution to (84) is

$$\left(\frac{B^1}{Y_0}\right) = \left(\frac{B^0}{Y_0}\right) + 8 \left(\frac{b}{\lambda_0}\right) \left[\frac{\beta^2 \Delta_1}{1 + \alpha^2 \Delta_1} \right] \quad (85)$$

$$u(\theta) = \text{constant} \cdot \left[1 - \left(\frac{2\alpha\beta\Delta_1}{1 + \alpha^2\Delta_1} \right) \cos \theta \right]. \quad (86)$$

(β in (85) et seq. and in other equations not using the change of variable (61) should not be confused with the phase constant $(2\pi/\lambda)$.) It may be observed that the correction of (85) vanishes for the symmetrical window; however the correction including Δ_2 may be obtained in a similar fashion and reads

$$\begin{aligned} \left(\frac{B^2}{Y_0}\right) = \left(\frac{B^0}{Y_0}\right) + 8 \left(\frac{b}{\lambda_0}\right) \left[\frac{\beta^2 \Delta_1}{(1 + \alpha^2 \Delta_1)} \right. \\ \left. + \frac{(1 - \alpha^2 - 2\beta^2)^2 \Delta_2}{(1 + 2\alpha^2 \Delta_2)} \right]. \end{aligned} \quad (87)$$

It is seen that the correction of (87) corresponds to the first two terms in the correction of (83) where $\alpha^2 \Delta_1$ and $\alpha^2 \Delta_2$ are small, but near $\lambda_0 = 2b$, corresponding to the cutoff of the next propagated mode, the correction of (87) remains finite, while that of (83) is infinite with Δ_1 .

The foregoing formulas simplify considerably for the symmetrical case ($c = b/2$); (72) becomes

$$\left(\frac{B}{Y_0}\right) = 4 \left(\frac{b}{\lambda_0}\right) \log \left[\csc \left(\frac{\pi d}{2b} \right) \right] \quad (88)$$

while the remainder of the formulas are simplified by setting $\beta=0$ and $\alpha=\sin(\pi d/2b)$. For the asymmetrical case ($c=d/2$), the static result is clearly twice that of (88).

The reduction of the asymmetrical problem to the symmetrical problem may be generalized by observing that, in the latter case, the electric field is everywhere normal to the plane of symmetry $y=b/2$. The asymmetrical window of opening $d/2$ in a guide of height $b/2$ is, therefore, equivalent to a symmetrical window of opening d in a guide of height b . Inasmuch as the susceptance of either window can depend only on the ratios (d/b) and (b/λ_0) , it follows that the susceptance of a given asymmetrical window is given by substituting half the actual wavelength in the formula for the symmetrical window having the same openings. Since the result is always multiplied by (b/λ_0) , the susceptance of the asymmetrical window is *approximately* twice that of the symmetrical window.

The results given by (85) and (87) may, of course, be further improved by substituting the corresponding fields in the perturbation of (81); however (87) is sufficiently accurate for all practical purposes, and generally (72) will suffice. For the case of the half-open symmetrical window ($c=d=b/2$) and $(b/\lambda_0)=1/4$ (87) yields an upper bound of $(B/Y_0)=0.355$, while (88) yields $(B/Y_0)=0.346$. Adding the perturbation involving Δ_3 , Δ_4 , etc., to (87) and calculating a lower bound by the formulation (53) shows that the true result lies between 0.35510 and 0.35512. Thus, the variational solution is capable of yielding results precise to better than 0.006 per cent, while the simple static approximation is precise to $2\frac{1}{2}$ per cent. The most extreme cases encountered in practice would be $(b/\lambda_0)=\frac{1}{2}$ (since the TE_{11} and TM_{11} modes are propagated for larger b), in which case (87) yields $(B/Y_0)=0.770$, (88) yields $(B/Y_0)=0.692$, while the true answer can be shown to lie between 0.77028 and 0.77034. It therefore appears that (87) is sufficiently precise for all practical purposes, while (88) will often suffice.

The capacitive window has been treated in some detail to demonstrate the power of the approach; the inductive window could have been treated similarly, although with somewhat more difficulty, as elliptic integrals are involved.

CHANGES OF CROSS SECTION

In general, those problems involving changes of cross section require four terminal networks for equivalent circuits and, accordingly, are more complicated than simple obstacles. However, the relation of equation (35) furnishes a convenient approximation, and in the case of a "capacitive" change of cross section in a rectangular guide and changes of cross section in coaxial guides it is exact.

CAPACITIVE CHANGE OF CROSS SECTION

The problem to be studied is shown in Fig. 8. The eigenfunctions and field admittances are given by (66)

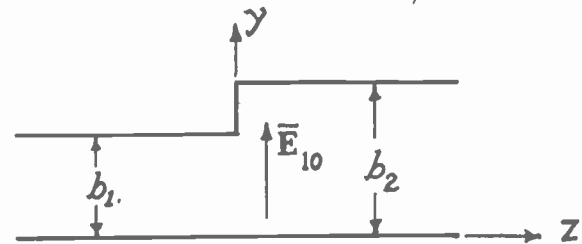

Fig. 8—Capacitive change of cross section.

and (67) if the superscripts 1, 2 are added to differentiate between b , y , ϕ , and Y in the two guides. It is seen that

$$\bar{\phi}_{1n}^2 = N \bar{\phi}_{1n}^1, \quad N = \left(\frac{b_1}{b_2}\right)^{1/2} \quad (89)$$

so that (35) is satisfied exactly. The equivalent circuit is then given by Fig. 3, and the problem reduces to finding $1/Z_{11}(=jB)$. Moreover, the arguments advanced in the case of the capacitive window allow the results to be deduced from the two-dimensional problem if only λ in the latter problem is replaced by λ_0 .

Whinnery and Jamieson⁴ have treated the two-dimensional problem and suggested approximations by which more general capacitive changes of cross section can be represented by various combinations of the asymmetrical result. Actually, the most important cases in practice are the symmetrical and asymmetrical, and, since it may be shown by images (exactly as in the case of the capacitive window) that the susceptance of the symmetrical change is given by using twice the actual wave length in the result for an asymmetrical change (for the same ratio of b_2/b_1), it suffices to study the asymmetrical problem.

The simplest approach to the present problem is to use the static result for the extra capacitance due to the step in a pair of plane-parallel plates. This result is available in several texts, and Whinnery and Jamieson⁴ give it as

$$C_d' = \frac{\epsilon}{\pi} \left[\left(\frac{\alpha^2 + 1}{\alpha} \right) \cosh^{-1} \left(\frac{1 + \alpha^2}{1 - \alpha^2} \right) - 2 \log \left(\frac{4\alpha}{1 - \alpha^2} \right) \right] \quad (90)$$

$$\alpha = b_2/b_1$$

in m-k-s units per unit width, where ϵ is the dielectric constant. For a plane parallel-plate transmission line the characteristic admittance per unit width is

$$Y_0 = \zeta/b = \frac{\epsilon\omega\lambda}{2\pi b} \quad (91)$$

while $B = \omega C_d'$ per unit width; hence

$$\left(\frac{B^0}{Y_0}\right) = \frac{\omega C_d'}{Y_0} = 4 \left(\frac{b}{\lambda}\right) \cdot \log \left[\left(\frac{1-\alpha^2}{4\alpha}\right) \left(\frac{1+\alpha}{1-\alpha}\right)^{1/2(\alpha+1/\alpha)} \right] \quad (92)$$

where the arc-hyperbolic cosine has been replaced by its logarithmic equivalent. For the case of finite width, λ_0 should be substituted for λ .

Whinnery and Jamieson⁴ correct (92) by applying the frequency dependence factor for the lowest mode which contributed to B , i.e., $\bar{\phi}_{11}^1$, which, for the rectangular guide, yields

$$\left(\frac{B}{Y_0^1}\right) = \left[1 - \left(\frac{2b_1}{\lambda_0}\right)^2 \right]^{-1/2} \left(\frac{B^0}{Y_0^1}\right). \quad (93)$$

As may be seen by substituting $\bar{\phi}_{1n}^1$, $\bar{\phi}_{1n}^2$, Y_{1n}^1 , and Y_{1n}^2 from (66) and (67) in (34), the frequency factor in the n th term is $[1 - (2b_1/n\lambda_0)^2]^{-1/2}$, so that (93) is larger than the true answer.

Another correction to (92) may be effected by following a perturbation scheme such as indicated in (81) for the capacitive window. The result, using the *approximation* $\mathcal{E}(y) = \text{constant}$ to evaluate the integrals in (34), after substituting $\bar{\phi}_{1n}$, $\bar{\phi}_{1n}^2$, Y_{1n}^1 , and Y_{1n}^2 , and separating out the static portion, is

$$\left(\frac{B}{Y_0^1}\right) = \left(\frac{B^0}{Y_0^1}\right) + 4 \left(\frac{b_1}{\lambda_0}\right) \sum_1^{\infty} \Delta_n \left[\frac{\sin(n\pi\alpha)}{(n\pi\alpha)} \right]^2 \quad (94)$$

where Δ_n is given by using b_1 in (82).

A third method of correcting the static result suggests itself if it is observed that a change of cross section gives rise to approximately half the excess capacitance of the geometrically similar window (since there is approximately half as much fringing of the flux). Accordingly, the correction to be added is half that for the asymmetrical window, which in turn is the correction for the symmetric window where $\lambda_0/2$ is substituted for λ_0 ; hence, setting $\beta=0$, $\Delta_2 = \Delta_1$, and $\alpha = \sin(\pi b_2/2b_1)$ in the correction of (87),

$$\left(\frac{B}{Y_0^1}\right) = \left(\frac{B^0}{Y_0^1}\right) + 8 \left(\frac{b_1}{\lambda_0}\right) \left[\frac{\Delta_1 \cos^4(\pi b_2/2b_1)}{1 + 2\Delta_1 \sin^2(\pi b_2/2b_1)} \right]. \quad (95)$$

For a typical case where $(b_2/b_1) = \frac{1}{2}$ and $(2b_1/\lambda_0) = \frac{1}{2}$, (93), (94), and (95) yield $(B/Y_0^1) = 0.452$, 0.460 , and 0.452 , respectively.

It should be remembered that, although the values of the relative susceptance (B/Y_0^1) in the foregoing problem are independent of the definition of Y_0^1 , this is not true for N , and the value of N given by (89) is valid if Y_0^1 and Y_0^2 are both defined as in (57). For many purposes it will be convenient to define Y_0 in a rectangular guide as

$$Y_0(a, b) = \left(\frac{a}{b}\right) \left[\frac{\lambda}{\lambda_0(a, b)} \right] \zeta \quad (96)$$

which corresponds to $A = B^{-1} = (a/b)^{1/2}$ in (12). Several

writers⁶ have chosen the definition (96), and it offers certain advantages. Thus, in the case of the capacitive change of cross section, N becomes unity, and the equivalent circuit of the discontinuity is reduced to a simple shunt element.

THE INDUCTIVE CHANGE OF CROSS SECTION

The inductive change of cross section is shown in Fig. 9. The eigenfunctions, eigenvalues, and field admittances are given by (103), (106), and (8) if superscripts 1 and 2 are appended to x , a , $\bar{\phi}$, and Y . It is seen that (39) is no longer satisfied, and the equivalent circuit is therefore a four-terminal network.

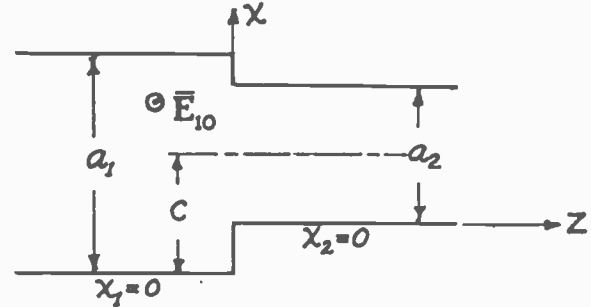

Fig. 9—Inductive change of cross section.

Fortunately the inductive change of cross section is not of too great practical importance, and it will generally be sufficiently accurate to use the approximation (35). The equivalent circuit is then given by Fig. 3. Substituting $\bar{\phi}_0^1$ and $\bar{\phi}_0^2$ in (37) yields

$$N = \left(\frac{a_1}{a_2}\right)^{1/2} \left(\frac{I_1^2}{I_1^1}\right) \quad (97)$$

while substitution in (34) yields

$$\frac{1}{Z_{11}} = \zeta \sum_2^{\infty} \left\{ \left[1 - \left(\frac{m\lambda}{2a_1}\right)^2 \right]^{1/2} \left(\frac{I_m^1}{I_1^1}\right)^2 + \left[1 - \left(\frac{m\lambda}{2a_2}\right)^2 \right]^{1/2} \left(\frac{I_m^2}{I_1^1}\right)^2 \right\} \quad (98)$$

$$I_m^1 = \int_{c-a_2/2}^{c+a_2/2} \mathcal{E}(x) \sin\left(\frac{\pi x_1}{a_1}\right) dx \quad (99)$$

$$I_m^2 = \int_0^{a_2} \mathcal{E}(x) \sin\left(\frac{\pi x_2}{a_2}\right) dx. \quad (100)$$

While (98) may be evaluated in (29), (30), (31), (32), and (33), a good approximation is to use the field found for the inductive window. Such a substitution gives approximately half the susceptance of the geometrically similar window; namely,

$$\left(\frac{B}{Y_0^1}\right) = -\left(\frac{\lambda_0^1}{2a_1}\right) \left[\csc^2\left(\frac{\pi c}{a_1}\right) \csc^2\left(\frac{\pi a_2}{2a_1}\right) - 1 \right] \quad (101)$$

if $(2a_1/m\lambda)^2$ is neglected compared to unity; this last approximation could be improved by multiplying (101) by $[1 - (a_1/\lambda)^2]^{1/2}$, the factor by which the leading term in (98) differs from its static approximation.

Although (97) is perhaps best evaluated, for use in conjunction with (101), by using the inductive window field, it is sufficiently accurate to use the field $\mathcal{E}(x) = \sin(\pi x/a_1)$, in which case (97) becomes

$$N = \left(\frac{a_2}{a_1}\right)^{1/2} \left(\frac{\pi}{4}\right) \left[1 - \left(\frac{a_2}{a_1}\right)^2\right] \cdot \left[\sin\left(\frac{\pi u_2}{a_1}\right) \cos\left(\frac{\pi c}{a_1}\right)\right]^{-1} \quad (102)$$

It may be observed that the choice of $Y_0^{1,2}$ given by (96) would remove the factor of $(a_2/a_1)^{1/2}$ from (101) but would not leave $N=1$, as in the case of the capacitive window.

APPENDIX I

The solutions to (2), (3), and (4) in a rectangular wave guide bounded by $x=0$, $x=a$, $y=0$, and $y=b$ are, in Cartesian co-ordinates (x, y) ,

$$\begin{aligned} \bar{\phi}_{mn}^{TE} = N_{mn} & \left[-i\left(\frac{n}{b}\right) \cos\left(\frac{m\pi x}{a}\right) \sin\left(\frac{n\pi y}{b}\right) \right. \\ & \left. + j\left(\frac{m}{a}\right) \sin\left(\frac{m\pi x}{a}\right) \cos\left(\frac{n\pi y}{b}\right) \right] \quad (103) \end{aligned}$$

$$\begin{aligned} \bar{\phi}_{mn}^{TM} = N_{mn} & \left[i\left(\frac{m}{a}\right) \cos\left(\frac{m\pi x}{a}\right) \sin\left(\frac{n\pi y}{b}\right) \right. \\ & \left. + j\left(\frac{n}{b}\right) \sin\left(\frac{m\pi x}{a}\right) \cos\left(\frac{n\pi y}{b}\right) \right] \quad (104) \end{aligned}$$

$$N_{mn}^{-2} = \frac{1}{2} \left[\frac{n^2}{(2 - \delta_n^0)} \left(\frac{a}{b}\right) + \frac{m^2}{(2 - \delta_n^0)} \left(\frac{b}{a}\right) \right] \quad (105)$$

$$\mu_{mn}^2 = \left(\frac{m\pi}{a}\right)^2 + \left(\frac{n\pi}{b}\right)^2 \quad (106)$$

For a circular guide of radius a the solutions are, in cylindrical polar co-ordinates (r, ϕ) ,

$$\begin{aligned} \bar{\phi}_{mn}^{TE}(r, \phi) = M_{mn} & \left[\bar{r}_1 \frac{mJ_m(\mu_{mn}r)}{(\mu_{mn}r)} \sin(m\phi + \psi_{mn}) \right. \\ & \left. + \bar{\phi}_1 J_m'(\mu_{mn}r) \cos(m\phi + \psi_{mn}) \right] \quad (107) \end{aligned}$$

$$\begin{aligned} \bar{\phi}_{mn}^{TM}(r, \phi) = N_{mn} & \left[\bar{r}_1 J_m'(\mu_{mn}r) \sin(m\phi + \psi_{mn}) \right. \\ & \left. - \bar{\phi}_1 \frac{mJ_m(\mu_{mn}r)}{(\mu_{mn}r)} \cos(m\phi + \psi_{mn}) \right] \quad (108) \end{aligned}$$

$$J_m(\mu_{mn}^{TM}a) = 0 \quad (109)$$

$$J_m'(\mu_{mn}^{TE}a) = 0 \quad (110)$$

$$M_{mn}^{-2} = \frac{\pi}{(2 - \delta_m^0)} \left[a^2 - \left(\frac{m}{\mu_{mn}}\right)^2 \right] J_m^2(\mu_{mn}a) \quad (111)$$

$$N_{mn}^2 = \frac{\pi}{(2 - \delta_m^0)} [aJ_m'(\mu_{mn}a)]^2 \quad (112)$$

where the prime denotes differentiation with respect to the entire argument, and $J_m(x)$ is the Bessel function of the first kind.

For a coaxial line of inner and outer radii b and a ,

respectively, the solutions in cylindrical polar co-ordinates (r, ϕ) are given by (107), (108), (109), (110), (111) and (112) if, for the TE modes, $J_m(\mu_{mn}r)$ is replaced by

$$\begin{aligned} R_m(\mu_{mn}r) = & [N_m'(\mu_{mn}b)J_m(\mu_{mn}r) \\ & - J_m'(\mu_{mn}b)N_m(\mu_{mn}r)] \quad (113) \end{aligned}$$

and, for the TM modes, by

$$\begin{aligned} S_m(\mu_{mn}r) = & [N_m(\mu_{mn}b)J_m(\mu_{mn}r) \\ & - J_m(\mu_{mn}b)N_m(\mu_{mn}r)] \quad (114) \end{aligned}$$

where $N_m(X)$ is Neumann function (Bessel function of the second kind). In addition, there appears the solution

$$\bar{\phi}_0(r) = \left(\log \frac{a}{b}\right)^{-1/2} \frac{1}{r}, \quad \mu_0 = 0 \quad (115)$$

which corresponds to a "principal wave," since it has the propagation constant $\beta_0 = \beta$ and therefore has a zero cutoff frequency.

In dealing with the coaxial solutions the Wronskian

$$N_{p-1}(x)J_p(x) - N_p(x)J_{p-1}(x) = \frac{2}{\pi x} \quad (116)$$

may be often used to simplify apparently complex results. The phase parameters ψ_{mn} which appear in (107) and (108) determine the polarity of the modes and can generally be set equal to zero or $\pi/2$.

APPENDIX II

To prove the orthogonality of the solutions to (2), (3), and (4), as assumed in (15), it is necessary to obtain a vector form of Green's second identity. We start with the vector identity

$$\nabla \cdot (\bar{A} \times \bar{C}) = \bar{C} \cdot \nabla \times \bar{A} - \bar{A} \cdot \nabla \times \bar{C} \quad (117)$$

and insert $\bar{C} = \Delta \times \bar{B}$ to obtain the identity

$$\nabla \cdot [\bar{A} \times (\nabla \times \bar{B})] = (\nabla \times \bar{A}) \cdot (\nabla \times \bar{B}) - \bar{A} \cdot \nabla \times (\nabla \times \bar{B}). \quad (118)$$

If we integrate (118) over a volume edS , bounded by the cross section S of the wave guide and two parallel planes a distance e apart, apply the divergence theorem, and take the limit as e approaches zero (assuming \bar{A} and \bar{B} to be continuous) (observing that the contribution of the two faces cancels), allowing the surface integral in the divergence theorem to be written as a line integral, we obtain

$$\begin{aligned} \oint [\bar{A} \times (\nabla \times \bar{B})] \cdot d\bar{n} \\ = \int_S [(\nabla \times \bar{A}) \cdot (\nabla \times \bar{B}) - \bar{A} \cdot \nabla \times (\nabla \times \bar{B})] dS \\ d\bar{n} = \bar{n} dl \quad (119) \end{aligned}$$

where the line integral is taken around the guide boundary S in a plane of constant z , \bar{n} is the outward normal to this boundary, and the surface integral is taken over the surface S . Equation (119) may be regarded as a vector form of Green's first identity; to obtain the desired result we interchange \bar{A} and \bar{B} in

(119) and take the difference of the two equations to obtain

$$\oint [\bar{B} \times (\nabla \times \bar{A}) - \bar{A} \times (\nabla \times \bar{B})] \cdot d\bar{n} \\ = \int_s [\bar{A} \cdot \nabla \times (\nabla \times \bar{B}) - \bar{B} \cdot \nabla \times (\nabla \times \bar{A})] dS \quad (120)$$

which may be regarded as a vector form of Green's second identity.

If we now let $\bar{A} = \bar{\phi}_i$ and $\bar{B} = \bar{\phi}_j$ be solutions of (2), apply the vector identity

$$\nabla \times (\nabla \times \bar{A}) = \nabla(\nabla \cdot \bar{A}) - \nabla^2 \bar{A} \quad (121)$$

and assume zero divergence of $\bar{\phi}_i$ and $\bar{\phi}_j$, (120) becomes

$$\oint [\bar{\phi}_i \times (\nabla \times \bar{\phi}_j) - \bar{\phi}_j \times (\nabla \times \bar{\phi}_i)] \cdot d\bar{n} \\ = \int_s [\bar{\phi}_j \cdot \nabla^2 \bar{\phi}_i - \bar{\phi}_i \cdot \nabla^2 \bar{\phi}_j] dS. \quad (122)$$

Now from (3) it can be shown that the left side of (122) vanishes identically; then, using (2) to evaluate the Laplacians, we obtain

$$(\mu_i^2 - \mu_j^2) \int_s \bar{\phi}_i \cdot \bar{\phi}_j dS = 0 \quad (123)$$

which proves the orthogonality for a set of $\bar{\phi}_i$ satisfying (2) and (3) and having zero divergences. Thus the solutions to (2) for the total electric field are orthogonal, and, inasmuch as the longitudinal components of the fields satisfying the scalar wave equation are orthogonal,⁷ it follows that the transverse field solutions are orthogonal.

APPENDIX III

Reflection and transmission coefficients will be calculated for the electric fields. Assuming the incident mode in guide 1, let $a_1 = 1$, $b_1 = R_1$, $a_2 = 0$, and $b_2 = T_2$ in (16). Substituting these values in (21), (22), and (23), ($z = 0$) R_1 and T_2 are given by

$$R_1 = 1 - 2(\Gamma \bar{Z}_{22} + 1)\Delta^{-1} \quad (124)$$

$$T_2 = 2\bar{Z}_{12}\Delta^{-1} \quad (125)$$

$$\Delta = (1 + \bar{Z}_{11})(1 + \Gamma \bar{Z}_{22}) - \Gamma \bar{Z}_{12}^2 \quad (126)$$

$$\Gamma = Z_0^1/Z_0^2 \quad (127)$$

$$\bar{Z}_{ij} = Z_{ij}/Z_0^i. \quad (128)$$

For the special case (36), (124), (125), (126), (127), and (128) reduce to

$$R_1 = \frac{(1 - \Gamma N^2)\bar{Z}_{11} - 1}{(1 + \Gamma N^2)\bar{Z}_{11} + 1} \quad (129)$$

$$T_2 = \frac{2N\bar{Z}_{11}}{(1 + \Gamma N^2)\bar{Z}_{11} + 1}. \quad (130)$$

For the incident mode in guide 2, it is merely necessary to reverse the subscripts 1 and 2 in the above formulas. For a plane obstacle $N = \Gamma = 1$.

It may be observed that the reflection and transmission coefficients depend only on impedance ratios, and

it is not necessary to determine any impedances absolutely. Of course, other definitions of the transmission coefficient, such as on the basis of the magnetic field, voltage, current, etc., are possible.

APPENDIX IV

In order to prove that (34) is stationary with respect to first-order variations about the true fields \bar{E}_0^1 and \bar{E}_0^2 , it suffices to set $\bar{E}^{1,2} = \bar{E}_0^{1,2} + p^{1,2}\bar{f}^{1,2}$, where $\bar{f}_{1,2}$ and $p_{1,2}$ are arbitrary vector functions and constants, respectively, substitute in (34), multiply both sides of the equation by the denominator of the right hand side, and take the first variation of both sides of the equation with respect to p^1 or p^2 , after which it may be seen that the first order variation Z_{ij} vanishes for p^1 or p^2 , respectively, equal to zero.

Of more practical interest is the special case where $i = j$ and only *TE* or only *TM* modes are present. For this latter case, (34) becomes, after substituting (20) and writing $Z_{ii}^{-1} = Y_{ii} = jB_{ii}$, $Y_{mn}^p = jB_{mn}^p$, and $\bar{E}^1 = \bar{E}^2 = \bar{E}$,

$$B_{ii} = \sum_{m,n} \sum_{p=1,2} B_{mn}^p \frac{(\int_s \bar{E} \cdot \bar{\phi}_{mn}^p dS)^2}{(\int_s \bar{E} \cdot \bar{\phi}_0^i dS)^2}. \quad (131)$$

Referring to (8) and (9), it is seen that the B_{mn}^p are positive and negative for *TM* and *TE* modes, respectively, and $(\bar{D}1)$ is therefore either positive or negative definite. Letting \bar{E}_0 be the true field, \bar{E} the trial field, and defining $\bar{\Delta}$ by

$$\bar{\Delta} = \bar{E} \left(\int_s \bar{E} \cdot \bar{\phi}_0^i dS \right)^{-1} - \bar{E}_0 \left(\int_s \bar{E}_0 \cdot \bar{\phi}_0^i dS \right)^{-1}. \quad (132)$$

It may be asserted that

$$\sum_{m,n} \sum_{p=1,2} B_{mn}^p \left(\int_s \bar{\Delta} \cdot \bar{\phi}_{mn}^p dS \right)^2 \leq 0 \quad (133)$$

where (132) is greater or less than the zero for *TM* or *TE* modes, respectively. From (27) and (28)

$$jB_i^0 = \left(\int_s \bar{E}_0 \cdot \bar{\phi}_0^i dS \right)^{-1} \quad (134)$$

$$\bar{\phi}_0^i = j \sum_{m,n} \sum_{p=1,2} B_{mn}^p \bar{\phi}_{mn}^p \left(\int_s \bar{E}_0 \cdot \bar{\phi}_{mn}^p dS \right) \quad (135)$$

where B_i^0 is the true value of B_i . Substituting (132) in (133), expanding (133), and substituting (131), (134), and (135) in the expansion, it is seen that

$$B_i - B_i^0 \geq 0 \quad (136)$$

respectively, where B_i is the susceptance corresponding to the trial field \bar{E} . It follows that the magnitude of B_i is greater than the magnitude of B_i^0 for either case (*TM* or *TE* modes), and the true value $|B_i^0|$ is, therefore, an absolute minimum. This proof is due essentially to Schwinger.

In the more general case, where both *TE* and *TM* modes are excited, the sign of the variational expression (34) is not a priori evident, and no such proof is possible.

The Theory of Impulse Noise in Ideal Frequency-Modulation Receivers*

DAVID B. SMITH†, SENIOR MEMBER, I.R.E., AND WILLIAM E. BRADLEY†, SENIOR MEMBER, I.R.E.

Summary—The following paper contains a quantitative analysis of the effect of impulse noise on ideal frequency-modulation receivers. It is shown that two types of detected noise may result from an impulse transient. The amplitude and wave form of the generated noise are substantially independent of the amplitude or wave form of the initiating noise provided the noise transient exceeds the desired signal. Of the two types, the weaker is determined largely by the characteristics of the audio amplifier and results from a perturbation of the phase of the detector signal by the noise. The characteristics of the second and more objectionable type are established by the de-emphasis circuit and result when the phase of the detector signal is caused to slip one revolution by the noise. The question as to which type of noise will obtain is shown to be purely a matter of chance. An operational formula for the ideal detection process is also given from which both steady-state and transient solutions of the process of detection may be derived.

INTRODUCTION

UNDER ACTUAL listening conditions, with present frequency-modulation broadcast receivers, thermal noise is not noticeable except under extremely poor receiving conditions. On the contrary, noise picked up from other electrical apparatus, such as automobile ignition systems, sparking commutators, or relay contacts, is the limiting factor and is audible ordinarily as isolated clicks or pops standing out against a relatively quiet background. Because of the prevalence of this type of noise under practical reception conditions, this report is concerned with the behavior of a frequency-modulation receiver when a noise impulse is applied to its input while it is receiving a constant-amplitude carrier wave which is frequency modulated with an audio program. The impulse noise in accordance with present experience is taken to be of very short time duration, delivering its energy to the first tuned circuit of the receiver in a time short compared to the time-constant of that circuit.

ANALYSIS OF RECEIVER OPERATION

It is very difficult to carry through an exact analysis of the behavior of a receiver under all conditions. However, by making certain simplifying assumptions a fairly accurate and very illuminating picture of the operation can be obtained. The simplified receiver is defined to consist of a linear band-pass filter, an ideal frequency-modulation detector including de-emphasis¹

* Decimal classification: R148.7. Original manuscript received by the Institute, January 18, 1946; revised manuscript received, March 25, 1946. Presented, 1946 Winter Technical Meeting, New York, N. Y., January 26, 1946.

† Philco Corporation, Philadelphia, Pennsylvania.

¹ The I.R.E. Technical Committee on Frequency Modulation has proposed the following definition of an ideal frequency-modulation detector: "1FM27. *Ideal Frequency-Modulation Detector*. A detector whose voltage or current output is proportional to the frequency deviation of a modulated wave and which is unresponsive to amplitude modulation." We have modified it only to the extent of including the de-emphasis circuit as part of the detector.

and a linear low-pass audio amplifier. In general, when such a receiver is excited by an impulse noise, a transient is produced which will exceed the desired signal and momentarily take control of the detector causing a perturbation of the desired detected signal. In our analysis we shall first determine the nature of the transient signal produced at the detector input as a result of impulse-noise excitation of the linear band-pass filter; second, the form of the combined noise and desired signal at the detector input; and third, the process of detection and the audio signal resulting from detection of the combined signals.²

There is, of course, a variety of specific forms of band-pass filters which might be used in a frequency-modulation receiver. All of them, however, will be characterized in a practical set by having adequate bandwidth to transmit the desired frequency-modulated signal with as much attenuation outside the channel as can conveniently be obtained. It is characteristic of such an amplifier that when shock-excited it will ring or oscillate at its natural frequency producing a wave train which builds up and decays at a rate determined by the bandwidth of the amplifier. Variations in the specific form of the noise impulse and variations of pole configurations of the amplifier will vary the exact form of the noise envelope, but in general these variations are all minor. To get a quantitative picture of the behavior of the amplifier, we will analyze a system of n identical single-tuned stages; however, were other practical amplifiers employed, the results from a noise standpoint would not be essentially different. The operational form for the response of such an amplifier is given by

$$e_n(t) = \left[\frac{g_m}{c} \right]^n \left[\frac{p}{(p + \alpha)^2 + \omega_0^2} \right]^n \cdot e_0(t) \quad (1)$$

in which n is the number of stages, α is the damping factor of each stage, ω_1 is the natural angular frequency, p is the usual Heaviside operator, and g_m is the inter-stage transconductance. The initial driving current is $e_0 \cdot g_m$ and $\omega_0^2 = \omega_1^2 - \alpha^2$. For steady-state conditions the frequency-response curve of such a filter will have a moderately blunt nose with steep-sloping sides. To complete the synthesis of the amplifier we will so adjust the individual stage damping that at frequencies off the mid-band point by an amount δ_0 equal to the deviation of the frequency-modulated signal for 100 per cent modulation, the over-all response of the filter will be down 3 decibels. As shown in Appendix I, which contains a detailed analysis of the filter for steady-state and

² V. D. Landon, "Impulse noise in frequency-modulation reception," *Electronics*, vol. 14, pp. 26-76; February, 1941.

noise conditions, this bandwidth obtains when

$$\alpha = \frac{\delta_0}{\{2^{1/n} - 1\}^{1/2}} \quad (2)$$

Values of this ratio for various values of n are given in Table I. As the carrier frequency ω_0 can be any convenient value $\gg \delta_0$, this completes the synthesis of the filter.

In addition, it is convenient to use $1/\delta_0$ as the unit of time against which to observe the variations and interplay of the several signals, and this will be done throughout the rest of the paper. As δ_0 is in terms of angular velocity, $1/\delta_0$ is the time required for a sinusoidal signal corresponding in frequency to the deviation for 100 per cent modulation to advance in phase by one radian.

teristic which is important is the area under the initial impulse-voltage-envelope time curve, which area we

TABLE I
 $\frac{\delta_0}{\alpha} = \{2^{1/n} - 1\}^{1/2}$

n	δ_0/α
1	1.000
2	0.644
3	0.510
4	0.435
5	0.385
6	0.350
7	0.323
8	0.302
9	0.283
10	0.268
11	0.255
12	0.244

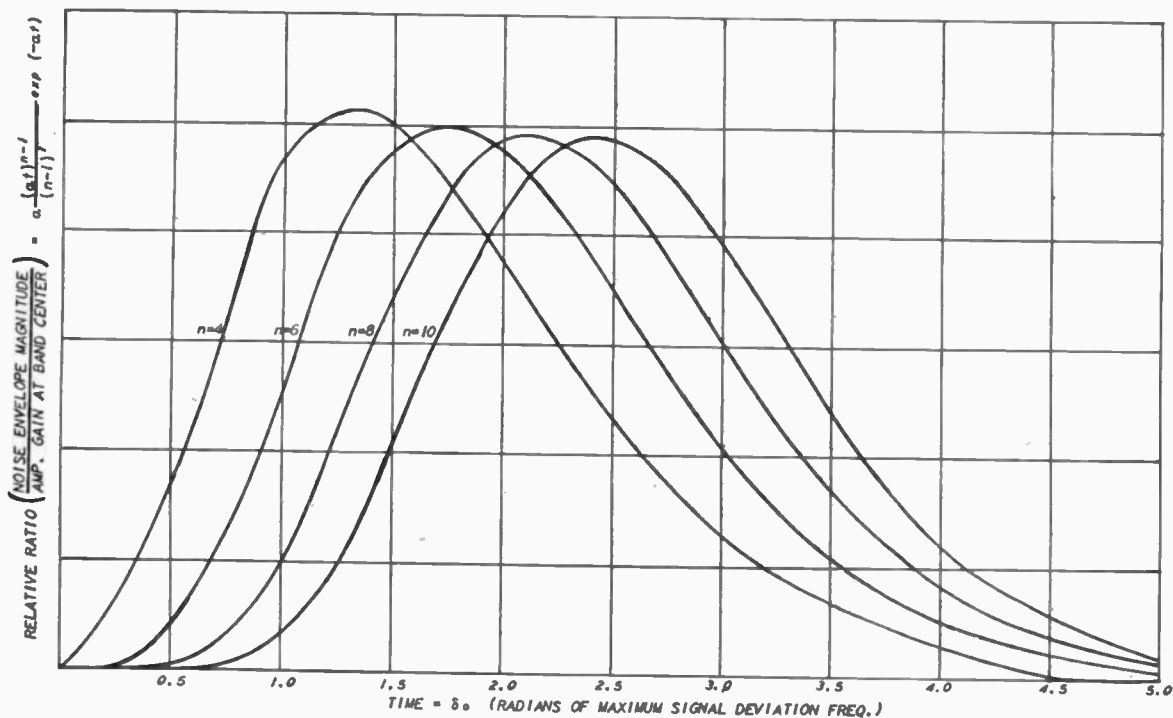

Fig. 1 —Noise-pulse envelopes for intermediate-frequency amplifiers of number of stages n having identical bandwidth over all, between half-power points.

$$\text{Noise-pulse envelope form } N(t) = a \frac{(at)^{n-1}}{(n-1)!} \exp(-at)$$

$$\text{where } a = \frac{\delta_0}{\{2^{1/n} - 1\}^{1/2}} \text{ (to make over-all bandwidth constant for any } n).$$

The Technical Committee on Frequency-Modulation Receivers of the Institute of Radio Engineers has tentatively defined impulse noise as follows: "1FM38. *Impulse Noise*. Noise characterized by transient disturbances separated in time by quiescent intervals." In practice it has been observed that the time duration of most common impulse-noise sources such as ignition systems, door bells, etc., is less than $1/\delta_0$. This can be verified by observing such noise on a wide-band system such as a television receiver. Under these circumstances, the exact wave shape is not important and has little to do with the resulting transient in the filter. The charac-

shall call D . For analytical purposes, any short exciting impulse of area D and duration less than $1/\delta_0$ can be represented by the spike function $D\delta(t)$.³ As shown in Appendix I when the n -stage filter is excited by this function it produces a transient noise signal

$$N_n(t) \cong 2D \cdot \alpha \cdot \left[\frac{g_m}{G} \right]^n \cdot \frac{(at)^{n-1}}{(n-1)!} \cdot \exp(-at) \cdot \cos \omega_0 t. \quad (3)$$

³ This tacitly assumes the nominal carrier frequency of the noise train to be the same as that of the filter. If it is not, D will be reduced by an amount determined by the relative energy content at the band-pass frequencies.

This corresponds to a signal having a fixed frequency about equal to that of the unmodulated program signal carrier and having an envelope which rises to a peak amplitude at $\alpha t = n - 1$ and then decays more or less exponentially. Some of these envelopes for various values of n are shown in Fig. 1. Since α is uniquely determined by the half bandwidth δ_0 , the resulting transient is largely determined by the characteristics of the receiver. Hence, when a noise impulse occurs which produces a transient greater than the program signal, the noise momentarily "captures" the detector and takes over the control of the detected signal. When such a "capture" happens we are first interested in how long it lasts, and second in what effect it produces in the detector. Neglecting the minor variation in amplitude of the desired program signal as a result of modulation and the frequency-response characteristic of the filter, we find that the ratio of the peak noise envelope to the program signal envelope at the detector is given by

$$\frac{e^{N_{n\max}}}{E_{n\max}} = \frac{2 \cdot D \cdot \delta_0}{E_0} \left\{ \frac{(n-1)^{n-1} \cdot \exp(1-n)}{\{2^{1/n} - 1\}^{1/2} \cdot (n-1)!} \right\} = S. \quad (4)$$

This expression, while very formidable looking, is nevertheless practically independent of n for three or more stages. The function of n is tabulated in Table II. It is interesting to note that, for a given disturbance and

TABLE II

$$A = \frac{(n-1)^{n-1} \exp(1-n)}{\{2^{1/n} - 1\}^{1/2} (n-1)!}$$

n	A
1	1.00
2	0.57
3	0.53
4	0.51
5	0.51
6	0.50
7	0.50
8	0.50
9	0.49
10	0.49
11	0.49
12	0.49

desired signal, the resulting transient noise to signal is directly proportional to the receiver bandwidth.

The capture time can be determined as shown in the

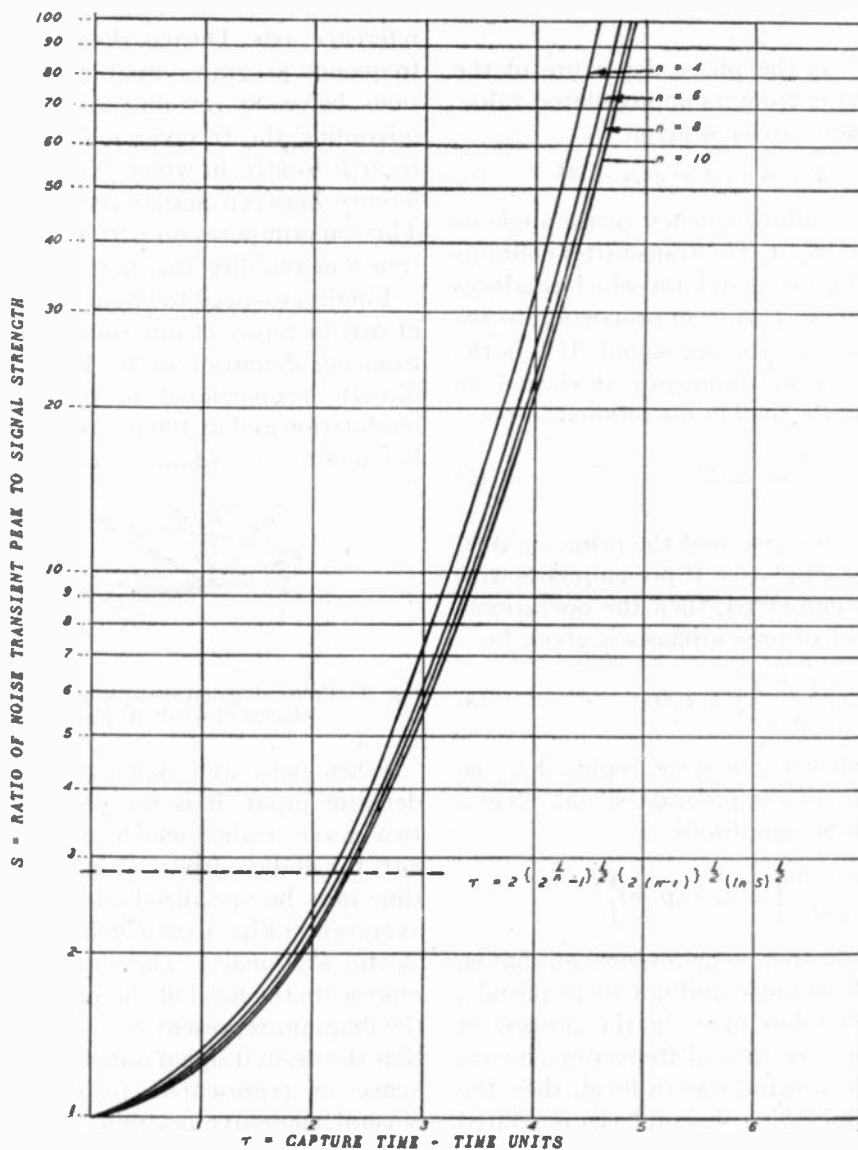

Fig. 2—Effect of noise-to-signal ratio on capture time. One time unit = 1 radian of maximum deviation frequency.

appendix by calculating the time interval during which the noise envelope exceeds that of the program signal at the detector. This time, which we shall call τ , is approximately given by

$$\tau \cong 2 \cdot \{2^{1/n} - 1\}^{1/2} \cdot \{2(n-1)\}^{1/2} \{\ln S\}^{1/2}. \quad (5)$$

Again the expression, while formidable in appearance, is practically independent of n and varies only slightly with the noise transient to signal ratio S . The value of τ for various values of n and S is given in Fig. 2. In general τ is of the order of three or four. Essentially, this means that if the noise impulse at the detector is not as strong as the signal there is no serious interruption, but if the noise once captures the signal, then it does not make too much difference whether it is a strong noise or a weak one.

While we are nominally dealing with a frequency-modulation system, it is more convenient to deal in terms of the phase variation since this is tangible and can be easily visualized. During the admixture of noise transient and desired signal, certain rather striking phenomena take place. Before discussing this, however, we need an operational expression for the detection process.

We shall define $\phi(t)$ as the phase departure of the modulated program carrier from its unmodulated value. Then the radio-frequency carrier is given by

$$E_{\text{radio frequency}} = E \cdot \cos \{ \omega_0 t + \phi(t) + \theta \} \quad (6)$$

where θ is an arbitrary radio-frequency phase angle as observed at the detector input. The transmitter contains some device such as a Travis modulator which produces a frequency deviation of the carrier in proportion to the strength of the modulating program signal. If h is the conversion constant relating frequency deviation to modulating signal strength, then in operational terms

$$\phi'(t) = \frac{1}{p} \cdot h \cdot e_p(t) \quad (7)$$

where $e_p(t)$ is the program signal and the prime on $\phi'(t)$ indicates the lack of pre-emphasis. If pre-emphasis with a time constant $1/\gamma$ is employed, then the operational form including the effect of pre-emphasis is given by

$$\phi(t) = \left[\frac{p + \gamma}{p \cdot \gamma} \right] \cdot h \cdot e_p(t). \quad (8)$$

For a steady-state condition, p may be replaced by $j\sigma$, where σ is the frequency of the program signal. Hence, for steady-state monotone conditions

$$\phi(t) = \text{Re} \left\{ \left[\frac{j\sigma + \gamma}{j\sigma\gamma} \right] \cdot h \cdot e_p \cdot \exp j\sigma t \right\}.$$

If the receiver is ideally frequency responsive, that is, responds only to the phase angle and not to amplitude, then the reverse of (8) takes place in the process of reception. If we assume a reciprocal frequency-conversion constant and neglect variations in level, then the audio output signal e_d including de-emphasis is related to $\phi(t)$ by the operational form

$$e_d(t) = \left[\frac{p \cdot \gamma}{p + \gamma} \right] \cdot \frac{1}{h} \cdot \phi(t) \quad (9a)$$

and

$$e_d(t) = \left[\frac{p + \gamma}{p \cdot \gamma} \right] \cdot h \cdot \left[\frac{p \cdot \gamma}{p + \gamma} \right] \cdot \frac{1}{h} \cdot e_p(t) = e_p(t). \quad (9b)$$

The above equations completely define the mechanism of modulation under ideal conditions for both transient and steady-state conditions. Further, they show that, when pre-emphasis is included, the output signal after de-emphasis is that signal which would be obtained across the resistance of a series resistance-capacitance circuit having the de-emphasis time constant and driven by a voltage proportional to the phase deviation of the carrier. Such a circuit will, of course, attenuate frequencies below the transition frequency of the de-emphasis network; consequently, $\phi(t)$ must be quite large for low-frequency signals.

On a vector diagram it is convenient to take the center frequency as the reference, and in this case $\phi(t)$ is represented by a spoke of constant amplitude with its hub at the origin deviating to and fro from the reference axis. During the course of one cycle of low-frequency program signal it may wind up many revolutions before it reverses and goes back. The effect of mistuning the receiver may be included by adding a term βt to $\phi(t)$, in which β is the angular frequency difference between actual tuning and the proper tuning. This superimposes on $\phi(t)$ a slow constant rate of rotation β in the direction determined by the sign of β .

Finally, we need to know the maximum rate of change of $\phi(t)$ in terms of our time unit $1/\delta_0$, and this follows from our definition of δ_0 . The rate of change of $\phi(t)$ is directly proportional to the instantaneous degree of modulation and at 100 per cent modulation is numerically equal to one radian per time unit.

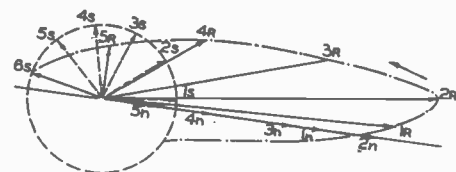

Fig. 3—Vector diagram showing how noise pulse causes momentary change of resultant phase, resulting in a click.

When noise and signal occur simultaneously at the detector input, it is the phase of the resultant of the two wave trains which must be used to calculate $e_d(t)$ the audio output. This phase angle as a function of time may be visualized on a complex number diagram as shown in Fig. 3, on which waves of angular frequency ω_0 are stationary. The dotted circle near the origin represents the level of the program signal. In order that the diagram represent a typical situation, it is assumed that the desired signal is deviated somewhat from ω_0 and hence is represented by a slowly rotating vector. Several successive positions of the signal in the absence of noise are depicted by the numbers 1s to 6s on Fig. 3.

When a noise transient occurs, it may be regarded as a fixed vector which grows out from the hub, past the circle to some maximum value, and then recedes. A possible set of positions of the noise vector for the same times are given by the numbers $1n$ to $6n$. The time that it exceeds the circle is given by τ in (5) above. This may amount to three or four time units and, with maximum modulation, the signal vector may rotate three or four radians during this interval.

The successive positions of the terminus of the resultant of the program signal plus the noise transient are also shown by the numbers $1r$ to $6r$. It can be seen that, qualitatively speaking, the phase is momentarily perturbed by the noise but shortly resumes its former locus. The consequences at the audio output of this momentary excursion of phase are treated in detail later, but it is apparent that, since the duration of the whole excursion is of the order of magnitude of the reciprocal of the total receiver bandwidth, and since the amplitude of the excursion is limited to less than π radians, the effect at the audio output is small if not insignificant for the case shown in Fig. 3, and sounds somewhat like a faint click.

A startlingly different result appears if, by chance, the relative phase of the noise-wave train and the useful signal have the relations shown in Fig. 4. In this case, the resultant phase makes a backward loop around the origin ending up with a permanent displacement of one whole revolution. After this sudden discontinuity, the phase is again under the control of the useful signal and continues its prescribed course as if nothing had happened. In other words, in the first case, the phase of the

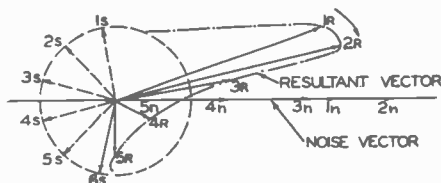

Fig. 4—Vector diagram showing how noise pulse causes resultant phase to slip one revolution, resulting in a pop.

resultant noise and signal vectors is fixed for a short time by the large noise signal, causing a sort of rectilinear perturbation; whereas in the second case, where the two signals pass through phase opposition, the phase of resultant is pulled back when the noise grows, and drops back further to the program-signal vector when the noise transient is over, having in the process slipped one complete revolution.

Due to the fact that, in a relatively short time, the phase of the resultant undergoes a permanent displacement, the effect on the audio output can be investigated by assuming that $\phi(t)$ has subtracted from it a noise impulse in the form of a unit function. In this case, the audible effect is quite noticeable and sounds like a "pop."

A very interesting feature of this type of interference is the fact that whether a radio-frequency noise impulse of sufficient amplitude produces a "pop" or a faint

"click" depends only on the radio-frequency phase relation between signal and noise transient. Since this phase is purely random, quantitative calculations of noise power output must be done on the basis of probability.

A little thought shows that if, during the time that the noise train exceeds the signal, the two trains pass through phase opposition, then the phase undergoes the permanent displacement of one revolution in the direction towards reducing the phase deviation. Since all relative phases are equally likely, the probability that the signal and noise will pass through phase opposition during the capture time is numerically equal to the fraction of a revolution that the useful signal changes in phase during this time. If k is the ratio of the instantaneous deviation (at the time of the noise impulse) to the deviation corresponding to 100 per cent modulation, then the phase of the program signal will change by $(k + \beta/\delta_0)\tau$ radians during the capture time.

The factor β/δ_0 represents effect of mistuning and for low modulation is the predominant factor. Hence, the probability P that a sufficiently strong noise impulse will produce a pop noise is given by

$$P = (k + \beta/\delta_0) \cdot \frac{\tau}{2\pi} \tag{10}$$

If the average rate of noise impulses of sufficient strength to capture the desired signal is given by R , then it is to be expected that the average rate of pop noises will be RP and the average rate of click noises, some of which may be inaudible, will be $R(1-P)$. It is also possible that in a few instances the program signal and noise might (with high modulation) pass through phase opposition twice. In this case the permanent phase displacement would be twice as large, but otherwise the same.

DETECTED SIGNAL-TO-NOISE RATIO

With the above expression we can now calculate the detected signal-to-noise ratio in terms of probabilities, for noises of the pop type. When the phase of the resultant vector at the detector input slips one revolution, the effect is to superimpose on $\phi(t)$ an additional term having the form of a unit function of amplitude 2π . Hence, the detected signal becomes⁴

$$e_d(t) = \left[\frac{p \cdot \gamma}{p + \gamma} \right] \frac{1}{h} [\phi(t) \pm 2\pi 1] \tag{11}$$

Performing the indicated operations, we find then that there is a noise term $e_{dnl}(t)$ subtracted from the detected useful signal of the following form:

$$e_{dnl}(t) = 2\pi\gamma \cdot h \exp(-\gamma t) \tag{12a}$$

or since E_{dm} , the detected signal for 100 per cent modulation, is equal to $h\delta_0$ we can rewrite (12a) as

$$e_{dnl}(t) = \left(\frac{2\pi\gamma}{\delta_0} \right) \cdot E_{dm} \cdot \exp(-\gamma t) \tag{12b}$$

⁴ The polarity of the unit function is always opposite the polarity of the time derivative of $\phi(t)$ at the time of the noise impulse.

The sign of the noise signal is such as momentarily to reduce the amplitude of the detected signal, and the wave form is simply the discharge curve of a resistance-capacitance circuit having the de-emphasis time constant. For a system of 75-kilocycle deviation for maximum modulation and a time constant of 100 microseconds, the peak amplitude of the generated noise signal is about 13 per cent of the program signal amplitude corresponding to 100 per cent modulation.

The output power for this type of noise is the product of the number of input pulses per second, the probability of a pop noise occurring, and the integral of the square of the voltage of a pop noise pulse. In calculating the probability it must be kept in mind that this is a function of the instantaneous modulation. For example, if sinusoidal modulation is employed, the probability (neglecting mistuning) of a noise pulse occurring is zero when the deviation is zero and a maximum for the peak of modulation. Hence,

$$\frac{W_{n1}}{W_{smax}} = \frac{R \cdot \tau}{2\pi} \frac{\left\{ \frac{1}{\sigma} \int_{-\pi/2\sigma}^{+\pi/2\sigma} \left(k \cdot \cos \sigma t + \frac{\beta}{\delta_0} \right) dt \right\} \left\{ \left(\frac{2\pi\gamma}{\delta_0} \right)^2 \int_0^\infty \exp(-2\gamma t) dt \right\}}{\frac{1}{\sigma} \int_{-\pi/2\sigma}^{+\pi/2\sigma} \{ \cos \sigma t \}^2 dt} \quad (13)$$

$$= \frac{2\pi R \cdot \tau \gamma}{\delta_0^2} \left\{ \frac{2k}{\pi} + \frac{\beta}{\delta_0} \right\}$$

where W_{n1} and W_{smax} represent the probable noise power due to pops and the desired audio signal power for 100 per cent modulation, respectively.

In the case of the click type of noise mentioned above, the amplitude of the resultant noise is considerably less for two reasons. In the first place, the maximum possible phase excursion is $\pm \pi$ radian, and second, the duration of the excursion is very short instead of being permanent. From the above discussion it will be seen that there is equal probability of a click noise having any value of phase displacement from $-\pi$ to $+\pi$ radians. Hence, we will call the amplitude of the displacement $Q\pi$, where Q is a probability factor and has an equal chance of being any value from -1 to $+1$.

The duration of the excursion is equal to the capture time τ . Hence, for this type of noise the program signal has added to it a noise impulse in the form of a sudden excursion of amplitude $Q\pi$ lasting for a time interval τ . As before, the resultant detected noise can be found by applying the detector operator. Hence, with click noise the signal plus noise is given by

$$e_d(t) = \left[\frac{p \cdot \gamma}{p + \gamma} \right] \frac{1}{h} [\phi(t) + \pi Q(1 - \tau)] \quad (14)$$

where, as is customary, the subscript τ on the second function indicates that the step function starts at $\delta t = \tau$ instead of $t = 0$. The noise part of the signal E_{dn2}

which in phase represents a rectangular pulse of duration τ will, of course, pass through the circuit represented by the operation substantially without change, since τ/δ_0 is small as compared with $1/\gamma$. It will, however, be attenuated and integrated by the audio circuit if the bandwidth of the circuit is appreciably less than δ_0 . Let us suppose that the audio amplifier has a cutoff as determined by a resistance-capacitance circuit of bandwidth σ_0 radians per second and that $\sigma_0 \ll \delta_0$. The transient resulting in such an amplifier can then be represented by the operational expression.

$$e_{dn2}(t) = \left(\frac{p \cdot \gamma}{p + \gamma} \right) \frac{1}{h} \cdot \left(\frac{\sigma_0}{p + \sigma_0} \right) [\pi Q(1 - \tau)] \quad (15a)$$

$$\cong \frac{\gamma}{h} \left(\frac{\sigma_0}{p + \sigma_0} \right) [\pi Q(1 - \tau)]. \quad (15b)$$

Performing the indicated operation we find then that the resulting pulse in the audio circuit, after having

been modified by the frequency response of the audio circuit, has the following approximate form⁵:

$$e_{dn2}(t) = \left(\frac{\gamma \pi Q E_{dm}}{\delta_0} \right) [1 - \exp(-\sigma t)] \text{ for } 0 \leq t \leq \tau/\delta_0$$

$$= \left(\frac{\gamma \pi Q E_{dm}}{\delta_0} \right) [\exp \sigma(\tau - t) - \exp(-\sigma t)]$$

for $t > \tau/\delta_0$. (16)

Bearing in mind that τ is given in the earlier part of the paper in units of time of $1/\delta_0$ instead of seconds, the peak value of $e_{dn2}(t)$ may be calculated, giving

$$[e_{dn2}(t)]_{max} = \frac{\gamma \pi Q \sigma \tau}{\delta_0^2} \cdot E_{dm}. \quad (17)$$

Hence, the click noise after transition through the audio amplifier has the following form. It builds up quickly at a rate determined by the top frequency response of the audio amplifier to a maximum value given by (17) and then decays exponentially at the same rate.

The amplitude of such a click pulse is considerably less than that of a pop noise, first because of the smaller value of Q , and second because of attenuation and integration of the pulse in the audio amplifier. For example,

⁵ There is one unimportant exception to this which obtains when the noise and program carrier vectors pass through phase coincidence during the capture time, in which case the resultant noise form is roughly of the form of the time derivative of $e_{dn1}(t)$.

for the case given above of 75-kilocycle maximum deviation, 100-microsecond time constant, and if in addition the audio amplifier has a high-frequency cutoff of 15 kilocycles, the maximum value of e_{dns} for $\tau=3$ would correspond to about 4 per cent modulation instead of 13 per cent for the pop noise, and most of the clicks would be considerably less than 4 per cent. Further, the duration of the clicks are considerably less, since they decay at a rate determined by the high-frequency cutoff of the audio amplifier instead of by the considerably longer time constant of the de-emphasis circuit.

In all of the above cases we have considered large noise transients. If, however, the noise transient is weaker than the program signal, no capture obtains and the resultant noise will be similar to but weaker than a click noise. This condition has not been delineated here because the resulting noise is negligible for most practical receivers.

CONCLUSIONS

From the above analysis, quite a few interesting conclusions about impulse noise in frequency-modulation receivers may be drawn. First, any given noise impulse may produce either one of two kinds of noise: a faint click, or a louder pop. The click type is characterized by being high-pitched in tone quality and variable in amplitude, but always faint. The wider the audio amplifier passband, the louder and higher pitched the click. Conversely, the louder pop is of lower pitch, being determined by the time constant of the de-emphasis circuit, and is more or less independent of the frequency response of the audio amplifier.

Second, the amplitude of a click is largely, and of a pop completely, independent of the amplitude of the original noise impulse, and in an ideal system is uniquely determined by the constants of the receiver.

Third, whether a noise impulse will produce a click or a pop is largely a matter of random chance as far as the noise impulse is concerned, although due to the slight increase in capture time with increasing signal strength the chances of producing a pop are somewhat greater with stronger signals.

Fourth, the chances of a noise impulse producing a pop instead of a click increase linearly with the degree of instantaneous modulation and with mistuning. In fact, the whole analysis emphasizes the need for accurate tuning in frequency-modulation receivers.

Both the existence and wave shape as well as the probabilities of occurrence of clicks and pops have been fully verified by experiments conducted for us by C. T. McCoy of the Philco Research Laboratories. It is hoped that this experimental work will be the subject of a later paper.

Finally, one practical example illustrating the above conclusions should be mentioned. An electric drill or razor produces a series of noise impulses which vary considerably in amplitude from impulse to impulse. However, if one listens to a frequency-modulation program on a properly tuned high-quality receiver subject

to such interference, one will hear only a few interrupting noises which will sound like and are, in fact, pops of the type described above. All of these pops in the audio signal will be found to be of the same amplitude. Further, if the modulation of program signal is removed, leaving only an unmodulated carrier, and if the receiver is then mistuned, it will be observed that, with mistuning, the number of interruptions or noises increases about linearly but again the volume of each individual noise is the same. Further, one will then hear the anticipated background of sizzling clicks, much weaker than the pops but nevertheless there. This is perhaps the most striking verification of the above theory.

ACKNOWLEDGMENT

The authors wish to acknowledge the substantial assistance in making numerical calculations and curves which was done for them by Miss Olga Yeaton and Mrs. Elaine Houston. In addition, they wish to acknowledge considerable assistance from C. T. McCoy and many members of the Research Division with whom the theory has been discussed from time to time.

APPENDIX I

For the purposes of this paper we are concerned, not with the specific form of frequency-response or phase characteristic of our receiver, but only with the broad form of frequency selection. Hence, for analytical purposes we shall assume a tuner comprising a number of identical stages each consisting of a parallel-tuned circuit of inductance L , capacitance C , and conductance G , driven by a one-way current transducer having the characteristic $i_k = g_m \cdot e_{k-1}$. The operational form for the transfer impedance of each stage then is

$$\frac{1}{Y_{(p)}} = \frac{g_m}{C} \frac{p}{(p + \alpha)^2 + \omega_0^2} \quad (18)$$

where

$$\alpha = \frac{1}{2} \frac{G}{C}$$

$$\omega_1^2 = \frac{1}{LC}$$

$$\omega_0^2 = \omega_1^2 - \alpha^2$$

and p is the usual Heaviside operator. Then the output voltage e_n across the n th circuit is given by

$$e_n(t) = \left[\frac{g_m}{C} \right]^n \cdot \left[\frac{p}{(p + \alpha)^2 + \omega_0^2} \right]^n e_0(t) \quad (19)$$

where $e_0 g_m$ is the current driving the first stage.

For a continuous-wave signal, the maximum response will obtain for the frequency ω_1 which is also the mid-band frequency. Hence, if the continuous-wave signal frequency is ω we let $\omega = \omega_1 + \nu$, where ν is the departure of the continuous-wave signal from the center frequency. If the continuous-wave signal is frequency-modulated at a relatively slow rate and stays within the channel,

then v can be considered to be the deviation. Then the gain and frequency response of a single stage is given by

$$\frac{e_1}{e_0} = -\frac{g_m}{G} \left[\frac{+1}{1 + j \frac{v}{\alpha}} \right]. \quad (20)$$

It will be noted that the frequencies at which the response is 3 decibels down are $v = \pm \alpha$. We will use the 3-decibel point to define the edges of the passband of the tuner, and we will define δ_0 (in terms of angular frequency) as the half-bandwidth of the system. Then, if the system consists of one stage, $\alpha = \delta_0$ and the conductance of the stage would be adjusted accordingly.

For n stages, the gain and frequency response is given by

$$\frac{e_n}{e_0} = \left[\frac{g_m}{G} \right]^n \cdot \left[\frac{+1}{1 + j \frac{v}{\alpha}} \right]^n. \quad (21)$$

The damping α for a passband δ_0 at the 3-decibel point is determined from

$$\left\| \frac{+1}{1 + j \frac{\delta_0}{\alpha}} \right\|^n = \frac{1}{\sqrt{2}}$$

or

$$\frac{\delta_0}{\alpha} = \{2^{1/n} - 1\}^{1/2}.$$

Hence, for a tuner of n stages and passband δ_0 and center frequency ω_1 , the gain is given by

$$\frac{e_n}{e_0} = \left[\frac{g_m}{G} \right]^n \quad \text{at } \omega = \omega_1 \quad (22a)$$

and the natural decrement of each stage by

$$\alpha = \frac{\delta_0}{\{2^{1/n} - 1\}^{1/2}}. \quad (22b)$$

$$N_n(t) = D \cdot \left[\frac{g_m}{C} \right]^n \cdot \frac{1}{(n-1)!} \left\{ \frac{d^{n-1}}{dz^{n-1}} \left[\left(\frac{z}{z - \lambda_2} \right)^n \exp tz \right]_{z \rightarrow \lambda_1} + \frac{d^{n-1}}{dz^{n-1}} \left[\left(\frac{z}{z - \lambda_1} \right)^n \exp tz \right]_{z \rightarrow \lambda_2} \right\}. \quad (25d)$$

The behavior of such a system when shock-excited is as follows: The initial exciting force is taken as $e_0 = D \cdot p1$ where D has the dimensions of the product of voltage envelope and time. This function has an equal distribution of energy with frequency. An actual impulse noise of duration short as compared with $1/\delta_0$ will have an energy distribution with frequency which will be a maximum at its nominal carrier and fall off with frequency at a rate determined by its shape. However, over the acceptance band of the filter the energy distribution is substantially uniform. Hence, the spike function $Dp1$ will give the proper transient wave shape, but quantitative values of D must be used with caution and regard to the actual energy distribution of the noise

impulse. Then for a single stage

$$N_1(t) = \left[\frac{g_m}{C} \right] \left[\frac{p}{(p + \alpha)^2 + \omega_0^2} \right] Dp1 \quad (23)$$

where $N_1(t)$ is the resulting form. Hence,

$$N_1(t) = \frac{D \cdot g_m}{C} \cdot \exp(-\alpha t) \cdot \cos \omega_0 t \quad (24a)$$

which has a peak value

$$N_{1 \max} = \frac{D \cdot g_m}{C}.$$

The ratio of noise peak to continuous-wave signal for a single stage is

$$\frac{N_{1 \max}}{E_1} = \frac{D \cdot g_m \cdot G}{E_0 \cdot C \cdot g_m} = \frac{2D \cdot \alpha}{E_0} \quad (24b)$$

where E_0 is the peak value of the desired input signal envelope. For n stages

$$N_n(t) = \left[\frac{g_m}{C} \right]^n \left[\frac{p}{(p + \alpha)^2 + \omega_0^2} \right]^n D \cdot p1. \quad (25a)$$

This expression may be most easily evaluated by use of the contour integral form

$$N_n(t) = \frac{D}{2\pi j} \left[\frac{g_m}{C} \right]^n \cdot \int_{-j\infty}^{j\infty} \frac{z^n \cdot \exp t \cdot z}{[(z + \alpha)^2 + \omega_0^2]^n} \cdot dz \quad (25b)$$

The above integral has two poles, each of order n , at

$$\left. \begin{aligned} \lambda_1 &= -\alpha + j\omega_0 \\ \lambda_2 &= -\alpha - j\omega_0 \end{aligned} \right\} \quad (25c)$$

The contour may be closed for all positive values of t by a semicircle of infinite radius from $+j\infty$ to $-j\infty$ enclosing the poles. The value of the integral is hence $2\pi j$ times the sum of the residues at λ_1 and λ_2 . These may be found in the usual way by expanding the integral in a Taylor's series around the poles. Hence,

For convenience we write the derivatives, respectively, as

$$\left. \begin{aligned} \psi_1(\lambda_1, \lambda_2) &= \frac{d^{n-1}}{dz^{n-1}} \left[\left(\frac{z}{z - \lambda_2} \right)^n \exp tz \right]_{z \rightarrow \lambda_1} \\ \psi_2(\lambda_2, \lambda_1) &= \frac{d^{n-1}}{dz^{n-1}} \left[\left(\frac{z}{z - \lambda_1} \right)^n \exp tz \right]_{z \rightarrow \lambda_2} \end{aligned} \right\} \quad (25e)$$

Since λ_1 and λ_2 are conjugate functions, ψ_1 and ψ_2 are likewise conjugate functions. Hence, we need treat only ψ_1 . First removing the exponent from under the derivative

$$\psi_1(\lambda_1, \lambda_2) = \exp \lambda_1 t \left[t + \frac{d}{dz} \right]^{n-1} \cdot \left[\frac{z}{z - \lambda_2} \right]_{z \rightarrow \lambda_1}^n \quad (25f)$$

where the expression in the first bracket is to be treated as an operator operating $n-1$ times on the succeeding terms. In this particular case, it is legitimate to expand the operator in a binomial series, hence

$$\psi_1(\lambda_1\lambda_2) = \exp \lambda_1 t \cdot \sum_{k=0}^{n-1} \binom{n-1}{k} \cdot t^{n-1-k} \cdot \frac{d^k}{dz^k} \left[\frac{z}{z-\lambda_2} \right]_{z=\lambda_1} \quad (25g)$$

The principle term of this series is the first for which $k=0$. This term is as follows:

$$\exp \lambda_1 t \cdot t^{n-1} \cdot \left(\frac{\lambda_1}{\lambda_1 - \lambda_2} \right)^n = \frac{1}{2} \left(\frac{t}{2} \right)^{n-1} \cdot \left\{ 1 + \left(\frac{\alpha}{\omega_0} \right)^2 \right\}^{n/2} \exp [(-\alpha + j\omega_0)t + jn\theta] \quad (25h)$$

where $\theta = \tan^{-1}(d/\omega_0)$. Noting that $\alpha/\omega_0 \ll 1$, neglecting the phase angle, and adding the conjugate term in ψ , we have approximately

$$N_n(t) \cong \frac{D \cdot g_m}{C} \cdot \left[\frac{g_m}{G} \right]^{n-1} \cdot \frac{(\alpha t)^{n-1}}{(n-1)!} \cdot \exp - \alpha t \cdot \cos \omega_0 t. \quad (25i)$$

The higher terms ($k > 0$) if added to (25i) will give terms of the following form and very approximate value,

$$\left\{ \frac{D \cdot g_m}{C} \cdot \left[\frac{g_m}{G} \right]^{n-1} \right\} \cdot \binom{n-1}{k} \left(\frac{\alpha}{2\omega_0} \right)^k \frac{(\alpha t)^{n-1-k}}{(n-1-k)!} \cdot \exp - \alpha t \cos \left(\omega_0 t + \frac{k\pi}{2} \right). \quad (25j)$$

Expression (25i) represents an oscillation which has an envelope given by

$$eN_n(t) = \frac{D \cdot g_m}{C} \left[\frac{g_m}{G} \right]^{n-1} \cdot \frac{(\alpha t)^{n-1}}{(n-1)!} \exp (-\alpha t). \quad (26a)$$

Equating the time derivative to zero we find the maximum value of the envelope obtains for $\alpha t = n-1$. Hence,

$$eN_{nmax} = \frac{D \cdot g_m}{C} \left[\frac{g_m}{G} \right]^{n-1} \frac{(n-1)^{n-1} \exp (1-n)}{(n-1)!} \quad (26b)$$

and the form of the signal in terms of its peak value is

$$y_n(t) = \frac{eN_n(t)}{eN_{nmax}} = \left(\frac{\alpha t}{n-1} \right)^{n-1} \cdot \frac{\exp (-\alpha t)}{\exp (1-n)}. \quad (26c)$$

The higher terms given in (25j) above come to their maximum earlier at $\alpha t = n-1-k$. These peaks, however, are smaller in amplitude than the principal term for all important values of t . They are displaced in phase by approximately ninety degrees per term. The net effect is to introduce a small amount of phase or frequency modulation which, however, finally settle down to the natural frequency ω_0 . For our purposes, this modulation

plus such minor variations in the envelope as accompany it may be neglected.

From (22a) and (26a) we can calculate the noise-peak to output-signal ratio, which is given by

$$\frac{eN_{nmax}}{E_n} = \frac{2 \cdot D \cdot \alpha}{E_0} \cdot \frac{(n-1)^{n-1} \exp (1-n)}{(n-1)!}. \quad (27a)$$

Including the variation in bandwidth of individual stages with the number of stages as given in (22b), this becomes

$$\frac{eN_{nmax}}{E_n} = \frac{2 \cdot D \cdot \delta_0}{E_0} \cdot \frac{(n-1)^{n-1} \exp (1-n)}{\{2^{1/n} - 1\}^{1/2} (n-1)!} = S. \quad (27b)$$

We now wish to determine the time interval during which the noise impulse exceeds the desired signal for various signal-to-noise ratios. Let τ/δ_0 be that time interval and $y_n(t)$ the ratio of the noise envelope at time t to the maximum noise envelope peak. We can assume the signal envelope to be of constant amplitude. Hence the ratio $S \cdot y_n(t)$ of noise envelope to signal as a function of time from (26c) is

$$S \cdot y_n(t) = S \cdot \left(\frac{\alpha t}{n-1} \right)^{n-1} \exp [n-1-\alpha t] \quad (28)$$

where S is the peak-noise to signal ratio.

This expression is zero for $t=0, \infty$ and equals S for $\alpha t = n-1$. The time interval τ/δ_0 is given by $\tau\delta_0 x_2 - x_1$ where x_2 and x_1 are the roots of the transcendental equation

$$S \left(\frac{\alpha t}{n-1} \right)^{n-1} \exp [n-1-\alpha t] = 1. \quad (29a)$$

To solve this equation we substitute $x = \alpha t - n + 1$, then, taking the log of each side and rearranging the terms,

$$(n-1) \ln \left[\frac{x}{n-1} + 1 \right] - x = -\ln S. \quad (29b)$$

Using the first few terms of the series for the logarithm we have

$$x - \frac{x^2}{2(n-1)} - x = -\ln S \quad (30a)$$

or

$$x = \pm \sqrt{2(n-1) \ln S}. \quad (30b)$$

Hence,

$$\frac{\tau}{\delta} = \frac{2}{\alpha} \sqrt{2(n-1) \ln S} \quad (31a)$$

$$\tau = 2 \{2^{1/n} - 1\}^{1/2} \{2(n-1) \ln S\}^{1/2}. \quad (31b)$$

It will also be noted that the transcendental equation may easily be solved graphically by plotting on semilog paper.

Radio Direction Finding at 1.67-Meter Wavelengths*

LUKE CHIA-LIU YUAN†, SENIOR MEMBER, I.R.E.

Summary—Different antenna systems such as the Adcock, V-type, double-V-type, parabolic, and the H-type were tested for measuring both the vertical and the azimuthal angles of an incident wave at the wavelength of 1.67 meters. A null method using the Adcock antenna for defining the azimuthal angle and the H antenna for determining the vertical angle was found to be most satisfactory for high angles of incidence.

As the frequency used is too high for sky-reflected waves, erroneous directions attributed to the effect of sky waves at longer wavelengths are eliminated.

With the antenna system one and one-half wavelengths above ground and with the ground surface dry and homogeneous and no reflecting objects in the immediate vicinity, the direction of the incident wave thus determined agrees within $\frac{1}{2}$ degree with the optical direction in the azimuthal angle and within $\pm \frac{1}{2}$ degree in the vertical angle. But when the ground is wet, the error in the vertical angle may reach as high as $3\frac{1}{2}$ degrees.

A mathematical analysis of the reception by these two types of antenna systems, taking into consideration the ground-reflected waves, is given. The theoretical response agrees well with the experimental one.

INTRODUCTION

IN THE past years, many methods have been devised for direction finding at various wavelengths using different kinds of antenna systems. The most widely used systems among these are the closed loop and the spaced aerial or the Adcock types.¹⁻⁴ The present paper describes a simple method for measuring the vertical as well as the azimuthal directions of an incoming wave at a wavelength of 1.67 meters.

The main problems of direction finding involved at ultra-high frequencies include the building of a highly sensitive receiver⁵ with a satisfactory response, shielding perfectly to prevent stray pickup of signals from parts other than the antenna elements, providing perfect mechanical and hence electrical symmetry, avoiding of possible reflections from nearby objects, using low-loss insulation, etc.

Various types of antenna systems, including parabolic, V-type, double-V-type, Adcock, and double-dipole antennas, were tested for both vertical and azimuthal direction-finding purposes at distances of from seven to thirty miles.

* Decimal classification: R125.31×R325.31. Original manuscript received by the Institute, September 18, 1945; revised manuscript received, February 11, 1946. The work described in this paper was done during 1939 and 1940 at the California Institute of Technology.

† Formerly, Norman Bridge Laboratory, California Institute of Technology, Pasadena, California; now, RCA Laboratories, Princeton, N. J.

¹ A complete bibliography up to 1938 is given by R. Keen, "Wireless Direction Finding," Iliffe and Sons, Ltd., London, Third Edition, 1938.

² R. L. Smith-Rose and H. G. Hopkins, "Direction-finding at 50-30 mc./sec." *Jour. I. E. E.* (London), vol. 83, pp. 87-97; July, 1938.

³ H. G. Hopkins, "A loop direction-finder for ultra-short waves," *Wireless Eng.*, vol. 15, pp. 651-657; December, 1938.

⁴ F. E. Terman and J. M. Pettit, "The compensated-loop direction finder," *Proc. I.R.E.*, vol. 33, pp. 307-318; May, 1945.

⁵ Luke C. L. Yuan and C. E. Miller, "An ultra-high frequency superheterodyne receiver for direction finding," *Rev. Sci. Instr.*, vol. 11, pp. 273-276; September, 1940.

An attempt has been made to give a mathematical analysis of the reception by the antenna systems employed, taking into account the reflected signal from ground.

APPARATUS

(a) Transmitter

The transmitter operated on a wavelength of 1.67 meters and had a power output of a small fraction of a watt. It weighed less than two ounces and could be sent aloft readily on either a free or a captive balloon with a small power supply. Fig. 1 shows the actual layout of the transmitter.

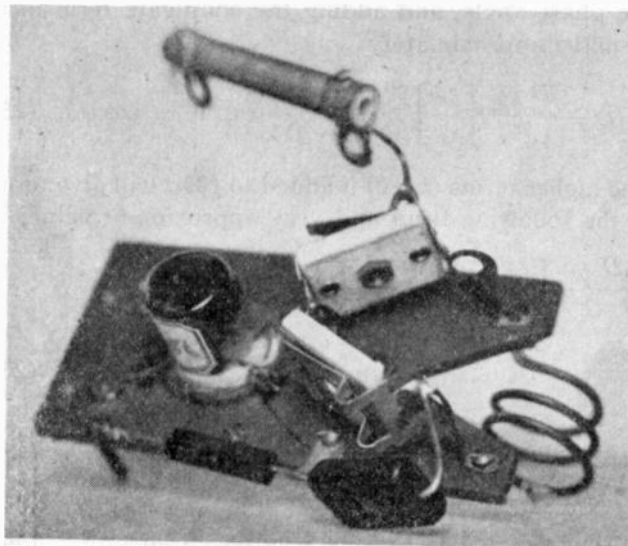

Fig. 1—Transmitter.

A fixed transmitter with a vertical dipole antenna was permanently set up on top of Mt. Wilson, which is about seven miles air distance from the laboratory site of the direction finder.

(b) Antenna System

For measuring the azimuthal angle, an Adcock antenna system was found to be most satisfactory. It is well known that, when the plane of the antenna system is in a position perpendicular to the direction of the incoming wave, the signals induced in the opposite pairs of elements of the antenna are equal. These signals are differentially combined and are transmitted to the two ends of a coil which is coupled to the input coil of the receiver, thus giving a null signal in the receiver. The layout of the antenna is shown in Fig. 2(A).

For measuring the vertical angle of the incoming wave, an H antenna (Fig. 2(B)) was formed by turning one end of the Adcock antenna insulator support through 180 degrees, thus forming two half-wave dipoles spaced $\lambda/2$ apart and connected in parallel. The

whole antenna system was turned about the vertical axis until the plane of the antenna was in the direction of the incoming wave, and the antenna was rotated about the horizontal element of the transmission tube as an axis until a null signal was obtained in the receiver.

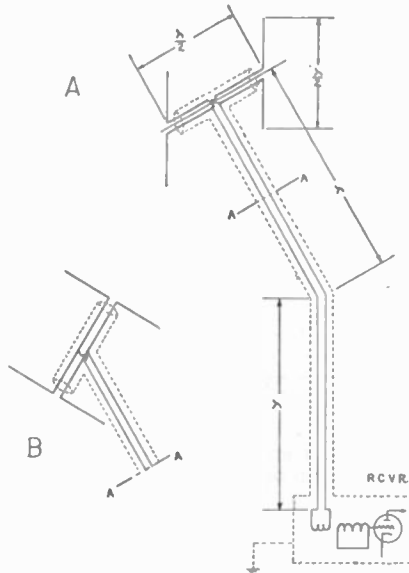

Fig. 2—A: General layout of the Adcock antenna system. B: General layout of the H antenna.

The position of the antenna elements pointed to the direction of the incoming wave in a vertical plane. The complete assembly of the apparatus is shown in Fig. 3.

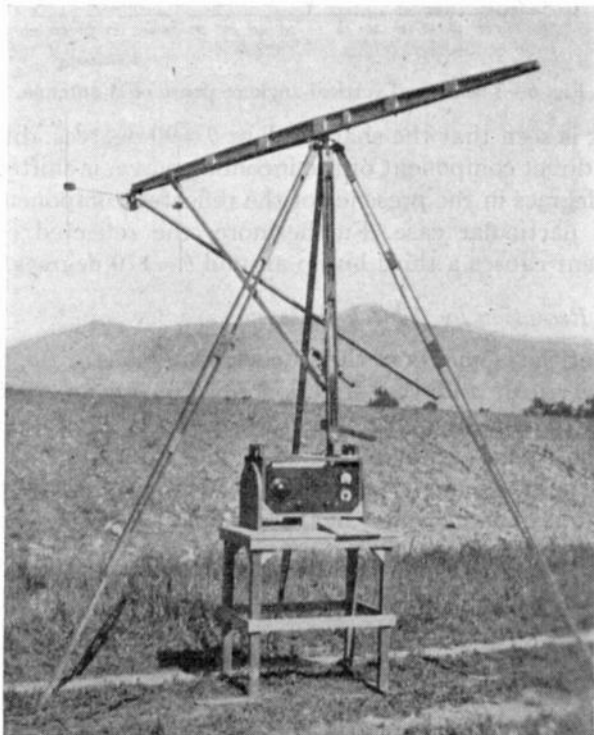

Fig. 3—Complete assembly of the direction finder.

(c) Receiver

The receiver used was a specially designed super-heterodyne type with a resistance-coupled wide-band

intermediate-frequency amplifier. It had a high sensitivity and was very stable in operation. The output of the receiver was fed to a sensitive meter which served as an indicator. A detailed description of the receiver is given in a previous paper.⁵

MATHEMATICAL ANALYSIS OF THE RECEPTION BY DIRECTION FINDER

We shall analyze the reception of a plane-polarized wave and its ground reflection by (a) an H or double-dipole antenna, and (b) an Adcock antenna.

(a) Reception by H Antenna

Consider the H antenna as placed in an electromagnetic field E of a vertically polarized wave from a half-wave radiator. The electric-field strength in volts per meter at a distance r and at angle ψ from the center of the radiator is given by the expression

$$E = 60 \frac{i_0}{r} \frac{\cos\left(\frac{\pi}{2} \cos \psi\right)}{\sin \psi} \sin \omega\left(t - \frac{r}{c}\right) \quad (1)$$

where i_0 is the current in amperes at the center of the radiating antenna and in the direction perpendicular to that of the radial vector. Writing in exponential form we have

$$E = 60 \frac{i_0}{r} \frac{\cos\left(\frac{\pi}{2} \cos \psi\right)}{\sin \psi} e^{j\omega(t-r/c)} \quad (1a)$$

Let the H antenna be in the plane containing r and E and be tilted at an angle θ from E , as shown in Fig. 4. Further, let the height of the center of the antenna system be h_0 above ground, and the angle of incidence of

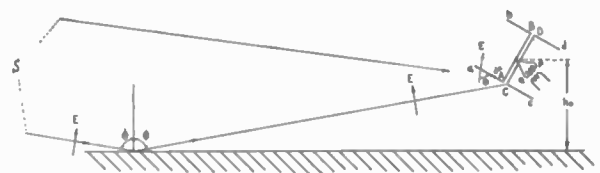

Fig. 4—Sketch showing the reception of both the direct component and the reflected component of the radiation emitted from a distant source S (to the left of the figure) by an H-antenna system at a height h_0 above ground.

the incoming wave be ϕ with respect to ground. Neglecting the effects due to refracted waves in the ground because of the high frequencies used here one finds the resultant field at any point h above ground is then⁶

$$E' = E(1 + r_v e^{-j(\gamma+\theta)}) \quad (2)$$

where

$$r_v e^{-j\gamma} = \frac{\epsilon' \cos \phi - \sqrt{\epsilon' - \sin^2 \phi}}{\epsilon' \cos \phi + \sqrt{\epsilon' - \sin^2 \phi}} \quad (2a)$$

⁵ C. B. Feldman, "The optical behavior of the ground for short radio waves," Proc. I.R.E., vol. 21, pp. 764-801; June, 1933.

- r_v = magnitude ratio of reflected to direct intensity
- $\epsilon' = \epsilon - j2\sigma\lambda c$
- ϵ = dielectric constant of the surface of ground (assuming $\epsilon = 1$ for air)
- ϕ = angle of reflection from ground measured from vertical
- σ = conductivity of surface in electromagnetic units ($\sigma = 0$ for air)
- $\beta = (4\pi h \cos \phi) / \lambda$
- γ = phase lag at reflection (referred to phase of reflected wave from perfect conductor).

We shall, however, consider the antenna system as a source of radiation consisting of two dipoles ac and bd , and proceed to find the resultant electromagnetic field and hence the induced voltage in a receiving antenna at a distant point S . Then, by the reciprocity theorem, this result would be equivalent to the received signal at the antenna system due to a single radiation source at S .

The voltages induced in a receiving antenna at S of an effective height H , due to the dipoles ac and bd respectively, are

$$V_{ac} = 60H \frac{i_0}{r_0} e^{j[\omega(t-r_0/c) + \frac{\pi}{2} \cos \theta]} \left\{ \frac{\cos\left(\frac{\pi}{2} \sin \theta\right)}{\cos \theta} + r_v \frac{\cos\left[\frac{\pi}{2} \sin(\theta + 2\phi)\right]}{-\cos(\theta + 2\phi)} e^{-j[\gamma + \beta_0 h_0 + \beta_0(\lambda/l) \cos(\theta + \phi)]} \right\} \quad (3)$$

$$V_{bd} = 60H \frac{i_0}{r_0} e^{j[\omega(t-r_0/c) - \frac{\pi}{2} \cos \theta]} \left\{ \frac{\cos\left(\frac{\pi}{2} \sin \theta\right)}{\cos \theta} + r_v \frac{\cos\left[\frac{\pi}{2} \sin(\theta + \phi)\right]}{-\cos(\theta + 2\phi)} e^{-j[\gamma + \beta_0 h_0 - \beta_0(\lambda/l) \cos(\theta + \phi)]} \right\} \quad (4)$$

where r_0 is the distance from the point S to the center of the antenna system whose height is h_0 and $\beta_0 = (4\pi/\lambda) \cos \phi$.

When the two dipoles are fed in phase, as is the case of the H antenna, we have the resultant voltage

$$V_H = K[V_{ac} + V_{bd}]$$

where K is a factor involving the mutual impedance of the two dipoles, and is a constant for a given frequency. Thus

$$V_H = 60HK \frac{i_0}{r_0} e^{j\omega(t-r_0/c)} \left\{ \underbrace{\frac{\cos\left(\frac{\pi}{2} \sin \theta\right)}{\cos \theta} \cdot 2 \cos\left(\frac{\pi}{2} \cos \theta\right)}_{v_d} + \underbrace{\frac{\cos\left[\frac{\pi}{2} \sin(\theta + 2\phi)\right]}{-\cos(\theta + 2\phi)} e^{-j(\gamma + \beta_0 h_0)} \cdot 2 \cos\left[\frac{\pi}{2} \cos \theta - \pi \cos \phi \cos(\theta + \phi)\right]}_{v_r} \right\} \quad (5)$$

For a given frequency and a fixed r_0 , V_H is proportional to $v_d + v_r$. Graphical representation of (5) (real part) in

the form of $|v_d|$ and $|v_d + v_r|$ as a function of θ are plotted in Figs. 5 and 6, for the case of dry soil ($\sigma = 10^{-15}$ electromagnetic units, $\epsilon = 4$) with an angle of incidence ϕ of 80 degrees. Under these conditions r_v is calculated⁷ to be 0.383 and γ negligible at this frequency.

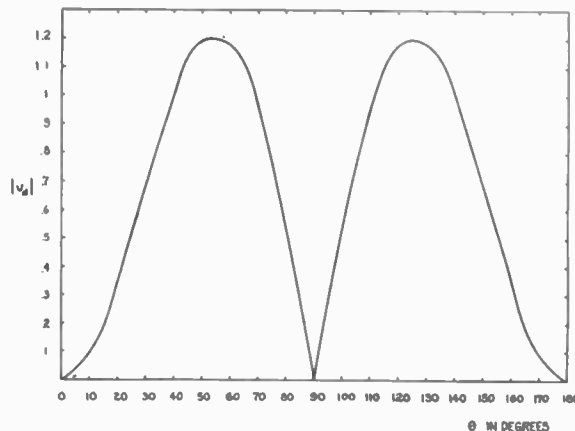

Fig. 5—Direct component of the signal received by H antenna as a function of θ calculated theoretically.

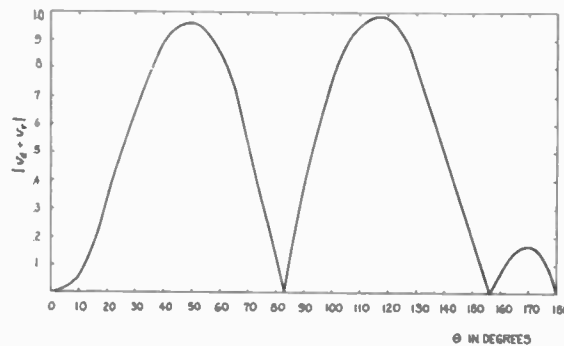

Fig. 6—Theoretical vertical-angle response of H antenna.

It is seen that the sharp null at $\theta = 90$ degrees, due to the direct component of the incoming wave, is shifted to 83 degrees in the presence of the reflected component in this particular case. Furthermore, the reflected component causes a third hump around $\theta = 170$ degrees.

(b) Reception by Adcock Antenna

Let the elements of the Adcock antenna Aa, Bb , etc., be vertical, and the direction of S make an angle θ with the antenna elements. Furthermore, let the plane of the Adcock antenna, including the elements Aa, Dd , etc., make an angle ξ with the vertical plane that comprises S and the center of the antenna system as shown in Fig. 7.

⁷ J. S. McPetrie, "The reflection coefficient of the earth's surface for radio waves," *Jour. I. E. E.* (London), vol. 82, pp. 214-218; February, 1938.

Similar to (a), the voltage induced in a receiving antenna at S due to the dipole ac is given by

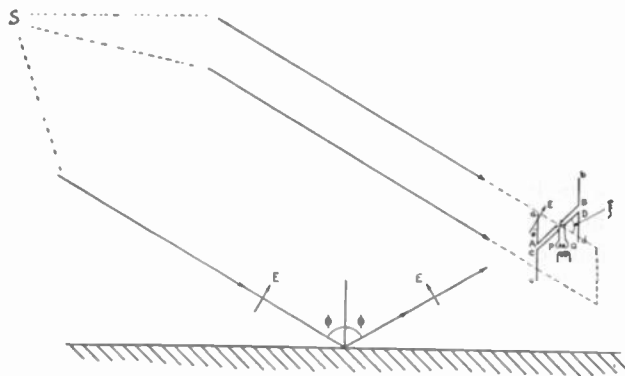

Fig. 7—Reception of both the direct component and the reflected component of the radiation emitted from a distant source S (to the left of the figure) by an Adcock antenna at a height h_0 above ground.

$$V_{ac'} = 60H \frac{i_0}{r_0} e^{j[\omega(t-r_0/c) + \frac{\pi}{2} \cos \xi \cos \theta]} \left\{ \frac{\cos\left(\frac{\pi}{2} \sin \theta\right)}{\cos \theta} + r_v e^{-j(\gamma + \beta_0 h_0)} \frac{\cos\left[\frac{\pi}{2} \sin(\theta + 2\phi)\right]}{-\cos(\theta + 2\phi)} \right\} \quad (6)$$

Similarly,

$$V_{bd'} = 60H \frac{i_0}{r_0} e^{j[\omega(t-r_0/c) - \frac{\pi}{2} \cos \xi \cos \theta]} \left\{ \frac{\cos\left(\frac{\pi}{2} \sin \theta\right)}{\cos \theta} + r_v e^{-j(\gamma + \beta_0 h_0)} \frac{\cos\left[\frac{\pi}{2} \sin(\theta + 2\phi)\right]}{-\cos(\theta + 2\phi)} \right\} \quad (7)$$

Thus, the resultant voltage is given by

$$V_{Ad} = K(V_{ac'} - V_{bd'})$$

since the two dipoles are fed opposite in phase in the Adcock. Hence

$$V_{Ad} = 60jHK \frac{i_0}{r_0} e^{j\omega(t-r_0/c)} \cdot 2 \sin\left(\frac{\pi}{2} \cos \xi \cos \theta\right) \underbrace{\left\{ \frac{\cos\left(\frac{\pi}{2} \sin \theta\right)}{\cos \theta} + r_v e^{-j(\gamma + \beta_0 h_0)} \frac{\cos\left[\frac{\pi}{2} \sin(\theta + 2\phi)\right]}{-\cos(\theta + 2\phi)} \right\}}_{v'} \quad (8)$$

It is apparent from (8) that $V_{Ad} = 0$ at $\xi = 90$ degrees, regardless of the presence of the ground-reflected component. Graphical representation of (8) (real part) in the form v' as a function of ξ for various values of θ and ϕ and for the case of dry soil ($\sigma = 10^{-15}$ electromagnetic units, $\epsilon = 4$) are shown in Fig. 8.

EXPERIMENTAL RESULTS AND DISCUSSION

With a small transmitter installed on top of Mt. Wilson and the direction finder located in an open field seven miles away, directional responses for both types

of antenna were obtained. The vertical angle of the incident wave measured optically is $7\frac{3}{4}$ degrees.

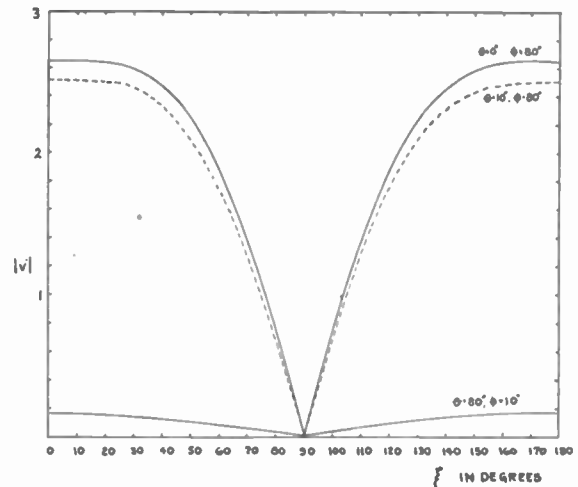

Fig. 8—Theoretical response of Adcock antenna for azimuthal directions.

The directional response of the Adcock antenna for azimuthal angles is shown in Fig. 9. There is a sharp null at $\theta = 90$ degrees and it agrees very well with the theoretical response as given in Fig. 8.

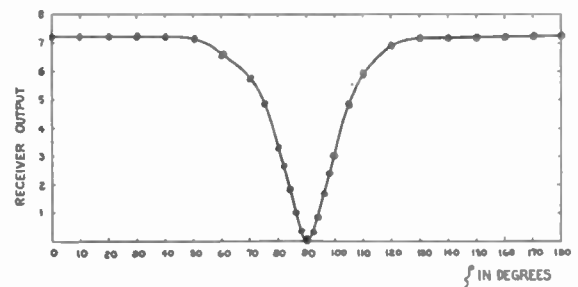

Fig. 9—Experimental response of Adcock antenna for azimuthal directions.

Fig. 10 shows the directional response of the H antenna as a function of vertical angles. It agrees fairly well with the theoretical response given in Fig. 6, which was calculated on the assumption of an angle of incidence ϕ of 80 degrees for the reflected wave and that the

reflection took place on dry soil. The fact that the actual null is not as sharp as the theoretical one, and that the receiver output does not fall down to zero at $\theta = 0$ and $\theta = 180$ degrees, is probably due to the presence of a small amount of other reflected waves or possibly refracted signals at such low vertical angles of incidence.

With the antenna system one-and-one-half wavelengths above ground, and with the ground surface dry and homogeneous and no reflecting objects in the immediate vicinity, the direction of the incident wave thus determined agrees within $\frac{1}{2}$ degree with the optical

direction in the azimuthal angle and within $\pm \frac{1}{2}$ degree in the vertical angle. But when the ground is wet, the error in the vertical angle may reach as high as $3\frac{1}{2}$ degrees. (See Table I.)

TABLE I

Azimuth of Incoming Wave as Determined by Direction Finder at Repeated Times in Degrees	Average in Degrees	Azimuth of Transmitter as Determined Visually in Degrees
0		
0		
$+\frac{1}{2}$	+1/7	0
$+\frac{1}{2}$		
$+\frac{1}{2}$		
$+\frac{1}{2}$		
(Observations made at a different date but at approximately the same location)		
0		
0		
$-\frac{1}{2}$	-1/4	0
$-\frac{1}{2}$		
$-\frac{1}{2}$		
$-\frac{1}{2}$		
Vertical Angle of Incoming Wave as Determined by Direction Finder at Repeated Times in Degrees		
$+8\frac{1}{2}$	+8 1/4	+7 1/4
+8		
$+8\frac{1}{2}$		
$+8\frac{1}{2}$		
$+8\frac{1}{2}$		
$+8\frac{1}{2}$		
$+8\frac{1}{2}$		
$+8\frac{1}{2}$		
(Observations made at a different date but at approximately the same location)		
$+7\frac{1}{2}$	+7 3/4	+7 1/4
$+7\frac{1}{2}$		
$+7\frac{1}{2}$		
+8		
+8		
+8		
+8		

It was found that an automobile placed unsymmetrically on one side of the receiving antenna at a distance of over 25 feet does not affect the observations noticeably. But when it is placed closer to the antenna it affects the readings to as much as 3 degrees.

Since the antenna height of one-and-one-half wavelengths above ground is much greater than in the experiments of Smith-Rose and Hopkins,² the position of the observer is not as critical as in their case. Provided he is not too close to the antenna, his influence can be ignored.

As the lower half of the Adcock antenna is closer to ground than the upper half, there is an asymmetry in the antenna system. Barfield³ showed that the error due to this asymmetry of the Adcock antenna causes a

deviation from the true direction which decreases linearly as s/d , where s is the length of each antenna element (in this case one-fourth wavelength) and d is the height of antenna above ground measured from the lower tip of the lower antenna elements. According to him, a deviation of 9 degrees was observed when $s/d=8$, and the deviation decreases to 2 degrees when $s/d=1$. Thus it may be expected that when the antenna is high enough, say a few wavelengths above ground, the error due to this asymmetry might be eliminated.

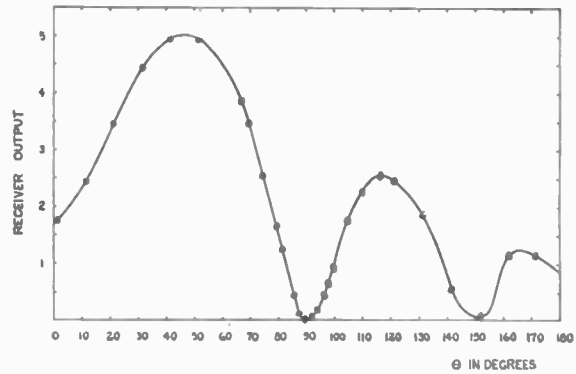

Fig. 10—Experimental vertical-angle response of H antenna.

It is to be noted that large trees at distances of 30 wavelengths away still have considerable effect on the observed directions.

A method for measuring vertical angles with the elimination of the effect due to ground-reflected waves is to be described in a later paper.

ACKNOWLEDGMENT

The author is deeply indebted to Professor R. A. Millikan for his continued interest and encouragement. He wishes also to express his thanks to Professor S. S. Mackeown and Dr. George H. Brown of the RCA Laboratories for many helpful discussions, and to Mr. C. E. Miller for his help in the construction of the apparatus and the experimental work. Grateful acknowledgement is made to Julien P. Friez and Sons, and the United States Weather Bureau, without whose funds and co-operation these experiments would not have been possible.

³ R. H. Barfield, "Some principles underlying the design of spaced-aerial direction finders," *Jour. I. E. E.* (London), vol. 76, pp. 423-443; April, 1935.

Discussion on

Tonal-Range and Sound-Intensity Preferences of Broadcast Listeners*

HOWARD A. CHINN AND PHILIP EISENBERG

Edward Massell:¹ This raises many interesting points. The main thesis, that narrow- and medium-band reproduction is inherently more pleasing than high-fidelity reproduction, other things being equal, leads to several startling conclusions.

Radio and sound engineers always have felt instinctively that ideal reproduction of sound would be exactly the same as the original, except for volume. According to the Chinn-Eisenberg article, this instinctive judgment must be set aside. One must conclude that perhaps narrow-range reproduction would be preferable to the original sound, that perhaps concert-goers would prefer to have musical instruments designed with the low notes and high overtones eliminated. Perhaps entirely new instruments, with their range restricted to the narrow band, would be preferable. A great amount of design, development, and production cost has been wasted in attempting high fidelity.

However, I do not believe that the point has yet been proved. For one thing the question of distortion is dismissed with the statement "trained observers failed to detect distortion." Since the ear accommodates itself, it would seem that the more "trained" an observer, the less qualified he would be to detect distortion. If distortion, particularly that resulting from crossmodulation with creation of new discordant frequencies, were present, it would be most evident in the higher frequencies, and hence cut out by the narrower reproduction. This is borne out by the correlation of preference for narrow range with the complexity of the original sound, i.e., classical orchestra was most definitely preferred at "low fidelity," whereas wide-range was preferred over medium-range in the piano, popular orchestra, and female speech selections.

The authors have gone to some pains to show that the preferences were not caused by usage. They used frequency-modulation listeners and professional musicians for comparison tests, attempting to show that their tastes were practically the same as the average listeners. But the frequency-modulation listeners did show much greater preference for the medium range for classical music, and this is the range they were presumably used to at home. In addition, we have no way of telling how many of them set their tone controls to bass. As to the professional musicians, who as orchestra members are used to musical sounds entirely different in emphasis from those the common listener hears, it is

hard to understand what relevancy their preferences can have.

Another factor is background noise. The level was apparently considerably below normal in the studio, with the effect of widening all bands as compared to what the listener would hear from the same reproducer in his home. Increasing the effect, is the probability that many of the listeners were used to low volume levels at home.

Adding to the uncertainty of the results is the uncertainty of the meaning of constant volume intensity. At narrow band width 60 decibels would have greater intensity in the region of greatest ear sensitivity than would 60 decibels in wide band, hence volume preference would perforce enter into the tonal range choice.

Before submitting to the conclusions of the authors, further study seems called for. The distortion characteristics of the loudspeaker and electrical system should be checked with the double-frequency technique. Also, the possibility of transient distortions is not to be ruled out. It would be instructive, as a last resort, to use some method whereby the original sound, without any electroacoustical system, is compared to the reproduced sound.

Walter van B. Roberts:² This paper appears to be of such possible far-reaching practical importance to the listening public that I feel impelled to question the validity of some of its conclusions, or rather the form in which they are stated. I believe the statements should have been along these lines: "Listeners to our reproducing system prefer . . .," etc. This may appear a trifling criticism because it is obviously the case, but since the paper lays some stress on the purely scientific nature of the investigation reported, it would seem well to be careful not to give the impression of enlarging the conclusions beyond what was actually proved. For example, if the reproducing system used in the experiments had been sufficiently bad, the conclusion might have been that "listeners prefer total silence," a conclusion that surely would require qualification.

Now I do not imply that the equipment used was bad; in fact, I assume that it provided more faithful reproduction than can be expected from home equipment. Hence, the conclusions of the paper may well be a proper guide for the design of current equipment. But I do not feel that there has been a convincing proof

* PROC. I.R.E., vol. 33, pp. 571-581; September, 1945.
¹ 62-12-102 St., Forest Hills, L. I., M. Y.

² Palmer Physical Laboratory, Princeton University, Princeton, N. J.

that listeners prefer any particular change from the original sound except with reference to the particular sound system used.

What sort of a test would I consider suitable for determining the absolute preference of listeners? One instructive experiment would be to engage a good orchestra with first-quality instruments, and put them on a platform behind a light screen, or have the audience blindfolded. The audience would then alternately hear the actual orchestra and recordings thereof. If the audience prefers the real thing to any reproduction but prefers narrow-range reproduction to wide-range, the conclusion would be that the human ear objects to distortions in the high-frequency range that are too small to measure by instruments. In this case the goal of the engineer would still be merely (!) exact reproduction. But it is quite conceivable that the audience would prefer narrow-range reproduction to the real thing, and if this should be the case a disturbingly wide new field would be opened to the profession. Perhaps our future radios and phonographs will be advertised with a real basis in fact to have "new tone quality," etc. Future symphony orchestras may perform behind sound-proof glass on dime-store instruments, the sounds being delivered to the audience through the new reproducing (?) systems as super-Stradivarii tones—or better.

Anyway, I believe it should be emphasized that the conclusions of the paper referred to apply only to comparisons made when using the particular actual sound reproducing system, and cannot be extended to apply to an ideal, or even a considerably improved, system. But I also believe that something could be determined experimentally about absolute preferences, and that such experiments would be very desirable for the purpose of determining whether exact reproduction, or improvement over the original sound, is to be the aim of the engineer.

C. C. Eaglesfield:³ This paper describes listening tests in which a number of people were asked to state which of three tonal ranges they *found the most pleasant*.

They disliked the wide range.

It is evident from the paper that the tests were carried out with scrupulous care and that the listeners knew their own minds; the authors were justified in concluding that, of the three reproductions offered, the listeners disliked the one with the wide tonal range.

But they seem to proceed from the particular to the general, so that in their conclusions we find: "Listeners prefer either a narrow or medium tonal range to a wide one."

This new natural law needs more substantiation. It implies, if true, that nature has been overzealous with her gift of hearing, and that mankind is not thanking her.

We may now expect some inventor to devise, with profit to himself and pleasure to everyone, a new form

³ The Langham, Meyrick Road, Bournemouth, England.

of hearing aid—one which reduces the natural tonal range of the ear.

But surely the more likely explanation of the result of the tests is that there was something about the condition of the reproducing apparatus in the wide tonal range condition that the listeners found objectionable. The authors state that background noise and nonlinear distortion were negligible.

Wide tonal range is not in itself enough; it must be obtained without undue emphasis of some frequencies. The amplitude versus frequency characteristics given in the paper see (Fig. 1) seem tolerably flat, but only such tests as the authors have made can determine what is tolerable. In any case they do not include the loudspeaker, which one would expect to contain many resonances.

The authors do not give a phase-frequency characteristic. It is not usual to do so, but it may be important.

All of these points, and probably others, should be disposed of before we are asked to believe that listeners dislike their own ears.

Bryan Groom:⁴ This article is very interesting, but so completely ignores one very important point that, in my opinion, the conclusions arrived at are completely unsound, or would be were conditions different.

For many years, apart from being director of a number of wire broadcasting systems in this country, I have also been chief engineer, so that my experience in dealing with the public's tastes covers not only a very extended period, but very many thousands of people. It is quite definitely a fact that if people are used to listening to the usual broadcast receiver, which commences to cut off at about 3000 cycles and reproduces practically nothing above 6000 (and in many cases not even as high as this), then they come to suffer from a form of aural drugging, so that any reproduction sounds hard and harsh to them if it reproduces higher frequencies than those mentioned. But it is equally true that if forcible education is carried out gradually, the frequency response being steadily raised over a considerable period of time, listeners do not notice the difference at all, but in the fullness of time find that the kind of reproduction to which they used to listen sounds very flat and muffled, and they very much prefer the clearness and brilliance of the wider range.

Fourteen years ago my companies reproduced broadcast programs to the people in the towns covered by the service with an attenuation similar to that given by broadcast receivers of that day, but now reproduction is flat to over 6000 cycles, within 2 decibels, and is appreciable up to 10,000. I have yet to hear of one of the many thousands of listeners who does not now comment on the much better reproduction available on this system than is available by the use of a broadcast receiver, or of one who has the slightest intention of changing back to that type of reception because he prefers "woolly" reproduction.

⁴ The Hollies, Galashiels, Selkirk, Scotland.

Philip Eisenberg and Howard A. Chinn:⁴ The results of the studies to determine the tonal range preferences of broadcast listeners seem to have surprised and even disturbed some persons. On the other hand, we have received several letters from others congratulating us on having verified their previous convictions. In performing the experiment, it was not our purpose to surprise, to disturb, or to please anyone. We were merely trying to discover the tonal range preferences of the people who listen to the radio. We most certainly did not have an "axe to grind," or a "thesis," as Mr. Massell puts it. Nor were we aware of any experimental or theoretical evidence as to the "ideal" against which comparisons can or should be made. Certainly the "instincts" of engineers, or of anyone for that matter (a concept which psychologists have shown to be mythical), can play no part in such research.

In the interests of clarifying our studies, as well as future research which may be undertaken in this field, we feel it necessary to consider some of the objections and questions raised by Dr. Roberts and Mr. Massell:

1. Both writers imply that there must have been some distortion in our reproducing system. While their reluctance to accept our results is laudatory, since there may have been defects in the experiment, this criticism is not justified. Every possible precaution was taken to insure as near perfect reproduction as it was possible to achieve. It was the kind of system of which engineers approve. To do otherwise would have been foolhardy in view of the time and expense involved in making the study.

In accordance with our usual practice, the performance of the reproducing channel was measured both at the normal operating level and at 10 decibels above normal. At the normal level, the distortion ran only a few tenths of one per cent, and even at the *10 decibel above normal level*, the distortion was less than 0.5 per cent over the frequency range from 200 to 5000 cycles and not more than one per cent at lower and higher frequencies within the pass band. Lacking means for measuring the loudspeaker performance quantitatively we relied upon critical observers—skill in detecting distortion, not in ignoring it! We do not believe that distortion played any part in the outcome of the tests.

On the other hand, Dr. Roberts may be entirely right when he says that the conclusions of the study should be limited to the type of reproducing system that we used. It may very well be that the equipment we used, even though considered excellent by engineers, is not the type that broadcast listeners prefer. If this is so it is not due to distortion, but may be traced to the way the ear responds to changes in loudness level. For this reason, we may continue the study with a reproducing system that is compensated, for the particular reproduction level employed, in accordance with the Fletcher equal-loudness contours. This possibility was recognized before the study was started, but a choice

had to be made to make the initial study in one way or the other.

2. Dr. Roberts' suggestion that an experiment be performed with an actual orchestra has been considered heretofore. In fact, a contemporary proposes to place an acoustical filter between the performers and the auditors and thereby determine the latter's tonal range preference without introducing any intervening reproducing channel. We hope that this experiment can be performed because it would extend our knowledge about tonal range preference. *However*, the results would apply to binaural listening and not to monaural listening, which is common practice for present-day broadcasting, and to which our studies were limited. Likewise, assuming a perfect reproducing channel were available, the results of the experiment proposed by Dr. Roberts would indicate a listener's preference for binaural or for monaural reproduction—not for tonal range. Furthermore, even if listeners prefer wide range binaurally, it does not follow that that will be their preference monaurally.

In addition, Dr. Roberts is not entirely consistent in his criticism and in his suggestion for a new experiment. On the one hand, he proposes that the results of our experiment should be limited perhaps more than is necessary when he states "that the conclusions of the paper . . . (should) apply only to comparisons made when using the particular actual sound reproducing system. . . ." On the other hand, he goes far beyond the limits of our study when he implies that we wished to extend the results "to apply to an ideal, or even a considerably improved system," and when he suggests that "something could be determined experimentally about absolute preferences." We wonder what "absolute preferences" may mean when we recall that every judgment is *relative* to a given situation—the reproducing system (if any is used), the program content, the type of orchestra or performers, the type of listener, the instructions given him, etc.

3. Dr. Roberts, implicitly, and Mr. Massell more directly, also seem to suggest that the ultimate goal of sound reproduction is to capture the original sound faithfully. While only future research may reveal that the capturing of the original sound is the correct goal, at this point in our knowledge we have no right to make such an assumption. Why should we assume that the original sound is the most beautiful when we know that certain instruments, like the trombone, are marred by excessive noise, and certainly many human voices could stand improvement? As Hollywood producers well know, it is possible to improve on nature.

If we wish to reproduce sound like the original, we must recognize that the reproducing system changes the quality of sound. In order to make a monaural system sound like the binaural original (aside from stereophonic possibilities) we must first understand the characteristics of radio as a sound medium. What are its limitations? What are its possibilities? The more knowledge

⁴ Columbia Broadcasting System, New York 22, N. Y.

we have, the more we can control the sound reproduced. It is the purpose of this experiment, and other experiments which we are undertaking, to explore radio as a sound medium in terms of the reactions of listeners. We can learn a lesson from radio producers who have discovered long ago that if they wish to imitate sound effects as they occur in life, they often have to invent new apparatus or devices to obtain the effect, rather than use the original. We are not necessarily proposing that this be done with all sound transmitted over radio. Rather, we are proposing that, aesthetically, we must know the characteristics of radio so that we can produce the sound most pleasant to listeners. We begin with no biases and no prejudgments of what the results will be.

4. With regard to usage as a factor in influencing preferences, we frankly admitted that we had no crucial evidence to ascertain the effect of experience or lack of it on preference. We also feel that, since no one else has such evidence, this question should be kept in abeyance until conclusive evidence is obtained.

However, several points ought to be considered: (a) Since suggestion plays a very significant role in tonal-range preferences, experiments on usage must be more carefully controlled than others, and results interpreted with great caution. (b) We recognize that frequency-modulation listeners, as well as musicians, have not experienced the widest range in reproduced sound. Our only claim is that they were more likely to have had a wider experience than others. Furthermore, we used such selected groups to determine whether narrow range preference was limited to the average listener or whether it was fairly universal. We discovered that it was not limited to the average listener.

Some engineers are disturbed by our findings because it runs contrary to their expectations and to their wishes. They may feel that time, effort, or expense have been wasted in the perfection of high-fidelity sound transmission systems. This, we feel, would be an incorrect interpretation of our results. Scientists always will, and in our opinion should, set perfection as a goal. But what is perfection? Is it the creation of a new device for the reproduction of sound? Or is it reproducing sound *the way people like it*? We do not know the answer to this question, but we propose an attempt to discover the answer. If we learn that it is incorrect to neglect the desires of listeners, then entirely new perspectives are opened to the engineer. We do think that engineers should remove their rose-colored glasses and ascertain for themselves some of the aural likes and dislikes of their fellow beings, and not limit themselves to their "instincts," or to the study of auditory acuity.

Edward Massell:¹ My use of the word "thesis" for "conclusion" was loose and wholly unintended to have the implications it apparently did, and I apologize for it. However, I do maintain my objections to the first conclusion in the original article, that listeners prefer low to high fidelity.

First, since the variation of tonal range was carried out at constant sound intensity level, there was necessarily a simultaneous variation of loudness which probably affected the choices, and the preferences cannot be ascribed solely to tonal range variations.

Second, it is very possible that the preferences are, in many cases, due to reduced distortion resulting from the restriction in range, rather than an actual preference for reproduction with certain frequencies eliminated or reduced. Even if the distortion is limited to a few tenths of one per cent, the probability is great that intermodulation products exist in much greater proportions, sufficient to affect the choices without being detectable by trained listeners. It might be argued that the ultimate cause of the preference is immaterial so long as the listener is pleased by a reduction in frequency range. Nevertheless, if the preference tests are to influence design, it is crucial to know which is the controlling factor, even though the system used may contain the least distortion which it is at present possible to attain.

Third, the tests were carried out at room and system noise levels considerably below those common in the home, so that the conclusions as to choice should be qualified in this respect also.

I think that Messrs. Chinn and Eisenberg have unquestionably contributed substantially by utilizing scientific methods to determine choice, and questioning what had hitherto been assumed. However, I think that the following altogether different theory would still be compatible with their results:

(a) The original sound is, in general, more pleasing than the reproduction.

(b) The most displeasing effect of inexact reproduction is the addition of sounds unpleasant to the ear, e.g., intermodulation products, system noise, relative increase of background noise, etc.

(c) Elimination of or changes in the proportions of the original components detract from the listener's pleasure, but are of comparatively little importance except when noise and distortion are extremely low. Frequency discrimination would be included under this heading. Probably much more important than frequency distortion is the masking of low-loudness sounds at high noise levels.

(d) Usage causes the listener to tend to ignore (b), and to be satisfied despite (c).

The authors say there is no scientific reason for assuming (a), but it seems probable that musical evolution has been largely directed by the exercise of listener preferences, and that monaural preferences are substantially the same as binaural preferences for tonal range, volume, and signal-to-noise ratio. The authors pose the question as to whether the main aim of sound reproduction should not be to reproduce sound the way people like it (as distinguished from the way it originates in the studio), and imply that the results of tests such as they have conducted might be used as the basis for design of systems

with restricted tonal range, or other characteristics found preferred by pluralities in further experiments. With respect to tonal range and sound intensity levels it is obviously fairly easy to satisfy not merely a great part of the listeners, but all of them, by allowing them to make their own choices on individual receivers. I therefore feel that a more productive investigation might be along the lines of checking the importance of intermodulation products to the listener, and also checking preferences for volume compression. On the basis of my own preferences and those of some others, I strongly suspect that the most important consideration in radio listening is ordinarily the intermodulation products, and that these are frequently strong when the receiver is far from overloaded. I also believe that the greatest contribution of increased sound intensity, besides the negative one of masking the noise, is to enable the listener to hear low-loudness components otherwise masked by noise. Since this effect could be achieved by volume compression and low- and high-frequency emphasis, the effect of these variables on choice should be investigated. Because of the widely different characteristics of different pieces of music with regard to variations in sound intensity, frequency range, and sound complexity, a very wide selection of program material is necessary in drawing conclusions.

The main province of the engineer in the field of broadcasting is, I believe, to provide the technical means by which the greatest number of listeners may be pleased at least cost. The job of improving on nature belongs to the artist rather than the engineer, except in development of technical means. Wherever possible, the artistic choice should be in the hands of the listener. Any choice made for him by engineers on the basis of plurality or even majority preferences must be only a temporary one, a compromise based on the present state of the art, or there will result artistic regimentation and technical stagnation.

Walter van B. Roberts:² There appears to be no disagreement between Messrs. Eisenberg and Chinn and myself as to the desirability of determining listener preferences in an unprejudiced manner, regardless of any preconceived ideas. The only question I wished to raise was whether their conclusions were not stated in a manner that, to the average reader, would make them appear more far-reaching than justified by the experiments. I think it should be made clear that the experiments should not be taken to prove that a selective absorption of high frequencies by the atmosphere in a symphony hall would be considered by the audience as constituting an improvement, although this might quite possibly be the case. If such an experiment could be carried out, and if it indicated that the original sound was less pleasing than the modified version, then perhaps engineers should become to some extent artists as well, and strive to produce the best effects with the equipment available, just as a painter does not limit

himself to mere photographic reproduction of a subject including any unpleasant features that may be present. I did not intend to imply that the engineer has no business doing this sort of thing. But at this point I do feel certain misgivings: I am not sure that I would always see eye to eye with the artist regarding his improvements. Therefore, I hope that on my future machine there will be a knob by which I may obtain as nearly as possible the same effect as if I were listening to the original sound in all its stark and possibly unpleasant photographic reality. Perhaps I won't often want to turn this knob, but I would feel better knowing that it was there.

But coming back to the question of immediate practical interest, namely, listeners' preferences with respect to conventional monaural reproducing equipment, I am still sufficiently suspicious to regard the conclusions as proved only for apparatus similar to that used in the test. In particular, I see no a priori reason to agree that a few tenths of a per cent distortion is necessarily negligible, any more than that a similarly small percentage of essence of skunk would be a negligible matter in a flower garden. It may be true; I simply do not know. But the human senses are such surprisingly sensitive devices that it is possible that they unconsciously resent objectionable qualities too minute to show up on meters or to be consciously recognized as "distortion" in the case of sound. Of course, commercial sound equipment is by no means free of distortion so that as previously noted, I have no criticism of the experiments so long as it is understood that they are limited to the exploration of listener preferences as they exist in connection with such radios and phonographs as are now available.

The whole subject is complicated by so many factors, as pointed out by the authors, that it seems to me that it would be just as unscientific to freeze our ideas of listener preferences in accordance with the broadly stated conclusions of the paper, as it would be unbusinesslike to try to force on the public a type of reproduction that is displeasing by actual test on the grounds that it is "high fidelity" according to laboratory instruments.

Philip Eisenberg and Howard A. Chinn:³ We have read with great interest the rebuttals of Dr. Roberts and Mr. Massell, as well as the comments of Messrs. Eaglesfield and Groom. We feel that there is not much point in continuing the discussion on the level of "talk," based largely upon conjecture rather than fact.

We would much rather answer through further experiments. In a short time, we will have completed a new series of experiments which seem to support our original findings. In due course, we shall probably submit for publication a report of these studies and will, of course, welcome criticism.

Meanwhile, we hope that others will also undertake research of this type and that, as a result, the true facts (as contrasted to opinions) will be established.

Contributors to the Proceedings of the I.R.E.



WILLIAM E. BRADLEY

William E. Bradley (SM'45) was graduated from the Moore School of the University of Pennsylvania in 1936, after which he joined the Philco Corporation. He served first as a factory test engineer in the radio-receiver production department, and in 1937 became a research engineer in the Philco television engineering department, where he helped to design wide-band amplifiers for experimental television receivers. In 1940, Mr. Bradley was placed in charge of the advanced-research section of the Philco research division, and in 1945 he became assistant director. He has recently been named director of research of that division.

Mr. Bradley is a member of Tau Beta Pi and Sigma Xi. He is credited with numerous patents and patent applications in the fields of frequency-modulation radio, television, and radar.



JOHN W. MILES

David B. Smith (A'35-SM'44) received the degrees of S.B. and S.M. in electrical engineering from the Massachusetts Institute of Technology in 1933. Joining the Philco Corporation in 1934, he served first as a patent engineer on radio, television, and other applications of electronics, and was later placed in charge of a special advanced-studies group in the research and engineering department.

Mr. Smith was appointed technical consultant to the vice president in charge of engineering in 1938, and promoted to director of research in 1941. In this capacity he directed the fundamental microwave and ultra-high-frequency research that led to the production of many important types of airborne radar used by the Army and Navy. He has recently been appointed vice president in charge of engineering of the Philco Corporation.

Mr. Smith was a member of the original television committee of the Radio Manufacturers Association and chairman of Panel 9 of the National Television System Committee in 1940. In November, 1945, he was named chairman of the new television systems committee of the Radio Manufacturers Association.

A member of Tau Beta Pi, Mr. Smith is now serving as chairman of the Philadelphia Section of the Institute of Radio Engineers. He is credited with a substantial number of patents and patent applications, covering inventions in radio, radar, and television.

John W. Miles was born on December 1, 1920, in Cincinnati, Ohio. He received the B.S. degree in electrical engineering in 1942, the M.S. degree in electrical engineering, the M.S. degree in aeronautical engineering, and the Ph.D. degree in aeronautical engineering, all from the California Institute of Technology.

In the summer of 1942, Dr. Miles was associated with the General Electric research laboratory, and later was a teaching fellow at California Institute of Technology, in Pasadena, California. He was subsequently employed by the Radiation Laboratory at the Massachusetts Institute of Technology, and recently has been on leave of absence from the engineering department of the University of California to participate in Operations Crossroads.

Dr. Miles is a member of the American Institute of Electrical Engineers, Tau Beta Pi, and Sigma Xi.



DAVID B. SMITH

Luke Chia-Liu Yuan (A'40-SM'45) was born at Changtehfu, Honan, China on April 5, 1912. He received the B.S. and the M.S. degrees in physics at Yenching University, Peiping, China, in 1932 and 1934, respectively, and the Ph.D. degree in physics at the California Institute of Technology in 1940. From 1932 to 1934 he was a teaching assistant in physics at Yenching University, and in 1936 was an International House fellow at the University of California. From 1937 to 1940 he was an assistant, and from 1940 to 1942, research fellow in physics at the California Institute of Technology.

Since 1942 Dr. Yuan has been with the RCA Laboratories at Princeton, New Jersey as a research physicist. At present he is also research associate in the physics department, Princeton University. He is a member of American Physical Society and Sigma Xi.



LUKE CHIA-LIU YUAN

Institute News and Radio Notes

Tentative Program Rochester Fall Meeting

NOVEMBER 11, 12, 13, 1946

SHERATON HOTEL, ROCHESTER, N. Y.

Monday, November 11

- "Electronics Transducers," by H. F. Olson, RCA Laboratories
- "Some Canadian Television Aspects," by Gordon W. Olive, Canadian Broadcasting Corporation
- "Television at Bikini," by Donald G. Fink, McGraw-Hill Publishing Company, and Captain Christian L. Engleman, Electronics Coordinating Officer, Operation Crossroads
- "Television Broadcasting as a Public Service," by Raymond F. Guy, National Broadcasting Company
- "Color Television," by Paul H. Reedy, Columbia Broadcasting System
- "Measurement Methods for Ferromagnetic Materials," by Horatio W. Lamson, General Radio Company
- "Death Rays—Are There Such Things?," by A. F. Murray, Consulting Engineer

Tuesday, November 12

- "Television Sound Channel," by R. B. Dome, General Electric Company
- "Report of RMA Data Bureau," by L. C. F. Horle, RMA Data Bureau
- "Some New Tube Developments," by F. E. Gehrke, Sylvania Laboratories.
- Wide-Band Intermediate-Frequency Amplifiers Above 150 Megacycles," by Matthew T. Lebenbaum, Airborne Instruments Laboratory, Inc.
- "A New Frequency-Modulated Signal Generator," by D. M. Hill, Boonton Radio Corporation
- "A Comparison of Amplitude Modulation With Frequency Modulation In Broadcasting," by M. G. Nicholson, Colonial Radio Corporation

Wednesday, November 13

- "Application of Selenium Rectifiers to Receiver Designs," by Harold Heins and T. M. Liimatainen, Sylvania Electric Products, Inc.
- "Report on Television Standards," by D. B. Smith, Philco Corporation
- "Recent Improvements in Television Equipment" (with demonstration), by G. L. Beers, RCA Victor Division
- "Production Design of Magnetic-Wire Recorders," by Roy S. Anderson and George W. Carlson, Stromberg-Carlson Company
- "High-Frequency Amplitude-Modulation Broadcasting Designed for Small-Community Use," by Sarkes Tarizan, A. Valdetaro, and M. Weijdel, Consulting Engineers
- "Recent Developments in Color Photography," by A. L. Terlouw Eastman Kodak Company
- "Measurement Methods for Ferromagnetic Materials," by Horatio W. Lamson, General Radio Company

SUBSCRIPTION PRICES

Effective with the January, 1947, issue of the PROCEEDINGS OF THE I.R.E. AND WAVES AND ELECTRONS, the price of individual nonmember subscriptions will be \$12.00 per year; subscriptions from libraries and colleges, \$9.00 net; subscriptions from agencies, \$9.00 net. In each case, there will be an additional charge of \$1.00 per year for postage to persons and organizations not residing within the United States and Canada.

RMA PARTS SUBCOMMITTEE

The appointment of R. W. Andrews (A'35) as chairman of the parts subcommittee, radio amateur section, of the Radio Manufacturers Association has been announced. He has named W. W. Eitel (A'39), W. B. Swank (A'43), and James Millen (J'24-A'26) as members of the subcommittee. Mr. Andrews, who is active in amateur radio, is merchandising manager for the radio tube division of Sylvania Electric Products, Inc.

The subcommittee has been formed to stimulate interest in the establishment of reference standards, accurate product comparisons, and to encourage the co-operation of parts manufacturers in improved advertising and cataloging for the radio amateur.

Attention, Authors

PAPERS DESIRED FOR 1947 I.R.E.

TECHNICAL MEETING

Outstanding papers on timely subjects are desired for the program of the I.R.E. Technical Meeting scheduled for March 3, 4, 5, and 6, 1947. All of the radio-and-electronic fields should be included if the program is to be truly representative of the interests of the Institute. It will be possible to accept only a limited number of papers for the technical program. In order to receive consideration of your paper, the following rules should be followed:

1. The title and a brief abstract of the paper, similar to the summaries published at the beginning of the articles in the PROCEEDINGS OF THE I.R.E. AND WAVES AND ELECTRONS, but not more than 75 or 80 words in length, should be submitted as soon as possible. No abstracts can be considered, which are received after November 30, 1946.

2. Correspondence should be sent to Professor Ernst Weber, Polytechnic Institute of Brooklyn, 99 Livingston St., Brooklyn 2, New York, marked to the attention of the Papers Committee, 1947 I.R.E. Technical Meeting.

3. The length of the paper should be such that oral presentation can be made within 20 minutes, in order to allow adequate time for general discussion.

4. Authors are responsible for obtaining military clearance where required.

5. Submission of the papers for publication in the PROCEEDINGS OF THE I.R.E. AND WAVES AND ELECTRONS is desired, but is not a necessary requirement for acceptance.

6. Papers published in any journal prior to the date of the Technical Meeting neces-

sarily will be withdrawn from the program.

7. A condensed version or summary of the paper, including the most important illustrations, must be prepared by the authors whose papers are accepted, and must be available by January 1, 1947.

Williamsport Annual Meeting

At the annual meeting of the Williamsport, Pennsylvania, Section of The Institute of Radio Engineers the following officers were elected: Walter C. Freeman, Jr. (A'39-M'44), chairman; Frederick H. Scheer (A'35), vice-chairman; and Sedgwick R. Bennett (A'44-M'45), secretary-treasurer.

Mr. Freeman was graduated from the University of Rochester in 1939 with a B.S. degree in physics. Presently associated with Sylvania Electric Products, Inc., as senior engineer in the electronics division, he was first engaged in the production and design of receiving tubes at the Emporium, Pennsylvania, plant. A member of the American Radio Relay League, Mr. Freeman has been a licensed amateur radio operator since 1930. He has served as vice-chairman of the Emporium Section and as chairman of the Papers and Meetings committee of the Williamsport Section.

Mr. Scheer received his B.S. degree in chemistry in 1923 from Worcester Polytechnic Institute. Formerly affiliated with the William H. Bristol Talking Picture Corporation, the F. W. Sickles Company, the Colonial Radio Corporation, and the Massachusetts plants of the Westinghouse Electric Corporation, he now serves as a project engineer with the Westinghouse's Sunbury, Pennsylvania, plant. Mr. Scheer has served as chairman of the Connecticut Valley and Buffalo-Niagara Sections.

Mr. Bennett, a product engineer with Sylvania Electric Products, Inc., received a B.S. degree in electrical engineering from Pennsylvania State College in 1935. From 1935 to 1937 he was associated with the Sun Gazette Company, and from 1937 to 1943 with the Bell Telephone Company of Pennsylvania.

DELAYS MAY OCCUR—PLEASE WAIT!

It is intended that the PROCEEDINGS OF THE I.R.E. AND WAVES AND ELECTRONS shall reach its readers approximately at the middle of the month of issue. However, present-day printing and transportation conditions are exceptionally difficult. Shortages of labor and materials give rise to corresponding delays. Accordingly, we request the patience of our PROCEEDINGS readers. We suggest further that, in cases of delay in delivery, no query be sent to the Institute unless the issue is at least several weeks late. If numerous premature statements of nondelivery of the PROCEEDINGS were received, the Institute's policy of immediately acknowledging all queries or complaints would lead to severe congestion of correspondence in the office of the Institute.

I.R.E. People

MERITORIOUS CIVILIAN SERVICE AWARDS

Meritorious Civilian Service Awards have recently been presented by the Navy to Naval Research Laboratory staff members Carl M. Russell (A'42), Kenneth M. Watson (A'43), Robert B. Quinn (M'46), Robert L. Ramp (S'41-A'43), Edwin L. Powell (A'14-M'29-SM'43), James O. Spriggs (S'42-A'45), and Harold E. Dinger (A'27-M'43-SM'43) for outstanding service to the Navy.

Mr. Russell, a graduate of the University of Colorado, is a member of the American Institute of Electrical Engineers. Prior to his present affiliation, he was associated with the International General Electric Company until 1941. His citation reads as follows: "For outstanding work in the development of the ASB Airborne Radar Equipment which was extensively used by the Navy in the war in the Pacific."

Mr. Watson was graduated from Iowa State College in 1943, and is a member of the American Physical Society. He was honored "for exceptional work in the theoretical analysis of noise modulation of radar jamming transmitters for maximum effectiveness."

Dr. Quinn received his B.S. degree at the University of Indiana in 1930, and his Ph.D. degree at the University of Chicago in 1941. He is a member of Sigma Xi, the American Physical Society, and the Indiana Academy of Science. Prior to joining the staff of the Naval Research Laboratory, Dr. Quinn, who was a physics instructor in Carleton College, Northfield, Minnesota, received, his citation "for early contributions to the tropicalization of electronic equipment and for your guidance in the development of quartz crystal circuits."

Mr. Ramp received the B.S. degree from the Illinois Institute of Technology, Chicago, in 1941, immediately entering the employ of the Naval Research Laboratory. His citation reads as follows: "For making a major contribution to the development and the construction of the first navy pre-production early-warning receiver and for co-operation and perseverance in obtaining suitable units to fill the urgent needs of the naval forces."

Mr. Powell, a government employee for twenty-five years, was with the Radio Laboratory, Navy Yard, Washington, D. C. from 1918 to 1923, going then to the Naval Research Laboratory, where he remained until 1928, and returning to the Laboratory in 1939. He is a member of the American Radio Relay League and has been inventor or co-inventor of 15 United States patents pertaining to radio and allied arts. He received his citation "for technical development of shipboard radio antenna distribution systems and accessories, which permitted much greater standardization in the manufacture of such equipment as well as flexibility in its use in shipboard and shore installations."

Mr. Spriggs, who is a graduate of the

University of Syracuse, received his citation "for outstanding contributions and radio development work in connection with low-loss radio frequency switches and coaxial line couplings."

Mr. Dinger is a graduate of Akron University, Akron, Ohio, and is a member of the American Radio Relay League. He was a radio engineer with Catterall, Incorporated, in Canton, Ohio, prior to coming to the Naval Research Laboratory. His citation reads as follows: "For efforts in reducing significantly radio noise interference aboard amphibious and landing craft which permitted landing operations against the enemy to be successfully carried out by providing interference-free communications."



George Van

TODOS M. ODARENKO

TODOS M. ODARENKO

Todos M. Odarenko (SM'45) recently received the Distinguished Civilian Service Award from the Secretary of the Navy. The citation reads as follows: "For outstanding service to the United States Navy in the field of electronics during World War II."

"During the war period Mr. Odarenko was employed in the Electronics Division of the Bureau of Ships as technical director of the Radio-Frequency Transmission Lines and Fitting Section. In this capacity he made several outstanding contributions, one of which was the development and production of the new cable dielectric Polyethylene, a material so valuable that it was universally adopted by cable manufacturers producing Army-Navy radio-frequency cables. Mr. Odarenko's vision and foresight in arranging for expansion of cable-producing facilities permitted the production of high-quality radio-frequency cables in quantities at all times sufficient to meet the ever-increasing demands of the war years. It was also through his efforts that a unified joint Army-Navy inspection procedure in cable plants was achieved thereby reducing inspection personnel requirements.

"Mr. Odarenko's expert guidance of his section resulted in the standardization of

the Army-Navy use of approximately 40 cable types in contrast to the 200-odd types which were then in current production. He was instrumental in the formation of the War Committee on Dielectrics, which committee co-ordinated dielectric requirements and specific problems of the various agencies and arranged for investigation by the Laboratory for Insulation Research and other laboratories.

"By his leadership, administrative ability and loyalty to the best interests of the Navy, Mr. Odarenko has conducted himself in a manner deserving of the Navy's highest civilian award."

❖

PIERRE H. BOUCHERON

Captain Pierre H. Boucheron (SM'46), United States Naval Reserve, now director of public relations for Farnsworth Television and Radio Corporation, has been awarded the Legion of Honor, rank of Chevalier, by the French government for distinguished service during the liberation of France. The citation stresses his "outstanding services as communications officer for the commander of American naval forces in France, and the skillful and unflinching support which he devoted to the organization and efficiency of the communications branch of the French navy during the course of combined operations against the common enemy."

A World War I naval-service veteran, Captain Boucheron was called to active duty in 1941 and was sent to establish a communications base in Greenland. In 1943, he became communications officer for the Moroccan Sea Frontier at Casablanca, and the following year he was transferred to the staff of the commander of naval forces in France. He returned to the United States in 1945 to resume his business career with Farnsworth. Formerly associated with the Radio Corporation of America for twenty years, Captain Boucheron held the position of general sales manager for Farnsworth since the corporation's inception in 1939.

❖

MURRAY BRIMBERG

Murray Brimberg (A'37) has been appointed vice-president of Massey Associates, Inc., Washington, D. C. Formerly a radio engineer for RCA Communications, Inc., he later became communications and broadcast engineer with the City of New York Broadcasting System in the operation and design of audio, control, and transmitting systems. Mr. Brimberg then served with the United States Civil Aeronautics Administration where he had charge of the design, procurement, and installation of instrument landing programs for civilian and military airports. He also participated in the establishment programs involving very-high-frequency range systems, very-high-frequency marker, and intermediate-frequency range facilities installed throughout the United States and foreign territories by the CAA

I.R.E. People



C. R. KNIGHT

C. R. KNIGHT

The appointment of C. R. Knight (M'45) as an application engineer of the tube and Ken-Rad divisions of General Electric Company's electronics department at Schenectady, New York, has been announced by O. W. Pike (A'26-M'29-SM'43), engineer of the tube division and responsible for the engineering activities of the Ken-Rad division. Mr. Knight will be among those responsible for application and field engineering on receiving tubes, reporting to E. F. Peterson (M'44), designing engineer of receiver tubes for the department's tube division.

Mr. Knight received his B.S. degree in electrical engineering from the University of Utah and has served with General Electric Company's Schenectady plant in various engineering and sales positions for the past six years.



PHILIPS B. PATTON

Philips B. Patton (A'46) has recently joined the mobile communication staff of the Farnsworth Television and Radio Corporation, Fort Wayne, Indiana.

Mr. Patton began his communications career with the Western Union Telegraph Company in 1931. After serving eleven years in various positions with the company, he joined the Pan American Airways System, and in 1942 became associated with the Federal Communications Commission. He served with the FCC from 1942 to 1944 and again from 1945 to 1946, returning in the intermediary period to Pan American.

While with the FCC, Mr. Patton served with the Board of War Communications on telegraph and telephone operations, the San Francisco field office of the common-carrier division, and in 1946 was appointed acting chief of the radiotelephone and telegraph section of the engineering department of this division.

F. S. HOWES

F. S. Howes (A'37-M'43-SM'43), professor of electrical engineering at McGill University, Montreal, Canada, and consulting radio engineer, has recently been re-elected chairman of the Canadian Council of The Institute of Radio Engineers. H. S. Dawson (A'35-SM'45), chief engineer of the Canadian Association of Broadcasters, Toronto, Canada, was elected vice-chairman.

The Council, consisting of national representatives of the radio engineers of Canada, met in Toronto on June 26 to discuss matters of importance affecting the welfare of the radio engineering profession and laid plans to continue their activities for the coming year. It is the Council's aim to initiate and carry through to completion plans for improvement in the professional welfare of the professional engineer; to assist educators in planning courses in radio and electronics; and to guide students in planning their studies. The Toronto meeting heard reports of committees on professional status, character, papers and meetings, education, and on the activities of the Canadian Council of Professional Engineers and Scientists of which Dr. Howes is also chairman. Because of the tremendous growth of the radio industry and its various branches throughout Canada during the last few years, the radio engineers have played an increasingly important role. These men, responsible for the design and production of over \$5,000,000.00 worth of radio equipment for the armed forces of the United Nations, are now engaged in carrying their industry over to peacetime production.



JAMES L. MIDDLEBROOKS

James L. Middlebrooks (A'46), recently appointed director of engineering for the National Association of Broadcasters in Washington, D. C., has been awarded the Legion of Merit by Secretary of the Navy James Forrestal for his work with the electronics division, Bureau of Ships. The citation reads: "Commander Middlebrooks rendered invaluable service toward the great technical improvement established and maintained in the Naval Communication Service and in other electronic activities through efficient use of new antenna systems, application of modern electronic circuits, and application of commercial techniques. By his leadership, tireless efforts, and devotion to duty throughout, Commander Middlebrooks contributed materially to the successful prosecution of the war and upheld the highest traditions of the United States Naval Service."

A graduate in electrical engineering of Alabama Polytechnic Institute, Mr. Middlebrooks began his career by building the University of Alabama's station WAPI and later was in charge of construction for the Columbia Broadcasting System's general engineering department. After serving for three years in the Navy he joined Field Enterprises, Inc., as engineering director.



MAX W. BURRELL

MAX W. BURRELL

The appointment of Max W. Burrell (A'45) as general sales manager of Collins Radio Company has been announced. He will be in charge of marketing activities, including the New York and Los Angeles offices, and will also retain his duties as assistant secretary.

Mr. Burrell was graduated from the University of Minnesota in 1931. He joined the Collins Company in 1943 as assistant to R. S. Gates (A'45), vice-president in charge of the procurement and marketing division.



LOUIS F. MUNZER, BERNARD HECHT, AND HERBERT SHERMAN

Louis F. Munzer (A'31-M'45), Bernard Hecht (M'45), and Herbert Sherman (S'40-A'41-M'44), graduates of the College of the City of New York, have recently changed their business affiliations.

Mr. Munzer, formerly a Major in the Air Corps, has joined the staff of RCA Communications, Inc., Marion, Massachusetts, as assistant engineer. He holds the degree of electrical engineer.

Mr. Hecht has been promoted from chief engineer to manager of the Quality Control department of the International Resistance Company. He received the B.E.E. degree in 1940. Having served as an engineer with the Army Signal Corps, Mr. Hecht later went on active duty, engaging in the preparation of American War Standards and Joint Army-Navy Specifications on electronic components. He is a member of the Institute of Mathematical Statistics and the American Society for Quality Control.

Mr. Sherman has joined the United States Army Signal Corps as a senior engineer attached to the Philadelphia Signal Corps Procurement District. He was graduated from college with the B.E.E. degree, and has served in the Navy as an electronics officer with the rank of Lieutenant.

I.R.E. People

NEW FARNSWORTH RADIO CENTER

E. A. Nicholas (A'16-SM'46), president of the Farnsworth Television and Radio Corporation, Fort Wayne, Indiana, has announced the near completion of the company's new radio center, designed to provide northeastern Indiana with television, frequency-modulation, and improved regular amplitude-modulation broadcasting services. B. R. Cummings (A'18-M'20-SM'43), vice-president in charge of engineering, is directing the development, installation and technical operation of equipment, while Captain Pierre Boucheron (SM'46), general manager of the Farnsworth broadcast division, will supervise operations of the center.



EDWARD J. CONTENT

GARRARD MOUNTJOY

Garrard Mountjoy (A'37-M'40-SM'43), who has been named president of the Electronic Corporation of America, Brooklyn, New York, will direct the company's engineering research and production and shape

its general policies and merchandising. Formerly vice-president in charge of engineering, Mr. Mountjoy holds numerous patents on radio and television design and, during the war, participated in developmental work on the loran system of navigation.

EDWARD J. CONTENT

Edward J. Content (SM'43) recently established his own business as an acoustical consultant and studio design specialist in Stamford, Connecticut.

Beginning his engineering career in the Signal Corps of the Rainbow Division in World War I, Mr. Content, in 1922, went on to specialize in broadcast engineering. In 1926 he joined WOR where he served as transmitter supervisor until 1930, and as assistant chief engineer until 1945. Mr. Content is responsible for the acoustics in numerous theaters and auditoriums throughout the country, his most recent project being for the United Nations Security Council meetings at Hunter College, New York City.

A member of the Acoustical Society of America and the Society of Motion Picture Engineers, Mr. Content was the 1946 convention chairman for the Institute of Radio Engineers. He also served as group chairman for the Papers Procurement Committee, and as a member of the Papers, Tellers, and New York Program Committees of the Institute.

ADMISSIONS

G. T. Royden, *Chairman*
F. A. Polkinghorne, *Vice-Chairman*

R. D. Avery	T. T. Goldsmith, Jr.
H. H. Beverage	A. R. Hodges
R. M. Bowie	A. R. Morton
J. T. Brothers	H. J. Reich
J. L. Callahan	C. E. Scholz
H. A. Chinn	S. W. Seeley
J. D. Cobine	R. F. Shea
E. D. Cook (W. A. Ford, alternate)	M. E. Strieby
M. G. Crosby	J. C. Stroebel
C. M. Dunning	W. L. Webb
Lloyd Espenschied	F. D. Webster
	G. S. Wickizer
	R. C. G. Williams

AWARDS

E. W. Engstrom, *Chairman*

Ralph Bown	W. B. Lodge
D. E. Harnett	G. T. Royden
Keith Henney	W. C. White

MEMBERSHIP

D. G. Fink, *Chairman*
L. G. Hector, *Vice-Chairman*

C. M. Burrill	L. B. Headrick
J. M. Clayton	Albert Preisman
R. I. Cole	J. L. Reinartz
J. M. Comer, Jr.	Bernard Salzberg
E. D. Cook	R. B. Shanck
W. C. Copp	J. C. Stroebel
W. H. Doherty	Sarkes Tarzian
A. V. Eastman	Bertram Trevor
W. G. Eaton	K. S. Van Dyke
A. J. Ebel	H. M. Wagner
W. N. Eldred	Ernst Weber
Samuel Gubin	R. H. Williamson

(Section Secretaries (*Ex Officio*))

Institute Committees—1946

BOARD OF EDITORS

Alfred N. Goldsmith, *Chairman*

F. W. Albertson	L. C. Marshall
W. L. Barrow	E. D. McArthur
R. R. Batcher	Knox McIlwain
A. E. Bowen	J. W. McRae
Ralph Bown	L. A. Meacham
R. S. Burnap	G. F. Metcalf
O. H. Caldwell	E. L. Nelson
P. S. Carter	D. O. North
L. M. Clement	H. F. Olson
J. D. Cobine	R. M. Page
M. G. Crosby	H. O. Peterson
R. B. Dome	G. W. Pickard
W. G. Dow	R. A. Powers
E. W. Engstrom	Haraden Pratt
W. L. Everitt	C. A. Priest
W. G. H. Finch	John Ragazzini
D. G. Fink	Simon Ramo
H. C. Forbes	H. J. Reich
G. W. Gilman	F. X. Rettenmeyer
P. C. Goldmark	L. N. Ridenour
A. W. Graf	P. C. Sandretto
F. W. Grover	V. W. Sherman
L. B. Headrick	L. C. Smeby
E. W. Herold	C. E. Smith
J. A. Hutcheson	J. A. Stratton
C. M. Jansky, Jr.	W. C. Tinus
J. K. Johnson	E. K. VanTassel
L. F. Jones	E. C. Wente
H. S. Knowles	H. A. Wheeler
J. D. Krause	J. R. Whinnery
F. R. Lack	W. C. White
J. T. Lawson	L. E. Whittemore
D. K. Lippincott	G. W. Willard
D. G. Little	William Wilson
F. B. Llewellyn	Irving Wolff
S. S. Mackeown	C. J. Young
Nathan Marchand	V. K. Zworykin

CONSTITUTION AND LAWS

R. F. Guy, *Chairman*

G. W. Bailey	B. E. Shackelford
I. S. Coggeshall	F. E. Terman
R. A. Heising	H. R. Zeamans

INVESTMENTS

W. C. White, *Chairman*

Fulton Cutting	F. B. Llewellyn
R. A. Heising	Haraden Pratt
	H. M. Turner

EDUCATION

A. B. Bronwell, *Chairman*

R. G. Anthes	Glenn Koehler
W. E. Arcand	R. C. Manhart
R. E. Beam	W. H. Radford
W. H. Campbell	H. J. Reich
C. C. Chambers	J. D. Ryder
J. D. Cobine	W. W. Salisbury
Melville Eastham	E. H. Schulz
G. H. Fett	W. J. Seeley
A. W. Graf	R. P. Siskind
R. F. Guy	Karl Spangenberg
Alan Hazeltine	F. R. Stansel
W. D. Hershberger	W. O. Swinyard
G. B. Hoadley	G. R. Town
L. N. Hollard	Ernst Weber
F. S. Howes	W. C. White
R. W. Jones	Alexander Wing, Jr.
F. H. Kirkpatrick	Irving Wolff
	G. A. Wootton

EXECUTIVE

F. B. Llewellyn, *Chairman*
W. C. White, *Vice-Chairman*
Haraden Pratt, *Secretary*

S. L. Bailey	R. F. Guy
Alfred N. Goldsmith	Keith Henney

NOMINATIONS

S. L. Bailey, *Chairman*

E. J. Content	D. D. Israel
Beverly Dudley	R. C. Poulter
W. L. Everitt	P. F. Siling
	W. C. White

PUBLIC RELATIONS

E. L. Bragdon, *Chairman*

F. W. Albertson	C. M. Jansky, Jr.
G. W. Bailey	(S. L. Bailey, alternate)
R. B. Beetham	E. K. Jett
O. H. Caldwell	T. R. Kennedy, Jr.
A. B. Chamberlain	J. R. Poppele
I. S. Coggeshall	A. F. Van Dyck
O. B. Hanson	E. M. Webster
Keith Henney	Will Whitmore
C. W. Horn	L. P. Wheeler

SECTIONS

W. O. Swinyard, *Chairman*

S. L. Bailey	G. B. Hoadley
E. D. Cook	Earl Kent
A. W. Graf	P. B. Laeser
J. A. Green	L. E. Packard
R. A. Heising	J. E. Shepherd

(Section Chairmen *Ex Officio*)

ANNUAL REVIEW

L. E. Whittemore, *Chairman*

R. S. Burnap	H. C. Gillespie
W. G. Cady	E. A. Guillemain
P. S. Carter	R. F. Guy
I. S. Coggeshall	Keith Henney
M. G. Crosby	E. A. Laport
Eginhard Dietze	W. B. Lodge
B. S. Ellefson	D. E. Noble
D. G. Fink	E. W. Schafer
D. E. Foster	F. E. Terman

C. J. Young

CIRCUITS

E. A. Guillemain, *Chairman*

H. W. Bode	J. M. Miller
Cledo Brunetti	C. A. Nietzert
C. R. Burrows	E. E. Overmier
F. C. Everett	A. F. Pomeroy
W. L. Everitt	J. B. Russell, Jr.
L. A. Kelley	S. W. Seeley
D. E. Maxwell	W. N. Tuttle

ELECTROACOUSTICS

Eginhard Dietze, *Chairman*

P. N. Arnold	F. V. Hunt
B. B. Bauer	A. C. Keller
S. J. Begun	H. S. Knowles
R. H. Bolt	G. M. Nixon
R. K. Cook	Benjamin Olney
J. E. Dickert	H. F. Olson
M. J. Di Toro	R. A. Schlegel
F. L. Hopper	H. H. Scott

E. S. Seeley

PAPERS REVIEW

Murray G. Crosby, *Chairman*

H. A. Affel	H. C. Leuteritz
C. B. Aiken	C. V. Litton
E. W. Allen	H. R. Lubcke
F. J. Bingley	H. F. Mayer
F. T. Bowditch	H. R. Mimno
J. R. Boykin	R. E. Moe
C. W. Carnahan	F. L. Mosely
H. A. Chinn	I. E. Mouromtseff
J. K. Clapp	G. G. Muller
I. S. Coggeshall	A. F. Murray
S. B. Cohn	J. R. Nelson
E. J. Content	K. A. Norton
C. W. Corbett	A. P. G. Peterson
F. W. Cunningham	W. H. Pickering
O. S. Duffendack	A. F. Pomeroy
R. D. Duncan, Jr.	J. D. Reid
R. L. Freeman	W. W. Salisbury
Stanford Goldman	M. W. Scheldorf
W. M. Goodall	S. A. Schelkunoff
G. L. Haller	S. W. Seely
O. B. Hanson	Harner Selvidge
A. E. Harrison	C. M. Slack
T. J. Henry	L. P. Smith
J. V. L. Hogan	E. E. Spitzer
C. N. Hoyler	E. K. Stodola
F. V. Hunt	H. P. Thomas
Harley Iams	Bertram Trevor
D. L. Jaffe	Dayton Ulrey
W. R. Jones	A. P. Upton
D. C. Kalbfell	G. I. Usselman
A. G. Kandoian	K. S. Van Dyke
J. G. Kreer, Jr.	R. M. Wilmotte
Emil Labin	J. W. Wright

H. R. Zeamans

PAPERS PROCUREMENT

D. D. Israel, *General Chairman*
E. T. Dickey, *Vice General Chairman*

G. L. Beers	T. P. Kinn
Howard Benner	C. J. Madsen
W. F. Bonner	H. B. Marvin
R. M. Bowie	Jesse Marsten
A. B. Bronwell	H. D. Middel
S. L. Burgwin	I. E. Mouromtseff
C. T. Burke	J. R. Nelson
R. S. Burnap	H. F. Olson
J. M. Cage	Walter Peck
Madison Cawein	J. D. Reid
J. T. Cimorelli	Walter Richter
I. S. Coggeshall	G. L. Rogers
J. I. Cornell	R. M. Serota
A. C. Crossley	D. B. Sinclair
Harry Diamond	A. M. Skellet
A. M. Glover	H. C. Steiner
V. M. Graham	H. J. Tyzzer
A. E. Harrison	K. S. Van Dyke
R. K. Honaman	M. P. Vore
T. A. Hunter	D. E. Watts
G. F. Jones	W. L. Webb
Martin Katzin	W. C. White

P. D. Zottu

TELLERS

Trevor Clark, *Chairman*

H. A. Chinn	H. M. Lewis
	J. E. Shepherd

Technical Committees

MAY 1, 1946—MAY 1, 1947

ANTENNAS

P. S. Carter, *Chairman*

Andrew Alford	K. A. MacKinnon
W. L. Barrow	D. C. Ports
T. M. Bloomer	M. W. Scheldorf
G. H. Brown	S. A. Schelkunoff
Harry Diamond	(W. E. Kock, alternate)
W. S. Duttera	J. C. Schelleng
Sidney Frankel	George Sinclair
George Grammer	P. H. Smith
R. F. Guy	L. C. Van Atta
W. E. Jackson	(J. E. Eaton, alternate)
R. B. Jacques	J. W. Wright
E. C. Jordan	J. E. Young
Ronald King	

ELECTRON TUBES

R. S. Burnap, *Chairman*

A. Y. Bentley	D. E. Marshall
E. L. Chaffee	J. A. Morton
K. C. DeWalt	I. E. Mouromtseff
W. G. Dow	L. S. Nergaard
A. M. Glover	G. D. O'Neill
J. W. Greer	L. M. Price
L. B. Headrick	H. J. Reich
E. C. Homer	A. C. Rockwood
D. R. Hull	A. L. Samuel
S. B. Ingram	J. R. Steen

C. M. Wheeler

FACSIMILE

C. J. Young, *Chairman*

J. C. Barnes	J. V. L. Hogan
F. R. Brick, Jr.	Pierre Mertz
Henry Burkhard	L. D. Prehn
J. J. Callahan	H. C. Ressler
A. G. Cooley	Arthur Rustad
R. C. Curtis	W. E. Stewart
P. E. Fish	E. F. Watson
C. N. Gillespie	R. J. Wise

HANDBOOK

H. A. Wheeler, *Chairman*

C. T. Burke	Sidney Frankel
R. S. Burnap	Knox McIlwain
J. D. Crawford	Frank Massa
W. H. Crew	F. E. Terman
C. B. DeSoto	B. F. Wheeler
R. L. Dietzold	J. R. Whinnery
D. G. Fink	R. M. Wilmotte

INDUSTRIAL ELECTRONICS

H. C. Gillespie, *Chairman*

W. B. R. Agnew	F. K. Priebe
G. P. Bosomworth	W. C. Rudd
C. A. Ellert	V. W. Sherman
C. W. Frick	Douglas Venable
Otto Glasser	C. H. Warriner
Robert Hampshire	D. E. Watts
T. J. McCarthy	Julius Weinberger
Eugene Mittelmann	T. L. Wilson
H. L. Palmer	P. D. Zottu

FREQUENCY MODULATION

M. G. Crosby, *Chairman*

R. A. Berg
H. S. Black
J. E. Brown
F. L. Burroughs
C. C. Chambers
Paul DeMars
C. W. Finnigan
G. L. Fredendall
W. F. Goetter
A. C. Goodnow
D. D. Grieg
R. F. Guy
D. M. Hill

M. H. Jennings
V. D. Landon
B. D. Laughlin
C. T. McCoy
G. W. Olive
E. M. Ostlund
D. B. Smith
H. M. Stearns
G. R. Town
Bertram Trevor
William Tuller
J. A. Worcester
J. W. Wright

J. E. Young

SYMBOLS

E. W. Schafer, *Chairman*

A. E. Anderson
R. R. Batcher
M. R. Briggs
R. S. Burnap
C. R. Burrows
H. F. Dart
J. H. Dellinger

E. T. Dickey
H. S. Knowles
O. T. Laube
C. A. Nietzert
A. F. Pomeroy
A. L. Samuel
J. R. Steen

H. M. Turner

TELEVISION

I. J. Kaar, *Chairman*

W. F. Bailey
J. E. Brown
F. L. Burroughs
K. A. Chittick
D. G. Fink
D. E. Foster
P. C. Goldmark
R. N. Harmon
A. G. Jensen
R. D. Kell
C. D. Kentner

P. J. Larsen
L. M. Leeds
Leonard Mautner
Jerry Minter
Garrard Mountjoy
J. A. Ouimet
D. W. Pugsley
R. E. Shelby
D. B. Sinclair
D. B. Smith
M. E. Strieby

NAVIGATION AIDS

D. G. Fink, *Chairman*

Henri G. Busignies
P. A. D'Orio
R. C. Ferrar
A. B. Hunt
H. R. Mimno

G. H. Phelps
John Rankin
P. C. Sandretto
Ben Thompson
R. R. Welsh

PIEZOELECTRIC CRYSTALS

W. G. Cady, *Chairman*

C. F. Baldwin
F. A. Barrow
W. L. Bond
J. K. Clapp
Clifford Frondel
Paul Gerber

E. W. Johnson
W. P. Mason
P. L. Smith
R. A. Sykes
K. S. Van Dyke
Sidney Warner

J. M. Wolfskill

RADIO RECEIVERS

W. O. Swinyard, *Chairman*

G. L. Beers
J. E. Brown
W. L. Carlson
W. F. Cotter
L. F. Curtis
W. L. Dunn
H. C. Forbes
D. E. Foster
C. J. Franks
A. R. Hodges

J. K. Johnson
C. R. Miner
Garrard Mountjoy
H. O. Peterson
J. M. Pettit
F. H. R. Pounsett
John Reid
R. F. Shea
R. M. Wilmotte
C. F. Wolcott

RADIO TRANSMITTERS

E. A. Laport, *Chairman*

M. R. Briggs
Clede Brunetti
H. R. Butler
Harry Diamond
F. A. Gunther
W. E. Jackson
L. A. Looney

W. W. Lindsay
C. H. Meyer
J. F. Morrison
R. L. Roblins
J. C. Schelleng
Robert Serrell
I. R. Weir

J. E. Young

RADIO WAVE PROPAGATION
AND UTILIZATIONJ. A. Stratton, *Chairman*

S. L. Bailey
C. R. Burrows
T. J. Carroll
A. E. Cullum
W. S. Duttera
D. E. Kerr

H. O. Peterson
J. A. Pierce
S. A. Schelkunoff
George Sinclair
R. L. Smith-Rose
H. M. Wells

J. W. Wright

RAILROAD AND VEHICULAR

COMMUNICATION

D. E. Noble, *Chairman*

A. E. Abel
George Brown
T. G. M. Brown
Frederick Budelman
W. T. Cooke
W. A. Harris

P. R. Kendall
C. N. Kimball, Jr.
G. H. Phelps
F. M. Ryan
Winfield Salisbury
Frank Walker

RESEARCH

F. E. Terman, *Chairman*

W. L. Barrow
Fred Bowditch
R. M. Bowie
E. W. Engstrom
W. L. Everitt

D. G. Fink
H. T. Friis
A. F. Van Dyck
L. C. Van Atta
Julius Weinberger

STANDARDS

R. F. Guy, *Chairman*

R. S. Burnap
W. G. Cady
P. S. Carter
A. B. Chamberlain
I. S. Coggeshall
M. G. Crosby
Eginhard Dietze
D. G. Fink
D. E. Foster
H. C. Gillespie
V. M. Graham
E. A. Guillemin

Keith Henney
L. C. F. Horle
E. A. Laport
Knox McIlwain
D. E. Noble
E. W. Schafer
H. L. Spencer
F. E. Terman
H. M. Turner
H. A. Wheeler
L. E. Whittemore
C. J. Young

Institute Representatives on Other Bodies—1946

American Documentation Institute: J. H. Dellinger
ASA Standards Council: Alfred N. Goldsmith (R. F. Guy, alternate)
ASA Sectional Committee on Letter Symbols and Abbreviations for Science and Engineering: H. M. Turner
ASA Subcommittee on Letter Symbols for Radio Use: H. M. Turner
ASA Sectional Committee on National Electrical Safety Code, Subcommittee on Article 810, Radio Broadcast Reception Equipment: E. T. Dickey (Virgil M. Graham, alternate)
ASA Sectional Committee on Preferred Numbers: A. F. Van Dyck
ASA Sectional Committee on Radio: Alfred N. Goldsmith, chairman; Haraden Pratt, and L. E. Whittemore
ASA Sectional Committee on Radio-Electrical Co-ordination: J. V. L. Hogan, C. M. Jansky, Jr., and L. E. Whittemore
ASA Board of Directors: F. R. Lack
ASA Electrical Standards Committee: H. M. Turner (H. P. Westman, alternate)
ASA Sectional Committee on Acoustical Measurements and Terminology: Eginhard Dietze, R. B. Jacques, and H. F. Olson
ASA Sectional Committee on Definitions of Electrical Terms: Haraden Pratt
ASA Subcommittee on Vacuum Tubes: B. E. Shackelford
ASA Sectional Committee on Electric and Magnetic Magnitudes and Units: J. H. Dellinger
ASA Sectional Committee on Electrical Installations on Shipboard: I. F. Byrnes
ASA Sectional Committee on Electrical Measuring Instruments: Wilson Aull, Jr.
ASA Sectional Committee on Graphical Symbols and Abbreviations for Use on Drawings: Austin Bailey (H. P. Westman, alternate)

ASA Subcommittee on Communication Symbols: H. M. Turner
ASA Sectional Committee on Specifications for Dry Cells and Batteries: H. M. Turner
ASA Sectional Committee on Standards for Drawings and Drafting Room Practices: Austin Bailey (H. P. Westman, alternate)
ASA Committee on Vacuum Tubes for Industrial Purposes: B. E. Shackelford
ASA War Committee on Radio: Alfred N. Goldsmith*
ASA War Standards Committee on Methods of Measuring Radio Noise: C. J. Franks and Garrard Mountjoy
Council of the American Association for the Advancement of Science: J. C. Jensen
Joint Co-ordination Committee on Radio Reception of the E.E.I., N.E.M.A., and R.M.A.: C. E. Brigham
National Research Council, Division of Engineering and Research: F. E. Terman
Radio Technical Planning Board: W. L. Barrow (D. B. Sinclair, alternate)
U. R. S. I. (International Scientific Radio Union) Executive Committee: C. M. Jansky, Jr.
U. S. National Committee, Advisers on Electrical Measuring Instruments: Melville Eastham and H. L. Olesen
U. S. National Committee, Advisers on Symbols: L. E. Whittemore and J. W. Horton
U. S. National Committee of the International Electrotechnical Commission: H. M. Turner

* Also chairman of its Subcommittee on Insulating Material Specifications for the Military Services.

Institute Representatives in Colleges—1946

Alabama Polytechnic Institute: Appointment Later
 Alberta, University of: J. W. Porteous
 Arkansas, University of: Appointment Later

British Columbia, University of: H. J. MacLeod
 Brooklyn, Polytechnical Institute of: G. B. Hoadley

California Institute of Technology: S. S. Mackeown
 California, University of: L. J. Black
 Carleton College: Appointment Later
 Carnegie Institute of Technology: E. M. Williams
 Case School of Applied Science: P. L. Hoover
 Cincinnati, University of: W. C. Osterbrock
 Colorado, University of: Appointment Later
 Columbia University: J. R. Raggazzini
 Connecticut, University of: F. P. Fischer
 Cooper Union: J. B. Sherman
 Cornell University: True McLean

Detroit, University of: Appointment Later
 Drexel Institute of Technology: Appointment Later
 Duke University: W. J. Seeley

Florida, University of: P. H. Craig

Georgia School of Technology: M. A. Honnell

Harvard University: E. L. Chaffee

Idaho, University of: H. E. Hatstrup
 Illinois Institute of Technology: C. S. Roys
 Illinois, University of: E. C. Jordan
 Iowa, State University of: L. A. Ware

Johns Hopkins University: Ferdinand Hamburger, Jr.

Kansas State College: Karl Martin
 Kansas, University of: G. A. Richardson

Lawrence Institute of Technology: H. L. Byerlay
 Lehigh University: D. E. Mode
 Louisiana State University: W. E. Owen

Maine, University of: W. J. Creamer, Jr.
 Manhattan College: E. N. Lurch
 Maryland, University of: G. L. Davis
 Massachusetts Institute of Technology: E. A. Guillemin and W. H. Radford
 McGill University: F. S. Howes
 Michigan State: J. A. Strelzoff
 Michigan, University of: L. N. Holland
 Minnesota, University of: O. A. Becklund
 Missouri, University of: D. L. Waidelich

Nebraska, University of: F. W. Norris
 Newark College of Engineering: Solomon Fishman
 New Mexico: University of: H. L. Jones
 New York, College of the City of: Harold Wolf
 New York University: Philip Greenstein
 North Carolina State College: W. S. Carley
 North Dakota, University of: C. W. Rook
 Northeastern University: G. E. Pihl
 Northwestern University: R. E. Beam
 Notre Dame, University of: H. E. Ellithorn

Ohio State University: E. M. Boone
 Oklahoma Agriculture and Mechanical College: H. T. Fristoe
 Oregon State College: A. L. Albert

Pennsylvania State College: G. L. Crossley
 Pennsylvania, University of: C. C. Chambers
 Pittsburgh, University of: L. E. Williams
 Princeton University: J. G. Barry
 Purdue University: R. P. Siskind

Queen's University: H. H. Stewart

Rensselaer Polytechnic Institute: H. D. Harris
 Rice Institute: M. V. McEnany
 Rose Polytechnic Institute: Appointment Later
 Rutgers University: J. L. Potter

Southern Methodist University: H. J. Smith
 Stanford University: Karl Spangenberg
 Stevens Institute of Technology: F. C. Stockwell

Texas, University of: E. W. Hamlin
 Toronto, University of: R. G. Anthes
 Tufts College: A. H. Howell

Union College: F. W. Grover
 United States Military Academy: P. M. Honnell
 United States Naval Academy: G. R. Giet
 Utah, University of: O. C. Haycock

Virginia, University of: L. R. Quarles
 Virginia Polytechnic Institute: R. R. Wright

Washington, University of: A. V. Eastman
 Washington University: Stanley Van Wanbeck
 Wayne University: G. W. Carter
 Western Ontario, University of: G. A. Woonton
 West Virginia University: R. G. Colwell
 Wisconsin, University of: Glenn Koehler
 Worcester Polytechnic Institute: H. H. Newell

Yale University: H. M. Turner

PHILIPS RESEARCH REPORTS

A new scientific journal covering theoretical and experimental research in physics, chemistry, and other fields, edited by the Research Laboratory staff of N. V. Philips Gloeilampenfabrieken, Eindhoven, Holland, has been announced by O. S. Duffendack (SM'44), president of Philips Laboratories, Inc. Subscription orders will be handled by Elsevier Publishing Company, New York, and the yearly subscription price for six issues is \$5.00 including postage.

The first volume contains papers on the theory of elastic aftereffect and diffusion of carbon in alpha iron; the current to a positive grid in electron tubes (in two parts); the theory of the stability of lyophobic colloids; and the ratio between the horizontal and vertical electrical field of a vertical antenna of infinitesimal length. The intro-

duction reads in part as follows: "During the period of German occupation, scientific research was continued in our laboratories as far as lay in our power although, for obvious reasons, some of the research had to be interrupted temporarily. In order to present in a suitable form the results of our research work to research workers in other countries, we have decided to publish a new periodical in the English language, entitled *Philips Research Reports*. We hope that it will not be long before our laboratories in other countries will be able to publish the results of their research in *Philips Research Reports* also, so that the new periodical will present a picture of Philips' total research activities."

Among the articles to appear in subse-

quent issues are scale glass as a substitute for mica; radiation resistance of an antenna with arbitrary current distribution; the problem of optimum current distribution in antennas; network synthesis, especially the synthesis of resistanceless four-terminal networks; extension and application of Langmuir's calculations for a plane diode with a Maxwellian distribution of the electrons; extension of Langmuir's tables for a plane diode with a Maxwellian distribution of the electrons; an improved method for coupling tubes at ultra-short waves; the error in the determination of the median plane of a radio beacon in a tilted airplane; contraction phenomenon in a glow discharge with molybdenum cathode; and the normal cathode fall for molybdenum and zirconium in the noble gases.

Books

Design of Crystal Vibrating Systems, by William J. Fry, John M. Taylor, and Bertha W. Henvis

Published (1945) by the Naval Research Laboratory, Office of Research and Inventions, Sound Division. 176 pages+vii pages. 141 illustrations. 9½×11 inches. Free on request.

The recent declassification of this book from its earlier confidential status makes a very extensive collection of computational material which was done under the stress of wartime need now available to a wider group of workers in the rapidly developing field of ultrasonics. The arrangement of the material is such as to make it most conveniently useful to the specialist in detailed design problems, but on the other hand it offers considerable problems of orientation to the uninitiated before he can make direct use of it.

In a small portion of the book called Part II, there are developed the fundamental equations for the vibration of a piezoelectric-crystal element, for the electrical and its acoustical impedance which it presents to the two media which it connects as a transducer, for the condition for resonance of the element with various mechanical loading components, and for its sensitivity as an acoustic receiver, and also formulas for stress in the vibrator, this latter with the problem of energy losses in glue joints between the crystal and the loading or mounting elements particularly in mind. Expanding of Part II, placing it ahead of Part I and giving greater attention to the orientation of the reader and to the explanation of the specific relation of curves to equations, would, in the view of the reviewer, provide a reference work of considerably greater convenience in use.

The greater portion of the book, about six sevenths of the whole, designated as Part I, consists of charts for the calculation of practicable transducer systems from the formulas of Part II. In addition to tables which list for reference the appropriate physical constants of the various materials which are commonly used in transducer design, such as metals, glass, crystals, liquids, and air, there are shown families of curves of convenient functions of these properties and of dimensions and frequency as they appear in the theoretical formulas. Curves are plotted for many values of the several variables to permit of easy interpolation, and are for the most part full-page graphs.

Of the 176 pages, about 30 are of textual material and of these about half are devoted to formulas. The ready use of the thirteen tables which make up the equivalent of about six pages would be greatly facilitated if a list of tables were provided. The book is of the multiring type and is divided into fourteen sections by protruding tabs, each bearing the section number.

KARL S. VAN DYKE
Wesleyan University
Middletown, Conn.

SECTIONS

Chairman		Secretary
	ATLANTA October 15	M. S. Alexander 2289 Memorial Dr., S.E. Atlanta, Ga.
H. L. Spencer Associated Consultants 18 E. Lexington Baltimore 2, Md.	BALTIMORE	G. P. Houston, 3rd 3000 Manhattan Ave. Baltimore 15, Md.
Glenn Browning Browning Laboratories 750 Main St. Winchester, Mass	BOSTON	A. G. Bouquet General Radio Co. 275 Massachusetts Ave. Cambridge 39, Mass.
I. C. Grant San Martin 379 Buenos Aires, Argentina	BUENOS AIRES	Raymond Hastings San Martin 379 Buenos Aires, Argentina
H. W. Staderman 264 Loring Ave. Buffalo, N. Y.	BUFFALO-NIAGARA October 16	J. F. Myers Colonial Radio Corp. 1280 Main St. Buffalo 9, N. Y.
T. A. Hunter Collins Radio Co. 855-35 St., N.E. Cedar Rapids, Iowa	CEDAR RAPIDS	R. S. Conrad Collins Radio Co. 855-35 St., N.E. Cedar Rapids, Iowa
A. W. Graf 135 S. La Salle St. Chicago 3, Ill.	CHICAGO October 18	D. G. Haines Hytron Radio and Electronic Corp. 4000 W. North Ave. Chicago 39, Ill.
J. D. Reid Box 67 Cincinnati 31, Ohio	CINCINNATI October 15	P. J. Konkle 5524 Hamilton Ave. Cincinnati 24, Ohio
H. C. Williams 2636 Milton Rd. University Heights Cleveland 21, Ohio	CLEVELAND October 24	A. J. Kres 16911 Valleyview Ave. Cleveland 11, Ohio
E. M. Boone Ohio State University Columbus, Ohio	COLUMBUS November 8	C. J. Emmons 158 E. Como Ave. Columbus 2, Ohio
Dale Pollack 352 Pequot Ave. New London, Conn.	CONNECTICUT VALLEY October 17	R. F. Blackburn 62 Salem Rd. Manchester, Conn.
R. M. Flynn KRLD Dallas 1, Texas	DALLAS-Ft. WORTH	J. G. Rountree 4333 Southwestern Blvd. Dallas 5, Texas
J. E. Keto Aircraft Radio Laboratory Wright Field Dayton, Ohio	DAYTON October 17	Joseph General 411 E. Bruce Ave. Dayton 5, Ohio
H. E. Kranz International Detrola Corp. 1501 Beard Ave. Detroit 9, Mich.	DETROIT October 18	A. Friedenthal 5396 Oregon Detroit 4, Mich.
N. L. Kiser Sylvania Electric Products, Inc. Emporium, Pa.	EMPORIUM	D. J. Knowles Sylvania Electric Products, Inc. Emporium, Pa.
E. M. Dupree 1702 Main Houston, Texas	HOUSTON	L. G. Cowles Box 425 Bellaire, Texas
H. I. Metz Civil Aeronautics Authority Experimental Station Indianapolis, Ind.	INDIANAPOLIS	Max G. Beier 3930 Guilford Ave. Indianapolis 5, Ind.
R. N. White 4800 Jefferson St. Kansas City, Mo.	KANSAS CITY	Mrs. G. L. Curtis 6003 El Monte Mission, Kansas
B. S. Graham Sparton of Canada, Ltd. London, Ont., Canada	LONDON, ONTARIO	C. H. Langford Langford Radio Co. 246 Dundas St. London, Ont., Canada
Frederick Ireland 950 N. Highland Ave. Hollywood 38, Calif.	LOS ANGELES October 15	Walter Kenworth 1427 Lafayette St. San Gabriel, Calif.

Chairman

L. W. Butler
3019 N. 90 St.
Milwaukee 13, Wis.

J. C. R. Punchard
Northern Electric Co.
1261 Shearer St.
Montreal 22, Que., Canada

J. T. Cimorelli
RCA Victor Division
415 S. Fifth St.
Harrison, N. J.

L. R. Quarles
University of Virginia
Charlottesville, Va.

D. W. R. McKinley
211 Cobourg St.
Ottawa, Ont., Canada

Samuel Gubin
4417 Pine St.
Philadelphia 4, Pa.

W. E. Shoupp
911 S. Braddock Ave.
Wilkesburg, Pa.

C. W. Lund
Rt. 4, Box 858
Portland, Ore.

A. E. Newlon
Stromberg-Carlson Co.
Rochester 3, N. Y.

S. H. Van Wambeek
Washington University
St. Louis 5, Mo.

David Kalbfell
941 Rosecrans Blvd.
San Diego 6, Calif.

R. V. Howard
Mark Hopkins Hotel
San Francisco, Calif.

E. H. Smith
823 E. 78 St.
Seattle 5, Wash.

H. S. Dawson
Canadian Association of
Broadcasters
80 Richmond St., W.
Toronto, Ont., Canada

M. E. Knox
43-44 Ave., S.
Minneapolis, Minn.

F. W. Albertson
Room 1111, Munsey Bldg.
Washington 4, D. C.

W. C. Freeman, Jr.
2018 Reed St.
Williamsport 39, Pa.

MILWAUKEE

MONTREAL, QUEBEC
November 13NEW YORK
November 6

NORTH CAROLINA-VIRGINIA

OTTAWA, ONTARIO
October 17PHILADELPHIA
November 7PITTSBURGH
November 11

PORTLAND

ROCHESTER
October 17

ST. LOUIS

SAN DIEGO
November 5

SAN FRANCISCO

SEATTLE
November 14

TORONTO, ONTARIO

TWIN CITIES

WASHINGTON
November 11WILLIAMSPORT
November 6**SUBSECTIONS**MONMOUTH
(New York Subsection)PRINCETON
(Philadelphia Subsection)SOUTH BEND
(Chicago Subsection)
October 17WINNIPEG
(Toronto Subsection)

K. G. Jansky
Bell Telephone Laboratories,
Inc.
Box 107
Red Bank, N. J.

C. W. Mueller
RCA Laboratories
Princeton, N. J.

H. E. Ellithorn
417 Parkovash Ave.
South Bend 17, Ind.

W. A. Cole
323 Broadway Ave.
Winnipeg, Manit., Canada

Secretary

E. T. Sherwood
9157 N. Tennyson Dr.
Milwaukee, Wis.

E. S. Watters
Canadian Broadcasting Corp.
1440 St. Catherine St., W.
Montreal 25, Que., Canada

J. R. Ragazzini
Columbia University
New York 27, N. Y.

J. T. Orth
4101 Fort Ave.
Lynchburg, Va.

W. A. Caton
132 Faraday St.
Ottawa, Ont., Canada

A. N. Curtiss
RCA Victor Division
Bldg. 8-9
Camden, N. J.

C. W. Gilbert
52 Hathaway Ct.
Pittsburgh 21, Pa.

L. C. White
3236 N.E. 63 Ave.
Portland 13, Ore.

K. J. Gardner
111 East Ave.
Rochester 4, N. Y.

N. J. Zehr
1538 Bradford Ave.
St. Louis 14, Mo.

Clyde Tirrell
U. S. Navy Electronics Labo-
ratory
San Diego 52, Calif.

Lester Reukema
2319 Oregon St.
Berkeley, Calif.

W. R. Hill
University of Washington
Seattle 5, Wash.

C. J. Bridgland
Canadian National Telegraph
347 Bay St.
Toronto, Ont., Canada

Paul Thompson
Telex Incorporated
1633 Eustis Ave.
St. Paul, Minn.

G. P. Adair
Federal Communications
Commission
Washington 4, D. C.

S. R. Bennett
Sylvania Electric Products,
Inc.
Plant No. 1
Williamsport, Pa.

A. V. Bedford
RCA Laboratories
Princeton, N. J.

J. E. Willson
WHOT
St. Joseph and Monroe Sts.
South Bend, Ind.

C. E. Trembley
Canadian Marconi Co.
Winnipeg, Manit., Canada

Books**Electron and Nuclear Counters,
Theory and Use, by Serge A.
Korff**

Published (1946) by D. Van Nostrand Company, Inc., 250 Fourth Avenue, New York, N. Y. 212 pages+6-page index+xi pages. 69 illustrations. 5½×8½ inches. Price, \$3.00.

The author has succeeded in covering the subject of nuclear and electronic counters and associated circuits at an intermediate level easily understood by graduate students of physics or electronics and by practicing electronics engineers. Counters are gas-filled chambers which are so connected that they can detect and count passages of charged particles, ionizing particles, or radiation. Among the particles which can trigger a counter are alpha and beta particles, fast and slow neutrons, and cosmic rays.

The electronic theory of such chambers in the low-voltage or ionization-chamber region, the medium-voltage or proportional region, and the high-voltage or Geiger region is fully discussed. On the practical side, the physical construction, operating techniques, and probable errors are covered. Good descriptions of the associated electron circuits such as quenching, triggering, scaling, amplifying, recording, and power-supply circuits are well described. It is this section in particular which is of interest to electronics engineers, because the circuits discussed may be used in other applications such as pulse generators, triggering circuits, relay circuits, and similar systems. Many of the circuits used in radar control systems were developed for counters originally. The book is well documented with up-to-date references and the writing style is excellent and easily readable, though it is by no means elementary.

While counters are used primarily by physicists, various applications are quoted by the author which indicate a considerable field of use in industry and medicine. Because of this and the numerous other uses to which the electronic circuits for counters may be put, electronics engineers will profit by reading this book.

JOHN R. RAGAZZINI
Columbia University
New York 27, N. Y.

Electronic Equipment and Accessories, by R. C. Walker

Published (1945) by Chemical Publishing Company, Inc., 26 Court Street, Brooklyn, N. Y. 383 pages+10-page index+viii pages. 343 illustrations. 5½×8½ inches. Price, \$6.00.

This book was apparently written in Great Britain and published in the United States. It provides an introduction to the subject of electronics for those students, mechanics, and practical engineers who have at least an elementary knowledge of electricity and magnetism. The book is

Books

not written for specialists in the use or design of electronic apparatus. Its scope is limited to electronics outside the field of telecommunication.

The first chapters treat the fundamental characteristics of thermionic tubes and the amplification of steady and low-frequency voltages. Applications of vacuum and gas-filled tubes to electrical measurements, impulse recording, relays, and switching controls are discussed and illustrated.

Three chapters are devoted to light-sensitive devices and their application to the measurement of illumination.

The fundamental principles of cathode-ray tubes are covered in one chapter. Another chapter is devoted to the application of cathode-ray tubes to electrical measurements such as the phase angle between two alternating voltages, frequency comparison, time bases, pressure, and the observation of receiver characteristics.

A short chapter reviews miscellaneous electronic devices such as grid glow tubes, glow gap dividers, magic eyes, and pointalite tubes.

In the last three chapters of the book consideration is given to small switchgear and delayed-action devices, impulse recording or counting, and miscellaneous circuit accessories.

The most serious shortcoming of the book is the fact that the terminology and symbols employed conform to British standards and in several instances may be confusing to the American reader.

The book is written in a simple, easily read manner and is illustrated by a wealth of circuit diagrams and photographs. It should be particularly valuable to electrical engineers, mechanics, and students who desire a general knowledge of electronic devices and their applications.

G. L. BEERS
RCA Victor Division
Camden, N. J.

Television Simplified, by Milton S. Kiver

Published (1946) by D. Van Nostrand Company, Inc., 250 Fourth Ave., New York, N. Y. 369 pages+5-page index+vii pages. 222 illustrations. 5½×8½ inches. Price, \$4.75.

As the television audience grows, so will grow the demand for books that take those now technically informed on radio broadcast reception into the field of television reception. "Television Simplified" is such a book; written for—and recommended to—future television-receiver owners, broadcasters, radio workers, and servicemen. The television engineer will find nothing new.

The accent is on television reception, so transmission is described only sufficiently to give the reader an understanding of the entire system. In contrast is the thoroughgoing exposition of each of the many parts that comprise the typical television receiver—from antenna to picture tube. To illustrate the manner of subdivision, these are some of the chapter headings: Ultra-High-Frequency Waves and the Television Antenna; Wide-Band Tuning Circuits—Radio-Frequency Amplifiers; High-Frequency Oscillators, Mixer and Intermediate-Frequency Amplifier; Diode Detectors and Automatic-Gain-Control Circuits; Video Amplifiers; Cathode-Ray Tubes; Synchronizing Circuits; A Typical Television Receiver—Analysis and Alignment; Color Television; Frequency Modulation; Servicing Television Receivers.

The plan followed by the author is to state early in each chapter the purpose of the portion of the receiver discussed and from here lead the reader through the usual, accepted forms of circuits. The information is basic, free from obsolete or extraneous material and on the whole technically accurate. The book is nonmathematical and the illustrations are clear and numerous.

Written apparently early in 1946 it can be called up to date, although recent developments such as the image orthicon, automatic-frequency-control synchronization, aluminized picture-tube screens, and late color-television developments are missing.

To live up to the title of the book it was necessary for the author to digest the technical facts concerning each portion of the receiver, then, with due regard for relative importance, produce a clear explanation in a simplified manner for the semitechnical reader. In this Mr. Kiver has done an excellent job.

ALBERT F. MURRAY
Consulting Television Engineer
Washington, D. C.

I.R.E. Publication Problems and Author Co-operation

Shortly after the cessation of hostilities, The Institute of Radio Engineers received many excellent papers which it wished to publish as speedily as possible. The situation had been prudently anticipated by the Board of Directors, and in 1945 they earmarked a fund of \$20,000 for postwar publication. At the costs prevailing at that time, it was thought that this fund would enable the publication of between 900 and 1000 extra pages of technical material in the PROCEEDINGS OF THE I.R.E. AND WAVES AND ELECTRONS. Sharply rising costs, however, completely negated this plan, and it has become regrettably necessary to apply the

entire fund solely to keeping the PROCEEDINGS OF THE I.R.E. AND WAVES AND ELECTRONS at its present augmented size. Thus, no further increase in number of published pages will be possible under present conditions.

As pointed out, printing costs rose far beyond expectations. According to Mr. Harry West, managing director of the American Book Publishers Council, who addressed the American Booksellers Association on May 13, during their annual convention, "In 1941 the cost of composition was \$.902 per thousand ems. As of April this year it was \$1.425, an increase of 58 per cent. Electrotyping in 1941 cost \$.029 per square inch. It now costs \$.043 per square inch, an increase of 49 per cent. Printing a 320-page book in units of 10,000 copies cost \$.045 in 1941; it now costs \$.063, an increase of 40 per cent. Binding 10,000 copies of a book of the same page length cost \$.097 in 1941 and it now costs \$.153, an increase of 58 per cent. The increases in the cost of composition, printing, and binding books of lesser or greater length are approximately proportionate."

It had also been anticipated that after the war paper would become more readily available. Instead, paper is even more scarce than during wartime. Paper stocks are low, prices high, and in many cases, smaller customers are cut off completely.

Because of this situation and in view of the large number of meritorious papers on hand, paper shortages, and rising printing costs, it became necessary for the Editorial Department, as an equitable procedure, to request authors to submit their manuscripts in the briefest possible form. In many cases, papers which already had been accepted for publication were regrettably returned to the authors with the request that they be shortened in some cases as much as sixty per cent.

The Editorial Department finds it regrettable and distasteful to be forced to return otherwise acceptable papers to their authors for considerable condensation and, thereafter, somewhat delayed publication. But the Department must function within the physical and financial conditions imposed on it by present circumstances. In justice to our authors, any one of them may, as long as present conditions prevail, withdraw his paper from consideration for publication by the Institute if he believes that more prompt publication is elsewhere obtainable.

The Editorial Department has been particularly gratified by the co-operation and friendly response of our authors in acceding to the requests for shortening of papers and accepting with a good and understanding spirit the fact that publication, even in the cases of condensed papers, must inevitably be delayed for some months.

Waves and Electrons Section

Engineering education is a matter of major interest to the members of The Institute of Radio Engineers. Studies of educational problems and projects have appeared in these PROCEEDINGS, and the Institute has established an active Committee on Education. Accordingly the Institute membership will read with interest a basic study of one factor involved in successful engineering education, as presented by the Chief Engineer of the Hazeltine Electronics Corporation.—*The Editor.*

A Gap in Engineering Education

A. V. LOUGHREN

To the members of the Institute, the subject of engineering education seems to be of continuing interest. The contributions on this subject by outstanding engineers and educators which have appeared in the PROCEEDINGS in recent years testify to this interest.

One objective of a complete engineering education should be the developing in the engineer of an understanding of the economic basis of his profession. Whether this understanding can be developed during the man's formal schooling I do not know; perhaps it must be sought subsequently, as the man's experiences broaden his view sufficiently.

From the engineer's personal standpoint, this understanding is important. In personal terms, it becomes the answer to the question, "Why does an engineer get paid?" One who seeks to get paid better should first know why he is paid at all! Although many young engineers do not seem to understand well the answer to this question, it can be formulated rather simply.

The engineer gets paid directly, of course, by his immediate employer. The employer, however, gets paid either directly or ultimately by money received from the sale of a product. The

product is sold, in general, not because the buyer knows that an engineer has spent effort upon it, but because the buyer believes it to offer value superior to other products which he might buy. In other words, the engineer is contributing to the payment of his salary when, and only when, he makes a product more readily salable by his efforts.

Viewed in this fashion, engineering can hardly be thought to exist without relation to a product. The product, and its prospect of satisfying a user's need, are the whole economic motivation of our profession.

A young engineer should take a lively interest in all aspects of this engineer-product-user relation, both to understand his present job better and to acquire some of the foundation knowledge on which his future progress must be based. He should seek to know, and understand, what the user will regard as satisfactory service, and what alterations in the product will be accepted by the *user* as improvements. Without such knowledge, he will be handicapped even in research work, through inability to appraise the value of results. In design work, responsibility cannot safely be entrusted to one ignorant of or unsympathetic to the views of the user.



John Palmer

H. S. Dawson

CHAIRMAN, TORONTO SECTION, 1946

New Toronto Section Officers

At the May meeting of The Institute of Radio Engineer's Toronto Section, the following officers were elected for the coming year: H. S. Dawson (A'35-SM'45), chairman; C. A. Norris (A'43-SM'46), vice-chairman; and C. J. Bridgland (A'41-SM'44), secretary-treasurer.

Mr. Dawson is a graduate of Cornell University in electrical engineering. He has previously been associated with the Canadian Marconi Company, Rogers Radio Tubes Ltd., and was on the engineering staff of station CFRB. During hostilities, he served with Research Enterprises Ltd., as project engineer and later as assistant chief engineer. Since 1945, Mr. Dawson has been consulting engineer for the Canadian Association

of Broadcasters, serving also as a representative of that organization on the Canadian Radio Technical Planning Board. He is a member of the Association of Professional Engineers of Ontario and was chairman of the Toronto Section of The Institute of Radio Engineers during 1940-1941.

Mr. Norris served on the engineering staff of Canadian National Telegraphs, and later joined Research Enterprises Ltd., becoming assistant chief engineer. He is presently chief engineer of J. R. Longstaffe Ltd.

Mr. Bridgland, formerly engineering section head of Research Enterprises Ltd. and of research development at the National Research Council, is associated with Canadian National Telegraphs as radio engineer.

Microwave Measurements and Test Equipments*

F. J. GAFFNEY†, MEMBER, I.R.E.

Summary—The techniques used in the measurement of electrical quantities in the microwave region of the spectrum differ considerably from those employed at lower frequencies; indeed, the quantities which it is desired to measure are often fundamentally different.

A brief summary of some of the more important measurement methods is given and the electrical and mechanical considerations in the design of microwave measurement apparatus are discussed. Accuracies obtainable with the present state of the art are given. Application to measurement of radar systems is treated briefly.

INTRODUCTION

THE EXTENT of the microwave spectrum has been variously defined. This paper will concern itself with the range of frequencies between approximately 2000 and 30,000 megacycles per second. This corresponds to a range of free-space wavelengths of 15 centimeters to 1 centimeter. In this region of the spectrum the wave lengths are sufficiently short to make practical the use of hollow-tube transmission systems. For wavelengths longer than approximately 3 centimeters coaxial transmission systems may also be used, the limitation being concerned with increased attenuation and with the appearance of a higher mode of propagation when the mean circumference between the outer and inner conductors becomes larger than the free-space wavelength. In this range of wavelengths it was necessary to develop measurement equipment for use with both coaxial and wave-guide transmission systems.

In the microwave region the electrical quantities of interest are in several instances not the same as those of interest at longer wavelengths. We are, for instance, more interested in the electric field than in potential difference; in fact, the latter quantity becomes difficult to define in circuits other than coaxial lines supporting the fundamental transmission mode. For this reason, the output of an oscillator or signal generator is usually specified in terms of power delivered to a load matched to the transmission system rather than in terms of the available voltage across a specified impedance.

Again, while it is possible to measure frequency by direct comparison with the harmonics of a quartz-crystal oscillator, the more common measurement is that of wavelength in a resonant section of coaxial line or wave guide.

Inductance and capacitance are seldom measured as such. In fact, the characteristic impedance of a wave-guide transmission system may be defined in various ways, each giving a different numerical value. This presents little practical difficulty, however, since the

impedance of a termination, such as an antenna, is usually desired in a form which is normalized to that of the transmission system feeding it, and this latter quantity is readily obtainable.

The current in a wave-guide transmission system has a distribution over the walls of the guide which depends on the mode of propagation. The total current then becomes a matter of arbitrary definition and has little practical interest. We are, however, often interested in the current density, since the losses in the wave-guide walls may be obtained from it by integration.

The microwave region is characterized by the use of distributed rather than lumped-constant circuits. Inductances and capacitances take the form of off-resonant irises in a wave guide. The conventional coil-and-capacitor tuned circuit is replaced by a resonant cavity which combines the properties of inductance and capacitance in distributed form, or, saying it in another way, provides a mechanism for the storage of energy in both magnetic and electric fields.

THE MEASUREMENT OF STANDING WAVES AND IMPEDANCE

One of the most useful quantities at microwaves is that of reflection coefficient, a quantity having both magnitude and phase, which is derivable from the measured value of standing-wave ratio on a coaxial or wave-guide transmission system and the position of the minimum voltage with respect to an arbitrary reference point. From the reflection coefficient, the impedance of the termination producing the standing waves may be calculated (normalized to the line or wave-guide impedance).

In making measurements at microwaves, we are normally concerned with transmission lines whose loss per wavelength is small. When a traveling wave of voltage and current on such a line meets a discontinuity (such as an imperfectly matched antenna or crystal detector), the resulting voltage and current distribution on the line may be expressed as the sum of the original traveling wave and a reflected wave of voltage or current, produced by the discontinuity, which travels in the opposite direction. The magnitude and phase relationship of the reflected voltage or current, as observed at the discontinuity, are determined by the impedance of the discontinuity relative to the real line impedance.

On such a line, the equations for voltage and current at any point become

$$E = E_A e^{-i\beta z} + E_B e^{+i\beta z} \quad (1)$$

$$I = \frac{1}{Z_0} (E_A e^{-i\beta z} - E_B e^{+i\beta z}) \quad (2)$$

* Decimal classification: R210×R310. Original manuscript received by the Institute, March 5, 1946. Presented as part of the Radar Lecture Series sponsored jointly by the Communication Group, New York Section, American Institute of Electrical Engineers, and the New York Section of The Institute of Radio Engineers.

† Chief engineer, Polytechnic Research and Development Company, Brooklyn, N. Y.

where

E = total voltage

I = total current

E_A = voltage of initial wave

E_B = voltage of reflected wave

$\beta = (2\pi/\lambda)$ = phase constant of line

χ = distance from reference point

Z_0 = characteristic impedance of line.

E , I , E_A , and E_B are phasor quantities; i.e., quantities having both magnitude and phase. Z_0 is real for a lossless line.

Both E and I are made up of the sum of two phasor quantities which rotate in opposite directions as we move in a given direction along the line. The total voltage and current will have a maximum value when these two phasors are in phase and add, and a minimum value when they are out of phase and subtract. The ratio of the maximum and minimum values of voltage and current (which exist at different points on the line) is called the voltage or current standing-wave ratio. The voltage standing-wave ratio is customarily employed in calculations and may be expressed as

$$\rho = \frac{|E_A| + |E_B|}{|E_A| - |E_B|} = \frac{1 + \frac{|E_B|}{|E_A|}}{1 - \frac{|E_B|}{|E_A|}} \quad (3)$$

As defined above, ρ is a real number, not a phasor.

For purposes of calculation, we are usually interested in a phasor quantity K called the reflection coefficient. This quantity, whose phase rotates as we move along the line, is simply defined as

$$K = \frac{E_B}{E_A} \quad (4)$$

From (3) it may be seen that the magnitude of K is given by

$$|K| = \frac{\rho - 1}{\rho + 1} \quad (5)$$

The phase of K is determined by the position of minimum voltage on the line, being zero at these points.

The impedance at any point in the line is simply the ratio of total voltage to total current at the point in question, and is a phasor quantity.

$$Z = \frac{E}{I} = \frac{E_A}{I_A} \frac{1 + K}{1 - K} = Z_0 \frac{1 + K}{1 - K} \quad (6)$$

We are usually interested in the ratio of this impedance to the characteristic impedance of the line

$$z = \frac{Z}{Z_0} \quad (7)$$

From (6), it may be seen that this normalized impedance may be calculated directly from the reflection coefficient as

$$z = \frac{1 + K}{1 - K} \quad (8)$$

If M and N are any two points on a transmission line separated by the distance χ , with M nearer the generator, the reflection coefficient at N in terms of that at M is given by

$$K_N = K_M e^{j2\beta\chi} \quad (9)$$

Using this relationship together with (8), the normalized impedance at any point in the line may be calculated from the reflection coefficient determined at any arbitrary reference point by measuring the value of the standing-wave ratio and the position of the minimum with respect to the chosen reference point. Actually, such calculations are usually performed with the aid of a graphical calculator such as the Smith Chart.¹

Measurements of standing waves are made with devices known as standing-wave machines or slotted sections. Fig. 1 shows a picture of a slotted section intended for use in the region around 3000 megacycles.

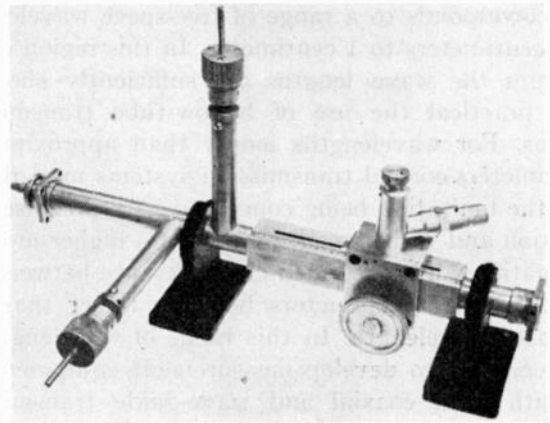

Fig. 1—Coaxial slotted section.

Such a device consists essentially of a carefully made coaxial line having a milled slot in the outer conductor and equipped with a carriage in which is mounted the probe unit used to sample the radio-frequency field as the carriage is moved along the slot. In the device shown, tuning plungers are incorporated in the end of the slotted section placed toward the radio-frequency source in order to maximize the power into the termination under test. These tuning plungers have no effect on the measured standing-wave ratio of the test specimen since this value is independent of the impedance seen looking back toward the radio-frequency source. They are necessary, however, in order to insure sufficient power into the termination to allow measurements to be made with small probe insertion.

In the construction of such an instrument, rather close mechanical tolerances must be held. If the probe insertion, for instance, varies by as much as 0.001 inch as the carriage is moved along the slot, an error of several per cent in the measured value of the standing-wave ratio will result. This requires that the slotted section of the line be bored from solid block, since

¹ P. H. Smith, "Transmission line calculator," *Electronics*, vol. 12, p. 29; January, 1939; and vol. 17, p. 130, January, 1944.

commercial tolerances on tubing are inadequate. The design of the carriage must be such as to allow no play, and the surfaces on which it moves must be machined carefully if satisfactory results are to be obtained.

While sources of reflection at the input end of the slotted section are of no importance, reflections due to supports for the center conductor at the output end of the instrument directly affect measurements made on terminations attached to it. For this reason, the center conductor must either be supported by a bead system of very low reflection or, alternatively, left unsupported in the slotted section and held in position by the device under test. The latter construction is used in the device shown, the center conductor being cantilevered from the stub supports at the input end. In line with other tolerance requirements, the center conductor must be very straight throughout its length. This is usually accomplished by using a piece of carefully selected and straightened drill rod of the proper diameter which is then plated to obtain the desired high conductivity.

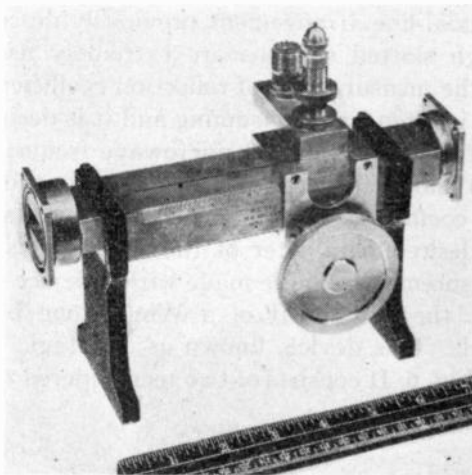

Fig. 2—Wave-guide slotted section.

The probe unit for the slotted section is arranged to accommodate a crystal rectifier or bolometer unit. Tuning adjustments are provided to effect an optimum transfer of radio-frequency power into the detector unit. The output of the probe unit is taken off through a coaxial-line connector to a flexible cable which is connected to the galvanometer or amplifier used for indicating the amplitude of the radio-frequency voltage. Bolometers have a rectification characteristic which is quite accurately square-law. When fed to a linear amplifier and meter, this results in a meter deflection which is proportional to the power of the radio-frequency field at a given point in the line. The meter in the output of such an amplifier is usually calibrated to read the voltage standing-wave ratio directly when used with a square-law detector. This is accomplished by adjusting the sensitivity of the amplifier so that the maximum voltage along the line produces full scale deflection, then moving the probe to the minimum voltage and reading the voltage standing-wave ratio directly from the meter scale.

Crystal detectors have approximately a square-law characteristic but must be calibrated if accurate voltage standing-wave-ratio measurements are desired. This calibration can be accomplished quite easily by making use of the fact that the voltage distribution along the line is sinusoidal.

Fig. 2 shows a similar slotted section for use with a wave-guide transmission line in the 10,000-megacycle region. In order to obtain the required mechanical tolerances, the section of wave guide used in the explorer is made in two halves from milled solid-brass blocks and carefully fitted together. This construction is made possible by the fact that no transverse currents cross the center of the broad side of the guide. The same general tolerances on the construction of the carriage and ways apply here as was the case with the longer-wavelength coaxial slotted section, with the exception that the absolute tolerances are even greater, due to the reduced size of the unit.

In the case of a wave-guide slotted section, the problem of supporting a center conductor is no longer present, and this allows more accurate measurements to be made in wave guide than are possible in coaxial lines. The slotted section is equipped with standard choke and flange fittings which mate with terminal equipment designed for the wave-guide size utilized.

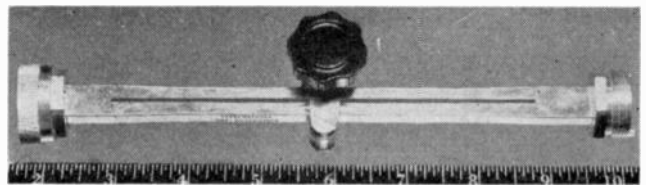

Fig. 3—Wave-guide squeeze section.

In making accurate voltage standing-wave-ratio measurements, the slotted section is usually used with the flange section facing the test specimen. Should the test specimen be fitted with a choke connector, the voltage standing-wave ratio produced by the connector is considered as contributing to the over-all voltage standing-wave ratio of the specimen. Where it is desired to make accurate measurements in connection with the design of devices such as tees and reflectionless terminations, the measurements are usually made by coupling the test specimen with a flange, carefully made and polished, which is butted against the output flange of the slotted section.

Errors due to changes in probe insertion for small probe insertions are greater in the case of wave-guide slotted sections than with coaxial slotted sections, due to the fact that the radio-frequency field is constant throughout the height of the guide in the former case, whereas it increases more rapidly near the center conductor in the latter.

A simpler device but one which is not nearly so useful as a slotted section is shown in Fig. 3. This device, known as a squeeze section, makes use of the fact that the wavelength of the fields in a wave guide depends on

the width of the guide. By mounting a detector probe at some point in a wave-guide transmission system and interposing a squeeze section between this point and the test specimen, it is possible to move the standing waves past the detector and to produce an effect which is similar to that obtained by sliding a probe along the line. The instrument consists simply of a section of wave guide having slots in both the broad faces and equipped with a mechanism which allows the guide to be distorted in such a way as gradually to change its width over the length occupied by the slots. With such an instrument, the values of the maximum and minimum in the standing-wave pattern can be obtained, but no indication is given of the phase of the reflection coefficient in the device under test. Unlike measurements made with slotted sections, the impedance seen looking toward the radio-frequency source now plays an important part in the measurements obtained. Consequently, squeeze sections must always be used with sources which are as nearly matched to the wave guide as possible. Knowing the standing-wave ratio of the source, it is possible to calibrate its effect on the measured standing-wave ratio of the test specimen.

Fig. 4 shows a bench setup for making impedance measurements in the 3000-megacycle region of the spectrum. The radio-frequency power is fed into the slotted section from a klystron oscillator through a

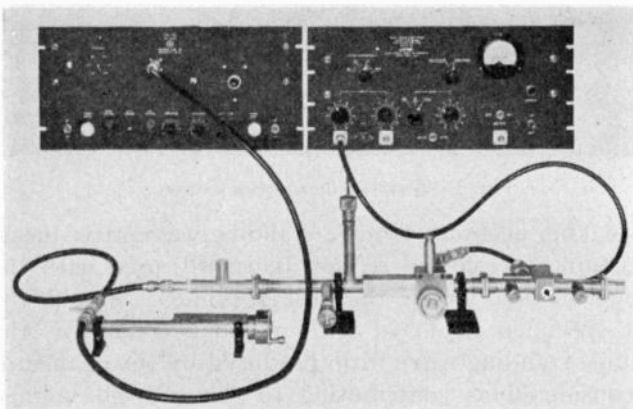

Fig. 4—Coaxial standing-wave setup.

flexible cable and a rigid-line-to-flexible-line adapter. A reaction-type wavemeter is interposed in the feed line to permit the measurement of the radio frequency. The device under test is connected to the left end of the slotted section. The output of the detector in the probe unit is fed through a flexible cable to an amplifier shown in the upper-right corner of the illustration. The amplifier is arranged to permit dual inputs, since more than one slotted section is sometimes employed. A switch between the inputs is provided, as are separate gain controls. The amplifier shown incorporates an audio filter network which is sharply tuned to pass only the frequency used to modulate the radio-frequency source. This eliminates interference which might otherwise be present in a high-gain amplifier of this type.

A similar setup for use in making wave-guide standing-wave measurements is shown in Fig. 5. Here a

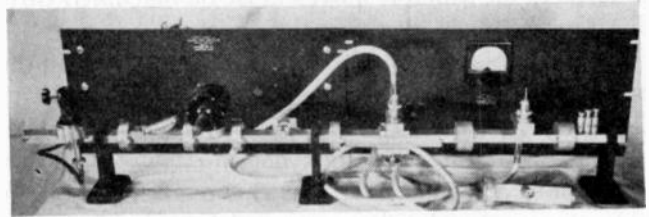

Fig. 5—Wave-guide standing-wave setup.

klystron oscillator is mounted directly on the wave guide, as is shown in the extreme left of the picture. A level-set attenuator is used to adjust the power in the wave guide to a convenient value. In the setup shown this takes the form of a hinged curved strip of resistance material inserted into the wave guide from a slot in the broad face. A cavity wavemeter is mounted on the guide to allow measurement of radio frequency. Other particulars of the setup are quite similar to those of the coaxial-line arrangement previously described.

Although slotted sections are extremely useful devices for the measurement of reflection coefficient, their operation is often time-consuming and it is desirable, in much of the design work at microwave frequencies, to be able to make measurements of the magnitude of the reflection coefficient of a test specimen instantaneously as some desired parameter of the specimen is varied. Such measurements can be made with a device which is somewhat the equivalent of a Wheatstone bridge in wave guide. This device, known as a "Magic Tee," is shown in Fig. 6. It consists of two tees soldered together,

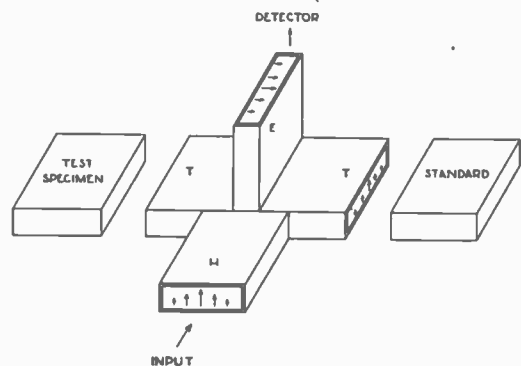

Fig. 6—Magic Tee.

one lying in the plane of the electric vector and the other in the plane of the magnetic vector. These arms are referred to as the E -plane and the H -plane arm, respectively. The tee has the property of dividing power fed into the H -plane arm equally between the two test arms if the two test arms are terminated in reflectionless loads. Under these conditions no power is delivered to the E -plane arm. If, however, a standard termination which is perfectly matched to the guide is placed on one of the test arms and an imperfectly matched test specimen on the other test arm, power is

delivered to the *E*-plane arm and the magnitude of this power is proportional to the square of the magnitude of the reflection coefficient of the test specimen. Consequently, if a power source is connected to the *H*-plane arm and a detector to the *E*-plane arm, the detector can be calibrated in terms of the voltage standing-wave ratio of the test specimen. For test specimens which are quite close to being matched, the power output of the detector is extremely small. For this reason, a sensitive receiver is usually employed as the detector.

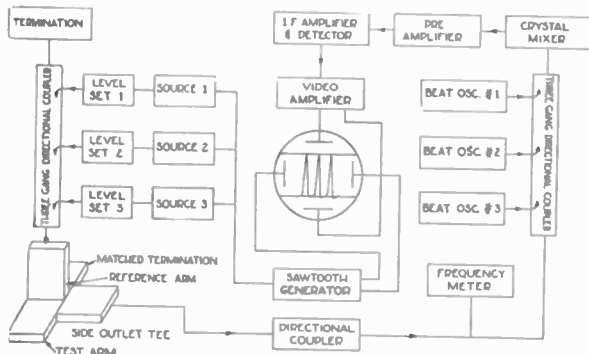

Fig. 7—Block diagram of the three-frequency impedance bridge, superheterodyne type.

In investigating the impedance characteristics of a microwave specimen, it is usually desired to measure the reflection coefficient at several frequencies throughout a band. This can be accomplished with a magic-tee impedance bridge by feeding several radio frequencies into the bridge simultaneously and feeding the output of the bridge to receivers tuned to the input frequencies. Such an arrangement allows broad-banding studies to be made very quickly. A block diagram of such an arrangement which utilizes three radio frequencies is shown in Fig. 7. In this device, a saw-tooth



Fig. 8—Three-frequency impedance bridge, superheterodyne type.

frequency modulation is applied to each of the three radio-frequency sources and the phases of the saw-tooth wave forms are arranged in such a way that the oscillator sweeps through the pass bands of the three receivers at slightly different instants of time. As a given radio-frequency source is swept through the pass band of its corresponding receiver, a pulse is produced which, after amplification and detection, is applied to the vertical plates of a cathode-ray oscilloscope, the horizontal sweep of which is synchronized with the saw-tooth wave forms. This results in the production, on the screen of the oscilloscope, of three pips, each of which is proportional to the reflection coefficient of the test specimen at the frequency of the radio-frequency source which produced it. Means must, of course, be provided for initially setting the level at the output from each receiver to match the known characteristics of a calibrated mismatch at each of the three frequencies. A picture of a complete impedance bridge as manufactured by the Boonton Radio Corporation is shown in Fig. 8.

In Fig. 9 is shown a simpler scheme for accomplishing the same end result. In this unit the radio-frequency

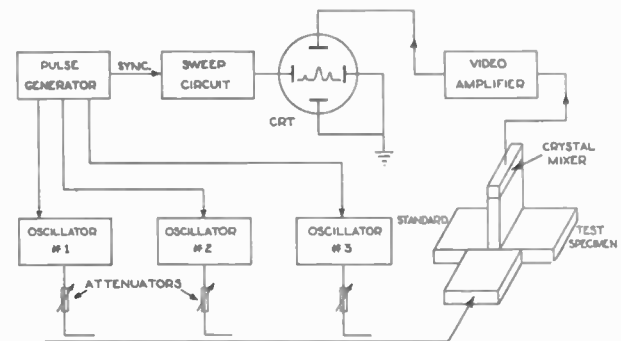

Fig. 9—Block diagram of the crystal-video impedance bridge.

energy from each of the three sources is delivered in short pulses, phased so that the pulse from each oscillator occurs at a different instant during the horizontal sweep of the cathode-ray indicator. The output from the magic tee is then applied to a crystal detector which is followed by a video amplifier. The amplified voltage is applied to the vertical deflection plates of the oscilloscope. The disadvantage of this system consists in its inability to indicate very small values of reflection coefficient due to the limitations on video amplifier gain and on the output from the radio-frequency pulsed oscillators. It has the advantage of being considerably simpler in construction and operation and, in the form shown, is quite useful for measuring standing waves down to values of about 1.05.

The properties of a magic-tee impedance bridge are not completely realized in practice for two reasons. One is concerned with the match looking into the test arm of the tee, which must be perfect if the operation initially outlined is to be obtained. The other is concerned with mechanical imperfections in the construction of the tee itself. For the operation to be as outlined, the tee must

have perfect mechanical symmetry; that is, the H and E arms must be accurately located on the same center line and each of these arms must be accurately at right angles to the test arms. Further, the inside dimensions of the guides used must be held to close tolerances throughout their length. The effect of mechanical asymmetries is usually stated in terms of the standing-wave ratio of a test specimen which will produce zero detector output.

A general idea of the magnitude of errors which may be incurred in using the magic-tee impedance bridge is shown in Fig. 10. If perfect matches are placed on

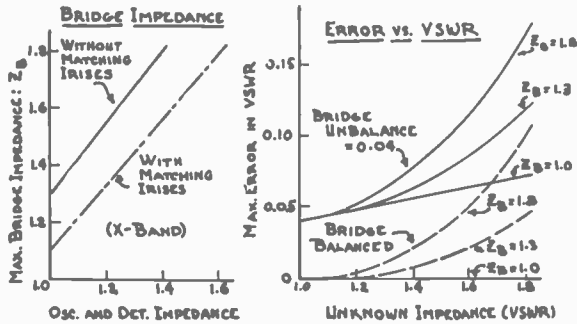

Fig. 10—Impedance-bridge measurement errors.

each of the other three arms of 1- by $\frac{1}{2}$ -inch wave guide in the 10,000-megacycle region, the standing-wave ratio seen looking into the test arm is approximately 1.3. As the oscillator and detector impedance depart from perfect match, the standing-wave ratio seen looking into the test arm varies as shown in the solid line in the left-hand diagram. It is possible to design a matching iris to be placed in the tee which at one frequency will cancel this error when the oscillator and detector impedance are matched. It is also possible with such an iris to obtain partial cancellation over a fairly broad frequency range. The dot-dash line in the figure shows typical results which may be obtained in this way.

The right-hand diagram in Fig. 10 shows the error in measuring an unknown voltage standing-wave ratio resulting from the mismatched bridge and mechanical asymmetry. The lower dotted curves show the error in the case of a perfectly balanced bridge and various values of mismatch looking into the test arm. The upper solid curves show a practical case of an imperfect tee and various values of mismatch looking into the test arm. It will be noted that the error increases rather rapidly as one attempts to measure high values of voltage standing-wave ratio. This is a fortunate characteristic, inasmuch as accurate measurement is desired as the voltage standing-wave ratio of the test specimen approaches unity.

MEASUREMENT OF POWER

It has previously been pointed out that power at microwave frequencies is of much greater interest than voltage or current. Power measurement is, in general, accomplished by one of two methods, the first utilizing

calorimeter techniques, the second utilizing the change in resistance of bolometer elements which absorb the radio-frequency power and convert it into heat. An illustration of a calorimeter-type power meter for use with coaxial line is shown in Fig. 11. In this instrument, the microwave power is absorbed in water which flows

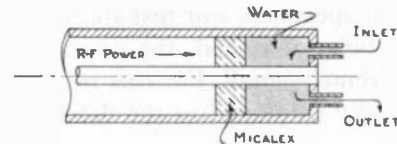

Fig. 11—Coaxial water load.

through a section of the coaxial line. The temperature of the inlet and outlet streams is measured as well as the rate of flow, and from these data it is possible to calculate the absorbed power. Due to the high dielectric constant of water, a mismatch is produced at the junction of the air-filled and water-filled lines. This mismatch can be eliminated through the use of a dielectric transformer between the two sections of line. The transformer is made so as to have an effective length of a quarter wavelength, and is made of a material such that the characteristic impedance of the section of line serving as a transformer is the geometric mean between that of the water-filled and air-filled lines.

Water calorimeters are in general useful only for measuring fairly large powers. Their operation is sluggish and heat losses are such as to prohibit their use for powers smaller than a few watts. For larger powers, however, water loads serve as reliable power standards and have seen considerable use in this connection.

Devices similar to that shown in Fig. 11 have also been constructed for use with wave-guide systems. Physical arrangements have varied considerably, but the general principles employed are the same.

For the measurement of radio-frequency power in the range from 1 microwatt to several milliwatts, bolometer-type power measurers are used. A diagram of one form of such a device is shown in Fig. 12. Here a

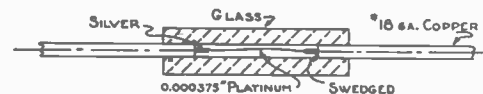

Fig. 12—Microwave Littelfuse bolometer.

thin platinum wire is suspended between supports of heavier copper wire which also serve as the leads for carrying the radio-frequency currents. The assembly is mounted in an insulated cartridge of glass or polystyrene. When power is fed to the unit the resistance of the platinum wire changes, because of variation of its temperature, and this change results in a resistance change which can be measured on a direct-current or low-frequency alternating-current impedance bridge.

A bolometer cartridge must be mounted in a circuit which will effectively conduct the radio-frequency power into the platinum resistance unit. Stated differently, the bolometer unit must be matched to the radio-frequency

line or wave guide in which it is desired to measure the power. A coaxial mount for such a bolometer unit is shown in Fig. 13. Here, the high-impedance line formed

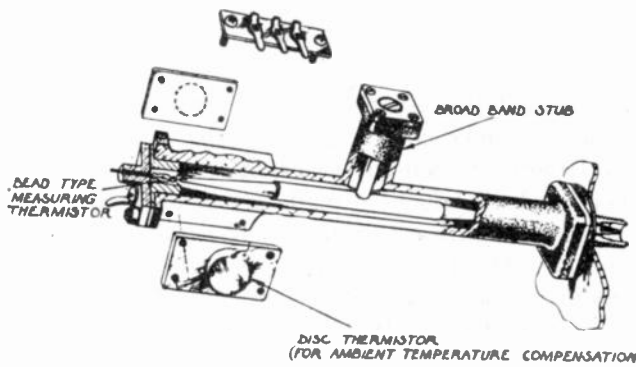

Fig. 13—Broad-band coaxial thermistor mount with taper to type-N connector.

by the bolometer wire and its leads is matched to the 50-ohm line in which it is desired to measure power by means of a tapered section. The illustration actually shows a thermistor as the power-measuring element, but the same construction is used for hot-wire bolometers.

Thermistor-type bolometer units have seen considerable application for microwave power measurement due to their greater temperature-resistance change for a given increment of radio-frequency power and their excellent overload characteristics. These units are made of various metallic oxides and have a negative temperature coefficient of resistance rather than a positive one, as is the case with hot-wire bolometers. Their high overload capabilities and large temperature coefficient makes possible a wide variation in the resistance of a thermistor bead through varying the amount of direct-current power fed to it by the measuring circuit. The adjustment of resistance of the bead is one parameter which may be used for matching the power-measuring unit to the transmission line.

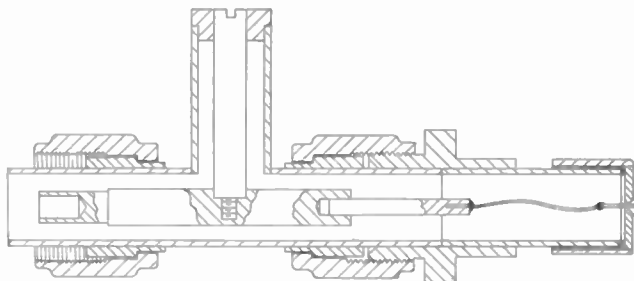

Fig. 14—Cross section of $\frac{1}{4}$ -inch metalized-glass coaxial bolometer mount.

While bolometer units of the type described can be matched successfully to a coaxial-line transmission system over a fairly broad frequency range, the problem of matching such units to a wave-guide system is a more difficult one. Fig. 15 shows a typical wave-guide mount which was designed to utilize thermistor-type bolometers. In this unit the thermistor is mounted across the wave guide which is equipped with a back-tuning plunger and an additional tuning plunger on the

coaxial line of which the thermistor lead is the center conductor. The coaxial-line output must be arranged so as to insulate the thermistor lead for direct current, and yet allow the radio-frequency voltage to be by-passed.

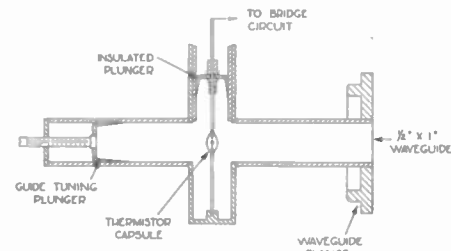

Fig. 15—Wave-guide thermistor mount.

The bolometer units described are useful in measuring power in the region from 1 microwatt to over 1 milliwatt. A bolometer unit for measuring powers up to about 0.2 watt is shown in Fig. 14. In this unit the temperature-sensitive element consists of a glass fiber on which is deposited a thin film of metal. The high-impedance line formed by the bolometer element is matched to the feeder line by means of a section of line with intermediate characteristic impedance which serves as a transformer. The center conductor of the transmission line is supported by means of a broadly resonant stub.

The standing-wave ratio of the complete terminal is such that less than 4 per cent of the power is reflected over the range of 2500 to 3700 megacycles.

Various bridge circuits have been designed for use with bolometer elements. One of the simpler designs is shown in Fig. 16. This design consists essentially of a direct-current bridge so arranged as to provide an indi-

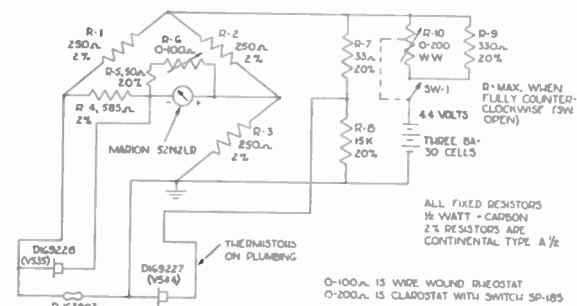

Fig. 16—Two-milliwatt thermistor bridge, temperature compensated.

cator which is direct reading in power with full-scale deflection corresponding to 2 milliwatts. The bridge is initially balanced, with no radio-frequency power being fed to the thermistor, by varying the direct voltage across the bridge. This changes the direct-current power in the thermistor until its resistance is such as to produce balance.

One of the problems in the design of such bridge circuits is concerned with drift due to ambient temperature changes. These effects can be considerably reduced through the use of compensating circuits which utilize temperature-sensitive elements having good thermal contact with the bolometer or thermistor cartridge. Disk-type thermistors serve this purpose

very well; two such elements are shown in the circuit of Fig. 16.

MEASUREMENT OF ATTENUATION

At microwave frequencies it is necessary, as is the case at lower frequencies, to provide means for attenuating the power in a transmission system. Attenuators at these frequencies have in general taken two forms. One of these, the wave-guide beyond-cutoff type, is shown in Fig. 17. This attenuator makes use of

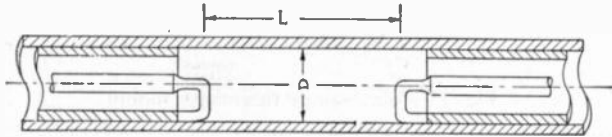

Fig. 17—Wave-guide beyond-cutoff attenuator. Attenuation for $\Delta l = D$, (DB/Dia.):

$$TE_{1,1} \text{ Mode: } 32.0 \sqrt{1 - \epsilon \left(\frac{1.71D}{\lambda} \right)^2};$$

$$TM_{0,1}: 41.8 \sqrt{1 - \epsilon \left(\frac{1.30D}{\lambda} \right)^2}$$

the fact that, for diameters smaller than the critical diameter, waves are no longer propagated in a wave guide, but rather the fields are attenuated exponentially at a rate which depends on the diameter of the tube and the mode of oscillation. The rates of attenuation for the $TE_{1,1}$ mode (such as is utilized in a loop-coupled attenuator similar to that shown) and the $TM_{0,1}$ mode (such as is utilized in a disk-coupled attenuator) are given in the figure. These rates are given in terms of decibels-per-diameter change in separation of the loops or disks. Since these values are known analytically and can be calculated to a high degree of accuracy, the wave-guide beyond-cutoff attenuator provides an excellent standard of attenuation. In practice, however, considerable difficulty has been experienced due to the presence of modes other than the desired attenuation mode, and great care must be exercised in the use of such attenuators for this reason. This difficulty arises because of the fact that the impedance of the loop is not zero in the case of a loop-coupled attenuator and is due to asymmetries in the case of a disk-coupled attenuator. Since the rate of attenuation for the $TM_{0,1}$ mode is higher than that of the $TE_{1,1}$ mode, the loop-coupled attenuator is most often used, since the attenuation curve becomes accurately linear in decibels when the displacement is sufficient so that the effect of the $TM_{0,1}$ mode is negligible. A large initial displacement corresponds, however, to a high insertion loss and this undesirable feature is present in all wave-guide beyond-cutoff attenuators.

Loop or disk pickups constitute very high reactances terminating the coaxial input and output lines. It is often desirable to provide resistive pads at the input and output loops of a wave-guide beyond-cutoff attenuator to reduce the standing-wave ratio to a reasonable value. Such pads also contribute to the initial insertion loss.

Another type of attenuator, which is not amenable to calibration on an analytical basis but which has many advantages over the wave-guide beyond-cutoff type, utilizes resistive materials in the coaxial or wave-guide transmission system to absorb a fraction of the radio-frequency power. Resistive attenuators for coaxial lines may be made by using a section of coaxial line having a resistive inner conductor. In order to obtain minimum frequency sensitivity of attenuation, a resistive inner conductor is best made by coating a dielectric such as glass with a thin film of resistive metal such as nichrome. The unit resistance of such an attenuating element can be controlled by controlling the thickness of the metallic deposit. If the thickness of the metallic deposit is made less than the depth of penetration, the frequency sensitivity can be kept low. This requirement is compatible with the resistance values needed in this type of attenuator. Such attenuators may be made in either fixed or variable form.

Inasmuch as the characteristic impedance of a line with a resistive center attenuator is no longer a pure real number, it is necessary to provide transformer matching sections if the attenuator is to be reflectionless. These matching transformers can be made by using additional sections of resistive center conductor having lower resistance per unit length than the main body of the attenuator and approximately one-quarter wavelength long. In Fig. 18, metalized glass tubes

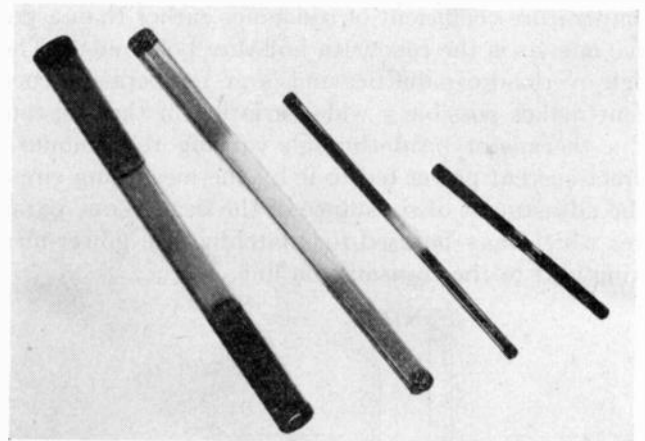

FIG. 18—Coaxial attenuator inserts. Metalized-glass type with matching sections.

used for fixed resistive attenuator pads are shown. The lower-resistance (thicker film) matching sections are visible on either end of the main attenuating section. The metalized tubes are equipped with bullet-type terminals and inserted into appropriate sections of coaxial line. Attenuators so formed can be made to have excellent impedance characteristics over a fairly broad frequency range and can withstand power of the order of several watts. Through the use of nichrome as the resistive element a low dependence of attenuation on temperature can be achieved.

If attenuating elements such as those described above are placed in a coaxial line arranged to have a

telescoping section which can slide over the resistive film, a variable attenuator is obtained. In order to preserve a good match looking into either end of such a variable attenuator, an additional tapered resistance matching section is mounted on the telescoping metallic sleeve. Such a slider is shown in Fig. 19. An attenuator so

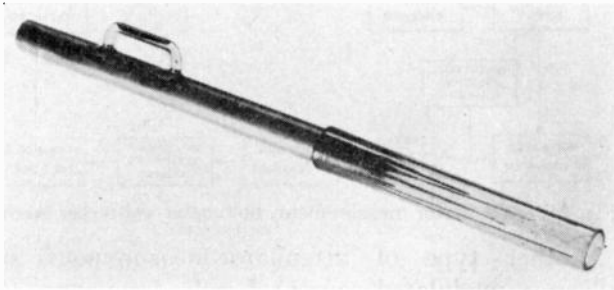

Fig. 19—Slider for coaxial variable attenuator showing tapered matching section.

constructed has an insertion loss of the order of 1 decibel and may be constructed for maximum attenuations which depend only on the allowable length and on leakage considerations. Attenuators which cover a range of from 1 to 60 decibels in the 3000-megacycle region have been produced.

A similar type of resistive attenuator may be constructed for use with wave-guide transmission lines by inserting a resistive plate into the wave guide in a plane parallel to the electric field. Suitable plates for this purpose may be made in several ways. One of these consists in coating a strip of bakelite or other dielectric with carbon or a similar type of resistive film. A better way from the standpoint of stability, both mechanical and electrical, utilizes a glass vane metalized in a way similar to that employed in making coaxial resistive attenuators. In order to vary the attenuation, the strip may be lowered into the guide through a slot in the broad face or, alternatively, may be moved across the guide from an initial position close to one of the narrow sides. The latter method has been found to be the most desirable, since, in the former, difficulties are experienced due to radiation out of and back into the slot through which the strip is lowered. This reduces the attenuation obtainable and in addition makes calibration somewhat dependent upon the presence of near-by metallic objects.

If a metalized plate is placed in a wave guide with the metalized surface very close to one of the narrow sides of the wave guide, the attenuation produced is extremely small. As the plate is moved into the guide to the region of stronger electric fields, higher losses occur. In this way it is possible to construct variable attenuators which have an almost immeasurable insertion loss and a maximum attenuation depending only on the physical length. In the 10,000-megacycle region, for instance, units 6 inches long have been made to give maximum attenuation of approximately 60 decibels.

In order to preserve the impedance match looking

into such an attenuator, it again becomes necessary to use resistive matching sections. Such sections may take various forms. One form which gives excellent results consists of a gradual taper extended over about one half of a guide wavelength. Another form which can be made to give comparable results in a shorter plate utilizes tongues of resistive material extending from the main body of the film. Examples of these units are illustrated in Fig. 20.

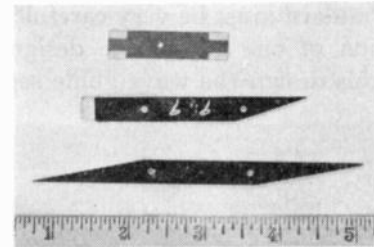

Fig. 20—Metalized plates for wave-guide attenuators: top, tongue-type matching sections; center, unilaterally matched with taper; bottom, bilaterally matched with tapers.

In order to obtain attenuators of this form which are capable of accurate calibration, considerable care must be exercised in the design and construction of the mechanical system which moves the plate across the guide. This will be understood from the fact that, in typical designs, a displacement of 0.001 inch produces a change of attenuation of several decibels. The plates are, in general, mounted on two struts which extend across the guide and which can be metallic inasmuch as they lie at right angles to the electric vector. The reflection from such struts is quite small, and in a properly designed unit can be made to have a negligible effect over most of the attenuation region due to the masking effect of the resistive film itself. A picture of a typical wave-guide attenuator is shown in Fig. 21.

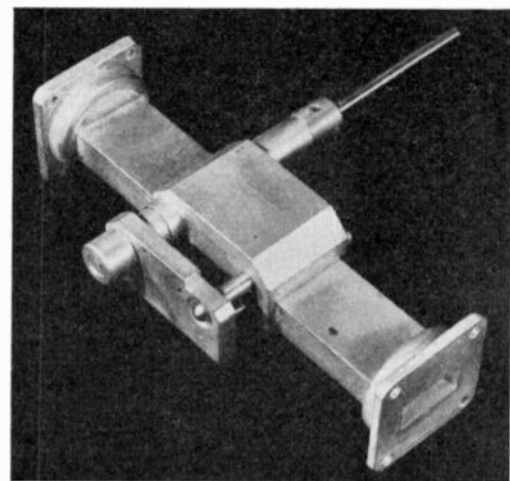

Fig. 21—Metalized-glass-type wave-guide attenuator.

All of the resistive-type out attenuators must be calibrated against some standard which, by virtue of its history, using several methods of attenuation measurement, is known to a high degree of accuracy. While

carefully constructed wave-guide beyond-cutoff attenuators serve well as primary standards, the difficulties with this type have already been pointed out. Particularly troublesome is the high insertion loss which makes very difficult the calibration of high-value attenuators due to limitations on the available power source and receiver sensitivity. For this reason it is usually desirable to calibrate carefully made resistive substandards which, by virtue of their low insertion loss, can be used readily for the calibration of high-value attenuators. Such a substandard must be very carefully constructed. An illustration of one acceptable design is shown in Fig. 22. In this design the wave-guide section is milled

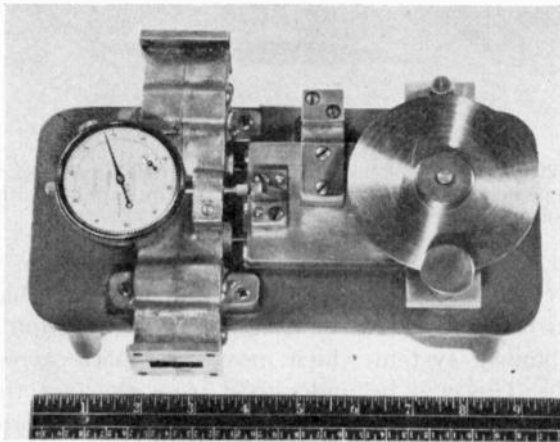

Fig. 22—Standard wave-guide attenuator, metalized-glass type.

from a casting to insure close tolerances in the height of the wave guide throughout the length of the attenuating section. The struts which support the glass plate are rigidly attached to a heavy carriage which moves on ball bearings over ground ways. The displacement of the resistive plate from the side of the wave guide is measured with a dial indicator which, in turn, is calibrated, at several frequencies, in terms of attenuation.

Several methods for accurately comparing attenuators against such standards as those described may be employed. One such method of measurement is illustrated in Fig. 23. Here a standard attenuator and the

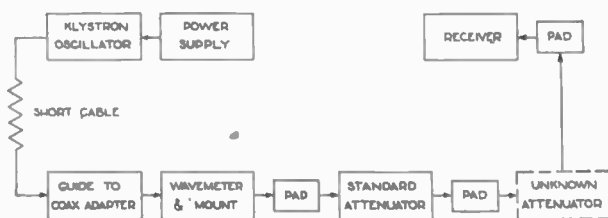

Fig. 23—Block diagram of the attenuator comparator.

unknown are placed in series and a receiver is used as a constant level indicator. As attenuation of the unknown attenuator is increased, the attenuation in the standard attenuator is reduced to maintain the same receiver output, and it is possible in this way accurately to calibrate the unknown. In order to eliminate errors

which may arise due to reflections from the standard or unknown attenuators, well-matched fixed-pad attenuators are used on both sides of the standard and unknown. These pads effectively mask out undesirable impedances seen looking back toward the generator and looking into the receiver detector, respectively.

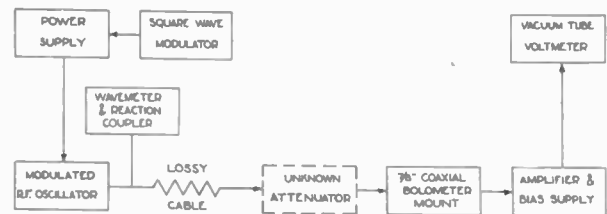

Fig. 24—Attenuator measurement, bolometer-voltmeter method.

Another type of attenuator-measurement setup utilizes a modulated source of radio-frequency power and a bolometer detector whose law is known to be accurately square. The output from the detector is fed to a vacuum-tube voltmeter and the unknown attenuator may be calibrated by noting the change in voltmeter reading as its attenuation is increased from zero to maximum. As before, the bolometer terminal must be accurately matched to the wave-guide or coaxial-line transmission system used, and the impedance seen looking back toward the source must also be the characteristic line impedance. A block diagram is shown in Fig. 24.

MEASUREMENT OF FREQUENCY

The same quartz-crystal techniques utilized at lower frequencies may be used in the microwave region of the spectrum provided only that suitable multiplier units are designed for the purpose. Frequency multiplication up to approximately 1000 megacycles per second may be obtained using triode-type tubes especially designed for high-frequency application. Beyond this frequency, one must resort either to velocity-modulation-type multiplier tubes or to rectifier-type crystals such as silicon or germanium. The former type of multiplier is capable of producing sizeable power output in the microwave region but is somewhat difficult to adjust if it is desired to cover a range of frequencies. Crystal-rectifier multipliers, on the other hand, may easily be adjusted in frequency but suffer from very low power output due to their low multiplier efficiency and the limited allowable input at the fundamental. Used with adequate receivers, however, crystal multipliers provide a facile means for making frequency measurements at microwave frequencies.

A typical primary frequency standard is shown in Fig. 25. It consists of the usual temperature-controlled quartz-crystal oscillator together with amplifier and buffer stages feeding suitable multiplier and divider stages. In order to get a variable-frequency output, an accurately calibrated tunable oscillator is mixed with the crystal output in an early multiplier stage. The outputs from the higher multiplication stages are taken off to silicon-crystal rectifiers which are usually mounted

in a wave guide or coaxial line to feed harmonic power directly to a calibration receiver. If a stable microwave oscillator is now mixed in the input of the calibration receiver with the output from the crystal multiplier, zero beat may be obtained between the two frequencies and in this way a source of considerable microwave power of accurately known frequency may be obtained.

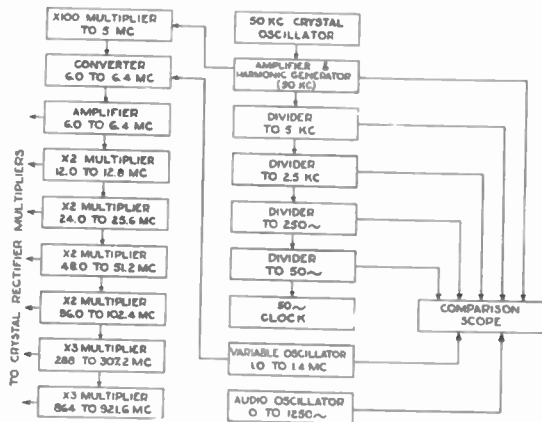

Fig. 25—Crystal frequency standard for microwave application.

While it is necessary to utilize such schemes as those described above for determining frequencies with high precision, most laboratory requirements do not demand precision of this order. For routine laboratory measurements, resonant sections of coaxial line may be employed as frequency-measuring devices. One form of wavemeter which utilizes a quarter-wavelength open-ended section of coaxial line is shown in Fig. 26. The

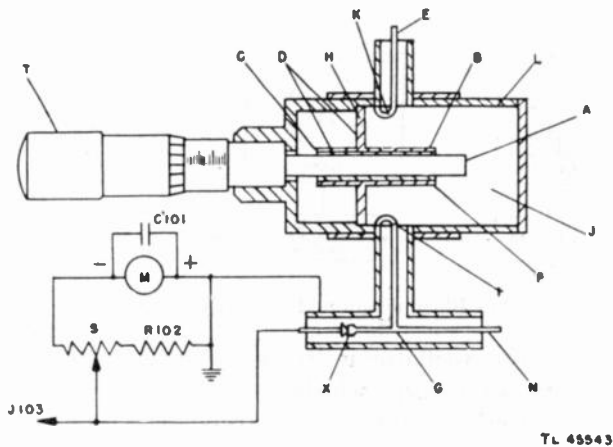

Fig. 26—Open-end coaxial-line wavemeter.

resonant frequency is adjusted by moving the plunger *A* by means of the micrometer mechanism. The micrometer may then be calibrated in either wavelength or frequency. In order to obtain the highest possible *Q*, contacts to the movable plunger are usually made at some distance from the short-circuited end of the coaxial line at a point where the current in the line is small. In the diagram shown, metallic contact is not actually made; rather, a choke arrangement is utilized which can be made to present a fairly low impedance at the point of contact over a fairly wide frequency range.

The device shown is known as a transmission-type wavemeter, microwave energy being fed in through loop *K* from an input coaxial line and taken out through loop *F* to a detector system which, in this case, consists of a crystal mount in a suitable cartridge. The output from the crystal is fed to a milliammeter which indicates when the wavemeter is tuned to resonance, since the transmission loss from such a cavity is very high at frequencies other than the resonant one and can be made quite low at the resonant frequency.

Another type of coaxial wavemeter which uses a half-wave short-circuited section of coaxial line is shown in Fig. 27. This type of wavemeter is freer from end effects

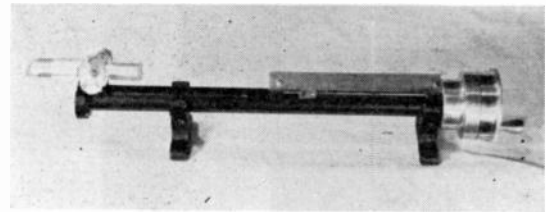

Fig. 27—Short-circuited coaxial-line wavemeter.

than the open-ended coaxial-line type and can be made to cover a very wide frequency range. Further, errors in the pitch of the screw may be somewhat minimized by taking readings at several resonant positions which are multiples of a half wavelength.

The resolution that may be obtained with such a wavemeter is a function of the *Q* of the resonant cavity which, in turn, depends upon losses in the cavity and the tightness of coupling to the input and output loops. Here, as at low frequencies, *Q* is defined as

$$Q = \frac{f}{\Delta f} \quad (10)$$

The bandwidth of the wavemeter is then given by

$$\Delta f = \frac{f}{Q} \quad (11)$$

where *f* is the frequency of resonance and Δf the bandwidth between the half-power points. The resolution which can be obtained with such a wavemeter is approximately 1/20 of the bandwidth.

For a coaxial wavemeter operating in the 10-centimeter region, having an outer diameter of 1 inch and an optimum ratio of outer to inner diameters, the *Q* is approximately 5500.

Where greater resolution is required than can be obtained with coaxial lines, cavity wavemeters operating in any one of several possible modes are utilized. In the 10-centimeter region, for instance, a cavity operating in the $TE_{0,1,1}$ mode has an unloaded *Q* of approximately 60,000. When such cavities are used, problems arise due to the presence of modes other than the one which it is desired to utilize. Means have been evolved for suppressing some of these undesirable modes, but the band which can be covered is, none the less, severely restricted with this type of wavemeter.

An illustration of a cavity wavemeter designed for operation in the 10,000-megacycle region is shown in Fig. 28. This wavemeter is one of the so-called reaction

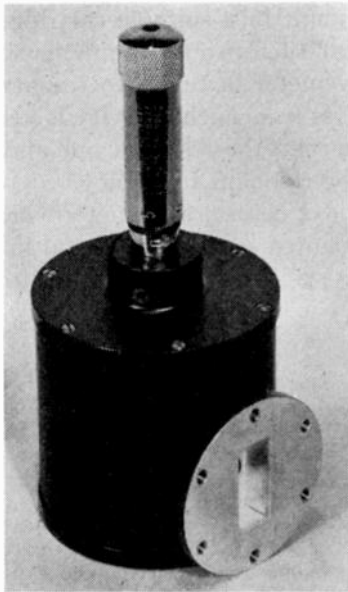

Fig. 28—Cavity-type wavemeter for 10,000-megacycle use.

type having a single input. It is designed to be mounted on a section of wave guide in such a way as to present a high impedance in series with the wave guide when the wavemeter is tuned to resonance, thus producing a dip in the power-transfer characteristic of the guide. Coupling to the wavemeter is made through an iris in the wall of the cavity, rather than with a coupling loop, due to the simplicity of this method of coupling for wave-guide applications. The unloaded Q of such a wavemeter is of the order of 10,000. The loaded Q depends on the size of the coupling iris. When such a wavemeter is connected to a wave-guide system, the distance between the junction and the wavemeter must be made such that a resistive impedance is seen looking toward the wave guide from the wavemeter iris if accurate calibration is to be maintained. This is required since a reactive component in this impedance would result in a shift in the resonant frequency of the cavity from the value obtained during calibration. Similarly, in the case of a transmission-type wavemeter, resistive pads must be employed at the input and output of the wavemeter to prevent frequency pulling of the cavity.

Two possible sources of error exist when wavemeters of either the coaxial or cavity type are used over wide temperature and humidity ranges. The first of these is due simply to the temperature coefficient of expansion of the metal of which the wavemeter is made. The percentage change in resonant frequency is equal to the percentage change in the linear dimensions of the cavity. In the case of steel, this amounts to approximately 10 cycles per megacycle per degree centigrade. An increase in temperature produces an increase in wavelength and a decrease in frequency. Cavities of invar steel have a temperature coefficient of about one tenth this value.

The second source of error is due to the change in dielectric constant of the medium filling the cavity as either the relative humidity or the temperature is changed (this change depends on the total moisture content, which changes with relative humidity at constant temperature or with changes in temperature at constant relative humidity). The effect of this variable is best shown by means of the nomograph of Fig. 29. The nomograph is normalized at 25 degrees centigrade and 60 per cent relative humidity, and gives frequency corrections in per cent for other conditions of temperature and humidity.

Where precise measurement of frequency is required, it is necessary to employ sealed cavities filled with dry air to eliminate the humidity error. In addition to the use of invar-type alloys, the expansion error may be reduced through the use of various temperature-compensation schemes involving the balancing action obtained by opposing metals with different temperature coefficients.

Cavity wavemeters have, in general, a calibration such that the frequency is a nonlinear function of the position of the tuning plate (height of the cavity). Such wavemeters are usually calibrated by comparison with a tertiary standard which, in turn, has been calibrated against a quartz crystal. A useful circuit arrangement for making such comparisons is shown in Fig. 30. Here,

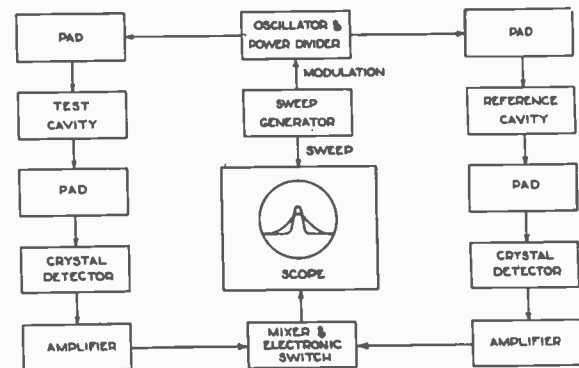

Fig. 30—Block diagram of the cavity comparator.

a microwave oscillator is frequency modulated with a saw-tooth wave form which is also used as the horizontal deflection voltage for a cathode-ray oscilloscope. The power from the oscillator is split into two channels. One of these feeds through a transmission-type reference cavity to a crystal detector. As the frequency of the source is swept through the resonant frequency of the reference cavity, the voltage output from the crystal detector plotted as a function of time has the shape of the bandpass of the cavity. This voltage is amplified and fed through an electronic switch to the vertical deflection plates of the oscilloscope. Inasmuch as the horizontal position of the oscilloscope beam is proportional to the frequency of the radio-frequency oscillator, the band-pass curve of the reference cavity is plotted on the screen of the oscilloscope.

The other output from the radio-frequency power divider is fed through the test cavity, so that the bandpass of this cavity is displayed on the oscilloscope in the same way. If, now, the resonance frequency of the test

cavity is adjusted so that its bandpass curve is centered on the same vertical line as that of the reference cavity, the test cavity is tuned to the same frequency as the reference cavity. As previously indicated, it is necessary

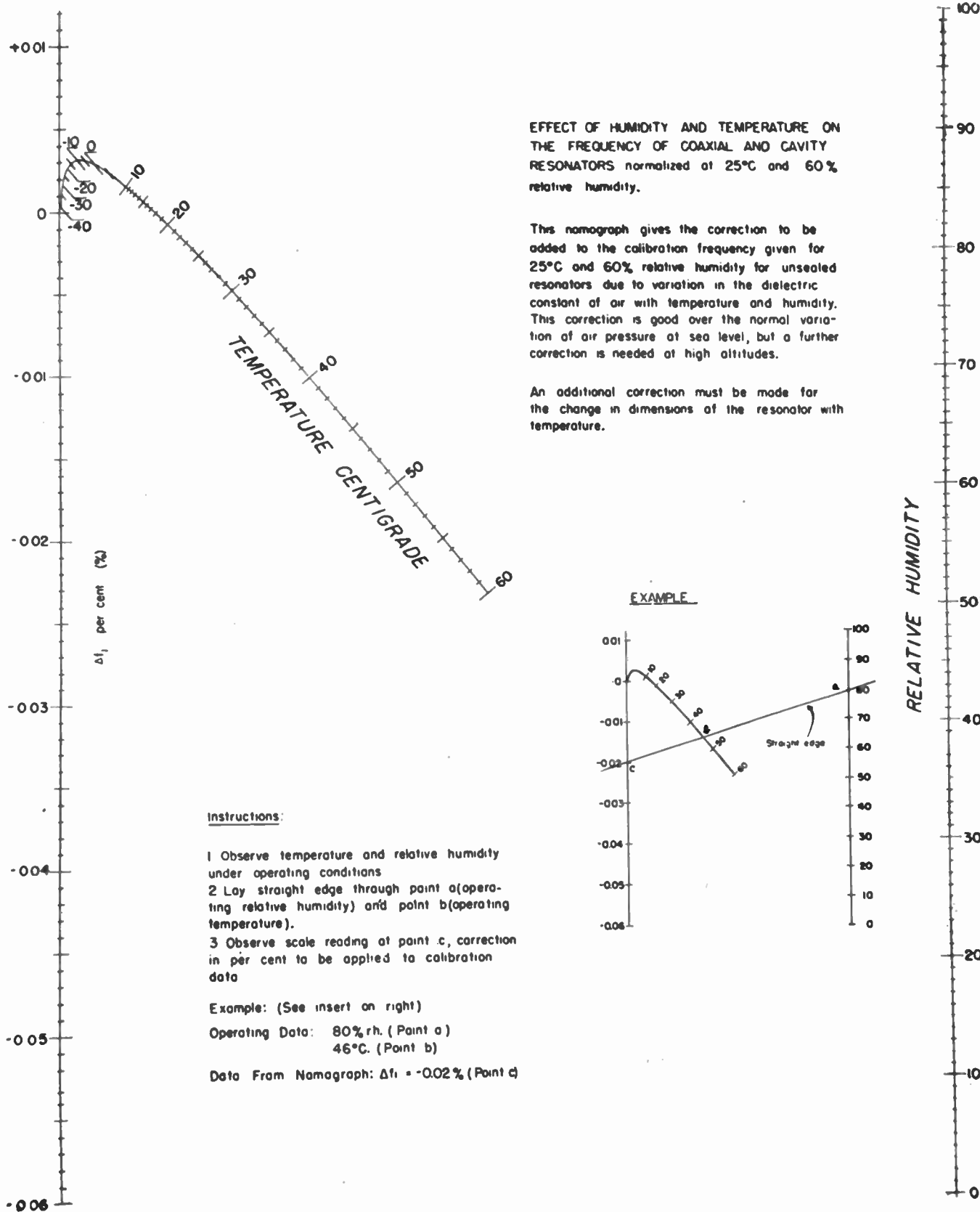

Fig. 29—Nomograph for calculating humidity effect on wavemeters of the resonant-line or cavity type

to utilize resistive pads on input and output of both test and reference cavities to insure freedom from frequency pulling.

Another arrangement which may be used when very precise measurement of cavity frequency is required is shown in Fig. 31. With this arrangement, the resonant

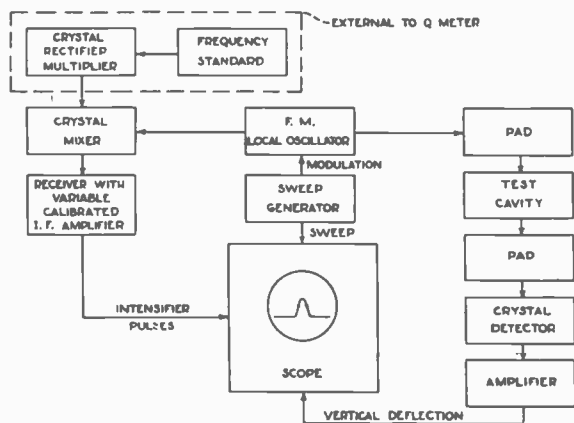

Fig. 31—Block diagram of the cavity comparator and Q meter.

frequency of the cavity is measured by means of a quartz-crystal standard. In this system, a microwave oscillator is frequency-modulated in a manner similar to that of the previous setup and fed to the cavity under test. The bandpass characteristic of the cavity is then displayed on an oscilloscope, as before. The microwave oscillator is also used as the beating oscillator of a superheterodyne receiver into which is fed the output of a crystal multiplier operating from a quartz-crystal frequency standard. As the microwave oscillator sweeps through a band of frequencies, beats with the crystal-multiplier signal are obtained. If the output of the crystal mixer is fed to an intermediate-frequency amplifier, signals will be produced in the output of the intermediate-frequency amplifier when the frequency of the microwave oscillator differs from that of the crystal multiplier by the intermediate frequency. Two side bands are produced in this way, corresponding to the local oscillator having frequencies above and below that of the crystal multiplier. If the output of the intermediate-frequency amplifier is fed to a detector, this results in the production of two pips at corresponding instants of time. These pips may be fed to the cathode-ray oscilloscope as intensifier pulses to produce bright dots on the trace. Remembering that the horizontal position of the cathode-ray beam corresponds to frequency, the intensified dots will occur at frequencies separated by twice the intermediate frequency. If the test cavity is tuned so that these dots fall in a horizontal line, the cavity is accurately tuned to the standard frequency.

By varying the frequency of the intermediate-frequency amplifier, these dots may be made to slide up and down the cavity resonance curve. When the dots are adjusted so as to fall on the half-power points of the resonance curve, the bandwidth of the cavity may be

read directly from the calibrated frequency dial on the intermediate-frequency amplifier.

Very accurate frequency adjustments may be made with this method, because of the fact that the slope of the resonance curve is a maximum at the half-power points. Assuming a perfect standard, the cavity frequency can be set to a precision of approximately $\pm 1/100Q_L$. Accuracy of measurement of bandwidth depends on the calibration of intermediate frequency and on the power calibration of the detector and video amplifier fed from the test cavity. The law of a crystal detector is approximately square, so that, for rough measurements, half power corresponds to half amplitude of the bandpass trace. Q measurements can, in general, be made to an accuracy of about 5 per cent.

BENCH OSCILLATORS AND SIGNAL GENERATORS

For measurements work in the microwave region, velocity-modulation-type tubes have proved most advantageous. While these tubes are not amenable to sine-wave amplitude modulation they can be square-wave-modulated conveniently, and in addition can be frequency-modulated quite easily. With suitable cavity designs, such tubes can be made to tune over broad frequency bands. A typical cavity used with a tube designed for the 3000-megacycle region is shown in Fig. 32. In this design a rectangular wave-guide cavity

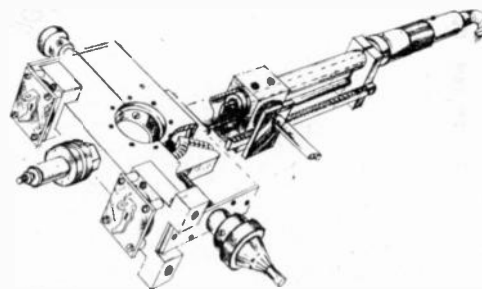

Fig. 32—Velocity-modulation tube, wave-range cavity.

is used, and outputs are taken from coupling loops inserted into the cavity through the narrow sides of the wave guide. Tuning plungers allow adjustment of the resonant frequency of the cavity. In the design shown, the right-hand output is fed to a wave-guide beyond-cutoff attenuator and the left-hand output is fed to a power-monitoring thermistor. Provision is also made for mounting disk-type thermistors for ambient-temperature-drift correction.

Fig. 33 shows the same type of cavity with the velocity-modulation tube installed. The two modulator grids of the tube are clamped by means of split rings to the two broad faces of the resonant cavity. In the design shown, direct-current connections to the tube are made through filter chokes which consist of coaxial lines with "lossy" material replacing the dielectric. This provides the necessary leakage protection if the oscillator is to be used for signal-generator applications. The matter of leakage in such oscillators is of considerable concern

and requires that all joints be very carefully made.

In Fig. 34, the assembled cavity is shown installed in a signal-generator unit which, in addition to the radio-frequency circuit previously described, contains a power supply for the velocity-modulation oscillator and the pulsing and phasing circuits for pulsed operation. The unit shown was designed to cover the frequency range of from 4000 to 2500 megacycles.

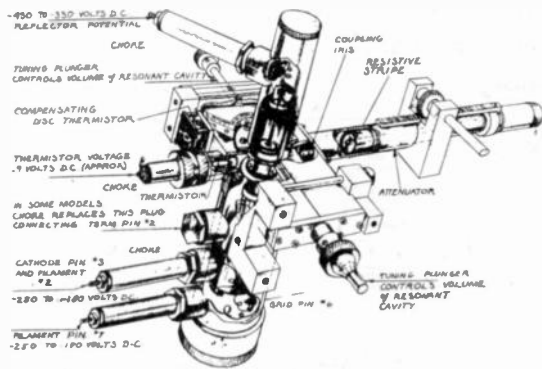

Fig. 33—Cavity for velocity-modulation tube showing tube in place.

A type of signal generator which is considerably easier to construct from a circuit standpoint than the pulsed signal generator has been called a frequency-modulation signal generator. In this type of signal generator the radio frequency is varied in saw-tooth fashion as a function of time and is caused to sweep through the bandpass of the receiver under test. As the signal-generator oscillator sweeps through the receiver bandpass, a pulse in the output of the receiver is produced which has the shape of the re-

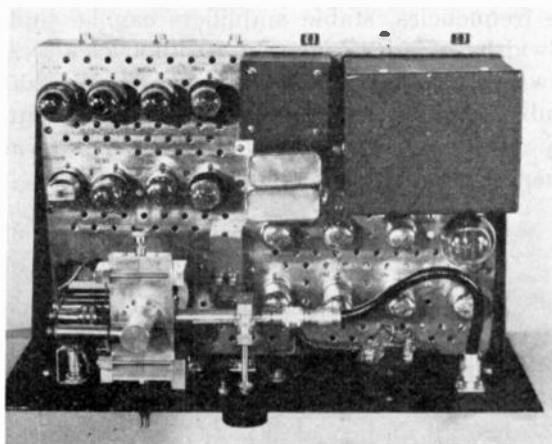

Fig. 34—Signal generator for use in the 3000-megacycle region of the spectrum.

ceiver bandpass. A block diagram of the operation of this type of test set is shown in Fig. 35. The frequency modulation is accomplished by feeding the saw-tooth voltage to the reflector of a reflex-type velocity-modulation tube. In the diagram, the solid line *A* indicates the wave form applied to the reflector and may also be taken as representing the frequency versus time characteristic of the oscillator. The pulse produced

as the oscillator frequency is swept through the receiver bandpass is shown by the curve below the saw

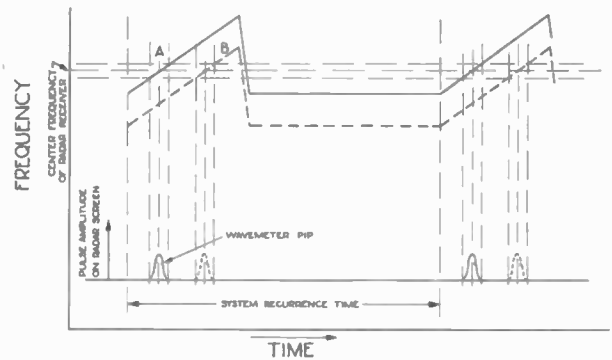

Fig. 35—Operational diagram of the frequency-modulation test set.

tooth. When testing a radar system, the saw-tooth voltage must, of course, be synchronized with the radar-system recurrence if a study pulse is to be observed on the screen of the radar receiver. If, now, the direct-current level of the reflector voltage is

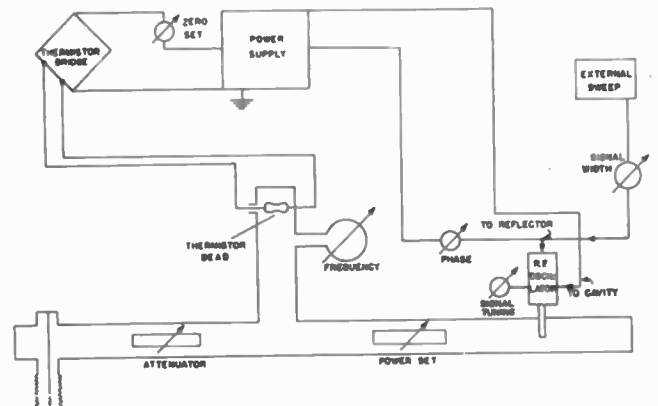

Fig. 36—Block diagram of the frequency-modulation test set.

changed as shown in the dotted curve *B*, the pulse observed on the radar screen will be moved effectively in time phase, since the oscillator sweeps through the

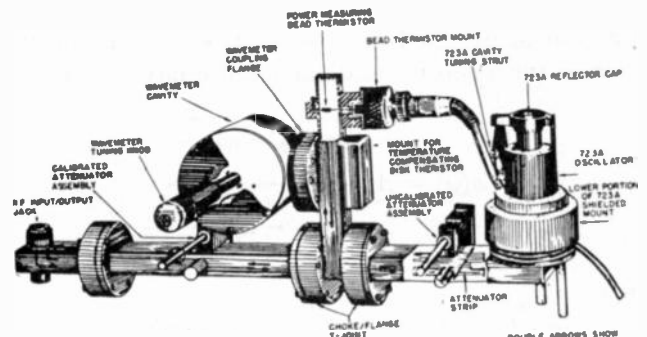

Fig. 37—Frequency-modulation test set; radio-frequency plumbing layout.

bandpass at a different instant of time. This operation provides a very simple phasing means.

A block diagram of the frequency-modulation test set is shown in Fig. 36. A schematic of the plumbing

layout is shown in Fig. 37. The power from the signal-generator oscillator is fed from a level-set attenuator to a junction where it divides between a thermistor power measurer and the output line in which is mounted a calibrated attenuator. A wavemeter is incorporated in the power-measuring arm to allow measurement of the oscillator frequency. As the radio-frequency oscillator is swept through the wavemeter frequency, a reaction is also produced on the power in the main output line so as to result in a decrease in power output at that frequency. On the pattern displayed on the radar A-scope screen, this appears as a pip on the pulse. By noting the position of the pip with respect to the peak of the signal pulse as adjustments are made on the radar system, frequency changes in the receiver local oscillator can be observed.

A picture of an experimental model of this type of test set is shown in Fig. 38.

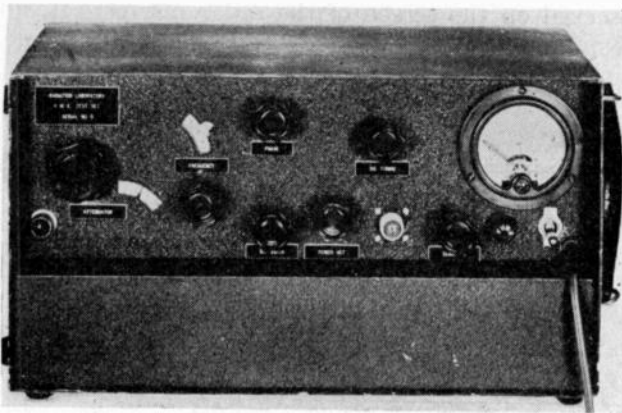

Fig. 38—Frequency-modulation test set.

MEASUREMENT OF SPECTRUM

In most types of microwave radar systems, pulse modulation with very short pulses is employed. Magnetrons are usually used as the high-power pulsed oscillators and pulse widths used fall in the region from 5 to 0.1 microseconds. The radio-frequency energy is then spread over a band of frequencies, the spectrum function for a short rectangular pulse having a form

$$a(\omega) = A \frac{\sin(\omega_0 - \omega) \frac{\tau}{2}}{(\omega_0 - \omega) \frac{\tau}{2}} \quad (12)$$

where

ω_0 = angular velocity of oscillator signal

τ = pulse width.

To determine the correct operating voltages and magnetic fields for magnetron oscillators, it is necessary to provide a means for presenting the spectrum function on some type of indicator such as a cathode-ray oscilloscope. The instrument designed for this application is known as a spectrum analyzer, and a block diagram of such a unit is shown in Fig. 39. In this instru-

ment, a superheterodyne receiver having a very narrow pass band is utilized together with a local oscillator whose frequency is swept through a bandwidth equal to several lobes of the spectrum to be examined. The time of sweep of the local-oscillator frequency is made long compared to the system-recurrence time, so that a number of pulses is emitted during a single sweep. For each of these pulses the receiver is tuned to a different frequency, and in this way the amplitude of the pulses in the output of the receiver has an envelope which is the spectrum function.

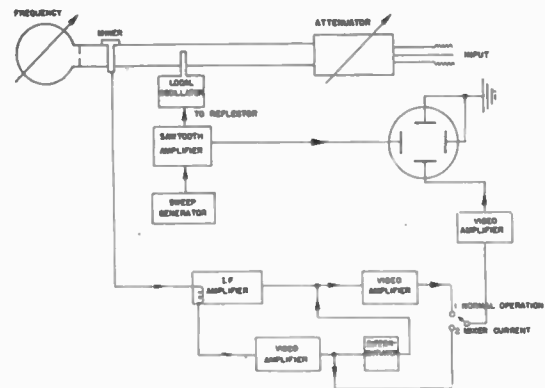

Fig. 39—Block diagram of the spectrum analyzer.

In order to obtain maximum resolution it is desirable that the bandwidth of the intermediate-frequency amplifier be kept narrow. The intermediate frequency, on the other hand, must be high enough so that trouble is not experienced due to image frequencies since no radio-frequency preselection is employed. For the range of pulse widths indicated, intermediate frequencies of the order of 20 megacycles prove satisfactory. At these frequencies, stable amplifiers can be built with bandwidths of approximately 50 kilocycles. Narrower bandwidths can be obtained through the utilization of a double-superheterodyne system, but sufficient selectivity must be obtained at the higher intermediate frequency to provide adequate image rejection.

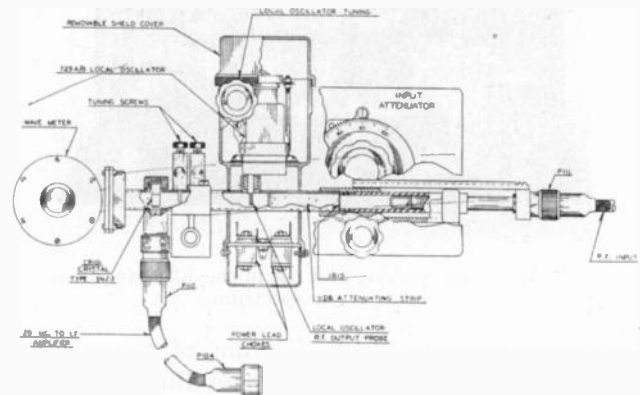

Fig. 40—Spectrum analyzer for use in the 10,000-megacycle region.

A cut-away diagram of the radio-frequency plumbing in a spectrum analyzer designed for use in the 10,000-megacycle region is shown in Fig. 40. The instrument is equipped with a wave-guide beyond-cutoff

input attenuator to allow its use for various measuring applications. A continuous-wave signal, for instance, produces a single pip in the output of the receiver, and the instrument can therefore be used as a sensitive receiver for such purposes as power comparison, frequency measurements, etc. The radio-frequency input signals are combined with the output of a microwave local oscillator in a wave-guide system and are fed to a crystal detector whose output is taken off to the intermediate-frequency amplifier. A wave-meter is provided which produces a reaction in the local-oscillator power output when tuned to resonance. So that the device may be used as a measuring tool, the entire radio-frequency system is thoroughly shielded and direct-current leads are brought in through "lossy" filters. A picture of the complete unit is shown in Fig. 41.

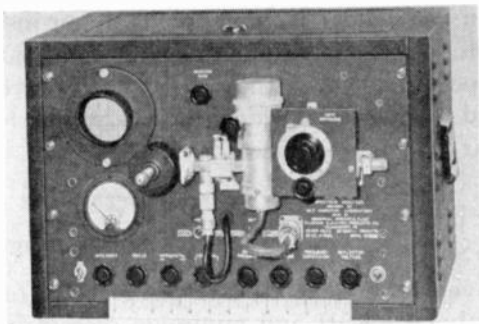

Fig. 41—Spectrum analyzer for 10,000 megacycles.

DIRECTIONAL COUPLERS

In order to connect measuring apparatus to a radar system, some means of radio-frequency coupling to the system must be provided. One such means makes use of a small pickup antenna located at a definite position with respect to the radar antenna. With such a system, however, it is difficult to standardize the coupling between the two antennas, and severe difficulties arise due to reflections from surrounding objects.

To eliminate these difficulties, it is desirable to provide a means of coupling directly to the main transmission line of the radar system. Remembering, however, that the transmission lines of a radar system are seldom perfectly matched, it is necessary to provide a coupling means which is independent of standing waves which may exist in the radar transmission line. Such coupling devices have been designed and are termed "directional couplers," since the amount of power extracted from (or put into) the main transmission line is proportional only to the power in a wave which travels in a preferred direction (toward the antenna or receiver, as the case may be).

Operation of such a device is illustrated in Fig. 42. Here, two coupling paths are provided between the main guide and the auxiliary guide. The auxiliary guide is fitted with a matched detector on one end and a matched termination on the other. Proceeding in the direction of the main wave, it may be seen that the

contribution from the two waves traveling toward the detector add in phase since the path lengths are the same regardless of the spacing of the coupling holes. If, now, the coupling holes are separated by one quarter of a guide wavelength, waves traveling in a direction opposite to the main wave (waves due to reflection) combine at the detector 180 degrees out of phase and so cancel. At the termination, however, these waves add and are completely absorbed. In this way, the power indicated by the detector is proportional only to the power in the main wave and is independent of the reflected power. If, in place of the detector shown, a signal-generator input is provided, waves in the main guide will be launched only in a direction opposite to that indicated; that is, toward the receiver if we consider the main wave shown as proceeding toward the antenna.

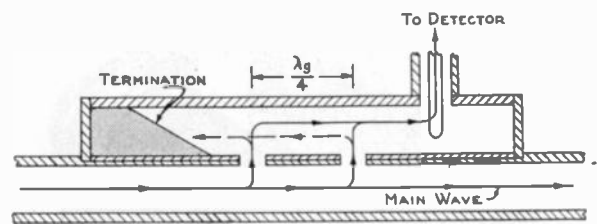

Fig. 42—Wave-guide directional-coupler schematic diagram.

For most applications, it is desired that only a small fraction of the power in the main wave be diverted to the detector. The ratio of the power in the main wave to that fed to the detector is defined as the coupling of the directional coupler. The ratio is usually expressed in decibels and is given by

$$C_{db} = 10 \log_{10} \frac{P_M}{P_A}$$

where P_M = power in main wave

P_A = power in auxiliary guide.

The coupling is a function of the size, number, and position of the coupling holes, and of the frequency of operation. It can be made reasonably constant over a band of frequencies, a typical example having a variation of 1 decibel in 20 over a 15 per cent band. Reduced frequency sensitivity of coupling sometimes can be obtained by combining two couplers, operating on different principles, and having opposite frequency characteristics.

It will be seen that the directional properties of the coupler depends on the spacing of the holes, and it is, for this reason, somewhat frequency sensitive although fairly high directivity can be obtained over a reasonable frequency band.

The directivity of a coupler is defined as the ratio of the power fed to the detector when the main wave travels in the preferred direction to that which would be fed to the detector if the direction of the main wave were reversed. This quantity is also expressed in decibels and is given by

$$D_{db} = 10 \log_{10} \frac{P_P}{P_R}$$

where

P_P = power in detector when main wave flows in preferred direction

P_R = power in detector where main wave flows in reverse direction.

The directivity of a coupler is a measure of its ability to discriminate in favor of a wave traveling in the preferred direction, and as such is a criterion of its effectiveness when used as a transmission-line tap for measurement purposes.

A picture of a complete unit operating on the principles of Fig. 42 is shown in Fig. 43. Here the auxiliary

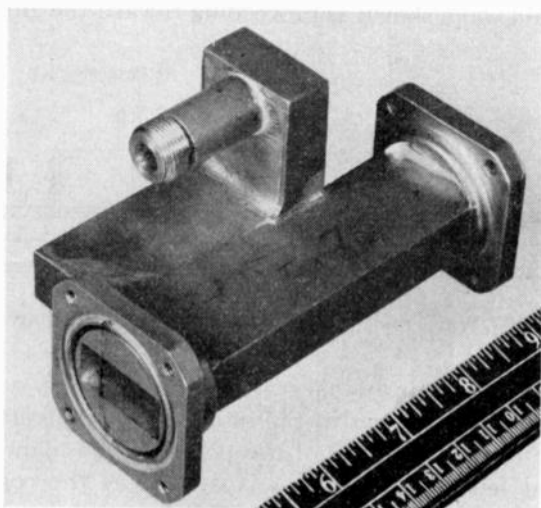

Fig. 43—Wave-guide directional coupler.

guide is bent at right angles to the main guide, to provide a convenient connection to the input probe. The unit shown was designed for use in the 10,000-megacycle region of the spectrum.

A cut-away diagram illustrating the operation of a similar type of directional coupler for use in coaxial lines is shown in Fig. 44. Here the hollow tube used as

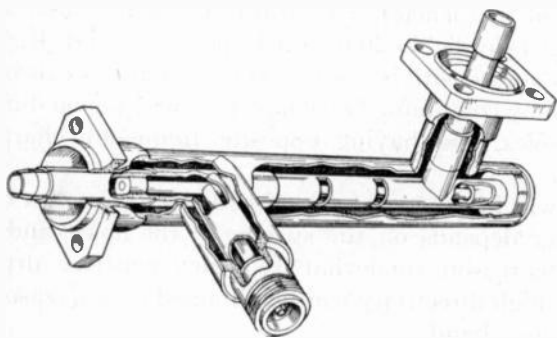

Fig. 44—Coaxial directional-coupler schematic diagram.

the inner conductor for the main coaxial line is also employed as the outer conductor for the auxiliary line, and coupling between the two lines is provided by cutting slots in this tube. The input to the directional

coupler is shown at the left-hand portion of the diagram, while the output of the main line is taken off through a right-angle connector supported by means of a broad-band stub. The auxiliary-line output is similarly constructed and is provided with a type-N fitting for use with flexible-cable connectors.

The directional couplers illustrated above are illustrative of only one type of design. Other designs have been evolved which utilize resistive coupling loops into the main line so arranged as to couple to both electric and magnetic fields. One interesting design utilizes a single iris which couples to both magnetic and electric fields in a way such as to provide directional properties.

OVER-ALL RADAR PERFORMANCE MEASUREMENT

While signal generators and power meters of the type described above find wide application in measurements on radar systems where detailed knowledge is required, it is often convenient to have available an instrument which will, in a single reading, give an indication of the over-all performance of the radar. For a given pulse width and receiver bandwidth, the over-all performance of a radar may be expressed as

$$\text{radar performance} = \frac{\text{peak power output}}{\text{minimum discernible signal}}$$

It is convenient to express the peak power output in decibels above 1 watt and minimum discernible signal in decibels below 1 watt. The performance in decibels may then be expressed as

$$P_{erab} = P_{oab} + P_{sab}$$

where

P_{oab} = peak power output in decibels above 1 watt

P_{sab} = receiver sensitivity in decibels below 1 watt.

A radar in good operating condition usually has a performance of at least 170 decibels.

A simple device for measuring the over-all performance figure consists of a high- Q resonant cavity coupled to the radar by means of either a pickup antenna or a

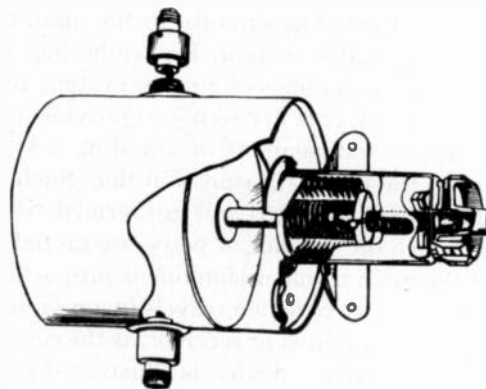

Fig. 45—Resonant-cavity echo box.

directional coupler in the radar line. An outline drawing of such a cavity design for the 3000-megacycle region, utilizing the $TE_{0,1,1}$ mode of oscillation, is shown in

Fig. 45. Such a device is termed an echo box or a ring box.

When a radar emits a pulse of microwave energy a small fraction of this energy is fed to the resonant cavity, causing oscillations to build up within the cavity. Because the Q of the cavity is high, oscillations corresponding to peak amplitude of the pulse are never achieved but the energy stored in the cavity at the end of the pulse is proportional to the peak transmitter power. At the end of the pulse period the echo box begins to dissipate the stored energy. Part of this energy is dissipated in the walls of the cavity and part is reradiated to the radar line. The energy present in the box then decreases exponentially with time at a rate which depends on the loaded Q of the cavity. Since very loose coupling to the radar system is employed, the rate of energy dissipation depends primarily on losses in the cavity.

Immediately after the occurrence of the radar transmitter pulse, sufficient energy is radiated from the cavity to produce saturation of the radar receiver. After a period of time, however, the power coupled to the radar system falls below the saturation level and an exponential curve appears on the screen of the radar scope (assuming a type-A scope which plots amplitude versus time). Eventually the power will decay to a value equal to the noise power of the radar receiver after which the trace will no longer be discernible. The total elapsed time between the radar transmitter pulse and the instant that the echo-box signal is no longer discernible is then a measure of over-all radar performance, since this decay time depends on both the radar transmitter power and the noise power (sensitivity) of the radar receiver.

The accuracy with which over-all performance measurements can be made depends primarily on the sensitivity of the echo box, which in turn depends on the loaded Q of the cavity. The sensitivity is usually expressed in terms of microseconds change in ring time per decibel change in system performance. A typical figure for an echo box in the 3000-megacycle region is 0.5 microsecond per decibel, which corresponds to a loaded-cavity Q of approximately 50,000. It is difficult to maintain the sensitivity as the operating frequency is made higher, due to the fact that the loaded Q required for the same sensitivity must increase as the square root of the frequency. The $TE_{0,1,1}$ mode is the highest- Q first-order mode, so that it becomes necessary to go to higher-order $TE_{0,1,n}$ modes if the same sensitivity is to be achieved at higher frequencies. The use of higher-order modes introduces problems due to the possibility of modes other than the desired one being present which may give extraneous responses or may interfere with the operation of the desired mode. Considerable work has been done, however, in evolving

mode-suppression techniques and it has been possible to produce resonant cavities in the 10,000-megacycle region whose loaded Q is of the order of 80,000 resulting in a sensitivity of approximately 0.35 microsecond per decibel.

To utilize echo boxes for precise measurements it is necessary, in addition to providing a high- Q cavity, to provide means for accurate determination of the ring time. Many radar systems are equipped with accurate range-measuring devices which serve this purpose well. On some types of systems, however, accurate ranging is not incorporated, and it becomes necessary to provide an auxiliary ranging-type oscilloscope.

In addition to providing over-all performance measurements, the echo box may, by virtue of its narrow bandwidth, be used as a spectrum analyzer. This is accomplished by providing the cavity with a second coupling loop or iris which couples out a small portion of the energy to a crystal detector or indicator. As the echo box is tuned through the band of the magnetron frequency spectrum, the indicator plots the spectrum function. The tuning dial of the cavity is calibrated in terms of frequency so that the width and form of the spectrum may be determined.

If the echo box is coupled to the line of a radar which utilizes a rotating antenna, the operation of the system as the antenna is rotated may be observed by watching the variation of ring time on the radar scope. In this way, bad frequency pulling of the magnetron due to defective rotary joints or to similar causes may be observed.

The echo box constitutes a simple device for measuring many of the characteristics of a radar system. It should be pointed out, however, that in cases where the performance figure is below normal the echo box does not discriminate between troubles with the radar transmitter and receiver, nor does it give an indication of the pulse-response characteristics of the radar receiver. For obtaining data on these factors it is necessary to supplant the echo box with signal-generator and power-measuring instruments such as those previously described.

ACKNOWLEDGMENT

The instruments and measuring techniques described in this paper are the result of the combined efforts of many individuals working in several laboratories during the war years. While it is impossible to give individual credit in such a case, the science owes a particular indebtedness to workers in the Massachusetts Institute of Technology Radiation Laboratory, the Bell Telephone Laboratories, the Polytechnic Institute of Brooklyn, and the Sperry Gyroscope Company.

Stability and Frequency Pulling of Loaded Unstabilized Oscillators*

JACK R. FORD† AND N. I. KORMAN†, SENIOR MEMBER, I.R.E.

Summary—Conditions are established under which the frequency of a loaded unstabilized oscillator will not jump discontinuously as the load susceptance is changed. Frequency-pulling equations and stability criteria are established for an oscillator coupled to a resistive load through a pair of coupled resonant circuits.

GLOSSARY OF SYMBOLS

- ω_o = resonant angular frequency of the load circuit
 ω = angular frequency in radians per second
 ω_r = resonant angular frequency of the unloaded tank circuit
 L = tank inductance
 L_p = inductance of the load coupling coil
 M = mutual inductance between L and L_p
 L_o = equivalent inductance in the load circuit contributed by the coupling transformer.
 L_o = total inductance in load circuit
 C = tank capacitance
 C_o = capacitance in load circuit
 r_p = internal resistance of an oscillator
 R = load resistance
 Z_L = load impedance including tuning impedances
 Z = Z_L plus the leakage reactance of the transformer
 $G_o(\omega)$ = the conductance of Z
 $B_o(\omega)$ = the susceptance of Z
 $\Delta B_o(\omega)$ = a change in the susceptance of $B_o(\omega)$
 $B(\omega)$ = the susceptance into which the tube works—the susceptance function
 K = the kilovolt-ampere ratio of the tank circuit, sometimes called the loaded Q
 K_p = the kilovolt-ampere ratio of the load circuit
 δ = the per-unit change in frequency
 100δ = the percentage change in frequency
 y = an unspecified parameter influencing $B_o(\omega)$
 $(L/M)^2 Z$ = an impedance which, shunted across the tank, will replace Z_L plus the coupling coil.

I. THE PROBLEM

TUNING UP a loaded self-excited oscillator to a given frequency is often difficult due to an apparent discontinuity in the frequency-determining controls. If, for example, the frequency is too low and one decreases the tank capacitance slowly, the frequency may increase slowly for a time and then hop past the desired value. If an attempt is made to lower the frequency a similar discontinuity is noted, and so on *ad nauseam*. If the coupling between the oscillator

and the load is sufficiently lowered the discontinuity will disappear, but so also may the power output.

Furthermore, coupling a load to a self-excited oscillator may be complicated by discontinuous jumps in frequency as the tuning controls are manipulated to increase the power into the load. As the load is tuned up to the oscillator frequency, the power into the load increases up to a point at which the oscillator suddenly changes its frequency to one at which there is less power in the load. A further attempt to tune the load to the new frequency is likewise unsuccessful because the oscillator will again change its frequency.

Since the problem is important in such applications as radar transmitters and industrial heating, simple design formulas, adequately describing this phenomenon, are desirable.

II. THE GENERAL CASE OF THE LOADED UNSTABILIZED OSCILLATOR

In a large number of self-excited oscillators such as the Hartley, Colpitts, transitron, magnetron, etc., the output tank and the circuits connected to it are the main frequency-determining elements. In other types of oscillators, such as crystal-controlled oscillators, master-oscillator power-amplifier systems, etc., the output tank and the circuits connected across it are not the most important factors in determining the frequency of oscillation. It is beside the main purpose of this paper to discuss this second type of oscillator. In this connection we may note, however, that a characteristic of the first type is that the electron stream factor delivers negligible reactive power to the tank circuit. Stated in other terms, we shall concern ourselves in this paper only with consideration of oscillators in which the current delivered by the electron stream to the tank is in phase with the voltage across the tank.

In Appendix II it is shown quite generally that, in any closed circuit, the reactive power as well as the real power is conserved. If we remember that the electron stream can be a source of reactive power as well as real power, we can use the law of the conservation of energy to determine the frequency of oscillation of an oscillator. In particular, if the tube and circuit are such that the electron stream does not deliver reactive power, then the frequency of oscillation will be that at which the susceptance "seen" by the electron stream vanishes. That is

$$B(\omega) = 0 \quad (1)$$

where the parentheses indicate that the susceptance is a function of frequency.

We can use this equation to investigate the change

* Decimal classification: R355.91. Original manuscript received by the Institute, December 6, 1945; revised manuscript received, February 28, 1946.

† Radio Corporation of America, Camden, N. J.

in frequency with respect to any of the frequency-determining elements. Let y be such an element. Remembering that the susceptance is now a function of y in addition to ω , we write

$$\begin{aligned}
 B(\omega, y) &= 0 \\
 dB(\omega, y) &= \frac{\partial}{\partial \omega} B(\omega, y)d\omega + \frac{\partial}{\partial y} B(\omega, y)dy \\
 \frac{d\omega}{dy} &= - \frac{\frac{\partial}{\partial y} B(\omega, y)}{\frac{\partial}{\partial \omega} B(\omega, y)} \quad (2)
 \end{aligned}$$

We note that $d\omega/dy$ becomes infinite whenever $(\partial/\partial\omega) B(\omega, y)$ vanishes, except for the unimportant case in which $B(\omega, y)$ is unaffected by a change in y . Frequency instability occurs whenever the derivative, with respect to frequency, of the susceptance "seen" by the electron stream is zero. It is interesting to note that this result is independent of which of the many frequency-determining elements is considered to be the variable.

In the balance of this paper we shall assume, when differentiating with respect to frequency, that all circuit elements are constant. Dropping the partial notation, instability will occur in an oscillating system when (1) and (3) are satisfied simultaneously.

$$\begin{aligned}
 B(\omega) &= 0 \\
 \frac{d}{d\omega} B(\omega) &= 0. \quad (3)
 \end{aligned}$$

By multiplying both sides of (3) by $f(\omega)$, an alternate expression is obtained that is usually more convenient to use. Here $f(\omega)$ is restricted to include only such continuous functions of frequency that do not vanish within

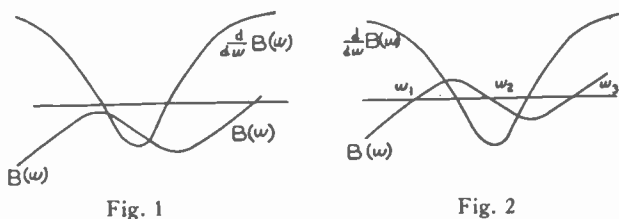

the region of frequencies to be investigated. Furthermore, within this region, such a function may always be arranged to be positive, so that $f(\omega)(d/d\omega) B(\omega)$ will have the same sign as $(d/d\omega) B(\omega)$. The alternate expression is then

$$f(\omega) \frac{d}{d\omega} B(\omega) = 0; f(\omega) > 0. \quad (3a)$$

In cases in which the slope of the susceptance function is negative at some frequency, it usually happens that the slope goes through zero and becomes positive in frequency regions on each side of the region of negative slope. This, in turn, implies that a frequency region exists in which, as the frequency increases in a uniform

manner, the susceptance function will at first increase, reach a maximum, decrease, reach a minimum, and then increase again. This is shown in Figs. 1 and 2; here $B(\omega)$ represents the susceptance function, while $(d/d\omega) B(\omega)$ is its slope.

If oscillations are to occur in this region, there must be at least one point within it at which the susceptance function will vanish. From the nature of the curve it may be seen that if but one such point exists (as illustrated in Fig. 1) the addition of a susceptance, varying but slowly with frequency and of proper sign, will cause the susceptance function to vanish at three frequencies $=\omega_1, \omega_2,$ and ω_3 as in Fig. 2. Furthermore, if the frequency of oscillation is ω_1 , or ω_2 , the addition of a sufficiently large negative susceptance will make oscillation impossible at these points. This causes the frequency to hop to ω_3 , which is now the only frequency at which oscillation can occur. Conversely, if the frequency of oscillation is ω_2 or ω_3 , the addition of a sufficiently large

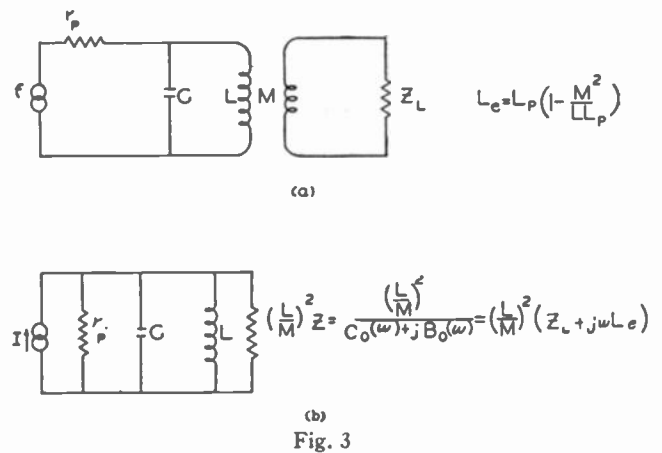

positive susceptance will make oscillation impossible at these points, thus making the frequency hop to ω_1 which is now the only frequency at which oscillation can occur. Hence, if we reject this type of performance as conditionally unstable, oscillating systems that have regions in which the slope of the susceptance function is negative should be regarded with the greatest suspicion. In connection with the above, we have the following theorem:

If, in the immediate neighborhood of the oscillation frequency, as determined by $B(\omega) = 0$, the slope of the susceptance function is negative, and if this region of negative values is surrounded by a region of positive values, the oscillating system will be conditionally unstable. (4)

Fig. 3(a) and its equivalent¹ Fig. 3(b) represent an oscillator inductively coupled to its load. Fig. 3(b), without essential change, also represents the case in which the load Z_L is connected directly across all or a part of the tank inductor L . What follows applies to all three cases.

¹ Ernst A. Guillemin, "Communication Networks," vol. 2, John Wiley and Sons, Inc., New York, N. Y., 1935, pp. 153-156.

The susceptance function of Fig. 3 is

$$B(\omega) = \omega C - \frac{1}{\omega L} + \left(\frac{M}{L}\right)^2 B_o(\omega)$$

$$B(\omega) = \sqrt{\frac{C}{L}} \left(\frac{\omega}{\omega_r} - \frac{\omega_r}{\omega}\right) + \left(\frac{M}{L}\right)^2 B_o(\omega) \quad (5)$$

where ω_r is defined by the relation

$$\omega_r = \frac{1}{\sqrt{LC}}$$

The slope of the susceptance function as given by (6) is equal to the rate of change of the susceptance of the unloaded tank circuit plus the rate of change of the susceptance of the load circuit multiplied by the ratio of transformation. The first quantity is always positive.

$$\frac{d}{d\omega} B(\omega) = \frac{1}{\omega} \sqrt{\frac{C}{L}} \left(\frac{\omega}{\omega_r} + \frac{\omega_r}{\omega}\right) + \left(\frac{M}{L}\right)^2 \frac{d}{d\omega} B_o(\omega). \quad (6)$$

In accordance with (1) and (3), instability will occur if, at the frequency of oscillation,

$$\frac{d}{d\omega} B_o(\omega) = -\frac{1}{\omega} \left(\frac{L}{M}\right)^2 \sqrt{\frac{C}{L}} \left(\frac{\omega}{\omega_r} + \frac{\omega_r}{\omega}\right). \quad (7)$$

In accordance with (3a), it is usually more convenient to write (7) in the form

$$f(\omega) \frac{d}{d\omega} B_o(\omega) = -\frac{f(\omega)}{\omega} \left(\frac{L}{M}\right)^2 \sqrt{\frac{C}{L}} \left(\frac{\omega}{\omega_r} + \frac{\omega_r}{\omega}\right).$$

If, in the immediate neighborhood of the frequency of oscillation, the curve of the rate of change of the susceptance of the load circuit versus frequency passes through a minimum, and if, in addition, the minimum value is sufficiently negative when multiplied by the ratio of transformation as to make the susceptance function (given by (6)) negative, theorem (4) will apply. The criteria for stable operation will then become

$$\left[\frac{d}{d\omega} B_o(\omega)\right]_{\min} > -\frac{1}{\omega} \left(\frac{L}{M}\right)^2 \sqrt{\frac{C}{L}} \left(\frac{\omega}{\omega_r} + \frac{\omega_r}{\omega}\right). \quad (8)$$

In accordance with (3a), it is usually more convenient to write this inequality in the form

$$\left[f(\omega) \frac{d}{d\omega} B_o(\omega)\right]_{\min} > -\frac{f(\omega)}{\omega} \left(\frac{L}{M}\right)^2 \sqrt{\frac{C}{L}} \left(\frac{\omega}{\omega_r} + \frac{\omega_r}{\omega}\right).$$

FREQUENCY PULLING

The per-unit change in frequency δ , as the susceptance in the load circuit $B_o(\omega)$ is changed an amount $\Delta B_o(\omega)$, can be found from the frequency-determining equation $B(\omega) = 0$. Hence, the relation between the frequency of oscillation ω_1 and the susceptance $B_o(\omega_1)$ is obtained by equating the right hand side of (5) to zero.

$$\sqrt{\frac{C}{L}} \left(\frac{\omega_1}{\omega_r} - \frac{\omega_r}{\omega_1}\right) + \left(\frac{M}{L}\right)^2 B_o(\omega_1) = 0. \quad (9)$$

Should the susceptance of the load be increased by an amount $\Delta B_o(\omega)$ the frequency will change to a new value ω_2 , so that

$$\omega_2 = \omega_1(1 + \delta).$$

In a manner similar to that used in obtaining (9) we have

$$\sqrt{\frac{C}{L}} \left(\frac{\omega_1}{\omega_r} (1 + \delta) - \frac{\omega_r}{\omega_1(1 + \delta)}\right) + \left(\frac{M}{L}\right)^2 [B_o(\omega_1) + \Delta B_o(\omega)] = 0.$$

If δ is very small compared to 1, we have, approximately,

$$\sqrt{\frac{C}{L}} \left[\frac{\omega_1}{\omega_r} - \frac{\omega_r}{\omega_1} + \delta \left(\frac{\omega_1}{\omega_r} + \frac{\omega_r}{\omega_1}\right)\right] + \left(\frac{M}{L}\right)^2 [B_o(\omega_1) + \Delta B_o(\omega)] \cong 0. \quad (10)$$

Subtracting (9) from (10), we have

$$\delta \cong -\frac{1}{\frac{\omega_1}{\omega_r} + \frac{\omega_r}{\omega_1}} \sqrt{\frac{L}{C}} \left(\frac{M}{L}\right)^2 \Delta B_o(\omega). \quad (11)$$

Now ω_1 will be in the neighborhood of ω_r for a practical oscillator and we may use the approximation

$$\frac{\omega_1}{\omega_r} + \frac{\omega_r}{\omega_1} \cong 2.$$

Therefore (11) becomes

$$\delta \cong -\frac{1}{2} \sqrt{\frac{L}{C}} \left(\frac{M}{L}\right)^2 \Delta B_o(\omega). \quad (12)$$

To recapitulate:

If, in the immediate neighborhood of the oscillation frequency, as determined by $B(\omega) = 0$, the slope of the susceptance function is negative, and if this region of negative values is surrounded by a region of positive values, the oscillating system will be unstable. The region of stable operation is marked by the inequality

$$\left[f(\omega) \frac{d}{d\omega} B_o(\omega)\right]_{\min} > -\frac{f(\omega)}{\omega} \left(\frac{L}{M}\right)^2 \sqrt{\frac{C}{L}} \left(\frac{\omega}{\omega_r} + \frac{\omega_r}{\omega}\right).$$

The per-unit frequency pulling resulting from a change in load susceptance is given by

$$\delta \cong -\frac{1}{2} \sqrt{\frac{L}{C}} \left(\frac{M}{L}\right)^2 \Delta B_o(\omega).$$

III. AN OSCILLATOR COUPLED TO A RESISTIVE LOAD THROUGH A PAIR OF COUPLED RESONANT CIRCUITS

Fig. 4 represents an oscillator coupled to its load through a pair of coupled resonant circuits. The total inductance in the load circuit is L_o , which is equal to the

sum of the load tuning and leakage reactances. The admittance Y of the load circuit is given by

$$Y = \frac{1}{R + j\left(\omega L_o - \frac{1}{\omega C_o}\right)} \quad (13)$$

Defining μ and ω_o by the relations

$$\tan \mu = \frac{1}{R} \left(\omega L_o - \frac{1}{\omega C_o}\right) \quad (14)$$

$$\omega_o = \frac{1}{\sqrt{L_o C_o}} \quad (15)$$

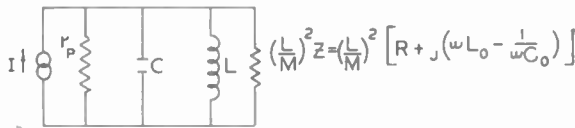
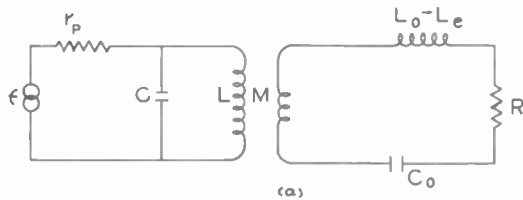

Fig. 4

In Appendix I it is shown that the slope of the susceptance of the load circuit takes on the simple form

$$f(\omega) \frac{d}{d\omega} B_o(\omega) = -\frac{1}{R^2} \sqrt{\frac{L_o}{C_o}} \cos^2 \mu \cos 2\mu \quad (16)$$

where

$$f(\omega) = \frac{\omega}{\frac{\omega}{\omega_o} + \frac{\omega_o}{\omega}} \quad (17)$$

A plot of the factor $\cos^2 \mu \cos 2\mu$ versus μ and ω is shown in Fig. 5. Reference to Appendix I, together with

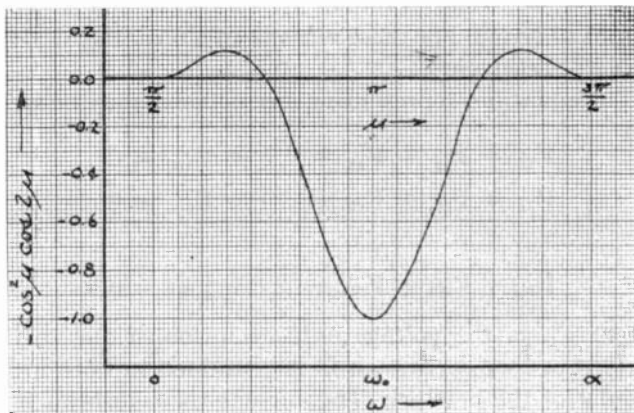

Fig. 5

an inspection of this curve, will show that $f(\omega)(d/d\omega)\beta_o(\omega)$ passes through a minimum at $\omega = \omega_o$ and that its most negative value is given by

$$\left[f(\omega) \frac{d}{d\omega} B_o(\omega) \right]_{\min} = -\frac{1}{R^2} \sqrt{\frac{L_o}{C_o}} \quad (18)$$

Furthermore, an inspection of (17) will confirm that $f(\omega)$ is everywhere continuous and greater than zero except when $\omega = 0$. Hence, if the frequency of oscillation is in the neighborhood of ω_o , inequality equation (8) will define the region of stable operation.

$$\left[f(\omega) \frac{d}{d\omega} B_o(\omega) \right]_{\min} > -\frac{f(\omega)}{\omega} \left(\frac{L}{M}\right)^2 \sqrt{\frac{C}{L}} \left(\frac{\omega}{\omega_r} + \frac{\omega_r}{\omega}\right)$$

or in this case

$$-\frac{1}{R^2} \sqrt{\frac{L_o}{C_o}} > -\frac{\frac{\omega}{\omega_r} + \frac{\omega_r}{\omega}}{\frac{\omega}{\omega_o} + \frac{\omega_o}{\omega}} \left(\frac{L}{M}\right)^2 \sqrt{\frac{C}{L}}$$

which we can rewrite approximately (since $\omega_o \cong \omega_r$) as

$$1 < R \sqrt{\frac{L_o}{C_o}} \cdot R \sqrt{\frac{C}{L}} \left(\frac{L}{M}\right)^2 \quad (19)$$

When $\omega = \omega_o$, the impedance presented to the tank circuit by the load circuit is real and equal to $(L/M)^2 R$. Therefore, the kilovolt-ampere ratio of the tank circuit is given by

$$K = \frac{\text{reactive power}}{\text{real power}} = \omega_r C \left(\frac{L}{M}\right)^2 R = R \sqrt{\frac{C}{L}} \left(\frac{L}{M}\right)^2 \quad (20)$$

and the kilovolt-ampere ratio of the load circuit is given by

$$K_P = \frac{\text{reactive power}}{\text{real power}} = \frac{1}{\omega_o C R} = \frac{1}{R} \sqrt{\frac{L_o}{C_o}} \quad (21)$$

Consequently, (19), the criterion for stability, becomes approximately

$$K_P < K \quad (22)$$

It should be noted that when ω_r equals ω_o a stable oscillating system has its closest approach to the unstable region, and that at this point inequality equation (22) is not an approximate but an exact expression.

FREQUENCY PULLING

Suppose the oscillator is operating so that $\omega_r = \omega_o = \omega$ and a change in the load susceptance $\Delta B_o(\omega)$ is caused by the introduction of a reactance ΔX_o , which is small compared to the load resistance. In Appendix I it is shown that

$$\Delta B_o(\omega) \cong -\frac{\Delta x_o}{R^2}$$

Introducing this into (12), we have

$$\delta \cong \frac{1}{2} \sqrt{\frac{L}{C}} \left(\frac{M}{L}\right)^2 \frac{\Delta x_0}{R^2}$$

Recalling (20) we see that this can be written

$$\delta \cong \frac{1}{2} \frac{\Delta x_0}{KR} \quad (23)$$

To summarize:

The oscillating system will be stable if the kilovolt-ampere ratio of the tank circuit exceeds the kilovolt-ampere ratio of the load circuit. The per-unit frequency pulling resulting from a change in load reactance is given by

$$\delta \cong \frac{1}{2} \frac{\Delta x_0}{KR}$$

APPENDIX I

DERIVATION OF EXPRESSIONS FOR THE SUSCEPTANCE OF THE LOAD CIRCUIT AND ITS SLOPE FOR USE IN PART III

Equation (13) gives for the load admittance

$$Y = \frac{1}{R + j\left(\omega L_o - \frac{1}{\omega C_o}\right)} = \frac{R - j\left(\omega L_o - \frac{1}{\omega C_o}\right)}{R^2 + \left(\omega L_o - \frac{1}{\omega C_o}\right)^2}$$

Hence, taking the imaginary part for $B_o(\omega)$, we have

$$B_o(\omega) = - \frac{\omega L_o - \frac{1}{\omega C_o}}{R^2 + \left(\omega L_o - \frac{1}{\omega C_o}\right)^2} \quad (24)$$

Recalling that ω_o and μ are defined by the relations

$$\omega_o = \frac{1}{\sqrt{L_o C_o}} \quad (25)$$

$$\tan \mu = \frac{1}{R} \left(\omega L_o - \frac{1}{\omega C_o}\right) = \frac{1}{R} \sqrt{\frac{L_o}{C_o}} \left(\frac{\omega}{\omega_o} - \frac{\omega_o}{\omega}\right) \quad (26)$$

Equation (24) becomes

$$B_o(\omega) = - \frac{1}{R} \frac{\tan \mu}{1 + \tan^2 \mu} = - \frac{1}{2R} \sin 2\mu \quad (27)$$

To find $(d/d\omega)\beta_o(\omega)$ we make use of the relation

$$\frac{d}{d\omega} B_o(\omega) = \frac{d}{d\mu} B_o(\omega) \cdot \frac{d\mu}{d\omega} \quad (28)$$

We find $d\mu/d\omega$ by differentiating (26)

$$\frac{d\mu}{d\omega} = \frac{1}{\omega R} \sqrt{\frac{L_o}{C_o}} \left(\frac{\omega}{\omega_o} + \frac{\omega_o}{\omega}\right) \cos^2 \mu \quad (29)$$

Differentiating (27) with respect to μ , we have

$$\frac{d}{d\mu} B_o(\omega) = - \frac{1}{R} \cos 2\mu \quad (30)$$

Equation (28) can now be rewritten

$$\frac{d}{d\omega} B_o(\omega) = - \frac{1}{\omega R^2} \sqrt{\frac{L_o}{C_o}} \left(\frac{\omega}{\omega_o} + \frac{\omega_o}{\omega}\right) \cos^2 \mu \cos 2\mu$$

which may be rearranged to give (16)

$$\frac{\omega}{\frac{\omega}{\omega_o} + \frac{\omega_o}{\omega}} \frac{d}{d\omega} B_o(\omega) = - \frac{1}{R^2} \sqrt{\frac{L_o}{C_o}} \cos^2 \mu \cos 2\mu \quad (31)$$

The derivation of the approximation used in Part III

$$\Delta B_o(\omega) = - \frac{\Delta x_0}{R^2}$$

will now be given. If an oscillator is operating so that $\omega = \omega_o = \omega_r$, $\beta(\omega)$ must vanish in accordance with (1). If either L_o or C_o is changed slightly, the frequency of oscillation will shift to a new value ω_1 . We define ΔX_o by the relation

$$\Delta x_0 = \omega_1 L_o - \frac{1}{\omega_1 C_o}$$

From (24) we see that $\beta_o(\omega_1)$, which is now the change in $\beta_o(\omega)$, will be

$$\Delta B_o(\omega) = - \frac{\Delta x_0}{R^2 + (\Delta x_0)^2}$$

which, if $R \gg \Delta X_o$, will be given approximately by

$$\Delta B_o(\omega) \cong - \frac{\Delta x_0}{R^2}$$

APPENDIX II

CONSERVATION OF REAL AND REACTIVE POWER

Oscillator-stability problems can be solved most adequately by use of the theory of the conservation of energy. This method was first developed by Posthumus and Douma.² Their derivation is not wholly satisfactory, however, and their examples are spoiled by many typographical errors. For these reasons an alternative derivation will be given.

The equations representing any network may be written

$$\begin{aligned} V_{11} + V_{12} + V_{13} + \cdots + V_{1N} &= 0 \\ V_{21} + V_{22} + V_{23} + \cdots + V_{2N} &= 0 \\ \dots & \\ V_{N1} + V_{N2} + V_{N3} + \cdots + V_{NN} &= 0 \end{aligned} \quad (32)$$

where V_{ik} is the voltage induced in loop i due to the current in loop k . Branch ik is contained in both loops i and k of the network. The current through branch ik

² K. Posthumus and Tj. Douma, "Frequency stability of oscillators," *Philips Trans. News*, vol. 3, pp. 1-11, 1936; also vol. 6, pp. 31-35, 1939.

is $I_{ik} = I_i - I_k$ because, by convention, we choose all the currents to flow in the same sense. (I_i is the current flowing in loop i). The voltage V_{ik} equals the negative of the voltage V_{ki} , ($V_{ik} = -V_{ki}$). The branch kk is contained only in loop k and the current through it is I_k . Multiply line 1 of (32) by I_1 , line 2 by I_2 , etc., and add all the lines together. We obtain

$$\begin{aligned} & (V_{11}I_1 + V_{22}I_2 + \cdots + V_{NN}I_N) + \\ & (V_{12}I_1 + V_{21}I_2) + (V_{13}I_1 + V_{31}I_3) + \cdots \\ & + \cdots \cdots \cdots + \cdots \cdots \cdots \\ & (V_{ik}I_1 + V_{ki}I_k) = 0. \end{aligned} \quad (33)$$

Equation (33) can be rewritten (since $V_{ik} = -V_{ki}$)

$$\begin{aligned} & (V_{11}I_1 + V_{22}I_2 + V_{33}I_3 + \cdots + V_{NN}I_N) + \\ & V_{12}(I_1 - I_2) + V_{13}(I_1 - I_3) + V_{23}(I_2 - I_3) + \cdots \\ & + \cdots + V_{ik}(I_i - I_k) = 0. \end{aligned} \quad (34)$$

Equation (34) can be rewritten (since $I_{ik} = I_i - I_k$ is the total current through branch ik) as follows:

$$\sum_{ik} V_{ik} I_{ik} = 0. \quad (35)$$

In words, (35) states that, if the product of voltage by the current is taken for every branch of a circuit and all these products added, the result should be zero.

Since, in general, V_{ik} and I_{ik} are complex numbers, we may write

$$V_{ik} I_{ik} = R_{ik} + jI_{ik}$$

Therefore, since the real and imaginary parts of (35) must be independently equal to zero.

$$\sum_{ik} R_{ik} = 0 \quad (36)$$

$$\sum_{ik} I_{ik} = 0 \quad (37)$$

R_{ik} is the power in branch ik , and $\sum_{ik} R_{ik}$ is the total power in the network. Therefore, (36) is just a statement of the conservation of energy. I_{ik} is the reactive power in branch ik , and $\sum_{ik} I_{ik}$ is the total reactive power in the network. Therefore, (37) states that the total reactive power in any network is zero.

The Inductance-Capacitance Oscillator as a Frequency Divider*

ERNST NORRMAN†

Summary—The use of an inductance-capacitance oscillator as a frequency divider is discussed. A fundamental circuit is described, and the values of its circuit elements are given. The effect on the control range of variations in the values of the circuit elements is revealed. A diagram of a four-stage divider, together with values of the circuit elements, is given, and the procedure of tuning the successive oscillator stages is described. Similar units have been in operation for several years without requiring retuning of the oscillators.

INTRODUCTION

AS A FREQUENCY divider, the inductance-capacitance oscillator offers considerable advantage over the more commonly used multivibrator. Larger divisors may be used without risking loss of control under severe conditions such as great changes in line voltage, aging of the circuit elements and the tubes, etc. Furthermore, only one triode section of a vacuum tube is used in each divider stage.

It is readily realized that apparatus to be used by the public must be designed with a much greater safety factor than devices to be used in laboratories or factories where trained service men are at hand. As a comparison, it may be mentioned that a multivibrator dividing by 27 in a single stage was successfully used by the author on the RCA New York-to-London facsimile circuit. Adjustments every three or four weeks were sufficient to keep the multivibrator in step with the control frequency. Yet, when division by 10 in

three stages was used in commercial watch-timing apparatus, a great deal of trouble was experienced; and it was decided to divide in steps of 4 and 5. With a quartz crystal having a frequency in the neighborhood of 100 kilocycles, it took five twin triodes to come down to a frequency suitable to drive a standard-type motor.

Later some units employing three stages of controlled inductance-capacitance oscillators dividing by 10–10–12, using one twin triode and one single triode, were built. These units have now been in service for over three years without adjustment of the oscillator stages.

Most commonly, divisions by 10 are used, but some times smaller divisors are used advantageously. If divisors as small as 5 or 6 are used, and if the parts are of high quality with close tolerances, it is hardly necessary to tune the various stages individually. It will be sufficient to make a check at the last stage to determine whether the allover frequency limits are satisfactory.

CIRCUIT CONSTANTS AND THEIR EFFECT ON THE CONTROL RANGE

Fig. 1 shows an oscillator circuit suitable for frequency division. The direct-current plate voltage is supplied to the plate of a triode V through a 50,000-ohm resistor R_1 . A tuned circuit consisting of part of the winding of an autotransformer T and a capacitor C_2 is coupled to the plate of the tube through capacitor C_1 . The other part of the winding of the transformer is included in the grid circuit and connected to the grid through a 50,000-ohm resistor R_2 . A control voltage,

* Decimal classification: R357.3. Original manuscript received by the Institute, December 6, 1945; revised manuscript received, March 25, 1946.

† Williams Bay, Wis.

the frequency of which is some multiple of the desired output frequency of the oscillator, is applied to the grid of the vacuum tube through a 400,000-ohm resistor R_3 . The transformer was wound for a $\frac{3}{8} \times \frac{5}{8}$ -inch core of audio C iron. The plate-circuit and the grid-circuit windings each contained 3000 turns of wire. The vacuum tube may be a 6J5 or one section of a 6SN7GT.

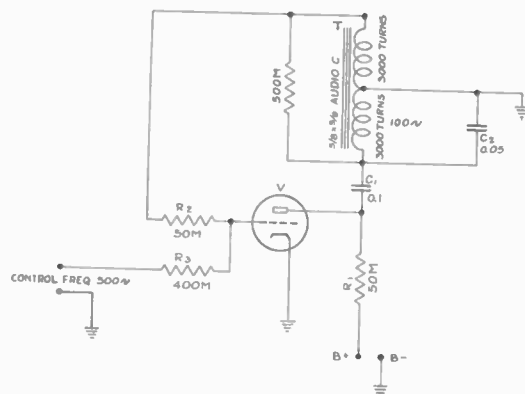

Fig. 1—Basic circuit of frequency-controlled oscillator.

With circuit constants as shown by the diagram, an output frequency of 100 cycles was obtained when the control frequency was a multiple of 100.

In order to obtain a wide control range, the control voltage must be properly proportioned to the grid voltage generated in the grid circuit of the oscillator. Usually, a given control voltage is available; for instance, the output voltage of a quartz-crystal oscillator, a tuning-fork amplifier, or the output voltage from a previous oscillator stage. The problem is then to reduce that voltage to a level suitable to feed into the grid of the vacuum tube.

Resistors R_2 and R_3 form a voltage divider for this purpose. Various values for resistors R_2 and R_3 were tried, and it was found that the actual values of these resistors were not critical so long as their ratios were such that the proper control voltage was applied to the grid of the tube. Usually, the source of supply of the control voltage is of high impedance; therefore, the resistance value of resistor R_3 should be rather high. As a consequence, the value of grid resistor R_2 must also be high. On the other hand, if the grid resistor has too high a value the circuit will not operate properly. Therefore, certain values of resistance were selected as being most suitable for R_2 and R_3 .

Even divisions require less control voltage than odd divisions. Therefore, the control resistor R_3 should have a higher value in even stages than in odd stages.

It was found that the turns ratio between the plate-circuit winding and the grid-circuit winding of transformer T has a great influence on the control range. For odd divisions the ratio between plate-winding turns and grid-winding turns may be from 1:1 to 2:1, and at even divisions it should preferably be from 3:1 to 4:1. The curves of Figs. 2 and 3 clearly illustrate that fact. The curves of Fig. 2 were taken with a transformer ratio of 1:1, and it is very clear that the odd di-

visions have a good frequency range compared to that of the even divisions. Fig. 3 shows curves taken with a transformer ratio of 3:1. Here the even divisions have the widest control range.

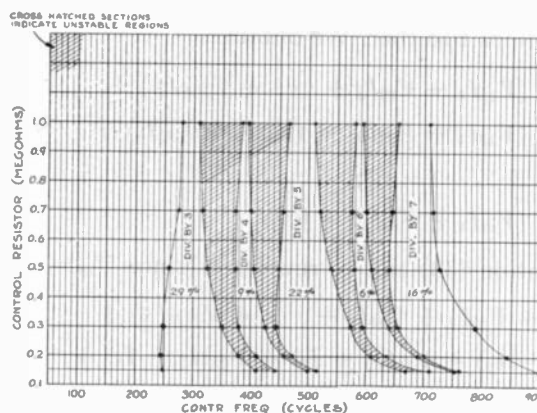

Fig. 2—Characteristic curves for odd divisions.

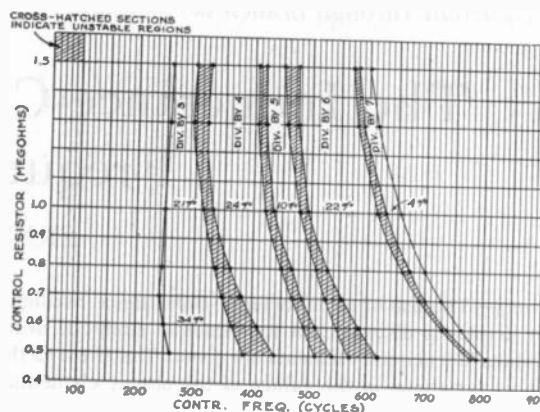

Fig. 3—Characteristic curves for even divisions.

The curves of Figs. 2 and 3 also show the effect of variations in the value of the control resistor R_3 on the control range. It may be seen that, particularly in the case of odd divisions, the control range decreases when the control resistor exceeds a certain value. At low values of control resistance there is a considerable change in the frequency of the control limits versus change of the value of control resistor. The control resistor should be selected not only on the basis of wide control range, but the frequency stability also should be taken into consideration. Fig. 2 shows that a control resistor of about 400,000 ohms would be suitable for a division by 5. From Fig. 3 it may be seen that, for a division of 6, a value for resistor R_3 of from 700,000 ohms to 1 megohm would be suitable.

The control voltage applied to resistor R_3 (Fig. 1) was about 25 volts. That is approximately the output voltage of an oscillator stage in a cascade of dividers as illustrated by Fig. 4.

The various circuit constants affect the natural frequency of the oscillator circuit and will therefore shift the control limits. The influence of variations in the value of the control resistor is shown by the curves of Figs. 2 and 3. An increase in the value of grid resistor R_2

causes a slight increase in the frequency of the oscillator, and vice versa. Moderate changes in the value of plate resistor R_1 have a negligible effect on the frequency of the oscillator. Increasing the capacitance of coupling capacitor C_1 causes a decrease in the frequency of the oscillator, and vice versa. The effect of changes in the inductance value of the tuned part of oscillator transformer T is obvious; and the purpose of tuning capacitor C_2 is, of course, to select the proper oscillator frequency. Different tubes give a slightly different frequency and also somewhat different control ranges. With the circuit constants shown in Fig. 1, the oscillator remained under control at line voltages between 80 and 140 volts when an unregulated power supply was used.

Tests have shown that any one of resistors R_1 , R_2 , and R_3 could be halved or doubled without changing the frequency of the oscillator enough to bring it out of control. The values of the tuning capacitor and the coupling capacitor could be changed plus or minus 25 per cent before control was lost. It is, of course, presumed that the oscillator was properly tuned before the test was made.

The Q of the oscillator transformers does not seem to have any appreciable effect on the control range. Transformers stacked with mu-metal laminations gave the same control range as with audio C laminations.

Reasonable variations in the inductance-capacitance ratios from the values indicated by transformer data and tuning capacitances of Fig. 4 have little effect on the tuning range. Fig. 5 shows a typical curve of the tuning range and control range of one of the transformers used. The maximum difference in the control range was about 3 per cent for tuning capacitors from 0.003 to 0.015 microfarad; and even higher values give good results. That feature makes it possible to use the same transformer over a relatively wide frequency band.

The load resistors (500,000 ohms in Figs. 1 and 4) cause the frequency of the oscillator to increase. Thus, a lower resistance value increases the frequency. Some loading of the oscillator transformers is desirable for

Transformer Data

	Plate Turns	Grid Turns	Iron Core
T_1	500	335	1/2 x 1/2 Audio A
T_2	1100	315	1/2 x 1/2 Audio A
T_3	2200	630	1/2 x 1/2 Audio A
T_4	3000	3000	5/8 x 5/8 Audio A

stabilizing purposes, so that, for instance, connecting the input of an oscilloscope across the oscillator will not greatly affect its frequency.

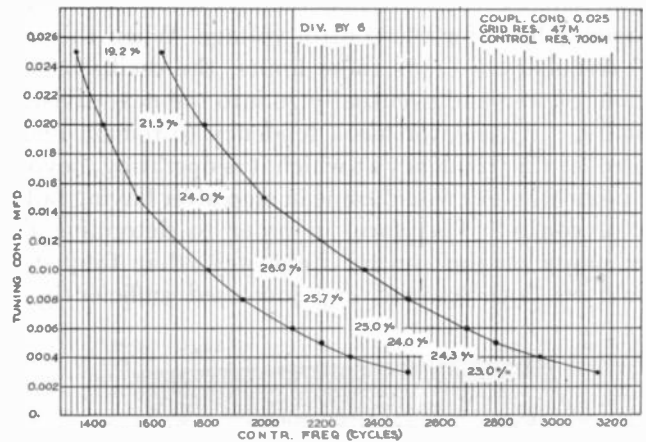

Fig. 5—Frequency versus tuning capacitance. Turns in plate circuit = 2200; turns in grid circuit = 630.

METHODS OF TUNING AND TESTING THE OSCILLATOR

The best method of observing when the oscillator goes in and out of step with the control frequency and by what division it is operating is to connect one pair of plates of a cathode-ray tube across the source of control voltage and the other pair of plates across the output terminals of the oscillator to observe the pattern generated on the screen. The number of loops indicate the division, and an unstable or undistinguishable pattern shows that the oscillator is out of control.

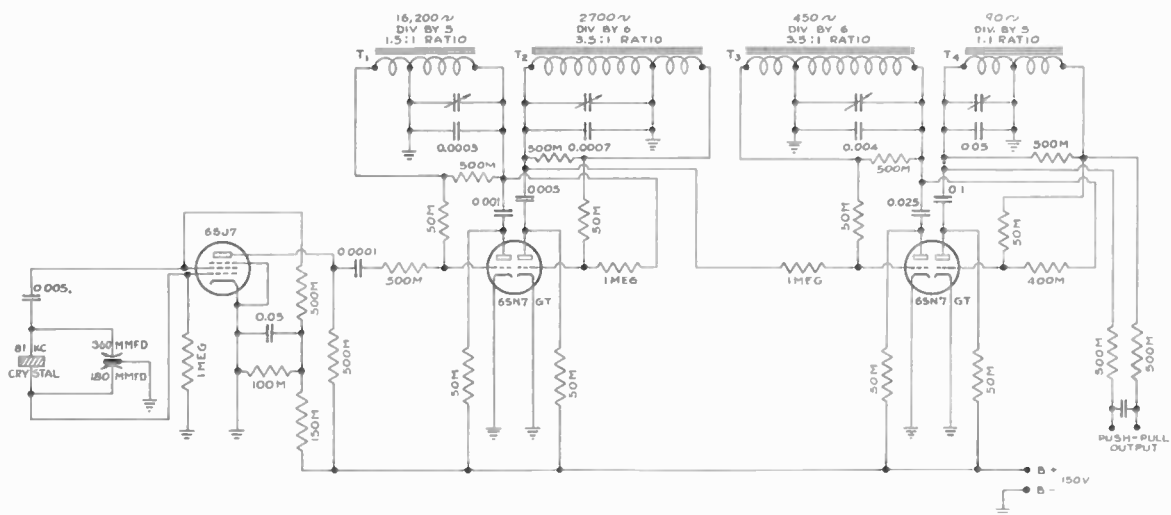

Fig. 4—Frequency-controlled inductance-capacitance oscillator. (Capacitances expressed in microfarads.)

One way of tuning the oscillator is to use a decade capacitor or other variable capacitor as the tuning capacitance and change the capacitance so that the oscillator falls out of step at one low value and at one high value of tuning capacitance. The average of these two values is then selected for the tuning capacitor. If it is desirable to find the oscillator frequencies corresponding to these capacitance values, the control voltage may be disconnected and the frequencies determined by comparison with an audio oscillator.

Another method is to use a variable source of control frequency. By varying the control frequency it will be found that for each division there is a low- and high-frequency limit for the control voltage. When the control frequency exceeds these limits, the oscillator will fall out of step and eventually go into the next division. Usually, the oscillator has a tendency to remain under control at the frequency at which it is operating, beyond the point where it would come in step after having fallen out of control. Therefore, in order to determine the true limits of the control frequency, that frequency should be both lowered and increased sufficiently to

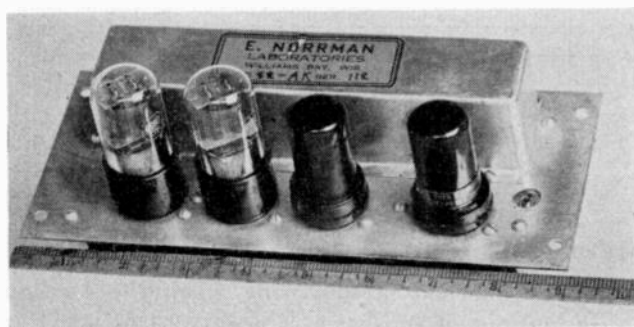

Fig. 6—Top view of four-stage frequency divider.

bring the oscillator out of control and then increased or decreased to bring the oscillator in step. The frequency band between the low and the high limits of control frequency is the control frequency range. By dividing that frequency range by the particular division used, the oscillator frequency range is obtained. The tuning capacitor is so selected that the high and the low control-frequency limits are equidistant from the actual control frequency to be used.

Divisions by 5 or 6 usually give a frequency range of plus or minus 10 per cent of the actual control frequency to be used. Usually the control frequency is stable, but the natural frequency of the oscillator may change. The amount of change allowable without loss of control is indicated by the range of the control frequency expressed in per cent of the average control frequency. At divisions by 10 the frequency range is about 4 per cent.

TUNING OF A MULTISTAGE DIVIDER

Figs. 4, 6, and 7 show a four-stage divider. An 81-kilo-quartz-crystal oscillator controls the first oscillator stage, which divides by 5, generating a frequency of 16,200 cycles. The two following stages divide by 6,

giving frequencies of 2700 and 450 cycles respectively. The last division is by 5, and thus an output frequency of 90 cycles is obtained.

To accomplish the tuning the quartz crystal is disconnected and replaced by the output circuit of a variable radio-frequency oscillator. The output voltage

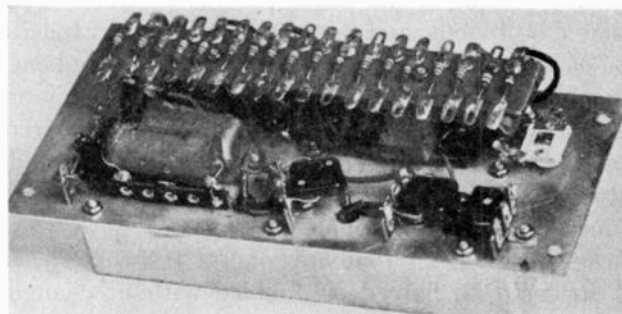

Fig. 7—Bottom view of multistage frequency divider.

of the radio-frequency oscillator is so adjusted that the output voltage of the 6SJ7 oscillator attains the same amplitude that it had with the crystal as controlling element. By varying the control frequency as previously described, the low- and high-frequency limits for dividing by 5 are found. The trimming capacitor is then adjusted so that the two limits become equidistant in respect to 81 kilocycles.

The cathode-ray oscilloscope was used as previously described, with one set of deflection plates connected to the radio-frequency oscillator and the other set of plates connected to the output of the 16,200-cycle oscillator. To tune the next stage, the oscilloscope clips are advanced one step.

The 16,200-cycle oscillator is now to control the second oscillator stage at 2700 cycles. When control is obtained, a six-loop pattern appears in the oscilloscope. The frequency of the radio-frequency oscillator is varied, and the trimming capacitor of the second oscillator stage is adjusted so that the radio-frequency control limits become equidistant in respect to 81 kilocycles. If the frequency range of this stage is less than that of the first oscillator stage, then the radio-frequency range will be less than it was for the first stage. If the second stage has a greater frequency range than the first stage that fact will not be apparent, because as soon as the first stage falls out of step with the radio-frequency oscillator the second stage also falls out of step.

The following stages are tuned in the same manner; the apparent frequency limits of the last stage indicate the all-over limits of the unit.

The frequency range—or control range—of the four-stage divider circuit shown by the diagram of Fig. 4 was slightly over 20 per cent. A line-voltage variation from 80 to 140 volts would not cause loss of control.

CONCLUSIONS

Experience with a large number of units of various types has proved that divisions by 10, or even larger

numbers, can be made in apparatus intended for public use. Circuits similar to the one shown by the diagram of Fig. 4, some dividing in as many as three stages, were used in watch-timing apparatus operated by watch repairmen. Some of these units were checked after over three years of service, and the oscillators had not drifted sufficiently to warrant retuning. This shows that the control range is large compared to the frequency drift that normally takes place in the oscillators.

In the apparatus used, the controlling element has usually been a quartz crystal or a tuning fork. When using a tuning fork, it is often desirable to select one of a higher frequency than the desired output frequency. For instance, a 600-cycle tuning-fork amplifier followed by an oscillator stage dividing by 10 makes a very good 60-cycle frequency standard.

A stable radio-frequency oscillator may be used in

connection with a number of divider stages to obtain a variable, relatively stable audio-frequency output. If small divisors are used, the audio-frequency range may be considerable.

The dividing oscillators, as well as a quartz-crystal oscillator or a tuning-fork amplifier, may be operated with plate voltages as low as 12 volts, a fact which is of interest where direct operation from storage batteries is desirable.

Various types of inductance-capacitance oscillators were tried with good results. Control of resistance-capacitance oscillators also gave satisfactory results. A thyratron inverter tuned to a certain frequency is very easily controlled by a multiple of the desired output frequency. The type of oscillator shown by the diagrams was selected on account of its simplicity and good operating characteristics.

A Wide-Band Wattmeter for Wave Guide*

H. C. EARLY†, ASSOCIATE, I.R.E.

Summary—A direct-reading wattmeter is described which uses a directional coupler and one or more thermocouples to monitor the power transmitted by a wave guide or a coaxial transmission line. It was used in connection with a 1000-watt magnetron transmitter which had a tuning range of 8 to 12 centimeters, and the calibration was substantially constant over this range.

DESIGN CONSIDERATIONS

THE PROBLEM of wave-guide power measurement is quite simple if there is no standing wave present and the frequency is fixed. Under these conditions, a simple "pickup" probe or loop attached to a bolometer or thermistor is quite satisfactory. These conditions, however, are seldom realized in practice, and power measurements usually involve calibration curves and computations.

When a simple, nondirectional probe or loop is used for power measurement, a slotted section is usually required in order to locate the maximum and minimum points in the standing-wave pattern. Otherwise, a small reflection from the termination, which represents a very small part of the total power, will set up a standing wave that will cause a large error if the pickup probe happens to be near a maximum or a minimum. This is shown in Fig. 1. For instance, if 1 per cent of the power in the forward wave is reflected back again, then the reflection coefficient $K = \sqrt{0.01} = 0.1$, the voltage standing-wave ratio $= (K+1)/(1-K) \cong 1.22$, and the power standing-wave ratio $\cong (1.22)^2 \cong 1.5$, so that a 50 per cent difference between maximum and minimum power

readings is caused by a reflection of only 1 per cent of the total power.

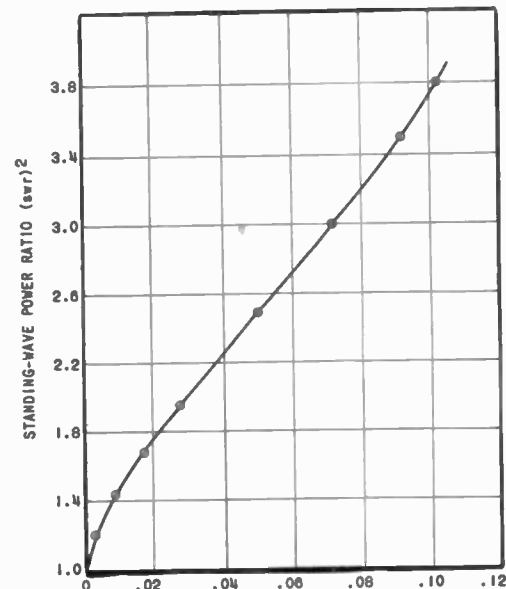

Fig. 1—A very small amount of reflected power in a wave guide can cause a large variation in the power picked up by a nondirectional probe. Abscissa shows the fraction of incident power reflected.

This situation is greatly improved if the sample of power from the wave guide is obtained by means of a directional coupler. If the coupler is oriented so as to respond only to the power in the forward wave, the response is independent of its location with respect to the voltage nodes and a reasonable amount of reflected power will not cause a serious error. In the situation mentioned above, the 1 per cent reflected power would produce an error of only 1 per cent instead of the much larger value. For many applications, this error is small

* Decimal classification: R245×R310. Original manuscript received by the Institute, March 7, 1946. The work reported in this paper was done at the Radio Research Laboratory of Harvard University, under contract with the Office of Scientific Research and Development, National Defense Research Committee, Division 15.

† University of Michigan, Ann Arbor, Michigan.

enough to be tolerated and the forward power can be considered as equivalent to the power delivered to the load. When the reflected power is too large to be neglected, it is possible to employ two directional couplers and arrange them so that one of them registers forward power and the other reverse power. Then, these two values of power can be converted into equivalent direct voltages by means of thermocouples. If these direct-voltage sources are connected in series so that they buck or subtract, then the resulting voltage is proportional to the net power transmitted by the wave guide, and is independent of standing-wave ratio.

DESCRIPTION

Fig. 2 shows the wattmeter equipment. It includes a directional-coupler assembly, two rolls of lossy cable,

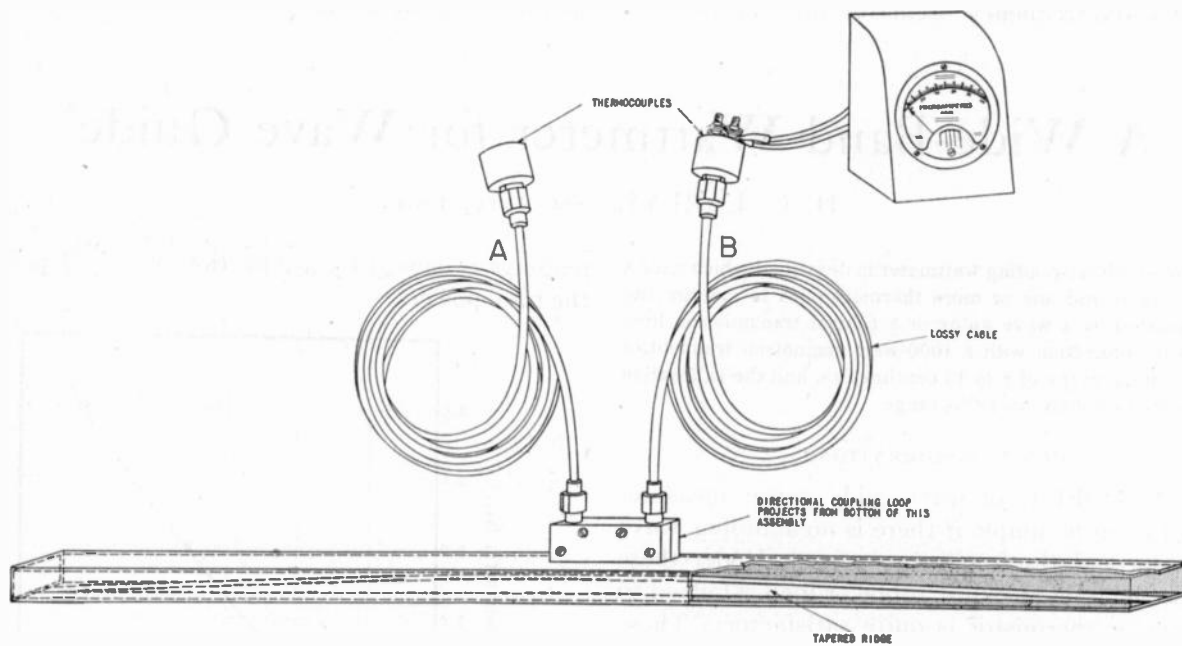

Fig. 2—Wattmeter assembly.

two thermocouples, a low-resistance microammeter, and a special section of $1\frac{1}{2}$ -inch by 3-inch wave guide which contains a tapered ridge. The directional coupler is described in another paper.¹ It consists of a small loop of a special geometry, which responds to both the electric and magnetic fields in the wave guide. This loop generates a voltage in cable *A* which is proportional to the power in the forward wave in the wave guide, and a voltage in cable *B* which is proportional to the power in the reflected wave. Each roll of lossy cable has enough attenuation so that its input impedance is essentially a pure resistance over a wide frequency range. The thermocouple consists of a spot-welded junction between a piece of nichrome wire 0.001 inch in diameter and a piece of constantan wire of the same size. A junction of this type is soldered across the end of each cable, between the center and outer conductor,

¹ H. C. Early, "A wide-band directional coupler for wave guide," accepted for future publication in the WAVES AND ELECTRONS section of Proc. I.R.E.

so that it is heated by the radio-frequency current in the cable.

Circuit Arrangement

Fig. 3 shows the direct-current circuit. The direct-current blocking capacitor is built into the outer conductor of the cable in such a manner that it does not disturb the radio-frequency circuit. Although each cable has about 15 decibels of attenuation for the radio-frequency current, the direct-current resistance is only a few ohms, which is small compared to the resistance of the meter. It is essential that the two thermocouples have the same sensitivity, or else the more sensitive one must be shunted with a radio-frequency choke and resistance combination.

The original design of this wattmeter employed both

of the thermocouples as described. However, in the particular application for which it was first used, the standing-wave ratio was low enough so that the thermocouple which corrected for reverse power flow resulted in no significant increase in accuracy and it was omitted in the interest of simplicity.¹ The direct-current blocking capacitor was then no longer needed, and the microammeter was connected directly across the end of the cable.

FREQUENCY SENSITIVITY

It is desirable that the meter be calibrated in terms of watts per division, and that this calibration be independent of frequency over the required range. To accomplish this, the following types of frequency sensitivity must be compensated:

(1) The voltage picked up by a probe or loop increases with frequency. If the field strength in the wave guide is held constant, the voltage picked up will vary directly with frequency, and the apparent power with the square of the frequency.

(2) The attenuation of solid-dielectric cable increases with frequency. The rate of increase is somewhat faster than the square root of the frequency.

(3) The guide impedance tends to change with frequency. This tends to affect not only the field strength per kilowatt but also the directional properties of the coupler.

The resistance of the thermocouple can be neglected in comparison with its reactance, so that

$$I^2 = \frac{E^2}{(50^2 + X_L^2)}$$

The reactance can be compensated if it is small com-

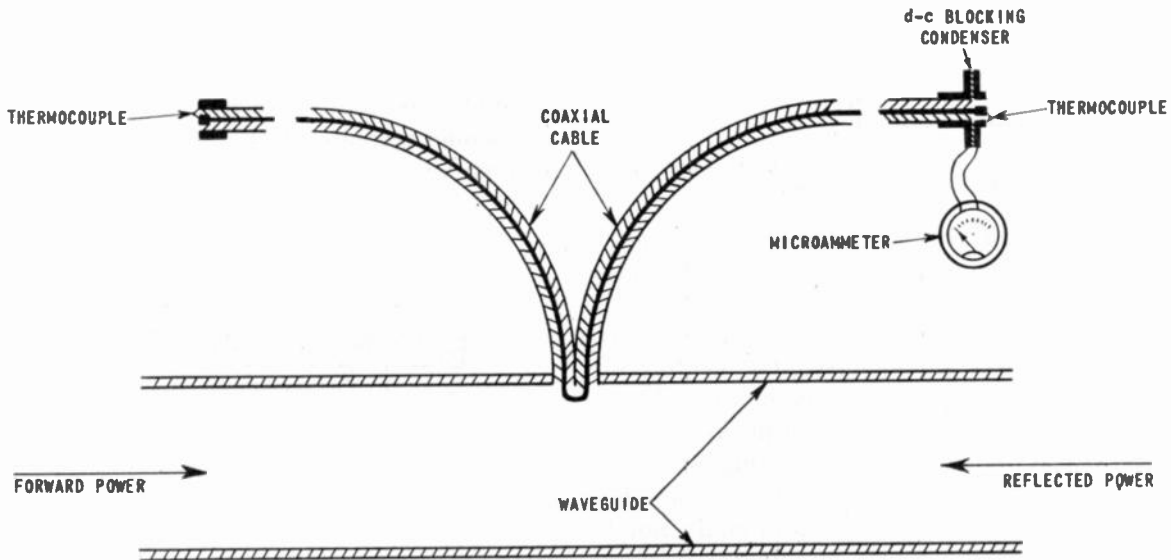

Fig. 3—Direct-current circuit arrangement.

(4) The wires forming the thermocouple junction have an inductive reactance which increases with frequency.

(5) The skin depth and radio-frequency resistance of a thermocouple is a function of frequency.

The first two of these effects are in opposite directions and if the proper length of cable is used, there is a good compensation over a significant frequency range. Fig. 4 shows the effectiveness of 15 feet of RG21/U cable in providing this compensation over the wavelength range from 7 to 13 centimeters. The lower curve shows the frequency variation in voltage picked up by the loop of the directional coupler when the field strength in the wave guide is held constant. The top curve shows the frequency variation in voltage at the thermocouple end of the cable when the voltage at the input end of the cable is held constant, and the center curve shows how effectively these two variables compensate one another. The slope of the upper curve is determined by the length of the cable. In this particular application a 15-foot length of RG21/U cable produced the right slope for the best compensation.

pared to 50 ohms. If the two supports for the thermocouple are fastened to the inner and outer conductor in

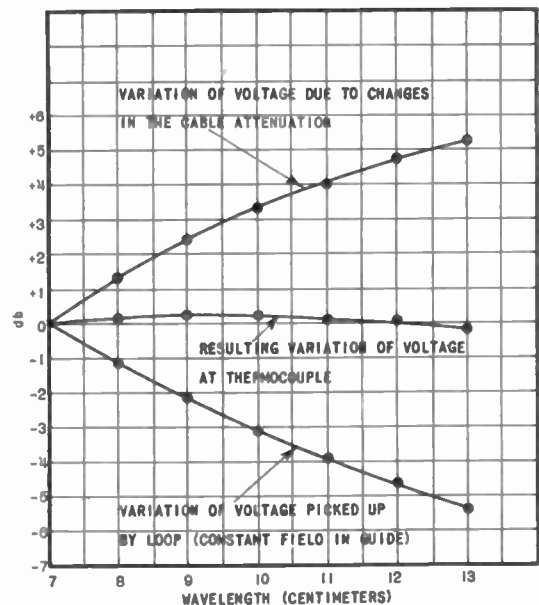

Fig. 4—When the frequency is changed, the variation in cable attenuation compensates for the variation in voltage picked up by the probe.

Effects due to change in guide impedance are minimized by means of the tapered section of ridge wave guide which increases the cut-off wavelength by a factor of three. In the vicinity of the probe, the guide wavelength and also the ratio of the transverse components of the *E* and *H* fields are practically the same as in free space. This is discussed in the literature.¹

Effects due to thermocouple inductance can be analyzed by means of an equivalent circuit (Fig. 5) based on Thevenin's theorem.

such a way that the distance between them is 1/16 inch or less, the length of the wires can be made so short that the reactance is less than 25 ohms (at 3000 megacycles). In Fig. 5, the dotted capacitance represents the capacitance between the two supports of the thermocouple junction. If this capacitance is correctly adjusted, it

will compensate for the effect of the thermocouple inductance so that the current through X_L does not change appreciably, despite substantial changes in the generator frequency.

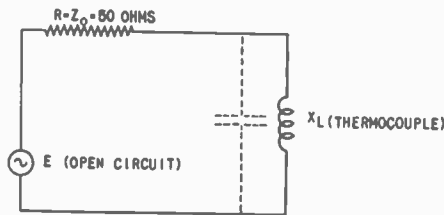

Fig. 5—Equivalent circuit of the lossy cable and thermocouple based on Thevenin's theorem.

The construction of the thermocouple assembly is shown in Fig. 6. The removable part consists of a small polystyrene washer with a brass ring around the edge and a brass slug in the center which are the supports to which the fine wires are soldered. The center conductor of the coaxial cable is threaded and the replaceable thermocouple unit is screwed in, as shown in the drawing. It was found that type N fittings and other cable connectors would introduce errors of more than ± 10 per cent at certain frequencies and could not be used at either end of the cable. The dielectric of the cable is continuous from the wave guide to a point within $\frac{1}{8}$ inch of the thermocouple.

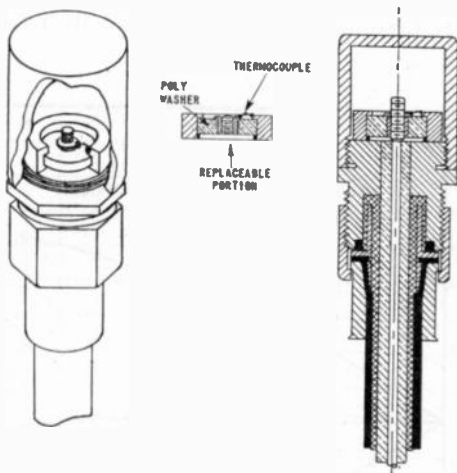

Fig. 6—Thermocouple construction.

Skin effect does not cause trouble if the penetration distance of the current into the wires forming the thermocouple junction is large compared to the radius of the wire. In this case, with a wire diameter of 0.001 inch, a certain amount of skin effect was present which tended to produce slightly more sensitivity at the high-frequency end of the range. The inductance tends, however, to reduce the high-frequency response, and good compensation could be obtained easily.

THERMOCOUPLE DESIGN

The type of thermocouple described above developed a larger electromotive force than was required to produce a full-scale deflection on a 0-to-100-microampere

microammeter which had a resistance of 110 ohms. This could be adjusted to a suitable value by changing the location of the directional probe with respect to the center of the wave guide. Moving it away from the center towards the edge decreases the pickup without affecting the directional properties, if the plane of the loop is kept parallel to the longitudinal axis of the guide.

For measuring lower levels of power there are several ways by which the sensitivity might be increased without resorting to bridge circuits or vacuum tubes. One possibility is to use a vacuum thermocouple. Although this would increase the thermal electromotive force for a given level of radio-frequency power, the objection is

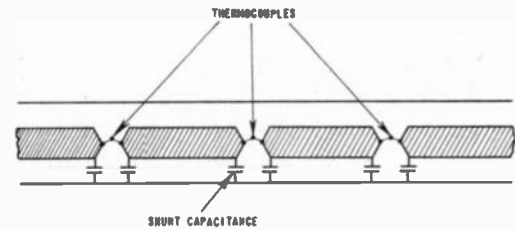

Fig. 7—Arrangement for using more than one thermocouple to obtain greater sensitivity.

that the meter calibration would no longer be linear. The heat dissipation from a vacuum thermocouple is principally by radiation and the relation between radio-frequency power and direct current is not nearly so linear as it is in the case of the air-cooled variety. For this reason, vacuum thermocouples would not be suitable in the arrangement of Fig. 3, where the reflected power is subtracted. The air-cooled junction has one minor disadvantage, however, which the vacuum type would not have. When the cooling is caused by convection currents of air, the calibration is affected by the position of the thermocouple, and if it is turned upside down, the sensitivity will change. This effect is of the

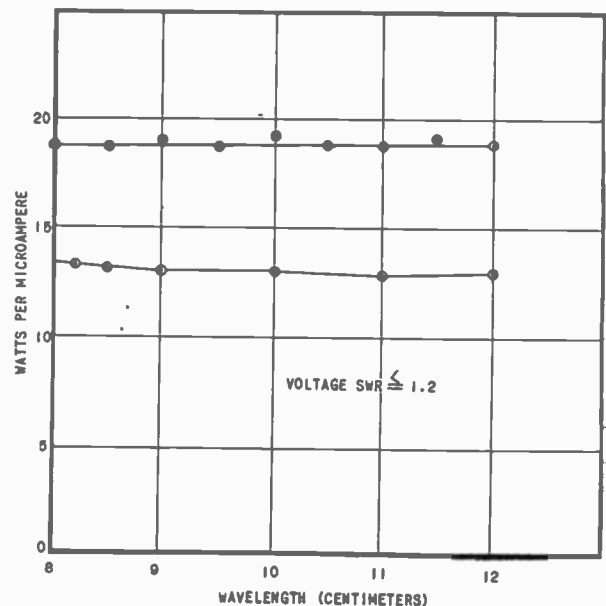

Fig. 8—Calibration curves for two representative thermocouples.

order of 5 per cent and is present even when the junction is enclosed in a metal cup. Changes in ambient temperature affect both the hot and cold junctions alike, and produce no noticeable effect on the calibration.

Another way to increase the meter deflection is to use a large number of thermocouples in series, as shown in Fig. 7. These junctions are all in series with the center conductor. The spacing between them should be large enough so that the "cold" junctions will remain at ambient temperature. At each end of the thermocouple a shunt capacitance (a polystyrene washer) is added between the center and outer conductor of the coaxial line, so that a low-pass π -filter section is formed. The values of the shunt capacitances can be adjusted until the filter section has the same characteristic impedance as the cable, and no noticeable reflections are introduced. If the cut-off frequency of this section is high

compared to the frequency at which it is used, the performance is fairly satisfactory from a bandwidth standpoint. This arrangement was used at frequencies in the vicinity of 500 megacycles. A 3000-megacycle version was not developed.

Fig. 8 shows calibration curves relative to a calorimeter water load for two typical thermocouples. These curves were taken for a line that was reasonably flat, and only forward power was measured. A standing-wave voltage ratio of $\sqrt{2}$ or a power ratio of 2 would have caused the meter to read about 3 per cent too high.

ACKNOWLEDGMENT

The author wishes to thank Gunnar Hok, Seymour Cohn, and W. G. Dow for advice pertaining to this development.

Contributors to Waves and Electrons Section



F. J. GAFFNEY

F. J. Gaffney (A'38-M'45) was born on June 27, 1912, at Middleton, England. He received the B.S. degree in electrical engineering from Northeastern University in 1935. He did graduate study at Tufts College in 1939 and 1940, and at the Massachusetts Institute of Technology in 1942 and 1943.

During 1936 and 1937 Mr. Gaffney was a radio engineer for the National Company of Malden, Massachusetts, and in 1937 became chief engineer of the Browning Laboratories, in Winchester, Massachusetts. From 1941 to 1945 he was a member of the Research Staff of the Radiation Laboratory of the Massachusetts Institute of Technology. In January, 1942, he was placed in charge of the measurement and test-apparatus group of that organization. In November, 1945, he joined the staff of the Polytechnic Research and Development Company, Brooklyn, New York as chief engineer.

Mr. Gaffney is a member of Tau Beta Pi, the American Institute of Electrical Engineers, and the American Physical Society.

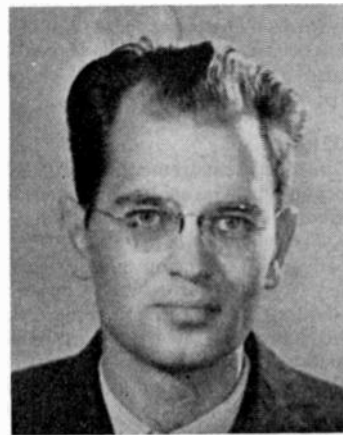

H. C. EARLY

H. C. Early (S'40-A'42) was born at Beaverton, Michigan, in 1912. He received the M.S. degree in physics from the University of Michigan in 1941. From 1941 to 1943 he was employed by the engineering research department of the University of Michigan to investigate certain industrial applications of high-frequency power. In 1943 he accompanied Professor W. G. Dow to the Harvard Radio Research Laboratory where they participated in the development of high-power microwave transmitters for jamming enemy radar.

Mr. Early is at present a part-time student at the University of Michigan, and a part-time industrial consultant.



For a photograph and biographical sketch of W. I. Korman, see the July, 1946 issue of the PROCEEDINGS OF THE I.R.E. AND WAVES AND ELECTRONS.

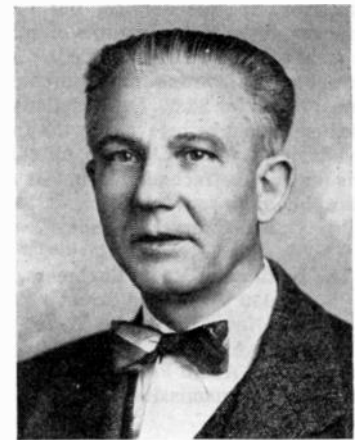

ERNST NORRMAN

Ernst Norrman was born in Sweden, in 1896. He is a graduate of the Visby Gymnasium and Swedish Government radio schools. In 1928, he joined the Radio Corporation of America, where he remained until March, 1932. Since that time, Mr. Norrman has carried on independent development work, and has also been employed by The International Business Machines Company and by the Thomas B. Gibbs Company.



JACK R. FORD

Jack R. Ford was born at Haddon Heights, New Jersey, on November 25, 1908. He received the B.S. degree from the Massachusetts Institute of Technology in 1929. He was employed by various companies in the radio-manufacturing field until 1940, when he became affiliated with the Radio Corporation of America. Mr. Ford is now a member of the radar-design section of that organization.

Abstracts and References

Prepared by the National Physical Laboratory, Teddington, England, Published by Arrangement with the Department of Scientific and Industrial Research, England and *Wireless Engineer*, London, England.

The number at the upper left of each Abstract is its Universal Decimal Classification number and is not to be confused with the Decimal Classification used by the United States National Bureau of Standards. The number in heavy type at the top right is the serial number of the Abstract.

The Institute of Radio Engineers has made arrangements to have these Abstracts and References reprinted on suitable paper, on one side of the sheet only. This makes it possible for subscribers to this special service to cut and mount the individual Abstracts for cataloging or otherwise to file and refer to them. Subscriptions to this special edition will be accepted only from members of the I.R.E. and subscribers to the Proceedings of the I.R.E. and Waves and Electrons at \$15.00 per year. Subscribers to this special edition will also receive an Annual Index to Abstracts and References as part of their subscription service. All others, who are not subscribers to this service, but who are either members of the Institute or subscribers to the Proceedings of the I.R.E. and Waves and Electrons may purchase the Annual Index for \$5.00. Subscriptions to the Index only must be received by the Institute not later than March 1, 1947. All subscriptions for the Abstract service and its Annual Index should be sent to

Mr. George W. Bailey
Executive Secretary

The Institute of Radio Engineers, Inc.
330 West 42nd Street
New York 18, N. Y.

	PAGE
Acoustics and Audio Frequencies	808
Aerials and Transmission Lines	809
Circuits	810
General Physics	812
Geophysical and Extraterrestrial Phenomena	813
Location and Aids to Navigation	814
Materials and Subsidiary Techniques	815
Mathematics	816
Measurements and Test Gear	817
Other Applications of Radio and Electronics	818
Propagation of Waves	819
Reception	819
Stations and Communication Systems	820
Subsidiary Apparatus	821
Television and Phototelegraphy	822
Transmission	822
Vacuum Tubes and Thermionics	823
Miscellaneous	824

ACOUSTICS AND AUDIO FREQUENCIES

534:621.392 2447
Electro-Mechanical Analogy in Acoustic Design—A. M. Wiggins. (*Radio*, vol. 30, pp. 28–29; April, 1946.) An explanation and justification of the analogy whereby mechanical problems can be solved by the solution of equivalent electrical circuits. The method is applied to a unidirectional microphone.

534.2 2448
The Absorption of Sound of High Frequency in Metals—L. Gurevich. (*Zh. Eksp. Teor. Fiz.*, vol. 14, no. 6, pp. 202–204; 1944.) From an equation (1) determining the change in the number of sound quanta (phonons) resulting from their interaction with electrons, a formula is derived for calculating the absorption coefficient τ_g . It appears that τ_g is proportional to the sound frequency. It is also shown that for frequencies exceeding the inverse value of the time of the free travel of electrons, sound is absorbed during an interval of the order of the sound period, i.e., propagation cannot take place.

This paper is related to 2232 of 1937 (Landau and Rumer).

534.321.9 2449
Ultrasonic Velocity in Water—P. L. F. Jones and A. J. Gale. (*Nature*, London, vol. 157, p. 341; March 16, 1946.) A graph is given showing the velocity as a function of temperature. There is a maximum of 1552.7 meters per second at 72.7 degrees centigrade. See also B. K. Singh, *Nature*, London, vol. 156, p. 569, 1945.

534.321.9 2450
On the Measurement of Ultra-Sound Absorption in Gases by Spherical Waves Methods—P. Krasnushkin. (*Zh. Eksp. Teor. Fiz.*, vol. 14, no. 5, pp. 152–155; 1944.) The advantages of using spherical instead of plane waves for the measurements are pointed out, and the following two new methods proposed. (a) A point receiver is moved along the axis of the central diffraction lobe of the radiation field of a point radiator, and amplitudes V of the field are measured with respect to distance R between the radiator and the receiver. (b) The receiver is replaced by a metallic plane that reflects the waves back to the radiator. With a continuous movement of the plane the acoustic reactance of the radiator and therefore the anode current I_a of the oscillator are varied. A formula determining the relationship between I_a and d (distance between the plane and the radiator) is given.

The results obtained by both methods in room air are shown in a table. It appears that for the frequencies used (400 to 710 kilocycles) $d\lambda^2$ remains constant within 7 per cent, and its average value is 23.7×10^{-6} , i.e., it exceeds by 44 per cent the value given by the classical theory.

534.321.9:621.396.9 2451
Ultrasonic [Radar] Trainer Circuits—Larsen. (See 2582.)

534.417:534.88 2452
Navy Releases Sonar Story—(*Electronics*, vol. 19, pp. 284, 294; May, 1946.) A general account of the system and its history. See also 1750 of July (Lanier and Sawyer).

534.43:621.395.61 2453
A New Moving-Coil [Gramophone] Pickup—(*Electronic Eng.*, vol. 18, pp. 224–226; July, 1946.) Detailed description of the "Lexington" pickup, which has a flat response from 30 cycles to 12 kilocycles, with a weight of $\frac{1}{2}$ ounce on the record. Sapphire or steel needles of special shape are used.

534.43:621.395.61:538.652 2454
Torsional Magnetostriction [Gramophone] Pickup—S. R. Rich. (*Electronics*, vol. 19, pp. 107–109; June, 1946.) The device makes use of the variation of magnetic reluctance in a wire subjected to torsion in a magnetic field. It has a small moving mass, low distortion, and wide frequency response. The torsional magnetostriction element also operates successfully as a recording mechanism.

534.43:621.395.645.3 2455
Unique Phono Amplifier—Pett. (See 2515.)

534.61:621.317.35 2456
Range Extender for General Radio 760A Sound Analyzer—J. D. Cobine and J. R. Curry. (*Rev. Sci. Instr.*, vol. 17, pp. 190–194; May, 1946.) Details of a circuit to extend the frequency range to 1 megacycle by a heterodyne principle.

621.395.2+621.395.625 2457
Nuernberg Trials Recording System—P. C. Erhorn. (*Elec. Ind.*, vol. 5, pp. 70, 114; June, 1946.) A block diagram of the equipment is given, with a general description of the circuits. Eight microphones and five hundred pairs of headphones are catered for, and provision is made for various recorders and for broadcasting.

621.395.613.32 2458
Microphones: Part 3 (cont.)—S. W. Amos and F. C. Brooker. (*Electronic Eng.*, vol. 18, pp. 221–223; July, 1936.) A description of various makes of microphone of the moving coil, condenser, and piezoelectric types, and of their equivalent circuits, including the acoustic networks incorporated to maintain an even response curve. A polar diagram for a typical pressure-operated microphone shows variation of directional properties with frequency. For parts 1 and 2, see 1755 of July; for part 3(a), see 2120 of August.

621.395.614 2459
Sound-Pressure Measurement Standard—F. Massa. (*Electronics*, vol. 19, pp. 218–228; May, 1946.) A microphone comprising a pile of piezoelectric crystal plates in a rigid housing has wider frequency and dynamic ranges than other microphones generally available for making absolute sound measurements.

621.395.623.54:621.395.92 2460

A New Earpiece [for Deaf Aid Equipment]—C. M. R. Balbi. (*Wireless World*, vol. 52, p. 179; June, 1946.)

621.395.623.7 2461

Corner [Loud-speaker] Deflector Baffles—(*Wireless World*, vol. 52, p. 181; June, 1946.) The walls of the room housing the loud-speaker are used as elements in the combined horn and baffle system. Two outward radiating paths of logarithmically increasing section are produced, and a diffuser is incorporated to give even distribution of high frequencies. There is ample bass response, and the full rated power is delivered without any signs of overloading. A short illustrated description of the system.

621.395.625.2 2462

Embossing Sound on Film—S. Kempner. (*Radio News*, vol. 35, pp. 36, 108; June, 1946.) A general description of the Record-graph and its performance. See also 537 of March.

621.395.625.3 2463

The German Magnetophon—R. A. Power. (*Wireless World*, vol. 52, pp. 195-197; June, 1946.) A description of the magnetic recording equipment in which the medium is a polyvinyl-chloride strip impregnated with an equal weight of finely powdered magnetic Fe_2O_3 . Compared with other tape or wire recorders, the equipment offers (a) better quality (25 to 10,000 cycles, dynamic range about 70 decibels with 2 per cent distortion); (b) a lighter, tougher, and cheaper medium; (c) easy cutting and splicing of the tape; (d) facility for writing notes, titles, etc., may be written along the roll. See also 834 of April and back references.

621.395.645.3 2464

Additional Notes on the Parallel Tube Amplifier—F. C. Jones; J. Velasco. (*Radio*, vol. 30, pp. 26, 38; June, 1946.) Notes on an experimental high-fidelity amplifier with a parallel-tube output and separate high- and low-frequency tone controls. Follows a previous paper on the subject, 263 of February (Jones). A comment on the latter by Velasco is included.

621.395.82:621.395.645:621.317.79 2465

Measuring Audio Intermodulation—Pickering. (See 2641.)

621.396.667 2466

Low-Frequency Correction Circuit—(See 2532.)

621.396.667 2467

Tone Correction—Gregory. (See 2533.)

AERIALS AND TRANSMISSION LINES

621.392 2468

On the Calculation of the Radiation Field of a Wave Guide—N. Maloff. (*Zh. Eksp. Teor. Fiz.*, vol. 14, no. 6, pp. 224-225; 1944.) In calculating the field at the open end of a wave guide from Kirchhoff's formula it is usual to assume that the configuration of this field is the same as that of the field inside an infinitely long wave guide. In the present paper the validity of this assumption for the H_{01} mode in a cylindrical guide is examined by checking whether the

ratio A_2/A_1 remains equal to unity for all values of the ratio λ/λ_0 ($=\Delta$), where A_1 is the energy flux through the cross section of the wave guide, A_2 the energy flux through a sphere at the center of which the opening of the wave guide is located, λ the free-space operating wavelength, and λ_0 the critical wavelength. The calculated results which are collected in a table throw considerable doubt on the validity of the assumption, particularly in the region of most practical interest, i.e., when $\lambda/\lambda_0 > 0.8$.

621.392 2469

On the Propagation of Electromagnetic Waves in Curved Pipes—M. Jouguet. (*Compt. Rend. Acad. Sci.*, Paris, vol. 222, pp. 440-442; February 18, 1946.) A theoretical analysis of a curved guide of circular cross section excited in the E_0 and H_0 modes. It is concluded that for E_0 the curve causes no change in phase velocity and that the E and H fields are not orthogonal. Analysis for H_0 gives incompatible equations from which it is concluded that waves cannot be propagated in this mode.

621.392 2470

Wave Guide Transmission Systems—T. Moreno. (*Electronics*, vol. 19, pp. 136-141; June, 1946.) A sequel to 2136 of August. A discussion of the attenuation and standing waves produced by various joints and bends used in wave guides. If the inner radius of a bend is greater than a guide wavelength λ_g , the voltage standing-wave ratio produced will be under 1.05. A rectangular guide of length $2\lambda_g$ or more, twisted by 90 degrees about its axis, will introduce a standing-wave ratio generally less than 1.1. Graphs showing the required dimensions of corner connectors for minimum reflection are given, and couplings, tee joints, matching diaphragms, and coaxial-line transformers discussed.

621.392.2 2471

Propagation Along a Line Having Only Distributed Resistance and Capacitance Which are Functions of Position but Have a Particular Relationship to Each Other—M. Parodi. (*Compt. Rend. Acad. Sci.*, Paris, vol. 222, pp. 257-259; September 3, 1945.) A mathematical paper. For a particular relationship between C and R , given in the paper, the differential equation can, by change of variable, be transformed to one with constant coefficients and solved explicitly.

621.392.2 2472

Remarks on the Equations of Propagation on Any Line—F. Raymond. (*Compt. Rend. Acad. Sci.*, Paris, vol. 220, pp. 497-500; April 4, 1945.) A mathematical paper. It gives formally the solution for the propagation of any disturbance along a transmission line of which the characteristics L , C , R , and G are functions of the distance along the line.

621.392.2 2473

Propagation Along Any Polyphase Symmetrical Line—M. Parodi and F. Raymond. (*Compt. Rend. Acad. Sci.*, Paris, vol. 220, pp. 522-523; April 9, 1945.) A very general, formal matrix analysis of a symmetrical system of n lines with nonuniform characteristics.

621.392.2 2474

Transmission Problems—R. H. Paul. (*Electrician*, vol. 136, pp. 1097-1099 and 1165-1167; April 26 and May 3, 1946.) A discussion of "some rigorous methods of solving problems connected with long transmission lines without having recourse to hyperbolic functions of complex angles or convergent series."

621.392.2 2475

Some Novel Expressions for the Propagation Constant of a Uniform Line—J. L. Clarke. (*Bell Sys. Tech. Jour.*, vol. 25, pp. 156-157; January, 1946.) By a simple extension of well-known equations for the characteristics of a line, the attenuation constant is expressed in terms of the electrostatic and electromagnetic energies per unit length of line, and the characteristic impedance is expressed in terms of the phase velocity.

621.392.2 2476

Propagation Characteristics of a Uniform Line—I. F. Macdiarmid and H. J. Orchard. (*Wireless Eng.*, vol. 23, pp. 168-171; June, 1946.) A geometrical method of deriving the real and imaginary components of the propagation constant of a uniform transmission line is given. The form of the expressions thus derived are such as to indicate the physical significance of the different line parameters.

621.392.2 2477

Simplified Input Impedance Chart for Lossless Transmission Lines—L. Mautner. (*Communications*, vol. 26, pp. 44-45, 63; May, 1946.) A chart giving the range of input impedance for lines of length $n\lambda/8$ terminated resistively and reactively.

621.392.2:621.396.61 2478

Transmission Lines as Resonant Circuits—L. R. Quarles. (*Communications*, vol. 26, pp. 22, 52; May, 1946.) Formulas for calculating the dimensions for any reactance using either coaxial or twin lines, with some examples of their application. Part 1 of a three-part series; for part 2, see 2480 below.

621.392.43 2479

Graphical Calculation of Double Stubs—R. C. Paine. (*Radio*, vol. 30, pp. 23-25, 37; June, 1946.) Circle diagrams, together with a parabolic locus defining the admittance of stubs, can be used to solve double-stub transmission-line matching problems. The diagrams are given, and examples are worked out.

621.392.52 2480

Transmission Lines as Filters—L. R. Quarles. (*Communications*, vol. 26, pp. 34, 48; June, 1946.) The design of filters for the following types of application are considered: (a) suppression of unwanted radio-frequency harmonics on transmission lines, by means of a shunt stub; (b) band-pass inter-circuit coupling with filters of T configuration; (c) wide-band matching filters. Part 2 of a series beginning with 2478 above.

621.396.67 2481

Coaxial Feed F. M. Loop Antennas—A. G. Kandoian. (*Elec. Ind.*, vol. 5, pp. 74, 126; May, 1946.) Paper based on 1180 of May by the same author.

- 621.396.671:621.396.822 **2482**
Fluctuation Noise in a Receiving Aerial
 —Burgess. (See 2699.)
- 621.396.674 **2483**
Inductive Tuned Loop Circuits: Parts 1 and 2—W. J. Polydoroff. (*Radio*, vol. 30, pp. 21–22 and 20–22; April and May, 1946.) The advantages of permeability-tuned loop aerials in respect of signal-to-noise ratio and directional discrimination against interference are described. The need for balancing and shielding the loop to obtain these advantages is explained.
- 621.396.674:621.317.79 **2484**
An Improved Method of Testing Loop Receivers—W. J. Polydoroff. (*Radio*, vol. 30, pp. 15–17, 36; June, 1946.) A single-wire transmission line is strung across a screened room. One end of the line is connected to a signal generator, the other is terminated with its characteristic impedance. The radiation simulates the field of a horizontally propagated, vertically polarized wave. The receiver loop under test is supported underneath the transmission line.
- 621.396.674:621.318.323.2.029.5 **2485**
Iron-Cored Loop Receiving Aerial—R. E. Burgess. (*Wireless Eng.*, vol. 23, pp. 172–178; June, 1946.) "The complex effective permeability of a mass core is expressed in terms of the relevant factors, and the imaginary part is related to the eddy current loss in the particles, which should predominate over other components of loss.
 "The increase of pickup due to a spheroidal core is calculated and it is shown that the core should be elongated in a direction parallel to the axis of the loop. The effect of a hollow spheroidal core is discussed and it is found that in a typical case 80 per cent of the iron can be removed before the increase of pickup is halved; the effect of spacing the winding from the core is treated approximately.
 "Recommendations are made regarding the design for maximum sensitivity."
 An editorial comment (G.W.O.H.) appears in the same journal, pp. 156–157.
- 621.396.677 **2486**
Radar Technique—W. T. C. (*Wireless World*, vol. 52, pp. 151–154; May, 1946.) A review of papers on wave-guide and aerial techniques presented at the Institution of Electrical Engineers Radiolocation Convention.
- 621.396.677 **2487**
A Current Distribution for Broadside Arrays Which Optimizes the Relationship Between Beam Width and Side-Lobe Level—C. L. Dolph. (Proc. I.R.E. AND WAVES AND ELECTRONS, vol. 34, pp. 335–348; June, 1946.) "A one-parameter family of current distributions is derived for symmetric broadside arrays of equally spaced point sources energized in phase. For each value of the parameter, the corresponding current distribution gives rise to a pattern in which (1) all the side lobes are at the same level; and (2) the beam width to the first null is a minimum for all patterns arising from symmetric distributions of in-phase currents none of whose side lobes exceeds that level."
 Design curves expressing both the value of the parameter and the relative current values as functions of side-lobe level are given for the cases of 8-, 12-, 16-, 20-, and 24-element linear arrays.
- 621.396.677 **2488**
Long-Wire Antennas—W. van B. Roberts. (*QST*, vol. 30, pp. 36–39; June, 1946.) A simplified qualitative treatment of the operation of rhombic and V aerials. The power gains of the rhombic and the half-wave dipole are compared.
- 621.396.677+621.396.61].029.63 **2489**
CQ 2400 Mc/s: Transceivers and Antennas for the 13-Centimetre Band—Koch and Floyd. (See 2758.)
- 621.396.677.029.64 **2490**
Radio Lenses—W. E. Kock. (*Bell Lab. Rec.*, vol. 24, pp. 193–195; May, 1946.) The phase velocity of a radio wave propagated between parallel metal plates is greater, on wave-guide principles, than the velocity of propagation in free space. A pile of equally spaced parallel plates therefore acts like a block of material with refractive index less than that of free space. Converging lenses have been made by shaping the edges of the plates in such an array to the profile of a concave lens. A general description of the principle and illustrations of lenses are given. Beams 0.1 degree wide have been obtained. Other possible applications of the principle are mentioned.
- 621.392 **2491**
Problèmes de Propagations Guidées des Ondes Électromagnétiques [Book Review]—L. de Broglie. Gauthier-Villars, Paris, 1941, 160 fr. (*Wireless Eng.*, vol. 23, p. 171; June, 1946.) "... a carefully prepared review of the subject..."
- CIRCUITS**
- 621.3.017 **2492**
Loss Due to Shunt or Series Resistance Inserted Between Matched Source and Sink—(*Radio*, vol. 30, p. 38; April, 1946.) A chart giving the loss as a function of the ratio of the shunt or series resistance to the load resistance.
- 621.314.2 **2493**
Equivalent Capacitances of Transformer Windings—W. T. Duerdoth. (*Wireless Eng.*, vol. 23, pp. 161–167; June, 1946.) "The paper shows that the distributed capacitances between windings, or windings and screens, of transformers may be represented by lumped capacitances provided that the magnetic coupling between the turns of a winding is perfect. Expressions have been obtained for the equivalent capacitances of a number of different arrangements including windings in layers, sections, and with screens."
- 621.316.722.078.3:621.392.5 **2494**
The Theory of the Non-Linear Bridge Circuit as Applied to Voltage Stabilizers—G. N. Patchett. (*Jour. I.E.E.* (London), Part I, vol. 93, pp. 189–190; April, 1946.) Long summary of 867 of April.
- 621.316.974:621.318.4.017.31 **2495**
Power Loss in Electromagnetic Screens—Siocos. (See 2716.)
- 621.318.572 **2496**
Design and Use of Directly Coupled Pentode Trigger Pairs—V. H. Regener. (*Rev. Sci. Inst.*, vol. 17, pp. 180–184; May, 1946.) Discussion of a trigger circuit using two pentodes with direct plate-to-screen intercoupling. Comprehensive characteristics curves are given for a typical trigger using 6AK6 pentodes, showing the effect of biasing either the control or suppressor grids of one or both tubes. Circuits for a pulse generator and an electronic switch are given, and the limits of input for successful operation are deduced from the curves. Another circuit, in which each suppressor is capacitively coupled to the screen of the same tube, may be used to obtain triggering with pulses of one sign only.
 Scaling circuits up to scale of eight are briefly mentioned.
- 621.318.572 **2497**
Decade Counting Circuits—V. H. Regener. (*Rev. Sci. Inst.*, vol. 17, pp. 185–189; May, 1946.) A simple ring-of-ten counter designed around the directly coupled pentode trigger discussed in 2496 above. The essential characteristic of the circuit is that it has ten possible equilibrium conditions. Two detained circuits are given, one of which will count sharp pulses up to a frequency of 10^8 cycles. The other will do the same for impulses of arbitrary shape and frequency. The number of pulses counted by each ring of ten may be indicated by the position of the spot on a cathode-ray tube. Multiplicity of circuits and tubes enable decimal counting to be obtained to any required number.
- 621.392.43:621.365.92 **2498**
Coupling Method for Dielectric Heating
 —R. C. Kleinberger. (*Elec. Ind.*, vol. 5, pp. 78–79; June, 1946.) The necessary impedance matching to obtain maximum power transfer from transmission line to load can be most conveniently obtained by the use of adjustable stubs. Procedure and equations are given whereby stubs may be designed to effect approximate tuning of the load impedance and matching of the transmission line. Final adjustments are determined by actual trial.
- 621.392.5+621.395.665 **2499**
Radio Design Worksheet: No. 47—Bridged T and H Attenuators; Diode Conduction—(*Radio*, vol. 30, pp. 36–37; April, 1946.)
- 621.392.5 **2500**
Solving 4-Terminal Network Problems Graphically: Part 2—R. Baum. (*Communications*, vol. 26, pp. 40, 53; May, 1946.) Further discussion of the Smith diagram and inversion charts, and an illustration of the technique by the solution of a problem containing tuned circuits, resistances, and lines. For part 1, see 1786 of July.
- 621.392.5 **2501**
Determination of a Class of Coupled Circuits with n Degrees of Freedom, Having the Same Natural Frequencies as a Given Assemblage of Coupled Circuits—M. Parodi. (*Compt. Rend. Acad. Sci.*, Paris, vol. 222, pp. 281–283; January 28, 1946.) A mathematical paper. It derives formally, by matrix methods, the values of the circuit elements (L , C , and R) for all members of a class of coupled circuits having the same natural frequencies as a given assembly of

such circuits. The demonstration depends on the fact that the determinant of a product of matrices is equal to the product of the determinants of the matrices.

621.392.52 2502

Preferred Numbers and Filter Design—P. Blanchet; H. Jefferson. (*Wireless Eng.*, vol. 23, p. 179; June, 1946.) A comment, in French, on 3823 of 1945 (Jefferson) with Jefferson's reply. See also 871 of April (Jefferson).

621.392.52 2503

Filter Design Tables Based on Preferred Numbers: High-Pass Filters—H. Jefferson. (*Wireless Eng.*, vol. 23, pp. 197-199; July, 1946.) Tables are given for the design of constant- k high-pass filters of T- or π -sections. See also 871 of April and 3823 of 1945 (Jefferson).

621.392.52 2504

A Tunable Rejection Filter—R. C. Taylor. (*Trans. A.I.E.E. (Elec. Eng.)*, May, 1946), vol. 65, pp. 263-267; May, 1946.) The theory and design of a bridge-type narrow-band filter. Range of adjustment and effect of component variations are discussed with the aid of impedance circle diagrams. Approximate formulas for attenuation and bandwidth are deduced.

621.392.52 2505

Transmission Lines as Filters—Quarles. (See 2480.)

621.394/.396].645 2506

Radio Design Worksheet No. 48—Reactive Feedback Factors—(*Radio*, vol. 30, p. 24; May, 1946.) Analysis of reactive feedback in an amplifying stage having an elliptical load line.

621.394/.397].645.2 2507

The Cathode-Coupled Amplifier—K. A. Pullen, Jr. (*Proc. I.R.E. and Waves and Electrons*, vol. 34, pp. 402-405; June, 1946.) Further applications of the double-triode cathode-coupled circuit previously described by Sziklai and Schroeder (3811 of 1945), including its use as a high-frequency amplifier, multivibrator, audio-frequency and radio-frequency oscillators, resonant-resistance meter, and mixer circuit. Design data, including gain characteristics for a typical tube (6SN7), are given. See also 2157 of August (Crosby).

621.394/.397].645.2 2508

Wide-Band Amplifiers: Part 3—(*Wireless World*, vol. 52, pp. 161-162; May, 1946.) An analysis of band-pass coupling by critically coupled, equally damped circuits, showing the arrangement to give less gain for the same bandwidth than the arrangement of stagger-tuned circuits described in 1789 of July.

621.394/.397].645.29 2509

An Analysis of Cascode Coupling—R. G. Middleton. (*Radio*, vol. 30, pp. 19, 32; June, 1946.) A graphical analysis of a "cascode" amplifier based on the family of plate-current curves. In this circuit the signal is applied equally to the grids of two amplifying tubes, of which the cathode of one is connected directly to and in series with the anode of the other. The basic direct-current

amplifier may be adapted for alternating current.

621.394.645.35:621.317.715 2510

A Contact Modulated Amplifier to Replace Sensitive Suspension Galvanometers—Liston, Quinn, Sargeant, and Scott. (See 2629.)

621.394.645.35:621.383 2511

Direct-Current Amplifier for a Photocell with Low Insulation Resistance or Large Dark-Current—J. Dubois. (*Compt. Rend. Acad. Sci.*, Paris, vol. 220, pp. 768-770; May 28, 1945.) Note on a modification of the input circuit to a B405 amplifier tube that gives a substantial improvement of sensitivity by maintaining the operating point on the linear part of the characteristic.

621.395.645+621.396.621 2512

Superamp with Tuner—C. G. Brennan. (*Radio Craft*, vol. 17, pp. 539, 563; May, 1946.) Details of a high-fidelity audio-frequency amplifier and superheterodyne receiver.

621.395.645 2513

Additional Notes on the Parallel Tube Amplifier—Jones; Velasco. (See 2464.)

621.395.645 2514

Negative Feedback and Hum—"Cathode Ray" (*Wireless World*, vol. 52, pp. 142-145; May, 1946.) A series of experimental results is given for typical triode and pentode amplifier stages. It is concluded that (a) feedback from the anode, when the load is transformer coupled, is generally bad practice unless the high-voltage supply is very smooth; (b) with triodes when feedback is generally not used, parallel feed should be used; (c) with tetrodes and pentodes, freedom from hum is obtained by smoothing the screen supply, or by use of feedback; (d) a transformer-coupled pentode is remarkably hum-free without feedback. See also 1477 of June (Builder).

621.395.645:534.43 2515

Unique Phono Amplifier—C. E. Pett, Jr. (*Radio News*, vol. 35, pp. 50, 90; May, 1946.) Constructional details of an amplifier with circuits for bass and treble boost and for contrast expansion.

621.395/.397].645:621.314.25 2516

Phase Inverters—H. A. Bustard. (*Radio News*, vol. 35, pp. 57, 104; February, 1946.) Circuit diagrams of nine different types, with a detailed discussion of their design and operation.

621.395.645:621.317.733 2517

A Convenient Amplifier and Null Detector—Scott and Byers. (See 2634.)

621.395.645:621.395.665.1 2518

A Volume Expander Compressor Preamplifier—R. C. Moses. (*Radio News*, vol. 35, pp. 32, 149; June, 1946.) Constructional details of a preamplifier with a maximum overall gain of 110 decibels. The time delay of the automatic gain control can be adjusted to give a minimum rise time of 3 milliseconds, and maximum decay time of 500 milliseconds.

621.396.6.018.1 2519

Phase Relationships—M. G. Scroggie:

J. H. Barrett. (*Wireless World*, vol. 52, pp. 170-171; May, 1946.) Critical discussion of 1794 of July (Cooper).

621.396.61 2520

Tuned Circuits for the U.H.F. and S.H.F. Bands—F. C. Everett. (*Communications*, vol. 26, pp. 19-21, 51; June, 1946.) A review of fixed and variable tuned circuits including a more detailed description of a symmetrical wide-band cylindrical circuit similar to those described in 1797 of July (Gross).

621.396.611:536.7 2521

Boltzmann's Law of Slow Transformation and the Theory of Electromagnetic Cavities—T. Kahan. (*Compt. Rend. Acad. Sci.*, Paris, vol. 222, pp. 70-71; January 2, 1946.) Derivation of a general formula for the Q of a cavity which "leads to new methods of determining dielectric constants, multiplication factors, and magnetic permeabilities at hyperfrequencies."

621.396.615 2522

A Study of Locking Phenomena in Oscillators—R. Adler. (*Proc. I.R.E. and Waves and Electrons*, vol. 34, pp. 351-357; June, 1946.) "Impression of an external signal upon an oscillator of similar fundamental frequency affects both the instantaneous amplitude and instantaneous frequency. Using the assumption that time constants in the oscillator circuit are small compared to the length of one beat cycle, a differential equation is derived which gives the oscillator phase as a function of time. With the aid of this equation, the transient processes of 'pull-in' as well as the production of a distorted beat note are described in detail.

"It is shown that the same equation serves to describe the motion of a pendulum suspended in a viscous fluid inside a rotating container. The whole range of locking phenomena is illustrated with the aid of this simple mechanical model."

621.396.615 2523

Notes on the Stability of LC Oscillators—N. Lea. (*Jour. I.E.E.* (London), Part I, vol. 93, pp. 235-236; May, 1946.) Summary of 569 of March.

621.396.615:621.396.611.21+621.317.361 2524

Series-Resonant Crystal Oscillators—F. Butler. (*Wireless Eng.*, vol. 23, pp. 157-160; June, 1946.) Most crystal oscillators use the crystal in the parallel-resonant mode. Quartz crystals however possess a series-resonant mode that has the advantage of somewhat higher constancy of frequency. The frequency, in the series mode, is unaffected by changes in parallel reactance (e.g., holder capacitance) but is affected by changes in series reactance. Circuits of the Hartley type are described in which the crystal is connected between the cathode of the tube and the center of the oscillatory coil.

621.396.615.17 2525

Kinematic Definition of Relaxation Oscillations—J. Abelé. (*Compt. Rend. Acad. Sci.*, Paris, vol. 220, pp. 511-513; April 9, 1945.) Van der Pol (1930 Abstracts, p. 503) defined relaxation oscillations in terms of a nonlinear second-order differential equation. The present author calls this a "dynamic" definition, and proposes a "kinematic" defi-

dition analogous to the definition of sinusoidal oscillations as the projection of a circular motion. Consideration is given to the projection of the end of a uniformly rotating vector on an axis that oscillates according to a fixed law relative to the rotation. "The curves so obtained are analogous to those of van der Pol who used a more laborious and less accurate method of graphical integration." A more detailed account is to appear elsewhere.

621.396.615.17 2526

Linear Saw-Tooth Oscillator—W. T. Cocking. (*Wireless World*, vol. 52, pp. 176-178; June, 1946.) A modification of the transitron time base, operating with a single pentode, and essentially a combination of the prewar transitron and the Miller integrator developed during the war. The control grid, cathode, and anode are used for the linearizing action, and the screen and suppressor grids are resistance-capacitance coupled to give a transitron type of circuit, thus providing a self-oscillating linear time base.

621.396.619.16:621.396.9 2527

Radar Technique—W. T. C. (*Wireless World*, vol. 52, pp. 156-158; May, 1946.) Review of papers on pulse circuits presented at the Institution of Electrical Engineers Radiolocation Convention.

621.396.645 2528

Intermediate Frequency Amplifier Stability Factors.—D. L. Jaffe. (*Radio*, vol. 30, pp. 26-27, 55; April, 1946.) The stability is determined by the plate-grid capacitance of the individual tubes, wiring, over-all gain, and coupling between the input and output. The last is important for amplifiers with gains in excess of 80 decibels. It is shown, by considering the phase of the feedback current, that the maximum anode impedance for stability is given by $\sqrt{(2/g_m\omega_0 C_{gp})}$ for a single tuned circuit, and $\sqrt{(2g_m/\omega_0 C_{gp})}$ is the maximum stable gain. The corresponding figures for double tuned circuits critically coupled are $\sqrt{(0.79/g_m\omega_0 C_{gp})}$ and $\sqrt{(0.79g_m/\omega_0 C_{gp})}$. Values for the latter are shown in graphs against frequency for a number of commonly used tubes.

621.396.645.3.029.58 2529

Long Leads Aren't Necessary—Shuart. (See 2772.)

621.396.66 2530

Clamping Circuits—J. McQuay. (*Radio Craft*, vol. 17, pp. 541, 561; May, 1946.) "A clamping circuit maintains either the positive extreme or the negative extreme of a wave form within the limits of a desired reference level of voltage."

621.396.662.2.029.6 2531

V.H.F. Coil Design—Meyerson. (See 2732.)

621.396.667 2532

Low-Frequency Correction Circuit—(*Wireless World*, vol. 52, pp. 199-200; June, 1946.) Design of a circuit giving a rising response characteristic at the lower frequencies, such as is required for gramophone reproduction. The circuit also gives a small amplification.

621.396.667 2533

Tone Correction—L. Gregory. (*Wireless World*, vol. 52, p. 204; June, 1946.) Brief description of a circuit combining bass and treble boost with negative feedback.

621.397.645.2:621.396.621.54 2534

I.F. Amplifiers in Television Receivers—M. H. Kronenberg. (*QST*, vol. 30, pp. 62-65; June, 1946.) Circuits are given for two 12.75-megacycle amplifiers with 2.5-megacycle and 4-megacycle bandwidth respectively, having attenuation at the 8.25-megacycle sound channel. Design formulas are discussed.

621.392 2535

Heaviside's Electric Circuit Theory [Book Review]—H. J. Josephs. Methuen & Co., London, 115 pp., 4s. 6d. (*Wireless Eng.*, vol. 23, p. 200; July, 1946.) One of the monographs on physical subjects. "... a valuable addition to the Heaviside literature."

GENERAL PHYSICS

535.343.4+621.317.1.011.5+621.396.11.

029.64]:546.171.1 2536

Ammonia Spectrum in the 1 cm. Wavelength Region—Bleaney and Penrose. (See 2662.)

535.43:537.122 2537

On the Theory of the Scattering of Light on Free Electrons—M. Al'perin. (*Zh. Eksp. Teor. Fiz.*, vol. 14, nos. 1, 2, pp. 3-13; 1944.) The existing methods for studying the problem are valid for small intensities of the incident wave only. It is possible, however, by choosing suitable variables to find an exact solution of the Dirac equations for an electron in the field of a plane wave. This is done in the present paper, and the solution found (17) is used to derive a formula (47) similar to the one obtained by Klein and Nishina (1929 Abstracts, p. 588), but applicable to large intensities of the incident radiation and taking into account the possibility of a simultaneous absorption of several quanta. The results obtained are discussed in the light of quantum electrodynamics.

535.5 2538

A Graphical Method for Determining the Refractive Index and Thickness of Thin Film—I. Obreimoff. (*Zh. Eksp. Teor. Fiz.*, vol. 14, nos. 10, 11, pp. 431-438; 1944.) It is assumed that the film has a uniform thickness h and a constant refractive index n_2 , and that a plane wave falls on the film at an angle i_1 . If, under these conditions, E_p and E_s denote respectively the component of the electric vector in the plane of incidence and the component perpendicular to it, then E_p^r and E_s^r in the reflected wave will be reflected differently, viz., $E_p^r = \rho_p E_p$ and $E_s^r = \rho_s E_s$. Moreover, there will be a phase difference δ between these components. A system of equations (2) determining the relationship between ρ_p , ρ_s and δ was derived by Vlasoff who also pointed out that if γ and δ are determined experimentally ($\rho_p \rho_s = \tan \gamma$), then h and n_2 can be calculated from equations (2). With the many measurements required, however, the calculations would be too laborious, and a number of nomograms are given in order to simplify these, as well as those required in the measurements of γ and δ . Numerical examples are

worked out and the accuracy of the method is estimated.

621.396.611:536.7 2539

Boltzmann's Law of Slow Transformation and the Theory of Electromagnetic Cavities—Kahan. (See 2521.)

537.226 2540

The Theory of the Polarization of Dipole Liquids in Strong Electric Fields—A. Anselm. (*Zh. Eksp. Teor. Fiz.*, vol. 14, no. 9, pp. 364-369; 1944.) It was shown by the author in previous papers (*Zh. Eksp. Teor. Fiz.*, vol. 12, p. 274; 1942; vol. 13, p. 432; 1943) that the theory of the inner field proposed by Debye for interpreting the polarization of dipole liquids in weak fields is incorrect. The same considerations also apply to Debye's theory of polarization in strong fields. In the present paper the author develops a new theory from the method used by Kirkwood (*Jour. Chem. Phys.*, vol. 7, p. 911; 1939), investigating the polarization in weak fields. It is pointed out, however, that Kirkwood, having derived formula (1) for determining the permittivity ϵ in a weak field has attempted to calculate M_∞ , the electric moment appearing in an infinite dielectric with a fixed orientation of one of its molecules. Such attempts are bound to fail with the present state of knowledge of intramolecular forces in a liquid, so the author proposes to treat M_∞ as a parameter which characterizes the molecular interaction, and which can be determined experimentally. Accordingly, a formula (14) is derived for calculating the dielectric constant ϵ' in strong fields. It is possible to check the new theory experimentally by considering other phenomena determined quantitatively by M_∞ . Thus it is shown that the value of $(\epsilon' - \epsilon)/\epsilon$ depends on M_∞ . A comparison between the theoretical and experimental values of the ratio for water and nitrobenzene indicates that the theoretical results are of the correct order of magnitude.

537.312.62 2541

Notes on the Theory of Superconductivity—V. Ginsburg. (*Zh. Eksp. Teor. Fiz.*, vol. 14, no. 5, pp. 134-151; 1944.) The theory is discussed in the light of the latest experimental and theoretical investigations under the following headings: (a) main properties of superconductivity; (b) phenomenological electrodynamics; (c) microscopic aspect of superconductivity; (d) energy spectrum and properties of the electron liquid; (e) statistical and some other properties of superconductors.

The main conclusion reached is that the theory of superconductivity is closely associated with the electron theory of metals in a normal state. Efforts therefore should be directed towards further development of the latter theory, but on the basis of the electron liquid concept, i.e., without using the electron gas hypothesis. A list of 16 references is given.

537.525:535.34 2542

On the Absorption of Light by a Plasma—A. Kompaneyets. (*Zh. Eksp. Teor. Fiz.*, vol. 14, pp. 171-176; 1944.) It is known that free electrons do not absorb light. It would therefore appear that a completely ionized gas at a sufficiently high temperature would

have a very low absorption coefficient. To verify this, a mathematical investigation of the propagation of electromagnetic oscillations in a plasma is presented. It is shown that owing to the forces acting between the electrons and the positive ions of the plasma the latter possesses a considerable absorption coefficient. This absorption, as distinct from the photoelectric absorption, does not decrease with the frequency of the light wave and the temperature of the plasma. A formula (37) is derived determining the absorption coefficient, and methods are indicated for carrying out the necessary calculations.

538.222:538.56 2543

A New Method for Investigating Paramagnetic Absorption—S. Altschüller, E. Zavoiski, and V. Kozirev. (*Zh. Eksp. Teor. Fiz.*, vol. 14, nos. 10, 11, pp. 407–409; 1944.)

538.3 2544

Electromagnetic Field Equations for a Conducting Medium with Hysteresis—Rozovski. (*Zh. Eksp. Teor. Fiz.*, vol. 14, nos. 10, 11, pp. 402–406; 1944.) In Maxwell's equations, it is usually assumed that $B(\mathbf{z}, t) = \mu H(\mathbf{z}, t)$. If, however, the magnetic lag is taken into account, the latter formula must be so modified as to reflect the dependence of $B(\mathbf{z}, t)$, not only on the value of $H(\mathbf{z}, t)$ at the given moment, but also on the states of $H(\mathbf{z}, t)$ preceding this moment. Using the relationship (3) between $B(\mathbf{z}, t)$ and $H(\mathbf{z}, t)$, introduced by Volterra, an integral-differential equation (11) of a more general character is derived from Maxwell's equations. It is shown that this equation can be solved by the Fourier method.

538.31 2545

Two Electromagnetic Problems—G. W. O. H. (*Wireless Eng.*, vol. 23, pp. 181–182; July, 1946.) If a current-carrying solenoid, placed in a magnetic field from a source remote from the solenoid, is reversed in direction, the reduction of magnetic energy within the solenoid is balanced by the increase outside it, and all the work done against the field appears as energy in the electric circuit.

538.31 2546

On the Parametric Oscillations of an Iron Body in an Alternating Magnetic Field—S. Rytoff. (*Zh. Eksp. Teor. Fiz.*, vol. 14, no. 9, pp. 370–378; 1944.) An electromechanical system is considered consisting of a circular loop and an iron ball capable of moving along the axis of the loop. If a current is passed through the loop the ball will be attracted into the loop, and the coefficient of elasticity of the system for a current of frequency ω will vary between zero and maximum values with a frequency 2ω . This is therefore an oscillating system with a periodically variable parameter determining its natural frequency, and, as is known, the equilibrium of such a system may become unstable under certain conditions.

A mathematical analysis of the system is offered and equation (4) determining the appearance of oscillations is derived. It is shown that there are discrete regions of instability which can be reached by varying the strength of the loop current. A detailed

description of experiments is given in which the following two types of oscillations were observed: (a) oscillations at the current frequency with small amplitudes and only slight nonlinearity; and (b) oscillations at fractional current frequencies with large amplitudes and a strongly pronounced nonlinearity. The parametric interaction between the loop current and eddy currents in the ball is also briefly discussed.

538.32:621.385.832 2547

Problem of Two Electrons—R. E. Burgess: G.W.O.H. (*Wireless Eng.*, vol. 23, p. 178; June, 1946.) Discussion of 913 of April (G.W.O.H.). Burgess points out that the apparent paradox in the problem of two electrons is easily resolved by application of the principle of special relativity. G.W.O.H. replies editorially in the same journal, pp. 155–156. See also 587 of March (Tripp).

538.56:517.948.3 2548

The Boundary Problem of Electrodynamics and Integral Equations of Certain Diffraction Problems—Ya. Feld. (*Zh. Eksp. Teor. Fiz.*, vol. 14, no. 9, pp. 330–341; 1944.) In a number of problems of electrodynamics it is required to determine the electromagnetic field set up by given exciters in a space bounded by metallic surfaces. Problems of this type can be reduced to the following: it is required to find, in a space v bounded by a surface s , a field with the tangential component of the electric vector vanishing at the surface s . In the present paper the case of harmonic oscillations only is considered, and a solution (1) of the problem is derived. The results obtained can be used to reduce some of the problems of electromagnetic diffraction to Fredholm's integral equations of the first kind. This is shown in a number of examples dealing with the diffraction of electromagnetic waves at an aperture in an infinite plane. Methods for solving the equations so derived are also indicated.

541.133:[621.3.029.5]/.6 2549

The Variation of the Electrical Conductivity of Electrolytes with Frequency—N. Maloff. (*Zh. Eksp. Teor. Fiz.*, vol. 14, no. 6, pp. 221–223; 1944.) In a previous investigation (2682 of 1940) into the electrical conductivity of highly concentrated solutions of sodium chloride in water (up to 0.3 mol/litre) the author found a considerable decrease in the conductivity at high frequencies. In the present paper, a mathematical analysis of the phenomenon is proposed based on a study of Belikoff (*Zh. Eksp. Teor. Fiz.*, vol. 9, p. 969; 1939) of the movement of ions in electrolytes and on the conductivity of electrolytes at low frequencies. To simplify the discussion it is limited to the case of a symmetrical binary monovalent electrolyte, and it is shown that Belikoff's equations, when extended to higher frequencies, indicate a fall in the conductivity. In the case of low concentrations this becomes apparent at frequencies within the range of centimeter waves, while with high concentrations the effect begins to take place at frequencies of the order of 10^6 cycles. A physical interpretation of the results obtained is also given.

621.314.6:621.383.2 2550

Experimental Behaviour of a Photoelec-

tric Cell Under the Influence of an Alternating Potential of Very High Frequency—Charles. (See 2725.)

621.314.6:621.383.2 2551

Theory of the Behaviour of a Photoelectric Cell Under the Influence of an Alternating Potential of Very High Frequency—Charles. (See 2726.)

621.314.63+621.315.34 2552

An Anomalous Phenomenon in Thermal Rectification in Lead Sulphide (Preliminary Communication)—Kh. Amirhanoff. (*Zh. Eksp. Teor. Fiz.*, vol. 14, no. 6, pp. 193–194; 1944.) Experiments were conducted with lead sulphide obtained chemically in the form of a black powder. Samples at room temperature and a pressure of 10,000 kilograms per square centimeter possessed a hole-type conductivity, and a resistivity of $5 \cdot 10^6$ ohms per centimeter. After heat treatment at 200 to 300 degrees centigrade, depending on the duration of the treatment, the resistivity decreased, and the hole-type conductivity was replaced by that of the electron type. In one sample, however, conductivity of the electron type changed again to the hole type after a current had passed for 30 to 60 seconds. The phenomenon also occurred when the direction of the temperature gradient was changed. No residual polarization or other effects were observed. A table with the experimental data is given.

GEOPHYSICAL AND EXTRATERRESTRIAL PHENOMENA

523.7+525.24]:551.51.053.5 2553

The Application of Solar and Geomagnetic Data to Short-Term Forecasts of Ionospheric Conditions—A. H. Shapley. (*Terr. Magn. Atmos. Elec.*, vol. 51, pp. 247–266; June, 1946.) The ways in which recurrence tendencies of geomagnetic activity, reports of solar activity, and various solar-terrestrial relationships are used in preparing forecasts at the Department of Terrestrial Magnetism, Carnegie Institution of Washington. Forecasts are compared with magnetic activity over a 15-month period, and are 70 per cent satisfactory. Analysis of coronagraphic and spectroheliographic data with magnetic activity show that for two years there was a decided tendency for disturbances to occur when solar regions identified by these observations were east of the central meridian of the sun. A minimum in solar activity occurred early in 1944, as indicated by reduction of solar and geomagnetic data.

Recorders have been constructed which give an instantly visible record of variation of the earth's magnetic field.

"Solar-geomagnetic relationships are still too general to be the sole factor in detailed forecasts. The manifestation, if any, of the solar cause of geomagnetic disturbance has not yet been found."

523.7+525.24] "1946.09./03" 2554

Solar and Magnetic Data, January to March 1946, Mount Wilson Observatory—S. B. Nicholson and E. S. Mulders. (*Terr. Magn. Atmos. Elec.*, vol. 51, pp. 284–286; June, 1946.)

- 523.72 2555
The Solid Angle of the Corpuscular Solar Radiation—M. N. Gnevishev and A.I.or. (*Terr. Magn. Atmos. Elec.*, vol. 51, pp. 163-170; June, 1946.) The solid angle may be evaluated by using data on (a) duration of magnetic storms; (b) equinoctial increase of geomagnetic activity; (c) correlation-coefficients between magnetic activity and sunspot area in the central zone with different radii; and (d) the lag of the 11-year variation of geomagnetic activity. The researches indicate an angle of from 8 to 9 degrees.
- 523.72 2556
A Theoretical Discussion of the Continuous Spectrum of the Sun—G. Münch. (*Astrophys. Jour.*, vol. 102, pp. 385-394; November, 1945.) Experimental data are examined in relation to the theory of radiative equilibrium. The intensity distribution and the law of darkening in the different wavelengths can be explained in terms of the absorption coefficient. The required variation of this coefficient in the visual and near infrared regions of the spectrum is also explained.
- 523.72:525.24 2557
Geomagnetic Data on Variations of Solar Radiation: Part 1—Wave-Radiation—J. Bartels. (*Terr. Magn. Atmos. Elec.*, vol. 51, pp. 181-242; June, 1946.) Homogeneous time-series for W (a wave-type of solar radiation) and P (a particle-type) are derived from magnetic observations. Daily values for the deviations of W from a normal value are inferred from the variation of the horizontal intensity. These are compared with tables derived for the solar activity R and radiation P , the correlation for "slow" variations between R and W being well marked. "Fast" variations in R due to solar rotations are followed after a time lag by similar variations in W . The physical meaning of W and its extraction from geomagnetic records are discussed.
- 523.746"1945" 2558
Final Relative Sunspot-Numbers for 1945—M. Waldmeier. (*Terr. Magn. Atmos. Elec.*, vol. 51, pp. 267-269; June, 1946.)
- 523.746"1946.01/.03" 2559
Provisional Sunspot-Numbers for January to March, 1946—M. Waldmeier. (*Terr. Magn. Atmos. Elec.*, vol. 51, p. 274; June, 1946.)
- 523.746.5 2560
A Prediction of the Next Maximum of Solar Activity—M. Waldmeier. (*Terr. Magn. Atmos. Elec.*, vol. 51, p. 270; June, 1946.) The maximum should be expected to take place as early as 1947.6. A table gives the smoothed monthly relative numbers for the epochs two years before to five years after the maximum.
- 523.78:525.23 2561
Atmospheric-Electric Potential-Gradient in Kokkola, Finland, During the Solar Eclipse of July 9, 1945—E. Sucksdorff. (*Terr. Magn. Atmos. Elec.*, vol. 51, pp. 171-176; June, 1946.) Measurements were made using a bifilar electrometer and an ionium collector. The eclipse caused a marked and smooth diminution of the potential gradient which began two hours prior to the beginning of the eclipse and continued even after the end of the visual eclipse.
- 523.78:551.51.053.5:621.396.11 2562
The Influence of an Eclipse of the Sun on the Ionosphere—R. L. Smith-Rose. (*Jour. Brit. Instn. Radio Eng.*, vol. 6, pp. 82-97; June, 1946.) A survey of the structure of the ionosphere and its effects on propagation. The information gained from radio observations during solar eclipses is outlined. Experimental evidence shows that the main source of ionization is ultraviolet radiation from the sun; the possible contribution in the F_2 region from incident neutral particles is an open question. A more complete understanding is required of long-distance transmission, particularly at very low frequencies. A bibliography of 20 items is given.
- 533.6.013.22 2563
On Atmospheric Turbulence—A. M. Obukhov. (*Jour. Phys.*, U.S.S.R., vol. 6, no. 5, pp. 228-229; 1942.) Abstract of a paper of the Academy of Science, U.S.S.R.
- 550.38 2564
Geomagnetic Secular Variations and Surveys—J. A. Fleming. (*Proc. Phys. Soc. London*, vol. 58, pp. 213-246; May 1, 1946.)
- 550.38"1945.07/.09" 2565
Five International Quiet and Disturbed Days for July to September, 1945—W. E. Scott. (*Terr. Magn. Atmos. Elec.*, vol. 51, p. 284; June, 1946.)
- 550.38:523.75 2566
Relations Between Magnetic Disturbances and Solar Eruptions—M. Burgaud. (*Compt. Rend. Acad. Sci.*, Paris, vol. 222, pp. 449-450; February 18, 1946.) Observations lead to the following conclusions: (a) magnetic storms do not depend on the size or growth of sunspots and faculae, but on violent eruptions; (b) a storm can be caused by an eruption on any part of the solar disk, but maximum effects are associated with eruptions near the central meridian; and (c) magnetic disturbances have taken place in the absence of visible sunspots; they follow eruptions.
- 550.385"1945.10/1946.03" 2567
Principal Magnetic Storms [Reported from Various Observatories]—(*Terr. Magn. Atmos. Elec.*, vol. 51, pp. 287-301; June, 1946.)
- 550.385"1946.01/.03" 2568
Geomagnetic Storms—(*Curr. Sci.*, vol. 15, p. 146; May, 1946.) A brief review of the more intense storms recorded at the Alibag Magnetic Observatory in the period January to March, 1946.
- 550.385"1946.03.23/.29" 2569
Two Notable Geomagnetic Storms—(*Nature*, London, vol. 157, p. 435; April 6, 1946. Reprinted *Terr. Magn. Atmos. Elec.*, vol. 51, pp. 283-284; June, 1946.)
- 550.385"1946.03.28" 2570
Geomagnetic Storm at Elisabethville, March 28, 1946—W. E. Scott. (*Terr. Magn. Atmos. Elec.*, vol. 51, pp. 281-283; June, 1946.)
- 551.51.053.5"1940/1944" 2571
Annual Variation of the Values at Noon of the Critical Frequencies of the Ionized Layers at Tromsø During 1940, 1941, 1942, 1943, and 1944—L. Harang. (*Terr. Magn. Atmos. Elec.*, vol. 51, pp. 275-277; June, 1946.) The monthly mean values show a continuous decrease for all three layers, compared with those taken before 1940, the decrease being particularly pronounced for the F_2 layer.

LOCATION AND AIDS TO NAVIGATION

534.417:534.88 2572
Navy Releases Sonar Story—(See 2452.)

551.576:621.383 2573
On Atmospheric [Cloud-Height] Sounding—Barthélemy. (See 2657.)

621.396.674:621.318.323.2.029.5 2574
Iron-Cored Loop Receiving Aerial—Burgess. (See 2485.)

621.396.677.1 2575
Aperiodic Combination of an Antenna and a Frame. Application in Direction-Finding to an Aperiodic Arrangement for Indicating Sense—F. Carbenay. (*Compt. Rend. Acad. Sci.*, Paris, vol. 222, pp. 63-64; January 2, 1946.) The potential difference at the terminals of a small resistance at the base of an aerial can be written $u = RC \frac{dF}{dt}$ where R =resistance, C =aerial capacitance, h =effective height, F =vertical electrical intensity, t =time. The electromotive force in the frame is $e = NS \frac{dH}{dt}$ where N =turns, S =area, H =horizontal magnetic intensity. The resultant of the two in series is zero or a maximum of $RC \frac{dF}{dt} = NS$ where c =velocity which is a relationship independent of signal frequency. The arrangement is used in connection with atmospheric locators.

621.396.9 2576
[I.E.E.] Radiolocation Convention—(*Engineering*, London, vol. 161, pp. 306-308, 319-320, 367, and 389-390; March 29, April 5, 19, 26, 1946.) Summary of the proceedings. For other accounts, see *Engineer*, London, vol. 181, pp. 296-297; March 29, 1946; and *Radio*, vol. 30, pp. 26, 48; May, 1946. See also 1850 of July.

621.396.9 2577
Radar in War and Peace—L. N. Ridenour. (*Elec. Eng.*, vol. 65, pp. 202-207; May, 1946.) The fundamental principles of radar, with brief notes on outstanding wartime achievements. The postwar possibilities of pulse navigation systems, radar beacons, and relay radar are discussed.

621.396.9 2578
Marine Radar for Peacetime Use—L. H. Lynn and O. H. Winn. (*Trans. A.I.E.E.* (*Elec. Eng.*, May, 1946) vol. 65, pp. 271-273; May, 1946.) Brief description of a commercial radar system for use on cargo vessels. Simplicity of operation for nontechnical personnel is claimed.

621.396.9 2579
Radar for Blind Bombing: Part 2—J. V. Holdam, S. McGrath, and A. D. Cole. (*Electronics*, vol. 19, pp. 142-149; June, 1946.) The conclusion of 2196 of August, giving details, with circuit diagrams of the modula-

tors, scanners, radio-frequency systems, receiver-indicator systems, and synchronizers in the APQ-13 and APS-15 versions of the H2X equipment.

621.396.9 2580

Airborne Radar for Navigation and Obstacle Detection—R. C. Jensen and R. A. Arnett. (*Trans. A.I.E.E. (Elec. Eng., May, 1946)*, vol. 65, pp. 307-313; May, 1946.) An account of wartime achievements as a basis for peacetime applications.

621.396.9 2581

Early Fire-Control Radars for [U.S.] Naval Vessels—W. C. Tinus and W. H. C. Higgins. (*Bell Sys. Tech. Jour.*, vol. 25, pp. 1-47; January, 1946.) An account of the development in the Bell Telephone Laboratories of equipments "Mark I" to "Mark IV". The first operated at 680 to 720 megacycles using 2-kilowatt pulses of adjustable duration 1 to 5 microseconds, repetition rate 1640 pulses per second, obtained from a pair of "doorknob" tubes (see 126 of 1938, Samuel). The aerial was an array of 8 half-wave dipoles in line with a parabolic cylinder reflector 6 feet square, giving a beam width of 12 degrees and gain of 22 decibels. The receiver operated with 30-megacycle intermediate frequency, 1-megacycle intermediate-frequency bandwidth, and had a noise factor of 24 decibels. The equipment gave range to an accuracy of about ± 200 yards up to 10 miles or more, and azimuth to 1 to 2 degrees.

The Mk II radar was superseded by Mk III before production began. Aerial lobe switching was used in Mk III to give azimuth determination and tracking to ± 15 minutes. A new type of range presentation gave an accuracy better than the requirement of ± 50 yards. A magnetron (WE 701-A) for 700 megacycles, based on the 3000-megacycle British cavity type, gave 40-kilowatt, 2-microsecond pulses, and the receiver, using "lighthouse" tubes for radio frequency amplification, had a noise factor of 9 decibels, so that there was a substantial improvement of range. A gas-discharge transmit-receive switch was used for aerial duplexing (see 2784).

The Mk IV set had two aerial arrays one above the other, and used lobe switching in elevation as well as azimuth, but was otherwise similar to Mk III. All types were first installed in 1941.

621.396.9:534.321.9 2582

Ultrasonic [Radar] Trainer Circuits—F. J. Larsen. (*Electronics*, vol. 19, pp. 126-129; June, 1946.) A 15-megacycle pulsed ultrasonic beam is projected in a water trough which has a special map made on its bottom surface with graduated surface roughening to represent terrain of different kinds. Sound waves reflected from the rough parts of the map are received by the crystal transducer and used to operate radar equipment. The beam is rotated, and the device is used to give plan-position indicator presentation of the map. Auxiliary equipment is used to simulate aerial bombing runs. A general description is given, with details of some of the circuits.

621.396.9:621.317.79 2583

Techniques and Facilities for Micro-

wave Radar Testing—Green, Fisher, and Ferguson. (See 2645.)

621.396.9:621.385.18 2584

The Gas-Discharge Transmit-Receive Switch—Samuel, Clark and Mumford. (See 2784.)

621.396.9:[621.396.11.029.64+538.569.4 2585

Radio Echoes from the Planets—W. D. Hershberger. (*Science*, vol. 103, p. 371; March 22, 1946.) A note on the effect of absorption of microwaves by various gases. See also 1336 of May.

621.396.9:621.396.82 2586

Radar Countermeasures—O. G. Villard, Jr. (*Proc. Radio Cl. Amer.*, vol. 23, pp. 7-15; March, 1946.)

621.396.933:629.1.052 2587

Pulse-Type Radio Altimeter—A. Goldman. (*Electronics*, vol. 19, pp. 116-119; June, 1946.) General description and circuit details of a high-altitude altimeter, designated SCR-718-C, that operates on the radar principle. The sine-wave output from a crystal-controlled oscillator is clipped, differentiated, and amplified in pulse-generating circuits to form the modulating signal for the 440-megacycle transmitter, which provides 0.25-microsecond signals of 5 to 10 watts. The cathode-ray indicator has a circular sweep, and the signals received directly from the transmitter and after ground reflection produce radial deflexions. The height is given by the angular separation of the deflexions. 5,000-foot and 50,000-foot scales are provided. Accuracy, 50 feet.

621.396.933.23 2588

Use of Microwaves for Instrument Landing: Parts 2 and 3—D. F. Folland. (*Radio*, vol. 30, pp. 23-25, 55, and 16-19; April and May, 1946.) Further details of the Sperry blind-landing system. For part 1, see 1866 of July.

MATERIALS AND SUBSIDIARY TECHNIQUES

531.788.7 2589

Ionization Gauge Control Unit—A. H. King. (*Jour. Sci. Instr.*, vol. 23, p. 85; April, 1946.) A device for maintaining constant filament emission.

533.5 2590

An Apparatus for Stirring Under Vacuum—B. R. Atkins. (*Jour. Sci. Instr.*, vol. 23, p. 84; April, 1946.)

533.5:621.3.032.53 2591

Coppered-Tungsten Seals through Hard Glass—A. L. Reimann. (*Jour. Sci. Instr.*, vol. 23, pp. 121-124; June, 1946.) The fine longitudinal cracks in tungsten wire which cause air leaks may be filled by plating the wire with Cu, with or without an added layer of Ni, and fusing the coating to the wire in a hydrogen furnace. The wire is then plated further with Cu and sealed into a glass with suitable properties, depending on the diameter of the wire and the thickness of the plating.

535.37 2592

On the Inhibiting Effect of Oxygen on the Fluorescence of Solutions—C. Chéchan.

(*Compt. Rend. Acad. Sci.*, Paris, vol. 222, pp. 80-82; January 2, 1946.)

535.37 2593

Note on the Behaviour of Zinc Sulphide Phosphors Under Conditions of Periodic Excitation—M. P. Lord and A. L. G. Rees. (*Proc. Phys. Soc.*, vol. 58, pp. 280-289; May 1, 1946.) The effect of periodic excitation on luminescent solids and the electronic processes involved in the emission of luminescent radiation, are examined theoretically, showing that the phase shift with respect to the exciting radiation and the ratio of the maximum to the minimum emitted intensities are the significant factors in the time function of the luminescent intensity. The variations of these parameters with intensity and period of excitation can be used to distinguish between the various mechanisms of the luminescent process, as is illustrated by an experimental examination of zinc sulphide and zinc-cadmium sulphide phosphors. These phosphors show a semiquantitative agreement with the characteristics of a simple ionization-recombination process, deviations from the theory being attributed to the activation of these phosphors by more than one type of activator atom.

535.37 2594

Note on the Rapid Determination of Decay Characteristics of Luminescent Solids—M. P. Lord and A. L. G. Rees. (*Proc. Phys. Soc.*, vol. 58, pp. 289-291; May 1, 1946.) Square-wave light pulses from a gaseous discharge tube, obtained by using a small vibrator to interrupt the direct-current supply to the tube, and used in conjunction with a cathode-ray display, afford a convenient and rapid method of investigation.

536.48+539.893 2595

Measurements at Low Temperatures and High Pressures: Part I—Development of the Method for Obtaining High Pressures at Low Temperatures—B. Lazareff and L. Kahn. (*Zh. Eksp. Teor. Fiz.*, vol. 14, nos. 10 and 11, pp. 439-447; 1944.) The method proposed is based on the fact that certain substances, such as water, bismuth, antimony, and gallium, increase in volume during the transition from a liquid into a solid state. In a bomb containing such a substance high pressures can thus be generated and transmitted to a body immersed in it. Accordingly, a bomb was developed (Fig. 2) utilizing water and intended for investigating superconductivity by the induction method. A description is also given of a simple device for accurate measurements of the pressure by observing the expansion of the bomb. Pressures of the order of 2000 kilograms per square centimeter were obtained with this bomb at the liquid helium temperature. It is indicated that with bismuth and gallium pressures up to 10,000 kilograms per square centimeter would be possible.

536.55 2596

Temperature Indicating Compounds—G. A. Williams. (*Electronic Eng.*, vol. 18, pp. 208-212; July, 1946.) An account, with colored illustrations, of methods of estimating temperature by the use of (a) paints formulated to change color at given temperatures in the range 80 to 800 degrees centigrade, and (b) compounds available in the form of crayons, emulsions, or pellets, which

melt at sharply defined temperatures in the range 52 to 982 degrees centigrade.

537.226 2597
The Theory of the Polarization of Dipole Liquids in Strong Electric Fields—Anselm. (See 2540.)

539.234:535.87 2598
Anti-Reflexion Films Evaporated on Glass—J. Bannon. (*Nature*, London, vol. 157, p. 446; April 6, 1946.) Reflection from a glass surface may be reduced substantially by evaporating a metallic fluoride onto the surface. Magnesium fluoride is particularly suitable, and the results of various laboratory evaporation processes with this material are given.

620.197:621.357.7:669.56 2599
Corrosion-Resisting Properties of Electrodeposited Tin-Zinc Alloys—R. M. Angles and R. Kerr. (*Engineering*, London, vol. 161, pp. 289-292; March 29, 1946.) Alloys with tin content varying from 0 to 100 per cent, were tested on iron and steel. The 78 per cent alloy gives the greatest protection and is able to withstand a reasonable amount of deformation by bending or cupping.

621.314.63+621.315.34 2600
An Anomalous Phenomenon in Thermal Rectification in Lead Sulphide (Preliminary Communication)—Amirkhanoff. (See 2552.)

621.314.63+621.315.34 2601
The Asymmetry of Conductivity in Electronic Semiconductors—Kh. Amirkhanoff. (*Zh. Eksp. Teor. Fiz.*, vol. 14, no. 6, pp. 187-192; 1944.) The following factors are enumerated, with which the appearance of the asymmetry is associated: (1) difference in the shape of the two contacts (plane, needle); (2) difference in the specific conductivity of the two electrodes; (3) temperature gradient.

Experimental data supplemented by the author's own experiments are surveyed, and the theoretical implications of each of the above factors discussed. The effects of combining several of these factors are then considered under the following headings: (a) Contact between a metallic needle and a crystal. Heat is generated at the point of the contact, and thus both factors 1 and 3 are effective in this case. The two effects are cumulative or oppose each other according to the type of conductivity of the semiconductor (electrons, holes). (b) Solid plate rectifiers. No definite indication is available as to whether factors 1 and 3 are coexistent in this case with factor 2. (c) Thermal rectification. This is effective simultaneously with factors 1 and 2. It is pointed out that in the case of copper oxide, thermal rectification can take place only when there is a high-resistance layer on the electrode. This is proved by a number of experiments in which copper-oxide plates were etched by nitric acid. The results of these experiments given in table 2 show that thermal rectification becomes negligible in plates with polished surface.

621.314.632 2602
The Effect of Temperature Gradient on the Rectifying Action of Copper Oxide Rectifiers—Kh. Amirkhanoff. (*Zh. Eksp. Teor. Fiz.*, vol. 14, no. 6, pp. 195-201; 1944.)

Experiments were conducted with plates of various types with facilities for varying the temperature at both sides of the plate within a range—15 to 150 degrees centigrade. The apparatus used is described, and the results obtained are shown in three tables. The main conclusion reached is that heating the upper electrode (oxide) and cooling the lower (copper) considerably improves the rectifying action. At the same time the sensitivity of the plate is also raised. It appears that under these conditions the thermal rectification is superimposed on the normal rectifying process. It is therefore suggested that, in practice, provision should be made for cooling only the copper surface of the rectifier elements. This would not only decrease the forward resistance, but also raise the permissible current density, as shown by Sharavski (307 of 1938).

Some of the results obtained in these experiments are also discussed from the point of view of an investigation of the barrier layer in copper-oxide rectifiers by means of a thermal sonde, reported by the author elsewhere.

621.315.59:621.396.822 2603
Voltage Fluctuations in Electronic Semiconductors—B. I. Davidov. (*Jour. Phys.*, U.S.S.R., vol. 6, no. 5, p. 230; 1942.) A general formula for the square of the voltage fluctuation is given, which reduces to those expressions for shot effect and Johnson effect under appropriate conditions. Abstract of a paper of the Academy of Science, U.S.S.R.

621.315.61:[621.315.2/.3 2604
Insulated Wire and Cable in Communications Today—A. P. Lunt. (*Communications*, vol. 26, pp. 30, 53; June, 1946.) The paper is concerned with available insulating materials, their properties and use in radio applications. Recommended types of insulation for a wide range of applications are given in tables.

621.315.611 2605
The Electrical Strength of Solid Solutions and Their Melting Temperature—N. Bogdanova. (*Zh. Eksp. Teor. Fiz.*, vol. 14, nos. 1 and 2, pp. 30-31; 1944.) A report of an experimental investigation. Data obtained by von Hippel (1186 of 1938) were used to plot the curves in Fig. 1 (system KCl-RbCl; system KCl-KBr also behaves in a similar manner) and Fig. 2 (system NaCl-AgCl). In the first case, the maximum electrical strength is obtained with a melting temperature of the order of 750 degrees centigrade. In the second case, there is a linear decrease in electrical strength with increase in melting temperature indicated. Systems KI-NaI and KI-KBr were also investigated, and the results are plotted in Figs. 3 and 4, respectively. It appears that the electrical strength of these solutions increases with the melting temperature. The effect of the composition of solid dielectric solutions was also investigated, but no sharp strengthening of the dielectric with the introduction of admixtures was observed.

621.316.86:546.281.26 2606
Silicon Carbide [Non-Ohmic] Resistors—F. Ashworth, W. Needham and R. W. Sillars. (*Engineering*, London, vol. 161, p. 295; March 29, 1946.) Summary of an

Institution of Electrical Engineers paper. See also 1885 of July.

621.318.22/.23 2607
Modern Hard Magnetic Materials—K. Hoselitz. (*Jour. Sci. Instr.*, vol. 23, pp. 65-71; April, 1946.) A survey of the preparation and properties of the alloys, and data for the design of permanent magnets made with them.

621.318.322.029.54/.64 2608
The Permeability of Ferromagnetic Materials at Frequencies Between 10^6 and 10^{10} Cycles—J. T. Allanson. (*Jour. I.E.E.* (London), Part I, vol. 93, pp. 234-235; May, 1946.) Summary of 645 of March.

621.318.323.2.029.3 2609
Study of Ferromagnetic Cores exposed to Sinusoidal Induction [Frequencies up to 10 Kilocycles]—I. Epelboim. (*Compt. Rend. Acad. Sci.*, Paris, vol. 220, pp. 651-653; April 30, 1945.)

621.38/.39](058.7) 2610
1946 Electronic Engineering Directory—(*Electronic Ind.*, vol. 5, 48 pp., following p. 96; May, 1946.) A directory of American sources of supply of electronic and radio equipment and materials.

621.386.1:548.73 2611
X-Ray Studies of Surface Layers of Crystals—E. J. Armstrong. (*Bell Sys. Tech. Jour.*, vol. 25, pp. 136-155; January, 1946.) When a crystalline substance is sawed, ground, lapped, or polished, the crystal structure adjacent to the worked surface is distorted, and the disturbance is detectable by X-ray diffraction. A single crystal spectrometer, in which the intensity of reflection of X-rays by the surface is measured, can be used to detect highly distorted layers. Less distorted surfaces can be detected by means of a double crystal spectrometer, or by photography of X-rays transmitted through the crystal. In quartz crystals, the amount of misorientation is mainly of the order of a minute of arc, but some material may be misoriented by three or four degrees. In addition, there is usually some randomly oriented powder which can be detected only by electron diffraction. The distorted layers may be removed by etching. The paper reviews the appropriate X-ray techniques, and gives examples of their application. Thirty-eight references are given.

669.231.635.8:621.326.21 2612
Welding Small Platinum Heaters and Electrodes—A. R. Morris. (*Jour. Sci. Instr.*, vol. 23, p. 84; April, 1946.) Simple device to facilitate hammer welding of thin platinum wire or foil.

621.793 2613
Metallizing Non-Conductors [Book Review]—S. Wein. Metal Industry Publishing Co., New York, N. Y., 62 pp., \$2.00. (*Electronics*, vol. 19, p. 324; May, 1946.) A survey of commercial methods of forming metallic films on almost any type of surface, including chemical formulas and detailed procedures.

MATHEMATICS

517.92:518.42:531.721 2614
Simple Differential Equations Arising in

Physics; Rapid Solution by Using Hatchet Planimeters—A. Callender. (*Jour. Sci. Instr.*, vol. 23, pp. 77–81; April, 1946.)

517.947.44 2615

On the Near-Periodicity of Solutions of the Wave Equation: Part 3—S. L. Soboleff. (*Compt. Rend. Acad. Sci. U.R.S.S.*, vol. 49, pp. 12–15; October 10, 1945. In French.) For parts 1 and 2 see, 1901 and 1902 of July.

518.5 2616

A Slide Rule for the Addition of Squares—W. E. Morrell. (*Science*, vol. 103, pp. 113–114; January 25, 1946.) Instructions for making a slide rule for solving problems of the form $d = (x^2 + y^2 + \dots)^{\frac{1}{2}}$.

518.6 2617

On Relaxation Methods: A Mathematics for Engineering Science—R. V. Southwell. (*Proc. Roy. Soc. A*, vol. 184, pp. 253–288; August 21, 1945.) Review of a powerful method for obtaining approximate solution of boundary value problems (e.g., Laplace's or Poisson's equation), illustrated by application to various mechanical and electrical systems.

538.56:517.948.3 2618

The Boundary Problem of Electrodynamics and Integral Equations of Certain Diffraction Problems—Feld. (See 2548.)

538.3 2619

The Transformation of the Integral of Retarded Potentials to the Linéard-Wiechert Formulae—E. Durand. (*Compt. Rend. Acad. Sci.*, Paris, vol. 222, pp. 284–286; January 28, 1946.) The derivation is based on Jacobi's theorem on the changing of variables in definite integrals.

518.2 2620

Circular and Hyperbolic Functions, Exponential and Sine and Cosine Integrals, Factorial Function and Allied Functions, Hermitian Probability Functions (British Association Mathematical Tables, Volume I). [Book Review]—Cambridge University Press, London, 2nd edition, 1946, 72 pp., 10s. (*Proc. Phys. Soc.*, vol. 58, pp. 339–340; May 1, 1946.)

MEASUREMENTS AND TEST GEAR

621.317.1:721.396.621.029.6 2621

V.H.F. Receiver [Selectivity] Measurements—H. Gordon and L. George. (*Electronics*, vol. 19, pp. 214, 218; June, 1946.) Most very-high-frequency signal generators have frequency scales that are too coarsely calibrated to show the small frequency increments to the required accuracy. Measurements of the signal-frequency increments are made by observing the change in the intermediate frequency of the receiver under test.

621.317.1.011.5 + 621.396.11.029.64 + 535.

343.4]:546.171.1 2622

Ammonia Spectrum in the 1 cm Wavelength Region—B. Bleaney and R. P. Penrose. (*Nature*, London, vol. 157, pp. 339–340; March 16, 1946.) Measurements were made over the pressure range 0.2 to 600 millimeters of mercury by observing, at the higher pressures, the decrease of power transmitted in a wave guide filled with the gas, and at the lower pressures, the damping

of a cavity resonator. The results are briefly described and discussed. The absorption spectrum at 1.2 millimeters of mercury is shown graphically for the wavelength range 1.15 to 1.48 centimeters. See also 1934 Abstracts, page 260, (Cleeton and Williams).

621.317.1.011.5:621.392 2623

The Theory of the Second Method of Drude—B. K. Maibaum. (*Zh. Eksp. Teor. Fiz.*, vol. 14, nos. 10, 11, and 12, pp. 448–458 and 501–513; 1944.) One of the more serious difficulties arising in the use of this method of measuring the dielectric constants and specific conductivities of dielectrics with the aid of a Lecher system is the possibility of negative displacements (see 471 of 1941—Maibaum), i.e., of conditions under which an increase, instead of a decrease, in the spacing between the two bridges becomes necessary. Six different existing theories of the method are examined critically, and it is shown that none of them is applicable to the above conditions. The effects of the following factors on the sign of the displacement are discussed: (1) ϵ' and ϵ'' (real and imaginary parts, respectively, of the complex dielectric constant); (2) suspension straps of the capacitor; (3) increase in diameter of the line conductors at the points at which the straps are connected; (4) the presence of an inductively coupled indicator. The effects of various constants of the capacitor on the results obtained by the Drude method are also discussed, and formulas for calculating these constants are given together with a description of the necessary experiments. In part 2 equations (1) for calculating ϵ' and ϵ'' are quoted and a general solution of these is found. Simplified formulas (46) are also derived in which the attenuation of the measuring system and the effect of the suspension straps are taken into account.

621.317.32:621.3.015.33 2624

The Influence of Irradiation on the Measurement of Impulse Voltages with Sphere-Gaps—J. M. Meek. (*Jour. I.E.E.*, London, Part II, vol. 93, pp. 97–115; April, 1946.) Full paper summaries of which were noted in 365 of February, and 967 of April.

621.317.33:621.611.21 2625

The Measurement of the Activity of Quartz Oscillator Crystals—A. J. Biggs and G. M. Wells. (*Jour. I.E.E.*, London, Part I, vol. 93, pp. 191–192; April, 1946.) Long summary of 969 of April.

621.317.335 2626

Measurement of the Ratio of Two Small Capacitances Using a Tetrode Electrometer—J. Lacaze. (*Compt. Rend. Acad. Sci.*, Paris, vol. 220, pp. 876–877; June 18, 1945.)

621.317.35:534.61 2627

Range Extender for General Radio 760A Sound Analyzer—Cobine and Curry. (See 2456.)

621.317.361 + 621.396.615:621.396.611.21 2628

Series-Resonant Crystal Oscillators—Butler. (See 2524.)

621.317.715:621.394.645.35 2629

A Contact Modulated Amplifier to Re-

place Sensitive Suspension Galvanometers—M. D. Liston, C. E. Quinn, W. E. Sargeant, and G. G. Scott. (*Rev. Sci. Instr.*, vol. 17, pp. 194–198; May, 1946.) A high-gain amplifier with low input impedance for measurement of small direct-current and very-low-frequency alternating-current voltages and currents. The input is chopped by mechanical contacts, amplified, rectified by other synchronous contacts, and recorded by a milliammeter. Contact troubles are avoided in the input circuits by extreme rigidity, and by the use of gold for contacts and a special cadmium-tin mixture for soldering, as both have a low thermal electromotive force against copper. The input circuit is also carefully shielded with mu-metal, and the size of all loops minimized. The equipment will operate from mains or batteries, and has a noise level of the order of 10^{-9} volts, the actual value depending on the input circuit. On test, a zero drift of 4.10^{-9} volts was recorded over a period of 4 hours.

621.317.715.5 2630

The Use of a Moving Coil Galvanometer for Recording at Frequencies Higher Than Its Own—D. C. Johnson. (*Jour. Sci. Instr.*, vol. 23, pp. 113–114; June, 1946.) The speed of response of the galvanometer can be increased at the expense of sensitivity by introducing "electromagnetic stiffness" by means of external resistive and reactive circuits.

621.317.72.029.62 2631

A Field-Intensity Meter for V.H.F.—D. C. Summerford. (*QST*, vol. 30, pp. 40–42; June, 1946.) Constructional details of a small instrument incorporating an acorn triode rectifier for rough measurements at frequencies up to 225 megacycles.

621.317.725 2632

A Correction Formula for Voltmeter Loading—R. E. Lafferty. (*PROC. I.R.E. AND WAVES AND ELECTRONS*, vol. 34, p. 358; June, 1946.) The finite resistance of a current-operated voltmeter causes errors on account of the load it imposes on the source being measured. A simple formula is derived which enables the true voltage to be obtained from measurements on two voltage ranges which have a known internal resistance ratio. A similar equation may be used to correct the reading of an ammeter having appreciable resistance.

621.317.725 2633

Suppressed-Range Recording Peak Voltmeter—F. G. Brockman. (*Rev. Sci. Instr.*, vol. 17, pp. 177–179; May, 1946.) Description of an instrument designed to detect small fluctuations (0.00095 volts) in relatively large audio-frequency voltages (5 to 30 volts). A single-tube circuit is used, but stabilized filament and high-voltage supplies are required. Calibration methods are given in detail.

621.317.733:621.395.645 2634

A Convenient Amplifier and Null Detector—H. H. Scott and W. F. Byers. (*Gen. Radio Exp.*, vol. 20, pp. 1–3; March, 1946.) The high-gain amplifier is suitable for the range 20 cycles to 100 kilocycles. A semi-logarithmic tube voltmeter is included to

provide null deflection indications. Miniature tubes are used throughout. The circuit diagram and gain versus frequency curves are given.

621.317.733.085.3 2635

Phase Sensitive [a.c.-] Bridge Detector—P. H. Hunter. (*Elec. Ind.*, vol. 5, pp. 60-61; June, 1946.) The detector consists of a twin-triode network essentially similar to a full-wave grid-controlled rectifier system. It needs no direct-current power supply, and indicates the direction as well as the magnitude of the bridge unbalance. The inclusion of an amplifier increases the sensitivity. The device may be useful in industrial process recording and automatic control, as well as in ordinary bridge work.

621.317.738 2636

Production Bridge for Incremental [Inductance] Tests—W. Muller. (*Elec. Ind.*, vol. 5, pp. 72, 122; May, 1946.) The apparatus contains direct-current and alternating-current power sources with an oscillograph as detector. A switch permits operation as either a Hay or an Owen bridge. Inductances from 1 millihenry to 50 henries may be measured with up to 1 ampere, 50 to 500 henries with 0.15 ampere, and above 500 henries with 15 milliamperes.

621.317.78:621.317.382 2637

Oscillographic Arrangement for Measuring Small Powers—J. Benoit. (*Compt. Rend. Acad. Sci.*, Paris, vol. 222, pp. 59-60; January 2, 1946.) The voltage across the load is applied to the X plates, and the voltage across a very small resistance in series with the load is applied, through a tube with a capacitive load, to the Y plates, so that the area enclosed by the cathode-ray trace is proportional to the power in the load.

621.317.78.029.5/.6]:621.326 2638

Load Lamp for Microwave Power Measurements—J. E. Beggs. (*Electronics*, vol. 19, pp. 204, 210; June, 1946.) To reduce lead inductance and glass losses in small load lamps, a concentric-line construction has been used with multiple filaments of fine wire strung from inner to outer line. Low-loss sealing glass and a gettered vacuum prevent breakdown when measuring pulsed high-frequency power.

621.317.79:621.314.24:621.396.823 2639

Maintenance Testing of Dynamotors—H. M. Tremaine. (*Electronics*, vol. 19, pp. 158, 168; June, 1946.) Description and circuit diagram of an equipment for the rapid testing of load characteristics and radio noise interference.

621.317.79:621.318.4 2640

Coil Short Tests—N. L. Chalfin. (*Elec. Ind.*, vol. 5, p. 77; May, 1946.) A solenoidal iron-cored transformer, with two secondaries connected in opposition, is unbalanced when a coil with a shorted turn is placed on the core near one of the secondaries. The resulting voltage operates a relay or indicator.

621.317.79:621.395.82:621.395.645 2641

Measuring Audio Intermodulation—N. C. Pickering. (*Elec. Ind.*, vol. 5, pp. 56, 125; June, 1945.) Sine waves at 100

cycles and 7 kilocycles are fed to an amplifier under test. The 100-cycle component is filtered from the amplifier output, leaving the 7-kilocycle component as a carrier with intermodulation sidebands 7 kilocycles \pm 100 cycles. This combined signal is amplified and applied to a linear detector which feeds a carrier-level meter and a modulation meter calibrated to read percentage distortion. The theory of the method is summarized, and results of typical measurements are shown graphically.

621.317.79:621.396.62 2642

Multipurpose Tester—B. White. (*Radio Craft*, vol. 17, pp. 534, 567; May, 1946.) Description of a radio-frequency and an alternating-frequency signal tracer that incorporates a volt-, ohm-, and milliamperemeter.

621.317.79:621.396.645 2643

Visual Radio Alignment—E. J. Thompson. (*Radio Craft*, vol. 17, pp. 540, 574; May, 1946.) Description and circuit diagram of a frequency-modulated signal generator ("wobbulator"), mean frequency 415 to 540 kilocycles, bandwidth adjustable from 0 to 40 kilocycles.

621.317.79:621.396.712 2644

Portable Precision Amplifier-Detector—F. A. Peachey, S. D. Berry, and C. Gunn-Russell. (*Wireless Eng.*, vol. 23, pp. 183-192; July, 1946.) Description of an instrument for tone-level measurements at 50 to 10,000 cycles to the nearest 0.1 decibel over the range +20 to -50 decibels with respect to 1 milliwatt in 600 ohms. Facilities are provided for measuring peak program level and noise level down to -110 decibels. The two main attenuator controls are geared together so that the algebraic sum of the attenuators is seen directly on the calibrated dial through a window.

621.317.79:621.396.9 2645

Techniques and Facilities for Microwave Radar Testing—E. I. Green, H. J. Fisher, and J. G. Ferguson. (*Trans. A.I.E.E. (Elec. Eng.)*, May, 1946) vol. 65, pp. 274-290; May, 1946.) Equipments and procedures developed at the Bell Telephone Laboratories for testing radar apparatus in the range 500 to 25,000 megacycles. The requirements are outlined, and the following items are described: signal generators, their design and application to receiver testing; frequency measurement by the use of tuned cavities; power measurement by the use of thermistors, and, for high power, by the use of directional couplers of known loss in conjunction with thermistors; echo boxes, their design, properties, and uses for testing over-all performance; spectrum analysis with echo boxes; standing-wave measurements with various devices; directional couplers; attenuators and pads; oscilloscopes; range calibration; and computer test sets.

621.317.79:621.397.62 2646

A Television Signal Generator: Part 2—Monoscope and Video Circuits—R. G. Hibberd. (*Electronic Eng.*, vol. 18, pp. 204-207; July, 1946.) A detailed description, with circuit diagrams. The frame- and

line-scanning generators each consist of a thyatron feeding a cathode follower with a suitable output stage matched to the low-impedance scanning-coil system, synchronizing impulses being fed to the grid of each thyatron. The monoscope output passes to a video amplifier with a cathode-follower input and output, and then to the impulse-mixing unit where the blanking and synchronizing impulses are mixed into the video signal. All units are supplied from a stabilized power pack. For part 1, see 2255 of August.

621.317.79:621.397.645 2647

Transient Video Analyzer—C. Moritz. (*Electronics*, vol. 19, pp. 130-135; June, 1946.) A description, with circuit details, of a test set combining a five-signal transient generator and wide-band oscilloscope for checking the performance of wide-band amplifiers connected between them. The five signals are (a) a 30-cycle square-wave, (b) a 5-kilocycle sawtooth, (c) a 10-microsecond pulse repeated at 5,000 per second, (d) a step function, and (e) a spike function. The sweep of the oscilloscope is synchronized with the signal. The oscilloscope amplifier is designed to have higher fidelity than any ordinary equipment likely to be tested.

621.317.79.029.5 2648

LCR Meter for Amateur Use—W. B. Bernard. (*Radio News*, vol. 35, pp. 40, 125; June, 1946.) Constructional details of an instrument which measures Q from 10 to 600, capacitance up to 350 micromicrofarads accurately and up to 1 microfarad less accurately, and which can be used as a modulated or unmodulated local oscillator with an output of 1 watt in the frequency range 90 kilocycles to 36 megacycles.

621.318.4.013.22 2649

On a System of Coils Producing a Uniform Magnetic Field for a Narrow Wilson Chamber—Nageotte. (*See* 2720.)

621.396:621.317 2650

Application of Radio Technique to General Measurements—G. R. Polgreen. (*Jour. I.E.E. (London)*, Part I, vol. 93, p. 160; April, 1946.) Abstract only.

621.396.615.029.5/.63 2651

Test Oscillator TS-47/APR—D. W. Moore, Jr. (*Radio News*, vol. 35, pp. 32-34, 68; May, 1946.) Detailed description of a robust (army) test oscillator covering 40 to 500 megacycles in two bands, with 1 per cent frequency accuracy. Provision is made for 1,000-cycle sine-wave modulation or pulse modulation.

OTHER APPLICATIONS OF RADIO AND ELECTRONICS

621.3.078 2652

On Increasing the Stability of Self-regulation by Means of Back Coupling—Peshkoff. (*See* 2795.)

621.317.39.082.7 2653

Rapid Moisture Testing of Granular Material—J. H. Jupe. (*Electronics*, vol. 19, pp. 180, 186; May, 1946.) An account of the instrument described in 388 of February (Hartshorn and Wilson).

- 621.365.92:664.84 2654
Electronics in Processing Foods—S. R. Winters. (*Radio News*, vol. 35, pp. 31, 123; June, 1946.) Report on use of dielectric heating in food preservation. See also 393 of February (Moyer and Stotz).
- 621.38:6(048) 2655
Electronic Uses in Industry—W. C. White. (*Elec. Ind.*, vol. 5, pp. 66, 111; June, 1946.) The fourth of a series of selected references, published annually. About four hundred titles are given, with a subject index. For previous lists, see 2844 or 1945.
- 621.383:522.2 2656
Photoelectric Sight for Solar Telescope—W. O. Roberts. (*Electronics*, vol. 19 pp. 100-103; June, 1946.) A separate guiding telescope is attached to the main telescope, and a disk which masks most of the solar light is automatically centered within 1 second of arc by means of 4 photocells and associated amplifiers and relays.
- 621.383:551.576 2657
On Atmospheric [Cloud-height] Sound- ing—R. Barthélemy. (*Compt. Rend. Acad. Sci.*, Paris, vol. 222, pp. 450-451; February 18, 1946.) Brief account of an optical echo-sounding device for cloud-height determination apparently identical in principle with the equipment described in 1943 of July (Moles). Extreme range, 7000 meters.
- 621.383.078:778.6 2658
Photoelectric Controls for [Photographic] Color Printing—J. Robins and L. E. Varden. (*Electronics*, vol. 19, pp. 110-115; June, 1946.) A discussion of the problems involved in the production of high-quality photographic color prints on a large scale. Details of photoelectric circuits used in various processes are given.
- 621.385.833:537.133 2659
On a Project for a Proton Microscope—C. Magnan, P. Chanson, and A. Ertaud. (*Compt. Rend. Acad. Sci.*, Paris, vol. 220, pp. 770-772; May 28, 1945.) By using protons instead of electrons the resolving power due to diffraction will be improved by a factor of 40 for the same aperture and equal energy. A resolving power of 3 angstroms is expected with a magnification of 20,000. Enlargement of the photograph increases magnification to 600,000.
- 621.389:535-1 2660
Night Vision with Electronic Infrared Equipment—(*Electronics*, vol. 19, pp. 192, 204; June, 1946.) A description of the application of infrared image converters and searchlights in German military equipments.
- 621.389:623.555.2:535-1 2661
Electronic Night Sight—W. Mac.D. (*Electronics*, vol. 19, p. 95; June, 1946.) See also 2346 of August.
- 621.392.43:621.365.92 2662
Coupling Method for Dielectric Heating—Kleinberger. (See 2498.)
- 621.396.619.16:621.385.38 2663
Thyratron Pulsar Tube for Industrial Microwaves—(See 2770.)
- 621.398:534.43 2664
[Gramophone] Remote Record-Selection System—F. M. Berry. (*Electronics*, vol. 19, pp. 104-106; June, 1946.) An oscillator transmits radio-frequency pulses by a carrier-current system to discriminator circuits in the gramophone cabinet. Twelve carrier frequencies and the use of both alternations of the power line permit the selection of 24 records.
- 621.398:621.397 2665
Tele-Guided Missiles—(See 2738.)
- 623.26:621.396.9 2666
Mine Detectors—(*Wireless World*, vol. 52, pp. 166-168; May, 1946.) An account of the British Army detector number 4, with circuit diagram. See also 1626 of June (West).
- 623.454.25:621.396.9 2667
The Radio Proximity Fuze—L. G. Hector. (*Proc. Radio Cl. Amer.*, vol. 23, pp. 3-6; March, 1946.)
- 786.6:621.383 2668
Photo-Electronic Organ: Part 1—R. E. Campbell and L. E. Greenlee. (*Radio News*, vol. 35, pp. 25, 110; June, 1946.) A beam of light passes through a tone pattern printed on a rotating wheel to a photocell. The impulses are amplified and reproduced on a loud-speaker. A detailed description of the construction of the instrument.
- 621.385.833 2669
The Electron Microscope [Book Review]—D. Gabor. Hulton Press, 1945, 104 pp., 4s. 6d. (*Wireless World*, vol. 52, p. 168; May, 1946.) Concerned with the electron-optical aspects.
- PROPAGATION OF WAVES**
- 523.78:551.51.053.5:621.396.11 2670
The Influence of an Eclipse of the Sun on the Ionosphere—Smith-Rose. (See 2562.)
- 541.133:[621.3.029.5]/.6 2671
The Variation of the Electrical Conductivity of Electrolytes with Frequency—Maloff. (See 2549.)
- 621.396.11 2672
Theory of the Coastal Refraction of Electromagnetic Waves—G. Grünberg. (*Zh. Eksp. Teor. Fiz.*, vol. 14, nos. 3, 4, pp. 84-111; 1944. English version in *Jour. Phys.*, U.S.S.R., vol. 6, no. 5, pp. 185-209; 1942.) The difficulties of investigating the propagation of electromagnetic waves in the presence of three different media (air, sea, and land) are pointed out, and a simplified treatment of the problem is presented. The propagation of the waves along a boundary plane between the media (air and ground) is considered, and approximate boundary conditions (16) for the electric field component normal to the surface of the ground are derived, using the fact that for sufficiently high conductivity of the medium the fall of the intensity of the field penetrating it does not depend on the character of the field outside the medium. From these conditions, assuming that the sea is an ideal conductor and also that the surface of the earth is a horizontal plane, an integral equation (21) of the component is obtained.
- This is the main equation of the problem, an exact solution of which would give a complete answer. In the present paper an approximate solution (41) of the equation is found and its implications discussed in detail for the case of plane waves impinging on an unlimited rectilinear coast. General considerations are also given regarding an approximate solution of the equation for the case of small islands of an arbitrary shape. Formulas are given for evaluating definite and indefinite integrals containing Bessel functions.
- This is the paper referred to in 1830 of 1943, and 3386 of 1944.
- 621.396.11.029.64 2673
An Experimental Investigation of the Reflection and Absorption of Radiation of 9-Cm. Wavelength—L. H. Ford and R. Oliver. (*Proc. Phys. Soc.*, vol. 58, pp. 265-280; May 1, 1946.) Using angles of incidence ranging from 45 to 80 degrees, measurements were made on the reflecting power of the surfaces of level and uneven bare ground, vegetation-covered ground, tap water, and a 4 per cent salt solution. "Specular reflection was found to occur only from very level surfaces; the absorptions of these surface media were measured, and from the combined measurements of reflection and absorption their electrical constants were derived.
- "Rough surfaces, either of bare ground or vegetation-covered ground, gave values of reflection coefficient in general agreement with the optical rule that regular reflection is only observed from an uneven surface if the product of the depth of the surface irregularities and the cosine of the angle of incidence is a small fraction of the wavelength. If this fraction exceeded $\frac{1}{4}$ wavelength, the values of reflection coefficient measured were about 0.1.
- The calculated values of reflection coefficient corresponding to dry soil, wet soil, and sea water for angles of incidence varying from 0 to 85 degrees are given in an appendix to the paper."
- 621.396.11:551.51.053.5 "1946.05" 2674
Short-Wave Conditions: Expectations for May—T. W. Bennington. (*Wireless World*, vol. 52, p. 165; May, 1946.)
- 621.396.11:551.51.053.5] "1946.06" 2675
Short-Wave Conditions: Expectations for June—T. W. Bennington. (*Wireless World*, vol. 52, p. 207; June, 1946.)
- RECEPTION**
- 621.396.61+621.396.621].029.63 2676
Getting Started on 420 Mc/s—Hoisington. (See 2757.)
- 621.396.61+621.396.677].029.63 2677
CQ 2400 Mc/s: Transceivers and Antennas for the 13-Centimeter Band—Koch and Floyd. (See 2758.)
- 621.396.61.029.63 2678
A U.H.F. Ham Transceiver—I. Queen. (*Radio Craft*, vol. 17, pp. 545, 588; May, 1946.) Description of a small equipment for 420 to 450 megacycles.
- 621.396.621+621.395.645 2679
Superamp with Tuner—Brennan. (See 2512.)

- 621.396.621 2680
The Radio News Circuit File—(*Radio News*, vol. 35, pp. 60, 82 and 62, 72; May and June, 1946.) Circuit diagrams and parts lists of 21 American postwar commercial broadcast receivers, arranged so that they can be cut out and attached to 3- by 5-inch filing cards.
- 621.396.621 2681
Looking Over the Postwar Receivers—B. G. (*QST*, vol. 30, pp. 24, 108; June, 1946.) Review of the mechanical and electrical features of the Hammarlund HQ-129-X. The noise limiter is explained with the aid of a circuit diagram.
- 621.396.621 2682
High-Level Detector—J. C. Rankin. (*Electronics*, vol. 19, pp. 212, 218; May, 1946.) Audio-frequency amplification is eliminated from a radio receiver by using a low-impedance copper-oxide rectifier immediately before the loud-speaker and following an intermediate-frequency power amplifier.
- 621.396.621 2683
Radio Data Sheet 335—(*Radio Craft*, vol. 17, p. 547; May, 1946.) Servicing data for RCA Victor receivers 54B1, 54B1-N, 54B2, and 54B3.
- 621.396.621:621.396.662 2684
Practical Radio Course: Part 43—A. A. Ghirardi. (*Radio News*, vol. 35, pp. 46, 107; April, 1946.) Automatic-frequency control of receivers. For previous parts of the series, see 1646 of June.
- 621.396.621:621.396.9+621.396.61 2685
Radar Technique—F. L. D. (See 2751.)
- 621.396.621.004.67 2686
Radio Servicing—(*Elec. Rev.*, London, vol. 138, p. 70; January 11, 1946.) Summary of an Institution of Electrical Engineers discussion led by R. C. G. Williams. The need for more test equipment and for a recognized qualification for servicemen was stressed.
- 621.396.621.029.56/.58 2687
The "Super-3"—(*Radio News*, vol. 35, pp. 76, 88; June, 1946.) Constructional details of a three-tube regenerative receiver for 1.7 to 14.5 megacycles.
- 621.396.621.029.6:621.317.1 2688
V.H.F. Receiver [Selectivity] Measurements—Gordon and George. (See 2621.)
- 621.396.621.029.62.004.67 2689
100 Mc/s Receivers Require New Servicing Techniques—D. W. Gunn. (*Radio News*, vol. 35, pp. 36, 68; May, 1946.) Brief survey of the complications which a service engineer will encounter in frequency-modulation receivers for frequencies over 50 megacycles.
- 621.396.621.5 2690
Super-Regenerative Receivers—"Cathode Ray"—(*Wireless World*, vol. 52, pp. 182-186; June, 1946.) A simple explanation of the manner of operation prompted by the recent successful application of the principle in military equipments.
- 621.396.621.5 2691
The Super-Regenerative Detector: an Analytical and Experimental Investigation—F. R. W. Strafford. (*Jour. I.E.E.*, (London), Part I, vol. 93, p. 192; April, 1946.) Summary of 1032 of April.
- 621.396.621.54 2692
Practical Radio Course: Parts 44 and 45—A. A. Ghirardi. (*Radio News*, vol. 35, pp. 48, 123, and 55, 70; May and June, 1946.) An account of frequency conversion in superheterodyne receivers. For previous parts of the series, see 2684 above.
- 621.396.621.54.029.62 2693
Miniature Tubes in a Six-Meter Converter—R. W. Houghton. (*QST*, vol. 30, pp. 18-21; June, 1946.) Constructional details of a set for frequency conversion to 10.5 megacycles.
- 621.396.622 2694
Audio-Modulated Detection: An Improved Method for Reception of C.W. Signals—D. A. Griffin and L. C. Waller. (*QST*, vol. 30, pp. 13-15, 124; July, 1946.) Two diodes are connected in opposite senses, in parallel, with a common load resistance. One diode is biased by a square-wave audio-frequency signal from a special generator. This provides audio-frequency modulation of continuous-wave signals, and also an upper-level limiting action. Bias applied to the other diode provides low-level limiting. The advantage in signal-to-noise ratio is considerable, especially if an audio-frequency output filter is used.
- 621.396.82 2695
Analysis of Radio Interference Phenomena—(*Radio News*, vol. 35, p. 54; June, 1946.) A table showing character, cause, type of receivers affected, where prevalent, and suggested service remedies for eleven types of interference.
- 621.396.822 2696
A Theory of Valve and Circuit Noise—N. R. Campbell and V. J. Francis. (*Jour. I.E.E.* (London), Part I, vol. 93, p. 190; April, 1946.) Summary of 1037 of April.
- 621.396.822:621.315.59 2697
Voltage Fluctuations in Electronic Semiconductors—Davidov. (See 2603.)
- 621.396.822:621.396.13 2698
Theoretical Signal-to-Noise Ratios—J. E. Smith. (*Electronics*, vol. 19, pp. 150-152, 154; June, 1946.) The sources of noise are described. Signal-to-noise ratios are derived in terms of the frequency bands of the signal and of the transmitted radio carriers for single or double amplitude modulation or frequency modulation, as used in ultra-high-frequency multiplex relay systems. The relative advantages of the systems are shown in tabular form.
- 621.396.822:621.396.671 2699
Fluctuation Noise in a Receiving Aerial—R. E. Burgess. (*Proc. Phys. Soc.*, vol. 58, pp. 313-321; May 1, 1946.) "The factors" which determine the signal-to-noise ratio at the terminals of a receiving aerial are discussed. The aerial noise considered is the random fluctuation type, consisting of (i) thermal noise associated with the loss resistance of the aerial, and (ii) noise associated with the radiation resistance which is induced by the surroundings. The effective temperature of the radiation resistance is expressed in terms of the temperature distribution of the surroundings and the distribution of power dissipation when the aerial is transmitting. Radiation from the sun and from the Milky Way are briefly discussed, and it is shown that the detection of solar radiation at radio frequencies requires the use of highly directional aerials. The limitations imposed by the receiver noise on (a) the sensitivity of the reception of signals, and (b) the accuracy of measurement of aerial noise, are discussed, and the results presented graphically.
- The conclusions are of most practical interest at the higher radio frequencies (above about 20 megacycles) where atmospheric noise is negligible."
- 621.396.823 2700
Interference From Industrial Electronic Apparatus—(*Wireless World*, vol. 52, p. 198; June, 1946.) Report of an Institution of Electrical Engineers discussion led by M. R. Gavin.

STATIONS AND COMMUNICATION SYSTEMS

- 621.396 2701
Engineers Study F.M.—(*Electronic Ind.*, vol. 5, pp. 66-70; May, 1946.) Extracts from papers read at the sixth Broadcasting Conference, held at Columbus, Ohio, in March, 1946, covering other subjects besides frequency-modulation. See also 2125 of August and cross references.
- 621.396.1 2702
The Conference on [Allocation of] Radio Frequencies for Civilian Services in the Liberated Countries of Europe—L. B. de Cléjoulx. (*Onde Élect.*, vol. 26, pp. 45-46; January, 1946.) A short account of the conference held in London in September, 1945.
- 621.396.619.018.41 2703
Frequency Modulation: Parts 1 and 2—P. Besson. (*Onde Élect.*, vol. 26, pp. 6-25, 74-91, 107-129, 155-172, and 204-214; January-May, 1946. Other parts to follow.) A comprehensive review of existing knowledge. Part 1 is in 9 chapters as follows: introduction; history; principles of frequency-modulation, production of frequency-modulation oscillations; spectra of frequency-modulation oscillations; reception; comparison of frequency-modulation and amplitude-modulation reception; propagation of frequency-modulation waves; comparative advantages and disadvantages of frequency-modulation and amplitude modulation. Part 2, dealing with technique and applications, is in four chapters as follows: transmitters; receivers; measurements; applications. The installments to which references are given include part 1, and chapters 1, 2, and part of chapter 3 of part 2.
- 621.396.619.018.41 2704
Spectrum of a Phase- or Frequency-Modulated Wave—R. E. Burgess. (*Wireless Eng.*, vol. 23, pp. 203-204; July, 1946.) If the carrier frequency is an integral or half-integral multiple of the modulation fre-

quency, each side wave is a doublet and, in general, the mean square value of the wave is not equal to half the square of the amplitude. See also 2637 or 1944 (Colebrook).

621.396.619.018.41:621.396.61 2705
Frequency Modulated Transmitters for Police and Similar Services—Fairbairn. (See 2750.)

621.396.619.16+621.396.61.029.64 2706
Multi-Channel Pulse Modulation—(Wireless World, vol. 52, pp. 187–192; June, 1946.) Details of the British Army Signaling Equipment No. 10, operating on a wavelength in the 6- to 7-centimeter band, and using pulse modulation.

“Narrow pulses recurrent at 9 kilocycles are width-modulated by the audio-frequency signals which are to be transmitted. The pulses are narrow with an average duration of 3.5 microseconds. Each of the eight speech channels modulates a separate train of pulses of the same recurrence frequency, but all the trains are staggered in time so that they can fit together without interference. A synchronizing pulse is also included to control the receiving apparatus which sorts out the pulses, demodulates them, and routes the audio-frequency signals to the proper output circuits.” See also 470 of February.

621.396.619.16 2707
Pulse Modulation—F. F. Roberts and J. C. Simmonds. (Wireless Eng., vol. 23, p. 204; July, 1946.) Continuation of correspondence on 183 of January (Roberts and Simmonds), following 1676 of June (Shepherd).

621.396.7(058.7) 2708
Radio Stations—(Elec. Ind., vol. 5, pp. 89–92; May, 1946.) Directory giving the addresses of U. S. broadcasting stations for amplitude modulation, frequency modulation, and television, and names of the chief engineers.

621.396.712.004.5 2709
Preventive Maintenance for Broadcast Stations—C. H. Singer. (Communications, vol. 26, pp. 22–28, 52; June, 1946.) First of a series of papers dealing with the methods and equipment used. The need for proper care of tools is emphasized. Descriptions are given of simple tools used in the maintenance of relay contacts and commutators.

621.396.931 2710
Railroad F.M. Satellite System—W. S. Halstead. (Communications, vol. 26, pp. 17–21, 55; May, 1946.) See also 2325 of August.

621.396.931 2711
Railroad Radio—from F.C.C. to I.C.C.—J. Courtney. (Electronics, vol. 19, pp. 92–94; June, 1946.) A general discussion of the advantages of a railway radio service compared with existing manual block systems.

621.396.931.029.62 2712
V. H. F. Communication Equipment—(Wireless World, vol. 52, pp. 180–181; June, 1946.) A short general description of some of the equipment for the police radio system described in 1357 of May and 2326 of August.

SUBSIDIARY APPARATUS

621.314.2 2713
Equivalent Capacitances of Transformer Windings—Duerdoth. (See 2493.)

621.314.632 2714
The Effect of Temperature Gradient on the Rectifying Action of Copper Oxide Rectifiers—Amirkhanoff. (See 2602.)

621.316.86:546.281.26 2715
Silicon Carbide [Non-Ohmic] Resistors—Ashworth, Needham, and Sillars. (See 2606.)

621.316.974:621.318.4.017.31 2716
Power Loss in Electromagnetic Screens—C. A. Siocos. (Wireless Eng., vol. 23, p. 202; July, 1946.) A letter in which the method of Davidson, *et al.* (1077 of April) is extended to the calculation of the eddy-current density produced by a coil in an infinite shielding plane.

621.317.755 2717
A Simple Oscilloscope: Using the Mains as a Time Base—F. P. Williams. (Wireless World, vol. 52, p. 206; June, 1946.) Deflecting and focusing coils are made nearly to follow television practice. The “straight” middle portion of the sinewave from the mains is used to provide a time base.

621.318.22/23 2718
Modern Hard Magnetic Materials—Hoselitz. (See 2607.)

621.318.24 2719
Capacitor Discharge Magnetizer for Plant Shops—W. L. Porta. (Electronics, vol. 19, pp. 168, 188; June, 1946.) Description of an equipment for magnetizing small permanent magnets. The essential components are a source of direct-current voltage, a capacitor, and a special transformer. The transformer, which must have a low leakage-reactance factor, carries a 1-millisecond power impulse. The capacitor discharge into the primary is initiated through a manually controlled ignitron tube.

621.318.4.013.22 2720
On a System of Coils Producing a Uniform Magnetic Field for a Narrow Wilson Chamber—E. Nageotte. (Compt. Rend. Acad. Sci., Paris, vol. 220, pp. 557–559; April 16, 1945.) The coils are each wound on a rectangular former of which the long sides are curved in a direction normal to the plane of the undistorted rectangle. The coils are arranged so that the convex sides of the formers are together. The magnetic field shows variations of 0.1 per cent over a space in which the Helmholtz arrangement would show variations of 0.5 per cent.

621.318.44 2721
The Technique of Toroidal Winding—F. E. Planer. (Electronic Eng. vol. 18, pp. 199–203; July, 1946.) A brief description of the advantages of toroidal coils, and an account of the principle of a toroidal winding machine. Various methods are given for maintaining constant tension in the wire, illustrated by photographs of representative types of machine.

621.318.57 2722
A Simple Electronic Relay—F. A. P. Maggs. (Jour. Sci. Instr., vol. 23, pp. 85–86; April, 1946.) Simple vacuum-tube circuits for operating electromagnetic and thermal types of relay.

621.319.42 2723
Capacitance Machine—(Radio, vol. 30, pp. 10, 12; April, 1946.) Illustrated note on a U. S. Department of Commerce OPB report PB421 by F. E. Henderson, describing a German (Bosch Co.) method of making paper capacitors, in which the usual metal foil is replaced by a film of zinc or cadmium deposited on the paper dielectric.

621.383 2724
Cooling Photosensitive Cells [by the Use of Solid CO₂]—E. F. Coleman. (Electronics, vol. 19, pp. 220, 224; June, 1946.)

621.383.2:621.314.6 2725
Experimental Behaviour of a Photoelectric Cell Under the Influence of an Alternating Potential of Very High Frequency—D. Charles. (Compt. Rend. Acad. Sci., Paris, vol. 221, pp. 495–497; October 29, 1945.) It has previously been shown (1948 of 1941, Geest) that over particular frequency ranges and for particular voltages the cell gives abnormally high rectified currents, even when not illuminated. Special cells were made to investigate this phenomenon, using a number of different photoelectric materials. Potential differences of 0 to 300 volts were applied at frequencies of 60 to 120 megacycles. The following results were obtained: (a) Ni and Al cathodes did not show the phenomenon; (b) for a given frequency, the rectified current increases to a maximum, then drops abruptly to zero as the high-frequency voltage is increased; (c) for a given voltage, the output rises to a maximum and falls again as the frequency is increased; (d) positive bias increases, and negative bias decreases the output; (e) the phenomena are unaffected by illumination; (f) cooling to –140 degrees centigrade neither stops the phenomenon nor prevents it from starting; (g) modulation at 10 megacycles has no effect; (h) a magnetic field normal to the axis stops the phenomenon. See also 2726 below.

621.383.2:621.314.6 2726
Theory of the Behavior of a Photoelectric Cell Under the Influence of an Alternating Potential of Very High Frequency—D. Charles. (Compt. Rend. Acad. Sci., Paris, vol. 222, pp. 65–67; January 2, 1946.) For experimental work, see 2725 above. Electron trajectories were calculated by numerical integration of the equations of motion. For a fixed high-frequency voltage and frequency a group of electrons with initial velocities lying within a small range are concerned in a resonant phenomenon. Complete calculation of the response curves as a function of frequency for different values of high-frequency voltage for a caesium cell gives results in good agreement with experiment.

621.385.18:621.396.9 2727
The Gas-Discharge Transmit-Receive Switch—Samuel, Clark, and Mumford. (See 2784.)

- 621.389:535-1 2728
Night Vision with Electronic Infrared Equipment—(See 2660.)
- 621.389:623.555.2:535-1 2729
Electronic Night Sight—W. MacD. (See 2661.)
- 621.394.624 2730
Electronic Code Translator—H. W. Babcock. (*Electronics*, vol. 19, pp. 120-122; June, 1946.) Code signals (e.g., Morse) from a receiver are fed into a discriminator in which five or more pairs of thyratrons produce, a unique voltage determined by each group of dots and dashes. This triggers a gas-filled tube. Illumination from the tube causes corresponding letters and numerals to appear on a moving fluorescent screen.
- 621.396.66:621.395.63 2731
Selective Calling System—J. K. Kulansky. (*Electronics*, vol. 19, pp. 96-99; June, 1946.) A description of a system for positive control of remote communication equipment based on the transmission of suitably pulsed audio signals. The coding and decoding devices can be added to existing transmitter and mobile receivers respectively, enabling a control operator to call any of 84 stations by dialing a 4-digit number.
- 621.396.662.2.029.6 2732
V.H.F. Coil Design—A. H. Meyerson. (*Communications*, vol. 26, pp. 46-47, 50; June, 1946.) The influences of coil shape and dimensions on the Q and on stability with temperature are examined experimentally for frequencies in the range 60 to 120 megacycles. See also 66 of January (Meyerson).
- 621.396.682 2733
Type 1261-A Power Supply—E. E. Gross. (*Gen. Radio Exp.*, vol. 20, pp. 4-6; March, 1946.) Description and circuit diagram of an alternating-current operated power supply for instruments which use the U. S. Signal Corps BA48 Battery Block (Burgess Type 6TA60).
- 621.396.689:621.362 2734
Thermoelectric Generator for Portable Equipment—J. M. Lee. (*Electronics*, vol. 19, pp. 196, 202; May, 1946.) Banks of chromel-P/constantan thermocouples embedded in ceramic material and heated by a gasoline burner give power outputs up to 20 watts at 12 volts. The couples have a useful life of about 2000 hours, and the generator weighs about $2\frac{1}{2}$ pounds per watt output.
- 771.448.1:778.39 2735
A High-Power Stroboscope—D. A. Senior. (*Jour. Sci. Instr.*, vol. 23, pp. 81-83; April, 1946.) Description of the circuit for producing, with a suitable discharge tube, 1000 5-microsecond flashes a second for periods of several seconds, each with sufficient intensity to permit photography by reflected light of areas up to 50 square feet.
- TELEVISION AND
 PHOTOTELEGRAPHY**
- 621.397 2736
Practical Television—R. A. Monfort. (*Radio News*, vol. 35, pp. 38, 120; May, 1946.) A semitechnical explanation of the principles and of the main parts of the equipment.
- 621.397 2737
4-Color Facsimile Transmission—E. C. Thomson. (*Communications*, vol. 26, pp. 32-34; May, 1946.) Four black and white pictures for use in a color-superposition process are transmitted separately. Report of a partly successful experimental transmission by Cable & Wireless, Ltd. between England and Australia.
- 621.397:621.398 2738
Tele-Guided Missiles—(*Elec. Ind.*, vol. 5, pp. 62-65, 118; May, 1946.) A 325-line, 40-frames-per-second television transmitter in a remotely controlled bomb sends a picture of the target to the bomb aimer. A "Vericon" tube is used in the transmitter, with stabilized supplies, and the iris of the lens system is controlled by the video signal to give a constant average signal intensity. Circuit diagrams are given.
- 621.397:621.398 2739
Television Equipment for Guided Missiles—C. J. Marshall and L. Katz. (*PROC. I.R.E., AND WAVES AND ELECTRONS*, vol. 34, pp. 375-401; June, 1946.) "A brief history of the technical problems associated with the development of compact airborne television equipment is outlined. The system provides resolution, linearity, and stability which approaches that obtained from broadcast equipment. Technical difficulties which arose after the completion of the equipment design are described. The final solution of these and other problems resulting from its installation in guided missiles are discussed. Photographs taken from the receiver screen during experimental flights are shown."
- 621.397.5 2740
Contribution to the Study of a Video Standard—Y. Angel. (*Onde Élect.*, vol. 26, pp. 60-73; February, 1946.) The definition of a television image is no longer limited by technique, but by economic and practical considerations. As a preliminary to the large-scale development of television it is necessary to agree on standards for the transmitted signal. For this purpose it is necessary to determine the optimum definition. The article gives a detailed analysis of the technical and subjective factors involved, and concludes that the standard should be (a) 1200 to 1300 lines with fourfold interlacing with the sequence 1-3-4-2 (or 1-3-2-4), or (b) 800 to 900 lines with twofold interlacing.
- 621.397.5 2741
1015-Line Television Apparatus of the Compagnie des Compteurs, Montrouge—P. Mandel. (*Onde Élect.*, vol. 26, pp. 26-37; January, 1946.) A description of development work by the company; a theoretical and practical examination of the requirements for a television system with detail limited only by visual acuity. The work eventually realized a complete system, including the radio link, on 145 megacycles. The development included apparatus permitting a wide range of scanning, both in lines and degree of interlacing. The final selection of interlaced scanning with 1015 lines was based on tests over a wide range of values.
- 621.397.62:621.317.79 2742
A Television Signal Generator: Part 2—Monoscope and Video Circuits—Hibberd. (See 2646.)
- 621.397.621 2743
Television Deflection Channels—E. M. Noll. (*Radio News*, vol. 35, pp. 55, 147; May, 1946.) Description of circuits for generating and synchronizing the sweep signals, with particular reference to the General Electric Model 90 receiver. For other parts of this series on television circuits, see 2349 of August (which should read part 14) and back references.
- 621.397.645.2:621.396.621.54 2744
I.F. Amplifiers in Television Receivers—Kronenberg. (See 2534.)
- 621.397+621.396 2745
Modern Practical Radio and Television [Book Review]—Quarrington. (See 2789.)
- 621.397 2746
Television, the Eyes of Tomorrow [Book Review]—W. C. Eddy. Prentice-Hall, New York, N. Y., 1945, 330 pp., \$3.75. (*Electronics*, vol. 19, p. 320; May, 1946.)
- TRANSMISSION**
- 621.396.61 2747
F.C.C. Approved A.M. Broadcast Transmitters—R. G. Peters. (*Communications*, vol. 26, pp. 26, 34; May, 1946.) Some features, including circuit diagrams, of Collins, Gates, and RCA amplitude-modulation transmitters in the range 100 watts to 500 kilowatts.
- 621.396.61 2748
Modern A.M. Transmitter Design—W. E. Phillips and C. Probeck. (*Radio*, vol. 30, pp. 30, 54; April, 1946.) Some modern improvements, and a description (with circuit diagram) of a 250-watt transmitter of quality comparable with that of the largest stations.
- 621.396.61 2749
High Power in Two Stages—D. Mix. (*QST*, vol. 30, pp. 13-17; June, 1946.) A crystal oscillator operating in the 3.5-, 7-, 14-, and 28-megacycle bands feeds an 800-watt beam-tetrode transmitter. Shunt feed enables plug-in coils to be used with safety.
- 621.396.61:621.396.619.018.41 2750
Frequency Modulated Transmitters for Police and Similar Services—E. P. Fairbairn. (*Electronic Eng.*, vol. 18, pp. 213-218; July, 1946.) The main advantage of frequency modulation is freedom from interference in dense traffic areas. Tests show that a small deviation at the transmitter gives widest service area at some expense in signal-to-noise ratio. A circuit diagram is given of a 10-watt phase-modulated transmitter. Other illustrations show typical headquarters and mobile equipments. Crystal-controlled receivers are used. See also 2326 of August (Brinkley).
- 621.396.61+621.396.621]:621.396.9 2751
Radar Technique—F. L. D. (*Wireless World*, vol. 52, pp. 154-156; May, 1946.) Review of papers on receivers and transmitters presented at the Institution of Electrical Engineers Radiolocation Convention.

- 621.396.61:621.396.933 2752
Unit-Type Multi-Channel Aircraft Ground Transmitter—R. G. Peters. (*Communications*, vol. 26, pp. 54-55; June, 1946.) Description of an equipment covering the ranges 200 to 540 kilocycles, 2 to 20 megacycles, and 108 to 140 megacycles, with circuit diagram of the 108- to 140-megacycle, 220-watt radio-frequency circuit.
- 621.396.61.029.5/.62 2753
1000 Watt R.F. Amplifier for the Ham—H. D. Hooton. (*Radio News*, vol. 35, pp. 28, 88; May, 1946.) Constructional details and performance. Uses two 4-125A tubes, and can be operated at frequencies up to 250 megacycles.
- 621.396.61.029.56/.58 2754
A Beginner's Two-State Transmitter—A. D. Middelton. (*QST*, vol. 30, pp. 16-22, 126; July, 1946.) Constructional details of a mains- or battery-operated crystal-controlled continuous-wave circuit of very simple design for 3.5 and 7 megacycles.
- 621.396.61.029.62 2755
A Mobile Rig for 50 and 28 Mc/S—E. P. Tilton. (*QST*, vol. 30, pp. 31-35, 110; June, 1946.) For economical operation from a car battery. A crystal-controlled "push-to-talk" transmitter uses midget tubes with quick-heating filaments. A rotary converter is used for the high voltage source.
- 621.396.61.029.62 2756
More Stations per Megacycle at Two Meters—C. F. Hadlock and R. S. Hawkins. (*QST*, vol. 30, pp. 61-66; July, 1946.) Constructional details of a 100-watt push-pull crystal-controlled transmitter. A 5.4-megacycle crystal is used with three frequency tripler stages and a power amplifier.
- 621.396.61.+621.396.621].029.63 2757
Getting Started on 420 Mc/s—W. F. Hoisington. (*QST*, vol. 30, pp. 43-45; June, 1946.) Constructional details of a portable station comprising a half-wave-line transmitter feeding a 6-element array, a modulator, two power units, and a superregenerative receiver.
- 621.396.61+621.396.677].029.63 2758
CQ 2400 Mc/s: Transceivers and Antennas for the 13-Centimeter Band—A. R. Koch and G. H. Floyd. (*QST*, vol. 30, pp. 32-38; July, 1946.) A cavity-tuned 2C40 (lighthouse) tube is used as oscillator and superregenerative detector with a separate quench oscillator working at 100 to 250-kilocycles. Constructional details are given for the tuned-plate tuned-grid cavity; two aerials with parabolic reflectors are described. The smaller has a gain of about 25, the larger has a 7-degree beam and a power gain of about 200.
- 621.396.61.029.63 2759
A U.H.F. Ham Transceiver—Queen. (*See* 2678.)
- 621.396.615:621.396.611.21+621.317.361 2760
Series-Resonant Crystal Oscillators—Butler. (*See* 2524.)
- 621.396.615.17 2761
Power Pulse Generator—M. Levy. (*Wireless Eng.*, vol. 23, pp. 192-196; July, 1946.) Pulses of the required amplitude are produced in a high impedance by a low-power pulse generator, then a succession of cathode followers increases the power and reduces the impedance, without materially reducing the amplitude. In the circuit given, 1000-volt pulses in 150 ohms with a peak pulse output power of 6.5 kilowatts, were obtained with an over-all efficiency of about 20 per cent.
- 621.396.619 2762
Features of Grid and Plate Modulation in New System—(*Electronics*, vol. 19, pp. 192, 196; May, 1946.) Greater power output for size in portable transmitters is obtained by the use of grid modulation on negative half cycles and an additional radio-frequency amplifier as side-band generator on positive half cycles. A circuit diagram is given.
- 621.396.619 2763
Class "C" Grid Bias Modulation: Part 2—W. W. Smith. (*Radio News*, vol. 35, pp. 70, 129; May, 1946.) Study of an inexpensive 100- to 125-watt grid-modulated transmitter, based on 2379 of August.
- 621.396.619.018.41 2764
Frequency-Shift Keying—G. G. (*QST*, vol. 30, pp. 46-48; June, 1946.) While the system speeds up commercial traffic, the bandwidth required appears to be too large for its use in amateur communication.
- 621.396.619.018.41 2765
F.M. Carrier Stabilization: Part 1—The General Electric and Federal Systems—I. Queen. (*Radio Craft*, vol. 17, pp. 537, 549; May, 1946.) An illustrated, simple account of the phasitron (see 1405 of May), and of the Miller-effect method.
- 621.396.619.018.41 2766
F.M. Transmitters Using Phase Modulators—N. Marchand. (*Communications*, vol. 26, pp. 38-42; June, 1946.) Phase-modulator circuits used in commercial transmitters are analyzed in relation to the principles described in 2767 below. Part 6 of a series.
- 621.396.619.018.41 2767
Phase to Frequency Modulation—N. Marchand. (*Communications*, vol. 26, pp. 36, 58; May, 1946.) An analysis of the Armstrong method, and an account of the phasitron (see 1405 of May, part 5 of a series). For other parts in this series, see 2766 above, 2383 of August, and back references.
- 621.396.619.018.41 2768
A New Angular-Velocity-Modulations System Employing Pulse Techniques—J. F. Gordon. (*PROC. I.R.E. AND WAVES AND ELECTRONS*, vol. 34, pp. 328-334; June, 1946.) A two-tube multivibrator is controlled by synchronizing pulses from a crystal oscillator applied to the grid of one tube and the relative duration of the conducting periods of the two tubes is controlled by the amplitude of an audio-frequency modulating voltage applied to the grid of the second tube. The multivibrator output is differentiated, and the positive pulses clipped, leaving a series of negative pulses which operate a class-C amplifier. A radio-frequency voltage is therefore produced, of which the phase is controlled by the phase of the pulses, and thus by the amplitude of the modulating voltage. In an experimental transmitter, a multivibrator frequency of 200 kilocycles was multiplied to 105.6 megacycles. Phase deviation was constant within ± 4 per cent for modulation frequencies between 50 and 20,000 cycles, and harmonic distortion was small.
- 621.396.619.018.41:621.396.611.21 2769
Crystal-Controlled Frequency Modulation—A. Treskinsky. (*Wireless World*, vol. 52, p. 170; May, 1946.) A letter commenting on 479 of February (Lewer).
- 621.396.619.16:621.385.38 2770
Thyratron Pulsar Tube for Industrial Microwaves—(*Electronics*, vol. 19, pp. 170, 180; May, 1946.) Application of a hydrogen thyratron in a line modulator circuit to new methods of plastic manufacture, high-speed welding, and electroplating. The system with a 4C35 tube can provide, e.g., 100 kilowatt pulses at a rate of 1500 per second, with average power of 1 kilowatt.
- 621.396.645.3.029.56/.58 2771
A Conservative Kilowatt—D. Mix. (*QST*, vol. 30, pp. 54-56; July, 1946.) Description of a push-pull amplifier for four amateur bands.
- 621.596.645.3.029.58 2772
Long Leads Aren't Necessary—V. W. Shuart. (*QST*, vol. 30, pp. 55-57; June, 1946.) Parasitic oscillations are avoided in a push-pull tetrode amplifier for 28 megacycles by careful arrangement of components and by neutralizing.
- 621.396[.65+.71+.812.3 2773
Radio Communication Developments—A. H. Mumford. (*Nature*, London, vol. 157, p. 83; January 19, 1946.) Summary of the inaugural address of the chairman of the Radio Section, Institution of Electrical Engineers. For full paper, see 1102 of April.
- VACUUM TUBES AND THERMIONICS
- 621.385 2774
Radio Design Worksheet: No. 49—Perveance—(*Radio*, vol. 30, p. 29; June, 1946.)
- 621.385 2775
The Electron-Optical Theory of Ultra-High-Frequency Oscillators—P. Golubkoff. (*Zh. Eksp. Teor. Fiz.*, vol. 14, nos. 7, 8, pp. 289-306; 1944.) There are three types of ultra-high-frequency oscillators: retarding-field type, magnetrons, and electron-beam type. Various theories of these oscillators have been developed, but they are usually based on a study of the movement of a single (isolated) electron, and each applies to one type of oscillator only. The author proposes a new theory based on the following considerations: 1. The electronic processes and the mechanisms for sustaining oscillations in all types are identical. The primary mechanism is a continuous electron stream in which a process of phase focusing takes place, and this establishes the necessary interaction between the stream and the elements of the oscillatory system. Thus all types of oscillators can be regarded as electron-beam devices and interpreted by a single theory. 2. From the point of

view of kinematics, the physics of ultra-high frequencies can be regarded as a development as well as a practical application of electron optics.

From these considerations, the author has developed a general method of investigation in which the conception of a moving focus in an electron stream is introduced, and the movement of the focus studied. It is possible, with the aid of this method, to interpret the main characteristics of ultra-high-frequency oscillators of all types. A brief survey of an extensive theoretical and experimental investigation by the author is presented to support this claim. The following are the main points of the survey.

The movement of an electron stream in the absence of a retarding field is examined, and the conclusions reached are applied to the case of klystrons. An analogy between klystrons and Barkhausen oscillators is established. The focusing of the stream in constant and in alternating retarding fields is discussed, and the main features of the Barkhausen circuit, such as the discreteness of the regions of oscillations, the position of the centers of these regions, the appearance of "dwarf" waves, etc., are explained. For a general case of the triode when the electron stream is acted upon by two electrodes at the boundaries of the focusing space (and not by one—the phase lens—as in the previous cases), a law is formulated governing the distribution of the centers of the regions of oscillations in the plane V_A, V_G . The focusing of the electron stream in a magnetic field is also considered, and a theoretical interpretation of the operation of the magnetron with a whole anode is given.

621.385 2776
Contribution to the Study of Reflex Velocity-Modulation Oscillators—M. Kuhner and A. M. Gratzmuller. (*Onde Élect.*, vol. 26, pp. 38–44; January, 1946.) A simple account of the theory of the reflection klystron, and a description of a number of types developed at the L.M.T. laboratories in 1943 and 1944. These embody glass-metal disk seals and external tunable cavities, tuning either by the screwing in of pistons, or by single or double rectangular plungers moving in rectangular cavities. One model of the latter type gave a maximum output of 200 milliwatts at 149-millimeter wavelength, with an efficiency of 1 per cent, and had a tuning range of 95 to 156 millimeters.

621.385 2777
Electron Ballistics in High-Frequency

Fields—A. L. Samuel. (*Bell Sys. Tech. Jour.*, vol. 25, supplementary page; January, 1946.) Corrections to 1396 of May.

621.385:621.396.9 2778
Radar Technique—M. G. S.:H. B. D. (*Wireless World*, vol. 52, pp. 146–151; May, 1946.) Review of papers on vacuum tubes presented at the Institution of Electrical Engineers Radiolocation Convention.

621.385.1.032.216:537.583 2779
On a New Method of Measuring the Intensity of the Saturation Current in an Oxide Cathode—R. Champeix. (*Compt. Rend. Acad. Sci.*, Paris, vol. 220, pp. 736–738; May 23, 1945.) A capacitor is discharged through the tube under test, once per second. The resulting impulsive current is passed through a noninductive resistor of small value, and the potential drop so produced is used to trigger a thyatron which carries an adjustable grid bias. The bias is set to the maximum negative value at which the impulses will fire the discharge, and its value is used as a measure of the current in the tube under test.

Curves of electron current against applied voltage have the same general shape as those for pure tungsten, though higher voltages are necessary to produce saturation. The phenomenon of increasing saturation current with increase of applied voltage gradient at the cathode (Schottky's law) is much more marked for oxide cathodes than for pure metals.

621.385.16 2780
Recent Developments in Magnetron Technique—G. Goudet. (*Onde Élect.*, vol. 26, pp. 49–59; February, 1946.) A short account of the basic theory of the simple magnetron and of the multiple-cavity tube. The frequency and phase relationships of the latter are derived in terms of a closed ring of filter cells, and the field conditions by application of Maxwell's equations to an approximately equivalent system of plane parallel electrodes with equispaced gaps in one of them. The mechanism of oscillation is explained in terms of the interaction between the emitted electrons and the high-frequency fields in the annular interelectrode space.

621.385.16.029.64 2781
The Cavity Magnetron—J. T. Randall. (*Proc. Phys. Soc.*, vol. 58, pp. 247–252; May 1, 1946.) An address delivered to the Physical Society giving an historical outline of the development.

621.385.16.029.64 2782
An Introduction to Multi-Resonator

Magnetrons—R. Latham, A. H. King, and L. Rushforth. (*Engineer*, London, vol. 181, pp. 310–312 and 331–333; April 5, 12, 1946.)

621.385.18:621.396.9 2783
The Gas-Discharge Transmit-Receive Switch—A. L. Samuel, J. W. Clark, and W. W. Mumford. (*Bell Sys. Tech. Jour.*, vol. 25, pp. 48–101; January, 1946.) A detailed account of the purpose, design, construction, testing, method of application, and performance of gas-filled resonant-cavity tubes used to protect radar receivers from damage due to the high-power transmitted pulse, and to prevent energy received in the dual-purpose aerial from being absorbed by the quiescent transmitter instead of by the receiver. The tubes operate by presenting a virtual short-circuit when discharged by the transmitted pulse, and an open-circuit when undischarged. A mathematical analysis of an idealized system is developed, and an account is included of the parameters of the coupling holes in the associated wave guides.

MISCELLANEOUS

621.3.078 2784
On Increasing the Stability of Self-Regulation by Means of Back Coupling—V. Peshkoff. (*Zh. Éksp. Teor. Fiz.*, vol. 14, no. 12, pp. 514–518; 1944.) Very often self-oscillations appear in automatic regulating systems. In many cases this can be prevented by introducing back coupling between the regulating indicator and the regulated mechanism. A detailed mathematical analysis is given as an example, confirmed by experiments, of Bancroft's thyatron thermostat (2253 of 1942) in which a transformer provides the required back coupling.

621.38/.39(058.7) 2785
1946 Electronic Engineering Directory—(See 2610.)

621.396 2786
Engineers Study F.M.—(See 2701.)

621.396.621.004.67 2787
Radio Servicing—(See 2686.)

621.396.7(058.7) 2788
Radio Stations—(See 2708.)

621.396+621.397 2789
Modern Practical Radio and Television [Book Review]—C. A. Quarrington. W. H. Date (Editor). The Caxton Publishing Company, London, 3 vols., 70s. (*Electronics Eng.*, vol. 18, p. 227; July, 1946.)

44th year of specialization

ALSIMAG CUSTOM MADE TECHNICAL CERAMICS

• In all these years of concentration on custom made technical ceramics, the American Lava Corporation has developed special equipment, practical skill and specialized engineering knowledge available from no other source.

Complicated shapes, obtainable only by machining, can be produced quickly on high speed semi-automatic turning and milling equipment. Surprisingly low prices are possible. Send your designs and let us review them from our production standpoint, submit recommendations, and show you what American Lava can do for you.

• Chart of the physical characteristics of the more frequently used ALSMAG compositions sent free on request.

AMERICAN LAVA CORPORATION

CHATTANOOGA 5, TENNESSEE
44TH YEAR OF CERAMIC LEADERSHIP

ENGINEERING SERVICE OFFICES:

ST. LOUIS, Mo., 1123 Warington Ave., Tel. Garfield 4959 • NEWARK, N. J., 671 Broad Street, Tel. Mitchell 2-8159
CAMBRIDGE, Mass., 38 B Beacon St., Tel. Rinkland 4498 • CHICAGO, 9 S. Clinton St., Tel. Central 1721
SAN FRANCISCO, 163 S. Market St., Tel. Douglas 2464 • LOS ANGELES, 324 N. San Pedro St., Tel. Mutual 9076

HERE'S HELP in making FM and TELEVISION measurements

THE TYPE WV-75A
VOLTOHMYST—
a new member of
the famous RCA line

Flat up to 250 megacycles!

A newly developed diode probe, with which it is possible to read peak-to-peak voltages up to 250 megacycles, makes the Advanced VoltOhmyst ideal for television, FM, and routine, high-frequency measurements. The diode response is also flat down to 30 cycles.

The WV-75A is calibrated in rms voltages up to 100 volts in 4 ranges. An adaptor is supplied for low-frequency measurements up to 1000 volts.

The WV-75A also measures d-c voltages up to 1000 volts in six ranges and resistances to 1000 megohms in six ranges.



A Quick Way to Get Details

Radio Corporation of America
Test and Measuring Equipment Section
Dept. '67-J, Camden, New Jersey

Please send me the bulletin on the
—RCA Type WV-75A VoltOhmyst for high-frequency measurements.
—RCA Type 195A for low-frequency testing.

Name _____

Company _____

Street Address _____

City _____ Zone _____ State _____



TEST AND MEASURING EQUIPMENT

RADIO CORPORATION of AMERICA

ENGINEERING PRODUCTS DIVISION, CAMDEN, N. J.



ATLANTA

"Very High Frequency Along the Federal Airways," by G. C. Hawkins, Communications Branch of Civil Aeronautics Administration; July 19, 1946.

EMPORIUM

"Sonar," by N. A. Butz, Jr., Naval Ordinance Laboratories, State College of Pennsylvania; (presented by A. H. Waynick) August 16, 1946.

"Engineering Organization," by L. M. Clement, Crosley Corporation; August 16, 1946.

"Aircraft Electronic Applications," by A. P. Upton, Minneapolis-Honeywell Regulator Company; August 17, 1946.

"Powder Metallurgy," by A. Burris, Keystone Carbon Company; August 17, 1946.

LOS ANGELES

"Columbia Broadcasting System Color Television," by P. C. Goldmark, Columbia Broadcasting System; April 9, 1946.

"Problems in Broadcast Studio Programs," by J. Fredericks, 6000 Sunset Radio Center Studios; May 21, 1946.

"Some Problems in Frequency Allocations," by H. M. Plotkin, Federal Communications Commission; May 21, 1946.

NEW YORK

"Microwave Converts," by C. F. Edwards, Bell Telephone Laboratories; April 10, 1946.

"Metallic-Lens Antenna," by W. E. Kock, Bell Telephone Laboratories; April 10, 1946.

"Wide-Range Double-Heterodyne Spectrum Analyzers," by L. Apker, J. Kahnke, E. Taft, and R. Watters, General Electric Company; May 1, 1946.

"Moon Radar," by J. Mofenson, Evans Signal Laboratory; May 8, 1946.

SAN DIEGO

"Quartz-Crystal Impedance Considerations in Oscillator Applications," by T. Lambert, United States Navy Electronics Laboratory; August 6, 1946.



The following transfers and admissions were approved on September 3, 1946:

Transfer to Senior Member

Berkeley, J. B., Bureau of Ships, Navy Department, Washington 25, D. C.
Brown, C. W., Johns Hopkins University, 8621 Georgia Ave., Silver Spring, Md.

Chance, B., Radiation Laboratory, Massachusetts Institute of Technology, Cambridge, Mass.

(Continued on page 36A)

Because of the bakelite-insulated metal-clad resistance element, these **CLAROSTAT SERIES MMR RESISTORS** in actual operation are . . .

Definitely
COOLER

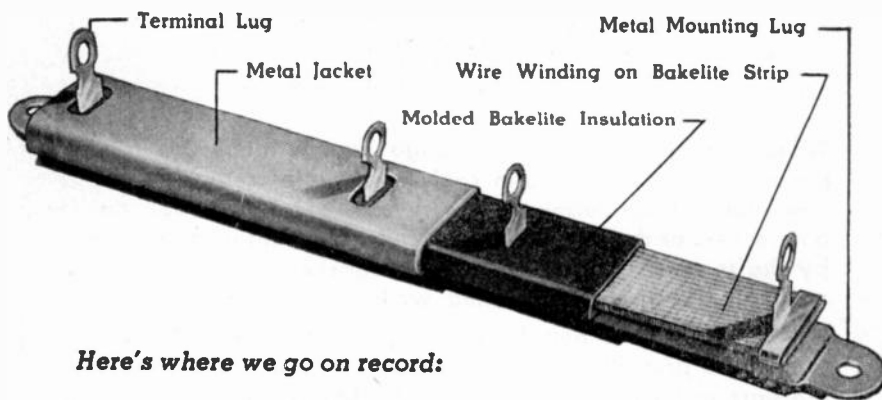
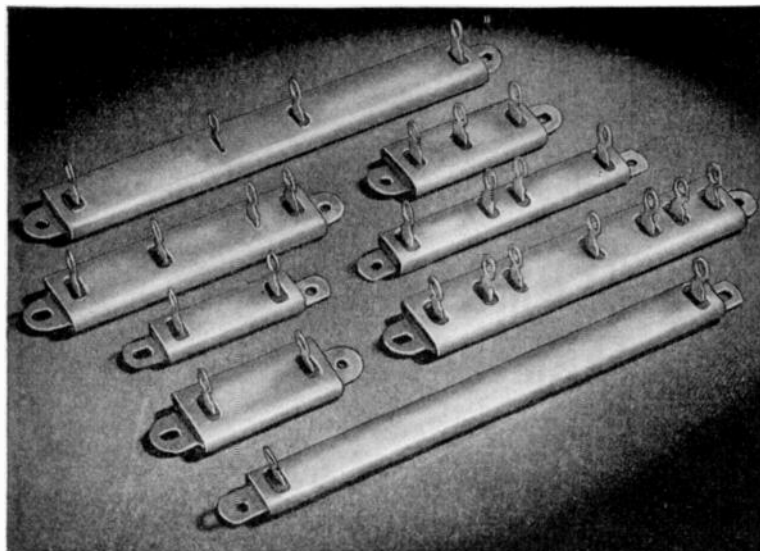

Here's where we go on record:

★Clarostat Series MMR bakelite-insulated metal-clad resistors are definitely **COOLER** than any other similar types, **SIZE FOR SIZE**; or putting it another way, these resistors will **DISSIPATE MORE POWER** for the same temperature rise, **SIZE FOR SIZE**.

That's our statement. We invite your own tests. Sample on request if you write on your business letterhead. Also detailed literature.



An Advertisement about **TRANSFORMER DESIGN**
 ... Directed to those who manufacture electronic equip-
 ment that must be **MOISTURE PROOF** and/or **FAILURE PROOF**

*Chicago
Transformer's*

HERMETICALLY-SEALED TERMINAL CONSTRUCTION

is . . .

- 1 Permanent Proof Against Moisture
- 2 Impervious to Temperature Changes in the Unit or Surrounding Air
- 3 Unaffected by Heat Transfer from Soldering of Terminal Connections
- 4 Cushioned Against Mechanical Shock

These qualities stem from Chicago Transformer's use of special neoprene rubber gaskets in conjunction with ceramic bushings to seal and insulate terminals where they extend through the steel base covers or drawn steel cases. Under constant pressure, imposed by the terminal assembly itself, the gaskets are forced into and retained by specially-designed wells in the bushings.

By this method, a non-deteriorating, highly resilient seal is obtained. Its protection of the vital parts of the transformer against moisture and corrosion is equally effective in extreme heat or cold and against corrosive fumes or liquids.

As components of Army and Navy electronic apparatus, Hermetically-Sealed Chicago Transformers gained an outstanding reputation for durability and dependability under the most severe wartime operating conditions. Today, this same basic design is available to manufacturers who are building electronic equipment to comparable standards of peacetime excellence.



CHICAGO TRANSFORMER

DIVISION OF ESSEX WIRE CORPORATION

3501 ADDISON STREET · CHICAGO, 18



(Continued from page 34A)

- Cleeton, C. E., 2424—34 St., S.E., Washington 20, D. C.
 Dean, W. W., 158 Parkway Dr., Syracuse 7, N. Y.
 Druz, W. S., 5143 W. Fletcher St., Chicago 41, Ill.
 Epstein, J., 15 Jefferson Rd., Princeton, N. J.
 Gaffney, F. J., 216 Rider Ave., Malverne, L. I., N. Y.
 Geist, H. J., c/o W. E. Batchellor, 1-N Alden House, Larchmont, N. Y.
 Glover, A. M., Radio Corporation of America, Lancaster, Pa.
 Goodale, E. D., 184 Woodland Ave., New Rochelle, N. Y.
 Hall, A. C., Massachusetts Institute of Technology, 77 Massachusetts Ave., Cambridge 39, Mass.
 Howell, A. H., 35 Grafton St., Arlington 74, Mass.
 Kalb, R. M., 310 N. Dover Ave., La Grange, Ill.
 Labin, E., Calle Florida 1065, Buenos Aires, Argentina
 McKinley, D. W. R., 211 Cobourg St. Ottawa, Ont., Canada
 Oxley, A. B., 4035 Harvard Ave., Notre Dame de Grace, Montreal, Que., Canada
 Patrick, P. E., South African Broadcasting Corporation, Box 8606 Johannesburg, South Africa
 Penn, W. D., 3003 N. Henderson, Dallas 6, Texas
 Salton, L. V., T. Eaton Company, Ltd., Winnipeg, Man., Canada
 Smith, P. H., 35 Clay St., Fair Haven, N. J.
 Wendt, K. R., RCA Laboratories, Princeton, N. J.
 Williamson, R. H., 161 Parkway Dr., Syracuse 7, N. Y.

Admission to Senior Member

- Ehrbar, R. D., 180 Varick St., Rm. 1213, New York 14, N. Y.
 Farris, W. R., Code 1392, R. F. Research Section, E.S.R.D., Naval Research Laboratory, Washington 20, D. C.
 Goldstein, M. K., 2701 Branch Ave., S.E., Washington 20, D. C.
 Marcroft, H. C., 2923 Hiss Ave., Parkville, Baltimore 14, Md.
 O'Callaghan, J. J., 8537 Skokie Blvd., Skokie, Ill.
 Yeandle, R. S., 131 Aberdeen Ter., Syracuse, N. Y.

Transfer to Member

- Boyce, C. F., c/o Chief Engineer, General Post Office, Pretoria, South Africa
 Brown, J., 4804 Lackawanna St., Berwyn, Md.
 Budenkaye, A. C., 789 Stuyvesant Ave., Irvington, N. J.
 Burmester, E. R. R., Calle Tacuari 1609, Buenos Aires, Argentina
 Caywood, T. E., 28 Langdon St., Cambridge 38, Mass.
 Christeler, A., Beaulieu, St., Blaise, Switzerland

(Continued on page 38A)

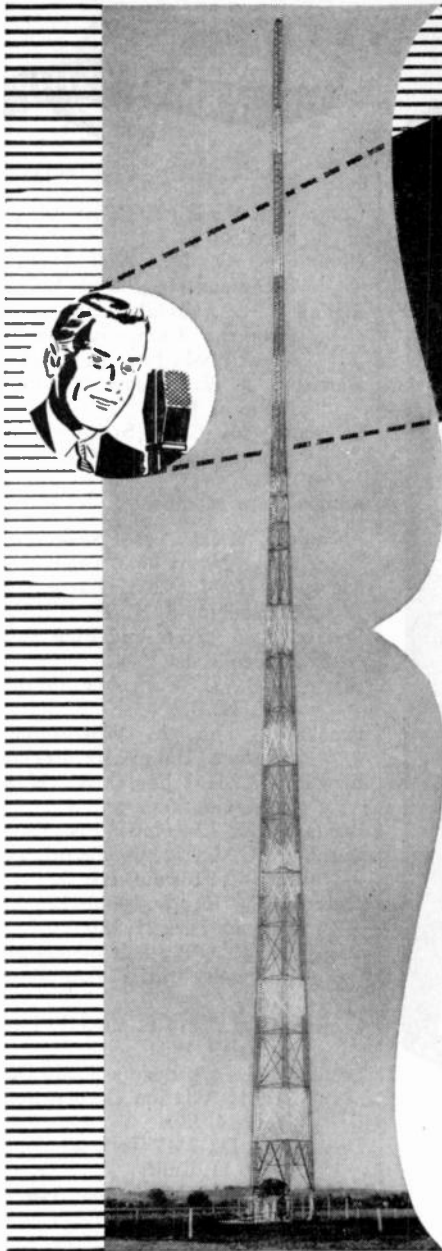

KFAB OMAHA **INSTALLS THREE POSTWAR** **TRUSCON RADIO TOWERS!**

● First in the long list of Truscon installations to follow the war is the new directional system consisting of three 435 foot towers for the 50 Kilowatt KFAB station, which blankets Omaha and surrounding territory.

Truscon Radio Towers dot the American landscape. Tall or small . . . AM or FM . . . every type of radio tower need is met by Truscon engineering and manufacturing services.

Truscon Radio Towers are triangular in cross section and are built entirely of heavy steel members with most shop assembled connections made by means of electric arc-welding.

If you contemplate FM broadcasting, your radio tower facilities will undoubtedly have to be modified. Perhaps you will require a new and higher tower to adequately serve your needs.

Experienced Truscon engineers will be glad to help solve your radio tower problems of today and tomorrow.

TRUSCON STEEL COMPANY

YOUNGSTOWN 1, OHIO • Subsidiary of Republic Steel Corporation

Manufacturers of a Complete Line of
Self-Supporting Radio Towers . . .
Uniform Cross-Section Guyed Radio
Towers . . . Copper Mesh Ground
Screen . . . Steel Building Products.



The unique differences in the design of an electronic product often call for components that are slightly different than so-called standard. Here is an Acme Electric transformer which may give expansion to your ideas — to take advantage of all the "extras" for better performance.

We call this "Mounting Type 130" — two hole horizontal mounting, with lead holes on bottom or side of shell. It is developed in ratings from 15 VA to 100 VA to the exact electrical characteristics that you require. Made from standard parts to special specifications and produced by straight line volume production methods. For further details, write for Bulletin 168, or better still, tell Acme Electric transformer engineers about your problems and let them assist you.



THE ACME ELECTRIC CORPORATION
44 Water St. CUBA, N. Y.



(Continued from page 36A)

- Conway, J. F., Jr., 502 Post Ave., Lyndhurst, N. J.
 Cummings, G. M., 7200 Delta Ave., Richmond Heights 17, Mo.
 Figlia, J. R., Fairchild Camera and Instrument Company, 88-06 Van Wyck Blvd., Jamaica 1, L. I., N. Y.
 Harrison, A. E., Glenwood Dr., Short Hills, N. J.
 Schramm, M. C., 5 Steinmetz Homes, Schenectady 4, N. Y.

Admission to Member

- Alexander, R. B., 1113 Nashville Trust Bldg., Nashville 3, Tenn.
 Ames, F. H., Jr., 2005 Eastern Pkwy., Schenectady 8, N. Y.
 Benner, T. A., State and Pine Sts., Curwensville, Pa.
 Black, P. B., 317 Park Ave., Manhasset, L. I., N. Y.
 Brooks, G. R., 23 Wilberforce Rd., Southsea, Hampshire, England
 Brown, J. C., 162 Fourth St., N.W., Atlanta, Ga.
 Bruns, W. H., Lincolnale, N. Y.
 Burnham, G. L., 722 N. Broadway, Rm. 1208-C, Milwaukee 2, Wis.
 Cannon, R. E., Jr., 400 Boyd Ave., Takoma Park 12, Md.
 Carpenter, R. O'B., Baird Associates, 33 University Rd., Cambridge 38, Mass.
 Crowell, G. F., 1614 E. Royall Place, Milwaukee 2, Wis.
 Daniel, R. L., c/o Bendix Radio Division, Bendix Aviation Corporation, Baltimore 4, Md.
 De Voe, H. D., 7317 Templeton St., San Diego 11, Calif.
 Dill, E. C., 307 Millington Ave., Baltimore 23, Md.
 Downing, L. B., 2095 Scudder Ave., St. Paul 8, Minn.
 Eaton, R. D., 51 Bailey Ave., Watertown 72, Mass.
 Edney, B., 3475 Harding Ave., Hapeville, Ga.
 Edwards, J. R., Process Department, Delco-Remy Division, General Motors Corporation, Anderson, Ind.
 Faries, W. R., 15 Llanberris Rd., Bala-Cynwyd, Pa.
 Fisher, D. L., 81 Cornwell Ave., Williston Park, N. Y.
 Fox, W. F., 2883 Temple Ave., Cincinnati 11, Ohio
 Franks, B. W., 434 "G" Ave., Coronado, Calif.
 Godbold, B. C., 195 Lawrence St., Mill Hill, London N.W. 7, England
 Goetz, L. P., 615 S. Jennings, Bartlesville, Okla.
 Greene, H. A., Jr., 1303 Hopkins Ave., Redwood City, Calif.
 Hammond, R. S., 258 Furman St., Syracuse 5, N. Y.
 Haney, D. W., 3427—13 St., N.W., Washington, D. C.

(Continued on page 40A)

ZIRMET* USED BY SPERRY IN KLYSTRON TUBES!

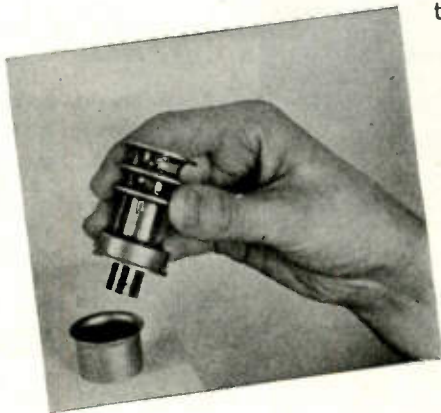

Here's Zirmet (Foote Ductile Zirconium) applied by famed Sperry Gyroscope Company. The bombardment-type cathode (see cut) is part of the Klystron tube for new radar guide systems that shepherd aircraft to safe landings in pea-soup fog.

The narrow strip of ZIRMET is welded around the edge of the

* T. M. Reg. U.S. Pat. Off.

tantalum heat shield, which operates at a sizzling 1000° C. ZIRMET, thanks to its low vapor pressure, earns a spot in tubes where ordinary volatile getters are not satisfactory.

Does this suggest uses in miniature and sub-miniature tubes and in low noise level tubes for Television and Frequency Modulation? It does!

Remember, Zirmet is a gas free metal as produced. Gasses absorbed in tube processing are not liberated by heating. If anodes or other parts are made of ZIRMET, final vacuum can be obtained by induction heating of the part *without* recourse to volatile getters.

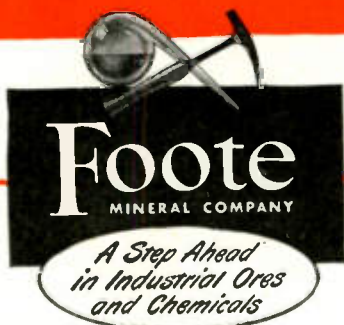

Chemicals • Ores • Metals • Alloys

PHILADELPHIA • ASBESTOS • EXTON, PENNSYLVANIA

Home Office: 502 GERMANTOWN TRUST COMPANY BLDG., PHILA. 44, PA.
West Coast Representative: Griffin Chemical Co., San Francisco, Cal.

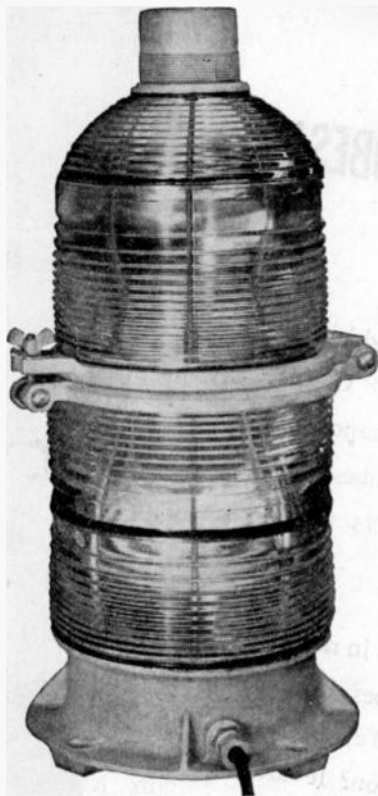

CODE BEACON FOR RADIO TOWERS

A 300 MM code beacon designed and built by ANDREW for lighting radio towers as aviation hazards. Required by the CAA on radio towers of 150 feet or greater in height. Two 500-watt prefocus lamps provide an intense light which passes through red pyrex glass filters and is radiated in a circular, horizontal beam by cylindrical fresnel lenses. Metal parts are made of light-weight cast aluminum, with hardware of corrosion-resistant bronze.

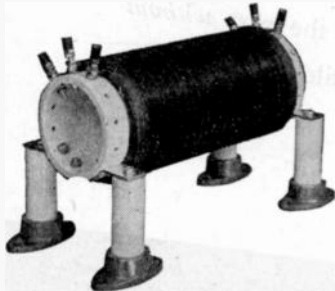

LIGHTING FILTER. The ANDREW Model 1803 lighting filter serves to connect the 60-cycle lighting voltage across the base insulator of a series excited tower without detuning the tower. Three windings provide for operation of code beacon and obstruction lights. Mica insulated by-pass condensers of ample current rating included. Also offered in weatherproof steel housing.

*Pioneer Specialists in the Manufacture
of a Complete Line of
Antenna Equipment*

ANDREW CO.

363 EAST 75th STREET
CHICAGO 19, ILLINOIS

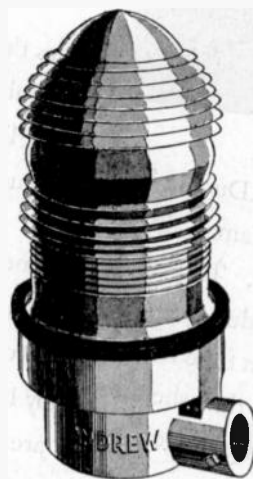
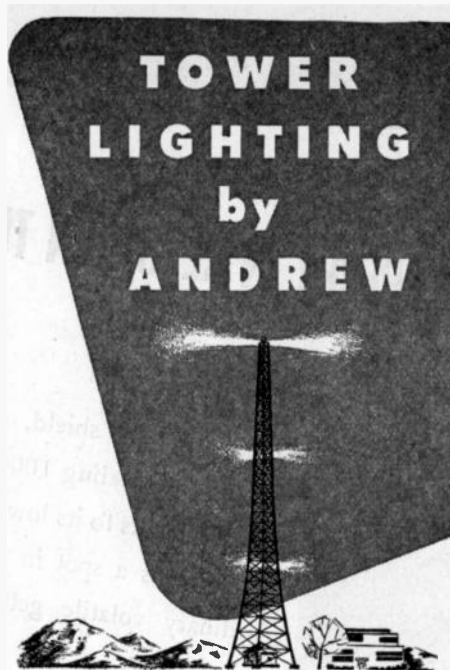

OBSTRUCTION LIGHT. Type 661 is a 100-watt unit fitted with a red fresnel lens to concentrate the light in a nearly horizontal direction. Used in pairs at $\frac{1}{3}$ and $\frac{2}{3}$ levels on radio towers for aircraft warning.

BURNOUT INDICATORS. Highly damped meter with special wattmeter scale indicates when code beacons or obstruction lights need re-lamping.

FLASHERS. Designed to flash 300 MM code beacons at rate of 40 cycles per minute, as prescribed by government regulations. Flashers have 25-ampere contacts and condensers for radio interference elimination. Use K-10347 for one or two beacons; use K-10348 to maintain constant 2000-watt load with three beacons.

TIME SWITCHES. Switch tower lights on at sunset and off at sunrise. Special astronomic dial follows seasonal variations in sunset and sunrise time. Photo-electric models also available.

LAMPS. A complete stock of lamps for code beacons and obstruction lights is carried for the convenience of users. Available in a wide variety of filament voltages.



(Continued from page 38A)

- Hannon, J. P., 4937 Chippewa, St. Louis 9, Mo.
 Herrick, J. F., Box 41, Ashbury Park, N. J.
 Hicks, H. J., 5622 Cates Ave., St. Louis 12, Mo.
 Horner, S. G. L., Hudson's Bay Company, Hudson's Bay House, Winnipeg, Man., Canada
 Huth, A. G., 91-17—118 St., Richmond Hill, N. Y.
 Jacobson, A. E., 264 Stadacona St. W., Moose Jaw, Sask., Canada

Admission to Associate

- Abramovich, M. N., Code 918a, Bureau of Ships, Navy Department, Washington 25, D. C.
 Aha, R. S., 138-12—232 St., Laurelton 10, L. I., N. Y.
 Alexander, G. M., 263 Earle Ave., Lynbrook, N. Y.
 Angst, E., 32 Scheuchzerstrasse, Zurich, Switzerland
 Ashworth, N. P., 9841 N.E. Mason St., Portland 13, Ore.
 Baloga, J. J., 4635 Castor Ave., Philadelphia 24, Pa.
 Bartet, J. F., 64 Livingston St., Brooklyn, N. Y.
 Beck, D. H., Department of Electrical Engineering, New York University, University Heights, New York 53, N. Y.
 Bennett, L. F., 64 Roseford Rd., Cambridge, England
 Blaisdell, K. L., 215 Shennecossett Pkwy., Groton, Conn.
 Borde, E. H., 52 Mucurapo Rd., Port-of-Spain, Trinidad, British West Indies
 Boyd, J. E., Jr., 23 E. 76 St., New York 21, N. Y.
 Brant, R. E., 1852 Miller Rd., Whittier, Calif.
 Brooks, W. R., 239 Auburn Rd., West Hartford 7, Conn.
 Brown, J. R. B., 65 Queenston St., Winnipeg, Man., Canada
 Cain, W. O., 1329 Park Ave., Bremerton, Wash.
 Candler, W. S., 503 Hanover St., Fredericksburg, Va.
 Carlsten, C. A., 195 Edgewater Apts., Essex, Baltimore 21, Md.
 Case, B., 122 W. White Ave., San Antonio 4, Texas
 Childs, S. A., 6306 Eberhart Ave., Chicago, Ill.
 Clarke, C. V., Jr., Box 907, Pasadena, Texas
 Cooke, J. L., 1213 Prince Edward St., Fredericksburg, Va.
 Cooper, F. S., Haskins Laboratories, 305 E. 43 St., New York 17, N. Y.
 Criswell, G. K., 7441 La Jolla Blvd., La Jolla, Calif.
 Dalen, G. S., AGA, Stockholm-Lidingo, Sweden
 Dalke, J. L., 4803 Chevy Chase Dr., Chevy Chase 15, Md.

(Continued on page 42A)

**MATCHED
PAIRS
of**

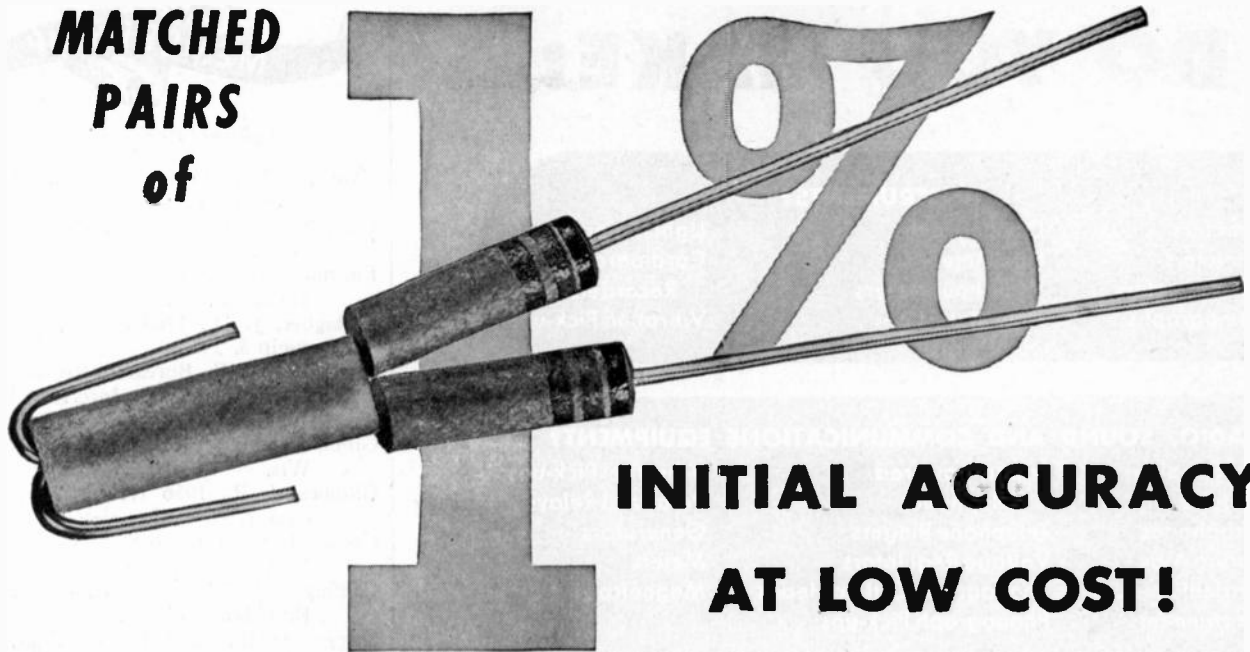

**INITIAL ACCURACY
AT LOW COST!**

Here's the low cost solution to close tolerance requirements—IRC Matched Pairs—two resistors matched in series or parallel to as close as $\pm 1\%$ initial accuracy.

IRC introduced Matched Pairs, has matched millions of BT Metallized and BW Wire Wound Resistors. Both types are stable, excel-

lent for close tolerance requirements. Matched Pairs are widely used as meter multipliers and recommended for any application requiring low cost close initial tolerances.

IRC tests, matches, identifies, and ties together each pair as shown in the illustration above.

MATCHED PAIR RESISTANCE LIMITS					
Type	Parallel Matched Pairs		Series Matched Pairs		
	Minimum Resistance	Maximum Resistance	Minimum Resistance	Maximum Resistance	
BW-1/2	5 Ohms	410 Ohms	20 Ohms	1640 Ohms	
BW-1	2.5 Ohms	2550 Ohms	10 Ohms	10,200 Ohms	
BW-2	3.75 Ohms	4100 Ohms	15 Ohms	16,400 Ohms	
BTS	235 Ohms	10.0 Megohms	940 Ohms	40.0 Megohms	
BTA	165 Ohms	10.0 Megohms	660 Ohms	40.0 Megohms	
BT-2	235 Ohms	10.0 Megohms	940 Ohms	40.0 Megohms	

Matched Pairs are available only to manufacturers. Address inquiries to Dept. H-10



**Matched Pair Resistors
INTERNATIONAL RESISTANCE CO.**

401 N. BROAD ST., PHILADELPHIA 8, PA.

Canadian Licensee: International Resistance Co., Ltd., Toronto

DO YOU MAKE:

INSTRUMENTS?

Ammeters	Oscillographs	Light Meters
Voltmeters	Flux Meters	Cardiograph
Galvanometers	Watt-hour Meters	Recorders
Seismographs	Flow Meters	Vibration Pick-ups

RADIO, SOUND AND COMMUNICATIONS EQUIPMENT?

Loud Speakers	Sound-powered	Vibration Pick-ups
Headsets	Telephones	Polarized Relays
Microphones	Telephone Ringers	Generators
Hearing Aids	Voltage Regulators	Meters
Electrical Musical Instruments	Phonograph Cutting Heads	Magnetron Fields
	Phonograph Pick-ups	

AUTOMOTIVE AND AVIATION EQUIPMENT?

Magnetos	Voltage Regulators	Generators
Tachometers	Motors	Magnetic Oil
Compasses	Speedometers	Filters

THESE PRODUCTS?

Magnetic Separators	Arc Blow-out Magnets	Clocks
Magnetic Chucks	Temperature and Pressure Control Equipment	Toys and Novelties
Magnetic Conveyors	Circuit Breakers	Coin Separators for Vending Equipment
Magnetic Clutches	Limit Switches	
Magnetic Damping Devices	Holding Magnets	

IF YOU make any of the above products, you should be interested in finding out how *better permanent magnets* can improve efficiency and reduce costs. Put your design, development or production problems up to The Arnold Engineering Company. Arnold engineers have been of great assistance to many manufacturers and are at your service to advise exactly what Alnico permanent magnet will solve your particular problem.



Write for Technical Bulletin—"Permanent Magnets for Industry," containing valuable data on design, production characteristics and applications of Permanent Magnets.

THE ARNOLD ENGINEERING COMPANY

SUBSIDIARY OF ALLEGHENY LUDLUM STEEL CORPORATION
147 EAST ONTARIO STREET, CHICAGO 11, ILLINOIS

Specialists in the manufacture of ALNICO PERMANENT MAGNETS



(Continued from page 40A)

Evans, J. W., Minnetonka Rd., RFD 1, Severn, Md.
 Fine, S., 82 Church Ave., Brooklyn 18, N. Y.
 Fuhrmeister, P. F., 255 Regent St., Hampton, Va.
 Gallagher, J. D., 1403 Schley, San Antonio 3, Texas
 Garretson, H. W., Bureau of Reclamation, Department of Interior Bldg., Washington 25, D. C.
 Giffin, B. L., 6931 Aetnact, Milwaukee 13, Wis.
 Gilmore, J. P., 1956 W. 13 Ave., Vancouver, B. C., Canada
 Goesser, J. N., 66 W. 84 St., New York 24, N. Y.
 Griffing, W. W., 2004 E. Third St., Brooklyn 23, N. Y.
 Griggs, J. R., 3575 Boston Ave., San Diego 2, Calif.
 Hancock, P. L., 1655 Sommerfield Ave., Brooklyn, N. Y.
 Hark, G., Jr., 900 Delaware Ave., Buffalo 9, N. Y.
 Hoff, R. S., 1225 S. Ninth St., RFD 2, Gainesville, Fla.
 Hogg, R. A., 904 N. 22 St., Boise, Idaho
 Horobin, G. T., 112 Nottingham Rd., Long Eaton, Nottingham, England
 Husten, B. F., Central Radio Propagation Laboratory, National Bureau of Standards, Washington 25, D. C.
 Jacobsen, H. V., 48 E. 91 St., New York 28, N. Y.
 James, W. B., 2111 Taft St., Houston 6, Texas
 Johnson, M. S., 610 W. Oakland Ave., Bloomington, Ill.
 Johnson, R. C., Jr., 624 S. Eighth St., Gainesville, Fla.
 Johnson, R. E., 29 Bay Rd., Sharon, Mass.
 Keary, H. F., Box 408, RFD 3, Indianapolis 44, Ind.
 Kemp, E. M., 1115 R St., Sacramento 14, Calif.
 Kolar, A., 4826 S. 19 St., Omaha 7, Neb.
 Landis, F. G., 1280 Main St., Buffalo 7, N. Y.
 Leet, D. N., 1912 Calvert St., N.W., Washington, D. C.
 Lenfest, G. C., Jr., 43-17 Bowne, Flushing, L. I., N. Y.
 Levenstein, H., 134-43—231 St., Rosedale 10, N. Y.
 Leventer, I. P., 21 Weisel St., Tel Aviv, Palestine
 Mathwich, H. R., 250 Mountwell Ave., Haddonfield, N. J.
 Merrigan, C. F., Pinewoods Ave., Rd., Troy, N. Y.
 Mezger, C. C., 518 Mellon St., S.E., Washington 20, D. C.
 Miller, E. A., 4304 Wentworth Rd., Baltimore 7, Md.
 Milnes, W. G., Jr., 27 Becker Ave., Mantion 9, R. I.
 Sreeramamoorthy, D., Radio Service Engineer, India Radio Service, New Queen's Road, Bombay 4, India

(Continued on page 62A)

Constant Voltage

Let a SOLA CONSTANT VOLTAGE TRANSFORMER insure the claims made for your equipment

- When you establish the performance standards for your equipment—are you taking into consideration the fact that line voltages in the field will vary as much as $\pm 15\%$ from the nominal value specified on your label?

These voltage variations are *your* problem. Your equipment must work properly in spite of them.

You can build voltage variations out of your equipment by building SOLA Constant Voltage Transformers INTO it. These transformers will absorb line voltage variations as wide as 30%, while maintaining rated voltage to your equipment.

Many manufacturers have built this protection into their product at an actual saving, both in original cost and maintenance. Consultation with SOLA Engineers may show you the way to similar savings.

SOLA Constant Voltage Transformers are available in capacities from 1 VA to 15 KVA. Many standard designs are available from stock. If standard units are not suited to your requirements, special transformers can be designed to your specifications.

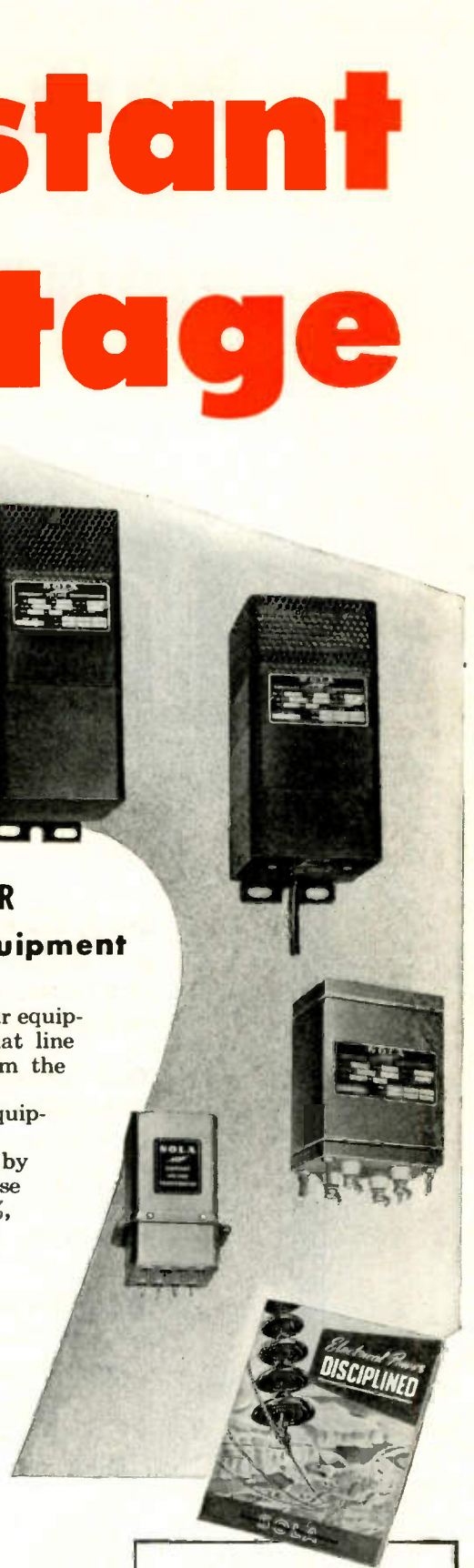

SOLA *Constant Voltage*
TRANSFORMERS

IMPORTANT READING
for every designer, manufacturer, salesman and user of electrical or electronic equipment.

Ask for Bulletin KCV-102

Transformers for: Constant Voltage • Cold Cathode Lighting • Mercury Lamps • Series Lighting • Fluorescent Lighting • X-Ray Equipment • Luminous Tube Signs
Oil Burner Ignition • Radio • Power • Controls • Signal Systems • etc. **SOLA ELECTRIC COMPANY, 2525 Clybourn Avenue, Chicago 14, Illinois**
Manufactured in Canada under license by FERRANTI ELECTRIC LIMITED, Toronto

WHEN RADIO WAS YOUNG



Blaw-Knox engineered, designed and fabricated towers for radio stations even before the pioneer days of home-made crystal sets.

Our accumulated engineering knowledge and experience enables us to assume complete responsibility for the radio towers which you will need to carry out your station's expansion program.

**BLAW-KNOX DIVISION
OF BLAW-KNOX COMPANY**
2037 Farmers Bank Building
Pittsburgh 22, Pa.

**BLAW-KNOX ANTENNA
TOWERS**



Positions Wanted By Armed Forces Veterans

In order to give a reasonably equal opportunity to all applicants, and to avoid overcrowding of the corresponding column, the following rules have been adopted:

The Institute publishes free of charge notices of positions wanted by I.R.E. members who are now in the Service or have received an honorable discharge within a period of one year. Such notices should not have more than five lines. They may be inserted only after a lapse of one month or more following a previous insertion, and the maximum number of insertions is three per year. The Institute necessarily reserves the right to decline any announcement without assignment of reason.

ELECTRONIC DEVELOPMENT— INSTRUCTOR

BEE 1943, Cooper Union, UHF graduate theory. Studying N.Y.U. evenings. 1 year civilian experience UHF development. Organized and instructed army radar school. Civilian radio instructing. Desires part time instructing, research or development. Box 40W.

BEGINNING ENGINEER

BS in EE, Tufts College. Age 22, single. 1 year experience in the installation and maintenance of teletype equipment in the Navy. Box 41W.

SALES ENGINEER

Completed Navy Officer Radar course at Bowdoin College and M.I.T. Member of Tau Beta Pi, Eta Kappa Nu. Age 23. Desires position with Mid-West firm along lines of engineering administration or sales engineering. Box 42W.

ENGINEER

BEE 1943. Former Naval officer. Two years Navy experience special supersonics equipment. One year civilian experience, design of electronic marine equipment. Particularly interested in rocket research or development. Box 43W.

JUNIOR ENGINEER

BS in Engineering, majored in electrical. Desires position in New York area in communications or UHF field. Age 23. Ensign USNR (inactive) Box 44W.

PRACTICAL ENGINEER

BS in EE, Illinois Institute of Technology, final tested, as U.S.N. inspector, all types radar at Western Electric Company, Chicago, 1941-44. As Lt. (j.g.) installed GCA fixed blind landing radar unit in Florida. Ham 12 years. Hold commercial phone 1st. Age 28, married. Details on request. Box 45W.

(Continued on page 46A)

Brass for variable condensers

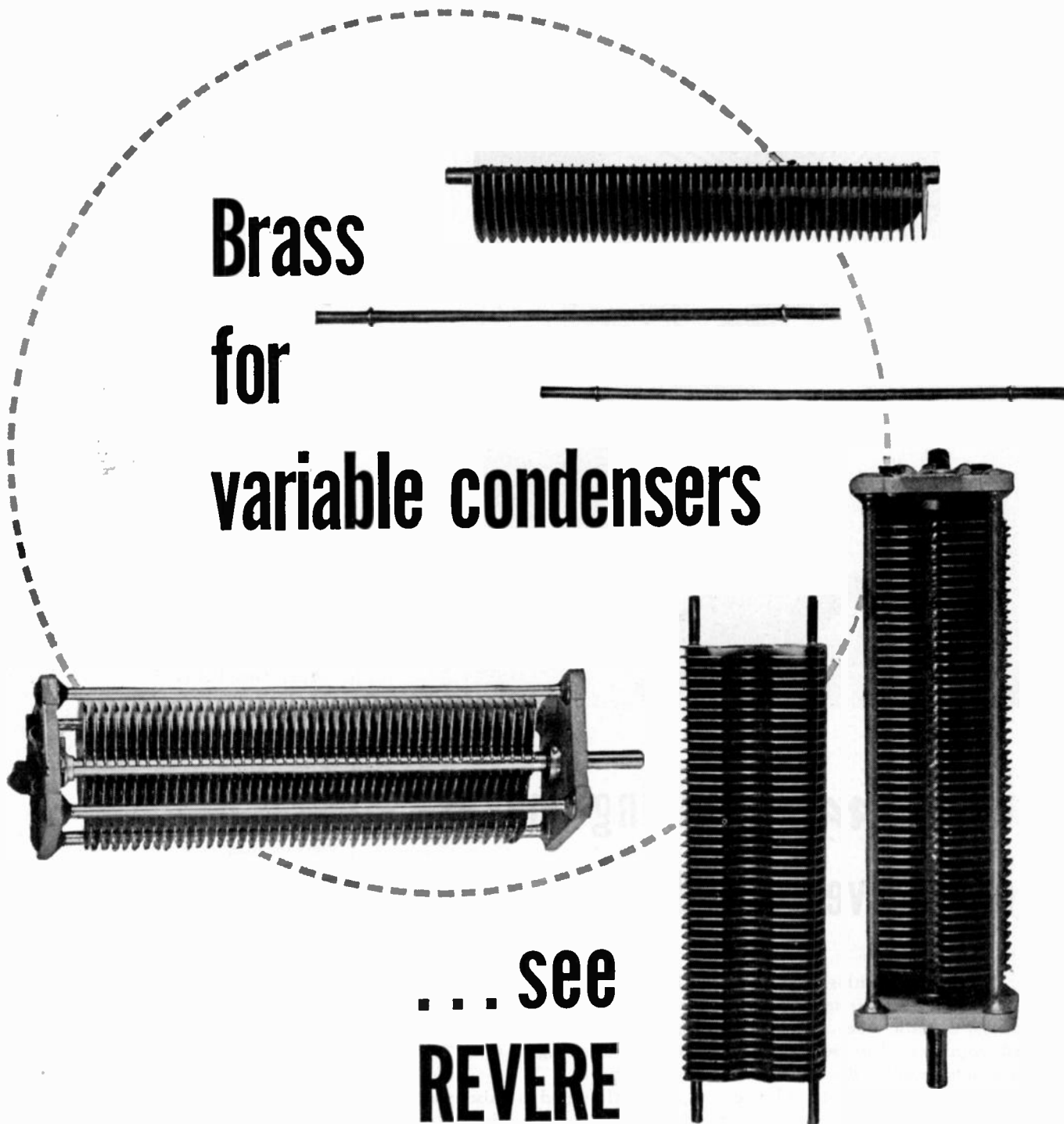

... see
REVERE

THE rods, shafts and plates of these variable condensers were made of brass furnished by Revere. We are especially proud of this because orders received for metal for this important purpose reflect our ability to hold gauges to the exceedingly close tolerances that are necessary in order to permit rapid manufacture of uniform units. Thus the critical distances between rotors and stators are maintained on a production basis. Brass is also highly desirable because of its low "creep" or drift with temperature changes, its strength and rigidity, and the ease with which it can be machined, stamped, soldered and plated if necessary.

In addition to various types of brass and bronze, Revere also offers Electrolytic Copper, Free-Cutting Copper, O.F.H.C. Copper, and other copper and copper alloys of special interest to the electronic industry. These may be had in the usual mill forms of bar and rod, sheet and strip, tube and pipe, and extruded shapes. When you do development

work the question is sure to arise as to which material is best, and which form most economical to work. We have assisted a number of electronic manufacturers solve perplexing problems, and will be glad to work with you through the Revere Technical Advisory Service.

REVERE
COPPER AND BRASS INCORPORATED

Founded by Paul Revere in 1801
230 Park Avenue, New York 17, New York
Mills: Baltimore, Md.; Chicago, Ill.; Detroit, Mich.;
New Bedford, Mass.; Rome, N. Y.
Sales Offices in Principal Cities, Distributors Everywhere.

Listen to *Exploring the Unknown* on the Mutual Network every Sunday evening, 9 to 9:30 p. m., EST.

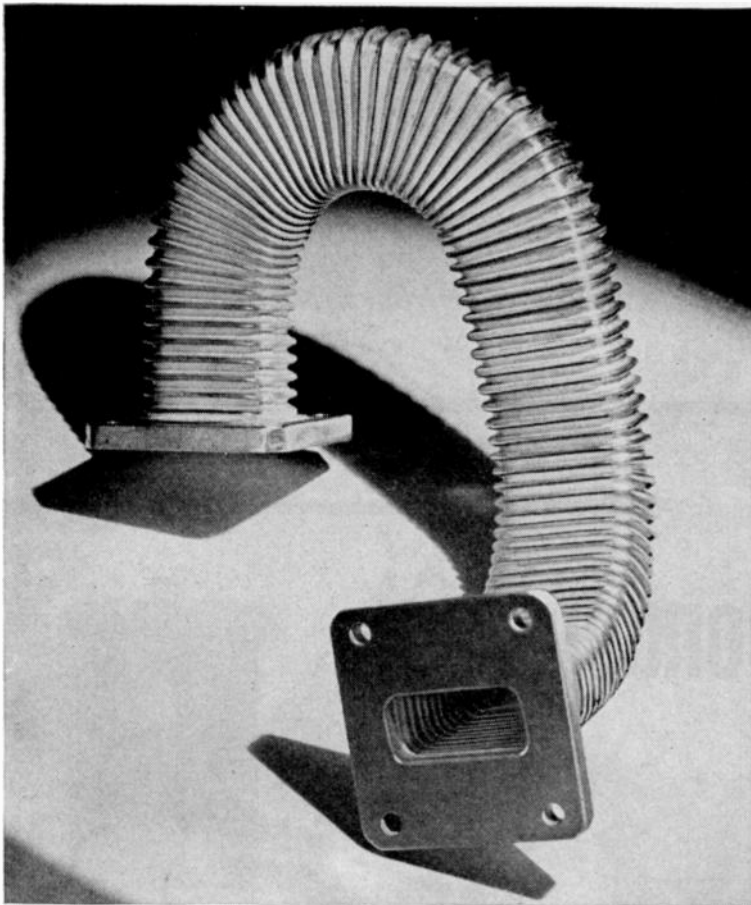

This *Flexible* Tubing makes Radio Waves TURN CORNERS...

THIS AMERICAN Seamless Flexible Wave Guide is made from thin-wall rectangular metallic tube... can be extended, compressed or bent in two planes to small radii and withstands a large number of flexures of moderate amplitude.

Other widely used American Flexible Wave Guides are the "Vertebra" type, consisting of a series of choke-plate wafers inserted in a synthetic rubber jacket, and the "Moldlock" type, made of spirally wound strip with fully interlocked joints, with (or without) a synthetic jacket.

These high precision units mate electrically and mechanically with the standard sizes of rigid guide for operation at wave lengths from 20 to less than 3 Cm.

We will be glad to assist in selecting the wave guide best suited to the specific requirements of your installation. Write for our "Electronics Data Book"

40001



ANACONDA

American

METAL HOSE

THE AMERICAN BRASS COMPANY

American Metal Hose Branch

General Offices: Waterbury 88, Conn.
Subsidiary of Anaconda Copper Mining Company

Positions Wanted

(Continued from page 44A)

ENGINEER

3½ years EE. Age 31, married. Varied and colorful Naval radio career. Radiotelegraph 1st and Radiotelephone 1st class licenses since 1940. Prefer joining small progressive concern. Box 46W.

ELECTRONICS ENGINEER

BEE 1943. Army radar officer, trained M.I.T. Desires research development or testing in electronics New York area. Age 25. Henry L. Pernick, 1120 Wyatt St., Bronx 60, New York.

NAVAL OFFICER

Age 28, married. Three years Naval radar, Chief Petty Officer. First class radiotelephone and telegraph since 1939. Experienced in transmitter maintenance both FM and AM. Box 30W.

ELECTRONIC DEVELOPMENT-CONSULTING

B.S. Physics, Chemistry, 2½ years Navy Radio-Radar Officer. Three years civilian teaching, radio theory-design. Class A license. High fidelity amplifier experience. Charles J. Fuchs, 160 E. Third St., New York 9, N.Y.

SALES OR SALES ENGINEER

Coast Guard electronics officer, age 27, five years military experience, pre-war electronic sales. Excellent sales record in industrial field since discharge. Will go anywhere in United States or foreign. Box 32W.

ELECTRICAL ENGINEER

B.S. in E.E., graduate work at University of Pennsylvania. Three and one-half years civilian experience in design, development, and production of radio, radar, and electronic equipment. Radio engineering or production engineering position desired. A. F. Driesman, 2169 Pacific St., Brooklyn 33, N.Y.

ENGINEER

B.E.E. 1943, some postgraduate work. 1½ years civilian experience in design and construction of electronic instruments for ballistic measurements. U. S. Army Ordnance; 1½ years abstracting German technical documents. Available October. Box 33W.

JUNIOR ENGINEER

BS in EE, broadcast license since 1940, technician. Desire position with station or assistant in design or manufacture. Age 24. J. M. McClamrock, 751 E. Burnside St., Portland, Ore.

AAF ELECTRONIC OFFICER

AAF Electronic Officer with good experience in installation and operation of Loran transmitters or receivers. Experienced with all types of control circuits. Box 15W.

ENGINEER

BEE. UHF. Age 22. Some experience in research and design of test equipment. Navy work in radar and communication. Desires research or engineering in electronics near NYC. Available August. Box 16W.

(Continued on page 48A)

**FOR GREATER VALUE TO
USERS AND EQUIPMENT
MANUFACTURERS**

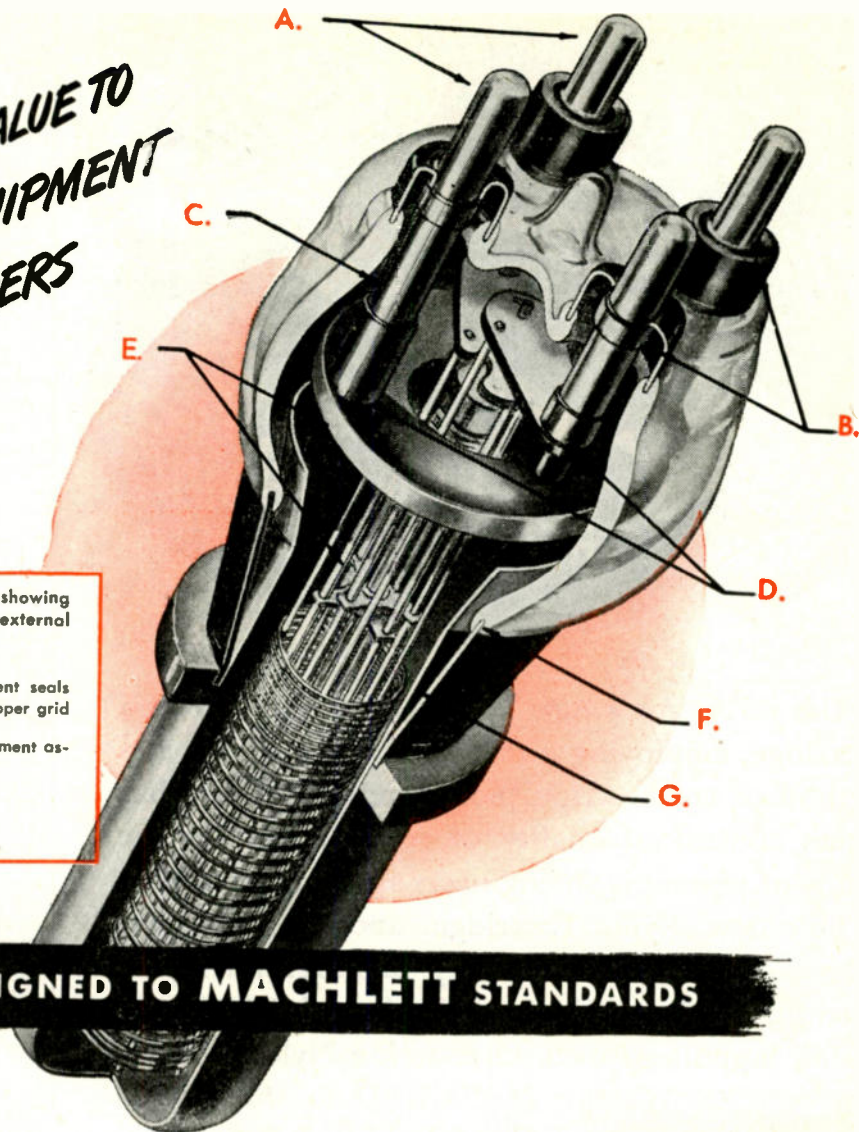

Sectional view of the ML-889-A, showing features typical of Machlett external anode tube construction.

- A. Gold-plated contact surfaces
- B. Rugged Kovar grid and filament seals
- C. One-piece high-conductivity copper grid and filament support leads
- D. Rigidly-supported grid and filament assemblies
- E. Surgically-clean internal parts
- F. Rugged Kovar plate seal
- G. One-piece anode and shield

REDESIGNED TO MACHLETT STANDARDS

For better performance and longer life! ML-889A

HERE, in the ML-889A and ML-889RA, is another outstanding example of Machlett's ability to apply to the design and manufacture of high-power triodes its unique skills acquired through a half-century of electron tube production... a half-century of leadership in producing the most critical and exacting of all electron tubes. This background and resulting know-how are effectively reflected in the design and construction of all Machlett external anode tubes. Note, for instance, these features of the ML-892 and ML-892R:

1. Heavy Kovar sections for grid and plate seals, instead of feather-edge copper. Result ... greatly increased mechanical strength.
2. Grid assembly supported by heavy Kovar cup, for strength and stable inter-element spacing.
3. Filament assembly greatly strengthened to increase life and preserve correct spacing.
4. All internal parts processed by special

Machlett techniques which prevent contamination by foreign particles, assuring permanent outgassing.

5. Tube pumped by unique Machlett continuous, straight-line, high-voltage process, assuring same high standards maintained in Machlett high-voltage X-ray tubes.

• • •
For complete details of this greatly improved tube, write Machlett Laboratories, Inc., Springdale, Connecticut.

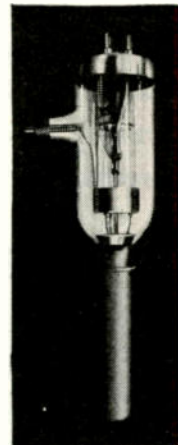

GENERAL CHARACTERISTICS		ML-892	ML-892-R
Filament Voltage	...	22	22 volts
Filament Current	...	60	60 amps.
Amplification Factor	50	50
Maximum frequency for full power	...	1.6	1.6 mc.
Capacity grid to plate	27	30 uuf
Capacity grid to filament	18	18 uuf
Capacity plate to filament	2	2 uuf
Cooling	Water	Air
		3 to 8 G.P.M.	400-700 C.F.M.



APPLIES TO RADIO AND INDUSTRIAL USES
ITS **41** YEARS OF ELECTRON TUBE EXPERIENCE

Positions Wanted

(Continued from page 46A)

RADIO ENGINEER

BS 1941. Courses at C.C.S.Y., N.Y.U., L.I.U., B'klyn Polytech., Yale, Harvard, and M.I.T. Experience testing, research and teaching. Former Radar countermeasures officer. Desiring position New York area. Box 17W.

ENGINEER

M.I.T. trained radar officer, BS physical chemistry Rutgers 1941, photochemical research, electronic teaching, vacuum tube manufacturing experience. Seeks development work electronics or physical chemistry. Box 18W.

RADIO ENGINEER

BS in EE. Three years development electronic equipment and systems. Four years research and development in RF and antenna field both VHF and microwave. Now holding responsible technical position. Available July. Box 19W.

RADAR-COMMUNICATIONS ENGINEER

EE graduate, 25, with Navy officer training at Princeton and M.I.T. in electronics plus duty at NRL. 1½ years experience as radar instructor. First class radio telephone licence held. Desires position in June. Box 20W.

NAVAL ELECTRONICS OFFICER

BEE, age 23, married. First class phone license; broadcast and industrial experience. Desire radio design or broadcast engineer position. Prefer middle west. Available July 1. Box 22W.

ELECTRICAL ENGINEER

BEE, age 24. Instrument research experience. Studied Navy electronic equipment. Commercial operator's license. Prefer east. Box 24W.

SALES ENGINEER

BE Yale 1940, project engineer Naval Research Lab. and Radiation Lab., M.I.T., aeronautical and marine radar, Loran, UHF radio experience. Résumé of experience on request. Box 25W.

TWO-WAY RADIO AND MICROWAVES

Well-known highly experienced engineer, investor and author on two-way radio and microwaves. Long successful record pre-war and in Navy. Available for top-flight technical or administrative position in field engineering, sales, research or production. Minimum salary \$7200. Any location. Box 28W.

ENGINEER

Living in South Africa, diploma Professor Barkhausen (Dresden); A.M. (S.A.) I.E.E. seeks position with American manufacturing concern. Box 29W.

SALES ENGINEER

BSEE Harvard. Age 25, married. M.I.T. Radar Officer, officer in charge of German office of the Chief of Council (War Crimes Trials) telephone network cooperative, experience with light and power utility. Available September. A. J. Ward, 840 Michigan Ave., Evanston, Illinois.

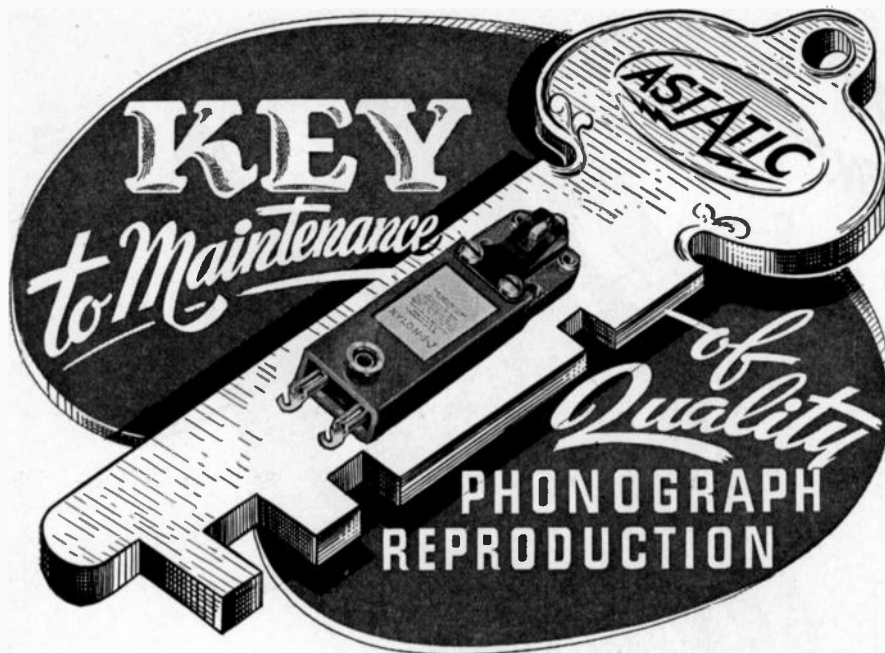

● Use of Astatic's new Nylon 1-J Crystal Pickup Cartridge, employing a revolutionary material and method of construction, not merely improves but places control of quality of reproduction in the hands of phonograph engineers and manufacturers.

This new Nylon Cartridge, another important Astatic contribution to quality phonograph reproduction, employs a Nylon Chuck and REPLACEABLE, sapphire-tipped, knee-action Nylon Needle, MATCHED to the Crystal Cartridge.

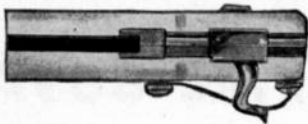

Thru-section view of cartridge end, showing part of crystal element, Nylon Chuck, Nylon Needle and needle guard.

The Nylon Needle designed for this Nylon 1-J Cartridge is the ONLY NEEDLE that can be used with it. REGARDLESS of needle replacements, therefore, the original quality of reproduction must remain constant and unalterable.



NEW **EBY** MINIATURE SOCKETS

FLAT SADDLE

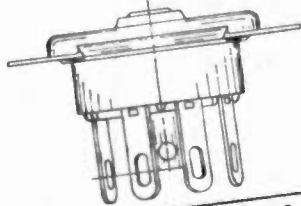
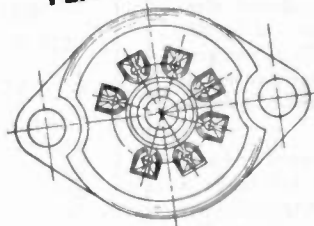

INSULATOR	CONTACTS	
	Phos. Bronze	Beryl. Copper
General Purpose	8323	8100
Ceramic	8326	8083
Mica-filled Phenolic	8327	8082

SHOCK SHIELD

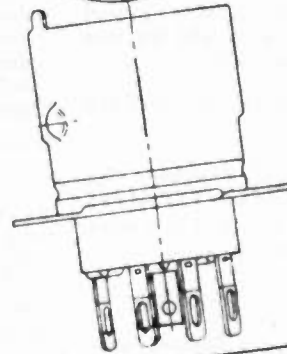
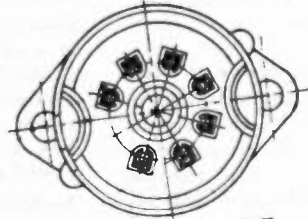

INSULATOR	CONTACTS	
	Phos. Bronze	Beryl. Copper
General Purpose	8322	
Ceramic	8328	7676
Mica-filled Phenolic	8329	7670

NON-MICROPHONIC

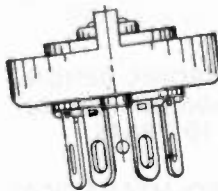
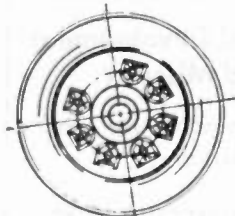

PART NO. 8341

**Flat Saddle
Shock Shield
Non-Microphonic**

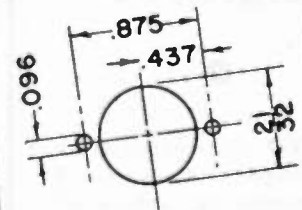

MOUNTING LAYOUT

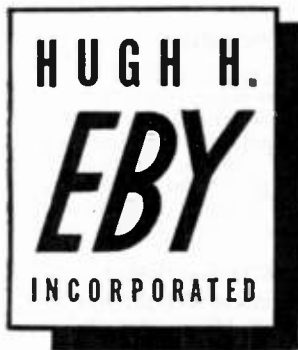

WRITE TODAY for complete details —

HUGH H. EBY, INC.

18 W. Cheltenham Ave.

Phila. 44, Pa.

WANTED: CHIEF RESEARCH ENGINEER

To direct Electronic Division of Industrial Research Laboratory

We offer

1—A permanent and stable position. Parent company has a 75-year unbroken record of growth and an unsurpassed reputation for integrity. Normal gross sales over \$100 million.

2—An opportunity to assume as much responsibility as you can carry. The research facility is organized as a separate company, and its policies are established and administered for and by research men. We expect you to set up your research program and, within our general policy limits, to choose and run your organization as you see fit.

3—An ample budget for both staff and equipment.

4—Excellent working conditions. The electronics laboratory is an unusually attractive one and is located in a pleasant suburban community.

5—A high bracket starting salary.

6—A 100% Company financed retirement plan, in addition to the usual participating group life and health benefits.

We require

1—At least a bachelor's degree plus 1 or 2 years of graduate work in communications or physics. We prefer an E.E. or Ph.D.

2—A minimum of eight years' experience in communications or industrial electronics. This experience should include high and low frequency RF power generation, servo system design and operation, and general industrial electronic control systems.

3—Ability not only to organize and conduct research efficiently, but to do a good production engineering job on any developed instrument or device. This includes fool-proof design for unskilled operation, as well as neat packaging.

4—Age between 30 and 45 years.

* * *

Please submit sufficient information in your reply to warrant a personal interview. We recognize the need for protecting your identity and present position, and all replies will be handled, in strict confidence, by the President only. Box 438.

THE INSTITUTE OF RADIO ENGINEERS
330 West 42nd Street, New York 18, N.Y.



The following positions of interest to I.R.E. members have been reported as open. Apply in writing, addressing reply to company mentioned or to Box No. . . . The Institute reserves the right to refuse any announcement without giving a reason for the refusal.

PROCEEDINGS of the I.R.E.

330 West 42nd Street, New York 18, N.Y.

SOUND-POWERED ENGINEER

Sound-powered telephone engineer wanted. Experienced in design of sound-powered telephone equipment. EE graduate or physicist with minimum 4 years' design experience in this field. Up to \$6000. Long established Connecticut manufacturer. Box 439.

ENGINEERS—TECHNICIANS

Expanded guided missile research, manufacture, and experimentation require long term services of a new development group in the Electronics Department. Positions open for graduate engineers, physicists, and experienced technicians. Masters and Doctors degrees desirable for better positions. Educational background in mathematical-physics, electronics, aerodynamics preferred. Work will be on broad aspects of electronic servo mechanism control systems. Salaries \$2500-\$8000, commensurate with ability. Location Farmingdale, Long Island. Communicate with A. E. Sutton, Pilotless Plane Division, Fairchild Engine and Airplane Corporation, 184-10 Jamaica Avenue, Jamaica 1, N.Y.

RADIO ENGINEER

Needed for extensive laboratory development work in circuit detailed investigation and design of RF components. Must have experience in experimental radio or allied techniques. Write to: Employment Department, The F. W. Sickles Company, Chicopee, Mass. Give full particulars as to experience, salary desired, etc.

ASSOCIATE PROFESSOR OF ELECTRICAL ENGINEERING

Man with MS in Electrical Engineering with specialization in electronics to take charge of Electronics Option. Teaching experience required. Industrial or military experience desirable. Salary \$3200 to \$3600, for nine month school year, depending on age and experience. Write: Department of Electrical Engineering, North Dakota Agricultural College, Fargo, North Dakota.

PHYSICIST

Applied physicist wanted to carry on research in government-sponsored program. Prefer man with doctorate in electronic physics and with practical experience in radio circuits, acoustics, and instrument design. Address inquiries to the Haskins Laboratories, 305 East 43rd Street, New York City. Or phone MU 5-7956.

RESEARCH ENGINEERS

Research engineers and physicists having experience in micro-wave and ultra high frequency techniques to work at new

(Continued on page 56A)

Electronics Engineer

WANTED—for work on design and development of new types of radio transmitting tubes. Good salary with excellent opportunities; new large air conditioned laboratory with excellent facilities. 40 hour, 5 day week.

Applicant should have B.S. in Electrical Engineering or Physics with an M.S. preferred. Experience in electron tube work desirable but not necessary. Location: RCA Tube Department, Lancaster, Pa.

Write to National Recruiting Office, RCA Victor Division, Camden, N.J.

WANTED

THREE ELECTRICAL ENGINEERS

Research and Development
Guided Missiles

Experience required for each
position

1. SERVO-MECHANISMS
6 to 8 YEARS
2. ELECTRONIC DESIGN
AND ADMINISTRATION
10 YEARS
3. ELECTRO-MECHANICAL
DESIGN AND SUPERVISION
12 YEARS

APPLY BY LETTER

giving full information concerning
education and experience.

All replies held confidential

BENDIX AVIATION CORP.

TETERBORO, NEW JERSEY
Att: Employment Manager

For the Man Who Takes Pride in His Work

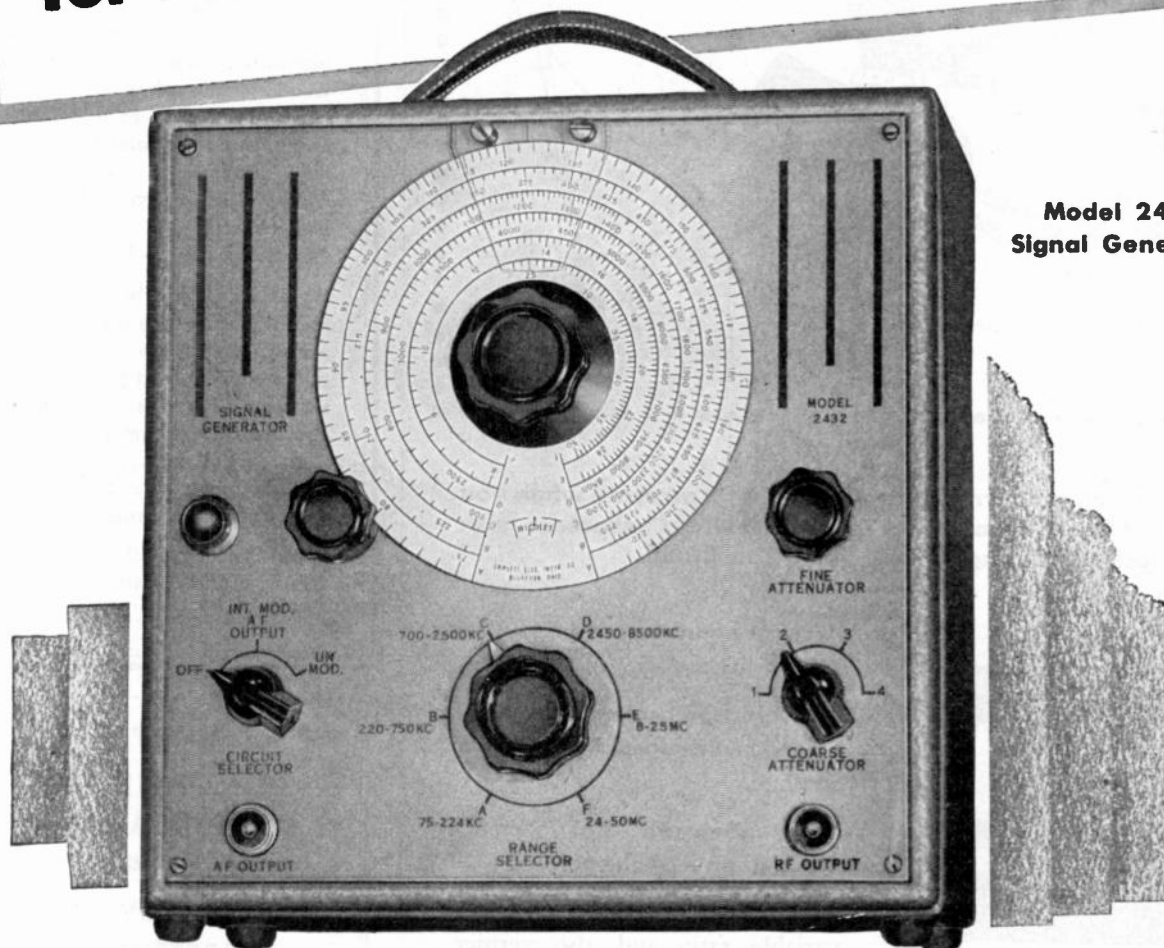

**Model 2432
Signal Generator**

**FM AND TELEVISION BAND COVERAGE ON STRONG HARMONICS
STRONG FUNDAMENTALS TO 50 (MC)**

Another member of the Triplet Square Line of matched units this signal generator embodies features normally found only in "custom priced" laboratory models.

FREQUENCY COVERAGE—Continuous and overlapping 75 KC to 50 MC. Six bands. All fundamentals. **TURRET TYPE COIL ASSEMBLY**—Six-position turret type coil switching with complete shielding. Coil assembly rotates inside a copper-plated steel shield. **ATTENUATION**—Individually shielded and adjustable, by fine and course

controls, to zero for all practical purposes. **STABILITY**—Greatly increased by use of air trimmer capacitors, electron coupled oscillator circuit, and permeability adjusted coils. **INTERNAL MODULATION**—Approximately 30% at 400 cycles. **POWER SUPPLY**—115 Volts, 50-60 cycles A.C. Voltage regulated for increased oscillator stability. **CASE**—Heavy metal with tan and brown hammered enamel finish.

There are many other features in this beautiful model of equal interest to the man who takes pride in his work.



Triplet



ELECTRICAL INSTRUMENT CO. BLUFFTON, OHIO

STAYS ACCURATE—Year After Year



Here's a sturdy, modern test oscillator that's accurate when you buy it—and keeps its accuracy in long service. Convenient push button selection of ranges from 100KC to 30MC.

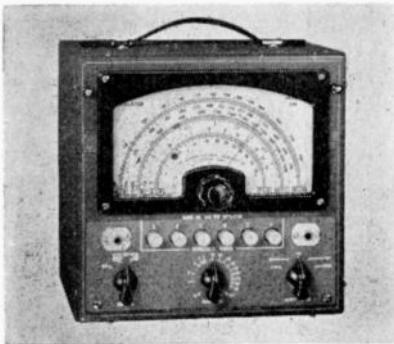

MODEL 640 TEST OSCILLATOR

A complete standard type oscillator for all general purpose work. Full range direct reading dial. All ranges are fundamental frequencies. No skips or harmonics calibrated.

Accuracy guaranteed to 1/2 of 1% on all ranges.

Push button selection of all ranges makes operation fast and accurate.

Glass enclosed dial prevents dust and protects the pointer.

Two circuit attenuator provides variable ratio and also vernier control.

Powerful signal output usable as pure or modulated R. F. carrier is modulated at approximately 30%. The A. F. voltage is available for external use.

Operates from 110 volts 60 cycles. Uses three tubes: rectifier, oscillator, and modulator.

Dimensions: 8 1/2" x 8 1/2" x 6 1/2".

JACKSON

Fine Electrical Testing Instruments

JACKSON ELECTRICAL INSTRUMENT COMPANY, DAYTON, OHIO

PHYSICIST ELECTRON TUBES

WANTED—for advanced development work on Cathode Ray Camera tubes for television. Work includes research on photosensitivity and electron optics. Good starting salary with excellent opportunities in a progressive organization and in a new air conditioned, completely equipped laboratory with excellent facilities for development. 40 hour, 5 day week.

Applicant should have a Ph.D. in Physics or equivalent with some training in electronics, photo emission and primary and secondary emission phenomena. Experience with television and Cathode Ray tube circuits desirable. Employment in RCA Tube Department, Lancaster, Pa.

Write to National Recruiting Office, RCA Victor Division, Camden, N.J.

BELMONT RADIO CORPORATION of Chicago NEEDS SEVERAL ELECTRONIC ENGINEERS

Development and Research Engineers, Seniors and Juniors, well versed in all phases of RF circuits wanted. VHF or Microwave experience desirable. Top-notch applicants with Engineering degree or equivalent background for this type of work only will be considered. Chicago Area residents preferred, top salary, steady position, 40-hour week, occasional field trips. Appointment by letter only. Give background experience, educational and employment history. Address letter to Research Division, Belmont Radio Corporation, 5921 W. Dickens Ave., Chicago 39, Illinois.

Everything you need in a console

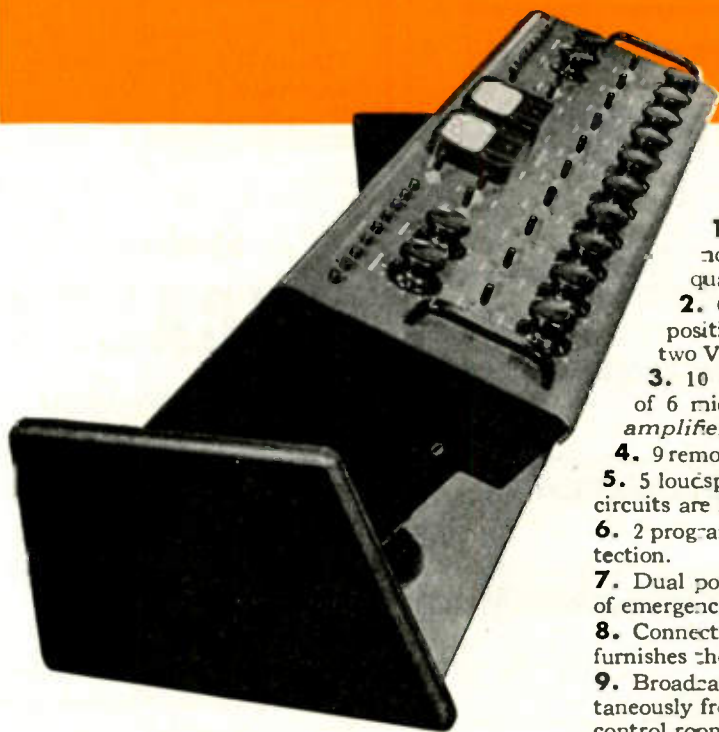

Exclusive with Collins! The up-to-the-minute design allows the entire console to be tilted for under-chassis access, *without requiring any additional space*. The 212A-1 can be placed against a window or wall without sacrificing accessibility.

Here are 9 good reasons why the Collins 212A-1 speech input console is superior for AM and FM applications:

1. High fidelity—30-15,000 cps within 2 db. The clear noise-free output of this new console maintains the high quality of your program.
2. Operator convenience—sloping front panel, lever type positive action switches, push button remote line selection, two VU meters, and maximum accessibility.
3. 10 independent input channels—simultaneous operation of 6 microphones and two turntables, *with individual pre-amplifiers for each*, and two remote channels.
4. 9 remote lines with push button selection and monitor facilities.
5. 5 loudspeakers fed by the monitor amplifier—selective talkback circuits are interlocked to prevent program interruption.
6. 2 program amplifiers—provide dual operation or emergency protection.
7. Dual power supplies available—automatic switch-over in case of emergency.
8. Connections for external on-the-air light relays. The 212A-1 furnishes the power.
9. Broadcasting, rehearsing and cueing can be performed simultaneously from any combination of two studios, an announce booth, control room microphone, two turntables, and nine remote lines.

The 212A-1 will give added efficiency to your operations. Its attractive, dignified, metallic gray and black finish will enhance the appearance of your studio. Let us send you complete details of this and other Collins broadcast accessories.

FOR BROADCAST QUALITY, IT'S . . .



COLLINS RADIO COMPANY, Cedar Rapids, Iowa

11 West 42nd Street, New York 18, N. Y.

458 South Spring Street, Los Angeles 13, California

Hi-Q CERAMIC CAPACITORS

EACH TYPE SPECIFICALLY DESIGNED TO HELP YOU MAKE BETTER PRODUCTS!

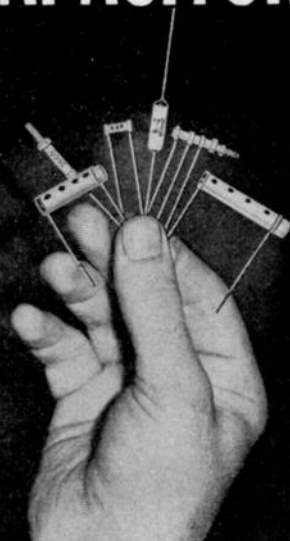

● Hi-Q Ceramic Capacitors are manufactured of titanium dioxide (for temperature compensating types). Electrodes are of pure silver, precision coated. They are individually tested for accuracy of physical dimension, temperature coefficient, power factor and dielectric strength. Available in C. I. type (axial leads) and C. N. type (parallel leads) also S. I. type Durez coated for fullest protection against extremes of fungus and climatic conditions.

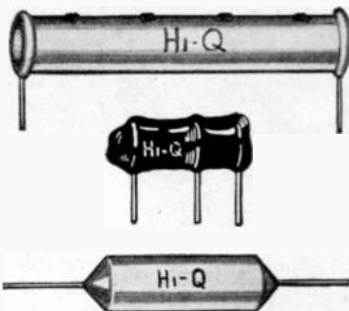

OTHER COMPONENTS

WIRE WOUND RESISTORS

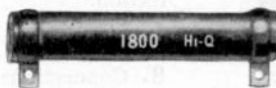

CHOKE COILS



STAND-OFF CONDENSERS

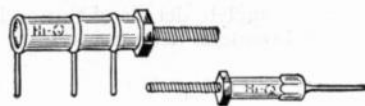

Hi-Q

ELECTRICAL REACTANCE CORPORATION
FRANKLINVILLE, N. Y.

ELECTRICAL ENGINEER OR PHYSICIST UHF ELECTRON TUBES

WANTED—for advanced development work on UHF electron tubes, involving design of microwave tubes, particularly magnetrons. Theoretical ability and thorough background in microwave techniques desired.

Good starting salary with excellent opportunities in a progressive organization with new air conditioned laboratory and excellent development facilities. 40 hour, 5 day week.

Applicant should have M.S. or Ph.D. in Electrical Engineering or Physics and 2 to 4 years experience on UHF tubes. Location: RCA Tube Department, Lancaster, Pa.

Write to National Recruiting Office, RCA Victor Division, Camden, N.J.

Specify

MYCALEX

LOW LOSS INSULATION

Where high mechanical and electrical specifications must be met.

MYCALEX 410

(MOLDED MYCALEX)

makes a positive seal with metals . . . resists arcing, moisture and high temperatures.

27 years of leadership in solving the most exacting high frequency insulating problems.

MYCALEX CORPORATION OF AMERICA

"Owners of 'MYCALEX' Patents"
Plant and General Offices: Clifton, N.J.
Executive Offices: 30 Rockefeller Plaza
New York 20, N.Y.



Unit 524
Transcription
Turntable

FM

Performance

IF IT'S ON THE RECORD IT'S ON THE AIR!

Let's start with the record. Disc recording has attained a fidelity that is uncanny. Fine quality disc recordings actually duplicate the original sound. It is difficult, even for the trained ear, to distinguish the recording from the original live studio performance.

What has this to do with FM performance? Just this. FM sound reproduction equipment must also possess a fidelity that is uncanny! It must keep the record "alive"!

FM performance puts a premium on precision-built sound equipment that

has been engineered for wide dynamic range, minimum distortion content and wide frequency range.

Fairchild has long anticipated the needs of FM. The Unit 524 Transcription Turntable is one outstanding example. It is completely new. The drive and turntable were designed especially for cabinet installation. Turntable noise, rumble and vibration are practically non-existent because of the unique method of mounting the drive and filtering out vibration.

'WOW'-free operation is assured at either 33.3 or 78 rpm by the famed Fairchild direct-from-the-center drive. Evenness of speed is attained by a carefully calculated loading of the drive mechanism that keeps the synchronous motor pulling constantly. Intermittent grab and release is prevented by precision control of all alignments.

If you're interested in FM performance for either FM or AM recorded broadcasts, you'll be interested in Fairchild Sound Equipment.



CAMERA AND INSTRUMENT CORPORATION

SOUND
EQUIPMENT

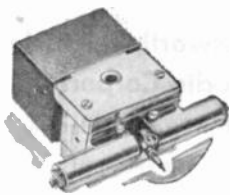

UNIT 541
MAGNETIC CUTTERHEAD

FOR IMPROVED PERFORMANCE

Earlier FAIRCHILD portable models and many other types of recorder-playbacks will give vastly improved performance if equipped with an adapter and an improved Fairchild Pickup and Cutterhead. For complete information address: 88-06 Van Wyck Boulevard, Jamaica 1, New York.

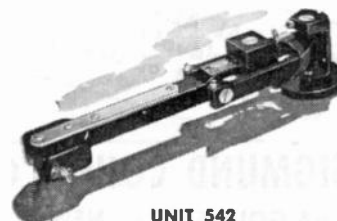

UNIT 542
LATERAL DYNAMIC PICKUP

MICRO-DIMENSIONAL

WIRE & RIBBON
for
VACUUM TUBE
FILAMENTS & GRIDS

● Many sizes and alloys for a range of applications such as miniature tubes, hearing aid tubes, low-current-drain battery tubes, receiving tubes . . .

● Melted and worked to assure maximum uniformity and strength. WIRES drawn to .0004" diameter; RIBBON rolled to .0001" thickness . . .

● Wollaston Process Wire drawn as small as .000010"; made to your specifications for diameter and resistance.

● SPECIAL ALLOYS made to meet individual requirements. Write for list of stock alloys.

SIGMUND COHN & CO.

44 GOLD ST. NEW YORK

SINCE  1901

POSITIONS OPEN

(Continued from page 50A)

laboratory of well established parent company. Salaries commensurate with qualifications. Suburban location in Westchester County, N.Y. 30 Miles from New York City. All replies treated confidentially. Box 433.

ELECTRONICS RESEARCH ENGINEER OR PH.D.

Experience in research and development of servo mechanisms, calculating devices, electronic controls, etc. Project engineer required by an established development and manufacturing company. Include résumé of experience and background. Address Box 434.

SALES ENGINEER

Manufacturer of railway equipment seeks young man between 20 and 30 years of age. Excellent opportunity for one who has some or all of these qualifications:

1. Knowledge of electrical engineering, especially electronics.
2. Knowledge of railroad operation and signaling.
3. Ability to meet people and make friends.
4. College education.

Training will be given to cover any deficiencies applicant may have. In reply state age, education, sales and engineering experience and other qualifications. Include three references and photograph. Box 435.

ENGINEERS (Electrical or mechanical)

SP-7 and P1-P5 inclusive. Work involves the development and design of small and intricate electro-mechanical integrating and computing systems. The design and development of computing machines, fire control devices, automatic pilots, or similar devices represent the type and scope of work.

P-5. Must have background in the design and development of electronic and associated mechanical devices, with marked ability in administration and the preparation of technical papers and reports. Must have excellent personality.

Feminine applicants will be carefully considered for this position.

P-3. Must have background in the design and development of electronic and associated mechanical devices, with specific experience in laboratory techniques. Administrative experience desirable. The engineer Board, Applied Electronics Branch, Fort Belvoir, Virginia.

ENGINEER

Engineering firm in New York City requires two engineers with at least two years of design and development experience on communication equipment. VHF background desirable. Write, stating full particulars and salary expected. Box 436.

ELECTRONICS RESEARCH ENGINEER

Experienced in research, development and design, special devices, servo, electronic controls, etc. Top man required by a nationally known manufacturing company. State complete résumé of experience and background. Box 425.

(Continued on page 58A)

WANTED PROJECT ENGINEERS

Engineering laboratory of precision instrument manufacturer has interesting opportunities for graduate engineers with research, design and/or development experience on radio communications systems, electronic & mechanical aeronautical navigation instruments and ultra-high frequency & microwave technique.

WRITE TO BOX 142

EQUITY ADVERTISING AGENCY

113 W. 42nd St., New York 18, N.Y.

Radio Engineers

Must be experienced in television techniques.

Circuit engineers and designers for television studio and transmitter equipments.

Also FM transmitter circuit engineer.

A very excellent opportunity in this special engineering field.

Write to:

Farnsworth Television & Radio Corporation

Fort Wayne 1, Indiana

Attention of:

Chief Engineer,

Electronic Apparatus Division



FIXED INSULATED RESISTORS

1/2 - WATT

Length $3/8$ in. Diam. $9/64$ in.



1 - WATT

Length $9/16$ in. Diam. $7/32$ in.



2 - WATT

Length $11/16$ in. Diam. $5/16$ in.



Length of all leads— $1 1/2$ inches

Available in $1/2$, 1, and 2-watt ratings in RMA standard values from 10 ohms to 22 megohms in tolerances of 5%, 10%, and 20%.



Type JS Bradleyometer differs radically from paint or sprayed film adjustable resistors. The resistor element is solid-molded for permanence. Any resistance-rotation characteristic is available.

These Bradleyunits speed up receiver assembly and cut our costs because . . .

1-They are packed in honeycomb cartons to keep the leads straight . . . no tangled mess of resistors in shop pans.

2-They have leads that are tempered near the resistor to avoid sharp bends. They are easily soldered.

3-They are small in size but "tops" in passing all load and endurance tests. For example, under continuous load test of 200% load for 100 hours or 100% load for 1000 hours, resistance change is less than 5%.

Send for technical data sheet today.

Allen-Bradley Co.,
114 W. Greenfield Ave., Milwaukee 4, Wis.



ALLEN-BRADLEY

FIXED & ADJUSTABLE RADIO RESISTORS

QUALITY

YOU CAN NOW GET THESE DAILY ESSENTIALS



(Continued from page 56A)

INSTRUCTIONAL STAFF

Electrical Engineering Department in large Middle Western University has staff opening in grades of Instructor to Associate Professor depending upon training and experience. For details write Box 426.

ACOUSTIC ENGINEERS, PHYSICISTS, RESEARCH ASSISTANTS

To do research in the field of acoustics full or part-time while carrying graduate work in allied subjects at Washington University. Stipend commensurate with proven ability and past earnings. St. Louis Microphone Company, Box 3440, Maplewood 17, Mo.

TUBE DESIGN DEPARTMENT HEADS

Electron Tube General Development and Magnetron Section Heads (2) Completely equipped laboratory; 10 scientists and technicians now in each group; extremely broad, going research and development programs; salary above \$5000. Thorough physics background, varied tube experience, creative ability, administrative ability required. State education, experience, salary expected. Replies will be treated confidentially. Present groups informed of this notice. Box No. 428.

EXPERIENCED TEACHERS

A well-known New York City Educational Organization is contemplating expanding its present Radio Courses to include engineering and technical courses in Radio.

Personnel who can assist with the work entailed in planning and setting up such a school, that would be on a college level, would be offered positions that would probably lead to supervisory work at this school. The proper persons would be excellently remunerated.

Kindly respond in a detailed letter, outlining educational, teaching and radio background. Please enclose a photograph, if one is available. The photograph cannot be returned. Write Box No. 429.

ELECTRONIC RESEARCH ENGINEER

An Eastern manufacturer of electronic devices has an opening for a man with five to ten years experience in electronics and familiar with blind landings systems or airport traffic control.

This is essentially a liaison job, requiring contact with companies and government agencies engaged in electronic systems work, to evaluate their work in terms of its applicability to specific problems. Must be able to carry on some theoretical and experimental work in addition to laying the technical ground work for possible formation of a group to engage in advanced development.

Prefer B.S. or M.S. in Physics, E.E., Radio Engineering, or Communications. Please send sufficient information relative to age, education, experience and salary desired to warrant an early interview. Box No. 431.

(Continued on page 60A)

INSTRUMENT & TESTER SWITCHES

12-14 and 20 position.
Shorting; non-shorting
1-6 decks.

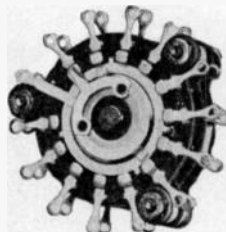

(SS-14-2)

OPERATING TEMPERATURE TESTERS

Automatically compensated,
typical range for ovens,
0-650°F.



(32-JPI)

400 CYCLE PORTABLES

Accuracy to $\pm 0.3\%$; pocket
size metal case; other ranges.



(33-FP9-400 cy.)

VACUUM-TUBE FREQUENCY METERS

Accuracy, $\pm 0.25\%$; six
specific bands, to 3600 cps.
No drift.



(39-VTF)

MOST COMPACT FREQUENCY METERS

Matches standard $2\frac{1}{2}$ " panel
instruments. 60, 120 cps.



(21-FX-60 cy.)

ELAPSED TIME—FREQUENCY METERS

$3\frac{1}{4}$ " mounting; encourages
periodic servicing and tube-
life checking.



(31-FE)

MULTIPLE RANGE PORTABLES

Standard—4 frequency groups
at 3 voltages. Many special
order variations.



(60-FP)

POTENTIOMETER-PYROMETERS

Measures and follows tem-
peratures continuously after
initial balancing.



(70-PO)

... many of these, and others from the J-B-T line, are now stocked by leading jobbers.

J-B-T INSTRUMENTS, INC.

423 CHAPEL STREET • NEW HAVEN 8, CONNECTICUT

NOW READY : 3 NEW MODELS

SHERRON *Quality* LABORATORY INSTRUMENTS

SHERRON MULTIWAVE SHAPE GENERATOR

Designed to serve as a source of several wave shapes, and will prove very useful in the testing of amplifiers and associated equipment at audio and video frequencies. A regulated power supply is incorporated, which supplies plate and screen voltages for all stages.

SPECIFICATIONS:
OUTPUTS—Sine wave, square wave, positive pulses, negative pulses, and a trigger pulse.
 Impedance (output) 250 ohms for all voltages
FREQ. RANGE—50 cycles to 50,000 cycles for all voltages continuously variable with a direct reading dial.
SQUARE WAVE—Rise time is less than .3 of a micro-second at the highest frequency and about .7 of a microsecond at the lowest frequency.
PULSES—Pulse width of both the positive and negative outputs is variable from about 1 to 75 micro-second.
POWER REQUIREMENTS
 —115 V., 60 cycle, 300 watts.



MODEL SE-317

SHERRON R.F. NULL DETECTOR

Visual indications permit this unit to be operated in noisy locations where aural indications may be useless. May be used as a signal generator to provide power at 1 MC, or as a sensitive detector at the same frequency. Both generator and detector are housed in the same cabinet.

SPECIFICATIONS:
FREQUENCY
 1 MC
GENERATOR OUTPUT
 0-5 volts
DETECTOR GAIN
 500,000 plus
HARMONIC SUPPRESSION
 2nd down more than 100 db
POWER REQUIREMENTS
 115 volts, 60 cycle, 120 watts



MODEL SE-318

SHERRON D.C. VACUUM TUBE VOLTMETER-MICROAMETER

Measures minute direct current and voltages on a new and different principle—a vast improvement over conventional methods. Converts electronically, the D.C. voltage to be measured to alternating voltages of a fixed frequency—amplifies, and then meters. An instrument of extremely high sensitivity. Can also be used as a megohmmeter with external voltage source.

SPECIFICATIONS:
VOLTMETER
RANGES—.015, .05, .15, .5, 1.5, 5, 15, 50, 150, 500, 1500 volts full scale.
INPUT IMPEDANCE—i megohm on all ranges with exception of 1500V scale, where the impedance is 3 megohms. This gives a sensitivity of 68 megohms/volt on the lowest range.
MICROAMETER
RANGES—.015, .05, .15, .5, 1.5, 5, 15, 50; 150, 500 microamps full scale.
VOLTAGE DROP—Maximum .15 volts. On lower ranges it drops to .045 volts.
OHMMETER—Resistance can be determined by measuring E & I from any external power supply. With 500 volts, 67,000 megohms, gives half scale reading on maximum range.
POWER REQUIREMENTS:
 —115 volts, 60 cycle, 175 watts.

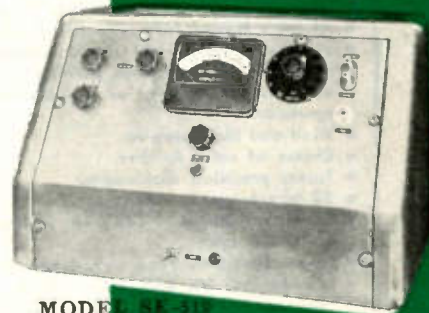

MODEL SE-319



SHERRON ELECTRONICS CO.

Division of Sherron Metallic Corporation
 1201 FLUSHING AVENUE BROOKLYN 6, NEW YORK
 WEST COAST MECHANICS INSTITUTE BLDG., 57 POST ST.,
 SALES OFFICE SAN FRANCISCO, CALIF.

Colorful BEAUTY WITH ACCENT ON PERFORMANCE

TURNER COLORTONE MICROPHONES

*New crystal and dynamic microphones
in a choice of rich, gem-like colors*

Modern as tomorrow . . . packed with new performance features that give more accurate pick-up and higher fidelity reproduction of voice and music . . . Turner Colortone Microphones bring the beauty of matching color to microphone applications. Styled of rich, long lasting, shock resisting plastic in a choice of color finishes, they are especially adapted to orchestras, night spots, home recorders, and television studios. Green, orange, yellow and ivory models are now in production for limited delivery. Ask your dealer or write for details.



TURNER COLORTONE CRYSTAL

- Highest quality Metalseal, moisture proofed crystal.
- 90° tilting head. Semi or non-directional operation.
- Wind and blast proofed.
- Barometric compensator.
- Choice of color finishes.
- Turner precision diaphragm.
- 20 ft. removable cable set.
- Response: Within ± 5 db from 50 cycles to 10,000 cycles.
- Level: -52db below one volt/dyne/sq.cm.

Crystals licensed under patents of the Brush Development Company

TURNER COLORTONE DYNAMIC

- Heavy duty dynamic cartridge.
- Alnico V Magnet for increased sensitivity.
- Mu metal transformer shield eliminates possibility of extraneous pick-up.
- 90° tilting head. Semi or non-directional operation.
- Wind and blast proofed.
- Choice of color finishes.
- Turner precision diaphragm.
- 20 ft. removable cable set.
- Response: Within ± 5 db from 50 cycles to 10,000 cycles.
- Level: -54db below one volt/dyne/sq.cm.
- Impedances: 50, 250, 500 or high.

Licensed under U. S. Patents of the American Telephone and Telegraph Company, and Western Electric Company, Incorporated.



Microphones **BY TURNER**
THE TURNER COMPANY

909 17th Street N. E.

Cedar Rapids, Iowa

TURN TO TURNER FOR THE FINEST IN ELECTRONIC EQUIPMENT



(Continued from page 58A)

ELECTRONIC PHYSICIST

A New York manufacturer of electrical and electronic devices has an interesting opening for an M.S. or Ph.D. with five to fifteen years background in teaching, research, or advanced development in physics.

Requirements are: 1. Ability to devise and develop unusual systems which are fundamentally electronic in nature, but may include also other physical operations.

2. The evaluation of system possibilities, and theoretical predictions of performance.

3. Organization and utilization of the technical assistance of skilled consultants, and the experimental verification of theoretical work. Qualified applicants will be interviewed at an early date in New York City. Please send particulars outlining age, education, experience, and salary expectation. Box No. 430.

ELECTRONIC RESEARCH ENGINEER

A large and progressive manufacturer of electronic equipment has an opening in the New York area for a man with five to ten years experience in radar, loran, or aircraft navigation aids. This experience should cover an entire system and be broad in nature. Must be able to devise and plan new and complex electronic systems as well as evaluate their possibilities and limitations. Must also supervise and carry out the design and development of the circuits required by the system.

B.S. or M.S. in Physics, Electrical Engineering, Radio Engineering or Communications preferred.

Early interviews will be arranged for qualified applicants furnishing full details regarding age, education, experience, and salary requirements. Box No. 432.

ENGINEERS

Junior and senior electrical engineers or physicists for general development engineering in television and allied radio and electronic fields. Established manufacturing concern located suburban New York City. Box #437.

PHYSICISTS AND ELECTRICAL ENGINEERS

For vacuum tube research. Apply by letter stating qualifications to Director of Research, National Union Radio Corporation, 57 State Street, Newark, New Jersey.

ELECTRONIC ENGINEERS

Development and research engineers, seniors and juniors, well versed in all phases of RF circuits. VHF or Microwave experience desirable. Only top-notch applicants with engineering degree or equivalent background for this type of work will be considered. Chicago area residents preferred. Top salary, steady position, 40-hour week, occasional field trips. Appointment by letter only. Give background experience, educational and employment history. Address letter to Research Division, Belmont Radio Corporation, 5921 W. Dickens Ave., Chicago 39, Illinois.

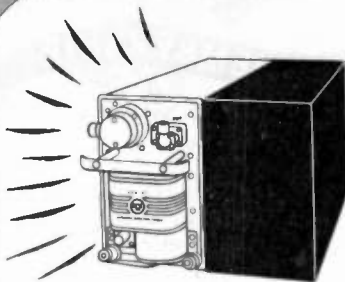

**HALF
THE SIZE...**

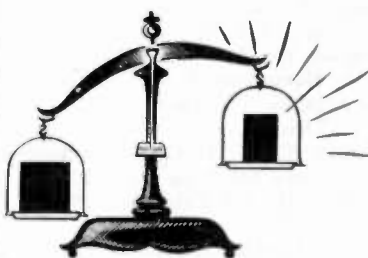

**ONE-THIRD
LESS WEIGHT**

New

RCA MODEL AVR-21
AUTOMATIC DIRECTION FINDER



Azimuth Indicator Unit. Electrical operation—no mechanical connections required. Dual pointer indicator for Dual ADF operation.



Pilot's Control Box. New drum dial for improved readability. All controls grouped for easy operation. Controls may be removed for console mounting.



Loop Antenna. Streamlined design. Continuously variable quadrantal error correction. For use in aircraft with pressurized cabins.

RCA, designer and co-producer of the first aircraft automatic direction finder, leads again with a completely new lightweight and smaller ADF.

This new RCA Model AVR-21 is one-half the size, two-thirds the weight of similar equipment used for airline service. Total weight for an average AVR-21 installation is 53 lbs. With the AVR-21 Dual ADF operation is now possible at almost the same weight as existing single ADF installations.

Among the many outstanding features of the AVR-21 are: band and function switching on one-gang switch, by a trouble-free ratchet motor drive . . . inductance tuning

of input circuit for higher gain and improved signal-to-noise ratio . . . streamlined loop antenna for pressurized cabin installations . . . coated and shielded loop reduces precipitation static interference . . . one-half ATR case designed for rack or individual mounting . . . continuously variable quadrantal error correction.

Available Soon. AVR-21 is part of a new RCA family of aircraft radio equipment engineered to meet modern requirements in size, weight and performance required for airline operation.

For complete information write: Aviation Section, Dept. 67-J, RCA, Camden, N. J.



AVIATION SECTION
RADIO CORPORATION of AMERICA
ENGINEERING PRODUCTS DEPARTMENT, CAMDEN, N. J.

In Canada: RCA VICTOR Company Limited, Montreal



These books will furnish the authoritative information necessary to keep abreast of present-day scientific progress in Communications—Electronics. Look over the important titles listed below. Then make your selection and order from the coupon today.

ELECTRON OPTICS AND THE ELECTRON MICROSCOPE

By V. K. ZWORYKIN, G. A. MORTON,
E. G. RAMBERG, J. HILLIER, A. W. VANCE
(1946) 747 Pages \$10.00

The new comprehensive guide to the electron microscope in all its phases. It is designed to aid the electron microscopist in understanding his instrument and in using it to greatest advantage, and to present the practical and theoretical knowledge which must form the basis for further progress in electron microscope design.

HIGH VACUUM TECHNIQUE

Second Edition
By J. YARWOOD
(1946) 140 Pages \$2.75

Presents the theoretical and technical data essential for an understanding of high vacuum work, including latest developments in apparatus, important individual processes, and facts regarding the properties and uses of materials encountered in all types of vacuum work.

PRINCIPLES OF INDUSTRIAL PROCESS CONTROL

By DONALD P. ECKMAN
(1945) 237 Pages \$3.75

A thorough and comprehensive treatment of the principles governing automatic control, emphasizing the basic principles necessary for industrial instrumentation. Includes present-day information on measuring characteristics of controllers, process load changes, multiple control systems.

PRINCIPLES OF RADIO

Fifth Edition
By KEITH HENNEY
(1945) 556 Pages \$3.75

Offers a working knowledge of the basic principles of radio communications. Starts with the fundamental principles of electricity, and gradually develops the subject of radio practice includes a chapter on the fundamentals of radar.

FIELDS AND WAVES IN MODERN RADIO

By SIMON RAMO and JOHN R. WHINERY
(1944) 503 Pages \$5.50

An authoritative coverage of this field, requiring only a basic knowledge of elementary calculus and physics. Gives a rigorous account of the technique of applying field and wave theory to the solution of modern radio problems.

HYPER AND ULTRA-HIGH FREQUENCY ENGINEERING

By ROBERT I. SARBACHER and WILLIAM A. EDSON
(1943) 644 Pages \$6.00

A practical treatment of an important new branch of communications engineering, requiring no special advanced knowledge. Of value to the beginner, as well as to those having some familiarity with the subject.

JOHN WILEY & SONS, Inc., 440 Fourth Ave., New York 16, N.Y.

ON APPROVAL COUPON

JOHN WILEY & SONS, Inc.
440 Fourth Ave., New York 16, N.Y.

Please send me on ten days' approval the books I have checked in this advertisement (or I am attaching to this coupon a separate list of the books desired). At the end of that time, if I decide to keep the books, I will remit indicated price plus postage; otherwise I will return the books postpaid.

Name
Address
City and State
Employed by IRE-10-46

FUNDAMENTALS OF ELECTRIC WAVES

By HUGH H. SKILLING
(1942) 186 Pages \$3.00

Discusses the principles of wave action as applied to engineering practice, with particular emphasis on the basic ideas of Maxwell's equations and repeated use in simple examples; also on physical concepts and mathematical rigor.

APPLIED ELECTRONICS

By the Electrical Engineering Staff, Massachusetts Institute of Technology
(1943) 772 Pages \$6.50

Provides a thorough understanding of the characteristics, ratings, and applicability of electronic devices. Gives a working knowledge of the physical phenomena involved in electronic conduction, plus its applications common to various branches of engineering.

PRINCIPLES OF ELECTRONICS

By ROYCE G. KLOEFFLER
(1942) 175 Pages \$2.75

Tells clearly and simply the story of electron theory and the operation of the electron tube. Beginning with the discovery of the electron and the forces of attraction and repulsion of charged particles, the entire action taking place in electronic devices is carefully explained.

HIGH FREQUENCY THERMIONIC TUBES

By A. F. HARVEY
(1943) 244 Pages \$3.50

Gives the details of these important tubes and describes the experimental work that has been done with them. Presents a thoroughly comprehensive account of the properties of thermionic tubes at very high frequencies and their relation to those of the associated electric circuits.

TIME BASES (Scanning Generators)

By O. S. PUCKLE
(1943) 204 Pages \$3.00

Covers the subject from both the design and the development points of view; assembles more time bases circuits than have heretofore been available in one volume.



(Continued from page 42A)

- Nelson, J. W., Jr., 1221 Glen Cove Rd., S., Syracuse 6, N. Y.
Oster, F. J., 76 Atlantic Ave., Matawan, N. J.
Pantry, W. H., 155 Tyrrel Ave., Toronto, Ont., Canada
Patterson, J. C., 1934 W. Olmes Dr., San Antonio 1, Texas
Perdiue, H. L., General Electric Company, Electronics Department, 570 Lexington Ave., New York 22, N. Y.
Pinnow, R. L., 2244 N. 67 St., Wauwatosa 13, Wis.
Pitt, C. J., 3723 Udal, San Diego 7, Calif.
Pointer, R. L., 417 Penn St., Camden, N. J.
Prager, M., 1288 St. Johns Place, Brooklyn 13, N. Y.
Preston, W. H., 7 Tyler Rd., Lakeview, Hempstead, L. I., N. Y.
Price, J. H., 716 Third St., Portsmouth, Ohio
Ranires, E. F., 37 Gillette, Candlestick Cove, San Francisco, Calif.
Read, J. H., 375 Third Ave., Watervliet, N. Y.
Risk, J. E., 4273 Athlone Ave., St. Louis 15, Mo.
Rives, J. B., 1721 Kentucky Ave., San Antonio 1, Texas
Roller, W. P., 176 E. 85 St., New York 28, N. Y.
Rosenkranz, R. J., 1210 W. Eighth St., Los Angeles 14, Calif.
Rutherford, E. D., 306 Sackville St., St. James, Man., Canada
Schulman, J. R., 250 W. 104 St., New York 25, N. Y.
Skobel, F., 43-23-42 St., Sunnyside 4, N. Y.
Spainhour, E. S., Jr., Army Ground Fortes, Board 1, Fort Bragg, N. C.
Sperry, L., Sr., 808 E. Clarke St., Milwaukee 12, Wis.
Steinkraus, A. W., Jr., 16 Benmore Ave., Franklin Sq., L. I., N. Y.
Stone, C. A., 3415 W. Eighth St., Los Angeles 5, Calif.
Valdes, L. B., 501 Bonnabel Blvd., New Orleans 20, La.
Kagali, S. T., c/o T. P. Kagali, Gokak, Belgaum, Bombay, South India
Wallace, E. C., 24 W. Sixth St., Locust Valley, N. Y.
Waring, J. A., 1250 1/2 Westgate Ave., Los Angeles 25, Calif.
Watson, E. E., 1429-56 Ave., Oakland 1, Calif.
Watson, E. S., 45 Walworth Ave., Scarsdale, N. Y.
Wendelken, G. J., 5 Pinehurst Ave., New York, N. Y.
Wiegert, P. G., Jr., 545 Aberdeen Ave., Dayton 9, Ohio
Wilder, W. W., Jr., 29 Brent St., Dorchester 24, Mass.
Williams, H. S., 28 Rectory Rd., Weston, Ont., Canada
Zak, S., 76 Maple Ave., Wallington, N. J.
Zauderer, J., M. W. Kellogg Company, Danforth St., Jersey City 3, N. J.,

USE STANDARD PARTS—SAVE TIME AND MONEY



TRANSITION

The K-TRAN has been acclaimed as an outstanding development in I. F. Transformer design.

The K-TRAN is now being used by many manufacturers in newly designed receivers. The small size and high performance of the K-TRAN makes possible the use of a few standardized K-TRANS throughout a complete line of chassis, simplifying purchasing, stocking, and design problems tremendously.

Our production of old-style I. F. Transformers for existing designs will continue.

AUTOMATIC MICA TRIMMER CONDENSERS are still the standard of the industry.



MASS PRODUCTION COILS & MICA TRIMMER CONDENSERS

900 PASSAIC AVE.

EAST NEWARK, N. J.

One of Our Most Important Announcements in 19 Years of Proven Leadership in Training Professional Radio Men!

Here it is! Your First Practical Step Toward a Good-Paying Career in TELEVISION



CREI Introduces a Streamlined Home Study Course in Practical

Television

ENGINEERING

AVAILABLE NOW—FOR THE FIRST TIME! Here's Your Chance to "Get in on the Ground Floor" of TELEVISION Opportunities.

Don't say, "I never had a chance." Prepare NOW for the good paying jobs awaiting trained television engineers and technicians. Be in a position to command a "key" job in the growing TELEVISION Industry by preparing now with the type of thorough, practical TELEVISION Engineering training that the industry requires. The new CREI TELEVISION Engineering course is (1) A complete well-coordinated course of study that covers the entire field of practical TELEVISION Engineering (2) Presented in CREI's professional and proven home study form (3) Prepared by CREI's experienced staff, based on actual experience in our own TELEVISION Studios and Laboratories, plus years of close contact with leaders in television development. Here's your opportunity to be prepared for television well ahead of competition, if you start NOW!

CAPITOL RADIO ENGINEERING INSTITUTE

Dept. PR-10, 16th and Park Road N.W., Washington 10, D.C.



Just Off the Press
MAIL COUPON
FOR COMPLETE
FREE DETAILS
And Outline
of Course

Capitol Radio Engineering Institute
16th and Park Road N.W., Washington 10, D.C.
Gentlemen: Please send me complete details describing the new CREI home study course in Practical Television Engineering. I am attaching a brief résumé of my experience, education and present position.

Name
Street
City..... Zone.... State.....
 I am entitled to training under the G. I. Bill.

Member of National Home Study Council—National Council of Technical Schools—and Television Broadcasters Association



Patterson
Phosphors
for Contrast...
Brilliance...Detail
in Television
Images

PATTERSON PHOSPHORS are designed for maximum luminescence with minimum input energy. Quality phosphors for television, radar, oscilloscopes and other electronic instruments are available from Patterson Screen Division of E. I. du Pont de Nemours & Co. (Inc.), Towanda, Pa. Manufacturers, experimental laboratories and schools are invited to write us outlining their requirements.

PATTERSON PHOSPHORS ARE AVAILABLE IN A WIDE RANGE OF

1. Colors
2. Grain Size
3. Brilliance
4. Types of Excitation
5. Afterglow
6. Special Blends

PATTERSON
LUMINESCENT CHEMICALS

BETTER THINGS FOR BETTER LIVING . . . THROUGH CHEMISTRY



Don't Overlook C.T.C.'s New
I-F Slug Tuned INDUCTOR

This compact, easy-to-mount LS-3 coil is available in four windings (see below). Total possible frequency span is from 1/2 mc. to better than 150 mc. You'll find them ideal for many applications.

The chart gives the individual characteristics:

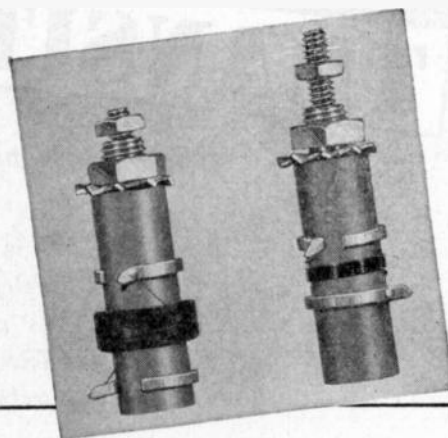

	Q	DC RESISTANCE	INDUCTANCE	VARIATION OF INDUCTANCE	TYPE & SIZE OF WIRE	NO. OF TURNS	TYPE OF WINDING
1 meg. unit	56	18.14 ohm @23°C.	420 microhenries ± 5%	325 to 750 microhenries	#38 SCE	198	Multiple
10 meg. unit	44	1.90 ohm @19.5°C.	8.4 microhenries ± 5%	4.75 to 14.25 microhenries	#38 SCE	24.5	Multiple
30 meg. unit	46	.126 ohm @20°C.	0.7 microhenries ± 5%	.350 to 1.0 microhenries	#28 E	7	Single layer
60 meg. unit	46-50	.126 ohm @20°C.	.061 .102 microhenries ± 5%	.065 to .095 microhenries	#28 E	2	Single layer

If these standard LS-3 don't meet your requirements, we'll be pleased to submit quotations on coils built to your specifications. Write for C.T.C. Catalog No. 100.

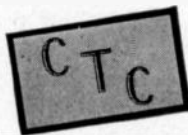

CAMBRIDGE THERMIONIC CORPORATION
456 Concord Avenue Cambridge 38, Mass.

PROFESSIONAL CARDS

W. J. BROWN

Electronic & Radio Engineering Consultant
Electronic Industrial Applications, Commercial and Broadcasting Transmitter and Receiver Design, Test Equipment, etc.

23 years experience in electronic development

P.O. Box 5106, Cleveland, Ohio
Telephone, Superior 1241
Office, 912 Park Building

EDWARD J. CONTENT

Acoustical Consultant

and

Audio Systems Engineering, FM Standard Broadcast and Television Studio Design.

Roxbury Road Stamford 3-7459
Stamford, Conn.

STANLEY D. EILENBERGER

Consulting Engineer

INDUSTRIAL ELECTRONICS

Design—Development—Models

Complete Laboratory and Shop Facilities
6309-13—27th Ave.

Kenosha, Wis. Telephone 2-4213

F. T. Fisher's Sons Limited

Consulting Engineers

Broadcast Transmitters, Antenna Systems, Studio Equipment, Mobile and Fixed Communication Systems.

6202 Somerled Ave., Montreal 29, Quebec

SAMUEL GUBIN

Consulting Engineer

Transmitting Equipment, Industrial Electronics

17 years of design experience
affiliated with

SPECTRUM ENGINEERS, INC.

Philadelphia 4, Pa. EV 6-7950

DAVID C. KALBFELL, Ph.D.

Engineer — Physicist

Complete laboratory facilities
Industrial instrumentation and control
Broadcast engineering and measurements
941 Rosecrans St. Bayview 7303
San Diego 6, California

RICHARD C. KLEINBERGER

Licensed Professional Engineer

**ELECTRONIC HEATING
APPLICATIONS**

20 Cushman Road,
White Plains, N.Y.

News—New Products

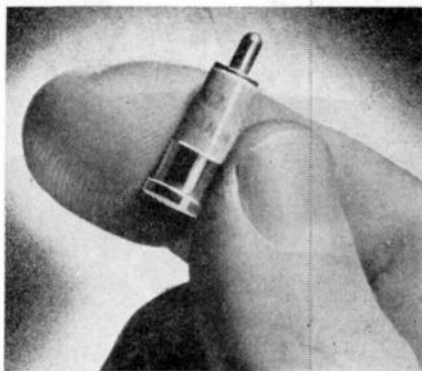

Silicon Crystal Converters

Compact silicon crystal converters for use as first detectors in HF superheterodyne receivers have been announced by the Electronics Division, Sylvania Electric Products Inc., Emporium, Pa. The crystals which are permanently preset in a small cartridge measuring approximately $\frac{3}{8}$ " long and $\frac{1}{4}$ " in diameter are available in three types designed for frequencies up to 10,000 mc.

The efficiency of these crystals in the microwave region suggests several interesting possibilities, such as, rectifiers in wave meters, monitors and field strength meters as well as detectors in portable shf receivers.

FRANK MASSA

Electro-Acoustic Consultant

DEVELOPMENT PRODUCTION DESIGN
PATENT ADVISOR

ELECTRO-ACOUSTIC & ELECTRO-MECHANICAL
VIBRATING SYSTEMS

SUPERSONIC GENERATORS & RECEIVERS

3393 Dellwood Rd., Cleveland Heights 18, Ohio

ALBERT PREISMAN

Consulting Engineer

Television, Pulse Techniques, Video Amplifiers, Phasing Networks, Industrial Applications

Affiliated with

MANAGEMENT TRAINING ASSOCIATES
3308-14th St., N.W. Washington 10, D.C.

HAROLD A. WHEELER

Consulting Radio Physicist

Radio - Frequency Measurements

Special Antenna Problems

Wideband Amplifiers and Filters

259-09 Northern Boulevard

Great Neck, New York Imperial 645

Paul D. Zottu

Consulting Engineer

Industrial Electronics

High Frequency Dielectric and Induction Heating Applications, Equipment Selection, Equipment and Component Design, Development, Models.

272 Centre St., Newton, Mass. BIG-9240

Here Is the Book CIRCUIT DESIGNERS Have Been Waiting For!

At last—a thoroughly practical book, telling in simple words and diagrams how to understand and use capacitors. Until this time, much of the essential knowledge in this field was widely scattered in various books, technical journals, and manufacturers' catalogs. Now, all important information on capacitors has been brought together in this brand-new, highly useful book.

CAPACITORS

Their Use In Electronic Circuits

By M. BROTHERTON, Ph.D.

Bell Telephone Laboratories, Inc.

This book is based upon seventeen years' experience in the largest industrial electronic laboratory on earth—the Bell Telephone Laboratories. It presents in streamlined form all the important existing data on capacitors—types, dimensions, characteristics, and how to choose and use capacitors for electronic circuits.

It tells the circuit designer the important elements he must understand and consider in transforming capacitance from a circuit symbol into a practical item of apparatus, capable of meeting today's operation requirements. The book is well organized, numerous diagrams are included, and all the data is arranged and summarized in convenient tables and charts for fingertip reference. It tells you in detail:

- How to make best use of capacitors in electronic circuits
- A perspective view of available capacitor types
- Their relative performance, size and cost
- What types to use, and why
- A concrete working picture of what happens between the terminals of a capacitor and how it affects your selection of capacitors
- How a capacitor behaves as a circuit element
- How materials determine and limit performance
- Why capacitors fail
- How to avoid capacitor failures
- How to attack your capacitor problems
- Twenty questions to the right capacitor

**FOR EXAMINATION COPY
MAIL THIS COUPON**

D. VAN NOSTRAND COMPANY, INC.
250 Fourth Avenue
New York 3, New York

Please send me a copy of CAPACITORS for examination. Within 10 days I will either return the book or send you \$3.00 plus a few cents postage.

Name

Address

City..... State.....

I.R.E. Oct. 1946

News—New Products

(Continued from page 65A)

Planar Triodes

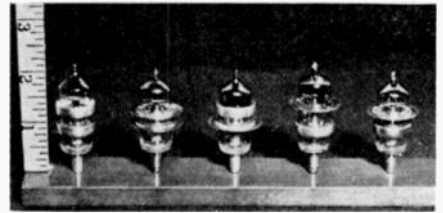

Five types of disc-seal triodes, all having the same internal construction but differing externally. Left to right: folded anode disc, flat grid disc, inverted discs, widely-spaced discs, and type 2C37.

During the war requests were made by the Armed Forces for the development of a triode capable of operating at frequencies up to or beyond the 3000 megacycle region. The tube was also required to be capable of large-scale production and to operate at a minimum of heater power so that it could be used in portable equipment. The photo above shows five types of the planar-grid, disc-seal triodes developed by the Sylvania Electric Products Inc., Kew Gardens, L. I., N. Y., to fulfill those conditions. They are now available for general use.

Three design features of these tubes are of major importance to simplified and efficient operation at ultra-high frequencies: (1) the cathode-pencil design eliminates mechanical and electrical lumps from the heater-cathode line, (2) the stretched-grid method of making planar grids provides a means for obtaining uniformity and stability of performance characteristics, and (3) the disc-seal type of construction satisfied the requirement for low lead inductance, because the leads become zero in length. Part of the radio-frequency circuit then appears inside the tube envelope.

These tube types are provided with more simplified tuning features than are characteristic of other tubes which generate UHF, and are adaptable to a wide range of uses in the industrial-electronic, communication and navigation fields.

The anode disc has a flat external surface to act as a reference plane and stop when the tube is inserted into the tuner and, in addition, the large area of contact allows heat to be conducted away readily. The grid disc has a folded external surface with a rolled lower edge for insertion into a cylinder which forms one conductor of the concentric transmission line. All external surfaces are silver plated for low radio-frequency resistance.

According to the manufacturer, one of the advantages of this type of tube construction is the flexibility in disc arrangements to fit various types of circuits. Additional technical information and tube operating characteristics may be obtained by writing to the manufacturer.

(Continued on page 68A)



NOW AVAILABLE for immediate delivery

A ruggedly constructed direct reading laboratory instrument specially designed to measure Q, inductance, and capacitance values quickly and accurately. Invaluable in selecting proper low loss components for high frequency applications.

SPECIFICATIONS:—FREQUENCY RANGE: 30-200 mc, accuracy 1%

RANGE OF Q MEASUREMENT: 80 to 1200

Q CAPACITOR RANGE: 11-60 mmf; accuracy $\pm 1\%$ or 0.5 mmf, whichever is greater

WRITE FOR
CATALOG "C"

BOONTON RADIO

BOONTON · N · J · U · S · A ·

Corporation

FOR RADIO AND ELECTRONICS
PARTS • SETS • EQUIPMENT
ask NEWARK they'll
have it!

anywhere, you'll save time by phoning or wiring Newark Electric. Tremendous, up-to-the-minute stocks are maintained in all three stores.

IF YOUR NEEDS in radio or electronics parts, sets or equipment are available

★ Literature and full information on ANY manufacturer's products will be sent promptly on request. Wire or phone for quick action.

★ Our big bargain counters are loaded with new parts and unusual special equipment. Inquiring minds enjoy these displays.

COMPETENT TECHNICAL MEN handle your inquiries intelligently and promptly and can quote prices and delivery dates on specific merchandise. Orders shipped same day. When writing address Dept. NI.

NEW YORK
302-50 W. 35th St.
New York 18, N. Y.

NEWARK CHICAGO
323 W. Madison St.
Chicago 4, Ill.

ELECTRIC COMPANY, INC.

New York City Branches: 115-17 W. 45th St. & 212 Fulton St.

NEWARK ELECTRIC COMPANY, INC. Dept. NI

Please send informative literature on the following:

NAME: _____

ADDRESS: _____

STATE: _____

CITY: _____

P.A. Depts. in
all stores. Set
& Appl. Depts.
in N. Y. C.

BUILT TO CARDWELL STANDARDS

The Cardwell Fifty-Four

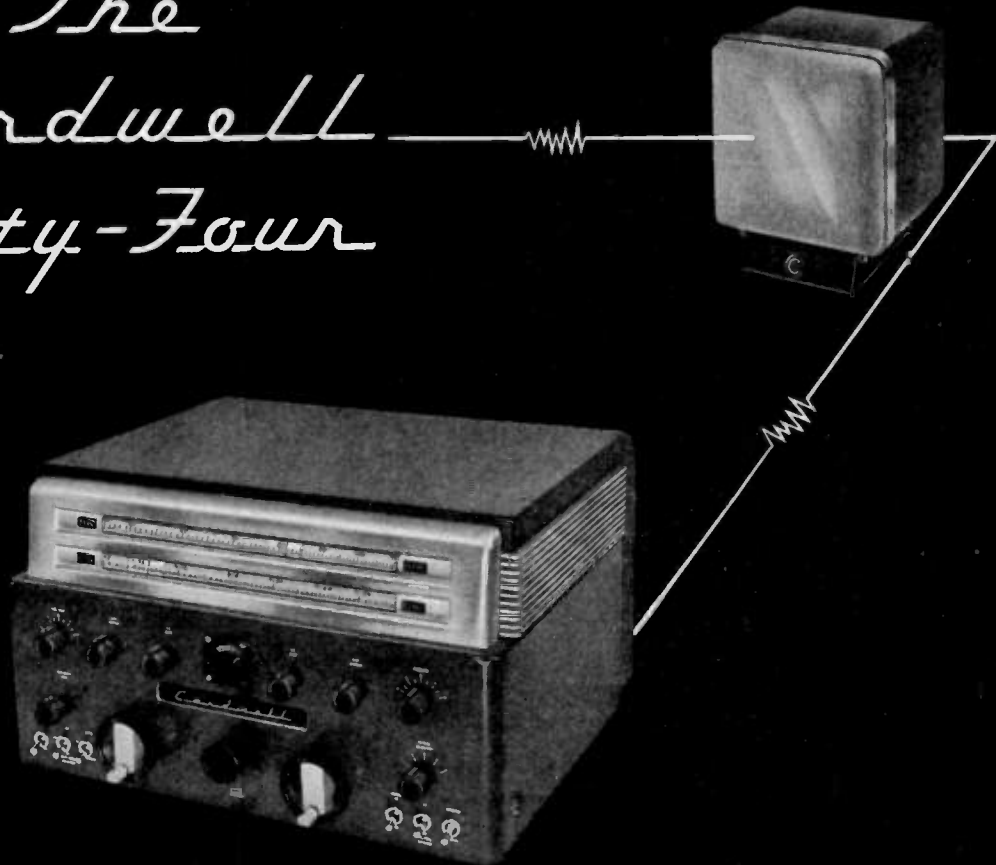

truly a postwar communications receiver

It is gratifying to note how many orders followed the recent announcement of the Cardwell Fifty-Four . . . gratifying, because these orders were placed regardless of price . . . indicating unmistakable recognition of Cardwell quality. This completely new communications receiver will be ready for delivery this fall. Check the following outstanding features:

- 1. Full Turret Type R. F. Section.**
(Sturdy cast aluminum construction assures absolute mechanical and electrical stability.)
- 2. Wide Frequency Coverage.**
(Range .54 to 54.0 mcs. Basic turret covers .54 through 40 mcs. Extra coil strip supplied with set extends range to 54 mcs. and can be installed in ten minutes using only a screwdriver.)
- 3. Secondary Frequency Standard.**
(Unique type crystal calibrator provides check points of either 100 or 1000 kcs. and can also be used to check sensitivity or realign set.)
- 4. "Custom Built" Gang Condensers by Cardwell.**
(STANDARD OF COMPARISON.)
- 5. Variable Selectivity Crystal Filter.**
(Combined with variable selectivity I. F. amplifier circuit allows choice of 5 degrees of selectivity—three with crystal, two without.)
- 6. Exceptionally Good Signal to Noise Ratio.**
(Two grounded grid R. F. amplifier stages assure actual receiver noise less than 6 db above thermal!)

- 7. New Type Noise Limiter.**
(A really effective aid in reducing local ignition interference and similar noises.)
- 8. Electrical Band Spread.**
(Band spread scales, excluding standard broadcast, calibrated directly. Arbitrary scale 0-100 also visible on each setting.)
- 9. Large Direct Reading Precision Dials.**
(Excellent visibility—pointer travel better than 10½ inches on every range—velvet smooth dial action that is a pleasure to use.)
- 10. Temperature Compensated Oscillator.**
(Stability is better than 25 parts per million per degree centigrade. V. R. tube maintains maximum frequency stability against line voltage fluctuations.)
- 11. Mechanical Coupling Provisions.**
(Control shafts are brought out at rear for linkage to other units such as a transmitter exciter.)
- 12. All Miniature Tubes.**
(18, including rectifiers.)

- 13. Threshold Squelch.**
(Operating level controllable from 0 to 10,000 micro volts.)
- 14. Panoramic Adaptor Jack.**
(Provision is made for connecting a panoramic adaptor unit.)
- 15. All Aluminum Unit Construction.**
(Receiver and power supply combined in one sturdy lightweight unit 18¼" wide x 16" deep x 11" high. Weight approximately 70 lbs.)
- 16. Heavy Duty Speaker.**
(Compact tilting unit 9¼" wide x 8¼" deep x 11" high for wall or table mounting. Angle of sound projection adjustable to individual preference.)
- 17. Eight Watts Audia Output.**
(Push-pull class AB—with four output impedances. Connections are provided for feeding the audio section from an external source such as phono pick up or microphone.)
- 18. Rack Mounting Model.**
(Will be available.)

WRITE FOR COMPLETE TECHNICAL BULLETIN

THE ALLEN D. CARDWELL MANUFACTURING CORP.

MAIN OFFICE
& FACTORY:



97 WHITING STREET
PLAINVILLE, CONN.

MICRO-MIKER



A new type of instrument
for the measurement
of small capacities

1. Measures capacities from 1 to 230 Micro-Micro-Farads by direct substitution.
2. This capacity is measured at the end of a shielded cable, thereby eliminating connection errors.
3. Wiring capacity in an amplifier may be measured without disconnecting the load resistor. Condensers as small as 1 MMF may be measured when shunted by a 1500 ohm resistor.

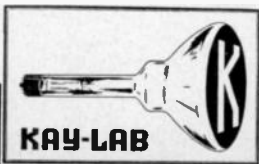

Write for Bulletin 4-D

KALBFELL LABORATORIES
941 ROSECRANS ST. • SAN DIEGO 6, CALIF.
Manufacturers Representatives are invited to reply.

CHECK THE PATENTED
FEATURES AND GREATER
ECONOMY OF DRAKE
LIGHT ASSEMBLIES

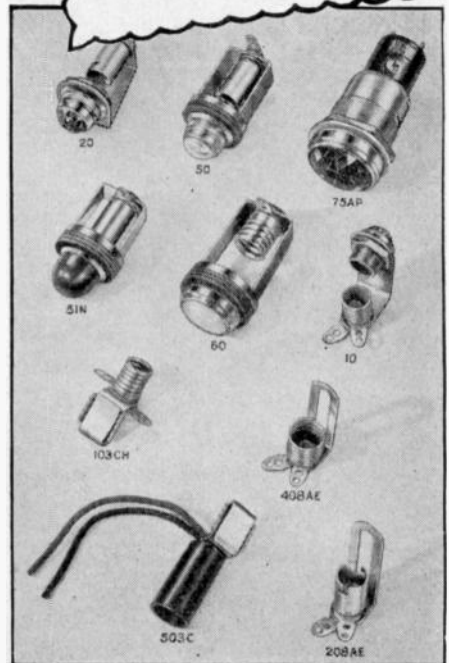

You'll lower production costs yet increase quality and efficiency with DRAKE Socket and Jewel Pilot Light Assemblies. Get the benefit of our patented features . . . of high speed precision methods and machinery developed thru 15 years of specialization. Every conceivable type offered in standard and special designs. Refer to the newest DRAKE catalog for complete information. Do you have a copy?



IF IT'S WORTH MAKING
IT'S WORTH PROTECTING!

There is plenty of power behind the usual electric connection to burn out any electrical instrument or equipment not properly protected—if something goes wrong. Such burn-outs usually mean costly delays and expensive replacements or repairs—frequently create a bad impression. Littelfuse precision-built fuses are so inexpensive that every manufacturer can effectively protect his product and reputation at a relatively small cost. Complete range of types and sizes for instruments, small motors, radio and electronic circuits, automobile, aircraft and marine instruments, and all types of electrical equipment. Write, phone or wire for prices.

LITTELFUSE Plus FEATURES!



Vibration-Proof. Element twisted 90 degrees to effectively brace against severe vibration.



Non-Crystallizing. Spring-like formation prevents crystallization and cracking at fusion point.



Locked Cap Assembly. Caps always remain firmly in position for identification and replacement.

LITTELFUSE



Incorporated

4757 N. RAVENSWOOD AVE.

CHICAGO 40, U.S.A.

NOTE-T-LITE • SWITCH-LITE • IGNITION FRITZ • NEON INDICATORS • SWITCHES • CIRCUIT BREAKERS • FUSES, MOUNTINGS AND ACCESSORIES

DRAKE



SOCKET AND JEWEL LIGHT ASSEMBLIES

DRAKE MANUFACTURING CO.

1713 W. HUBBARD ST., CHICAGO 22, ILL.

...a metal for inserts that won't work loose from ceramic insulation as temperatures fluctuate.

Mycalex Corp.

...a metal to hold other parts in place under the searing heat of a high-voltage discharge.

General Electric Co.

...a metal that won't develop high surface resistance because of corrosion.

Vendo Corp.

...a metal whose electrical resistance varies measurably with temperature changes.

The Simmons Co.

...a metal for an armature that vibrates continuously 94,000,000 times a year.

Union Switch and Signal Co.

...a metal that can stand spark erosion without pitting or burning.

Scintilla Magneto Co.

...a metal that will remain non-magnetic during spot-welding.

General Thermostat Corp.

THESE ARE TYPICAL METAL SELECTION PROBLEMS THAT WERE SOLVED BY USE OF
**MONEL
NICKEL
INCONEL**

	MONEL	"R" MONEL	"K" MONEL	"KR" MONEL	"S" MONEL	NICKEL	"Z" NICKEL	INCONEL
CORROSION RESISTANCE	HIGH	HIGH	HIGH	HIGH	HIGH	HIGH	HIGH	HIGH
STRENGTH	GOOD	GOOD	HIGH	HIGH	GOOD	GOOD	HIGH	GOOD
TOUGHNESS	GOOD	GOOD	HIGH	GOOD	GOOD	HIGH	HIGH	HIGH
HARDNESS	GOOD	GOOD	GOOD	GOOD	HIGH	FAIR	HIGH	GOOD
MACHINABILITY	GOOD	HIGH	GOOD	HIGH	GOOD	GOOD	GOOD	GOOD
NON-GALLING	NO	NO	NO	NO	HIGH	NO	NO	NO
SPRING PROPERTIES	GOOD	NO	HIGH	NO	NO	GOOD	HIGH	HIGH
ELEC. CONDUCTIVITY	POOR	POOR	POOR	POOR	POOR	GOOD	GOOD	POOR
HEAT RESISTANCE	GOOD	GOOD	GOOD	GOOD	HIGH	GOOD	GOOD	HIGH
HEAT TREATABLE	NO	NO	YES	YES	YES	NO	YES	NO
NON MAGNETIC	NO	NO	YES	YES	YES	NO	NO	YES

Think of the INCO Nickel Alloys first when you need a metal with a hard-to-find combination of properties.

These high-Nickel alloys are Strong... Tough... Hard... Rustless. They resist High Temperatures... Corrosion... Wear... Fatigue. Their use is insurance for long, trouble-free service.

MORE INFORMATION! Tell us the alloy that interests you, and we'll mail more information. Or, send for "List B-100" which lists over 100 bulletins explaining the properties and applications of the INCO Nickel Alloys.

THE INTERNATIONAL NICKEL COMPANY, INC.
67 Wall Street, New York 5, N. Y.

NICKEL  ALLOYS

MONEL* • "K" MONEL* • "R" MONEL* • "KR" MONEL*
"S" MONEL* • INCONEL* • NICKEL • "L" NICKEL* • "Z" NICKEL*
*Reg. U. S. Pat. Off.

Laboratory Standards

FM

MODEL 78

SIGNAL GENERATOR

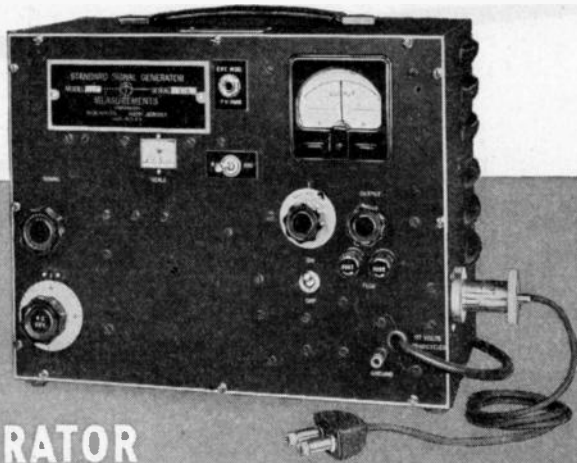

SPECIFICATIONS:

- CARRIER FREQUENCY RANGE:** 86 to 108 megacycles. Individually calibrated dial.
- OUTPUT SYSTEM:** 1 to 100,000 microvolts with negligible carrier leakage.
- OUTPUT IMPEDANCE:** Constant at 17 ohms.
- MODULATION:** 400 cycle internal audio oscillator. Deviation directly calibrated in two ranges: 0 to 30 kc. and 0 to 300 kc. Can be modulated from external audio source. Audio fidelity is flat within two db from d.c. to 15,000 cycles. Distortion is less than 1% at 75 kc. deviation.

PROMPT DELIVERY

MANUFACTURERS OF
 Standard Signal Generators
 Pulse Generators
 FM Signal Generators
 Square Wave Generators
 Vacuum Tube Voltmeters
 UHF Radio Noise & Field Strength Meters
 Capacity Bridges
 Megohm Meters
 Phase Sequence Indicators
 Television and FM Test Equipment

MEASUREMENTS CORPORATION
 BOONTON NEW JERSEY

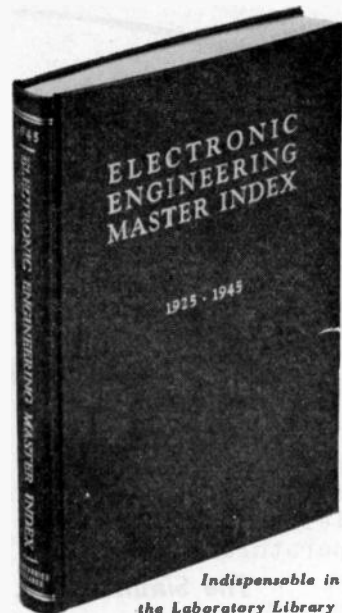

Indispensable in the Laboratory Library

ELECTRONIC ENGINEERING MASTER INDEX

A subject index of 15,000 titles of electronic engineering articles from 1925 to 1945 selected from 65 periodicals. Authoritative, exhaustive, time-saving.

A \$500 Reference Library in one volume. 320 pages. Price. **\$17.50**

Descriptive circular on request

ELECTRONICS RESEARCH PUBLISHING COMPANY
 2 West 48 St., New York 19, N.Y.

News—New Products

(Continued from page 66A)

New Enterprises

- Alni Corporation, 10 East 52nd St., New York 22, N. Y., will manufacture miniature horsepower motors and electro-mechanical devices.
- R. C. Powell & Co. Inc., 730 Fifth Avenue, New York, N. Y. will handle the national distribution of a number of new electronic devices.
- Taco West Corporation, 2620 South Park Avenue, Chicago, Ill., will manufacture automatic electronic control devices

in the fields of combustion control, gas analysis, pyrometry, process control and allied apparatus.

- Remler Company Ltd., 2101 Bryant St., San Francisco 10, Calif., will coordinate activities in radio, television, plastics and allied fields.

Plant Expansions

- At Greenburgh, Westchester County, N. Y., by Indiana Steel Products Company, which recently purchased the Cinaudagraph Corporation of Stamford, for the production of special products in the permanent magnet field.

- At Bristol, Penna., by Barker & Williamson, totaling 93,000 square feet for development work relating to air inductors, variable capacitors and instruments.

Selenium Rectifier

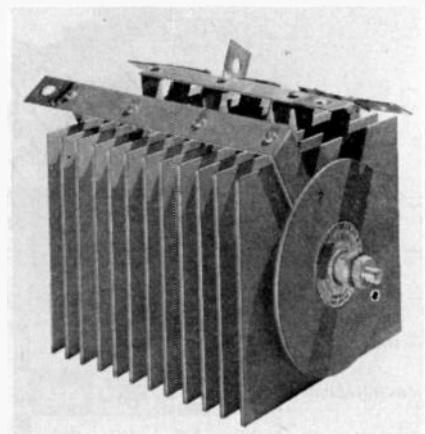

Developed specifically for high current capacity the new 5" x 5 1/2" selenium rectifier plates built on aluminum, are now being manufactured by the Seletron Division, Radio Receptor Company, Inc., 251 West 19 Street, New York 11, N.Y.

(Continued on page 72A)



Get your **FREE** copy

Thousands of items illustrated, described and priced in our new 1947 catalog. Hams, Servicemen, Experimenters, Engineers, Schools, Institutions, Govt. Depts., Industrial Organizations, Laboratories, etc. will find this book a great help in their search for "hard-to-find" equipment.

RADIONIC EQUIPMENT CO.
 170 Nassau St. Dept. 6510, New York 7, N. Y.
 Please send me a FREE copy of your catalog.

Name

Address

City..... State.....

RADIONIC EQUIPMENT CO.
 170 Nassau St., New York 7, N. Y.

DU MONT'S 5RP Type 5RP

Cathode-Ray Tube

permits visual observation
or recording of high-fre-
quency signals possessing
writing rates in excess of
2500 km/sec.

OPERATES UP TO 25,000 ACCELERATING POTENTIAL

By ingeniously subdividing the intensifier into multibands, a total accelerating potential of 25,000 volts may be used without serious loss of deflection sensitivity and practically no distortion with Eb3/EB2 ratios as high as 10. Thus, adequate brilliance is provided for signals which ordinarily could not be seen or recorded on a conventional cathode-ray tube. A low-capacitance deflection system, with leads brought out through the neck of the tube, makes the 5RP particularly useful for high-frequency applications.

Write for descriptive literature.

ALLEN B. DU MONT LABORATORIES, INC.

DUMONT

Precision Electronics & Television

ALLEN B. DUMONT LABORATORIES, INC., PASSAIC, NEW JERSEY • CABLE ADDRESS: ALBEEDU, PASSAIC, N. J., U. S. A.

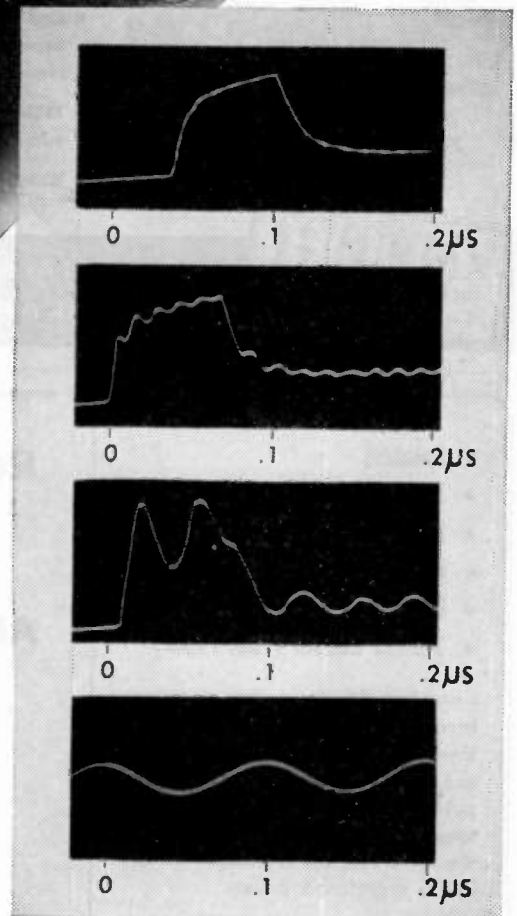

Typical high-speed single-transient recordings with 5RP at 18,000 volts accelerating potential. (Courtesy of Prof. M. Newman, Institute of Technology, University of Minnesota.)

ATTENUATORS by TECH LABS



MIDGET
TYPE
600

"Midget" model is especially designed for crowded apparatus or portable equipment.



STANDARD
TYPE
700

- Solid silver contacts and stainless silver alloy wiper arms.
- Rotor hub pinned to shaft prevents unauthorized tampering and keeps wiper arms in perfect adjustment.
- Can be furnished in any practical impedance and db. loss per step upon request.
- TECH LABS can furnish a unit for every purpose.
- Write for bulletin No. 431.



Manufacturers of Precision Electrical Resistance Instruments
337 CENTRAL AVE. • JERSEY CITY 7, N. J.

News—New Products

(Continued from page 70A)

Sub-Miniature Tube Socket

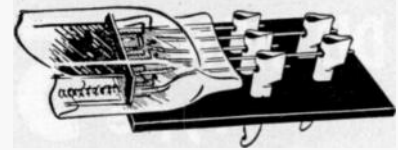

By assembling the required number of "flea" contacts in square holes pierced in a chassis of insulating material, Instrument Specialties Company, Inc., Little Falls, New Jersey, has produced an integral socket unit for use with sub-miniature tubes having co-planar leads with a spacing of .050 inches or more.

Recent Catalogs

••• On ship-to-shore radiotelephone, by Radiomarine Corporation of America, 75 Varick St., New York 13, N. Y. Catalog No. ET-8027.

••• On "How Plastics Solved War Problems," by Chemical Department, General Electric Co., Pittsfield, Mass.

••• On FM transmission lines, by the Andrew Co., 363 East 75 St., Chicago 19, Ill. Catalog No. 42.

••• On electronic heating and sealing and selenium rectifiers, by Radio Receptor Co., Inc., 251 West 19 St., New York 11, N. Y. Catalog No's. 7005 and Seletron.

••• On tri-core solder, by Alpha Metals, Inc., 363 Hudson Avenue, Brooklyn 1, N. Y. Bulletin T-200.

••• On etched name plates, dials, etc., by Premier Metal Etching Co., 21-09 44th Avenue, Long Island City 1, N. Y.

••• On transmitting tubes, by Tube Division, General Electric Co., Schenectady, N. Y. This 600-page technical manual sells for Two Dollars.

••• On low inertia "Servo-Motors," by Transcoil Corporation, 114 Worth St., New York 13, N. Y.

••• On phenolic grommets, by Creative Plastics Corp., 963 Kent Ave., Brooklyn 5, N. Y.

••• On all types of microphones, by Electro-Voice, Inc., 1239 South Bend Ave., South Bend 24, Indiana.

••• On general radio parts, by Concord Radio Corp., 901 West Jackson Blvd., Chicago 7, Ill.

••• On FM square loop antennas and 5 and 50-KW AM transmitters, by Federal Telephone and Radio Corp., Newark 1, N. J. Bulletin No's. F-242 and F-248.

- Speakers
- Amplifiers
- Recording Machines
- Public Address Systems
- Microphones (Guitar)
- Volume Control (Foot Pedal)

Complete facilities for manufacturing all types of Radio, Sound, Recording, Directional Finding and associated equipment. Our public address systems and theatre speakers are known all over the world. Write for literature on the above mentioned lines.

Many products formerly manufactured under the trade names of Fox and De Armond are now combined with Rowe Industries.

15 years experience at your command. Submit your problem. Address Dept. 62.

ELECTRONICS DIVISION

ROWE Industries

3120 MONROE ST., TOLEDO 6, OHIO

Remler Appointed Agent for WAR ASSETS ADMINISTRATION

(Under Contract No. 59A-3-48)

... to handle and sell a wide variety of

ELECTRONIC EQUIPMENT

released for civilian use

Write for Bulletin Z-1A

Remler Company Ltd.
2113 Bryant St.
San Francisco 10, Calif.

REMLER

SINCE 1918

Radio • Communications
Electronics

Now...

ACCURACY within $\pm 1\%$

Plus...

**CONTINUOUS
AUTOMATIC
RECORDING
of EXPANSION
and CONTRACTION
MEASUREMENTS**

with the new

SYLVANIA DILATOMETER



THE SYLVANIA DILATOMETER measures expansion and contraction by the concentric quartz tube principle . . . providing the extreme accuracy characteristic of this method.

Simultaneously it automatically records the measurements . . . plotting them in the form of a complete elongation-temperature curve for an entire 8-hour cycle.

No special attention is needed to operate this new instrument. Simply insert the specimen and start the equipment. No laborious, time-consuming plotting of curves. The record is continuous. With indicating-type instruments, it is often difficult to take readings fast enough to follow true changes in length at critical points. The recording instrument overcomes this difficulty.

This Dilatometer is one of many electronic devices pioneered by Sylvania Electric. Other Sylvania products include Spectrum Analyzers, Synchrosopes, Thermistor Bridges, Capacity Bridges, Oscilloscopes and Modulation Monitors. Inquiries are invited.

SYLVANIA ELECTRIC

Electronics Division . . . 500 Fifth Avenue, New York 18, N. Y.

MAKERS OF ELECTRONIC DEVICES; RADIO TUBES; CATHODE RAY TUBES; FLUORESCENT LAMPS, FIXTURES, WIRING DEVICES; ELECTRIC LIGHT BULBS

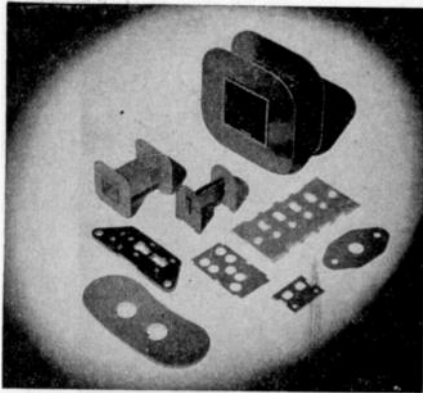

Serving the Radio Industry with dependable laminated plastics

NATIONAL VULCANIZED FIBRE

PHENOLITE
Laminated PLASTIC

—because of their lightness in weight, high dielectric strength, ready machinability, exceptional wearing and other qualities—are playing a vital part.

NATIONAL VULCANIZED FIBRE CO.
WILMINGTON, DELAWARE

Offices In  Principal Cities

In Canada: National Fibre Co. of Canada, Ltd.
Toronto • Montreal

for every photo tube application

there is a High Sensitivity

RAULAND VISITRON



There is a *Rauland VISITRON* available for every phototube application . . . for industrial electronic control devices, sound-on-film, research and development. For high sensitivity, uniformity and dependability, *Rauland VISITRONS* are the preferred phototubes.

Specify VISITRON . . . and be sure!
Send for valuable *Rauland VISITRON* Catalog—it's yours for the asking.

THE RAULAND CORPORATION
CHICAGO 41, ILLINOIS

RADIO **Rauland** RADAR
SOUND • COMMUNICATIONS • TELEVISION

INDEX

Section Meetings	35A
Membership	35A
Positions Open	50A
Positions Wanted	44A
News and New Products	65A

DISPLAY ADVERTISERS

Accurate Spring Mfg. Co.	29A
Acme Electric Corporation	38A
Aerovox Corporation	2A
Aircraft Radio Corp.	1A
Allen-Bradley Company	57A
Alliance Mfg. Co.	3A
American Brass Company (Metal Hose Branch)	46A
American Lava Corp.	33A
American Phenolic Corp.	27A
American Transformer Co.	12A
Amperex Electronic Corp.	11A
Andrew Co.	40A
Arnold Engineering Co.	42A
Astatic Corp.	48A
Automatic Mfg. Corp.	63A
Bendix Aviation Corp.	50A
Belmont Radio Corp.	52A
Bell Telephone Laboratories	6A & 7A
Blaw-Knox Co.	44A
Boonton Radio Corporation	66A
W. J. Brown	65A
Cambridge Thermionic Corp.	64A
Capitol Radio Engineering Institute	64A
Allen D. Cardwell Mfg. Corp.	67A
Chicago Transformer	36A
Clarostat Mfg. Co.	35A
Sigmund Cohn & Co.	56A
Collins Radio Co.	53A
Edward J. Content	65A
Cornell-Dubilier Electric Corp.	Cover III
Drake Mfg. Co.	68A
Allen B. DuMont Labs., Inc.	16A, 71A
E. I. DuPont de Nemours & Co., Inc.	64A
Hugh H. Eby, Inc.	49A
Stanley D. Eilenberger	65A
Eitel-McCullough, Inc.	8A, 9A
Electrical Reactance Corp.	54A
Electronics Research Publishing Co.	70A
Fairchild Camera & Inst. Corp.	55A
Farnsworth Television & Radio Corp.	56A
Finch Telecommunications, Inc.	75A
F. T. Fisher's Sons	65A
Footc Mineral Co.	39A
General Electric Company	25A
General Radio Co.	Cover IV
Samuel Gubin	65A
Hewlett-Packard Company	19A
Hytron Radio & Electronics Corp.	13A
Iliffe & Sons	76A
International Nickel Co., Inc.	69A
International Resistance Company	41A
Jackson Electrical Inst. Co.	52A
J. B. T. Instruments	58A
E. F. Johnson Co.	28A
David C. Kalbfell	65A
Kalbfell Laboratories	68A
Richard C. Kleinberger	65A
Langevin Co.	30A
Littelfuse, Incorporated	68A
Machlett Laboratories, Inc.	47A
Frank Massa	65A
Measurements Corp.	70A
Mycalex Corp. of America	54A
National Carbon Co., Inc.	17A
National Company, Inc.	10A
National Vulcanized Fibre Co.	74A
Newark Electric Co., Inc.	66A
Albert Preisman	65A
Premax Products	74A
Press Wireless Mfg. Corp.	15A
Presto Recording Corp.	21A
Radio Corp. of America	26A, 32A, 34A, 50A, 52A, 54A, 61A
Radionic Equipment Co.	70A
Rauland Corp.	74A
Raytheon Mfg. Co.	18A, 24A
Remler Co. Ltd.	72A
Revere Copper & Brass, Inc.	45A
Rowe Industries	72A
Sherron Electronics Co.	59A
Sola Electric Company	43A
Solar Mfg. Corp.	4A, 5A
Sperry Gyroscope Co., Inc.	23A
Sprague Electric Company	20A
Stackpole Carbon Co.	22A
Sylvania Electric Products	73A
Tech Labs.	72A
Triplett Electrical Instrument Co.	51A
Truscon Steel Co.	37A
Tung-Sol Lamp Works, Inc.	14A
Turner Co.	60A
United Transformer Company	Cover II
D. Van Nostrand Company, Inc.	65A
Western Electric Company	6A, 7A
Harold A. Wheeler	45A
Wilcox Electric Company, Inc.	31A
John Wiley & Sons, Inc.	62A
Paul D. Zottu	65A



Antennas

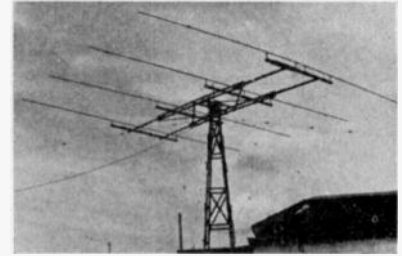

For FM and Television

Antennas for Television and FM reception which give excellent response on both old and new bands . . . novel "V-Type" design that allows the proper impedance matching to 300 ohm line . . . sturdy mechanical construction that makes them easy to erect . . . simple design with pleasing appearance . . . require less horizontal space than any conventional dipole for the same frequency response.

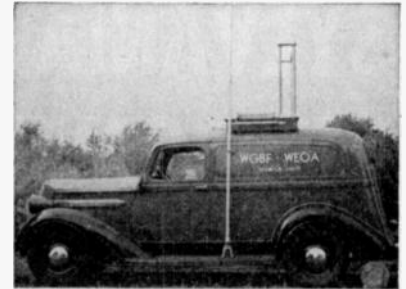

For Mobile Units

Telescoping Tubular Antennas varying in height from 6 to 35 feet . . . light-weight yet sturdy enough to resist great shock . . . easily adjustable in height . . . in steel, monel, aluminum and stainless steel. Also the popular "whip" type with special Premax mountings that stand the road-shocks. If your problem is a satisfactory antenna, investigate Premax.

Get the new Premax Antenna and Mounting Catalog . . . or the Premax Antenna Manual . . . from your radio jobber.

Premax Products
Division of Chisholm-Ryder Co., Inc.
4713 Highland Ave., Niagara Falls, N.Y.

PRINTED AND ILLUSTRATED MESSAGES BY WIRE OR RADIO



Finch Telefax Duplex Unit

finch facsimile

Finch Telefax equipment transmits and records exact facsimiles of written or printed messages — as well as drawings, photographs, signatures, etc. at a speed by telephone of 900 square inches per hour — or

by radio of 2760 square inches per hour, equivalent to 30,000 words! This provides a fast, flexible, accurate and economical new service to solve your communication problems. Write for full particulars.

FINCH TELECOMMUNICATIONS, INC.

Address all inquiries to Sales Office

10 EAST 40th STREET • NEW YORK 16, N. Y.

Makers also of Facsimile Broadcast Transmitting Equipment, Facsimile Home Recorders, Facsimile Duplicating Machines, and Finch Rocket Antenna for all FM stations.

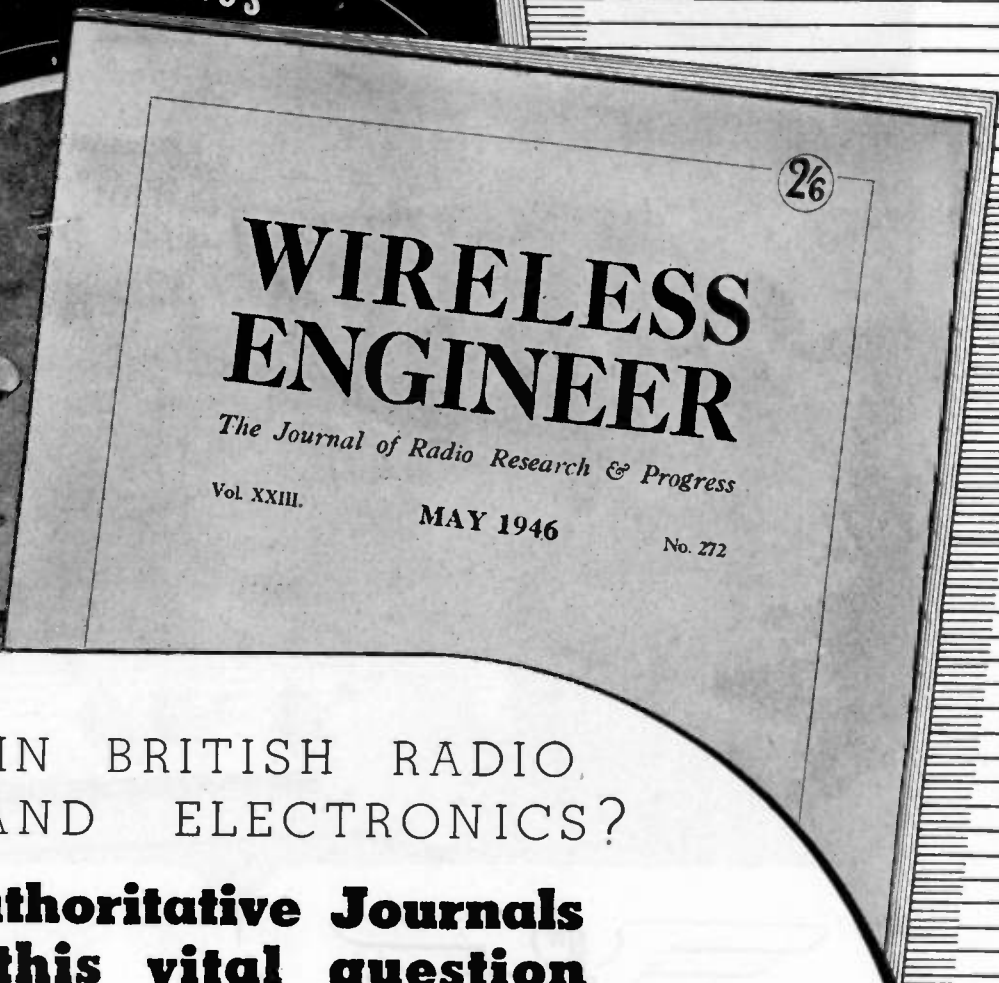
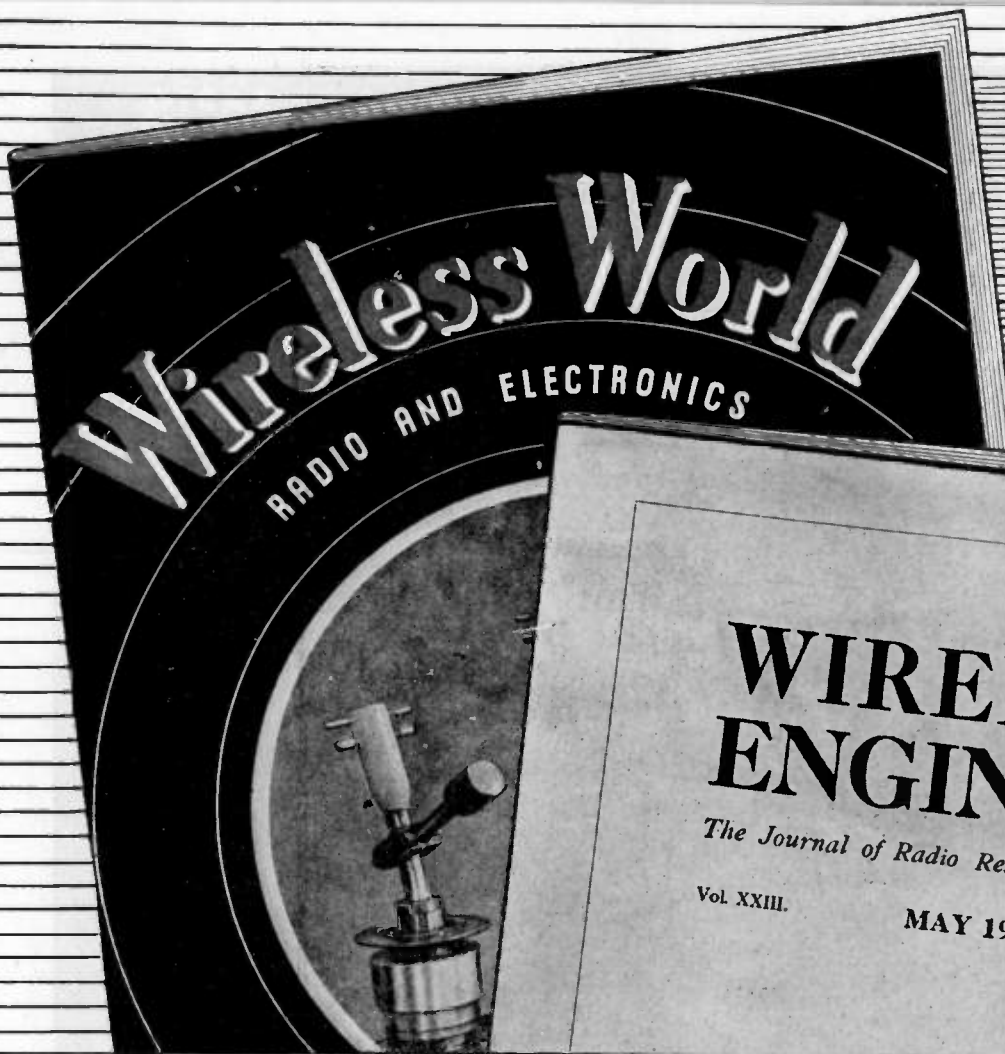

WHAT'S NEW IN BRITISH RADIO, TELEVISION AND ELECTRONICS?

These authoritative Journals answer this vital question

THE JOURNAL OF RADIO RESEARCH AND PROGRESS FOR ENGINEERS & PHYSICISTS

WIRELESS ENGINEER is read by research engineers, designers and students, and is accepted internationally as a source of information for advanced workers. The Editorial policy is to publish only original work and representatives of the National Physical Laboratory, the British Broadcasting Corporation and the Engineering Department of the British Post Office are included on the Editorial Advisory Board. In addition to original papers, the correspondence columns form a recognised debating ground for all matters of technical interest.

WIRELESS ENGINEER

PUBLISHED MONTHLY 32 shillings (\$6.50) A YEAR

THE JOURNAL FOR MANUFACTURERS AND TECHNICIANS OF ALL GRADES

WIRELESS WORLD is Britain's leading technical magazine in the general field of radio, television and electronics. Founded over 35 years ago, it has consistently provided a complete and accurate survey of the newest British technique in design and manufacture. Articles of a high standard cover every phase of the radio and allied industries, with reviews of equipment, broadcast receivers and components. Theoretical articles deal with design data and circuits for every application.

Wireless World

PUBLISHED MONTHLY 20 shillings (\$4) A YEAR

SUBSCRIPTIONS (by International Money Order) and correspondence should be addressed to:—Dorset House, Stamford St., London, S.E.1, England. Cables: "Iliffe, Sedist, London."



every time we do this stunt— A Manufacturer Cuts His Production Costs!

Bending over backwards for our customers is part of C-D's service. Actually though, designing a special type capacitor may not be so strenuous a job for us. Not because your capacitor problem is a breeze. It simply comes easier to us, than to most other manufacturers, to bend ourselves to specialized tasks.

For, in the course of designing and manufacturing over 1/4 of a million different types of capacitors, our engineers have gathered a wealth of information, experience, or call it "know-how" that speeds the solution to every problem

they handle. And the sooner your requirements are met . . . the more perfect the design—the greater are your savings. Typical of the many problems C-D engineers have successfully licked are the capacitor types shown below.

If your plans call for anything in capacitors, consult with our engineers. Catalog of standard types available on request.

Cornell-Dubilier Electric Corporation,
South Plainfield, New Jersey. Five other
plants in New Bedford, Providence,
Worcester and Brookline.

MICA • DYKANOL • PAPER • ELECTROLYTIC CAPACITORS



A FEW OF C-D's MADE-TO-ORDER CAPACITORS

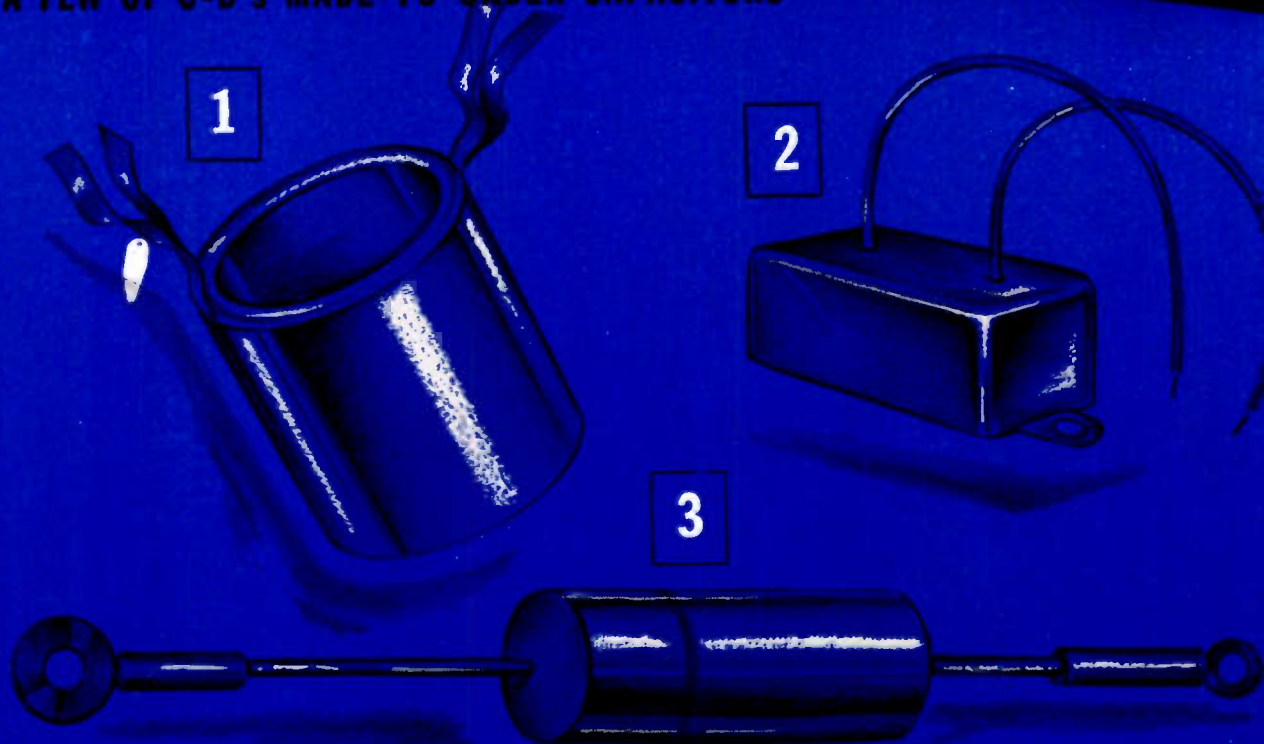

CAPACITOR #1. This capacitor unit was designed for a manufacturer of motors. Mounts directly on motor shaft.

CAPACITOR #2. Designed for spark suppressor applications in home appliance equipment. An inexpensive dependable unit for competitively priced mixers, juicers, grinders, etc.

CAPACITOR #3. Standard paper tubular capacitor adapted for automobile ammeter, oil pump, radio noise filter applications, etc.



CORNELL-DUBILIER
world's largest manufacturer of
CAPACITORS

VARIACS

for High Power

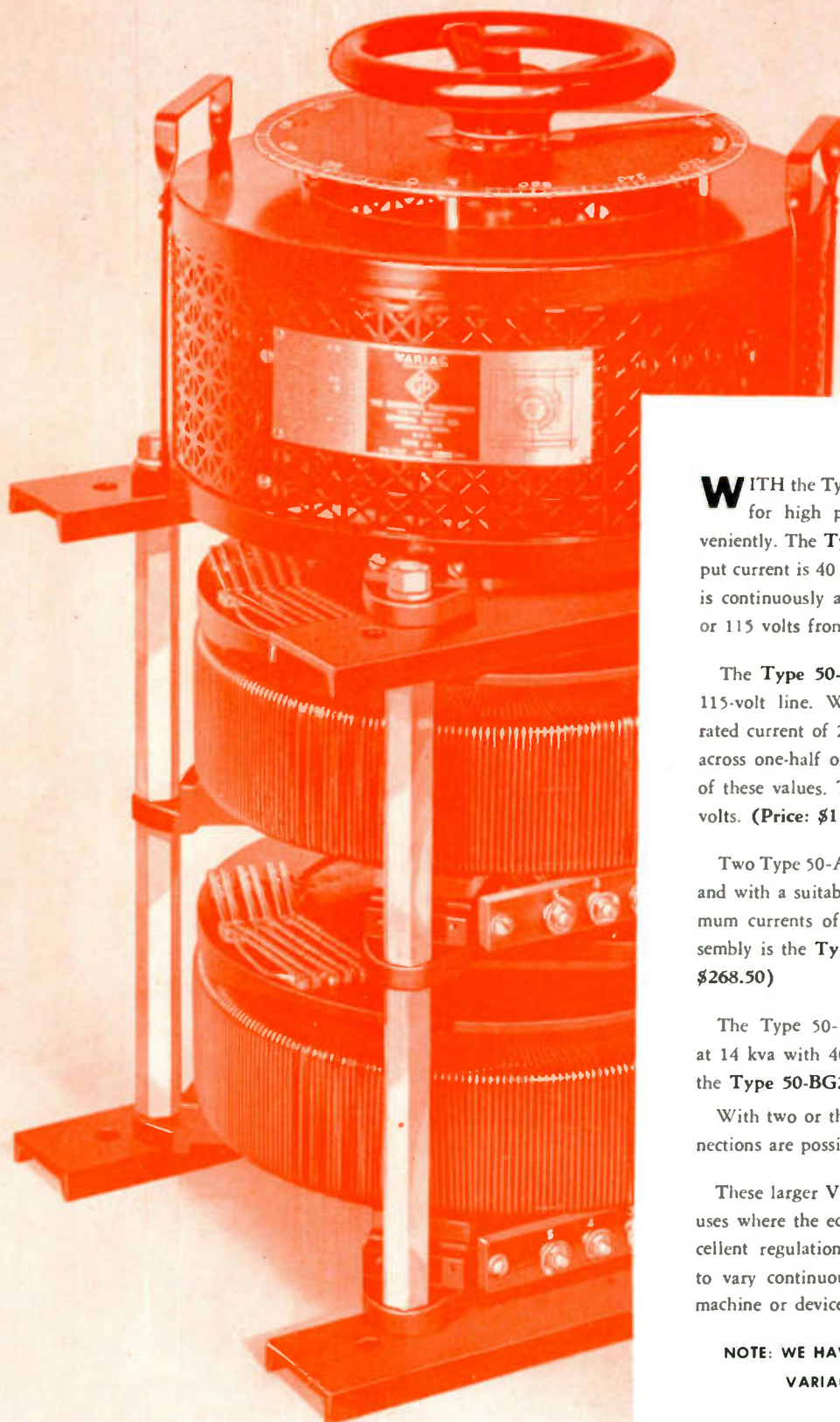

WITH the Type 50-A or Type 50-B VARIAC quite large currents for high power operation can be handled safely and conveniently. The Type 50-A VARIAC is rated at 5 kva; its rated output current is 40 amperes, with a maximum of 45; its output voltage is continuously adjustable from zero to a maximum of either 135 or 115 volts from a 115-volt line. (Price: \$116)

The Type 50-B designed for 230-volt input, may be used on a 115-volt line. With 230-volt input it is rated at 7 kva with a rated current of 20 amperes and a maximum of 31. With 115 volts across one-half of the winding, the ratings are reduced to one-half of these values. The output voltages are zero to either 270 or 230 volts. (Price: \$116)

Two Type 50-A's ganged, with their windings connected in parallel and with a suitable choke, are rated at 10 kva with rated and maximum currents of 80 and 90 amperes respectively. The ganged assembly is the Type 50-AG2. (Price, with one Type 50-P1 Choke: \$268.50)

The Type 50-B's, when similarly used on 230-volts, are rated at 14 kva with 40 and 62 ampere current ratings. This assembly is the Type 50-BG2. (Price, with one Type 50-P1 Choke: \$268.50)

With two or three Type 50 VARIACS a number of 3-phase connections are possible. Various powers up to 25 kva can be handled.

These larger VARIACS are proving indispensable in hundreds of uses where the economical operation, convenient rotary control, excellent regulation and high efficiency of the VARIAC is desired to vary continuously the current on any high-power a-c operated machine or device.

NOTE: WE HAVE A FEW OF THE SINGLE TYPE 50-A AND 50-B VARIACS IN STOCK FOR IMMEDIATE SHIPMENT



GENERAL RADIO COMPANY Cambridge 39, Massachusetts

90 West St., New York 6

920 S. Michigan Ave., Chicago 5

950 N. Highland Ave., Los Angeles 38