

PROCEEDINGS OF THE I.R.E.



AND



WAVES AND ELECTRONS

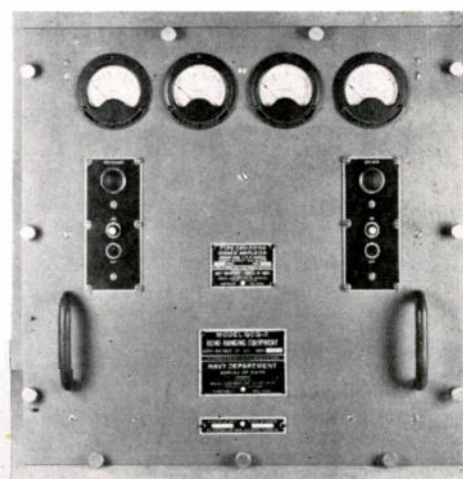
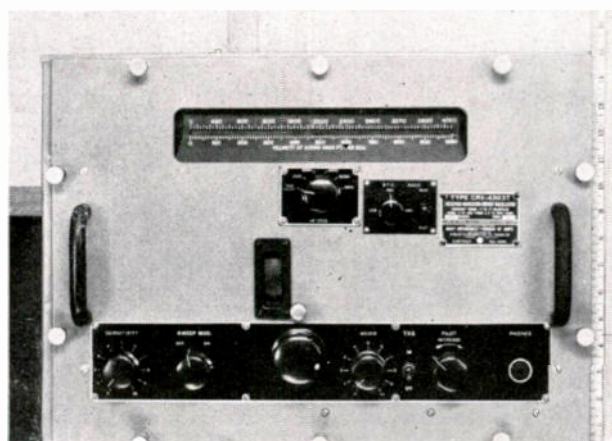

RCA-USN

SONAR—UNDERWATER SOUND ECHO-RANGING-LISTENING SYSTEM

The driver-oscillator portion of the assembly (upper left) excites the projector (center) through the driver amplifier (upper right). The tell-tale echo, picked up by the projector, is fed into the receiver-indicator portion of the unit at upper left.

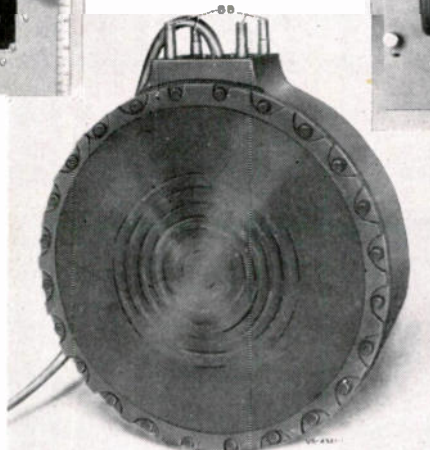

September
1946

Volume 34 Number 9

PROCEEDINGS OF THE I.R.E.

Universal Optimum-Response Curves
Triple-Resonant-Circuit Band-Pass Filters
Mutual Effects Between Half-Wave Dipoles
Gain Formula for Feedback Amplifiers
Balanced Shielded Loops
Equalized Delay Lines

Reflection-Coefficient Meter
Parallel-T R-C Network

WAVES AND ELECTRONS
Section

Naval Airborne Radar
Abstracts and References

The Institute of Radio Engineers

AMPEREX

ONE SOURCE • ALL TYPES



892R

COMMUNICATION



889AR

673



INDUSTRIAL



857B

866A

RECTIFICATION



VC50 / VC25

HF200

ELECTRO-MEDICAL



8011

SPECIAL PURPOSE

AND ALL OTHER IMPORTANT TYPES

Is it a special development for new equipment? Or a "standard" tube for replacements? A quarter century of creative research, precision manufacture and helpful service has given Amperex a unique position in the power tube field. This means a backlog of experience and forward-looking viewpoint which naturally translate themselves into tube performance, reliability and economy. Consult us — no obligation.

Write for: Catalog; Technical Rating and Data Sheets

AMPEREX ELECTRONIC CORPORATION

25 WASHINGTON STREET, BROOKLYN 1, N. Y., CABLES: "ARLAB"

In Canada and Newfoundland: Rogers Majestic Limited, 622 Fleet Street West, Toronto 28, Canada



MAKING TUBES IS EASY... If YOU KNOW HOW!



**HEATER
COATING**

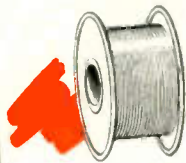

**BARE
TUNGSTEN
WIRE**



**COATED
HEATER
WIRE**

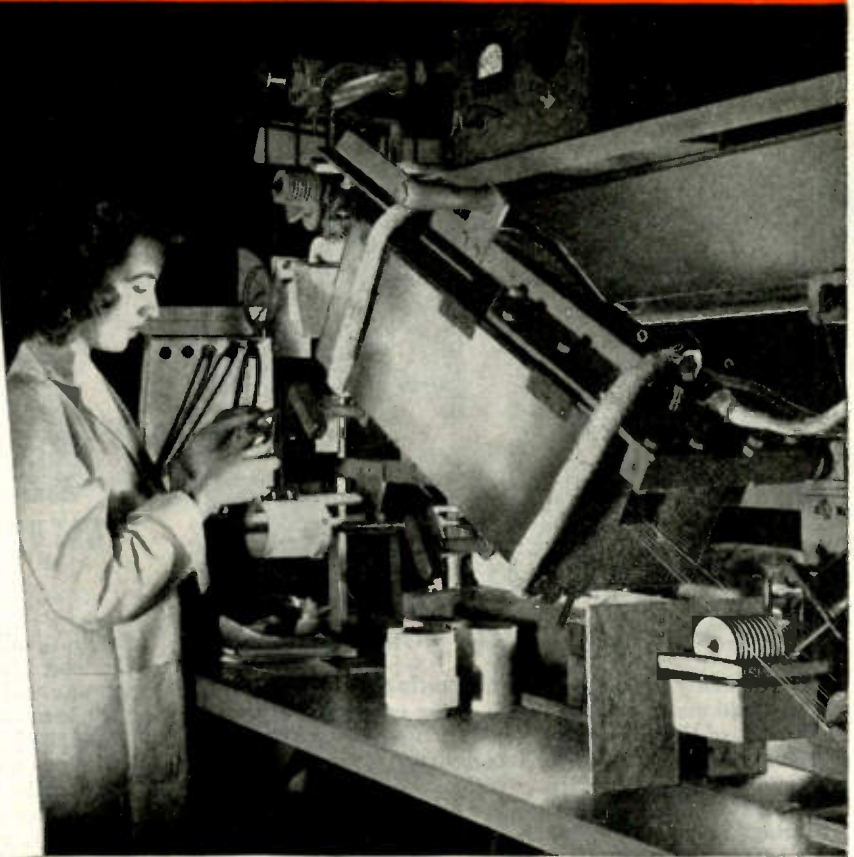

HYTRON KNOW-HOW MAKES EASY THE APPARENTLY EASY

MERELY to apply an insulating coating to tungsten heater wire—that should be easy. To say the illustrated heater-wire coating machine simplifies the job appears a paradox. Why, the machine looks like a product of Rube Goldberg's fertile mind!

Imagine, however, the complexity of producing a thin but perfect insulating coating—a dielectric with a resistance of tens of megohms—yet capable of operating at over 1500° Kelvin! Chemical purity of the coating must be rigidly controlled. Application must be in thin multiple layers to achieve uniform adhesion and density. Thickness must be exact for correct stacking of the folded heater when inserted into the cathode sleeve. Just the right degree of hardness must be

maintained to provide stiffness without brittleness.

A complex precision machine actually does simplify the job. Fundamentally its compact mechanism unspools and spools the wire. Guided by threading pulleys, the wire passes eighteen times through coating cups and drying oven via a cross-over figure-8 path. Speed and oven temperature are finely regulated. An ingenious electromagnetic device smoothly maintains proper wire tension. Completely coated wire is wound by a spooling head in a basket-weave pattern.

The know-how of this Hytron coating operation is hidden away within the cathode sleeve. Trouble-free tube performance, however, gives you concrete proof of the know-how Hytron constantly strives to expand.

SPECIALISTS IN RADIO RECEIVING TUBES SINCE 1921



HYTRON

RADIO AND ELECTRONICS CORP.



MAIN OFFICE: SALEM, MASSACHUSETTS

PROCEEDINGS OF THE I.R.E. AND WAVES AND ELECTRONS, September, 1946, Vol. 34, No. 9. Published monthly in two sections by The Institute of Radio Engineers, Inc., at 330 West 42nd Street, New York 18, N.Y. Price \$1.00 per copy. Subscriptions: United States and Canada, \$10.00 a year; foreign countries \$11.00 a year. Entered as second class matter, October 26, 1927, at the post office at Menasha, Wisconsin, under the act of March 3, 1879. Acceptance for mailing at a special rate of postage is provided for in the act of February 28, 1925, embodied in Paragraph 4, Section 412, P. L. and R., authorized October 26, 1927.

Table of contents will be found following page 32A

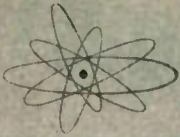

Designers

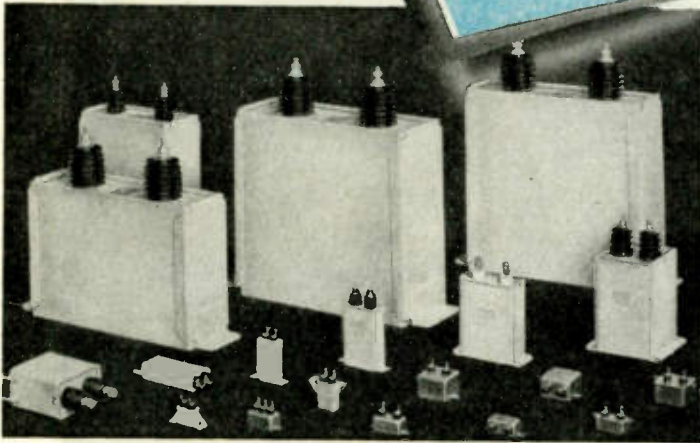

NEW PYRANOL* CAPACITORS

new sizes, new quality

Strict quality control, new manufacturing techniques, and improved materials — the basis of the excellent war-time records of G-E d-c capacitors — are now incorporated in a new line of Pyranol capacitors designed to meet rigorous commercial requirements.

This new line makes possible a broad selection of sizes, ratings and mounting arrangements, with characteristics which permit operation over a wide temperature range (from 85C to -55C), at altitudes up to 7,500 feet. Sizes and shapes range from "bathtub" and small rectangular case styles to large, welded steel-case designs. Capacitance ratings are offered from .01 muf to 100 muf, and voltage ratings from 100 to 100,000 volts. Write Transformer Division, General-Electric Co., Pittsfield, Mass.

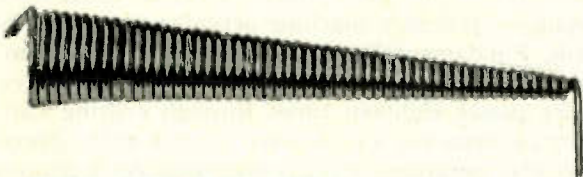

MORE COMPACT COILS

wound faster

Formex* magnet wire, available in all standard wire sizes, puts more turns and more copper in a given coil cross-section area than fibrous-covered wire does, particularly if square or rectangular Formex wire is used. It's a natural where coil shapes require acute angle bends. Higher winding speeds are practical without increasing rejects; time-saving steps are possible that you wouldn't dare use with ordinary magnet wire. In most sizes, first cost of Formex is less than fibrous-covered wire, and only slightly greater than enameled. Check Bulletin GEA-3911.

*Reg. U.S. Pat. Off.

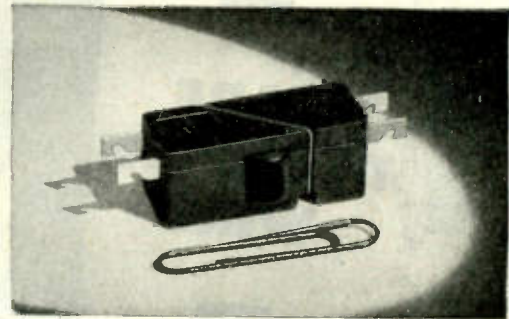

SWITCHETTES do big jobs *in cramped quarters*

G-E manually-operated Switchettes are outstanding for the long life and lightning-fast snap action packed into an unusually small, lightweight case. The Size 1 Switchette weighs only 9 grams, and is approximately 1¼ in. by ½ in. by ½ in. Size 1 Switchettes are available in ratings up to 10 amperes at 24 volts d-c, or 230 volts a-c, and in ten different contact arrangements. Size 2 Switchettes are rated 25 amperes at 24 volts d-c, (230 volts a-c), and are available in three contact arrangements: single circuit, normally open; single circuit, normally closed; and two circuit. Totally enclosed, with screw terminals, size 2 Switchettes measure about 2 by 1⅜ by 1 inch, and weigh approximately 2 ounces. Write for Bulletin GEA-3818C (Size 1) or GEA-4259 (Size 2).

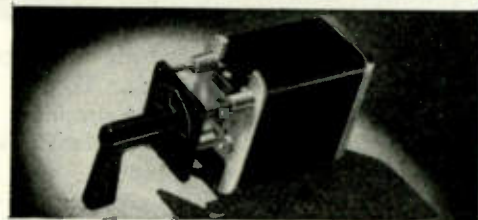

A VERSATILE SWITCH

with 4,000 possibilities

There's a standard SB-1 switch for most of the ordinary control and transfer jobs. Where the number or arrangement of circuits is unusual, special switches can be made from standard SB-1 cams, contacts, fingers, and other parts, giving great flexibility of application. Precision-built parts make even a 40-stage tandem switch easy to operate.

Already more than 4,000 different arrangements of circuits and sequences have been made by varying contacts and cam arrangements. Others can be made to meet your specifications. Write for Bulletin GEA-1631E.

GENERAL  ELECTRIC

Digest

TIMELY HIGHLIGHTS ON G-E COMPONENTS



SMALL DC METERS

that are lighted two ways

General Electric Type DO-58 d-c meters are 4 by 4½ inches. Voltmeters are available registering from 0 to 1 volt, to 0 to 750 volts in self-contained models, and up to 30 kv with external resistors. Accuracy is to within 2 per cent of full scale value. The d-c ammeters, milliammeters and microammeters cover a range from 0 to 50 amperes, to 0 to 50 microamperes. Cased in black Textolite with a deep cover, these meters are offered in front-illuminated and rear-illuminated types, with lance-type, pointer-tip standard, and knife-edge and pear-shaped tips optional. These flush-mounted instruments are also available in alternating-current, a-c rectifier and rf types. Write for Bulletin GEA-4272.

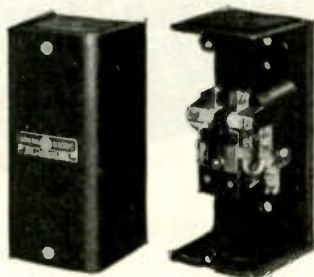

INDUSTRIAL RELAY *does a lot of jobs*

This sturdy, compact industrial voltage relay has a lot of uses, such as controlling pilot circuits in response to remote control switches or thermostats, or for direct control of small motors driving cooling blowers. It may be used as a fractional-horsepower motor starter, or in conjunction with magnetic switches controlling larger apparatus. Rated 10 amperes, continuous, with make-or-break rating of 45 amperes on normally open poles, 20 amperes on normally closed poles, at either 110 v or 220 v a-c. Three contact arrangements — double-pole, double-throw; double-pole, single-throw; and single-pole, single-throw — are available in either open or enclosed models. Write for Bulletin GEA-4668.

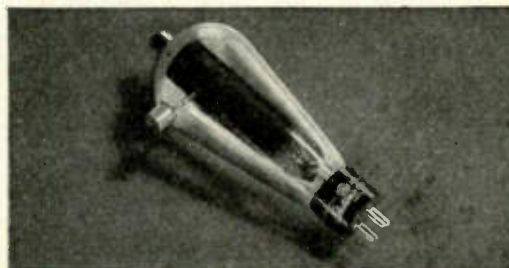

SPLIT-CYCLE CONTROL

of heavy currents

Thyratron Type FG-95 tubes are designed for rapid control applications where available grid power is very small, where it is necessary to actuate the grid from a high-impedance source, and where tube temperature can be maintained at a relatively constant level. This tube's negative grid characteristics mean lower overall power requirements for heavy-duty control work. Peak voltage, 1000 v, peak current 15 amp, average current 2.5 amp. Surge current (for design only) 200 amp for 0.1 second.

Among the applications of Thyratron tubes are resistance welding control, motor control, lighting control, rectification, and power supply for photoelectric relays. Write for Bulletin ETI-125. (For general data on Thyratrons, ask for ETI-116). *General Electric Co., Electronics Division, Syracuse, N.Y.*



DURABLE NAMEPLATES

with beauty built-in

General Electric laminated plastic nameplates are tough, durable, and resistant to impact. They are available stamped, engraved, or printed, in a variety of color combinations. Their appearance is exceptional — both satin and mirror finishes are offered with surfaces that need neither buffing nor polishing. The hard, smooth surfaces of G-E plastic nameplates are easily cleaned. They do an outstanding job for a wide range of diversified applications. For further information, write *General Electric Co., Plastics Division, Pittsfield, Mass.*

GENERAL ELECTRIC COMPANY, Sec. 642-12
Apparatus Department, Schenectady 5, N. Y.

Please send me

.....GEA-1631E (SB-1 Switches)

.....GEA-3818C (Switchettes—Size 1)

.....GEA-3911 (Formex)

.....GEA-4259 (Switchettes—Size 2)

.....GEA-4272 (Small D-C Meters)

.....GEA-4668 (Industrial Relay)

NOTE: More data available in Sweets' File for Product Designers

Name _____
Company _____
Address _____
City _____ State _____

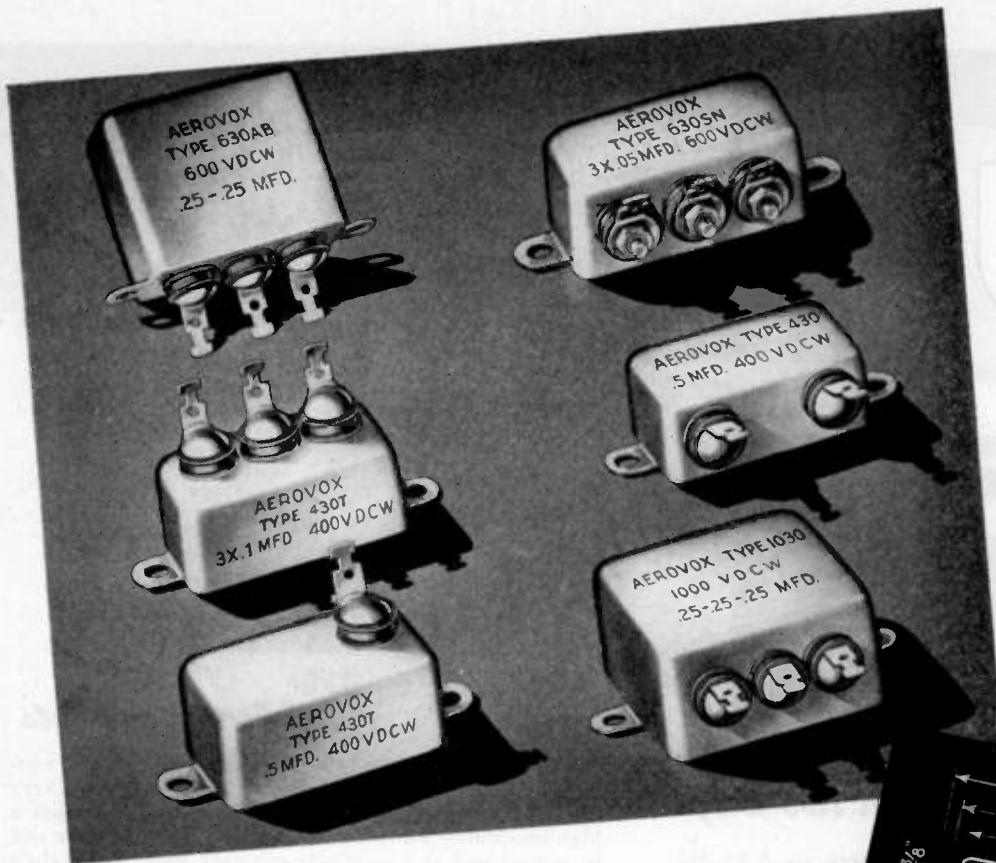

pid

Meeting the severe operating conditions encountered in military, aircraft, police, broadcast, P-A and other equipment...

HYVOL "BATHTUB" *Capacitors*

● These drawn-container units are designed for applications requiring compact, extra-quality capacitors. Aerovox Type 30 capacitors are specified for equipment that must undergo severe-service operating conditions, more particularly in military, aircraft, police, broadcast, public-address, and other classes of communications equipment, as well as in electronic assemblies operating hour after hour. These "bathtubs" are standard capacitors in Government radio and electronic equipment.

Type 30 is Hyvol impregnated and filled. Type 30M is mineral-oil impregnated and filled. One-piece drawn

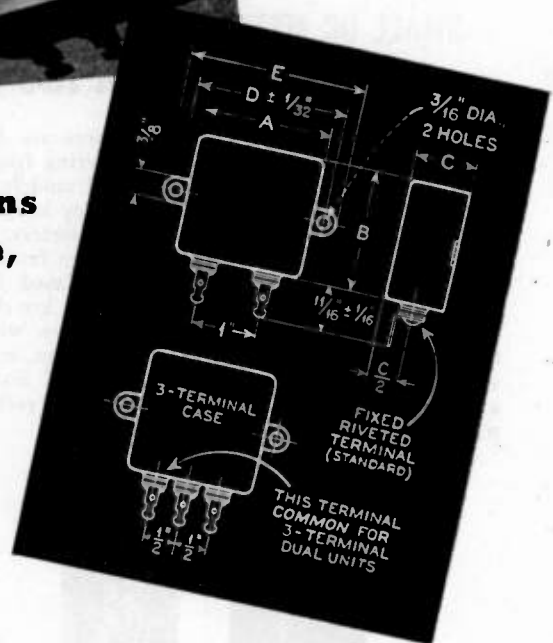

metal case with soldered bottom plate. Terminals are constructed with the Aerovox-originated "double-rubber" bakelite insulators permanently riveted to the case, making a sturdy, absolutely immersion-proof assembly. Terminals on side, top, bottom or ends to suit mounting and wiring requirements.

In 400, 600 and 1000 v. D.C.W. Choice of capacitances. Single, dual and triple sections.

● Write for descriptive literature and listings.



Capacitors

INDIVIDUALLY TESTED

AEROVOX CORPORATION, NEW BEDFORD, MASS., U. S. A. SALES OFFICES IN ALL PRINCIPAL CITIES
Export: 13 E. 40 ST., NEW YORK 16, N. Y. • Cable: 'ARLAB' • In Canada: AEROVOX CANADA LTD., HAMILTON, ONT.

**New 50,000 watt AM broadcast transmitter —
one of an advanced line (5 KW to 50 KW)
by Federal Telephone and Radio Corporation**

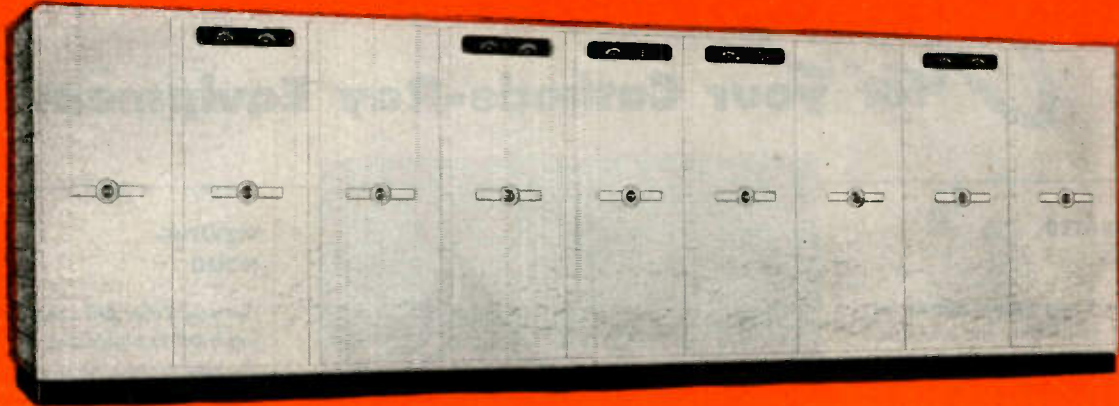

**AGAIN, as in the past, Federal's design
includes AMERTRAN TRANSFORMERS
and REACTORS**

**A few examples of AMERTRAN
Transformers and Reactors in
Federal Transmitters:**

Broadcast Transmitter "WABC",
C.B.S., New York, 50,000 watts.
O.W.I. "Tokyo Broadcast" stations,
Pacific Coast, 200,000 watts.
C.B.S. short wave transmitters, New
York area.
I.T.T. short wave transmitters, Long
Island, N. Y.—and scores of others.



Left—50,000
watt
AmerTran
Modulation
Transformer,
one of a
matched set
for
Class "AB"
operation in
a Federal
Transmitter.

Above—AmerTran
Type "WSB" Filament
Transformer
used in Federal-
built O. W. I.
Transmitters.

For a good many years we at AmerTran have enjoyed the confidence and cooperation of Federal's staff—a relationship which has enabled us to furnish transformer and reactor units which fully meet the strict specifications of Federal's requirements. Those units include filament, plate and audio transformers for many important installations in commercial and government enterprise.

AmerTran Transformers are "built-in" components in the best known electronic assemblies now in operation. They are designed and manufactured in a modern plant devoted exclusively to transformers and allied products. You may feel free to use the entire facilities of the AmerTran organization.

AMERICAN TRANSFORMER COMPANY
178 Emmet Street Newark 5, N. J.

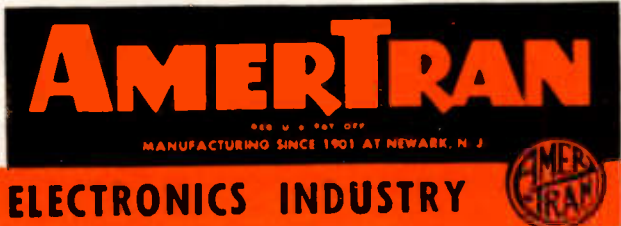

TRANSFORMER SUPPLIERS TO THE ELECTRONICS INDUSTRY



Du Mont has many

Accessories

for your Cathode-Ray Equipment...

CALIBRATED SCALES

Provide a convenient means for making calibrated and quantitative measurements with a cathode-ray oscillograph. Types 216 are available in 3-inch and 5-inch rectangular coordinate scales calibrated in inches and tenths of inch; also in 5-inch polar coordinate scales. 5-inch logarithmic scales are also available for direct-reading of logarithmic decrements or Q measurements.

COLOR FILTERS

Increase contrast and relieve eye-strain by filtering out all but the desired light. Available in the 5-inch size for use with blue, green or amber screens. Made of plexiglass which fits between the calibrated scale and the face of the cathode-ray tube.

VIBRATION PICKUPS

Types VP-5 and DP-1 convert vibrations into electrical potentials which can be applied to the input circuit of the oscillograph. The response of the VP-5 is proportional to velocity; that of the DP-1 is proportional to displacement. The DP-1 is especially suited to low-frequency work.

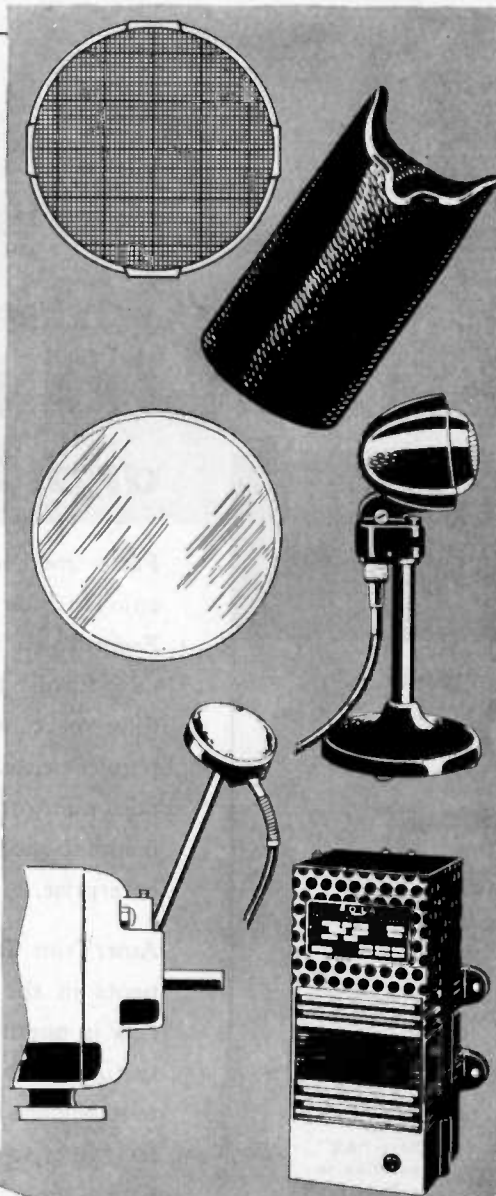

VIEWING HOOD

Use our Type 276 rubber viewing hood to shield the eyes and the tube screen when observing oscillographic patterns under unfavorable ambient light conditions. It fits any oscillograph equipped with a 5-inch cathode-ray tube.

CRYSTAL MICROPHONE

The Type 277, of unusually high impedance, is specially designed for direct connection to cathode-ray oscillograph input circuits. The directional response is practically circular in both horizontal and vertical planes at all audio frequencies.

CONSTANT-VOLTAGE TRANSFORMER

A "must" where irregularity of supply voltage interferes with the performance of oscillographic equipment. The Type 283 is designed for operation from 60-cycle, single-phase alternating current. It delivers a constant secondary-output potential of 115 volts, at loads up to 250 volt-amperes, for input-potential variations from 95 to 125 volts.

Write for descriptive literature

© ALLEN B. DUMONT LABORATORIES, INC.

DUMONT

Precision Electronics & Television

ALLEN B. DUMONT LABORATORIES, INC., PASSAIC, NEW JERSEY • CABLE ADDRESS: ALBEEDU, PASSAIC, N. J., U. S. A.



STACKPOLE

MOLDED IRON CORES

STANDARD AND HIGH-FREQUENCY TYPES

A pioneer in Iron Core production, Stackpole can supply practically any desired type from 100 cycles to upward of 175 megacycles and in an infinite variety of shapes, sizes and characteristics. Also available are High-Resistivity Cores showing a resistance of practical infinity; Insulated Cores wherein the screws are kept out of the coil field and "Q" consequently increased; Iron Cores for choke coils; and Side-Molded Iron Cores featuring uniform permeability with respect to linearity. Write for details and samples of any type.

for higher "Q" STACKPOLE SCREW-TYPE MOLDED CORES

These Stackpole developments are proving highly popular for circuits where small assemblies are the order of the day, and where "Q" must be kept at an absolute minimum. The cores themselves are threaded, thus eliminating the conventional brass core screw. Tubes can be threaded to fit cores if desired. More economical, however, is the use of a wire C-spring clip placed (obtainable from usual sources of supply) in a slot in an unthreaded tube. Stackpole Screw-Type Cores are ideal for the design of I-F and dual I-F Transformers for AM and FM.

IRON SLEEVE TYPES

... for better coils in less space

By use of Stackpole Sleeve Cores, much smaller cans of any material may be used to provide "Q" that is equal to, or better than, that of conventional cores and cans. Thus they facilitate an exceptionally high order of tuning unit efficiency in greatly reduced size. Cans are not always necessary — and, where they are, inexpensive aluminum containers may often be used.

LOOK FOR THE
STACKPOLE MINUTE MAN . . .
your assurance of
the highest in
molded materials
quality.

STACKPOLE CARBON CO., Electronic Components Division, ST. MARYS, PA.

REVERE TUBE FOR ELECTRONIC USES

The tubes shown here happen to be made of aluminum. We also furnish shapes in magnesium, copper, copper alloys and welded steel.

Revere tube may be used for structural purposes in radio equipment, and for parts such as shafts, rivets, soldering and solderless connectors and conductors.

In addition to tube, we also supply to the electronic industry rod and bar, sheet and strip, in copper and its alloys, for use in variable condensers, vacuum tubes, anode radiators, transmitter and receiver shields, sub-bases and similar parts. Of special interest at present is the *new* Revere Free-Cutting Copper, setting new standards in quick, economical and accurate machining.

We have assisted a number of manufacturers in the electronic industry solve difficult problems encountered in the selection and working of aluminum, magnesium, copper and its alloys. Through the Revere Technical Advisory Service similar cooperation is offered to you without obligation.

REVERE

COPPER AND BRASS INCORPORATED

Founded by Paul Revere in 1801

230 Park Avenue, New York 17, N. Y.

Mills: Baltimore, Md.; Chicago, Ill.; Detroit, Mich.;
New Bedford, Mass.; Rome, N. Y.—Sales Offices in
Principal Cities, Distributors Everywhere.

Listen to Exploring the Unknown on the Mutual Network every Sunday evening 9 to 9:30 p. m., EDST.

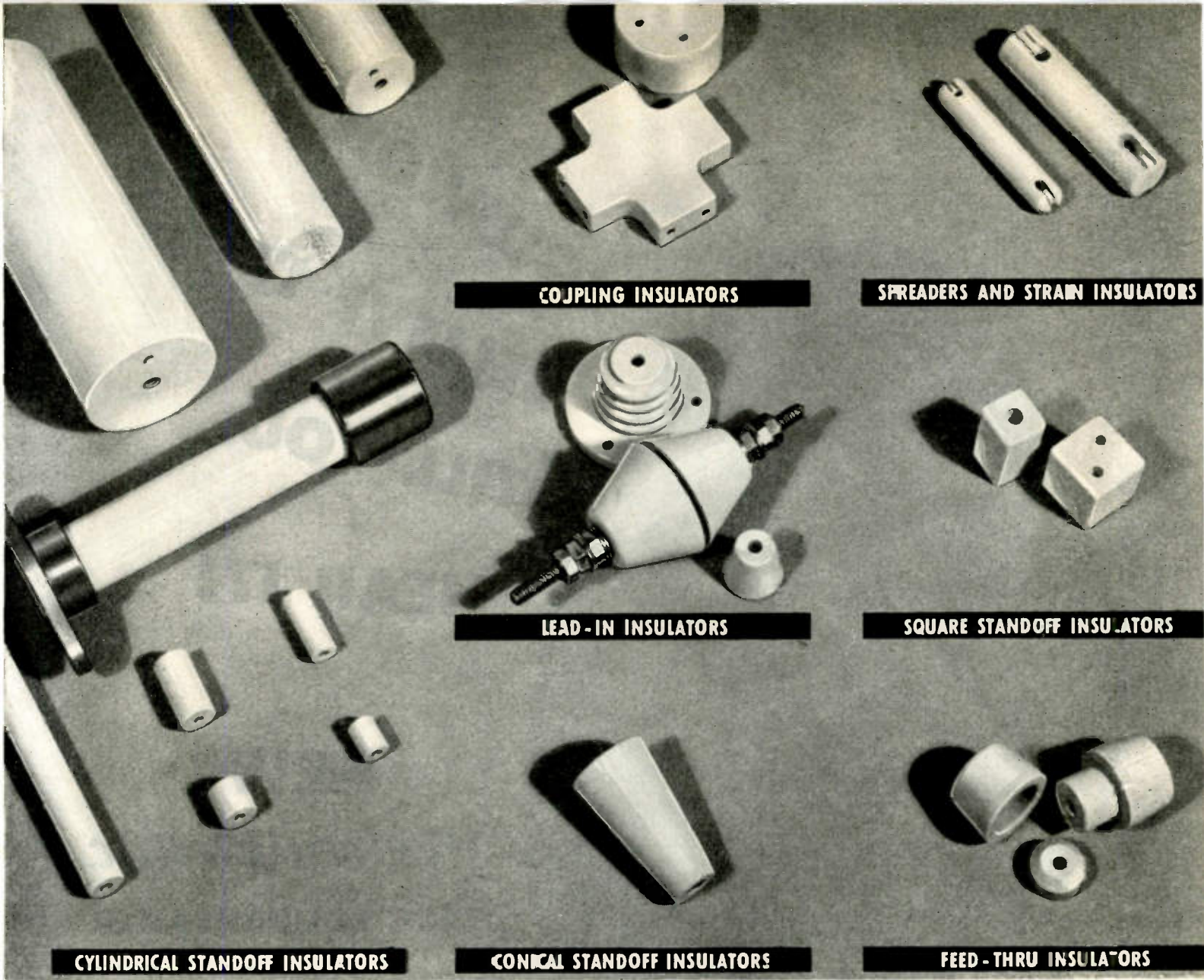

IMMEDIATE DELIVERY FROM STOCK ON MOST SIZES AND TYPES OF STANDARD INSULATORS

These insulators are the types most frequently used in radio and other high frequency applications. They are made of AlSiMag 196. They are in keeping with the trend toward standardization and interchangeability. American Lava Corporation has worked for more than a year toward building stocks to the point where its pre-war service on these standard insulators could be resumed. Now volume deliveries can be made immediately on almost the entire range of these standard insulators. Write for Bulletin 143 which gives complete data.

AlSiMag technical ceramics made to customer's specifications are our principal products. Our engineering staff will be glad to review and make recommendations on your designs.

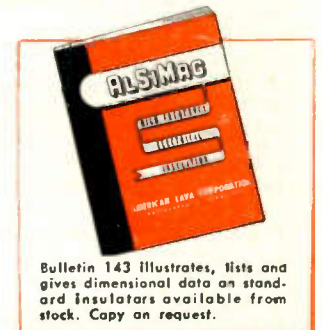

Bulletin 143 illustrates, lists and gives dimensional data on standard insulators available from stock. Copy on request.

ALSiMAG
TRADE MARK REGISTERED - ALL PATENT OFFICES

AMERICAN LAVA CORPORATION

CHATTANOOGA 5, TENNESSEE
44TH YEAR OF CERAMIC LEADERSHIP

ENGINEERING SERVICE OFFICES:

ST. LOUIS, Mo., 1125 Washington Ave., Tel: Garfield 4959 • NEWARK, N. J., 671 Broad Street, Tel: Mitchell 2-8159
CAMBRIDGE, Mass., 38-B Brattle St., Tel: Kirkland 4498 • CHICAGO, 9 S. Clinton St., Tel: Central 1721
SAN FRANCISCO, 163 Second St., Tel: Douglas 2464 • LOS ANGELES, 324 N. San Pedro St., Tel: Mutual 9076

**YOU WON'T
BELIEVE IT
TILL YOU
HEAR IT!**



TECHNICAL DATA

FREQUENCY RANGE: 60 to 10,000 cycles.

IMPEDANCE: 4 ohms.

EFFICIENCY: At a distance of 100 feet on axis, the 728B will produce a level of 81 db above 10^{-16} watt per sq. cm. at 30 watts. This level is on a basis of a warble frequency covering a range from 500 to 2500 c.p.s.

COVERAGE ANGLE: 50 degrees.

POWER CAPACITY: 30 watts continuous.

DIMENSIONS: Diameter 12-11/32"; depth 4".

WEIGHT: Approximately 18 pounds.

BAFFLE HOLE DIAMETER: 11".

MOUNTING: An enclosure of approximately 2½ cubic feet of space is required.

NEW *Western Electric* **728B LOUDSPEAKER**

The first time you hear this revolutionary Western Electric loudspeaker in action, you'll get an entirely new conception of sound reproduction. It delivers speech and music with such "presence," such emotional quality, that you'll find it hard to believe you're listening to *reproduced* sound!

New design features, developed by Bell Laboratories scientists, make the 728B ideal for broadcast studios and sound systems where high quality reproduction is a "must".

For complete technical details and information on delivery, talk to your Graybar Broadcast Equipment Representative—or write Graybar Electric Company, 420 Lexington Ave., New York 17, N. Y.

— QUALITY COUNTS —





For Ground-to-Plane Communication

IT'S FEDERAL'S RADIO TRANSMITTER 184

Adopted by United Air Lines



Major air lines like United know the vital importance of dependability in maintaining radio contact with their planes. That's why the unsurpassed reliability of Federal equipment—backed by more than 30 years of experience in radio and electronics—means so much for airline service. Federal's new ground-station transmitter is general-purpose equipment—adaptable to a wide range of operating requirements. It is available in combinations of power supplies, modulators, r-f units and auxiliaries to provide the frequencies, emissions and types of operation desired.

Write today for bulletin A054, giving descriptive and performance "specs."

DATA:

Frequency Range Power Output, and Type of Emission

(HF) 2 to 20 Mc 500 watts, Telephone and Telegraph
(VHF) 108 to 140 Mc . . . 200 watts, Telephone
(LF) 200 to 540 Kcs . . . 400 watts

Frequency Control—Low temperature-coefficient crystals for all operating frequencies. Facilities can be supplied for switching in either of two crystals for adjacent-channel operation.

Frequency Response—300 to 4000 cycles, plus or minus 3 db with reference to response at 1000 cycles.

Distortion—Less than 10% at 95% modulation.

Remote Control—Transmitter on-off, channel selection, push-to-talk, and keying may be performed over telephone circuits by remote control equipment.

Primary Power—220 volts, 50/60 cycles, single phase.

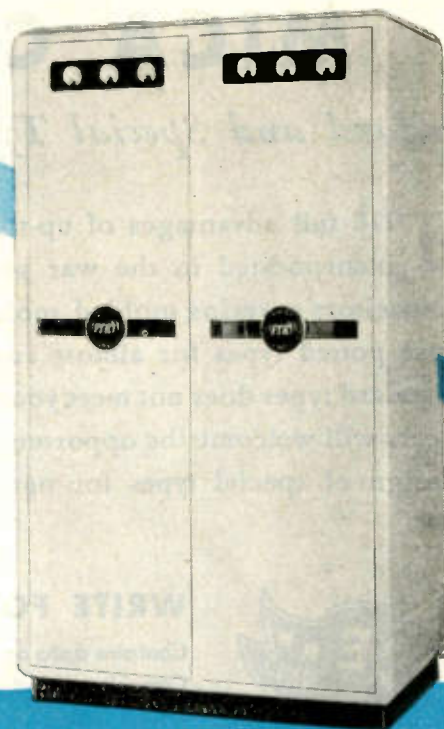

Federal Telephone and Radio Corporation

In Canada:—Federal Electric Manufacturing Company, Ltd., Montreal
Export Distributor:—International Standard Electric Corporation



Newark 1,
New Jersey



SPRAGUE

MICA CAPACITORS . . .

Standard and Special Types to Meet Practically Any Requirement

THE full advantages of up-to-the-minute engineering are incorporated in the war proven line of Sprague Mica Capacitors covering molded, molded-case potted and ceramic-case potted types for almost any need. If one of the many standard types does not meet your requirements Sprague engineers will welcome the opportunity to cooperate in the design of special types for out-of-the-ordinary uses.



WRITE FOR CATALOG 30

Contains data on all standard Sprague Mica Capacitors and outlines the many special types that can be engineered and produced as required.



SPRAGUE ELECTRIC COMPANY
NORTH ADAMS, MASS.

MACHLETT ELECTRON TUBES FOR ALL RADIO TRANSMITTING AND INDUSTRIAL PURPOSES



2C-39

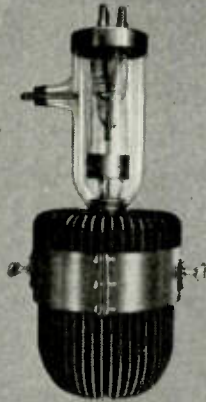

ML-891R



ML-893A



ML-889RA



ML-889A

MAACHLETT LABORATORIES, Incorporated, one of the country's earliest producers of electron tubes, and today the world's largest supplier of tubes for X-ray purposes, brings to the radio and industrial fields its half century of electron tube experience. The tubes illustrated are typical examples of the Machlett line of radio transmitting and industrial tubes.

Machlett's comprehensive background of leadership in the design and production of X-ray tubes places it in a most effective position to meet the increasingly stringent requirements of modern electron tube manufacture. The production methods used in the manufacture of quality X-ray tubes are, more than ever before, essential to meet the constantly increasing requirements for higher power, higher frequencies and higher voltages in practically all fields of electron tube application. Processes essential to assure quality, performance and long useful life at voltages of 50 KV and higher, precision assembly of parts for the accurate control of electron stream, complete and permanent outgassing of the assembled tube and its individual parts have long been characteristic of X-ray tube manufacture and inherent in Machlett's design and productive operation. These skills and techniques developed for, and long used in its X-ray activities, now find unique additional value in their application to electron tubes for radio and industrial purposes.

The Machlett background of almost 50 years of continuous electron tube production, modern, laboratory-like manufacturing facilities, and up-to-the-minute experience assures the user that he will receive tubes engineered and processed for a long life of trouble-free operation.

For complete information write our nearest representative, or the factory at Springdale, Connecticut.

MACHLETT LABORATORIES, INC., Springdale, Connecticut



ML-892

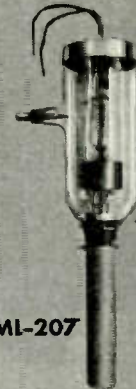

ML-207



ML-880



APPLIES TO RADIO AND INDUSTRIAL USES
ITS **49** YEARS OF ELECTRON TUBE EXPERIENCE

For the Man Who Takes Pride in His Work



**Model 2432
Signal Generator**

**FM AND TELEVISION BAND COVERAGE ON STRONG HARMONICS
STRONG FUNDAMENTALS TO 50 (MC)**

Another member of the Triplet Square Line of matched units this signal generator embodies features normally found only in "custom priced" laboratory models.

FREQUENCY COVERAGE—Continuous and overlapping 75 KC to 50 MC. Six bands. All fundamentals. **TURRET TYPE COIL ASSEMBLY**—Six-position turret type coil switching with complete shielding. Coil assembly rotates inside a copper-plated steel shield. **ATTENUATION**—Individually shielded and adjustable, by fine and course

controls, to zero for all practical purposes. **STABILITY**—Greatly increased by use of air trimmer capacitors, electron coupled oscillator circuit, and permeability adjusted coils. **INTERNAL MODULATION**—Approximately 30% at 400 cycles. **POWER SUPPLY**—115 Volts, 50-60 cycles A.C. Voltage regulated for increased oscillator stability. **CASE**—Heavy metal with tan and brown hammered enamel finish.

There are many other features in this beautiful model of equal interest to the man who takes pride in his work.



Triplet

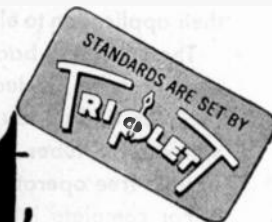

ELECTRICAL INSTRUMENT CO. BLUFFTON, OHIO



Impromptu Discussions about Miniature Tubes



Of course I'm using a TUNG-SOL Miniature Power Amplifier in this circuit. You can get them now for a wide range of radio receiver applications. They all have high efficiency beam construction and provide for maximum Class A. power output ranging from $\frac{1}{4}$ to $4\frac{1}{2}$ watts. You'll find that miniatures generally give even better performance than the big ones.

Take the TUNG-SOL 50B5 for example. It's designed as the miniature tube equivalent of type 50L6GT. It's outstanding for its power sensitivity and adaptability to AC/DC circuits. In the 50B5 this high performance standard has been maintained with a volume displacement of less than 30%

of the 50L6GT. With the same internal dissipation, the bulb operating temperatures are higher in the smaller envelope but, several type 50B5 tubes may be safely operated in an enclosed cabinet with an ambient temperature as high as 150° centigrade.

Small physical size of the 50B5 and ability to perform in "transformerless" circuits permits unusual applications. Power outputs as high as 1.9 watts afford ample volume for intercommunication systems. Its ability to deliver 130 milliamperes of peak plate current with 5.25 rms. volts signal may suggest use as a trigger tube or to operate control relays.

Either as a tetrode or triode, its transconductance of 7500 umhos means high circuit efficiency. Even though it is designed as a Class A power amplifier, the 50B5 may be adaptable to certain oscillator applications at low and medium frequencies.

If you want the real low down on this or other unusual applications, write to the TUNG-SOL Commercial Engineering Department. You see those fellows are only interested in tubes. They aren't set builders. Your consultations with them are held in strictest confidence.



TUNG-SOL
vibration-tested
ELECTRON TUBES

TUNG-SOL LAMP WORKS INC., NEWARK 4, NEW JERSEY
Sales Offices: Atlanta • Chicago • Dallas • Denver • Detroit • Los Angeles • New York
Also Manufacturers of Miniature Incandescent Lamps, All-Glass Sealed Beam Headlight Lamps and Current Intermittors

More and More 250 Watt Stations

are being powered by Raytheon

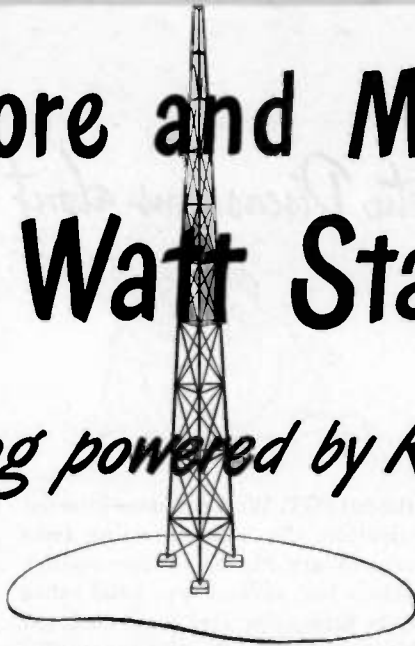

Here's the AM Transmitter that small-station owners are turning to...for its dependable, simpler circuits...its advanced design...its modern, "dress-up" beauty!

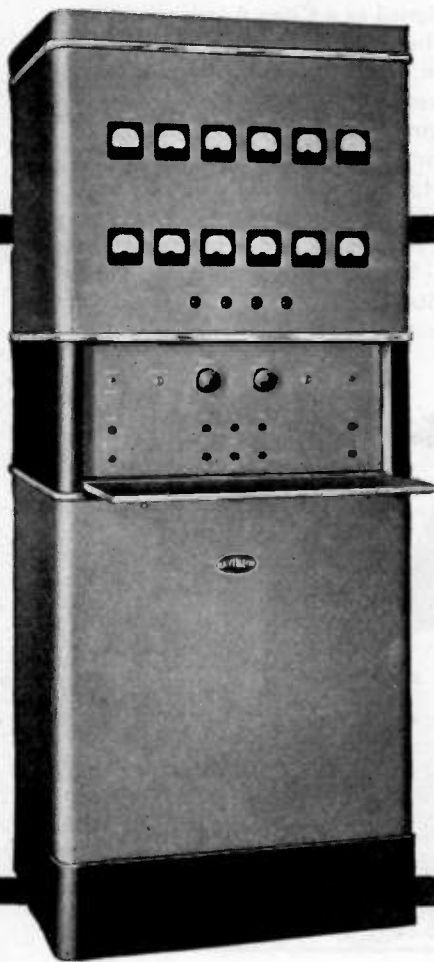

HERE'S WHAT THE SMALL STATION NEEDS!

... Study these RAYTHEON features before you choose any transmitter, for replacement or new installation.

1. **Simplified, More Efficient Circuits**—A high level modulation system eliminates necessity of complicated and critical adjustment of linear amplifiers and minimizes harmonic distortion.
2. **Increased Operating Efficiency**—The use of the most modern improved components which are operated at well below their maximum capacity together with simplified circuit design greatly increases overall operating efficiency.
3. **Greater Dependability**—Due to the use of Triode type tubes, feedback failure will not cause a complete breakdown and the signal quality will still be good. Cooled by natural convective air currents, it is not subject to damage or fire caused by a blower failure.
4. **Simple, Speedy and Accurate Tuning**—All operational controls are centralized on the front panel; every circuit is completely metered and instantly checked. A clutch-equipped low-speed motor makes micrometer adjustment of the two tuned stages very easy.
5. **No Buffer Stage Tuning**—The use of a Video type amplifier in the buffer stage eliminates this complicated tuning.
6. **Silent Operation**—Natural air cooling means no blower noise, permits microphones in same room with transmitter.
7. **Low Audio Distortion**—Triode type tubes used in the audio stages have inherently lower distortion level. Specially designed audio transformers reduce audio distortion still further.
8. **Easy Servicing**—Vertical chassis, symmetrical mechanical layout and complete accessibility through double rear doors and hinged side panels make the RA-250 a favorite.
9. **Easily Meets All F.C.C. Requirements**—All electrical characteristics are well within the F.C.C. requirements. Noise level is -60 db below 100% modulation. Frequency response ± 1 db from 30 to 10,000 cycles per second.

ANNOUNCED only a few short months ago, the Raytheon 250 Watt AM transmitter has already won its way into the forefront of small station broadcasting. Presented as a transmitter of unsurpassed design, unsurpassed styling and unsurpassed engineering excellence, it has proved its claims on all three points. Visitors exclaim over its strik-

ing, modern beauty... beauty that gives a "show-place" air to any station. Station owners are delighted with its dependable performance... its silent operation... and the high fidelity signal it puts on the air.

Before you select a 250 Watt transmitter, be sure you possess *all* the facts. Write or wire for our specification bulletin.



Excellence in Electronics

RAYTHEON MANUFACTURING COMPANY

Broadcast Equipment Division, 7517 No. Clark Street, Chicago 26, Illinois

DEVOTED TO RESEARCH AND MANUFACTURE FOR THE BROADCASTING INDUSTRY

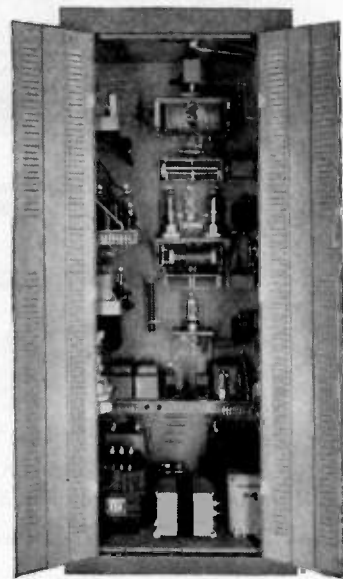



LS SERIES

The Ultimate in Quality

UTC Linear Standard Audio Transformers represent the closest approach to the ideal component from the standpoint of uniform frequency response, low wave form distortion, high efficiency, thorough shielding and utmost dependability. Wartime restrictions having been lifted, and UTC production running at full capacity, we now offer these transformers for immediate delivery.



UTC Linear Standard Transformers feature...

- **True Hum Balancing Coil Structure** . . . maximum neutralization of stray fields.
- **Balanced Variable Impedance Line** . . . permits highest fidelity on every tap of a universal unit . . . no line reflections or transverse couplings.
- **Reversible Mounting** . . . permits above chassis or sub-chassis wiring.
- **Alloy Shields** . . . maximum shielding from induction pickup.
- **Multiple Coil, Semi-Toroidal Coil Structure** . . . minimum distributed capacity and leakage reactance.
- **Precision Winding** . . . accuracy of winding .1%, perfect balance of inductance and capacity; exact impedance reflection.
- **Hiperm-Alloy** . . . a stable, high permeability nickel-iron core material.
- **High Fidelity** . . . UTC Linear Standard Transformers are the only audio units with a guaranteed uniform response of ± 1.5 DB from 20-20,000 cycles.

For Immediate Delivery

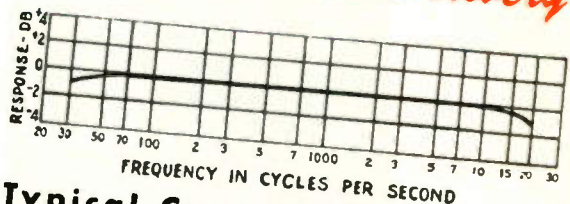

Typical Curve for LS Series

Type No.	Application	Primary Impedance	Secondary Impedance	Max. Level	Relative hum-pickup reduction	Max. unbalanced DC in primary	List Price
LS-10	Low impedance mike, pick-up, or multiple line to grid.	50, 125, 200, 250 333,500 ohms	60,000 ohms in two sections				
LS-10X	As above	As above	50,000 ohms	+15 DB	-74 DB	5 MA	\$22.50
LS-21	Single plate to push pull grid:	8,000 to 15,000 ohms	135,000 ohms; turn ratio 1.5:1 each side. Split Pri. and Sec.	+14 DB	-92 DB	5 MA	\$28.10
LS-30	Mixing, low impedance mike, pickup, or multiple line to multiple line	50, 125, 200, 250 333, 500 ohms	50, 125, 200, 250, 333, 500 ohms	+14 DB	-74 DB	0 MA	\$21.25
LS-30X	As above	As above	As above	+17 DB	-74 DB	5 MA	\$22.50
LS-50	Single plate to multiple line	8,000 to 15,000 ohms	As above	+15 DB	-92 DB	3 MA	\$28.10
LS-55	Push pull 2A3's, 6ASG's, 300A's, 275A's, 6A3's	5,000 ohms plate to plate and 3,000 ohms plate to plate	500, 333, 250, 200, 125, 50, 30, 20, 15, 10, 7.5, 5, 2.5, 1.2	+17 DB	-74 DB	1 MA	\$21.25
LS-57	Same as above	5,000 ohms plate to plate and 3,000 ohms plate to plate	30, 20, 15, 10, 7.5, 5, 2.5, 1.2	+36 DB			\$25.00
				+36 DB			\$17.50

The above listing includes only a few of the many units of the LS Series. For complete listing - write for catalogue.



United Transformer Corp.

150 VARICK STREET

EXPORT DIVISION: 13 EAST 40th STREET, NEW YORK 16, N. Y.

NEW YORK 13, N. Y.

CABLES: "ARLAB"



Crystal detector—1946 model

ONE INCH

ENLARGED
8 TIMES

Remember the crystal detector in the first radios — hunting for the right spot with a cat's whisker? For years the detector lay discarded in favor of the vacuum tube. But when microwaves came, and with them the need to convert minute energy to amplifiable frequencies, a Bell Laboratories' scientist thought back to the old crystal.

Silicon of controlled composition, he discovered, excelled as a microwave detector. Unlike the old-style natural crystals, it was predictable in performance, stable in service. From 1934 to Pearl Harbor, the Laboratories developed silicon units to serve microwave research wherever needed.

Then Radar arrived. The silicon crystal came into its own, and found application in long-distance microwave Radar. Working with American and British colleagues, the Laboratories rapidly perfected a unit which the Western Electric Company produced in thousands. It became the standard microwave detector.

Crystal detectors are destined to play a big role in electric circuits of the future. They will have an important part in Bell System microwave radio relay systems. In various forms, they may reappear in radio sets. Here again Bell Laboratories' research has furthered the communication art.

BELL TELEPHONE LABORATORIES



EXPLORING AND INVENTING, DEVISING AND PERFECTING FOR CONTINUED ECONOMIES AND IMPROVEMENTS IN TELEPHONE SERVICE



LABORATORY INSTRUMENTS FOR SPEED AND ACCURACY

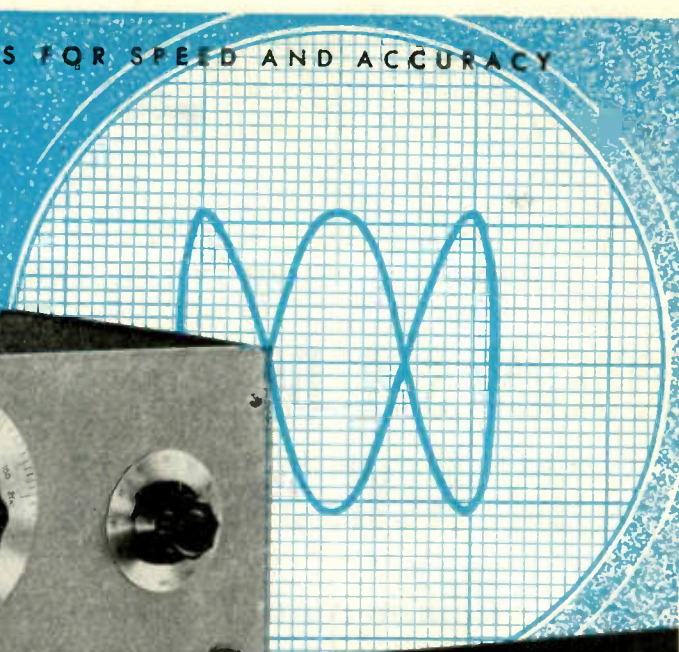

dependable measurements assured

**OTHER OUTSTANDING
-hp- INSTRUMENTS**

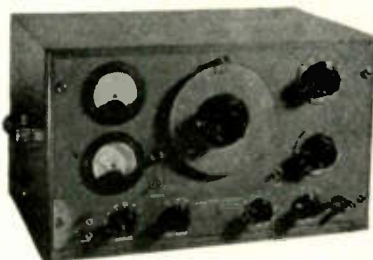

**-hp- MODEL 205AG
AUDIO SIGNAL GENERATOR**

Frequency range—20 cps to 20 kc
Power output—5 watts
Output impedance—50, 200, 500, and
5000 ohms, all ct



**-hp- MODEL 2001
SPREAD SCALE AUDIO OSCILLATOR**

Frequency range—6 cps to 6 kc
Hair-line tuning, no parallax
Effective scale length nearly eight feet

**-hp- system of hand calibration
guarantees accuracy of AF oscillators**

The calibration of every -hp- Resistance Tuned Oscillator is guaranteed accurate to within 2%—a guarantee that is possible only because of the high inherent stability of these instruments. To exploit this stability to the utmost, each -hp- oscillator is hand-calibrated using an extremely accurate technique.

The frequency source used in this procedure is the Model 100B Secondary Frequency Standard. This provides frequencies of 100 cps, 1000 cps, and 10,000 cps, accurate to within 0.001%. By frequent comparison with U. S. Bureau of Standards Station WWV this accuracy is increased to within 0.0002%.

The output of the oscillator under test is compared with these standard frequencies by means of a cathode-ray

oscilloscope. Using Lissajous figures of high order a large number of calibration points are established over the entire frequency range; the Model 2001 Spread-Scale Audio Oscillator, for example, has a total of 277 calibration points.

Individual hand-calibration is but one of the many precautions taken to insure the dependability and accuracy of -hp- oscillators. Rugged mechanical design maintains the calibration. Careful layout minimizes temperature effects. Unique circuit arrangements assure high stability.

Ten models are available, covering the frequency-range from 2 cps to 200 kc, and with various power outputs and impedance terminations. Write today for full technical information.



HEWLETT-PACKARD COMPANY

1200D PAGE MILL ROAD, PALO ALTO, CALIFORNIA, U.S.A.

Audio Frequency Oscillators Signal Generators Vacuum Tube Voltmeters
Noise and Distortion Analyzers Wave Analyzers Frequency Meters
Square Wave Generators Frequency Standards Attenuators Electronic Tachometers

SYLVANIA NEWS

CIRCUIT ENGINEERING EDITION

SEPT.

Prepared by SYLVANIA ELECTRIC PRODUCTS INC., Emporium, Pa.

1946

MODERN SET DESIGN SEEN GREATLY INFLUENCED BY NEW SYLVANIA ELECTRIC T-3 TUBE

*Commercial Version of Proximity Fuze Tube
Is Tiny, Rugged, Has Long Life*

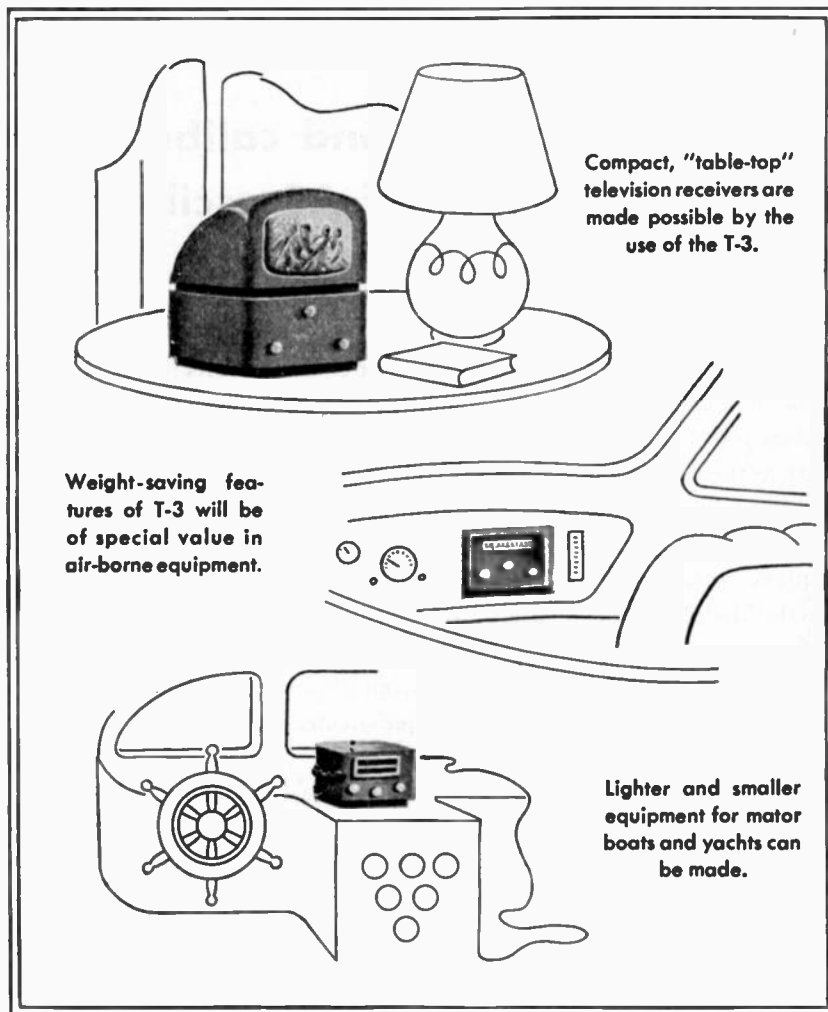

Radio equipment manufacturers are viewing with marked interest the radical reductions in size and weight now made possible in many types of electronic equipment through the use of the sensationally small Sylvania vacuum tube, T-3.

The commercial version of the former proximity fuze transceiver tube is noted for exceptional ruggedness... long life... ideal suitability for high frequency operation.

Some of the design possibilities opened by the T-3 are shown here. Of course, its potentialities are not limited to these fields.

Write Sylvania Electric Products Inc., Emporium, Pa.

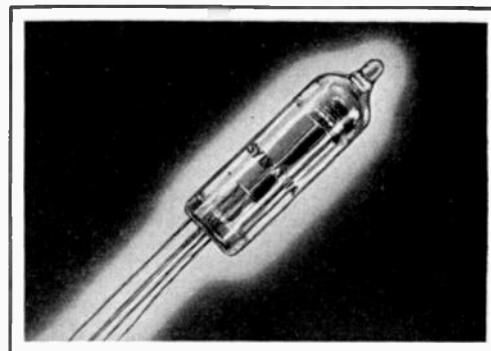

The T-3 tube is shown here in its actual size.

SYLVANIA ELECTRIC

Emporium, Pa.

MAKERS OF RADIO TUBES; CATHODE RAY TUBES; ELECTRONIC DEVICES; FLUORESCENT LAMPS, FIXTURES, WIRING DEVICES; ELECTRIC LIGHT BULBS

here's the
true operator's
transmitter

-----BACKED BY THE
OPINIONS OF FM OPERATORS
IN 56 CITIES IN 22 STATES

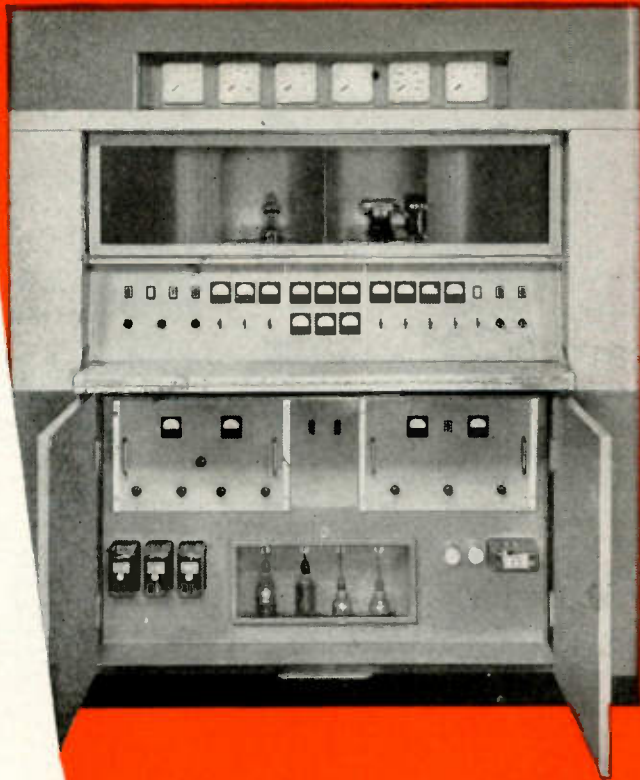

Smartly styled FM transmitters (in two-tone blue and grey) are built in lightweight aluminum cubicles to facilitate portability and rapid installation.



Here's the answer to many of your hopes . . . an FM transmitter packed with the features you want most, as revealed by an extensive survey among station owners and operators throughout the country.

In this survey, 96% wanted a roomy transmitter . . . one with complete, fast and easy accessibility. This important feature shows up in many ways in the Westinghouse FM transmitters:

Example: you can service any tube quickly from easily-opened front panels.

Example: high-voltage rectifier tubes can be checked visually, any time, through glass panels.

Example: oscillator-driver-audio and center frequency control units are built on standard relay rack chassis and equipped with plug-in

connectors for easy removal.

Making your job easy is a keynote of the entire Westinghouse FM design. Meters and indicating instruments are at eye level. All overload protection is fuseless. And to place the transmitter in operation it is only necessary to connect the audio input, r.f. transmission line and input power supply.

This improved design is the product of another vital fact: the unmatched experience of Westinghouse engineers in actual station operation of five FM and six AM stations. Get the facts today from your nearest Westinghouse office. Westinghouse Electric Corporation, P. O. Box 868, Pittsburgh 30, Pennsylvania.

J-02082-A



This new book gives you the complete picture story of the operating advantages built into Westinghouse transmitters and the way operators approved them. Ask for your copy of B-3829.

Westinghouse
PLANTS IN 25 CITIES . . . OFFICES EVERYWHERE



Electronics at Work

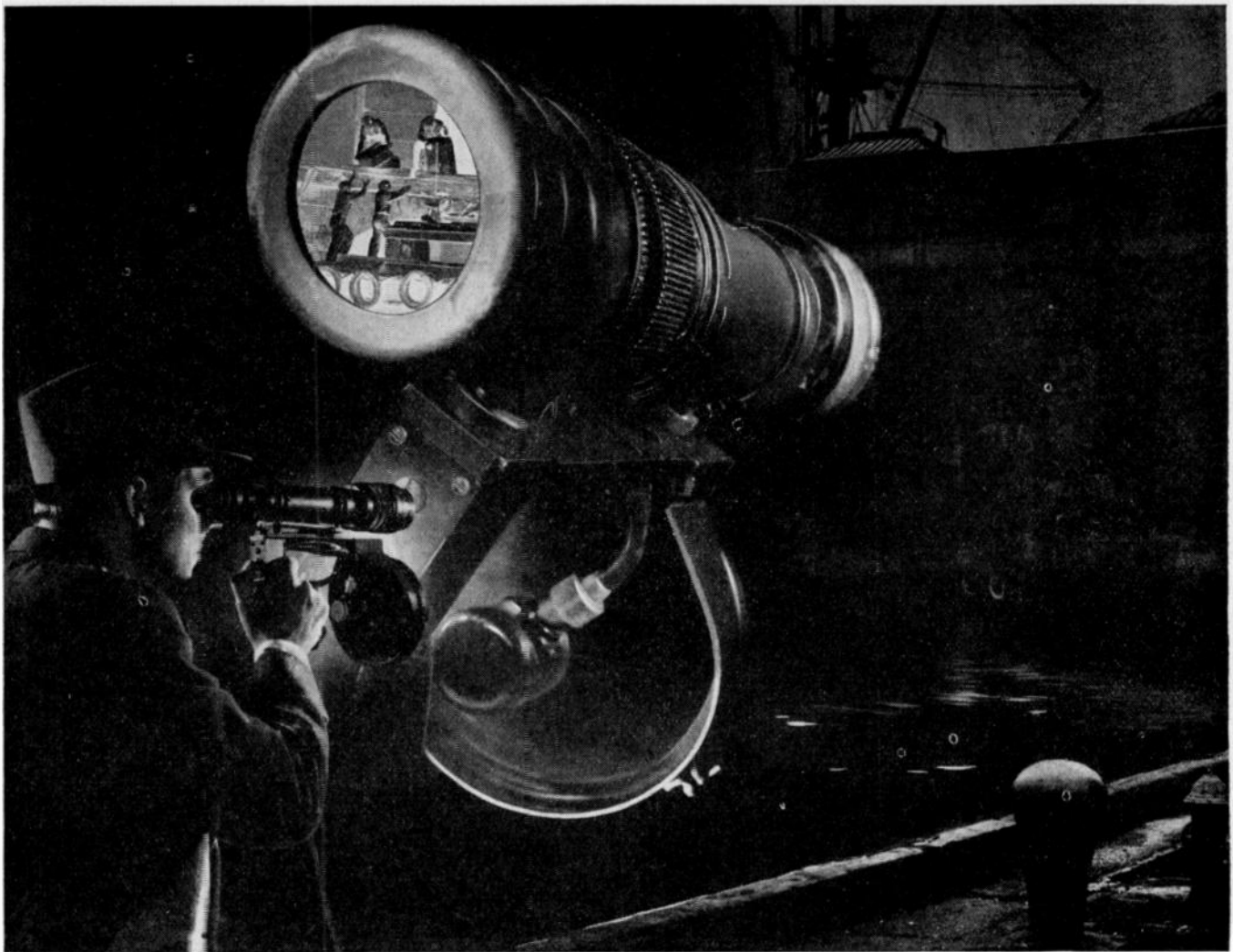

Hobbery at the waterfront—detected and observed in total darkness through the amazing infrared ray "snooperscope."

"Snooperscope"—sees at night

with invisible light!

Crime detection is one of the many uses for this uncanny telescope that can distinguish objects more than a quarter of a mile away in a complete blackout.

The sniperscope and snooperscope are two wartime developments of RCA Laboratories in co-operation with the U. S. Army which are now being converted to civilian, industrial and police uses.

These instruments were made possible through a tiny image tube less than two inches in diameter and less than five inches long. Adapted to various military equipment, these telescopes provided the Army with some of its best night-fighting

devices. A helmet-mounted binocular employing these image tubes enabled scout cars to speed over roads at 40 to 50 miles an hour without lights.

The same engineering skill that produced the snooperscope is reflected in every RCA and RCA Victor product—whether it is a Victrola* radio-phonograph, made exclusively by RCA Victor, or a television receiver, or a radio tube. If it's an RCA, it is one of the finest instruments of its kind science has achieved.

Radio Corporation of America, RCA Building, Radio City, New York 20. Listen to The RCA Victor Show, Sundays, 2:00 P. M., Eastern Daylight Time, over NBC Network.



The "Sniperscope." Here our infrared telescope is mounted on a carbine. The combination was aptly called a "sniperscope" for it enabled a soldier in total darkness to hit a target the size of a man at 75 yards. Thirty per cent of the Japanese casualties during the first three weeks of the Okinawa campaign were attributed by the Army to this amazing sniperscope.



RADIO CORPORATION of AMERICA

*Victrola T. M. Reg. U. S. Pat. Off.

**16
words
per
second**

and never a slip for this fast, recording team

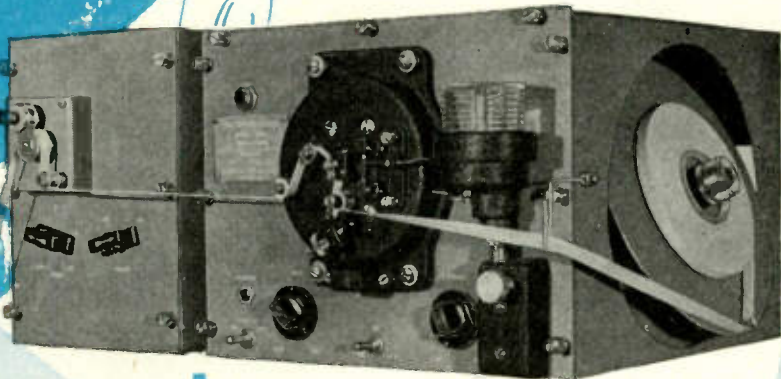

A PRESS WIRELESS *Recording Achievement*



This variable Tape Puller has been designed for use with the Press Wireless Ink Tape Recorders. They are built as separate equipment fully enclosed. The Tape Puller has a speed that is continuously variable from 5 to 1,000 words-per-minute. Drive mechanism is extremely smooth in operation. No gears or clutch need be changed to cover operating range. Unique coupling system affords long life to the rotating members. Under light or no load a minimum of pressure is exerted on the friction drive. As the load increases, the friction automatically increases to compensate.



Simply, yet expertly engineered, the Model ITR-2 more than meets all requirements of high-speed recording. This automatic ink tape recorder can rapidly transcribe code signals at rates up to 1,000 word per minute. A slender, hollow stylus, actuated by the incoming tone signal, from a receiver or land-line, records the message in the form of inked square wave pulses on a narrow paper tape. Used in conjunction with the Variable Tape Puller, VTP-11, the ITR-2 forms a *Press Wireless* Recording team that is a "must" for any automatic receiving assembly.

FEATURES

- Operation from 115 volt, 50/60 cycles, A.C.
- Power switch: D.P.S.T. to permit cross connection of the STAND-BY switch of the Recorder
- Terminals: An A.C. female and male outlet are located on the rear of the unit
- Power cord: Six-foot A.C. cord with a female connector at one end and a male connector on the other end
- Modern finish: Smooth, grey enamel
- Dimensions: 10 inches high, 7 1/4 inches wide, 12 1/4 inches deep (in cabinet).

FEATURES

- Simplicity of controls and ease of adjustment
- Power requirements: 115 volts 50/60 cycles, A.C. 150 watts
- Terminals INPUT: A.C. female and male outlets located on rear of unit
- Power cord: Six-foot A.C. cord with a female connector at one end and a male connector at the other end
- Cabinet mounting
- Modern finish: Smooth, grey enamel
- Dimensions: 10 inches high, 15 inches wide, 12 inches deep.



For complete information on these units and other Press Wireless communications equipment write to:

PRESS WIRELESS MANUFACTURING CORP.

Executive offices: 1475 Broadway, New York 18, N.Y. Cable Address: PRESSRAD NEWYORK



Quick Facts On SUPERIOR VOLTAGE CONTROL

for the
**DESIGN
ENGINEER**

BULLETIN 150...

Contains twelve terse, factual-laden pages of valuable data on the standard line of Superior Electric voltage control equipment. All information has been brought up to date wherever design, electrical or mechanical features have been improved to meet more exacting requirements.

Apparatus described in this bulletin includes all types of POWERSTAT variable transformers, SECO Automatic Voltage Regulators and VOLTBOX a-c power supplies. Operating and electrical characteristics are clearly shown by charts and schematic diagrams. Every design engineer, laboratory technician, and purchasing agent needs the product information contained in Bulletin 150.

Write Dept. ER for your copy today.

**THE SUPERIOR
ELECTRIC COMPANY
BRISTOL, CONNECTICUT**

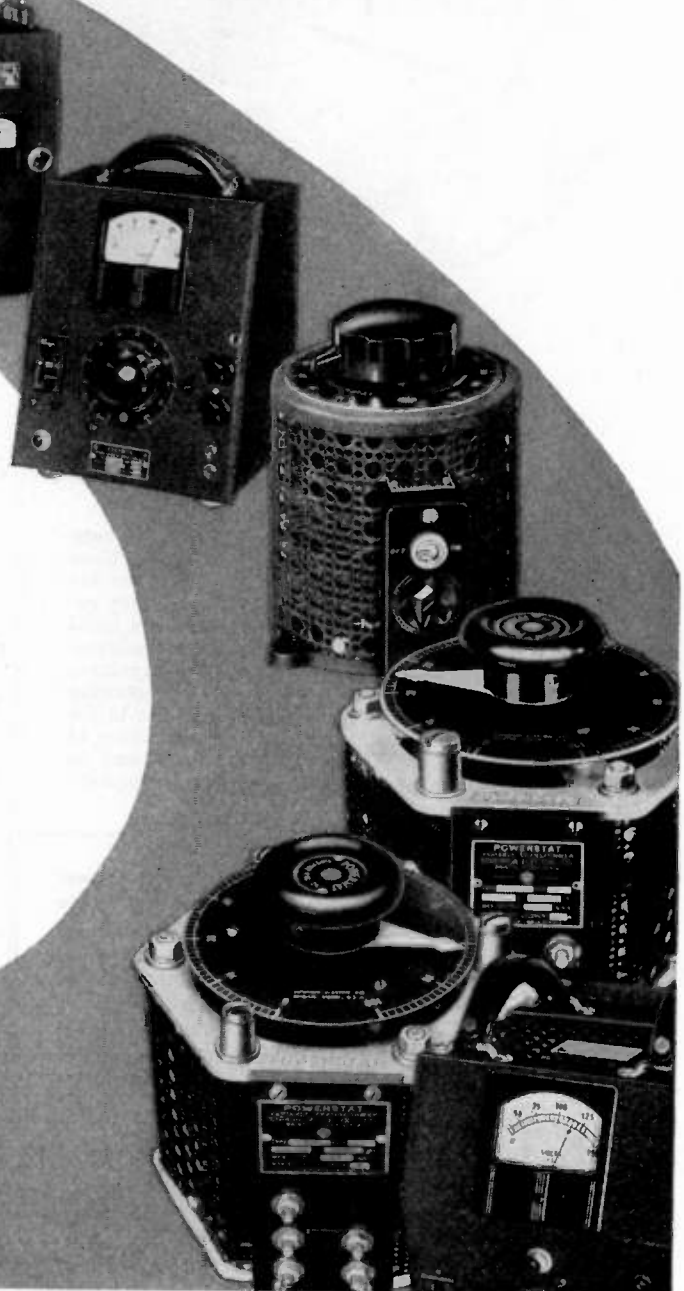

It's PRECISION PLUS

IN MICROWAVE ACCESSORIES

The **PLUS-VALUE** in all A.R.C. equipment is the know-how, the background of knowledge and experience, that makes this equipment outstanding

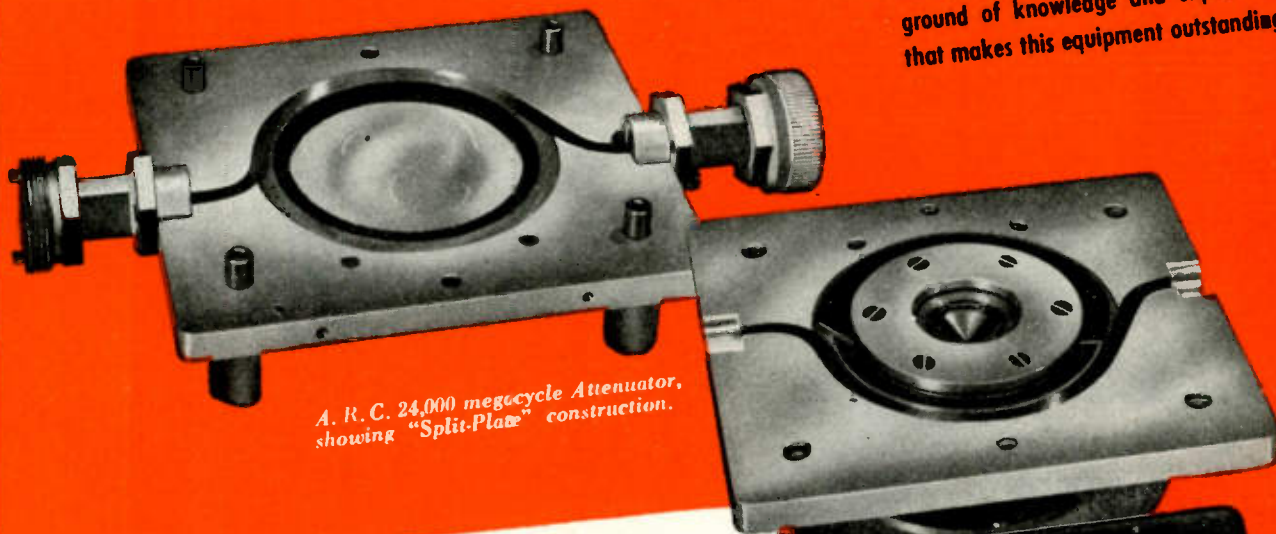

A. R. C. 24,000 megacycle Attenuator, showing "Split-Plate" construction.



A.R.C. "Magic Tee" — a specialized item of Microwave Plumbing designed and manufactured to the highest standards of precision.

A.R.C. Directional Coupler—another product reflecting in the accuracy of its construction the precision methods employed by A.R.C.



NOW AVAILABLE: free, illustrated catalog of A.R.C. Radio and Electronic Component Parts and Accessories.

The ever-increasing importance of microwave transmission in the field of electronic navigation, communication, and industrial controls turns the spotlight on the A.R.C. line of equipment and accessories to serve this field.

The A.R.C. 24,000 megacycle attenuator with its unique "split-plate" construction typifies the quality of A.R.C. design and manufacture. This design (patent pending) permits the machin-

ing of the wave-channel to an accuracy impossible to achieve through other methods of construction, while the jointure of the plates themselves is so precise as to leave no possibility of leakage and loss.

A complete line of A.R.C. Microwave Accessories is available. For full details on these and other A.R.C. Radio and Electronic Component Parts, write:



AIRCRAFT RADIO CORPORATION
708 MAIN STREET
BOONTON, NEW JERSEY



HERE THEY COME!



THE NEW
S-38's
4 Bands—540 kc. to 32 Mc.

\$39.50
 ADD 3%
 IN
 ZONE 2

The Model S-38 meets the demand for a truly competent communications receiver in the low price field. Styled in the post-war Hallicrafters pattern and incorporating many of the features found in more expensive models, the S-38 offers performance and appearance far above anything heretofore available in its class. Four tuning bands, CW pitch control adjustable from the front panel, automatic noise limiter, self-contained PM dynamic speaker and "Airodized" steel grille, all mark the S-38 as the new leader among inexpensive communications receivers.

FEATURES

1. Overall frequency range—540 kilocycles to 32 megacycles in 4 bands.
 Band 1—540 to 1650 kc.
 Band 2—1.65 to 5 Mc.
 Band 3—5 to 14.5 Mc.
 Band 4—13.5 to 32 Mc.
 Adequate overlap is provided at the ends of all bands.
2. Main tuning dial accurately calibrated.
3. Separate electrical band spread dial.
4. Beat frequency oscillator, pitch adjustable from front panel.
5. AM/CW switch. Also turns on automatic volume control in AM position.
6. Standby/receive switch.
7. Automatic noise limiter.
8. Maximum audio output—1.6 watts.
9. Internal PM dynamic speaker mounted in top.
10. Controls arranged for maximum ease of operation.
11. 105-125 volt AC/DC operation. Resistor line cord for 210-250 volt operation available.
12. Speaker/phones switch.

CONTROLS: SPEAKER/PHONES, AM/CW, NOISE LIMITER, TUNING, CW PITCH, BAND SELECTOR, VOLUME, BAND SPREAD, RECEIVE/STANDBY.

EXTERNAL CONNECTIONS: Antenna terminals for doublet or single wire antenna. Ground terminal. Tip jacks for headphones.

PHYSICAL CHARACTERISTICS: Housed in a sturdy steel cabinet. Speaker grille in top is of airodized steel. Chassis cadmium plated.

SIX TUBES: 1—12SA7 converter; 1—12SK7 IF amplifier; 1—12SQ7 second detector, AVC, first audio amplifier; 1—12SQ7 beat frequency oscillator, automatic noise limiter; 1—35L6GT second audio amplifier; 1—35Z5GT rectifier.

OPERATING DATA: The Model S-38 is designed to operate on 105-125 volts AC or DC. A special external resistance line cord can be supplied for operation on 210 to 250 volts AC or DC. Power consumption on 117 volts is 29 watts.



hallicrafters RADIO

THE HALLICRAFTERS CO., MANUFACTURERS OF RADIO AND ELECTRONIC EQUIPMENT, CHICAGO 16, U. S. A.

DE MORNAY • BUDD STANDARD TEST EQUIPMENT

For Precision Measurements in the Microwave Field

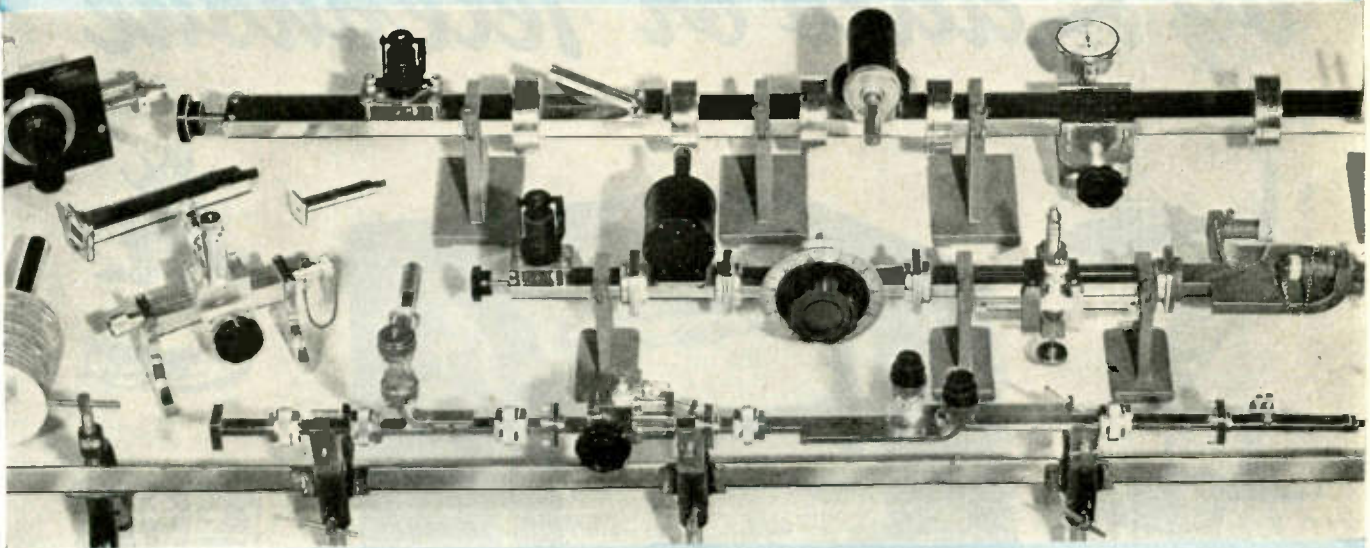

The complete line of De Mornay • Budd standard test equipment covers the frequency range from 4,000 mcs. to 27,000 mcs. It provides all R. F. waveguide units necessary for delicate, precision test work requiring extremely high accuracy in attenuation measurements, impedance measurements, impedance matching, calibration of directional couplers, VSWR frequency measurements, etc.

To eliminate guesswork, each item of this De Mornay • Budd test equipment is individually tested and, where necessary, calibrated, and each piece is tagged with its electrical characteristics. All test equipment is supplied with inner and outer surfaces gold plated unless otherwise specified.

Our greatly expanded microwave research facilities are at your disposal for consultation.

The three test set-ups illustrated above include:

Tube Mount
Flap Attenuator
Frequency Meter
Calibrated Attenuator
Tee
Stub Tuner

Tunable Dummy Load
Standing Wave Detector
Type "N" Standing Wave Detector
Directional Coupler
High Power Dummy Load
Cut-Off Attenuator

Stands, etc.

DE MORNAY
BUDD



EQUIPMENT
FOR
97% OF ALL
RADAR SETS

DE MORNAY • BUDD INC., 475 GRAND CONCOURSE, NEW YORK 51, NEW YORK. CABLE ADDRESS "DEMBUD," N. Y.

FINCH FACSIMILE TELEFAX MEANS

PICTURES and WRITING

by Radio or Telephone



FINCH FACSIMILE TELEFAX GIVES — to government, private business, public utilities and *individual homes* — a means of high-speed communication never before equalled for convenience, flexibility and dependability.

The two-way Telefaxer shown above — and now in production and use commercially — transmits and/or receives, by radio, 2760 square inches of pictures and text per hour or about 30,000 words — without one error! The speed by telephone reaches 918 square inches per hour. Definition is high and accuracy absolute.

The strong Finch patents assure to Finch customers the maximum of service, quality and protection. Write for full particulars.

FINCH TELECOMMUNICATIONS, INC. • PASSAIC, N. J.
Address All Correspondence to Sales Office: 10 E. 40 St., New York 16, N. Y.
Mfrs. also of the Finch Rocket Antenna for FM stations

**finch**

First in Facsimile

ANOTHER **FIRST** FOR **PRESTO**

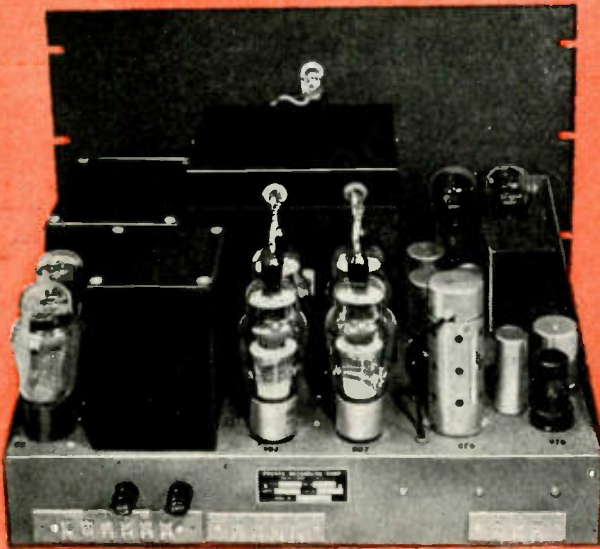

PRESTO 88-A amplifier has three calibrated frequency response curves...one flat from 30 to 17,000...two with rising high frequency characteristics complement either the NBC "Orthacoustic" playback system or standard high fidelity transcription playback equipment.

88-A RECORDING AMPLIFIER



THE *FIRST* recording amplifier capable of standardizing frequency response of instantaneous recordings so that they will complement the characteristics of high fidelity reproducing equipment now used in most broadcasting stations.

Instantaneous recordings made with the 88-A amplifier and the Presto 1-C cutting head equal the response of the finest commercial recordings and reproduce uniformly a range from 50 to 9,000 cps.

Ample reserve power makes it possible to obtain complete groove modulation at all cutting pitches without distortion. Delivery 30 days after order.



RECORDING CORPORATION
242 West 55th Street, New York 19, N. Y.
WALTER P. DOWNS, LTD., in Canada

WORLD'S LARGEST MANUFACTURER OF INSTANTANEOUS SOUND RECORDING EQUIPMENT



Be Right with.. OHMITE

Vitreous Enameled Rheostats

Available in 10 sizes, ranging from 25 to 1000 watts, in a wide range of resistances. Ceramic parts insulate the shaft and mounting. The resistance winding is permanently locked in vitreous enamel. The metal-graphite brush provides unmatched smoothness of action. Engineered and constructed for long, trouble-free life.

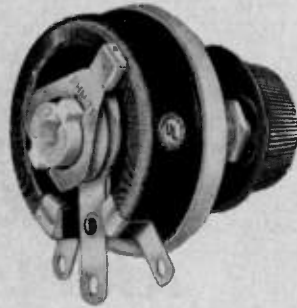

Non-Inductive Resistors

Used as dummy antennas for radio transmitters, load resistors in high frequency circuits, and terminating resistors for radio antennas. Available in vitreous-enamel type wound on a tubular ceramic core and in hermetically sealed-in-glass type mounted on a 4-prong steatite tube base. Sizes from 50 to 250 watts.



All Ceramic Tap Switches

A popular switch for use with tapped transformers in power supply units. Compact, dependable, and convenient to operate. Available in ratings of 10, 15, 25, 50, and 100 amperes, A.C. Contacts are of the silver-to-silver, non-shorting type. Switch shaft is insulated by a strong ceramic hub. The heavy, one-piece ceramic body is unaffected by arcing.



Parasitic Suppressor

Designed for the suppression of unwanted ultra-high frequency parasitic oscillations due to incidental resonance between tube plate and grid circuits of push-pull and parallel operated transmitting amplifiers. Consists of a 50-ohm vitreous enameled non-inductive resistor which supports a choke of 0.3 microhenries and .003 ohms d-c resistance.

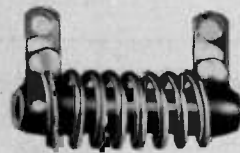

Radio Frequency Plate Chokes

For use in the plate circuits of diathermy oscillators and amateur, aviation, police, and commercial short wave transmitters. Consists of a single layer winding on a steatite core, rigidly held in place, insulated and protected by a moisture-proof coating. Rated at 1 ampere.

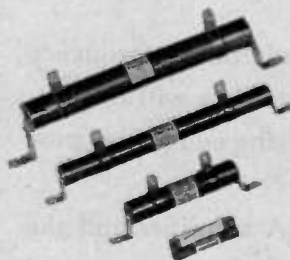

Wire Wound Resistors

Ohmite offers a complete line of dependable resistors wound on a ceramic tube and protected by vitreous enamel. Ratings from 10 to 200 watts. Available in the fixed type for general use, and in the "Dividohm" type with adjustable lugs for use as a multi-tap resistor or voltage divider.

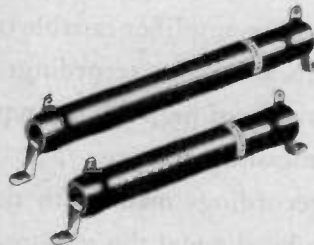

OHMITE MANUFACTURING CO., 4861 Flournoy St., Chicago 44, U. S. A.

OHMITE

Write on Company Letterhead for Catalog and Engineering Manual No. 40.

Provides 96 pages of useful data on the selection and application of rheostats, resistors, tap switches, chokes, attenuators, and other equipment.



RHEOSTATS RESISTORS TAP SWITCHES CHOKES

Save audio power

WITH THE MS-92A

Eliminate multiple audio outputs from receivers — eliminate separate interphone amplifiers. Flight engineered to Bendix Radio's rigid performance requirements, the MS-92A is a new type of audio selector jack box having an attenuation network which reduces coupling between a multiplicity of selected receivers.

It permits simultaneous reception of a variety of receivers by a number of crew members without interference due to audio coupling between the receivers—multiple audio outputs from each receiver no longer required.

Desired signals from the attenuation network are returned to original level by use of an amplifier inside the box. This amplifier, which also serves as interphone amplifier, uses a type 28D7 tube with filament and plates operating entirely from 28 v.d.c. A front panel masking plate may be engraved per customer's order, permitting unlimited flexibility in use of the jack box with any desired complement of receiving or transmitting equipment. The MS-92A Jack Box is fully approved by the CAA for scheduled air carrier aircraft installation.

BENDIX RADIO DIVISION • TOWSON 4, MARYLAND

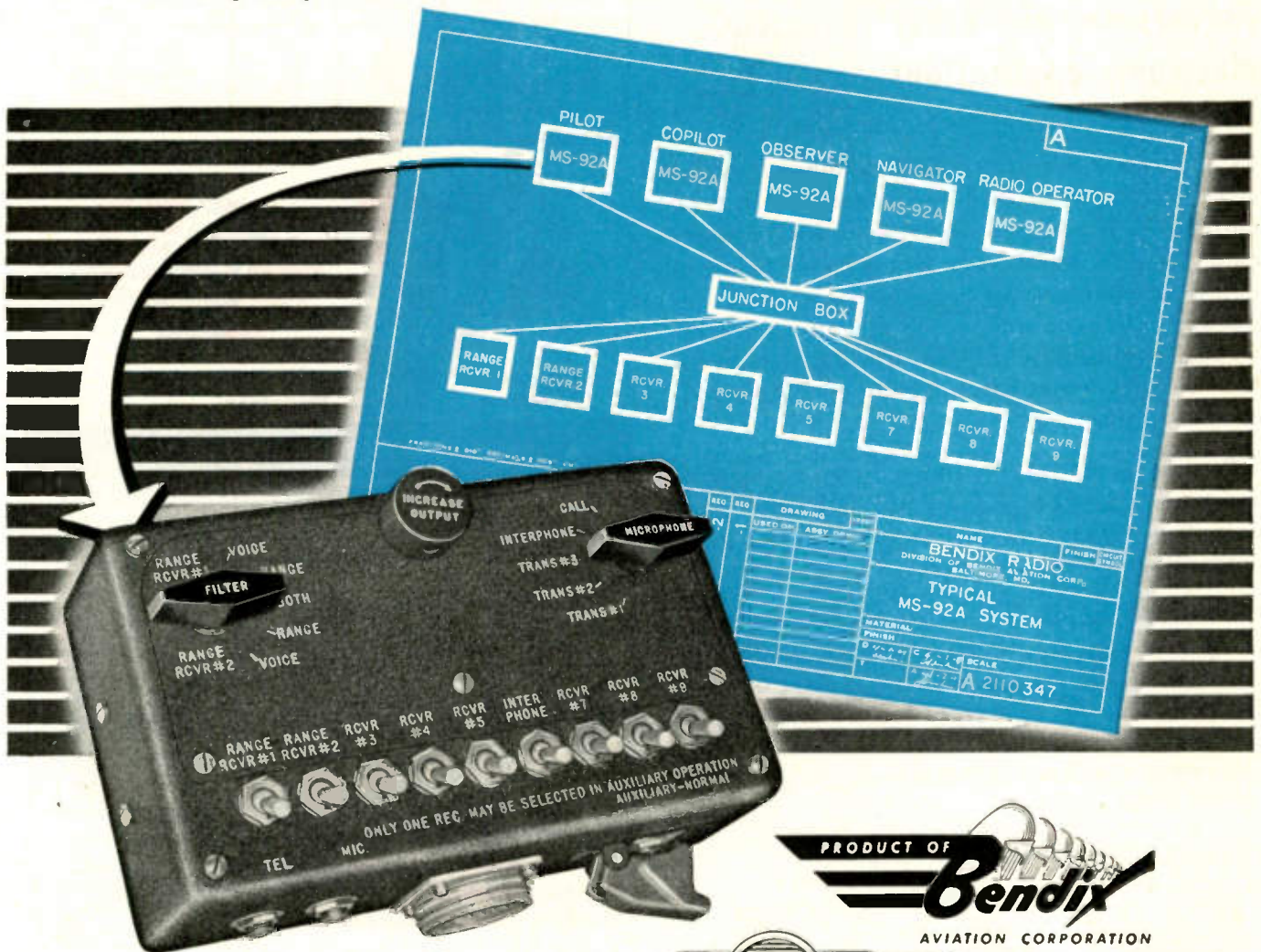

BENDIX RADIO

STANDARD FOR THE AVIATION INDUSTRY

Look to
RCA
for a comprehensive line of
*Industrial Electron
Tubes*

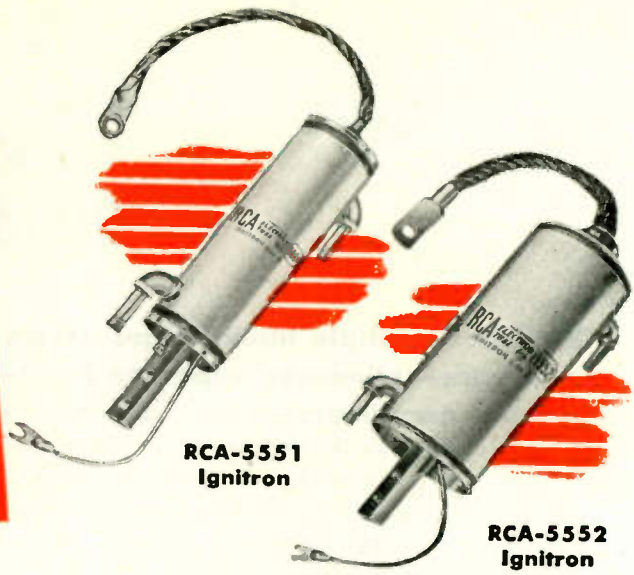

**RCA-5551
Ignitron**

**RCA-5552
Ignitron**

**Featuring types for
welding and motor control, power
conversion, and other industrial
electronic applications**

RCA IGNITRONS					
Type	Size	Max. Dimensions Inches		Max. Anode Ratings*	
		Approx. Length	Radius	KVA Demand	Corresponding Av. Anode Amp.
5550	(A)	10	1 3/8	300	12.1
5551	(B)	13 1/2	2 7/8	600	30.2
5552	(C)	14 1/2	3 3/8	1200	75.6
5553	(D)	20	4 1 1/8	2400	192.

*For welding control.

RCA now has over 200* *standard* tube types that meet practically all modern industrial design requirements. In addition to a complete line of power amplifiers and high-current rectifiers, the family of industrial types includes Ignitrons for welding control and power conversion, and Thyratrons suitable for such applications as Ignitron firing, high-power relay circuits, motor control, and virtually all grid-control rectifier applications.



**RCA-5560
Thyatron**

**RCA-3D22
Thyatron**

Because of the inherent ruggedness, top quality, and long service life of these RCA Industrial Electron Tubes, they can be counted on to deliver outstanding performance value.

RCA THYRATRONS					
Type	Cathode Volts	Max. Dimensions Inches		Max. Anode Ratings	
		Length	Diam.	Peak Inv. Volts	Av. Amp.
Triodes					
3C23	2.5	6 3/8	2 1/8	1250	1.5
5559	5	7 1/4	3	1000	2.5
676	5	11 3/4	3 1 3/8	2500	6.4
Tetrodes					
2D21	6.3	2 3/8	3/8	1300	0.1
2050	6.3	4 3/8	1 9/16	1300	0.1
3D22	6.3	4 3/8	2 3/8	1300	0.75
672	5	8 3/8	2 1/8	1500	2.5
5560	5	7 1 1/8	2 1/4	1000	2.5
105	5	11 1/4	2 1 3/8	2500	6.4
172	5	10 3/8	2 5/8	2000	6.4

*Maximum radius

RCA tube application engineers are ready to co-operate with you in the adaptation of these or other RCA tube types to your equipment designs. Data sheets on the tube types you are interested in will be sent on request. For further information write RCA, Commercial Engineering, Section D-18-1, Harrison, New Jersey.

*Exclusive of types for broadcast reception.

RCA PRINCETON LABORATORIES
THE FOUNTAINHEAD OF
MODERN TUBE DEVELOPMENT IS RCA



TUBE DEPARTMENT
RADIO CORPORATION of AMERICA
HARRISON, N. J.

PROCEEDINGS OF THE I.R.E.

AND

WAVES AND ELECTRONS

Published Monthly by

The Institute of Radio Engineers, Inc.

VOLUME 34

September, 1946

NUMBER 9

BOARD OF DIRECTORS, 1946
Frederick B. Llewellyn
President
Edmond M. Deloraine
Vice-President
William C. White
Treasurer
Haraden Pratt
Secretary
Alfred N. Goldsmith
Editor
Hubert M. Turner
Senior Past President
William L. Everitt
Junior Past President
1944-1946
Raymond F. Guy
Lawrence C. F. Horle
1945-1947
Stuart L. Bailey
Keith Henney
Benjamin E. Shackelford
1946-1948
Walter R. G. Baker
Virgil M. Graham
Donald B. Sinclair
1946
Ralph A. Hackbusch
Frederick R. Lack
George T. Royden
William O. Swinyard
Wilbur L. Webb
Edward M. Webster
●
Harold R. Zeamans
General Counsel
●
George W. Bailey
Executive Secretary
●
BOARD OF EDITORS
Alfred N. Goldsmith
Chairman
●
PAPERS REVIEW COMMITTEE
Murray G. Crosby
Chairman
●
PAPERS PROCUREMENT COMMITTEE
Dorman D. Israel
General Chairman
Edward T. Dickey
Vice General Chairman
●

PROCEEDINGS OF THE I.R.E.

Gossamer.....	Knox McIlwain	622
Alfred N. Goldsmith.....		623
Universal Optimum-Response Curves for Arbitrarily Coupled Resonators.....	Paul I. Richards	624
The Universal Characteristics of Triple-Resonant-Circuit Band-Pass Filters.....	Karl R. Spangenberg	629
Simplifications in the Consideration of Mutual Effects Between Half-Wave Dipoles in Collinear and Parallel Orientations.....	Kosmo J. Affanasiev	635
A Variation on the Gain Formula for Feedback Amplifiers for a Certain Driving-Impedance Configuration.....	Thomas W. Winternitz	639
Special Aspects of Balanced Shielded Loops.....	L. L. Libby	641
Equalized Delay Lines.....	Heinz E. Kallmann	646
Note on a Reflection-Coefficient Meter.....	Nathaniel I. Korman	657
Note on a Parallel-T Resistance-Capacitance Network.....	Alfred Wolf	659
Correspondence:		
"Note on Critical Damping".....	Nelson Thompson	660
"Node-Pair Method of Circuit Analysis".....	William H. Huggins	661
"Elimination of Interference-Type Fading at Microwave Frequencies with Spaced Antennas".....	Ross Bateman	662
"Specification of Receiver Sensitivity and Transmitter Power Output at Ultra-High Frequencies".....	Leonard S. Schwartz	663
Contributors to PROCEEDINGS OF THE I.R.E.....		663

INSTITUTE NEWS AND RADIO NOTES

1946 National Electronics Conference.....		665
Sections.....		666
Technical Committees, I.R.E.....		668
Books:		
"High Vacuum Technique," by J. Yarwood.....		668
Reviewed by E. D. McArthur.....		668
"Quartz Crystals for Electrical Circuits," by Raymond A. Heising.....		668
Reviewed by W. G. Cady.....		668
"Mechanische Eigenschaften quasi-elastischer isotroper Körper," by Friedrich Popert.....		668
Reviewed by Walter G. Cady.....		668

WAVES AND ELECTRONS

SECTION

Officers, Rochester Section, 1946.....		669
The Future of Electronic Engineering.....	M. W. Smith	670
Naval Airborne Radar.....	Lloyd V. Berkner	671
Abstracts and References.....	707	Positions Open..... 50A
Section Meetings.....	34A	Positions Wanted..... 56A
Membership.....	34A	
Advertising Index.....	70A	

EDITORIAL DEPARTMENT

Alfred N. Goldsmith
Editor

Helen M. Stote
Publications Manager

Clinton B. DeSoto
Technical Editor

Mary L. Potter
Assistant Editor

William C. Copp
Advertising Manager

Lillian Petranek
Assistant Advertising Manager

Responsibility for the contents of papers published in the PROCEEDINGS OF THE I.R.E. AND WAVES AND ELECTRONS rests upon the authors. Statements made in papers are not binding on the Institute or its members.

Changes of address (with advance notice of fifteen days) and communications regarding subscriptions and payments should be mailed to the Secretary of the Institute, at 450 Ahaip St., Menasha, Wisconsin, or 330 West 42nd Street, New York 18, N. Y. All rights of republication, including translation into foreign languages, are reserved by the Institute. Abstracts of papers, with mention of their source, may be printed. Requests for republication privileges should be addressed to The Institute of Radio Engineers.



The tragic courses and consequences of World Wars I and II, and the natural dread of the still more devastating results of a possible World War III, have prompted the following constructive guest editorial from the chief consulting engineer of the Hazeltine Electronics Corporation, who is as well a member of the I.R.E. Board of Editors. It is commended to the thoughtful attention of forward-looking engineers. *The Editor.*

Gossamer

KNOX McILWAIN

The gossamer of patriotism holds a nation together. The gossamer of a powerless royalty holds the British Empire together. Perhaps gossamer can bind the world together.

The book "Gossamer" (G. A. Birmingham pseudonym, James Owen Hannay author, George H. Doran Co., publisher, 1915) describes the plight of Carl Ascher, a German-born international banker with offices in London at the start of World War I. Every time he patriotically tried to return home some minor detail of his business held him. Finally he realized that his proper loyalty was to his international financial empire, rather than to his country.

There may be a good lesson here for professional men in general and for radio engineers in particular, since they are to a large extent responsible for the shrunken size of the world. Perhaps we can weave a web of gossamer over the nations. All strong-arm methods of binding the nations into "one world" do not seem to be working very well. Professional diplomacy has not in 6000 years discovered the technique of preventing war. And the influences of religion have not solved the problem even between those countries who belong to the same church.

Could a thousand webs of gossamer between two nations so involve them in each other's affairs that, even when professional diplomacy's failure evoked the will to war, they could not break out of the web? Webs of business, webs of religion, webs of culture, and webs of friendship and understanding. If we engineers do not desire to be the street cleaners for what little is left after the third World War, it seems at least worth trying.

But what can the individual engineer do? Usually he doesn't speak many languages and has few friends in foreign lands. Consequently alone he can do little. But as a group there may be some web he can help weave.

Looking over the list of committees in The Institute of Radio Engineers, I find few devoted to international co-operation. It is true that at a higher level of international organization many of our members have worked toward international standardization of technical matters. But why not work at a lower level toward increased international understanding and friendship?

If an added committee were appointed what could it do? At the start much of its work would have to be exploratory. The first thing to do would be to make up a list of counterparts of the I.R.E. in all other nations, including Germany and Japan, with their officers. The second would be to try to get each of them to appoint similar committees. This very exchange of professions of friendship on a low level, cutting through the protocol and formality of governmental relationship, would of itself be worth while. An exchange of publications would of course be instituted and possibly a series of international reprintings. For instance let each society pick one paper each year to be translated and reprinted by every co-operating technical society in the world. International joint meetings over the short waves, such as that held with the Institution of Electrical Engineers last February could be held on a world-wide scale. As the work progressed other strands of the web would be developed. The main thing is to break down the barriers of reserve and suspicion and establish even a tentative contact.

If our offers of friendship are refused, or even disallowed by government authority, then at least we shall be put on guard as to which governments fear to allow international friendships to their people. Furthermore we shall have initiated an attempt to make the professional man a force for social good, instead of just talking about it.

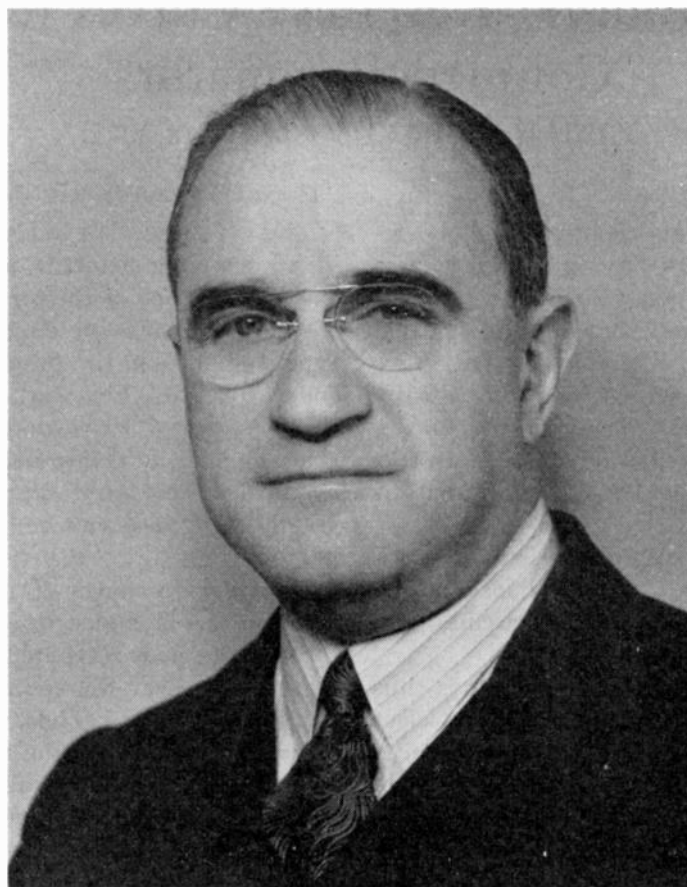

Alfred N. Goldsmith

As one of the three founders of The Institute of Radio Engineers, Dr. Goldsmith joined that organization as a Member in 1912 and was elected a Fellow in 1915. He has served as President, Secretary, and Director of the Institute and has been its Editor since 1913 and the chairman of its Board of Editors since 1928. He has also acted as chairman of the Awards, Constitution and Laws, Nominations, Papers, Standardization, and Tellers Committees of the Institute; as Secretary of the Standardization Committee; and as a member of the Admissions, Bibliography, Executive, Finance, Meetings and Papers, Membership Solicitation Policy, Special Papers, Television, Facsimile, and Wave Length Regulation Committees of the Institute.

He was born in New York, New York, on September 15, 1889. He received his B.Sc. degree from The College of the City of New York in 1907, his degree of Ph.D. from Columbia in 1911, and the Sc.D. degree from Lawrence College in 1935. Dr. Goldsmith was associated with The College of the City of New York from 1906 to 1923, at which time he had become associate professor of electrical engineering. He retains the post of associated professor of electrical engineering at this College. He also became a consulting engineer for the

General Electric Company in 1914. In 1917, he served as director of research for the Marconi Wireless Telegraph Company of America, then joined the Radio Corporation of America in 1919 where he successively held the posts of chief broadcast engineer, and later vice-president and general engineer. From 1928 to 1931, he was chairman of the Board of Consulting Engineers of the National Broadcasting Company, and vice-president of RCA Photophone, Inc. Dr. Goldsmith at this time is a consulting engineer, active primarily in the radio, motion-picture, photographic, electrical, and optical fields.

He is a member of the Academy of Motion Picture Arts and Sciences, an honorary member of the Radio Club of America, and a Fellow of the American Institute of Electrical Engineers, the Acoustical Society of America, the American Physical Society, and the American Association for the Advancement of Science. Among the awards bestowed upon Dr. Goldsmith are the Medal of Honor of The Institute of Radio Engineers, the Modern Pioneer Award of the National Association of Manufacturers, the Townsend Harris Medal of The College of the City of New York, and the Medal Award of the Television Broadcasters Association.

Universal Optimum-Response Curves for Arbitrarily Coupled Resonators*

PAUL I. RICHARDS†, ASSOCIATE, I.R.E.

I. INTRODUCTION

IN MANY radio-engineering applications it is desired to provide a network having a narrow pass band and very high rejection near by. In lumped-constant work it has been found that a useful solution to this problem is the familiar coupled circuit. Two resonant circuits are generally used, and occasionally three. Similar problems arise at very-high frequencies, where transmission-line or even wave-guide networks must be used. This paper provides a general analysis of this type of circuit.

It is shown that, to a first approximation, the optimum response obtainable has a universal form which depends solely on the number of resonant circuits, and not on the type of circuits or of coupling.

The problem of construction of such circuits is thus greatly simplified. The engineer can immediately select from the curves given here (Figs. 3, 4, 5) the minimum number of tuned circuits which he can use in view of the specifications given him. He can then be sure that other factors are perfectly arbitrary. Hence, he may select the type of resonators and coupling to be used entirely from considerations of ease of manufacture,

II. STATEMENT OF THE PROBLEM AND RESTRICTIONS

The type of circuit analyzed is shown in Fig. 1. The A_i are coupling elements, and the B_i resonant circuits. The B_i take one of the forms shown in Fig. 2, but the resonators of any one circuit need not be of the same type. In addition, the B_i may be any of the wave-guide counterparts of Fig. 2(a), (b), (c). It is well known that lengths of wave guide behave in essentially the same manner as transmission lines. The effects of mechanically necessary discontinuities may be much greater, but these can be lumped in with the coupling nets A_i .

The reactive parts of the generator and load impedances are included in A_0 and A_n respectively. The form of the A_i is restricted only in that they must not be resonant near the center frequency either alone or in any combination. Thus, the A_i may be loops, probes, irises, etc., as well as the many familiar coupling nets of lumped-constant circuits. It might at first seem that the usual mutual-inductance coupling cannot be placed in the form of Fig. 1. Recall, however, that a transformer can be replaced (insofar as its behavior as a 2-terminal-pair net is concerned) by an equivalent T

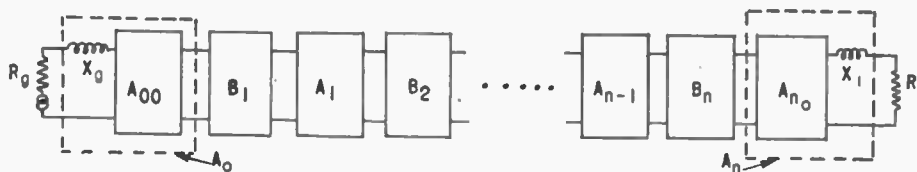

Fig. 1—Schematic coupled-circuit network.

ease of calculation or of empirical adjustment, stability, cost, procurements, etc.

Another paper¹ discusses the analysis of such circuits under coupling conditions other than "optimum." In that discussion, a general method of analysis is presented and then applied to the cases of 1, 2, and 3 tuned circuits. The result is a set of universal curves for such configurations under varying conditions of coupling. The analysis of the present paper shows that, although a specific circuit is analyzed by Spangenberg, the results are truly universal. Conversely, his results form a valuable complement to those of the present paper, inasmuch as they are extremely useful in empirical adjustments and preliminary calculations of the various couplings.

* Decimal classification: R142. Original manuscript received by the Institute, March 14, 1946. This paper is based on work done for the Office of Scientific Research and Development under Contract No. OEMsr-411 with the President and Fellows of Harvard College.

† Harvard University, Cambridge, Mass.

¹ Karl R. Spangenberg, "The universal characteristics of triple-resonant-circuit band-pass filters," Proc. I.R.E., this issue, pp. 629-635.

or π of inductances. Thus, the center inductance becomes the coupling element A_i , and the end inductances become part of the tuned circuits B_i and B_{i+1} .

Restrictions

(1) All elements (except R_0 and R_1) are considered to be lossless.

In the case of transmission-line and wave-guide circuits this is an excellent approximation, since "copper" losses are almost always entirely negligible compared to the end loadings R_0 and R_1 . With lumped constants, the same approximation holds if the transmitted power is much greater than the dissipated power (i.e., loaded $Q \ll$ unloaded Q).

(2) Coupling circuits are not resonant near the center frequency either individually or in any combination.

This restriction is necessary to insure that we may properly speak of only n resonant circuits being included in our network.

(3) All resonant circuits achieve their resonance at a

point near the center of the pass band (but not necessarily within the pass band).

(4) The desired bandwidth Δf is very much smaller than the center frequency f_o .

✓ III. RESULTS

We must first define what we shall mean by *optimum response*. The electrical specifications for the design of this type of circuit usually state that the loss in the

match. Hence, results in terms of insertion loss would have less meaning than those in terms of mismatch loss. *Mismatch loss M* is defined as the decibel loss in load power referred to the maximum power available from the generator. Thus, conditions of perfect match through the network correspond to $M=0$.

The primary result of this analysis is the fact that the optimum available response depends solely on the *number* of tuned circuits included in the net; it is inde-

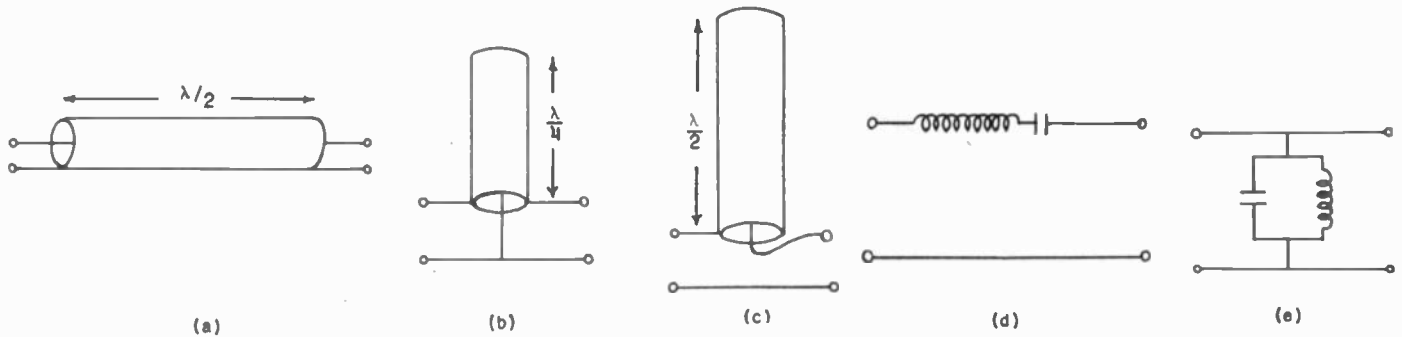

Fig. 2—Typical resonator elements.

pass band shall be less than some given value, and that the off-band rejection is to be as high as possible. We shall adopt the satisfaction of these requirements as our definition of *optimum response*. Thus, we shall allow the dips in the pass band to attain the value of the maximum allowable loss, since such a condition gives greater off-band rejection, as we shall see.

It is to be noted that the generator and load impedances of Fig. 1 are not necessarily a conjugate

pendent of the type of coupling or the form of the resonators. The couplings may all be dissimilar, as may be the resonators; no conditions of symmetry are imposed. It is further shown that for each such circuit, there are more than a sufficient number of parameters available to obtain this optimum response.

Despite possible asymmetry of the original circuit, the optimum response is entirely symmetric in frequency within the narrow bands considered.

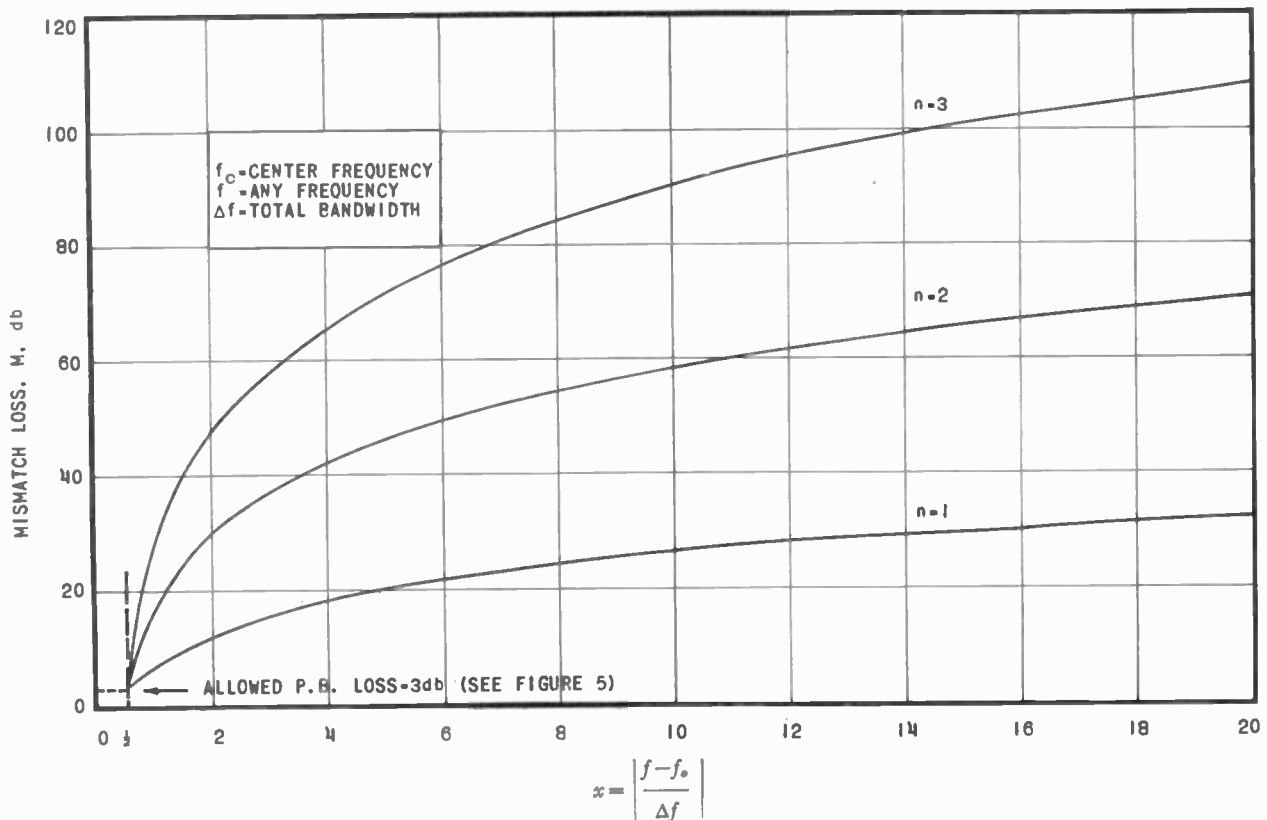

Fig. 3—Universal optimum-response curves for 1, 2, and 3 arbitrarily coupled resonators.

The quantitative results of this analysis are contained in Figs. 3, 4, and 5. Of these, Fig. 3 gives the optimum response for 1, 2, and 3 resonators under the assumption that the allowable pass-band loss M_o is 3 decibels.

Fig. 4 contains the same information for 4, 5, and 6 tuned circuits. Fig. 5 is a curve which enables one to correct the data of Figs. 3 and 4 if the allowed pass-band loss is not 3 decibels. To use these correction curves,

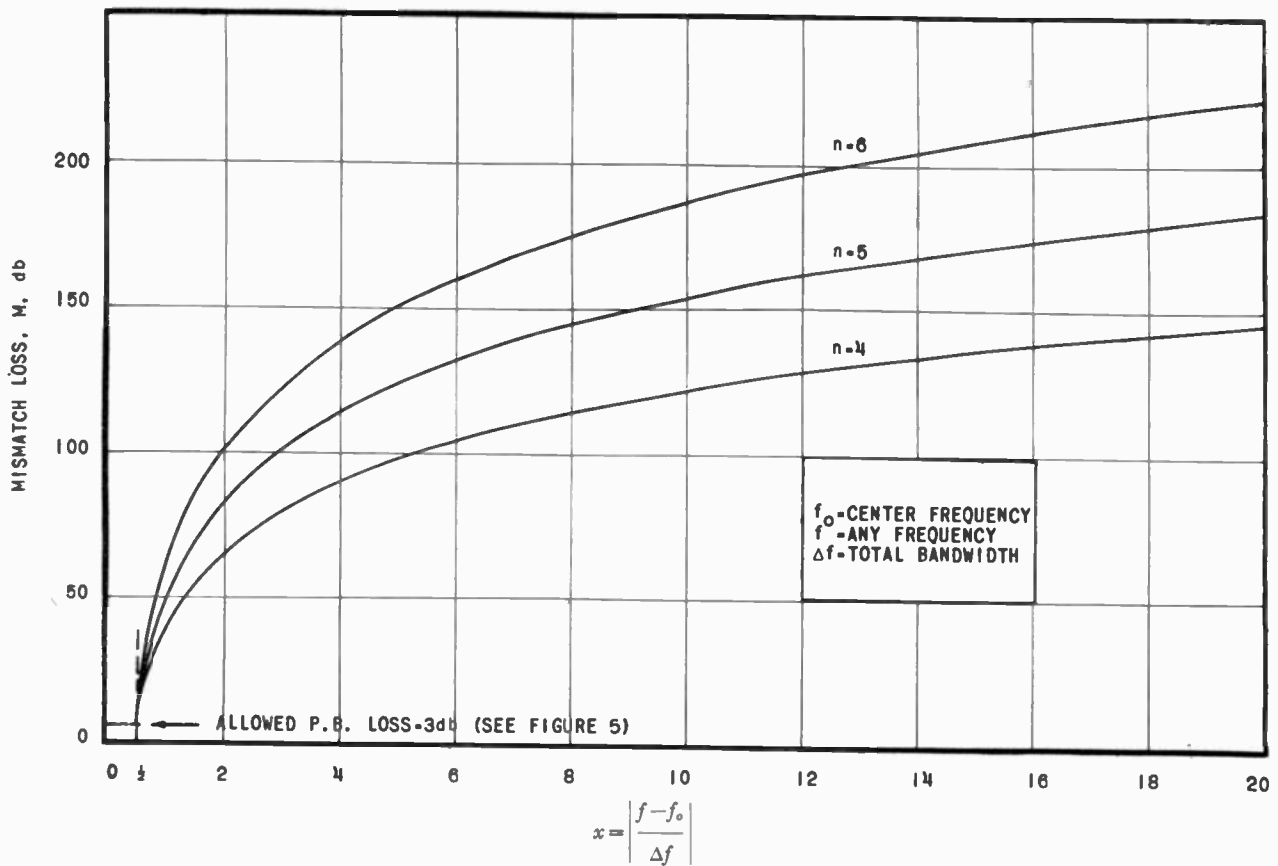
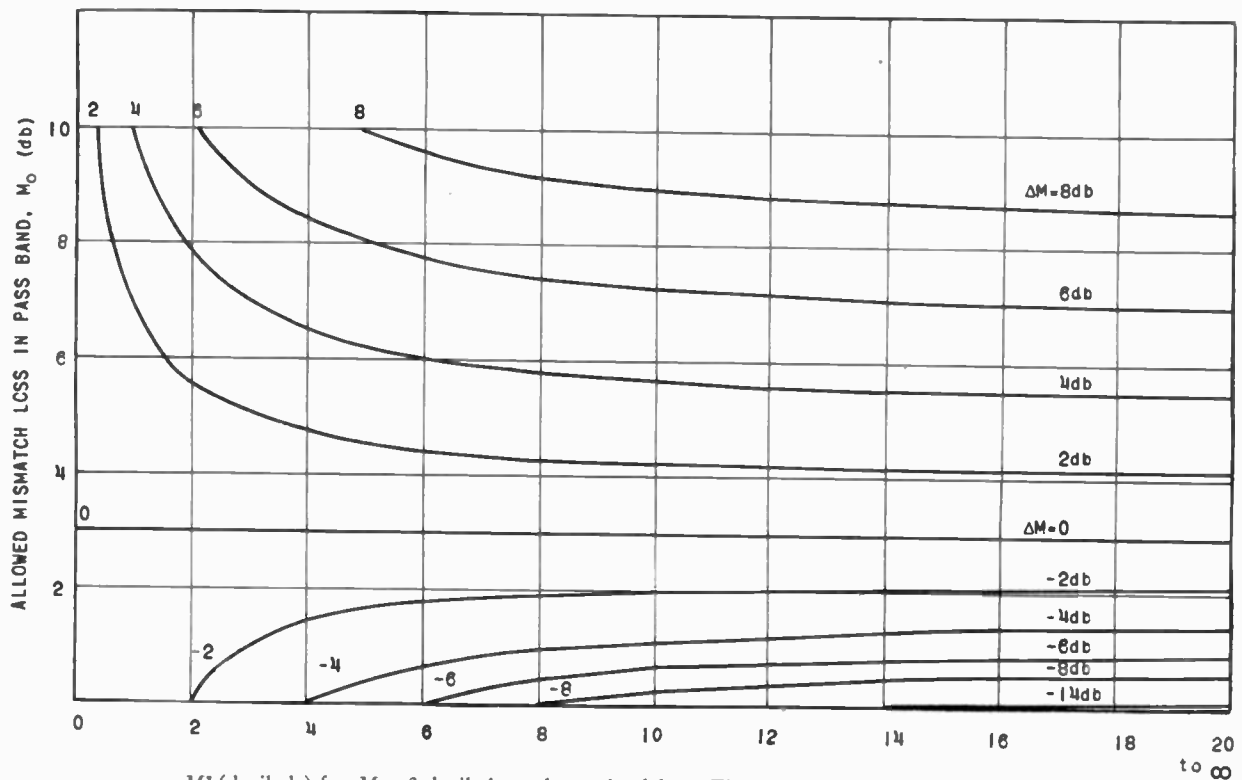

Fig. 4—Universal optimum-response curves for 4, 5, and 6 arbitrarily coupled resonators.



M^3 (decibels) for $M_o=3$ decibels as determined from Fig. 3 or 4; corrected $M = M^3 + \Delta M$.

Fig. 5—Universal correction curves.

first read from Fig. 3 or 4 the rejection that would be attained if M_o were 3 decibels. Next, find on Fig. 5 the point corresponding to this uncorrected loss (M_3) and the actual value of M_o . Interpolation between the plotted contours then gives a value of ΔM . Add this to the uncorrected M_3 to get the actual rejection. Note that the contours rapidly approach straight lines as M becomes large. The value of M_o for these contours at $M_3 = 20$ decibels is, in all cases, within 0.05 decibel of its value at $M = \infty$. Hence, for $M > 20$ decibels, the curves may be used with negligible errors at $M = 20$.

These curves give only the behavior outside the pass band. Within the pass band, there are $n - 1$ "dips" of height of M_o . This is illustrated for $n = 4$ by the solid curve of Fig. 6.

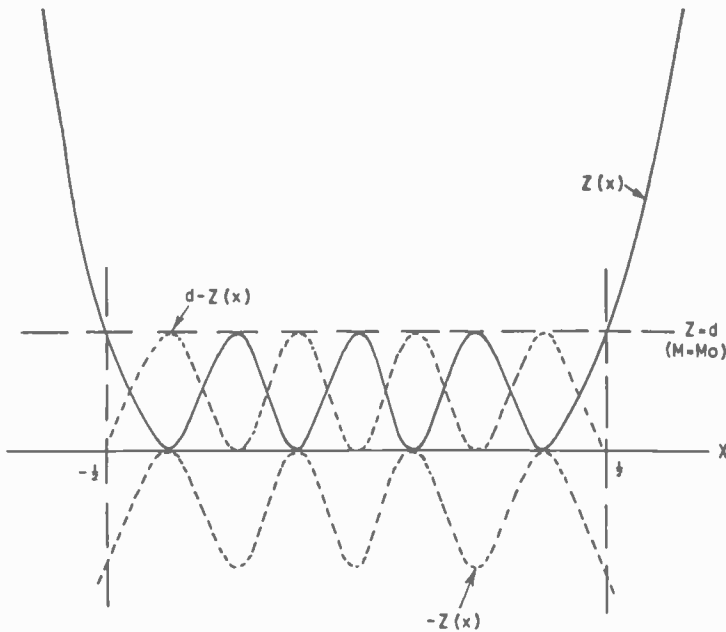

Fig. 6—Optimum $Z(x)$ and bounds for $p(x)$.

For frequencies outside the range of Figs. 3 and 4, the following asymptotic formula for M may be used with very little error:

$$M \cong (2n - 1)6.021 + 20n \log_{10} |x| + 10 \log_{10} d \quad (1)$$

where

$$x = (f - f_o) / \Delta f$$

$$d = (\text{antilog}_{10} M_o / 10) - 1$$

f_o = center frequency

f = any frequency

Δf = total bandwidth

M_o = allowed loss in pass band

M = mismatch loss

n = number of tuned circuits.

It will be noted that (1) may be written

$$M \cong (12.04 + 20 \log_{10} |x|) \text{ decibels per resonant circuit, less } (6.021 + \log_{10} d) \text{ decibels.} \quad (1a)$$

The formula from which Figs. 3, 4, and 5 were obtained is

$$M = 10 \log_{10} (1 + d(T_n(2x))^2). \quad (2)$$

In (2), $T_n(x)$ is the Tchebycheff polynomial of degree n . These functions are defined by (9), (10), and (11) of this paper.²

IV. ANALYSIS—INTRODUCTION OF THE RESTRICTIONS

We utilize, at this point, some of the techniques of matrix algebra. The needed concepts have been developed in a previous paper.³

If \bar{G} is the over-all matrix for the circuit of Fig. 1, we have

$$\bar{G} = \bar{A}_o \times \bar{B}_1 \times \bar{A}_1 \times \bar{B}_2 \times \bar{A}_2 \times \bar{B}_3 \times \bar{A}_3 \times \dots \times \bar{A}_{n-1} \times \bar{B}_n \times \bar{A}_n \quad (3)$$

where the \bar{A}_i and \bar{B}_i are the matrices for the circuits which they represent. Now the \bar{B}_i have a special property. For all of the circuits of Fig. 2, the matrices contain terms which are zero at their resonant frequency; i.e., at a point near the center frequency. Also, to a first approximation over the narrow bands considered, the variation with frequency of these terms is very nearly linear. Thus, for instance, the matrix for Fig. 2(a) is

$$\begin{array}{c|c} \cos \theta & jZ_o \sin \theta \\ \hline \frac{j \sin \theta}{Z_o} & \cos \theta \end{array}$$

where θ is the radian electrical length of the line. Near $\theta = \pi$ this matrix is approximately

$$\begin{array}{c|c} 1 & jZ_o(\pi - \theta) \\ \hline \frac{j(\pi - \theta)}{Z_o} & 1 \end{array}$$

If we now introduce the parameter $x = (f - f_o) / \Delta f$, defined in (1), we may say that the above matrix is of the form

$$\begin{array}{c|c} 1 & j(ax + b) \\ \hline (jcx + d) & 1 \end{array}$$

where b and d are small since the line resonates near the center frequency. (Otherwise the approximation of linear variation with frequency would not hold.) Similar arguments hold for the other circuits of Fig. 2.

Now the \bar{A}_i do not have this property; they are non-resonant (alone or in any combination) and hence do not contain terms that become small or infinite or change sign. Thus, over the narrow frequency band considered, we may assume as a first approximation that only the x in the \bar{B}_i varies with frequency, and that all other terms are "constant." This assumption in turn, along with (3), leads to the conclusion that we may consider each term in the matrix \bar{G} as a polynomial of degree n in x with "constant" coefficients.

² An excellent discussion of the properties of $T_n(x)$, along with a list of explicit expressions for $n = 1 \dots 10$, is given by van der Pol and Weijers, "Fine structure of triode characteristics," *Physica*, vol. 1, pp. 481-496; 1934. As will be seen in (9), we follow the notation of van der Pol and Weijers. Some writers prefer to use T_n for $T_n/2^{n-1}$ which has 1 for the leading coefficient.

³ Paul I. Richards, "Applications of matrix algebra to filter theory," *Proc. I.R.E.*, vol. 34, pp. 145P-150P; March, 1946.

We now introduce the mismatch-loss formula. (Mismatch loss = decibel loss in load power referred to maximum power available from the generator.) It has been shown⁸ that the mismatch loss is given by

$$M = 10 \log \frac{|AR_i + DR_o + B + CR_oR_i|^2}{4R_oR_i} \quad (4)$$

where $\bar{G} = \frac{A|B}{C|D}$. Moreover, $Z_o = R_o$, $Z_i = R_i$, since X_o

and X_i have been lumped in with A_o and A_n . That this procedure has no effect on the value of M can be seen from the physical definition and is easily demonstrated mathematically; this would not be true of the insertion loss. Because the net is lossless, we know that A and D are real, and B and C are pure imaginary. This fact, coupled with the relation $AD - BC = 1$, enables us to put (4) in the form

$$M = 10 \log \left[1 + \frac{1}{4} \left\{ A \sqrt{\frac{R_i}{R_o}} - D \sqrt{\frac{R_o}{R_i}} \right\}^2 + \frac{1}{4} \left\{ \frac{B'}{\sqrt{R_oR_i}} - C' \sqrt{R_oR_i} \right\}^2 \right] \quad (5)$$

where $B' = B/j$, $C' = C/j$ are both real.

Since A , B' , C' , and D can be considered as polynomials of degree n in x with real, "constant" coefficients, we may write

$$M = 10 \log (1 + Z) \quad (6)$$

where Z is a polynomial of degree $2n$ in x with real, "constant" coefficients.

V. DEDUCTION OF THE OPTIMUM FORM

We now investigate the possibility of adjusting the coefficients in Z (i.e., adjusting the couplings A_i , etc.) so as to produce optimum response. Optimum response has been defined as the curve combining greatest off-band rejection with the stipulation that M shall be no greater than some M_o throughout the pass-band ($-\frac{1}{2} \leq x \leq \frac{1}{2}$). It will be seen later that it makes no difference where in the stop band we attempt to maximize the rejection.

Let us note two properties of Z . First, Z is never negative; it is defined as the sum of two squares of real numbers. This situation corresponds to the physical fact that M , being referred to the maximum power available from the generator, cannot be less than zero. Secondly, $M=0$ when $Z=0$, and $M=M_o$ when $Z=d$ (see equation (1)). Moreover, M and Z always increase or decrease together (i.e., M is a monotonic function of Z). Thus, our criteria for optimum response may be stated as follows: Z must be as great as possible for $|x| > \frac{1}{2}$ and must satisfy $0 \leq Z \leq d$ for $|x| \leq \frac{1}{2}$. (In addition, $Z \geq 0$ always.)

We shall now show that optimum response corresponds to the form of Z illustrated (for $n=4$) by the solid curve in Fig. 6, and that there exists no more than one polynomial which gives this form. (Here Z has its largest

possible number of extrema $(2n-1)$; the maxima lie on $Z=d$, the minima on $Z=0$; when $x = \pm \frac{1}{2}$, $Z=d$.) Let us assume, on the contrary, that this is not the optimum form. Then we would be able to change the coefficients of $Z(x)$ in such a manner as to produce a new polynomial $\bar{Z}(x)$, which would be more nearly the optimum form. This change can be expressed as the addition of another polynomial $p(x)$ (of degree $\leq 2n$) to $Z(x)$ so that

$$\bar{Z}(x) = Z(x) + p(x). \quad (7)$$

Now $\bar{Z}(x)$ must be ≥ 0 by definition of M as previously noted. This gives $p(x) \geq -Z(x)$. Moreover, we require $\bar{Z}(x) \leq d$ in $|x| \leq \frac{1}{2}$, so that $p(x) \leq d - Z(x)$ in $|x| \leq \frac{1}{2}$. These two boundaries for $p(x)$ are sketched with dashed lines in Fig. 6. Further, $p(x)$, being a polynomial, cannot have zero slope at more than a finite number of points. It will be seen that if p is to lie within the bounds specified, it must have the same number of extrema as $Z(x)$, namely $2n-1$. In addition, if $\bar{Z}(x)$ is to be an "improvement" over $Z(x)$, we must have $p(x) > 0$ at some point *outside* the pass band. This, it will be seen, requires that $p(x)$ have an *additional* minimum over the number already assigned to it. This brings the number of extrema to $2n$. Hence, $p(x)$ must be of degree $\geq 2n+1$, which is impossible with only n tuned circuits. Thus, the form of Z given is the optimum. This same argument shows that there exists no more than one polynomial which gives this form.

Moreover, the optimum form is attainable. We have only $2n+1$ coefficients to adjust; against these we have $n+1$ coupling coefficients, the n resonant frequencies of the tuned circuits, and another parameter for each of the n tuned circuits, namely the ratio L/C for the lumped form or the characteristic impedance of the wave-guide or transmission-line sections. Thus, we have $3n+1$ parameters and only $2n+1$ conditions.

Having shown that there exists no more than one optimum polynomial, we need only exhibit such a function in order to be sure of having the required solution. Such a polynomial is given by

$$Z(x) = d(T_n(2x))^2 \quad (8)$$

where $T_n(x)$ is the Tchebycheff polynomial of degree n . Although T_n is an algebraic polynomial, it is best defined by transcendental functions, namely,

$$T_n(2x) = \cos(n \arccos 2x). \quad (9)$$

As is well known, these polynomials are even or odd functions of x according as n is even or odd. Thus, $Z(x)$ as given by (8) will be symmetric about $x=0$.

It may be seen that (8) satisfies the requirements for optimum $Z(x)$. First, for $|x| \leq \frac{1}{2}$, equation (9) shows that $T_n(2x)$ oscillates the required number of times between $+1$ and -1 , so that Z oscillates between zero and d and equals d at $x = \pm \frac{1}{2}$. For $|x| > \frac{1}{2}$, equation (9) may be written

$$T_n(2x) = \left(\frac{x}{|x|} \right)^n \cosh(n \operatorname{arc-cosh} 2x) \quad (10)$$

and thus Z will increase continually as $|x|$ increases above $\frac{1}{2}$. Thus (8) is the required solution.

The curves of Figs. 3 and 4 were plotted by the use

$$T_n(x) = 2^{n-1} \left(x^n - \frac{n}{1!2^2} x^{n-2} + \frac{n(n-3)}{2!2^4} x^{n-4} - \frac{n(n-4)(n-5)}{3!2^6} x^{n-6} + \frac{n(n-5)(n-6)(n-7)}{4!2^8} x^{n-8} - \dots \right). \quad (11)$$

of (2). The symmetry of $Z(x)$ about $x=0$ allows the plotting of only one half of the response curve. The correction curves, Fig. 5, are universal because of the appearance of d as an external factor in (8) and were calculated in the following manner: For $M_o=3$ decibels, $d=1$, and for any other value of M_o , the magnitude of $Z(x)$ and hence M can easily be computed from that for $d=1$.

The Tchebycheff polynomials for integral values of n are given by the following series, which is understood to contain only positive powers of x :

Notice that the leading term of $Z(x)$ as given by (8), (11) is $4^{2n-1}dx^{2n}$. Hence, an asymptotic formula for the loss far off the pass band is given by (1).

That the optimum available response depends solely on the number of tuned circuits now follows from the fact that we have used no other information in setting up our analysis and are thus free to vary other factors at will.

The Universal Characteristics of Triple-Resonant-Circuit Band-Pass Filters*

KARL R. SPANGENBERG†, SENIOR MEMBER, I.R.E.

Summary—The universal insertion-loss versus frequency characteristics of a band-pass filter composed of one, two, or three lossless resonant circuits in a loosely coupled cascade connection between a source and a load impedance are given. The effects of load and source coupling and of intermesh coupling upon pass-band insertion-loss variations and upon band width are discussed.

I. BASIC EQUIVALENT CIRCUITS

A TYPE of band-pass filter having many uses is shown in Fig. 1. In parts (a), (b), and (c), respectively, are shown filters with one, two, and three resonant circuits. The purpose of this note is to give the universal characteristics of the three-resonant-circuit case. For completeness the curves for two and one resonant circuits are also given, though the responses for slightly different types of these circuits are known.

Assumptions

1. The generator and load impedances are resistive and equal. (The case of unequal input and output resistances is treated in Appendix I.) The impedance of the first mesh is accordingly

$$Z_1 = R + j\omega_0 L_1 \quad (1)$$

where L_1 is the inductance of the coupling loop.

2. Input and output couplings are equal. The coefficient of coupling is defined by the equation

$$K_a^2 = \frac{M_a^2}{L_1 L_2} = \frac{X_a^2}{X_1 X_2} \quad (2)$$

For notation, see Fig. 1.

* Decimal classification: R386.1XR143.2. Original manuscript received by the Institute, January 16, 1946; revised manuscript received, February 27, 1946. The work reported in this paper was done at the Radio Research Laboratory under contract with the Office of Scientific Research and Development, National Defense Research Committee, Division 15.

† Formerly, Radio Research Laboratory, Harvard University, Cambridge, Massachusetts; now, Stanford University, California.

3. Intermesh couplings in the three-mesh case are equal. The coefficient of coupling is

$$K_b = \frac{M_b}{L_2} = \frac{X_b}{X_2} \quad (3)$$

4. Resonant circuits are lossless and the net reactance Z_2 is linear with frequency in the vicinity of resonance; i.e.,

$$Z_2 = j\omega L_2 + \frac{1}{i\omega C_2} \cong 2jL_2(\omega - \omega_0) \quad (4)$$

or

$$Z_2 \cong 2jL_2\Delta\omega. \quad (5)$$

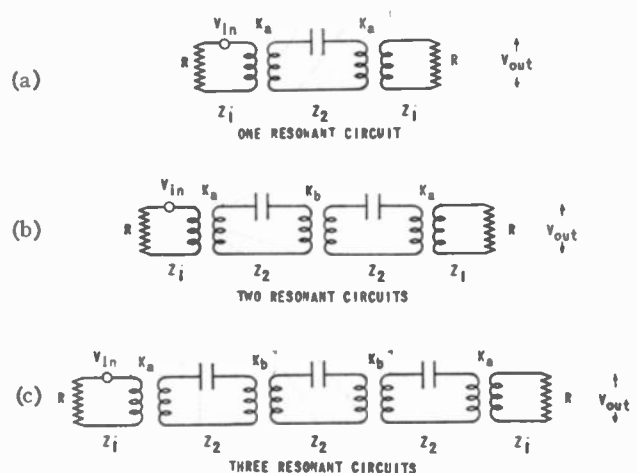

Fig. 1—Band-pass filters consisting of one, two, and three resonant circuits.

5. Bandwidths (reciprocal Q 's) are small enough so that the reactance of coupling loops does not vary appreciably in the vicinity of the pass band.

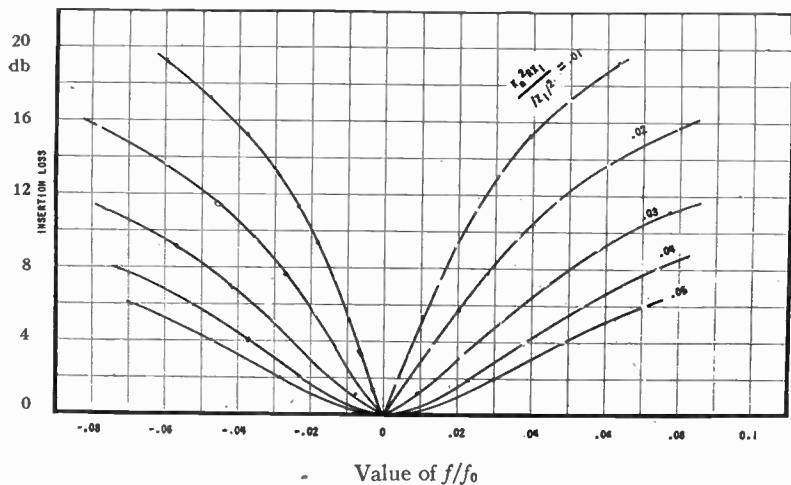

Fig. 2—Universal insertion-loss versus frequency characteristics of a single-resonant-circuit band-pass filter.

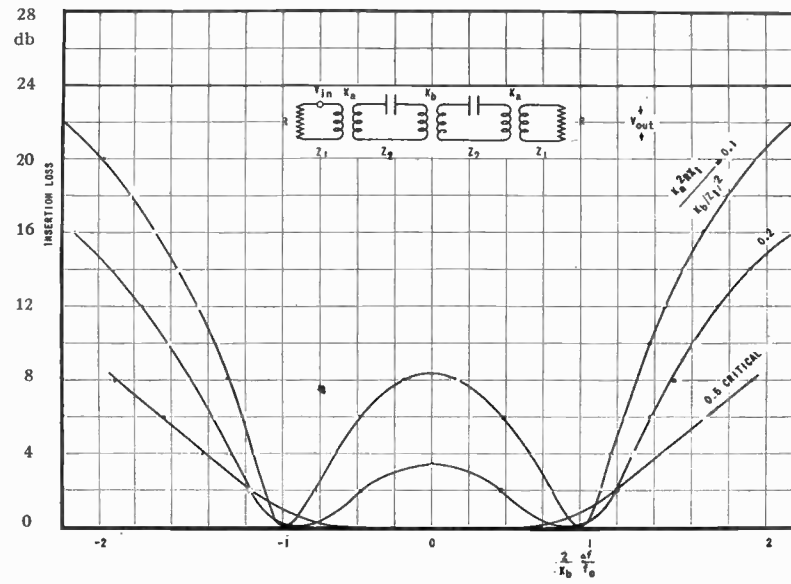

Fig. 3—Universal insertion-loss versus frequency characteristics of a double-resonant-circuit band-pass filter.

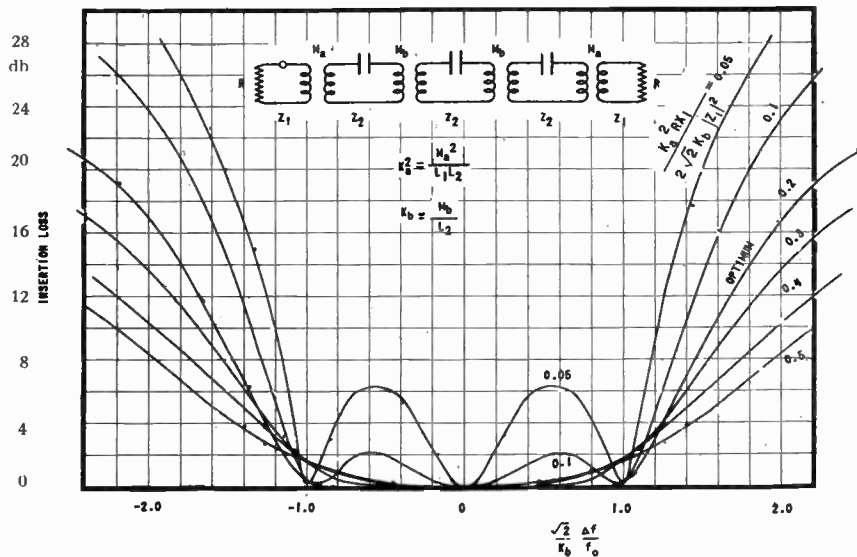

Fig. 4—Universal insertion-loss versus frequency characteristics of a triple-resonant-circuit band-pass filter.

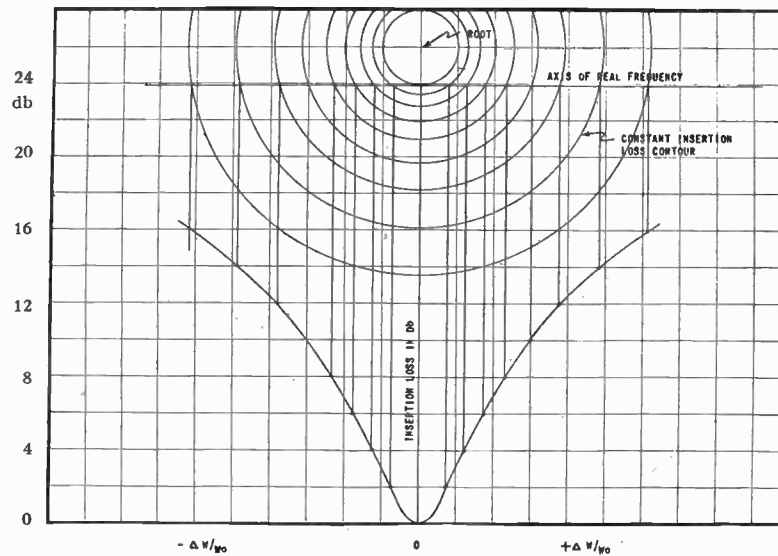

Fig. 6—Method of constructing the insertion-loss versus frequency characteristics from the contours of constant insertion loss of Fig. 5 for the case of the single-resonant-circuit filter.

II. UNIVERSAL INSERTION-LOSS VERSUS FREQUENCY CHARACTERISTICS OF A SINGLE-RESONANT-CIRCUIT FILTER

For the circuit of Fig. 1(a), the *relative* insertion-loss versus frequency characteristics are as shown in Fig. 2. These curves are well known in other forms and so are not given in great detail.

III. UNIVERSAL INSERTION-LOSS VERSUS FREQUENCY CHARACTERISTICS OF A DOUBLE-RESONANT-CIRCUIT FILTER

For the circuit of Fig. 1(b), the *relative* insertion-loss versus frequency characteristics are as shown in Fig. 3. Since these curves are available in numerous equivalent forms, they are not given in detail.

For the case of coupling greater than critical, the insertion loss at the peaks will be nearly zero.

IV. UNIVERSAL INSERTION-LOSS VERSUS FREQUENCY CHARACTERISTICS OF A TRIPLE-RESONANT-CIRCUIT FILTER

For the circuit of Fig. 1(c), the *relative* insertion-loss versus frequency characteristics are as shown¹ in Fig. 4. The insertion loss at the midband frequency is zero. In the analysis of the triple-resonant-circuit case, it has been assumed that (X_a^2/Z_1) is small compared with 1. This is reasonable because

$$X_a < X_1 < Z_1.$$

V. METHOD OF ANALYSIS

The insertion-loss characteristics given in the previous sections were obtained by solving the mesh equations and obtaining an expression for insertion loss from them. The expression for n resonant meshes is of the form

$$\frac{I_n}{V_{in}} = \frac{K\omega^{n+1}}{(\omega - \omega_1)(\omega - \omega_2) \cdots (\omega - \omega_n)} \quad (6)$$

where $\omega_1, \omega_2, \dots, \omega_n$ are the *complex roots* of the determinant of the mesh equations. Since the maximum output voltage with direct connection of input and output is $V_{out} = V_{in}/2$, the insertion loss L_{db} , is

$$L_{db} = 20 \log_{10} \left| \frac{2I_n R}{V_{in}} \right| \quad (7)$$

or

$$\frac{L_{db}}{20} = \log_{10} 2KR\omega^{n+1} - \log_{10} |\omega - \omega_1| - \log_{10} |\omega - \omega_2| \cdots - \log_{10} |\omega - \omega_n|. \quad (8)$$

This equation is of exactly the same form as the expression for the potential due to n equally charged infinite parallel wires located at points $\omega_1, \omega_2, \dots, \omega_n$ in the complex plane.² If the roots of the determinant of the

¹ The curves of Fig. 4 show the response only in the immediate vicinity of the pass band. The response outside of the pass band has been evaluated by Paul I. Richards, "Universal Optimum-Response Curves for Arbitrarily Coupled Resonators," PROC. I.R.E. this issue, pp. 624-629.

mesh equation $\omega_1, \omega_2, \dots, \omega_n$ can be determined, a plot of the electrostatic field can be constructed by graphical means. Every contour of constant potential then corresponds to a contour of constant insertion loss. Values of insertion loss have physical significance only along the real frequency axis, and the relative insertion-loss versus frequency curve thus looks like the potential profile along the X axis in the complex impedance plane. The location of the axis of real frequency relative to the roots of the determinant of the mesh equations is determined by the coupling between meshes and by the terminating impedances. When a curve of relative insertion loss versus frequency is obtained, it is necessary only to determine the absolute insertion loss at one point on the curve to obtain the true curve of insertion loss versus frequency.

To summarize: Use is made of the fact that the potential versus distance curve in the vicinity of n equally charged parallel wires of infinite length corresponds to the curve of insertion loss versus frequency of a circuit containing n identical resonant circuits when the wires are located at positions corresponding to the complex roots of the determinant of the mesh equations.

This method will now be illustrated for filters containing one, two, and three resonant circuits.

VI. ANALYSIS OF A SINGLE-RESONANT-CIRCUIT FILTER

The mesh equations of the circuit of Fig. 1(a) are

$$\begin{aligned} V_1 &= I_1 Z_1 + I_2 Z_a + 0 \\ 0 &= I_1 Z_a + I_2 Z_2 + I_3 Z_a \\ 0 &= 0 + I_2 Z_a + I_3 Z_1. \end{aligned} \quad (9)$$

The determinant of this set of equations is

$$D = \begin{vmatrix} Z_1 & Z_a & 0 \\ Z_a & Z_2 & Z_a \\ 0 & Z_a & Z_1 \end{vmatrix} \quad (10)$$

which has the value

$$D = Z_1^2 Z_2 - 2Z_1 Z_a^2. \quad (11)$$

The following approximations for the self and mutual impedances are made throughout the remainder of this paper:

$$Z_1 = R + jX_1 \cong R + j\omega_0 L_1 \quad (12)$$

$$Z_2 = j\omega L_2 + \frac{1}{j\omega C_2} \cong 2jL_2 \Delta\omega \quad (13)$$

$$Z_a = j\omega M_a \cong j\omega_0 M_a \quad (14)$$

$$Z_b = j\omega M_b \cong j\omega_0 M_b$$

where

$$\Delta\omega = \omega - \omega_0$$

$$\omega_0 = \text{resonant frequency of resonant meshes.} \quad (15)$$

² W. W. Hansen and O. C. Lundstrom, "Electrolytic tank impedance-function determination," PROC. I.R.E., vol. 33, pp. 528-534; August, 1945.

The determinant of (11) has a single root of value,

$$\Delta\omega_1 = \frac{Z_a^2}{jL_2Z_1} \quad (16)$$

which reduces to

$$\Delta\omega_1 = \frac{k_a^2 X_1^2 \omega_0}{|Z_1|^2} + j k_a^2 \frac{RX_1}{|Z_1|^2} \omega_0. \quad (17)$$

The real part of this root corresponds to a slight shift in the resonant frequency of the filter from the resonant frequency of the resonant mesh alone, and is not of any great importance or significance.

The imaginary part of this root results from the finite loss of the equivalent resonant circuit due to the terminating resistors and, together with the coupling factor, determines the equivalent Q of the filter. The location of the root in the complex-impedance plane and the contours of constant relative insertion loss are shown in

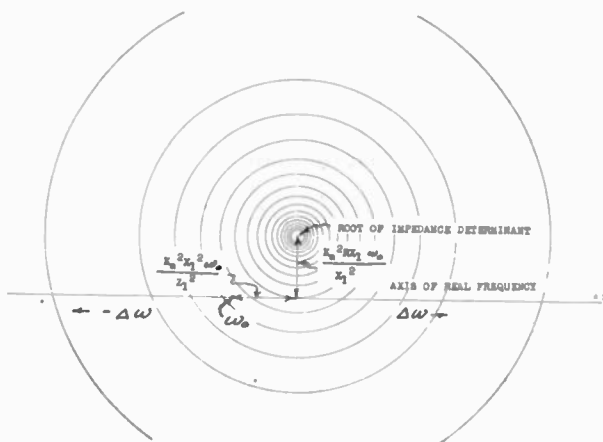

Fig. 5—Location of the root of the impedance determinant for the single-resonant-circuit filter together with contours of constant insertion loss in the complex-frequency plane.

Fig. 5. The contours of constant insertion loss (potential) are circles about the root and are so chosen that the change in the value of insertion loss between adjacent circles is 2 decibels.

The method of constructing a curve of relative insertion loss versus frequency is shown in Fig. 6. The universal curves of Fig. 2 were obtained by this method.

The insertion loss at the resonant frequency of the filter is obtained by substituting the real part of the root (11) in the expression for insertion loss, which for this case is

$$L_{db} = 20 \log_{10} \left| \frac{2Z_a^2 R}{Z_1^2 Z_2 - 2Z_1 Z_a^2} \right|. \quad (18)$$

This reduces to

$$-L_{db} = 20 \log_{10} \left| \left(\frac{Z_1}{R} - j \frac{X_1}{R} \right) \frac{Z_1^2}{|Z_1|^2} \right|. \quad (19)$$

This expression has an absolute value of unity and so the insertion loss is zero at the resonant frequency of the filter. This is, of course, an approximation based

upon the assumption that the resonator losses are negligible compared to the power transmitted to the load. This approximation breaks down when the couplings to the resonant circuit are very low.

VII. ANALYSIS OF A DOUBLE-RESONANT-CIRCUIT FILTER

The mesh equations of the circuit of Fig. 1(b) are

$$\begin{aligned} V_1 &= I_1 Z_1 + I_2 Z_a + 0 + 0 \\ 0 &= I_1 Z_a + I_2 Z_2 + I_3 Z_b + 0 \\ 0 &= 0 + I_2 Z_b + I_3 Z_2 + I_4 Z_a \\ 0 &= 0 + 0 + I_3 Z_a + I_4 Z_1. \end{aligned} \quad (20)$$

The determinant of this set of equations is

$$D = \begin{vmatrix} Z_1 & Z_a & 0 & 0 \\ Z_a & Z_2 & Z_b & 0 \\ 0 & Z_b & Z_2 & Z_a \\ 0 & 0 & Z_a & Z_1 \end{vmatrix} \quad (21)$$

which has the value

$$D = Z_2^2 (Z_1^2) - Z_2 (2Z_1 Z_a^2) + (Z_a^4 - Z_1^2 Z_b^2). \quad (22)$$

This expression has two roots of value

$$\Delta\omega_{1,2} = \frac{1}{2jL_2} \left(\frac{Z_a^2}{Z_1} \pm Z_b \right). \quad (23)$$

In terms of coupling coefficients, this is

$$\Delta\omega_{1,2} = j \frac{\omega_0}{2} \frac{RX_1}{|Z_1|^2} k_a^2 + \frac{\omega_0}{2} \frac{X_1^2}{|Z_1|^2} k_a^2 \pm \frac{\omega_0 k_b}{2}. \quad (24)$$

The location of the two roots in the complex-impedance plane is shown in Fig. 7. It is of interest to note that the factor Z_a^2/Z_1 , which occurred in the case of the single-resonant-circuit filter, also appears for the double-resonant-circuit filter. It is also reassuring to note that

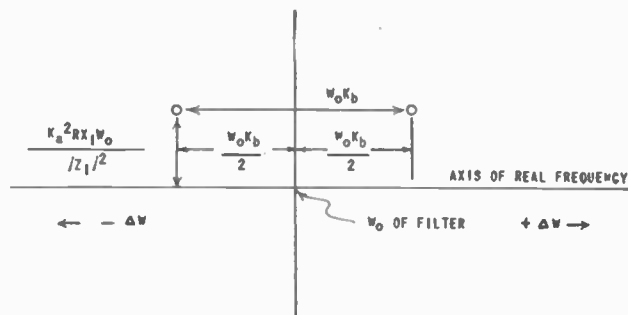

Fig. 7—Location of the roots of the impedance determinant for the double-resonant-circuit filter in the complex-frequency plane.

the roots are spaced by a distance $\omega_0 k_b$, a result which confirms the approximate rule that the band width of a two-mesh-circuit response is approximately equal to the coefficient of coupling when the circuits are over-coupled.

Contours of constant insertion loss in the complex-frequency plane are obtained by combining two single-

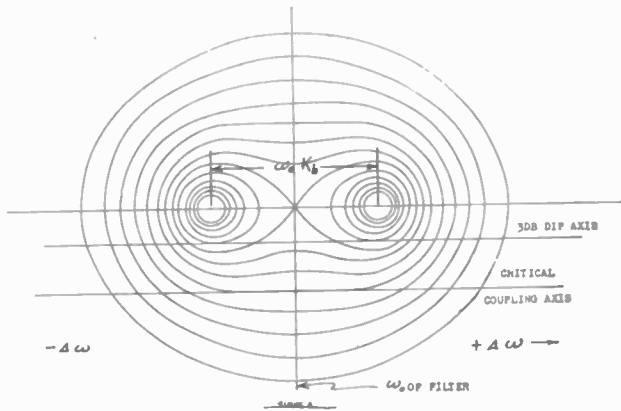

Fig. 8—Contours of constant insertion loss in the complex-impedance plane for the case of the double-resonant-circuit filter.

root plots as given in Fig. 5. The result of the combination yields the plot of Fig. 8, which is the same as the equipotential plot for the case of two equally charged infinite parallel wires.

The universal insertion-loss-frequency curves of Fig. 3 were obtained from Fig. 8 by the same construction as that illustrated in Fig. 6.

The insertion loss on the real-frequency axis opposite one of the roots—i.e., at one of the two response peaks when the circuits are overcoupled—is found by inserting the real part of $\Delta\omega_1$ into the expression for the insertion loss, which in this case is*

$$L_{db} = 20 \log_{10} \left| \frac{2RZ_a^2 Z_b}{D} \right|. \quad (25)$$

This substitution yields the equation

$$-L_{db} = 20 \log_{10} \left| \left(\frac{X_1 Z_1^2}{|Z_1|^2} - jZ_1 \right) + \frac{X_a^2}{RX_b} \left(\frac{1 - X_1^2 Z_1^2}{|Z_1|^4} + \frac{j2X_1 Z_1}{|Z_1|^2} \right) \right|. \quad (26)$$

Critical coupling exists when

$$\frac{X_1 X_b}{X_a^2} = \frac{k_b}{k_a^2} = \frac{RX_1}{|Z_1|^2} \quad (27)$$

as may be seen from the condition that the second derivative of the insertion loss is zero at mid-frequency. Reference to (26) shows that for couplings slightly greater than critical the first term of the logarithm dominates, and, since this has an absolute value of unity, the insertion loss at the response peaks is nearly zero.

VIII. ANALYSIS OF THE TRIPLE-RESONANT-CIRCUIT FILTER

The mesh equations of the circuit of Fig. 1(c) are:

$$\begin{aligned} V_1 &= I_1 Z_1 + I_2 Z_a + 0 + 0 + 0 \\ 0 &= I_1 Z_a + I_2 Z_2 + I_3 Z_b + 0 + 0 \\ 0 &= 0 + I_2 Z_b + I_3 Z_2 + I_4 Z_b + 0 \\ 0 &= 0 + 0 + I_3 Z_b + I_4 Z_2 + I_5 Z_a \\ 0 &= 0 + 0 + 0 + I_4 Z_a + I_5 Z_1. \end{aligned} \quad (28)$$

The determinant of this set of equations is

$$D = \begin{vmatrix} Z_1 & Z_a & 0 & 0 & 0 \\ Z_a & Z_2 & Z_b & 0 & 0 \\ 0 & Z_b & Z_2 & Z_b & 0 \\ 0 & 0 & Z_b & Z_2 & Z_a \\ 0 & 0 & 0 & Z_a & Z_1 \end{vmatrix}. \quad (29)$$

This determinant has the value

$$D = Z_2^3(Z_1^2) + Z_2^2(-2Z_1 Z_a^2) + Z_2(Z_a^4 - 2Z_1^2 Z_b^2) + 2Z_1 Z_a^2 Z_b^2. \quad (30)$$

This is a cubic equation in frequency and as such has three roots. Exact solution of such an equation is difficult, in general, but was achieved in this case. Examination of (30) plus physical considerations show that one root is located near $\Delta\omega = 0$. This root may be found by neglecting the first two terms and setting the last two equal to zero. The value obtained is

$$\Delta\omega_2 = \frac{k_a^2}{2} \frac{X_1^2}{|Z_1|^2} \omega_0 + j \frac{k_a^2}{2} \frac{R_1 X_1}{|Z_1|^2} \omega_0 \quad (31)$$

on the basis of the assumption that $X_a \ll Z_1$.

By a fortunate circumstance, $\Delta\omega_2$ turns out to be an exact root and (31) is equivalent to

$$Z_2 = Z_a^2 / Z_1. \quad (32)$$

This same factor Z_a^2 / Z_1 appeared in the one- and two-circuit cases. Therefore, the other two roots may be found by dividing (30) by the factor $(Z_2 - Z_a^2 / Z_1)$, which yields the reduced quadratic equation

$$Z_2^2 - \frac{Z_a^2 Z_2}{Z_1} - 2Z_b^2 = 0. \quad (33)$$

The roots of this quadratic are

$$Z_2 = \frac{Z_a^2}{2Z_1} \pm \sqrt{2} Z_b \sqrt{1 + \frac{Z_a^4}{8Z_1^2 Z_b^2}} \quad (34)$$

or approximately

$$Z_2 = \frac{Z_a^2}{2Z_1} \pm \sqrt{2} Z_b \quad (35)$$

on the assumption that $(Z_a / Z_1)^2$ is sn. .1 compared to 1. In terms of the coupling coefficients the roots are

$$\Delta\omega_{1,3} \cong j \frac{k_a^2}{4} \frac{RX_1}{|Z_1|^2} \omega_0 + \frac{k_a^2}{4} \frac{X_1^2}{|Z_1|^2} \omega_0 \pm \frac{k_b}{\sqrt{2}} \omega_0. \quad (36)$$

The location of these roots is shown in Fig. 9. It is not possible to make a universal field plot for the three-resonant-circuit case since the insertion-loss response depends upon the relative value of the coupling coefficients. The insertion-loss-frequency curves may, however, be obtained by combining the plots of Figs. 8 and 5 and taking profile values along the real-frequency axis. The curves of Fig. 3 were obtained in this fashion.

IX. SUMMARY OF RESULTS

A. Single-Resonant-Circuit Filter

1. Insertion loss at resonance is zero.
2. Sharpness of resonance decreases as either k_a^2 or the factor $RX_1/|Z_1|^2$ increases.

B. Double-Resonant-Circuit Filter

1. Bandwidth has a primary dependence upon k_b , inner coupling.
2. Size of insertion-loss-frequency dips in overcoupled case decreases as the factor $(k_a^2/k_b)(RX_1/|Z_1|^2)$ increases.
3. Flattest pass-band response is obtained for $(k_c^2/k_b)(RX_1/|Z_1|^2) = 0.5$ (critical coupling).
4. Insertion loss is approximately zero at the peaks in the overcoupled case.

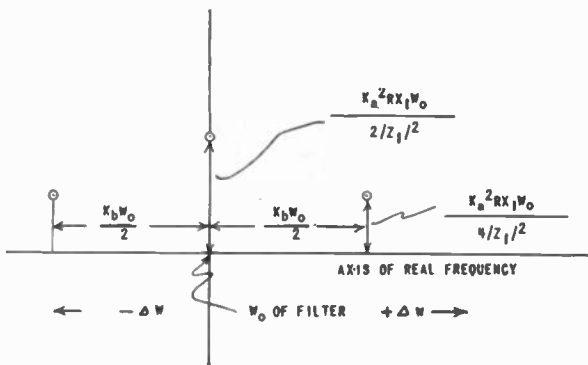

Fig. 9—Location of the roots of the impedance determinant for the triple-resonant-circuit filter in the complex-impedance plane.

C. Triple-Resonant-Circuit Filter

1. Bandwidth has a primary dependence upon inner coupling k_b .
2. Size of the insertion-loss-frequency dips decreases as the factor $(k_a^2/2\sqrt{2}k_b)(RX_1/|Z_1|^2)$ increases.
3. Flattest pass-band response is obtained for $k_a^2/2\sqrt{2}k_b RX_1/|Z_1|^2 \cong 0.2$.
4. The bandwidth of a three-resonant-circuit filter is approximately 40 per cent greater than that of a two-resonant-circuit filter with the same outer and inner coupling.
5. For the same bandwidth and for a condition of critical coupling, the inner coupling in the three-resonant-circuit filter will be 30 per cent less and the outer coupling 12 per cent less than the corresponding coupling in the two-resonant-circuit filter.
6. The performance of a triple-resonant-circuit filter with unlike terminal impedances is approximately the same as that of a filter with equal terminal impedances of value equal to the algebraic mean of the unlike impedances; i.e.,

$$Z_1 = \frac{Z_1' + Z_1''}{2} \tag{37}$$

(See Appendix I.)

7. In a filter in which the coupling is obtained by shunt reactances, as in the variations shown in Fig. 10,

all of the foregoing analysis and comments apply provided the coupling coefficients are defined in terms of



Fig. 10—Other resonant-circuit filters which may be analyzed by the method of this article.

reactances by the formulas

$$k_a^2 = \frac{X_a^2}{X_1 X_2} \tag{38}$$

and

$$k_b = \frac{X_b}{X_2} \tag{39}$$

where X_1 and X_2 are the total reactances of meshes 1 and 2 of the same sign as X_a and X_b .

APPENDIX I

CASE OF UNEQUAL INPUT AND OUTPUT RESISTANCES

For the circuit of Fig. 11 in which the input and output resistances are unequal, the determinant of the network is

$$D = \begin{vmatrix} Z_1' & Z_a & 0 & 0 & 0 \\ Z_a & Z_2 & Z_b & 0 & 0 \\ 0 & Z_b & Z_2 & Z_b & 0 \\ 0 & 0 & Z_b & Z_2 & Z_a \\ 0 & 0 & 0 & Z_a & Z_1'' \end{vmatrix} \tag{40}$$

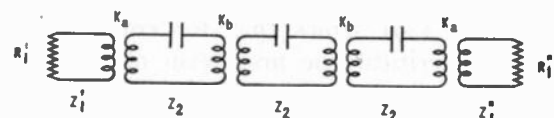

Fig. 11—Triple-resonant-circuit filter with unequal input and output impedances.

This expands to

$$D = Z_2^3(Z_1'Z_1'') - Z_2^2Z_a^2(Z_1' + Z_1'') + Z_2(Z_a^4 - 2Z_1'Z_1''Z_b^2) + (Z_1' + Z_1'')Z_a^2Z_b^2 \tag{41}$$

By comparing (41) with (30), it is seen that Z_1 in (30) is replaced by the algebraic and geometric means of Z_1' and Z_1'' in (41). When Z_1' and Z_1'' are not too different, the geometric and algebraic means are nearly equal and the conclusions of paragraph C-6 of Section IX, follow at once.

Simplifications in the Consideration of Mutual Effects Between Half-Wave Dipoles in Collinear and Parallel Orientations*

KOSMO J. AFFANASIEV†, MEMBER, I.R.E.

Summary—This paper presents a simplified approach for determining the absolute values of mutual impedance between half-wave dipoles in parallel and collinear orientations. The author feels justified in making simplifying assumptions because of two reasons, namely: (1) The results under this method are in close agreement with those under more exact methods; (2) under an exact method, the process of determining the absolute values of mutual impedance is quite complicated and time consuming.

INTRODUCTION

IN A system made up of two antennas placed above a perfectly conducting common ground, it becomes necessary to consider the mutual effects existing not only between the two physical antennas but between each of the antennas and their images. Such a system, in effect, becomes a rather complicated radiating system with its elements variously interacting upon each other. For example, when in such a system the two antennas are at the same height and are placed end to end with a given separation, the mutual effects existing in the system are due to the following orientations of the antennas and their images with respect to each other: (a) collinear, (due to the two physical antennas); (b) parallel (antenna 1 and its image); (c) parallel (antenna 2 and its image); (d) parallel at a given stagger distance (antenna 1 and the image of antenna 2); and (e) parallel at a similar stagger distance (antenna 2 and the image of antenna 1).

If we assume one of the antennas (1) to be a transmitting antenna and the other (2) as a receiving antenna, the question may arise as to what is the decoupling or attenuation in the radiated power, or what is the resultant electric force in the vicinity of antenna 2 due to the existence of the mutual interactions.

FORMULA BY CARTER VERSUS SIMPLIFIED EXPRESSION

A general solution of the problem is extremely complicated, but when confined to half-wave dipoles it can be greatly simplified. Fortunately, the actual case under consideration consisted of two half-wave dipoles. The operating wavelengths were of the order of 3 meters down to 1.5 meters. The separation between the dipoles often was in excess of 30 wavelengths.

Carter¹ has derived curves of the absolute values of

mutual impedance as a function of spacing for separations of up to 7 wavelengths in the case of parallel half-wave dipoles, where the corresponding ends of the dipoles were on a common perpendicular line; and for separations of up to 3 wavelengths in the case of collinear half-wave dipoles. Since in our case the separation was greater than 7 wavelengths and often in excess of 30 wavelengths, it was necessary to determine the values of the mutual impedance for the separations and orientations involved. Attempts to use the known methods and formulas¹⁻⁴ for determining the mutual impedance were found to be very laborious. For example, the expression by Carter⁵ for the mutual impedance of collinear half-wave dipoles consists of fourteen terms, and his expression for the parallel nonstaggered case consists of six terms. These expressions involve $\text{Si}(x)$ and $\text{Ci}(x)$ functions, that is, sine and cosine integrals. In this connection, it was surprising to find that the tables of $\text{Si}(x)$ and $\text{Ci}(x)$ functions are not readily available for the values of x greater than 25 or, if available, the successive steps in x were such that these tables proved unsuitable for our purpose. Of course, for large separations the evaluation of sine and cosine integrals is fairly simple by the use of the asymptotic expansions, but considering the number of terms involved in the expressions mentioned and the number of different antenna separations involved in our case, it seemed entirely too laborious to pursue the method. The need for some simpler approach was obvious.

The expressions for the mutual impedance which were developed, as a result, are quite simple and are free of $\text{Si}(x)$ and $\text{Ci}(x)$ functions. The expression for the collinear case simplifies to six terms and that for the parallel case simplifies to a single term. These expressions are based on certain simplifying assumptions, but the amount of error introduced is less than 10 per cent even at one-wavelength separation and it decreases to a negligible value at larger separations. (This can be seen from Figs. 4 and 5, which give a comparison of the mutual impedance by Carter versus that calculated on the basis of our simplified expressions.)

MUTUAL EFFECTS THAT MUST BE CONSIDERED

Before proceeding with our development, it will be

* Decimal classification: R231.3XR129. Original manuscript received by the Institute, August 6, 1945; revised manuscript received, December 2, 1945.

† Formerly, Airborne Instruments Laboratory, Columbia University, New York, N. Y.; now, Federal Communications Commission, Washington, D. C.

¹ P. S. Carter, "Circuit relations in radiating system and application to antenna problems," *Proc. I.R.E.*, vol. 20, pp. 1004-1041; June, 1932.

² G. H. Brown, "Directional antennas," *Proc. I.R.E.*, vol. 25, pp. 78-145; January, 1937.

³ A. A. Pistolokors, "The radiation resistance of beam antennas," *Proc. I.R.E.*, vol. 17, pp. 562, 579; March, 1929.

⁴ F. E. Terman, "Radio Engineers' Handbook," McGraw-Hill Book Company, New York, N. Y., 1943, pp. 776-781.

⁵ Equations (60) and (50) of footnote reference 1.

shown that of the five mutual effects enumerated at the outset, actually only three effects must be considered. For example, the current in antenna 2 is a function of the following mutual impedances: (a) between collinear antennas (antennas 1 and 2); (b) between nonstaggered parallel antennas (antenna 1 and its image); and (c) between staggered parallel antennas (antenna 1 and the image of antenna 2).

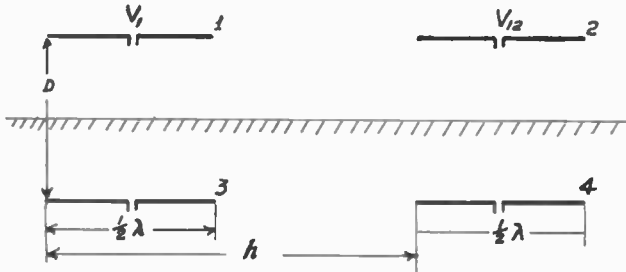

Fig. 1

Referring to Fig. 1, let V_1 be the impressed voltage in antenna 1 and V_{12} be the induced voltage in antenna 2 due to current I_1 in antenna 1. Then we can write

$$V_1 = Z_{11}I_1 + Z_{13}I_3 + Z_{12}I_2 + Z_{14}I_4 \quad (1)$$

$$V_{12} = Z_{21}I_1 + Z_{23}I_3 + Z_{22}I_2 + Z_{24}I_4 \quad (2)$$

But

$$I_3 = -I_1; \quad I_4 = -I_2; \quad Z_{23} = Z_{14}; \quad Z_{24} = Z_{13};$$

$Z_{11} = Z_{22} = Z_s$ or self-impedance of either antenna.

Then (1) and (2) become

$$V_1 = I_1(Z_s - Z_{13}) + I_2(Z_{12} - Z_{14}) \quad (3)$$

$$V_{12} = I_1(Z_{12} - Z_{14}) + I_2(Z_s - Z_{13}). \quad (4)$$

If the receiving antenna (antenna 2) is short-circuited, (4) becomes

$$0 = I_1(Z_{12} - Z_{14}) + I_2(Z_s - Z_{13}). \quad (5)$$

Eliminating I_1 from (3) and (5) and solving for I_2 we have

$$I_2 = \frac{V_1(Z_{12} - Z_{14})}{(Z_{12} - Z_{14})^2 - (Z_s - Z_{13})^2}. \quad (6)$$

From (6), the impedances that must be considered in a system such as shown in Fig. 1 consists of (a) the self-impedance or characteristic impedance of either of the dipoles; (b) the mutual impedance of nonstaggered parallel dipoles; (c) the mutual impedance of collinear dipoles; and (d) the mutual impedance of parallel dipoles in echelon.

MUTUAL IMPEDANCE FOR COLLINEAR HALF-WAVE DIPOLES—A SIMPLIFIED EXPRESSION

In Fig. 2, let wire 1 be a transmitting antenna and wire 2 be a receiving antenna. In general, the mutual impedance for such wires, situated in any orientation with respect to each other, is the ratio of the voltage V_{12} induced in antenna 2 to the current I_1 in antenna 1, or $Z_{12} = -(V_{12}/I_1)$. The negative sign follows, of course, from the concept of self-impedance. That is, for an-

tenna 1 alone, self-impedance is $Z_{11} = (V_1/I_1)$. But the induced voltage V_{11} is equal and opposite to V_1 , so that $Z_{11} = -(V_{11}/I_1)$. Assuming a sine-wave distribution of the current in antenna 2 due to the electric force produced along it by current I_1 in antenna 1, the voltage induced in antenna 2 is

$$V_{12} = \int_0^l E_{12} \sin \beta y dy$$

and the mutual impedance becomes

$$Z_{12} = -\frac{1}{I_1} \int_0^l E_{12} \sin \beta y dy \quad (7)$$

where E_{12} is the component of the field intensity parallel to antenna 2 due to current I_1 in antenna 1. As shown by Carter,⁶ this component is given by

$$E_{12} = j30I_1 \left[\frac{e^{-j\beta r_2}}{r_2} (-1)^n - \frac{e^{-j\beta r_1}}{r_1} \right] \quad (8)$$

where n = the number of half waves on the antenna, $\beta = 2\pi/\lambda$, and λ = wavelength.

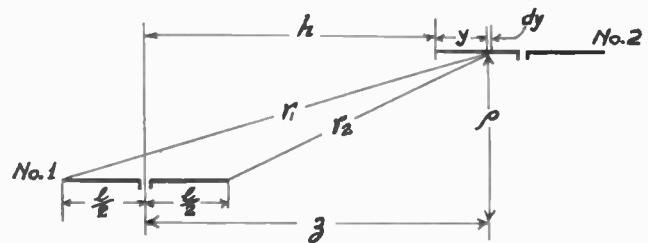

Fig. 2

For the case of a collinear system the distance p in Fig. 2 is zero, so that $r_1 = z + (l/2)$ and $r_2 = z - (l/2)$. For a half-wave dipole $n = 1$, so that (8) becomes

$$E_{12} = -j30I_1 \left[\frac{e^{-j\beta(z+l/2)}}{z+l/2} + \frac{e^{-j\beta(z-l/2)}}{z-l/2} \right] \\ = -\frac{j30I_1 e^{-j\beta z}}{z^2 - \frac{l^2}{4}} \left[\left(z - \frac{l}{2} \right) e^{-j\beta l/2} + \left(z + \frac{l}{2} \right) e^{j\beta l/2} \right]. \quad (9)$$

Remembering that $e^{-j\beta z} = \cos \beta x - j \sin \beta x$, $e^{j\beta z} = \cos \beta x + j \sin \beta x$, and $(\beta l/2) = (\pi/2)$ when $l = (\lambda/2)$, expression (9) reduces to

$$E_{12} = \frac{30I_1 l e^{-j\beta z}}{z^2 - \frac{l^2}{4}}. \quad (10)$$

By substituting (10) and since from Fig. 2, $z = h + y$, expression (7) becomes

$$Z_{12} = -30I_1 e^{-j\beta h} \int_0^l \frac{e^{-j\beta y} \sin \beta y dy}{(h+y)^2 - \frac{l^2}{4}}.$$

⁶ Equation (10), p. 1009, of footnote reference 1.

Expressing $\sin \beta y = (1/2j)(e^{i\beta y} - e^{-i\beta y})$,

$$\begin{aligned} Z_{12} &= -\frac{15l}{j} e^{-i\beta h} \int_0^l \left[\frac{1 - e^{-2i\beta y}}{(h+y)^2 - \frac{l^2}{4}} \right] dy \\ &= -\frac{15l}{j} e^{-i\beta h} \left[\frac{1}{l} \int_0^l \frac{dy}{(h+y) - \frac{l}{2}} \right. \\ &\quad - \frac{1}{l} \int_0^l \frac{dy}{(h+y) + \frac{l}{2}} \\ &\quad \left. - \int_0^l \frac{e^{-2i\beta y} dy}{(h+y)^2 - \frac{l^2}{4}} \right]. \end{aligned} \quad (11)$$

Considering the first two terms of (11),

$$\begin{aligned} \frac{1}{l} \int_0^l \frac{dy}{(h+y) - \frac{l}{2}} - \frac{1}{l} \int_0^l \frac{dy}{(h+y) + \frac{l}{2}} \\ &= \frac{1}{l} \left[\log \left(h + y - \frac{l}{2} \right) \right]_0^l \\ &\quad - \frac{1}{l} \left[\log \left(h + y + \frac{l}{2} \right) \right]_0^l \\ &= \frac{1}{l} \left[\log \frac{\left(h + \frac{l}{2} \right)^2}{\left(h + \frac{3l}{2} \right) \left(h - \frac{l}{2} \right)} \right]. \end{aligned}$$

Integrating the third term of (11) by parts,

$$\begin{aligned} \int_0^l \frac{e^{-2i\beta y}}{(h+y)^2 - \frac{l^2}{4}} dy &= \left[\frac{e^{-2i\beta y}}{-2j\beta(h+y)^2 - \frac{l^2}{4}} \right]_0^l \\ &\quad - \int_0^l f \left[\frac{1}{(h+y)^2} \right] dy. \end{aligned}$$

For $h > l$, the term involving $f(1/h^2)$ can be neglected, and (11) becomes

$$\begin{aligned} Z_{12} \simeq 15e^{-i\beta h} \left\{ j \log \left[\frac{\left(h + \frac{l}{2} \right)^2}{\left(h + \frac{3l}{2} \right) \left(h - \frac{l}{2} \right)} \right] \right. \\ \left. + \frac{l}{2\beta} \left[\frac{e^{-2i\beta l}}{(h+l)^2 - \frac{l^2}{4}} - \frac{1}{h^2 - \frac{l^2}{4}} \right] \right\}. \end{aligned}$$

Let the separation be defined as $S = (h/\lambda)$, and since $e^{-i\beta h} = e^{-i2\pi S} = \cos 2\pi S - j \sin 2\pi S$, and since for half-wave dipoles $l = (\lambda/2)$,

$$\begin{aligned} Z_{12} \simeq 15 \left\{ \sin 2\pi S \log \left[\frac{(4S+1)^2}{(4S+3)(4S-1)} \right] \right. \\ \left. - \frac{2}{\pi} \cos 2\pi S \left[\frac{1}{(4S)^2 - 1} - \frac{1}{(4S+2)^2 - 1} \right] \right\} \\ + j15 \left\{ \cos 2\pi S \log \left[\frac{(4S+1)^2}{(4S+3)(4S-1)} \right] \right. \\ \left. + \frac{2}{\pi} \sin 2\pi S \left[\frac{1}{(4S)^2 - 1} - \frac{1}{(4S+2)^2 - 1} \right] \right\}. \end{aligned} \quad (12)$$

MUTUAL IMPEDANCE FOR PARALLEL HALF-WAVE DIPOLES

In the case of parallel half-wave dipoles, expressions for the mutual impedance that do not involve $\text{Si}(x)$ and $\text{Ci}(x)$ functions can be developed, but such expressions become extremely complicated. Therefore, for our case, the values of mutual impedance of parallel half-wave dipoles at a stagger distance of $\frac{1}{2}\lambda$ were calculated using the expression by Carter and evaluating $\text{Si}(x)$ and $\text{Ci}(x)$ by the asymptotic expansions whenever needed.

In the case of parallel half-wave dipoles without stagger (Fig. 3) the simplifying assumption as in the collinear case was that the separation between the antennas is large in relation to the length of dipole. The assumption was consistent with the actual arrangement involved in the study. The error introduced by the assumption is of the order of 10 per cent even at a separation as small as one wavelength, and it becomes negligible at larger separations.

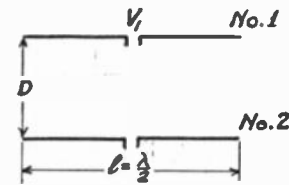

Fig. 3

The voltage V_{12} induced in antenna 2 due to current I_1 in antenna 1 may be taken as the product of the component of the field intensity parallel to antenna 2 and its effective height, or

$$V_{12} = E_{12}h_2. \quad (13)$$

But

$$|E_{12}| \simeq \frac{60I_1}{D} \quad \text{and} \quad h_2 = \frac{\lambda}{\pi}, \quad \text{so that}$$

$$|V_{12}| \simeq \frac{60I_1\lambda}{\pi D} \quad (14)$$

$$|Z_{12}| = \left| \frac{V_{12}}{I_1} \right| \simeq \frac{60}{\pi S} \quad (15)$$

where

$$S = \frac{D}{\lambda}.$$

DECOUPLING

$$Z_{12} = -\frac{V_{12}}{I_1}, \quad \text{but} \quad I_1 = \frac{V_{11}}{Z_{11}} = \frac{V_{11}}{Z_0}$$

Taking the characteristic impedance of a half-wave dipole to be 72 ohms,

$$I_{11} \approx \frac{V_{11}}{72},$$

so that

$$Z_{12} \approx -\frac{72V_{12}}{V_{11}},$$

from which

$$\frac{V_{12}}{V_{11}} \approx -\frac{Z_{12}}{72}$$

$$Db \approx 20 \log \left(-\frac{Z_{12}}{72} \right) = 20 \log \frac{72}{|Z_{12}|} \quad (16)$$

RESULTS

The absolute values of the mutual impedance for half-wave dipoles are shown in Figs. 4, 5, and 6. As previously discussed, Fig. 4 is for the collinear case and the antenna separations of up to 4 wavelengths; Fig. 5

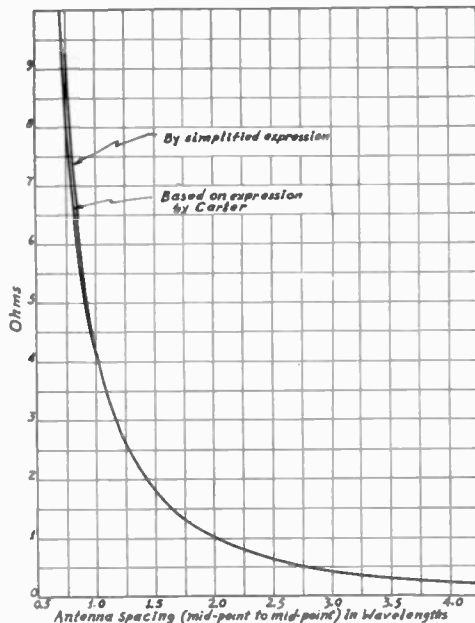

Fig. 4—Mutual impedance of collinear half-wave dipoles. Absolute values by Carter versus those by approximate method.

is for the parallel nonstaggered case and the antenna separations of up to 7 wavelengths. Fig. 6 is for all the three orientations and for the antenna separations of up to 32 wavelengths. Finally, Fig. 7 shows decoupling versus spacing of up to 32 wavelengths. As one would expect, the curve of decoupling for the parallel half-wave dipoles placed at a stagger distance of $\frac{1}{2}\lambda$ falls

between the curves for the other two cases; namely, the collinear and parallel nonstaggered case. It will be noted

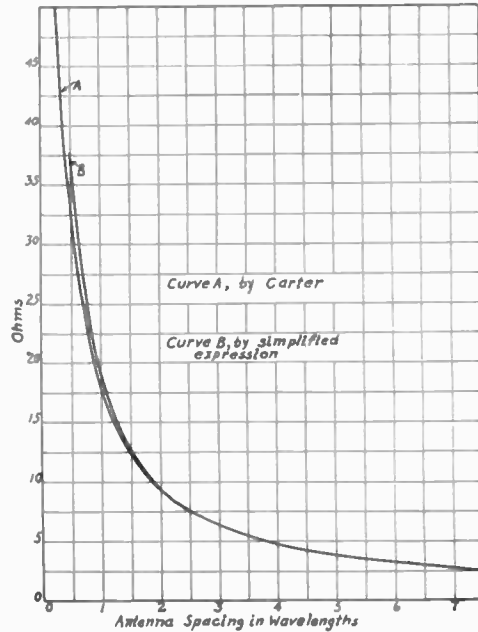

Fig. 5—Mutual impedance of nonstaggered parallel half-wave dipoles. Absolute values by Carter versus those by simplified method.

that these decoupling curves are straight lines on semi-log paper. The straight-line curve for the parallel-staggered case is quite close to the straight-line curve for the collinear case. The slope of the straight line for the

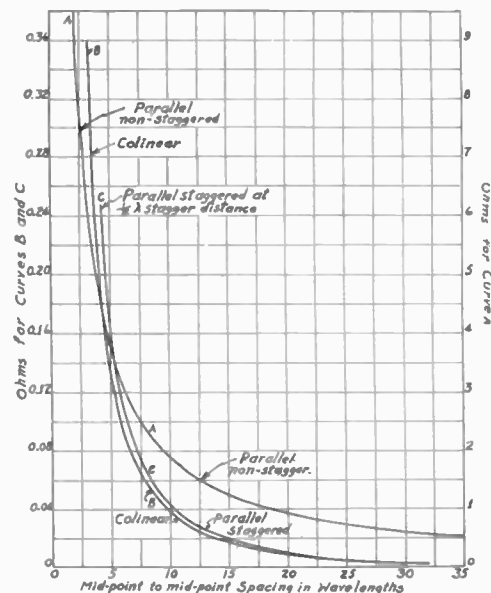

Fig. 6—Mutual impedance of half-wave dipoles in various orientations by simplified method.

parallel-staggered case is such that at zero separation it must become zero, the mutual impedance and, therefore, decoupling becoming constant; at a very large separation the parallel-staggered case approaches the collinear case.

A Variation on the Gain Formula for Feedback Amplifiers for a Certain Driving-Impedance Configuration*

THOMAS W. WINTERNITZ†, ASSOCIATE, I.R.E.

Summary—An expression for the gain of a feedback amplifier, in which the source impedance is the only significant impedance across which the feedback voltage is developed, is derived. As examples of the use of this expression, it is then applied to three common circuits in order to obtain their response to a Heaviside unit step-voltage input.

THE ANALYTICAL treatment of feedback amplifiers in which the driving impedance, whether it be the resistance of the source or an impedance intentionally added in series with the input, constitutes a part of the feedback network, requires certain modifications of the conventional relation $G = A/(1 - Ab)$.

In particular, the present analysis applies to the specific case in which the source impedance driving the feedback circuit is the only significant impedance across which the feedback voltage is developed. Circuits of this description have the form shown in Fig. 1.

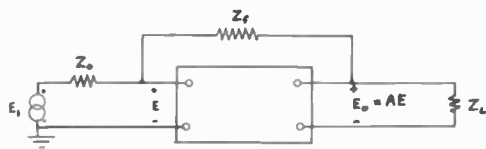

Fig. 1—Amplifier general circuit.

With the voltage-sign conventions of Fig. 1, and A being given the required sign to indicate whatever phase inversion there may be in the amplifier, we may write

$$E_0 = AE \quad (1)$$

$$E = E_1 + (E_0 - E_1)b$$

where

$$b = Z_0/(Z_f + Z_0)$$

then

$$E_0 = A(E_1 + (E_0 - E_1)b)$$

and

$$G = E_0/E_1 = \frac{A(1 - b)}{1 - Ab} \quad (2)$$

This last relation defines the voltage gain for the circuit described above; and, since it is such a simple expression, it can be applied readily to the solution of circuits which fall in this category.

Before applying (2) to the solution of specific problems, consider the expression for A , of (1), in terms of

the configuration of the circuit of Fig. 1. To find the voltage E_0 due to a voltage E applied, the pertinent circuit may be redrawn as in Fig. 2.

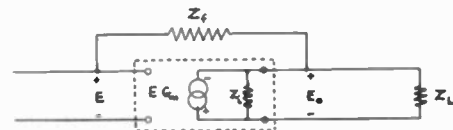

Fig. 2—Equivalent circuit for determination of A .

In this figure, the generator supplies a constant current equal to $G_m E$. G_m is the total transconductance of the enclosed circuit and Z_i is the impedance, as viewed across the output terminals of the network with external connections removed and the generator open-circuited. It is assumed that there is a net phase reversal of 180 degrees between E and $G_m E$, so that the feedback is negative. E_0 is given by a superposition of the voltage across Z_L due to E with the generator open-circuited, and the voltage due to $G_m E$ with the input terminals short-circuited.

Thus

$$A = E_0/E = - \left[G_m \frac{Z_L' Z_f}{Z_L' + Z_f} - \frac{Z_L'}{Z_L' + Z_f} \right]$$

$$A = - \left(G_m - \frac{1}{Z_f} \right) \frac{Z_L' Z_f}{Z_i + Z_f} \quad (3)$$

where Z_L' is the parallel combination of Z_L and Z_i or $Z_L' = Z_L Z_i / (Z_L + Z_i)$.

It is interesting to note that the feedback impedance enters this expression in two distinct ways; namely, as a shunt on the load, as indicated by the term, in the form of parallel impedances, and as a modification of the transfer admittance through the subtractive term inside the parenthesis.

Let us consider the application of these relations (2) and (3) to the three examples which follow.

Example 1: Integrating Amplifier

Consider the circuit of Fig. 3.

From equation (3),

$$A = - (G_m - pc) \frac{Z_L' / pc}{Z_L' + 1/pc}$$

$$= - (G_m/c - p) \frac{1}{p + 1/Z_L'c}$$

$$b = \frac{R}{R + 1/pc} = \frac{p}{p + 1/Rc}$$

where p is the familiar Heaviside operator of operational

* Decimal classification: R363.23. Original manuscript received by the Institute, October 15, 1945; revised manuscript received, January 9, 1946.

† Formerly, Bell Telephone Laboratories, New York, N. Y.; now, Cruft Laboratory, Harvard University, Cambridge, Massachusetts.

calculus. By substituting these relations in the gain expression (2) above, we have

$$\begin{aligned}
 -E_0/E_1 &= (G_m/c - p) \frac{1}{p+1/Z_L'c} \frac{1/Rc}{p+1/Rc} \\
 &= \frac{1}{Z_L'} \frac{1}{1+(G_m/c-p) \frac{1}{p+1/Z_L'c} \frac{p}{p+1/Rc}} \\
 &= \frac{- (p-G_m/c)}{Rc(1+G_mZ_L') + Z_L'c} \\
 &\times \frac{1}{p+1/Rc}
 \end{aligned}$$

The associated time function is

$$-E_0/E_1 = G_mZ_L'(1 - e^{-at}) - Z_L'ace^{-at}$$

where

$$a = \frac{1}{Rc(1 + G_mZ_L') + Z_L'c}$$

This relation shows that the response of the integrating amplifier to a step function is given by the difference of

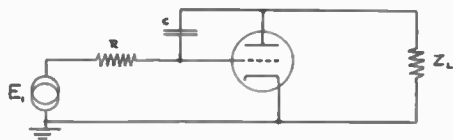

Fig. 3—Integrating amplifier.

two terms, the first of which is in the form of an exponential rise $(1 - e^{-at})$ having the time constant $1/a$ and amplified by the factor G_mZ_L' ; the second term is in the exponential form (e^{-at}) with the same time constant but multiplied by the factor $Z_L'ac$.

Example 2: Differentiating Amplifier

Consider the circuit of Fig. 4.

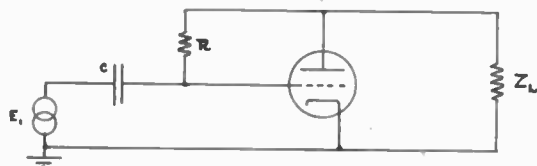

Fig. 4—Differentiating amplifier.

In this case, since the impedance Z_L is a pure resistance, and since in the usual case this is large compared with Z_L' , we will assume the feedback resistance to be large with respect to Z_L' so that its bridging effect may be neglected. If in a particular case this approximation is not justified, recourse may be made to the exact expression for A as given by (3) above.

In Fig. 4, in practice, a blocking capacitor whose value is chosen so as to allow its effect to be negligible is usually inserted in series with R . Similarly, the grid is normally returned to ground through a grid leak resistor, and in accordance with the initial assumption of the analysis the resistor must be sufficiently large so that it is not a significant element across which feedback voltage is developed.

With the above assumptions, we have

$$\begin{aligned}
 A &= -G_mZ_L' \\
 b &= \frac{1/pc}{R + 1/pc} = \frac{1}{Rc} \times \frac{1}{p + 1/Rc}
 \end{aligned}$$

Then

$$\begin{aligned}
 -E_0/E_1 &= \frac{G_mZ_L'p/(p + 1/Rc)}{1 + G_mZ_L' \frac{1/Rc}{p + 1/Rc}} \\
 &= \frac{G_mZ_L'p}{p + /Rc(1 + G_mZ_L')}
 \end{aligned}$$

and the associated time function is

$$-E_0/E_1 = G_mZ_L'e^{-(1+G_mZ_L)/Rc}$$

This relation shows that the response of the differentiating circuit (Fig. 3) to a step function is an exponential wave amplified by the factor G_mZ_L' but having the time constant $Rc/(1+G_mZ_L')$.

Example 3: Magnetic-Sweep Driving Stage

Consider the circuit of Fig. 5.

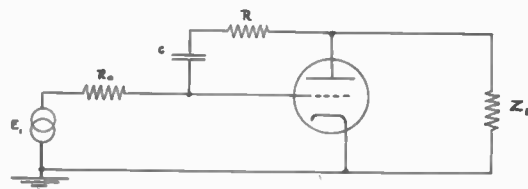

Fig. 5—Magnetic-sweep driving stage.

With the same approximation as in the above cases and making the further restriction that $|Z_i| \gg |Z_L|$, we have

$$\begin{aligned}
 A &= -G_mZ_L \\
 b &= \frac{R_0}{R_0 + R + 1/pc} = \frac{R_0}{R + R_0} \frac{p}{p + \frac{1}{(R_0 + R)c}}
 \end{aligned}$$

Then

$$\begin{aligned}
 -E_0/E_1 &= \frac{G_mZ_L \left(1 - \frac{R_0}{R_0 + R} \frac{p}{p + 1/(R_0 + R)c} \right)}{1 + G_mZ_L \frac{R_0}{R_0 + R} \frac{p}{p + 1/(R_0 + R)c}} \\
 &= \frac{G_mZ_LR}{R + R_0(1 + G_mZ_L)} \frac{p + 1/Rc}{p + 1/(R + R_0(1 + G_mZ_L))c}
 \end{aligned}$$

The associated time function is

$$\begin{aligned}
 -E_0/E_1 &= \frac{G_mZ_LR}{R + R_0(1 + G_mZ_L)} \\
 &\times \left[e^{-at} + \frac{R + R_0(1 + G_mZ_L)}{R} (1 - e^{-at}) \right]
 \end{aligned}$$

where

$$a = \frac{1}{(R + R_0(1 + G_m Z_L))c}$$

$$-E_0/E_1 = G_m Z_L \left(1 - e^{-at} \left(\frac{R_0(1 + G_m Z_L)}{R + R_0(1 + G_m Z_L)} \right) \right) \quad (4)$$

which is a wave of the type shown in Fig. 6. It rises abruptly and then follows an exponential wave in increasing to its final magnitude. This is the type of wave required to drive a linear current through a combination of resistance and inductance in series if the time constant $(R + R_0(1 + G_m Z_L))c$ is long, compared with the required length of sweep so that the exponential rise may be approximated by a linear rise. To show this,

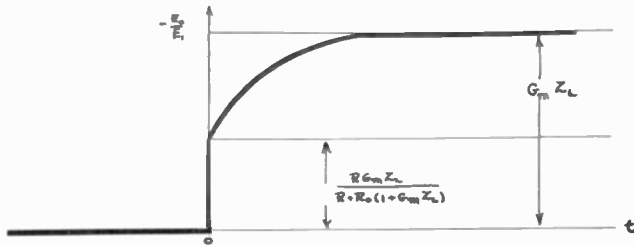

Fig. 6—Sweep-circuit output-voltage wave form.

consider a load consisting of R_1 and L in series, as shown in Fig. 7. The required condition is that $i = K/p$ where

$$K = \frac{\text{the total deflection current}}{\text{the total sweep time}}$$

$$E_0 = i(R_1 + Lp)$$

$$= KL + KR_1/p.$$

The associated time function is $E_0 = KL + KR_1 t$ which should match (4) (approximating e^x by $1 + x$).

From (4)

$$-E_0/E = G_m Z_L \left(1 - \frac{R_0(1 + G_m Z_L)}{R + R_0(1 + G_m Z_L)} \cdot \left(1 - \frac{t}{(R + R_0(1 + G_m Z_L))c} \right) \right)$$

$$= G_m Z_L \left[\frac{R}{R + R_0(1 + G_m Z_L)} + t \frac{R_0(1 + G_m Z_L)}{[R + R_0(1 + G_m Z_L)]^2 c} \right].$$

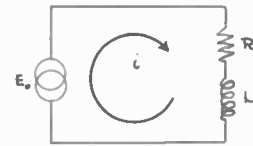

Fig. 7—Simple equivalent circuit of a magnetic deflection yoke.

Thus, the conditions that must be met by the values of L and R_1 of the magnetic-sweep inductor are

for
$$\frac{1}{2[R + R_0(1 + G_m Z_L)]^2 c^2} t^2 < 0.1$$

(neglected term in the series expansion)

$$L = \frac{R A_0}{K[R + R_0(1 + A_0)]}$$

$$R_1 = \frac{A_0 R_0(1 + A_0)}{K[R + R_0(1 + A_0)]^2 c}$$

or

$$L/R_1 = R c \frac{R + R_0(1 + A_0)}{R_0(1 + A_0)}$$

where $A_0 = G_m Z_L =$ gain of the amplifier without feedback.

Special Aspects of Balanced Shielded Loops*

L. L. LIBBY†, SENIOR MEMBER, I.R.E.

Summary—The theory of operation of the balanced shielded loop antenna is reviewed. A method of analysis of this type of antenna is described, wherein transmission-line principles are utilized to account for the distributed nature of the loop constants for loops whose perimeters are of the order of one-quarter wavelength. It is shown that the loop conductor within the shield may be treated as a coaxial transmission line having uniformly distributed constants, and that the outer surface of the shield may be treated as a balanced two-conductor transmission line having nonuniform constants. A method is described whereby the relatively cumbersome equations of the latter type of transmission line may be avoided by the use of an "equivalent" line having uniform characteristic impedance. A sample calculation is included to illustrate the utility of this method of analysis.

* Decimal classification: R125.3. Original manuscript received by the Institute, September 17, 1945; revised manuscript received, November 20, 1945.

† Federal Telecommunication Laboratories, Inc., New York, N. Y.

INTRODUCTION

THE BALANCED shielded loop antenna is widely used in specialized types of radio equipments, e.g., direction finders, homing devices, etc. Its behavior at low frequencies is generally understood and has been covered quite completely in numerous texts on radio and communications. However, the high-frequency behavior of the loop requires further analysis, some of the features of which will be covered in this paper.

The basic principles underlying the operation of this type of antenna are fundamentally the same as those for any other type of antenna. This means that the loop antenna operates so as to satisfy Maxwell's equations at each and every infinitesimal point in space, whether this be a point on the loop shield surface, within the

shield conducting material, or anywhere in the dielectric medium surrounding the loop antenna. Strictly speaking, then, the complete electromagnetic field, including all retardation effects, must be considered in analyzing the behavior of the loop antenna at high frequencies. However, it is often possible to take advantage of the analytical simplifications afforded by the use of conventional circuit theory, as will be shown.

In the discussion which follows the analysis will be restricted to the case of a single-turn, balanced, shielded loop wherein an inner conductor is positioned within a

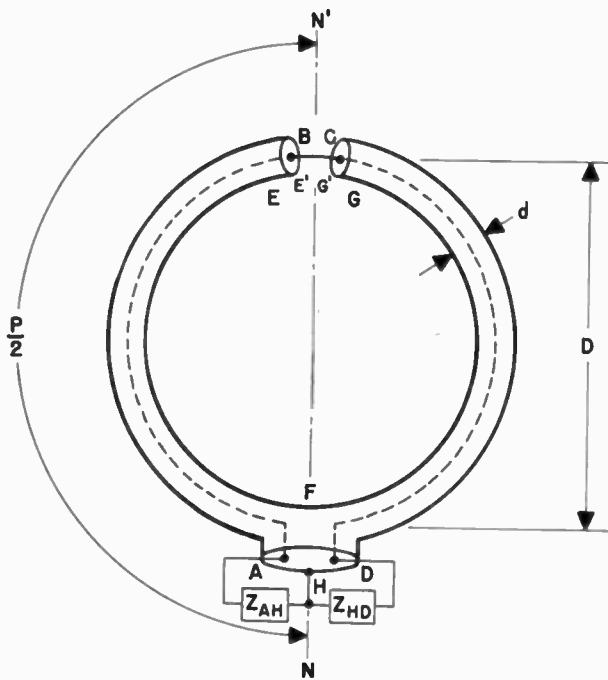

Fig. 1—Single-turn balanced shielded loop antenna.

shielding tube of highly conductive nonferrous material such as copper, aluminum, or brass. The conductivity is considered great enough so that the so-called "depth of penetration" of current and field is less than 10 per cent of the wall thickness of the tubing, thus ruling out any interaction between current on the outside of the shield and current on the inside of the shield. This restriction represents the usual case for shielded loops. A further restriction is made in that the half-perimeter ($P/2$) of the loop shield is not to exceed a length equal to one fourth of the free-space wavelength (i.e., 90 electrical degrees) of the highest frequency under consideration, thus ruling out cases where the loop-shield current may undergo a reversal of phase and hence complicate the analysis. Such a loop antenna is shown diagrammatically in Fig. 1, wherein the inner conductor $ABCD$ is contained within the outer shield EFG . Although this loop is pictured as being circular, the analysis applies equally to other commonly encountered shapes such as square, diamond, and rectangular with long axis vertical. The rectangular loop with long axis horizontal tends to act like a folded-dipole antenna, and, therefore, will not be considered in this discussion.

In accordance with the theory of symmetrical balanced circuits, the vertical axis $N-N'$ of the loop is the line of intersection between a virtual infinite equipotential plane and the plane of the loop. This virtual infinite plane is, of course, perpendicular to the plane of the loop. Thus, the balanced loop behaves the same as any other balanced or "push-pull" system, and it is possible to consider any point whose physical position coincides with the virtual equipotential plane to be at reference ground potential. (An implication contained in the above statement is that the axes of physical symmetry and electrical symmetry of the loop are the same.) Therefore, points F and H and the point on the inner conductor midway between points B and C may all be considered to be at reference ground potential. The half-perimeter of the loop is represented by $P/2$, this distance being measured along the center line of the shield tubing.

BASIC PRINCIPLES OF OPERATION

The shielded loop receives energy from a vertically polarized, horizontally propagated electromagnetic wave by the following process:

The propagated field induces electromotive forces on the outside surface of the shield, along each of its legs, but induces none on the inside surface of the shield nor on the inner conductor, since the depth of penetration of the field is much less than the thickness of the shield material.¹ This fact, incidentally, permits us to treat phenomena on the outside surface of the shield independently from phenomena on the inside surface of the shield. Thus, for example, points E and G on the edge of the loop shield (Fig. 1) may be considered to be associated only with currents and impedances on the outside

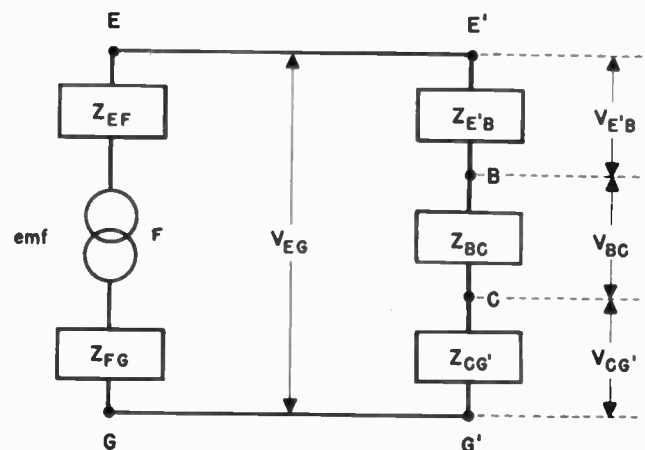

Fig. 2—Equivalent circuit of shield and gap impedances.

surface of the loop shield, whereas points E' and G' (actually the same points as E and G) may be considered to be associated only with currents and impedances on the inside surface of the loop shield. It should be noted that this inside surface of the shield and the inner

¹ S. A. Schelkunoff, "Electromagnetic Waves," D. Van Nostrand Company, Inc., New York, N. Y., 1943, Chapter 4, page 89.

conductor of the loop form a coaxial transmission line, a fact which will be made use of later in the analysis.

The electromotive forces induced along the outside surface of the loop-shield legs cause current to flow thereon and produce a resultant voltage V_{EG} across the shield gap EG (or $E'G'$). This gap voltage is thus impressed across the points $E'B$, BC , and CG' in series, so that the resultant voltages appearing across these individual points ($E'B$, BC , and CG') will be proportional to the impedances existing between them. This may be understood by referring to Fig. 2, which shows the equivalent circuit of the loop-shield and gap impedances. This method of analysis has been presented in a previous paper.²

EVALUATION OF LOOP IMPEDANCES

It is obvious that for small gaps the impedance between points B and C is negligibly small, since it is composed of the inductive reactance of but a very short length of connecting wire. As a consequence, the loop-shield-gap voltage can be considered as being impressed only across impedances $Z_{E'B}$ and $Z_{CG'}$ in series, resulting in voltages $V_{E'B}$ and $V_{CG'}$. These voltages will be equal if the corresponding impedances are equal. The impedances will be equal if the two coaxial transmission lines, formed by the two legs of the loop shield surrounding the inner conductor, are equal in Z_0 , in electrical length, and in terminating impedances Z_{AH} and Z_{HD} .

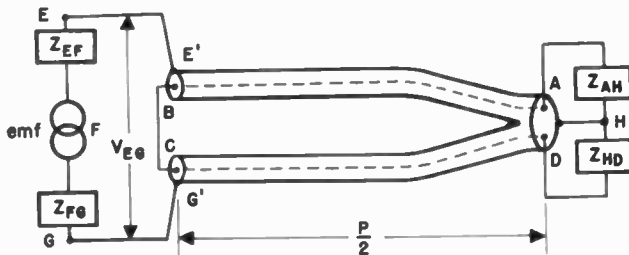

Fig. 3—Modified equivalent circuit showing coaxial lines.

Thus, referring to Fig. 3, we can see that the evaluation of the impedances $Z_{E'B}$ and $Z_{CG'}$ is resolved into the comparatively simple problem of solving the well-known equation for the input impedance of a transmission line of known termination. One convenient form of this is

$$Z_{IN} = Z_0 \frac{1 + \rho / -2\theta}{1 - \rho / -2\theta} \tag{1}$$

where Z_0 = the characteristic impedance of the coaxial line formed by the loop conductor within the shield,

θ = electrical length of the line in degrees, and
 ρ = the reflection factor.

The reflection factor ρ is given in turn by the equation

$$\rho = \frac{Z_L - Z_0}{Z_L + Z_0}, \tag{2}$$

² N. Marchand, "Complex transmission line network analysis," *Elec. Comm.*, vol. 22, pp. 124-129; no. 2, 1944.

where Z_L is the terminating impedance of the line, represented by the impedances Z_{AH} and Z_{HD} in the illustration.

As a further simplification of the analysis, it is convenient to make use of the fact that the magnitude and phase angle of the impedance of any two-terminal network is unaffected by the order of connection of the terminals of this network into any circuit. This allows us to substitute Fig. 4 for Fig. 3, wherein terminals B and C of the coaxial transmission lines have been interchanged respectively with terminals E' and G' . This interchanging of terminals, applying as it does only to

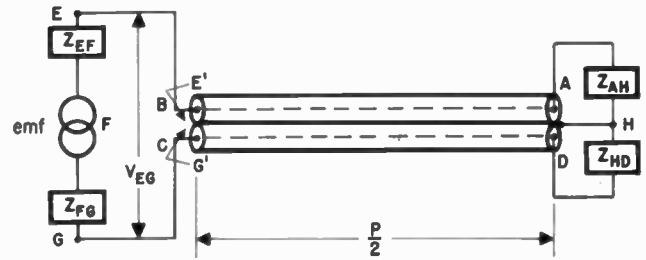

Fig. 4—Simplification of transmission-line connections.

phenomena associated with the inner surface of the loop shield, in no way affects the action of the outer surface of the shield with respect to the impedances Z_{EF} and Z_{FG} . It allows us to treat the two coaxial sections as two halves of a conventional balanced transmission-line system in which the shields are connected together, rather than separated.

The evaluation of the impedances Z_{EF} and Z_{FG} of the outside surface of the loop shield is comparatively simple at the lower radio frequencies (i.e., at frequencies where $P/2$ is less than 10 electrical degrees) since the current along the length of the shield is then substantially constant in amplitude and phase. This allows us to calculate the inductance of the outer shield, and also the radiation resistance, using standard formulas. The inductance for the case of a circular loop carrying current of constant amplitude and phase is given to a close approximation by the expression (referring to Fig. 1)

$$L = 0.01595D \left(2.303 \log_{10} \frac{8D}{d} - 2 \right) \text{ microhenry,} \tag{3}$$

where D and d are in inches, and the radiation resistance for this same case is given by the approximate expression

$$R = 31,000 \frac{A^2}{\lambda^4} \text{ ohms,} \tag{4}$$

where A is the area enclosed by the loop-shield centerline in square meters and λ is the wave length in meters.

Examination of (4) shows that the radiation resistances of the loop shields considered above are of the order of 0.002 ohm or less, and as such are negligible compared to the corresponding inductive reactances. The impedances Z_{EF} and Z_{FG} are thus substantially pure inductive reactances at low radio frequencies, and

the equivalent circuit in Fig. 4 becomes that shown in Fig. 5.

The value of L referred to in this figure is that calculated from (3), and the electromotive force of the generator shown is obtained from the expression

$$\text{electromotive force} = h_e \mathcal{E} \text{ volts,} \quad (5)$$

where \mathcal{E} is the field strength of the received wave in volts per meter, and h_e is the so-called effective height of the

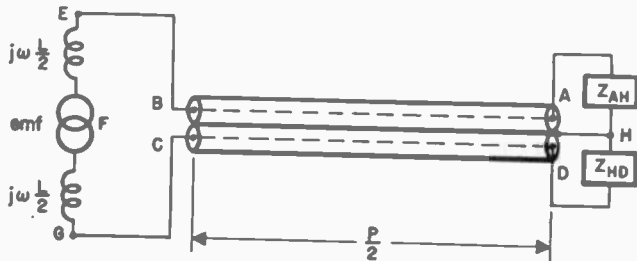

Fig. 5—Low-frequency condition corresponding to Fig. 4.

loop shield in meters, it being assumed above that the horizontal direction of propagation of the wave is in the plane of the loop.

The effective height h_e is given in turn by the following equation for a single-turn loop,

$$h_e = 2\pi A / \lambda, \quad (6)$$

where A and λ are the same as for (4).

For the higher radio frequencies the evaluation of the impedances Z_{BF} and Z_{FG} and of the total induced electromotive force becomes a somewhat more difficult problem than for the low-frequency case, since the current distribution along the shield can no longer be considered uniform. The current distribution is closely sinusoidal, having a maximum value at the base of the loop shield and dropping off in each leg as the gap position is approached. As a consequence, the loop shield tends to behave like a section of balanced transmission line, but not of uniform characteristic impedance. This nonuniformity of characteristic impedance is obviously a result of the fact that the current in each element of length of one leg of the loop shield is not fixed in distance and/or direction with respect to the oppositely flowing current element in the other leg of the loop shield. Because of this, relations which apply for uniform transmission lines do not apply in their regular sense for voltages, currents, and impedances involved on the outside surface of the loop shield. A quantitative analysis of the induced electromotive-force relationships is beyond the scope of this paper; but an analysis of impedance values is given below which should aid in establishing a picture of what takes place.

Referring to Fig. 6, the loop shield may be considered to comprise a two-conductor balanced transmission line of nonuniform characteristic impedance wherein each leg of the loop shield is a conductor of this transmission line, and the spacing S_x between conductors is a function of the distance x from the gap, as is the angle ϕ_x between

the conductors (and between their currents I_x and I_x') at this point. It is evident from the figure that the terminating impedance of this nonuniform transmission line is zero, since at the point where the distance x becomes equal to the diameter of the loop the two conductors join to form a short circuit, and the shield current I becomes a maximum. In attempting to obtain the solution for the input impedance of such a transmission line, one usually encounters some rather cumbersome mathematical expressions which tend to make this work laborious. As a consequence, the writer has developed an approximate expression, verified empirically for a number of different cases, which greatly simplifies the problem of evaluating the above impedances. This empirical relation may be obtained from the following considerations.

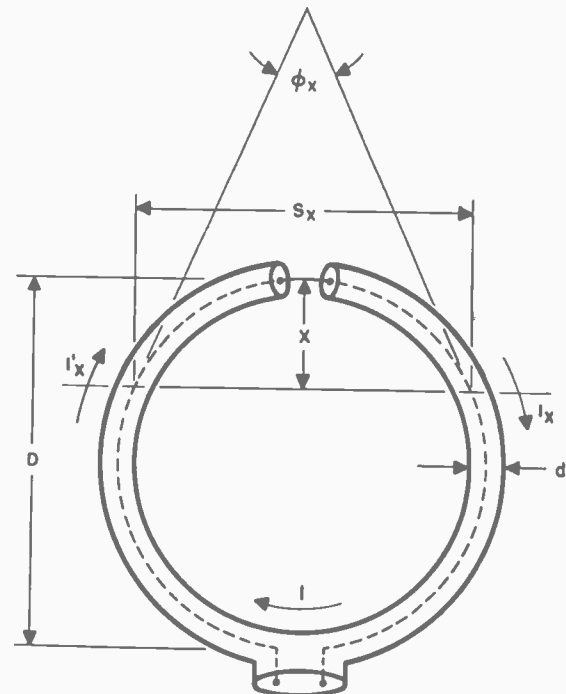

Fig. 6—Loop shield considered as a nonuniform transmission line.

The loop-shield configurations discussed above may be reduced to an equivalent uniform transmission-line section by postulating that:

- (1) the length of this transmission line section be equal to the half-perimeter ($P/2$) of the loop shield;
- (2) the conductors of this transmission line be of the same cross-sectional dimensions as the legs of the loop shield;
- (3) the mean spacing between these conductors be such that the mean area of this equivalent transmission-line section be equal to the mean area of the loop shield; and
- (4) the transmission-line section be perfectly short-circuited at its far end.

By applying these rules we get the transmission-line configuration shown in Fig. 7 as the equivalent of the loop-shield configuration of Fig. 6, and it is now possible

to calculate the characteristic impedance of this transmission-line section by using the well-known relation (referring to Fig. 7)

$$Z_0 = 276 \log_{10} \frac{2S}{d} \quad (7)$$

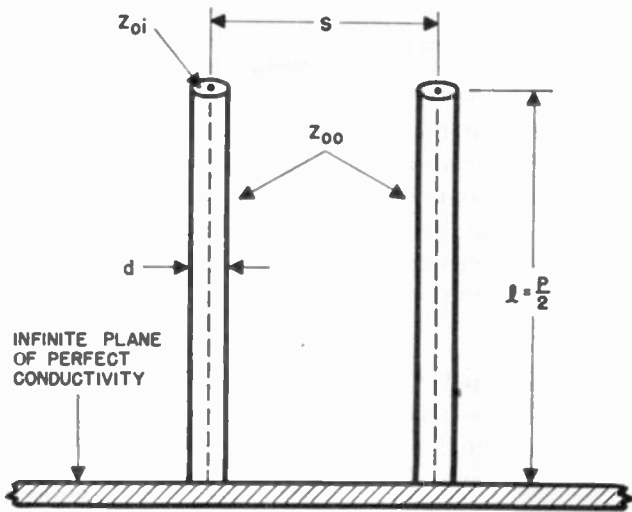

Fig. 7—Transmission-line section equivalent to the loop shield of Fig. 6.

This effective characteristic impedance of the loop shield we shall designate as Z_{00} to distinguish it from the characteristic impedance of the “inner” transmission line referred to in (1), which we shall now designate as Z_{0i} .

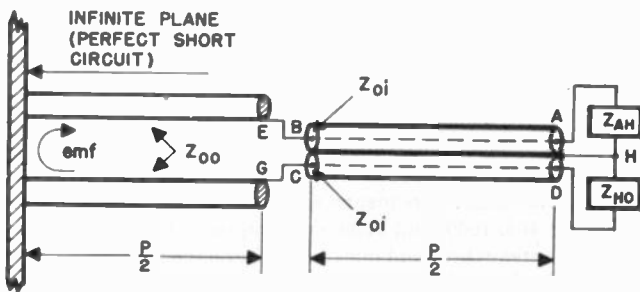

Fig. 8—High-frequency condition corresponding to Fig. 4 and incorporating the equivalent transmission-line section for the loop shield.

We may now draw the equivalent transmission-line network, Fig. 8, which is applicable to our problem for the high-frequency condition. This problem has now been reduced to the relatively simple case of a composite transmission-line system, the solution for the voltages, currents, and impedances of which may be obtained in the usual manner.

As a matter of note, the transmission-line network of Fig. 8 may be employed for the low-frequency solution also, since the relationships and equivalences established therein do not depend on frequency. Thus, calculating the inductance of the loop shield by means of the well-known equation for the input impedance of a section of short-circuited lossless transmission line,

$$Z_{IN} = jZ_0 \tan \theta, \quad (8)$$

we get for the inductance

$$L = \frac{Z_{IN}}{j\omega} = \frac{1}{\omega} Z_0 \tan \theta, \text{ henry} \quad (9)$$

and we find that this gives a value for the loop-shield inductance which is within a few per cent of that given by (3), thereby helping to verify the validity of the “equivalent transmission-line” method of analyzing loop-shield impedances.

NUMERICAL EXAMPLE

An example of how the above principles for evaluating the loop impedance components may be applied in finding the resonant frequency of a typical shielded-loop structure is given below.

Referring to Fig. 1, suppose that the following values are chosen:

- mean loop diameter $D = 12$ inches,
- outside diameter of shield tubing $d = 1$ inch,
- inside diameter of shield tubing $d' = 0.9$ inch,
- diameter of inner conductor $d'' = 0.064$ inch, and
- loop load impedances $Z_{AH} = Z_{HD} = \infty$ (i.e., open circuit).

Solving for the spacing S of the equivalent transmission-line section (Fig. 7), we get

$$S = \frac{A}{P/2} = \frac{\pi(D/2)^2}{\pi(D/2)} = \frac{6^2}{6} = 6 \text{ inches.} \quad (10)$$

The characteristic impedance of this section is then

$$Z_{00} = 276 \log_{10} \frac{2S}{d} = 276 \log_{10} 12 = 298 \text{ ohms.} \quad (11)$$

The characteristic impedance of each inner coaxial line is

$$Z_{0i} = 138 \log_{10} \frac{d'}{d''} = 138 \log_{10} 14 = 158 \text{ ohms.} \quad (12)$$

The half-perimeter $P/2$ is given by

$$P/2 = \pi(D/2) = 6\pi = 18.9 \text{ inches} = 0.48 \text{ meter,} \quad (13)$$

so that the corresponding electrical angle in degrees is, (assuming air dielectric throughout),

$$\theta = \frac{(0.48)(360)}{\lambda} = \frac{173}{\lambda} \text{ degrees.} \quad (14)$$

Since both the outside transmission-line section and the inside transmission-line section are equal in electrical length for this case, we may write

$$\theta_0 = \theta_i = \theta. \quad (15)$$

The total electrical length of the transmission-line network, θ_T , would then be the sum of θ_0 and θ_i if the characteristic impedance Z_{00} were equal to twice the characteristic impedance Z_{0i} . Since such is not the case, we must obtain the equivalent electrical length θ_{eq} of

the outside transmission line with respect to the inner transmission lines. This is obtained by equating the impedance to the left of BC (Fig. 8) in terms of Z_{00} to the same impedance in terms of twice Z_{0i} , whereby,

$$jZ_{00} \tan \theta_0 = 2jZ_{0i} \tan \theta_{eq}, \quad (16)$$

which then yields

$$\theta_{eq} = \arctan \frac{Z_{00} \tan \theta_0}{2Z_{0i}} = \arctan \left(\frac{298}{316} \tan \frac{173}{\lambda} \right), \quad (17)$$

and then θ_T may be obtained from

$$\theta_T = \theta_i + \theta_{eq} = \frac{173}{\lambda} + \arctan \left(0.944 \tan \frac{173}{\lambda} \right). \quad (18)$$

To obtain the lowest frequency at which this transmission-line network goes through resonance, i.e., the frequency at which the reactive component of the impedance across terminals A and D becomes zero, we set θ_T equal to 90 degrees and solve for λ . This is done by first transforming (18) to

$$\tan \theta_T - \tan \frac{173}{\lambda} = 0.944 \tan \frac{173}{\lambda} + 0.944 \tan \theta_T \left(\tan \frac{173}{\lambda} \right)^2. \quad (19)$$

Then, dividing through by $\tan \theta_T$ to get rid of some undesirable infinities, and setting θ_T equal to 90 degrees, this expression reduces to

$$\tan \frac{173}{\lambda} = \sqrt{\frac{1}{0.944}} = 1.030 \quad (20)$$

whereby

$$\lambda = \frac{173}{\arctan 1.030} = \frac{173}{45.85} = 3.78 \text{ meters}, \quad (21)$$

so that the resonant frequency is

$$f = \frac{300}{\lambda} = 79.4 \text{ megacycles}. \quad (22)$$

Actual measurements of the resonant frequencies of shielded-loop structures similar to the one calculated above indicate that the calculations give values accurate within 5 per cent. This again helps to verify the validity of the "equivalent-transmission-line" method of analyzing loop-shield impedances.

CONCLUSIONS

It is to be concluded that the balanced shielded loop antenna may be analyzed by the use of conventional transmission-line theory; and if the simplifications introduced in this paper are utilized, the amount of labor in making such an analysis is greatly reduced.

The method of analysis may be extended to include cases wherein certain compensating impedances are introduced between points B and C and across points E and G (Fig. 1) of the loop, it then being necessary merely to include these impedances at the appropriate points in Fig. 2.

Equalized Delay Lines*

HEINZ E. KALLMANN†, SENIOR MEMBER, I.R.E.

Summary—An improved design of signal delay lines is discussed in which phase distortion is held within the narrow limits required. The decrease of time delay at higher frequencies due to decrease of effective inductivity is compensated by a rise in effective capacitance due to distributed bridge capacities. In some high-impedance lines the natural coil capacitance will suffice for this compensation; in other cases a controlled amount of bridge capacitance is introduced by means of floating patches of metal foil along the coiled conductor, insulated from it, from each other, and from ground. Echoes, due to mis-

match of the lines at high frequencies, may be suppressed by dividing the winding into sections, each too short to yield an echo component within the transmitted frequency range. The design of typical delay lines for 400, 1000, and 3000 ohms impedance is discussed and their delay, attenuation, and impedance characteristics are shown. A delay line with lumped iron-dust cores is described. A practical design is presented for the lumped-parameter low-pass filter $m=1.27$, as used for delay lines with very low impedance and for very high voltages.

BRIEF PREFACE ON THE EFFECTS OF AMPLITUDE AND PHASE DISTORTION

DELAY lines are now widely used to delay steep-fronted pulses and other wide-band signals for periods of the order of one microsecond. Equalized delay lines are especially designed for low signal distortion; they are, for example, used in self-triggering

oscilloscopes to delay, with negligible distortion, the signal front until the sweep is under way.

For fair transient response, both the amplitude and phase characteristics of a system must be fair over an adequate frequency range. Examples¹ of the relation between the amplitude and phase characteristics and the transient response are shown in Figs. 1A, 1B, and 1C, where various combinations of amplitude and phase characteristics are plotted on the left and the resulting distortions of a square pulse are shown on the right. A pulse may be considered as composed of two unit steps which are of opposite sign and follow each other with a

* Decimal classification R282.1XR117.11. Original manuscript received by the Institute, January 7, 1946; revised manuscript received, March 5, 1946. This paper is based on work done for the Office of Scientific Research and Development under contract OEMsr-262 with the Radiation Laboratory, Massachusetts Institute of Technology.

† Formerly, Radiation Laboratory, Massachusetts Institute of Technology; now, consulting engineer, New York, N. Y.

¹ H. E. Kallmann, R. E. Spencer, and C. P. Singer, "Transient response," PROC. I.R.E., vol. 33, pp. 169-195; March, 1945.

separation equal to the pulse length. Except in nonlinear devices such as rectifiers, both unit steps undergo the same distortion independently, though this is less evident in the case of shorter pulses where two trains of oscillations are adding up to produce a single "pulse response."

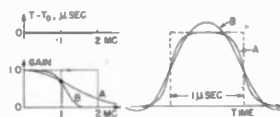

A Amplitude distortion only.

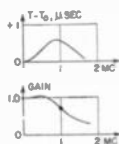

B Amplitude and phase distortion.

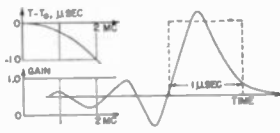

C Phase distortion only.

Fig. 1—Correlation of amplitude and phase response with pulse distortion.

A transient may suffer two types of distortion. One type, due to unequal attenuation of its component waves, leaves it always symmetrical around the middle. In a symmetrical transient, of which the unit step is an example, the point of inflection of all component sine waves coincides with the middle of the transition, and no change of their relative amplitudes due to pure amplitude distortion can spoil this symmetry. The other type of distortion is caused by uneven time delay within the transmitted frequency range. This results in asymmetrical distortion of the transient; a rounded start and oscillatory tail result if the higher harmonics arrive late and the opposite occurs if they are early.

Two examples of pure amplitude distortion are shown in Fig. 1A. Both amplitude responses drop to 0.707 at the frequency of 1 megacycle, but differ in the shape of their cutoff. The steeper the cutoff in proportion to the transmitted bandwidth, the more the corresponding transient tends to oscillatory recoil and overshoot.

Filter networks of conventional type distort both amplitude and phase. Fig. 1B shows the performance of the "series peaking coil" $L = 0.64 R^2 C$, corresponding to a symmetrical bandpass in carrier amplification with 1.1 times critical coupling. The amplitude response drops to 0.707 at 1 megacycle and the phase at 1 megacycle is about 20 degrees late. Both types of distortion do about equal harm to the pulse response which shows the expected moderate asymmetry.

Pure phase distortion is rare and its effect is, therefore, generally underestimated. One can, however, state with comparable inaccuracy that to an amplitude "cutoff" of 3-decibel attenuation there corresponds a phase "cutoff" at the frequency which is $\frac{1}{2}$ radian out of step with the midband frequency of the transient. Fig. 1C shows the distortion of a square 1-microsecond pulse in a system which has no amplitude distortion, but whose phase distortion rises to -90 degrees at 1 megacycle.

The limitation to $\frac{1}{2}$ -radian phase distortion imposes rather close tolerances upon the delay characteristics of signal delay lines. For example, if frequencies up to 5 megacycles are to be delayed by 1 microsecond, then a maximum deviation of $\frac{1}{2}$ radian at 5 megacycles equals an error in time of 0.016 microsecond; i.e., 1.6 per cent. Corresponding tolerance limits of the time delay for other frequency ranges are plotted in Fig. 2, from

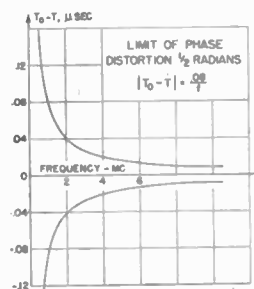

Fig. 2—Limits of delay distortion for $\frac{1}{2}$ -radian phase distortion.

$(T_0 - T) \approx 1/(4\pi f) \approx 0.08/f$. The limits are quite close for appreciable delays of wide bands, but methods have been developed to isochronize delay lines to any desired degree within manufacturing tolerances without the need for external correcting sections.

CAUSE AND CONTROL OF DELAY DISTORTION

An analysis of equalized delay lines may be lucid but not simple; nor does it lend itself to an adequate mathematical treatment.

Simple delay lines^{2,3} consist of a single-layer coil of insulated wire wound around a core of insulating material over, or covered by, grounded conductors not forming a closed turn. The delay of a signal is accomplished by storage in the magnetic field of the coil and in the electrostatic field between coil and ground, and should thus only depend on the two reactive parameters, the inductance and the ground capacitance per unit length. However, these two parameters also comprise the mutual inductance between any two parts of the line and the capacitance between them; both effects vary with frequency and may vary periodically along the line.

The delay T_0 at low frequencies agrees in all types of lines with (1).

$$T_0 = \sqrt{L_0 C_0} \quad (\text{the terms being in seconds, henries, and farads, respectively}) \quad (1)$$

where L_0 is the inductance of the coiled conductor at low frequencies and C_0 its capacitance to ground; the capacitance C_0 is independent of frequency and may thus be measured at audio frequencies where the distributed inductance can be ignored.

² H. E. Kallmann, "Transversal filters," *Proc. I.R.E.*, vol. 28, pp. 302-310; July, 1940.

³ J. H. Rubel, H. E. Stevens, R. E. Troell, "Design of delay lines," *General Electric Co. Report*, October 25, 1943. Note that the design of these lines was later (1945) modified so as to equalize their delay.

The inductance of a line at low frequencies is best computed from information in Fig. 3. The value of Nagoaka's correction factor k approaches unity for long coils such as continuously wound delay lines. The inductance of a delay line wound in sections exceeds by

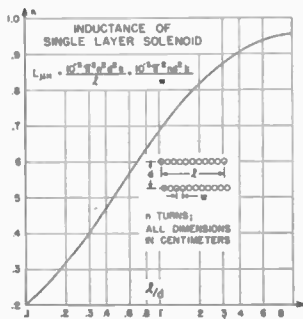

Fig. 3—Inductance of single-layer solenoid as function of l/d .

less than 2 per cent the sum of the inductances of the sections if they are separated by gaps equal to, or exceeding, the diameter d .

The effective inductance L of a delay line decreases with higher frequencies where the wavelengths along the line become comparable to, or shorter than, the length of the line. Currents in different turns along a delay line, while still magnetically linked, are less and less in phase with each other the higher their frequency; thus, they add less and less to each other's magnetic field. The decay of inductance with frequency f thus depends on d/l and on the delay T . It has been computed by L. H. Poritsky and Mrs. M. H. Blewett⁴; the curve in Fig. 4 is plotted from their result and shows L/L_0 as a function of fTd/l . If there are no capacitances other

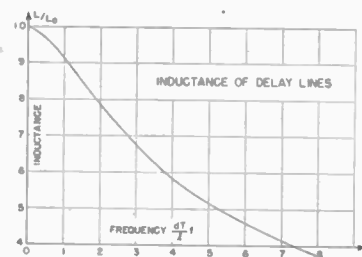

Fig. 4—Decrease of inductance in delay lines with higher frequencies.

than those to ground, the decrease of time delay with frequency can be computed from the curve of Fig. 4 and from (1). The resulting curve of T/T_0 as a function of fTd/l is plotted in Fig. 5. Its agreement with observations is excellent, if all capacitances other than those to ground are negligible. This applies, for example, to lines manufactured⁵ by the General Electric Company in which a grounded braid of insulated copper wires fits closely around the coiled conductor, thereby suppressing all capacitances other than those between neighboring turns. Lines of this design are made relatively long and thin so as to keep phase distortion low; this approach

increases both the space requirements and the length of wire required for a given delay, and hence the attenuation.

A simple means of equalizing the time-delay characteristic has been found in a capacitance which effectively increases with higher frequencies. How this is achieved

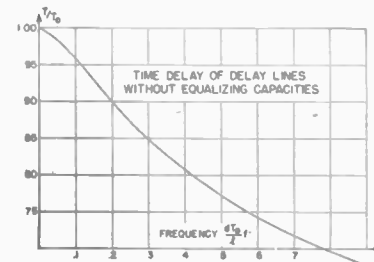

Fig. 5—Decrease of time delay in delay lines with higher frequencies.

may be understood from the observations plotted in Fig. 6. A continuous coil of No. 28 enameled wire was close wound on an insulator of $\frac{3}{4}$ -inch diameter and 16-inch length, over a paper-insulated strip of copper foil 0.001 inch \times 0.160 inch \times 16 inch. Its time delay is plotted as $N=0$ in Fig. 6; it drops steadily from 0.78 microsecond at low frequencies to 0.616 microsecond at 16 megacycles, at a somewhat less rapid rate than calculated from Fig. 5. Another strip of copper foil was then mounted along the outside of the coil and held in place with sticky tape. Connecting it to the inner copper strip and to ground just doubled the ground capacitance; the initial time delay was thus increased by $\sqrt{2}$ to 1.1 microsecond, dropping steadily to 0.764 microsecond at 16 megacycles. One of the two strips was then disconnected from ground, but left in place; a different

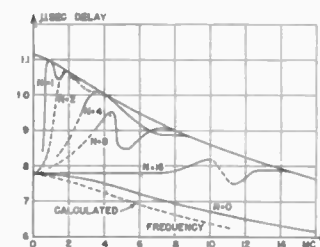

Fig. 6—Delay characteristic of a delay line model with 0; 1; 2; 4; 8; 16 equalizing patches.

type of curve was then observed. The new curve started at $T_0=0.78$ microsecond, as must be expected, since at very low frequencies there is no phase difference between any two turns of a low-loss line and thus no alternating current flows in any bridge circuit formed by the capacitances from any turn via the floating strip to another turn. However, at very high frequencies, when $f \ll 1/T$, the time-delay response must be the same as if the floating strip were grounded, because the strip then will be capacitively coupled equally to turns at all phases, so that all couplings will cancel in their effect upon the potential of the strip. At high frequencies the floating strip thus reacts with the coil exactly as if

⁴ T. P. Blewett, R. V. Langmuir, R. B. Nelson, and J. H. Rubel, "Delay lines," General Electric Co. Report, p. 11 ff., May 31, 1934.

grounded. Similar cancellations should also take place at certain lower frequencies, such as $f=1/T$; $2/T$; etc. These are seen near $f=0.9$ megacycle and $f=1.8$ megacycle in the curve for $N=1$.

It is reasonable to expect, and it is confirmed by the curve for $N=2$ in Fig. 6, that the delay at very low and very high frequencies is unaffected if the floating copper strip is cut into two equal pieces, each extending over one half of the line. The curve for $N=2$ resembles the curve for $N=1$, except that the peaks at lower frequencies must occur at twice the former frequency when $f=2/T$; $4/T$; etc. If the floating copper strip is divided into three or four equal lengths, then the peaks will occur at proportionally higher frequencies. Continued subdivision of the floating copper strip leads, however, to a different type of curve. The delay at very low frequencies is still that of the unpatched line, but rises steadily with increase of frequency to a peak just below the frequency

$$f_p = N/2T \quad (2)$$

where T is the total delay at that frequency and N the number of equal floating patches along the line. The delay drops sharply after f_p , and then recovers to follow the curve of a line with all patches grounded. This type of response is observed on the model with 8 and with 16 equal floating patches. It will be noted that the delay response for these higher numbers of patches has its peak at a frequency when each patch extends over about one-half wavelength on the line. This fact together with the changed shape of the peak indicates that the phenomenon is different from that observed for $N=4$, when the patches were one whole wavelength long at the first peak. The change-over is rather sudden as shown in Fig. 7.

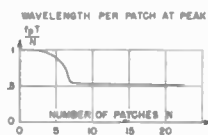

Fig. 7—Wavelength per patch, at peak delay, of patched delay-line model.

It is the smooth rise to the peak of the time-delay characteristic that is made use of for the equalization of delay lines. The desired isochronism—or some other desired time-delay characteristics suitable for compensation of phase distortion originating elsewhere in a system—is achieved by the choice of two parameters, the length and the width of each patch; periodic change of their size may offer a third. The number of patches is always so large that (2) applies. The characteristic is generally smooth over a frequency range to at least $0.8f_p$. Thus the lowest number of patches required for the equalization up to $0.8f_p$ is

$$N = 2Tf_p \quad (3)$$

There is no harm in choosing a larger number of patches,

provided that they can be made proportionally wider. The width of the patches, the thickness, and the dielectric constant of the insulation between them and the coiled conductor, all serve to control the amount of bridge capacitance. The delay characteristic at higher frequencies is lifted as these bridge capacitances are increased; thus isochronism is adjusted by the width, or thickness of insulation, of the patches. This is illustrated in Fig. 8 for a line with $T_0=0.90$ microsecond. Before equalization its response dropped steadily to 0.82 microsecond at 16 megacycles; the use of 24 patches, each 0.10 inch wide and 1 inch long, yielded too much compensation over too narrow a frequency range, with $f_p=10.8$ megacycles. Another curve shows

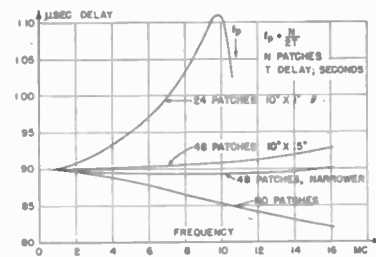

Fig. 8—Adjustment of equalizing patches for constant delay.

the result after each patch was cut in two, so that there were 48 patches, 0.10 inch \times 0.50 inch; the peak frequency f_p has now moved outside the observed range, presumably to 25 megacycles, while the equalization is now nearly correct, rising to 0.93 microsecond at 16 megacycles. By a slight reduction of patch width, the delay characteristic is adjusted to just equal delay of 0.90 microsecond at 0 and at 16 megacycles, with a drop of less than 1 per cent in between. If necessary, this curvature can be equalized further by adding another row of about 14 slim patches which contribute a slight lift with a peak frequency near 8 megacycles.

It was noted that in these models the delay characteristics even before patching did not drop as much as would be expected from calculations. This discrepancy can be attributed to the natural coil capacitance. This capacitance C_L may be found from the coil inductance and from the frequency at which it resonates without external capacitance. It is best estimated from

$$C_L \approx d, \quad (4)$$

where the terms are in micromicrofarads and inches, respectively. Accordingly, the effect of natural bridge capacitance in delay lines is found to increase with their diameter. Most of the bridge capacitance resides on the outside of these long, slim coils; if, therefore, a substantial part of their outside is covered by grounded conductors, such as the metal braid of the General Electric Company's type of lines, then all but neighboring turns are effectively screened from each other and equalization due to natural coil capacitance is suppressed, as indicated in Fig. 9.

The higher the impedance of a line with given coil diameter, the less ground capacitance per turn is required. The natural coil capacitance, however, is not reduced, so that narrower, and finally no, equalizing patches are required as the line impedance is increased.

Another means of influencing the delay characteristic of a line is to divide its windings into sections. The loss of inductance results in less delay per length, and thus less drop in the delay characteristic. That this is not the whole story is shown by the lower curve in Fig. 9, representing a coil wound in spaced sections with natural coil capacitance suppressed by a cover of braid. The sections show a conspicuous cutoff frequency at which the delay rises to a peak. Delay lines which are wound in sections and have floating patches have certain special merits; several examples of such lines will be discussed.

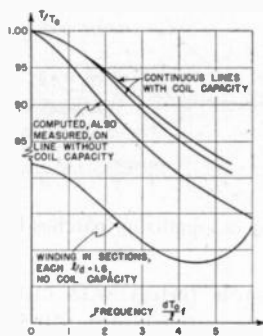

Fig. 9—Comparison of computed and observed delay characteristics, on continuous and section-wound delay lines.

MEASUREMENT OF DELAY CHARACTERISTICS

The delay characteristic of lines is measured by comparing the phase of sine waves at the input with their phase at the output in order to determine those frequencies at which the phases are exactly equal or opposite. This is done by feeding the input and the output voltage of the line to the two pairs of deflecting plates of a cathode-ray tube and adjusting the frequency of the sine wave fed to the line so that the Lissajou's ellipse reduces to a diagonal line. A suitable source of sine waves is a continuously variable signal generator calibrated to better than 0.5 per cent over a range up to, perhaps, 30 megacycles and yielding about 2 volts root-mean-square with moderate harmonic content. Its output may be amplified in a single stage and then fed to the line. The line is best terminated on both ends with its characteristic impedance, but mismatches as large as two to one are harmless. The 3-inch cathode-ray-tube indicator is run, to be the more sensitive, at the lowest practicable anode voltage, such as 300 volts for type 3BP1. The circuit used is shown in Fig. 10. Strong harmonics and overload of the amplifier will curve the diagonals without impairing the measurements, and if the harmonics suffer a different time delay the diagonal lines will grow into slim figures of eight due to the second harmonic, with more nodes for higher harmonics; the correct frequency is that observed when the lobes are

equal, and it can be found with little difficulty. The delay characteristic is then measured by tuning the signal generator from the lowest to higher frequencies and noting the frequencies $f_1, f_2, f_3, \dots, f_n$ at which the ellipses reduce to diagonal lines. The delay at the frequency f_n is then

$$T(f_n) = n/(2f_n) \quad (5)$$

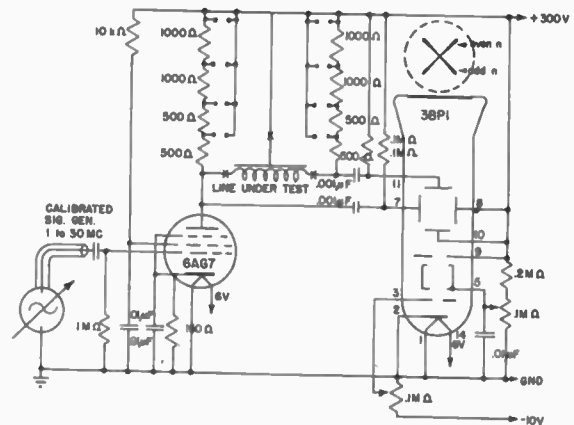

Fig. 10—Circuit for measurement of time-delay characteristics.

If the readings are marked as odd n and even n , according to the slant of the diagonal, the proper value of n will be identified without missing a point. A fair curve can then be drawn through the points thus found, such as the one in Fig. 11 drawn through the points marked x .

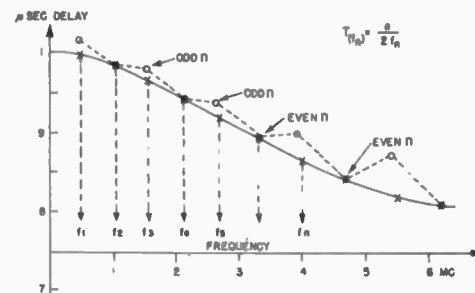

Fig. 11—Plot of time-delay characteristics from observed data.

It is important that coupling capacitances between the input and the output of the line be kept very small. The circuit of Fig. 10 should be built to meet this requirement and the deflecting electrodes of the cathode-ray tube connected as marked in Fig. 10. Even a few micromicrofarads coupling capacitance will yield readings as marked with circles in Fig. 11. It will be noted that the even points are hardly affected, but that the delay at all the odd points is increased. The reason is that, at even points, input and output are in phase and there is no potential difference between them except that due to attenuation; at odd points, they are of opposite phase and the coupling capacitance acts as bridge capacitance.

The points obtained by this method are spaced closely enough for most measurements. For the measurement

of fine structure such as in Fig. 6, two auxiliary devices are useful. One is a relatively large, well-calibrated delay line simply matched in series with the unknown. Readings of the total delay are then spaced more closely in proportion to the increased total delay, and the unknown delay is found by subtracting that of the known delay line from the total. The other refinement is the insertion of a calibrated variable delay line. This not only permits delay measurements at any prescribed frequency but also readings spaced as closely as may be desired.

A variable delay line may be any sufficiently rugged line whose characteristic delay is very flat, either through conservative design or by means of equalization, and which is provided with a slider movable over a bare path along the coil. A much-used unit whose characteristic was quite flat well beyond 20 megacycles, for any position of the contact, was wound with Ameri-

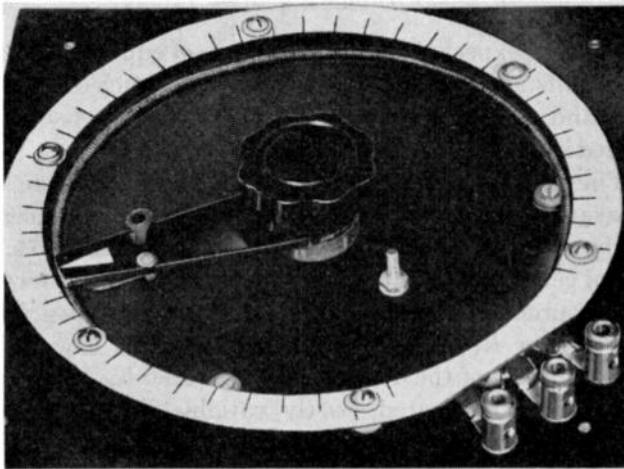

Fig. 12—Variable delay line.

can Wire Gauge No. 30 Formex wire with a pitch of 0.011 inch on 25 inches of Saran tubing, a flexible plastic, of 0.30-inch diameter. The grounded conductor is a copper foil 0.001 \times 0.090 inch under 0.001-inch waxed paper, yielding $C_0 = 480$ micromicrofarads. The impedance Z_0 is 1000 ohms, with which value the far end is permanently terminated; the largest available delay is 0.435 microsecond. The line is bent to a circle of 9-inch diameter around the bearing of the contact arm and resembles a large wire-wound potentiometer, as shown in Fig. 12. It is calibrated in steps of 0.01 microsecond which are reliable to 0.002 microsecond. The calibration is remarkably insensitive to the load at the contact even if that is comparable to Z . The unit is best used at the output of the unknown delay line, taking the place of its load resistor and with its moving contact loaded only by the cathode-ray-tube deflecting plate. Several readings at any given frequency can be found over the range of the variable delay line, permitting several overlapping and mutually checking plots each with closely spaced points.

MEASUREMENT OF TRANSMISSION LOSS

The outlined method of delay equalization can easily be carried to frequencies so high that transmission losses remain the sole factor limiting applications of delay lines.

Except for resonances at the cutoff frequency of lumped-parameter lines or the corresponding peak frequency in patch-equalized lines, the attenuation is due to the same losses as in any other transmission line; these are resistive losses, enhanced by skin effect, in the conductor and dielectric losses in the insulation.

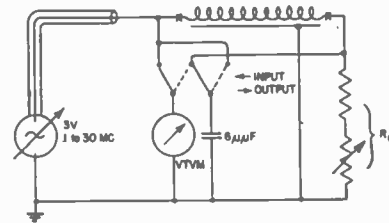

Fig. 13—Circuit for measurement of attenuation in delay lines.

The transmission losses of delay lines are measured by comparing the amplitude of sine waves at their output with that at their input by means of the circuit shown in Fig. 13. With a signal generator serving as source, the amplitudes are compared by means of a single vacuum-tube voltmeter. When switched, its input capacitance of 6 micromicrofarads is replaced by a dummy capacitor of equal value.

The ratio of output voltage to input voltage thus found is strongly oscillatory because of the reflections due to mismatch at the termination, even if the line is terminated with its nominal impedance and if reactive

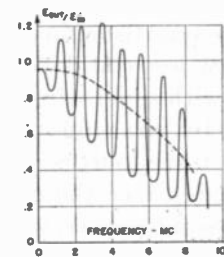

Fig. 14—Typical output-versus-input-voltage characteristic of a delay line.

loads are kept to a minimum. A typical plot is shown in Fig. 14. Barring the use of a wobbled signal generator to eliminate the oscillation, a fair average must be drawn through the curve, as shown by the dotted line. Transmission loss in decibels is computed from this. The procedure was checked by measuring the transmission losses of several similar lines separately and of all in series. The sum of their losses was found equal to the loss measured over all.

It will be noted that the losses begin to rise at relatively low frequencies and continue to rise with increasing steepness. It was found that only a small fraction of these losses arise within the conductors. The attenuation A of a delay line of the impedance Z due to the

resistance R of its conductor is given by

$$A_{db} = \frac{4.35R}{Z} \quad (6)$$

Increase due to skin effect in the resistance of wires was computed on the basis of Butterworth's theory.⁵ The resistances of coiled wires, as measured with a Q meter, agree well with the computed values. The attenuation in delay lines is however, much larger than can be accounted for by skin effect.

A considerable variety of experiments has removed all doubt that most of the losses observed at higher

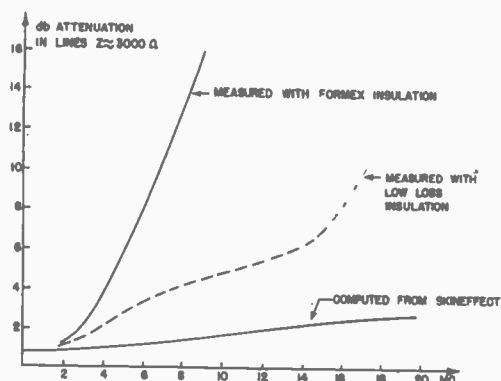

Fig. 15—Attenuation in delay lines with Formex, and with low-loss wire insulation.

frequencies arise in the insulation of the wire. The polyvinylacetal coating of the Formex wire, although better than others, is known to have a loss factor above 0.02. Attenuation improved when coils were pitch wound of thin Formex wires with a substantial air gap between the wire and a grounded metal shell. Lines pitch wound with bare silver wire 0.003 inch on smooth or grooved polystyrene rod were unsatisfactory both when dry and when coated with low-loss coil dope. Much the best results were obtained with silver wire⁶ hand coated with a low-loss insulation by drawing the wire through a benzene solution⁷ of three-fourths polystyrene and one-fourth polyisobutylene; since the mixture was not copolymerized, the coating was very uneven and tended to form flakes. No two lines wound with this wire on polystyrene rod gave equal results. The attenuation characteristic of the line likely to have the least number of short-circuited turns is shown as a broken line in Fig. 15; it is typical in that it rises much less at higher frequencies than any obtained with Formex wire.

Since delay cannot be had without attenuation, at least equal attenuation over the desired frequency range is desirable. Since the rise in wire resistance starts at the higher frequencies the thinner the wire, choice of No. 40 American Wire Gauge or even thinner gauge

⁵ S. Butterworth, "Effective resistance of inductance coils at radio frequency," *Exper. Wireless and Wireless Eng.*, vol. 3, pp. 203-210, April, 1926; pp. 309-316, May, 1926; pp. 417-424, July, 1926; pp. 483-492, August, 1926.

⁶ Resistive losses in silver are hardly smaller than in copper, but fine wires of coin silver are much stronger than those of copper, yet cost little extra.

⁷ Prepared by L. G. Wesson, Massachusetts Institute of Technology Laboratory for Insulation Research.

would help equalize attenuation, provided such wires with low-loss insulation were available. Though they are not manufactured at present, they were anticipated in designing most of the delay lines described here. Since delay equalization can be had without any drawback elsewhere, it was extended in all cases well beyond the range of reasonably low attenuation.

MEASUREMENT AND MATCHING OF INPUT IMPEDANCE

The input impedance Z_0 at very low frequencies has in all cases been found to agree with the value computed from

$$Z_0 = T_0/C_0 \quad (\text{terms in ohms, seconds, and farads, respectively}) \quad (7)$$

taking T_0 from the measurement of time delay and C_0 as measured at audio frequencies.

From

$$Z = \sqrt{L/C} \quad \text{ohms, henries, farads} \quad (8)$$

one should expect that the impedance of equalized delay lines falls steadily with increasing frequencies since L falls and C effectively increases. This has not been observed in any case.

The impedance characteristic of delay lines can be measured by comparison with a nearly nonreactive calibrated resistor, as shown in the circuit in Fig. 16. A signal generator with moderate harmonic content serves as a source of sine waves; its impedance increased by the resistor R_i may be at least equal to Z . The input impedance Z_i of the delay line is measured by substituting for it a calibrated, partly variable resistor R and varying it until the readings of the vacuum-tube voltmeter (noted necessarily calibrated) are equal for both.

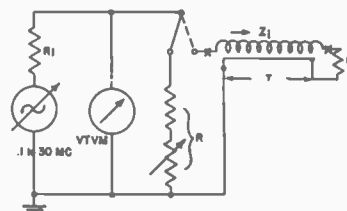

Fig. 16—Circuit for measurement of input impedance of delay lines.

The line under test is terminated with a load resistance R_L equal to its expected impedance. Even when every avoidable load capacitance is excluded, the input impedance Z_i will be found to oscillate strongly with a period $\Delta f = 1/(2T)$ due to mismatch. These oscillations increase noticeably with every single micromicrofarad additional load capacity. The impedance Z of the line is found from a fair average through the plot of Z_i by means of

$$Z = \sqrt{R_i Z_i} \quad (9)$$

(A typical example will be found in Fig. 21D for a line of about 0.35 microsecond delay, matched correctly at low frequencies.) The input impedance of all lines was

found to rise, slowly at first, then steeply, to a peak near the cutoff frequency of the system. From all indications, the input impedance of lines appears to be nonreactive and not to vary so much as to require terminating sections.

Nevertheless, mismatch trouble is experienced. It is caused by the load, rather than the line, and is the more serious the higher the impedance level. Mismatch causes echoes, small pips following a transient, spaced in time twice the length of the delay line, as shown in Fig. 17. The pips are composed of parts of the high-frequency components of the transient which are reflected twice, once at the end and again at the front of the line. They vanish if the high-frequency components are much attenuated either in, or outside of, the line. They grow more conspicuous when the load of the line



Fig. 17—Pulse with echo pips, due to mismatch at higher frequencies.

has a reactive component, as is usually the case when stray and electrode capacitances are present. Such load capacitances may be "coiled out" by insertion of a series inductance so as to complete a half section of a low-pass filter. An example of this practice is shown in Fig. 18 where a delay line of 3000 ohms impedance is inserted between the plate of a 6AG7 amplifier tube and a 3BP1 cathode-ray tube, both presenting about 11 micromicrofarads capacity. In that case, small coils each of about 50 microhenries inductance were inserted in series with each end of the delay line. The improvement was distinct, though the value of the inductances was not critical.

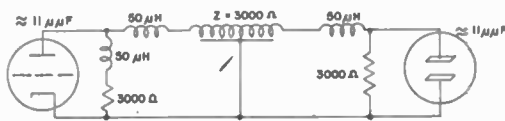

Fig. 18—Inductances in series with a delay line, adjusted to compensate for source and load capacities.

Another serious mismatch occurs already within the line, just before its end. In this region the inductance per unit length of the line changes because each turn is coupled to fewer and fewer others. This decrease of inductance may be compensated for by a corresponding decrease of capacitance; for example, flaring of the grounded braid cover at the ends has been suggested.³ Insertion of conical pieces of iron-dust core may also be considered for manufactured lines. Another at least temporary solution has been found in the simple expedient of cutting the line into small pieces. Thus, the line is wound in many equal sections each of which produces an end echo, but the sections are so short that the echoes form a ripple of invisibly high frequency. If, for example, each section has a delay of 0.025 microsecond, then the echo ripple would correspond to 20 megacycles and its harmonics, none of which could be

noticed in a line with, for instance, a 16-megacycle cut-off frequency. Designs of such lines will be given; they are used in oscilloscopes for signal delay at high-impedance levels.

Faults in the manufacture of delay lines, such as contact between two patches or uneven distribution of ground capacitance, may show up as anomalous humps in the time-delay characteristic. They are certain to show up conspicuously in the transient response as echoes from the place of the fault. Touching a point of the line will also give an echo pip because of the locally increased ground capacitance. As one's finger moves along the line the echo pip will move along the transient response and ride on the fault echo when the faulty place is touched.

SOME TYPICAL EQUALIZED DELAY LINES

Delay lines, both wound continuously and in sections, can be made with much higher impedance than can be

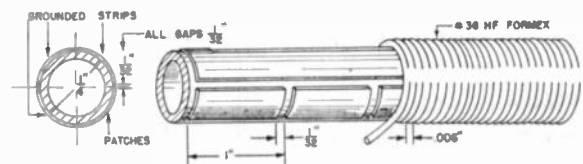

Fig. 19A—Patch-equalized delay line with 400 ohms impedance.

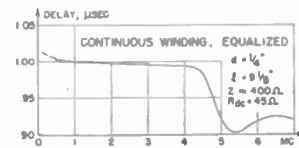

Fig. 19B—Delay.

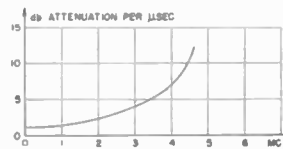

Fig. 19C—Attenuation.

properly matched; useful models were made up to 4000 ohms impedance.

A lower limit to attainable impedance is set by the operating voltage, the dielectric constant of the insulator, and the space available, since it is necessary to attach more and more distributed ground capacitance to less and less inductance. Barring special dielectrics and thick or multiple wires or tape,¹ the lowest practicable impedance is of the order of 300 ohms.

Various designs are illustrated in Figs. 19, 20, 21, and 22. Fig. 19A shows the construction of a continuously wound delay line designed for a moderate frequency range. Its delay is 1 microsecond for about 10 inches; its impedance is 400 ohms. An insulating core of 1/4-inch diameter is covered with a conducting layer (by copper plating, or with thin soft copper foil cemented with self-curing rubber) cut into four full-length strips separated

by gaps of about 1/32-inch width. Three of the strips are grounded. The fourth is cut up into a row of floating patches, each 31/32 inch long and spaced with

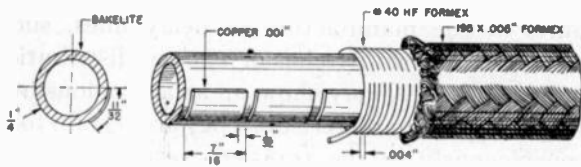

Fig. 20A—Patch-equalized delay line with grounded-braid cover, impedance 1000 ohms.

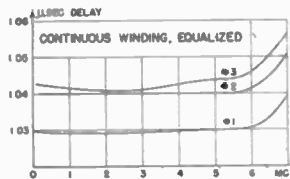

Fig. 20B—Delay.

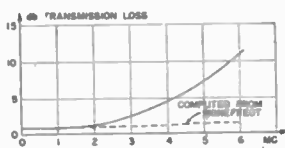

Fig. 20C—Attenuation.

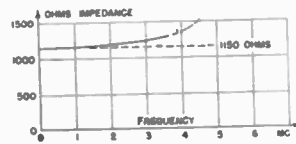

Fig. 20D—Impedance.

Fig. 20

1/32-inch gaps.⁸ The complete core is given a thin coating of low-loss dielectric and then wound with No. 36 HF Formex wire. The resulting time-delay characteristic will then be found equalized to better than 1 per cent nearly up to the frequency $f_p = 4.5$ megacycle, as shown in Fig. 19B. A symmetrical transient response results whose shape is entirely due to attenuation (Fig. 19C); losses rise to 10 decibels per microsecond before any phase distortion sets in. The upturn of the delay characteristic at lowest frequencies is uncertain; it is, in any case, harmless since it corresponds to a phase shift well below 1 degree.

Another design of a continuously wound line, shown in Fig. 20A, is a modification of the Formex-braid-covered lines manufactured by the General Electric Company. The introduction of patches permits making them thicker and thus shorter, and with somewhat less attenuation for a given delay. This line is wound on a tube of insulating material with 1/4-inch outer diameter. The patches on this core are each 0.001-inch thick by 0.345-inch wide, spaced 7/16 inch from center to center with about 0.02-inch gaps between them; they are covered with one-layer of ceresin-wax-impregnated 0.001-inch condenser paper, not shown in Fig. 20A. The line is close wound with No. 40 HF Formex and covered with a tight-fitting braid of 195-strand Formex-insulated 0.005-inch copper wire. The delay for a 10-inch length is then one microsecond, with an impedance of

⁸ Such cores are commercially available from Corning Glass Works; they are made of Pyrex glass rod or heavy tube with grounded and floating strips of burnt-on silver.

about 1150 ohms. The delay characteristic of several models 10 1/16 inch long is plotted in Fig. 20B. Ground capacitance, delay, and impedance varied slightly since finished braid was drawn over the windings and tightened by hand. Faults such as that exhibited by No. 3 may thus be excused. The transmission loss of such a line is plotted in Fig. 20C and its impedance characteristic in Fig. 20D.

Lines of higher impedance are (barring the use of wire thinner than American Wire Gauge No. 40) wound on thicker cores and thus need more equalization. The required capacitances are, however, small and easily accommodated. Formex wire, rolled flat to about 1/3 of its diameter, makes good grounded or floating conductors. Fig. 21A shows a signal delay line wound in sections, $l/d = 1.6$. Each section yields a delay of about 0.038 microsecond at an impedance of 1000 ohms. The line is wound on bakelite tubing of 3/8-inch outer diameter and 1/32-inch wall thickness, with 85 close-wound turns No. 34 HF Formex wire per section and

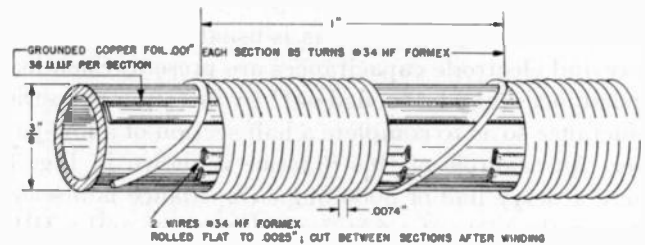

Fig. 21A—Equalized, section-wound delay line, impedance 1000 ohms.

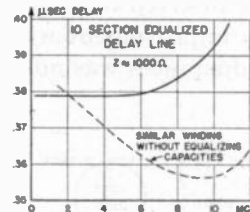

Fig. 21B—Delay.

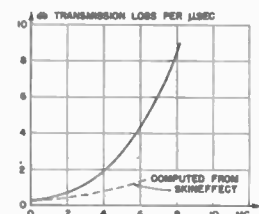

Fig. 21C—Attenuation.

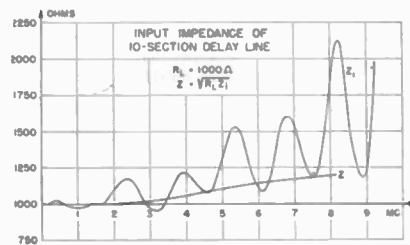

Fig. 21D—Impedance.

Fig. 21

with the sections spaced 1 inch from center to center. The capacitance to ground is 39 micromicrofarads per section and is provided in this example by four strips of No. 20 HF Formex wire rolled to 0.010 inch and placed between core and coil. In addition there are inserted three strips of No. 34 HF Formex wire rolled to 0.0025 inch. After winding, these latter strips are cut between each two coils so as to form the floating bridge

capacitances. It is both reasonable and very convenient to make the number of equalizing patches equal to that of the sections. The width and exact location of the cut between the coils is, of course, quite immaterial. The delay response of 10 sections is plotted in Fig. 21B; the response of an unpatched line is included for comparison. The transmission loss of such lines is plotted in Fig. 21C, and the input impedance and the characteristic impedance of a very similar line of 0.35 microsecond are plotted in Fig. 21D.

Another signal-delay line wound in sections is illustrated in Fig. 22A. This one is designed for a delay of about 0.05 microsecond per section at an impedance of 3000 ohms. The line is wound on bakelite tubing of 3/8-inch outer diameter and 1/32-inch wall thickness, with 164 close-wound turns of No. 40 HF Formex per section and with 10 sections spaced 1 inch from center to center. The ground capacitance of 14.5 micromicrofarads per section was provided by inserting three grounded strips under the winding, each a No. 36 HF Formex wire rolled flat to 0.0025 inch. Winding of fine wire by hand does not yield closely predictable ground capacitance. Those of various models differ, resulting in impedances from 2600 to 3100 ohms and delays from 0.43 to 0.51 microsecond, as shown in Fig. 22B. Capacitances may also be uneven within a line, as in line No. 5, and may cause a hump in the delay character-

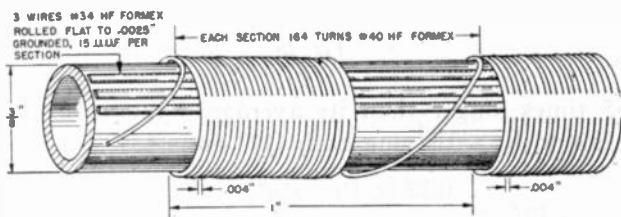

Fig. 22A—Section-wound delay line, impedance 3000 ohms.

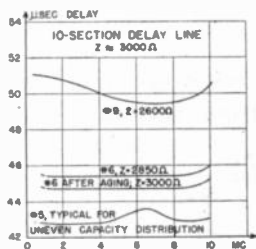

Fig. 22B—Delay.

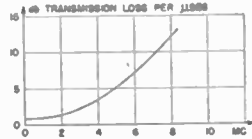

Fig. 22C—Attenuation.

Fig. 22

istic. There is no visible equalizing capacitance provided with these lines, since the distributed coil capacitances happen to be of the right value for the 3000-ohm model. The delay of line No. 9 drops, since the greater delay time of 0.051 microsecond per section needs more equalization; similar models for higher impedances have too much natural coil capacitance, which results in steadily rising delay characteristics. The transmission-loss characteristic of the line for 3000 ohms is plotted in Fig. 22C; the input impedance, as far as observed,

resembles that of Fig. 21D, but oscillates too much for a reliable plot when the usual test setup is used.

Only one model of a delay line with iron cores was made. Development of such lines appears promising since inductance in a given space can be increased without the use of too thin wire. This type of line also offers a means of breaking the line into sections and yet retaining a continuous winding. Fig. 23A shows the construction of the line built around a few iron-dust cores which were readily available. The cores⁹ were short

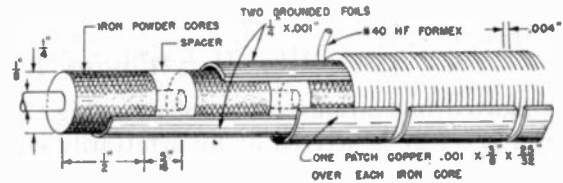

Fig. 23A—Equalized delay line with iron-powder cores.

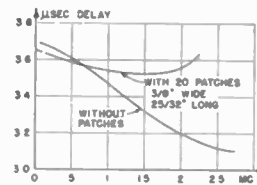

Fig. 23B—Delay.

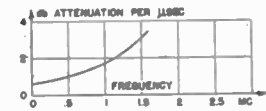

Fig. 23C—Attenuation.

Fig. 23

tubes with 1/4-inch outer diameter, 1/8-inch inner diameter, 1/2 inch long, described as having moderate permeability and very low losses. The core of the line was built by aligning 20 such iron cores on 1/8-inch diameter rod of insulating material, with a tubular spacer of insulating material 5/16 inch long between each two iron cores. The whole was held together by a layer of thin paper tape. The ground capacitance was provided by two strips of copper foil 0.001 inch by 0.25 inch under a layer of ceresin-waxed paper 0.001 inch thick (not shown in Fig. 23A). On this was close wound a continuous coil of American Wire Gauge No. 40 HF Formex wire, 16-1/4 inch long. The delay characteristic of this line started at 3.7 microseconds and dropped to 3.2 microseconds at 2 megacycles, as plotted in Fig. 23B. Twenty patches of copper foil, 0.001 inch by 3/8 inch wide by 25/32 inch long, were then placed on the outside of the line, held with sticky tape and spaced 13/16 inch from center to center, each patch located over one iron core as shown in Fig. 23A. This equalization nearly leveled the delay characteristic over a range of more than 2 megacycles (Fig. 23B); the reduction in delay to 3.65 microseconds was due to some loss of ground capacitance in loose turns. This line has an impedance of 1400 ohms and its losses are considerable, as shown in Fig. 23C. The transient response after 3.65 microseconds delay rises from 0.10 to 0.90 in about one third of a microsecond.

⁹ Stackpole SK 18.

LUMPED-PARAMETER LOW-PASS FILTERS

For very low impedances and for very high voltages it is more convenient to provide lumped ground capacitances instead of distributing them along the winding. It has long been the practice to improve upon the delay characteristic of the ordinary series-inductance shunt-capacitance low-pass filter by the use of *m*-derived sections with a value of *m*=1.27. The time delay of an *m*-derived filter is given as a function of the frequency ω/ω_0 by (10)

$$T = \frac{2m}{\sqrt{1 - (\omega/\omega_0)^2 [1 - (1 - m^2)(\omega/\omega_0)^2]}} \quad (10)$$

and is plotted for various values of *m* in Fig. 24. The choice of *m*=1.27 is arrived at by arbitrarily equating the delay at $\omega=0$ with that at one half the cutoff frequency ω_0 ; but it can also be seen from Fig. 24 that

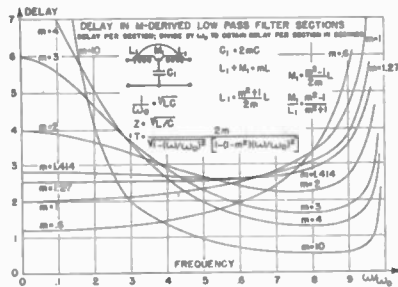

Fig. 24—Delay characteristics of *m*-derived low-pass filters, computed for values of *m*>1.

this happens to offer the flattest possible delay characteristic up to about 0.55 ω_0 . As shown in Fig. 24, each *m*-derived filter section is built with one inductance L_1 on each side of each capacitor C_1 , and those pairs of inductances are coupled with a mutual inductance M_1 whereby

$$\begin{aligned} C_1 &= 2mC = 2.54C \\ L_1 &= \frac{m^2 + 1}{2m} L = 1.03L \\ \frac{M_1}{L_1} &= \frac{m^2 - 1}{m^2 + 1} = 0.237. \end{aligned} \quad (11)$$

Delay equalization depends critically on the coupling between the two coils L_1 . Apparently the most convenient way to control it is to wind both coils as a continuous, close-wound or pitch-wound, single coil with a tap at the center, and to choose its core diameter, wire gauge, and thickness of insulation so that the coupling between the two halves is then correct. It can be shown that all that this design requires is to make the ratio of the length to the diameter of the whole coil equal to 1.55. In a proper coil the total inductance is $2mL = 2L_1 + 2M_1 = 4m^2/(m^2 + 1) L_1 = 2.46L_1$. The total inductance is thus 1.23 times larger than the sum of the halves L_1 . The choice depends only on the coefficients *k*, which can be found from Fig. 3 by searching for a pair of values k_1 and k_2 such that $k_2 = 1.23k_1$ when the cor-

responding values $l_2/d = 2l_1/d$. There is only one such pair of values, that of $k_1 = 0.62$ and $k_2 = 0.77$, with $l_2/d = 1.55$.

The simplified prescription then requires the choice of an average coil diameter and pitch such that the desired total inductance 2.46 *L* is obtained with a coil

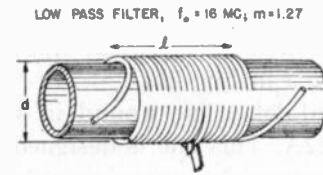

Fig. 25A—Delay network, designed for *m*=1.27: coil.

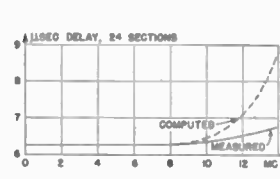

Fig. 25B—Delay.

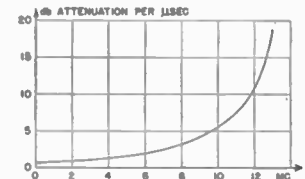

Fig. 25C—Attenuation.

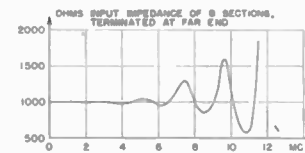

Fig. 25D—Impedance.

Fig. 25

1.55 times longer than its average diameter *d*. They are found by satisfying both (12) and (13).

$$\begin{aligned} 2.46L_1 &= \frac{0.77 \times 10^{-9} \pi^2 n^2 d}{1.55} \\ &\cong 5 \times 10^{-9} n^2 d, \text{ henries, centimeters} \quad (12) \\ l &= nw. \quad (13) \end{aligned}$$

Satisfactory coils for delay filters were wound, as illustrated in Fig. 25A, on cores from 3/16 inch to 1 inch,

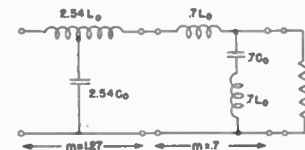

Fig. 26—Terminating half section, *m*=0.7, for delay network.

for impedances from 70 ohms to over 1000 ohms, and for voltages up to 25,000 volts. Capacitances were not only selected to tolerances of ± 1 per cent, but preferably placed in the order of their value so as to minimize impedance changes between adjacent sections. Results measured on a typical filter of 24 sections, *m*=1.27, are plotted in Fig. 25. The impedance is 1000 ohms, the nominal cutoff frequency 16 megacycles, and the delay per section 0.25 microsecond. In this, as in all similar cases, it was noted that the delay characteristic stays

flat over a somewhat larger frequency range than computed from (10), as shown in Fig. 25B. The attenuation, Fig. 25C, in such a filter with mica or ceramic capacitors is much lower than in delay lines, because of the greatly reduced dielectric losses. The input impedance, shown for a piece of line without input termination in Fig. 25D, is very flat, rising slowly above $0.5\omega_0$. Conventional methods of termination can be used for further improvements. Most satisfactory results were obtained with an m -derived half section as shown in Fig. 26. The best choice, according to the plot of Fig. 27, would be the familiar value $m=0.6$, but a choice of $m=0.7$ yielded slightly better results as well as simpli-

fied production, since both coils of the half section were then equal.

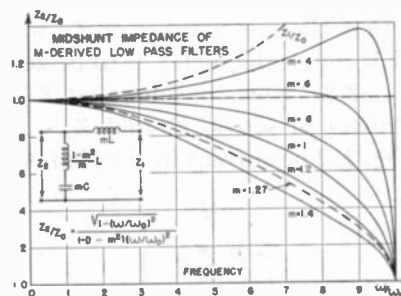

Fig. 27—Impedance characteristics of m -derived low-pass filters.

Note on a Reflection-Coefficient Meter*

NATHANIEL I. KORMAN†, SENIOR MEMBER, I.R.E.

Summary—Sufficient conditions have been established under which a certain general type of circuit can be used to measure reflection coefficients. Several techniques are suggested for adjusting this type of reflection-coefficient meter.

THERE HAS been considerable interest recently in devices which are sensitive to one or the other of the two traveling waves on a transmission line or wave guide. Such a device, if it is used to sample one of the traveling waves on the line or to initiate a wave traveling in one direction, is known as a wave selector; if the device is used to determine the reflection coefficient of a line termination, it is known as a reflectometer. Some devices which have desirable characteristics for use as reflectometers are so complex that it is difficult to state the conditions under which they are true reflectometers; i.e., the conditions under which the indication is proportional to some function of the reflection coefficient of the load.

It is the purpose of this note to develop the conditions which a true reflectometer must satisfy. First, however, it might be well to elucidate the term "reflection coefficient." If a uniform dissipationless transmission line is terminated in a critical value of impedance known as the characteristic impedance, the electrical behavior of the line may be described in terms of a single wave traveling toward the termination. If it is terminated in an impedance whose value is other than the characteristic impedance, the electrical behavior of the line may be described in terms of two traveling waves, one traveling toward the termination and the other traveling away from the termination. These two waves are known as the forward and backward waves, respectively. The ratio of the amplitude of the backward-traveling wave to that of the forward-traveling wave is known as the reflection

coefficient, and depends only upon the impedance of the termination and the characteristic impedance. The reflection coefficient is given by the following equation:

$$r = \frac{Z_0 - Z_L}{Z_0 + Z_L} \tag{1}$$

Although the reflection-coefficient concept probably first arose in connection with transmission lines and transmission-line-like networks, (1) may be used as the definition of the reflection coefficient of Z_L with respect

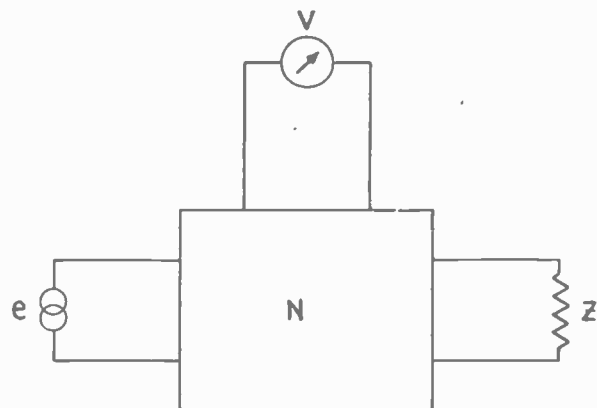

Fig. 1

to Z_0 entirely apart from any connection with transmission-line considerations. In this note we will take the point of view that a reflection-coefficient meter is a device which measures the reflection coefficient as it is defined in (1); the fact that transmission lines or wave guides may be involved in the construction or use of the reflection-coefficient meter does not affect the line of reasoning.

Consider the diagram shown in Fig. 1. N is a linear, passive, bilateral network which is to be used as a reflectometer, e is a generator which energizes the system,

* Decimal classification: R290XR117.1. Original manuscript received by the Institute, November 16, 1945; revised manuscript received, March 11, 1946.

† Radio Corporation of America, Camden, New Jersey.

Z_L is the impedance whose reflection coefficient is to be measured, and V is the meter whose deflection is to indicate the value of the reflection coefficient.

Assume that there is a value of Z_L which will cause the current through the meter V to be zero; denote this value of Z_L as Z_0 . Now consider that Z_L is made up of two impedances in series, Z_0 and $Z_L - Z_0$. This is depicted in Fig. 2. The current in the load is denoted as I_L .

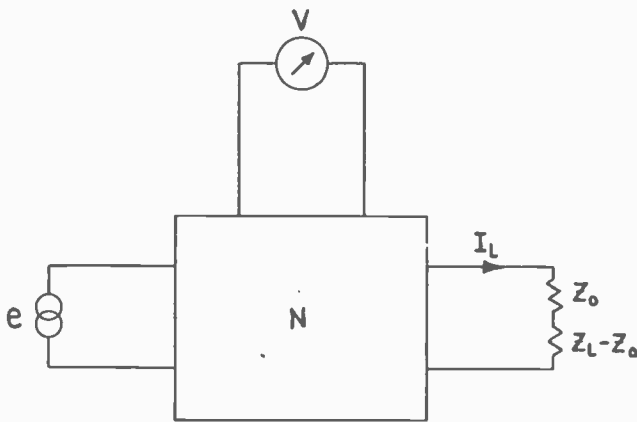

Fig. 2

By the compensation theorem¹ $Z_L - Z_0$ may be replaced by a generator e_L (see Fig. 3).

$$e_L = (Z_0 - Z_L)I_L. \quad (2)$$

By the use of Thevenin's theorem,¹ I_L can be found by replacing the network N , the meter V , and the generator e by an equivalent generator with an internal voltage proportional to e , and an internal series impedance Z_s . The current I_L is, therefore,

$$I_L = \frac{ae}{Z_s + Z_L} \quad (3)$$

where a is a constant of proportionality.

Now, by the superposition theorem,¹ the current flowing through the indicator V can be considered to be the sum of the current caused by e and the current caused by e_L . But Z_0 was so chosen that the current through the meter V due to e is zero. Therefore, the current through the meter is only that caused by the generator e_L . Since N is linear, bilateral, and passive, the current through the meter will be proportional to e_L , and is given by the expression

$$I_v = be_L \quad (4)$$

where b is a transfer admittance whose exact value is unimportant for the purposes of this note. By (2) and (3) we may write (4) as follows:

$$I_v = bI_L(Z_0 - Z_L) = abe \frac{Z_0 - Z_L}{Z_s + Z_L}. \quad (5)$$

If we put in the condition that $Z_s = Z_0$, we are im-

PLICITLY specifying that Z_0 shall be a physically realizable impedance (because Z_s is physical) and we can write

$$I_v = abe \frac{Z_0 - Z_L}{Z_0 + Z_L}. \quad (6)$$

Since $(Z_0 - Z_L)/(Z_0 + Z_L)$ is by definition a reflection coefficient, it is now apparent that the current in the meter will be proportional to the reflection coefficient of Z_L with respect to Z_0 .

When Z_0 is a pure resistance, there is a neat way of determining whether $Z_s = Z_0$. This is done by making Z_L a pure reactance whose magnitude we can vary. When Z_0 is a pure resistance and Z_L is a pure reactance, it is not difficult to show that only if $Z_s = Z_0$ will the magnitude of I_v (as given in (5)) not change as the magnitude of the purely reactive Z_L is changed. In particular, when the leads to Z_L are a transmission line or a wave guide, we may test our reflectometer by sliding a short circuit along this line and noting whether the meter reading varies.

If the network N is such that a null is obtained when Z_L is replaced by Z_0 , it will be found possible, in many cases, to make adjustments in the network N so that $Z_s = Z_0$ without affecting the null. For instance, impedances placed in series or shunt with the generator e or

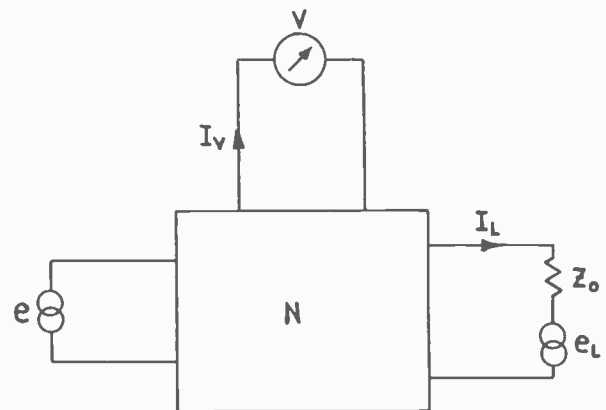

Fig. 3

the meter V may be varied without affecting the null balance.

Summarizing, in a configuration of the type shown in Fig. 1, the current in the meter V will be proportional to the reflection coefficient of Z_L with respect to Z_0 if

- (1) N is a linear, bilateral, passive network;
- (2) Z_0 is a physically realizable impedance;
- (3) upon replacing Z_L by Z_0 the current through the meter V becomes zero;
- (4) the impedance looking back from the terminals to which Z_L is attached equals Z_0 .

These conditions have been shown to be sufficient, but they have not been shown to be necessary. It is possible for N to be nonlinear, unilateral, and nonpassive to some extent not investigated in this paper, and still have the system act as a true reflection-coefficient meter.

¹ T. E. Shea, "Transmission Networks and Wave Filters," D. Van Nostrand Company, New York, N. Y., 1929, chapter 2.

Note on a Parallel-T Resistance-Capacitance Network*

ALFRED WOLF†

Summary—Formulas are developed for the performance of a four-terminal parallel-T resistance-capacitance network which serves for the elimination of a given frequency. It is shown that an unsymmetric form of the network is advantageous when a high degree of frequency discrimination is desired.

THE FOUR-TERMINAL network shown in Fig. 1 has many applications in low-frequency measuring apparatus and oscillators. In the following, the network will be referred to as a filter; it is generally inserted between a low-impedance source and a high-impedance receiver for the purpose of eliminating signals of some given frequency. A special type of this filter, with $x=y=1$, has been described in the literature^{1,2} but no general theory has been available heretofore.

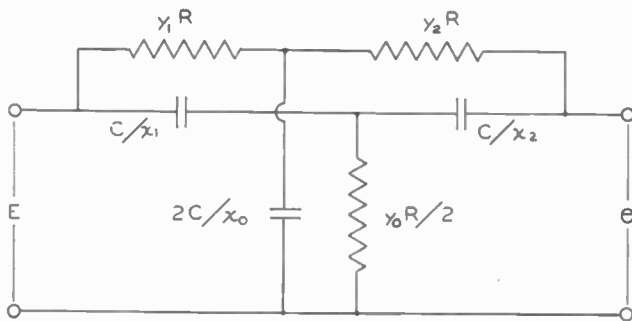

Fig. 1—Resistance-capacitance filter circuit.

Assume that the input voltage is E , and the output is e when the filter is terminated by an infinite impedance on its output side. The condition that the response of the filter e/E be zero at some frequency is given by the equation

$$x_0 y_0 = \frac{2x_1 x_2}{x_1 + x_2} \cdot \frac{2y_1 y_2}{y_1 + y_2} \quad (1)$$

and, when (1) is satisfied, which is assumed throughout the following analysis,

$$\frac{e}{E} = \frac{1}{1 - \frac{4jAv}{1 - v^2}} \quad (2)$$

where f = frequency, $j = \sqrt{-1}$,

$$v = \sqrt{\frac{x_0(x_1 + x_2)}{2y_1 y_2} \cdot \frac{1}{2\pi fCR}} \quad (2a)$$

$$A = \left[\frac{x_1 + x_2}{4y_2} + \frac{x_1}{2y_0} \right] \sqrt{\frac{2y_1 y_2}{x_0(x_1 + x_2)}} \quad (2b)$$

* Decimal classification: R143.2 Original manuscript received by the Institute, January 11, 1945; revised manuscript received, March 1, 1946.

† Geophysical Research Corporation, Tulsa, Oklahoma.

¹ H. H. Scott, "A new type of selective circuit and some applications," *Proc. I.R.E.*, vol. 26, pp. 226-236; February, 1938.

² W. N. Tuttle, "Bridged-T and parallel-T null circuits for measurements at radio frequencies," *Proc. I.R.E.*, vol. 28, pp. 23-30; January, 1940.

It follows easily that the vector diagram of the filter is a circle of unit diameter in the complex e/E -plane, tangent to the imaginary axis at the origin. The frequency of infinite attenuation f_∞ is obtained from the condition $v=1$, and is given by

$$f_\infty = \sqrt{\frac{x_0(x_1 + x_2)}{2y_1 y_2}} \cdot \frac{1}{2\pi CR} \quad (3)$$

In the neighborhood of f_∞ , the response of the filter is given by

$$\left| \frac{e}{E} \right| = \frac{1}{2A} \left| \frac{f}{f_\infty} - 1 \right|, \quad (4)$$

which shows that the smaller the value of A , the steeper the response characteristic of the filter at f_∞ .

To derive the conditions to be satisfied by x_0, \dots, y_2 in order that A be a minimum, the following procedure will be adopted: the parameters x_1, x_2, y_1, y_2 are first regarded as given constants; this leaves only x_0, y_0 as variables in (2b), which variables must also satisfy (1); by differentiation,

$$x_0 = \frac{2y_1 x_2}{y_1 + y_2}, \quad y_0 = \frac{2x_1 y_2}{x_1 + x_2} \quad (5)$$

are obtained as minimum conditions; substituting (5) in (2b), the expression

$$A = \sqrt{\frac{(x_1 + x_2)(y_1 + y_2)}{4x_2 y_2}} \quad (5a)$$

is obtained; the latter is sufficiently simple to make it possible to determine without further calculation the conditions to be satisfied by x_1, x_2, y_1, y_2 to make A a minimum.

It is seen that a symmetrical network ($x_1 = x_2, y_1 = y_2$) leads necessarily to the minimum value $A = 1$; the latter is also attained in the usual design ($x = y = 1$).

In the more general case of an unsymmetric network, the value of A can be made smaller than unity by choosing $x_2 > x_1, y_2 > y_1$. The limiting value of the minimum of A , as given by (5a), is clearly $\frac{1}{2}$ obtained when $x_2 \gg x_1, y_2 \gg y_1$.

A convenient design equation for the unsymmetric network may be stated as follows

$$2\pi f_\infty CR = 1, \quad x_1 = y_1 = 1, \quad x_2 = y_2 = k \quad (6a)$$

$$x_0 = y_0 = \frac{2k}{1+k} \quad (6b)$$

from which

$$A = \frac{1+k}{2k} \quad (6c)$$

The assumption $k=5$ gives $A=0.6$, a considerable improvement in discrimination over the symmetrical form of the filter.

Correspondence

Correspondence on both technical and nontechnical subjects from readers of the PROCEEDINGS OF THE I.R.E. and WAVES AND ELECTRONS is invited, subject to the following conditions: All rights are reserved by the Institute. Statements in letters are expressly understood to be the individual opinion of the writer, and endorsement or recognition by the I.R.E. is not implied by publication. All letters are to be submitted as typewritten, double-spaced, original copies. Any illustrations are to be submitted as inked drawings. Captions are to be supplied for all illustrations.

Note on Critical Damping

The behavior of the ballistic galvanometer or the d'Arsonval-type ammeter is described by the differential equation

$$M \frac{d^2\theta}{dt^2} + \rho \frac{d\theta}{dt} + k\theta = T, \quad (1)$$

M = the moment of inertia of the rotating parts of the instrument

ρ = the resistance factor, due to viscosity of the air, friction of the bearings, and molecular friction resulting from strain in the torque springs (or fibers)

k = the restoring torque factor due to deflection from equilibrium position;

θ = the angular deflection

$\frac{d\theta}{dt}$ ($=w$) = the angular velocity

$\frac{d^2\theta}{dt^2}$ ($=\frac{dw}{dt}$) = the angular acceleration of the rotating members

T = the externally applied torque.

This torque is supplied by the interaction of current in the moving coil and the magnetic field of the stationary pole pieces. Its value depends on the current I , the magnetic field strength or flux density B , and also on the number of turns in and the geometry of the moving coil. In some instruments B varies with the deflection angle θ ; but in this discussion it is assumed that B is constant and independent of θ . The number of turns N and the geometry of the coil is fixed; so that by use of a suitable constant the expression for the torque is

$$T = aI. \quad (2)$$

Equating (1) and (2) gives the relation between the mechanical parameters of the instrument and the current being measured. If a constant direct current is passed through the moving coil and the coil has finally come to rest, $d\theta/dt$ and $d^2\theta/dt^2$ will both be zero in (1), and so (1) and (2) taken together give

$$k\theta = aI \quad \text{or} \quad \theta = aI/k; \quad (3)$$

that is, the deflection is proportional to the current, as is well known. If now the circuit supplying current to the coil is opened, I in (2) will be zero, and hence the right-hand member of (1). The moving element will then perhaps return to its original rest position.

If it were physically possible to reduce ρ in (1) to zero; that is, if all friction and resistance in the instrument could be eliminated; the system would never come to rest, but would oscillate back and forth forever with a frequency

$$= \frac{\sqrt{k/M}}{2\pi}$$

and an amplitude equal to the original deflection from its no-current rest position. This is an idealism; for ρ is ever present, even though it may be made small. Because of this, the moving element oscillates with a proportionately decreasing amplitude and a slower frequency given by

$$f = \frac{1}{2\pi} \sqrt{\frac{k}{M} - \frac{\rho^2}{4M^2}} \quad (4)$$

until finally it comes to virtual rest.

If ρ has a larger value the amplitudes of oscillation decrease in greater ratio, and as can be seen from (4), the frequency decreases as ρ increases. Increasing ρ sufficiently results in the frequency becoming zero. The moving element approaches its rest position exponentially without oscillation under this condition, which is defined as *critical damping*. If ρ is made larger than this critical value, the system still approaches its rest position exponentially, but at a slower rate.

In most instruments of the type, the mechanical resistance is kept to a low value. In some cases damping is introduced mechanically, but it is usual to introduce it electrically. The action is as follows:

Suppose a current is flowing through the meter coil, and then this current is suddenly reduced to zero without opening the coil circuit, thus leaving the impedance of the external circuit still connected to the meter. The moving element will return to its no-current rest position as before, but its behavior will be modified by the fact that the right-hand member of (1) is not now zero. Assuming, for simplicity, that the inductance of the moving coil is small enough to be neglected and that the reactive elements of the external circuits are negligible compared to its resistance, then the motion of the moving coil through the magnetic flux will induce a voltage in the coil circuit and cause a current to flow. The value of this induced voltage depends on the rate at which the flux lines are cut by the moving coil and is proportional to this rate. The functional relation is

$$E = -h \frac{d\theta}{dt} \quad (5)$$

where h is a positive constant. Now the rate of cutting flux is the same as the rate of change in the deflection angle θ , and the current in the circuit is given by $I = E/R$, R being the total resistance of the coil and the external circuit. Combining these with (5) gives

$$I = -\frac{h}{R} \frac{d\theta}{dt}$$

If this value of I is substituted in (2), the value of the torque is now

$$T = -\frac{ah}{R} \frac{d\theta}{dt}, \quad (6)$$

and combining this with (1) gives

$$M \frac{d^2\theta}{dt^2} + \rho \frac{d\theta}{dt} + k\theta = -\frac{ah}{R} \frac{d\theta}{dt}. \quad (7)$$

By transposing and combining like terms, (7) becomes

$$M \frac{d^2\theta}{dt^2} + \left(\rho + \frac{ah}{R}\right) \frac{d\theta}{dt} + k\theta = 0$$

or

$$M \frac{d^2\theta}{dt^2} + \rho' \frac{d\theta}{dt} + k\theta = 0 \quad (7a)$$

in which $\rho' = \rho + ah/R$. This equation is similar to (1) for the case in which $T=0$ as discussed above. Thus it is seen that the change in behavior is due to an increase in the effective damping factor ρ . Increasing R lowers the damping factor and decreasing R increases it. If ρ' is substituted for ρ in (4), it is seen that the damping of the system is effectively controlled by varying R .

Finally, the behavior of the system in the case where current is supplied to the instrument from an external source, there being originally no current flow, is exactly the same as just outlined if the deflection angle θ is now thought of as being measured from the rest position of the system with this current flowing.

An example of the application of the above principle is the Ayrton shunt. Suppose it is desired to change the sensitivity of a shunt-type direct-current ammeter without altering the damping characteristic of the instrument. Fig. 1 represents the

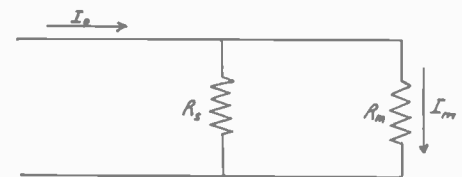

Fig. 1

electrical circuit of such a meter in which R_m is the resistance of the coil circuit and R_s is the shunt resistance. By redesigning the input circuit as follows, the above desideratum is achieved.

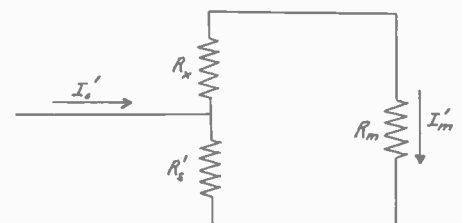

Fig. 2

Let Fig. 2 represent the altered circuit in which R_m is the same as in Fig. 1, R_s' is the new value of the shunt resistance, and R_x is the value of resistance to be inserted in series with the coil circuit. From Fig. 1

$$I_m = \frac{R_s}{R_m + R_s} I_0 \cdot \frac{I_0}{I_m} = a$$

is the given current ratio. Let $R_m + R_x = R$. This is the value which controls the damping

factor of the instrument as it appears in (7). From Fig. 2

$$I_m' = \frac{R_o I_o'}{R_m + R_x + R_o'} \cdot \frac{I_o'}{I_m'} = b = na$$

where n is the factor by which the sensitivity is to be decreased. Then specifying that $R_m + R_x + R_o' = R$ have the same value as before,

$$R_m + R_x = R_m + R_x + R_o', \text{ or } R_x = R_x - R_o'$$

From these relations it follows that $R/R_o = a$ for the case of Fig. 1 and that $R/R_o' = b$ for the case of Fig. 2. Combining these two equations by division

$$\frac{R_o}{R_o'} = \frac{b}{a} = n, \text{ or finally } R_o' = \frac{R_o}{n}$$

Thus it is seen that a shunt of given value may be tapped to give resistance ratios that are the same as the line-current-to-meter-current ratios, and the damping characteristics of the meter are not changed.

NELSON THOMPSON
1 Myrtle Place
Uphams Corner 25, Mass.

Node-Pair Method of Circuit Analysis

I wish to make a plea for greater use of the node-pair viewpoint in electronics. It is encouraging that a number of recent textbooks and journal articles have appeared in which the node-pair method of circuit analysis is presented.¹⁻⁶ However, most engineers with whom I have talked still seem to have the impression that there really is but little distinction of importance between the mesh and node-pair methods of circuit analysis, and that the method that one should use depends largely upon "which school one is from"! Now, I cannot agree with this impression at all. Despite "which school one is from," there are certain points which indicate that the node-pair viewpoint deserves much more serious attention than it has received in the past. These points are as follows:

(1) The analysis of any physical problem involves the establishment of a system of co-ordinates. Ordinarily, certain co-ordinate systems will yield the simplest formulation of the problem. Such co-ordinate systems will be called the most "natural" systems, and the viewpoints associated with those co-ordinate systems will be called the "natural" viewpoints of the problem. Electrical networks may be analyzed in terms of mesh co-ordinates or node-pair co-ordinates. These two types of co-ordinate systems are, in a sense, independent of each other, and a given network may be analyzed in terms of

either. For a given electrical network, however, one type will usually be more "natural" than the other.

(2) The mesh viewpoint is the most natural for circuits that are predominantly magnetic in nature, whereas the node-pair viewpoint is the most natural for circuits that are predominantly electric in character. From this it follows that magnetic devices such as transformers, direct-current generators, alternators, and the like are best analyzed in terms of mesh quantities. Electronic devices such as vacuum tubes are best analyzed in terms of node-pair quantities.

(3) The measurements of current and voltage in a network are usually made at solder points or terminals (i.e., nodes). It is of utmost significance that the node-pair viewpoint is in terms of precisely those currents and voltages that would be measured by clip-leads connected to the circuit at these points. The mesh viewpoint, on the other hand, is in terms of "internal" quantities that have no such simple significance. Thus, whereas the node-pair analysis is always in terms of these "clip-lead" quantities, it is possible in a mesh analysis that some of the mesh currents may be purely hypothetical and not directly measurable anywhere in the circuit. In other words, since our measurements are usually in terms of voltages and currents at various nodes in the circuit instead of in terms of magnetic flux linkages with, or total voltage around, a given closed path, we see that the node-pair quantities are the most natural and consistent with those already used in everyday measurements.

(4) There exists an "admittance concept" which is distinct from, although fully as important as, the "impedance concept." The average engineering student is led to believe that an admittance is a quantity defined as the reciprocal of an impedance solely as an aid in "combining impedances in parallel." I cannot agree with this naive concept. It is unfortunate that the beginning engineering student is not taught the rudimentary working knowledge of matrix algebra so that he would be able to think in terms of several variables at once. He would then see that his mesh equations $e = z \cdot i$ and node-pair equations $I = Y \cdot E$ give rise to impedance values z and admittance values Y which only in the simplest case of a single-element circuit may be said to have a reciprocal relation to each other. (Since different currents and voltages are involved, it should be noted that in general $e \neq E$, $i \neq I$, so that $Y \neq z^{-1}$.)

To measure the Y 's, one need only fasten clip leads to the various nodes in the circuit. Then, with all other node pairs short-circuited by means of these clip leads, a unit voltage is applied across a particular node pair. The value of the current impressed through the clip lead to give a unit voltage across the particular node pair is then numerically equal to the self-admittance of that node-pair, and the short-circuit currents in each of the clip leads that short-circuit the other node pairs are numerically equal to the various transadmittances between the particular node pair in question and each of the others. Thus, the admittance concept

implies currents flowing into various nodes as a result of a voltage acting at some one node in the circuit, all other node voltages being zero.

To measure the z 's, one must produce open circuits by unsoldering (figuratively, at least) connections in all of the meshes except one. A voltage of sufficient strength to produce unit current is then impressed in that particular mesh. As a result of this unit current, voltages will appear across the open circuits temporarily introduced in each of the other meshes. The self-impedance of that particular mesh is then numerically equal to the applied voltage, and the mutual impedances of that particular mesh with the other meshes are numerically equal to the voltages appearing across the open circuits in the other meshes. Thus, the impedance concept implies voltages coupled into various meshes as a result of a current flowing in some one mesh, all other mesh currents being zero. (In some complicated circuits, it may be impossible to open-circuit a given mesh without simultaneously open-circuiting an adjoining mesh. The analogous difficulty in the node-pair analysis can never occur.)

(5) The choice of whether the mesh or node-pair viewpoints is the more natural for a given circuit depends, in part, upon whether current or voltage, respectively, is the more independent co-ordinate. In magnetic devices the magnetic fields are ideally linearly related to the currents, and voltages are induced because of the variation of each of these currents. Before these voltages can be concisely defined, a closed path or mesh must be established; hence, the mesh (or impedance) viewpoint is the natural one for magnetic devices where voltages are a consequence of the currents acting in the circuit.

On the other hand, an electron tube consists of various electrodes (nodes), and the charges induced thereon are linearly related to the relative potentials of the various nodes. The flow of charge (i.e., nodal current) into each of these electrodes is expressible in terms of the voltages between the electrodes. Hence, the node-pair (or admittance) viewpoint is the natural one for such devices where the currents are a consequence of the electric fields and voltages acting in the circuit.

In the argument just presented, one might object that I have tried to declare that "the chicken came before the egg," and that so long as there exists a relation between current and voltage, one can always express the inverse relation. Unfortunately, this is not always so. Let us consider, for example, a triode tube. In general, there will exist (for small signals, at least) a linear relation between the grid and plate currents, I_g and I_p , and the grid and plate voltages, E_g and E_p . We might express this relation as either $e = z \cdot i$ or $I = Y \cdot E$, where

$$z = \begin{matrix} & \begin{matrix} i & p \end{matrix} \\ \begin{matrix} e \\ g \\ p \end{matrix} & \begin{bmatrix} Z_{gg} & Z_{gp} \\ Z_{pg} & Z_{pp} \end{bmatrix} \end{matrix}$$

¹ Gabriel Kron, "Tensor Analysis of Networks," John Wiley and Sons, New York, N. Y., 1939.

² Electrical Engineering Staff, Massachusetts Institute of Technology, "Electric Circuits," John Wiley and Sons, New York, N. Y., 1940, pp. 121-164, 391-398, and 420-430.

³ Murray F. Gardner and John L. Barnes, "Transformations in Linear Systems," John Wiley and Sons, New York, N. Y., 1942, p. 38 et sequens.

⁴ F. B. Llewellyn and L. C. Peterson, "Vacuum-tube networks," PROC. I.R.E., vol. 32, pp. 144-166; March, 1944.

⁵ Myril B. Reed, "Node equations," PROC. I.R.E., vol. 32, pp. 355-359; June, 1944.

⁶ John W. Miles, "Junction analysis in vacuum-tube circuits," PROC. I.R.E., vol. 32, pp. 617-620; October, 1944.

and

$$Y = \begin{matrix} & \begin{matrix} g & p \end{matrix} \\ \begin{matrix} g \\ p \end{matrix} & \begin{bmatrix} Y_{gg} & Y_{gp} \\ Y_{pg} & Y_{pp} \end{bmatrix} \end{matrix}$$

and the elements have the meaning discussed in part 4 above.

Let us now consider what happens in a negative-grid tube. Since the grid current is then always zero, we may still write the admittance equations as

$$Y = \begin{matrix} & \begin{matrix} g & p \end{matrix} \\ \begin{matrix} g \\ p \end{matrix} & \begin{bmatrix} 0 & 0 \\ g_m & 1/r_p \end{bmatrix} \end{matrix}$$

where the elements have been replaced by their conventional symbols. The impedance equations, on the other hand, become indeterminate because one of the currents is zero. Thus, it is apparent that voltage is "more independent" than current in electronic devices.

(6) Electronic engineers today are suffering from an "impedance hangover." This hangover was acquired, innocently enough and through no fault of their own, because historically the development of magnetic (or mesh) devices preceded the development of electric (or nodal) devices. How else can we explain the befuddled terminology which leads the engineer to speak of the various *transconductances* of an electronic device and then to use the term "plate-resistance" in the same breath, when what he really means is the reciprocal of the "plate conductance"? How else can we explain the fact that the "General Radio Experimenter" found it advisable to publish an explanatory article on series and parallel components? How else can we explain the observable fact that equations which may be expressed with beautiful simplicity in terms of admittances are still written in terms of impedances, despite their more complicated form? (As an interesting example of this latter situation, it will be found that the delta-to-wye transformation formulas expressed in terms of impedances are identical to the wye-to-delta formulas expressed in terms of admittances. Hence, only one type of formula need be remembered instead of two.)

(7) The importance of the node-pair viewpoint is not limited to electronic circuits alone. It may often be used to good advantage in any analysis wherein the current and voltage relations at discrete terminals are desired. As an illustration, the so-called "short-circuit impedances" of power transformers and alternators are closely related to the admittance concept as described above. As a matter of fact, the power-distribution engineer has found that the node-pair viewpoint lends itself beautifully toward

calculating fault currents and load voltages in a large power-distribution grid.

WILLIAM H. HUGGINS
Communications Laboratory
Cambridge Field Station
Air Matériel Command

Elimination of Interference-Type Fading at Microwave Frequencies with Spaced Antennas

Severe fading resulting from interference between the direct and ground-reflected waves has been observed at microwave frequencies on point-to-point communication circuits over both land and sea line-of-sight paths.¹ The observed fading is caused by tropospheric effects which produce changes in the path-length difference between the

lies between two adjacent lobes. It has been shown that this type of fading can be overcome effectively by the use of a "complementary diversity" reception system¹ in which two receiving antennas are spaced vertically half a lobe apart, so that, as the lobe pattern shifts up and down, either one or both of the antennas will be in a region where strong signals can be received. Connection of the antennas to two receivers with common automatic-volume-control and output circuits provided a diversity receiving system which derives its output from the antenna in the region of highest field intensity. The voltage outputs of the two antennas were observed to be complementary, as the lobes wobbled up and down, in that weak signals in one antenna always occurred at a time when strong signals were being re-

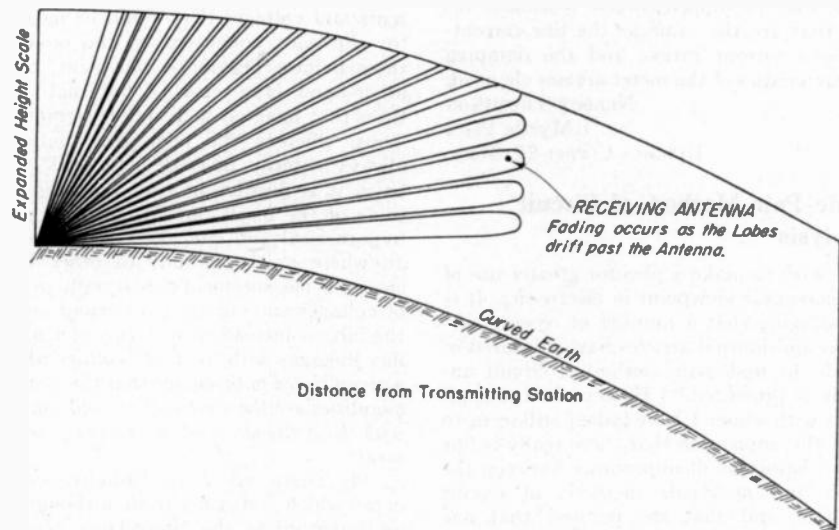

Fig. 1—Contours of constant field intensity (lobe pattern) formed by reflections from a smooth surface.

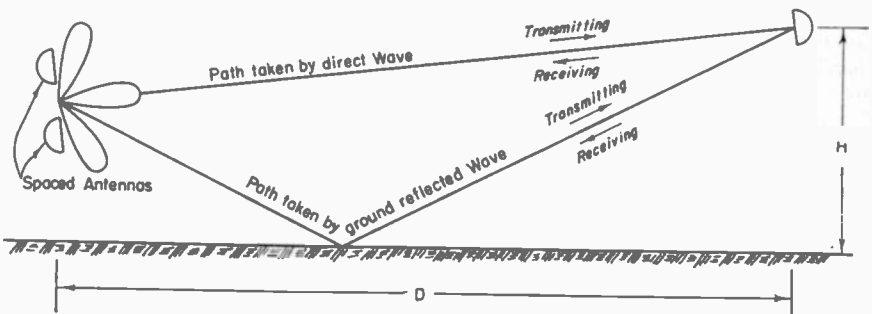

Fig. 2—Elimination of ground-reflected wave with spaced antennas. (Note: Only three lobes of the spaced-antenna pattern are shown and the parabola directivity pattern is not shown.)

direct wave and the ground-reflected wave. One way to visualize this type of fading is to think of the lobe pattern of Fig. 1, formed by interference between the direct and ground-reflected waves, as wobbling up and down over a period of time. If the contours of the pattern shown in Fig. 1 represent minimum usable field intensities, reception will be possible with a single receiving antenna only when the receiving antenna is within one of the lobes, but not possible when the antenna

is positioned on the other antenna. Tests of this arrangement indicated that it provided apparently complete protection against fading caused by ground reflections.

Another way to eliminate this type of fading is to confine the radiated energy in a narrow beam in the vertical plane, so that only a very small fraction of the energy is radiated toward the ground. Experiments carried out by the Bell Telephone Laboratories² with antennas having a beam width

¹ Thomas J. Carroll, "Complementary Diversity Reception on Microwaves," Propagation Report No. 2, in connection with "Comparative Tests of Radio Relay Equipment," Radio Propagation Section, Office of the Chief Signal Officer, Washington, D. C.

² W. M. Sharpless, "Measurements of the Angle of Arrival of Microwaves in the X Band," Bell Telephone Laboratories Report MM-44-160-249; November 7, 1944.

between half-power points of less than one-half degree in the vertical plane showed that a marked improvement in fading could be realized by this method of discrimination against ground reflections.

With antennas of moderate directivity it is possible to obtain some discrimination against the ground-reflected wave by tilting the antenna up so that the power radiated along the path of the direct wave is greater than that radiated along the path of the ground-reflected wave.¹ This method is, in general, limited to sites where the angle between the paths taken by the direct and ground-reflected waves is comparable to or larger than half the beam width of the antenna between half-power points. It is important to note that the usual practice of adjusting the vertical tilt of the antenna for maximum signal strength is the worst condition for experiencing deep interference fades.

Further study of the problem indicates that it should be possible to reduce or eliminate the ground-reflected wave by the use of two spaced antennas transmitting simultaneously or receiving simultaneously. The principle of the method is illustrated in Fig. 2. In its simplest form, two similar antennas (which may be either directional or nondirectional) equidistant from the antenna at the remote terminal, are driven in phase, and are spaced vertically so that the first null in the pattern due to their spacing is pointed along the path taken by the ground-reflected wave.

In the usual case where the distance D between terminals is very much larger than either terminal height, the required spacing between the two antennas, expressed in quarter wavelengths, is simply D/H for transmission over a plane earth (as shown in Fig. 2), where H is the height of the antenna at the opposite terminal. The above relation applies also for the actual curved earth, provided H is taken as the height of the remote antenna above the plane tangent to the earth at the point of reflection.¹ It is interesting to note that this spacing is just the half-lobe spacing required for "complementary diversity reception." For minimum

separation, the spaced antennas for both transmission and reception should be installed at the lower terminal. This spaced-antenna method is strictly applicable only for point-to-point circuits. The success of this method depends upon the smallness of variations in the path-length differences between the two adjacent direct paths and between the two adjacent ground-reflected paths, as compared to the variations in the path-length differences between the pair of direct paths and the pair of ground-reflected paths.

Spaced antennas may also have applications in television broadcasting or television relay circuits for the elimination of ghosts as well as fading. In this use, the spacing between the receiving antennas would be adjusted in either the horizontal or vertical plane, or both, so as to direct a null toward the building or other object causing the multipath distortion. It is believed that, in many cases, the use of spaced antennas will be a more effective means of eliminating television ghosts than a single antenna of moderate directivity.

ROSS BATEMAN

Radio Propagation Section
Office of the Chief Signal Officer
The Pentagon, Washington 25, D. C.

Specification of Receiver Sensitivity and Transmitter Power Output at Ultra-High Frequencies

A plea is made that the sensitivity of ultra-high-frequency receivers be specified in terms of decibels below one watt, and that it be measured by a signal generator calibrated for power delivered to a matched load. This is contrary to the practice in the radio industry in that there the signal generator is calibrated in terms of its open-circuit voltage.

The reasons for this plea are as follows: At ultra-high frequencies it is not possible to express correctly an absolute value for a voltage or current unless the distribution of

the standing waves on the transmission line, which is in general not accurately known, is defined. It would seem, therefore, more advisable to work in terms of power and impedance rather than voltage and impedance, since these are the quantities which are actually measured. An advantage is that power is invariant under all impedance transformations assuming matched or approximately matched conditions. Furthermore, measurements of receiver sensitivity in terms of power have a firm physical basis in that the limit to the receiver sensitivity is the thermal noise and the absolute sensitivity of a receiver is usually specified in terms of a power necessary to produce a signal at the output equal to this noise.

Radar engineers have an additional reason for thinking in terms of power. They think of the transmitter, feeders, transmitting antenna, aerial path, receiving antenna, feeders, and receiver as forming a continuous chain, and the over-all performance is most easily handled in terms of the powers and attenuations expressed in decibels.

Also, manufacturing experience has been gained in determining the sensitivities of receivers in the centimeter range, and these are always specified in terms of power. It is expected that the primary standard of power measurement at ultra-high frequencies may ultimately be a thermistor bridge. Hence, it will be more convenient, though not necessary, to express receiver sensitivity in terms of power; i.e., decibels below one watt. If sensitivities are expressed in volts, whether open-circuit or terminated, calculations are necessary to refer back to the power as a standard. In so doing, errors may be introduced by changes in impedance.

Finally, in the case of radar and beacon systems it would seem desirable to express transmitter output in decibels above one watt to make the procedure consistent throughout.

LEONARD S. SCHWARTZ
Security Systems Section
Office of Research and Inventions
Naval Research Laboratory
Washington 20, D. C.

Contributors to the Proceedings of the I.R.E.



KOSMO J. AFFANASIEV

Kosmo J. Affanasiev (M'45) was born in Russia. He was graduated from the Russian Midshipmen's College (Naval Academy) in 1919, and the State University at Vladivostok in 1922. He received the B.Sc. degree in electrical engineering in 1932, and the M.Sc. degree in electrical engineering in 1935, from the University of Wisconsin.

In 1923 Mr. Affanasiev became associated with the Pacific Telephone and Telegraph Company, and in 1927 he transferred to the International Telephone and Telegraph Corporation, where he remained until 1929. While at the University of Wisconsin, he assisted in one of the early experimental works dealing with high-frequency induction and dielectric heating. From 1932 to 1934 he was employed by the Wisconsin State Public Service Commission as assistant electrical engineer and telephone engineer. He was a member of the special

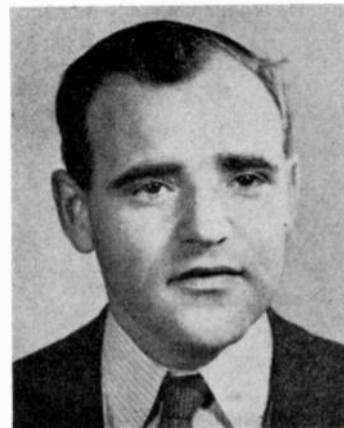

THOMAS W. WINTERNITZ



NATHANIEL I. KORMAN

investigation engineering staff of the Federal Communications Commission from 1935 to 1938, and from 1939 to 1943 served as special studies engineer for the Pennsylvania Water and Power Company in Baltimore, Maryland.

Mr. Affanasiev joined the scientific staff of the Airborne Instruments Laboratory of Columbia University in 1943, later becoming a project engineer, and remaining with the Laboratory until it was discontinued in 1945. He then became a consulting engineer for the Federal Communications Commission, and was appointed principal engineer later in the same year.

He is a member of the American Institute of Electrical Engineers, and the National Roster of Scientific and Technical Personnel, and is a licensed professional engineer in the states of Maryland and New York.

Nathaniel I. Korman (S'38-A'39-SM'45) was born in Providence, Rhode Island, on February 23, 1916. He received the B.S. degree from Worcester Polytechnic Institute in 1937. Working at Massachusetts Institute of Technology under a Charles A. Coffin Fellowship, he received the M.S. degree in electrical engineering in 1938. That same year he became a student engineer with the RCA Manufacturing Company. Mr. Korman is now with the Government Radiation Engineering department of this company. He is a member of Sigma Xi.

Thomas W. Winternitz (S'39-A'41) was born in 1916, at Baltimore, Maryland. He received the B.S. degree from the University of Chicago in 1938, and the M.S. degree from Harvard University in 1940. From 1940 to 1942 he was employed by the Western Electric Company in Chicago, Illinois, in the equipment engineering department, and later as test engineer on radar apparatus. In 1942 he was transferred to the Bell Telephone Laboratories in New York City where he worked on radar and associated projects as a member of the technical staff. Since September, 1945, Mr. Winternitz has been at Cruft Laboratory of Harvard University on a half-time teaching fellowship working for the Sc.D. degree.



KARL R. SPANGENBERG

L. L. Libby (S'36-A'41-SM'46) was born at Hartford, Connecticut, on January 26, 1914. He received the B.S. and M.S. degrees in electrical engineering from the Worcester Polytechnic Institute in 1935 and 1936, respectively. During the summers of 1934 and 1935 he served as radio transmitter operator and as assistant to the chief engineer of WTAG, Worcester, Massachusetts.

From 1936 to 1938, he was employed as a radio-tube design engineer for RCA Radiotron, and from 1938 to 1941 he served in the radio receiving-tube division of Tung-Sol Lamp Works in a similar capacity.

He joined the Federal Telegraph Company in 1941, in its radio-receiver laboratory. He was project engineer in the direc-

tion-finder division from 1942 to 1944, then transferring to the laboratories division in the capacity of senior engineer. He is now a section head with the Federal Telecommunication Laboratories, in charge of development of microwave radio-link equipment for pulse-time-modulation multiplex systems. He is a member of Sigma Xi.

For a photograph and biographical sketch of Paul I. Richards, see the March, 1946, issue of the PROCEEDINGS OF THE I.R.E. AND WAVES AND ELECTRONS; for Heinz E. Kallmann, see the June, 1946, issue.



LESTER L. LIBBY

Karl R. Spangenberg (A'34-SM'45) was born at Cleveland, Ohio, on April 9, 1910. He received the B.S. degree in electrical engineering in 1932, and the M.S. degree in electrical engineering in 1933, both from Case School of Applied Science; and the Ph.D. degree from Ohio State University in 1937.

Since 1937 Dr. Spangenberg has been a member of the faculty of the electrical engineering department of Stanford University, as associate professor of electrical engineering. During the war he was granted a leave of absence from Stanford University to serve as consultant to the Signal Corps and to work at the Radio Research Laboratory for a period of a year and a half.

Institute News and Radio Notes

1946 National Electronics Conference

Electronic physicists, engineers, designers, production men and others engaged in the electronic industry will be interested in the comprehensive program planned for the 1946 National Electronics Conference to be held at the Edgewater Beach Hotel, in Chicago, on October 3, 4, and 5.

Continuing the aims set down in 1944 at the time of the first National Electronics Conference, the purpose of the Conference is to serve as "a national forum on electronic research, development, and application." The Conference is planned to provide: (1) technical meetings for the presentation of original papers covering latest developments in electronics and applications of electronic apparatus; (2) forums for the review and correlation of recent progress in the many branches of the field; (3) symposia for the interchange of ideas, methods of approach, and technique of scientists, electronic engineers, and others working in different fields of application.

Dealing with new developments in communications, television, instrumentation, industrial electronics, and theoretical research, approximately 60 papers will be offered at the Conference this fall, which is open to all persons having a genuine and sincere interest in electronic development.

The National Electronics Conference is sponsored by the Illinois Institute of Technology, Northwestern University, and the University of Illinois, together with the Chicago sections of The Institute of Radio Engineers and the American Institute of Electrical Engineers. Dr. J. E. Hobson, Armour Research Foundation, is chairman of the Board of Directors of the Conference, and Mr. W. O. Swinyard, Hazeltine Research, Inc., is the president.

Adding interest to this year's Conference will be a display of manufacturers' exhibits. These exhibits will consist of educational approaches to various electronic subjects and demonstrate recently developed electronic equipment. The exhibitors are manufacturers of electronic equipment in communications, power, television, instrumentation, industrial processes and controls, and transportation. Other displays will present recent applications of electronics in medicine and related fields.

All Conference activities will be held at the Edgewater Beach Hotel. Arrangements have been made to accommodate approximately 650 persons at this hotel, and its management has agreed to make accommodations for all in excess of this number at near-by hotels. Single rooms are \$4.40, and double rooms \$6.60 for two persons.

Since a large attendance is anticipated, those planning to attend the Conference are asked to make advance registration by mail prior to September 19. No registration can be accepted after this date. Advance remittance of \$14.00 will cover all Conference activities, including copy of the Proceedings, and should be sent to Mr. E. H. Schulz, Secre-

tary, Technology Center, Chicago 16, Illinois. No advance registration will be considered without remittance.

Every effort has been made to develop a program of outstanding technical excellence with papers presented by authorities in their respective fields. Several sessions will run concurrently, but the program has been planned to minimize, if not eliminate, overlapping of papers on related topics. Following is a listing of principal speakers together with the various panels, including the papers and their authors.

PRINCIPAL SPEAKERS

- Dr. E. U. Condon, Director, National Bureau of Standards, "Electronics and the Future"
 Dr. Frederick L. Hovde, president, Purdue University. Subject to be announced later
 Dr. C. G. Suits, vice-president, General Electric Company, "Physics of Today Becomes the Engineering of Tomorrow"
 Dr. J. O. Perrine, assistant vice-president, Bell Telephone Laboratories, "Radar and Microwaves"

CONFERENCE PROGRAM TELEVISION-A

- "Color Television—Latest State of the Art," by P. C. Goldmark, Columbia Broadcasting System
 "Westinghouse Color-Television Studio Equipment," by D. L. Balthis, Westinghouse Electric Corporation
 "Television Transmitter for Black-and-White and Color Television," by N. Young, Federal Telecommunication Laboratories

TELEVISION-B

- "Stratovision System of Communication," C. E. Nobles, Westinghouse Electric Corporation, and W. K. Ebel, Glenn L. Martin Company.
 "The Electrostatic Image Dissector," by H. Salinger, Farnsworth Television and Radio Corporation
 "The Use of Powdered Iron in Television Deflecting Circuits," by A. W. Friend, Radio Corporation of America
 "Television Equipment for Guided Missiles," by C. J. Marshall, Wright Field, Ohio, and Leonhard Katz, Raytheon Manufacturing Company

ANTENNAS AND WAVE PROPAGATION-A

- "Problems in Wide-Band Antenna Design," by A. G. Kandoian, Federal Telecommunication Laboratories
 "Slot Radiators," by Andrew Alford, Consulting Engineer
 "Results of Field Tests on Ultra-High-Frequency (490-Megacycle) Color-Television Transmissions in the New York Metropolitan Area," by W. B. Lodge, Columbia Broadcasting System

ANTENNAS AND WAVE PROPAGATION-B

- "Radio Propagation at Frequencies Above 30 Megacycles," by K. Bullington, Bell Telephone Laboratories
 "Interference Between Very-High-Frequency Radio Communication Circuits," by W. R. Young, Jr., Bell Telephone Laboratories
 "Aircraft-Antenna Pattern-Measuring System," by Otto Schmitt, Airborne Instruments Laboratory
 "Improvements in 75-Megacycle Aircraft Marker Systems," by Bruce Montgomery, Northwest Airlines

MICROWAVE GENERATORS

- "Continuous-Wave Ultra-High-Frequency Power at the 50-Kilowatt Level," by W. G. Dow, University of Michigan
 "Microwave Frequency Stability," by A. E. Harrison, Sperry Gyroscope Company
 "An All-Metal Tunable Squirrel-Cage Magnetron," by F. H. Crawford, Williams College
 "Design of Wide-Range Coaxial-Cavity Oscillators Using Reflex-Klystron Tubes," by J. W. Kearney, Airborne Instruments Laboratory

AIR-NAVIGATION SYSTEMS

- "Automatic Radio Flight Control," by F. L. Moseley, Collins Radio Company
 "Navaglobe—Long-Range Aerial Navigation System," by P. R. Adams and R. I. Colin, Federal Telecommunication Laboratories
 "Teleran—Air Navigation and Traffic Control by Means of Television and Radar," by D. H. Ewing and R. W. K. Smith, Radio Corporation of America

RADIO-RELAY SYSTEMS

- "A Microwave Relay Communication System," by G. G. Gerlach, Radio Corporation of America
 "Pulse-Time Multiplex Broadcasting of the Ultra-High Frequencies," by D. D. Grieg and A. G. Kandoian, Federal Telecommunication Laboratories
 "The Cyclophon—A Multipurpose Beam-Switching Tube," by J. J. Glauber, D. D. Grieg, and S. Moskowitz, Federal Telecommunication Laboratories

FREQUENCY MODULATION

- "A Permeability-Tuned 100-Megacycle Amplifier of Specialized Coil Design," by Z. Benin, Zenith Radio
 "Very-High-Frequency Tuner Design," by G. Wallin and C. W. Dymond, Galvin Manufacturing Company
 "Front-End Design of Frequency-Modulation Receivers," by C. R. Miner, General Electric Company
 "A Single-Stage Frequency-Modulation Detector," by W. E. Bradley, Philco Radio and Television Corporation

"Frequency Modulation of High-Frequency Power Oscillators," by William R. Rambo, Airborne Instruments Laboratories

MOBILE RADIO COMMUNICATION

A panel on selective-calling systems in mobile radio communication will be included.

"Signal Systems for Improving Railroad Safety," by K. W. Jarvis, Consulting Engineer

INFRARED AND MICROWAVE COMMUNICATION SYSTEMS

"Reflex Oscillators for Radar Systems," by J. O. McNally and W. G. Shepherd, Bell Telephone Laboratories

"Modulation of Infrared Systems for Signaling Purposes," by W. S. Huxford, Northwestern University

"Photo Detectors for Ultraviolet, Visible, and Infrared Light," by R. J. Cashman, Northwestern University

RECORDING AND FACSIMILE

"Review of Facsimile Developments," by H. F. Burkhard, Camp Coles Signal Laboratory

"The Reduction of Background Noise in the Reproduction of Music from Records," by H. H. Scott, Technology Instrument Corporation

"Recent Developments in Magnetic Recording," by R. B. Vaile, Jr., Armour Research Foundation

THEORETICAL DEVELOPMENTS

"Bunching Conditions for Electron Beams with Space Charge," by L. Brillouin, Cruft Laboratory, Harvard University

"Generalized Boundary Conditions in Electromagnetic Problems," by S. A. Schelkunoff, Bell Telephone Laboratories

"Conformal Transformations in Orthogonal Reference Systems," by C. S. Roys, Illinois Institute of Technology

INDUSTRIAL APPLICATIONS

"Large Electronic Direct-Current Motor Drive," by M. M. Morack, General Electric Company

"Electronic Speed Control of Alternating-Current Motors," by W. H. Elliot, Cutler-Hammer Company

"The Electronic Method of Contouring Control," by J. Morgan, General Electric Company

"Production Test Facilities for High-Power Tubes," by W. L. Lyndon, Radio Corporation of America

ELECTRONIC INSTRUMENTATION-A

"A Method for Changing the Frequency of a Complex Wave," by E. L. Kent, C. G. Conn, Ltd.

Chairman

H. L. Spencer
Associated Consultants
18 E. Lexington
Baltimore 2, Md.

Glenn Browning
Browning Laboratories
750 Main St.
Winchester, Mass.

Ian C. Grant
San Martin 379
Buenos Aires, Argentina

H. W. Staderman
264 Loring Ave.
Buffalo, N. Y.

T. A. Hunter
Collins Radio Co.
855-35 St., N.E.
Cedar Rapids, Iowa

A. W. Graf
135 S. La Salle St.
Chicago 3, Ill.

J. D. Reid
Box 67
Cincinnati 31, Ohio

R. A. Fox
2478 Queenston Rd.
Cleveland Heights 18, Ohio

E. M. Boone
Ohio State University
Columbus, Ohio

Dale Pollack
Templetone Radio Corp.
New London, Conn.

R. M. Flynn
KRLD
Dallas 1, Texas

J. E. Keto
Aircraft Radio Laboratory
Wright Field
Dayton, Ohio

H. E. Kranz
International Detrola Corp.
1501 Beard Ave.
Detroit 9, Mich.

N. L. Kiser
Sylvania Electric Products,
Inc.
Emporium, Pa.

E. M. Dupree
1702 Main
Houston, Texas

H. I. Metz
Civil Aeronautics Authority
Experimental Station
Indianapolis, Ind.

R. N. White
4800 Jefferson St.
Kansas City, Mo.

B. S. Graham
Sparton of Canada, Ltd.
London, Ont., Canada

Frederick Ireland
950 N. Highland Ave.
Hollywood 38, Calif.

SECTIONS

ATLANTA
September 20

BALTIMORE

BOSTON

BUENOS AIRES

BUFFALO-NIAGARA
September 18

CEDAR RAPIDS

CHICAGO
September 20

CINCINNATI
September 17

CLEVELAND
September 26

COLUMBUS
September 13

CONNECTICUT VALLEY
September 19

DALLAS-Ft. WORTH

DAYTON
September 19

DETROIT
September 20

EMPORIUM

HOUSTON

INDIANAPOLIS

KANSAS CITY

LONDON, ONTARIO

LOS ANGELES
September 17

Secretary

M. S. Alexander
2289 Memorial Dr., S.E.
Atlanta, Ga.

G. P. Houston
3000 Manhattan Ave.
Baltimore 15, Md.

A. G. Bousquet
General Radio Co.
275 Massachusetts Ave.
Cambridge 39, Mass.

Raymond Hastings
San Martin 379
Buenos Aires, Argentina

J. F. Myers
Colonial Radio Corp.
1280 Main St.
Buffalo 9, N. Y.

R. S. Conrad
Collins Radio Co.
855-35 St., N.E.
Cedar Rapids, Iowa

D. G. Haines
4000 W. North Ave.
Chicago 39, Ill.

P. J. Konkle
5524 Hamilton Ave.
Cincinnati 24, Ohio

Walter Widlar
1299 Bonnieview Ave.
Lakewood 7, Ohio

C. J. Emmons
158 E. Como Ave.
Columbus 2, Ohio

R. F. Blackburn
2022 Albany Ave.
West Hartford, Conn.

J. G. Rountree
4333 Southwestern Blvd.
Dallas 5, Texas

Joseph General
411 E. Bruce Ave.
Dayton 5, Ohio

A. Friedenthal
5396 Oregon
Detroit 4, Mich.

D. J. Knowles
Sylvania Electric Products,
Inc.
Emporium, Pa.

L. G. Cowles
Box 425
Bellaire, Texas

Max G. Beier
3930 Guilford Ave.
Indianapolis, Ind.

Mrs. G. L. Curtis
6003 El Monte
Mission, Kansas

C. H. Langford
Langford Radio Co.
246 Dundas St.
London, Ont., Canada

Walter Kenworth
1427 Lafayette St.
San Gabriel, Calif.

Chairman

L. W. Butler
3019 N. 90 St.
Milwaukee 13, Wis.

J. C. R. Punchard
Northern Electric Co.
1261 Shearer St.
Montreal 22, Que., Canada

J. T. Cimorelli
RCA Victor Division
415 S. Fifth St.
Harrison, N. J.

W. A. Steel
298 Sherwood Dr.
Ottawa, Ont., Canada

Samuel Gubin
4417 Pine St.
Philadelphia 4, Pa.

W. E. Shoupp
911 S. Braddock Ave.
Wilkesburg, Pa.

C. W. Lund
Rt. 4, Box 858
Portland, Ore.

A. E. Newlon
Stromberg-Carlson Co.
Rochester 3, N. Y.

S. H. Van Wambeek
Washington University
St. Louis 5, Mo.

David Kalbfell
941 Rosecrans Blvd.
San Diego 6, Calif.

R. V. Howard
Mark Hopkins Hotel
San Francisco, Calif.

E. H. Smith
823 E. 78 St.
Seattle 5, Wash.

H. S. Dawson
Canadian Association of
Broadcasters
80 Richmond St., W.
Toronto, Ont., Canada

M. E. Knox
43-44 Ave., S.
Minneapolis, Minn.

F. W. Albertson
Room 1111, Munsey Bldg.
Washington 4, D. C.

W. C. Freeman, Jr.
2018 Reed St.
Williamsport 39, Pa.

MILWAUKEE

MONTREAL, QUEBEC
October 9

NEW YORK
October 2

OTTAWA, ONTARIO
September 19

PHILADELPHIA
October 3

PITTSBURGH
October 14

PORTLAND

ROCHESTER
October 17

ST. LOUIS

SAN DIEGO
October 1

SAN FRANCISCO

SEATTLE
October 10

TORONTO, ONTARIO

TWIN CITIES

WASHINGTON
October 14

WILLIAMSPORT
October 2

SUBSECTIONS

K. G. Jansky
Bell Telephone Laboratories,
Inc.
Box 107
Red Bank, N. J.

C. W. Mueller
RCA Laboratories
Princeton, N. J.

H. E. Ellithorn
417 Parkovash Ave.
South Bend 17, Ind.

W. A. Cole
323 Broadway Ave.
Winnipeg, Manit., Canada

MONMOUTH
(New York Subsection)

PRINCETON
(Philadelphia Subsection)

SOUTH BEND
(Chicago Subsection)
October 17

WINNIPEG
(Toronto Subsection)

Secretary

E. T. Sherwood
9157 N. Tennyson Dr.
Milwaukee, Wis.

E. S. Watters
Canadian Broadcasting Corp.
1440 St. Catherine St., W.
Montreal 25, Que., Canada

J. R. Ragazzini
Columbia University
New York 27, N. Y.

A. N. Curtiss
RCA Victor Division
Bldg. 8-9
Camden, N. J.

C. W. Gilbert
52 Hathaway Ct.
Pittsburgh 21, Pa.

L. C. White
3236 N.E. 63 Ave.
Portland 13, Ore.

K. J. Gardner
111 East Ave.
Rochester 4, N. Y.

N. J. Zehr
1538 Bradford Ave.
St. Louis 14, Mo.

Clyde Tirrell
U. S. Navy Electronics Labo-
ratory
San Diego 52, Calif.

Lester Reukema
2319 Oregon St.
Berkeley, Calif.

W. R. Hill
University of Washington
Seattle 5, Wash.

C. J. Bridgland
Canadian National Telegraph
347 Bay
Toronto, Ont., Canada

Paul Thompson
Telex Incorporated
1633 Eustis Ave.
St. Paul, Minn.

G. P. Adair
Federal Communications
Commission
Washington 4, D. C.

S. R. Bennett
Sylvania Electric Products,
Inc.
Plant No. 1
Williamsport, Pa.

A. V. Bedford
RCA Laboratories
Princeton, N. J.

J. E. Willson
WHOT
St. Joseph and Monroe Sts.
South Bend, Ind.

C. E. Trembley
CJOB
Lindsay Building
Winnipeg, Manit., Canada

"Detectors for Buried Metallic Bodies," by
L. F. Curtis, Hazeltine Electronics Cor-
poration

"The Pressuregraph," by A. Crossley, Elec-
tro Products Laboratories, Inc.

ELECTRONIC INSTRUMENTATION-B

"The Notch Wattmeter for Low-Level
Power Measurement of Microwave
Pulses," by D. F. Bowman, Hazeltine
Electronics Corporation

"The Mechanical Transients Analyzer," by
G. D. McCann, Westinghouse Electric
Corporation

"The Theory and Design of Several Types of
Wave Selectors," by N. I. Korman, Radio
Corporation of America

"High-Performance Demodulators for
Servomechanisms," by K. E. Schreiner,
Servomechanism Laboratory, Massachu-
setts Institute of Technology

ELECTRONIC INSTRUMENTATION-C

"An Oscillographic Method of Presenting
Impedances on the Reflection Coefficient
Plane," by A. L. Samuel, University of
Illinois

"Electron Optics of Deflection Fields," by
R. G. E. Hutter, Sylvania Products

"Cathode-Ray Oscilloscope as a Research
Tool," by W. L. Gaines, Bell Telephone
Laboratories

INDUCTION AND DIELECTRIC HEATING

"Ignitron Converters for Induction Heat-
ing," by R. J. Ballard and J. L. Boyer,
Westinghouse Electric Corporation

"Microwaves and Their Possible Use in
High-Frequency Heating," by T. P. Kinn
and J. Marcum, Westinghouse Electric
Corporation

"Dielectric Preheating in the Plastics In-
dustry," by D. E. Watts, G. F. Leland,
and T. N. Willcox, General Electric Com-
pany

"The Problem of Constant Frequency in
Industrial High-Frequency Generators,"
by Eugene Mittelman, Illinois Tool
Works

NUCLEAR PHYSICS

"The Betatron Accelerator Applied to
Nuclear Physics," by E. E. Charlton and
W. F. Westendarp, General Electric
Company

"Some Fundamental Problems of Nuclear
Power-Plant Engineering," by E. T. Neu-
bauer, Allis-Chalmers Company

"An Accelerator Column for Two to Six
Million Volts," by R. R. Machlett, Mach-
lett Laboratories

SPECTROSCOPY AND MEDICAL APPLICATIONS

"The Use of Radioactive Materials in Clin-
ical Diagnosis and Medical Therapy," by
J. T. Wilson, Allis-Chalmers Company

"The Mass Spectrometer as an Industrial
Tool," by A. O. Nier, University of
Minnesota

"Cathode-Ray Spectrograph," by R. Feldt
and C. Berkley, Du Mont Laboratories

Meetings of Technical Committees I.R.E.

ELECTRON TUBES

Power-Output High-Vacuum Tubes

Date..... June 21, 1946
Place..... McGraw-Hill Building
New York, N. Y.
Chairman..... I. E. Mourontseff

Present

I. E. Mourontseff, *Chairman*
T. A. Elder H. C. Mendenhall
C. E. Fay E. E. Spitzer
R. W. Grantham C. M. Wheeler
R. B. Jacques A. K. Wing

The following Test Methods were discussed and approved for submission to the Committee on Electron Tubes: 5.0 Residual Gas and Insulation Tests; 6.0 Grid-Emission Current Tests; 12.3 Operating Tests for High-Vacuum Diodes; and 12.4 Radio-Frequency Operating Tests of Power-Output High-Vacuum Tubes. This material must be approved by the Committee on Electron Tubes and the Committee on Standards before it will be presented to the Board of Directors for approval as a Standard of the I.R.E.

TELEVISION

Test Methods

Date..... June 14, 1946
Place..... McGraw-Hill Building
New York, N. Y.
Chairman..... Gerrard Mountjoy
Acting Chairman... B. Shmurak

Present

B. Shmurak, *Acting Chairman*
H. G. Boyle W. Lukas
R. B. Jacques R. Mautner
I. E. Lempert J. Minter
H. J. Tyzzer

Various test methods were presented by members of the committee. Tests for "Measurement of Linearity of a Television Receiver," "Test Methods for the Frequency-Modulation Portion of a Television Receiver," "Measurement Procedure for Susceptibility of Impulse Interference of Television Receivers," and "Methods and Means of Establishing the Sensitivity of the Picture Section of a Television Receiver," were discussed at length and corrected. These tests were then accepted by the committee as a whole and are to be sent to the Standards Committee for further action.

Subscription Prices

Effective with the January, 1947, issue of the PROCEEDINGS OF THE I.R.E. AND WAVES AND ELECTRONS, the price of individual nonmember subscriptions will be \$12.00 per year; subscriptions from libraries and colleges, \$9.00 net; subscriptions from agencies, \$9.00 net. In each case, there will be an additional charge of \$1.00 per year for postage to persons and organizations not residing within the United States and Canada.

Books

High Vacuum Technique (Second Edition, Revised), by J. Yarwood

Published (1945) by John Wiley & Sons, Inc., 440 Fourth Avenue, New York 16, New York. 140 pages+4-page index+xi pages. 91 illustrations. 6×9½ inches. Price, \$2.75.

This book is designed primarily for those who will have to design and use vacuum systems. To this end, emphasis is placed on the actual performance of the many types of equipment used in such systems.

The book covers the field rather well and contains a large amount of very useful specific information. Of particular value is the data included in the chapter on Properties of Materials.

In a few instances the text may be a little confusing to technicians who merely want specific recommendations for a process or type of equipment. These few instances arise from the inclusion of a brief discussion of several ways of performing a task, leaving the reader to choose one. This, however, cannot be considered a serious drawback.

On the whole, the book is a good one and one from which a vacuum technician will receive much help.

E. D. McARTHUR
General Electric Co.
Schenectady, N. Y.

Quartz Crystals for Electrical Circuits, by Raymond A. Heising

Published (1946) by D. Van Nostrand Company, Inc., 250 Fourth Ave., New York, N. Y. 554 pages+9-page index+vii pages. 367 illustrations. 6½×9½ inches. Price, \$6.50.

During the past few years a series of articles on the development and manufacture of quartz plates by members of the Bell Telephone Laboratories Technical Staff has appeared in the *Bell System Technical Journal* and other publications. These papers, together with a historical introduction to the subject, are now assembled in book form. They are reproduced practically without change, although Chapter VIII (Principles of Mounting Quartz Plates) has a new appendix, on "Location of Mass on Supporting Wire." In addition, four new chapters, which hitherto have only been privately circulated, are included. They are Chapter IX (Sawing, Grinding, and Lapping), Chapter X (Adjusting to Frequency), Chapter XI (Metal Electrodes Deposited on Quartz Crystals by the Evaporation Process), and Chapter XVI (The Wire-Mounted Crystal Unit).

The book offers the most complete and authoritative account of modern methods in quartz technique that has yet appeared. In its field it is incomparably more extensive and up-to-date than the well-known books by

Vigoureux and Scheibe*), although less comprehensive in the general treatment of quartz and its applications. Since it is devoted to the procedures in one institution, it makes but scant reference to work that has been done elsewhere.

The investigator with modest equipment will find that most of the methods of preparing and testing quartz plates are beyond his means. Nevertheless he can profit greatly from the descriptions of the various cuts and their uses. For those concerned with precision methods or large-scale production—and there are many—this is a "must" book.

In the passages on piezo oscillators the references to the important contribution of J. M. Miller seem hardly adequate. Considerable space is given to Lord Kelvin's theory of piezoelectricity, without mention of the more modern treatment by Born.

Readers of the book may become confused over the signs of the angles for the "−18°" and "+5°" cuts. It should be pointed out that these algebraic signs were adopted by the Bell Laboratories before the I.R.E. conventions respecting angles of orientation (mentioned on p. 62) had been adopted. According to the latter convention the two cuts would be called "+18°" and "−5°." The earlier convention of the Bell Laboratories is seen, for example, in Figure (1.9), where angles are represented as positive when laid off clockwise from the Z axis, whereas according to the I.R.E. convention clockwise angles are *negative*.

The book is clearly written, well printed, and with illustrations of highest excellence. Mr. Heising has rendered a valuable service by making the information available to a large circle of readers.

W. G. CADY
Wesleyan University
Middletown, Conn.

* P. Vigoureux "Quartz Oscillators and Their Applications," London, 1939; A. Scheibe, "Piezoelektrizität des Quarzes," Dresden and Leipzig, 1938.

Mechanische Eigenschaften quasi-elastischer isotroper Körper, by Friedrich Popert

Published (1946) by A. G. Gebr. Leemann and Co., Stockerstrasse 64, Zürich 2, Switzerland. 105 pages. 31 illustrations. 6½×8½ inches. Price, Fr. 8.

This book is a theoretical and experimental study of certain problems arising in the development of a new method for television projection at the Elektrotechnische Hochschule in Zürich. It has to do with the elastic and viscous properties of solids and liquids. Those who are concerned with the theory of viscosity, plasticity, relaxation times, and motions in viscous media will find much of interest here.

The experiments described have to do mainly with gelatine and oppanol. While apparently rigorous and thorough in its field, this is distinctly a book for specialists.

WALTER G. CADY
Wesleyan University
Middletown, Conn.

Waves and Electrons Section

OFFICERS—ROCHESTER SECTION—1946

KENNETH J. GARDNER
Secretary-Treasurer

Kenneth J. Gardner (M'45) was born April 7, 1907, in Rochester, New York, and was graduated from Mechanics Institute (now Rochester Institute of Technology) in 1929.

Mr. Gardner started his radio career as an operator and announcer for WHAM in 1925 and continued as an operator until 1929, when he was made control supervisor. In 1932 he was promoted to assistant technical supervisor, and in 1940 he became technical supervisor of station WHAM and later also of WHFM when that frequency-modulation station went on the air.

Mr. Gardner is a member of the Rochester Engineering Society, Rochester Amateur Radio Association, Radio Communication Committee of Rochester Red Cross, and has served on the Radio Technical Planning Board and on the Executive Committee of the Rochester Section of The Institute of Radio Engineers.



CONAN A. PRIEST
Vice-Chairman

Conan A. Priest (A'24-M'38-SM'43) was born in Solon, Maine, August 11, 1900. He received the B.S. degree in electrical engineering from the University of Maine in 1922, and the professional degree of electrical engineer in 1925.

Mr. Priest entered the General Electric test course in 1922, trans-



ferred to the transmitter engineering division in 1923, and was appointed section leader of high-power transmitters in 1924. He represented the International General Electric Company and the Radio Corporation of America in transmitter sales in Japan during 1927-1928. Upon his return to General Electric in 1928, he was made assistant to the engineer in charge of the transmitter division, appointed designing engineer of the same division in 1930, and engineer in 1936.

With the formation of the electronics department in 1943, Mr. Priest was made manager of the transmitter division and transferred with the division to Syracuse, New York.



ARTHUR E. NEWLON
Chairman

Arthur E. Newlon (A'38-SM'44) was born November 15, 1911, in New Lexington, Ohio, and was graduated from The Ohio State University in 1933 with the degree of bachelor of electrical engineering. He joined the United States Coast and Geodetic Survey in that year as assistant scientific aide and served in the capacity of geodetic computer until 1935.

During 1935 and 1936 Mr. Newlon worked as an engineer on carrier-current problems, particularly band-pass filters, for the Muzak Corporation of Ohio. In 1936 he went with the RCA license division laboratory (now the industry service division of RCA Laboratories).

Mr. Newlon left RCA in 1941 to join the research department of Stromberg-Carlson where he is presently employed, and is chiefly concerned with television. During the war he was engaged on radar and other war projects.

He served on the National Television System and Radio Technical Planning Board television committees, and is serving on several committees of the Radio Manufacturers Association at present. Formerly he was secretary-treasurer of the Rochester Section.

Engineering proceeds from the simplicity of its early days to the sometimes amazing complexity of its present practices. And important new branches of engineering spring into being to make their contributions to human welfare. There has thus arisen the significant and rapidly developing field of electronic engineering, the future of which is here considered by the vice-president in charge of engineering of the Westinghouse Electric Corporation. *The Editor.*

The Future of Electronic Engineering

M. W. SMITH

Before the war the electronics engineer was engaged not only in the development and refinement of electronic equipment for communications but also in the development and application of electronic devices for the solution of many industrial problems. Progress in this latter field was slow at first as the engineer felt his way but became increasingly more rapid as the record of successful work was built up. The story of the development of electronic devices for use in such industrial fields as air-cleaning, rotor-balancing, control of all forms of electric machinery, heating, and countless others, is too well known to warrant repetition here. It is significant, however, to note that most of these industrial devices have been made employing electronics devices which originally were developed for communication purposes.

Now we find ourselves on the threshold of a new era. As secrecy regulations are removed we see striking evidence of the extent to which technical methods and devices have been so successfully applied to military uses. I was particularly impressed by this fact as I listened to several papers presented in New York at the January Midwinter Convention of the American Institute of Electrical Engineers, describing the construction and performance of some of the most important radar and communications equipment used so effectively during the war. Undoubtedly the electronics engineer will now begin to find new industrial applications of these war-inspired devices. The direction which some of these developments will take is already indicated, as in the application of radar in the fields of navigation and the promotion of safety in all forms of transportation, the application of radar principles to television, the application of microwave devices to the relaying problems such as is made in stratovision, and other similar more or less obvious ways. However, it is the development of devices yet unborn which holds such great promise for the electronics engineer of the future. Here the possibilities seem limitless in view of the many problems yet unsolved and the many new devices so recently developed which may apply to the solution of them. Indeed one may say with confidence that we are now on the threshold of a new era in which there is no presently visible limit to the field for the electronics engineer.

Naval Airborne Radar*

LLOYD V. BERKNER†, SENIOR MEMBER, I.R.E.

Summary—The extension of radar to airborne applications is a natural evolution of its surface development. Aircraft radar fills a most important gap in aeronautics—that of providing actual contact with the earth's surface under all conditions of altitude, weather, and visibility. The airplane also serves as an elevated and highly mobile platform which is readily adaptable to a multitude of radar applications. Starting from scratch in 1938, airborne-radar developments have reached an advanced technological position in 1945. Requirements in the early months of the war were fulfilled by meter-wave radar using lobe-switching techniques. The development of microwave radar gave enormous impetus to airborne applications and produced advanced types for air-to-air interception, high- and low-altitude bombing, reconnaissance, submarine search, and many specialized applications. The sharp beam produced by microwave radiation with relatively small antennas makes microwave techniques particularly adaptable to aircraft use and provides a vastly improved display permitting installation with low aerodynamic drag. Several types of airborne radar are briefly described and illustrated. Fundamental problems of design are reviewed. Related problems such as size, weight, and performance at high altitude are considered and solutions are discussed. Several types of display particularly suited to aircraft use, such as PPI, B, O, and G are illustrated. Utilization, applications, and advantages of auxiliary devices, such as computers, beacons, delay circuits, etc., are discussed. Solutions to systems problems introduced by use of a multiplicity of electronic gear within the aircraft are reviewed. The limitations and advantages of airborne radar as a solution to future aircraft problems are briefly considered.

I. FUNCTIONS AND EVOLUTION OF AIRBORNE RADAR

SELDOME does a new art move from a purely experimental phase to a decisive, large-scale operational stage in an interval measured only in months. But this has occurred with airborne radar, which during the war grew from an elementary concept to a highly developed, complex, and effective weapon. Two great nations teamed together, the close collaboration of our best commercial and governmental laboratories and the Office of Scientific Research and Development, the combined efforts of our best scientists and engineers, and the intelligent planning and utilization of the armed services brought this new and decisive weapon to effectiveness in an incredibly short space of time. To those participating in it the development was more of romance than a job, for again and again the implements produced have brought to a dead stop a new tactic upon which the enemy had placed complete reliance.

The vitalizing reason is that airborne radar gives the airplane those functions whose absence earlier proved the principal deficiencies of airborne vehicles. The ability of airborne radar to "see" by direct electromagnetic contact with the ground under all conditions of weather and darkness, and at ranges far beyond the limits of perception of the human eye, establishes it as indispensable to modern aviation (Fig. 1).

* Decimal classification: R537×R565. Original manuscript received by the Institute, February 25, 1946. Presented, 1946 Winter Technical Meeting, New York, N. Y., January 25, 1946.

† Formerly, Bureau of Aeronautics, United States Navy; now, Carnegie Institution of Washington, Washington, D. C.

For example, in air reconnaissance, airborne radar is essential. It is sometimes estimated that the pilot is limited to less than 8 miles visibility during more than 65 per cent of his flight operations. Airborne radar provides "vision" to the reconnaissance plane 100 per cent of the time, and at ranges that extend to the horizon (Fig. 2). It can detect objects such as life rafts and periscopes at ranges many times that of the eye.

Similarly, in navigation airborne radar can determine exact location through precise determination of bearing and distance from selected objects or radar beacons on the earth's surface anywhere within horizon range. Salient surface geographical features such as coastlines, bays, rivers, lakes, mountains, etc., can be recognized readily from a map-like presentation (Fig. 3). Absolute altitude over terrain can be provided by means of radar. Information is available for precise computation of wind drift, ground speed, course to be flown, and any other parameter which is required to define the position and motion of the aircraft with respect to the earth. In making contact with objectives for purposes of landing or attack, the precision of the information supplied by radar can be as great as necessary. The provision of continuous and exact range as well as angular information permits exact and simplified solutions to problems of bombing, fire control, and landing (Figs. 4 and 5).

Moreover, as radar aids the aircraft, so does the aircraft augment the usefulness of radar for many special purposes. The aircraft supplies an elevated platform which greatly extends the horizon range and consequent range of detection of objects close to, or on, the earth's surface (Fig. 6). This can eliminate the otherwise serious restriction to low-angle coverage of even the highest-powered radar (Fig. 7). Since this elevated platform is highly mobile, the search coverage is many times the range of the radar taken by itself.

To make the greatest use of these general values which airborne radar offers, special design is, of course, necessary. The principal purposes which must thus be met are:

- (1) search and reconnaissance
- (2) navigation and beaconry
- (3) attack, torpedoing, rocketing, and bombing
- (4) intercept
- (5) fire control
- (6) identification of friend or foe
- (7) radar relay.

These categories are not, of course, rigid. Search and reconnaissance radar can provide a certain measure of navigation and beaconry, particularly when supplied with ground speed, drift, distance, and course computers. On the other hand, aircraft requiring only navigation and beaconry facilities do not require the power,

weight, and refinements of a search or reconnaissance radar. Similarly, certain types of attack computers can be provided to the search radar to permit accurate at-

tack. Smaller attack aircraft, however, cannot carry or operate more complex search radars and must depend upon more refined attack radars, leaving the initial

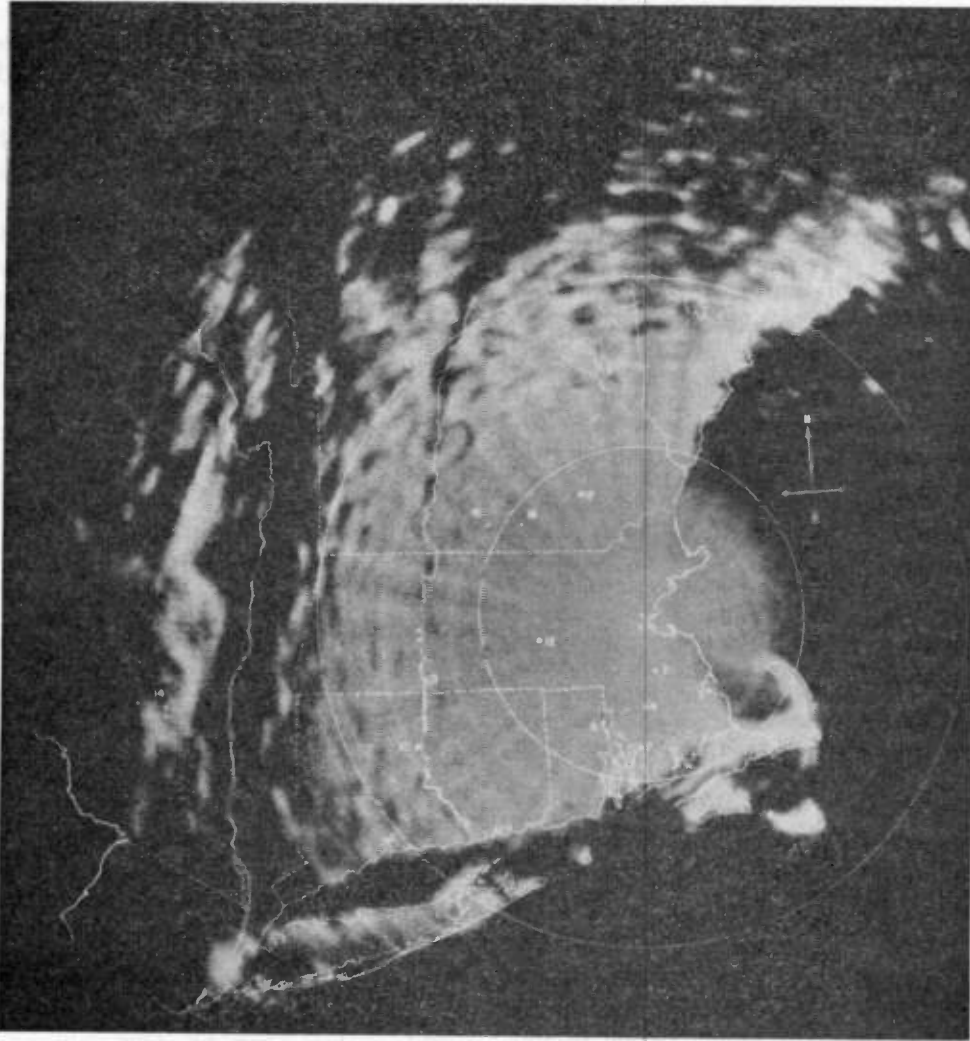

Fig. 1—Superimposed map on airborne-scope photograph. Parts or all of nine states are visible. Note general contour and coastline, which closely follow inapping contours. Aircraft at 20,000 feet.

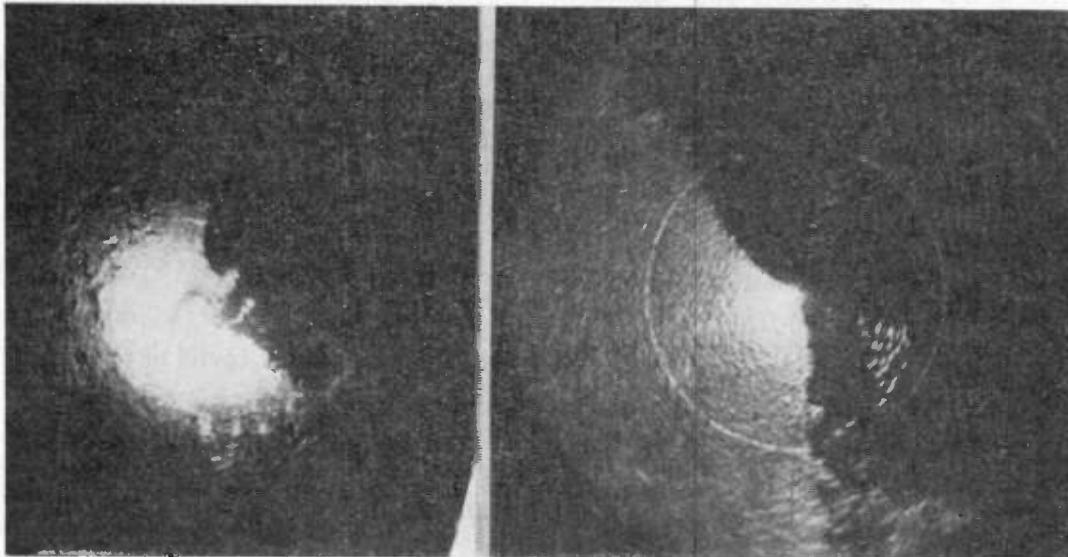

Fig. 2—Detection of ships. A convoy at 40 miles on 100-mile scale, showing individual ships on expanded 20- to 40-mile display.

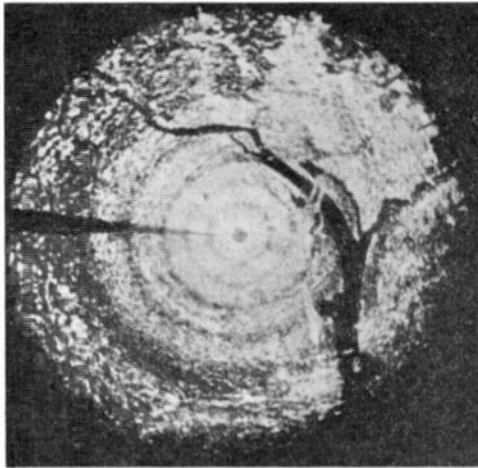

Fig. 3—Washington, D. C., and Virginia, showing Potomac and Anacostia Rivers, bridges, etc.

search and contact reports to the reconnaissance types. High-altitude-bombing radar equipment is similar to search radar in many respects. Nevertheless, the high-altitude bomber is most interested in the area immediately beneath it. The search plane is usually most concerned with targets at greater distances. Experience shows that the endeavor to combine these functions leads to reduction of the ultimate performance for each purpose, and therefore design of separate equipments for each function is often more effective and economical.

The principal classifications of airborne radar must often be further subdivided to achieve a peak of performance. Search-radar characteristics for short-range detection of small objects obscured by unwanted echoes are quite distinct from those required for long-range detection. Therefore, two different types of search radar are necessary where peak performance at both long and short ranges is essential. For example, detection of the submarine "schnorkel" through heavy sea return (unwanted echoes from waves) is so important that no compromise can be permitted in providing a maximum of

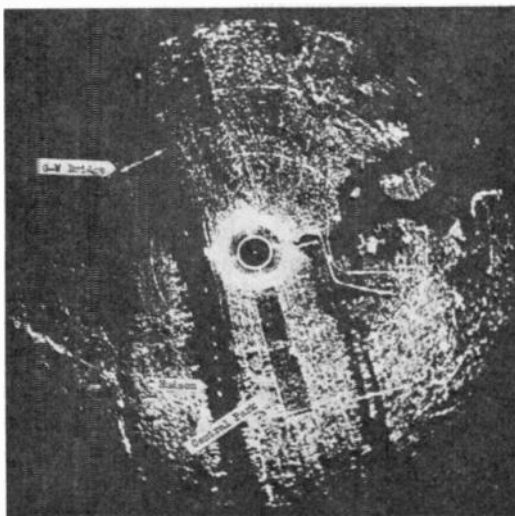

Fig. 4—Precise mapping of New York City and vicinity from airborne radar. Note Central Park, bridges, streets, shipping, etc.

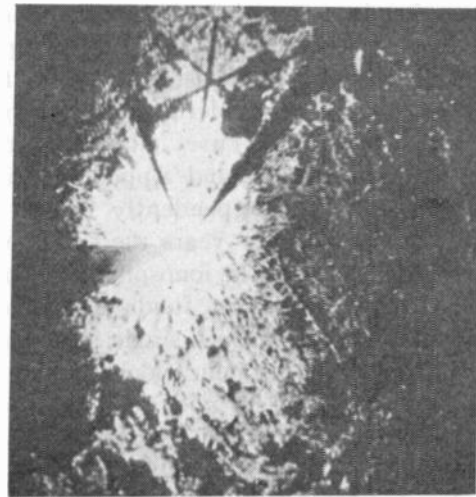

Fig. 5—Approaching Bedford Airfield for a landing, 2.5-mile sweep. Shadows are due to extended landing gear.

performance. Yet the circuitry and characteristics for peak long-range performance require either compromise in short-range characteristics or duplication of circuit

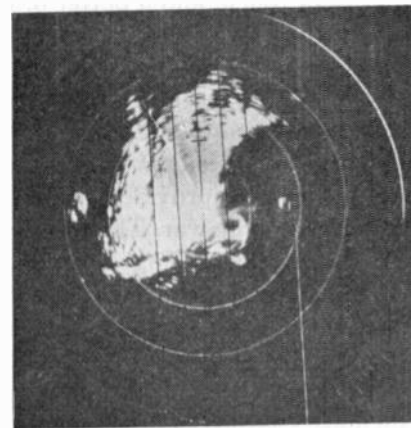

Fig. 6—Six type SNB-2 aircraft in close formation at 250 feet as seen from aircraft at 10,000 feet, range 90 miles. Arrow indicates low-flying aircraft.

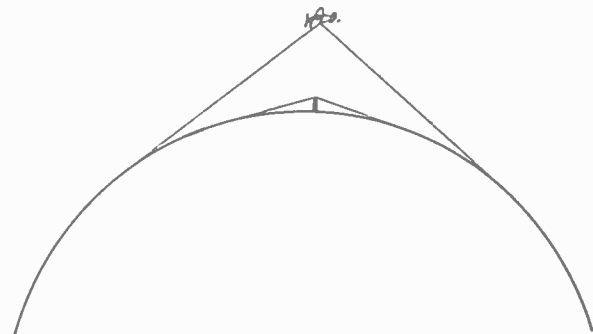

Fig. 7—Gain in maximum possible radar range and coverage with elevated antenna.

elements to an extent imprudently affecting weight, complexity, maintenance, and reliability. Such cases require distinct and separate designs.

The fundamental science embodied in our present-day applications was demonstrated when, in 1888,

Hertz succeeded in generating electromagnetic waves by methods predicted by the Maxwellian equations, and obtained reflection of these waves from flat surfaces. The development of modern radar concepts dates to 1925, when Breit and Tuve, employing the now widely used pulse methods, and Appleton, using continuous-wave methods, independently ranged on the ionosphere. For the next few years the development of radar was the extension of the ionospheric experiments. Here were developed certain fundamentals such as transmission and reception on a single antenna, pulse-forming techniques, and frequency-locking systems. The classic experiments of Taylor and Young at the Naval Research Laboratory, followed by Watson-Watt and his associates at Slough in the early 1930's, introduced radar ranging against discrete objects, and by the late 1930's, surface radar had moved from the purely experimental stage to that of elementary utilization.

These early techniques, however, involved heavy and cumbersome gear, so that airborne radar remained a matter for the imagination until 1938, when world events made it clear that the airplane must have better eyes, a better sense of touch, and a better brain to meet the real and impending threat of a potential enemy's superior air force, his navy, and his submarines. At first, working independently in the face of this peril, Great Britain and the United States had developed elementary airborne radar sets, developments which fixed the pattern for the future and provided for requirements during the early years of the war. Then the two nations joined their resources, exchanging information freely, and the golden age of airborne radar had arrived, with the design effort built around that fabulous but efficient producer of microwaves, the magnetron. To facilitate understanding of the special problems of design and development which are considered later, we will trace the growth of the art as exemplified by airborne radar of the Navy during the past seven years.

At the outset, radar development had visualized the use of very short waves to permit employment of small, high-gain antennas and to avoid ionospheric reflection. It was not until the winter of 1937 and 1938, however, that practical generation of substantial power levels, and achievement of high sensitivity with small components at frequencies above 150 megacycles, permitted consideration of airborne radar with antennas of any practical size. Development of airborne systems started along parallel lines about this time in Great Britain and the United States. The British development was undertaken in the neighborhood of 200 megacycles, and was initially directed toward a fighter-intercept type of airborne radar to fit requirements of the British network of early-warning and ground-control-interception stations. The United States development, undertaken by the Naval Research Laboratory, utilized frequencies in the neighborhood of 500 megacycles and visualized first an altimeter and later a naval airborne search radar to fit carrier-based aircraft requirements.

The British program, under the immediate threat of impending military operations, advanced rapidly, not only to the complete production development of the airborne intercept radar, AI Mk IV, on about 200 megacycles, but also to the derived development, about 1940, of the excellent ASV Mk II search radar, on about 175 megacycles. As the submarine threat appeared and United States military operations became a distinct possibility, arrangement for exchange of technical information with the British led the United States Navy to adopt the ASV Mk II for antisubmarine warfare (ASW) operations, with installation of British-produced equipment starting in 1941. Late in 1941, a Canadian model of the British equipment known as ASVC augmented the supply and, in March, 1942, American Philco-produced models of this equipment, designated ASE (Army SCR-521), gave an adequate supply for immediate ASW operations.

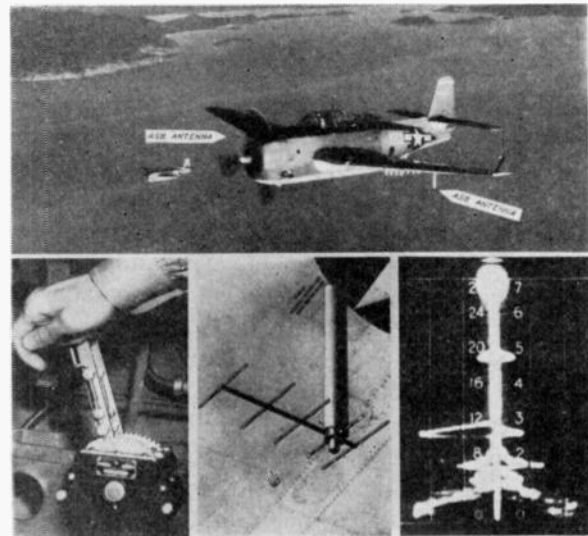

Fig. 8—The ASB radar in a formation of Avenger (TBM-3) aircraft on a combat mission approaching the coast of Indo-China. Antenna controls are at the 10-degree position. Ships are indicated at $1\frac{1}{2}$ miles, 5 degrees starboard; $2\frac{1}{2}$ miles, 30 degrees port; $4\frac{1}{2}$ miles (arrow), 5 degrees starboard.

The ASE search radar installed in patrol aircraft had a weight of about 375 pounds and achieved a peak pulse power of about 15 kilowatts. Fixed antennas of several types were employed, but most widespread use was made of two Yagi antennas, installed at $7\frac{1}{2}$ degrees on either side of dead-ahead for homing operations. Lobe switching between antennas was employed with the so-called Type-A display formed by a linear sweep upward on the scope (which was proportional to range). Blips from the right-hand antenna were deflected to the right, and from the left-hand antenna to the left, so that azimuth could be estimated from amplitude comparison and an exact homing course could be established (see Fig. 8 for similar display). An additional pair of antennas directed beams perpendicular to the line of flight. These were used as alternatives to the homing antennas and provided the broadest possible search pattern. While

this arrangement was undoubtedly crude, it greatly increased the search coverage of patrol aircraft, and led to excellent results in the ASW programs. Catalinas so fitted also initially undertook the famous "Black Cat" operations against the Japanese in the Pacific.

Meanwhile the Naval Research Laboratory's development culminated in the production design of the Navy ASB airborne radar late in 1941. This was a light-weight search radar installing complete at about 160 pounds. Power output ranged from 8 to 20 kilowatts peak in various models, and the high frequency (515 megacycles) permitted small antennas suitable for carrier-based aircraft installation. The principles of operation were similar to those of the ASV Mk II, but a single pair of small Yagi antennas could be used. These were rotatable by a hydraulic-servo system over an angular range from 10 to 90 degrees from line of flight, permitting search or homing operation as elected. Installation of Westinghouse- and RCA-produced ASB airborne radar in carrier-based aircraft was started in mid-1942, and by 1943 all carrier-based aircraft except fighters were equipped, the Avenger (TBM-3) installation illustrated in Fig. 8 being typical. The flexibility of the ASB installation and the added effectiveness it gave to carrier-based aviation gave a great impetus to the use of radar in aviation by the fleet. Evolutions in naval tactics became apparent as this new tool was made available. Carrier ASW operations and night carrier-aircraft attacks appeared, as at Truk. On occasion, ASB-equipped Avengers were even used as night fighters with some success prior to the advent of the carrier-based night fighters. The ASB was the work-horse of carrier-based aviation during the critical phases of the war.

Microwave techniques meanwhile had been advancing at the Radiation Laboratory and the Bell Telephone Laboratories, and in Great Britain. Microwave radar offered many advantages of vastly improved display and performance, which are discussed in subsequent sections. Many functions could now be fulfilled which were beyond reach at the lower wavelengths. The year 1941 saw two aircraft microwave developments of note—a 3000-megacycle search radar developed by the Radiation Laboratory (which was an outgrowth of 3000-megacycle intercept equipment) experimentally installed in naval aircraft, and the advance of 10,000-megacycle technique to the point where the specifications for the first carrier-based night-fighter equipment could be established.

The 3000-megacycle search-radar production program started in March, 1942, leading to the Radiation Laboratory-Philco development of the ASG and its successor, the AN/APS-2 radar (Fig. 9). Service installation of this radar, illustrated in Fig. 54, started toward the end of 1942, and the war history of early 1943 records the havoc wrought to the enemy submarine operations by the United States and British patrol aircraft and lighter-than-air craft equipped with ASG and AN/APS-2 (Fig. 10). The parallel development of the

similar SCR-717 by Western Electric played a substantial role in the program. Never, to the end of the war, did the enemy use any effective means of avoiding the piercing vision of microwave radar.

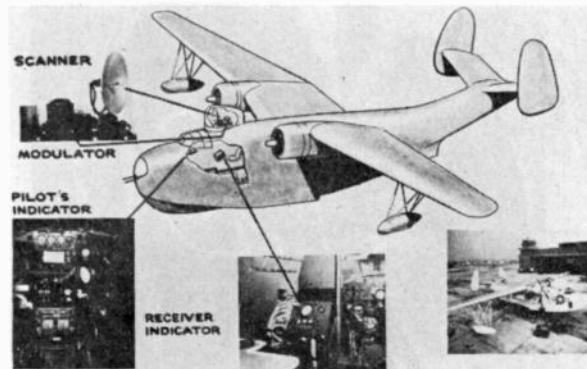

Fig. 9—AN/APS-2 radar in Mariner (PBM-3).

Late in October, 1941, the Radiation Laboratory and the Navy laid down the basic requirements and specifications for the first 10,000-megacycle radar—a Navy night-fighter radar for carrier-based aircraft. This development, undertaken by the Radiation Laboratory and Sperry Gyroscope Company, soon split into two

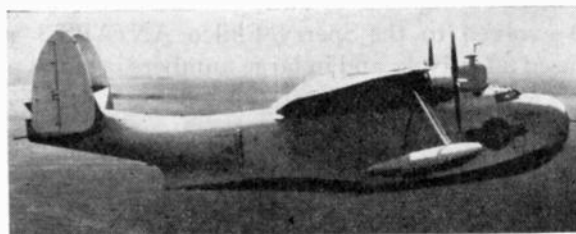

Fig. 10—Mariner (PBM-3) on radar patrol, showing radome.

parts—the AIA night-fighter radar and the ASD search radar, the latter for torpedo-bombers and small patrol aircraft. Service operation with the ASD commenced in Venturas early in 1943, while the more difficult night-

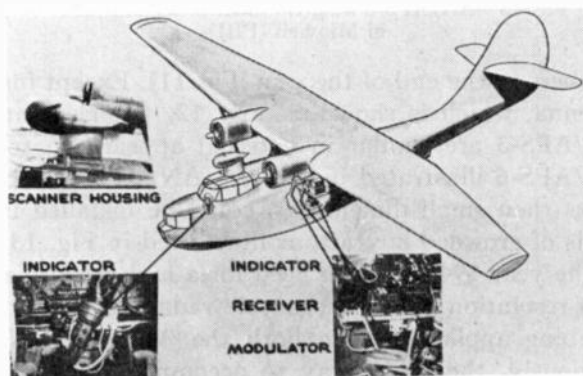

Fig. 11—AN/APS-3 radar in Catalina (PBY-5).

fighter installation went into operation in the Solomons in the F4U-1 Corsair night fighter later in 1943. Post-development of the AIA led to the Westinghouse-built AN/APS-6 (Fig. 43) which was installed in the F6F

Hellcat (Fig. 42) to form the standard Navy carrier-based night fighter and was used in large numbers and

As an interesting sidelight to this series of microwave developments, the Navy standard hard-tube modulator,

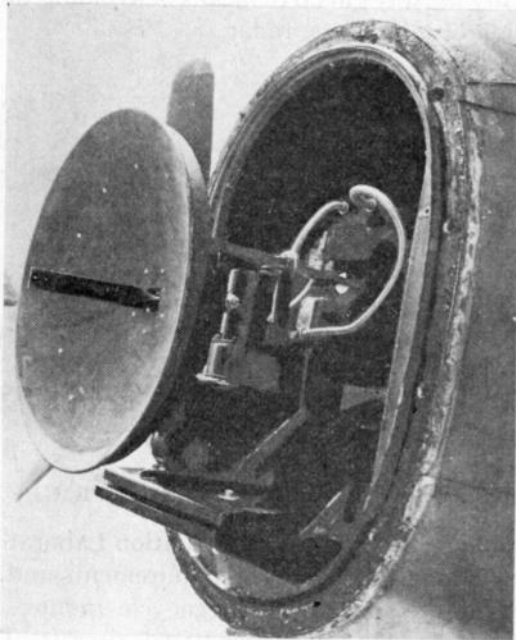

Fig. 12—AN/APS-3 radar antenna installation in Ventura (PV-1).

with outstanding success until the end of the war. The ASD evolved to the Sperry-Philco AN/APS-3 which was used effectively and in large numbers in small patrol



Fig. 13—AN/APS-3 wing-tip radar nacelle installation in Mitchell (PBJ).

bombers to the end of the war (Fig. 11). Except for the antenna, which is shown in Fig. 12, the elements of AN/APS-3 are similar in external appearance to the AN/APS-6 illustrated in Fig. 43. AN/APS-3, because of its then small dimensions, could be installed in all kinds of crowded aircraft, as illustrated in Fig. 13.

The year 1943 saw the need for a high-performance, high-resolution 10,000-megacycle radar for search and bombing applications by both the Army and Navy. Obviously, the quick way to accomplish this was to combine existing techniques. In June, 1943, the Radiation Laboratory, with Philco, undertook to combine the AN/APS-2 and ASD to form the Navy AN/APS-15, illustrated in Fig. 14. By November deliveries were flowing, and then opened the history of radar bombing by the Eighth Air Force and expanded Pacific search and attack operations by the Navy.

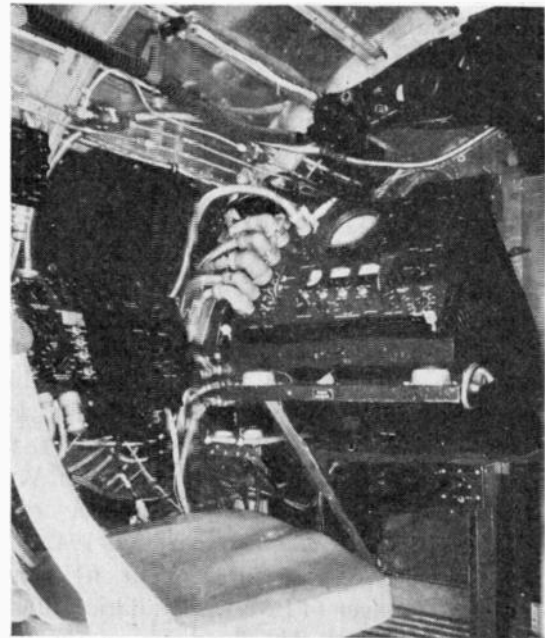

Fig. 14—AN/APS-15 radar in Liberator (PB4Y-1).

using the 715-B modulator tube, was designed late in 1941 by M. G. White and his associates at Radiation Laboratory for use in the AIA equipment. This

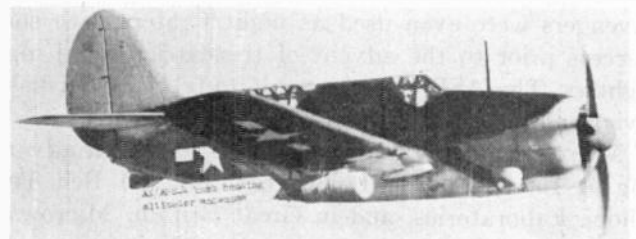

Fig. 15—AN/APS-4 radar in Helldiver (SB2C-4) showing wing-bomb-type installation. (Note also AN/APN-1 altimeter antennas.)

modulator proved so versatile and reliable that it subsequently formed the core of the AN/APS-2, AN/APS-3, AN/APS-6, and AN/APS-15 series of radars and all their derivative models, so that many thousands of these units saw combat in American and British service.

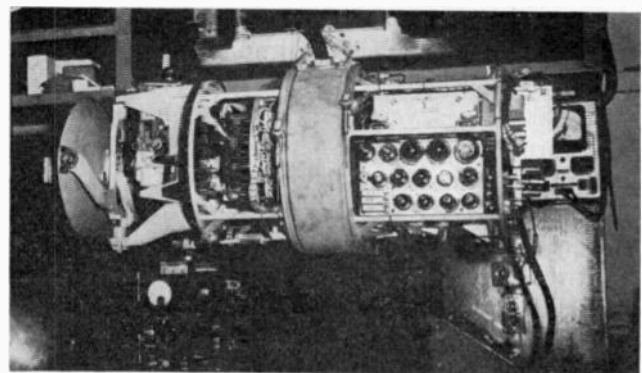

Fig. 16—AN/APS-4 radar, bomb housing removed, and associated test equipment.

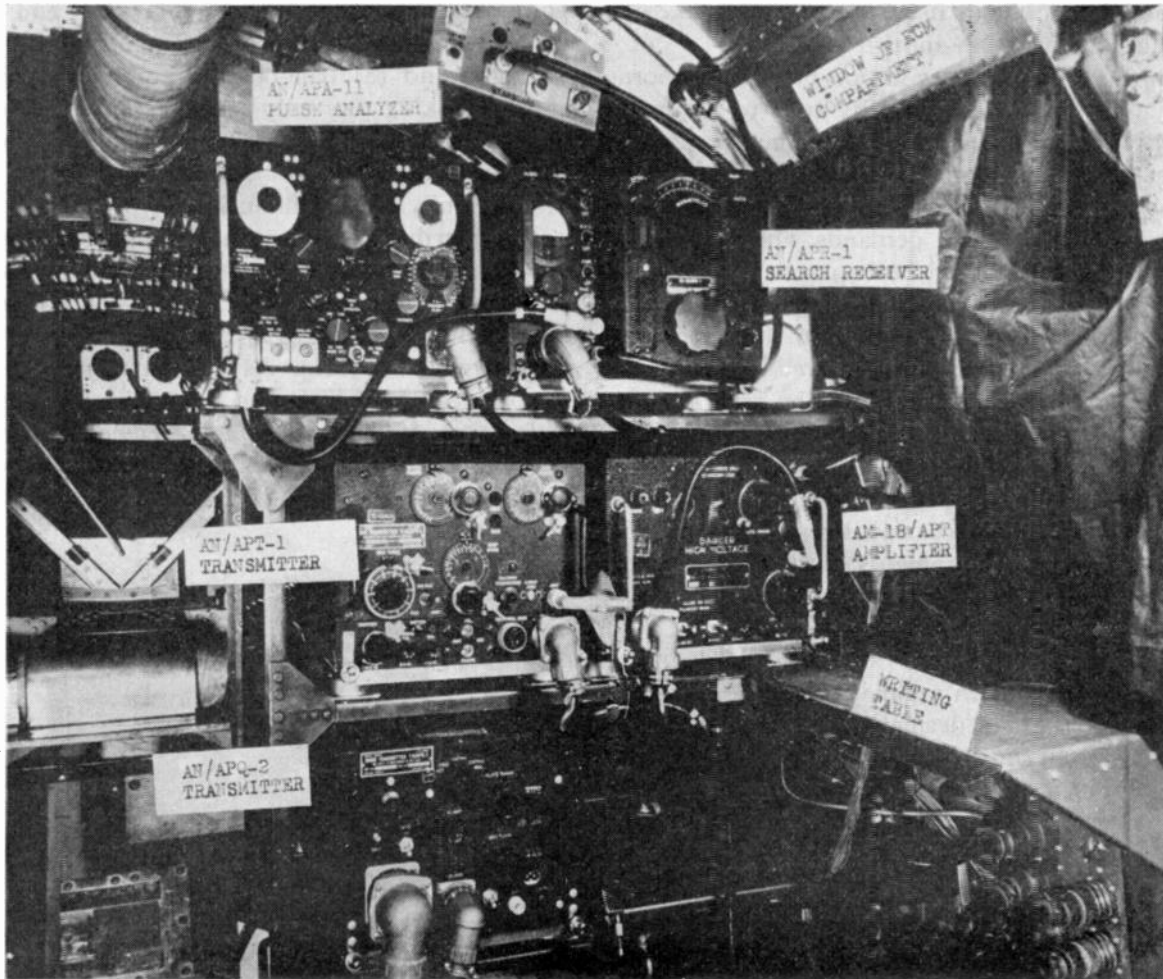

Fig. 17—Countermeasures equipment. Ready for an electronic slugging match is this RCM equipment in PB4Y-1 patrol bomber. The countermeasures operator could pick up signals from an enemy radar with the AN/APR-1 search receiver, look at them on the scope of the AN/APA-11 pulse analyzer, and jam them with the AN/APT-1 or AN/APQ-2 transmitters.

But carrier-based radar was not standing still. In June, 1942, Western Electric undertook the design of a 150-pound, 40-kilowatt carrier-plane search radar operating on 10,000 megacycles—the AN/APS-4. In this development the radar was designed in the form of a pressurized, quickly detachable “bomb” which mounted on a standard bomb-rack as illustrated in Fig. 15. When the bomb was detached, this installation left only a few pounds in the airplane. The AN/APS-4 radar had many advantages—easy removal and accessibility, as illustrated in Fig. 16, permitting ready maintenance or stowage when the aircraft was on nonradar missions such as ferrying bombs to targets over short ranges and under favorable conditions. Microwave carrier-plane radar permitted even more flexible naval tactics, such as those during the attack on Formosa when the weather was so sour that the enemy launched no planes against us. So the AN/APS-4 gradually replaced the ASB as the standard carrier-plane search radar.

No history, however brief, should omit mention of the countermeasures program. Radar was truly a weapon of the allies. It was useful to us, and we could deprive the enemy of it in substantial measure through aircraft, both carrier- and land-based, equipped for countermeasures (see Figs. 17 and 18). The counter-

measures program was of dual importance, first in neutralization of the enemy’s radar, and second, in advance testing of our own radar to make its design and our planning proof against anything the enemy might bring against us. Radical changes in types of radar in service from time to time led not only to improved performance, but also confused the enemy planning and nullified such countermeasures as he might have prepared. The success with which we retained our radar superiority

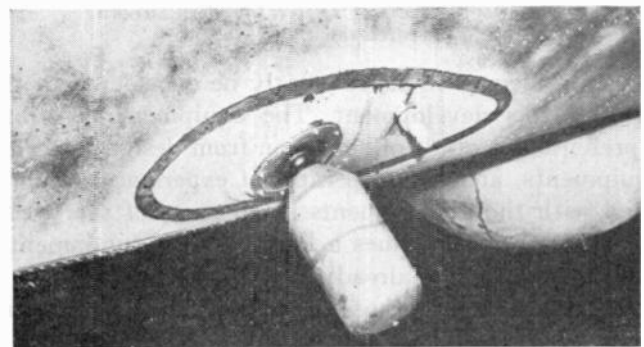

Fig. 18—“Jamming” antenna—nicknamed “potato masher” because of its shape. The object at left is the antenna for the AN/APQ-2 jamming transmitter installed on a PB4Y-2. At right is a “monitor antenna” which samples the transmission to check power output. In flight, a nacelle is fitted over both antennas.

demonstrates how difficult it is for one nation to catch up in a technique in which another is ahead.

From this survey of the evolution of naval airborne radar, discussion may now properly turn to a number of representative individual questions, the solutions of which constituted stages in the over-all development. Presumably a single airborne radar could be constructed to fulfill all of the demands which might be placed upon it. But it would be impractical because of aircraft limitations on permissible weight, power, size, reliability, and complexity of operation. Just as vastly different types of aircraft are required for different missions, it is necessary to consider the several functions required of airborne radar, and to design individual and simple equipments to provide most effectively for fulfillment of particular aircraft requirements, although, of course, it is occasionally possible to fulfill a number of related requirements with a single radar design without sacrificing effective utilization.

II. SEARCH RADAR

A typical modern search radar is briefly described to indicate the standard of design and performance now achieved and to form a background for the special problems of airborne radar. A number of airborne

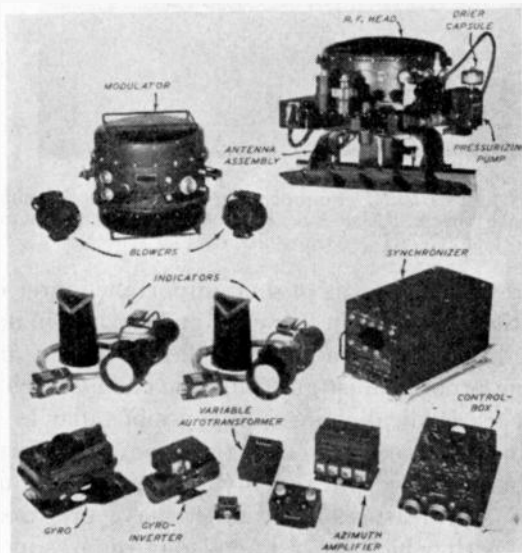

Fig. 19—Elements of a typical modern airborne search-radar system.

radar problems will subsequently be considered in the light of this development. The equipment described represents the result of evolution from design of earlier equipments, and from operational experience accumulated with those equipments in all parts of the world. This description assumes a knowledge of fundamental radar techniques as already described in the literature and emphasizes only those features peculiar to airborne application.

Fig. 19 illustrates a characteristic assembly of elements of a modern airborne search radar. These consist of *primary elements*: (1) synchronizer, (2) modulator-

power supply, (3) indicators, (4) gyro and inverter, (5) transmitter receiver, (6) antenna assembly, (7) control box, and (8) true-bearing amplifier (used in all-around looking sets only); and *accessory elements*: (1) blower units, (2) directional coupler, (3) junction boxes, (4) relay box, (5) variable autotransformer, (6) pressurizing unit, and (7) mountings.

The distribution of essential elements in this packaging arrangement and the principal functions of each package are illustrated in Fig. 20. The advantages of this method of packaging for installation in military aircraft are manifold. As will be shown, certain assemblies can be substituted for others to provide for a wide range of installation requirements, different frequencies of operation, and achievement of optimum operational characteristics for varying operational requirements.



Fig. 21—Synchronizer of modern aircraft search radar.

Four primary elements are common to any type of installation.

(1) *Synchronizer* (Fig. 21) provides the timing circuits and synchronizes functions of other units. It produces indicator sweeps and range marks and accepts video information from attachments such as bombing computers or identification of friend or foe (IFF) systems.

(2) *Modulator power supply* (Figs. 22 and 23) accepts the master trigger from the synchronizer, produces the pulse to the transmitter by means of a hydrogen thyatron through appropriate pulse-forming networks, and supplies triggers to attachments such as bombing computers and IFF devices. Pulse lengths of $\frac{1}{4}$, $\frac{1}{2}$, 1, 2, and 5 microseconds can be made available corresponding to certain functions and ranges selected at the control box. The high- and low-voltage supplies are housed in this unit, which is always pressurized to afford high-voltage protection required at high altitude.

(3) *Indicators* (Fig. 24) are of the magnetic type (called MS indicators) utilizing the 5FP14 cathode-ray tube to provide discriminating presentation.

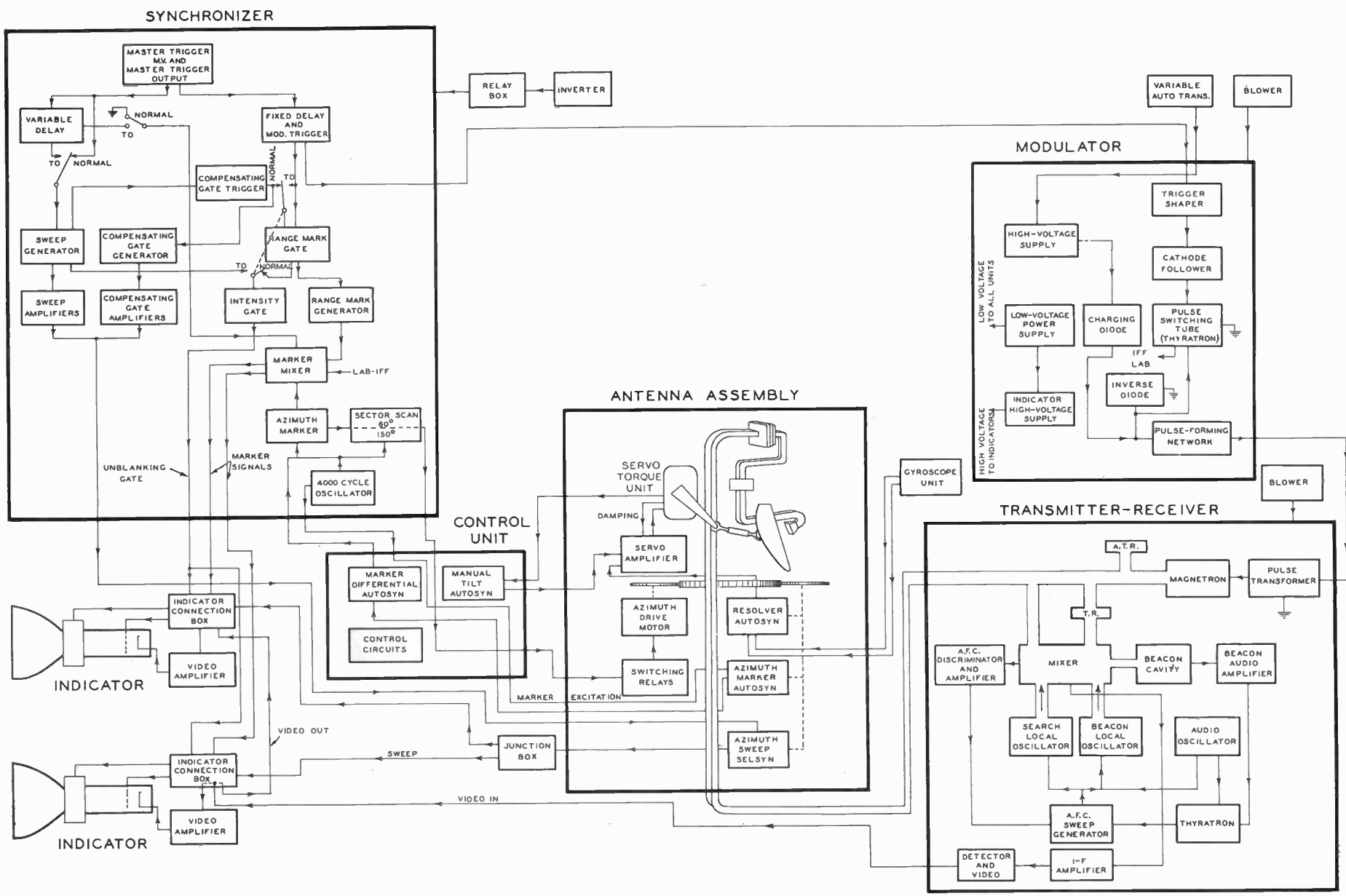

Fig. 20—Functions of primary elements of search radar shown in Fig. 19.

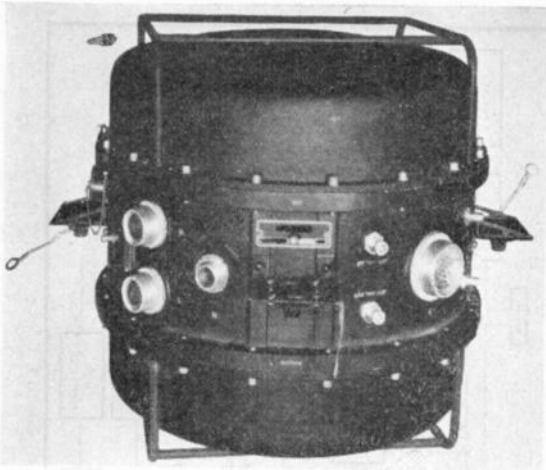

Fig. 22—Modulator-power supply of modern aircraft search radar.

Provision is made for plan-position indication (PPI), delayed PPI (see Fig. 1), open-center PPI, sector PPI with offset center and open center, and other special features of indication established as necessary from the control box. Final video amplification is performed in the indicator unit, obviating the need for high-impedance video cabling and insuring wide-band video response. Mounting provisions are designed to permit independent installation of indicators wherever needed, though the operator's indicator is always located at the control position.

(4) *Gyroscope and inverter* provide the primary source of information for the tilt or "line-of-sight" stabilization system. The servoamplifier and resolver portions of the stabilization system are incorporated in the antenna assembly and are determined by the type of antenna system utilized.

The remaining primary elements have a number of alternative assemblies which may be interchanged to provide a maximum latitude for installation, wave frequency, or operational requirements.

(5) *Transmitter-receiver* (radio-frequency head) (Figs.

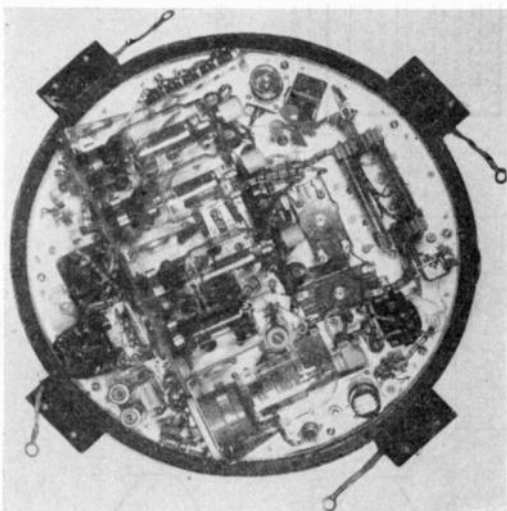

Fig. 23—Interior view of modulator.

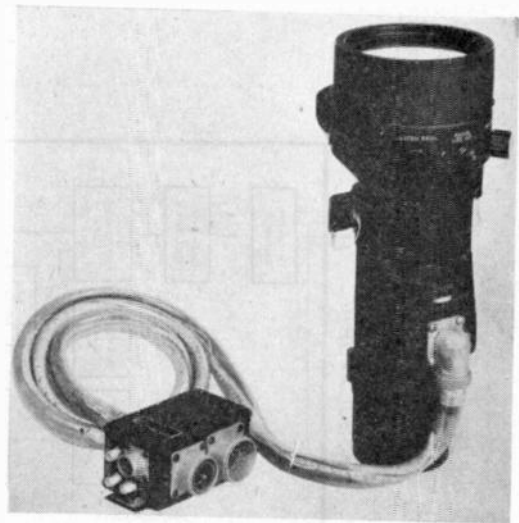

Fig. 24—Indicator of modern aircraft search radar.

25, 26, and 27) is assembled in a pressurized case of standardized form factor and cabling which is arranged

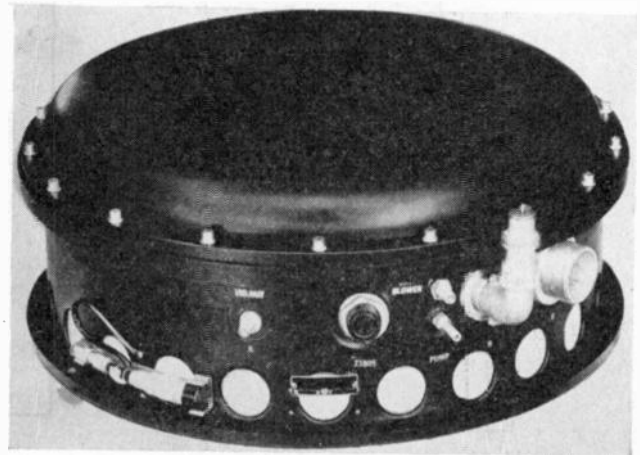

Fig. 25—Transmitter receiver (radio-frequency head) of modern aircraft search radar.

to mount directly on, and form a part of, any of the antenna assemblies of corresponding frequency. This unit receives the power pulse from the modulator and,

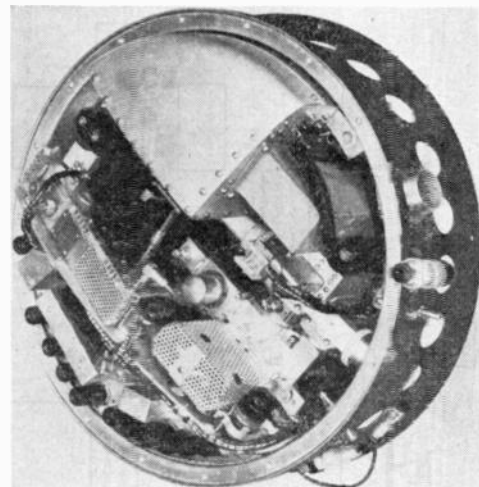

Fig. 26—Interior top view of transmitter-receiver.

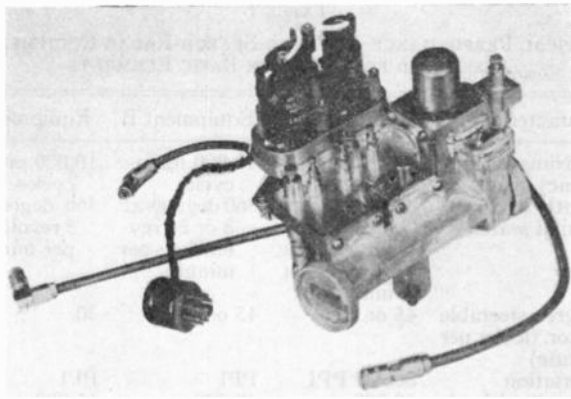

Fig. 27—Mixer assembly, showing radar and beacon local oscillators, cavities, T-R and R-T assemblies, and associated plumbing.

raises the pulse voltage to the magnetron through a pulse transformer, converts it to the desired radio frequency, and transmits this to the antenna system. The signal response is received from the antenna and converted to low-impedance video information for the indicators. This unit contains the necessary transmit-receive (T-R) and receive-transmit (R-T) and coupling circuits, local oscillators, and intermediate-frequency amplifiers, automatic frequency controls (AFC), anti-clutter circuits, etc. Interchangeable radio-frequency heads are supplied for different frequencies of operation.

(6) *Antenna assembly* includes the scanner with appropriate take-offs for supply of angular azimuthal information to indicators and any bombing of IFF attachments, radio-frequency feed and reflector system, pressurizing pump for radio-frequency plumbing, servo-amplifier and resolver of the tilt-stabilization system. The entire beam can be tilted through ± 30 -degree elevation from the nominal zero during stabilization. The entire antenna assembly forms the mounting for the radio-frequency head and is arranged for antivibration or "shock" mounting.

While antenna assemblies must be supplied for each frequency of operation, they must be supplied also with duplicate or triplicate scanner designs at each frequency to meet operational or installational require-

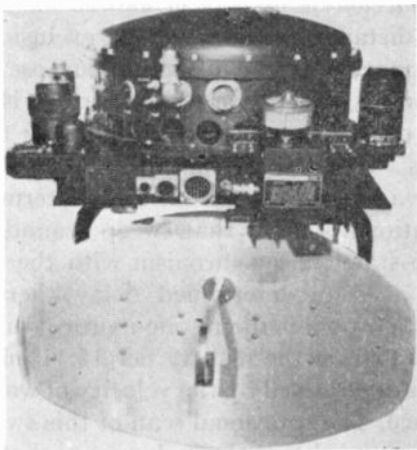

Fig. 28—All-around-looking antenna assembly of modern aircraft search radar with transmitter-receiver and pressurizing pump mounted in place.

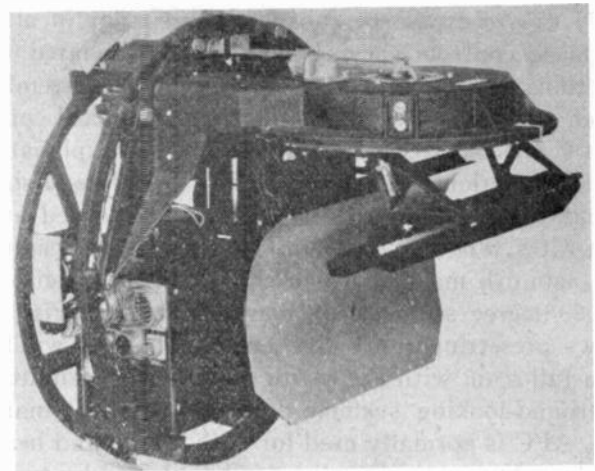

Fig. 29—Forward-looking antenna assembly of modern aircraft search radar without transmitter-receiver, showing "line-of-sight" stabilization amplifier in place.

ments. In general, two types of scanners meet most installational requirements, the all-around-looking type for belly or overhead installation, and the nose or wing type where forward looking only can be achieved because of limitations imposed by aircraft structure. In addition to these two classes, special antenna assemblies are employed for unusual applications or installations.

The all-around-looking scanner mounts a 30-inch reflector or "dish" and provides either complete rotation or a 60-degree sector scan that can be directed in any azimuthal position from the control box. One type of this antenna assembly is shown in Fig. 28. The forward-looking scanner mounts an 18-inch dish and provides for scanning over the forward 150-degree sector, or any 60-degree sector therein. One type of forward-looking antenna assembly is shown in Fig. 29. The entire antenna and radio-frequency head assembly mounts within a 24-inch cylinder for nose-, wing-, or external-teardrop installation. Azimuthal stabilization of the display is impractical with the forward-looking or "wig-wag" type of scan.



Fig. 30—Typical control box of modern aircraft search radar.

(7) *Control-boxes* are substantially similar in all assemblies, controls varying slightly as associated with functions of the several combinations of assemblies which can be used. Fig. 30 illustrates a typical control box. While most control features are self-explanatory, certain functions are of interest. Tilt or "line-of-sight" stabilization of the antenna pattern is afforded at all scan rates, whether in full rotation or sector scanning. The azimuth marker, which shows the midposition of the 60-degree sector (see "marker" control, Fig. 30), allows presetting the sector position before switching from full scan, with the sector stabilized in azimuth in all-around-looking systems during all aircraft maneuvers. AFC is normally used for both search and beacon response, but manual tuning can be selected by turning the tuning knob from the zero position.

(8) *True-bearing amplifier* derives its information from a take-off on the flux-gate compass to supply true-bearing information for azimuthal stabilization of the presentation of all-around looking systems. This permits holding the presentation in a fixed relative position with respect to north during all maneuvers, the airplane heading being indicated by an azimuth marker in the presentation.

Performance of three typical search-radar equipments assembled from these elements is given in Table I. This "building-block" design approach to the problem of achieving peak performance in the face of a diversity of operational and installational problems offers many advantages.

(a) Each of the three separate search radar equipments described in Table I requires the eight primary elements described above, and can be assembled from only 12 manufactured items together with accessories common to all systems. There are available a number of types of complete equipment to meet operational and installational eventualities with a minimum of engineering and manufacturing effort.

(b) A common philosophy of maintenance, and standardization of training, test procedure, and installation practice, is provided.

(c) Field, stock, supply, and replacement problems are simplified and minimized.

(d) Sufficient versatility is achieved to meet changing requirements with a minimum change in production or operational plans.

(e) Analysis shows that these advantages can be achieved with less than 20 per cent increase in weight over a series of separate search radars of equal performance, each uniquely designed for its particular function, a factor which is being steadily reduced toward 10 per cent as refinements in design are achieved.

III. FUNDAMENTAL PROBLEMS OF AIRBORNE RADAR DESIGN

In the previous section, certain design features of a modern airborne radar have been presented. We must now ask what are the factors governing decisions in

TABLE I
TYPICAL PERFORMANCE OF THREE SEARCH-RADAR EQUIPMENTS
ASSEMBLED FROM TWELVE BASIC ELEMENTS

Characteristics	Equipment A	Equipment B	Equipment C
Approximate frequency band	10,000 megacycles	10,000 megacycles	10,000 megacycles
Azimuth coverage, normal search	160-degree forward sector at 10 or 36 looks per minute	360 degrees at 8 or 24 revolutions per minute	360 degrees at 5 revolutions per minute
60-degree steerable sector (looks per minute)	45 or 95	45 or 95	30
Presentation	Sector PPI	PPI	PPI
Maximum altitude (feet)	40,000	40,000	15,000
Optimum altitude (feet)	5000-10,000	5000-10,000	300-1000
Peak power output (kilowatts)	70-100	70-100	70-100
Antenna type	Horn-fed modified paraboloid	Same as column A	Horn-fed paraboloid
Tilt stabilizer	Yes	Yes	No
Radar pattern:			
horizontal	5 degrees	3.5 degrees	0.85 degree
vertical	Equal energy return	Equal energy return	7 degrees with small downward lobes for short-range search
Automatic frequency control	Yes	Yes	Yes
Anticlutler	Yes	Yes	Yes
Azimuth stabilization	No	Yes	Yes
Maximum range in miles	200	200	170
Approximate installation weight (pounds)	390	405	540
Power demand, alternating current 400 to 1600 cycles per second, 115 volt-amperes.	1070	1070	1070
Direct current, 28 volt-amperes	30	30	20
Antenna dimensions:			
width	18 inches	29 inches	96 inches
height	15 inches	15 inches	36 inches

selection of wave frequency, pulse length, beam shapes, and many other parameters of design heretofore stated arbitrarily.

Clear and concise display of desired targets over the necessary distance range with the exclusion of undesired information is the ultimate purpose in the determination of design factors. Display is ordinarily presented on the face of the cathode-ray tube in two dimensions. Two-dimensional presentation is accomplished by a linear sweep from a predetermined center and a rotational scan of that sweep around the center. The sweep starts in synchronism with the transmitted pulse (or at a predetermined delay thereafter) and travels at a rate of about one-nautical-mile distance range as scaled on the display per 12.44 microseconds. This rate is determined by the velocity of wave propagation in space. The rotational scan of this sweep is made in synchronism with the angular scan of the antenna. The resultant display is a kind of map, known as PPI, or modified PPI where the center is displaced, arbitrary

delays are introduced, or resort is made to other artifice to produce the most usable presentation.

Clarity of the display along the scan is affected by beamwidth, and along the linear sweep by (a) pulse

λ is wavelength, and D the diameter of the reflector, and λ and D are expressed in the same linear units. Table II gives the computed beamwidths for 30- and 18-inch reflectors, respectively, at several frequencies.

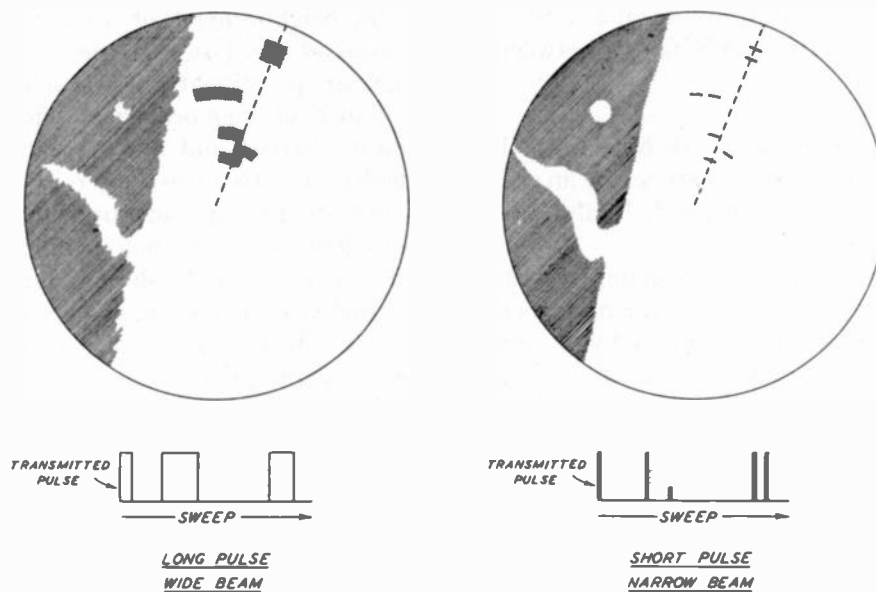

Fig. 31—Effect on display of variation of pulse length and beamwidth.

length; (b) fidelity of radio-frequency and video circuits in undistorted transmission of data to the display; and (c) quality of the cathode-ray tube and screen. Effect of beamwidth and pulse length on the display is illustrated in Fig. 31.

Selection of wave frequency is predominantly governed by three factors.

(1) Desired beam shape and antenna gain with respect to permissible antenna size.

(2) Limitations on range imposed by propagation characteristics of the various wave frequencies.

(3) Practical limits on generated power, input characteristics, and general availability of components at the several frequencies as dictated by the advancement of the art.

Aircraft installations generally will not accommodate large antenna sizes. While antennas as large as 16 feet across have been employed in aircraft for special purposes, and larger sizes will undoubtedly be introduced in the future to provide sharp beams and high gain, the tendency for the majority of applications is to push the designer to smaller antenna sizes to minimize adverse aerodynamic effects on the aircraft. Limits of 24 inches nacelle diameter for forward-looking and 33 inches nacelle diameter for all-around looking applications have been widely accepted in aircraft design during the war. These led to horizontal reflector dimensions of about 18 and 30 inches, respectively.

Azimuthal beamwidth in degrees, defined at half power points, is expressed from elementary optical theory by

$$\theta = 57.3(K\lambda/D) \quad (1)$$

where K is about 1.2 for ordinary parabolic reflectors,

TABLE II
BEAMWIDTHS OF FREQUENTLY USED AIRCRAFT RADAR
ANTENNAS AT VARIOUS FREQUENCIES

Approximate frequency, megacycles	Beamwidth	
	30-inch reflector, degrees	18-inch reflector, degrees
3300	8.2	13.7
10,000	2.7	4.5

Experience shows that, for search, a 5-degree beam provides a reasonably satisfactory display. The 30-inch reflector at 3300 megacycles is, therefore, decidedly marginal; the 18-inch dish at this frequency gives a beam too broad for consideration. At 10,000 megacycles the 18-inch dish becomes good and the 30-inch dish gives a very respectable pattern. At higher frequencies, both antennas become excellent.

Antenna gain for a specified antenna size also improves as wave frequency is raised, varying inversely with wavelength squared. The gain, defined as the ratio of power inputs to an isotropic radiator and to the antenna under consideration, respectively, required to produce equal field strengths at a remote point in free space, is given by

$$G = 4\pi K_1 A / \lambda^2 \quad (2)$$

where A is the area of the reflector, λ is the wavelength, and the dimensions A and λ are expressed in the same linear units. The constant K_1 is about 0.65 for a paraboloid reflector, and can properly be called the "area efficiency" of the antenna, for the product $K_1 A$ expresses the effective area. The value depends on the proportion of energy from the feed which is reflected within the beam limits from the dish, and the reduction in gain

due to nonuniform distribution of energy across the dish. In the case of the AN/APS-2 radar, for example, these are, respectively, 0.84 and 0.75, giving a value of $K_1 = 0.84 \times 0.75 = 0.63$. These factors, in turn, are primarily dependent on the ratio of focal length f to diameter D , the design limits usually falling between

$$0.3 < f/D < 0.35.$$

For $f/D < 0.3$ only the center of the dish is fully illuminated, while for $f/D > 0.35$ gain is lost because an excess of energy spills over the edges of the dish, and objectionable side lobes are generated.

Except for other factors, we would push our frequency higher and higher. Propagation at frequencies below 1200 megacycles is not seriously limited by weather, except for variation of atmospheric refraction and duct transmission which are important to aircraft only when operating at very low altitudes or searching at extreme ranges. As the frequency is increased, atmos-

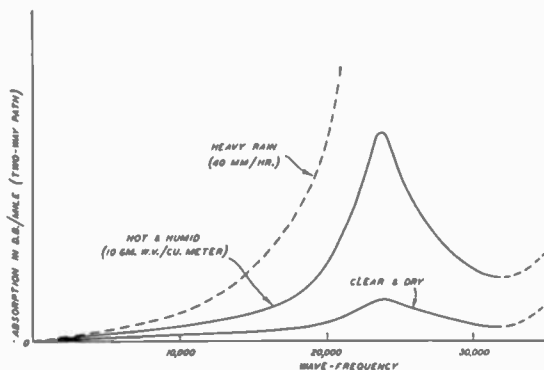

Fig. 32—Approximate dependence of absorption of super-high frequencies on weather conditions. (Numerical data as yet is very sparse.)

pheric phenomena become important limitations. *Absorption* increases, as illustrated in Fig. 32, and *reflection* from meteorological boundaries, such as clouds and precipitation, becomes perceptible. At 3000 megacycles, absorption during bad weather is hardly noticeable; at 10,000 megacycles, it is tolerable; but at higher frequencies it becomes so high as to restrict maximum distance ranges to a few miles. During clear, dry weather distance ranges at higher frequencies become quite satisfactory. Reflection from clouds and precipitation is noticeable but not usually objectionable at 3000 megacycles. At 10,000 megacycles, echoes are easily obscured in heavy cloud and precipitation unless anticlutter circuits are introduced and other precautions taken in design, while at higher frequencies absorption generally restricts substantial cloud returns.

Fig. 33 illustrates the nature of cloud return as seen on 10,000 megacycles. This information is commonly used by aircrews to avoid serious storm centers during flight operations.

Components, circuits, and circuit elements are more highly developed in general on the lower frequencies, and less power and sensitivity are available at the higher frequencies. Components and techniques at

10,000 megacycles are, however, rapidly approaching the same effectiveness already achieved at 3000 megacycles.

As a consequence of these factors, design of aircraft radar equipment tends toward selection of frequencies in the neighborhood of 10,000 megacycles for most widespread use. Lower frequencies (3000 megacycles or below) are prominent where absolute reliability militates avoidance of meteorological effects and dictates the highest-powered and most sensitive and reliable components. In such cases, larger antennas are usually permissible to produce adequate gain and narrow beamwidth. The use of frequencies much above 10,000 megacycles is restricted to short-range operations requiring very high discrimination, and to longer-range operations where occasional loss of display because of absorption due to weather is tolerable.

Selection of pulse length requires other compromises in design. Short pulses are desirable to increase discrimination in display, reduce the effect of clutter from clouds and land by increasing contrast of target against the background, provide short minimum range; permit a maximum pulse-recurrence frequency consistent with range and with duty cycle available from modulator, and to reduce design requirements on voltage regulation in modulator for stable magnetron operation which become prohibitive in aircraft modulators for very long pulses.

Long pulses are desirable to increase illumination on the target and to obtain higher amplification available from the narrower bandwidths permitted with longer pulses through reduction of first circuit noise.

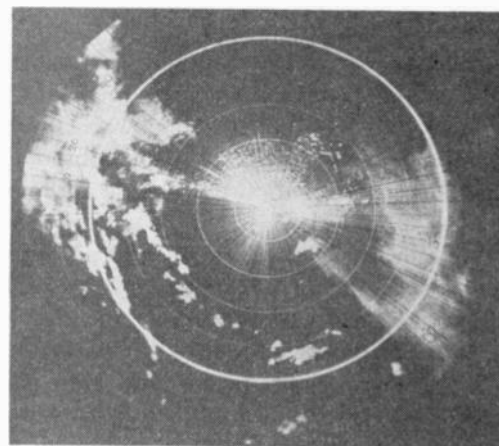

Fig. 33—Cloud echoes on 50-mile scale. Note fuzziness and lack of definition. Note also asymmetrical sea return indicating wind direction on starboard bow, probably from storm ahead.

Decision on pulse length requires examination of the radar-range equation for free space as developed by Purcell and others in reports of the Radiation Laboratory as yet unpublished.

$$R_{\max} = \left(\frac{P\sigma A^2 K_1^2}{4\pi S_{\min} \lambda^2} \right)^{1/4} = \left(\frac{P\sigma G^2 \lambda^2}{(4\pi)^3 S_{\min}} \right)^{1/4} \quad (3)$$

where P = output pulse-power
 σ = radar cross section of target

G = gain of antenna (see (2))

λ = wavelength

S_{\min} = minimum detectable input signal-power

Pulse length enters the range equation through the factor S_{\min} . $S_{\min} \sim 1/\Delta\nu$ where $\Delta\nu$ is the bandwidth of the receiver. In a well-designed receiver the bandwidth $\Delta\nu$ is adjusted to a minimum which will pass undistorted information to the display, and therefore $\Delta\nu \sim 1/\tau$ where τ is the pulse length. As a consequence, $S_{\min} \sim \tau$.

An analysis of the statistical problems of target display on the screen of the cathode-ray tube, with superimposition of noise, leads to the conclusion that a good approximation for the problem under consideration is

$$S_{\min} \sim 1/\sqrt{N_{\text{scan}}}$$

The number of pulses per scan on the target N_{scan} is given by

$$N_{\text{scan}} = \gamma\theta/\omega \quad (4)$$

where γ = pulse rate per second

θ = azimuthal beamwidth in degrees given by (1)

ω = scan rate in degrees per second

so that

$$S_{\min} \sim \frac{1}{\tau} \sqrt{\frac{\omega}{\gamma\theta}} \quad (5)$$

and
$$R_{\max} = (P\tau\sigma G^2 \lambda^2 K_2 \sqrt{\gamma\theta/\omega})^{1/4} \quad (6)$$

where K_2 is a proportionality factor. This equation states the maximum range in terms of the principal controllable design parameters.

The duty cycle or constant of a modulator is given by

$$\tau\gamma = d_c \quad (7)$$

where d_c must be fixed for a given design. Values of d_c are generally in the neighborhood of 10^{-3} for airborne modulators and determine the ratio of average to peak power of the modulator.

Then (6) can be rewritten

$$R_{\max} = (P\sigma G^2 \lambda^2 K_2 \sqrt{\tau\theta d_c/\omega})^{1/4}$$

Therefore, increase of pulse length results in an increase in illumination and resultant range. For example, if the pulse length is quadrupled, the range will be increased by an amount equivalent to doubling the power at the initial pulse length. If this full gain is to be realized, however, the bandwidth must always be related closely in the design to the pulse length, introducing a complication where two or more pulse lengths must be used. Careful proportioning of the bandwidth to the pulse length cannot be overemphasized. Too wide a bandwidth leads to loss of sensitivity through limitations on amplification by first-circuit noise. On the other hand, too narrow a bandwidth not only spreads the target on the display, thereby reducing discrimination between targets, but also unnecessarily superimposes noise from preceding intervals on the target pip, thereby reducing sensitivity.

Two or more pulse lengths plus the beacon pulse are

normally available in modern airborne radar design. Limits of pulse lengths in various modern airborne equipments are shown in Table III. Short pulses are

TABLE III
LIMITS OF PULSE LENGTHS IN MODERN DESIGNS

Pulse duration in microseconds			
Short pulse	0.1 to 0.5	2.0	2.5 to 5.0
Beacon pulse			
Long pulse	0.9 to 1.3		

essential at short ranges for reasons set forth at the beginning of this section, and adequate power is usually available to provide full target illumination at these ranges. At ranges beyond 20 miles, however, limitations on resolution of the display permit use of longer pulses without substantial diminution of target discrimination. Furthermore, objectionable clutter rapidly diminishes with range. Therefore, use of longer pulses at longer ranges provides an increase of illumination just when it is needed most to maintain high performance without serious loss of discrimination. When two widely different pulse lengths are employed, use of dual amplifier systems appears justified by the resultant gain enjoyed.

Pulse-recurrence frequency is limited by pulse length as defined by (7) though the practical lower limit in airborne sets so far designed is about 200 pulses per second. It is further restricted by the length of the sweep in nautical miles (M) plus recovery time of the sweep circuits, plus the small random departure from the periodic timing of modulator firing. About 20 per cent of sweep length is ordinarily allowed for these factors. The pulse-recurrence frequency in pulses per second is limited by

$$\gamma_{\max} < 1/1.2 \times 12.44 \times 10^{-6} M$$

$$\gamma_{\max} < 6.7 \times 10^3/M$$

Rates of scanner rotation are governed by four principal design factors.

(1) As shown by (6), some increase in gain can be achieved by low angular rates of scan. Halving the rate of scan produces a system gain about equivalent to a power gain of 1.5 decibels. As a consequence, scan rates are made as slow as permitted by other factors.

(2) Mechanical problems of scanner design, and of accurate data transmission which translates scanner position to the display, are much reduced at slower speed.

(3) Rapid movement of aircraft necessitates higher scanner speeds. Particularly at short-range scales, motion of the aircraft with respect to targets and surface features is very perceptible, and with low scan speeds, targets move across the screen in a series of discrete jumps. Scan speeds must be sufficient to provide a continuity of motion.

(4) When large volumes must be scanned, as with intercept-type radar, scanning speeds must be very high to provide complete coverage of the entire solid

angle with sufficient repetition. Scans must be frequent to avoid departure between successive scans of the fastest moving target from the volume scanned. In cases of very high scanning speeds, the maximum rate of scan is related to beamwidth, pulse-recurrence frequency, and maximum possible ranges in a critical way.

The ideal design for search radar provides two or more scan speeds. High scan speeds of 50 to 70 (and not less than 35) looks per minute are desirable for short-range search and bombing where motion is most evident on the display. Low scan speeds of 5 to 20 looks per minute (in some cases as low as 2) are desirable to provide maximum system gain at longer ranges when lower resolution of the display renders the motion

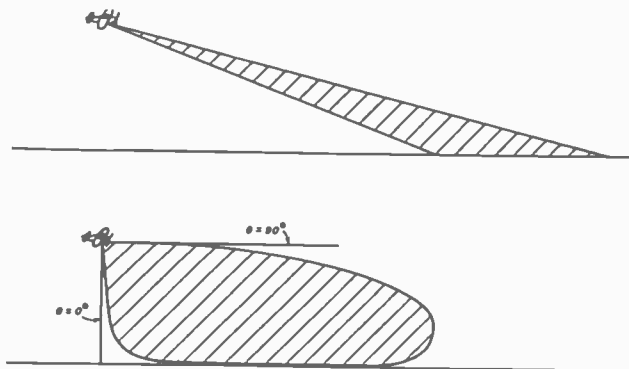

Fig. 34—Symmetrical versus approximate cosecant-squared antenna patterns for search operations.

imperceptible. Where only on-search scan speed is permissible, a compromise value between 20 and 35 is usually selected. Decay time of the cathode-ray display screen must be closely related to scan rate if all advantages of proper scan rate are to be realized.

Antenna pattern in the horizontal plane is a narrow beam as already described. Unwanted lobes must be kept to a minimum in this plane. Substantial radiation directed in a lobe other than the main lobe produces spurious display of a target at the incorrect azimuth. Lobes close to the main lobe cause a fuzzy and indistinct display. Unwanted lobes reflected from nearby aircraft structure increase unwanted clutter to a marked extent. Good aircraft design calls for lobes more than 40 decibels below the main lobe at angles more than one beamwidth from the central lobe. To avoid spurious indication and reduce clutter, nearby objects or protuberances must be kept out of the main beam or its lobes. If they cannot be kept out, they must be treated to minimize reflection.

The *antenna pattern* for intercept and fire-control radar is usually symmetrical with respect to the axis of the beam. In search, bombing, or navigation applications, a circular antenna pattern covers only a ring on the earth's surface around the search airplane and continuous operation of the tilt control on successive sweeps is necessary to obtain complete coverage as illustrated in the upper part of Fig. 34. The ideal vertical pattern for search, bombing, or navigation ap-

plications would provide the same input to the receiver at any range from a given target, with no radiation above the horizon. It can be shown from (6) that an antenna pattern whose gain in the vertical plane varies as $\csc^2\theta$ in the region below the horizon will produce this desirable condition (see lower part of Fig. 34). As height is changed, range of the ground varies with the altitude of the airplane but range to the horizon changes hardly at all. Therefore, the most favorable pattern can be obtained at only one value of height, and such designs must anticipate the average altitude of operation. In practice, good approximations can be made to the optimum pattern by properly shaping the dish, distorting the beam with strips appropriately located on the reflector, or introducing parasitic dipoles in the feed. Reflectors which have been so treated are commonly known as cosecant-squared or equal-energy dishes. Careful design is necessary to avoid excessive lobes, serious holes in the pattern, and excessive loss of gain through nonuniformity of reflector illumination. As average height for designed operation is increased, the gain in the downward direction must be increased. Fanning a portion of the energy downward does, of course, diminish the maximum range. Therefore, an antenna suitable for bombing operations at 40,000 feet is not at all suitable for search operations at 3500 feet, for maximum range is sacrificed and short-range clutter is markedly emphasized.

Antenna stabilization falls into two classes: azimuthal stabilization, and beam stabilization.

Azimuthal stabilization involves orientation of the display with a fixed relation to true north. This is accomplished from an information take-off from the flux-gate or equivalent compass. A heading marker on the scope indicates the relative heading of the airplane on the display. Azimuthal stabilization is used to retain the display pattern fixed on the scope as the aircraft maneuvers, thereby avoiding the smearing or wiping action which otherwise destroys the display during each slight maneuver. Loss of display is serious during extended turns or maneuvers usually made just prior to critical operations such as attack or landing. With forward-looking types of scan, azimuthal stabilization is impractical, for the scanning angles quickly converge to zero as the aircraft departs from its initial course.

Beam stabilization involves orientation of the beam in the vertical plane with a fixed relation to the horizon and can take two forms: "tilt" or "line-of-sight" stabilization, and "roll" stabilization.

With *tilt stabilization*, the scanner axis is attached rigidly to the aircraft, but the tilt of the dish is adjusted during stabilization to maintain a fixed angle with respect to the stable vertical established by the gyro. This type involves the least weight and can be incorporated in scanner design without serious difficulty. It provides uniform illumination of the target area during pitch, roll, and turn of the aircraft, but has the serious disadvantage that as the vertical axis of the

aircraft is tilted, the vertical-beam pattern is similarly tilted, leading to a false azimuthal displacement of the target on the display. This places a restriction on precise utilization of displayed information during banking of the aircraft.

With *roll stabilization*, the scanner is mounted in gimbals (or an equivalent artifice is employed) permitting the axis of scan to remain in the stable vertical at all times. Roll stabilization is the preferable form, and essential where precise synchronous tracking during maneuvers is required, for the azimuthal error, inherent to tilt of the scanner axis with tilt stabilization when the aircraft banks, is eliminated. The only disadvantage of this form lies in the additional weight required by all designs so far produced.

Power is usually made as high as feasible for the particular application up to, perhaps, 200 kilowatts

from a multiplicity of small scattered objects, and sea return over sea by reflection from waves. When such objects have an orderly arrangement, as is found in the flat areas of the middle United States where most structures are oriented with the cardinal points of the compass, lines appear along the compass points on the airborne radar screen extending for many miles. During gales at sea, the wind direction can be estimated from the asymmetrical pattern of sea return, and its velocity from the extent of sea return on the radar display (see Fig. 33).

The extent of sea return in range varies from zero on perfectly calm days to 20 miles or more under severe conditions, being dependent on sea conditions, altitude of the aircraft and, of course, the power, sensitivity, and circuit constants employed. The problem of clutter is more serious to airborne radar applications than any others, because the angle of attack of the beam pattern

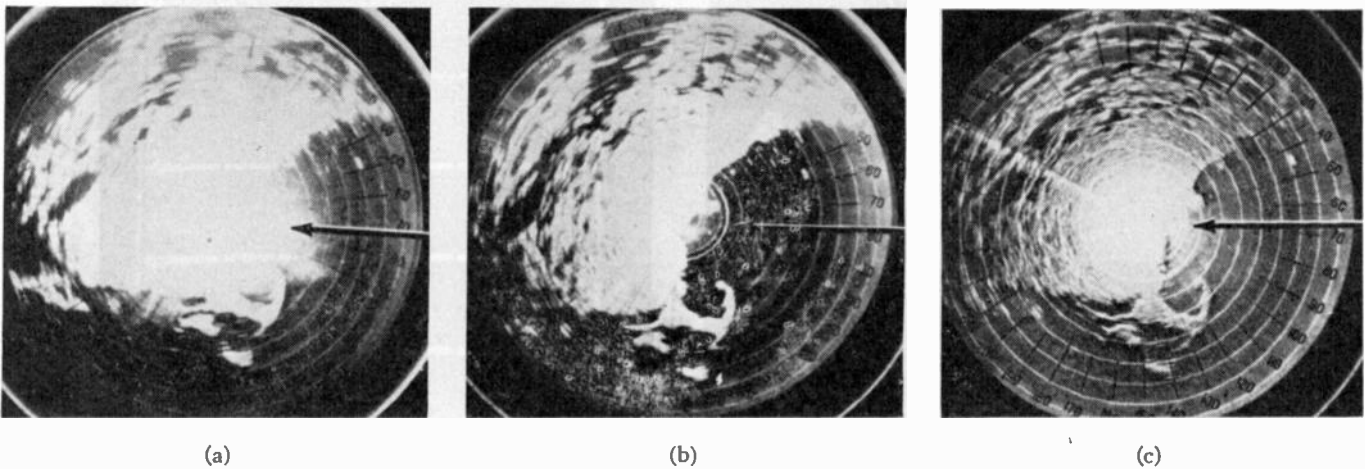

Fig. 35—Comparison of anticlutter circuits applied to normal radar-receiver operation. 100-mile sweep; altitude 10,000 feet.
 (a) Receiver normal—no anticlutter circuits.
 (b) Sensitivity time control applied to radar receiver.
 (c) Combination of all anticlutter circuits, STC, IAVC, FTC, and detector balanced bias applied to radar receiver.

pulse peak. This power in conjunction with present over-all systems gains, however, usually affords complete and adequate illumination of all targets at several miles. Higher power is desirable for many applications but serious clutter problems are experienced from aircraft, and higher power can only be employed after careful steps are taken in design to avoid the loss of targets in clutter, as discussed later, or no advantage is realized from the higher power.

Theoretical lower limit on receiver sensitivity is determined by first-circuit noise and expressed in input power in watts by $KT\Delta\nu$ where

K = Boltzman's constant (1.37×10^{-23} joule per degree)

T = absolute temperature in degrees

$\Delta\nu$ = bandwidth in cycles.

Airborne radar receivers have not yet achieved this limit, falling short by 4 to 10 decibels above $KT\Delta\nu$ because of losses in crystals and other input elements. The value of 4 decibels in service operations can as yet be achieved only by most careful selection of circuit elements.

Surface clutter is produced over land by reflection

is most favorable to clutter return with elevated antennas. Closely related to problems of surface clutter are the storm echoes previously mentioned.

The problem of design is selection and differentiation of the desired targets from the relatively uniform noise background. No solution is possible if clutter noise is permitted to saturate any part of the system or if distortion eliminates the unique differences between target and clutter upon which selection depends.

Design solutions lie in careful circuit design, use of shortest possible pulse lengths and sharpest feasible beamwidths, and in the introduction of anticlutter circuits. Reduction of pulse length and beamwidth reduces the amount of clutter noise superimposed on the displayed target signal, and improved resolution often allows recognizable forms to be discerned. The most important anticlutter circuits are (1) sensitivity time control (STC); (2) instantaneous automatic volume control (IAVC); (3) fast time constant (FTC); and (4) detector balanced bias (DBB). Application of these methods to clutter problems is illustrated in Fig. 35. In addition, special methods of indication have been proposed to increase the contrast of selected targets

against clutter. Aside from the use of special circuitry, it is essential that large antennas and short pulse lengths be available when very high power is used to permit solution of the clutter problem.

Automatic frequency control (AFC) is employed in all modern airborne radar sets to lock the receiver to the transmitter frequency. This control is imperative, for in the absence of a multiplicity of echoes, manual tuning is extremely difficult at best. Properly operating AFC is far superior to manual tuning by the most experienced operator. A number of AFC circuits have been used or proposed, but all have so far proved slightly marginal under the strains imposed on circuit elements of the system by severe aircraft-operating

tion which (1) changes transmitter pulse to 2 microseconds; (2) reduces PRF (to 200 pulses per second or less) to provide for long range and to avoid beacon overinterrogation; (3) changes tuning of transmit-receive (TR) box from magnetron to beacon frequency; (4) shifts from search to beacon local oscillator; (5) shifts from search to beacon AFC; (6) introduces video pulse stretching of beacon reply. Incorporation of these functions virtually creates a system within a system with all the attendant problems of added design. Display of beacon information is illustrated in Fig. 36 for PPI and Type-B display, respectively. Because the beacon reply is received on other than the radar wave frequency, no other clutter or echoes are displayed

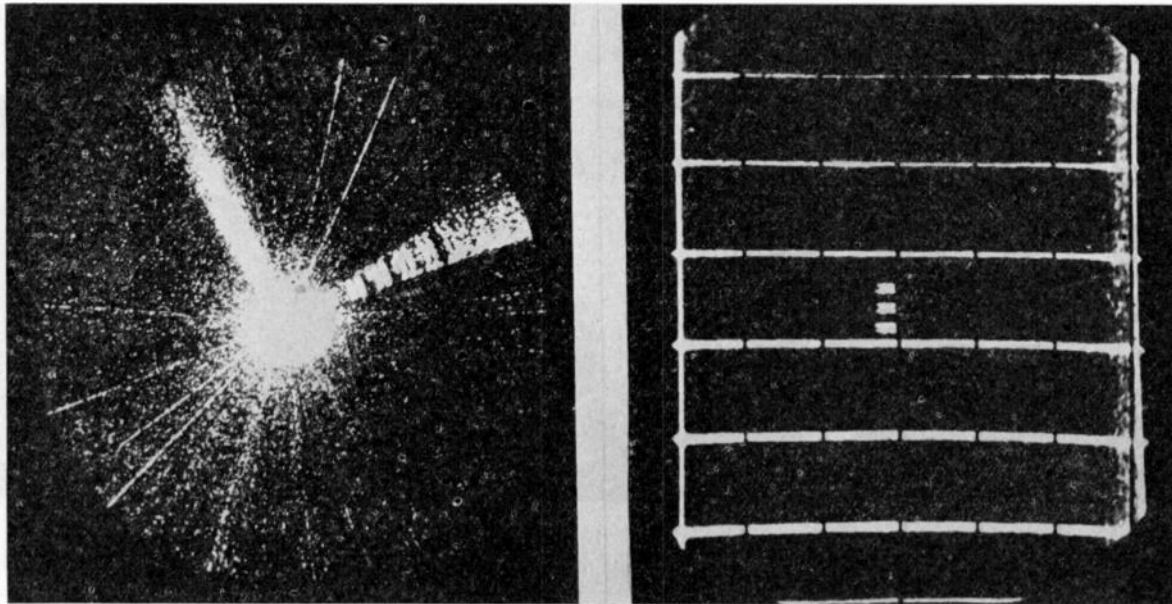

Fig. 36—Microwave beacon presentation on aircraft radar indicators, showing PPI and Type-B displays.

conditions. As a consequence, an auxiliary manual tuning control is usually provided as a precautionary measure.

The modern *microwave radar navigation beacon* is a transponder or "pulse repeater" which receives pulses over a broad designated band of wave frequencies and coincidentally transmits a characteristic recognizable pulse or pulse group designating its location on a specified frequency. Such a beacon employs a discriminator circuit which responds only to pulses of 2 microseconds length, rejecting pulses of all other lengths to avoid inadvertent interrogation by every radar in the vicinity. Radar equipment must therefore avoid the 2-microsecond pulse except for purposes of beacon interrogation, when it must be used.

Other types of beacons are sometimes employed for particular missions, but these either operate in conjunction with search or beacon facilities described herein, or may be introduced into the display through the video circuits from separate equipment.

Interrogation of the radar beacon is accomplished by the airborne radar equipment with a single switch selec-

during beacon interrogation, and so the beacon and its code are readily recognizable and measurable.

Indicators of four general types have been generally used in aircraft systems using map-type presentation. Space does not permit detailed description but the advantages and disadvantages of each are summarized.

(1) Magnetic-mechanical (MM) (with rotating coil geared synchronously with antennas).

Advantages: (a) Simple electrically, with simple sweep and driver circuits; (b) gives a well-focused picture with little distortion on any part of the display.

Disadvantages: (a) Most bulky of all types and about twice as heavy as MS; (b) requires an extra coil to off-center the display; (c) difficult to synchronize precisely during high accelerations associated with sector scan.

(2) Magnetic-electrical (ME).

Advantages: (a) Can follow high accelerations; (b) indicator is small and easy to mount; (c) indicators can be paralleled in a simple manner.

Disadvantages: (a) Requires more power-amplifier power than MM type; (b) amplifier must be linear and

system must be balanced and remain balanced; (c) length of indicator leads seriously limited; (d) Indicator distortion may be serious.

(3) Magnetic-synchro (MS) (all power is put through the synchro)

Advantages: (a) Eliminates amplifier and system-balancing problems; (b) indicator is small, much lighter than MM, and easy to mount; (c) can follow high accelerations; (d) provides practically same resolution as MM.

Disadvantages: (a) Number of indicators limited generally to two as all power goes through selsyn; (b) requires as much power as ME.

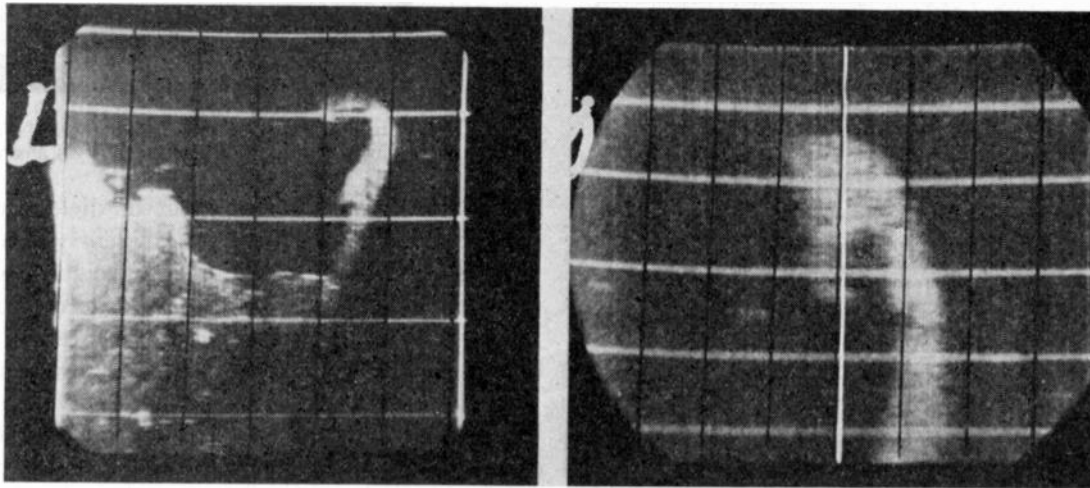

Fig. 37—Cape Cod on Type-B scan at long and short ranges illustrating distortion inherent at short range.

(4) Electric-electric (EE) (providing only electrostatic deflection)

Advantages: (a) Lightest, smallest, and simplest of all types; (b) power requirements low.

Disadvantages: (a) Lower-resolution presentation often with serious distortion; (b) certain important types of presentation (for example, PPI) excluded.

PPI, already described, and Type-B display have been most frequently used in microwave search and bombing equipment. Type-B display, illustrated in Figs. 36 and 37, provides range display along the sweep or vertical axis, and azimuth display along the scan or horizontal axis. The advantages of Type-B scan are that it (a) provides very accurate azimuthal estimates at short range which are particularly effective for bombing and attack operations; (b) permits use of simple EE or ME indicators most effectively; (c) provides a simple and effective method of displaying an expanded sector at a given range delay and azimuth; and (d) utilizes a large proportion of available cathode-ray-tube area effectively with forward-looking or sector scans. The disadvantages of Type-B scan are in distortion at ranges below four miles, which is so serious as to require special training in scope-reading at the edge of the azimuth scale.

PPI with sector scan can substantially duplicate advantages (a), (c), and (d) of the Type-B display when the sweep center is displaced to a point off the tube case and the sweep started near the edge of the tube, and at the same time retains the fundamental advantages associated with normal PPI. Modern airborne search radars provide accurate and calibrated delay circuits which permit expansion of any target area with or without sector scan, and allow accurate measurements on targets in the area (see Fig. 2). This expansion is a substantial aid in examining areas of cloud or clutter, particularly when short pulses and anticlutter circuits are employed.

When range scales of the display are switched at

short range (as, for example, from 20- to 5-mile range) violent change in the aspect of the display makes it difficult, if not impossible, to identify on the expanded scale a target which was previously followed on the longer range scale. Continuously variable range scales are provided in modern designs to permit a controllable transition to the desired scale as the target is closed.

Cathode-ray-screen decay time must be considered in relation to scan rate if smearing of the display is to be avoided at high aircraft speeds, and maximum average screen illumination retained. This effect involves a compromise where two scan speeds are used for different ranges, but the compromise is minimized when a separate scope is used for short ranges as with bombing-type equipments. In selection of the display, the relation of spot size to sweep rate and pulse length must be carefully considered to avoid loss of sensitivity due to superimposition of noise. Experiments at Radiation Laboratory have shown that the ratio of sweep length to spot diameter is equivalent to bandwidth, so that these quantities must be properly proportioned to bandwidth if the full performance of the system is to be realized. Selection of the proper size of display tube may therefore enter into system gain.

IV. SOME MECHANICAL AND ELECTRICAL PROBLEMS OF AIRCRAFT-RADAR DESIGN

Radomes

All aircraft installations require that the antenna be housed within the aircraft itself or within a housing of suitable aerodynamic characteristics. The "window" or covered aperture interposed between the antenna and free space must be constructed of material which is, as nearly as possible, invisible to the radar beam. Since the waves must pass this aperture on both outgoing and returning paths, the effect of its presence will be squared in the over-all system gain. This protective shell interposed between the antenna and space is known as the radome.

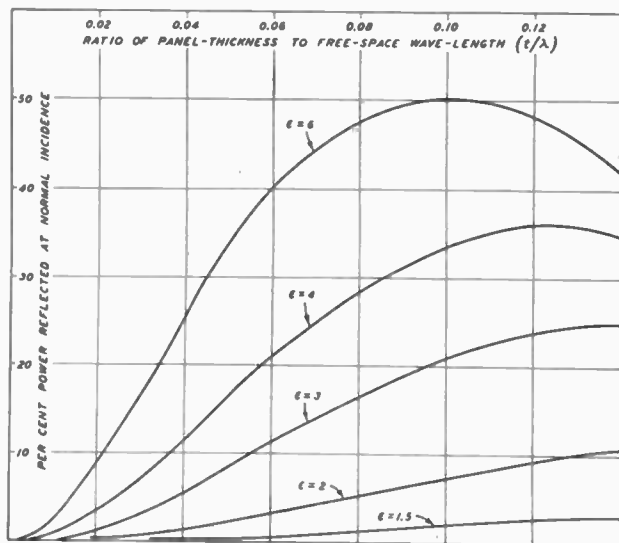

Fig. 38—Power reflected by plane dielectric sheet.

The mechanical and electrical requirements on radomes introduce unusually severe design problems. Some of the more important requirements are:

(1) Low aerodynamic drag achieved by designing the radome as a part of the aircraft wherever possible.

(2) High mechanical strength to resist flight stresses incident to speed, skids, slips, and violent yaw; these often exceed 20 pounds per square inch.

(3) Resistance to concussion of gunfire and shock waves from nearby gun muzzles.

(4) Resistance to fire.

(5) Nonshattering quality when hit by gunfire.

(6) Lasting mechanical properties of strength and shape under constant exposure to extremes of sun, rain and ice, salt spray, corrosive dust and exhaust gases, fungus and de-icer fluids, and under violent changes of temperature, pressure and humidity. It must not deform under any conditions.

(7) Low weight.

(8) Low electrical absorption and reflection of radar beam requiring low dielectric constant, low power factor, thin walls.

(9) "Duck's back" quality; the surface should have low "wettability" and not retain surface water, which in itself absorbs and reflects the beam.

(10) Fixed electrical and nonhygroscopic characteristics under the full range of conditions of requirement (6) above.

(11) In some cases, perfect imperviousness to air to permit sealed pressurized construction, with added strength to withstand the added static air loads thus imposed.

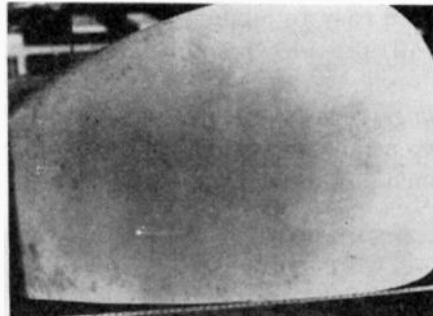

Fig. 39—Retractable streamlined radome for AN/APS-15 with 30-inch dish for Privateer (PB4Y-2) aircraft.

Fig. 38 illustrates the effect of dielectric constant ϵ and thickness t on reflection. Evidently, a high-strength and permanent structure of low weight, thin wall, and low dielectric constant and power factor requires superlative material and construction. Materials used during the war included molded plywood, fibreglass cloth with urea or other special resins, and polyfibre or foamed, plasticized rubber in sandwich construction. The development and processing of materials, the development of test procedures, and the molding of radomes forms a complete story by itself. Suffice it here to say that materials of great strength and permanence having densities of less than 0.90 gram per cubic centimeter and dielectric constant less than 2.3 have been developed.

Principal types of radome structure have been single-wall laminates, double-wall laminates (with walls so

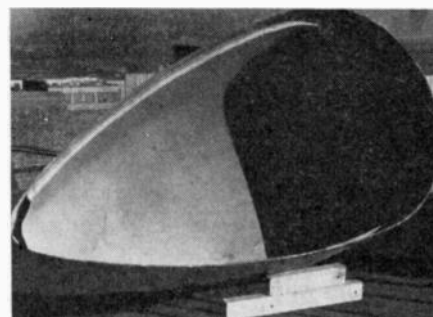

Fig. 40—Inside view of radome for Privateer (PB4Y-2). Note cutaway section showing double-wall construction.

spaced that reflections from each tend to cancel out), and sandwich types (in which material of low density and dielectric constant are formed between thin protective surfaces). De-icing boots of suitable properties have also been developed for radome protection.

Fig. 39 shows the standard retractable streamlined radome for the 30-inch antenna of the AN/APS-15 for the PB4Y-2 aircraft. Fig. 40 illustrates the double-wall

construction shown by the cut-away section. Fig. 41 shows the AN/APS-4 radome which forms an integral part of the pressurized bomb-type housing of this equipment.

Weight is the predominant factor which plagues the life of the aircraft designer in everything he does. Considering all factors over the life of the airplane, reduction of a single pound can be valued in thousands of dollars, and a single ounce in many hundreds. In the design of naval carrier-based aircraft, the maximum weight limit is imposed by the carrier's length and strength. Therefore, the inclusion of elements and equipment, however much they contribute to the ideal combat effectiveness, must be judged in terms of their performance per pound, for the ultimate weight limit of the aircraft cannot be exceeded. Every element of the structure, each screw, nut, washer, and piece of wire, must be examined to minimize its weight for the performance required. No excess material can be tolerated.

Aircraft design hence maintains a constant pressure on the electronic industry to utilize new materials, processes, and principles to reduce weight. Resort has been made to large-scale use of magnesium and aluminum alloys, plastics, and many other materials. Intense effort has been, and must be, made by the industry to perfect processes and methods of fabrication for light-weight components and assemblies.

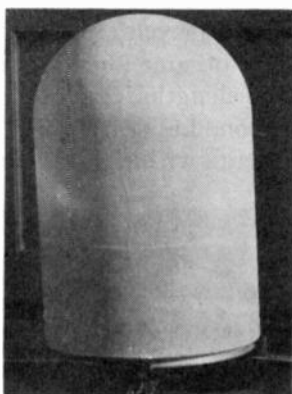

Fig. 41—The AN/APS-4 radome for pressurized bomb-type assembly.

Where many hundreds of components such as resistors, capacitors, and vacuum tubes must be used, the tendency is toward factory assembly of these units into semistandardized sub-assemblies to reduce weight. Under the older practice of supplying individual components as replacement spares, achievement of design performance by selection of components having better than standard tolerance could not be permitted. Selection of components in the field leads to intolerable difficulties. However, when factory-assembled subassemblies are supplied as replacement spares, selection of components is feasible, for it is the performance of the subassembly, and not that of the individual components thereof, which must be standardized within limits governed by design performance. Higher performance per

pound can be achieved under this policy, for the best components can be selected and used by the factory where most needed for peak performance, while those of poorer tolerance can be used in less-critical circuits. In some cases, the critical performance required of radar assemblies can be achieved in mass production in no other way.

Pressurization or hermetic sealing has been imperative in modulators and radio-frequency plumbing where high direct-current and radio-frequency voltages must be protected at high altitude (see Figs. 22, 23, 25, 26, and 27). Success with this technique has gradually led to its extension to a substantial part of aircraft electronics. While the exterior housing must be made strong and generally heavier, reduction in requirements on weight and spacing of the interior elements largely compensates for the extra weight of the case. Pressurized or sealed units are generally much more reliable because of their absolute protection from the elements. Heating problems in pressurized units may be severe and are usually solved by artificial cooling.

Reliability must approach the ultimate of perfection when the safety of the aircraft or conduct of its mission depends absolutely upon its electronics. Because of its high mobility, the airplane probably experiences a wider range of operating conditions than any other mechanical device, and in a shorter interval. There is no such thing as seasonal "winterization," for every flight may be into winter, although it may start under the most humid tropical conditions. Rapid descents from high altitude "pump" moisture into every conceivable crevice. Condensation combines with dust to form quantities of weak but corrosive acids and mud within the most delicate unprotected instruments.

Proper electrical and mechanical loading of each component is, of course, an essential element of reliability. But even more important in aircraft is protection from moisture. During analysis of night-fighter combat operations on the U.S.S. *Enterprise* at Okinawa, it was found by personal observation that more than half of the electronic failures were traceable to induction of moisture into parts of otherwise well-designed systems. Protection from moisture and other elements of environment is best achieved by sealed or pressurized systems. Any air induction in sealed systems must be made through a drier such as silica gel to avoid accumulation of moisture within the case (see Fig. 19).

Nonsealed assemblies must employ nonhygroscopic materials which are non-nutrient to fungus growth. As a stop-gap measure, "tropicalization" treatment using a spray with moisture and fungus-resisting lacquer or varnish may be employed, but it is never permanent.

Particularly important is the proper design, construction, and assembly of plugs. Plug insulation must be "melamine" or better. Pin arrangements must be carefully analyzed to provide low voltage gradients between pins. No trace of acid can be permitted to remain on plug assemblies. The reliability of the most carefully

designed airborne set can be destroyed utterly by use of acid-type fluxes or flux pastes in the plug assembly. Only pure resin fluxes are permissible. Dow Corning No. 4 compound or equivalent must be used to pack any spaces where moisture can accumulate. In general, most plug designs have not achieved the effectiveness of the cable insulation, so that plugs remain a weak point in electronics design. Better pressurized or sealed plugs are needed for pressurized or sealed electronic assemblies.

Vibration and Shock

Aside from the shocks inherent to take-off, landing, rough air, and gunfire, the advent of modern high-

TABLE IV
ARMY-NAVY AIRCRAFT CASE SIZES¹

Designation	Width in Inches	Height in Inches	Length in Inches	Load Range in Pounds
A1-C	4 $\frac{1}{2}$	7 $\frac{1}{8}$	15 $\frac{1}{8}$	12-20
A1-D	4 $\frac{1}{2}$	7 $\frac{1}{8}$	19 $\frac{1}{8}$	18-40
B1-B	10 $\frac{1}{2}$	7 $\frac{1}{8}$	12 $\frac{1}{8}$	18-40
B1-C	10 $\frac{1}{2}$	7 $\frac{1}{8}$	15 $\frac{1}{8}$	18-40
B2-C	10 $\frac{1}{2}$	10 $\frac{1}{8}$	15 $\frac{1}{8}$	18-40
B1-D1	10 $\frac{1}{2}$	7 $\frac{1}{8}$	19 $\frac{1}{8}$	25-50
B1-D2	10 $\frac{1}{2}$	7 $\frac{1}{8}$	19 $\frac{1}{8}$	40-80
B2-D1	10 $\frac{1}{2}$	10 $\frac{1}{8}$	19 $\frac{1}{8}$	25-50
B2-D2	10 $\frac{1}{2}$	10 $\frac{1}{8}$	19 $\frac{1}{8}$	40-80
C1-C	15 $\frac{3}{8}$	7 $\frac{1}{8}$	15 $\frac{1}{8}$	40-80
C2-C	15 $\frac{3}{8}$	10 $\frac{1}{8}$	15 $\frac{1}{8}$	40-80
C1-D	15 $\frac{3}{8}$	7 $\frac{1}{8}$	19 $\frac{1}{8}$	40-80
C2-D	15 $\frac{3}{8}$	10 $\frac{1}{8}$	19 $\frac{1}{8}$	40-80
S-1	5 $\frac{1}{2}$	7 $\frac{1}{8}$ maximum	9 $\frac{7}{8}$	6-12
S-2	4 $\frac{1}{2}$	7 $\frac{1}{8}$ maximum	13 $\frac{1}{8}$	10-22

¹ See specification JAN-C-172 for diagrams and data giving details, allowable protrusions, clearances, mounting provisions, mounting bases, permissible location of center of gravity, etc., for Army-Navy standards.

power power plants has so emphasized necessity for vibration absorption that entirely new antivibration mounts have been designed during the war. These mounts must be individually designed, taking into account the mounting plane, superimposed mass, dimensions of case, and center of gravity of the unit, and must be critically damped over the entire range of vibration. Satisfactory mounts are capable of attenuating vibration from 10 to 30 cycles per second to less than 1 per cent, and from 30 to 200 cycles per second to less than 0.1 per cent (prewar mounts often amplified vibration at one or more critical frequencies). The synchronizer illustrated in Fig. 19 is shown supported on such an antivibration mount.

Aircraft-case standardization has been adopted by the Army and Navy to simplify installation problems relating to space, clearance, and interchangeability and to reduce stock of antivibration mounting bases. The standard is based on multiples of the old commercial "ATR" rack, and common sizes are given in Table IV. Although certain assemblies of odd shape, particularly for use in aircraft wings or nacelles, cannot be designed to these shapes, most aircraft electronic equipment is now supplied in these standard sizes.

V. INTERCEPT OR "NIGHT-FIGHTER" RADAR

By the end of the war, the night fighter had become

firmly entrenched as a vital element of a fighting fleet. It was used effectively in both offensive and defensive roles, permitting our task forces to sail with comparative safety within range of enemy land-based planes. In conjunction with the shipborne long-range radars and under the direction of highly trained fighter-director officers, the night fighter was able to attack and destroy enemy bombers under all conditions of weather and darkness long before they came within range of our fleet. Furthermore, night fighters launched from carriers and often accompanied by radar-equipped night-attack planes were able to seek out enemy shore installations and surface targets under the cover of darkness and press home attacks which demoralized the enemy and reduced effectiveness of his plans. Navy night fighters were credited with hundreds of kills.

The Navy's requirement for a night fighter which would operate from a carrier made imperative the design of an intercept radar light enough for installation in single-place carrier fighters such as the Hellcat (Fig. 42) and Corsair without prohibitive reduction in their performance and combat effectiveness. Operation had to be automatic insofar as possible, for the pilot was also the radar operator. This fact meant extreme simplification of controls and indication, and led, in 1941, to development of the first set designed for 10,000-megacycle operation by any service. Clearly, the tiny carrier-based fighter could not utilize the 30-inch dish required for 3000-megacycle radar, so that 10,000-megacycle operation became imperative. Foreseeing the need for shorter wavelengths, the Radiation Laboratory and the Bell Telephone Laboratory had brought 10,000-megacycle components within reach, so that operation



Fig. 42—Hellcat (F6F-3N) night fighter, showing AN/APS-6 wing radar nacelle and altimeter antennas.

in this band appeared feasible. This development led to the AIA, AN/APS-6, and AN/APS-6A intercept radars, the latter illustrated in Fig. 43.

A current intercept radar weighing less than 150 pounds completely installed consists of five major elements: antenna assembly, transmitter-receiver, synchronizer-power unit, control unit, and indicator. These components lend themselves readily to several arrangements for installation in various aircraft. The indicator and control unit are the only components located in the cockpit, the former in the center of the instrument panel, and the latter usually within easy reach of the pilot's left hand. The other components are assembled

in the nose (of twin-engine aircraft), in a permanent wing nacelle, or in a dropable "bomb unit" suspended from the airplane's bomb racks.

General operation, circuitry, and components are similar to those of other microwave airborne radars. However, several requirements for a night-fighter radar require special emphasis.

(1) *Relative target angle in altitude* is a requirement which is peculiar to night-fighter radars and imposes more difficult design requirements on the scanner and indicator circuits. Coverage of a large solid angle scanned by a sharp symmetrical beam is required. Associated with this coverage are a higher pulse-recurrence frequency and a maximum-range limitation due to short pulses and rapid scan.

(2) *Minimum range* is extremely important. The pulse length and shape, receiver-gate shape, and receiver characteristics must permit following targets into not more than 100 yards.

(3) *Altitude line* is introduced by side lobes and "spillover." In night-fighter radars the altitude line can be extremely troublesome in obscuring targets when range equals altitude while the pilot is attempting to follow a target which is taking evasive action. The target must be followed through the altitude line and usually inside of it at the time of kill. Particular attention here must be given to the scanner and circuit design so that intensity of altitude line is minimized.

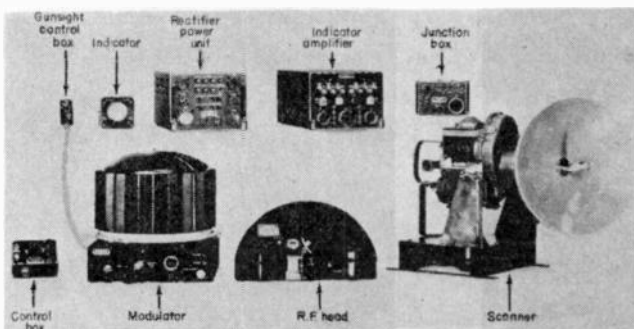

Fig. 43—AN/APS-6 intercept radar system assembly.

(4) *Sea clutter* at low altitude is a limiting factor resulting from reflections in the radar beam from sea and ground and similar to the altitude-line problem. Special circuitry not common to other radars is possible and required to minimize its effect. The range of the target is always comparable to the range of serious clutter.

The antenna of a modern night-fighter radar incorporates the most novel differences from other microwave equipments. The basic motions of the scanner as illustrated in Fig. 44 are:

(1) a scan suitable alone for forward-looking surface search with provision made for downward fanning of the beam during search operation;

(2) a nod (that is, a scan in the vertical plane) equal to and synchronized with the scan;

(3) a rotation of the scanner around the axis at an angle which is the vector sum of nod and scan;

(4) a tilt which adjusts the mean axis of scan.

From these motions a number of scans can be obtained:

(1) search scan;

(2) spiral scan up to 150 degrees solid angle depending on limits of nod and scan;

(3) conical scan for blind-firing sight.

The minimum rate of scan is governed by the beamwidth, the solid angle to be scanned, and the rate of picture recurrence required. When the antenna is ad-

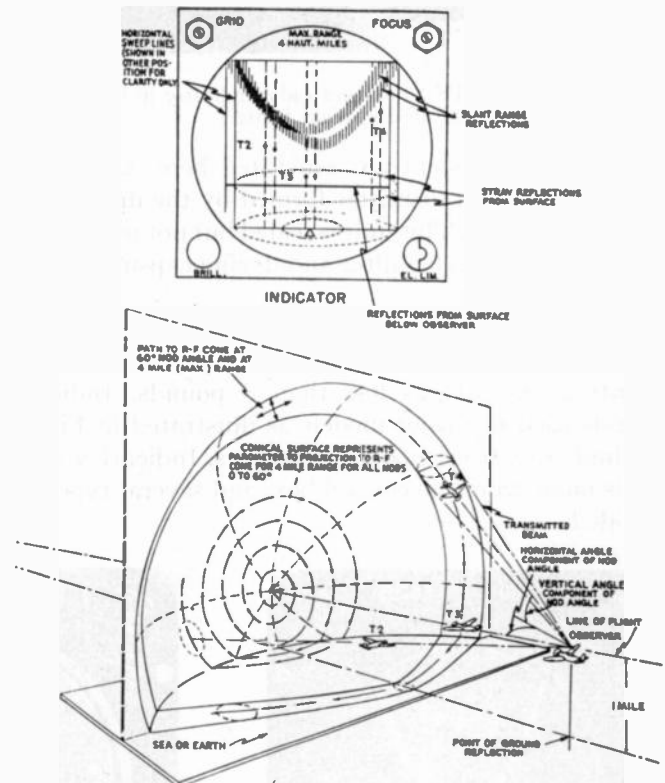

Fig. 44—Intercept spiral scan and display of resultant information.

justed to 150-degree scan and nod, and a rotation of 1200 revolutions per minute, a solid conical angle of 150 degrees can be swept at a rate of about 30 frames per minute with adequate coverage of the volume. Smaller solid angles can be covered more frequently, and at 60 degrees scan and nod, two frames per second can be displayed. Antenna assemblies weighing less than 30 pounds which include scanners capable of all of these motions are now in use.

The transmitter-receiver unit is housed in a pressurized container and incorporates a hydrogen-thyratron modulator, pulse transformer, pulse-forming network, magnetron transmitter of about 50 kilowatts peak power, RT and TR boxes, mixer assembly for radar and beacon, local oscillators, complete receiver, radar and beacon AFC circuits, and a high-voltage power supply. Weight is about 40 pounds.

The power synchronizer is the timing element of the system, in addition generating sweep voltages and indicator power. All the gates which control the other

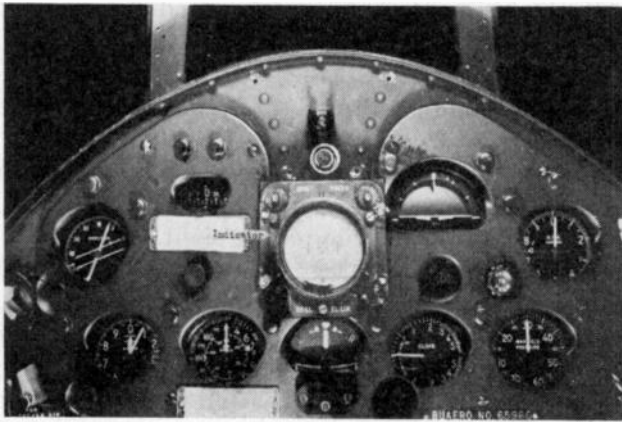

Fig. 45—AN/APS-6 intercept radar indicator in Hellcat (F6F-3N) night fighter.

circuits in the system are generated here, based on a trigger from the transmitter formed by the driver pulse for the magnetron. This unit is sealed but not pressurized, inducing air through a filter and drying capsule. Weight is about 37 pounds.

The indicator is a 3-inch EE-type cathode-ray tube housed in a small container for instrument-panel mounting and weighs less than 3 pounds. Indicator controls used in earlier models as illustrated in Fig. 45 are eliminated from modern indicators. Indication selection is made from the control box, and several types are provided.

(3) Gunsight indication for blind firing. One type of gunsight display, designated as type-H indication, is illustrated in Fig. 46(b) and (c). This results from location of a target in a narrow conical scan described about 5 to 10 degrees from the axis of scan. In type-H display, up, down, right, and left positions of the target airplane, with respect to the night fighter, have corresponding positions of the target dot with respect to the center of the display; i.e., azimuth angle is measured along the horizontal axis and altitude angle along the vertical axis. Range is not shown over 1000 yards, but as the target is closed, wings grow on the target dot, just filling the space between the fiducial lines at the range of 125 yards when the target is ready for the final treatment. (It is conceded to be a great thrill for a pilot to make a fast approach and see the wings grow completely across the tube and then disappear while he is furiously throttling back and trying to put on the brakes.) The accuracy of such scan and presentation is about $\frac{1}{2}$ degree, requiring careful initial bore sighting. This indication has achieved some success in operations.

Control is obtained from a simple control box, such as is illustrated in Fig. 47. This is a so-called "console" type of box of standardized dimensions, having a fixed width of 6 inches and length in multiples of $1\frac{1}{2}$ inches. Such control boxes can be arranged in aircraft control consoles as illustrated in Fig. 48, and provide a tremendous simplification in the pilot's control problem.

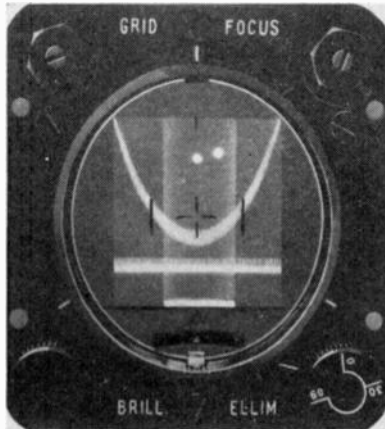

(a)—Intercept double-dot display. Target at 0-degree azimuth, 15-degree elevation, $2\frac{1}{2}$ -mile range.

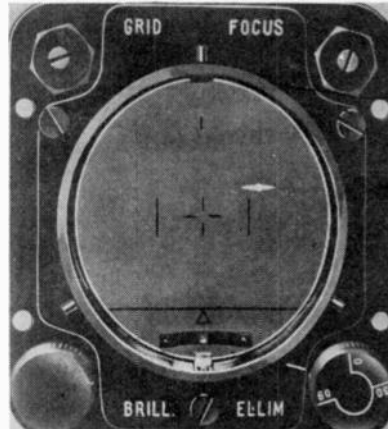

(b)—Intercept gunsight display. Target high-right, range 600 yards.

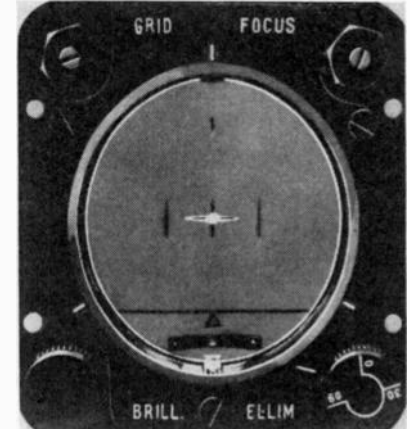

(c)—Intercept gunsight display. Target bore-sighted, range 400 yards.

Fig. 46

(1) Type-B indication for search with 150- or 60-degree linear scan (Fig. 37).

(2) Type-O indication for intercept with 150- or 60-degree spiral scan. This type of indication illustrated in Fig. 46(a) is identical to type-B with range sweep vertical and azimuth scan horizontal, and with the addition of an elevation dot displayed to the right of the target dot. When the target is in the plane containing the wings and axis of flight of the intercept airplane, the target and elevation dots are at the same level. When the target is above this plane, the elevation dot is high; when below it, the elevation dot is low.

In more recent pilot control boxes, all controls not required during the actual interception are located under a spring-loaded cover to avoid accidental operation. Too much emphasis cannot be placed on simplicity in the number, arrangement, and operation of the controls which must be operated by the pilot under the strain of combat.

The modern night-fighter radar has been designed from a practical standpoint taking into account lessons learned from previous designs, from operational experience, from maintenance experience, and from aircraft requirements. Everything possible has been done to

decrease weight and size, to simplify operation, increase performance and, in particular, improve reliability and ease of maintenance.

VI. AIRBORNE FIRE-CONTROL RADAR

This type of radar was developed to an advanced stage during the war, and with further extension of hostilities, would certainly have seen more widespread use. The United States Navy worked jointly with the Army in many of the developments in this field. The problems of fire control in aircraft are made particularly difficult by weight limitations on both equipment and associated computers, by the need for absolute reliability and unvarying accuracy with an achievable measure of maintenance, and by the necessity for additional operators unless the equipment very nearly approaches fully automatic operation. Under those conditions, no ambiguity of target selection and designation can be permitted.

Several general classes of airborne fire-control radar have been used, of which two typical classes are mentioned below.

(1) ARO denotes "airborne range only" equipment.

pletely pressurized construction, and with peak power of 5 to 10 kilowatts. The antenna is usually an end-fire



Fig. 47—Typical control box for pilot operation.

array or a "lens" antenna trained with the guns (or with the aircraft where fixed guns are employed). Range and

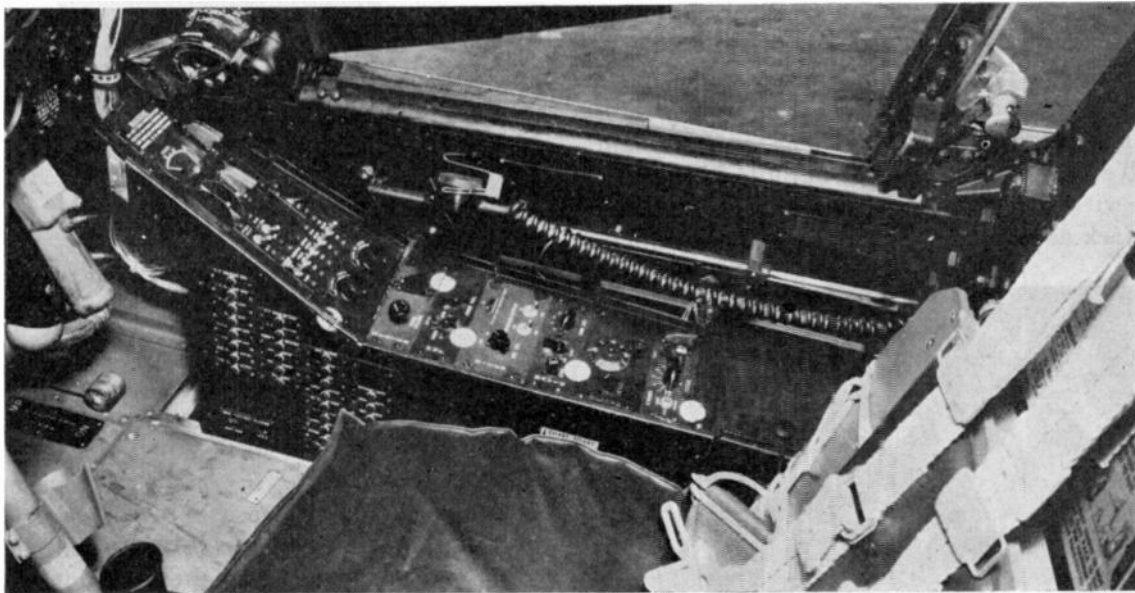

Fig. 48—Electronic console arrangement in cockpit of Corsair (F4U-4).

This automatically feeds continuous radar range of target to computers. The equipment automatically locks on and thereafter tracks the target in range. It is utilized in conjunction with visual sighting and manual gun-laying to provide more exact information than otherwise available to gunsight computers, and is valuable in both air-to-air and air-to-surface solutions.

(2) AGS denotes "airborne gunsight" which is designed to afford aiming information for blind firing in addition to the features of ARO outlined above. The turret gunner trains the turret manually, using the AGS scope for target position.

ARO equipment consists of a low-power light-weight equipment weighing not more than 25 pounds, of com-

range-rate information are supplied to the computer as voltages. Equipment may be used without display unless range selection of targets is desired. The AN/APG-5 is a good example of this class of fire-control radar used during the war.

AGS equipment usually comprises the basic radar of the ARO with a conical-scan antenna and H-type of display similar to the gunsight feature of the intercept equipment already described in Section V, and illustrated in Fig. 46 (b) and (c). Because of the added antenna and display features, the weight is somewhat over 100 pounds, installed. The operator is required to search constantly over a designated solid angle, and effectiveness is greatest within 20 degrees of "no-

deflection" firing. The AN/APG-15 is a good example of this type of fire-control radar used during the war.

VII. COMPUTERS

It is sometimes said of new weapons that, while the atomic bomb won the war, radar fought it. The application of airborne radar to blind attack and bombing gave



Fig. 49—Provincetown, Cape Cod, on 5-mile sweep, showing piers and anchored boats, lakes, and a lighthouse on top of the Cape, displayed for potential bombing run.

us a most effective and demoralizing weapon to meet tactics which the enemy believed would be decisive. A search or bombing radar supplies range and azimuth information of a selected target. This information, together with altitude and ballistic constants, is sufficient to solve the fire-control problem for level bombing or rocketry with precision. The search radar is an instrument of attack as well as search and detection, supply-

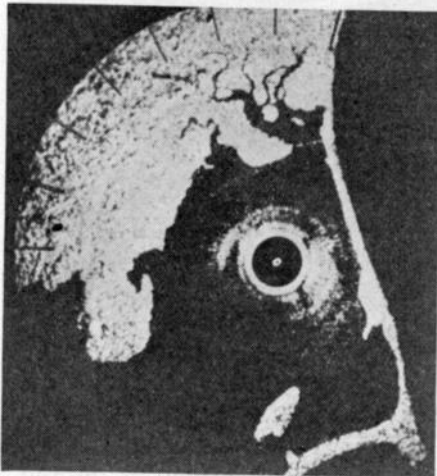

Fig. 50—Duxbury Bay, Massachusetts, on 3-mile sweep.

ing information with precision as shown in Figs. 49 and 50. A computer is necessary to evaluate such information to guide the airplane on its attack course, and to release the bombs or rockets automatically at the proper instant. In turn, an attack radar may be a simplified and light-weight version of the search radar to supply only that information required by the computer. All such airborne computers now in use are primarily electronic in nature.

The H+B-type computer was produced early in the war to supply quickly a need for utilization of radar information for high-altitude bombing, particularly with the AN/APS-15 radar. This is a relatively crude type of computer suitable for only general area bombing from high altitude, and was responsible for a large part of the area bombing done in this war. The H+B computer is illustrated in Fig. 51. Its operation is based on the fact that the "B function" (slant range minus altitude) is almost independent of altitude from about 10,000 to 40,000 feet. This computer is light and simple in construction, although not so simple to operate accurately. It is sometimes called an impact-predicting type of bombsight, since it does not use synchronous tracking to find closing rate. When the bombing information is set up on the computer, a range line appears on the display. Intersection of this range line with

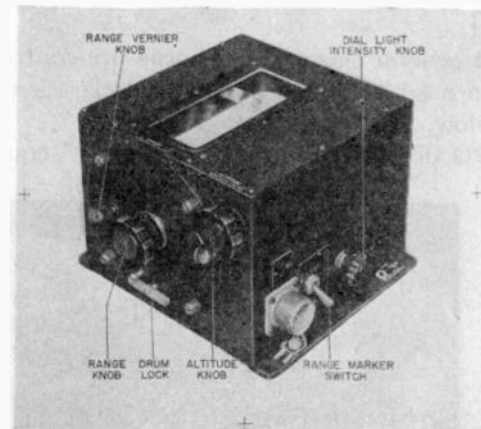

Fig. 51—H+B-type bombing computer used with AN/APS-15 radar.

the target indicates the instant of release. The computer, with associated range-delay circuits and special radar controls, is shown installed in conjunction with the AN/APS-15 radar in Fig. 14.

The synchronous-tracking computer (sometimes erroneously called LAB because of its similarity to earlier types suitable only for low-altitude bombing) is a precision type of radar bombsight attaching to any Army or Navy search or bombing radar. It consists essentially of a power supply, synchronizing and sweep-generating circuits, and an electronic bombing computer. It employs synchronous ground-range tracking, made possible by an electrical triangle solver, and thus can operate at both low and high altitudes with equal facility, being suitable for altitudes from 50 to 35,000 feet. A special 3-inch cathode-ray tube displays the 1- and 3-mile expanded traveling bombing sweeps which are synchronized with and remain about the target as the airplane approaches the target. Probable error at altitudes up to 1000 feet is about 80 feet; at high altitudes it is in the order of 20 to 25 miles. A typical computer of this type is illustrated in Fig. 52. This equipment has both ranging and azimuth circuits, and the bombardier controls the airplane in the bombing run through the autopilot. A simple attachment will

permit the firing of rockets in level flight under any conditions of visibility.

The "range-only" (LAB) computer is a light-weight ranging computer for attachment to radars in carrier-based aircraft. It is designed particularly for low altitudes and has been used for attacks on shipping or surfaced submarines. The closing rate upon the target is determined by means of synchronous tracking of the target. Bombs or rockets are released automatically when the correct instant arrives. This device has no azimuth circuits or controls, so that the pilot must be guided by the radar scope (via the radar operator, usually) and must fly a collision course for bombing or a pursuit course in the case of rocket firing. A simple attachment permits the firing of rockets in level flight. Results with both bombing and rocketry are excellent under even completely blind conditions of flying.



Fig. 52—Installation of synchronous-tracking-type bombing computer in Mariner (PBM-5) aircraft.

During the war a multitude of computers were designed, produced, and used for different purposes. It is beyond the scope of this discussion to describe or even mention them all. Rather, the attempt has been made to describe the simpler types so that the utilization of radar information can be illustrated by example. The radar is capable of supplying certain fundamental information that can be utilized in a thousand ways by a thousand computers.

VIII. AIRBORNE RADAR IDENTIFICATION

One of the more unfortunate features of the radar is the fact that in display all discrete targets have similar characteristics, normally varying in amplitude only. This means that the accurate recognition of a target and exact identification of its location may be quite difficult. To compensate for this weakness, two electronic systems have been developed and used. These systems are the IFF system and the radar beacon (or

racon), one form of the latter having been mentioned in Section III.

The IFF system is primarily designed to permit rapid and accurate identification of the targets as being friend or foe. The radar-beacon system is designed primarily to determine location, with identification a secondary feature.

Both of these systems utilize the principle of the pulse repeater. Their operation is shown in Fig. 53(a), (b) and (c). Here a pulse is emitted from the interrogating equipment. After a delay corresponding to the range between the equipments, this pulse is picked up by the beacon or IFF receiver, and a reply pulse is automatically transmitted by the beacon or IFF transmitter. The reply pulse, delayed again corresponding to the range, is received by the receiver associated with the interrogator transmitter and displayed in a suitable manner.

Because of the differences in tactics involved in the use of IFF equipment and radar beacons, these equipments are ordinarily quite different in construction.

The basic principle of IFF requires that the system be universal; that is all friendly ships, tanks, and aircraft must be equipped to give the proper IFF response, and all detection units, whether radar or some other type, must be equipped to determine whether the target is friendly or enemy. So numerous are the installations of IFF equipments that a special nomenclature is used to describe the components.

Three basic equipments are needed to provide an IFF system. These are the interrogator, the transponder, and the responder. The interrogator is the unit of the IFF which sends out challenges; the transponder is the unit of the IFF system which receives the challenge and automatically transmits a reply; and the responder is the unit of the IFF system which receives the reply. Since the interrogator and the responder are always in the same location, they are usually constructed as a unit described as an interrogator-responder (IR).

In an IFF system, the interrogator corresponds to the radar transmitter and the responder to the radar receiver. The transponder actually comprises a radar receiver and transmitter so interconnected that an incoming interrogation signal causes the transmitter to be energized. This automatic action of the transponder normally takes place without action on the part of personnel, and, in fact, usually without their knowledge. All combat aircraft are fitted with transponders, and aircraft interrogator responders are used in conjunction with airborne radar.

Since the IFF system is designed to identify a particular target after it has been detected by some method (usually by radar equipments), close interconnection between the interrogator responder and the radar equipment usually exists. The interrogating pulse must be synchronous with the transmitted pulse of the radar. Likewise, the reply pulse received by the responder is displayed in some way on the radar scope to permit close correlation between radar echo and any IFF response associated with the echo.

The basic principles of IFF can be illustrated by the IFF Mark 4 system, which was developed by the Naval Research Laboratory in conjunction with commercial laboratories and was under test on December 7, 1941. This system was not used extensively during the war but was held in reserve pending possible compromise by the enemy of the operational systems. Because of its age, this system is now obsolete, but it is of interest since it adequately shows the basic principles involved in an IFF system.

The basic or IFF function of the Mark 4 system may be understood by reference to Fig. 53(A). Here the shipborne radar has detected the presence of the aircraft overhead. The interrogator associated with the radar system challenges the aircraft whose transponder automatically sends back a reply. The reply pulse is received by the responder associated with the interrogator and displayed on the radar scope.

form of coding is therefore provided in the IFF transponder. Provisions are made for change of this code, and any IFF response not correctly coded is regarded with suspicion.

Because of the universal nature of the IFF equipment, it is readily adaptable to the indication of emergency by a special type of code which is available at all times but used only to indicate a condition of distress. This provision has saved the life of many airmen during the war by conveying the condition of distress and the exact location of the disabled plane to the displays of radars in the vicinity.

IX. CONTINUOUS-WAVE RADAR

We have so far confined our attention to conventional types of pulse radar for aircraft applications. However, continuous-wave radar has not only played an important role but seems destined for even more widespread

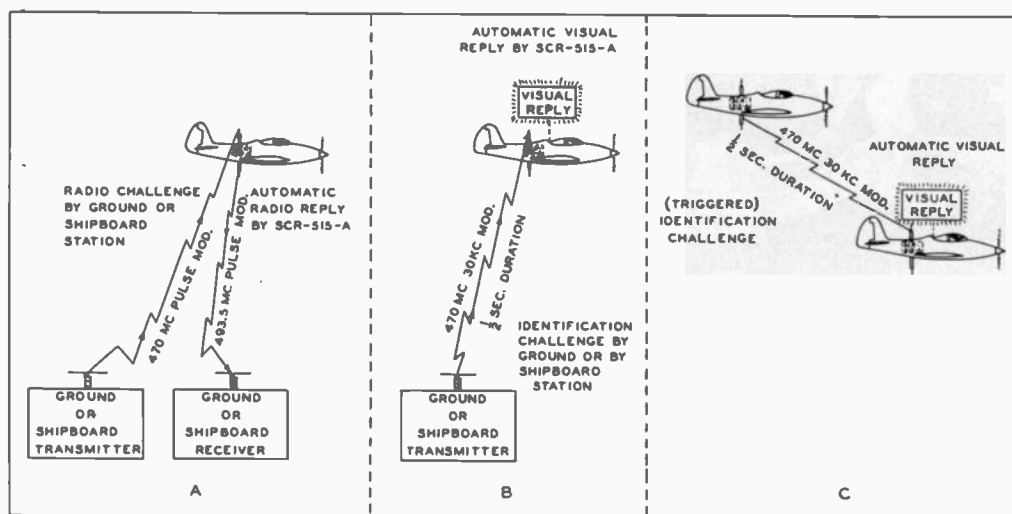

Fig. 53—Some IFF functions of IFF Mark IV.

In addition to the basic or IFF function in the Mark 4 system, two additional functions are provided. These permit recognition (the determination of friendly or enemy character of another) and identification (the process of establishing your own friendly character). These two actions are illustrated in Fig. 53(B) and (C). Here the pilot of one aircraft, wishing to determine the nature of the second one, has pressed a challenge switch which converts the transponder to an interrogator. This challenge signal is received at the second aircraft and a notification is automatically given to its pilot. This pilot, by operation of recognition lights or through maneuvers of the aircraft, may then signal that he is friendly. When the interrogating aircraft is equipped with radar, the IFF reply can be displayed on his scope in the same manner as shown by Fig. 53(A) for surface units.

The mere presence of an IFF type of response from a target is a signal that the target is friendly. This, however, cannot be considered a fully adequate indication, since it would not be impossible for an enemy to capture one or more working equipments. This possibility is lessened by the inclusion of destructor devices in the IFF equipment, yet still must be considered. A

use. Generically, pulse radar is related to amplitude modulation and stems clearly from the ionospheric pulse experiments of Breit and Tuve. Speaking also generically, continuous-wave radar is related to frequency modulation and traces equally clearly from the ionospheric-ranging experiments of Appleton and Barnett.

The principles most widely used in airborne continuous-wave radar are best illustrated by an examination of the AN/APN-1 radio altimeter. Many thousands of these indispensable instruments were used by Army and Navy, and by British services during the war; they were a standard requirement on all Naval combat aircraft except day combat fighters.

The AN/APN-1 altimeter, illustrated in Fig. 54, emits a radio-frequency carrier which is frequency-modulated at a set rate and radiated in a downward direction from the transmitting antenna. The earth's surface, or water, reflects some amount of this radiated carrier, and the reflected signal is received on a separate receiver antenna. During the time interval required for the signal to travel to the earth or water and return to the aircraft, the transmitter frequency has changed. The combination of the received signal with a signal

obtained directly from the transmitter produces an audio-frequency signal in the detector, the average frequency of which is proportional to the altitude of the aircraft above the ground or water. After passing through frequency-counter circuits, the detected signal is used to operate a meter which is calibrated directly in feet of altitude. It also is used to operate a pair of relays, at certain preset altitudes, which in turn may be utilized to provide altitude-limit indications or to control the altitude of flight when the altimeter is operated in conjunction with an automatic pilot.

The AN/APN-1 radar altimeter consists of a low-powered frequency-modulated transmitter of about 1 watt which operates on a center frequency of approxi-

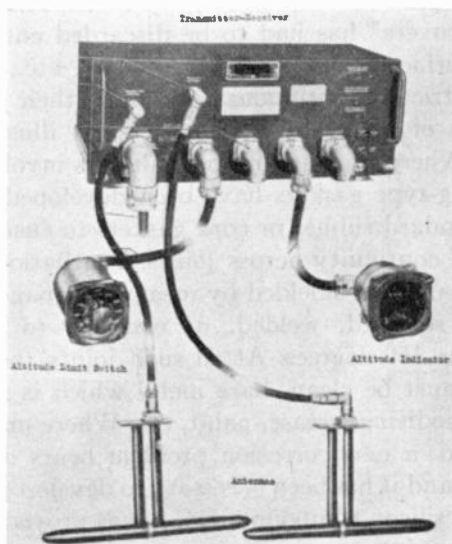

Fig. 54—N/APN-1 altimeter. (Top) transmitter receiver; (left) altitude-limit switch; (right) altitude indicator; (bottom) antennas.

mately 440 megacycles, two dipoles which mount under the wings or fuselage of the aircraft, as shown in Figs. 8 and 15, and a receiver having a balanced detector, audio-frequency amplifier, and a frequency counter which operate an altitude indicator mounted on the instrument panel. All the controls are located on the altitude indicator which has two ranges, 0 to 400 feet and 0 to 4000 feet. The change of range is accomplished by operating the range switch on the indicator which changes the bandwidth of the transmitter from 420 to 460 megacycles for the low range to 443 to 447 megacycles for the high range. The range switch also changes the dial markings on the indicator so that the pointer always reads in hundred-foot major units.

The existing altimeter, AN/APN-1, developed by RCA, was the only one in use at the war's end which would indicate clearance above the ground or water at low altitudes all the way down to the landing position. For this reason its application in blind approach at low altitudes has been extremely important. For low-altitude torpedo launchings, night carrier landings, and other low-altitude operations over water, it has served to make possible operations which might not have been carried out without such an instrument. It is now being

used in conjunction with several instrument-landing systems as an accurate indication above the ground during the approach.

The AN/APN-1 altimeter serves to highlight the advantages of continuous-wave radar for certain applications.

(1) Indication is continuous up to point of contact with the target.

(2) Only low average power (with no peaks) is required to range for several miles.

(3) Relatively narrow bandwidths allow high over-all system gain.

(4) Low voltages employed make feasible very small, light construction.

(5) Target motion can be recognized and measured with relative simplicity.

It is quite feasible to apply in continuous-wave systems the same principles of azimuth indication, utilizing highly directive antennas, as are employed for pulse-radar systems. For this purpose a number of kinds of display have been proposed and tested. There is little doubt that applications of continuous-wave radar are destined to come into more widespread use as their advantages for special purposes are exploited by careful design.

X. RELATED PROBLEMS

Power Supply

In the years before the war, the goal of standardized 28.5-volt direct-current aircraft power supply was in sight with the advent of low-impedance radio tubes operable from small dynamotors contained within the electronic equipage. Radar changed this. The demand for very high voltages (15,000 to 25,000 volts) made imperative a powerful source of alternating current.

The alternating-current supply has been generally obtained in two ways.

(1) Motor alternators operating from the 28.5-volt direct-current bus and supplying 115-volt, 400- or 800-cycle alternating current, of which the Navy type 800-1C, 1.2 kilovolt-amperes, is an example.

(2) Engine-driven double-voltage generators supplying both 28.5-volt direct current and 115-volt variable-frequency alternating current. The Navy type NEA-5 is an example of this type, supplying 200 amperes direct current and 1.2 kilovolt-amperes alternating current at 800 to 1600 cycles.

Double-voltage generators are generally employed on Navy single-engine aircraft, and occasionally on twin-engine aircraft where the alternating-current load of each generator can be used efficiently in separate equipments. Double-voltage generators permit a considerable saving of weight. On most twin-engined, and all other multiengine aircraft, motor alternators are employed to give the greatest flexibility in utilization of available electrical power. Increasing alternating-current power demands will probably dictate an ultimate change in basic aircraft power systems.

In the design of light-weight aircraft electrical

generating equipment, high speeds with minimum of material are the goal. Bad wave forms may, however, have a most serious effect on precise sweeps and other voltage-critical circuitry. It is sometimes found that the extra filtering of radar power supplies required with bad wave forms is more expensive in total weight of aircraft than is proper initial generator design. The irregular load of the pulsed radar modulator also takes its toll on generator wave form and output, so that ultimate load must be considered in generator design.

Good voltage regulation is extremely important and the war has seen the carbon-pile regulator almost universally adopted in aircraft for this purpose. Voltage tolerances for alternating current of ± 3 per cent are desirable and difficult to obtain with engine operating speeds varying in a ratio of 2 to 1.

Radio interference, as defined by the Services, is a generic term covering all electrical disturbances which cause undesirable response or malfunctioning of electronic equipment.

With airborne radar the extent of the parameters of radio interference is immense, encompassing a frequency range of, say, from 100 cycles to 30 billion cycles, a radio-frequency power range of roughly from one microwatt to one watt, and a radio-frequency voltage range of from one microvolt to 15 volts. It is the very essence of naval aircraft operation that the radar operate continuously, yet other electronic equipments of equal importance must also operate continuously. There are sometimes as many as 40 separate electronic devices in close proximity in a single aircraft.

Some interference appears in radio receivers via direct antenna coupling at carrier frequency from the radar antenna. This type of interference, however, is relatively mild, and can be eliminated by means of fairly simple wave traps or antenna-network filters, provided the difference between the rejected and desired frequencies is more than 10 per cent. Considerable difficulty has also been experienced from rotating direct-current equipment associated with the radar gear—flea-power blower motors being the outstanding example—but this type of interference is easily corrected and constitutes nothing unique in the field of interference caused by radar equipment.

The significant interference problem caused by airborne radar originates with all triggering and pulse circuits. The reason it is so vicious, as compared with other sources, arises from its high-voltage, square-wave pulsed modulation. As is commonly known, a square wave is made up of its fundamental frequency and an infinite number of harmonics. Pulse rates start in the low audio range of about 200 pulses per second, which is the lower limit of the range of standard headphones, and continue on up above 4000 pulses per second. These PRF's appear amplitude-modulated over the vast range of harmonics, which still have sufficient energy up in the medium-high frequencies to cause severe interference in communication and navigation receivers.

Since the coupling of this interference into the medium-

high-frequency receivers involves all paths, namely, by conduction in all power and control cabling, and by radiation to antenna circuits and through equipment cases into all stages of the receivers, and further, since a large number of radio receivers are likely to be affected by the one radar system, the approach to correction adopted by the Navy has been to "bottle-up" the radar interference within its own system. As a consequence of the voltages, power, and frequencies employed in the radar system, this "bottling-up" process has necessitated the development of new methods of shielding, compartmentation, isolation, grouping, and filtering.

New requirements for shielding and filtering which have evolved from considerable study are:

(1) *Complete metal continuity of cases*. The old idea of "dust covers" has had to be discarded entirely. All mating surfaces associated with covers, etc., must be made electrically continuous throughout their periphery by means of high-pressure contacts, as illustrated in Fig. 23. Where pressurizing or sealing is involved, new conducting-type gaskets have been developed in place of the standard rubber or cork gaskets to ensure radio-frequency continuity across joints. Ventilation louvers must be baffled or shielded by means of expanded mesh which is soldered, welded, or clamped to the case throughout 360 degrees. At all such joints the mating surfaces must be clean, bare metal which is free from pickles, anodizing, grease, paint, etc. Where magnesium is involved, a new corrosion problem bears on proper shielding, and it has been necessary to develop preventatives. The silicon compound, DC-4, has proved most effective for this use.

(2) *Open wiring and shielding continuity of flexible conduit and connectors*. As with the equipment cases, all shielding associated with radar cabling, usually in the form of flexible conduit, must meet the radio-frequency path-continuity requirements listed above. Connectors in particular have been found completely inadequate from the point of view of shielding. The necessary design for shielding has been worked out in ignition-system shielding and is gradually getting over into electrical-connector design. The fact that our electrical connectors were practically useless in shielding led to one important advance: It pointed a questioning finger at the use of all of the associated flexible conduit, and ultimately it was proved, when adequate design measures were employed, that 90 per cent of the cable shielding could be removed without affecting the interference problem. Thus, only cables carrying high trigger or pulse voltages require shielding and this is of the coaxial type with double-braid shielding. Here again, connectors have proved the weak link in the shielding system. A completely suitable practical design for all purposes as yet remains to be developed. Also, for the newer, higher-powered radars, present pulse cables are proving to be inadequately shielded. Developmental work is under way to produce a design of flexible shielding with connectors which will meet the "no measurable" interference requirements now established.

(3) Reduction of conducted interference on radar wiring.

Because the shielding means were inadequate as well as heavy, the effort to eliminate radio interference radiation from radar cabling focused upon ways of reducing the value of radio-interference voltages appearing on the cabling to a point where "open wiring" could be used satisfactorily. The obvious corrective was filtering, but if no other steps were taken, the attenuation and the number of such filters required would have been prohibitive for aircraft use because of weight and size. Thus, the radio-interference-reduction engineers had to "move in" on the design of the radar equipments. By placing interference-producing components in shielded compartments and filtering the leads issuing from these compartments; by separating high-level interference circuits from nominally "clean" circuits; by using lead-through capacitors from compartment to compartment; by assiduously observing the grounding of components without the commonly used, but useless, "grounding jumper"; by using shielded wiring or coaxial on high-interference lines such as trigger circuits; and by using electrostatically shielded transformers, they demonstrated that the size and number of filters could be reduced to a very practical minimum. On a 75-pound modulator, the resultant increase in weight was less than five pounds and the interference on all the wiring, excepting the pulse and trigger, did not exceed 50 microvolts. Before these design principles had been incorporated, interference levels greater than 100,000 microvolts had existed. The increase in equipment weight was only a small fraction of the weight of cable shielding (some 75 pounds) which could be removed from the airplane. Thus "open wiring" on radar systems has been demonstrated as completely satisfactory.

Systems Test

The war has seen the number of electronic equipments in aircraft multiply from a navigation and a communication equipment only, to an aggregate of 10 to 40 electronic devices including one or more radars. The close proximity of these equipments, and the overlapping frequency ranges covered by many of them, have introduced a terrific problem of design.

In the confined space of an aircraft we can no longer think of an individual equipment as comprising a system, but of each equipment as an element of the system into which all are integrated. A single manufacturer or designer cannot possibly foresee all possible reactions with other equipments of which he has little knowledge. When the equipment design is frozen it is often too late to undertake corrective action. A proving ground has, therefore, been necessary, in which the "ability of an apparatus to get along with its associates" can be proved, quickly and effectively; before it is produced, and perhaps before its parent airplane is even designed.

The solution has been in the establishment of a series of systems tests. It is emphasized that a "systems test" is a test of equipage, not of an aircraft installation. It is

a test to determine feasibility of simultaneous operation of any group of electronic devices in the aircraft environment and to establish such corrective measures in the design of each as are necessary for the successful operation of all.

The systems test involves the assembly of a representative group of equipment into a complete system in the laboratory under artificial conditions which simulate the environment of a particular class of aircraft and which permit complete and exact measurement of all interactions. Three general systems have been established at

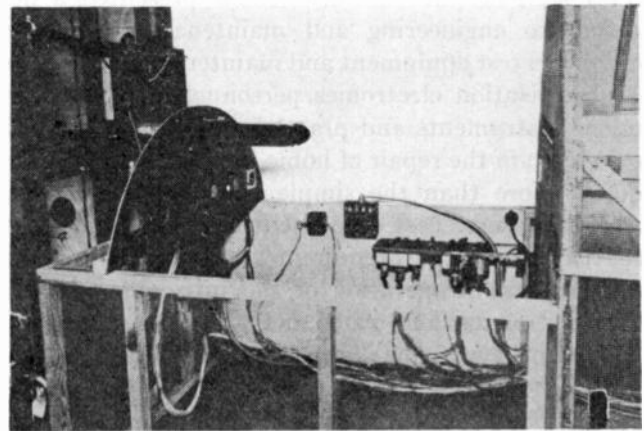

Fig. 55—BTM-1 systems test, looking forward.

the Naval Research Laboratory: (1) the carrier-based fighter system; (2) the carrier-based bomber system; and (3) the patrol-bomber system. Into each system a preproduction model of a new equipment can be inserted and completely checked against the others. A typical systems-test position is illustrated in Figs. 55 and 56. Each test position is so arranged that it can be modified readily to study contemplated new aircraft

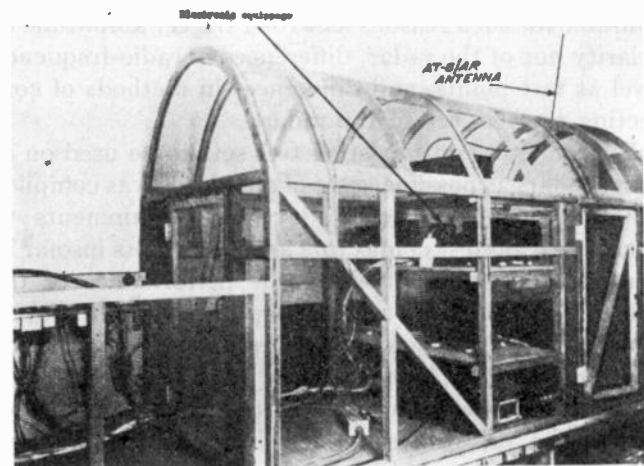

Fig. 56—BTM-1 systems test, looking aft.

arrangements associated with proposed new types. Systems tests completely simulate aircraft operation from the variable-speed aircraft-generator test stand to the antenna outside the simulated aircraft structure. The object of the tests is to ensure that each equipment design will function without interference to the others,

and to recommend corrective measures when necessary to the design.

The results of these tests have been remarkable in uncovering unsuspected design defects, one equipment beating with another to block an intermediate-frequency amplifier, a flea-power motor feeding noise through an unsuspected lead, the need for a new antenna-coupling filter, and so on. The systems test has proved to be an advance insurance that an aircraft electronic system would work without equipment re-design at the time when utilization was imperative.

Test equipment for airborne radar presented a new problem to engineering and maintenance personnel. Heretofore, test equipment and maintenance procedures used by aviation electronics personnel were the same familiar instruments and practices used by most radio service men in the repair of home radios. Airborne radar requires more than the simple signal generators and circuit analyzers. Test equipment has been designed to meet the more complex requirements of the radar, and to ensure successful operation of the intricate radar circuits with regular field personnel.

Early in the war, the Navy adopted the policy that a line of general test equipment applicable to all radar equipments should be established and standardized and complementary test sets should be developed only as required to perform special test functions peculiar to a newly designed radar. Volt-ohm-milliammeters, signal generators, tube testers, oscilloscopes, and the like, were included in the general line and these functions thereafter were not included in so-called universal test sets.

For microwave radars it became increasingly difficult to avoid special test sets. A particular stumbling block was cable connectors. Test sets could not be used on certain radars because connectors did not mate; adapters were required. In other instances, existing test sets were unusable for such reasons as wrong trigger amplitude or polarity out of the radar, differences in radio-frequency level at test points, and differences in methods of connecting the test set to the radar.

In order to permit existing test sets to be used on as many radars as possible, a set of standards was compiled which required all newly developed equipments to standardize on test connectors and test points insofar as practicable without affecting the performance of the new design. This was a great step in curbing the ever-growing list of test equipment required by any aviation electronic maintenance activity.

Going further in an effort to reduce the number of test sets, a program of standardization of test equipment was inaugurated in collaboration with the Army Air Forces. Considerable duplication of development and production was eliminated by this program and Army and Navy aviation activities could use each other's test equipment. This program was successful because it took advantage of common requirements of the two aviation forces without endeavoring to enforce arbitrary, unnecessary, impractical, or awkward standards.

An example of a typical radar test-equipment comple-

ment is that used for radars such as the AN/APS-15 or more modern sets operating in the vicinity of 10,000 megacycles.

(a) An echo box, which is simply a high- Q tunable cavity excited by the transmitted radar pulse, returns a continuous-wave damped signal to the radar receiver. It requires no power for operation and provides a handy rough preflight check on radar performance.

(b) A frequency-modulated test set which provides an accurately known calibrated signal for receiver sensitivity measurements and an accurately calibrated power meter for transmitter output measurements.

(c) A directional coupler which couples a known percentage of the radar transmitter output to the frequency-modulated test set. This coupling device is constructed to couple out energy traveling in the transmission line in one direction only. It stops transmission of reflected power traveling in the opposite direction in the transmission line which would add to apparent output power and lead to erroneous power readings on the frequency-modulated test set.

(d) Spectrum analyzer which produces an oscilloscope pattern of the radar pulse. This instrument discloses any irregularities in the pulse arising from improper shape, off-frequency, magnetron pulling, excessive standing wave in the transmission line, etc.

(e) Dummy antennas consisting of power-dissipating sand loads, which replace the radar antennas and still terminate the radar transmitter in a load impedance equivalent to the antenna normally used.

(f) Fluxmeter, which is a meter calibrated directly in gauss and is used to determine the flux density of the magnet portion of the magnetron tube.

(g) Signal generator for intermediate-frequency alignment, oscilloscope, tube tester, volt-ohm-milliammeter, pressurizing pump, and other items included in the standard general line.

Maintenance of electronic equipment is accomplished at the airplane and on the workshop bench. Rapid preflight checks at the plane are necessary to prevent take-off on radar missions with radar performance below optimum. Other at-the-plane maintenance concerns equipment which is difficult to remove. To prevent the necessity for two separate test sets, all late models developed are adaptable for either bench or field use.

Power supplies for maintenance simulate the actual airplane power supply by utilizing aircraft-type generators coupled to portable engines. Since none of the portable power supplies provide 60-cycle power, but only the higher-frequency output of the aircraft-type generators (400 to 1600 cycles), all test sets are designed for use on power-line frequencies from 50 to 1600 cycles.

Specifications

Combat operations are the final proving ground for all naval equipment, and this far-flung war has been unusually severe in this respect. To avoid repetitions of difficulties and failures experienced in the field, the

Bureau of Aeronautics maintained a file of "performance requirements and design objectives" for each equipment which provided a guide for subsequent design. Each time corrective action was indicated, the measures were carefully balanced against any disadvantages indicated and tests run to determine the best action. Performance requirements and design objectives were always flexible so that, at any time, they represented the accumulated experience of the past. This has proved an invaluable guard against repetition of errors.

With respect to contract specifications, the Army, Navy, and Civil Aeronautics Administration are now in close accord. Army and Navy specifications for electronic components agree in most possible cases through the AN and JAN specifications now widely extant. A common AN nomenclature is used for all equipment. Navy equipment is now required to pass all tests necessary for Civil Aeronautics Administration certification, and in some respects the Navy tests are more severe as dictated by experience particularly in relation to temperature, altitude, and vibration. In addition, a great many additional tests relating to combat requirements and systems operation are necessary. The story of specification testing in the attempt to simulate operational conditions would occupy a volume in itself. There is a critical need for national industrial standardization of tests involving electronic components and equipage concerned with the safety of life and property.

Radar Trainers

At the beginning of the war the limited availability of aircraft equipment and trained personnel, and the necessity of effecting every economy, made design of simulated training equipment imperative. A program was initiated to design electronic training equipment which would accurately simulate the performance of electronic equipment in flight. This has led to a reduction of both the flying time and the total time required to carry out the training since the operation and performance of training equipment on the ground is unaffected by weather conditions.

Radar training devices are primarily of two types: (1) synthetic trainers, and (2) multiple-indicator flight trainers. The synthetic trainers are designed for use in ground training to simulate actual flying conditions. Multiple-indicator training sets are designed to provide a multiplicity of indicators for flying classrooms in order to utilize the flying time of the classroom to the fullest extent. The synthetic trainers can be classified as radar trainers, navigational trainers, countermeasures trainers, and special-purpose trainers. Some of the trainers, however, may perform the function of two or more of these classifications as, for example, the AN/APS-T3 (ultrasonic trainer).

Most of the trainers are designed to operate in conjunction with certain units of the service electronic equipment, feeding simulated echoes or signals into the service equipment. The first synthetic trainers were bench trainers designed to demonstrate typical

echo patterns. Modern synthetic trainers accurately simulate the complete performance of the electronic equipment in flight. A brief summary of the major requirements of present trainers shows that they (1) produce accurate simulation of particular radar displays, including secondary effects such as noise and interference; (2) permit the manipulation of all the controls of the service gear, giving accurate simulation of the effect of each control; (3) provide crew training under conditions which approximate those obtained on combat operations; and (4) provide accurate simulation of radar displays for operational research, solution of actual tactical problems, and training-film production.

As a typical example, the AN/APS-T3 (ultrasonic trainer) is in reality a miniature radar system using ultrasonic waves in water. A three-dimensional plastic map represents the terrain. A quartz crystal which represents the airplane travels over the terrain in any direction and at any speed or altitude within limits. The crystal vibrates at an ultrasonic frequency and functions as both a transmitter and receiver. The reflected signal is mixed with a local oscillator and the output is fed into the intermediate frequency of the basic radar gear. This trainer can be used in conjunction with any of the search-radar equipments in production or development. A jamming attachment which simulates the several types of jamming is also incorporated in this trainer. The features of this trainer permit it to be used as a search-radar trainer, a radar navigational trainer, and a radar-countermeasures trainer.

In addition to the development of training equipment, an extensive training-film program has been necessary to assist in the preliminary phases of both operational and maintenance training.

Closely related to the trainer program is the "radar planning device" (RPD) which permits simulation of actual target information on the radar screen in advance of an operation, to permit advance study of various target approaches, protective shadows, and the like.

Handbooks

Electronic equipment is so complex by its very nature that it is ordinarily useless, even in the hands of relative experts in the field, unless accompanied by well-written, well-illustrated, exact and complete, technically accurate explanatory material. These instructions must be carried to the field in the form of a series of handbooks or manuals which give all necessary information.

The Navy had to take men by the tens of thousands who knew no more about electronics than how to turn on a radio and set them to work installing, operating, maintaining, testing, and calibrating electronic equipments. This had to be done quickly. The equipment with which they dealt was new in concept, so that even its function was often unrecognizable from examination of its assembly. The maze of circuitry and complexity of circuit elements foredoomed any attempt at successful operation without complete, consistent, and simple information. From this fact, the importance of the

handbook program in the success of our airborne radar operations is evident. Not only was it necessary to prepare the men who did the work but also to train the teachers who made them ready for the job. Throughout the war a continuing study has been made looking to the preparation of books which would be of the greatest value. As a result of accumulated experience, certain types of handbooks are believed to be desirable and to present a maximum of the types of information desired, with a minimum of overlapping.

(1) *The Operator's Manual*

Whether a given equipment produces expected results is, in the last analysis, in the hands of the operator of the equipment. Good engineering, faultless production, proper installation and servicing all are worthless if the operator doesn't see or hear what he should. But the operator is usually not a trained electronic expert; he may be a somewhat youthful pilot, or even a crewman with no notion of what goes on behind the panel. Any instructions which he will or can follow must be couched in nontechnical language. They must be complete, plainly written, and illustrated in great detail.

The operator's manual was developed rather late in the war and came about chiefly as the result of a fleet requirement for something better than was then available in the field of operation. This handbook was developed to be less technical than the others, but to have greater readability and to give increased attention to the details of results to be expected. Illustrations were developed to show in complete detail the results of proper and improper operational procedure. It became the least formal of the handbooks since it is used almost entirely by nontechnical personnel. It has developed into a valuable aid for training as a very necessary on-the-scene assistant.

(2) *The Installation Handbook*

Before any electronic equipment can function in combat it must be properly installed, with consideration given to proper placement for ease of operation, proper spacing, shielding, bonding, allowance for servicing space, proper shock mounting, and in some cases protection from the weather or from conditions of humidity and extremes of temperature. Information must be assembled by experts and made available to the men in the aircraft plant, at the air station, or aboard ship who must install the equipment.

The installation handbook, although not always called by this name, has been in existence for the duration of the war. The early attempt to combine installation instructions with operating instructions led to much criticism, and these have been separated. This type of handbook contains information which will enable an installing activity to make a complete installation. It has information such as outline, dimensional, cabling, and panel diagrams; space requirements; power requirements; installation testing; and on-off operational information.

(3) *The Maintenance Handbook*

Before an equipment is used, and at intervals during its use, the user must be sure that it is in good condition, calibrated to give answers which can be trusted. Life and success depend on it. Complete instructions on maintenance, testing, calibration, and inspection of equipments must be available to all in the field in time for them to learn what they must do and how to do it, before they are required to service the particular set covered by the instructions. This material must be constantly at hand while services are being performed.

The maintenance handbook is the complete handbook for the supporting activity. Given this book, a man who had studied the basic facts of electronics and who has had experience in working on electronic equipments can take a new equipment and with the assistance of the book, carry out testing, alignment, calibration, and maintenance procedures. It contains theory, for use by those who want to know why, and for use by the schools; parts lists for the convenience of maintenance personnel; and complete line, bench, and overhaul information. It is probably the most used of the handbooks, finding place in the field, in the classroom, in the shop, and on the deck.

(4) *The Training Handbook*

Before any operator, installation man, or maintenance man is sent to the field, he must be trained to develop facility in the work which he must do, but his teachers must first be trained to teach him the important things about those equipments which he may reasonably expect to meet in service. In both of these training jobs, handbooks are a very necessary portion of the study material. In addition, training is only begun in schools, and whether the occasion is the introduction of a new equipment, or whether it is merely learning more about an old acquaintance, good books are needed. The theoretical assistance given by the handbooks will help, because every intelligent person can do a better job if he knows why he is working as well as how. When possible, special handbooks were developed for the use of schools in their program of training. Certain of these were developed by the schools themselves and others were the product of training-literature groups outside the schools. All required experienced engineering aid in their preparation. These handbooks served well in assisting in the education of the men going to the fleet. Some of them were very useful in the re-education of fleet personnel in new techniques.

XI. SOME FUTURE PROBLEMS OF AIRBORNE RADAR

Airborne radar is a tool which peculiarly fits the needs of, and can be exploited by, the airplane. The facility with which it provides surface contact, independent of aid from the ground, makes it a natural element of aviation. But further, the advantages of elevation and mobility which the airplane can offer open many new avenues for the utilization of radar.

In the field of navigation there is much room for

advance. A single radar beacon can establish uniquely the position and motion of an aircraft in space. This is all the information needed to establish *any* ground track or flight path, however precise, within horizon range of the beacon. To utilize radar information efficiently and effectively, a computer is required. With a computer, automatic flight over any predetermined track within horizon range of the radar beacon or reference point is entirely feasible. Radar differs from ordinary vision or beaconry by providing exact range. There is a tendency to believe that a television picture would be ideal. In contrast, carefully selected and computed *necessary* information in properly presented form may ultimately prove the more important, for radar provides more than simple vision.

Air-traffic-control problems can certainly be simplified by radar. Collision prevention is feasible when information of position in range, azimuth, and elevation, and

other as a critical element of both defense and offense.

One lesson learned during the war must not be forgotten. With the entire resources of science and industry mobilized in the search for and design of new weapons, it took about nine months of the most intensive kind of effort to bring a new electronic design from the stage of basic design specification to that of elementary production. This interval included basic design, assembly, and test of models to ensure producibility, and production design with basic tooling. This schedule could only be met where fundamentals of component design were complete, and the basic concept of system design and performance were already demonstrated in the laboratory. In the few instances where this interval was less (the AN/APS-15 required five months) a substantial portion of the design was adapted from previously produced models.

An additional interval of nine months was required

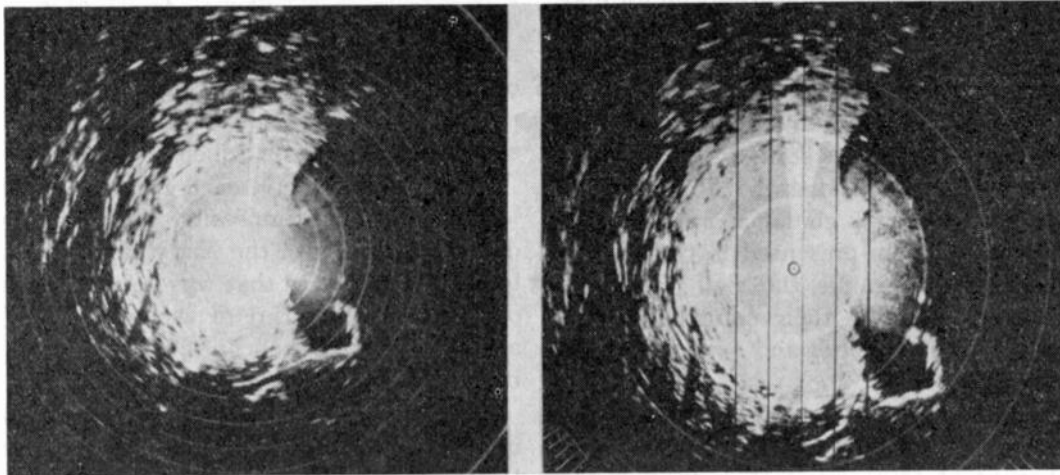

Fig. 57—Simultaneous photographs before and after relay of radar information.

rate of closing of near by objects, is given. Problems of air spacing, stacking, and close landing order will certainly yield to radar solutions. Crowding and channelization of traffic will be eased when tracks need not be confined to narrow ranges.

Relay of radar information, as illustrated in Fig. 57, can greatly enhance its value by supplying it to central filter points for evaluation. It is not essential that an airplane carry a high-powered radar to receive all possible radar information. Radar information can be relayed to an airplane equipped with a light-weight radar-relay receiver, making available the selected output of one or more powerful radars strategically located on the ground or in other aircraft. Control systems are particularly strengthened if each aircraft carries a form of radar beacon to reinforce its echo for any radar purpose and for identification.

A multiplicity of future military and naval applications of airborne radar must occur to every engineer. There appears to be no immediate limit on size or weight when justified by the application. One thing is certain—whatever the future trend of military and naval operations, airborne radar is here to stay in some form or

to bring production to a steady rate of satisfactory product, to test and evaluate the manufactured product, to start installation lines, to fill the supply pipe lines of complete equipments and replacement parts to the installers, the schools, and the fleet, and to initiate school and fleet training on an adequate scale. Still another six months was required to develop combat experience and evolve tactics to the point where the contributions of the weapon were substantially felt.

This represents a minimum interval of two years from design to combat effectiveness. It is doubtful whether this interval can be reduced under any circumstances in view of the *total effort* toward achievement which was exerted by every element of the chain. In the planning of national defense it is, therefore, imperative that new weapons be planned and carried completely through these stages during ordinary times, even though production rates are small, for to increase production and utilization of a product which has passed through this critical interval is relatively a simple matter. Adequacy of national defense depends upon public and industrial support of the necessary programs.

XII. ACKNOWLEDGMENTS

To acknowledge the sources of information contained in this summation after many years of close secrecy with no published reports is indeed a difficult task. The development and production of radar are the result of a total effort on the part of the whole electronic industry of the United States and Great Britain. The growth of ideas during development was so largely due to interplay of ideas among individuals, laboratories, manufacturers, and the services as to render almost impossible the assignment of credit for individual ideas to their proper source. It was this very anonymity, in which the individual submerged his personality for the benefit of the whole, that gave the radar development its enormous impetus.

To our British allies and to the Naval Research Laboratory must go the credit for devising the first of the naval airborne radars. Throughout the war the Radiation Laboratory, as prime consultant on all matters of microwave radar and technique, guided naval development. Much of the background of microwave development in this paper is derived from material presented in its colloquia and reports, and from intimate discussions and meetings with its staff. In particular, I am indebted to Drs. L. A. Dubridge, I. I. Rabi, and W. A. Loomis for their personal guidance and brilliant analysis of each new problem presented to them. With the Radiation Laboratory ranks the Bell Telephone Laboratories in the extent of their contributions to theory and design of components and systems of airborne radar.

The excellent counsel and advice of our able British colleagues gave us the full advantage of their experience and the benefit of thinking of their best minds, providing a constant critique of our plans and procedures.

Throughout the war the Army and Navy col-

laborated closely on all matters of electronics, both technical and operational. Both formal and informal meetings of the officers of the two services, and formalized procedures for the exchange of technical and operational information, ensured full utilization of the other results. The large measure of standardization achieved between the services by the end of the war is illustrative of the fine spirit of co-operation evident on the part of both services. The contributions of the Navy itself were notable. Aside from establishing the requirements, and striking the balance between aircraft and radar design, were solutions to the equally tough problems of test, installation, maintenance, training, distribution, and operation of an important weapon which became available only after the war had started. The contribution of the Naval Research Laboratory, the Naval Air Matériel Center, and the Naval Air Test Center to design, test, methods and processes, as well as to quick production of small but desperately needed quantities of new devices and special aircraft designs, was outstanding. The large-scale experimental flight operations of United States Navy Special Projects Cast and North under the most trying conditions provided much of the experimental data on which this paper is based.

To endeavor to give each group the credit it deserves would here prove impossible. The entire electronic industry teamed with the Navy to produce, and produce quickly, any device that was needed. These devices not only bear the imprint of the best of engineering, but also an artistry in concept of design which has nowhere been surpassed.

In particular, I desire to express my appreciation to my colleagues of the Navy Department and Naval Research Laboratory who have so substantially aided in the preparation of this material, and to the Radiation Laboratory who have permitted reproduction of many photographs obtained during experimental operations.

Lloyd V. Berkner (A'26-M'34-SM'43) was born at Milwaukee, Wisconsin, on February 1, 1905. He received his B.S. degree in electrical engineering from the University of Minnesota in 1927, taking graduate work in physics at Minnesota in 1927, and at George Washington University from 1933 to 1935. In 1927 he joined the Airways Division, United States Bureau of Lighthouses (subsequently the Civil Aeronautics Authority). In 1928 he joined the United States Bureau of Standards, representing that agency from 1928 to 1930 as radio engineer on the Byrd Antarctic Expedition I. Upon returning to the Bureau of Standards in 1930, he undertook early studies of the ionosphere.

In 1933 Captain Berkner joined the staff of the Carnegie Institution of Washington, Department of Terrestrial Magnetism, where he was responsible for the organization of ionospheric work at the Carnegie Institution's observatories at Watheroo, Western Australia, Huancayo, Peru, and College, Alaska.

Captain Berkner enlisted in the United

States Naval Reserve in 1926, being commissioned as Naval Aviator in 1927. He was called to active aviation duty in mid-1941 at



Harris & Ewing

LLOYD V. BERKNER

the Bureau of Aeronautics. He organized and headed the aircraft radar section and subsequently organized and headed the electronics material branch of that Bureau. He advanced to the rank of Captain in March 1945. Upon completion of active duty in 1946, he returned to the Carnegie Institution to continue research in wave propagation and geophysics. He is also acting as executive secretary of the Joint Research and Development Board of the Army and Navy.

Captain Berkner is a Fellow of the American Physical Society, and member of the American Institute of Electrical Engineers, Washington Academy of Sciences, Philosophical Society of Washington, Explorers Club, and American Geophysical Union. He is a member of the Executive Committee, International Scientific Radio Union (URSI), and of the International Commission on Ionosphere of the International Union of Geodesy and Geophysics. In 1941 he was given the science award of the Washington Academy of Sciences in recognition of his ionospheric research.

Abstracts and References

Prepared by the National Physical Laboratory, Teddington, England, Published by Arrangement with the Department of Scientific and Industrial Research, England and *Wireless Engineer*, London, England.

The number at the upper left of each Abstract is its Universal Decimal Classification number and is not to be confused with the Decimal Classification used by the United States National Bureau of Standards. The number in heavy type at the top right is the serial number of the Abstract.

The Institute of Radio Engineers has made arrangements to have these Abstracts and References reprinted on suitable paper, on one side of the sheet only. This makes it possible for subscribers to this special service to cut and mount the individual Abstracts for cataloging or otherwise to file and refer to them. Subscriptions to this special edition will be accepted only from members of the I.R.E. and subscribers to the Proceedings of the I.R.E. and Waves and Electrons at \$15.00 per year. Subscribers to this special edition will also receive an Annual Index to Abstracts and References as part of their subscription service. All others, who are not subscribers to this service, but who are either members of the Institute or subscribers to the Proceedings of the I.R.E. and Waves and Electrons may purchase the Annual Index for \$5.00. Subscriptions to the Index only must be received by the Institute not later than March 1, 1947. All subscriptions for the Abstract service and its Annual Index should be sent to

Mr. George W. Bailey
Executive Secretary
The Institute of Radio Engineers, Inc.
330 West 42nd Street
New York 18, N. Y.

	PAGE
Acoustics and Audio Frequencies . . .	707
Aerials and Transmission Lines	708
Circuits	709
General Physics	710
Geophysical and Extraterrestrial Phenomena	710
Location and Aids to Navigation	711
Materials and Subsidiary Techniques . .	712
Mathematics	713
Measurements and Test Gear	713
Other Applications of Radio and Electronics	714
Propagation of Waves	716
Reception	716
Stations and Communication Systems . .	717
Subsidiary Apparatus	718
Television and Phototelegraphy	720
Transmission	720
Vacuum Tubes and Thermionics	721
Miscellaneous	722

ACOUSTICS AND AUDIO FREQUENCIES

517.947.44: 534.25	2111
The Wave Equation in a Medium with a Variable Index of Refraction—Bergmann. (See 2170.)	
534.2	2112
Absorption and Scattering by Sound	

Absorbent Cylinders—R. K. Cook and P. Chrzanowski. (*Jour. Acous. Soc. Amer.*, vol. 17, pp. 315–325; April, 1946.) Theoretical and experimental studies, with fairly good agreement between them.

534.213.4 2113
Attenuation of Sound in Circular Ducts—E. Fisher. (*Jour. Acous. Soc. Amer.*, vol. 17, p. 338, April, 1946.) Correction to 257 of February.

534.231.3 2114
The Driving-Point Impedance of an Infinite Solid Plate—R. Clark Jones. (*Jour. Acous. Soc. Amer.*, vol. 17, pp. 334–336; April, 1946.) In the design of mechanical filters for preventing the transmission of vibration from one structure to another, it is necessary to know the impedances of the structures between which the filter is to be connected. Expressions for these impedances are derived, and the results applied to the case of a steel plate. Full paper, abstract of which was noted in 4089 of 1945.

534.43: 621.395.61 2115
Phonograph Reproducer Design—W. S. Bachman. (*Trans. A.I.E.E. (Elec. Eng.*, March, 1946), vol. 65, pp. 159–162); March, 1946. Description of the design and performance of two devices depending on the principle of the resistance-wire strain gauge. A variable-reluctance magnetic reproducer is also described.

534.771 2116
Monitored Live-Voice as a Test of Auditory Acuity—R. Carhart. (*Jour. Acous. Soc. Amer.*, vol. 17, pp. 339–349; April, 1946.) A statistical comparison between two methods of measuring deafness.

534.833: 534.61 2117
A Small Acoustical Tube for Measuring Absorption of Acoustical Materials in Auditoriums—D. P. Love and R. L. Morgan. (*Jour. Acous. Soc. Amer.*, vol. 17, pp. 326–328; April, 1946.) Useful over a frequency range of 200 to 1000 cycles.

534.833.1 2118
Demountable Soundproof Rooms—W. S. Gorton. (*Bell Lab. Rec.*, vol. 24, pp. 150–154; April, 1946.) See also 1753 of July and 825 of April.

534.861.1 2119
Acoustical Treatment of Broadcast Studios—J. B. Ledbetter. (*Radio*, vol. 30, pp. 17, 62; February, 1946.) A review of the requirements for studios of various sizes and the methods used to obtain the optimum reverberation time.

621.395.613.32 2120
Microphones: Part 3—Pressure-Operated Microphones—S. W. Amos and F. C. Brooker. (*Electronic Eng.*, vol. 18, pp. 190–192; June, 1946.) Early examples of carbon-granule microphones of both telephone and

Reisz transverse-current types are compared with the modern telephone inset and the double-button microphone. Frequency-response curves are given and the disadvantages of carbon types are listed. An early form of moving-coil microphone, the Magnetophone, is mentioned. For previous parts, see 1755 of July.

621.395.613.38+621.395.623.6]: 621.317.79

2121
Laboratory Method for Objective Testing of Bone Receivers and Throat Microphones—E. H. Greibach (*Trans. A.I.E.E. (Elec. Eng.*, April, 1946), vol. 65, pp. 184–187; April, 1946.) An account of the production and the performance of an artificial throat for test purposes.

621.395.613.38 2122
Inertia Throat Microphones—E. H. Greibach and L. G. Pacent. (*Trans. A.I.E.E. (Elec. Eng.*, April, 1946), vol. 65, pp. 187–191; April, 1946.) The theory and design of a magnetic microphone, with a frequency response of 100 to 5000 cycles, with a sharp high-frequency cutoff.

621.395.623.34 2123
Conical Sound Source—P. G. Bordini. (*Jour. Acous. Soc. Amer.*, vol. 17, p. 338; April, 1946.) Correction to 266 of February.

621.395.623.7 2124
New Permanent Magnet Public Address Loudspeaker—J. B. Lansing. (*Jour. Soc. Mot. Pict. Eng.*, vol. 46, pp. 212–219; March, 1946.) A duplex loudspeaker with high efficiency, wide frequency range, large distribution angle, and small physical size. The use of special types of baffle with the speaker for public address systems is discussed. Improved response is obtained by ribbon coil construction, increased magnetic flux, and a large voice coil.

621.395.625 2125
A Report on the Sixth Annual Conference of Broadcast Engineers—L. Winner. (*Communications*, vol. 26, pp. 30, 74; April, 1946.) Long illustrated summaries of the following papers: "Magnetic Recording," by S. J. Begun; "Tools for the Study of Disk Recording Performance," by H. E. Roys. For other papers, see 2143, 2319, and 2365.

621.395.625.2: 621.396.933.4 2126
Recording C.A.A. Traffic Control Instruction—K. M. MacIvain. (*Electronics*, vol. 19, pp. 116–119; May, 1946.) Automatic equipment records two-way communications between control center and aircraft pilots on a flexible plastic belt, giving 30 minutes of continuous recording, which can be stored for reference. There are separate recording and reproducing heads, and amplifiers which can be operated simultaneously; the reproduction can be within one second of the recording.

621.395.625.3 2127
A New Wire Recorder Head Design—
 T. H. Long. (*Trans. A.I.E.E. (Elec. Eng.,*
April, 1946), vol. 65, pp. 216–220; April,
 1946.) Description of a design that dis-
 tributes wear, and results in a head that is
 virtually self-cleaning.

621.395.625.6 2128
Stereophon Sound Recording System—
 C. Becker; H. B. Lee. (*Jour. Acous. Soc.*
Amer., vol. 17, pp. 356–357, April, 1946.)
 A brief description of a system for high
 quality sound recording on film developed
 in Germany since 1938. "The system em-
 ploys well-known means in some respects,
 but has the important advantage of giving
 excellent 3-channel reproduction of great
 dynamic range and low noise level, using a
 sound track of total width only 2.65 milli-
 meters."

621.395.8:621.317.79 2129
The Measurement of Audio Distortion
 —Scott. (*See* 2253.)

AERIALS AND TRANSMISSION LINES

621.315.21.029.5/.6 2130
Report of Conference on Radio-Fre-
quency Cables—(*Trans. A.I.E.E. (Elec.*
Eng. December, 1945), vol. 64, pp. 911–941;
 December Supplement, 1945.) A sym-
 posium of 17 short papers as follows: 1.
 "The Development of Radio-Frequency
 Cables in the United States," by J. H.
 Neher; 2. "General Characteristics of Poly-
 ethylene," by J. W. Schackleton; 3. "Poly-
 ethylene as Cable Insulation," by C. S.
 Myers and A. E. Maibauer; 4. "Dielectric
 Strength of Polyethylene," by W. A. Del
 Mar; 5. "Properties of Different Poly-
 ethylenes," by W. J. Clarke; 6. "Radio-
 Frequency-Cable Manufacturing Methods,"
 by T. M. Odarenko; 7. "General Consider-
 ations in Radio-Frequency-Cable Design,"
 by J. F. Wentz; 8. "Losses in Radio-Fre-
 quency-Cable Components," by G. L.
 Ragan; 9. "Radio-Frequency-Cable Power
 Ratings and Stability," by M. C. Biske-
 born; 10. "Shielding Characteristics of
 Radio-Frequency Cables," by R. G. Flu-
 hart; 11. "Types of Radio-Frequency
 Cables and Specifications," by E. E. Sheldon;
 12. "Design Considerations of High-Fre-
 quency Twin-Conductor Cable," by E. W.
 Greenfield; 13. "Methods of Electrical and
 Mechanical Testing of Radio-Frequency
 Cables at the Naval Research Laboratory,"
 by J. M. Miller; 14. "Electrical Tests Over
 Range of Frequencies," by C. C. Fleming;
 15. "The S-Function Method of Measuring
 Attenuation of Coaxial Radio-Frequency
 Cable," by C. Stewart, Jr.; 16. "Corona-
 Initiation Measurements on Polyethylene and
 Rubber Cables," by D. Depackh; 17. "A
 Corona Voltmeter," by A. E. Widmer.
 Discussions of the papers, grouped by sub-
 ject, are summarized.

621.315.212.1: 621.39] (091) 2131
Historic Firsts: The Coaxial System—
 (*Bell Lab. Rec.*, vol. 24, pp. 148–149, April,
 1946.)

621.315.212.1: 621.392.2 2132
Design Data for Beaded Coaxial Lines—

C. R. Cox. (*Electronics*, vol. 19, pp. 130–135;
 May, 1946.) Equations and curves are given
 for the determination of the characteristic
 impedance, optimum insulator spacing, at-
 tenuation, and maximum power rating. The
 choice of insulator materials and bead
 shapes is discussed. Standard attenuation
 curves are given for 70-ohm broadcast cab-
 les, and for 51.5-ohm cables used in fre-
 quency-modulation and television equip-
 ment.

621.392 2133
The Experimental Behaviour of the Co-
axial Line Stub—J. Lamb. (*Jour. I.E.E.*
(London), vol. 93, pp. 188–190; May, 1946.)
 An experimental counterpart of the theoret-
 ical paper by Allanson, Cooper, and Cowling
 (see 2134 below) at wavelengths of about 8
 and 11 centimeters. A standing-wave de-
 tector with a very small probe energizing a
 thermocouple gives the impedance, using
 Bruckmann's method (2904 of 1938), from
 which a circle diagram is constructed. The
 stub susceptance is expressible in the form
 $[A \cot 2\pi(y - \rho_s)/\lambda] + B$ where y is the
 stub length and ρ_s the distance of the first
 characteristic point from the stub entry.

621.392 2134
The Theory and Experimental Behaviour
of Right-Angled Junctions in Rectangular-
Section [H₀₁] Wave Guides—J. T. Allanson,
 R. Cooper, and T. G. Cowling. (*Jour.*
I.E.E. (London), vol. 93, pp. 177–187; May,
 1946.) A theoretical analysis of a wave-guide
 junction of n members made in terms of an
 equivalent transmission-line system is ap-
 plied to the problem. "The behaviour is ex-
 pressed in terms of six parameters, the values
 of which have been calculated over a range
 of wavelengths around 10 centimeters and
 determined experimentally at four points
 within this range. A description of the
 experimental technique employed is given,
 and an assessment made of the order of
 accuracy attained in the measurements."

621.392 2135
Normal Modes in the Theory of Wave
Guides—G. M. Roe. (*Phys. Rev.*, vol. 69, p.
 255; March 1–15, 1946.) When the bound-
 aries are not perfectly conducting there is
 only a finite number of nonorthogonal modes
 satisfying the continuity conditions and the
 conditions at infinity. Abstract of an Ameri-
 can Physical Society paper.

621.392 2136
Engineering Approach to Wave Guides—
 T. Moreno. (*Electronics*, vol. 19, pp. 99–
 103; May, 1946.) The advantages of wave-
 guides over coaxial air- and solid-dielectric
 cables in the frequency range 2000 to 30,000
 megacycles are described in relation to at-
 tenuation and power-carrying capacity. De-
 sign data and wave-guide materials are dis-
 cussed, and a list of standard guide sizes for
 various frequency ranges is given.

621.392.012.2 2137
New Transmission-Line Diagrams—
 A. C. Schwager and P. Y. Wang. (*Trans.*
A.I.E.E. (Elec. Eng., December, 1945),
 vol. 64, p. 955; December Supplement,
 1945.) Discussion of 548 of March.

621.392:621.396.67 2138
Feeding Combined FM and AM An-

tenna Arrays—W. Pritchett. (*Elec. Ind.*,
 vol. 5, pp. 72–74; April, 1946.) Briefly de-
 scribes two previous methods (2118 of 1941
 (Taylor), 3834 of 1945 (Alford), and a third
 method by which open-wire transmission
 lines are used with stub matching to sepa-
 rate the signals before applying them to
 their respective aerials.

621.392.21:621.315.1+621.396.664]:
 621.396.712 2139

The Design and Use of Radio-Fre-
quency Open-Wire Transmission Lines and
Switchgear for Broadcasting Systems—
 F. C. McLean and F. D. Bolt. (*Jour. I.E.E.*
(London), vol. 93, pp. 191–210; May, 1946.)
 Main points discussed are: the characteris-
 tic impedances, breakdown voltages, and
 attenuation of 2-, 4-, and other multiwire
 lines; the method of construction and sup-
 port as used in high-power transmitters; the
 systems of manual and automatic switching
 between a number of lines, and the influence
 of open-air operation; the matching of
 balanced lines, and the relation between the
 standing-wave ratio and the power-handling
 capacity of the line; the characteristics and
 costs of typical line systems; the work de-
 scribed is that of the British Broadcasting
 Corporation high-power broadcast stations
 at frequencies from 0.2 to 25 megacycles.

621.396.67+621.396.11 2140
A Note on a Simple Transmission For-
mula—Friis (*See* 2282.)

621.396.67 2141
Concerning Hallén's Integral Equation
for Cylindrical Antennas—S. A. Schelkunoff;
 R. King. (*PROC. I.R.E. AND WAVES AND*
ELECTRONS, vol. 34, pp. 265–269; May,
 1946.) Discussion by King of 851 of April.
 Comparative tables are given of experi-
 mental and theoretical values of the signifi-
 cant resonant parameters of aerials having
 $\Omega = 2\pi en(e/a) = 10, 15, \text{ and } 20$. Schelkunoff,
 in replying, points out that Hallén's first
 approximation as used by King in his series
 of papers gives considerable errors, and only
 the latest King and Middleton paper (1435
 of June) gives results of the right order.

621.396.67 2142
"Cloverleaf" Antenna for F-M Broad-
casters—(*Bell Lab. Rec.*, vol. 24, pp. 163–
 164; April, 1946.) Note on an array giving a
 horizontal sheet of horizontally polarized
 rays, eliminating multiple transmission
 lines, phase-correcting networks, balancing
 lines, etc. See also paper by P. H. Smith,
 referred to in 2143.

621.396.67 2143
A Report on the Sixth Annual Confer-
ence of Broadcast Engineers—L. Winner.
 (*Communications*, vol. 26, pp. 30, 74; April,
 1946.) Long, illustrated summaries of the
 following papers: "Circular Antennas," by
 M. W. Scheldorf; "F-M Broadcast Loops,"
 by A. G. Kandoian; "Super Turnstile An-
 tenna," by R. F. Holtz; "The Clover-Leaf-
 F-M Antenna," by P. H. Smith. For other
 papers, see 2125, 2319, and 23657.

621.396.677 2144
Vertical Rhombics—T. J. White. (*Radio*
Craft, vol. 17, pp. 469, 509; April, 1946.)
 A side-length of 49 feet and vertical di-

agonal of 41 feet were found to be the best dimensions for use at 3 to 4.2 meters. Other constructional details, and the advantages of vertical rhombics over both horizontal rhombics and vertical dipole arrays, are discussed.

621.396.677 **2145**

An Umbrella-Type Antenna—A. K. Robinson. (*QST*, vol. 30, pp. 70-73; May, 1946.) A number of radial wires slant downward from a mast and are terminated by resistances to earth. A switching box at the top of the mast selects any pair of adjacent wires to give a sloping-Vee aerial for reception directive in elevation and azimuth. It is shown how the radiation lobes of a single wire of length 4λ combine with ground images and with the lobes of an adjacent wire. A variable-frequency oscillator is used for the adjustment of the terminating resistances, and practical results are given.

CIRCUITS

621.3.011.3:621.3.012.3 **2146**

Nomogram for Computing Inductance of Straight Cylindrical Wires—J. I. Stephen. (*Communications*, vol. 26, pp. 48-49; April, 1946.)

621.318.572 **2147**

Design of Counter Circuits—E. R. Jacobson. (*Radio*, vol. 30, pp. 25, 59; February, 1946.) Description of a double-diode circuit for repetition-rate indication, giving a direct-current output proportional to the frequency of the applied impulses.

621.318.572 **2148**

Gate Circuit for Chronographs—L. B. Tooley. (*Electronics*, vol. 19, pp. 144-145; May, 1946.) A simple circuit, including two thyratrons fired by successive pulses applied to the input, which can be used as a switch controlling the time of operation of a counter system.

621.385.3:621.396.615 **2149**

Circuits for Sub-Miniature Tube—F. R. (*Electronics*, vol. 19, pp. 154-156; May, 1946.) Characteristics are given of the 6K4, a miniature triode suitable for audio-frequency and radio-frequency circuits; design data are given, and circuits suggested for its use in very-high-frequency line-oscillators. The mechanical properties of the tube fit it for use in apparatus subject to vibration.

621.392 **2150**

Theorem on Equivalent Representations of an Arbitrary Linear Network—E. J. Schremp. (*Phys. Rev.*, vol. 69, pp. 259-260; March 1-15, 1946.) Abstract of an American Physical Society paper.

621.392.4.012.3 **2151**

Phase-Shifter Nomograph—R. E. Lafferty. (*Electronics*, vol. 19, p. 158; May, 1946.) For calculating the component values of a bridge-type phase-shifting network with a range from 0 to 180 degrees.

621.394/.397].645.2:621.392.5 **2152**

Theory and Design of Double-Tuned Circuits—A. M. Stone and J. L. Lawson. (*Elec. Ind.*, vol. 5, pp. 62-68, 128; April, 1946.) A detailed analysis giving the exact

solution of shunt-fed, double-tuned, wide-band networks using inductive coupling, and of the equivalent T and π circuits. The results are shown graphically. Special applications considered are: (a) video-frequency amplifier interstage coupling; (b) intermediate-frequency amplifier interstage coupling (15 megacycles wide, 30 megacycles mean); (c) coupling of intermediate-frequency amplifier to line; (d) coupling of frequency converter to intermediate-frequency amplifier.

621.395.645.2:621.395.813 **2153**

Radio Design Worksheet: No. 45—[Harmonic Distortion in] Non-Linear Resistances; [And Effect on Gain of] Amplifier Coupling—(*Radio*, vol. 30, pp. 33-34; February, 1946.)

621.394/.397].645.3 **2154**

Balanced Output Amplifiers of Highly Stable and Accurate Balance—E.M.I. Laboratories. (*Electronic Eng.*, vol. 18, p. 189; June, 1946.) A pair of amplifying vacuum tubes have a common cathode circuit with the usual resistor replaced by a tube that is controlled from a potential divider connected between the anodes of the two amplifiers. The resulting stability and accurate balance is obtained without excessive potential drop in the cathode circuit.

621.395.645.3 **2155**

High-Fidelity All Purpose Amplifier—R. T. Rogers and M. Putnam. (*Radio News*, vol. 35, pp. 32-34; April, 1946.) Details of the circuit and performance of a 30-watt audio-frequency amplifier with negative feedback and bass and treble controls. The noise level is 50 decibels below maximum output and the distortion less than 4 per cent.

621.396.611.21 **2156**

Forced Vibrations of Piezoelectric Crystals—H. Ekstein. (*Phys. Rev.*, vol. 69, p. 257; March 1-15, 1946.) Abstract of an American Physical Society paper.

621.396.615 **2157**

Two-Terminal Oscillator—M. G. Crosby. (*Electronics*, vol. 19, pp. 136-137; May, 1946.) A twin triode is connected with one triode as a cathode follower driving the second triode through the common cathode resistance. The input-output transconductance is negative, so that an oscillator can be made by two-point connection of a tuned circuit. Several applications are given, including the use of the circuit as a class-A limiter and as a true square-wave multivibrator.

621.396.615.11/.12 **2158**

A Wide-Range Test Oscillator—C. F. Lober. (*QST*, vol. 30, pp. 40-42; May, 1946.) Constructional details of a resistance-capacitance oscillator for 17 to 218,000 cycles, sine- or square-wave, using a Wien-bridge circuit.

621.396.615.17+621.318.572 **2159**

Pulsing Circuits for Timing Applications—R. L. Rod. (*Radio*, vol. 30, pp. 27-30, 60; February, 1946.) Circuit details of the clipped-sine-wave pulse-generator, the self-running and triggered multivibrator, the

blocking oscillator, the triggered-blocking-oscillator dividing-circuit, the triggered-transitron pulse-generator, a simple circuit for pulse-width discrimination, the pentode gating-circuit, and a triode coincidence-indicator.

621.396.615.17 **2160**

Controlled and Uncontrolled Multivibrators—E. R. Shenk. (*Proc. Radio Club Amer.*, vol. 23, 18 pp.; February, 1946.) An analysis, on the basis of capacitor-resistor time constants, gives an equation relating the natural frequency to the characteristics of the vacuum tubes and to the circuit components. The conditions to be satisfied in a synchronized multivibrator to allow for variations in the circuit time constants are deduced, and the wave form and phase of the synchronizing voltage are considered. Percentage variations in the frequency of the synchronizing pulses over which a given order of division can be maintained, and the application of either positive or negative pulses are discussed. Design curves are included, and worked examples are given.

621.396.615.17 **2161**

Waves and Pulses—J. McQuay. (*Radio Craft*, vol. 17, pp. 470, 499; April, 1946.) The basic principles of pulse formation, followed by brief details of eight pulse-producing circuits.

621.396.615.17:621.317.755 **2162**

Single Sweep [Timebase] Generator—D. McMullan. (*Radio*, vol. 30, pp. 4, 8; February, 1946.) Illustrated summary of 571 of March.

621.396[.619+].621.53 **2163**

The Calculation of Intermodulation Products by Means of a Difference Table—A. Bloch. (*Jour. I.E.E.* (London), vol. 93, pp. 211-216; May, 1946.) The method of central differences used by Espley (3872 of 1940) is applied to the intermodulation products in a nonlinear device fed with two voltages of different frequency. Sheppard's difference and average operators σ and μ are applied and the evaluation carried out in terms of the function $F\ddagger(a)$ which is tabulated in the paper.

621.396.662.3:621.396.611.21 **2164**

The Crystal Filter: Parts 1 & 2—R. W. Ehrlich. (*Radio Craft*, vol. 17, pp. 398, 442 and 476, 507; March and April, 1946.) An elementary account of the principles and applications.

621.396.662.34:621.396.44:621.396.611.21 **2165**

A New Crystal Channel Filter for Broad Band Carrier Systems—E. S. Willis. (*Trans. A.I.E.E.* (*Elec. Eng.*, March, 1945), vol. 65, pp. 134-138; March, 1946.) Four crystal units are assembled in one lattice-type filter section, with substantial savings of weight and space. Attenuation of 50 to 60 decibels is obtained for frequencies of more than 700 kilocycles from the edge of the pass band, which is about 3 kilocycles wide. Temperature changes of 20 degrees Fahrenheit alter the frequency by 0.03 per cent.

621.396.69 **2166**

Printed Circuit Wiring—(See 2229.)

- 621.396.82:621.317.79 2167
Cylindrical Shielding and Its Measurement at Radio Frequencies—A. R. Anderson. (PROC. I.R.E. AND WAVES AND ELECTRONS, vol. 34, pp. 312–322; May, 1946.) “The effectiveness of shields from the point of view of the wave theory of shielding is discussed. Specific consideration is given to cylindrical shielding against low-impedance fields and its measurement at radio frequencies. Various methods and concepts of measurement are discussed briefly; inadequacy of probe-type tests and the advantages of an integrating-type test are pointed out.”
- “Equipment of the integrating type suitable for production testing of specimens of cylindrical shielding from 3/16 to 2 inches diameter at 3 megacycles is described and illustrated. With this equipment, shielding effectiveness of the unknown is determined in terms of the effectiveness of a specified rigid metal-tube standard. Sensitivity is sufficient to measure the leakage through 0.024-inch of copper at the test frequency. A shielded room is not required.”
- “Experimental results obtained with this and similar equipment from 200 kilocycles to 10 megacycles are given. Tests at various frequencies on thin-wall copper tubes of different thicknesses are shown to be in agreement with the results predicted by theory. Included are data on metal tubes, wire braids, coaxial cable, and flexible-shielding conduits.”
- “Test results are shown to be independent of current through the specimen, receiver gain or adjustment, and various other factors. Results are shown also, in general, to be independent of the length of specimen tested and its impedance. Various factors affecting test results are considered and formulas are given for correcting results obtained on exceptional specimens having abnormally high resistance.”
- 621.396.822 2168
A Generalization of Nyquist's Thermal Noise Theorem—Schremp. (See 2300.)
- 621.394/.397].645.3+621.392.5 2169
Network Analysis and Feedback Amplifier Design [Book Review]—H. W. Bode. D. Van Nostrand Company, Inc., New York, N. Y., 1945, 529 pp., \$7.50. (PROC. I.R.E. AND WAVES AND ELECTRONS, vol. 34, p. 277; May, 1946.) “The communication engineer, whose mathematical foundation has been well laid and well used, will find this advanced text to be an authoritative and up-to-date contribution to the field of network-theory applications.”
- GENERAL PHYSICS**
- 517.947.44:534.25 2170
The Wave Equation in a Medium with a Variable Index of Refraction—P. G. Bergmann. (Jour. Acous. Soc. Amer., vol. 17, pp. 329–333; April, 1946.) In the usual derivation of the wave equation for the sound pressure in air or in water no account is taken of the occurrence of density gradients. In this paper, preliminary consideration is given to the conditions under which these gradients should be considered in the derivation of the wave equation itself.
- 523.165+537.591.15 2171
The Origin of Large Cosmic-Ray Bursts—R. E. Lapp. (Phys. Rev., vol. 69, pp. 321–337; April 1–15, 1946.)
- 530.12+531.51+538.3 2172
A Classical Theory of Electromagnetism and Gravitation: Part 1—Special Theory—H. C. Corben. (Phys. Rev., vol. 69, pp. 225–234; March 1–15, 1946.) A unified electromagnetic and gravitational field theory is obtained by introducing a fifth-dimension *ict'* where *t'* is a second dimension of time symmetrical with *t*. The special theory (in which $\partial/\partial t' = 0$) is presented here. The extended conservation laws for charge, mass, energy, momentum, and the fields of a point charge-mass are derived. An accelerated mass radiates longitudinal gravitational waves which are propagated with the velocity of light *in vacuo*, and the resultant energy loss may be observable in the case of large bodies. In matter, gravitational waves are slowed down, and are identified with sound waves.
- 531.4+539.62 2173
Studies in Friction: Part 1—“Solid” Versus “Polar” Boundary Films—M. E. Merchant. (Phys. Rev., vol. 69, pp. 250–251; March 1–15, 1946.) The friction between iron surfaces and the durability of the boundary film are very different according to whether carbon tetrachloride or oleic acid is added to pure mineral-oil lubricant. Abstract of an American Physical Society paper.
- 536.2:546.87-1 2174
The Thermal Conductivity of Bismuth at Low Temperatures—S. Shalyt. (Jour. Phys., (U.S.S.R.), vol. 8, no. 5, pp. 315–316; 1944.) Short description of measurements made with a cylindrical specimen of high purity set up in a suitable magnetic field. At 65 to 80 degrees kelvin the thermal resistance was increased 15 to 20 per cent by the application of the field, but no detectable change was observed at 2 to 4 degrees kelvin. In the absence of the field, the thermal resistance reached a minimum value in the region of 4 degrees kelvin. It is concluded that the minimum “. . . is chiefly due to the lattice.”
- 537.122:538.3 2175
Classical Theory of the Point Electron—M. Schönberg. (Phys. Rev., vol. 69, pp. 211–224; March 1–15, 1946.)
- 537.32:537.312.62 2176
On the Thermoelectric Phenomena in Superconductors—V. L. Ginsburg. (Jour. Phys., (U.S.S.R.), vol. 8, no. 3, pp. 148–153; 1944.)
- 537.564 2177
On the Energy Loss of Fast Particles by Ionization—L. Landau. (Jour. Phys., (U.S.S.R.), vol. 8, no. 4, pp. 201–205; 1944.) A theoretical development of a formula for the energy loss distribution for a fast particle which traverses a layer of matter and loses a small part of its energy through ionization, i.e., a formula for the probability that the energy loss shall lie between given limits.
- 538.114 2178
On the Theory of Ferromagnetism—B. T. Geylikman. (Jour. Phys., (U.S.S.R.), vol. 8, no. 3, pp. 182–191; 1944.) “On the basis of a translation model of the metal the temperature dependence of the magnetic moment at high and low temperatures has been found. At high temperatures the dependence obtained differs slightly from Heisenberg's formula; the Curie temperature, however, appears to depend on the degree of filling of the zone. The dependence of the conductivity of ferromagnetics on the temperature, which agrees with experiment, is also determined.” An appendix gives a brief theoretical treatment of the fine structure of emission and absorption spectra from metals.
- 621.314.632:537.221 2179
Erratum: A Method for Measuring Effective Contact E.M.F. Between a Metal and a Semi-Conductor—W. E. Stephens, B. Serin, and W. E. Myerhof. (Phys. Rev., vol. 69, p. 244; March 1–15, 1946.) Graph omitted from 1519 of June.
- 621.385:538.312 2180
Energy Conversion in Electronic Devices—Gabor. (See 2394.)
- GEOPHYSICAL AND EXTRATERRESTRIAL PHENOMENA**
- 523.165+537.591.15 2181
The Origin of Large Cosmic-Ray Bursts—R. E. Lapp. (Phys. Rev., vol. 69, pp. 321–337; April 1–15, 1946.)
- 523.72:621.396.822 2182
Microwave Radiation from the Sun—G. C. Southworth. (Jour. Frank. Inst., vol. 241, March, 1946.) Correction to 3252 of 1945.
- 523.746 2183
Sunspots—A. L. Narayan. (Curr. Sci., vol. 15, pp. 95–98; April, 1946.) A general description of the structure and characteristics. The complex motion of the associated matter is discussed.
- 550.37 2184
Magnitude of the Earth's Charge—A. B. Arlick. (Curr. Sci., vol. 14, pp. 318–319; December, 1945.) In the light of modern theory, the value of *Q* is modified to 2.5×10^{24} coulombs instead of 4.5×10^{26} coulombs, as previously assumed.
- 550.37 2185
Structure of the Earth's Electric Field—A. B. Arlick. (Curr. Sci., vol. 15, pp. 105–106; April, 1946.) Certain anomalies in terrestrial magnetism and electricity are thought to be a natural consequence of the internal core, and of the existence of positive and negative ionic layers in the atmosphere.
- 550.37 2186
A Theory of the Fundamental Phenomena of Atmospheric Electricity—J. Frenkel. (Jour. Phys., (U.S.S.R.), vol. 8, no. 5, pp. 285–304; 1944.) Attention is drawn to the application of the concepts of colloidal suspensions to the case of the atmosphere in which charged water drops and ice crystals are suspended. Laboratory measure-

ments are considered in which a model of the atmosphere may be built using a suitable colloidal suspension.

In the atmosphere, the cloud of charged drops becomes polarized due to the drops' sinking under gravitational force. The steady downward field within the cloud is in the range of 30 to 150 volts per centimeter. The field in the space surrounding a spherical cloud is also calculated, and the numerical values agree fairly well with those measured in practice. "The clouds can thus be treated as electrical generators using the potential energy of the forces of gravity with a very small efficiency (of the order of 10^{-4}). . . The special conditions which are characteristic of thunder clouds are elucidated (large vertical thickness and high water content), as well as the role of the increase of the negative local fields (giving rise to lightning discharges)." The mechanism by which the initial negative charge on the rain drops is neutralized (and sometimes reversed) during their passage to the ground is discussed.

551.51.053.5:523.78 **2187**

Ionosphere Observations [at Uppsala] During the Solar Eclipse on September 10, 1942—W. Stoffregen. (*Ark. Mat. Astr. Fys.*, vol. 32, Part 4, Section B, 6 pp.; February 20, 1946.) "The observations agree with earlier ones, and show a well-marked ionization decrease of the F_2 -region during the obscuration of the sun. The virtual height of the F_2 -region increased parallel with the eclipse. No time difference of importance between the variation of the eclipse and the ionization was noted."

551.51.053.5:621.396.11 **2188**

On the Absorption of Radio Waves and the Number of Collisions in the Ionosphere—Ginsburg. (See 2287.)

631.437 **2189**

On the Theory of Seismic and Seismoelectric Phenomena in a Moist Soil—J. Frenkel. (*Jour. Phys.*, (U.S.S.R.), vol. 8, no. 4, pp. 230-241; 1944.) The propagation of elastic waves in the surface layers of the soil is accompanied by the appearance of electrical potential differences between points situated at different distances from the source. "According to the theory of Helmholtz and Smoluchovski, the difference of hydrostatic pressure Δp between two points of the soil must be connected with a difference of the electrical potential $\Delta V = (\epsilon\xi/4\pi\mu\sigma)\Delta p$ where ξ is the electrokinetic potential, i.e., the potential drop in the surface double layer, μ the viscosity of the water, and σ its electrical conductivity." The paper contains a very detailed theoretical analysis of the propagation of transverse and longitudinal waves in dry and moist soil, from which the electrical effects are derived in accordance with the above formula.

LOCATION AND AIDS TO NAVIGATION

621.396.11:551.51.053.5:621.396.9 **2190**

2-Mc Sky-Wave Transmission—J. A. Pierce. (*Electronics*, vol. 19, pp. 146-153; May, 1946.) A simplified review of present

ionospheric knowledge, with particular reference to loran operations and the effect upon the sky-wave delay times of reflections at the E and F layers. It is shown that the E layer is relatively stable, is little affected by ordinary disturbing phenomena, and can be used for loran operations at medium and long ranges.

621.396.9 **2191**

An Introduction to Loran—J. A. Pierce. (*PROC. I.R.E. AND WAVES AND ELECTRONS*, vol. 34, pp. 216-234; May, 1946.) The history and principles of the system are described. Within the ground-wave service area (ranges up to 700 nautical miles over sea) errors vary from about 300 yards to 1 mile; at night, distances up to 1400 miles may be covered by sky waves, giving errors of $1\frac{1}{2}$ to 8 miles.

The ultimate potential accuracy and the possibility of automatic position indicators and course followers are discussed, and mention is made of a new "cycle matching" technique which may considerably enhance the present accuracy of measurement.

The transmitting and receiving apparatus is broadly described, with block diagrams.

621.396.9 **2192**

The Decca Navigator—(*Electronic Eng.*, vol. 18, pp. 166-171; June, 1946.) A detailed description of the system with a functional account of the equipment. See also 1848 of July and back reference.

621.396.9 **2193**

Shoran Precision Radar—S. W. Seeley. (*Trans. A.I.E.E. (Elec. Eng.)*, April, 1946), vol. 65, pp. 232-240; April, 1946.) The system has been used extensively for air navigation, aerial mapping, and blind bombing. The aircraft transmits short pulses, at about 250 megacycles, to a pair of spaced ground stations fitted with repeaters that receive, reshape, and retransmit the pulses. The time delay between the original transmission and the reception at the aircraft of the retransmitted pulses determines the position of the craft relative to the repeaters. There is no transmission between the ground stations. The history of the project, the method of use, and the main technical features of the system are described. The equipment is designated AN/APN-3 and AN/CPN-2. Useful range about 250 miles, accuracy about 50 feet.

621.396.9 **2194**

Merchant Marine Radar—I. F. Byrnes. (*RCA Rev.*, vol. 7, pp. 54-66; March, 1946.) A survey of the essential requirements, based on the U. S. Coast Guard "Minimum Recommended Specification Briefs," and on a similar British document. It deals particularly with the so-called class-A type of radar, which operates in the 3-centimeter band, and is intended for navigation in restricted waters, with a receiver having a noise factor not worse than 15 decibels, and using a plan-position indicator. The importance of adequate power for operation under adverse conditions is emphasized.

621.396.9 **2195**

Radar Systems Considerations—D. A.

Quarles. (*Trans. A.I.E.E. (Elec. Eng.)*, April, 1946), vol. 65, pp. 209-215; April, 1946.) A technical background for the more detailed exposition of modern radar. A brief description is given of the nature and function of each major part of the system.

621.396.9 **2196**

Radar for Blind Bombing: Part 1—J. V. Holdam, S. McGrath, and A. D. Cole. (*Electronics*, vol. 19, pp. 138-143; May, 1946.) A description of the history and circuit details of H2X, the 3-centimeter radar system designed for use in aircraft as a navigational aid, and for the location and identification of ground targets obscured by cloud or smoke. The antenna, with a 29-inch modified paraboloid reflector, gives a beam width of 3 degrees, can be rotated through 360 degrees in azimuth, and tilted through ± 20 degrees in elevation. The echoes are displayed on an azimuth-stabilized plan-position indicator presentation, with the aircraft heading shown as a radial line starting at the center of the tube. An electronic bombing computer provides a range mark, the bombs being released when range mark and target coincide. For navigation, the system can be used in conjunction with the radar responder beacons situated on the ground. When these beacons receive a pulse of the proper duration in the airborne search-radar frequency band, they respond with a coded series of pulses in the beacon frequency band. The subsequent display on the plan-position indicator then gives the aircraft's position relative to a known point.

There are two versions of the equipment designated AN/APQ-13 and AN/APS-15.

621.396.9:523.3 **2197**

Radar Reaches the Moon—T. Gootée. (*Radio News*, vol. 35, pp. 25, 88; April, 1946.) For a more detailed account, see 1856 of July (Mofenson). For other brief accounts, see J. DeWitt, *Radio Craft*, vol. 17, pp. 464, 502; April, 1946; and H. Kauffman, *QST*, vol. 30, pp. 65-68; May, 1946.

621.396.9:621.385.832 **2198**

The Skiatron in Radar Displays—King: Watson. (See 2404.)

621.396.933.2 **2199**

The Omnidirectional Range—D. M. Stuart. (*Aero Digest*, vol. 49, pp. 76, 77, 150; June 15, 1945.) Outline description of the system. In the aircraft the azimuth of the ground station is determined from the phase of the received 60-cycle modulation, imposed at the ground by means of a continuously rotating goniometer on the carrier radiated from two pairs of cross-connected monopoles. Radiation from a central monopole is used for reference purposes.

621.396.933.2 **2200**

An Omnidirectional Radio-Range System: Part 3—Experimental Results and Methods of Use—D. G. C. Luck. (*RCA Rev.*, vol. 7, pp. 94-117; March, 1946.) For parts 1 and 2, see 458 and 2388 of 1942. Tests were made at about 6 and 125 megacycles. Ground measurements showed overall instrumental errors averaging less than 1 degree, but "flight tests. . . showed considerably larger errors, apparently related to

terrain or transmitter-site characteristics. Sky-wave operation at the lower frequency was found fairly satisfactory in the absence of violent fading. Standing-wave effects were sought but not found in the ultra-high-frequency field. Trouble was experienced in the higher-frequency flight tests with spurious modulation of received signals produced by spinning propellers and imperfect structural bonding of aircraft, as well as with ignition interference."

621.396.9 2201

Radar [Book Review]—O. E. Dunlap, Jr., Harper and Bros., New York, N. Y., 203 pp., \$2.50; 1946. (PROC. I.R.E. AND WAVES AND ELECTRONS, vol. 34, p. 277; May, 1946.) "The text is well written, easily read, and up-to-date. . . . It is a valuable nontechnical contribution to inform the general public. . . ."

621.396.9 2202

Radar—Radiolocation Simply Explained [Book Review]—R. W. Hallows. Chapman & Hall, London, 140 pp., 7s. 6d. (*Elec. Rev.*, London, vol. 138, p. 848; May 31, 1946.) ". . . not highly technical, but contains a clear exposition of the basic principles."

MATERIALS AND SUBSIDIARY TECHNIQUES

531.788 2203

A Reliable High Vacuum Gauge and Control System—R. G. Picard, P. C. Smith, and S. M. Zollers. (*Rev. Sci. Instr.*, vol. 17, pp. 125–129; April, 1946.) The instrument incorporates two gauges, a thermocouple, and a cold-cathode discharge gauge, neither of which is damaged by the admission of air to the vacuum system. The useful range is from atmospheric pressure to about 10^{-4} millimeters of mercury. The gauges are described, and a circuit is given whereby the gauge current can be used to operate other devices.

531.788.7 2204

An Ionization Gauge of Simple Construction—C. M. Fogel. (PROC. I.R.E. AND WAVES AND ELECTRONS, vol. 34, pp. 302–305; May, 1946.) For pressure range 10^{-4} to 10^{-8} millimeters of mercury. Advantages claimed include easy outgassing, good sensitivity, linear scale, small leakage current, and the fact that the filament is not damaged by heating it in air.

533.5 2205

A High Temperature Sodium Chloride to Glass Vacuum Seal for Infra-Red Cells—G. L. Simard and J. Steger. (*Rev. Sci. Instr.*, vol. 17, pp. 156–157; April, 1946.)

533.5 2206

A Rapidly Acting Vacuum Valve—D. D'Eustachio. (*Phys. Rev.*, vol. 69, p. 251; March 1–15, 1946.) Abstract of an American Physical Society paper.

535.37:661.1:546.791 2207

Polarization of Photoluminescence of Uranium Glasses—A. N. Sevchenko. (*Jour. Phys.*, (U.S.S.R.), vol. 8, no. 3, pp. 163–169; 1944.) An experimental investigation showing that the polarization depends markedly on the wavelength of the exciting radiation,

and that the fine structure of the polarization spectra depends on the structure of the uranium molecules. The maximum polarization in the specimens examined was 25 per cent. The polarization decreases with the decay of luminescence, showing that the ". . . energy of excitation is transmitted from the excited to the unexcited molecules. . . . It is proved that the nature of absorption and emission of radiation by uranium in glass and in solutions is due to electric dipoles."

537.228.1+539.32+621.3.011.5]: [546.32.85+546.39.85 2208

The Elastic, Piezoelectric, and Dielectric Constants of Potassium Dihydrogen Phosphate and Ammonium Dihydrogen Phosphate—W. P. Mason. (*Phys. Rev.*, vol. 69, pp. 173–194; March 1–15, 1946.) The full paper of which an abstract was summarized in 1260 of May.

539.234:535.87:546.621 2209

Numerical Data on the Optical Properties of Aluminized Mirrors—L. Dunoyer. (*Compt. Rend. Acad. Sci.*, Paris, vol. 220, pp. 686–688; May 7, 1945.) Mirrors were prepared by condensation in a vacuum, and the transmission and reflection factors measured for the metallized and unmetallized sides. The same factors are derived for the metal layer alone in air and in glass. A table shows these data for metal thicknesses from 7.5 to 80.9 millimicrons. For other measurements on the mirrors, see 2210 and 2212 below.

539.234:535.87:546.621 2210

On the Optical Density of Thin Films of Aluminium Deposited on Glass by Evaporation and the Thickness of the Protective Alumina Layer—L. Dunoyer. (*Compt. Rend. Acad. Sci.*, Paris, vol. 220, pp. 816–817; June 4, 1945.) The curve of optical density against film thickness (determined by weight) has a sharp bend for a thickness of 10.8 millimicrons which, together with previous evidence, suggests a change in layer structure for a thickness of about 11 millimicrons. Extrapolation indicates zero optical density for a film thickness of 5.4 millimicrons. This is explained as due to oxidation of an actual thickness of 2.9 millimicrons of metallic aluminium. Correction for the oxide layer converts the figure for the critical thickness from 11 to 8.5 millimicrons.

The absorption and extinction coefficients are calculated.

539.234:546.621 2211

On the Diffusion of Atoms or Molecules by a Glass Wall—L. Dunoyer. (*Compt. Rend. Acad. Sci.*, Paris, vol. 220, pp. 520–522; April 9, 1945.) A film of aluminium deposited on glass by condensation at oblique incidence in a vacuum was found to vary in thickness with distance from the emitting source at a rate that changed abruptly at the place where the thickness was about 11 millimicrons. It is suggested that the crystallites in films of greater thickness are sufficiently close to ensure the capture of each incident atom by the field of the nearest crystal lattice, whereas for thinner films an appreciable fraction of the incident atoms do not adhere, but are diffused away from the glass. It is

considered unlikely that the discontinuity in the rate of change of density of the film is associated with the difference in angle of incidence of the particles.

539.243:621.316.849.011.2:546.621 2212

Electrical Resistance of Thin Films of Aluminium Deposited on Glass by Thermal Evaporation—L. Dunoyer. (*Compt. Rend. Acad. Sci.*, Paris, vol. 220, pp. 907–909; June 25, 1945.) The resistivity of the metal film increases as the thickness is reduced. The ratio of film resistivity to bulk resistivity is about 2 for thicknesses near 100 millimicrons (corrected for the oxide layer), 9.4 for 7.2 millimicrons, 119 for 3.3 millimicrons, 860 for 1.9 millimicrons and ∞ for 0.9 millimicron, corresponding to a layer about two atoms thick. Figures are given for 19 different thicknesses.

539.32.082 2213

Elastic Constants of Crystals—S. Bhagavantam. (*Sci. Culture*, vol. 11, Suppt., p. 3, April, 1946.) Abstract of an address delivered at the Indian Science Congress, describing a new method of measuring the elastic constants of materials in the form of small plates.

546.287:621.315.612 2214

The Use of Liquid Dimethylsilicones to Produce Water-Repellent Surfaces on Glass-Insulator Bodies—O. K. Johannson and J. J. Torok. (PROC. I.R.E. AND WAVES AND ELECTRONS, vol. 34, pp. 296–302; May, 1946.) The article to be treated is thoroughly cleaned and dipped in a dilute solution of the silicone in an inert solvent. The solvent is allowed to evaporate and the article is then baked to fix the film on the surface. The routine is described.

Numerical and graphical results given in terms of surface resistance and power factor show that this finish is superior both to the untreated surface and to wax-dipped surfaces. The over-all power factor in the dry state is not affected by the finish. The silicone does not affect the resistance to fungus growth.

546.287:621.315.616.9:621.316.842 2215

Silicone Coating for [Wire-wound] Resistors—E. E. Marbaker. (*Radio*, vol. 30, p. 10; February, 1946.) Withstands repeated 275 degrees centigrade thermal shocks and repeated immersion in hot and cold salt water without cracking, crazing, or peeling, and has good dielectric strength. Summary of a paper in the *Jour. Amer. Ceramic Soc.*, December 1, 1945.

546.289:[621.315.59+621.314.63 +537.32 2216

Germanium Alloys—(*Phys. Rev.*, vol. 69, pp. 258–259; March 1–15, 1946.) Abstracts are given of the following American Physical Society papers: "Electrical Properties of Germanium Alloys: Part 1—Electrical Conductivity and Hall Effect," by K. Lark-Horovitz, A. E. Middleton, E. P. Miller, and I. Walerstein; "Electrical Properties of Germanium Alloys: Part 2—Thermoelectric Power," by K. Lark-Horovitz, A. E. Middleton, E. P. Miller, W. W. Scanlon, and I. Walerstein; "Theory of Impurity Scattering in Semiconductors," by E. Conwell and

- V. F. Weisskopf; "Theory of Resistivity in Germanium Alloys," by K. Lark-Horovitz and V. A. Johnson; "Theory of Thermo-electric Power in Germanium," by V. A. Johnson and K. Lark-Horovitz.
- 621.314.63+621.315.59 **2217**
Heat Treatment of Semi-Conductors and Contact Rectification—B. Serin. (*Phys. Rev.*, vol. 69, pp. 357-362; April 1-15, 1946.) The influence of heating silicon to about 1000 degrees centigrade probably causes evaporation of the impurities, and an analysis of this process is given which suggests that a surface layer of at least 10^{-6} -centimeter thickness is depleted. The characteristics of a rectifier so formed are given following Bethe's theory, and it is concluded that heat treatment results in increased back resistance and decreased contact capacity, with improvement in rectification efficiency.
- 621.315.59 **2218**
On the Theory of Electric Properties of Good Conducting Semi-Conductors—K. Shifrin. (*Jour. Phys.*, (U.S.S.R.), vol. 8, no. 4, pp. 242-252; 1944.) A theoretical and experimental study of the properties of substances such as lead sulphide and lead selenide, which have relatively high conductivities (of the order of 100 or even 1000 mhos per centimeter, and which differ from ordinary semiconductors in the sign of the temperature coefficients of conductivity and thermo-electromotive force. It appears that these distinctive properties are caused by the presence of atoms of impurity metals.
- 621.315.612.6:621.315.613.1 **2219**
Manufacture and Use of Glass Bonded Mica—D. E. Replogle. (*Elec. Ind.*, vol. 5, pp. 94-96; April, 1946.) A general survey of its properties and of its advantages over other synthetic insulators. It may be machined or moulded with greater ease and accuracy than steatite, has good electrical properties, does not require sealing, and will not support fungus growth.
- 621.315.615:621.319.4:621.365.5 **2220**
Capacitors for High-Frequency Induction-Heating Circuits—F. M. Clark and M. E. Scoville. (*Trans. A.I.E.E. (Elec. Eng.*, December, 1945), vol. 64, pp. 995-996; December Supplement, 1945.) Discussion of 636 of March.
- 621.315.616.7 **2221**
Sulfur in Synthetic Rubbers—F. S. Malm. (*Bell Lab. Rev.*, vol. 24, pp. 106-110; March, 1946.) A short study of the solubility and diffusion rates of sulphur in the process of vulcanization.
- 621.315.616.9 **2222**
The Development of Polythene as a High-Frequency Dielectric—W. Jackson and J. S. A. Forsyth. (*Jour. I.E.E. (London)*, vol. 92, p. 214; May, 1945.) Summary of 2768 of 1945.
- 621.318.32:621.318.42 **2223**
Ferroinductance as a Variable Electric-Circuit Element—J. D. Ryder. (*Trans. A.I.E.E. (Elec. Eng.*, December, 1945), vol. 64, pp. 962-963; December Supplement, 1945.) Discussion of 643 of March.
- 621.318.32.013:539.3 **2224**
Magnetization and Stress—R. M. Bozorth. (*Bell Lab. Rec.*, vol. 24, pp. 116-119; March, 1946.) A short account, illustrated by curves for iron, nickel, and 68 Permalloy, of the effect of mechanical stress on ferromagnetic properties.
- 621.318.322:[621.314.2.029.4/.5 **2225**
Applications of Thin Permalloy Tape in Wide-Band Telephone and Pulse Transformers—A. G. Ganz. (*Trans. A.I.E.E. (Elec. Eng.*, April, 1946), vol. 65, pp. 177-183; April, 1946.) An account of construction and properties, illustrated by graphs, and of the applications to both transformers and nonlinear inductors.
- 621.357.9 **2226**
Remarks on the Mechanism of Electrolytic Polishing and on Its Unevenness in the Case Where There Exists a Viscous Anodic Layer—C. Gutton. (*Compt. Rend. Acad. Sci.*, Paris, vol. 220, pp. 684-686; May 7, 1945.)
- 621.396.611.21 **2227**
Plating Quartz Oscillator Crystals—K. M. Laing. (*Communications*, vol. 26, pp. 26-28, 56; April, 1946.) An analysis of plating methods.
- 621.396.611.21:537.531.9 **2228**
Quartz Oscillator Plates; Frequency Adjustment by X-Ray Irradiation—L. A. Thomas. (*Beama Jour.*, vol. 53, p. 144; April, 1946.) Describes changes in color and in elastic properties when exposed to X-rays. Abstract of a paper in *Elec. Times*, vol. 109, pp. 336-340; March 7, 1946.
- 621.396.69 **2229**
Printed Electric-Circuit Process—(*Communications*, vol. 26, pp. 78, 79; April, 1946.) See also 1887 of July (Brunetti and Khouri), and *Elec. Ind.*, vol. 5, pp. 90, 120; April, 1946.
- 621.791.3:621.315.351 **2230**
Destructive Effect of High Temperature Solders on Copper Wire—R. H. Bailey. (*Wire and Wire Prod.*, vol. 20, pp. 197-199; March, 1945.) The influence of temperature, wire size, and tin content of the solder is discussed and illustrated by graphs, and the detrimental effect on wire life of high soldering temperatures and high tin content emphasized. It is recommended that fine wires should be soldered at temperatures below 600 degrees Fahrenheit.
- 66.002.3(03) **2231**
Encyclopedia of Substitutes and Synthetics. [Book Review]—M. D. Schoengold (Editor). Philosophical Library, New York, N. Y., 1943, 360 pp., \$10.00. (Proc. I.R.E. AND WAVES AND ELECTRONS, vol. 34, p. 280; May, 1946.)
- 666.1/.2 **2232**
The Elements of Glass Technology for Scientific Glass Blowers (Lampworkers). [Book Review]—W. E. S. Turner. The Glass Delegacy of the University of Sheffield, Sheffield, 1945, 29 pp. (*Rev. Sci. Instr.*, vol. 17, p. 147; April, 1946.) "... a very compact and concise summary of the fundamental properties of glass which are concerned in such working."
- 679.5 **2233**
Plastics: Scientific and Technological. [Book Review]—H. R. Fleck. English University Press, London, 25s. (*Engineer*, London, vol. 181, p. 294; March 29, 1946.) "Instructive and comprehensive treatise which will be of considerable value to all connected with the application of plastics in industry." Contains survey of literature.
- MATHEMATICS**
- 518.5 **2234**
A New Type of Differential Analyzer—V. Bush and S. H. Caldwell. (*Jour. Frank. Inst.*, vol. 241, March, 1946.) Correction to 361 of February.
- 621.396.67 **2235**
Concerning Hallén's Integral Equation for Cylindrical Antennas—Schelkunoff: King. (See 2141.)
- 51:62 **2236**
Engineering Mathematics. [Book Review]—H. Sohon. D. Van Nostrand Company, Inc., New York, N. Y., 1944, 278 pp., \$3.50. (*Rev. Sci. Instr.*, vol. 17, pp.142-143; April, 1946.)
- 518.2 **2237**
Tables of Functions with Formulae and Curves. [Book Review]—E. Jahnke and F. Emde. Dover Publications, New York, N. Y., 306 pp., 22s. 6d. (*Beama Jour.*, vol. 53, p. 138; April, 1946.) An enlarged and new edition (subsequent to the 1938 edition).
- MEASUREMENTS AND TEST GEAR**
- 621.3.083.7:629.13 **2238**
Electronic Recorder Aids Flight Research—T. A. Dickinson. (*Aero Digest*, vol. 49, pp. 76, 200; April 15, 1945.) General description of an 80-channel telemetering system for transmitting data from aircraft instruments to a pen-recorder assembly on the ground.
- 621.3.087.5 **2239**
Colored Trace Oscillograms—L. S. Trimble and F. W. Bowden. (*Jour. Soc. Mot. Pict. Eng.*, vol. 46, pp. 231-236; March, 1946.) A color-sensitive photorecording material has been used for the simultaneous recording of several electrical impulses. This allows the reproduction of interweaving traces in separate and distinct colors. A $5\frac{1}{2}$ -inch-wide film in combination with filtered light beams has given recording speeds up to 20 inches per second.
- 621.317:621.396.61 **2240**
Resonant-Cavity Measurements—R. L. Sproull and E. G. Linder. (Proc. I.R.E. AND WAVES AND ELECTRONS, vol. 34, pp. 305-312; May, 1946.) Methods of measuring the resonant frequency, Q , and shunt resistance of resonant cavities in the wavelength range 2 to 12 centimeters are described. A frequency-modulation oscillator is used with probe injection to the cavity under test. A similar probe is used with a crystal detector, of which the output is amplified and applied to the Y plates of a

cathode-ray oscilloscope. The 60-cycle time-base on the *X* plates controls the modulator of the oscillator so that a stationary "response" curve of the cavity is obtained. The procedure is described for using this apparatus for measuring the resonant frequency in terms of that of a cavity-resonator wavemeter, and for measuring the *Q*. The shunt impedance is derived from measurements of *Q* or resonant frequency before and after the insertion of a rod of lossy dielectric into the resonator.

621.317.1:621.315.21.029.5/6 2241
Testing of R.F. Cables—(See 2130.)

621.317.341.029.58/62:621.315.212 2242
The S-Function Method of Measuring Attenuation of Coaxial Radio-Frequency Cable—C. Stewart, Jr. (*Trans. A.I.E.E. (Elec. Eng., December, 1945)*, vol. 64, p. 966; December Supplement, 1945.) Discussion of 666 of March.

621.317.35+621.3.018.7 2243
Television Waveforms—(See 2359.)

621.317.35 2244
Complex Waveforms: The Harmonic Synthesiser (Cont.)—Wave Analysis—H. Moss. (*Electronic Eng.*, vol. 18, pp. 179-182; June, 1946.) A description, with illustrations, of wave analysis by superposition methods when only 2 or 3 wave components are present, and by the envelope method for high-frequency ratios and beats. Continuation of 1917 of July. Part 5 of a series on cathode-ray-tube traces.

621.317.36 2245
Recent Advances in the Measurement of Frequency—L. Essen. (*R.S.G.B. Bull.*, vol. 21, pp. 166, 172, and 182-184; May and June, 1946.) General historical description of developments in standard-frequency oscillators, heterodyne-frequency meters, and absorption wavemeters, for use up to 10,000 megacycles.

621.317.36:621.396.712 2246
The Measurement of Broadcast Station Frequencies—J. Hers. (*Trans. S. Afr. Inst. Elec. Eng.*, vol. 37, pp. 35-55; February, 1946.) The different methods of checking transmitter frequencies are reviewed. "The paper discusses various kinds of frequency standards, the generation of standard harmonic series, and their use in measurement. Various kinds of measuring equipment are described, with particular reference to the equipment built by the South African Broadcasting Corporation."

621.317.42 2247
A B-H Curve Tracer for Magnetic-Recording Wire—T. H. Long and G. D. McMullen. (*Trans. A.I.E.E. (Elec. Eng., March, 1946)*, vol. 65, pp. 146-149; March, 1946.) "The equipment described is able to show on the screen of an oscilloscope the cyclic hysteresis loop of a sample of magnetic-recording wire a little over one inch long and 0.004 inch in diameter. Results obtained with the equipment in studying recording wires are given." The magnetic properties are influenced by the tension of the wire, and this magnetostrictive charac-

teristic might be used to give an instantaneous measure of wire tension.

621.317.7.089.6:621.396.823 2248
A Study of Wave Shapes for Radio-Noise-Meter Calibrations—C. W. Frick. (*Trans. A.I.E.E. (Elec. Eng., December, 1945)*, vol. 64, pp. 890-901; December Supplement, 1945.) An account of a theoretical and experimental investigation to secure better agreement between meters used for assessing continuous impulsive interference with radio receivers, such as that caused by motors or gas-discharge tubes. The use of a signal of standard wave form is advocated for calibrating noise meters, and a method of evaluating the noise-producing effect of such signals is developed. It is shown that a 60-cycle substantially square wave, in which 63 per cent of the voltage change from peak to peak takes place exponentially in 0.075 microsecond ± 20 per cent is a useful calibrating signal that gives material improvement in the agreement between noise measurements made with actual radio receivers and with noise meters.

621.317.714+621.317.727:087.64 2249
Electronically Balanced Recorder for Flight Testing and Spectroscopy—A. J. Williams, Jr., W. R. Clark, and R. E. Tarpley. (*Trans. A.I.E.E. (Elec. Eng., April, 1946)*, vol. 65, pp. 205-208; April, 1946.) Description of the circuit and performance of a multipoint potentiometer recorder for thermocouples. The out-of-balance current is interrupted by a vibrator and amplified to drive a synchronous motor that drives the slide-wire contact and recorder. Adaptation for current (instead of electromotive force) and current-ratio recording is described.

621.317.72.029.5/62 2250
A Remote-Indicating Field-Strength Meter—E. P. Tilton. (*QST*, vol. 30, pp. 21, 152; May, 1946.) Practical details of two simple units, one containing switched coils for 28, 50, and 144 megacycles, a crystal rectifier and rod aerial, and the other housing a microammeter for reading the crystal current. The units are connected by a cable for remote measurements while adjusting the transmitter under test.

621.317.725.015.532 2251
A Corona Voltmeter—Widmer. (See 2130.)

621.317.76.029.54/58 2252
A Precision Frequency Standard—M. Saxon. (*Radio News*, vol. 35, pp. 36, 131; April, 1946.) Details of an amateur version of the U. S. Army's BC-211 oscillating frequency meter, range 630 to 11,000 kilocycles with a gap 1040 to 1260 kilocycles. A crystal oscillator provides check points. Accuracy, a few parts in 10⁴.

621.395.8:621.317.79 2253
The Measurement of Audio Distortion—H. H. Scott. (*Communications*, vol. 26, pp. 23, 56; April, 1946.) A study of methods used to measure nonlinear, amplitude, or harmonic distortion. The measuring instruments include distortion meters, wave analyzer, and intermodulation meter. Procedures used for measurement of distortion

in amplitude-modulation and frequency-modulation systems are also discussed.

621.317.79:621.396.615.14: 621.396.619.018.41 2254
High Frequency FM Signal Generator—(*Elec. Ind.*, vol. 5, pp. 86-87; April, 1946.) General description of an instrument for laboratory and production testing of frequency-modulation receivers over the range 86 to 108 megacycles. The instrument has low distortion, and a maximum deviation of ± 300 kilocycles. The Colpitts oscillator is modulated by two reactance tubes and the signal output is obtained from an H₁₁-mode piston attenuator calibrated directly in microvolts from 1 to 10⁴.

621.317.79:621.397.62 2255
A Television Signal Generator: Part 1—General Features—R. G. Hibberd. (*Electronic Eng.*, vol. 18, pp. 174-175, 178; June, 1946.) The generator is designed to give signals within the specification of the British Broadcasting Corporation transmissions for testing receivers. Vision modulation is derived from a monoscope (see 2865 of 1938, Burnett), which is briefly described, and synchronizing pulses are provided by a special impulse generator. A block diagram is given, and the display and monitoring equipment is briefly described.

621.317.79:621.396.82 2256
Cylindrical Shielding and Its Measurement at Radio Frequencies—Anderson. (See 2167.)

53.08 2257
Scientific Instruments. [Book Review]—H. J. Cooper (Editor). Hutchinson's Scientific & Technical Publications, London, 293 pp., 25s. (*Elec. Rev.*, London, vol. 138, p. 848; May 31, 1946.)

OTHER APPLICATIONS OF RADIO AND ELECTRONICS

621.3.078:621.791.76 2258
Electronic Controls for Resistance Welding—H. L. Horton. (*Machinery*, vol. 51, pp. 153-159; October, 1944.) A survey of methods of controlling the heat generated and of timing control, and their application to various types of industrial equipment. Part 3 of a series; for other parts, see 2273, 2259, 2269, and 2263.

621.3.078:621.9 2259
Electronic Control and Regulation of Motor Drives—H. L. Horton. (*Machinery*, vol. 50, pp. 165-172; June, 1944.) Control (i.e., arbitrary adjustment by external influence) is distinguished from regulation (i.e., self-correction by feedback of the deviation from a standard). An account of the principles and their application to typical practical problems of machine-tool practice. Part 2 of a series, for other parts, see 2273, 2258, 2269, and 2263.

621.317.39:531.717:667.613 2260
Instrument for Measuring Thickness of Nonconducting Films Applied over Nonmagnetic Metals—A. L. Alexander, P. King, and J. E. Dinger. (*Ind. and Eng. Chem. (Analyt. Edit.)*, vol. 17, pp. 389-393; June, 1945.) The inductance coil, 1 inch in diame-

ter, of an oscillator with a frequency of 5 kilocycles or more, is placed first on an uncoated metal surface, and then on a similar surface that has been coated, and the difference in oscillator frequency in the two cases, determined by a heterodyne method, is a measure of the coating thickness. The tuning capacitor of the oscillator, adjusted to bring the frequency always to that of a constant reference oscillator, can be calibrated in film thickness for different film substances. The device is simple and suitable for routine measurements in the range 0 to 0.025 inch, with an accuracy better than 0.001 inch. Measurements must be made on a flat surface not less than 2 inches in diameter in order to obtain freedom from edge effect. Complete circuit diagrams are given.

621.317.39:531.76

2261

Electronic Chronoscope for Measuring Velocities of Detonation of Explosives—C. R. Nisewanger and F. W. Brown. (*U. S. Bureau of Mines Rep. of Investigations*, R.I. 3879, 18 pp; March, 1946.) An instrument for measuring the time of travel (of the order of microseconds) of an explosion in a short length of material. The novel method used employs the voltage-time characteristics of a resistance-capacitance circuit, with thyratrons to give the switching action at the beginning and end of the time interval measured. The explosion can either be used to bridge two separated wires by the ionization it produces ("make" system), or to fuse a continuous wire ("break" system). A direct-current valve-voltmeter is used to indicate the charge on the capacitor of the resistance-capacitance circuit, and a meter reading nearly proportional to the time interval is obtained; there are five ranges with full-scale times from 5 to 150 microseconds. The instrument is mains-operated, with voltage-regulator tubes to ensure stability of calibration. An internal test circuit generating a pulse about 2 microseconds in length is incorporated. The method of operation is described in detail, and further improvements are suggested. A table of typical velocity measurements is given.

621.317.39:620.172.222

2262

Resistance Wire Strain Gage Applications and Circuits—E. G. Van Leeuwen and W. F. Gunning. (*Prod. Eng.*, vol. 16, pp. 443-449; July, 1945.) The construction, mounting operations, and associated electrical circuits are described, together with applications to the measurement of various types of strain.

621.317.39:621

2263

Electronic Measurement, Analysis, and Inspection: Parts 1 and 2—H. L. Horton. (*Machinery*, vol. 51, pp. 157-161 and 168-173; June and August, 1945.) A review of photocell applications, temperature regulation, metallurgical analysis with a cathode-ray tube, X-ray examination of materials, devices for measuring small mechanical irregularities and displacements, and the electron microscope. Parts 5 and 6 of a series. For other parts, see 2273, 2259, 2258, and 2269.

621.317.39.083.7:531.74:621.396.663 2264
Improvements in Devices for the Instan-

taneous Transmission of Angles—R. Barthélemy. (*Génie Civ.*, vol. 123, p. 52; February 15, 1946. *Compt. Rend. Acad. Sci.*, Paris, vol. 221, pp. 487-489; October 29, 1945.) Alternating current in the moving coil of a goniometer coil system induces currents in the stators proportional to the sine and cosine of the angle of the rotor. The currents from the stators are respectively passed through the rotor coils of two other goniometers of which the rotors are on a common spindle and bear the same angles to their respective stators. These four stators are corrected in series in pairs, the X coil of one with the Y coil of the other. The outputs from the two pairs of stators are applied with or without amplification to the deflector plates of a cathode-ray tube, and set the trace at an angle that is the sum of the angle of setting of the first goniometer and the common angle of setting of the other two. Further pairs of coupled goniometers can be added so that the output of the system defines an angle that is the sum of the angles of setting of each spindle. The systems can also be used to operate servomechanisms instead of a cathode-ray-tube display.

621.317.39.083.7:532.593.082

2265

Measurement of Ocean Waves Generated by Atomic Bombs—N. J. Holter. (*Electronics*, vol. 19, pp. 94-98; May, 1946.) A general description of the following equipment: underwater recording echo-sounders, self-contained wave-pressure recorders, shore-connected wave-pressure recorders, radio-synchronized cameras, recording television, maximum-water-height recording transmitters, and water level recorders.

621.317.755:545.822

2266

Spectrochemical Analysis with the Oscillograph—G. H. Dieke and H. M. Crosswhite. (*Jour. Opt. Soc. Amer.*, vol. 36, pp. 192-195; April, 1946.)

621.317.755:621.43

2267

Ignition Testing Unit—(*Flight*, vol. 48, pp. 47-48; July 12, 1945.) Description of a cathode-ray equipment that displays the ignition pulses derived from the potential drop at the magneto switch or ignition coil. Faults are detected by abnormalities in wave form. Circuit details are not given.

621.365.5+621.365.9+621.396

2268

Discussion on "The Place of Radiant, Dielectric and Eddy-Current Heating in the Process Heating Field"—L. J. C. Connell, O. W. Humphreys, and J. L. Rycroft. (*Jour. I.E.E.* (London), vol. 93, pp. 48-50; February, 1946.) For original paper, see 145 of January.

621.365.5+621.365.92

2269

Electronic Heating of Metals and Non-Metallic Materials—H. L. Horton. (*Machinery*, vol. 51, pp. 146-155; March, 1945.) A review of the principles and mechanical-engineering applications of induction and dielectric heating. Part 4 of a series. For other parts, see 2273, 2259, 2258, and 2263.

621.365.52

2270

Measurement of the Form Factor in Induction Ovens Without Magnetic Core—G. Ribaud and M. Leblanc. (*Compt. Rend. Acad. Sci.*, Paris, vol. 220, pp. 732-733;

May 23, 1945.) A table of values is given for a number of useful forms. See also 3821 of 1944.

621.365.52

2271

Design of Induction-Heating Coils for Cylindrical Non-Magnetic Loads—J. T. Vaughan and J. W. Williamson. (*Trans. A.I.E.E. (Elec. Eng.)*, December, 1945), vol. 64, pp. 965-966; December Supplement, 1945.) Discussion of 148 of January.

621.365.92:674.23

2272

Electronic Heating in the Furniture Industry—E. S. Winlund. (*Electronics*, vol. 19, pp. 108-113; May, 1946.) A review of the principles of generating the power for dielectric heating, transferring it to the load, and shaping the electrodes to concentrate the heat where it is required. Several examples are given of its application to the setting of the bonding-glues used in assembling joints, in producing plywood and veneered furniture. The efficient use of dielectric heating can effect a considerable saving in production costs.

621.38:621

2273

Electronics for the Machine Designer—G. A. Caldwell and C. Madsen. (*Machinery*, vol. 50, pp. 135-150; May, 1944.) A review of the fundamentals of electronics and of the features which make electronic devices potentially useful for application in the mechanical field. The first of a 6-part series. For other parts, see 2259, 2258, 2269, and 2263.

621.383+621.317.755]:535.243

2274

Spectral Intensity Measurements with Photo-Tubes and the Oscillograph—G. H. Dieke, H. Y. Loh, and H. M. Crosswhite. (*Jour. Opt. Soc. Amer.*, vol. 36, pp. 185-191; April, 1946.)

621.383:536.52:621.317.39

2275

Color Temperature Testing in Projector Lamp Production—S. Pakswar and J. Kirk. (*Rev. Sci. Inst.*, vol. 17, pp. 157-158; April, 1946.) Phototubes measure the blue and red radiations from the lamp, and their ratio (giving the temperature of the lamp) is displayed on a cathode-ray tube.

621.385.833

2276

On a Photographic Method for Investigating the Optical Properties of Magnetic Lenses and for Recording β -Ray Lines—H. Slätis. (*Ark. Mat. Astr. Fys.*, vol. 32, Part 4, Section A, 27 pp.; February 20, 1946.)

621.396.611:621.384

2277

On the Design of a Cavity of a Linear Electron Accelerator—E. S. Akeley. (*Phys. Rev.*, vol. 69, p. 255; March 1-15, 1946.) Abstract of an American Physical Society paper.

621.396.9:359

2278

Navy Radio and Electronics During World War II—J. B. Dow. (*Proc. I.R.E. AND WAVES AND ELECTRONS*, vol. 34, pp. 284-287, May, 1946.) A nontechnical review of some of the electronic devices used by the U. S. Navy emphasizing their importance in naval tactics. Extracts from action reports illustrate the use of radar fire control

and of sonar (see 1750 of July) against submarines.

621.396.9:623.454.25 2279

The Application of Radar to Ballistics: the Radar Shell-Fuse—M. A. (*Génie Civ.*, vol. 123, p. 63; March 1, 1946.) See also 1627 of June (Selvidge), and 624 of March (Huntoon and Miller).

621.396.91.083.7 2280

Radiosonde Telemetering Systems—V. D. Hauck, J. R. Cosby, and A. B. Dember. (*Electronics*, vol. 19, pp. 120-123; May, 1946.) A description of equipment used by the U. S. Army and Navy designated AN/AMQ-1D, and by the Weather Bureau, designated 506-WB. It is essentially a development of the Diamond and Hinman apparatus (see 2682 of 1938 and 58 of 1939). A temperature-compensated aneroid unit operates a multicontact switch connected to temperature- and humidity-sensitive resistors that control, in turn, the quench frequency of the transmitter. Batteries with lead and lead-dioxide plates are used, with perchloric acid as the electrolyte. Accuracy: pressure, 5 millibars in the range 10 to 1060 millibars and +60 to -90 degrees centigrade; temperature, 1 degree centigrade.

621.38:62 2281

Electronic Equipment and Accessories. [Book Review]—R. C. Walker. Chemical Publishing Co., Brooklyn, N. Y., 1945, 239 pp. \$6.00. (*Rev. Sci. Instr.*, vol. 17, pp. 141; April, 1946.) "... can be recommended as a 'first course' in electronic instrumentation as well as a compendium of information on electronic and associated devices."

PROPAGATION OF WAVES

621.396.11+621.396.67 2282

A Note on a Simple Transmission Formula—H. T. Friis. (*PROC. I.R.E. AND WAVES AND ELECTRONS*, vol. 34, pp. 254-256; May, 1946.) A formula relating the received and transmitted powers at the aerial terminals P_r and P_t in terms of the effective areas A_r and A_t of the aeri-als, their distance apart d , and the wavelength λ , is derived in the form

$$\frac{P_r}{P_t} = \frac{A_r A_t}{d^2 \lambda^2}$$

The meaning to be ascribed to the effective area is discussed, and its value given for certain special cases. The formula applies to free-space transmission only, and should not be used when d is small, because the assumption of a plane wave front is then not justified.

621.396.11 2283

Propagation of Radiation in a Medium With Random Inhomogeneities—P. G. Bergmann. (*Phys. Rev.*, vol. 69, pp. 255-256; March 1-15, 1946.) The use of ray optics shows that fluctuations of a radiative field are related to variations in refractive index, and increase with the $3/2$ power of distance. Abstract of an American Physical Society paper.

621.396.11:523.746.5 2284

DX and the Present Sunspot Cycle—A

Prophecy—E. H. P. Young. (*R.S.G.B. Bull.*, vol. 21, p. 170; May, 1946.) Discussion of 324 of February (Gleissberg).

621.396.11:551.51.053.5 2285

Radio Propagation Work at the National Bureau of Standards—N. Smith and R. Silberstein. (*QST*, vol. 30, pp. 45-50; May, 1946.) An account of the progress made in forecasting transmission conditions. Maximum usable frequencies and lowest useful high frequencies can now be predicted accurately from measurements of the properties of the ionosphere made at vertical incidence. A map shows the world-wide distribution of observing stations in January, 1946.

621.396.11:551.51.053.5 2286

Irregularities in Radio Transmission—O. P. Ferrell. (*Radio*, vol. 30, pp. 23-24; February, 1946.) A survey of sporadic-E propagation at very-high-frequency, and of the effect on frequency-modulation transmission. A bibliography with abstracts is included. For previous parts of this 3-part series, see 1333 of May and 1640 of June.

621.396.11:551.51.053.5 2287

On the Absorption of Radio Waves and the Number of Collisions in the Ionosphere—V. Ginsburg. (*Jour. Phys.*, (U.S.S.R.) vol. 8, no. 4, pp. 253-256; 1944.) "The measurement of the absorption of radio waves in the ionosphere enables one to determine the effective number of collisions in some of its regions. On the other hand, it is possible with the help of the usual method of kinetic equation to evaluate the number of collisions effective for the process of absorption of radio waves. Both the electrons' collisions with the molecules and their collisions with the ions can be thus calculated. The cross section for the latter process under conditions prevailing in the ionosphere is about a million times larger than for collisions with the molecules. In this connection the concentration of ions and molecules in the ionosphere, as derived from radio measurements, is discussed."

621.396.11:551.51.053.5:621.396.9 2288

2-Mc Sky-Wave Transmission—Pierce. (See 2190.)

621.396.13:621.397 2289

Vertical v. Horizontal Polarization—H. P. Williams. (*Jour. Televis. Soc.*, vol. 4, pp. 171-177; September, 1945.) A consideration of the relative merits for television transmission, with particular reference to the effect of ground reflection and aerial height. It is concluded that there is no distinct advantage in either mode, but "such differences as do exist are mostly in favor of horizontal polarization."

621.396.812.3:551.51.053.5 2290

On Some Observations of Fading of Short-Wave Signals—S. S. Banerjee and G. C. Mukerjee. (*Sci. Culture*, vol. 11, pp. 571-575; April, 1946.) Quasi-regular variations in the intensity of short-wave radio signals reflected from the ionosphere are interpreted as due to interference between multiple reflections.

RECEPTION

621.396.619.018.41:621.396.82 2291

Larger FM Carrier Suppresses Smaller—H. G. Shea. (*Elec. Ind.*, vol. 5, pp. 78-79; April, 1946.) A simple explanation with vector diagram illustrations.

621.396.621 2292

32-Volt [Broadcast] Receiver—L. Treacle. (*Radio Craft*, vol. 17, pp. 466, 516; April, 1946.) Constructional details.

621.396.621 2293

Radio Data Sheet 334—(*Radio Craft*, vol. 17, p. 475; April, 1946.) Servicing data for Farnsworth broadcast receivers.

621.396.621(43) 2294

Five New Circuits—R. M. Cater. (*Radio Craft*, vol. 17, pp. 467, 496; April, 1946.) Circuit details of German midget broadcast receivers.

621.396.621.029.62 2295

A Battery Operated V.H.F. Receiver—E. L. Cameron. (*R.S.G.B. Bull.*, vol. 21, pp. 185-186; June, 1946.) Design and construction of a simple two-unit portable receiver for the range 56 to 112 megacycles.

621.396.621.54.029.62 2296

A Two-Meter Crystal-Controlled Converter—C. F. Hadlock. (*QST*, vol. 30, pp. 31-35; May, 1946.) For selective reception in the 112- and 144-megacycle amateur bands, a crystal-controlled beat oscillator converts the signal frequency to the 30- to 40-megacycle region. Constructional details are given.

621.396.662.1 2297

New Tuning System for the Amateur Receiver—W. J. Halligan and N. Foot. (*QST*, vol. 30, pp. 18, 124; May, 1946.) An application of split-stator capacitors giving improved very-high-frequency performance with 3 to 1 tuning ranges up to 150 megacycles. Basic circuits are given for an oscillator and mixer, with 6-band switching, to operate in the range 540 kilocycles to 110 megacycles.

621.396.8:621.396.13:621.396.619.16 2298

Determination of Noise Power and Signal/Noise Ratio for the Case of Simplex or Multiplex Radio Transmission on Ultra-Short Waves by (A) Amplitude- or Duration-Modulated Pulses; (B) Frequency-Modulated Pulses—Chireix. (See 2307.)

621.396.8:621.396.619.018.41 2299

Nonlinearity in Frequency-Modulation Radio Systems Due to Multipath Propagation—Meyers. (See 2321.)

621.396.822 2300

A Generalization of Nyquist's Thermal Noise Theorem—E. J. Schrepf. (*Phys. Rev.*, vol. 69, p. 255; March 1-15, 1946.) Nyquist's theorem (1928 Abstracts, page 591) for the thermal current generator of a linear passive 2-terminal network at temperature T is extended for an M -terminal network to

$$[i^2 m n(r, a; \nu)] A \nu = 2kT g m n(r, a; \nu) d\nu$$

for the incoherent nodal currents if the generating parameter a obeys

$$a(-\nu)[a(\nu)-1] Y_n(\nu) + a(\nu)[a(-\nu)-1] Y_n(-\nu) + 0$$

where $y = g + jb$ is the admittance. Abstract of an American Physical Society paper.

621.396.823: 621.317.7.089.6 2301
A Study of Wave Shapes for Radio-Noise-Meter Calibrations—Frick. (See 2248.)

621.396.828 2302
Noise Limiting in C.W. Reception—G. Grammer. (*QST*, vol. 30, pp. 13, 122; May, 1946.) Explains the poor results obtained with the usual amplitude limiter when using a beat-frequency oscillator, and gives a detailed description of a satisfactory clipper circuit for headphone reception, using germanium crystal rectifiers.

621.397.81 2303
Local Oscillator Radiation and Its Effect on Television Picture Contrast—E. W. Herold. (*RCA Rev.*, vol. 7, pp. 32–53; March, 1946.) A study of the effect of continuous-wave interference arising from the local oscillators of nearby receivers. The chief annoying effect of such interference at the high end of the video band was a serious loss in contrast. "The observations and computations indicated that a 20-decibel signal-to-interference field strength ratio at the antenna is a minimum satisfactory value. To maintain this ratio in a 500-microvolt-per-meter region of a desired transmitter, nearby receivers must have a radiation below 0.01 microwatts. Prewar receivers, which used no radio-frequency stage, radiated 100,000 times as much as this and were extremely unsatisfactory. A grounded-grid triode radio-frequency stage may give a reduction of about 30 decibels or more and a pentode radio-frequency stage may be made even better." It is concluded that an adequate television service will require suppression of local-oscillator radiation if the frequency assignments are such as to make interference possible.

STATIONS AND COMMUNICATION SYSTEMS

621.396.1 2304
Communications: Implement to Peace—R. C. Wakefield. (*Elec. Eng.*, vol. 65, pp. 99–105; March, 1946.) Description of developments in U. S. Army communications during the war, and of their application and adaptation to peacetime conditions. The main new proposals put forward are the provision of sufficient radio-relay stations, with control by one international company, and the use of pulse modulation and other multiplex systems in place of the more expensive (in frequency and money) cable systems.

621.396.1 2305
We Have New Regulations—K.B.W. (*QST*, vol. 30, pp. 23–24; May, 1946.) Revised Federal Communications Commission rules for U.S. amateur radio.

621.396.13 2306
Observations and Comparisons on Radio Telegraph Signaling by Frequency Shift and On-Off Keying—H. O. Peterson, J. B. Atwood, H. E. Goldstine, G. E. Hansell, and R. E. Schock. (*RCA Rev.*, vol. 7, pp. 11–31; March, 1946.) A long and fully detailed account of a thorough comparison in respect

to communication reliability between on-off keying (CWT) and frequency-shift keying (FST) of transmissions on 200 kilocycles from Bolinas, California, to Riverhead, New York. The continuous-wave signals were received with a standard R.C.A. 3-receiver diversity group, and the frequency-shift transmissions through a frequency-shift adaptor, using two receivers of the same diversity group. The comparison was based on error-counts on a 5-unit start-stop printer using a recurring series of test words transmitted from a loop of perforated tape. The conclusions were mainly in favor of the frequency-shift system.

621.396.13: 621.396.8: 621.396.619.16 2307
Determination of Noise Power and Signal/Noise Ratio for the Case of Simplex or Multiplex Radio Transmission on Ultra-Short Waves by (A) Amplitude- or Duration-Modulated Pulses; (B) Frequency-Modulated Pulses—H. Chireix. (*Ann. Radiol.*, vol. 1, pp. 55–64; July, 1945.) A theoretical study. The signal-to-noise ratio depends in each case on the gain in the transmission system, as in the case of keyed continuous waves. The analysis shows the system of frequency-modulated pulses to be effectively equivalent to a carrier-current system with the same total frequency deviation. Pulse duration modulation compares favorably with multichannel frequency modulation, and with frequency-modulated pulses when an upper and lower amplitude limiter is used on the receiver with the two thresholds brought as close together as possible.

621.396.24+621.396.933 2308
Aircraft Microwave-Beam System—(*Aero Digest*, vol. 49, pp. 82–84; June 15, 1945.) A note on the application by the Raytheon Manufacturing Company, to the Federal Communications Commission for permission to erect a microwave relay system and television broadcasting chain along the west coast of the United States. The potentialities of the scheme are discussed. See also 186 of January.

621.396.41: 621.396.619.16 2309
A Selective Pulse Communication System—A. R. Knight and H. Storck. (*QST*, vol. 30, pp. 74, 144; May, 1946.) A proposal by which many stations might work on the same frequency without interference. A master station transmits synchronizing pulses which control pulses emitted in keyed transmission from subsidiary stations. The master pulses also control gates in the receiving circuits, which can be adjusted manually in time relative to the master pulses. The gate is just wide enough to admit one pulse from any subsidiary transmitter, and is adjusted until it is open at the instants when the pulses from the selected transmitter arrive at the receiver.

621.396.619.018.41 2310
The Fundamental Principles of Frequency Modulation—B. van der Pol. (*Jour. I.E.E.* (London) vol. 93, pp. 153–158; May, 1946.) A theoretical survey of the nature, generation, and circuit response of frequency-modulation waves. The voltage and current generated in a circuit with vari-

able parameters are expressed in a form similar to the W.K.B. solution familiar in quantum mechanics. The response of a circuit to a frequency-modulation wave is obtained in a form similar to that of Carson and Fry (464 of 1938), but it is shown that, in general, the resulting series is asymptotic.

621.396.619.018.41: 001.4 2311
Defining Common FM Engineering Terms—(*Elec. Ind.*, vol. 5, pp. 79, 81; April, 1946.) Short definitions of 17 terms.

621.396.619.018.41: 621.3.012.3 2312
Frequency and Phase Deviation—(*Elec. Ind.*, vol. 5, pp. 69–70; April, 1946.) Two nomographs. The first relates modulating frequency, modulation index, and frequency deviation, in the case of frequency-modulation, and modulating frequency, initial phase shift, and equivalent frequency-modulation deviation in the case of phase modulation. The second relates peak frequency-modulation deviation and the modulating frequency to the condition required to give zero amplitude of the carrier frequency.

621.396.619.018.41: 621.396.216 2313
FM Systems Engineering—R. R. Batchler. (*Elec. Ind.*, vol. 5, pp. 75, 132; April, 1946.) A general survey of the requirements and methods of frequency-modulation transmitting systems. A loose-leaf supplement gives schematic diagrams of the various parts of the system.

621.396.619.16 2314
Microwave Pulse [time] Modulation for Ham Communications—R. Endall. (*Radio News*, vol. 35, pp. 41, 94; April, 1946.) A general account of the principles and features of the system, including the use of the cyclodos and cyclophone cathode-ray-beam modulator and demodulator tubes. See also 1352 of May, 1056 of April (Black), and back references.

621.396.65.029.62/.64]: 621.396.619.16 2315
Pulse-Modulated Radio Relay Equipment—J. J. Kelleher. (*Electronics*, vol. 19, pp. 124–129; May, 1946.) An account of the development of the equipment used for military communications, with block diagrams and abridged specifications of the equipments AN/TRC-5 and AN/TRC-6. See also 1353 of May and back references.

621.396.664 2316
CBS Studio Control-Console and Control Room Design—H. A. Chinn. (*PROC. I.R.E. AND WAVES AND ELECTRONS*, vol. 34, pp. 287–295; May, 1946.) The chief considerations for studio control equipment are location of controls and visual monitoring facilities, visibility into the studio, pleasing appearance, ease of maintenance, and flexibility.

The way in which the Columbia Broadcasting System console fulfils these requirements is described and its fitting into a complete studio layout to give maximum visibility is discussed. The circuit facilities of the console are outlined; space is available for additional equipment if required for special purposes.

621.396.664 2317
Two-Studio Console—(*Elec. Ind.*, vol.

5, pp. 71, 130; April, 1946.) A Raytheon 7-channel program-mixing console with separate amplifiers for each channel, a program-level indicator and amplifier for the main output, and monitoring loudspeakers.

621.396.7+621.397.26 **2318**

The Programme of Work of la Radio-diffusion Française—M. A. (*Génie Civ.*, vol. 123, p. 52; February 15, 1946.) A brief summary of the plans for building new transmitting stations, studios, and laboratories, and for the development of television, and of a North African network.

621.396.712 **2319**

A Report on the Sixth Annual Conference of Broadcast Engineers—L. Winner. (*Communications*, vol. 26, pp. 30, 74; April, 1946.) Long illustrated summaries of the following papers: "Preventive Maintenance for Broadcast Stations," by C. Singer; "Irregular Room Surfaces in Studios," by K. C. Morrical; "F.M. Station Monitor," by H. R. Summerhayes, Jr. For other papers, see 2125, 2143, and 2365.

621.396.712:621.317.36 **2320**

The Measurement of Broadcast Station Frequencies—Hers. (See 2246.)

621.396.8: 621.396.619.018.41 **2321**

Nonlinearity in Frequency-Modulation Radio Systems Due to Multipath Propagation—S. T. Meyers. (*PROC. I.R.E. AND WAVES AND ELECTRONS*, vol. 34, pp. 256-265; May, 1946.) "A theoretical study is made to determine the effects of multipath propagation on over-all transmission characteristics in frequency-modulation radio circuits. The analysis covers a simplified case where the transmitted carrier is frequency-modulated by a single modulating frequency and is propagated over two paths having relative delay and amplitude differences. Equations are derived for the receiver output in terms of the transmitter input for fundamental and harmonics of the modulating frequency. Curves are plotted and discussed for various values of relative carrier- and signal-frequency phase shift and relative amplitude difference of the received waves.

"The results show that a special kind of amplitude nonlinearity is produced in the input-output characteristics of an over-all frequency-modulation radio system. Under certain conditions, sudden changes in output-signal amplitude accompany the passage of the input-signal amplitude through certain critical values. Transmission irregularities of this type are proposed as a possible explanation of so-called 'volume bursts' sometimes encountered in frequency-modulation radio circuits. In general, it appears that amplitude and frequency distortion are most severe where the relative delay between paths is large and the amplitude difference is small."

621.396.82: 551.57: 629.135 **2322**

[U.S.] Army-Navy Precipitation-Static Project: Part 4—Investigations of Methods for Reducing Precipitation-Static Radio Interference—G. D. Kinzer and J. W. McGee. (*PROC. I.R.E. AND WAVES AND ELECTRONS*, vol. 34, pp. 234-240; May, 1946.) "Studies showed that interfering noise associated with the use of bare-wire antennas

was roughly proportional to the amount of corona-current discharge. It was found that the use of antennas insulated with polyethylene provided comparatively static-free radio reception by preventing corona discharge from the antenna. Correlated ground and flight experiments showed that, unless the corona discharge occurs at areas adjacent to antennas, little noise is produced in the radio receiver. The characteristics of several types of electrostatic dischargers, intended to reduce the equilibrium potential of the airplane for a given charging condition, were examined. The dry-wick discharger recently adopted by the military services was found to give the best over-all electrical and mechanical performance."

The technique of measurement is described, and diagrams are shown of the noise as a function of the electric field intensity at the aerial.

621.396.82: 551.57: 629.135: 621.3.027.7

2323

[U.S.] Army-Navy Precipitation-Static Project: Part 5—The High Voltage Characteristics of Aircraft in Flight—R. Gunn and J. P. Parker. (*PROC. I.R.E. AND WAVES AND ELECTRONS*, vol. 34, pp. 241-247; May, 1946.) "The important high-voltage electrical characteristics of aircraft in flight are determined from (a) flight operations in precipitation areas; (b) flight operations using a new artificial charger to electrify the airplane in flight; (c) high-voltage experiments on the airplane supported in a giant hangar; and (d) theoretical analysis.

"It is shown how the fundamental electrical constants of the airplane may be approximately determined and how these may be used to forecast the high-voltage behavior of a flying aircraft. It is shown that, at a given altitude, the current I discharged by an airplane in flight is of the form

$$I = AE + B(E^2 - E_0^2)$$

where E is the magnitude of the electric field as measured on the belly and A , B , and E_0 are constants.

"The electrical capacitance of an aircraft in flight is about 20 per cent of the wing span expressed in centimeters." A theoretical analysis is given of the potential and space-charge distribution surrounding a sphere equivalent to an aircraft in a hangar, and close agreement is obtained between the observed and calculated currents.

621.396.931 **2324**

Mobile Radio Service—(*Elec. Ind.*, vol. 5, pp. 84-85; April, 1946.) An experimental and semiautomatic frequency-modulation radio telephone for party-line service to a fleet of vehicles.

621.396.931 **2325**

F.M. Railroad Radio Satellite System—W. S. Halstead. (*Elec. Ind.*, vol. 5, 6, pp. 62-65, 128; June, 1946.) Local 152 to 162 megacycles frequency-modulation transmitter receiver stations with restricted service zones are connected to a central station by a 150- to 250-kilocycle frequency-modulation induction link that uses overhead wires primarily used for another purpose. Mobile very-high-frequency units in the zone of any local station can communicate with any

part of the system, or with other mobile units in any very-high-frequency zone.

621.396.931.029.62 **2326**

A Method of Increasing the Range of V.H.F. Communication Systems by Multi-Carrier Amplitude Modulation—J. R. Brinkley. (*Jour. I.E.E. (London)*, vol. 93, pp. 159-176; May, 1946.) "The initial development of a method of extending the range or improving the coverage of very-high-frequency communication systems of the type used for police services is described. The method is based on the simultaneous amplitude modulation of a number of carriers closely spaced in frequency. The frequency spacing between the carriers is so chosen that they lie within the bandwidth of the very-high-frequency receiver, without producing audible interaction components of importance.

"Two-carrier schemes employing separate transmitters at the same site have been found to give improved coverage, while two- and three-carrier schemes using separate sites have been found to give greatly increased range.

"An unsuccessful attempt to achieve the same object with frequency-modulated transmitters using the same nominal carrier frequency is described. The difficulties of employing frequency modulation with common modulation are discussed and considered to be fundamental.

"Single-station very-high-frequency schemes upon which the development of the multicarrier scheme is based are briefly described." A long discussion is included. For a less detailed account, see 1357 of May.

SUBSIDIARY APPARATUS

621.314.2.029.4/.5]: 621.318.322 **2327**

Applications of Thin Permalloy Tape in Wide-Band Telephone and Pulse Transformers—Ganz. (See 2225.)

621.314.22/23 **2328**

The Impedances of Multiple-Winding Transformers: Part 3—S. A. Stigant. (*Beama Jour.*, vol. 53, pp. 139-141; April, 1946.) For previous parts, see 1685 of June and 2017 of July.

621.315.612: 546.287 **2329**

The Use of Liquid Dimethylsilicones to Produce Water-Repellent Surfaces on Glass-Insulator Bodies—Johannson and Torok. (See 2214.)

621.316.721/.722].078.3: 621.386 **2330**

The Stabilization of X-Ray Tube Current and Voltage—A. F. LeMieux and W. W. Beeman. (*Rev. Sci. Inst.*, vol. 17, pp. 130-132; April, 1946.) Description of circuits for stabilizing the current (up to 50 milliamperes) and voltage (35 kilovolts) of the discharge to 0.1 per cent by means of degenerative feedback of the amplified variations to the primary power line. The stabilizer operates at ground potential.

621.316.74 **2331**

Tapered-Thickness Bimetal—W. B. Elmer. (*Trans. A.I.E.E. (Elec. Eng.*, December, 1945), vol. 64, p. 962; December Supplement, 1945.) Discussion of 757 of March.

- 621.316.842: 546.287: 621.315.616.9 2332
Silicone Coating for [Wire-wound] Resistors—Marbaker. (See 2215.)
- 621.316.849.001.2: 539.234: 546.621 2333
Electrical Resistance of Thin Films of Aluminum Deposited on Glass by Thermal Evaporation—Dunoyer. (See 2212.)
- 621.316.93 2334
Lightning Investigations on 33-Kv Wood-Pole Lines—F. E. Andrews and G. D. McCann. (*Trans. A.I.E.E. (Elec. Eng., December, 1945), vol. 64, pp. 954-955, December Supplement, 1945.*) Discussion of 760 of March.
- 621.316.98 2335
The Frequency of Occurrence and the Distribution of Lightning Flashes to Transmission Lines—R. H. Golde. (*Trans. A.I.E.E. (Elec. Eng., December, 1945), vol. 64, pp. 902-910; December Supplement, 1945.*)
- 621.317.333.4 2336
Exploring Coils—T. C. Henneberger. (*Bell Lab. Rec., vol. 24, pp. 145-147; April, 1946.*) An audio-frequency source is used to produce a tracing current through the faulty cable, and an exploring coil detects the magnetic field so produced. Practical applications of the method are briefly discussed.
- 621.317.39.083.7: 531.74: 621.396.663 2337
Improvements in Devices for the Instantaneous Transmission of Angles—Barthélemy. (See 2264.)
- 621.317.755 2338
The Precision High-Tension Oscillograph with Four Cathode Rays—G. Induni. (*Brown Boveri Rev., vol. 30, pp. 222-223; September-October, 1943.*) Four separate deviation systems for voltages up to 3 kilovolts, and two for voltages up to 50 kilovolts. Continuously pumped. Abstract in *Rev. gén. Élec., vol. 55, 1, p. 2D; January, 1946.*
- 621.317.755.087.5 2339
An Automatic Oscillograph With a Memory—A. M. Zarem. (*Trans. A.I.E.E. (Elec. Eng., March, 1946), vol. 65, pp. 150-154; March, 1946.*) The instrument has a flat response up to 30 megacycles and can be used for problems concerning randomly occurring transients. Three cathode-ray tubes allow simultaneous indications of inter-related quantities. The screens, which have a long afterglow, are continuously excited, and the occurrence of a transient pulse releases a camera shutter and interrupts the beams, so that events prior to the photographic exposure are recorded. Illustrations of sporadic disturbances in mercury-arc rectifiers are given. The system is completely automatic, and 40 photographs can be taken without the aid of an operator. See also 3117 of 1937 and 666 of 1938 (Kuehni and Ramo), and 723 of 1939 (Pakala).
- 621.318.42 2340
Optimum Air Gap for Various Magnetic Materials in Cores of Coils Subject to Superposed Direct Current—V. E. Legg. (*Trans. A.I.E.E. (Elec. Eng., December, 1945), vol. 64, p. 969; December Supplement, 1945.*) Discussion of 763 of March.
- 621.318.423 2341
The Self-Inductance of a Toroidal Coil Without Iron—H. B. Dwight. (*Trans. A.I.E.E. (Elec. Eng., December, 1945), vol. 64, p. 999; December Supplement, 1945.*) Discussion of 765 of March.
- 621.319.4.001.4 2342
Resistance and Capacitance Relations Between Short Cylindrical Conductors—F. L. ReQua. (*Trans. A.I.E.E. (Elec. Eng., December, 1945), vol. 64, p. 962; December Supplement, 1945.*) Discussion of 766 of March.
- 621.319.42: 621.315.616.9 2343
Polystyrene Capacitors—J. R. Weeks. (*Bell Lab. Rec., vol. 24, pp. 111-115; March, 1946.*) Short description of the construction and performance. They are superior to mica capacitors in power factor, but are slightly larger for the same capacitance, and have a greater temperature coefficient of capacitance.
- 621.319.5: 621.317.2 2344
[U.S.] Army-Navy Precipitation-Static Project: Part 6—High-Voltage Installation of the Precipitation-Static Project—M. Newman and A. O. Kemppainen. (*PROC. I.R.E. AND WAVES AND ELECTRONS, vol. 34, pp. 247-254; May, 1946.*) Description of the artificial-lightning generator which gives any of (a) 1.5 millivolts at 1.5 milliamperes direct current, (b) impulse voltages up to 5 millivolts, (c) impulse currents up to 200,000 amperes. The Cockcroft-Walton method of cascade-rectifier connection is used to build up the high voltage. "Conditions of electrical-field stress before the lightning discharge are produced by an automatically controlled transition of a generator of high-voltage direct current into a surge generator, resulting in a doubled field stress and a surge breakdown with lightning current characteristics. The combination is thus very suitable for studying certain phases of aircraft operation, particularly communications, under controlled laboratory conditions, corresponding to flight under electrical-storm conditions."
- 621.38: 612.84 2345
The Electric Eye v. the Human Eye—Sommer. (See 2361.)
- 621.389: 623.555.2 2346
Invisible Light Aids Marksman—(*Radio News, vol. 35, 6, pp. 35, 129; June, 1946.*) General description of a device incorporating an infrared spotlight and image converter for use with a rifle sight in the dark. The image converter has a photoelectric screen on which the infrared image is formed, and the photoelectrons are focused by an electron lens on to a fluorescent screen to form a visible image.
- 621.396.614 2347
High-Frequency Alternators—J. H. Walker. *Jour. I.E.E. (Elec. Eng., February, 1946), vol. 93, pp. 67-80; February, 1946.* A review of homopolar and heteropolar induction alternators for frequencies up to 50 kilocycles, with an appendix giving the mathematics of novel features of the heteropolar type.
- 621.396.662 2348
A Visual Tuning Indicator Employing a Thyatron—L. S. Joyce. (*Electronic Eng., vol. 18, pp. 183-186; June, 1946.*) A thyatron with alternating-current anode supply is controlled by a grid bias combining an alternating-current supply of the same frequency but different phase, and a direct-current component obtained by rectification of the tuned signal. Change of the direct-current bias by tuning alters the striking point of the anode-voltage cycle and the mean anode current. The current is used to operate a meter or lamp indicator.
- 621.396.68: 621.397.6 2349
Television Voltage [Power Supply] Circuits: Part 13—E. M. Noll. (*Radio News, vol. 35, 6, pp. 50, 82; June, 1946.*) For previous parts of this series on television circuits, see 1710 of June.
- 621.396.68.027.226 2350
Constant 6 volt D.C. Supply for the Service Lab.—C. C. Springer. (*Radio News, vol. 35, 6, pp. 44, 146; June, 1946.*) Constructional details of a battery charger, with automatic regulation to prevent overcharge, that can be used with a battery across its terminals as a constant 6-volt source.
- 621.396.682: 621.397 2351
Power Frequency Changers for Color Television—D. L. Jaffe. (*Radio, vol. 30, pp. 15-16; February, 1946.*) A method for obtaining power at 120 cycles from 60-cycle mains using an induction motor driven in reverse by a synchronous motor. The output is in synchronism with the mains.
- 621.396.689 2352
Recent Developments in Heavy Duty Vibrator Type Power Supplies—M. R. Williams. (*Radio News, vol. 35, pp. 46, 151; June, 1946.*) Operates from 32 volts direct current, and gives a power supply of 350 watts, 110 to 120 volts alternating current, at 60 cycles. A multiple-contact vibrator is used for a circuit that makes it unnecessary for all contacts to close in exact synchronism.
- 621.398: 621.396.61 2353
All Purpose [Amateur] Transmitter Remote Control System—P. Johnson. (*Radio News, vol. 35, pp. 68, 70; June, 1946.*)
- 778.53: 621.3 2354
A Wide-Angle Fastax—J. H. Waddell. (*Bell Lab. Rec., vol. 24, pp. 139-144; April, 1946.*) A camera with a horizontal field of 40 degrees using 35-millimeter film "for studying the action of relays, switches, and other fast-moving electrical apparatus."
- 621.317.755+621.385.832 2355
The Cathode-Ray Tube Handbook. [Book Review]—S. K. Lewer. Isaac Pitman & Sons, London, 100 pp., 6s. (*R.S.G.B., Bull., vol. 21, p. 177; May, 1946.*) "... very useful introduction to c.r.o. work."
- 621.318.5 2356
Relay Engineering [Book Review]—C. A. Packard. Struthers-Dunn, Philadelphia, Pa., 1945, 640 pp., \$3.00. (*Elec. Ind., vol. 5, p. 130; June, 1946.*) "... covers the selection of relays, applications and circuits, auxiliary equipment, standards, and much

material relating to the specific problems of designing the coil and contact structures . . ."

621.384 2357

Le Cyclotron [Book Review]—M. E. Nahmias. Editions de la Revue d'Optique Théorique et Instrumentale, Paris, 1945, 254 pp., 200 fr. (*Rev. Sci. Inst.*, vol. 17, p. 135; April, 1946.) "The book is well written, concise and to the point," and particularly helpful in its treatment of theory and mathematical development.

621.385.833 2358

Electron Optics and the Electron Microscope. [Book Review]—V. K. Zworykin, G. A. Morton, E. G. Ramberg, J. Hillier, and A. W. Vance. John Wiley & Sons, New York, N. Y., 1945, 766 pp., \$10.00. (*Rev. Sci. Inst.*, vol. 17, pp. 138-139; April, 1946.) "In the opinion of the reviewer it is the best English language book yet published, not only for electron microscopy but for general electron optics as well." See also 1960 of July.

TELEVISION AND PHOTO-TELEGRAPHY

621.3.018.7+621.317.35 2359

Television Waveforms—(*Jour. Televis. Soc.*, vol. 4, p. 178; September, 1945.) Reproduction of chart from *Electronic Engineering* giving equations for 16 common wave forms.

621.317.79: 621.397.61 2360

A Television Signal Generator: Part 1—General Features—Hibberd. (See 2255.)

621.38: 612.84 2361

The Electric Eye v. the Human Eye—W. Sommer. (*Jour. Televis. Soc.*, vol. 4, pp. 150-170; September, 1945.) An account of the characteristics and functions of the human eye, and of photoelectric cells. Data for these (sensitivity, etc.) for photographic emulsions and for cathode-ray tube fluorescent screens are presented in tabular form. Long bibliography.

621.396.13: 621.397 2362

Vertical v. Horizontal Polarisation—Williams. (See 2289.)

621.397 2363

Where Color Television Stands—D. G. Fink. (*Electronics*, vol. 19, pp. 104-107; May, 1946.) The similarities and differences between the black-and-white and the color systems are discussed. It is shown that the color system is likely to be more costly, and that there are still uncertainties in its performance requiring further research. Whether to continue with the present system, or to introduce the color system immediately, depends upon the time required to assess the additional costs and to resolve the uncertainties. Whatever the decision, there should be no delay in the research on the color system.

621.397 2364

Color Television—Is it Ready to Adopt?—(*Elec. Ind.*, vol. 5, pp. 88, 120; April, 1946.) A critical discussion of the Columbia Broadcasting System color television demonstration, which, using films as a source of

programs, avoided the color fringe effect. "Quite a different result is expected by engineer critics when the live color-pickup camera goes into action." A list of the advantages and drawbacks of color and black-and-white television is given.

621.397 2365

A Report on the Sixth Annual Conference of Broadcast Engineers—L. Winner. (*Communications*, vol. 26, pp. 30, 74; April, 1946.) Summary of the paper, "Televising Motion Picture Films," by S. Helt. For other papers, see 2125, 2143, and 2319.

621.397: 621.396.619.16 2366

Pulse-Width Modulation [for Television Sound Channels]—(*Radio*, vol. 30, p. 4; February, 1946.) Illustrated summary of 459 of February.

621.397.2 2367

Discussion on "A Survey of the Problem of Post-War Television"—B. J. Edwards. (*Jour. I.E.E.* (London), Part III, vol. 93, pp. 216-220; May, 1946.) For original paper, see 1109 of 1945.

621.397.26 2368

The B.B.C. Television Waveform—(*Electronic Eng.*, vol. 18, pp. 176-178; June, 1946.) A revised specification of the radiated wave form of the British Broadcasting Corporation transmissions, with diagrams, and with an appendix explaining the method of interlacing. Reprinted from 637 of 1939.

621.397.26 2369

Facsimile Methods for Broadcast Work—(*Elec. Ind.*, vol. 5, pp. 74, 119; June, 1946.) A general account of the "Faximile" and "Telefax" systems.

621.397.26 2370

A New Television System: "Stratovision"—M. Adam. (*Genie Civ.*, vol. 123, pp. 76-77; March 15, 1946.) See also 3970 of 1945.

621.397.5 2371

Field Television—R. E. Shelby and H. P. See. (*RCA Rev.*, vol. 7, pp. 77-93; March, 1946.) A résumé of the history of National Broadcasting Company operations, with special reference to the greatly widened scope made possible by use of the image orthicon camera. The article concludes that there are now virtually no technical limitations on the televising of indoor programs with normal illumination, and that the image orthicon camera "represents the greatest single advancement so far made in field television." See also 2364 below.

621.397.6: 621.396.68 2372

Television Voltage [Power Supply] Circuits: Part 13—Noll. (See 2349.)

621.397.61 2373

CBS Color or Fine Line Television Transmitter—(See 2386.)

621.397.611 2374

Image Orthicon Camera—R. D. Kell and G. C. Sziklai. (*RCA Rev.*, vol. 7, pp. 67-76; March, 1946.) A description of one of a series of developmental television cameras using the image orthicon. It is self-

contained, and weighs less than 40 pounds. The power required is 300 watts, and may be taken from a nonregulated supply. As an illustration of the sensitivity, there are three half-tone reproductions of a television picture of the head and shoulders of a subject illuminated with a 3-kilowatt light, a 25-watt desk lamp, and one candle, respectively. For a brief description of the image orthicon itself, see 1376 of May.

621.397.62 2375

Tele Color Reception—R. R. B. (*Elec. Ind.*, vol. 5, pp. 82, 118; April, 1946.) A description of the Columbia Broadcasting System color television apparatus to guide experimenters in building receiving sets. Various designs for color-wheel filter segments are discussed. For a fuller account, see 2051 of July (D. G. F.).

621.397.82 2376

Local Oscillator Radiation and Its Effect on Television Picture Contrast—Herold. (See 2303.)

TRANSMISSION

621.396.61.029.58 2377

100 Watt—28 Mc Transmitter—N. Le-for. (*Radio News*, vol. 35, pp. 50-51, April, 1946.) Constructional details of a crystal-controlled 6L6 oscillator with 829B (beam double tetrode) frequency doubler, and anode-modulated output stages.

621.396.61.029.62 2378

Transmitter for 2 Meters—E. F. Crowell and R. L. Parmenter. (*Radio News*, vol. 35, pp. 28, 144; June, 1946.) Constructional details of an amateur amplitude-modulated or interrupted-continuous-wave equipment that can be received consistently over 15 to 25 miles.

621.396.619 2379

Class "C" Grid Bias Modulations: Part 1—W. W. Smith. (*Radio News*, vol. 35, pp. 55, 111; April, 1946.) An account of methods of reducing distortion by stabilization and by maintenance of correct operating conditions, including a comparison with class-B and anode modulation.

621.396.619.018.41 2380

A New Exciter Unit for Frequency Modulated Transmitters—N. J. Oman. (*RCA Rev.*, vol. 7, pp. 118-130; March, 1946.) A detailed account of the development and final design of a unit based on a reactance-tube modulator, as distinct from the Armstrong phase-shift system. A special feature is the stabilization of the carrier frequency by reference to a crystal-controlled oscillator by means of a capacitor mounted on a shaft of an induction motor which rotates in sense according to the sense of the frequency displacement. It is stated that the accuracy of this frequency control is limited by the heat cycle of the crystal oven. The distortion in the frequency-modulation output of the exciter is of the order of 0.5 per cent for modulating frequencies from 30 to 15,000 cycles. The noise level is 74 decibels below 100 per cent modulation.

621.396.619.018.41 2381

Frequency Modulation by Non-Linear Coils—L. R. Wrathall. (*Bell Lab. Rec.*,

vol. 24, pp. 102-105; March, 1946.) The current versus magnetic-flux relationship in a coil wound on a permalloy core is non-linear, and results in the occurrence of voltage pulses at each reversal of sign of the current. Addition of relatively low-frequency signal current to the carrier current causes shifting of the position in time of current zeros, and therefore of voltage pulses, in opposite directions for positive and negative pulses. The pulses are thus phase-modulated. Pulses of one polarity are separated by a rectifier, and one of the harmonics selected by a bandpass filter.

621.396.619.018.41 2382
WHFM's FM Converter—K. J. Gardner. (*Elec. Ind.*, vol. 5, pp. 80-81; April, 1946.) The adaptation of a 45.1-megacycle transmitter for simultaneous operation on 98.9 megacycles. A circuit diagram is given. The radio-frequency output is 1 kilowatt.

621.396.619.018.41 2383
Direct Frequency-Modulation Modulators—N. Marchand. (*Communications*, vol. 26, pp. 42, 59; April, 1946.) An analysis of miscellaneous types of modulators not using the reactance tube. Input-capacitance, transmission-line, resistance-capacitance frequency-modulated oscillator, and inductively coupled types are discussed, and design equations given. These systems employ a two-terminal impedance with a reactive component that varies with modulating voltage. For previous parts in this series, see 1994 and 2068 of July.

621.396.662.078.3: 621.396.619.018.41 2384
New Transmitter Circuits—(*Radio*, vol. 30, p. 35; February, 1946.) A block diagram of the Federal frequency-modulation stabilization system in which a frequency-modulation oscillator is controlled by a crystal oscillator. The resulting output of the modulated oscillator is phase-modulated with respect to the fixed oscillator.

621.396.662.078.3: 621.396.619.018.41 2385
F.M. Frequency Control System—J. R. Boykin. (*Radio*, vol. 30, pp. 20, 63; February, 1946.) Each cycle of the beat between the modulated frequency and a fixed reference frequency is used to produce a pulse, the polarity of which depends on whether the reference frequency is greater or less than the other. The pulses are sorted according to polarity, integrated, and used to produce a voltage for correcting the mean frequency of the modulated oscillator. The system regulates the oscillator frequency so that the areas of the frequency versus time curve above and below the reference frequency are kept equal.

621.397.61 2386
CBS Color or Fine Line Television Transmitter—(*Radio*, vol. 30, pp. 31, 58; February, 1946.) Description of a 600-watt transmitter for 490 megacycles that can be amplitude-modulated from 0 to 10 megacycles. A 6.8-megacycle crystal-controlled oscillator feeds a chain of frequency-multipliers and amplifiers, the final stage being modulated by the output of a video-frequency amplifier having direct-current coupling between stages.

VACUUM TUBES AND THERMIONICS

621.385 2387
Mechanism of the Operation of Kenotrons with Cold Emission—V. Sorokina. (*Jour. Phys. (U.S.S.R.)*, vol. 9, no. 1, p. 61; 1945.) Abstract of a paper of the Academy of Science, U.S.S.R.

621.385 2388
The Role of Surface Charges in Electron Devices—P. Timofeev. (*Jour. Phys. (U.S.S.R.)*, vol. 9, no. 1, p. 61; 1945.) When an insulator is placed near the cathode, a large potential gradient can be created due to secondary emission. Cold emission from the cathode can then occur. Kenotrons with cold cathodes have been devised with a potential drop below 100 volts. Abstract of a paper of the Academy of Science, U.S.S.R.

621.385 2389
The Passage of High-Frequency Current through Electronic Devices—G. Gvosdover. (*Jour. Phys. (U.S.S.R.)*, vol. 9, no. 1, p. 63; 1945.) The successive approximations for the potential drop in a plane capacitor, carrying a variable electron beam, are established by expanding a power series of a small parameter. Cases considered include electron currents in the klystron and diode, and in the former the dependence of amplitude, and wavelength of oscillation on current strength. Abstract of a paper of the Academy of Science, U.S.S.R.

621.385 2390
Electronic Devices with Effective Emitters of Secondary Electrons—P. Aranovich. (*Jour. Phys. (U.S.S.R.)*, vol. 9, no. 1, p. 61; 1945.) Various metallic oxides with large secondary-emission coefficients have been investigated. The emission varied considerably with field gradient, and was reduced by depositing fine metallic films on the oxide surface. Strong emission is accompanied by luminescence of the surface. Abstract of a paper of the Academy of Science, U.S.S.R.

621.385 2391
Velocity Modulation—J. E. Kauke. (*Radio News*, vol. 35, pp. 44, 74; February, 1946.) An elementary description of the principle, and its application to twin-cavity and reflex klystrons.

621.385 2392
Contribution to the Physics and Technique of Velocity-Modulated Electronic Transmitting Tubes—R. Warnecke. (*Onde Elect.*, vol. 20, pp. 47-60 and 72-100; September and October, 1945.) Reprint of 3879 of 1945.

621.385 2393
Some Electrical Characteristics of Reflex [Velocity-Modulated] Tubes—H. V. Neher. (*Phys. Rev.*, vol. 69, p. 134; February 1-15, 1946.) "... expressions are derived for the efficiency and electronic tuning when the transit angle across the gap in the cavity has its optimum value and the tube is delivering maximum power to the load." Abstract of an American Physical Society paper.

621.385: 538.312 2394
Energy Conversion in Electronic De-

vices—D. Gabor. (*Jour. I.E.E. (London)*, Part I, vol. 92, pp. 208-209; May, 1945.) Summary of 1071 of 1945. For discussion, see same journal, Part III, vol. 93, pp. 126-127.

621.385.012.6 2395
Oscillograms of Valve Characteristics—B. D. Chhabra, H. R. Sarna, and M. Parkash. (*Curr. Sci.*, vol. 14, pp. 319-320; December, 1945.) The dynamic characteristics traced with sine-wave excitation become looped or closed curves, even if the anode and grid resistances are noninductive, provided the grid resistance is greater than a certain maximum value.

621.385.032.21 2396
A Note on the Protection of Heaters for Cathodes—E.M.I. Laboratories. (*Elec. Eng.*, vol. 18, p. 112; April, 1946.) Protection of the brittle cathode-heater insulation during cathode assembly is obtained by coating it with a skin, e.g., by applying a solution of nitrocellulose in amyl acetate, which vaporizes during the heat-processing of the tube.

621.385.032.24 2397
Some Electrostatic Properties of Grid Electrodes—V. Lukoshkov. (*Jour. Phys. (U.S.S.R.)*, vol. 9, no. 1, p. 61; 1945.) An analysis using the conception of an infinitely fine ideal grid which can be replaced by a complete electrode of the same shape having an effective variable potential distribution. Abstract of a paper of the Academy of Science, U.S.S.R.

621.385.16 2398
Separate Cavity Tunable Magnetron—G. D. O'Neill. (*Elec. Ind.*, vol. 5, pp. 48, 123; June, 1946.) A disk-sealed tube is clamped in a single external annular-cavity resonator that is tuned by screwed plugs. The particular magnetron described generates 4-microsecond, 80-watt pulses of about 6-centimeter wavelength at about 10 per cent efficiency.

621.385.16(52) 2399
Japanese Magnetrons—M. Hobbs. (*Electronics*, vol. 19, pp. 114-115; May, 1946.) Japanese wartime vacuum tube research in the microwave region was concentrated on centimeter-wave magnetrons. Magnetrons were used as local oscillators. For practically no progress had been made with small klystrons.

621.385.16.029.64 2400
The Multi-Cavity Magnetron—(*Bell. Lab. Rec.*, vol. 24, pp. 219-223; June, 1946.) An illustrated descriptive account.

621.385.3: 621.396.615 2401
Circuits for Sub-Miniature Tube—F. R. (See 2149.)

621.385.832 2402
Improved Cathode-Ray Tubes with Metal-Backed Luminescent Screens—D. W. Epstein and L. Pensak. (*RCA Rev.*, vol. 7, pp. 5-10; March, 1946.) The application of a light-reflecting, electron-pervious, thin metallic layer on the beam side of the luminescent screen is claimed to have the following advantages: (1) improved efficiency of

conversion of electron beam energy into useful light; (2) elimination of ion spot, thus making other, generally less direct, means for eliminating the ion spot unnecessary; (3) improved contrast; (4) elimination of secondary emission restrictions, thus permitting the use of high voltages and screen materials with poor secondary emission. The chief effect of such a film is to throw forward the light that would otherwise be radiated back towards the gun. The idea is not new, but recent improvements in technique, which are detailed in the article, have now made it possible and practical. The metal now used is aluminum, the range of thickness being 500 to 5000 angstroms. An important innovation has been the covering of the fluorescent material, before the deposition of the aluminum, with a thin film of organic material. This makes it possible to get the necessary smooth and mirror-like surface on the aluminum.

621.385.832 2403

Origin of Ion Burn in Cathode-Ray Tubes—G. Liebmann. (*Nature*, London, vol. 157, p. 228; February 23, 1946.) This effect is thought to be due to negative ions issuing from the thermionic cathode. Ion burns showing distinctive patterns corresponding to the electron-emission patterns of the cathodes were observed. Details are given of an experiment demonstrating this effect using a tube with magnetic deflection and focusing.

621.385.832: 621.396.9 2404

The Skiatron in Radar Displays—P. G. R. King; D. S. Watson. (*Electronic Eng.*, vol. 18, pp. 172-173; June, 1946.) A description of the dark-trace tube used as a light valve to obtain large-screen radar displays by projection methods. Electron bombardment of a cathode-ray-tube screen composed of alkali-halide crystals produces a dark coloration on an otherwise white background, and episcopic projection using intense external illumination produces a magnified image. The coloration produced decays at a slow rate dependent on the conditions of electron bombardment, illumination, and temperature, the latter being regulated by forced-air circulation in the equipment described. Extract from a lecture by King at the Institution of Electrical Engineers Radiolocation Convention, with additions from a paper by Watson.

621.385.832: 621.397.62 2405

Some Novel Projection Type Television Tubes—(*Electronic Eng.*, vol. 18, p. 186; June, 1946.) A short note from the E.M.I. Laboratories.

621.396.694 2406

The Calculation of Amplifier Valve Characteristics—G. Liebmann. (*Jour. I.E.E.* (London), vol. 93, pp. 138-152; May, 1946.) "The anode-current/grid-voltage characteristics of valves are determined with the help of diagrams and design charts based on Langmuir's data on the current flow in plane diodes with consideration of initial electron velocities, and on Oertel's and Herne's equations for the amplification factor. The theory is extended to multi-grid valves and to valves possessing a more complicated shape. Special attention is given to

the 'variable-mu effect,' which represents one of the limiting factors in practical valve construction. A simple expression describing this effect is derived, and a chart of the 'variable-mu constant,' α , is presented, in which space charge is taken into account. Measurements on specially made experimental valves and on several types of modern mass-produced valves confirm the treatment of the variable-mu effect and show that the methods outlined in the paper, forming a complete design system, allow the prediction of the static valve characteristic with good accuracy even in closely spaced modern valves. Finally, the influences of a change in control-grid wire diameter, of a statistical variation of control-grid pitch, and of cathode misalignment, are discussed." See also 1812 of 1937 (Benjamin et al.) and 3395 of 1943 (Thompson).

MISCELLANEOUS

001.891: 08 2407

A Neglected Aspect of Research—T. Coulson. (*Jour. Frank. Inst.*, vol. 241, pp. 187-193; March, 1946.) A more thorough exploration of available literature and patent specifications by extensive library research at the outset of a research program would save effort and money.

026: 621.396 2408

A Reference Library for Radio Engineers—G. J. Hunt. (*Electronic Eng.*, vol. 18, pp. 187-188; June, 1946.) Suggested list of 10 journals and 75 textbooks for a radio reference library. Headings for an alphabetic subject index are suggested.

029 2409

Documentary Reproduction—L. Moholy. (*Nature* (London), vol. 157, p. 38-40; January 12, 1946.) Mainly an account of the present and possible uses of microfilm. The subject is also discussed editorially on pages 29 and 30.

061.22: 621.396(054) 2410

Waves and Electrons—The designation of this publication as "PROC. I.R.E., SECTION II," with separate paging, stopped after April, 1946. "PROC. I.R.E. AND WAVES AND ELECTRONS" is now paged as one journal, and will be so referred to. See 1740 of June, and 1122 of April.

061.231: 62 2411

[A.I.E.E.] Planning Subcommittee Issues Progress Report on Study of Organization of Engineering Profession—American Institute of Electrical Engineers. (*Elec. Eng.*, vol. 65, pp. 169-173; April, 1946.) Full text of report.

061.5: 621.3(054-2) 2412

Philips Research Reports—A new bi-monthly journal describing the results of research at the Philips Laboratories. Abstracts of papers in the first number appeared in July.

061.5: [621.38+621.396] 2413

The [Wartime] Work of the BTH Research Laboratory—(*Beama Jour.*, vol. 53, pp. 102-107; March, 1946.)

061.6: 621.3 2414

The British Electrical and Allied Industries Research Association—(*Engineer* (Lon-

don), vol. 181, pp. 155-156; February 15, 1946. A summary of the report for 1945. Items discussed include work on dielectric materials; gas-blast circuit breakers for heavy duty; radio interference at frequencies below 25 megacycles; magnetic material research; the "capacitor transformer"; surge phenomena and effects of lightning on overhead lines. See also *Electrician*, vol. 16, pp. 341-342; February 8, 1946.

061.6: 621.3.027.3 2415

High-Voltage Research at the National Physical Laboratory—R. Davis. (*Engineer*, (London), vol. 180, pp. 412-413 and 435-436; November 23 and 30, 1945. Very long summary of the Institution of Electrical Engineers Parsons Memorial Lecture.

061.6: [621.38+621.3.029.6] 2416

Research Laboratory of Electronics at the Massachusetts Institute of Technology—J. A. Stratton. (*Rev. Sci. Instr.*, vol. 17, pp. 81-83; February, 1946.) Announcement of the organization of a new laboratory to undertake research on microwaves, electronic techniques, and electronic aids to computation.

061.6: 621.39 2417

Telecommunications Research—(*Elec. Rev.* (London), vol. 138, pp. 811-812; May 24, 1946.) Description of work at the (British) Post Office research station at Dollis Hill. Lines of investigation include the submarine repeater, the vocoder system for converting speech to a telegraph-like code for transmission and reconstructing it at the receiver, coaxial-cable telephony, the production of crystal resonators, and methods of countering the effects of fading in radio reception.

347.771(73) 2418

Final Report of the National Patent Planning Commission—A. W. Graf. (PROC. I.R.E. AND WAVES AND ELECTRONS, vol. 34, p. 198W; April, 1946.) Suggestions for improving the American system.

5+6]: 623 2419

Impact of the War on Science—L. J. Briggs. (*Elec. Eng.*, vol. 65, pp. 8-10; January, 1946.) An account of the resulting acceleration in scientific research.

5+6] "1939/1945" 2420

The Scientist in Wartime—E. V. Appleton. (*Engineer* (London), vol. 180, pp. 417-419, 432-433, and 454-455; November 23 and 30, and December 7, 1945.) Very long summary of the Thomas Hawksley Lecture at the Institution of Mechanical Engineers.

519.283 2421

Quality Control through Product Testing—P. L. Alger. (*Elec. Eng.*, vol. 65, pp. 11-12; January, 1946.) The procedure required for statistical quality control is defined, and methods of sample testing to maintain an assigned level of quality are given.

519.283 2422

Statistical Methods in Quality Control: Part 8—A.I.E.E. Subcommittee on Educational Activities. (*Elec. Eng.*, vol. 65, pp. 23-24; January, 1946.) "The use of control charts for action when inspection is by the method of variables and the factors for con-

tol are averages and ranges. . . . The method is illustrated by a typical application; the cutting of small sleeves from a tubing material where weight is one of the critical characteristics to be controlled." For parts 7 and 9, see 1411 and 1412 of May; for previous parts, see 805 of March.

519.283 **2423**

Statistical Methods in Quality Control: Part 10—Classification of Defects and Quality Rating—A.I.E.E. Subcommittee on Educational Activities. (*Elec. Eng.*, vol. 65, pp. 117-119; March, 1946.) A measure of quality as the ratio of defective units to total units is usually adequate for simple products. It is suggested that for more complex products, classification of defects according to seriousness is needed, and quality rating by number of demerits per unit is explained.

519.283 **2424**

Quality Control of Production—Statistical. (*Beama Jour.*, vol. 53, pp. 42-44; February, 1946.)

519.283 **2425**

Statistical Tools for Controlling Quality—J. Manuele and C. Goffman. (*Trans. A.I.E.E. (Elec. Eng.)*, December, 1945), vol. 64, pp. 949-951; December Supplement, 1945.) Discussion of 503 of February.

519.283 **2426**

Statistical Methods in the Development of Apparatus Life Quality—E. B. Ferrell. (*Trans. A.I.E.E. (Elec. Eng.)*, December, 1945), vol. 64, pp. 998-999; December Supplement, 1945.) Discussion of 804 of March.

519.283: 519.24 **2427**

A Simple Test of Significance—(*Engineering* (London), vol. 160, p. 452; November 30, 1945.) Letter proposing a method of determining whether there is a significant difference between the results of two comparative series of measurements.

519.283: 621.315.62 **2428**

Statistical Methods Applied to Insulator Development and Manufacture—J. J. Taylor. (*Trans. A.I.E.E. (Elec. Eng.)*, December, 1945), vol. 64, p. 952; December Supplement, 1945.) Discussion of 255 of January.

536.2: 621.3.012.8 **2429**

The Accuracy of Lumping in an Electric Circuit Representing Heat Flow in Cylindrical and Spherical Bodies—V. Paschkis and M. P. Heisler. (*Jour. Appl. Phys.*, vol. 17, pp. 246-254; April, 1946.) "In using lumped resistance-capacitance circuits for studying heat conduction problems the influence of number and size of lumps is important. Several methods of lumping are conceivable for representation of cylindrical or spherical bodies and results of comparative tests show that equal geometrical size of lumps is most accurate. In the various lumps resistance and capacitance have to be in certain definite relationships, which are established in the paper. The influence of number of lumps is also investigated."

538.323 **2430**

An [Alternating-Current] Electromagnet for Non-Magnetic Substances—W. V. Lo-

vell. (*Phys. Rev.*, vol. 69, p. 251; March 1-15, 1946.) The device depends on the interaction between currents in the "magnet" coil and induced currents in nearby conductors. Abstract of an American Physical Society paper.

551.575 **2431**

A Method of Determining the Size of [Fog] Droplets Dispersed in a Gas—R. L. Stoker. (*Jour. Appl. Phys.*, vol. 17, pp. 243-245; April, 1946.) "A method applicable to determining droplet sizes in the interior of an already existing atmosphere of fog or mist is developed and described. The method makes use of the fact that if droplets strike a suitably [soot-] coated surface without wetting the surface, a track of the contact area is formed. A criterion is derived and experimentally evaluated for relating the droplet diameter and the track diameter."

614.825: 621.396.61 **2432**

Safety in the Shack—(*R.S.G.B. Bull.*, vol. 21, pp. 181, 184; June, 1946.) Recommendations for safe operation of amateur transmitters.

620.197+621.314.634 **2433**

Cathodic Protection and Applications of Selenium Rectifiers—W. F. Bonner. (*Elec. Comm.*, vol. 22, no. 4, p. 338; 1945.) Correction to 1944 of 1945.

621-752 **2434**

Modern Vibration Control Installations for Aircraft Radio and Instruments—(*Aero Digest*, vol. 49, pp. 89-91, 144; June 1, 1945.) Description and performance of the "Vibrashock" suspension mount. "... any attempt to design a so-called 'standard' mount will necessarily prove unsatisfactory."

621.3(07) **2435**

Post-Graduate Engineering—(*Elec. Rev.* (London), vol. 138, p. 257; February 15, 1946.) Summary of Institution of Electrical Engineers discussion on "Post-Graduate Courses in Electrical Engineering Including Radio," led by W. Jackson and J. Greig.

621.3.081.4 **2436**

Absolute Bels—F. S. G. Scott. (*Wireless Eng.*, vol. 23, pp. 132-139; May, 1946.) Author's definition: "When any power (P_a) is compared (in bels) with one watt, the resultant answer is expressed in absolute bels." The symbol B is proposed for the absolute bel, with dB for the absolute decibel. It is also proposed that factors (forces, lengths, resistances, etc.) which are not themselves power, but which determine power in certain circumstances, may be expressed in bels. The application of these proposals is illustrated by reference to electrical and acoustical systems.

621.316.93: 629.13 **2437**

Method of Removing Static Charges from Moving Bodies—R. C. Ayres. (*Radio*, vol. 30, p. 49; March, 1946.) Essentially for dissipating precipitation-static charges on aircraft. Summary of U. S. Patent 2,386,084.

621.38/.39(43) **2438**

German Electronic Equipment—(*Elec. Rev.* (London) vol. 138, p. 429; March 15,

1946.) A short account of the S.I.G.E.S.O. exhibition of German service equipment including radar, infrared technique, and guided missiles.

621.38: 778 **2439**

Electronic Flash Tubes—D. A. Senior. (*Electronic Eng.*, vol. 18, pp. 133-135, 141; May, 1946.) Application of high-speed photography to the study of under-water explosions. Exposure may be controlled by a high-speed shutter or by using intense flashes of short duration for illumination.

621.396 **2440**

Radio at the Paris Fair (8-24 Sept. 1945)—M. Adam. (*Génie Civ.*, vol. 122, pp. 168-169; November 1, 1945.) A review of the exhibits under the headings French broadcasting, broadcast receivers, television receivers, components, miscellaneous equipment, and test gear.

621.396.828: [621.365.5+621.365.92] **2441**

Radiation from R.F. Heating Generators—A. G. Swan. (*Electronics*, vol. 19, pp. 162, 170; May, 1946.) Sufficient attenuation of the radiation is obtained by the use of a double-shielded room constructed of copper or steel net up to $\frac{1}{2}$ -inch mesh. A filter at the mains input prevents radiation from the power lines.

621.396.933 **2442**

The Aircraft Radio Serviceman—T. Wayne. (*Radio News*, vol. 35, pp. 28, 116; April, 1946.) Hints on the installation and maintenance of radio equipment in small private aircraft. The causes of precipitation static and means of reducing it are considered.

658: 621.396.621 **2443**

Mass Production—H. G. Shea. (*Elec. Ind.*, vol. 5, pp. 51-55, 123; June, 1946.) Description of organization and methods employed in a typical receiver manufacturing plant. Emphasis is placed on cutting the number of departments to a minimum, thereby reducing the administrative staff required, and on keeping rigidly to time schedules for every operation.

519.283 **2444**

Sequential Analysis of Statistical Data: Applications. [Book Review]—Statistical Research Group, Columbia University, Columbia University Press, New York, N. Y., \$6.50 (*Science*, vol. 103, pp. 490-492; April 19, 1946.)

621.3 **2445**

Basic Electrical Engineering [Book Review]—A. E. Fitzgerald. McGraw-Hill Book Company, New York, N. Y., 1945, 441 pp., \$3.75. (*Elec. Ind.*, vol. 5, p. 128; January, 1946.) "A text book for students majoring in engineering, covering circuits, machines, and electronics."

621.396 **2446**

Principles of Radio [Book Review]—K. Henney. John Wiley & Sons, New York, N. Y., 5th edition 1945, \$3.50, 21s. (*Engineering*, London, vol. 160, p. 511; December 21, 1945.) "Can be recommended as a comprehensive course, suitable for those beginning the study of radio."

RADIO WAVE PROPAGATION

On July 1, 1946, the Interservice Radio Propagation Laboratory will cease to exist as such. At that time the duties and function of the IRPL will be absorbed by the Central Radio Propagation Laboratory, established at the National Bureau of Standards on May 1, 1946, to act as an organization for centralizing and co-ordinating basic research and prediction service in the field of radio wave propagation.

The IRPL-D series, "Basic Radio Propagation Predictions," will, commencing with the July, 1946, be known as the CRPL-D series, and the issue will bear the designation CRPL-D23.

Beginning with the July, 1946, issue the CRPL-D series, "Basic Radio Propagation Predictions," will be available on a purchase basis from the Superintendent of Documents, U. S. Government Printing Office, Washington 25, D. C., on the following terms:

Single copy 15 cents
Annual subscription (12 issues) . . . \$1.50

The rules of the Superintendent of Documents require that remittances be made in advance, either by coupons sold in sets of 20 for \$1 and good until used, or by check or money order payable to the Superintendent of Documents. Currency, if used, is at sender's risk. Postage stamps, foreign money, and defaced or smooth coins are not acceptable. Postage is not required in the United States, to United States possessions, and to countries extending franking privileges. For mailing to other countries an additional amount of about one third of the purchase price is required. Remittances from foreign countries should be by international money order payable to the Superintendent of Documents, or by draft on an American bank.

Each issue of the D series gives complete information enabling the user to calculate best sky-wave operating frequencies over any path at any time of day for average conditions for the month of prediction. Predictions are issued three months in advance; thus CRPL-D23 gives information concerning optimum working frequencies for October 1946.

Although the CRPL-D series is considered to be a monthly supplement to the IRPL Radio Propagation Handbook, Part 1, nevertheless each issue of the D series is complete in itself, so that it is possible to calculate the best sky-wave operating frequencies without reference to any other publication. The techniques given are improvements on those outlined in the Handbook.

Each issue contains charts of extraordinary-wave critical frequency for the F_2 layer and charts of maximum usable frequency under average conditions for a transmission distance of 4000 kilometers. These charts are provided for each of the three zones into which the world is divided for the purpose of taking into consideration the variation of the characteristics of the F_2 layer with longitude. There is a chart of maximum usable frequency for E -layer transmission over a path length of 2000 kilometers, and charts showing the highest frequency of

Attention, Authors

PAPERS DESIRED FOR 1947 I.R.E. TECHNICAL MEETING

Outstanding papers on timely subjects are desired for the program of the I.R.E. Technical Meeting scheduled for March 3, 4, 5, 6, and 7, 1947. All of the radio-and-electronic fields should be included if the program is to be truly representative of the interests of the Institute. It will be possible to accept only a limited number of papers for the technical program. In order to receive consideration of your paper, the following rules should be followed:

1. The title and a brief abstract of the paper, similar to the summaries published at the beginning of the articles in the PROCEEDINGS OF THE I.R.E. AND WAVES AND ELECTRONS, but not more than 75 or 80 words in length, should be submitted as soon as possible. No abstracts can be considered which are received after November 30, 1946.

2. Correspondence should be sent to Professor Ernst Weber, Polytechnic Institute of Brooklyn, 99 Livingston St., Brooklyn 2, New York, marked to the attention of the Papers Committee, 1947 I.R.E. Technical Meeting.

3. The length of the paper should be such that oral presentation can be made within 20 minutes, in order to allow adequate time for general discussion.

4. Authors are responsible for obtaining military clearance where required.

5. Submission of the papers for publication in the PROCEEDINGS OF THE I.R.E. AND WAVES AND ELECTRONS is desired, but is not a necessary requirement for acceptance.

6. Papers published in any journal prior to the date of the Technical Meeting necessarily will be withdrawn from the program.

7. A condensed version or summary of the paper, including the most important illustrations, must be prepared by the authors whose papers are accepted, and must be available by January 1, 1947.

Prospective Authors

The Institute of Radio Engineers has a supply of reprints on hand of the article "Preparation and Publication of I.R.E. Papers" which appeared in the January, 1946, issue of the PROCEEDINGS OF THE I.R.E. AND WAVES AND ELECTRONS. If you wish copies, will you please send your requests to the Editorial Department, The Institute of Radio Engineers, Inc., 26 West 58th Street, New York 19, New York, and they will be sent to you with the compliments of the Institute. It would be greatly appreciated if your requests were accompanied by a stamped, self-addressed envelope.

sporadic- E reflections as well as percentage of time occurrence for sporadic- E in excess of 15 megacycles. In addition there are various maps, charts, diagrams, and nomograms needed to make practical application of the world-contour charts, together with examples of their use.

NUCLEAR RESEARCH

A program of research into nuclear physics and the problems associated with the conversion of atomic energy into a useful source of peacetime power has been announced by scientists at the Westinghouse Research Laboratories. Dr. L. W. Chubb (M'21-F'40), director of the Laboratories, stated that the program will be in charge of Dr. W. E. Shoupp (SM'45), manager of the electronics department, whose research before the war culminated in the codiscovery of photofission.

Dr. Shoupp pointed out that this branch of science was accelerated during the war and that some of the knowledge gained then is available for postwar research. Added to previous discoveries it will provide a foundation on which to build a program for the future. First step in the program is modernization of the Westinghouse atom smasher which, during the war, was capable of building up a potential of 4,000,000 volts of electricity to hurl electrified particles against a target at speeds of between 30,000,000 and 100,000,000 miles an hour. Because of the ability to obtain from 0 to 4,000,000 volts with an accuracy of one tenth of one per cent precision studies can be made which are not possible with other types of apparatus. The vital consideration in studies of nuclear physics is to be able to determine at just what voltage reaction begins—when the specimen begins to disintegrate or change into another substance. This can be determined by increasing the voltage.

WESTINGHOUSE CENTENNIAL FORUM ACTIVITIES

At the Westinghouse Centennial Forum held in Pittsburgh, Pennsylvania, on May 16 to 18, prominent scientists, scholars, and engineers presented papers on the topic "Science and Life in the World." L. W. Chubb (M'21-F'40), director of Westinghouse Research Laboratories, and Frank B. Jewett (F'20), president of the National Academy of Sciences, delivered the centennial addresses at two luncheon meetings, the subjects of which were "Partners in Science" and "Horizons in Communications," respectively. Dr. Jewett, as chairman, also presided over the symposium on "The Future of Atomic Energy," and Major General Roger B. Colton (SM'46), United States Army (retired) and vice-president of Colton and Foss, served as chairman at a luncheon meeting.

The complete texts of the papers and addresses delivered at the forum are scheduled for early publication in the form of five books. These symposia and addresses will be accompanied by biographies of the speakers, text illustrations, and most of the audience questions and speakers' answers relative to each of the papers. Request for copies of the five books should be directed to Mr. Stanley R. March, Secretary, Westinghouse Centennial Forum, 306 Fourth Avenue, Pittsburgh 30, Pennsylvania.

Now You Can SEE The Performance Of Your Circuits

With the
HAR - CAM
Visual Alignment
SIGNAL
GENERATOR



The HAR-CAM Visual Alignment SIGNAL GENERATOR provides the swiftest and surest method for the adjustment and alignment of tuned circuits. With it the complete radio frequency response curve of any circuit under observation can be presented on an oscilloscope screen. Variations in circuit alignment can be accurately evaluated and necessary changes made in a matter of seconds — a far simpler, more precise method than the old technique of tuning for maximum audio or voltage output which often leads to improper alignment of I-F, discriminator or other circuits.



The HAR-CAM Visual Alignment Signal Generator instantly shows up the misalignment in the I-F circuit shown above.



With the assistance of the HAR-CAM Signal Generator, the performance of the circuit is easily and correctly adjusted.

SPECIFICATIONS

1. Linear frequency sweep deviation adjustable from zero to 900 kc peak to peak.
2. Vernier frequency control of 100 kc allows zero beat calibration of main tuning dial or for vernier frequency deviations, about main dial frequency setting.
3. Stable r-f gain control independent of frequency.
4. Five-step attenuator of r-f output giving over-all voltage range of 1 microvolt to .1 volt when used in conjunction with the gain control.
5. Output impedance, 1 ohm to 2500 ohms.
6. Phone jack for aural monitoring of zero beat calibration of main tuning dial.
7. Panel jack to feed linear sweep voltage to x-axis amplifier of oscilloscope, thus synchronizing the frequency linear sweep of the generator with the spot trace on the scope screen.
8. Voltage regulated supply for internal oscillators. Careful oscillator design to minimize drift.
9. Size, 7" wide, 9 1/2" high, 10 1/2" deep. Weight 18 pounds.

Write for Bulletin Number H-40

HARVEY RADIO LABORATORIES, INC.

456 CONCORD AVENUE • CAMBRIDGE 38, MASSACHUSETTS

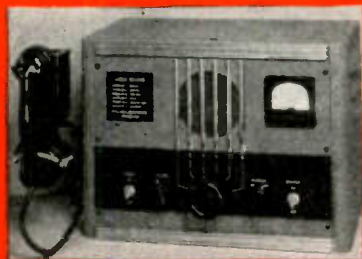

Typical HARVEY products: Above left: The HARVEY Marine Radio Telephone Model M-25; center: The HARVEY Regulated Power Supply 106 PA; right: The HAR-CAM Model MFT-25 FM Transmitter. Write for Bulletins.

DO YOU MAKE:

INSTRUMENTS?

Ammeters	Oscillographs	Light Meters
Voltmeters	Flux Meters	Cardiograph
Galvanometers	Watt-hour Meters	Recorders
Seismographs	Flow Meters	Vibration Pick-ups

RADIO, SOUND AND COMMUNICATIONS EQUIPMENT?

Loud Speakers	Sound-powered Telephones	Vibration Pick-ups
Headsets	Telephone Ringers	Polarized Relays
Microphones	Voltage Regulators	Generators
Hearing Aids	Phonograph Cutting Heads	Meters
Electrical Musical Instruments	Phonograph Pick-ups	Magnetron Fields

AUTOMOTIVE AND AVIATION EQUIPMENT?

Magnetos	Voltage Regulators	Generators
Tachometers	Motors	Magnetic Oil
Compasses	Speedometers	Filters

THESE PRODUCTS?

Magnetic Separators	Arc Blow-out Magnets	Clocks
Magnetic Chucks	Temperature and Pressure Control Equipment	Toys and Novelties
Magnetic Conveyors	Circuit Breakers	Coin Separators for Vending Equipment
Magnetic Clutches	Limit Switches	
Magnetic Damping Devices	Holding Magnets	

IF YOU make any of the above products, you should be interested in finding out how *better permanent magnets* can improve efficiency and reduce costs. Put your design, development or production problems up to The Arnold Engineering Company. Arnold engineers have been of great assistance to many manufacturers and are at your service to advise exactly what Alnico permanent magnet will solve your particular problem.



Write for Technical Bulletin—"Permanent Magnets for Industry," containing valuable data on design, production characteristics and applications of Permanent Magnets.

THE ARNOLD ENGINEERING COMPANY

SUBSIDIARY OF ALLEGHENY LUDLUM STEEL CORPORATION

147 EAST ONTARIO STREET, CHICAGO 11, ILLINOIS

Specialists in the manufacture of ALNICO PERMANENT MAGNETS



ATLANTA

"The Operation and Field Measurement of Developmental Broadcast Station W4XAJ," by R. A. Holbrook and O. H. Heely, Broadcast Station WSB; June 21, 1946.

BALTIMORE

"Considerations Involved in Designing Antennas Having High Order of Field Gains in the Horizontal Plane," by J. F. Morrison, Bell Telephone Laboratories; June 25, 1946.

Election of Officers.

CONNECTICUT VALLEY

Annual Outing, June 15, 1946.

DALLAS—FT. WORTH

"Very-High-Frequency and Ultra-High-Frequency and UHF Antennas," by C. M. Daniell, Associate of A. Earl Cullum, Jr., Consulting Radio Engineers; July 2, 1946.

"Electronics in Petroleum Research," by D. H. Clewell, Magnolia Field Research Laboratories; July 23, 1946.

DETROIT

"Stratovision—Television from the Stratosphere," by L. S. McLeod, Westinghouse Electric Corporation; June 21, 1946.

INDIANAPOLIS

Tour of the Experimental Laboratories of Weir Cook Airport, June 28, 1946.
Election of Officers.

LOS ANGELES

"This Electronic Age," by W. C. Eddy, United States Navy; June 10, 1946.

SAN DIEGO

"The Military Applications of Airborne Electronics," by H. R. Willis, United States Navy, Fleet Airborne Electronics Training Unit Pacific; July 9, 1946.

SAN FRANCISCO

"The Magnetophone, German Sound Recorder, and its Application to Film Recording," by J. Mullin, W. A. Palmer Company; May 9, 1946.



The following transfers and admissions were approved on August 6, 1946:

Transfer to Senior Member

Armstrong, C. A., 45 Hart St., Ramsey, N. J.

Bedford, A. V., 170 Jefferson Rd., Princeton, N. J.

Bernard, W. B., Office of Research and Inventions, Navy Department, Washington 25, D. C.

(Continued on page 36A)

more important
than ever before . . .

Quality

SHERRON TEST EQUIPMENT

. . . to help you maintain top engineering standards

Sherron Test Equipment gives you the assurance that your products will pass the most rigid requirements. We are well prepared, by virtue of our research and extensive laboratory work, to engineer test equipment for every type of manufacturing and inspection operation. We design and manufacture custom-built equipment to meet individual production problems. Our engineering and designing staff is available for consultation on your problem.

VACUUM TUBE TEST EQUIPMENT

RECEIVING, TRANSMITTING & POWER

Electrical Shorts, Heater, Cathode Leakage, G.M., Static Characteristics, Gas Emission, Plate Cut-Off, Diode Emission, Grid Currents, Trans Conductance, Power Output, Amplification.

CATHODE RAY & KINESCOPIES

Voltage Breakdowns, Gas, Focusing, Light Output, Spot Size and Position, Beam Current, Line Width, Screen Quality and Persistency.

COAXIAL CABLES

Production and Laboratory Test Equipment for the inspection of Coaxial Cables and other transmission lines for the following characteristics:

- Dielectric Strength
- Insulation Resistance
- Characteristic Impedance
- Capacitance
- Power Factor
- Corona

CONDENSERS & RESISTORS

Production and Laboratory Test Equipment designed to meet the individual application with an accuracy as demanded by requirements.

- Capacity
- Resistance
- "Q" Measurements
- Dielectric and Insulation Resistance and Breakdown

Automatic or manual, these units are designed to give accurate results.



CATHODE RAY NULL DETECTOR

Sherron's new precision Cathode Ray Null Detector is a stand-by and a "must" for A.C. Bridge measurements — 1000 cycle source is included. Unit has a gain of 80db at an input voltage of 100 micro volts.

SHERRON ELECTRONICS CO.

1201 FLUSHING AVE., BROOKLYN 6, N.Y.

DIVISION OF SHERRON METALLIC CORP.

For the convenience of West Coast Companies, we are pleased to announce the opening of our SAN FRANCISCO Sales Office, Mechanics Institute Building, 57 Post Street, San Francisco, Calif.



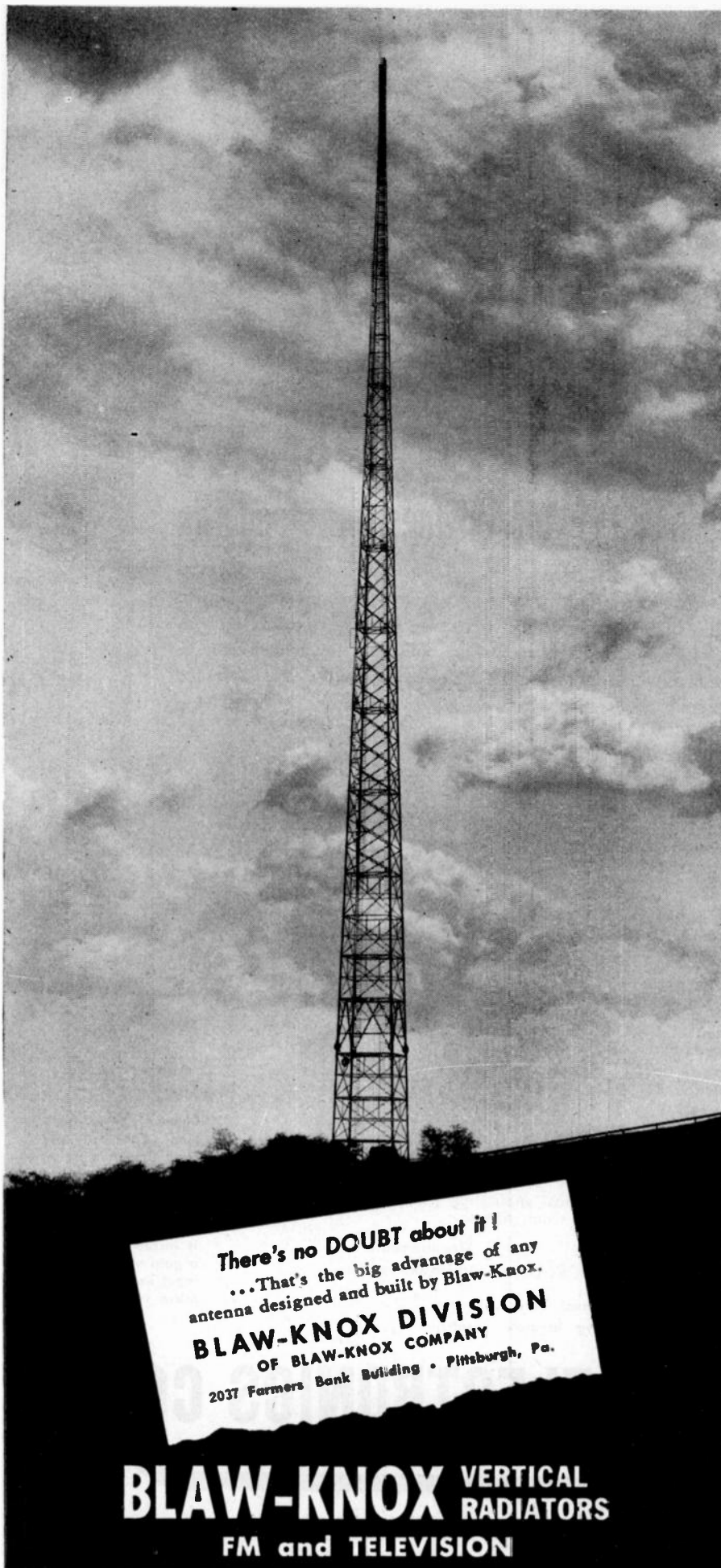

There's no DOUBT about it!
 ...That's the big advantage of any
 antenna designed and built by Blaw-Knox.
BLAW-KNOX DIVISION
 OF BLAW-KNOX COMPANY
 2037 Farmers Bank Building • Pittsburgh, Pa.

**BLAW-KNOX VERTICAL
 RADIATORS**
 FM and TELEVISION



(Continued from page 34A)

- Burnside, D. G., RCA Laboratories, Princeton, N. J.
- Cattell, G. W., 1155 Glen Ave., Berkeley 8, Calif.
- Copp, J. H., Broadcast Engineering Section, Bldg. A, Thompson Rd., Syracuse 1, N. Y.
- Crosby, D. R., RCA Laboratories, Bldg. 8-10, Camden, N. J.
- Cummings, J. J., 447 Carteret St., Camden, N. J.
- Day, G., 697 Sterling Pl., Brooklyn 16, N. Y.
- Diver, F. G., "Portway", 12, Buckland Ave., Slough, Bucks, England
- Ewing, L. M., 114 Michaels Ave., Syracuse 8, N. Y.
- Fick, C. G., General Electric Co., 1285 Boston Ave., Bridgeport, Conn.
- Fredendall, G. L., RCA Laboratories, Princeton, N. J.
- Gaines, B. R., c/o C. A. A., 1500 Fourth St., Santa Monica, Calif.
- Glaser, E. M., W2BRB, 14 Wallace Ave., Bellmore, N. Y.
- Glenn, A. B., 3115 Ave. 1, Brooklyn, N. Y.
- Grant, I. C., Venezuela 613, Buenos Aires, Argentina
- Green, J. A., Collins Radio Co., 855-35 St., N. E., Cedar Rapids, Iowa
- Groves, W. E., 67 W. Stratford Ave., Salt Lake City 5, Utah
- Hiehle, M. E., 1031 Euclid Ave., Syracuse, N. Y.
- Hollis, J. L., 7317 Harding Ave., Cincinnati 31, Ohio
- Keister, J. E., 821 Sanders Ave., Scotia 2, N. Y.
- Kiernan, E. F., 2741 Reynard Way, San Diego 1, Calif.
- Lofgren, E. O., Vartavagen 25, Stockholm, Sweden
- Lyons, W., 3235-210 St., Bayside, N. Y.
- Maciszewski, A. H., 606 Forest Ave., River Forest, Ill.
- Maynard, J. E., Box 380, Schenectady, N. Y.
- Mead, L. R., 200 N. Knight Ave., Park Ridge, Ill.
- Mingins, C. R., Department of Physics, Tufts College, Medford, 55, Mass.
- Parsegian, V. L., 540 Park Ave., Brooklyn 5, N. Y.
- Pugsley, D. W., 1233 Melville Ave., Fairfield, Conn.
- Rambo, W. R., 111-7 St., Garden City, N. Y.
- Schroeder, A. C., Feasterville, Pa.
- Shower, E. G., 94 California Ave., Freeport, N. Y.
- Shulman, C. I., RCA Laboratories, Princeton, N. J.
- Sinclair, G., 171 King Ave., Columbus 1, Ohio
- Somers, F. J., Engineering Department, National Broadcasting Co., 30 Rockefeller Plaza, New York 20, N. Y.
- Sproul, P. T., 463 West St., New York 14, N. Y.

(Continued on page 38A)

New!

Series 200

A RELAY BY GUARDIAN with Interchangeable Coils

BUILT IN TWO PARTS

A. C. Coil Assemblies available for 6 v., 12 v., 24 v., 115 v.
D. C. Coil Assemblies available for 6 v., 12 v., 24 v., 32 v., 110 v.

★ Two basic parts—a coil assembly and a contact assembly—comprise this simple, yet versatile relay. The coil assembly consists of the coil and field piece. The contact assembly consists of switch blades, armature, return spring, and mounting bracket. The coil and contact assembly are easily aligned by two locator pins on the back end of the contact assembly which fit into two holes on the coil assembly. They are then rigidly held together with the two screws and lock washers. Assembly takes only a few seconds and requires no adjustment on factory built units.

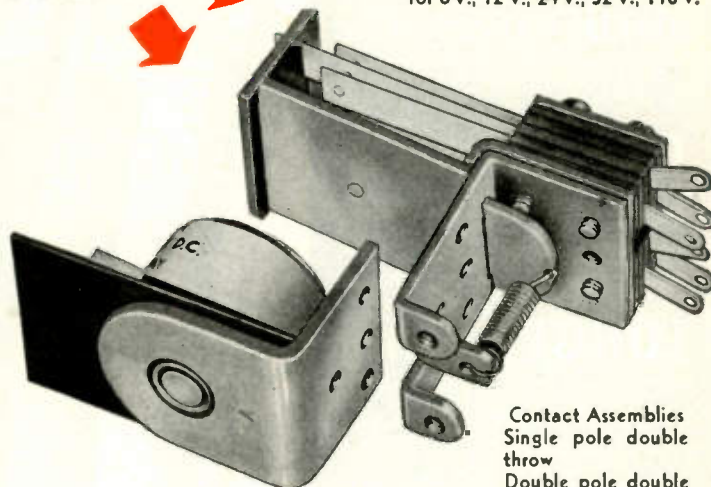

Series 200 Relay

Contact Assemblies
Single pole double throw
Double pole double throw

On Sale at Your nearest jobber NOW!

See it today! . . . this amazing new relay with interchangeable coils. See how you can operate it on any of nine different a-c or d-c voltages—simply by changing the coil. Ideal for experimenters, inventors, engineers.

TWO CONTACT ASSEMBLIES

The Series 200 is available with a single pole double throw, or a double pole double throw contact assembly. In addition, a set of Series 200 Contact Switch Parts, which you can buy separately, enables you to build dozens of other combinations. Instructions in each box.

NINE COIL ASSEMBLIES

Four a-c coils and five d-c coils are available. Interchangeability of coils enables you to operate the Series 200 relay on one voltage or current and change it over to operate on another type simply by changing coils.



Your jobber has this sensational new relay on sale now.
Ask him about it. Or write for descriptive bulletin.

GUARDIAN ELECTRIC

1628-K W. WALNUT STREET

CHICAGO 12, ILLINOIS

A COMPLETE LINE OF RELAYS SERVING AMERICAN INDUSTRY

ANDREW *Semi-Flexible* COAXIAL CABLE

BETTER ON 3 COUNTS

✓ **LOWER** loss than plastic 30% to 50% less loss than in plastic cables of same diameter.

✓ **GREATER** power capacity Insulation does not melt or soften . . . develops less heat than plastic cables.

✓ **LONGER** lasting Andrew cables are made entirely of copper and stone, two materials which have unlimited life and which impart the greatest resistance to crushing, corrosion and weathering.

ANDREW "FIRSTS" Here's proof of Andrew Leadership in the development of semi-flexible coaxial cables. 1) First to produce $\frac{3}{8}$ and $\frac{7}{8}$ inch soft temper cables in 100 foot lengths . . . 2) First to offer continuous coils of unlimited length with factory splicing . . . 3) First to offer lines shipped under pressure with all fittings attached.

Such continued leadership enables Andrew to offer *better* semi-flexible coaxial cables; cables that are better than those made from any other materials.

A complete line of coaxial cables, accessories, and other antenna equipment is produced by Andrew.

ANDREW CO.

363 E. 75th ST. • CHICAGO 19, ILL.

Pioneer Specialists in the Manufacture of a Complete Line of Antenna Equipment

These are the famous Andrew semi-flexible coaxial cables in $\frac{3}{8}$ and $\frac{7}{8}$ inch diameters (shown in actual size). Because of their better construction and design they are used throughout the world by thousands of broadcast, police, government, and military radio stations as the most efficient device for connecting antenna to transmitter or receiver.

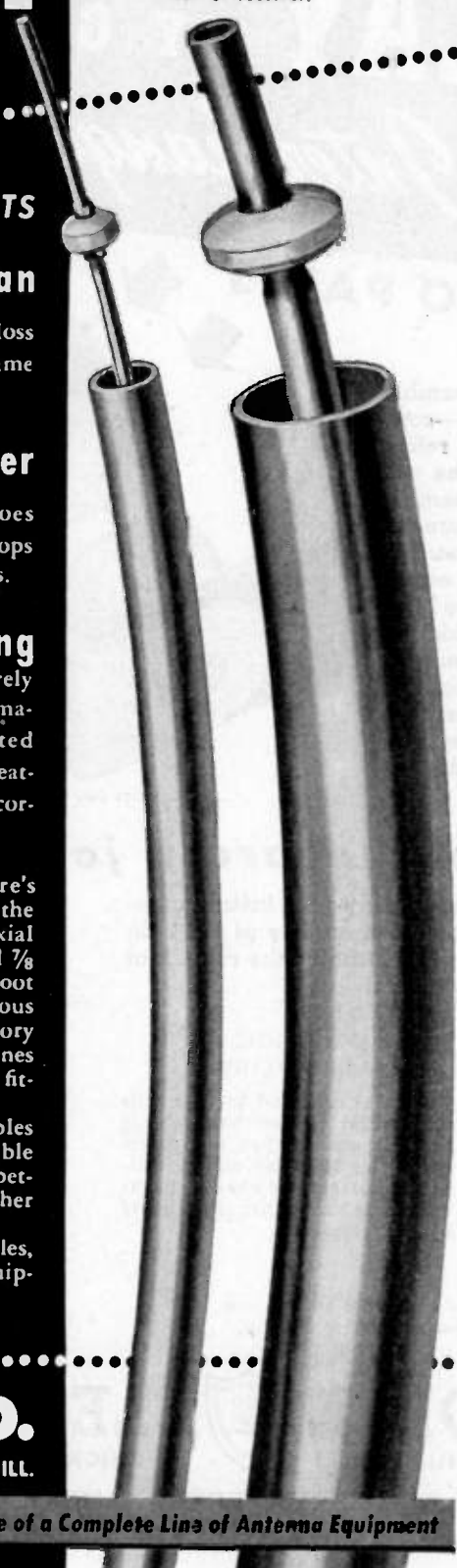

(Continued from page 36A)

- Stuart, D. M., 4709 Overbrook Rd., Washington 16, D. C.
Walker, O. F., 146 Jamesville Rd., DeWitt, N. Y.
Willis, C. H., School of Engineering, Princeton University, Princeton, N. J.
Young, C. P., 4616 N. 23 Rd., Arlington, Va.

Admission to Senior Member

- Abraham, L. G., 180 Varick St., New York 14, N. Y.
Bowen, A. E., Bell Telephone Laboratories, Red Bank, N. J.
Chaney, J. G., Postgraduate School, U. S. Naval Academy, Annapolis, Md.
Christensen, J. W., 84 Prescott St., Cambridge 38, Mass.
Ewing, D. H., 323 Westmont Ave., Westmont, N. J.
Ferry, M., 480 Hibbard Rd., Winnetka, Ill.
Gamertsfelder, G. R., Box 667, Pleasantville, N. Y.
Giboin, E. J., Rue Bouchut 12, Paris 15, France
Haedecke, A. D., 309 Onondaga Ave., Syracuse 4, N. Y.
Hale, N. H., 1295 Elmhurst Dr., N. E., Cedar Rapids, Iowa
Herzog, G., 2211 Montreal Blvd., Houston 5, Tex.
Klute, W. A., 234 Edgewood Ave., Westfield, N. J.
Martinelli, C. C., 1 Harris Rd., Princeton, N. J.
Mitchell, D., 463 West St., New York 14, N. Y.
Payman, H. S., Hatton Works, Great South West Rd., Feltham, Middlesex, England
Penin, C. F., Vitrolles, Bouches du Rhone, France
Selby, M. C., 4817-36 St., N. W., Washington 8, D. C.
Silbermann, H., P. O. Box 7703, Johannesburg, South Africa
Thatcher, J. W., 6601 Romaine St., Hollywood 38, Calif.
Vance, R. L., 131 Clifton St., Westfield, N. J.
Vose, C. H., 130 Moore St., Princeton, N. J.
Walstrom, J. E., Nelson Rd., RFD #6, Lexington 73, Mass.
Weiss, S. I., 26 Cornelson Ave., Jersey City 4, N. J.

Transfer to Member

- Adams, R. L., 130 Glebeholme Blvd., Toronto, Ont., Canada
Anselmi, S. C., Radio-Suisse-S.A., Munchenbuchsee (Eton. Berne), Switzerland
Archer, C. J., 116 Holmes Dr., Osborn, Ohio
Ausin, H. A., 1532 Centre St., Roslindale 31, Mass.

(Continued on page 42A)

Definitely in the Picture

FOR TELEVISION

ERIE CERAMICON

ERIE CERAMICON

Tubular Ceramicons
1—15,000 MMF

Stand-Off Ceramicons
1—2,500 MMF

Disc Ceramicons
51—7,500 MMF

Cinch-Erie Plexicon Tube
Socket with 1,000 MMF
built in by-pass condensers

Custom Injection Molded
Coil and Transformer Forms

High Voltage
Double Cup Ceramicons
20—600 MMF

Feed-Thru Ceramicons
3—1,000 MMF

Button Mica Condensers
15—6,000 MMF

ERIE RESISTOR
Components

THE special problems inherent in television receivers have been given careful attention by Erie Resistor engineers in designing condensers for these applications.

The components illustrated above have been correctly designed for efficient operation at high frequencies. The condensers have low series inductance and incorporate specially designed terminals and mounting arrangements. Of special interest is the high voltage Erie Double Cup condenser for power supply

filtering circuits. Rated at 10,000 volts D.C., and having a capacity of .006 mfd. these units are unusually compact and economical. Plastic coil and transformer forms are custom injection molded to customer's specifications.

We will be glad to send you technical data and samples on any of the condensers shown above. Our engineers are at your service to develop special ceramic or mica condensers for television applications.

★
BUY VICTORY
BONDS
★

ERIE RESISTOR CORP.
ERIE, PENNSYLVANIA
LONDON, ENGLAND . . . TORONTO, CANADA



PREMAX

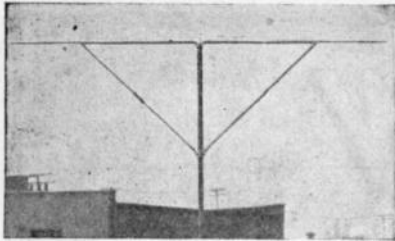

One Antenna For Both FM and Television

Antennas effective in the 44 to 88 mc. range and in the 174 to 216 mc. range as well as those satisfactory in the 44 to 216 mc. range are now available. This covers, with one antenna, both FM and Television bands.

Premax FM and Television Antenna No. FMT-150 handles satisfactorily BOTH ranges . . . gives excellent response for ALL Television bands, old and new . . . yet requires less horizontal space than any other conventional dipole for the same frequency response.

Premax FM Universal Dipole Antenna Model No. FM-130 provides better FM reception than single dipole in congested city areas where signals are reflected from high buildings.

Send for special FM and Television Bulletin No. 4613.

Premax Products

Division Chisholm-Ryder Co., Inc.

4613 Highland Ave. Niagara Falls, N.Y.

40A

News and New Products

Eight Bay FM Antenna

A square loop antenna, which establishes a new high in FM broadcast efficiency, has been developed by the Federal Telephone and Radio Corporation, Newark, N. J. This antenna, when 8 bays are utilized, provides a power gain of nine which in practical terms means that 90 KW of effective radiated power can be obtained from a 10 KW transmitter.

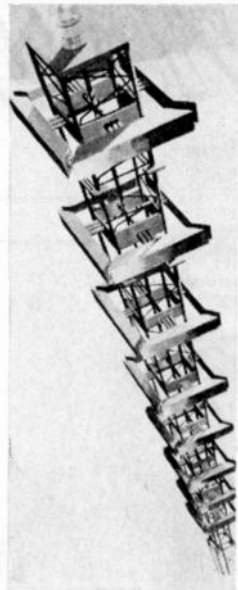

Other characteristics of this antenna are simplicity of mechanical and electrical design, omnidirectivity in the horizontal plane, horizontal polarization and a minimum of resonant circuits and operational maintenance.

Direct Reading Phase Angle and Impedance Meter

A new Z-Angle Meter measuring impedance in ohms and phase angle in degrees over the entire audio-frequency range has been announced by the Technology Instrument Corp., 1058 Main St., Waltham 54, Mass., in a recent bulletin.

This direct-reading meter Type 310-A may also be utilized as a universal bridge over extremely wide ranges of resistance, capacitance and inductance. The operating circuit is basically different from that of conventional AC bridges in that the measurement of impedance and phase angle is not dependent upon frequency. The manufacturer claims that in addition to being a direct-reading instrument, it opens up new possibilities in testing lines, transformers, filters and networks.

Technology Instrument Corp. was organized the early part of this year by I.R.E. members, H. H. Scott (M'35), President and Executive Engineer; L. E. Packard (SM'43), Treasurer and Sales Manager; and R. W. Searle (A'46), Secretary and Production Manager.

New Standards Lab Dedicated

The Ohmite Laboratory of the Armour Research Foundation of the Illinois Institute of Technology, Chicago, Ill., was recently dedicated.

The goal of the laboratory is to provide precision electrical measurements for the Chicago area, approaching in accuracy those of the National Bureau of Standards.

The Laboratory, which was established in 1945, is the result of contributions by David T. Siegel, (M'45), member of the IRE and president of the Ohmite Manufacturing Company.

New Firm Enters Resistor Field

The recently formed St. Clair Electric Products Co., St. Clair, Mich., has announced the establishment of both engineering and manufacturing facilities for the design and production of standard and special industrial heater and resistor units. The company is equipped to produce special wire wound components, voltage regulator resistors, thermal and viscosity control units, etc.

One Kilowatt Transmitter Announced

Raytheon Mfg. Co., Chicago, Ill., announces production of a new one-kilowatt broadcast transmitter of simplified circuit design for medium-power broadcast stations.

High-level modulation eliminates the necessity of complicated and critical adjustment of linear amplifier and reduces harmonic distortion to an absolute minimum. By the use of triode type tubes in this RA-1000 transmitter, feedback failure, should it occur, will not cause a complete breakdown and the signal quality will still be excellent, it is claimed.

New Impulse Scaler



A new scaling device for the counting of beta particles and gamma rays in radioactivity research has just been put on the market by Instrument Development Laboratories, 817 E. 55 St., Chicago 15, Ill. The new Model 161 Scaler is expected to find extensive use for tracer research work in metallurgy, medicine, food technology, chemistry and related fields. It operates on impulses from a Geiger-Müller tube, and actuates an external register once for each 64 impulses it receives.

Features of the new scaler are its self-contained high voltage supply, and the fact that no preamplifier is required for use with a Geiger-Müller tube.

(Continued on page 59A)

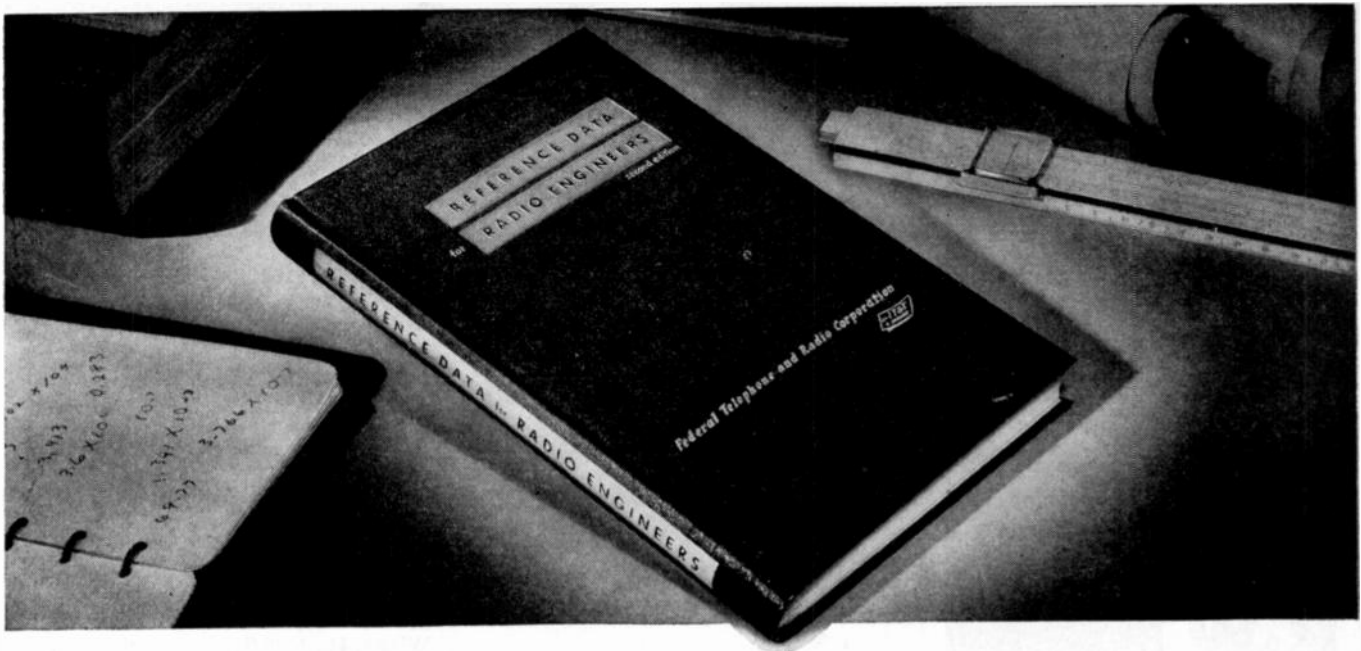

NOW READY—New and enlarged edition "REFERENCE DATA for RADIO ENGINEERS"

Compiled especially for Radio Engineers,
Students of Engineering, Educators, Electronic
Technicians, Radio Amateurs, Inventors.

The second edition of this widely accepted pocket-size hand-book . . . revised and enlarged . . . now includes important radio technical data developed during the war.

Compiled jointly by the physicists and electronic specialists of the Federal Telecommunication Laboratories and the International Telephone and Telegraph Corporation, the material in this new book has behind it the technical authority of an organization with international leadership in radio, communications and television.

Enlarged from 200 to 336 pages with over 400 charts and diagrams, it makes available quickly the answers to problems that normally arise in practical radio work. This ready reference feature is one reason why *Reference Data for Radio Engineers*, in its earlier edition, received such an enthusiastic welcome by electronic specialists. Orders totaled more than 50,000 copies. With the wealth of new material now included, the second edition can be of even greater aid to the practicing radio engineer.

Commenting on the first edition, Walter J. Seeley, Chairman, Department of Electrical Engineering, Duke University, wrote enthusiastically:

"It is so chock full of useful data that I am urging all students to purchase their own personal copies . . . fills a long-felt need for a convenient compilation of both mathematical and engineering data, and the combination will be appreciated by all who have to work with radio circuits and their concomitant mathematics. That applies especially to teachers and students and I should not be surprised if it becomes a must in many college courses."

The new, second edition of *Reference Data for Radio Engineers*, in green cloth binding, revised and enlarged to include much new data, is ready now. To order, merely fill in the convenient coupon.

PRICE \$2 (In lots of 12 or more, \$1.60 each)

Federal Telephone and Radio Corporation



Publication Dept., 67 Broad Street, New York 4, N. Y.

Proceedings of the I.R.E. and Waves and Electrons

September, 1946

PARTIAL OUTLINE OF CONTENTS

General Information. Conversion Factors, Greek Alphabet, Electromotive Force—Series of the Elements, Position of Metals in the Galvanic Series, Relative Humidity, Weather Data, Power Supplies in Foreign Countries, World Time Chart, Radio Frequency Charts, Frequency Band Widths Occupied by Emissions, Tolerances for the Intensity of Harmonics of Fixed, Land, and Broadcasting Stations, Classifications of Emissions, Decibels.

Engineering and Material Data. Wire Tables, Insulating Materials, Plastics: Trade Names, Wind Velocities and Pressure, Temperature Chart of Heated Metals, Physical Constants of Various Alloys and Metals, Thermocouples, Melting Points of Solder, Spark Gap Voltages, Head of Water in Feet, Approximate Discharge Rate, Materials and Finishes for Tropical, Marine Use, Torque and Horsepower.

Audio and Radio Design. Resistor and Capacitor—color codes, Inductance of Single-Layer Solenoids, Magnet Wire Data, Reactance Charts, Impedance Formulas, Skin Effect, Network Theorems, Circuits, Attenuators, Filters.

Rectifiers and Filters. Typical Rectifier Circuit Data, Rectifier Filter Design.

Iron-Core Transformers and Reactors. Major Types, Temperature, Humidity, Pressure Effects, General Limitations, Design of Power-Supply Transformers.

Vacuum Tubes. Formulas, Performance Limitations, Electrode Dissipation Data, Filament Characteristics, Ultra-High-Frequency Tubes, Cathode-Ray Tubes, Preferred Radio Electron Tubes.

Vacuum Tube Amplifiers. Graphical Design Methods, Classification of Amplifier Circuits, Cathode Follower Data.

Resistance-Coupled Audio Amplifier Design. Negative Feedback, Distortion. **Room Acoustics.** Good Room Acoustics, Optimum Reverberation Time, Computation of Reverberation Time, Electrical Power Levels Required for Public Address Requirements.

Wire Transmission. Telephone Transmission Line Data, Frequency Allocation Charts, Noise Measurement—Wire Telephony, Telegraph Data.

Radio-Frequency Transmission Lines. Attenuation Due to Mismatch on Transmission Lines, Impedance Matching with Shorted Stub, Open Stub, and coupled sections, Army-Navy List of R-F Cables, Attenuation of Standard R-F Cables, Resistance of Transmission Lines at Ultra-High Frequencies.

Wave Guides and Resonators. Propagation of Electromagnetic Waves in Hollow Wave Guides, Rectangular Wave Guides, Circular Wave Guides, Electromagnetic Horns, Resonant Cavities.

Radio Propagation and Noise. Propagation of Long, Medium and Very Short Waves, Great Circle Calculations, Time Interval Between Transmission and Reception of Reflected Signal, Radio Noise and Noise Measurement.

Antennas. Field intensity from Elementary Dipole, from Vertically Polarized Antenna with Base Close to Ground, Vertical Radiators, Field Intensity and Radiated Power from a Half-Wave Dipole in Free Space, Radiation from End-Fed Conductor of Any Length, Maxima and Minima of Radiation.

Non-Sinusoidal Wave Forms. Relaxation Oscillators, Electronic Integration and Differentiation Methods, Fourier Analysis of Recurrent Wave Forms, Analysis of Common Wave Forms.

Use This Coupon—Order Your Copy Now!

Federal Telephone and Radio Corporation
Publication Dept. A3, 67 Broad Street
New York 4, N. Y.

() I enclose _____ dollars, for which send me _____ copies, at \$2.00 per copy.*

NAME _____

ADDRESS _____

CITY _____ ZONE _____ STATE _____

*For 12 or more copies, sent to a single address, the price per copy is \$1.60

NEW!



◀ Interior view showing simplicity of making rigid connections

B&W COAXIAL CABLE CONNECTOR

- Easy to install
- Watertight
- Seals Cable Ends

**SERVES AS CENTER
INSULATOR ON
HALF-WAVE DOUBLET**

The new B & W CC-50 Connector does an excellent job of providing a waterproof termination for a coaxial line where it joins the center of a half-wave doublet antenna. Made of cast aluminum with steatite insulation and forged steel eyebolt with easy soldering connections. Weighs only 12 ounces. Absolutely watertight. Write for details.

BARKER & WILLIAMSON

Inductor Coil Headquarters
237 Fairfield Ave., Upper Darby, Pa.



(Continued from page 38A)

- Becken, E. D., 112 Marine Ave., Brooklyn 9, N. Y.
- Bowman, D. F., 214-23—33 Rd., Bayside, N. Y.
- Brady, C. L., WJIM, Inc., Lansing 16, Mich.
- Bunger, J. W., RFD #1, Fay Rd., North Syracuse, N. Y.
- Coy, B. A., Radio Station CKWS, Kingston, Ont., Canada
- Chow, B., 1020 Stockton St., San Francisco 8, Calif.
- Doherty, E. J., Walsingham 43, Colyton Rd., East Dulwich, London, S. E. 22, England
- Dorfman, J., 16 Martin Pl., Irvington 11, N. J.
- Earls, H. G., 950 Westcott St., Syracuse, N. Y.
- Friedenthal, A., 5396 Oregon St., Detroit 4, Mich.
- Green, W. I., 707 E. 29 St., Spokane 10, Wash.
- Hart, H. C., 20 Cleveland Lane, Princeton, N. J.
- Hartley, M. S., Philips Industries, Ltd., Sun Life Bldg., Montreal, Quebec, Canada
- Henson, C. E., Buechel Bank Lane, Buechel, Ky.
- Hogg, J. E., General Electric Co., 710 Second Ave., Seattle 4, Wash.
- Jackson, H. W., #1 R & C School RCAF, Clinton, Ont., Canada
- Keen, A. W., R. F. Equipment, Ltd., Plantation Rd., Amersham, Bucks., England
- Kimbrel, G. M., 6235 Orchard Lane, Cincinnati 13, Ohio
- LeBarre, S. D., 697 Ashland Ave., Detroit 15, Mich.
- Leist, L. G., 1124—12 St., N.W., Canton, Ohio
- Losey, J. J., 732 Allen St., Syracuse 10, N. Y.
- Luke, T. C., 18 Harding Ave., Belmont 78, Mass.
- McCormick, E. M., 3455 Lemon St., Riverside, Calif.
- McFarlane, D. J., 2 Bonad Rd, Winchester, Mass.
- Morrison, R. H., 947 James St., Syracuse 3, N. Y.
- O'Brien, D., 20 Queenborough Gardens, Ilford, Essex, England
- Packard, M. E., 325 Middlefield Rd., Palo Alto, Calif.
- Parkhurst, R. G., 947 James St., Syracuse 3, N. Y.
- Pinkerton, D. C., 312 Cherry Rd., Syracuse 9, N. Y.
- Ragazzini, J. R., Engineering Bldg., Columbia University, New York 27, N. Y.
- Reiche, H., 276 Sunnyside Ave., Ottawa, Ont., Canada
- Reveal, P. A., 129 Midland Ave., Glen Ridge, N. J.
- Revercomb, H. E., 222 Ferguson Park, North Syracuse, N. Y.
- Rochester, N., 79 Smith Rd., Milton 86, Mass.
- Rohrich, C. G., Jr., 535 Mellon St., S.E., Washington 20, D. C.
- Rowe, V. G., Box 644, Anchorage, Alaska
- Rowley, H., 3162 Fifth St., Victoria, B. C., Canada
- Sather, O. J., 755 Hartwell St., Teaneck, N. J.
- Shapiro, L., Box 36, Scott Field, Ill.
- Shepard, W. D., 6571 Winnebago St., St. Louis 9, Mo.
- Smith, N. A., Lloyds Bank, 40 Victoria St., London, S.W. 1, England
- Stanton, J. M., Box 559, Deadwood, S. D.
- Todd, T. H., 1307—18 Ave., Tuscaloosa, Ala.
- Wathen, R. L., Sperry Gyroscope Co., Garden City, N. Y.
- Webb, R. C., RFD #1, Princeton, N. J.
- Winter, H., 4629 S. 31 Rd., Arlington, Va.
- Wright, O., American Telephone and Telegraph Company, Box 98, Lawrenceville, N. J.
- Zimmerman, F. C., 3521 N. Broad St., Philadelphia 40, Pa.

Admission to Member

- Alexander, L. H., 7517 N. Clark St., Chicago, Ill.
- Andrews, F. J., 116 Irvington St., S.W., Washington 20, D. C.
- Archibald, R. M., Emergency and Miscellaneous Division, Federal Communications Commission, Washington 25, D. C.
- Barbier, L. I., 6905 Woodland Ave., Takoma Park 12, Md.
- Bertucci, J. F. H., Submarine Squad. Four (Staff) F.P.O., New York, N. Y.
- Bird, G. T., 1205 W. Market St., Honey Grove, Tex.
- Bredall, C. H., 1613—17 Pl., S.E., Washington 20, D. C.
- Brown, J. L., General Electric Co., 212 N. Vignes St., Los Angeles 12, Calif.
- Brown, W. C., No. 1 Carno Rd., Caersws, Montgomeryshire, Wales
- Calafati, S. S., Jr., 420 Memorial Dr., Cambridge, Mass.
- Carter, J. M., 5231 Patrick Henry Dr., Baltimore 25, Md.
- Carter, W. H., Jr., 1309 Marshall Ave., Houston 6, Tex.
- Chauchat, J. N., 124 Rue Reaumur, Paris, France
- Chester, B., 58 Berkshire Rd., Newtonville 60, Mass.
- Chisholm, K. G., RCA-Victor Co. Ltd., 36 Breadalbane St., Toronto, Ont., Canada
- Church, C. J., 240 E. Spring St., Marissa, Ill.
- Cochran, N. B., 947 James St., Syracuse 3, N. Y.
- Compton, J. M., 4300 Lomo Alto St., Dallas, Tex.
- Coomes, E. A., Department of Physics, Notre Dame, Ind.
- Crane, R. E., 463 West St., New York 14, N. Y.
- Cumpston, L. W., Coles Signal Laboratory, Red Bank, N. J.

(Continued on page 44A)

WESTON MODEL 686

*tests tubes exactly
as you use them!*

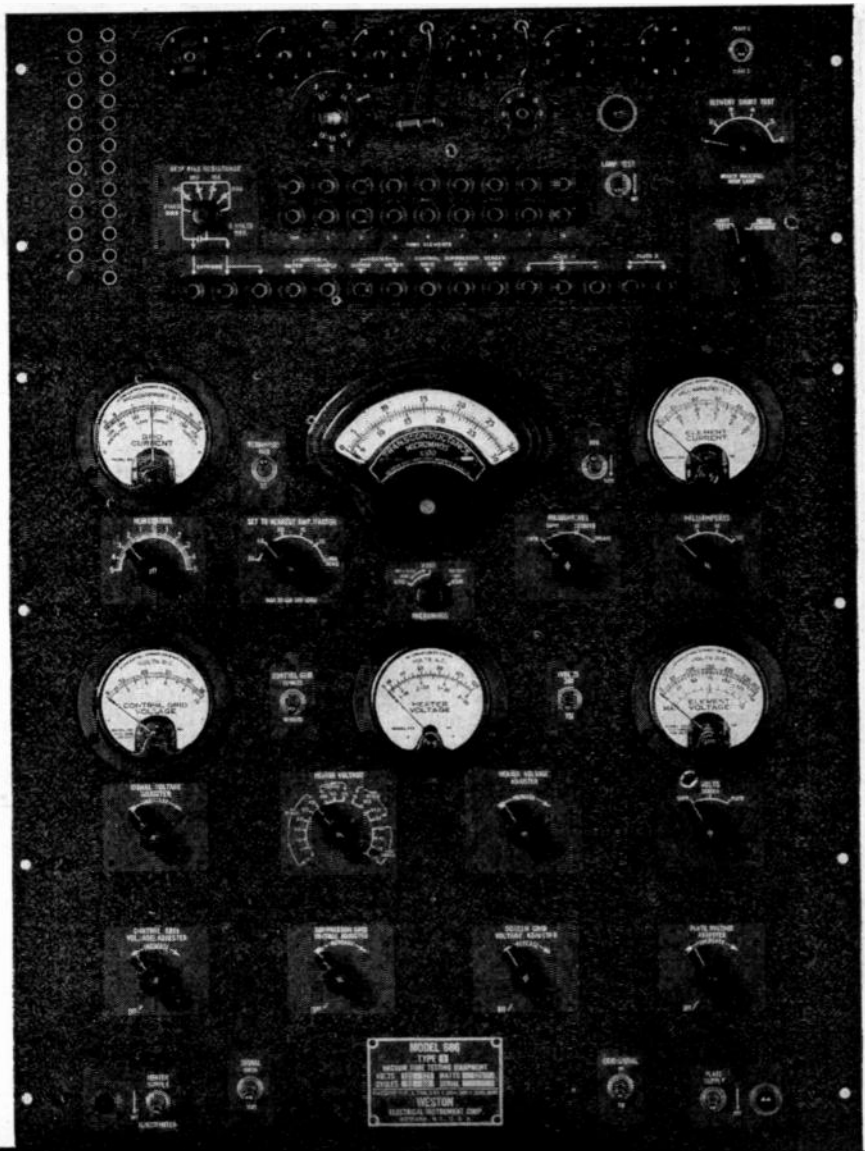

A *True* MUTUAL CONDUCTANCE ELECTRONIC TUBE ANALYZER

SPECIFICATIONS

Gm Range 0 to 3000/6000/15000 Micromhos
 Filament Potentials 1.0 to 117 Volts AC
 Plate Potentials 0 to 150, 0 to 300 Volts DC
 Screen Potentials 0 to 150, 0 to 300 Volts DC
 Suppressor, etc. Potentials... 0 to 150, 0 to 300 Volts DC
 Control Grid Potentials..... 0 to 10, 0 to 50 Volts DC
 Plate Current 0 to 5/10/50/100 Ma. DC
 Screen Current 0 to 5/10/50/100 Ma. DC
 Suppressor Current 0 to 5/10/50/100 Ma. DC
 Cathode Current 0 to 5/10/50/100 Ma. DC
 Control Grid Current 15-0-15 and 1500-0-1500 Microamperes DC
 Signal Voltage 0.2/0.5/1 Volt AC
 Self Bias 50/100/150/200 ohm bypassed by 1000 mfd

Extremely flexible, with virtually no obsolescence factor, Model 686 is essential for laboratory and production analysis, as well as for educational use. Full details from your nearest WESTON representative, or direct, Weston Electrical Instrument Corporation, 589 Frelinghuysen Avenue, Newark 5, New Jersey.



ALBANY • ATLANTA • BOSTON • BUFFALO • CHARLOTTE • CHICAGO • CINCINNATI • CLEVELAND • DALLAS • DENVER • DETROIT • JACKSONVILLE • KNOXVILLE • LOS ANGELES • MERIDEN • MINNEAPOLIS • NEWARK
 NEW ORLEANS • NEW YORK • PHILADELPHIA • PHOENIX • PITTSBURGH • ROCHESTER • SAN FRANCISCO • SEATTLE • ST. LOUIS • SYRACUSE • IN CANADA, NORTHERN ELECTRIC CO., LTD. POWERLITE DEVICES, LTD.

..This is Cardioid

"Cardioid" means heart-shaped. It describes the pickup pattern of a microphone as illustrated in this diagram. Unwanted sounds approaching from the rear are cancelled out and the pickup of random noise energy is reduced by 66%. The actual front to back ratio of reproduction of random sound energy is 7 to 1.

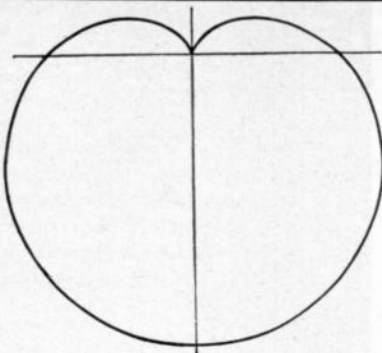

..This is Super-Cardioid

"Super-Cardioid" also describes a pickup pattern and is a further improvement in directional microphones. The Super-Cardioid has a wide front-side pickup angle with greater exclusion of sounds arriving from the sides and the rear. The front to back random sound ratio is 14 to 1 which makes it twice as unidirectional as the "Cardioid." A 73% decrease in the pickup of random noise energy is accomplished.

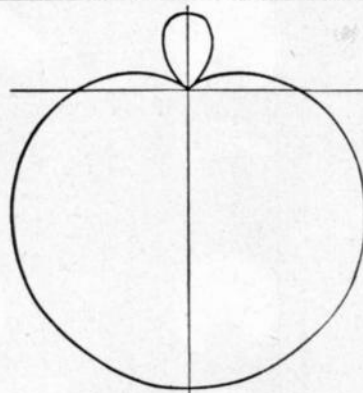

..This is Uniphase

"Uniphase" describes the principle by which directional pickup is accomplished in a single microphone unit. This is a patented Shure development and makes possible a single unit "Super-Cardioid" Directional Microphone eliminating the necessity of employing two microphone units in one case—it gives greater uniformity in production, greater ruggedness, lower cost for comparable quality and more uniform vertical pickup pattern.

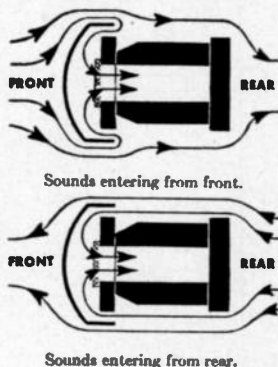

..This is the result

The SHURE Super-Cardioid

A decrease in the pickup of random sound energy by 73%—reduction of feedback and background noise—simplification of sound pickup are among the many advantages offered by the Shure "Super-Cardioid" Dynamic. These, plus faithful reproduction, are the reasons why Shure "Super-Cardioid" Microphones are used by more than 750 Broadcast Stations in the United States alone, by our Armed Forces throughout the world, and on thousands of Public Address Systems everywhere.



SHURE BROTHERS, Inc.

Microphones and Acoustic Devices

225 West Huron Street Chicago 10, Illinois

Cable Address: SHUREMICRO



(Continued from page 42A)

- Custin, T. G., 947 James St., Syracuse 3, N. Y.
 Danko, S. F., 3114-F Berkeley Dr., Philadelphia 29, Pa.
 Dove, P. S., 514 Buttermere Ave., Interlaken, N. J.
 Duffy, E. J., 834 S. Elmwood Ave., Oak Park, Ill.
 Engel, F. A., Jr., 327 Craft Ave., Pittsburgh 13, Pa.
 Evans, M. B., 906 S. Orchard St., Urbana, Ill.
 Fischler, P. E., 118 Shepard Ave., Kenmore 17, N. Y.
 Fluke, J. M., 4855—28 St. S., Arlington, Va.
 Frantz, D. R., Bell Telephone Laboratories, Inc., Whippany, N. J.
 Fritz, J. R., Lear Avia, Inc., Piqua, Ohio
 Gillette, P. R., Engineering Laboratories, Sperry Gyroscope Co., Garden City, N. Y.
 Green, K. E., 240 Jericho Manor, Jenkintown, Pa.
 Grieser, T. J., 70 East Gate St., Manhasset, N. Y.
 Groenier, R. S., 617 Western Ave., Madison 5, Wis.
 Haberland, E. R., 3986 Penn Ave., S.E., Washington 20, D. C.
 Hedler, A. C., 17 Palmer Pl., Valley Stream, N. Y.
 Holubow, H., 3223 W. Armitage St., Chicago 47, Ill.
 Hudson-Davies, J., Posts and Telegraphs Department, Sudan Government, Khartoum, Sudan, South Africa
 Hutton, E. A. D., Canadian Joint Staff Mission, 2222 "S" St., N.W., Washington 8, D. C.
 Ingham, W. E., 5 Westville Ave., Ilkley, Yorkshire, England
 Ketchum, P. M., 127 Nichols Ave., Syracuse 6, N. Y.
 Kienow, O. E., South Acton, Mass.
 Kirk, J. A., 3524 Rolling Rd., Baltimore 7, Md.
 Kleine, R. C., 3947 Holman Circle, Silverton 13, Ohio
 Kocherar, H. J., 947 James St., Syracuse 3, N. Y.
 Loeffler, H. F., 722 N. Broadway, Milwaukee 2, Wis.
 Lucas, V. M., General Electric Co., Syracuse, N. Y.
 Matarainen, K. O., 255—07 Hillside Ave., Floral Park, N. Y.
 Mathis, G., 210 Riverway, Boston 15, Mass.
 McMillan, F. L., Jr., 1737 Cherokee Pl., Bartlesville, Okla.
 Moerman, N. A., The Potter Instrument Co., 136—56 Roosevelt Ave., Flushing, N. Y.
 Mullin, J. T., 70 Clifford Terrace, San Francisco 17, Calif.
 Myers, H. L., 331 Waltham St., West Newton 65, Mass.
 Nelson, E. A., 246 Warren St., Dayton 2, Ohio

(Continued on page 46A)



**IMMEDIATE
DELIVERY...**

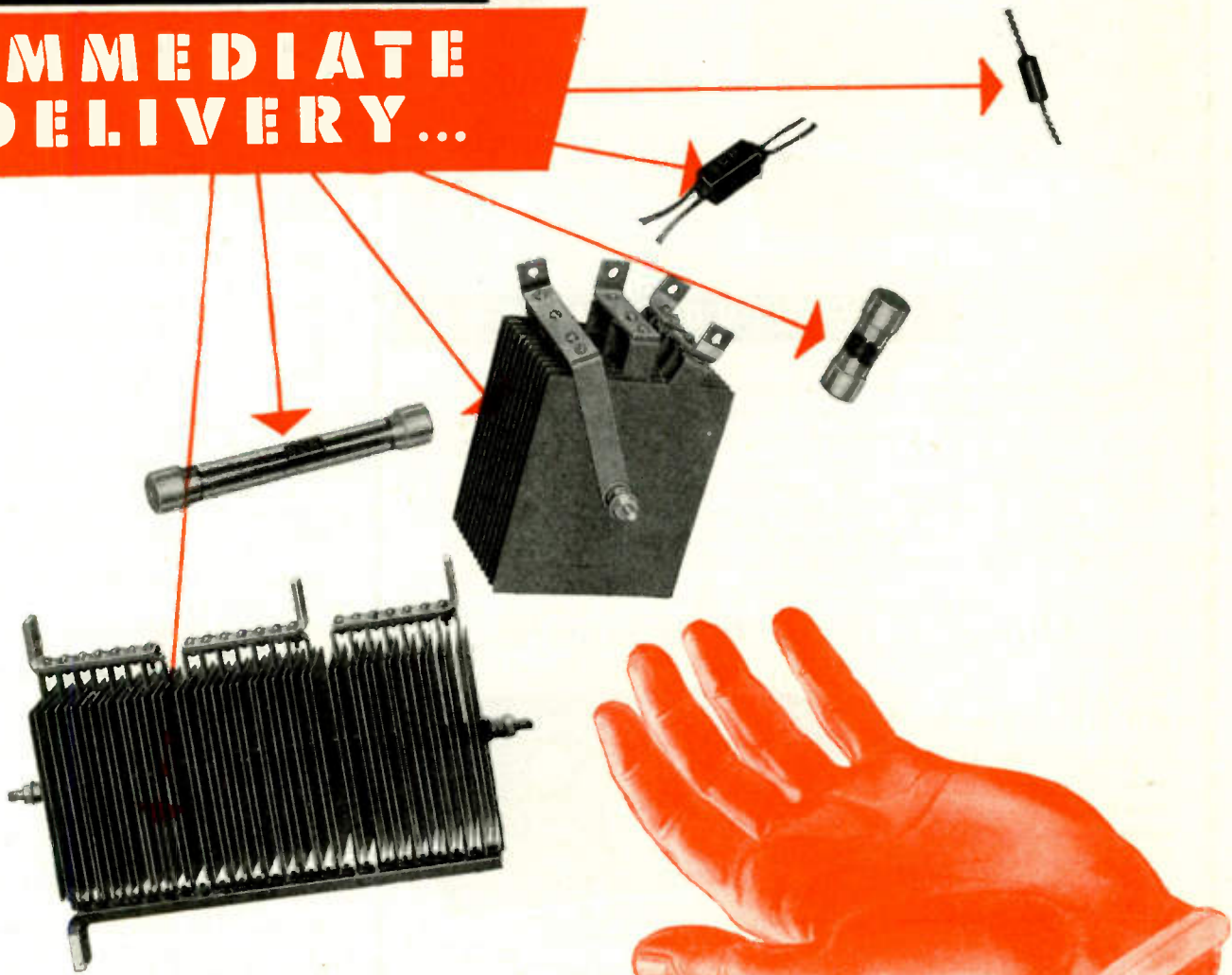

SELENIUM RECTIFIERS

FROM 10 MICRO AMPERES TO 10,000 AMPERES

Manufacturers of a broad line of SELENIUM Power and Instrument Rectifiers, Photo-Electric Cells and allied scientific products.

Solve your rectification problems with SELENIUM. SELENIUM rectifiers are rapidly becoming standard in industry. Check these outstanding features:

- ✓ Permanent characteristics.
- ✓ Adaptability to all types of circuits and loads.
- ✓ Unlimited life—no moving parts.
- ✓ Immunity to atmospheric changes.
- ✓ High efficiency per unit weight.
- ✓ Hermetically sealed assemblies available.
- ✓ From 1 volt to 50,000 volts RMS.
- ✓ From 10 micro-amperes to 10,000 amperes.
- ✓ Economical—No maintenance cost.



SELENIUM CORPORATION OF AMERICA

Affiliate of **VICKERS**, Incorporated
1719 WEST PICO BOULEVARD • LOS ANGELES 15, CALIFORNIA
Export Division: Frazer & Hansen, 301 Clay Street, San Francisco 11, Calif.
In Canada: Canadian Line Materials, Ltd., Toronto 13, Canada

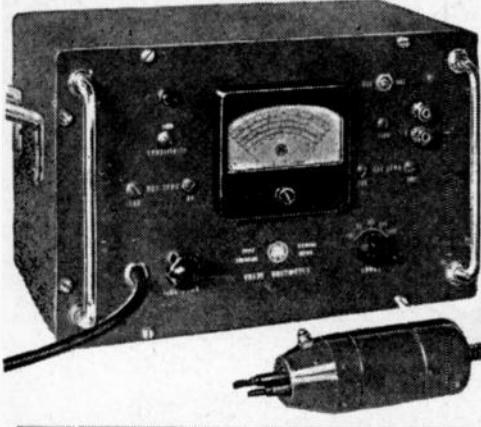

Precision Instruments
FOR
RESEARCH AND INDUSTRY
AWA

VALVE VOLTMETER

An instrument having a universal application for voltage measurements where a very high input impedance is required. It is suitable for use from low audio to high radio frequencies, typical applications being the measurement of oscillator output voltages, and both input and output voltages of audio amplifiers, R.F. amplifiers and filters.

Features: 0.2 volt to 150 volts in 5 ranges, capacity multipliers available to 7500 volts RMS, meter scales directly calibrated, shielded probe, voltmeter stabilised with respect to mains variations, self calibrating.

Other A.W.A. Instruments

● **B.F.O. TYPE A96060**

20 to 20,000 cycles, 40 in. spiral scale, incremental frequency dial, internal crystal calibration at subharmonics of 100 kc. down to 2 kc. Calibration of multiples of mains frequency up to 500 cycles. Output 1 watt. Distortion 1%. Variety of output impedances.

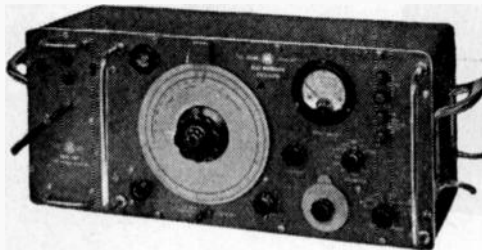

● **C.R.O. TYPE R6673**

2" cathode ray valve, fine trace, time base oscillator frequency continuously variable from 30 cycles to 40 kc., horizontal and vertical amplifiers suitable for audio and low R.F. Portable, rack mounting and intensity modulation types.



Amalgamated Wireless (Australasia) Ltd.

AUSTRALIA'S NATIONAL WIRELESS ORGANISATION

47 York Street, Sydney, Australia

- SIGNAL GENERATORS.
- "Q" METERS.
- C.R. OSCILLOGRAPHIS.
- HETERODYNE CALIBRATORS.
- A.F. METERS.
- IMPEDANCE MATCHING EQUIPMENT.
- BEAT FREQ. OSCILLATORS.
- OUTPUT METERS.
- DECADE RESISTANCE BOXES.
- WAVEMETERS.
- VALVE VOLTMETERS.
- MULTIVIBRATORS.



(Continued from page 44A)

- Owens, H. L., 239 Albert Pl., Elberon, N. J.
- Paul, A. D., 1227 E. Genesee St., Syracuse 10, N. Y.
- Powers, D. A., 275 Massachusetts Ave., Cambridge 39, Mass.
- Quimby, R. S., 24 Vinebrook Rd., Lexington 73, Mass.
- Ramey, R. A., 432 Riddle Rd., Cincinnati 20, Ohio
- Rauch, L. L., 116 Nassau St., Princeton, N. J.
- Ristow, H. E., Box 54, Whippany, N. J.
- Rogoff, M., 303 E. 37 St., New York 16, N. Y.
- Royalty, M. C., 1710 Ave. R., Lubbock, Tex.
- Rudolph, R. H., 1619 S. State St., Syracuse, N. Y.
- Schacht, E. L., 167—10 Cryders Lane, Beechhurst, N. Y.
- Semm, P. T., Box 428, Geneva, Ill.
- Sieck, L. W., U.S.N.A.F., Mercer Field, Trenton 5, N. J.
- Simon, C. J., 129 Milford Dr. E., Syracuse 6, N. Y.
- Simpson, O. T., 625 Diamond St., Philadelphia 22, Pa.
- Slack, W. J., Communications Department, American Export Airlines, La Guardia Field, N. Y.
- Smith, W. R., 134 N. Patterson St., State College, Pa.
- Sturley, K. R., Broadcasting House, London, W. 1, England
- Tate, G. D., Radio Station WMRC, Greenville, S. C.
- Warfel, G. H., 6841 S. Paxton Ave., Chicago 49, Ill.
- Watkins, C. E., RCA Building, Room 559, New York 20, N. Y.
- Watt, G. E., M & W Laboratories, 551 Louis Bldg., Dayton, Ohio
- White, R. T., 116 W. Molloy Rd., Syracuse 8, N. Y.
- Widenmann, J. A., 1430 Alhambra Rd., South Pasadena, Calif.

Admission to Associate

- Ackley, E. H., 240 N. Roxsford Rd., Syracuse, N. Y.
- Albert, M., 4503 Buchanan St., Hyattsville, Md.
- Aldrich, A. A., R & D Explosive Department, Naval Ordnance Test Station, Inyokern, Calif.
- Anderson, T. J., 39-C Oak Grove Dr., Baltimore 20, Md.
- Andrews, G. W., 38 Water St. W., Brockville, Ont., Canada
- Apolant, R. J., 251 W. 89 St., New York 24 N. Y.
- Atwood, N. A., 4400 Highland Ave., Bethesda 14, Md.
- Balsamello, J., 837 S. Carpenter St., Chicago 7, Ill.
- Batchelder, W. E., 98 Hawthorne St., Akron 3, Ohio
- Bevis, J. H., 22472 Beech St., Dearborn, Mich.

(Continued on page 48A)

External Beauty FOR "SHOWMANSHIP"

It will grace any 1000-Watt
Broadcasting Station!

Expertly Engineered
"Internally" for Performance



THE GATES 1-KILOWATT TRANSMITTER—

Has Everything!



... "oomph" and showmanship—thanks to good designing—that makes your station "super" in appearance and impression. But here beauty is more than skin deep. This Unit is engineered for super performance also. A peek inside reveals those modern circuits and mechanical improvements that make the statement, IT HAS EVERYTHING a "built-in" fact. Write for complete specifications.

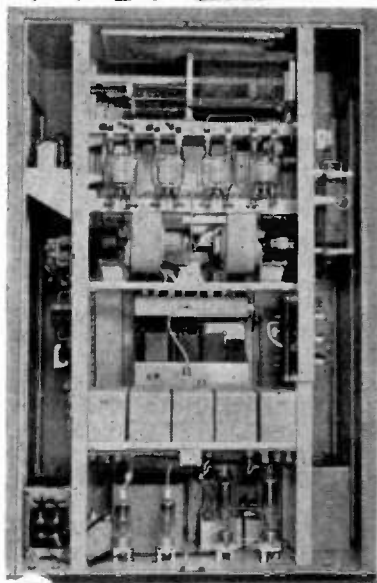

NEW YORK
OFFICE:
9th Floor • 40 Exchange Place

GATES
RADIO CO.
QUINCY, ILLINOIS

SOLD IN CANADA BY:
Canadian Marconi Co.,
Ltd., Montreal

Exclusive Manufacturers of Radio Transmitting Equipment Since 1922

CONDENSED SPECIFICATIONS

FREQUENCY RANGE: 530 to 1600 K. C.
FREQUENCY STABILITY: Plus or minus 10 cycles maximum.
POWER OUTPUT: 1000 Watts. May be operated as 500 Watt Transmitter. Power reduction for night operation may be incorporated to suit requirements.

POWER SUPPLY: 230 Volts, 60 cycles, single phase—Regulation not to exceed plus or minus 5%.
FREQUENCY RESPONSE: Within 1½ DB. from 30 to 10,000 cycles.
DISTORTION: Less than 3% from 50 to 7500 cycles. 0-95% modulation.
NOISE LEVEL: 60 DB. below 100% modulation.

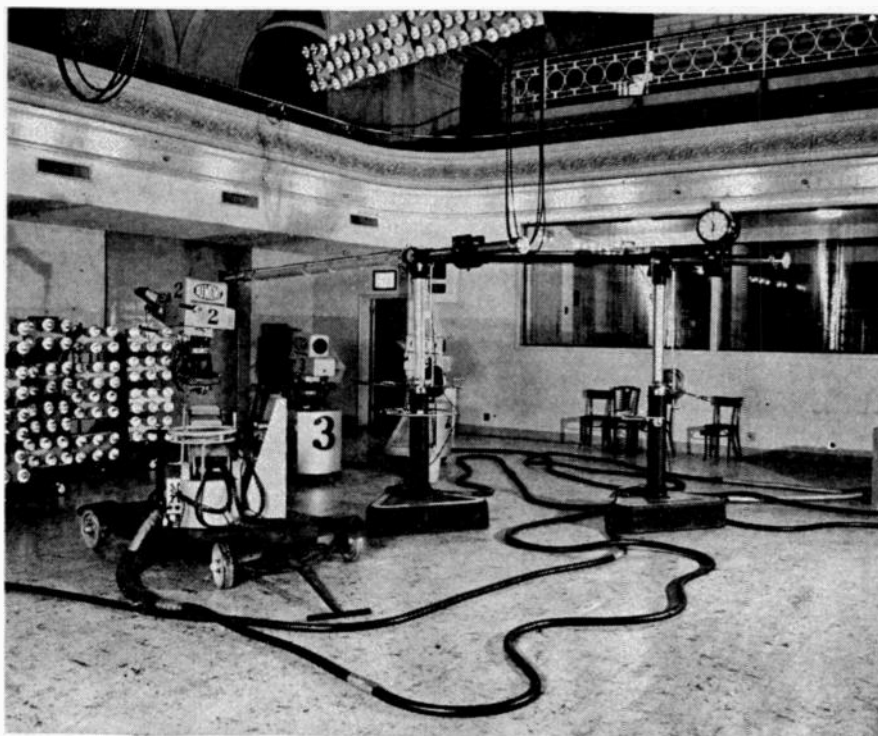

Flexible Protection for Television Cables

ON APRIL 15, 1946, in the John Wanamaker store, New York, the Allen B. DuMont Laboratories opened the world's largest, most modern television studio, Station WABD.

Among the many problems solved was that of providing flexible protection for power and coaxial cables running from the master terminal box on the studio floor to the various mobile camera units.

Because damage to such cables

might ruin a projection, they are enclosed in 1½" I.D. American Flexible Shielding Conduit, Polyvinyl covered to specification AN-WM-C-561A, Type 2. This conduit is sufficiently flexible to bend easily, tough enough to withstand bumping by camera dollies, and the synthetic covering prevents marring of the studio floors.

This is a good example of solving a difficult conduit hose and tubing problem, by combining flexible metal tubing made from the proper alloy, with synthetic covering provided with the required physical and electrical characteristics.



American
METAL HOSE

THE AMERICAN BRASS COMPANY
American Metal Hose Branch

General Offices: Waterbury 88, Conn.
Subsidiary of Anaconda Copper Mining Company



(Continued from page 46A)

- Birr, E. E., 122 Pullman Ave., Kenmore 17, N. Y.
 Bookout, P. G., 1622 Keith Bldg., 1703 Euclid Ave., Cleveland 15, Ohio
 Brundige, H. D., Colonial Radio Corp., 254 Rano St., Buffalo 7, N. Y.
 Cammisa, M. A., 754 E. 227 St., New York 66, N. Y.
 Carne, J. B., 1414 Hürt Bldg., Atlanta 1, Ga.
 Coriat, J. L., Standard Electric, Tomkinson 1700, San Isidro, Argentina
 Court, L. M., 141 Broadway, New York 6, N. Y.
 Dann, J. A., 126 Golden Rod Lane, Skyway Park, Osborn, Ohio
 Emerson, W. R., 416 S. 16 St., Lincoln 8, Neb.
 Evans, V. L., 5 Lon Wradoc, Whitchurch, Cardiff, South Wales
 Fleischhaker, A., 3579 Warder St., N.W., Washington, D. C.
 Forman, J. B., 500 St. Johns Pl., Brooklyn 16, N. Y.
 Frye, W. E., Aerophysics Laboratories, North American Aviation Inc., Los Angeles 45, Calif.
 Goggio, E. C., Westinghouse Research Laboratories, East Pittsburgh, Pa.
 Grainger, G. E., Glencoe, Ontario, Canada
 Griffin, D. H., 21 Everett St., Waltham 54, Mass.
 Habecker, T. B., Hillendale, Silver Spring, Md.
 Hamaty, L. A., 321 S. West St., Angola, Ind.
 Harris, O. R., 149 Shenandoah Rd., Hampton, Va.
 Haupt, G. E., 30 Ambassador Flats, Walker St., Sunnyside, Pretoria, Transvaal, Union of South Africa
 Harvard, W. L., 5603 Truett St., Houston 3, Tex.
 Hawkins, D. W., Box 1747, Brownsville, Tex.
 Heimburger, W. M., 1488 Riverside Dr., Beaumont, Tex.
 Hilgers, R. H., 3626—33 West, Seattle 99, Wash.
 Hoskins, E. E., 389 S. Arroyo Parkway, Pasadena 2, Calif.
 Jacobson, A. W., Jr., 90 Washington Ave., Pleasantville, N. Y.
 Kopecky, G. F., 304 E. 77 St., New York 21, N. Y.
 Kreisman, W. S., Hazeltine Electric Corp., Little Neck, N. Y.
 Lang, H., 604 Windermere Ave., Toronto 9, Ont., Canada
 Langhi, M. A., Standard Electric Co., Av. Tomkinson 1700 San Isidro (Pcia. de Buenos Aires), Argentina
 LaVier, E. C., Electronics Subdivision, Wright Field, Dayton, Ohio
 Le Blanc, R. E., III, 727 Sixth Ave., Laurel, Miss.
 Labian, E. A., 141-18—78 Rd., Flushing, N. Y.
 Lutz, C. F., Jr., 887 Parkside Ave., Buffalo 16, N. Y.

(Continued on page 58A)

There is a High Sensitivity

RAULAND VISITRON

for every photo tube application

The *Rauland VISITRON* family of Phototubes includes the widest selection of versatile types for practical application in the field of light-sensitive devices. (Representative *VISITRONS* are described here briefly.) Whatever the application . . . for industrial electronic control, sound-on-film, or research and development, there is a dependable, high sensitivity *Rauland VISITRON* available to do the job perfectly. *Rauland* phototube engineers are ready to consult with you on your special phototube requirements.

To be sure . . . specify *VISITRON!*



Send for this Descriptive Catalog

This valuable new *Rauland VISITRON* Catalog is yours for the asking. It's packed with informative data on phototube theory, characteristics and circuit applications. You will want this important treatise for your engineering reference library.



R-58 SERIES

Exceptionally dependable for use in electronic control equipment (for counting, sorting, burglar and smoke alarms, etc.) A preferred type for use in 16 MM sound-on-film equipment.

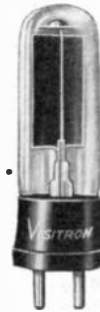

R-59 SERIES

Widely employed in theater sound projection equipment. Popularly used in 35 MM semi-portable systems. Rugged design makes it unusually adaptable to industrial electronic equipment. One of several series of *Rauland VISITRONS* also available for blue and ultra-violet applications.



R-60 SERIES

A dual-type phototube designed primarily for dual sound track systems; ideal wherever dual tube operation is required and space is at a premium.



R-64 SERIES

This rugged phototube in a short glass envelope is recommended for industrial light-operated relay and measurement applications where space is a limiting factor.



R-71 SERIES

One of the most widely used *VISITRONS*. Ideal for sound-on-film applications. Used extensively in electronic control devices for weighing, conveying; illumination controls; safety devices; flame control work; smoke and turbidity measurement controls.

ALSO MANUFACTURERS OF DIRECT-VIEWING AND PROJECTION TYPE CATHODE RAY TUBES

RADIO • RADAR • SOUND •

Rauland

COMMUNICATIONS • TELEVISION

Electroneering is our business

THE RAULAND CORPORATION • CHICAGO 41, ILLINOIS



The following positions of interest to I.R.E. members have been reported as open. Apply in writing, addressing reply to company mentioned or to Box No. The Institute reserves the right to refuse any announcement without giving a reason for the refusal.

PROCEEDINGS of the I.R.E.

330 West 42nd Street, New York 18, N.Y.

RESEARCH ENGINEERS

Research engineers and physicists having experience in micro-wave and ultra high frequency techniques to work at new laboratory of well established parent company. Salaries commensurate with qualifications. Suburban location in Westchester County, N.Y. 30 Miles from New York City. All replies treated confidentially. Box 433.

ELECTRONICS RESEARCH ENGINEER OR PH.D.

Experience in research and development of servo mechanisms, calculating devices, electronic controls, etc. Project engineer required by an established development and manufacturing company. Include résumé of experience and background. Address Box 434.

SALES ENGINEER

Manufacturer of railway equipment seeks young man between 20 and 30 years of age. Excellent opportunity for one who has some or all of these qualifications:

1. Knowledge of electrical engineering, especially electronics.
2. Knowledge of railroad operation and signaling.
3. Ability to meet people and make friends.
4. College education.

Training will be given to cover any deficiencies applicant may have. In reply state age, education, sales and engineering experience and other qualifications. Include three references and photograph. Box 435.

ENGINEERS (Electrical or mechanical)

SP-7 and P1-P5 inclusive. Work involves the development and design of small and intricate electro-mechanical integrating and computing systems. The design and development of computing machines, fire control devices, automatic pilots, or similar devices represent the type and scope of work.

P-5. Must have background in the design and development of electronic and associated mechanical devices, with marked ability in administration and the preparation of technical papers and reports. Must have excellent personality.

Feminine applicants will be carefully considered for this position.

P-3. Must have background in the design and development of electronic and associated mechanical devices, with specific experience in laboratory techniques. Administrative experience desirable. The engineer Board, Applied Electronics Branch, Fort Belvoir, Virginia.

There are now a few positions open for

ELECTRON TUBE ENGINEERS

who have a background of experience and responsibility in the design and production of high and ultra-high frequency electron tubes, including magnetron and related micro-wave devices, and who are seeking advancement on the basis of ability, ingenuity and accomplishment. For a limited number of men of this type Machlett Laboratories has something unique and attractive to offer.

Address Executive Offices-
Engineering Division

**MACHLETT LABORATORIES,
Inc.
Springdale, Conn.**

SYRACUSE UNIVERSITY

OPENINGS IN THE DEPARTMENT OF ELECTRICAL ENGINEERING

The College of Applied Science, Syracuse University, is seeking candidates for two positions in its Department of Electrical Engineering, one of which will include the Chairmanship of the Department.

It is desired that each applicant have the following qualifications, although it is not expected that all will be fully met:

1. Have Ph.D. or D.Sc. degree.
2. Have had considerable experience as a teacher in the field of Radio Engineering, including broad experience in the use of radio equipment and apparatus.
3. Possess considerable formal training in, and ability to use higher mathematics.
4. Have had considerable background and training in Electro-magnetic theory.
5. Have had a few years' experience with commercial organizations as design or development engineer on radio equipment.
6. Age range preferred, 35 to 45 years.

Address correspondence to:

**LOUIS MITCHELL, Dean
College of Applied Science
Syracuse University
Syracuse 10, New York**



ENGINEER

Engineering firm in New York City requires two engineers with at least two years of design and development experience on communication equipment. VHF background desirable. Write, stating full particulars and salary expected. Box 436.

ELECTRONICS RESEARCH ENGINEER

Experienced in research, development and design, special devices, servo, electronic controls, etc. Top man required by a nationally known manufacturing company. State complete résumé of experience and background. Box 425.

INSTRUCTIONAL STAFF

Electrical Engineering Department in large Middle Western University has staff opening in grades of Instructor to Associate Professor depending upon training and experience. For details write Box 426.

ACOUSTIC ENGINEERS, PHYSICISTS, RESEARCH ASSISTANTS

To do research in the field of acoustics full or part-time while carrying graduate work in allied subjects at Washington University. Stipend commensurate with proven ability and past earnings. St. Louis Microphone Company, Box 3440, Maplewood 17, Mo.

MICROWAVE DEVELOPMENT ENGINEERS

Experience desirable on antenna, waveguide component and general system design. Permanent. Write giving full details regarding education and experience to Personnel Department, Raytheon Manufacturing Company, Waltham 54, Mass.

ENGINEER OR PHYSICIST

Small research and development company in New York City has opening for a graduate engineer or physicist with an electronic or communications background. Work affords great opportunity for exploration and ingenuity in servos, optics, and radiation. Salary open. Box 420.

PHYSICISTS AND ELECTRICAL ENGINEERS

Research project leaders for work combining electronics and general applied physics. Bachelor's degree in physics or engineering plus graduate work and two to four years practical experience.

Junior research engineers for work in electronics. Bachelor's degree in electrical engineering or physics plus one or two years of graduate work or practical experience.

Communicate with R. F. Simons, Airborne Instruments Laboratory, Inc., 160 Old Country Rd., Mineola, N.Y.

APPLIED PHYSICISTS—MICROWAVE ENGINEERS

Organization with long term research and development program in microwaves, electronics and other branches of applied physics has openings for several senior and junior staff members. Seniors should have advanced degrees in physics or electrical engineering and be capable of taking complete charge of project. Juniors require B.S. degree and preferably two or

(Continued on page 52A)

THESE "LOOK ALIKE" RESISTORS SOLVE DIFFERENT RESISTANCE PROBLEMS



Whenever you require ultra high frequency power dissipation, specify IRC Type MP Metallized Resistors, which are specially designed for U.H.F. service. Used in radar during the war, IRC MP's are now available on short delivery cycle for industrial use. Their construction suits them for transmitter

dummy loads, rhombic antenna terminations and many similar high power applications. Remember IRC MP's by their solid coating of metallized resistance material, heavy varnish coating for protection against humidity and mechanical injury, and, of course, by the IRC trademark.



In high voltage applications where requirements are for high resistance and power, IRC MV High Voltage Metallized Resistors are designed and constructed to do the job. They are manufactured with the famous metallized coating applied spirally on ceramic forms. This provides a conducting path of extensive effective length. Turns are

spaced mechanically to allow uniform voltage gradient throughout the length of the resistor. Special size resistors for high voltage applications are available. Identify IRC MV's by the IRC trademark, the "striped" effect of the spiral filament and the special protective coats of varnish.

Note: On both MP's and MV's lugs or ferrules are available as well as colloidal silver ends for the application of special terminals. • For specifications and complete engineering assistance contact your IRC Sales Engineer or write Dept. (1)

INTERNATIONAL RESISTANCE CO.

401 N. BROAD ST., PHILADELPHIA 8, PA.

In Canada: International Resistance Co., Ltd., Toronto, Licensee



Wanted...

For Extremely Interesting Work With Excellent Facilities

We have openings for two physicists or communications engineers for research and advanced development on microwave power tubes and magnetrons.

Qualifications:

A. One position requires a Ph.D., or equivalent, with two to four years' microwave experience, experimental and theoretical ability. Magnetron design experience desirable.

B. The other position requires a B.S. or M.S. plus several years' magnetron design experience, or a Ph.D. majoring in electronics, electromagnetic theory, networks, etc.

Fine opportunity to join an enterprising organization providing excellent facilities for extremely interesting work. Send detailed application to:

Personnel Department
RCA Victor Division
Radio Corporation of America
Camden, New Jersey



(Continued from page 50A)

more years experience in development of electronic or microwave equipment. Salaries commensurate with abilities. Location N.Y.C. Give all details in first letter. Box 421.

PHYSICIST

Wanted by a large Mid-West petroleum company for the Physics Section of the Research and Development Laboratories. A man well versed in the design and construction of the electronic components of physical apparatus used in the testing of petroleum and its products, for example, spectrographs, mass spectrometers, electron diffraction and recording instruments. Some knowledge of and experience with high frequency oscillators would be desirable. This position is permanent and offers unusual and interesting opportunities for the right man. Give complete details as to personal history, education, experience and salary required in first letter. Box 422.

ENGINEERS AND PHYSICISTS

With experience in radar and/or microwave research, development and design, interested in working along these lines. Write full details as to education and experience to Box 424.

TUBE DESIGN DEPARTMENT HEADS

Electron Tube General Development and Magnetron Section Heads (2) Com-

pletely equipped laboratory; 10 scientists and technicians now in each group; extremely broad, going research and development programs; salary above \$5000. Thorough physics background, varied tube experience, creative ability, administrative ability required. State education, experience, salary expected. Replies will be treated confidentially. Present groups informed of this notice. Box No. 428.

EXPERIENCED TEACHERS

A well-known New York City Educational Organization is contemplating expanding its present Radio Courses to include engineering and technical courses in Radio.

Personnel who can assist with the work entailed in planning and setting up such a school, that would be on a college level, would be offered positions that would probably lead to supervisory work at this school. The proper persons would be excellently remunerated.

Kindly respond in a detailed letter, outlining educational, teaching and radio background. Please enclose a photograph, if one is available. The photograph cannot be returned. Write Box No. 429.

ELECTRONIC RESEARCH ENGINEER

An Eastern manufacturer of electronic devices has an opening for a man with five to ten years experience in electronics and familiar with blind landings systems or airport traffic control.

This is essentially a liaison job, requiring contact with companies and government agencies engaged in electronic sys-

(Continued on page 54A)



Admission to Associates[™]
held over from August issue

- Obrofta, A. L., 259 Ontario St., Buffalo 7, N. Y.
Olney, V. W., 73 Marigold St., Buffalo, N. Y.
Pearson, B. W., 30 W. Chicago Ave., Chicago 10, Ill.
Popkin, J. L., 1430 Plimpton Ave., New York 52, N. Y.
Price, R. E., 904-18 St., Des Moines 14, Iowa
Reese, J. S., 202-A Gibson St., Tonawanda, N. Y.
Reynolds, R. H., 102 Walnut Pl., Syracuse 10, N. Y.
Rhodes, C. L., 416 S. Westlake Ave., Los Angeles 5, Calif.
Rife, M. W., 6537 N. Maplewood Ave., Chicago 45, Ill.
Robidoux, F. T., 4630 Park Dr., Houston 3, Texas
Robinson, M. R., Longue Pointe Ordnance Depot, Montreal, P. Q., Canada
Rogers, E. S., Jr., 2012 Riverside Dr., Trenton, N. J.
Salazar, L. A., 110 Post Ave., New York 34, N. Y.
Schlee, M., Reeves Rd., Angola, N. Y.
Schukowski, J., 45 W. Mohawk St., Buffalo 2, N. Y.
Smith, C. A., c/o Central Fire Station, Castle St., Dunedin, New Zealand
Smith, N. B., 36 Beaumaris St., Buffalo, N. Y.
Smith, P. B., 14454 Chatsworth Dr., San Fernando, Calif.
Sparks, W. S., 66 Broad St., New York 4, N. Y.
Spicak, K. J. A., Tiefenbach n.D. 120, Czechoslovakia
Stambach, G. L., 43 Galveston Pl., S.W., Washington 20, D. C.
Stewart, D. F., 228 E. Del Mar St., Pasadena 5, Calif.
Sudbury, R. J., New Philadelphia and Golden Ring Rds., Baltimore 21, Md.
Swallow, J. H., 37 Brook St., Medfield, Mass.
Taylor, K. A., Bell Telephone of Pennsylvania, 416 Seventh Ave., Pittsburgh 19, Pa.
Thompson, G. D., 1028-14 St., Santa Monica, Calif.
Torrible, A. W., 1235-26 St., Santa Monica, Calif.
Valega, J. L., 330 W. 95 St., New York 25, N. Y.
Webb, R. H., 3914 Walnut St., Philadelphia 4, Pa.
Welch, W. E., 1625 Adams St., San Diego 3, Calif.
Werner, J. E., 69 Delaware Dr., Glenshaw, Pa.
Widmann, F. W., 328 Audubon Ave., Audubon, N. J.
Wiley, V. H., 125 Mayville Ave., Kenmore 17, N. Y.
Wong, H., 1019 Longwood Ave., Bronx 59, N. Y.
Van Every, B., 16 Copsewood Ave., Buffalo, N. Y.
Zajac, C., 62 Wall St., Passaic, N. J.

Bliley

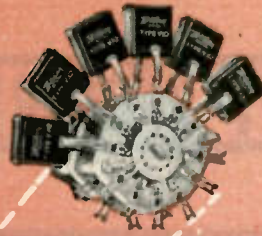

TECHNIQUALITY...



INTRODUCING THE NEW TYPE VX2

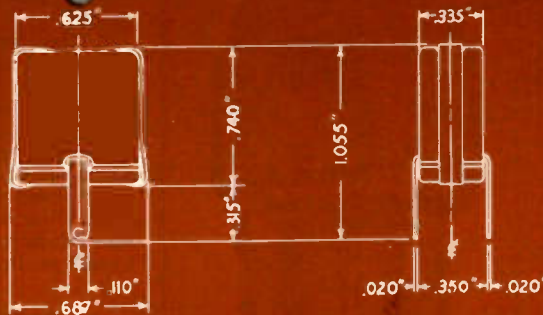

Designed for use where space is at a premium

Take a look at the space saving dimensions of this new Type VX2 crystal unit. Into this compact holder, Bliley engineers have packed a quartz crystal assembly that will perform, under rugged service conditions, with more dependable accuracy than was formerly possible in a crystal many

times the size of Type VX2.

This new Type VX2 unit is available for frequencies from 3000 kc to 11000 kc. Solder lugs, replacing the conventional pin type connections, permit easy mounting under chassis. For multifrequency applications a group of units may be mounted on a conventional rotary

selector switch. Gasket seals assure reliable operation under adverse service conditions.

Whenever there is an important frequency control problem to be solved—make it a habit to consult Bliley engineers first. You'll find their 15 years experience, in frequency control engineering exclusively, a short cut from the experimental models to your production line.

+ + +

Communications Engineers
Here are two important Bliley
Bulletins that should be in your
file—

Ask for Bulletins } P-27
P-31

Bliley CRYSTALS

BLILEY ELECTRIC COMPANY • UNION STATION BUILDING, ERIE, PENNSYLVANIA

BRILLIANT PERFORMANCE

that never grows dim

TURNER MODEL 211 DYNAMIC MICROPHONE

Designed and engineered for the user who wants finest reproduction under a variety of conditions, the Turner 211 Dynamic is the answer to the demand for a high fidelity yet highly rugged microphone.



Turner engineers utilize an improved magnet structure and acoustic network to extend the high frequency range and raise the extreme lows. A specially designed precision diaphragm results in unusually low harmonic and phase distortion without sacrifice of high output level.



Field tested under the most difficult operating conditions, the Turner 211 Dynamic is not affected by temperature or climate. Its response remains free from peaks or holes from 30 to 10,000 cycles. Adapted to both voice and music pickups, the Turner 211 is the ideal companion for quality recording, sound system, public address and broadcast equipment.

Ask your dealer or write

THE TURNER COMPANY

909 17th Street N. E., Cedar Rapids, Iowa



TURN TO TURNER FOR THE FINEST IN ELECTRONIC EQUIPMENT

Licensed under U. S. Patents of the American Telephone and Telegraph Company, and Western Electric Company, Incorporated.



SPECIFICATIONS

- Output Level: -54DB at high impedance (1 volt/dyne/sq. cm).
- Frequency Response: Flat within ± 5 DB from 30-10,000 cycles.
- Impedance: 30-50 ohms, 200 ohms, 500 ohms, or high impedance.
- Case: Salt-shaker type, chrome satin finish, 90° tilting head.
- Cable: 20 ft. heavy duty with removable type connectors.
- Uni-directional
- Mounting: 5-27 thread (Standard Thread).



(Continued from page 52A)

tems work, to evaluate their work in terms of its applicability to specific problems. Must be able to carry on some theoretical and experimental work in addition to laying the technical ground work for possible formation of a group to engage in advanced development.

Prefer B.S. or M.S. in Physics, E.E., Radio Engineering, or Communications. Please send sufficient information relative to age, education, experience and salary desired to warrant an early interview. Box No. 431.

ELECTRONIC PHYSICIST

A New York manufacturer of electrical and electronic devices has an interesting opening for an M.S. or Ph.D. with five to fifteen years background in teaching, research, or advanced development in physics.

Requirements are: 1. Ability to devise and develop unusual systems which are fundamentally electronic in nature, but may include also other physical operations.

2. The evaluation of system possibilities, and theoretical predictions of performance.

3. Organization and utilization of the technical assistance of skilled consultants, and the experimental verification of theoretical work. Qualified applicants will be interviewed at an early date in New York City. Please send particulars outlining age, education, experience, and salary expectation. Box No. 430.

ELECTRONIC RESEARCH ENGINEER

A large and progressive manufacturer of electronic equipment has an opening in the New York area for a man with five to ten years experience in radar, loran, or aircraft navigation aids. This experience should cover an entire system and be broad in nature. Must be able to devise and plan new and complex electronic systems as well as evaluate their possibilities and limitations. Must also supervise and carry out the design and development of the circuits required by the system.

B.S. or M.S. in Physics, Electrical Engineering, Radio Engineering or Communications preferred.

Early interviews will be arranged for qualified applicants furnishing full details regarding age, education, experience, and salary requirements. Box No. 432.

ENGINEERS

Junior and senior electrical engineers or physicists for general development engineering in television and allied radio and electronic fields. Established manufacturing concern located suburban New York City. Box #437.

PHYSICISTS AND ELECTRICAL ENGINEERS

For vacuum tube research. Apply by letter stating qualifications to Director of Research, National Union Radio Corporation, 57 State Street, Newark, New Jersey.

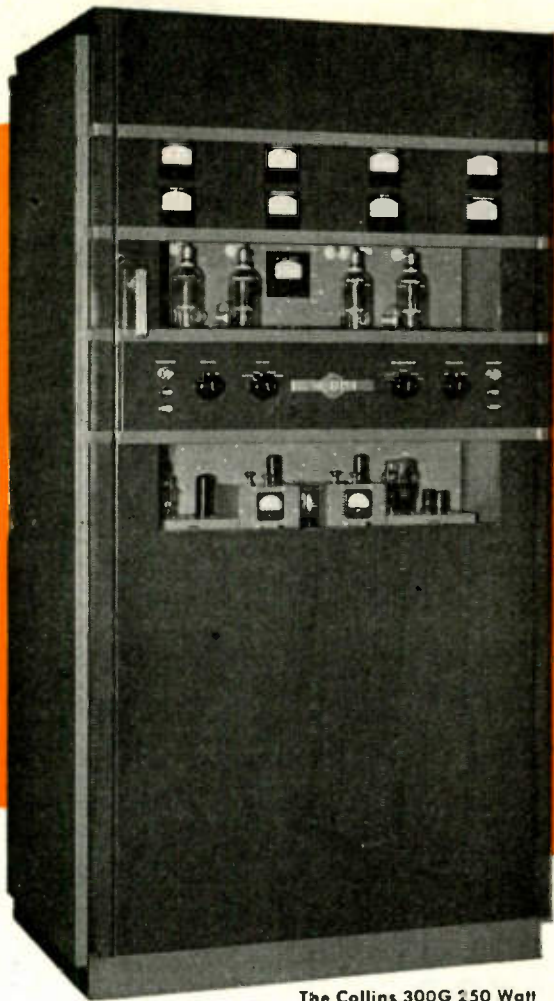

The Collins 300G 250 Watt Broadcast Transmitter

*Your audience
deserves the
best*



The Collins 212A-1 Studio Console

The excellence of Collins broadcast equipment is an accepted tradition, backed by years of reliable service under continuous operation. During the war years, when maintenance was a major problem, owners and operators of Collins equipment found their faith thoroughly justified by the thousands of hours of uninterrupted operation logged on their stations.

The new Collins transmitters and speech equipment reflect the soundest principles of design and construction. By careful attention to detail, and by combining foresight with experience, we have developed high fidelity broadcast equipment that is outstanding for endurance, style, and accessibility.

The 300G 250/100 watt AM transmitter is designed for continuous high fidelity service. The frequency response is within ± 1.0 db from 30-10,000 cps, and distortion and noise are far

better than FCC requirements. Stabilized feedback maintains the excellent performance over variations in operating conditions.

The Collins 212A-1 speech input console is a packaged unit providing simultaneous auditioning or rehearsing, cueing, and broadcasting from any combination of two studios, an announce booth, a control room announce microphone, two turntables, and six remote lines. The frequency response of 30-15,000 cps is ideal for AM, FM, and Television applications. The chassis rotates within the end supports, permitting maintenance during operation.

Write today for illustrated bulletins describing these and other Collins broadcast equipments.

FOR BROADCAST QUALITY, IT'S . . .



Collins Radio Company, Cedar Rapids, Iowa

11 West 42nd Street, New York 18, N. Y.

458 South Spring Street, Los Angeles 13, California

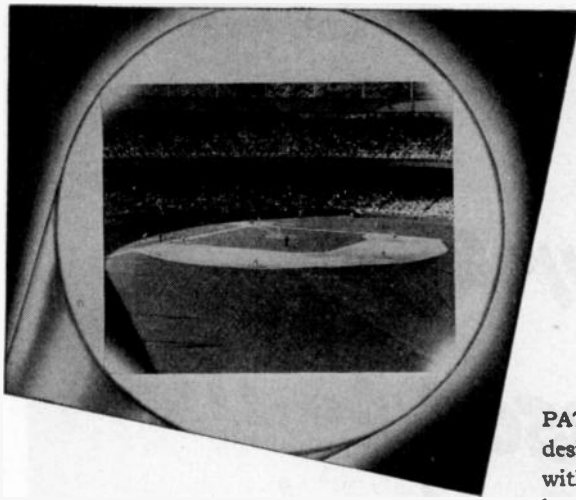

Patterson Phosphors for Contrast... Brilliance...Detail in Television Images

PATTERSON PHOSPHORS are designed for maximum luminescence with minimum input energy. Quality phosphors for television, radar, oscilloscopes and other electronic instruments are available from Patterson Screen Division of E. I. du Pont de Nemours & Co. (Inc.), Towanda, Pa. Manufacturers, experimental laboratories and schools are invited to write us outlining their requirements.

PATTERSON PHOSPHORS ARE AVAILABLE
IN A WIDE RANGE OF

- | | |
|---------------|------------------------|
| 1. Colors | 4. Types of Excitation |
| 2. Grain Size | 5. Afterglow |
| 3. Brilliance | 6. Special Blends |

PATTERSON LUMINESCENT CHEMICALS

BETTER THINGS FOR BETTER LIVING . . . THROUGH CHEMISTRY



STANDARD SIGNAL GENERATOR



**MODEL
65-B**
RANGE
75 KC
to
30 MC

Individually Calibrated Scale

- OUTPUT:** Continuously variable, .1 microvolt to 2.2 volts.
OUTPUT IMPEDANCE: 5 ohms to .2 volt, rising to 15 ohms at 2.2 volts.
MODULATION: From zero to 100%. 400 cycles, 1000 cycles and provision for external modulation. Built-in, low distortion modulating amplifier.
POWER SUPPLY: 117 volts, 50-60 cycles, AC.
DIMENSIONS: 11" high, 20" long, 10 1/4" deep, overall.
WEIGHT: Approximately 50 lbs.

Catalog on request

MANUFACTURERS OF
Standard Signal Generators
Pulse Generators
FM Signal Generators
Square Wave Generators
Vacuum Tube Voltmeters
UHF Radio Noise & Field
Strength Meters
Capacity Bridges
Megohm Meters
Phase Sequence Indicators
Television and FM Test
Equipment

MEASUREMENTS CORPORATION
BOONTON NEW JERSEY



Positions Wanted By Armed Forces Veterans

In order to give a reasonably equal opportunity to all applicants, and to avoid overcrowding of the corresponding column, the following rules have been adopted:

The Institute publishes free of charge notices of positions wanted by I.R.E. members who are now in the Service or have received an honorable discharge within a period of one year. Such notices should not have more than five lines. They may be inserted only after a lapse of one month or more following a previous insertion, and the maximum number of insertions is three per year. The Institute necessarily reserves the right to decline any announcement without assignment of reason.

SALES ENGINEER

17 years' experience all phases broadcast engineering. 4 years AAF as CO communications group, extensive experience aeronautical radio and navigational aids. Age 36. Desires permanent responsible position with progressive company. Will consider foreign assignment. Box 34W.

ELECTRONICS ENGINEER

MA in physics, MS in communications engineering. Three years' experience as physicist for U. S. Navy, both as civilian and officer. Desires position in electronics or physics, environs of New York City or Washington, D.C. Age 30. Box 35W.

ENGINEER

USNA BS, Harvard MS radio engineering, Commander USN. 13 years' naval electrical, engineering, and command experience. Age 43. Desires executive or administrative position. Boston, Mass. Available October 1946. Box 36W.

ENGINEER

BEE, age 24, married. 1 1/2 years' broadcast engineer, NDRC UHF research; two years' Signal Corps Officer. Experienced in police communications. Prefer Chicago area. Available October. Box 37W.

ENGINEER

BS in EE, Vermont 1941, age 29. Radar training M.I.T. 4 years' Naval Officer, specializing in maintenance and installation of radar, and radio equipment aboard aircraft. Interested in research and development. Box 38W.

BROADCAST CHIEF ENGINEER

BS in EE, age 28, radar project engineer, Aircraft Radio Laboratory, and Radiation Laboratory M.I.T. 50 KW broadcast experience. Desires position as Chief Engineer or project Engineer. Prefers Midwest or West. Box 39W.

ELECTRONICS TECHNICIAN

3 years' teaching, total experience 13 years. Desires opportunity in research laboratory, teaching, FM or television radio station work, theater sound maintenance, or commercial sound work. Box 40W.

Positions Wanted

(Continued from page 56A)

ELECTRICAL ENGINEER

BEE, R.P.I. plus one year training in electronics at Harvard, M.I.T. and Corpus Christi, Texas, for Navy. Two and one-half years' Naval Electronics Officer installing, maintaining shipboard radar and aircraft radio and radar. Seven months' commercial design and development experience in television video circuits. Age 27, married, Alfred R. Petrocelli, 21 Harrison Pl., Clifton, N.J.

ENGINEER

BS in EE, S.C. Harvard and M.I.T. electronics courses, advanced AAF electronics installation and maintenance; practical radio and industrial electronic and general EE experience; AAF Reserve Major, desire engineering position on West Coast. Box 26W.

RADIO ENGINEER

BS in EE and nearly BS in Physics, now at more study in both fields. Age 25, married, desire test, design, or maintenance in Central or West Coast. Taught Army A.A. radar one year. Navy, three years, taught fire control radars and like equipment plus installations. Milton H. Crothers, 914 8th St., Brookings, S.D.

RADIO ENGINEER

Army captain, 26, graduate radio engineer, one year research, three years' commanding officer of large radar installations; good appearance, pleasant personality. Interested in engineering sales, finance, or administrative work. Box 27W.

DRAFTSMAN

A start at the electronic bottom—capable draftsman—civilian and Army experience. Attending engineering college evenings, completing third year. Résumé of qualifications upon request. Bernard Meyer, 1320 Sheridan Ave., New York 56, N.Y.

SALES ENGINEER

Age 25, B.S. in Commerce and A.S.T.P. in E.E. Desire position in the electrical industry. Sales and laboratory experience. Box 12W.

PART TIME WORK

Desire part time while completing MEE, permanent after June, 1947. Age 23, married. Two years' design, production experience on radar. Navy RT instructor. Available June. East Coast. Box 13W.

SALES ENGINEER TRAINEE

MIT-Harvard trained electronics-radar officer, AAF, B.S., age 27, married. Experienced test engineer, electronic equipment. In service field, supervised men in installation and maintenance of all airborne navigational aids and high altitude microwave bombing equipment and computers. R. I. Gaines, 29 Wadsworth Ave., New York 33, N.Y.

EXECUTIVE'S ASSISTANT

M.S., stenographer, age 28. Four years' electronic engineering experience. Will work in New York City or environs. Box 14W.

For GRAND PERFORMANCE

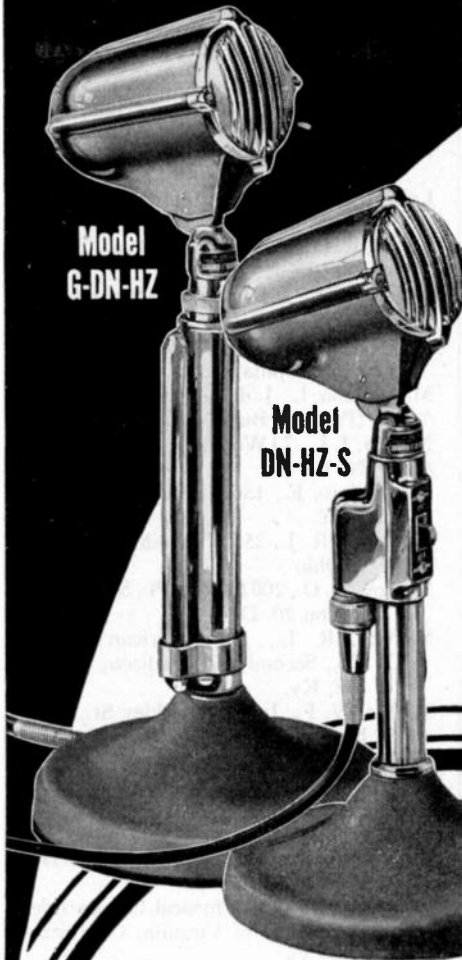

Astatic

DYNAMIC MICROPHONES NEWLY DESIGNED AND ENGINEERED

● Incorporating advanced ideas in operation and design, Astatic DN-Series Dynamic Microphones are highly recommended for a wide variety of communications and public address applications, especially where temperatures vary and high relative humidity is encountered.

Four Models
of different output impedances, are available: DN-50, DN-200, DN-500 and DN-HZ.

Any one of these models is available with the Type G, Grip-to-Talk Desk Stand. Only one model, however, DN-HZ-S, high impedance, is available with the Type S On-Off Switch. Astatic Dynamic Microphones are semi-directional in character, incorporate a unitary moving coil system and carefully proportioned acoustic circuit to highly damp the natural resonance of the moving parts and provide a response substantially flat from 50 to 7,000 cycles. All DN-Series Microphones are sturdy and dependable, relatively low in cost, smartly streamlined, attractively finished in opalescent gray with bright chrome grille, and sure to give long, satisfactory service.

THE *Astatic* CORPORATION
CONNEAUT, OHIO
IN CANADA: CANADIAN ASTATIC LTD., TORONTO, ONTARIO

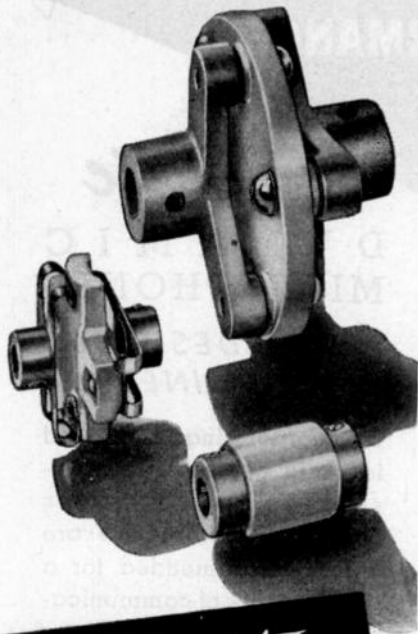

Shaft Couplings

A link between control and variable circuit element, shaft coupling design can be an important factor in proper functioning of electronic equipment.

Illustrated are but three of many Johnson insulated shaft couplings; among them units providing a high degree of flexibility but freedom from backlash common to others resembling them; rigid types where accurate shaft alignment is required and torque may be high; bar types for high voltages or very high frequencies. All are characterized by best steatite insulation properly proportioned for electrical and mechanical strength, by accurate metal parts finished to stand salt spray test, and by those little evidences of Johnson engineering and manufacturing skill that are most appreciated only after use and comparison.

Ask for Latest Catalog



JOHNSON
a famous name in Radio

E. F. Johnson Co. Waseca, Minn.



(Continued from page 48A)

- Lawrence, J. C., 1735 Holyoke Ave., East Cleveland, Ohio
- Lomas, E. G., 2007 Northcliffe Ave., Montreal, Que., Canada
- Lovell, E. L., 10035 S. Lowe Ave., Chicago 28, Ill.
- Lucas, C. A., 331 Cleveland St., Redfern, N.S.W., Australia
- Mac Elroy, C. W., Jr., 4306 Horrocks St., Philadelphia 24, Pa.
- Maragliano, L., J. de la Pena 262, Adroque (Pcia. de Buenos Aires), Argentina
- Martin, J. L., 73 Woodside Ave., Freeport, N. Y.
- Matsumoto, E., 136 Cottage St., Buffalo, N. Y.
- McComb, R. J., 255 N. Main St., Dayton 2, Ohio
- McCoy, D. O., 2002 Ridge Pl., S.E., Washington 20, D. C.
- Merwin, R. L., Jr., American Electric Co., Second and Madison, Covington, Ky.
- Mielke, W. F., Jr., 444 Berkley St., Dearborn, Mich.
- Mimms, C. E., Box 244, Centerport, N. Y.
- Morison, R., 241 S. Holliston St., Pasadena, Calif.
- Mott, O. B., Salisbury, Mo.
- Napolin, S., 31-14 Crescent St., Astoria 2, N. Y.
- Ney, E. P., Rouss Physical Laboratories, University of Virginia, Charlottesville, Va.
- Nill, A. A., 17 Av. Theophile Gautier, Paris 16, France
- Nurmi, M. K., 3945 N. Pulaski Rd., Chicago, Ill.
- Olson, H. O., Box 1023, 2046 First Ave., N.E., Cedar Rapids, Iowa
- Ortscheid, B. J., 7734 S. Vernon Ave., Chicago, Ill.
- Pangburn, J. P., Jr., 2730 S. Normandie, Los Angeles 7, Calif.
- Paterson-Jones, E. A., Posts and Telegraphs Department, Box 581, Nairobi, Kenya, East Africa
- Pellegrini, H. A., 697 E. 22 St., Brooklyn 10, N. Y.
- Pickert, C. E., 402 S. Superior St., Angolo, Ind.
- Posnikoff, P. W., 371 Keewatin Ave., Toronto 12, Ont., Canada
- Pratt, H. G., 614 Park Ave., Syracuse 4, N. Y.
- Reefman, W. E., 336 Pleasant St., Charlotte, Mich.
- Reisman, E., 409 Maplewood Rd., Wayne, Pa.
- Richter, E., 30-08—94 St., Jackson Heights, N. Y.
- Riffe, L. V., Box 359 B-RT #1, Colton, Calif.
- Russell, J. H., 1106 S. Spooner St., Pasadena, Tex.
- Rubin, A. E., 107 A Armstrong Dr., Hampton, Va.
- Sanford, R. W., 2815 Cheswolde Rd., Baltimore 9, Md.
- Schwarzmann, W. A., 94 E. Clinton Ave., Tenafly, N. J.
- Seiser, E. O., 2424 S. 31 St., Milwaukee 7, Wis.
- Shill, H. F., Jr., 6351 Primrose Ave., Hollywood 28, Calif.
- Sira, M. A., Jr., 452 Fort Washington Ave., New York 33, N. Y.
- Smith, S. A., RFD 1, Kennerdell, Pa.
- Stephenson, S. S., Jr., 520 W. 218 St., New York 34, N. Y.
- Stewart, J. A., 93 Hazelwood Rd., Fox Hills, N. Y.
- Strother, W. F., 34 Prospect Village, Trenton 8, N. J.
- Tatansky, M., 700 E. Ninth St., New York, N. Y.
- Thorne, P. A., 3001 Walnut St., Philadelphia, Pa.
- Trafford, W., Telecons Dept., Kuala Lumpur, Malaya
- Trip, R. E., 1215 S. Fife St., Tacoma, Wash.
- Trupiano, J. F., 247 Carroll St., Brooklyn 31, N. Y.
- Velleman, F. F., 52—15 St., Orange Grove, Johannesburg, South Africa
- Vijayaraghavan, K., Annamalai University, Annamalinagar (Madras presidency), South India
- Weinstein, D. H., Box 63, Bellaire, Tex.
- Wilson, M. C., 21 Webb Ave., Hempstead, N. Y.

News—New Products

(Continued from page 40A)

West Coast Electronics Trade Show

It has been announced by the West Coast Electronics Manufacturers Assn., 412 West 6 St., Los Angeles 14, Cal., that the Second Annual Electronics Trade Show will be held in Los Angeles, Cal., October 18 through 20. Exhibitors will consist mainly of western manufacturers and those eastern companies doing business on the west coast.

Orthocoustic Equalizers

A device, new to the commercial field of sound equipment, but a standard item in nearly every broadcasting and recording studio—orthocoustic equalizers—are now being manufactured commercially by the Cinema Engineering Co., 1510 W. Verdugo Ave., Burbank, California.

Available for 500- and 600-ohm circuits, these new equalizers are especially built to deliver a fixed orthocoustic curve, equalizing for high frequency losses.

Miniature Crystal Unit

The Bliley Electric Company, Erie, Pa., announces the release of a new crystal unit, type VX2, specifically designed for use where space is at a premium.



Type VX2 features a compact, gasket sealed assembly with over-all dimensions of 1 1/16" wide, 3/8" thick, and 1 1/16 high. Solder lug connections replace the usual pin contacts. The unit is supplied at 3105 kc for use in private aircraft transmitters and is available at any specified frequency between 3000 kc and 11,000 kc.

Radar Test Installation



Antenna of Raytheon's Mariners Pathfinder radar test installation aboard SS *Atlantic Mariner*, with E. B. Dunn, radar engineer, and Captains J. C. Hahs and Martin Johansen, Atlantic Refining Company, Philadelphia.

(Continued on page 60A)

TORQUE REDUCED TO A MINIMUM

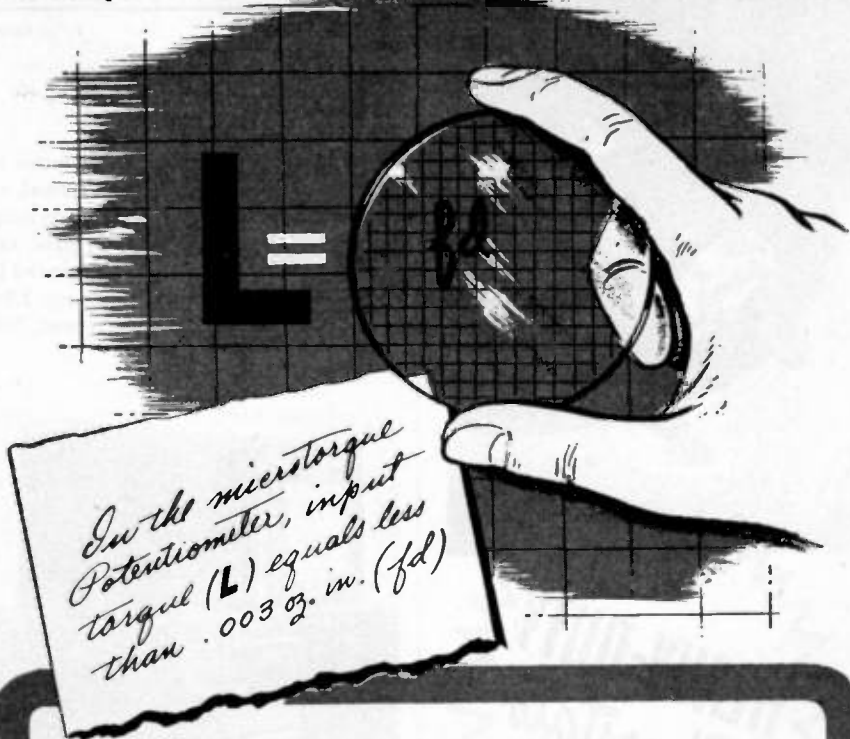

MICROTORQUE POTENTIOMETERS

for Remote Recording

Solve remote control and position repeating problems by adapting Microtorque Potentiometers to your particular needs. Built like a fine watch, Microtorque Potentiometers convert mechanical movement into proportional electrical voltages without causing excessive drag in sensitive mechanical measuring systems. A simple yoke adaption to the instrument pointer makes these tiny, ultra-low torque units ideal for take-offs from low torque indicating instruments. Microtorque Potentiometers may also be used as primary control elements in bridge type circuits to operate directly recorder controllers, recording galvanometers, oscillographs, polarized relays, and telemetering circuits.

FEATURES:

- Vibration-proof 4 to 55 cycles up to 6 G.
- Resistance values 100 to 2500 ohms.
- Higher ranges on request.
- Input torque less than .003 oz. in.
- Power dissipation of 2 watts.
- Linearity 1/2% or better.
- Weight less than 3/4 ounces.
- Size 1" x 1 1/4"



FULL SIZE

Manufacturers of remote pressure transmitters, controls, and aircraft compasses



AUTOFLIGHT INSTRUMENTS

A Division of G. M. Giannini & Co., Inc.

161 EAST CALIFORNIA STREET
PASADENA 5, CALIFORNIA

News and New Products

(Continued from page 59A)

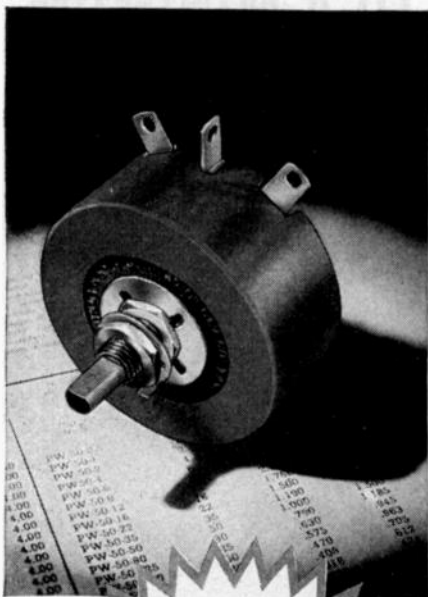

**HEAVY-DUTY
Rheostats**

★ If it's toughness you want for that radio or electronic assembly, you can have it with these Clarostat Power Rheostats. In 25- and 50-watt sizes. Tens of thousands in daily use prove that they can take it—and then some. Here's why:

Wire winding on insulated metal core and imbedded in cold-setting inorganic cement for maximum heat radiation even at fractional settings.

Smoother turning rotor because of properly tensioned support on collector ring and contact on winding. Graphited-copper contact shoe in cradle contacting both winding and collector ring for short-path conduction.

★ **Submit that Problem . . .**

If it has to do with resistors, controls or resistance devices, send it to us for engineering aid. Literature on request.



CLAROSTAT MFG. CO., Inc. • 285-7 N. 6th St., Brooklyn, N. Y.

Improved Recording Dilatometer

An improved automatic Dilatometer for continuous recording of the thermal expansion and contraction of a wide range of materials including metals, glass, ceramics and plastics has been announced by the Electronics Division, Sylvania Electric Products Inc., 500 Fifth Avenue, New York, 18 N. Y.



The equipment is designed to provide continuous graphic recording of the twelve hour expansion and contraction cycles of samples. In addition to eliminating the tedious plotting of instant values by older methods, the recording densitometer permits determination of true variations in length even when samples exhibit exceptions to the rule of elongation as a function of temperature.

The Dilatometer includes a furnace or sub-zero cooling chamber, furnace thermocouple, concentric quartz tube, specimen thermocouple, gearbox and support, transmission, contact mechanism, electronic relay, and recorder. Each one of these principal units performs a separate function and it is claimed that all functions are closely coordinated to hold specimen temperature uniform within 1° C.; provide uniform heating and cooling with the specimen in an inert atmosphere; automatic shutoff; and an over-all accuracy of 0.2%. Test samples three, four or five inches long may be subjected to temperatures up to 1000° C.

Eveready Battery Data Sheets

The National Carbon Company has recently announced the issuance of seven new pages for their Battery Engineering Data Book.

These pages include an outline drawing and service capacity curves on the "Eveready" No's. 1016 and 1016-E "A" batteries which are especially designed for pocket radios and hearing aids. Samples of these new "A" batteries are available on request.

VHF Radio for Railroads

Greater efficiency in railroad operations through the use of radio on freight trains is indicated following a comprehensive series of tests conducted recently by the Western Electric Company in cooperation with the Northern Pacific Railway Co., on a new type of VHF railroad intercommunications radio equipment. The tests were carried out on runs in the states of Washington and Oregon.

This new radio equipment was designed by Bell Telephone Laboratories to operate in the new 152 to 162-megacycle band to which the railroads have been assigned by the F.C.C.

Because the run over the Cascade Mountains includes long 2.2-percent grades, it is common railroad practice to cut in a helper engine about midway in the train. This has

(Continued on page 62A)

Remler Appointed Agent for WAR ASSETS ADMINISTRATION

(Under Contract No. 59A-3-48)

. . . to handle and sell a
wide variety of

ELECTRONIC EQUIPMENT

released for civilian use

Write for Bulletin Z-1A

Remler Company Ltd.
2113 Bryant St.
San Francisco 10, Calif.

REMLER

SINCE 1918

Radio • Communications
Electronics

Sealing the gun and stem assembly within the bulb

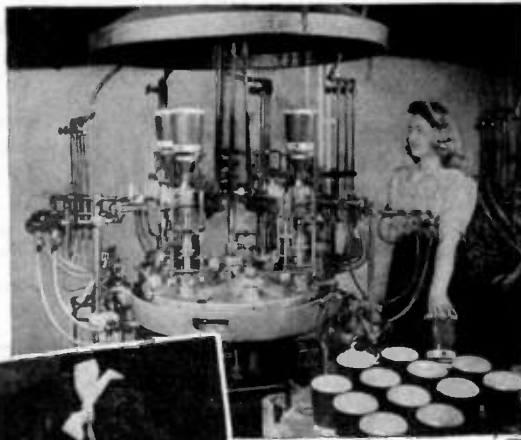

Evaluating the tube

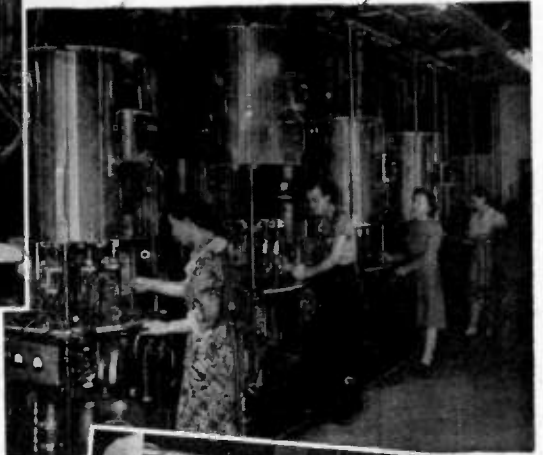

Assembling the electron gun

Basing the sealed tube

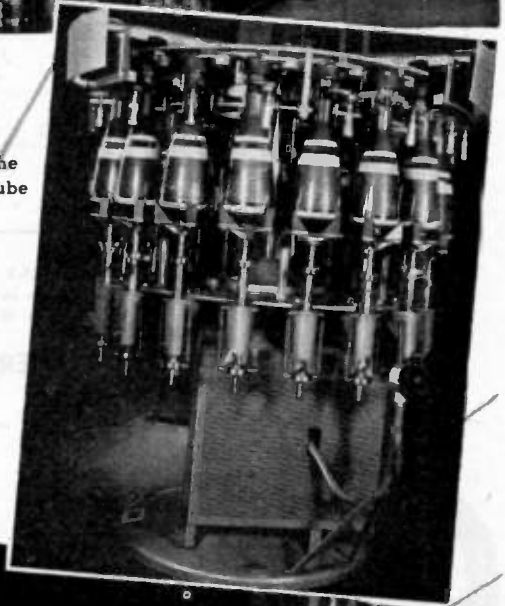

It's DU MONT for CATHODE-RAY TUBES

of Quality!

Into the making of the modern Du Mont cathode-ray tube has gone all the experience, skill and knowledge acquired during the many years since DuMont commercially pioneered the cathode-ray tube from its infancy to the present refined state.

Complete specialization, constant research and careful supervision of every step from the design sheet to the finished manufactured product combine to make DuMont cathode-ray tubes the accepted standard for quality, accuracy and performance.

When buying cathode-ray tubes, always insist on DuMont—your "best buy!"



Testing the completed cathode-ray tube

© ALLEN B. DU MONT LABORATORIES, INC.

DU MONT

Precision Electronics & Television

ALLEN B. DU MONT LABORATORIES, INC., PASSAIC, NEW JERSEY • CABLE ADDRESS: ALBEEDU, PASSAIC, N. J., U. S. A.

(Continued from page 60A)

Don't Overlook C.T.C.'s New I-F Slug Tuned INDUCTOR

This compact, easy-to-mount LS-3 coil is available in four windings (see below). Total possible frequency span is from 1/2 mc. to better than 150 mc. You'll find them ideal for many applications.

The chart gives the individual characteristics:

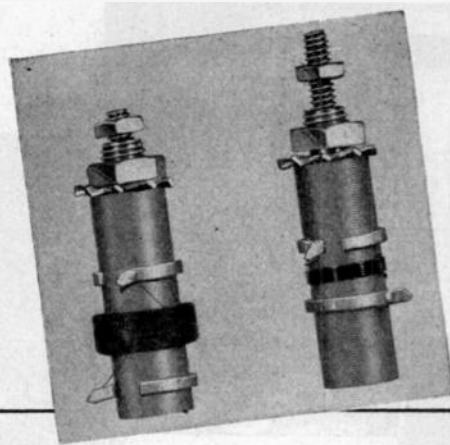

	Q	DC RESISTANCE	INDUCTANCE	VARIATION OF INDUCTANCE	TYPE & SIZE OF WIRE	NO. OF TURNS	TYPE OF WINDING
1 meg. unit	56	18.14 ohm @23°C.	420 microhenries ± 5%	325 to 750 microhenries	#38 SCE	198	Multiple
10 meg. unit	44	1.90 ohm @19.5°C.	8.4 microhenries ± 5%	4.75 to 14.25 microhenries	#38 SCE	24.5	Multiple
30 meg. unit	46	.126 ohm @20°C.	0.7 microhenries ± 5%	.350 to 1.0 microhenries	#28 E	7	Single layer
60 meg. unit	46-50	.126 ohm @20°C.	.061 .102 microhenries ± 5%	.065 to .095 microhenries	#28 E	2	Single layer

If these standard LS-3 don't meet your requirements, we'll be pleased to submit quotations on coils built to your specifications. Write for C.T.C. Catalog No. 100.



CAMBRIDGE THERMIONIC CORPORATION
456 Concord Avenue Cambridge 38, Mass.

confronted the engineers with the difficult problem of coordinating throttle positions particularly when the engines may be as much as a half-mile apart. During the tests it was found possible on all occasions to start the train smoothly with a minimum danger of a break-in-two.

Electronic Micrometers

Four models of Electronic Micrometers for precise measurements of compressible and non-compressible materials have been announced by the Carson Micrometer Corporation, Newark, N. J. The outstanding feature is the electronic circuit used in conjunction with the micrometer screw thread thus eliminating the human sense of touch and, according to the manufacturer, unskilled operators are assured of consistently accurate readings to 0.00005 inch on production testing lines. Bulletins are available with full technical information.

Transmitter Air Filters

The Air Filter Corporation of Milwaukee, Wis., announces the development of the Aircor Blower Motor Filter for radio transmitters. The filter is designed to trap dust particles and retard moisture.

This filter may be used either as a dry filter or as a viscous filter by charging it with filter adhesive oil. The manufacturer recommends its use in locations where sand and extreme dust conditions prevail—such as airports—to eliminate undesirable conditions of excessive dust on condenser plates, high resistance shorting of circuit parts and mechanical contamination.

Self Balancing Potentiometer

Announcement of a new portable self balancing potentiometer has been made by General Electric's Meter and Instrument Division, Schenectady 5, N. Y. Completely self-contained, the new instrument called an "autopot," is a device for converting small d-c voltages to measurable currents without appreciably overloading the measured circuit. Among the services to which the "autopot" may be applied are: telemetering, temperature measurement, analysis of electronic circuits, as a source of constant current, and measurement of unbalance in bridge circuits and the drop across shunts where lead resistance is critical.

Use of the unit also extends the range of conventional indicating and recording instruments so that they can be used for high-sensitivity measurement of low d-c voltages and direct currents. The potentiometer balances to ±1 microvolt. Bulletin GEA-4625 gives additional technical information.

SPECIAL TRANSFORMERS for the Electronic Industry

This transformer—designed and constructed by **ELECTRO**—exemplifies the service which our organization is equipped to render to all branches of the electronic industry. Write us concerning your special requirements.

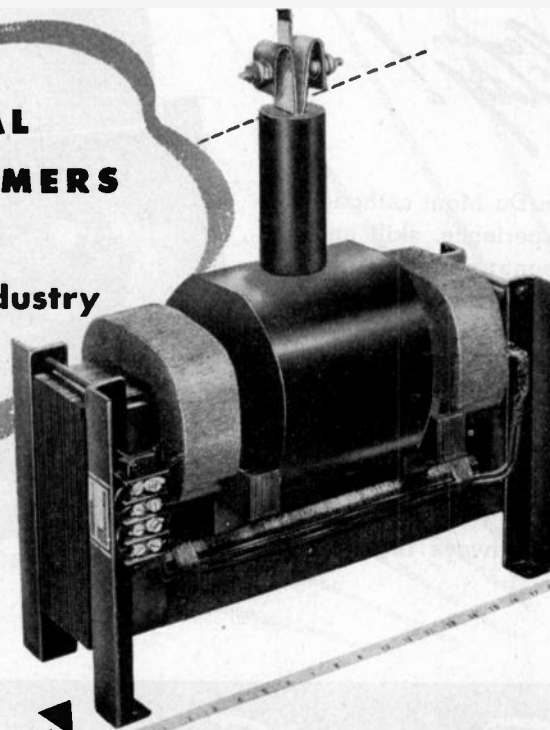

"Electro" Filament Transformer—Plastic Insulated, Dry Type, for External Anode 50 K.W. tube. 25 volts, 415 Amps. Short circuit, 750 Amps. 25 K.V. D.C. Wkg. Overall dimensions: 19 1/2" long x 8 1/4" wide x 18" high.



ELECTRO ENGINEERING WORKS
6021 College Avenue, Oakland 11, California

News—New Products

Lightweight Portable Oscilloscope

The "Pocketscope," so-called because it weighs but five and one-half pounds and its longest dimension is ten inches, has recently been placed on the market by Waterman Products Co., Inc., Philadelphia.

This oscilloscope embodies all functions of the conventional instrument and can be used in almost any position.

The "Pocketscope" cathode ray tube is magnetically shielded and the telescoping light shield (1¼") permits observation even in places of high light intensity. Miniature glass tubes are utilized throughout. The time base oscillator uses a double triode producing a substantial linear trace from 10 cycles to 50 kc. Synchronization with low voltages is possible in the audio, supersonic and low rf ranges.

Versatile Mike Floor Stand

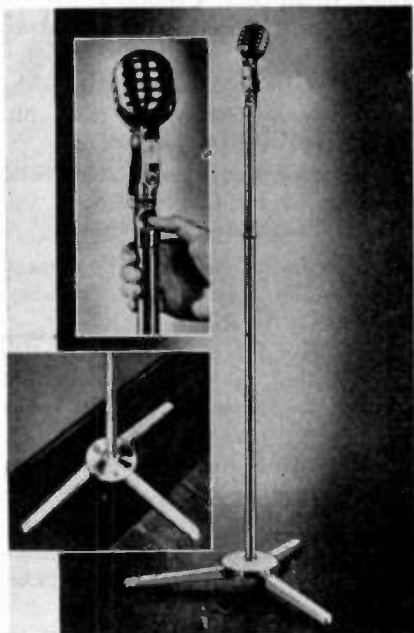

Finger-tip operation with lock and adjustable legs are features of a new microphone floor stand manufactured by Electro-Voice, Inc., South Bend, Ind.

Cascade Phase Shifter

The completion of development work on a new type of frequency modulator, called a Cascade Phase Shifter, has been announced by the Raytheon Manufacturing Company, Chicago.

Only standard types of tubes are used in this new development. It is claimed that noise and distortion are extremely low and because of the simplicity of the circuit, adjustment is easy, tube cost is low and maintenance negligible.

(Continued on page 64A)



in *Vertical* FULLY MOUNTED TRANSFORMERS

FIVE newly-developed vertical shields, accommodating core stacks with ½" to ⅝" center legs, now make it possible for Chicago Transformer to fully-mount both small and large transformers with uniformity.

Now, in radio chassis and similar applications, both small and large units can be vertically-mounted with standardized assembly techniques—with uniform appearance in the finished product.

Adaptable to many variations, Chicago Transformer's complete line of vertical shields allows for either screw or twist-lug mountings and for lead exits through either sides or bottoms of the shields.

CHICAGO TRANSFORMER



DIVISION OF ESSEX WIRE CORPORATION

3501 WEST ADDISON STREET

CHICAGO, 18



MICRO-MIKER



*A new type of instrument
for the measurement
of small capacities*

1. Measures capacities from 1 to 230 Micro-Micro-Farads by direct substitution.
2. This capacity is measured at the end of a shielded cable, thereby eliminating connection errors.
3. Wiring capacity in an amplifier may be measured without disconnecting the load resistor. Condensers as small as 1 MMF may be measured when shunted by a 1500 ohm resistor.

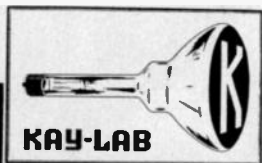

Write for Bulletin 4-D

KALBFELL LABORATORIES

941 ROSECRANS ST. • SAN DIEGO 6, CALIF.
Manufacturers Representatives are invited to reply.

Specify

MYCALEX

LOW LOSS INSULATION

Where high mechanical and electrical specifications must be met.

MYCALEX 410

(MOLDED MYCALEX)

makes a positive seal with metals
... resists arcing, moisture and high temperatures.

27 years of leadership
in solving the most
exacting high frequency
insulating problems.

MYCALEX CORPORATION OF AMERICA

"Owners of 'MYCALEX' Patents"
Plant and General Offices: Clifton, N.J.
Executive Offices: 30 Rockefeller Plaza
New York 20, N.Y.

News—New Products

(Continued from page 63A)

New Precision Metal Brake Announced

The DI-ACRO Brake No. 4 will rapidly duplicate complicated parts to a high degree of accuracy in a wide variety of ductile ferrous and non-ferrous metals, sensitized materials, varnished cambrics and dielectrics, it is claimed by the O'Neil-Irwin Manufacturing Co., of Minneapolis.

The capacity of the brake is limited to 24-inch wide material up to 16-gauge thickness. Features of the new unit include special material clamping action to make sharp bends. A double-edge vertical folding plate permits close reverse bends to be formed. Quickly adjustable material gauge assures precision in all duplicated parts.

The addition of roller bearings greatly increases speed and ease of operation. Precision angular degree stops have been provided for bends other than right angles.

Readers of the PROCEEDINGS are invited to request descriptive circulars by writing directly to the manufacturer.

Recent Catalogs

- ... On laminated phenolic plastics, by Continental-Diamond Fibre Co., Newark, 48, Delaware. Catalog No. DO-46.
- ... On porcelain as an insulator, by Na-

tional Electrical Manufacturers Association, 155 E. 44 St., New York 17, N. Y.

... On transmitting and industrial tubes, by Electronics Department, General Electric Co., Schenectady, N. Y. Catalog No. ETX-10.

... On capacitors, resistors, controls and switches, by R. P. Mallory & Co., Inc., Indianapolis 6, Ind. Catalog No. 467. Mallory has also released the Fifth Edition of their Radio Service Encyclopedia.

... On electronic tubes, by Chatham Electronics, 475 Washington St., Newark 2, N. J.

... On speakers, by University Loudspeakers Inc., 225 Varick St., New York 14, N. Y.

... On high nickel content alloy wire, by Alloy Metal Wire Co., Prospect Park, Pa. Catalog No. D-2.

... On photo-templates, photo-dials, etc., (a bibliography), by Industrial Photo Div., Eastman Kodak Co., 343 State Street, Rochester 4, N. Y. Booklet, "Industrial Photo-reproduction."

... On Microphones, Phono Pickups, Recording Heads and Accessories, by The Astatic Corp., Conneaut, Ohio. Catalog No. 46.

... On Midget Metal Base Relays, by Ward Leonard Electric Company, Mt. Vernon, N. Y. Bulletin No. 104.

... On properties and uses of High Nickel Alloy Steels, by Carpenter Steel Co., Reading, Pa. Catalog Fe-Ni 1946.

... On Steatite Insulators, by General Ceramics and Steatite Corp., Keasbey, N. J. Catalog No. 2000.

... On portable bench-type Induction Soldering Unit, by Marion Electrical Instrument Co., Manchester, N. H. Folder PM-1.

... On Vitreous Enameled Resistors, by Model Engineering & Mfg., Inc., Huntington, Ind.

... On Vacuum Capacitors, by Electronics Division, General Electric Co., Schenectady, N. Y. Catalog ETX-3.

... On Mycalex Insulating Material, by Chemical Department, General Electric Co., Pittsfield, Mass.

Readers of PROCEEDINGS are asked to make their requests directly to the above organizations.

Personalities

... Mr. Thomas B. Aldrich of Presto Recording Corporation, New York City has been appointed General Sales & Advertising Manager.

Tung-Sol Data Sheets

Ten new data sheets dated June 17, 1946 have been issued by the Electronic Tube Division, Tung-Sol Lamp Works, 95 Eighth Avenue, Newark 4, N. J., for addi-

(Continued on page 68A)

Announcing

NEW Electro-Voice CARDYNE

Now you get More Features...
More Advantages than ever... in a Single Head

Cardioid Dynamic Microphone

New E-V developments bring you true cardioid unidirectionality . . . smooth, wide-range response . . . high output . . . and other desirable advantages in a rugged single-head dynamic.

Through the exclusive new E-V *Mechanophase** principle, the CARDYNE virtually eliminates unwanted sounds . . . gives you only the sound you want, with greater definition and fidelity. Substantially reduces background noise and reverberation. Increases effective working distance from microphone. Stops feedback. Permits increased loudspeaker volume. Gives extremely accurate pick-up and reproduction of music and speech . . . indoors and outdoors. Highly suitable for the most exacting sound pick-up work . . . in studio and remote broadcasting, disc and film recording, public address and communications.

Trim, modern, functional design, finished in rich satin chromium. Smooth, firm tilting action. "On-Off" switch. Ruggedly built to withstand severe operating conditions. Available in 50, 250, 500 ohms impedance, or Hi-Z (direct-to-grid, 25,000 ohms). Low impedances balanced to ground. Also available without "On-Off" switch. Send now for Cardyne Bulletin No. 131.

CARDYNE II. Model 731. List Price \$75.00
Frequency response, substantially flat, 30-12,000 c.p.s.

CARDYNE I. Model 726. List Price \$55.00
Frequency response, substantially flat, 40-10,000 c.p.s.

Cardioid (heart-shaped) Polar Pattern. Wide-angle front pick-up, horizontally and vertically, diminishes sharply to dead zone at rear. Sound at rear dead zone cancels out and is not reproduced. Solves everyday sound problems—in a great many applications.

Only the Cardyne Gives You All This!

- New E-V Mechanophase* Principle
- True Cardioid Unidirectional Performance
- Reduces Background Noise, Reverberation
- Stops Feedback—Permits Greater Volume
- Relatively High Output
- New E-V Acoustalloy Diaphragm
- Substantially Flat, Wide-Range Response
- And other E-V Features

*Patents Pending

No finer choice than

Electro-Voice

ELECTRO-VOICE, INC., 1231-D South Bend Ave., South Bend 24, Indiana
Export Division: 13 East 40th St., New York 16, N. Y., Cables: Arlab

EXHIBITION FLOOR PLAN

for the Radio Engineering Show, March 3 to 6, 1947
at the Armory, 34th Street and Park Avenue, New York

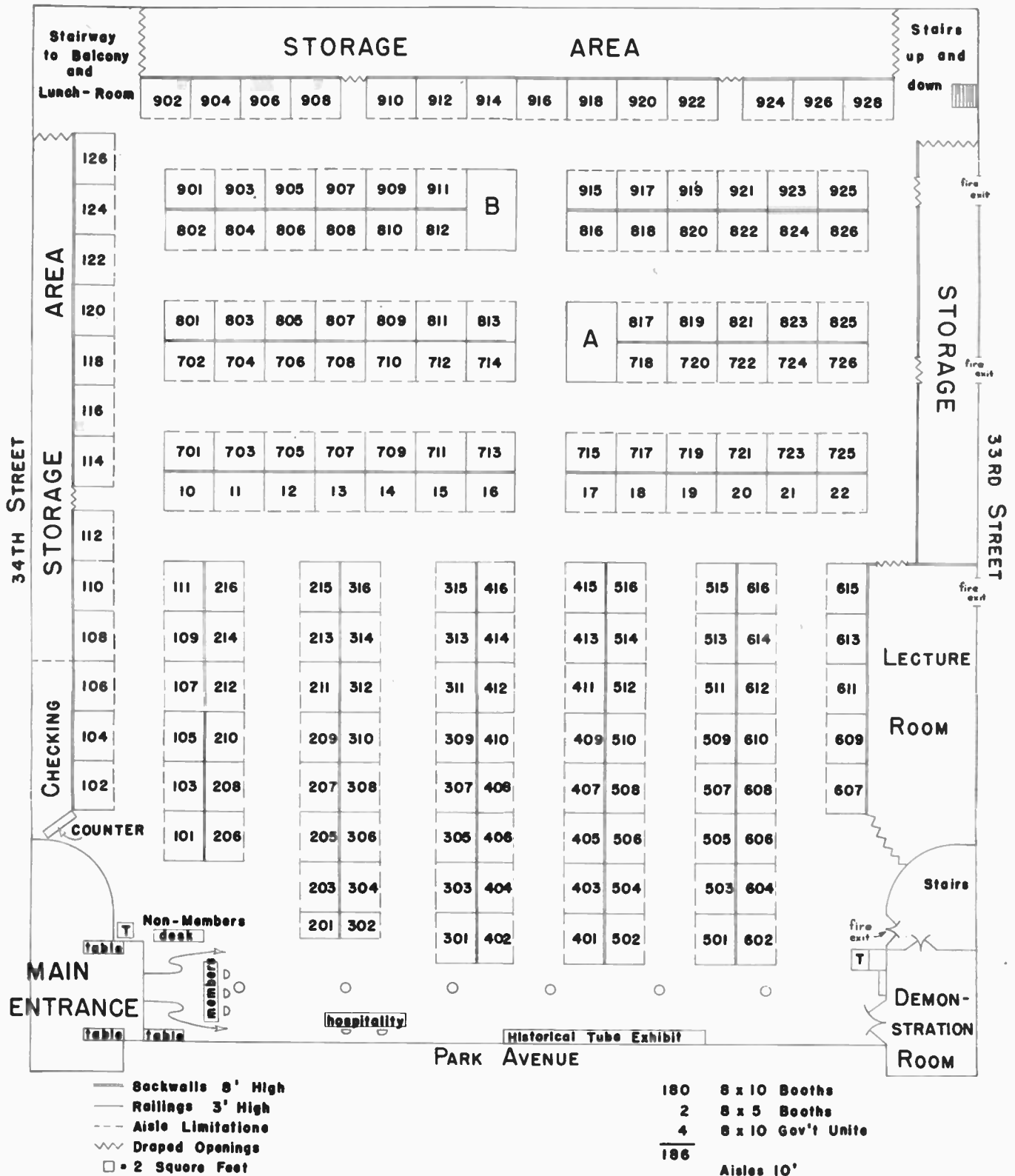

1947 I.R.E. CONVENTION AND RADIO ENGINEERING SHOW

180 Exhibit units, all a standard size of ten foot frontage and eight foot depth, will accommodate what is planned to be the largest and most interesting display of radio-electronic engineering equipment

ever assembled on one floor. Spacious, ten foot aisles, a 60 foot ceiling unobstructed by pillars, will make the exhibits easy to see. Already, 120 different manufacturers have reserved space and planned

their booths. They will display everything of interest to engineers from complete transmitters to the tiniest resistors, from towers to oscilloscopes.

1947 Radio Engineering Show Information

Locations: The Radio Engineering Show of the 1947 I.R.E. National Convention will be held in the 17th Regiment Armory at 34th Street and Park Avenue, New York. The Technical Sessions will be held in the Ballrooms of the Hotel Commodore, at 42nd Street, between Park and Lexington Avenues. Banquet and Lunches will be at the Hotel Commodore.

Dates and Hours: Starting Monday, March third. Technical Sessions will open at 9 A.M. Exhibits will be open from 1 to 10 P.M. each day except Wednesday when the hours will be 9 A.M. to 6 P.M. The Banquet will be Wednesday evening. The Exhibits will close Thursday at 10 P.M. Three evening periods make it possible to visit the Show after business hours or without missing technical sessions.

Connections: Travel time between the Hotel Commodore and the Armory is ten minutes or less by direct connection; one stop on the Lexington Avenue Subway. The walking distance is nine blocks and both the Lexington Avenue and Park Avenue busses give close connections.

Exhibits: Vital engineering knowledge can be gained from the many interesting exhibits of equipment, instruments, component parts, materials and transmitters. The Radio Engineering Show is strictly of professional engineering grade and is not of consumer character. It provides a meeting-ground between manufacturer and engineer, for the discussion of equipment and engineering problems.

Lecture Room: A small hall seating about 150 is provided for exhibitors to give half-hour talks, with movies or slide films, on a scheduled basis. 36 such lectures are being planned at the Show.

Demonstration Room: Sound equipment not permitted on the general exhibits floor in operation, may be demonstrated in a sound-proof room, also on a scheduled basis. Both the Lecture and Demonstration Rooms are on the same floor as the Exhibits and are provided to give the exhibitors the best possible opportunity to

explain their equipment to visitors.

Military Exhibits: Four standard units, 320 square feet of space, in special booths "A" and "B" on floor plan, are provided to the government services for display of military radio devices.

Historical Tube Exhibit: In the entrance hall will be cases containing transmitter tubes from an early "Fleming Valve" down through the development of radio to the huge modern tubes of broadcasting today. This collection is not limited to the tubes of any one manufacturer and is being provided through the courtesy of an exhibitor in The Radio Engineering Show. . . . If the visitor wishes to rest during his tour of exhibits, he can go up into the balconies surrounding the entire hall and watch the Show and crowds and visit there with his friends. Or, he can go down to the Oak Room on the floor below the Exhibits for a snack to eat, or a full meal.

Registration: Admission both to Technical Sessions, and to the Radio Engineering Show is by registration pocket-pass. For the convenience of visitors, both member and non-member registration will be handled at the Armory as well as at the Hotel Commodore, so you can register wherever you first come. Registration is free to I.R.E. Members, and at a nominal fee to non-members. One single registration will serve for all four days if the visitor keeps and displays his pocket-pass. A speedy registration method has been adopted so that this will take only a few moments and the visitor will not be delayed. Exhibitors will receive special identification passes for their booth personnel. Tickets for the Banquet, Lunches and Cocktail Party will be available only at the Hotel Commodore headquarters.

Hospitality: The I.R.E. Hospitality Committee will have service desks at both the Armory and at the Hotel Commodore.

The coupon below may be used by those desiring detailed information on renting Exhibit space.

Mr. Wm. C. Copp, Exhibits Mgr. Room 707, 303 W. 42nd Street New York 18, N.Y.	1947 R.E.S.
Please send me Exhibit Rates and details on the 1947 Radio Engineering Show.	
Name:	
Firm:	
Address:	
Place:	
Products:	

MICRO-DIMENSIONAL

WIRE & RIBBON
for
VACUUM TUBE
FILAMENTS & GRIDS

- Many sizes and alloys for a range of applications such as miniature tubes, hearing aid tubes, low-current-drain battery tubes, receiving tubes . . .
- Melted and worked to assure maximum uniformity and strength. WIRES drawn to .0004" diameter; RIBBON rolled to .0001" thickness . . .
- Wollaston Process Wire drawn as small as .000010"; made to your specifications for diameter and resistance.
- SPECIAL ALLOYS made to meet individual requirements. Write for list of stock alloys.

SIGMUND COHN & CO.
44 GOLD ST. NEW YORK
SINCE  1901

Professional Cards

W. J. BROWN

Electronic & Radio Engineering Consultant
Electronic Industrial Applications, Commercial and Broadcasting Transmitter and Receiver Design, Test Equipment, etc.
23 years experience in electronic development
P.O. Box 5106, Cleveland, Ohio
Telephone, Superior 1241
Office, 912 Park Building

EDWARD J. CONTENT

Acoustical Consultant
and
Audio Systems Engineering, FM Standard Broadcast and Television Studio Design.
Roxbury Road Stamford 3-7459
Stamford, Conn.

R. A. DINZL

Electronic Consultant
Ultra High Frequency Transmitters and Receivers, Pulse Modulation, Broadcast Studio Circuits and Equipment Selection.
648 Nottingham Place
Westfield, N.J. Telephone 2-4539

STANLEY D. EILENBERGER

Consulting Engineer
INDUSTRIAL ELECTRONICS
Design—Development—Models
Complete Laboratory and Shop Facilities
6309-13—27th Ave.
Kenosha, Wis. Telephone 2-4213

F. T. Fisher's Sons Limited

Consulting Engineers
Broadcast Transmitters, Antenna Systems, Studio Equipment, Mobile and Fixed Communication Systems.
6202 Somerled Ave., Montreal 29, Quebec

DAVID C. KALBFELL, Ph.D.

Engineer — Physicist
Complete laboratory facilities
Industrial instrumentation and control
Broadcast engineering and measurements
941 Rosecrans St. Bayview 7303
San Diego 6, California

RICHARD C. KLEINBERGER

Licensed Professional Engineer
ELECTRONIC HEATING APPLICATIONS
20 Cushman Road,
White Plains, N.Y.

FRANK MASSA

Electro-Acoustic Consultant
DEVELOPMENT PRODUCTION DESIGN
PATENT ADVISOR
ELECTRO-ACOUSTIC & ELECTRO-MECHANICAL
VIBRATING SYSTEMS
SUPERSONIC GENERATORS & RECEIVERS
3393 Dellwood Rd., Cleveland Heights 18, Ohio

M. F. M. Osborne Associates

Consulting Physicists
Fluid Dynamics, Mechanics, Electronic Design, Electromagnetic and Acoustic Wave Propagation, Mathematical Analysis.
703 Albee Bldg., Washington 5, D.C.
ATLantic 9084

ALBERT PREISMAN

Consulting Engineer
Television, Pulse Techniques, Video Amplifiers, Phasing Networks, Industrial Applications
Affiliated with
MANAGEMENT TRAINING ASSOCIATES
3308-14th St., N.W. Washington 10, D.C.

HAROLD A. WHEELER

Consulting Radio Physicist
Radio - Frequency Measurements
Special Antenna Problems
Wideband Amplifiers and Filters
259-09 Northern Boulevard
Great Neck, New York Imperial 645

Paul D. Zottu

Consulting Engineer
Industrial Electronics
High Frequency Dielectric and Induction Heating Applications, Equipment Selection, Equipment and Component Design, Development, Models.
272 Centre St., Newton, Mass. 81G-9240

News—New Products

(Continued from page 64A)

tion to their TECHNICAL DATA BOOK.

Changes and/or additions have been issued for the following tubes; OB2, 1AB5, 1Z2, 6BD6, 6SB7Y, 12BD6, 12BF6.

Plant Expansion

... At Charlotte, N. C., Asheboro, N. C., and St. Albans, Vt., by National Carbon Company, Inc., New York, for "Eveready" batteries and flashlights and "Krene" plastic products.

... At Stamford, Conn., by Airadio Inc., for production of a new line of Class B type variable condenser, and expansion of manufacturing facilities for therapeutic, marine communication and aviation communication equipment.

... At Coshocton, Ohio, by General Electric Company, totaling 240,000 square feet, for the manufacture of laminated plastics.

DX Radio Moves to Larger Quarters

As of September 1, 1946 the general offices and all production facilities of the DX Radio Products Co., Inc., will be moved to 2310 W. Armitage Avenue, Chicago, Ill.

The new building was purchased more than six months ago and represents an increase of over 20,000 square feet. In addition to greatly expanded production facilities, the laboratory and product development departments will be enlarged.

Wire Stripper

A hand tool for stripping No. 22 to No. 10 solid or stranded wire without nicking or jamming wire strands according to the manufacturer has been recently placed on the market by Holob Industries, Inc., Sycamore, Ill.

Worthy of an Engineer's Careful Consideration

TYPE 102 - A LINE AMPLIFIER

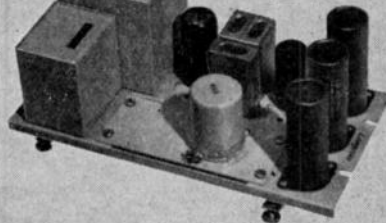

TYPE 102A Amplifier is one of the 102 Series Line Amplifiers of which four different types are available. The "A" is mostly used to drive the line after the master gain control. It is quiet; has excellent frequency characteristic and ample power output with low distortion products.

The Langevin Company

INCORPORATED
SOUND REINFORCEMENT AND REPRODUCTION ENGINEERING
NEW YORK 37 W. 65 St., 23
SAN FRANCISCO 1050 Howard St., 3
LOS ANGELES 1000 N. Seward St., 3B

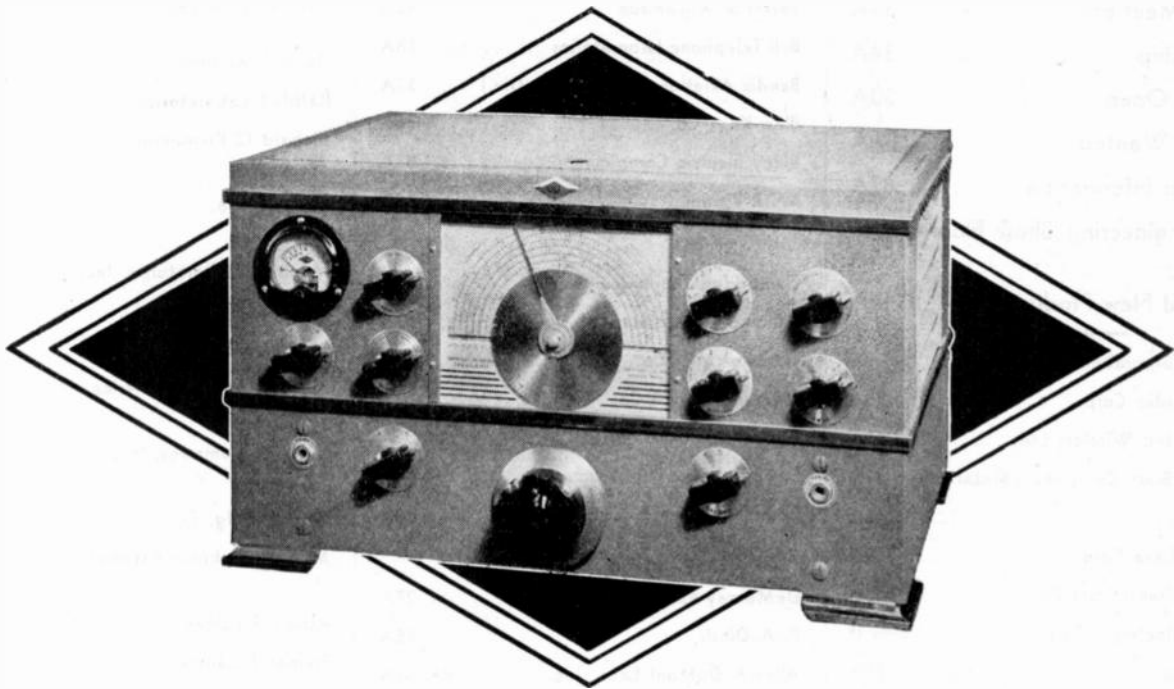

THE NC-2-40C RECEIVER

Back of the superb NC-2-40C receiver stand National's twenty-five years of experience in building to the highest quality. In the NC-2-40C as in other products, National has excellence for sale. Stability and sensitivity are outstanding. Controls are convenient to the hand and smooth in operation. All important auxiliary circuits — wide range crystal filter, noise limiter, S-meter, beat oscillator, AVC — are present in advanced design. You will find the operation of the NC-2-40C a gratifying pleasure and its ownership a source of pride. See it at your dealer's.

NATIONAL COMPANY, INC.



MALDEN, MASSACHUSETTS

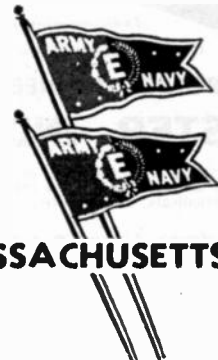

INDEX AND DISPLAY ADVERTISERS

Section Meetings	34A
Membership	34A
Positions Open	50A
Positions Wanted	56A
Exhibition Information	67A
Radio Engineering Show Floor Plan	66A
News and New Products	40A
<hr/>	
Aerovox Corporation	4A
Aircraft Radio Corp.	25A
Amalgamated Wireless Ltd.	46A
American Brass Company (Metal Hose Branch)	48A
American Lava Corp.	9A
American Transformer Co.	5A
Amperex Electronic Corp.	Cover II
Andrew Co.	38A
Arnold Engineering Co.	34A
Astatic Corp.	57A

Barker & Williamson	42A
Bell Telephone Laboratories	18A
Bendix Aviation Corp. (Radio Div.) ...	31A
Blaw-Knox Co.	36A
Bliley Electric Company	53A
W. J. Brown	68A
<hr/>	
Cambridge Thermionic Corp.	62A
Chicago Transformer	63A
Clarostat Mfg. Co.	60A
Sigmund Cohn & Co.	67A
Collins Radio Co.	55A
Edward J. Content	68A
Cornell-Dubilier Electric Corp.	Cover III
<hr/>	
DeMornay-Budd, Inc.	27A
R. A. Dinzl.	68A
Allen B. DuMont Labs., Inc.	6A, 61A
E. I. DuPont de Nemours & Co., Inc. ...	56A
<hr/>	
Stanley D. Eilenberger	68A
Eitel-McCullough, Inc.	72A
Electro Engineering Works	62A
Electro-Voice, Inc.	65A
Electronics Research Publishing Co. ...	70A
Erie Resistor Corp.	39A
<hr/>	
Federal Telephone & Radio Corp. ...	11A, 41A
Finch Telecommunications, Inc.	28A
F. T. Fisher's Sons	68A
<hr/>	
Gates Radio Co.	47A
General Electric Company	2A, 3A
General Radio Co.	Cover IV
G. M. Giannini & Co., Inc.	59A
Guardian Electric Mfg. Co.	37A
<hr/>	
Hallcrafters Company	26A
Harvey Radio Laboratories, Inc.	33A
Hewlett-Packard Company	19A
Hytron Radio & Electronics Corp.	1A
<hr/>	
Insulation Manufacturers Corp.	71A
International Resistance Company	51A
International Tel. & Tel. Corp.	11A, 41A

E. F. Johnson Co.	58A
David C. Kalbfell	68A
Kalbfell Laboratories	64A
Richard C. Kleinberger	68A
Langevin Co.	68A
<hr/>	
Machlett Laboratories, Inc.	13A, 50A
Frank Massa	68A
Measurements Corp.	56A
Mycalex Corp. of America	64A
National Company, Inc.	69A
Ohmite Mfg. Co.	30A
M. F. M. Osborne Associates	68A
<hr/>	
Albert Preisman	68A
Premax Products	40A
Press Wireless Mfg. Corp.	23A
Presto Recording Corp.	29A
<hr/>	
Radio Corporation of America 22A, 32A, 52A	
Rauland Corp.	49A
Raytheon Mfg. Co.	16A
Remler Co., Ltd.	60A
Revere Copper & Brass, Inc.	8A
<hr/>	
Selenium Corporation of America	45A
Sherron Electronics Co.	35A
Shure Brothers	44A
Sprague Electric Company	12A
Stackpole Carbon Co.	7A
Superior Electric Co.	24A
Sylvania Electric Products	20A
Syracuse University	50A
<hr/>	
Triplett Electrical Inst. Co.	14A
Tung-Sol Lamp Works, Inc.	15A
Turner Co.	54A
<hr/>	
United Transformer Company	17A
<hr/>	
Western Electric Company	10A
Westinghouse Electric Corp.	21A
Weston Electrical Inst. Corp.	43A
Harold A. Wheeler	68A
<hr/>	
Paul D. Zottu	68A

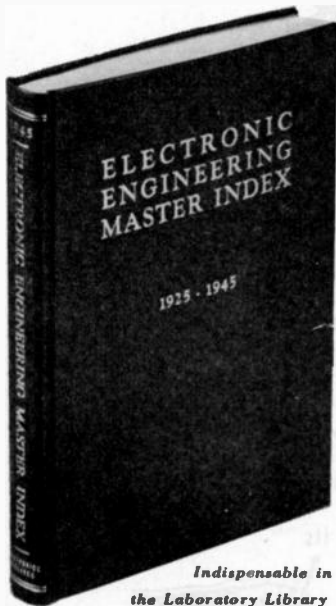

Indispensable in
the Laboratory Library

ELECTRONIC ENGINEERING MASTER INDEX

A subject index of 15,000 titles of electronic engineering articles from 1935 to 1945 selected from 65 periodicals. Authoritative, exhaustive, time-saving.

A \$500 Reference Library
in one volume, 230 pages.
Price. **\$17.50**

Descriptive circular on request

**ELECTRONICS RESEARCH
PUBLISHING COMPANY**
2 West 46 St., New York 19, N.Y.

A **BIGGER** HOME FOR THE **CLEVELAND** IMC ENGINEER . . .

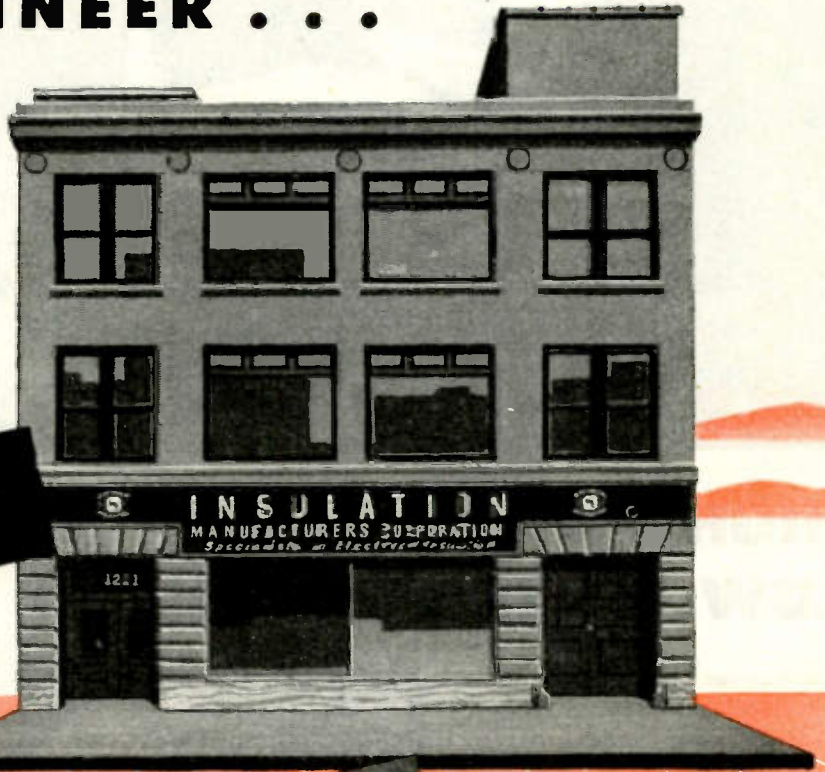

ON YOUR STAFF



BUT NOT ON YOUR PAYROLL

The increasing demands for IMC services and products have been calling for more space and greater facilities. Result... IMC has moved its Cleveland office into its own building at 1231 Superior Avenue. In so doing, extra space has been allowed for warehousing a complete stock of IMC electrical insulating materials to provide better service and faster deliveries.

Whether you're near Cleveland, or in another territory, the IMC engineer can help you. He's always ready to—

1. Assist you in the selection of the best insulating material for your job.
2. Familiarize you with its proper application.
3. Suggest ways to eliminate waste.
4. Help you increase your production.

Call on him whenever you need a specialist's help on your insulation problems.

INSULATION
MANUFACTURERS CORPORATION

*CHICAGO 6
565 W. Washington Blvd.

ELECTRICAL INSULATION

*CLEVELAND 4
1231 Superior Ave., N. E.

Also in Dayton, Detroit, Milwaukee, Minneapolis, and Peoria

IMC PRODUCTS: Vortex Varnished Cloth and Tapes—Varslot Combination Slot Insulation—Varnished Silk and Paper—Fiberglas Electrical Insulation—Manning Insulating Papers and Pressboards—Dow Corning Silicones—Pedigree Varnishes—Dieflex Varnished Tubings and Saturated Sleeveings—Wedgie Wood Wedges—National Hard Vulcanized Fibre and Fishpaper—Laminated Bakelite—Permacel Adhesive Tapes—Asbestos Woven Tapes and Sleeveings—Inmanco Corcoa Tapes, Webbing, and Sleeveings, and other insulating materials.



Eimac
TUBES

THE COUNTERSIGN OF
DEPENDABILITY IN ANY
ELECTRONIC EQUIPMENT

HIGH POWER LOW PLATE VOLTAGE

The famous Eimac 75T is now available in both high and low amplification factor types (75TH-75TL). These exceptionally flexible triodes provide a high power output at low plate voltage, and require a minimum of driving power. These Eimac 75T's are suitable for use as oscillators, amplifiers, or modulators. For example: a pair of 75TL's in a class-C amplifier can easily be operated at 500 watts input with only 1500 volts on the plate. The required grid driving power for the two tubes would be only 12 watts. In a class-B modulator, two 75TL's operated within 1500 plate volts will deliver 280 watts of audio power, sufficient to more than 100% modulate the above mentioned RF amplifier.

The Eimac 152T has twice the power handling capacity and twice the transconductance of the 75T, but less than twice the already low grid-plate capacity. At 1500 plate volts, 500 watts input can be run to a single 152TL, or a full kilowatt can be run to a pair of 152TL's in a class-C amplifier. For class-B audio, a pair of 152TL's will deliver 560 watts with 1500 plate volts. Eimac 152T's are also available in high and low amplification factor versions. Literature giving full technical information on these triodes available now. Write today, or contact your nearest Eimac representative.

Follow the leaders to

Eimac
REG. U. S. PAT. OFF.
TUBES

EITEL-McCULLOUGH, INC., 1245 J, San Mateo Ave., San Bruno, Calif.
Plant Located at San Bruno, California

Expert Agents: Frazar and Hansen, 301 Clay Street, San Francisco 11, California, U.S.A.

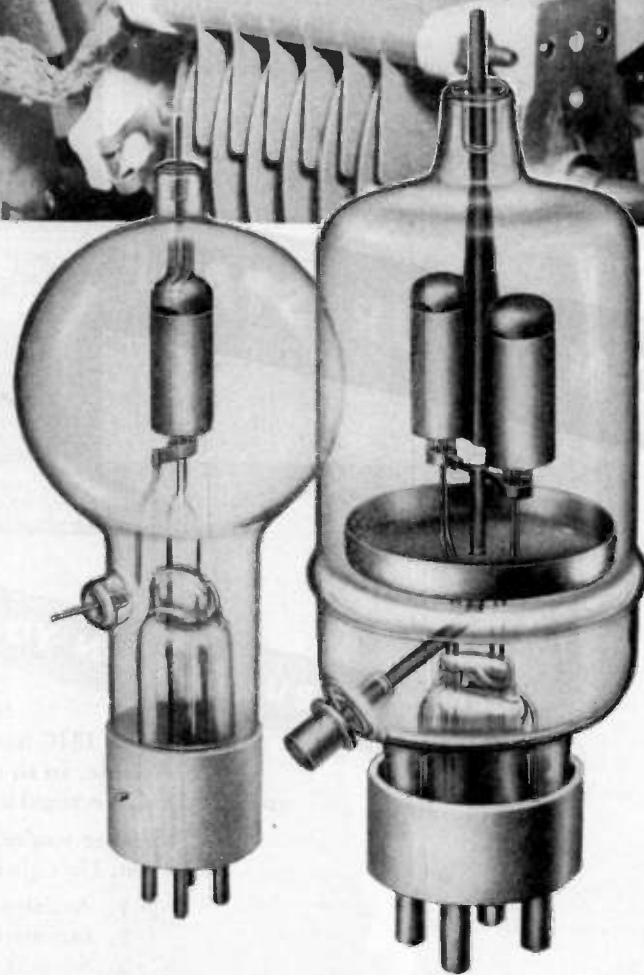

EIMAC 75T
POWER TRIODE

EIMAC 152T
POWER TRIODE

CALL IN AN EIMAC REPRESENTATIVE FOR INFORMATION

ROYAL J. HIGGINS (W9AIO), 600 S. Michigan Ave., Room 818, Chicago 5, Illinois. Phone: Harrison 5948.

VERNER O. JENSEN, Verner O. Jensen Company, 2616 Second Ave., Seattle 1, Washington. Phone: Elliott 6871

M. B. PATTERSON (W5CI) Patterson & Company, 1124 Irwin Keasler Bldg., Dallas 1, Texas. Phone: Central 5764.

ADOLPH SCHWARTZ (W2CN), 220 Broadway, Room 2210, New York 7, New York. Phone: Courtland 7-0011.

HERB. B. BECKER (W6QD), 1406 So. Grand Ave., Los Angeles 15, California. Phone: Richmond 6191.

TIM COAKLEY (W1KKP), 11 Beacon St., Boston 8, Massachusetts. Phone: Capital 0050.

RONALD C. BOWEN, 1886 So. Humboldt St., Denver 10, Colorado. Phone: Spruce 9468.

JAMES MILLAR ASSOCIATES, J. E. Joyner, Jr. (W4TO) 1000 Peachtree St., N. E., Atlanta, Georgia.

You're the fellow in the gold fish bowl ...



IF YOU'RE THE MAN who specifies components, you're in the public eye. Even the tiniest part you buy has "big things" to say in the quality of your product. You can't boast about cutting costs . . . if it means cutting quality. And still you've got to get the "most" for the "least."

That's why, when it comes to capacitors, you do better at Cornell-Dubilier. Others can offer capacitors that

look like C-D's. But no one else can offer the wealth of experience, the engineering flexibility, the tremendous production facilities that C-D can. These are things that can't be imitated or copied. These are things that don't show up on cost sheets at all, but add up big in product dependability. They are available to any manufacturer who brings his capacitor problems to Cornell-Dubilier.

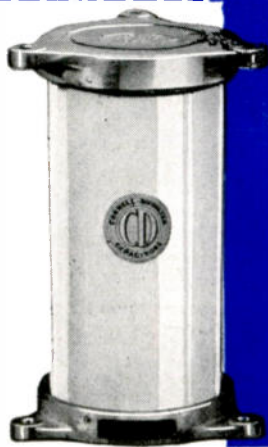

*Your inquiries are invited.
Cornell-Dubilier Electric
Corporation, South Plain-
field, New Jersey. Other
plants in New Bedford,
Providence, Worcester
and Brookline.*



CORNELL-DUBILIER

world's largest manufacturer of

CAPACITORS

MICA • DYKANOL • PAPER • ELECTROLYTICS

ANOTHER NEW VARIAC



FOR some time there has been a steady demand for an intermediate size VARIAC . . . something between the new Type V-5 (old Type 200-C) with a 5 ampere rated output, and the Type 100 with an 18 ampere rating. The new Type V-10 has been designed to supply this need. Its rated output is 10 amperes, with a maximum of 15. This maximum rating coincides with the capacity of outlets, plugs, cords and No. 14 circuits ordinarily found in the laboratory and in the home.

The electrical and mechanical features . . . many of them exclusively found in the VARIAC and practically all of them entirely new in the "V" types of VARIAC . . . are similar to those in the Type V-5, and include:

1. New Unit Brush—brush, holder, pressure spring and current lead in one unit, removable in a second without any tools—when brush wears away, holder cannot short-circuit winding
2. Improved terminal plate with molded barriers between terminals to prevent short-circuits from strands of wire—both screw- and solder-type terminals—wiring diagram on terminal plate shows normal voltage between turns
3. New strip-wound, silicon-steel core contributes to weight reduction of 25% below normal
4. Entirely new mechanical design of structural parts, mostly in aluminum
5. Double-pole, heavy-duty line switch breaks both sides of the line
6. New, large output-voltage dial with additional calibration points and larger figures
7. Polarized convenience outlet; useful if one side of output is grounded
8. A single screw, readily accessible under dial, loosens shaft for reversing dial and knob to change from table to panel mounting without affecting brush or stop settings.

The Type V-10 VARIAC will be in production soon; deliveries are scheduled to start in November. Prices of the six models of the Type V-10 range between \$27.50 and \$35.50.

Write for a copy of the new VARIAC BULLETIN. It describes the Type V-10 and all other VARIACS



GENERAL RADIO COMPANY Cambridge 39, Massachusetts

90 West St., New York 6

920 S. Michigan Ave., Chicago 5

95C W. Highland Ave. Los Angeles 38