

Proceedings



of the

I·R·E

A JOURNAL of the Theory, Practice, and Applications of Electronics and Electrical Communication

- Radio Communication • Sound Broadcasting • Television • Marine and Aerial Guidance •
- Tubes • Radio-Frequency Measurements • Engineering Education • Electron Optics •
- Sound and Picture Electrical Recording and Reproduction •
- Power and Manufacturing Applications of Radio-and-Electronic Technique •
- Industrial Electronic Control and Processes • Medical Electrical Research and Applications •

DECEMBER, 1945

Volume 33 Number 12, Pt. I

This Issue Published in Two Parts
Part I—Proceedings of the I.R.E.
Part II—Annual Index

Engineer's Place in Naval Research
Plastic Materials
Graphite-Anode Temperatures
Coil-Neutralized U-H-F Amplifier
Cathode-Follower Circuits
Television Line Structures
Loop-Antenna Transformer
Progressive Universal Winding
Cylindrical-Antenna Theory
Multipath F-M Distortion
Symmetrical Antenna Arrays
"T"- and "II"-Network Equivalents

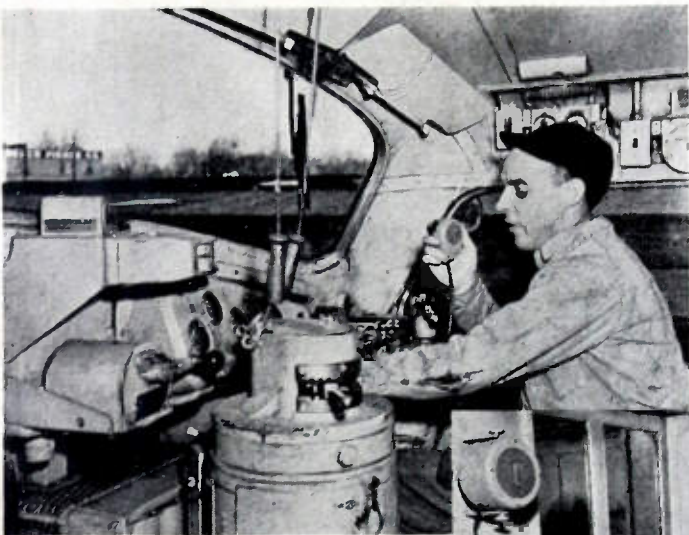

Motorola Radio

RADIO VOICE SPEEDS THE FREIGHT

Two-way frequency-modulation communication between engine cab and caboose clips hours from running time.

WINTER TECHNICAL MEETING, NEW YORK, N.Y.
January 23, 24, 25, and 26, 1946

The Institute of Radio Engineers



for every transformer application

FOR THE SET MANUFACTURER

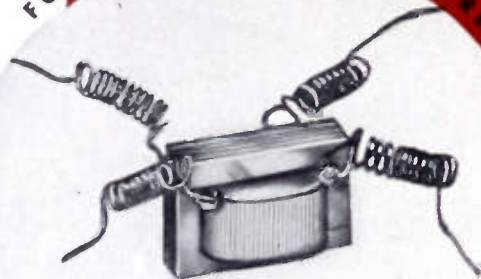

Miniature components to match the new "proximity fuse" miniature tubes. Output and Input transformers, and reactors with dimensions 9/16" x 3/4" x 5/8".

FOR THE RESEARCH LABORATORY



Typical of the special units produced by UTC is this high gain, 100 cycle, matching transformer. Primary impedance 500 ohms, secondary impedance 37,500,000 ohms, shielding suitable for -160 DB signal level.

FOR THE RADIO AMATEUR

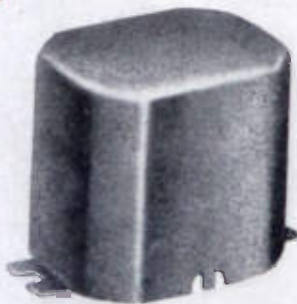

UTC Special Series components cover the entire range of amateur and low priced PA requirements . . . attractively cased . . . economically priced.

FOR THE BROADCAST STATION



UTC linear standard transformers are the ultimate in high fidelity design . . . frequency response guaranteed ± 1.5 DB 20 to 20,000 cycles . . . Low wave form distortion . . . Extremely low hum pickup.



United Transformer Corp.

150 VARICK STREET

NEW YORK 13, N. Y.

EXPORT DIVISION: 13 EAST 40th STREET, NEW YORK 16, N. Y.,

CABLES: "ARLAB"



We grew up with electronics

Our engineers and executives grew up with Electronics.

Before the war we manufactured commercial radio equipment. During the war we greatly expanded our engineering and research staff and did extensive work in advanced electronics for the Army and Navy. Our present engineering and research facilities occupy more than 30,000 square feet of space. Our current production program is centered on communications equipment for rail, air, highway, marine and commercial use. Other products, notably in the field of industrial electronics, are under development. Aireon's engineering and research staff will be glad to consult with you on your electronic problems. Your inquiry will have prompt attention.

Aireon

MANUFACTURING CORPORATION

Radio and Electronics • Engineered Power Controls

NEW YORK • GREENWICH • CHICAGO • KANSAS CITY • OKLAHOMA CITY • BURBANK • SAN FRANCISCO

Proceedings of the I.R.E. December, 1945

1A

PROCEEDINGS OF THE I.R.E., December, 1945, vol. 33, no. 12. Published monthly by The Institute of Radio Engineers, Inc., 330 West 42nd St., New York 18, N.Y. Price, \$1.00 per copy. Subscriptions: United States and Canada, \$10.00 a year; foreign countries, \$11.00 a year. Entered as second-class matter October 26, 1927 at the post office at Menasha, Wisconsin, under the act of February 28, 1925. Acceptance for mailing at a special rate of postage is provided for in the act of February 28, 1925, embodied in Paragraph 4, Section 412, P. L. and R., authorized October 26, 1927.

Measuring SOUND

Why Western Electric equipment leads the way!

1. Western Electric products are designed by Bell Telephone Laboratories — world's largest organization devoted exclusively to research and development in all phases of electrical communication.

2. Since 1869, Western Electric has been the leading maker of communications apparatus. During the war this company was the nation's largest producer of electronic and communications equipment.

3. The outstanding quality of Western Electric equipment has been proved daily on land, at sea, in the air, under every extreme of climate. No other company supplied so much equipment of so many different kinds for military communications.

In flight tests at Wright Aeronautical, a Western Electric sound analyzer is used to measure sound characteristics of the plane and locate major sound disturbances.

Western Electric

Today's world is a world of sound. How different it would be without the telephone, radio, public address systems, aids for the hard of hearing, talking pictures!

For many years, Bell Telephone Laboratories and Western Electric — working closely as research and manufacturing teammates — have led the way in building this world of sound.

In the course of their sound-transmission work, these teammates

Western Electric has specialized



AM • BROADCASTING • FM

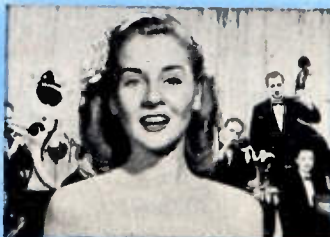

TELEVISION



AVIATION RADIO



MARINE RADIO

or spreading it around



A powerful Western Electric public address system spreads sound evenly throughout New York's huge Madison Square Garden which seats more than 18,000 people.

equipment leads the way!

have also developed scientifically accurate instruments for *measuring* and *analyzing* sound and vibration. These instruments have many important uses today — will have still more tomorrow.

Through their lifetime of pioneering in this field, Bell Labs and Western Electric have gained a unique knowledge of sound and how to handle it. Count on them for the finest equipment for measuring sound or spreading it around!



**Buy all the Victory Bonds you can
... and keep all you buy!**

knowledge in all of these fields



MOBILE RADIO



HEARING AIDS



SOUND MOTION PICTURES



VACUUM TUBES

I. R. E. Winter Technical Meeting and Radio Engineering Show

January 23 to 26, 1946

Hotel Astor, New York City

More than 3,000 members attended the last I. R. E. winter meeting—and with travel restrictions lifted, an even greater attendance is expected in 1946. Don't fail to make your reservations now for three days devoted to interesting and instructive technical papers—plus unusual features and entertainment.



TECHNICAL PAPERS

The lid has been lifted! Vital papers held back for security reasons will be among those presented in two and one-half days of technical sessions.

EXHIBITS

Two floors of the Hotel Astor will be given over to 150 exhibits revealing war-time advances and post-war equipment. War developments applicable to civilian equipment will be feature attractions.



BANQUET

The annual banquet, on January 24, is the social highlight of the I.R.E. year. 2,500 feasters will hear a nationally prominent speaker, see two major awards made, be entertained royally.

WOMEN'S PROGRAM



There'll be plenty to keep the better half busy—trips to points of interest, entertainment—and no men.

PRESIDENT'S LUNCHEON

The incoming president will be honored on January 25, at a get-together which has come to be a feature of these annual meetings.



DON'T DO THIS!



USE THIS →

The hotel situation in New York is still tight—and the parks are cold in January! Fill in the coupon to the right and mail it today.

The Institute of Radio Engineers
Advertising Department
303 West 42nd Street, Room 707
New York 18, N. Y.



Gentlemen:

Please send me an application form for reservations and a list of cooperating hotels.

Name _____

Address _____

Organization _____

The demand for hotel accommodations is so critical that reservations for the Winter Technical Meeting are being handled by the New York Convention and Visitors Bureau, a cooperative civic organization. Arrangements are being made to accommodate the membership in several New York hotels. Mail this coupon *immediately*.



WL-889R



WL-889



WL-473

OSCILLATING

WESTINGHOUSE

ELECTRONIC TUBES FOR ELECTRONIC HEATING

Westinghouse manufactures a complete line of electronic tubes that will meet your RF heating requirements. For descriptive data on any of the types shown,

call your local Westinghouse district office or write:
Electronic Tube Sales Department,
Westinghouse Electric Corporation,
Bloomfield, New Jersey



WL-892



WL-892R



WL-677



WL-678

CONTROLLING



WL-857B



WL-575A



WL-872A/872

RECTIFYING

Westinghouse

Electronic Tubes at Work

TUNE IN: John Charles Thomas
—Sunday, 2:30 P.M., EST—NBC
Ted Malone—Mon. through Fri.,
11:45 A.M., EST—ABC

Here's the easiest way to get 10 WATTS OUTPUT at 156 Mc!

Build your Xmtr around HK-24G Gammatrons

JAN 3C24

Designing transmitters for the 152 to 162 megacycle region can be greatly simplified through the use of HK-24Gs. In the circuit below one of these tubes produces 10 watts at 156 Mc; more than ample to excite a pair of HK-257Bs in a 400 watt final.

These efficient Gammatrons, with low inter-electrode capacities and short plate and grid leads, are the answer for those who are engineering 1.9-meter equipment for railroads, police point-to-point, fire, press or broadcast relays, maritime, geophysical, urban telephone, and experimental use. They are also ideally suited for amateur transmitters on the 144-148 megacycle band, authorized as of November 15.

Not only will HK-24Gs do the job, but they will do it at low cost. Made with tantalum elements, without internal insulators, they can withstand heavy overloads and have a long operating life. And they are offered at a new low price made possible by improved production methods.

HK-24Gs are available now in quantity . . . and are one of Heintz and Kaufman's *standardized* types. Maximum plate dissipation 25 watts. Write today for data.

HEINTZ AND KAUFMAN LTD.
SOUTH SAN FRANCISCO · CALIFORNIA

EXPORT AGENTS: M. SIMON & SON CO., INC., 25 WARREN STREET, NEW YORK CITY, N. Y.



Now
ONLY \$ **6⁰⁰**

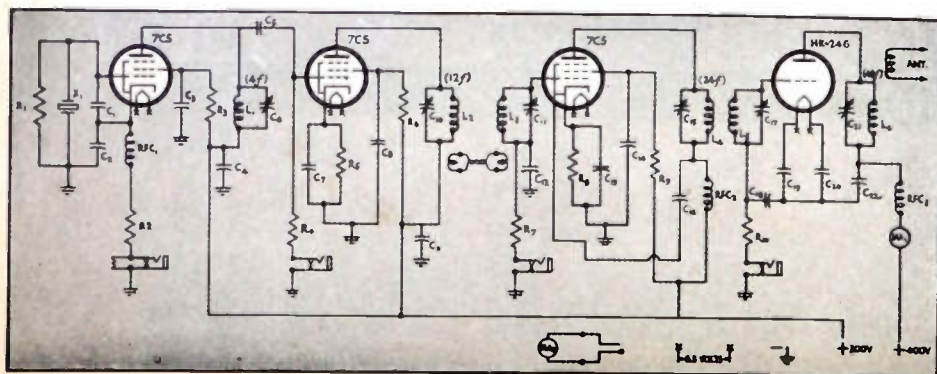

COMPONENT PARTS FOR WIRING DIAGRAM

- C1—35 mmfd.
 - C2—250 mmfd.
 - C3, C4, C7, C8, C9, C12, C13, C14—0.02 mfd.
 - C5—50 mmfd.
 - C6—APC 100
 - C10, C11, C15, C17—APC 25 mmfd.
 - C16, C18, C22—100 mmfd.
 - C19, C20—250 mmfd.
 - C21—15 mmfd.
 - R1—100,000 ohms, ½ watt
 - R2—200 ohms, 1 watt
 - R3—10,000 ohms, 1 watt
 - R4—250,000 ohms, ½ watt
 - R5, R8—500 ohms, ½ watt
 - R6, R9—20,000 ohms, 1 watt
 - R7—100,000 ohms, ½ watt
 - R10—15,000 ohms, 2 watts
 - RFC1—2.5 mh
 - RFC2
 - RFC3—Hf choke, approx. 50 turns No. 32 on ½" form.
 - MA1—0-100 ma.
 - MA2—0-25 ma.
 - X1—3.5 Mc. crystal
 - L1—19 turns No. 22 DCC ½" form
 - L2—7 turns No. 14 enamel, 3/16" dia. Length ½" air, link
 - L3—coupled to L2 with one turn.
 - L4—6 turns No. 14 enamel, dia. 3/16"; length 7/16" air, inductively coupled on same axis.
 - L5—5 turns coupled on same axis.
 - L6—4 turns No. 12 copper, dia. 3/16", length ½"
- Note: Grid and plate by-passes on driver and doubler final should be returned directly to tube cathode. All jacks are closed circuit jacks.

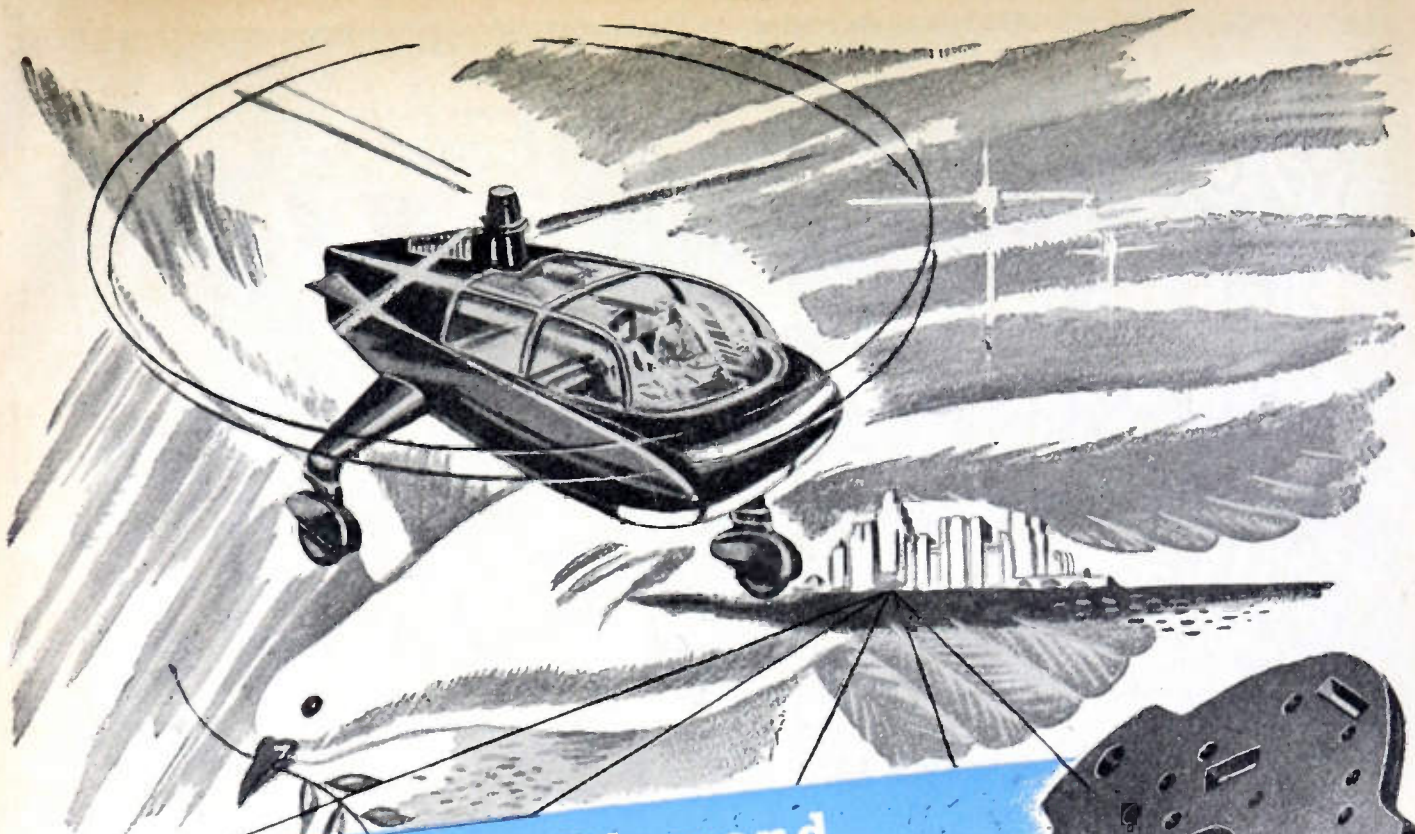

Continental-Diamond
Engineered Non-Metallic Materials

The DILECTO punched part illustrated is a stator for an aircraft booster switch. It must of course have high dielectric properties. It must also be strong enough to support current carrying parts, and not deteriorate from vibration and impact shock. Its dielectric properties must be stable regardless of temperature, humidity or dryness. Finally it had to be made from a material that could be accurately punched. DILECTO met all these requirements with a wide margin of safety.



There are many grades of DILECTO. Each developed to meet specific electrical, mechanical, chemical or thermal problems. Special grades can be developed to meet unusual problems. DILECTO is also available in combination with Diamond Fibre to still further enlarge its sphere of usefulness. This C-D NON-metallic may be the answer to your "What Material?" problem, in your present and future products, whether used in the air, on land or sea.

DISTRICT OFFICES
 NEW YORK 17 • CLEVELAND 14 • CHICAGO 11
 SPARTANBURG, S. C. • SALES OFFICES IN PRINCIPAL CITIES

WEST COAST REPRESENTATIVES
 MARWOOD LTD., SAN FRANCISCO 3

IN CANADA:
 DIAMOND STATE FIBRE CO. OF CANADA, LTD., TORONTO 8

C-D PRODUCTS

The Plastics
 DILECTO—A Laminated Phenolic.
 CELORON—A Molded Phenolic.
 DILECTENE—A Pure Resin Plastic Especially Suited to U-H-F Insulation.
 HAVEG—Plastic Chemical Equipment, Pipe, Valves and Fittings.

The NON-Metallics
 DIAMOND Vulcanized FIBRE
 VULCOID—Resin Impregnated Vulcanized Fibre.

MICABOND—Built-Up Mica Electrical Insulation.

Standard and Special Forms
 Available in Standard Sheets, Rods and Tubes; and Parts Fabricated, Formed or Molded to Specifications.

Descriptive Literature
 Bulletin GF gives Comprehensive Data on all C-D Products. Individual Catalogs are also Available.

Continental - Diamond FIBRE COMPANY
 Established 1895.. Manufacturers of Laminated Plastics since 1911—NEWARK 48 • DELAWARE



High power output, long life, feature these transmitting tube stalwarts!

- TYPE GL-892
Water-cooled . . . \$170
- TYPE GL-892-R
Forced-air-cooled . \$345

HERE is *proved* power, dependability, and long service life for the large AM transmitter owner or the manufacturer using electronic heating. General Electric Types GL-892 and GL-892-R have demonstrated their reliability in broadcasting and industrial sockets operating 2 1/2 hours a day, 7 days a week. With broad applications as high-power amplifiers, modulators, and oscillators, Types GL-892 and GL-892-R also are adaptable as to filament supply, their 2-unit filament permitting operation from 2-phase or single-phase a-c, as well as from d-c. For complete data to supplement the basic ratings at the right, see your nearest G-E Office or distributor, or write *Electronics Department, General Electric Company, Schenectady, N. Y.*



CHARACTERISTICS

Three-electrode high-vacuum power tubes for use as amplifiers and modulators in broadcasting and communications equipment—also oscillators in industrial electronic heating. Besides Types GL-892

and GL-892-R shown above, Types GL-891 and GL-891-R also are available at the same prices, and are similar in design characteristics except for the amplification factor, as given below.

Rating	GL-892	GL-892-R	GL-891	GL-891-R
Filament voltage	11 v	11v	11v	11 v
Filament current	60 amp	60 amp	60 amp	60 amp
Max plate voltage	15,000 v	12,500 v	12,000 v	10,000 v
Max plate current	2 amp	2 amp	2 amp	2 amp
Max plate input	30 kw	18 kw	18 kw	15 kw
Max plate dissipation	10 kw	4 kw	6 kw	4 kw
Amplification factor	50	50	8	8

Notes: (1) Filament voltage and current given above, are per unit of 2-unit filament. (2) Maximum frequency for all four tube types is 1.6 megacycles at max plate input; up to 20 megacycles at reduced ratings.

Come to GENERAL ELECTRIC with any special tube problems. A staff of experienced G-E tube engineers will work with you closely to meet your application or replacement needs.

TRANSMITTING, RECEIVING, INDUSTRIAL,
SPECIAL PURPOSE TUBES • VACUUM
SWITCHES AND CAPACITORS

GENERAL  ELECTRIC

Proceedings of the I.R.E.

101-D12-0850
December, 1945

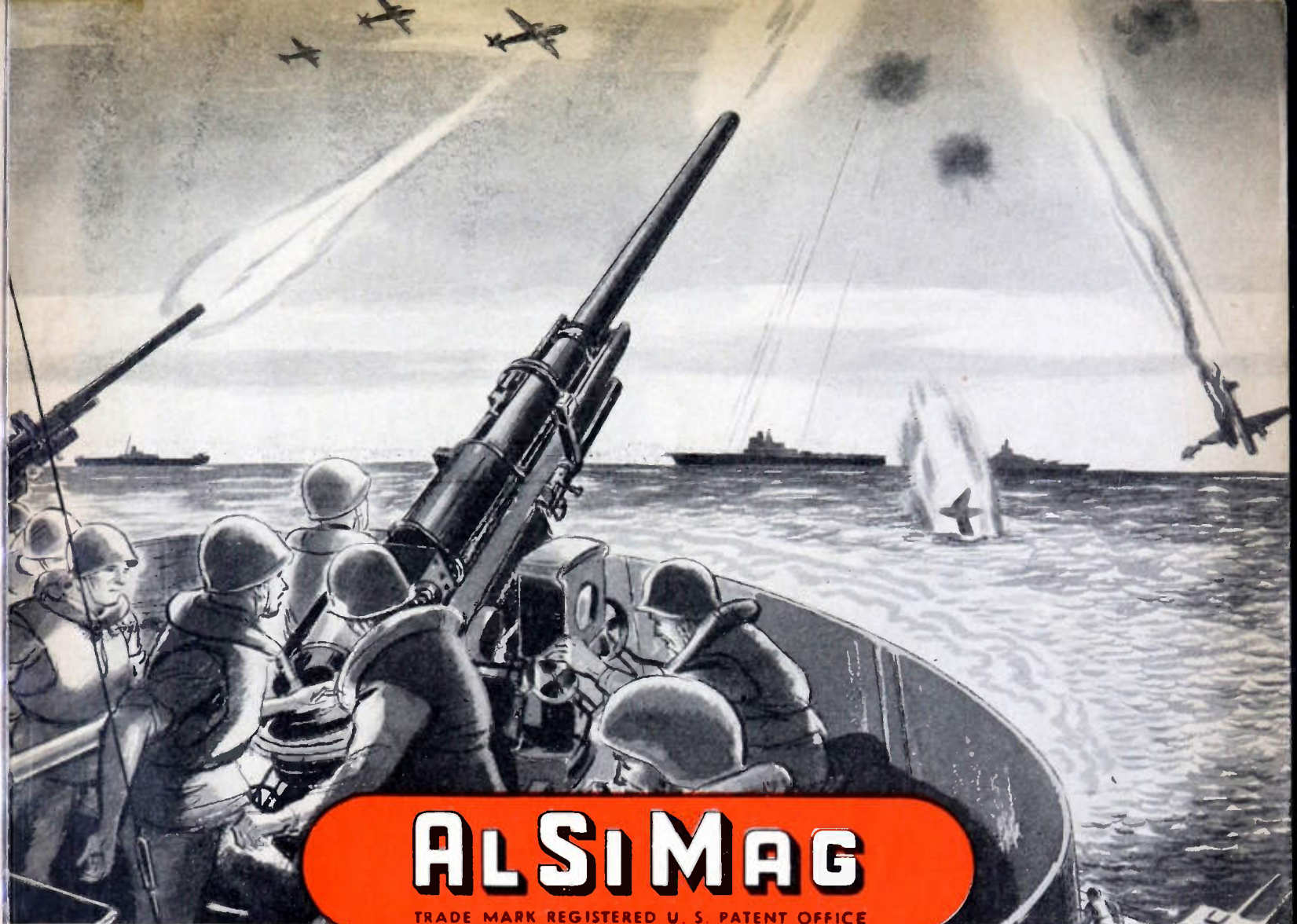

ALSiMAG

TRADE MARK REGISTERED U. S. PATENT OFFICE

CERAMICS
SO RUGGED THEY COULD WITHSTAND THE SHOCK
OF BEING FIRED FROM A GUN
WITH A FORCE OF
20,000g
in the
'RADIO PROXIMITY FUSE'
War's Number 2 Scientific Development

ALSiMAG Ceramic Insulators were extensively used in condensers for the 'Radio Proximity Fuse' described by high Navy officials as second only to the atomic bomb among the greatest scientific developments of the war.

Development of the fuse required production of electronic parts so rugged they could withstand the shock of being fired from a gun with a force 20,000 times that of gravity. The components had to be so small that a

complete unit could be installed in the nose of a projectile.

The fuse, developed at a cost of \$800,000,000 is an extremely rugged, five tube radio sending and receiving station which fits into the nose of a projectile. Reflected impulses explode the projectile when it passes within 70 feet of enemy planes.

The 'Radio Proximity Fuse' was the effective answer to Japanese suicide plane attacks,

as well as buzz bomb attacks on London.

American Lava Corporation is justly proud of the fact that it was able to provide the Ceramic Insulators capable of withstanding the tremendous shock of being fired from a gun in the 'Radio Proximity Fuse.'

Whatever you are planning in the field of electronics, we believe our specialized knowledge, research and production facilities will prove helpful. Let's work together.

AMERICAN LAVA CORPORATION
CHATTANOOGA 5, TENNESSEE

43RD YEAR OF CERAMIC LEADERSHIP



ALCO has been awarded for the fifth time the Army-Navy "E" Award for continued excellence in quantity and quality of essential war production.



more efficient
...in miniature



ACTUAL SIZE

The cast iron pump was modern two or three generations ago. It was a big improvement over the old oaken bucket. But today we use a comparatively small faucet that supplies water at a twist of the wrist. It is another milestone on the road to greater efficiency in miniature.

This same tendency is evident in the development of the Electronic Tube. The Tung-Sol Miniature is the result of the trend to smaller component parts. It is used to great advantage in reducing the over-all size of equipment. But more important, Tung-Sol Miniatures do a more efficient job than the old style tube; especially in high frequency circuits. They have a low capacity and high mutual conductance. Shorter leads give them low inductance. Smaller elements weigh

less, making Miniatures more rigid. This helps to eliminate distortion from vibration.

When planning new electronic devices or when improving old ones, discuss circuits and tube selection with Tung-Sol engineers. Their services are at your disposal. Such conferences are held in strictest confidence.

TUNG-SOL

vibration-tested

ELECTRONIC TUBES



TUNG-SOL LAMP WORKS INC., NEWARK 4, NEW JERSEY
Also Manufacturers of Miniature Incandescent Lamps, All-Glass Sealed Beam Headlight Lamps and Current Intermittors

*BLOW, BUGLES OF BATTLE, YOUR MARCHES OF PEACE;
EAST, WEST, NORTH AND SOUTH, LET THE LONG QUARREL CEASE.
SING THE SONG OF GREAT JOY THAT THE ANGELS BEGAN,
SONG OF GLORY TO GOD, AND GOOD WILL TO MAN..*

W H I T T E R

As the tumult and the shouting die . . . and the Yuletide bells ring out their old,
old story of peace on earth . . . it is good to make merry and wish our fellowmen
all over the world . . . Merry Christmas and a Grand New Year . . .

GENERAL INSTRUMENT CORPORATION
8 2 9 N E W A R K A V E N U E • E L I Z A B E T H 3 , N . J .

VARIABLE CONDENSERS • TUNING MECHANISMS • RECORD CHANGERS • SPEAKERS • OTHER RADIO COMPONENTS

new

VARIABLE-UNIT CAPACITOR TECHNIQUE

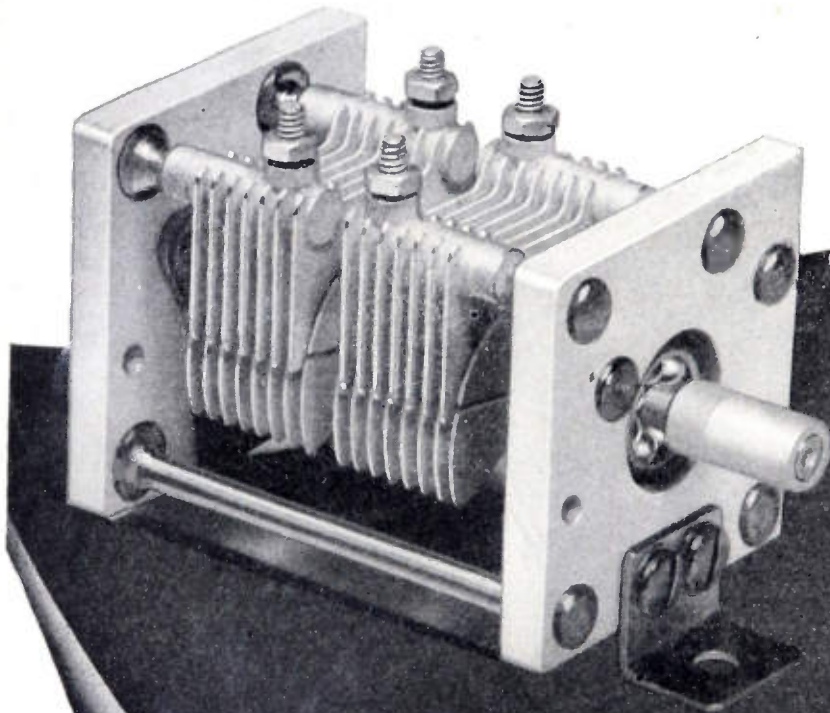

Send card for mechanical and electrical specifications.

Here's the answer to your UHF design problems. Noiseless operation — no rotor contacts — symmetrical layout. The new "VU" type variable capacitors can be used in conventional tuned circuits at frequencies as high as 500 megacycles. Write for folder with full technical data.



HAMMARLUND

THE HAMMARLUND MFG. CO., INC., 460 W. 34TH ST., NEW YORK 1, N. Y.
MANUFACTURERS OF PRECISION COMMUNICATIONS EQUIPMENT

**BUT THEY SAY CORNING SUPPLIES
4 ENGINEERS WITH EVERY ORDER!**

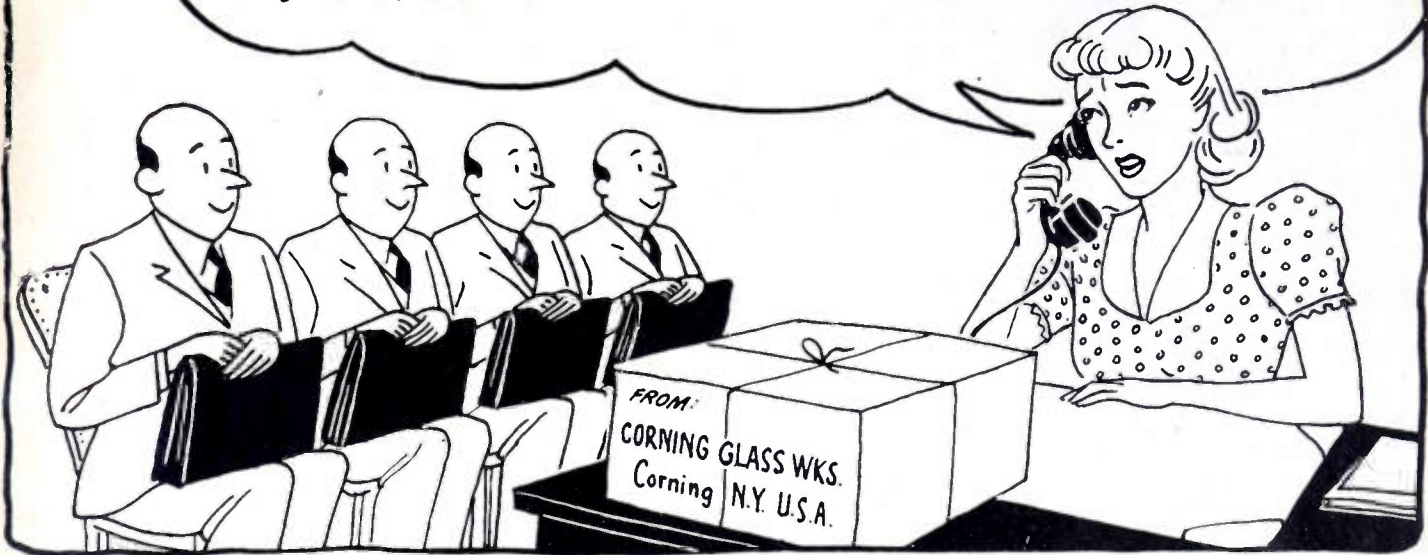

**HOW 4 SPECIAL CORNING SERVICES
CAN SAVE YOU LOTS OF GRIEF!**

IT'S quite a job getting a new electronic product into production. Materials, methods and prices buzz around your head like a bunch of bees. But you don't have to solve your problems all alone. For Corning has four special engineering services to help you:

1. Sales Engineers—To keep you in touch with latest developments and explain your problems to Corning's technical experts for prompt solution.
2. Product Engineers—Technical men who translate Corning Research in Glass into practical applications which may solve your particular headaches.
3. Plant Engineers—These men are anxious to see you get the best possible price on your order. They often point out changes in design which reduce costs.

4. Technical Service Engineers — These men get you started right. They help your people lick the production bugs.

Of course, Corning Electronic Glassware also means thousands of glass formulae so you can get the right one for your job. It means Corning's unique metallizing process forming a permanent bond between glass and metal. Tubes, bushings, headers, etc., can be soldered in place to form permanent hermetic seals. It means an entire plant at Bradford, Pa., devoted exclusively to the manufacture of electronic specialties quickly, in large quantities. To get the fastest service in solving your pet problem, write, wire or phone Electronic Sales Department, P-12, Technical Products Division, Corning Glass Works, Corning, New York.

Note—The metallized Tubes and Bushings, Headers and Coil Forms below are all made by the famous Corning Metallizing Process. Can be soldered into place to form true and permanent hermetic seals. Impervious to dust, moisture and corrosion.



Metallized Tubes for resistors, capacitors, etc. 20 standard sizes $\frac{1}{8}$ " x 2" to $1\frac{1}{4}$ " x 10". Mass-produced for immediate shipment.



Metallized Bushings. Tubes in 10 standard sizes, $\frac{3}{16}$ " x $\frac{3}{16}$ " to 1" x $4\frac{1}{2}$ " in mass production for immediate shipment.



Headers—The best way to get a large number of leads in a small space for assembly in one operation.

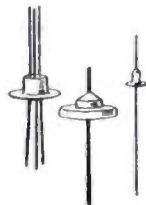

Eyelet Terminals—Single or multiple eyelets permit design flexibility. Standard items readily available in quantity.



Coil Forms—Grooved for ordinary frequencies—metallized for high frequencies. In various designs and mountings.



VYCOR Brand cylinders—very low loss characteristics. Stands thermal shock up to 900°C. Can be metallized.

CORNING
means
Research in Glass

Electronic Glassware



"PYREX", "VYCOR" and "CORNING" are registered trade-marks and indicate manufacture by Corning Glass Works, Corning, N. Y.

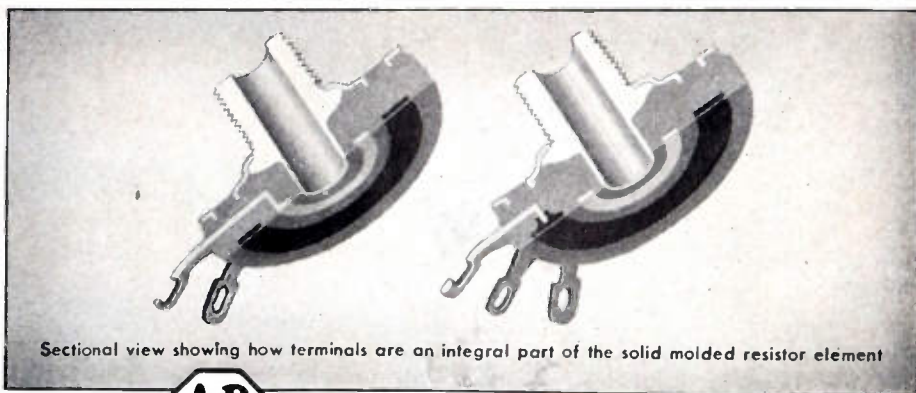
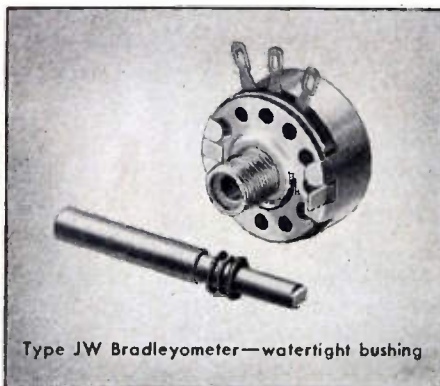
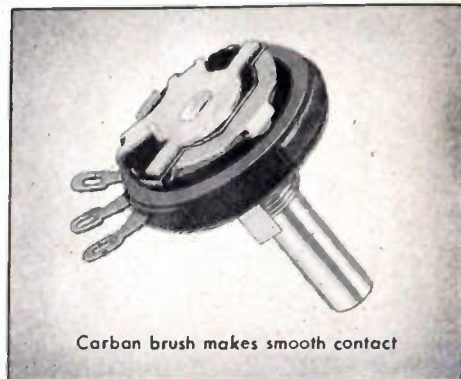
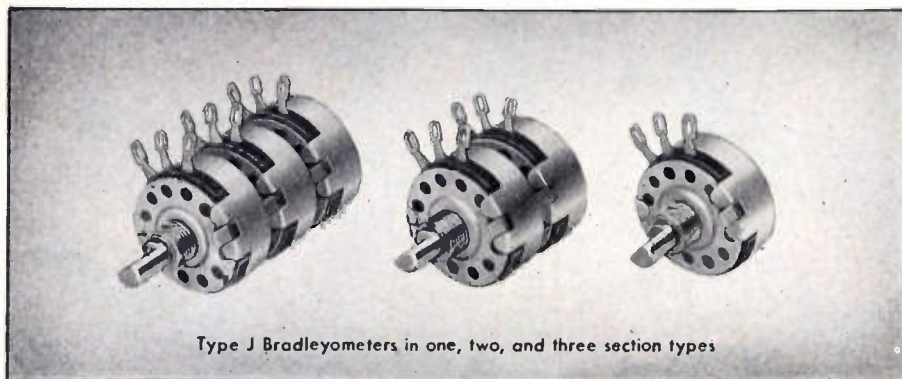
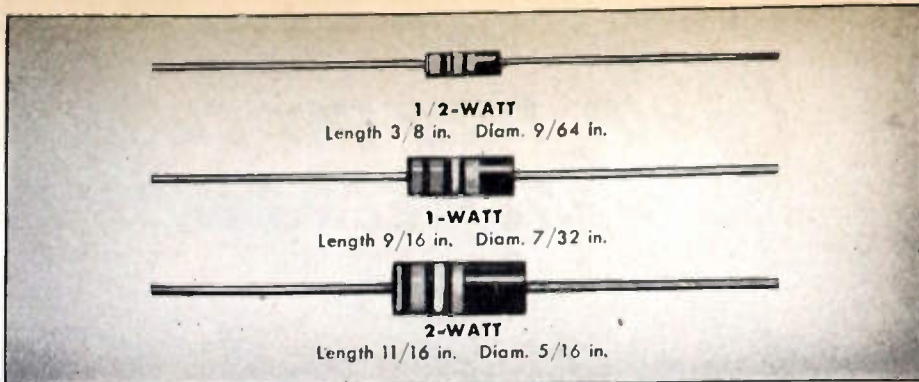
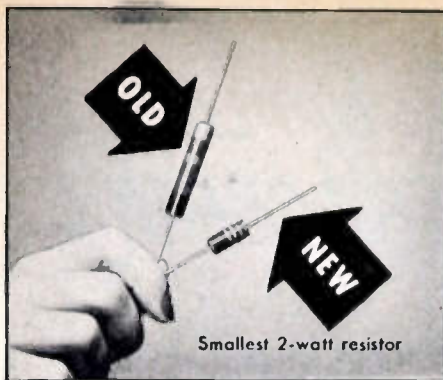



ALLEN-BRADLEY
FIXED & ADJUSTABLE RADIO RESISTORS
 QUALITY

FIXED INSULATED RESISTORS—Bradleyunits are available in 1/2-watt, 1-watt, and 2-watt ratings. They will sustain an overload of ten times rating for several minutes without failing. Wax impregnation is not necessary to pass salt water immersion test. The 1/2-watt and 1-watt units are available in all RMA standard values from 10 ohms to 10 megohms. Two-watt units available from 10 ohms to 1 megohm.

ADJUSTABLE RESISTORS—Type J Bradleyometers are the only continuously adjustable composition resistors having a 2-watt rating with good safety factor. Resistor element is solid molded and has substantial thickness. Not a film, paint, or spray type. Molded as single unit complete with insulation, terminals, face plate, and bushing. No rivets or soldered connections. Any resistance-rotation curve can be provided.

Allen-Bradley Company, 114 W. Greenfield Ave., Milwaukee 4, Wis.

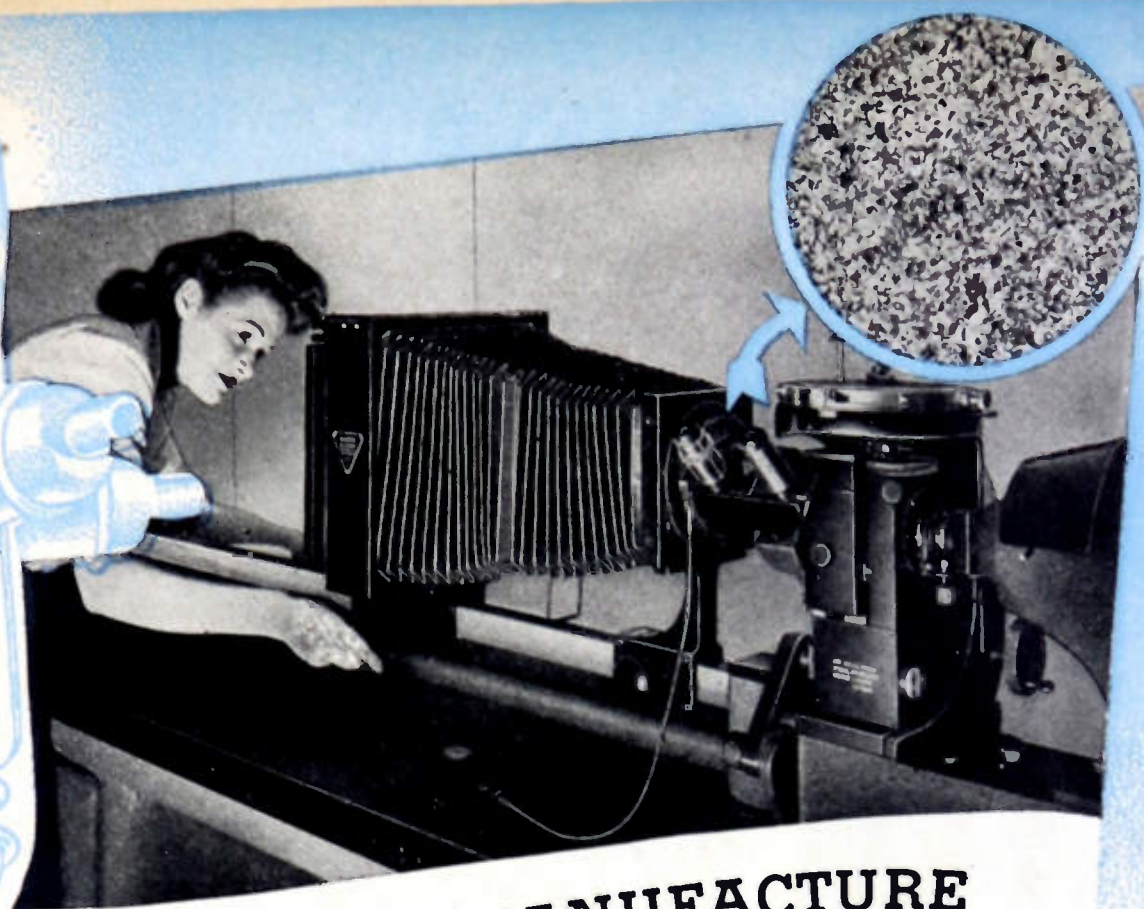
WHEN DEPENDABILITY AND PERFORMANCE ARE "MUSTS"... THE EXPERTS SPECIFY ALLEN-BRADLEY



IN TUBE MANUFACTURE ALL SMALL DETAILS ARE **LARGE**

TO *Federal*

From slender filament to anode block . . . *all* tube construction details, however small, are important to Federal. That is why this experienced and longtime manufacturer uses the illustrated high-magnification metallograph as part of its test equipment for checking raw material quality.

An example is the micro-photo inset. Here is shown oxide-free, high conductivity copper used for copper-to-glass seals . . . after the material has been reduced to a fine grain, non-porous structure through Federal's special metal-processing methods.

But whether copper, molybdenum or tungsten . . . they all are subjected to the same exclusive treatment and put through the same searching scrutiny . . . assurance that only the finest materials go to make up Federal tubes.

This exacting test is another good reason why Federal tubes are better tubes. Transmitting, rectifier, industrial power . . . they have a reputation that is deserved because they are *built to stay*.

Federal always *has* made better tubes.



Federal Telephone and Radio Corporation



Newark 1, N. J.



Target practice with Relays and Keys

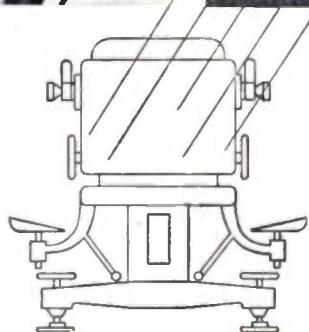
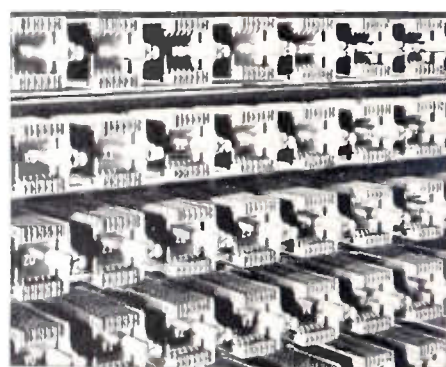

(Left to right) The operator punches the problem data on tape, which is fed into the computer. The solution emerges in the teletype receiver. Relays which figure out the problem look like your dial telephone system.

In designing the gun-control systems which shot down enemy planes, Army ballistic experts were faced by long hours of mathematical calculations.

So Bell Laboratories developed an electrical relay computer. It solved complicated problems more accurately and swiftly than 40 calculators working in shifts around the clock.

Resembling your dial telephone system, which seeks out and calls a telephone number, this brain-like machine selects and energizes electric circuits to

correspond with the numbers fed in. Then it juggles the circuits through scores of combinations corresponding to the successive stages of long calculations. It will even solve triangles and consult mathematical tables. The operator hands it a series of problems with the tips of her fingers—next morning the correct answers are neatly typed. Ballistic experts used this calculator to compute the performance of experimental gun directors and thus to evaluate new designs.

In battle action, Electrical Gun Directors are, of course, instantaneous. Such a director helped to make the port of Antwerp available to our advancing troops by directing the guns which shot down more than 90% of the thousands of buzz bombs.

Every day, your Bell System telephone calls are speeded by calculators which use electric currents to do sums. Even now, lessons learned from the relay computer are being applied to the extension of dialing over toll lines.



BELL TELEPHONE LABORATORIES

EXPLORING AND INVENTING, DEVISING AND PERFECTING FOR CONTINUED IMPROVEMENTS AND ECONOMIES IN TELEPHONE SERVICE

THE AMPEREXTRA FACTOR in SOUND TRANSMISSION

The Amperextra Factors of dependability and longevity represent important operational and replacement savings in the sound transmission field. Even in wartime, orders from essential civilian users were filled with fairly consistent regularity. Now, with nothing ahead but peace, the Amperextra Factor of service takes on an entirely new meaning for broadcasting stations, amateur radio operators and communications organizations. Your inquiries are invited.

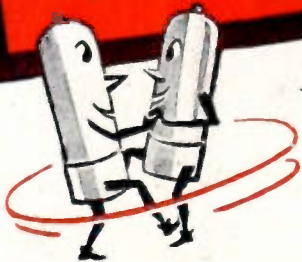

WHAT ONE USER SAYS...

... "the ease with which they can be driven to full output, the simplification of cooling arrangements, the relative immunity to heavy overloads, and the moderate plate voltages required result in a combination not easily surpassed."



AMPEREX INTERCHANGEABILITY

Amperex tubes will fit into all types of transmitters for which they are intended, and may be interchanged or used to replace tubes of other manufacture without need for circuit readjustment and without impairment of transmitter performance.

SPECIALLY PROCESSED GRAPHITE ANODES...

... in many of our exclusive designs make for more uniform temperature distribution, absence of change in characteristics with time, and a higher initial vacuum which keeps tubes harder and assures longer life.

AMPEREX

...THE HIGH PERFORMANCE TUBE

Many standard types of Amperex tubes are now available through leading radio equipment distributors. The Amperex Special Application Engineering Department will gladly work with you on the solution to your pressing problems.



Amperex Type 2B-120 Transmitting Tube. Filament voltage, 10-10.5 volts AC or DC. Filament current, 2 amperes. Amplification factor, 90. Grid-to-Plate Transconductance at 120 ma., 5000 micromhos. Direct Inter-electrode Capacitances: grid-to-plate, 5.2 μf ; grid-to-filament, 5.3 μf ; plate-to-filament, 3.2 μf .



Amperex Type 11F-3000 Transmitting tube. Filament voltage, 21 to 22. Filament current, 40.5 amperes. Filament emission, 6 amperes. Amplification factor, 16. Grid-to-Plate Transconductance of plate current of 1 ampere, 6500 micromhos. Direct Inter-electrode Capacitances: grid-to-plate, 10 μf ; grid-to-filament, 13 μf ; plate-to-filament, 4 μf .



Amperex Type 891-R Transmitting Tube. Filament, two-unit type for single-phase or two-phase AC or DC operation—voltage per unit, 11; current per unit, 60 amperes; amplification factor, 8. Grid-to-Plate Transconductance at a plate current of 0.75 ampere, 4000 micromhos. Direct Inter-electrode Capacitances: grid-to-plate, 30 μf ; grid-to-filament, 16 μf ; plate-to-filament, 3 μf .



AMPEREX ELECTRONIC CORPORATION

25 Washington St., Brooklyn 1, N.Y., Export Division: 13 E. 40th St., New York 16, N.Y., Cables: "Arlab"
Canadian Distributor: Rogers Majestic Ltd. • 622 Fleet Street West, Toronto

341 OF THE 9,675 CAPACITOR AND RESISTOR TYPES

engineered by SPRAGUE and produced in 1944



A good measure of any supplier is his ability to meet BOTH standard and highly specialized requirements. The Sprague war-time record offers convincing evidence in both respects.

CAPACITORS • *KOOLOHM RESISTORS • *CEROC 200 INSULATION



SPRAGUE

**SPRAGUE
ELECTRIC COMPANY
NORTH ADAMS, MASS.**

*Trademarks Registered U. S. Patent Office

PIONEERS OF ELECTRIC & ELECTRONIC PROGRESS

Compare the actual battery drain!*

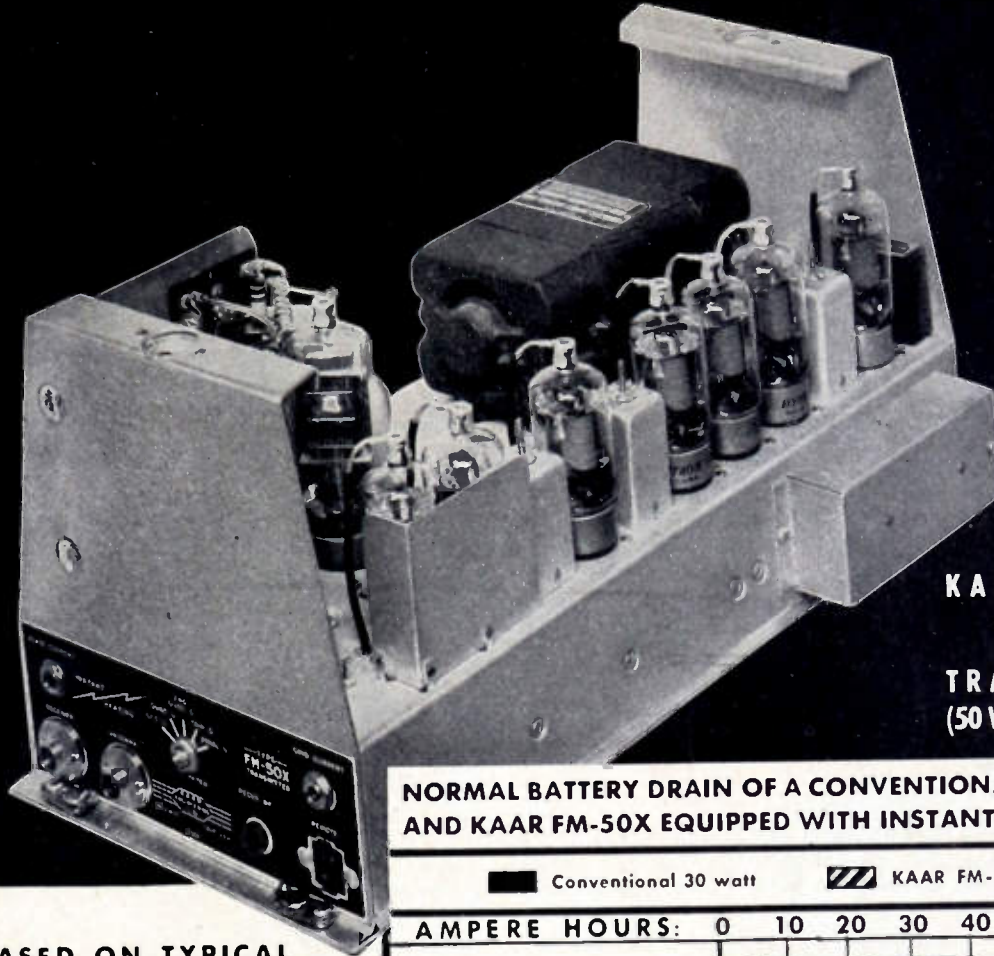

KAAR FM-50X
Mobile
TRANSMITTER
(50 WATTS OUTPUT)

NORMAL BATTERY DRAIN OF A CONVENTIONAL TRANSMITTER AND KAAR FM-50X EQUIPPED WITH INSTANT-HEATING TUBES

	0	10	20	30	40	50	60	70
STANDBY DRAIN 24 HOUR PERIOD	55.2 AMPERE HOURS		0.0 AMP. HRS.—YET READY TO TALK INSTANTLY!					
AVERAGE TOTAL BATTERY DRAIN 24 HOUR PERIOD	56.8 AMPERE HOURS		2.2 AMPERE HOURS					

* CHART BASED ON TYPICAL METROPOLITAN POLICE USE (140 Radiotelephone-equipped cars operating three shifts in city of 600,000 population.)

MESSAGES ORIGINATED BY CARS	904
MESSAGES ACKNOWLEDGED BY CARS	932
TOTAL TRANSMISSIONS PER CAR	13
AVE. LENGTH OF TRANSMISSION	15 sec.
AVE. TRANSMITTING TIME 24 HOURS	3 min. 15 sec.

KAAR mobile FM-50X transmitter gives you 20 watts more output with only 1/25th usual battery drain!

KAAR engineers—who pioneered the instant-heating AM radiotelephone—have now, through the use of instant-heating tubes, made 50 and 100 watt mobile FM transmitters practical! Thus you gain greater power and range—along with a tremendous reduction in battery drain!

With instant-heating KAAR equipment standby-current is zero—yet the moment you press the button microphone you are on the air. Contrast this with conventional emergency transmitters, over 90% of which operate with the filaments "hot" during stand-by. Since sturdy instant-heating tubes eliminate this great waste of energy without slowing the handling of messages,

Proceedings of the I.R.E. December, 1945

KAAR 50 and 100 watt transmitters can be operated from the standard ignition battery!

100 WATT MOBILE FM!

The KAAR FM-100X is identical to the FM-50X, except for the final amplifier. It puts 100 watts into a standard 34 ohm non-inductive load and is ideal for county and state police use. It requires no special batteries, wiring, or generator changes.

ADDITIONAL FEATURES

A new system of modulating the phase modulator tubes in KAAR FM transmitters provides excellent voice quality. Note that the equipment is highly accessible, and only two types of tubes are used. Frequency range: 30 to 44 megacycles.

Write today for free bulletin describing KAAR FM transmitters in detail. It's ready now!

KAAR ENGINEERING CO.

PALO ALTO

CALIFORNIA

Export Agents: FRAZAR AND HANSEN • 301 Clay St • San Francisco, Calif.

NEW RAYTHEON SUB-MINIATURE TUBES for Pocket Receivers

Since 1938 Raytheon has pioneered in the design, development and production of small, low drain, long life tubes. These have helped to make possible the modern extremely compact hearing aid.

Now for Radio Receivers—Now Raytheon announces a physically similar kit of flat style, sub-miniature tubes for radio receiver applications. Included is a shielded RF-pentode amplifier, a triode-heptode converter, a diode-pentode detector-amplifier and an output pentode for earphone operation.

Much Smaller Radios Possible—These tubes make it possible to construct radios a fraction the size of prewar "personals," with sensitivity rivaling much larger sets.

The ratio of performance to battery drain is maintained very high, thus assuring the maximum possible operating life from the small size batteries now available.

The line consists of tubes approximately 1 $\frac{1}{16}$ " long x 0.3" x 0.4" in cross section. Each type is available with pins for use with small commercially available sockets as illustrated, or may be had with long flexible leads for wiring the tube directly into the circuit.

No progressive radio manufacturer will overlook the tremendous possibilities inherent in the small pocket receiver—built around the new Raytheon sub-miniature tubes. But call on Raytheon for every tube need—large or small—for the finest in engineering, production and performance.

ELECTRICAL CHARACTERISTICS

	2E31† 2E32‡ Shielded RF Pentode	2G21† 2G22‡ Triode- Heptode	2E41† 2E42‡ Diode- Pentode	2E35† 2E36‡ Output Pentode
Filament Voltage	1.25 V	1.25 V	1.25 V	1.25 V
Filament Current	50 ma	50 ma	30 ma	30 ma
Max. Grid-Plate Capacitance	0.018 μ f	0.065 μ f†	0.10 μ f	0.2 μ f
Plate Voltage**	22.5 V	22.5 V	22.5 V	22.5 V
Screen Voltage	22.5 V	22.5 V	22.5 V	22.5 V
Control Grid Voltage*	0	0	0	0
Osc. Plate Voltage	—	22.5 V	—	—
Plate Current	0.35 ma	0.2 ma	0.4 ma	0.27 ma
Screen Current	0.3 ma	0.3 ma	0.15 ma	0.07 ma
Osc. Plate Current	—	1.0 ma	—	—
Transconductance	500 μ mas	60 μ mas (Gc)	400 μ mas	385 μ mas
Plate Resistance	0.35 meg	0.5 meg‡‡	0.25 meg	0.22 meg

*With 5 megohm grid resistance connected to F—.
**Higher voltage operation is possible as shown on engineering characteristics sheet available by request.

†Flexible Lead Types.
‡Plug-in Types.
‡‡Approximate conversion Rp.
‡Signal grid to mixer plate Capacitance

RAYTHEON
MANUFACTURING COMPANY

Radio Receiving Tube Division
NEWTON, MASSACHUSETTS • LOS ANGELES
NEW YORK • CHICAGO • ATLANTA

EXCELLENCE IN ELECTRONICS

Proceedings of the I.R.E. December, 1945

THIS NEW MIGHTY MIDGET



No. 412

has changed the lives of this whole family of "MINI-MAX" BATTERIES

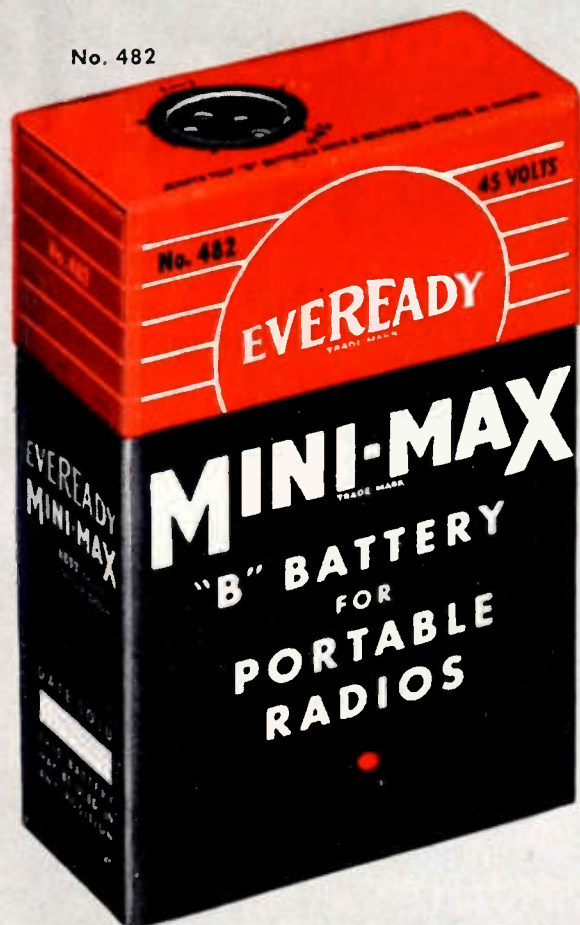

No. 482

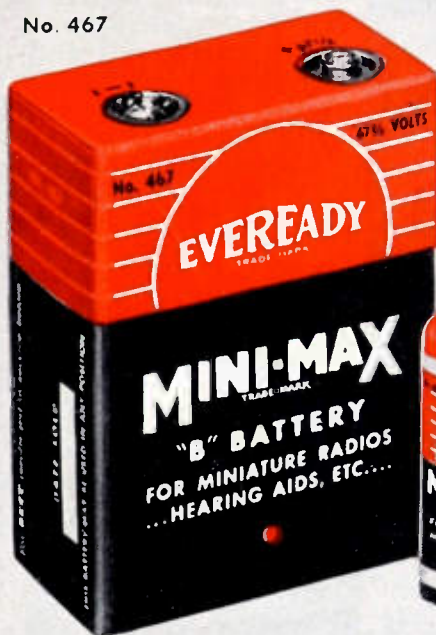

No. 467



No. 420

The four batteries shown above are approximately 2/3 of actual size

EVEN BEFORE PEARL HARBOR, battery construction principles developed by National Carbon Company were making possible new strides in portable radio and electronic equipment. Then came the war. The company was called upon to develop even more radical improvements in battery construction to meet the needs of light and extremely portable military communications of all types, and so the tiny 22½ volt "Eveready" "Mini-Max" "B" battery was born—a battery well under half the size of anything of comparable voltage—easy to carry as a match box!

This is what this new, improved battery construction means. It means a brand new line of portable radio equipment—equipment that will give the idea of the "personal radio" an entirely new meaning. It makes possible radio sets for individual use—sets so small that they can be slipped into the pocket of a vest, or carried in a woman's handbag. Portable radio business will not merely pick up where it left off December 7, 1941. It will be years ahead of itself.

Engineers and designers are already aware of the possi-

bilities of this new battery. They are already at work on new radio and electronic devices which exploit its portability. And at this time may we invite all these creative men to avail themselves of our experience, our laboratories and to consult with our engineers. National Carbon Company, Inc. extends to you complete cooperation.

The words "Eveready" and "Mini-Max" are registered trade-marks of National Carbon Company, Inc.

Now that radio batteries are back again, National Carbon Company is offering an extremely useful new Portable Radio Battery Replacement Guide. Write for your copy today to our nearest Division Office listed below.

NATIONAL CARBON COMPANY, INC.

Unit of Union Carbide and Carbon Corporation



General Offices: NEW YORK, N. Y.

Division Sales Offices: Atlanta, Chicago, Dallas, Kansas City, New York, Pittsburgh, San Francisco.



STUPAKOFF

CERAMIC INSULATORS

FOR YOUR PRODUCTS

PADDER AND TRIMMER BASES

Padder and trimmer bases that are mechanically strong, dimensionally accurate, and electrically stable, keep assembly lines flowing, minimize breakage in production and in use, insure consumer satisfaction. STUPAKOFF combines mass production with laboratory precision. Exact control extends from scientific testing of raw material through final packing. STUPAKOFF engineers are at your service.

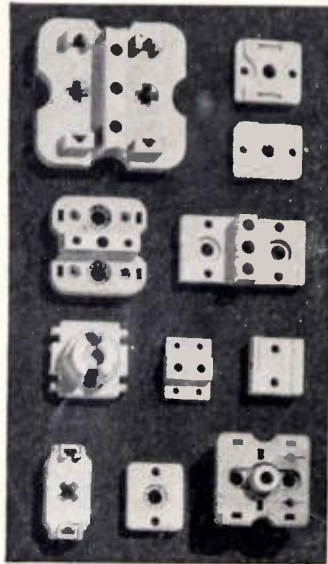

TUBE PARTS

From the day when the first STUPAKOFF ceramic heater insulator was produced for the first A. C. radio tube, the name STUPAKOFF has been a synonym for quality in the field of radio ceramics. Adherence to specification tolerances, both mechanical and electrical, and to the proper material for the specific application are integrated in every STUPAKOFF product.

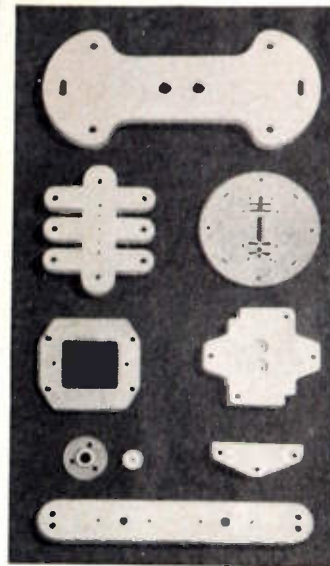

RESISTOR PARTS

STUPAKOFF produces precision-made ceramic resistor parts as rods, plain or threaded; as tubes, plain or threaded; as winding forms for all types of resistors; and metallized for solder-sealed resistors. STUPAKOFF ceramics are dense and sturdy, vitrified to withstand moisture, resistant to vibration and thermal shocks.

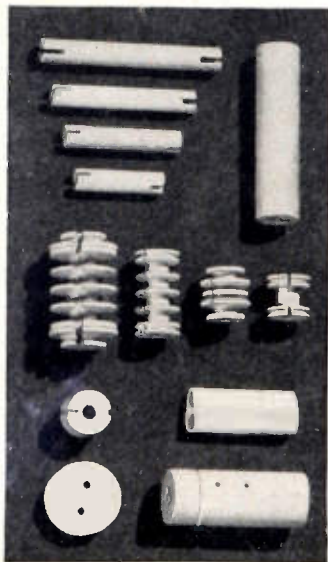

ELECTRIC APPLIANCE CERAMICS

STUPAKOFF insulators are planned to meet the demands of assembly line production and to endure the rigorous usage requirements, thus minimizing field failures and service calls. Made vitrified, dense, non-hygroscopic or porous as required. Made to withstand sudden temperature changes without fracturing. Engineered to suit the job.

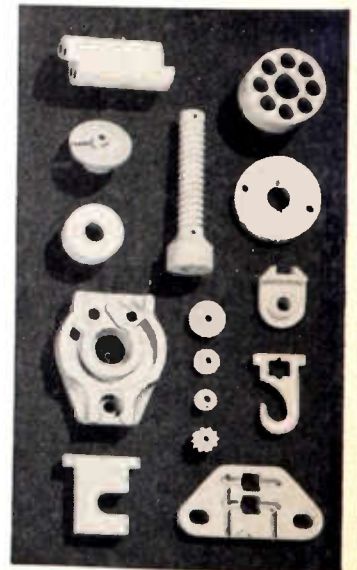

★ BUY VICTORY BONDS ★



STUPAKOFF CERAMIC AND MANUFACTURING CO., LATROBE, PA.

Products for the World of Electronics



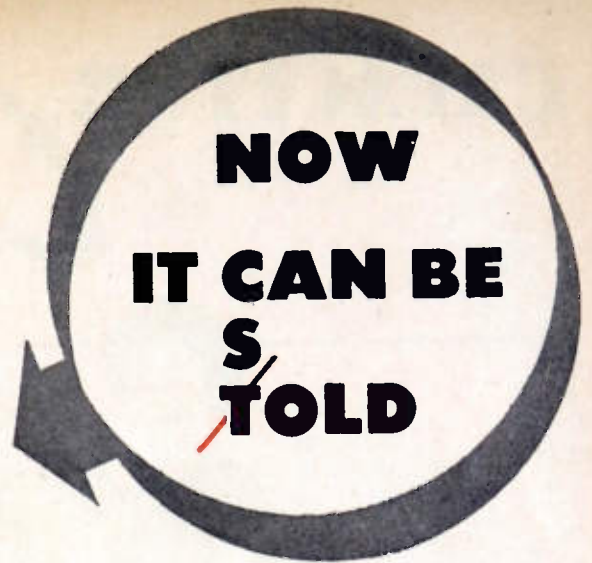
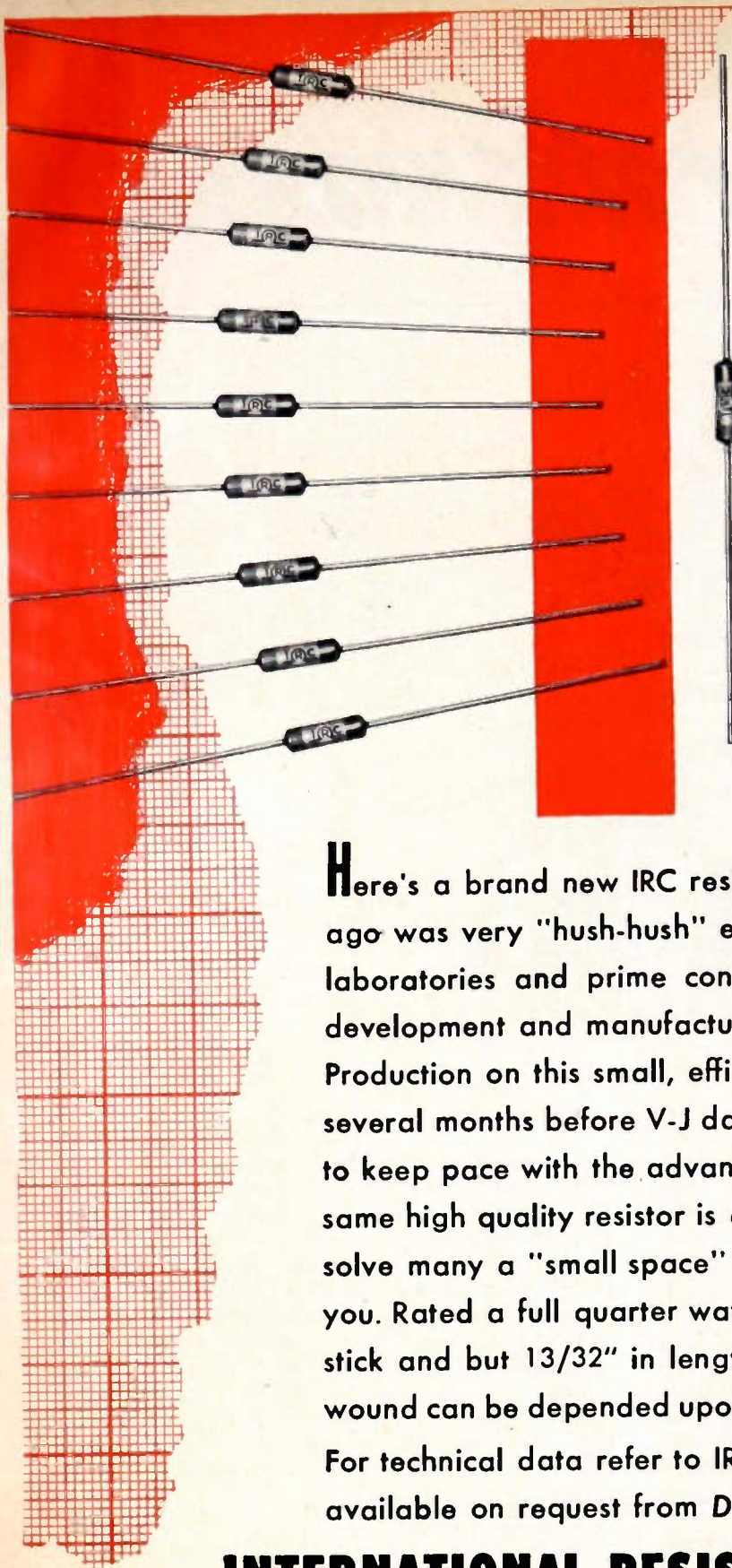

IRC TYPE **BWS**
 $\frac{1}{4}$ WATT INSULATED
WIRE WOUND RESISTORS

Here's a brand new IRC resistor that until a few weeks ago was very "hush-hush" except to a few selected laboratories and prime contractors engaged in development and manufacture of VT proximity fuzes. Production on this small, efficient unit, in the last several months before V-J day, mounted to amazing figures to keep pace with the advancing victory tempo. Now this same high quality resistor is available in quantity to help solve many a "small space" resistance problem for you. Rated a full quarter watt, small 'round as a match stick and but $\frac{13}{32}$ " in length, this sturdy insulated wire wound can be depended upon for "Preferred Performance." For technical data refer to IRC Engineering Bulletin No.3, available on request from Dept. 10-L.

INTERNATIONAL RESISTANCE CO.

401 NORTH BROAD STREET • PHILADELPHIA 8, PA.

In Canada: International Resistance Co., Ltd., Toronto

IRC makes more types of resistance units, in more shapes, for more applications, than any other manufacturer in the world.



CAPACITOR

Craftsmanship



● With tiny silvered micas, it's precision: capacitance tolerances of 1%, with temperature coefficients and stability requirements to meet the highest characteristics requirements of JAN-C-S; excellent retrace characteristics; practically no capacitance drift with time; exceptionally high Q. Yes, Aerovox specializes in such precision capacitors.

And at the other extreme are giant Type 26 oil-filled capacitors for high-voltage requirements such as in X-ray equipment, high-voltage test and laboratory equipment, and for carrier-current coupling. Again, Aerovox specializes in high-voltage

oil-impregnated, oil-filled capacitors.

But how, you ask, can one organization really specialize in such totally different products? The Aerovox answer:

The huge Aerovox plant is really several plants in one. Miccas are made in the Mica Department, oils in the Oil Department, electrolytics in the Electrolytic Department, and so on. Each has its OWN engineers, supervisors, trained workers.

Thus you are assured of that specialized craftsmanship that insures the best in highly specialized products, along with the convenience, certainty and economy of ONE outstanding source of supply.

● Try us on that capacitance problem



Capacitors

INDIVIDUALLY TESTED

AEROVOX CORPORATION, NEW BEDFORD, MASS., U. S. A.

Export: 13 E. 40 ST., NEW YORK 16, N. Y. - Cable: 'ARLAB' - In Canada: AEROVOX CANADA LTD., HAMILTON, ONT

SALES OFFICES IN ALL PRINCIPAL CITIES



ERIE STYLE TS1F CERAMIC TRIMMER

HERE is a new ceramic trimmer that's unique in design, extremely compact, with desirable capacity ratios and is priced for a wide range of applications in broadcasting and high frequency bands.

The Erie TS1F trimmer employs a ceramic dielectric and is available in nominal temperature coefficients, zero, -300, and -750 parts/million/°C. In the N750 coefficient, capacity range of 8-50 MMF is available. Corresponding ratios in lower capacities are furnished with zero and N300 coefficient.

Capacity change is essentially constant per degree of rotation, and full range is covered in 180° rotation.

The metal rotor completely covers the stator track. Contact surfaces of both rotor and stator are lapped, providing a high degree of stability, preventing dust or other foreign matter from affecting the performance characteristics of the unit, and keeping noise level to a minimum at high frequencies. Electrical characteristics are given at the right.

These trimmers are firmly held in place in a D hole in the chassis by means of a multiple-tooth spring clip, furnished with the trimmer.

For complete information contact our nearest representative or write us direct.

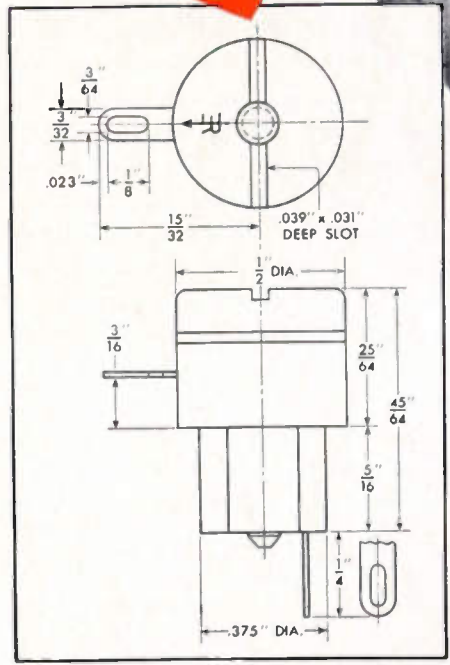

ERIE TS1F CERAMICON TRIMMER

- Voltage Rating: 350 volts D.C.
- Flash Test: 700 volts D.C. for 15 seconds
- Initial Q Factor at 1MC: 500 minimum
- Initial Leakage Resistance: 10,000 meg. min.



Electronics Division
ERIE RESISTOR CORP., ERIE, PA.
 LONDON, ENGLAND TORONTO, CANADA.

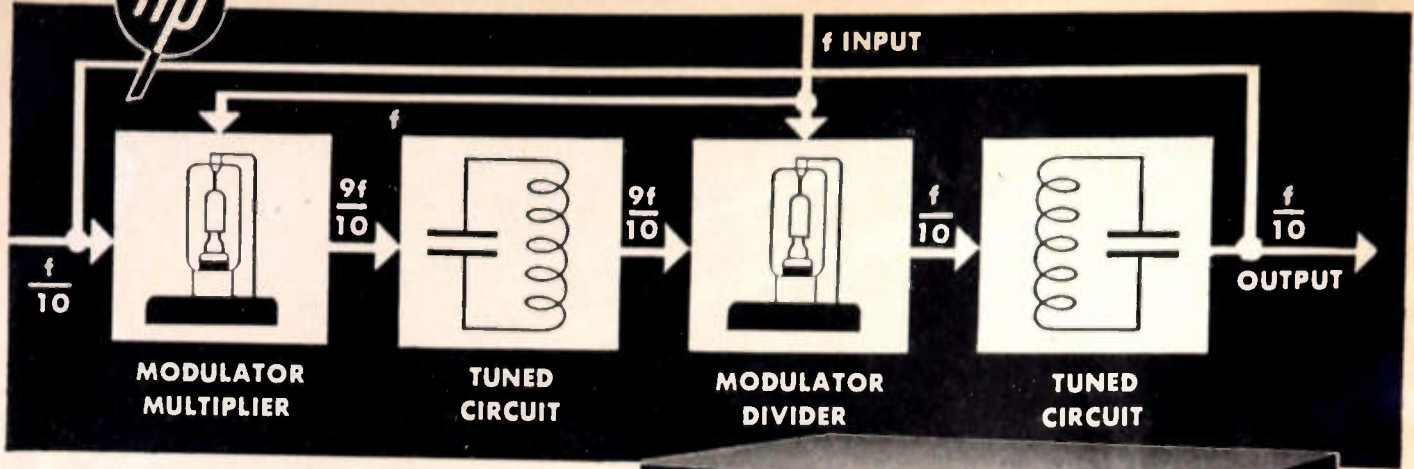

THIS CIRCUIT PROVIDES AN ACCURATE FIXED STANDARD FREQUENCY...

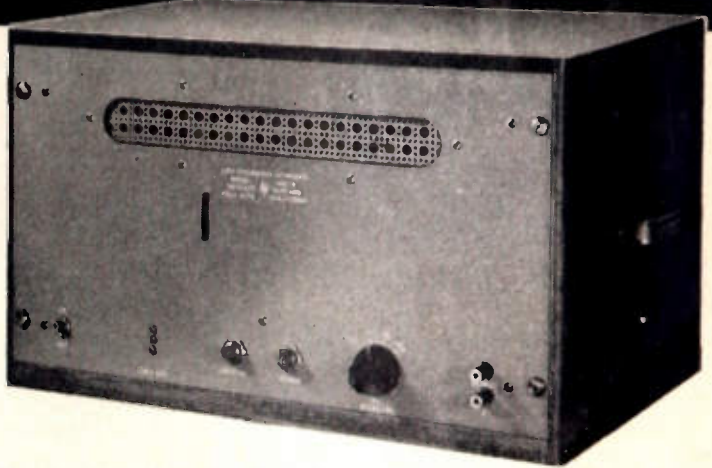

A modulator divider tube with a resonant circuit tuned to $1f/10$ and a modulator multiplier tube with a resonant circuit of $9f/10$ are the fundamentals of a frequency divider unit which is the basic element of this *-hp-* Secondary Frequency Standard.

A small transient voltage in the resonant circuit of the modulator divider tube is applied to the grid of the modulator multiplier tube, and the input voltage f is also applied to this tube. The two voltages mix to supply an output frequency of $9f/10$. This frequency ($9f/10$) is fed to the grid of the modulator divider tube where it is mixed with the input frequency (f), and results in a frequency of $1f/10$ in the modulator divider tuned circuit. The action is repeated and the voltage is built up until a stabilized condition is reached or until the frequency (f) is removed. Thus the output of the divider unit is controlled by the input frequency.

Three such frequency divider circuit units in conjunction with a temperature controlled oscillating quartz crystal, which generates

100 kc, make up the *-hp-* 100B Secondary Frequency Standard. By cascading the 100 kc down through the three dividers, accurate fixed frequencies of 10 kc, 1 kc and 100 cps are made available in addition

to the 100 kc supplied by the oscillator.

As can be noted by the block diagram, these frequencies are available through a selector switch (on front of panel) or individually from binding posts (rear of chassis). All four fixed frequencies can be utilized at separate test stations simultaneously, which is an economical feature. This instrument is extremely valuable for use in audio and the low radio frequency fields. More complete information will be gladly sent in response to your inquiry.

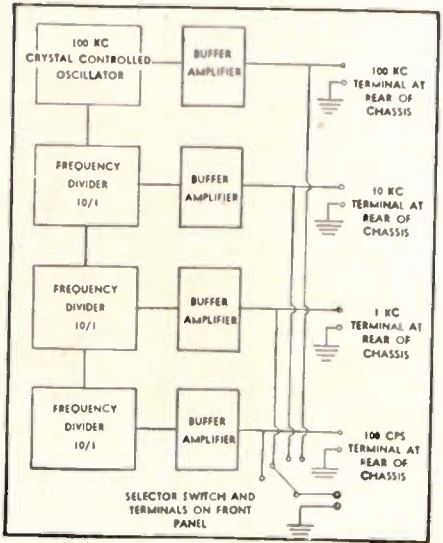

HEWLETT-PACKARD COMPANY

BOX 1072E : STATION A : PALO ALTO, CALIFORNIA

- Audio Frequency Oscillators
- Signal Generators
- Vacuum Tube Voltmeters
- Noise and Distortion Analyzers
- Wave Analyzers
- Frequency Meters
- Square Wave Generators
- Frequency Standards
- Attenuators
- Electronic Tachameters

These *-hp-* Representatives are at your Service

Eastern Representative:
Burlingame Associates, Ltd.
11 Park Place
New York 7, N. Y.—Worth 2-5563-4

Midwestern Representative:
Alfred Crossley
549 West Randolph St.
Chicago 6, Ill.—State 7444

Western Representative:
Norman B. Neely Enterprises
7422 Melrose Ave.
Hollywood 46, Calif.—Hillside 9133

Canadian Representative:
Atlas Radio Corporation
560 King Street West
Toronto 2, Canada—Wa 4761



The Tube that Makes Better Tubes

A NEW ACHIEVEMENT OF NATIONAL UNION RESEARCH LABORATORIES

IT was an important day in Vacuum Tube progress when engineers at National Union Research Laboratories perfected a new super-sensitive Ionization Gauge, capable of recording pressures well below a billionth of an atmosphere! With this precision instrument, new accuracy is possible in attaining uniform high vacuum in all N. U. Tubes. Especially advantageous in mass production are the simplicity of this streamlined electronic gauge and its low cost. For two reasons this original N. U. development warrants careful consideration. First, it is an improved production tool

which makes all N. U. Vacuum Tubes better tubes. Second, it typifies the electronic "know-how" of N. U. Research engineers. So if electron tubes have a place in your post-war picture, make a note to count on National Union.

N. U. IONIZATION GAUGE

- Filament voltage 3.0 volts
- Filament current 1.8 A.
- Electron Collector voltage 200 volts
- Electron Collector current 20 Ma.
- Ion Collector voltage -13 volts
- Sensitivity: Ten times the ion current in amperes equals the pressure in mms. of mercury.

It is possible to expose the hot filament of this gauge to air at atmospheric pressure and later have it function efficiently under vacuum conditions.

**NATIONAL UNION
RADIO AND ELECTRON TUBES**
NATIONAL UNION RADIO CORPORATION • NEWARK 2, N. J.



THE INSIDE STORY

A background of *Performance*—over 50 years—is the *inside story* of the popularity that has brought leadership to *Thordarson* transformers. Performance over the years, after all, is the only true test of product quality.

Consumer acceptance will continue because *Thordarson* research and design engineers are never satisfied just keeping abreast of the times. These men are continually developing many transformer components which are instrumental in the production of new and better performing devices and equipment for the electronics industry.

This same pioneering spirit has been responsible for many new *Thordarson* transformer applications and developments during the war . . . all of which will be available shortly for civilian requirements.

Thordarson's well-tested methods of sales promotion and distribution will continue their joint task of making *Thordarson* Transformers, together with complete information on their applications and use, available to everyone in the field.

Always think of Thordarson for top-notch transformers!

500 WEST HURON ST., CHICAGO, ILL.



ORIGINATORS OF TRU-FIDELITY AMPLIFIERS

THORDARSON

ELECTRIC MANUFACTURING DIVISION

MAGUIRE INDUSTRIES, INCORPORATED

MORE POWER OUTPUT **BUT** LESS BATTERY DRAIN WITH HYTRON INSTANT-HEATING BEAM TETRODES

ZERO STAND-BY CURRENT Thoriated tungsten filaments of the Hytron 2E25, HY69, and HY1269 permit simultaneous application of all potentials. During stand-by, no precious filament current is drawn from the battery. Especially with the larger tube complements of FM transmitters, is conservation of battery power mandatory.

MORE OUTPUT—GREATER RANGE Only 4% of the current required for cathode types, is necessary to operate the instant-heating 2E25, HY69, and HY1269. (See table below.) Even in a mobile FM transmitter, 100 watts output is practicable. Imagine the advantages of such increased output in police, marine, or other mobile equipment.

SPARES PROBLEM SIMPLIFIED Using the 2E25, HY69, and HY1269, you take full advantage of the beam tetrode's versatility. The 2E25, for example, can power a whole transmitter—AF and RF—AM or FM. If more output is required, HY69's or HY1269's in push-pull still confine the spares complement to only two types.

ADVANTAGES OVER CATHODE TYPES Yes, the 2E25, HY69, and HY1269 cost more than cathode types. But they are worth it. Not only are they easier on the battery, and permit larger outputs, but they are designed, built, and tested for transmitting. Some advantages are: centering of filament potential at 6.0 volts, r.f. shielding to eliminate the necessity for neutralization, low-loss insulation throughout, plate connection to top cap, and rugged construction.



BATTERY DRAIN OF A CONVENTIONAL TRANSMITTER AND KAAR FM-50X EQUIPPED WITH HYTRON INSTANT-HEATING TUBES

	Conventional 30 watt	KAAR FM-50X - 50 watt
AMPERE HOURS:	0 10 20 30 40 50 60 70	0 10 20 30 40 50 60 70
STANDBY DRAIN 24 HOUR PERIOD	55.2 AMPERE HOURS	0.0 AMP. HRS.—YET READY TO TALK INSTANTLY!
AVERAGE TOTAL BATTERY DRAIN 24 HOUR PERIOD	56.8 AMPERE HOURS	2.2 AMPERE HOURS

This chart, prepared by Kaar Engineering Co., is based on typical metropolitan police use of 140 radiotelephone-equipped cars operating three shifts in a city of 600,000 population. The 24-hour survey included 904 messages originated by cars and 932 messages acknowledged by cars. Transmissions averaged: 13 per car, 15 seconds in length, and 3 minutes 15 seconds transmitting time.

ABBREVIATED DATA HYTRON INSTANT-HEATING BEAM TETRODES

Characteristic	2E25	HY69	HY1269
Filament Potential (volts)	6.0	6.0	6/12
Filament Current (amps.)	0.8	1.6	3.2/1.6
Plate Potential (max. volts)	450	600	750
Plate Current (max. ma.)	75	100	120
Plate Dissipation (max. watts)	15	30	30
Grid-to-Plate Capacitance (mmfd.)	0.15	0.25	0.25
Maximum Seated Height (inches)	3 5/8	5 1/4	5 1/4
Maximum Diameter (inches)	1 7/16	2 1/16	2 1/16
Class C Power Output (watts)	24	42	63
Class C Driving Power (watts)	Less than one watt		

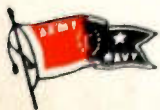

OLDEST MANUFACTURER SPECIALIZING IN RADIO RECEIVING TUBES

HYTRON

RADIO AND ELECTRONICS CORP.



MAIN OFFICE: SALEM, MASSACHUSETTS

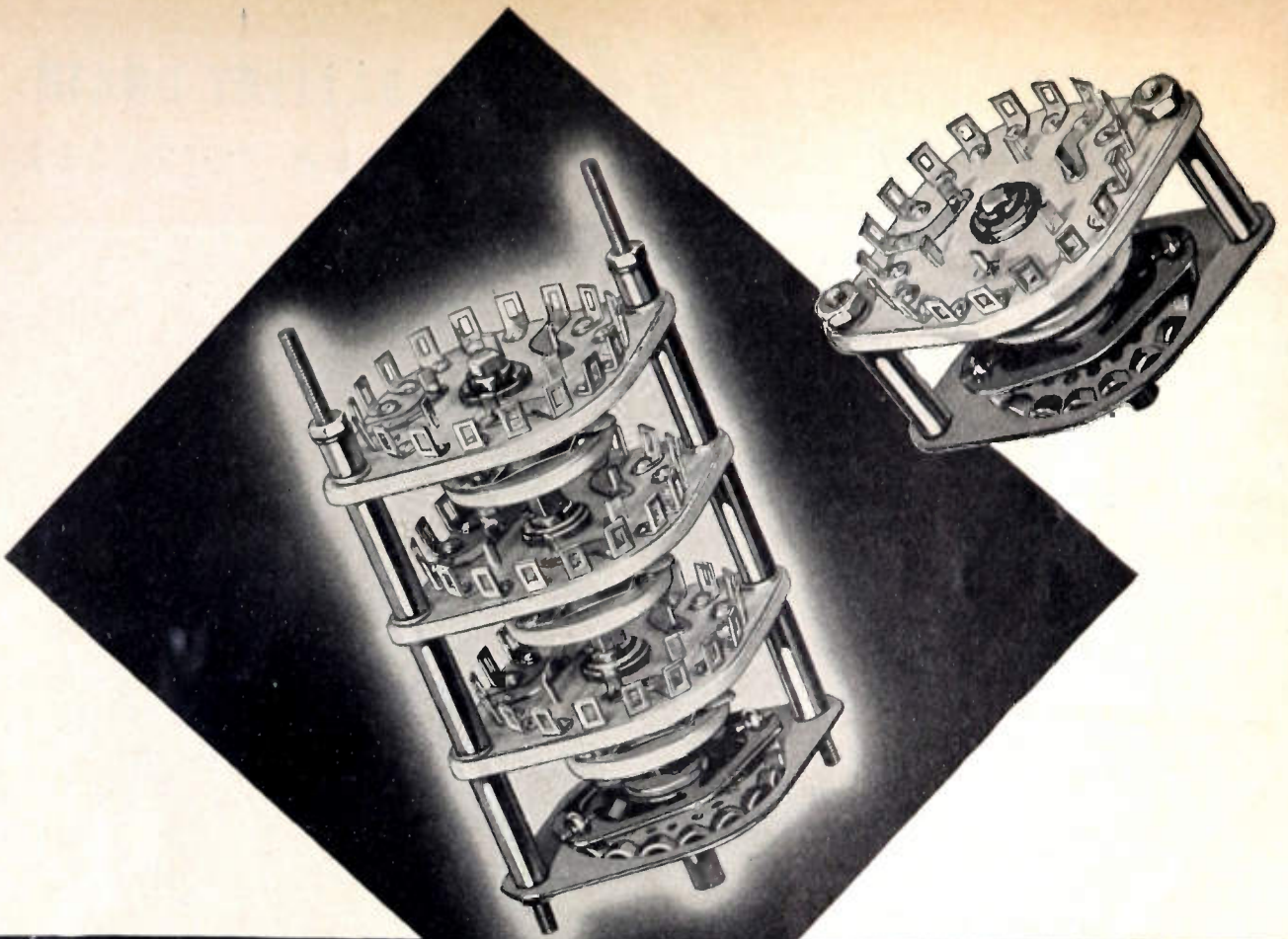

Centralab

MEDIUM DUTY POWER SWITCHES

Producers of:

- Variable Resistors
- Selector Switches
- Ceramic Capacitors
- Fixed and Variable Steatite Insulators
- and Silver Mica Button-type Capacitors.

... available for transmitters, power supply converters and many special industrial and electronic uses.

The units are assembled in multiple gangs with a choice of shorting or non-shorting contacts.

The switching combinations manufactured for stock delivery are in single or multiple sections . . . 3 pole, 5 positions and 1 pole, 17 positions. (17 positions can be furnished with 18 positions continuous rotation.) Special combinations available.

Rated at $7\frac{1}{2}$ amperes at 60 cycles, 115 volts, voltage breakdown 2500 volts D.C. to ground.

Write for Bulletin 815.

Centralab

Division of GLOBE-UNION INC., Milwaukee

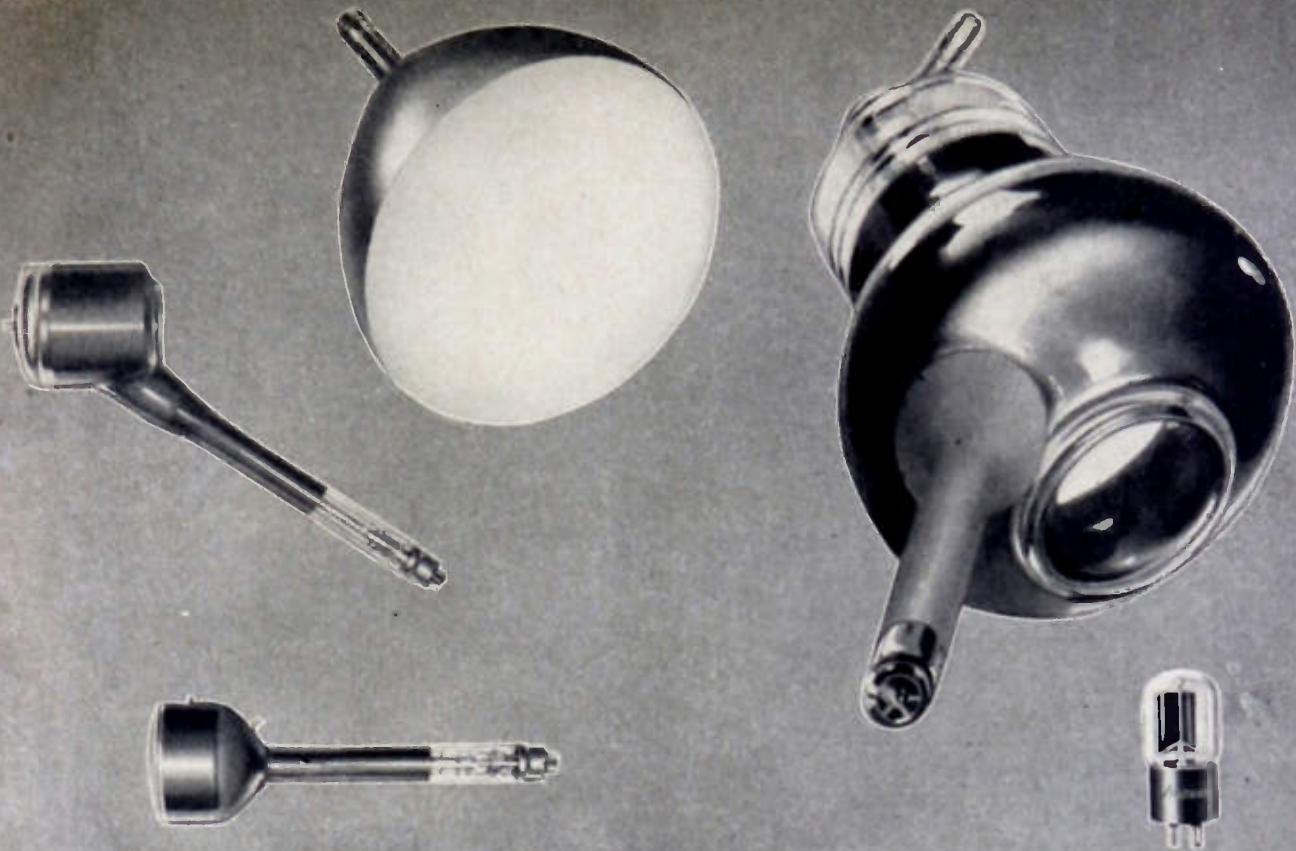

VISITRON

Television Tubes

by

Visitron is not a new name in tubes. *Visitron* is Rauland's name for all electronic tubes made in the Rauland Tube Division. It is the mark of the advanced Rauland Television thinking and planning based upon a pioneering experience second to none. Rauland *Visitron* tubes for direct-viewing for the home and projection for the home and theatre are ready to take their places in the new era of Television entertainment now unfolding before us.

To be sure of your tube, be sure it's "*Visitron*."

RADIO • RADAR • SOUND

Rauland

COMMUNICATIONS • TELEVISION

Electroneering is our business

THE RAULAND CORPORATION • CHICAGO 41, ILLINOIS

THREE HIGH FREQUENCY
TRANSMITTING TRIODES

ELECTRICALLY IDENTICAL

... but with different grid
terminal locations to aid
in your equipment design!

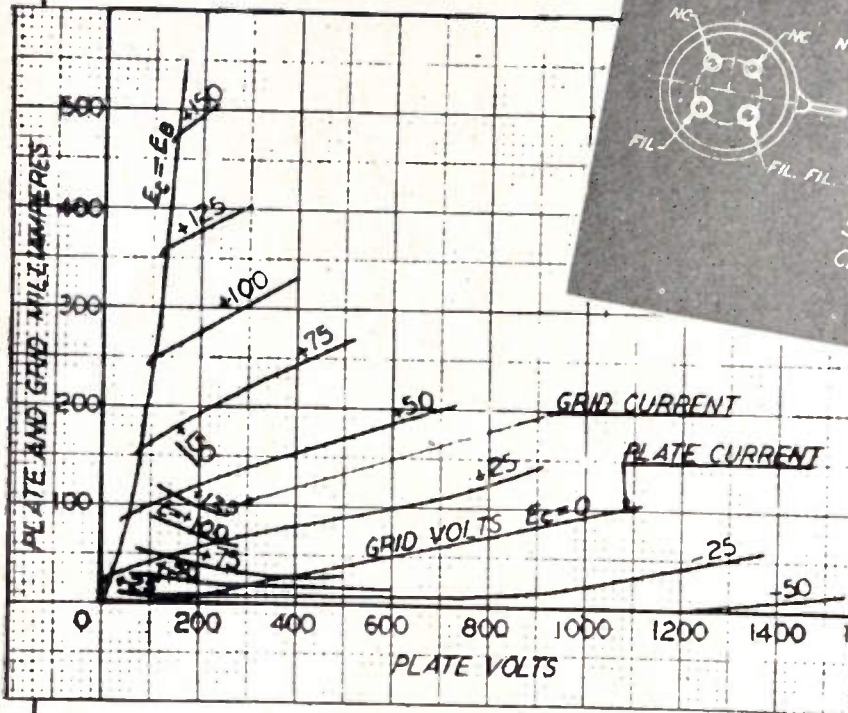
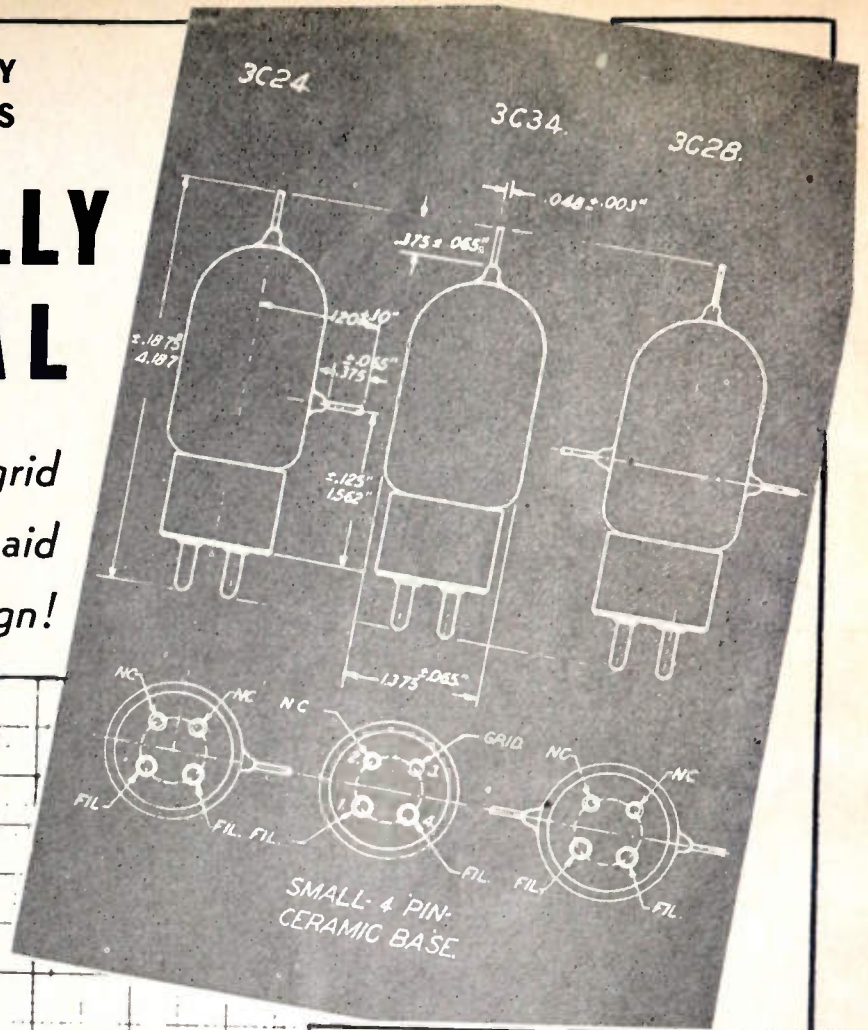

• Here, again, Lewis engineers offer wider latitude in equipment design through the development of these three electrically identical high frequency transmitting triodes . . . with different grid terminal locations. If you are interested in these, or other type tubes with *special design features* applicable to your equipment, write, wire or phone today.

3C24 • 3C34 • 3C28 HIGH FREQUENCY TRANSMITTING TRIODES

Filament Thoriated Tungsten
Voltage 6.3 ac or dc volts
Current 3.0 amps
Amplification factor 25

Direct Interelectrode Capacitances:

	3C24	3C34	3C28
Grid-Plate	1.6	1.7	1.8 mmlds
Grid-Filament	2.0	2.5	2.1 mmlds
Plate-Filament	0.2	0.4	0.1 mmlds

Class "C" R-F Amplifier Frequency Limits

	3C24	3C34	3C28
Full power input	60	60	100 mcs
Half power input	250	200	350 mcs

Licensed under R.C.A. Patents



NOW READY-



ABOVE: Station Handset and Control Unit — Control unit contains loudspeaker, plus controls for adjustment of "volume" and "squelch." Also, "transmit," "receive," and "stand-by," signal lights.



ABOVE: FM Transmitter and Receiver for mobile or low-powered station use — Ultra-modern circuits, construction, and styling. Small, compact, rugged.

NEW *RCA* FM TRANSMITTERS AND RECEIVERS

for Emergency Communications

WRITE TODAY FOR 24-PAGE BOOKLET DESCRIBING THIS EQUIPMENT

Please send me complete information about your new FM Transmitters and Receivers for emergency communications. Address: Emergency Communications Equipment Section, Radio Corporation of America, Camden, New Jersey.

Name

Title

Employed by

Street Address

City and State



RADIO CORPORATION OF AMERICA

RCA VICTOR DIVISION • CAMDEN, N. J.

In Canada, RCA VICTOR COMPANY LIMITED, Montreal



9 NEW RCA MINIATURES!

INCLUDES NEW COMPACT TYPES FOR AM, FM, AND TELEVISION RECEIVERS

• Here it is—that latest addition to the peacetime line of miniatures . . . 5 new miniature types that provide performance equivalents for the popular prewar kit 12SA7, 12SQ7, 12SK7 (or 12SG7), 35Z5GT/G, and 50L6GT—and 4 other tubes introduced as performance equivalents to the 6SA7, 6SQ7, 6SQT, and 6SH7.

These 9 new RCA miniatures bring to 35 the total number of tubes in the RCA miniature line—and all but 2 were developed by RCA engineers.

Such RCA pioneering means two important things to you:

1. That RCA knows your needs—keeps an eye on the industry—is ever striving to give you the tubes you want when you want them.
2. As the originator of miniatures and as the largest producer of them ever since their introduction, RCA can assure you of superior tube quality and uniformity at prices that are right.

For data on these 9 new tubes, send coupon.

If you are designing radio equipment and need tube-application assistance, don't forget that the RCA appli-

cation-engineering staff is always at your service for consultation. A telephone call to our nearest office, or a letter stating your problem, will do the trick. Address: Radio Corporation of America, Tube Division, Commercial Engineering Department, Section 62-41P, Harrison, N. J.

In Metals, Miniatures, or Glass Types . . .

THE FOUNTAINHEAD OF MODERN TUBE DEVELOPMENT IS RCA

AND HERE THEY ARE!

Miniatures New Tubes	DESCRIPTION	Performance Equivalent
★ 6AT6	Duplex-Diode High-Mu Triode	6SQ7
★ 6AUG	RF Amplifier Pentode with Sharp Cutoff	6SH7
★ 6BA6	RF Amplifier Pentode with Remote Cutoff	6SG7
★ 6BE6	Pentagrid Converter	6SA7
★ 12AT6	Duplex-Diode High-Mu Triode	12SQ7
★ 12BA6	RF Amplifier Pentode with Remote Cutoff	12SQ7 (or 12SK7)
★ 12BE6	Pentagrid Converter	12SA7
★ 35W4	Half-wave High-Vacuum Rectifier	35Z5GT/G
★ 50B5	Beam-Power Amplifier	50L6GT

MAIL THIS TODAY FOR FREE DATA SHEETS

RCA, Commercial Engineering Department,
Section 62-41P, Harrison, N. J.

I'd like all the data available on the 9 new RCA miniatures announced in your December advertisement. Please rush me a complete set of data sheets, including ratings, curves, drawings, etc.

Name.....
Position.....
Company.....
Address.....
City..... Zone..... State.....



62-01 Jan-41

RADIO CORPORATION OF AMERICA
TUBE DIVISION • HARRISON, N. J.

BOARD OF DIRECTORS, 1945
 William L. Everitt
President
 Hendrik J. van der Bijl
Vice-President
 Raymond A. Heising
Treasurer
 Haraden Pratt
Secretary
 Fred N. Goldsmith
Editor
 Sydney P. Wheeler
Senior Past President
 Hubert M. Turner
Junior Past President
 1943-1945
 Wilmer L. Barrow
 F. B. Llewellyn
 Harold A. Wheeler
 1944-1946
 Raymond F. Guy
 Lawrence C. F. Horle
 William C. White
 1945-1947
 Stuart L. Bailey
 Keith Henney
 E. Shackelford, 1945
 E. Finley Carter
 Lewis M. Clement
 Ralph A. Hackbusch
 Donald B. Sinclair
 William O. Swinyard
 ●
 Harold R. Zeamans
General Counsel
 George W. Bailey
Executive Secretary
 William H. Crew
Assistant Secretary
 ●
BOARD OF EDITORS
 Alfred N. Goldsmith
Editor
 Ralph R. Batcher
 Robert S. Burnap
 Philip S. Carter
 Lewis M. Clement
 J. D. Cobine
 William G. Dow
 Elmer W. Engstrom
 William L. Everitt
 William G. H. Finch
 George W. Gilman
 Peter C. Goldmark
 Alois W. Graf
 Frederick W. Grover
 Lewis B. Headrick
 C. M. Jansky, Jr.
 Hugh S. Knowles
 John D. Kraus
 Donald G. Little
 Frederick B. Llewellyn
 Samuel S. Mackeown
 Nathan Marchand
 E. D. McArthur
 Edward L. Nelson
 Harry F. Olson
 Harold O. Peterson
 Greenleaf W. Pickard
 Ralph A. Powers
 Haraden Pratt
 Conan A. Priest
 Herbert J. Reich
 Vernon W. Sherman
 Lynne C. Smeby
 E. C. Wentz
 Harold A. Wheeler
 William C. White
 Laurens E. Whittemore
 Gerald W. Willard
 William Wilson
 Charles J. Young
 Vladimir K. Zworykin

Proceedings

of the I·R·E

Published Monthly by
 The Institute of Radio Engineers, Inc.

VOLUME 33 *December, 1945* NUMBER 12, PART I

Section Meetings	820
I.R.E. Members, Their Institute, and Their PROCEEDINGS. The Editor	821
William O. Swinyard—Board of Directors—1945	822
The Engineer's Place in Naval Research	823
A Review of Plastic Materials	825
Effect of Surface Finish and Wall Thickness on the Operating Temperature of Graphite Radio-Tube Anodes	834
A Coil-Neutralized Vacuum-Tube Amplifier at Very-High Frequencies	838
Cathode-Follower Circuits	843
Television Resolution as a Function of Line Structures	855
Loop-Antenna Coupling-Transformer Design	865
On the Theory of the Progressive Universal Winding	868
Concerning Hallén's Integral Equation for Cylindrical Antennas	872
Frequency-Modulation Distortion Caused by Multipath Transmission	878
Symmetrical Antenna Arrays	892
General Formulas for "T"- and "Π"-Network Equivalents	897
Institute News and Radio Notes	900
Plans Go Forward for Winter Technical Meeting and Radio Engineering Show	900
Board of Directors	900
Executive Committee	901
Browder J. Thompson Memorial	902
I.R.E. People	902
Books:	
"The Decibel Notation and Its Applications to Radio Engineering and Acoustics," by V. V. L. Rao	903
"On the Propagation of Radio Waves," by Olof E. H. Rydbeck	903
UHF Radio Simplified, by Milton S. Kiver	903
Correspondence:	
"Note on Iron Powder Cores and Coils"	904
Contributors	904
Section Meetings	34A
Membership	38A
Positions Open	50A
Advertising Index	86A

EDITORIAL DEPARTMENT

Helen M. Stote
Publications Manager
 Winifred Carrière
Assistant Editor
 William C. Copp
Advertising Manager
 Ray D. Rettenmeyer
Technical Editor
 Lillian Petranek
Assistant Advertising Manager

Responsibility for the contents of papers published in the PROCEEDINGS rests upon the authors. Statements made in papers are not binding on the Institute or its members.



Changes of address (with advance notice of fifteen days) and communications regarding subscriptions and payments should be mailed to the Secretary of the Institute, at 330 West 42nd Street, New York 18, N. Y. All rights of republication, including translation into foreign languages, are reserved by the Institute. Abstracts of papers, with mention of their source, may be printed. Requests for republication privileges should be addressed to The Institute of Radio Engineers.

PAPERS COMMITTEE

Frederick B. Llewellyn
Chairman
 Herman A. Affel
 Wilmer L. Barrow
 Howard A. Chinn
 James K. Clapp
 Ivan S. Coggeshall
 Seymour B. Cohn
 Edward J. Content
 Clifford W. Corbett
 Murray G. Crosby
 Frederick W. Cunningham
 Robert B. Dome
 Enoch B. Ferrell
 Donald G. Fink
 Howard S. Frazier
 Robert L. Freeman
 Stanford Goldman
 Frederick W. Grover
 O. B. Hanson
 Thomas J. Henry
 Edward W. Herold
 John V. L. Hogan
 Frederick V. Hunt
 Harley Iams
 Loren F. Jones
 John G. Kreer, Jr.
 Emil Labin
 Frederick R. Lack
 Hugo C. Leuteritz
 Charles V. Litton
 Knox McIlwain
 Harry R. Mimno
 Ilia E. Mourontseff
 G. G. Muller
 Albert F. Murray
 James R. Nelson
 Dwight O. North
 Allen F. Pomeroy
 Jack R. Poppele
 Simon Ramo
 Francis X. Rettenmeyer
 Sergei A. Schelkunoff
 Donald B. Sinclair
 Karl Spangenberg
 Dayton Ulrey
 A. P. Upton
 Karl S. Van Dyke
 E. K. Van Tassel
 John R. Whinnery
 Irving Wolf
 J. Warren Wright
 Harold R. Zeamans

PAPERS PROCUREMENT COMMITTEE

Dorman D. Israel
General Chairman
 Edward T. Dickey
Vice General Chairman

GROUP CHAIRMEN

Arthur B. Bronwell
 Madison Cawein
 Ivan S. Coggeshall
 Murray G. Crosby
 Alfred C. Crossley
 Harry Diamond
 Arthur E. Harrison
 Theodore A. Hunter
 James R. Nelson
 Harry F. Olson
 John D. Reid
 Donald B. Sinclair
 Howard J. Tyzzer
 Karl S. Van Dyke
 Wilbur L. Webb
 William C. White



The Institute of Radio Engineers

INCORPORATED



SECTIONS

Sections	Next Meeting	Chairman	Secretary	Address of Secretary
ATLANTA	December 28	R. A. Holbrook	I. M. Miles	554-14 St., N.W., Atlanta, Ga.
BALTIMORE	—	R. N. Harmon	F. W. Fischer	714 S. Beechfield Ave., Baltimore, Md.
BOSTON	—	C. C. Harris	A. G. Bousquet	General Radio Co., Cambridge 39, Mass.
BUENOS AIRES (Argentina)	—	A. DiMarco	H. Krahenbuhl	Transradio Internacional, San Martin 379, Buenos Aires, Argentina
BUFFALO-NIAGARA	December 19	J. M. Van Baalen	H. W. Staderman	264 Loring Ave., Buffalo, N. Y.
CEDAR RAPIDS	—	F. M. Davis	J. A. Green	Collins Radio Co., 855-35 St., N.E., Cedar Rapids, Iowa
CHICAGO	December 21	Cullen Moore	L. E. Packard	General Radio Co., 920 S. Michigan Ave. Chicago 5, Ill.
CINCINNATI	December 18	L. M. Clement	J. F. Jordan	The Baldwin Co., 1801 Gilbert Ave., Cincinnati 2, Ohio
CLEVELAND	December 27	H. B. Okeson	A. J. Kres	16911 Valleyview Ave., Cleveland 11, Ohio
CONNECTICUT VALLEY	December 20	H. W. Sundius	L. A. Reilly	989 Roosevelt Ave., Springfield, Mass.
DALLAS-FORT WORTH	—	J. D. Mathis	B. B. Honeycutt	9025 Roanok, Dallas 18, Texas
DAYTON	December 20	L. B. Hallman	Joseph General	411 E. Bruce Ave., Dayton 5, Ohio
DETROIT	December 21	L. H. Larime	R. R. Barnes	1810 Sycamore, Royal Oak, Mich.
EMPORIUM	—	W. A. Dickinson	H. E. Ackman	West Creek, R. D. 2, Emporium, Pa.
INDIANAPOLIS	—	H. I. Metz	E. E. Alden	4225 Guilford Ave., Indianapolis, Ind.
KANSAS CITY	—	R. N. White	Mrs. G. L. Curtis	6003 El Monte, Mission, Kan.
LONDON (Canada)	—	B. S. Graham	C. H. Langford	Langford Radio Co., 246 Dundas St., London, Ont., Canada
LOS ANGELES	December 18	R. C. Mopdy	R. G. Denechaud	Blue Network Co., 6285 Sunset Blvd., Hollywood 28, Calif.
MONTREAL (Canada)	January 9	L. A. W. East	R. R. Desaulniers	Canadian Marconi Co., 211 St. Sacra- ment St., Montreal, Que., Canada
NEW YORK	—	G. B. Hoadley	J. T. Cimorelli	RCA Manufacturing Co., 415 S. Fifth St., Harrison, N.J.
OTTAWA (CANADA)	December 20	W. A. Steel	L. F. Millett	33 Regent St., Ottawa, Ont., Canada
PHILADELPHIA	—	D. B. Smith	P. M. Craig	Philco Corp., Philadelphia 34, Pa.
PITTSBURGH	December 10	J. A. Hutcheson	C. W. Gilbert	52 Hathaway Ct., R.F.D. 1, Wilkins- burg 21, Pa.
PORTLAND	—	Kenneth Johnson	C. W. Lund	Route 4, Box 858, Portland, Ore.
ROCHESTER	December 20	G. R. Town	A. E. Newlon	Stromberg-Carlson Co., Rochester 3, N.Y.
St. LOUIS	—	B. B. Miller	N. J. Zehr	KWK, Hotel Chase, St. Louis 8, Mo.
SAN DIEGO	—	David Kalbfell	Clyde Tirrell	U. S. Navy Radio and Sound Labora- tory, San Diego 52, Calif.
SAN FRANCISCO	—	David Packard	William Barclay	955 N. California Ave., Palo Alto, Calif.
SEATTLE	January 10	G. L. Hoard	K. A. Moore	5102 Findlay St., Seattle 8, Wash.
TORONTO (Canada)	—	F. H. R. Pounsett	Alexander Bow	137 Oxford St., Guelph, Ont., Canada
TWIN CITIES	—	H. E. Hartig	Merle Ludwig	Minneapolis-Honeywell Regulator Co., Minneapolis, Minn.
WASHINGTON	January 14	H. A. Burroughs	L. C. Smeby	4801 Connecticut Ave., N.W., Wash- ington, D. C.
WILLIAMSPORT	January 2	L. E. West	F. L. Burroughs	2030 Reed St., Williamsport 39, Pa.

SUBSECTIONS

Subsections	Next Meeting	Chairman	Secretary	Address of Secretary
COLUMBUS	December 14	R. C. Higgy	Warren Bauer	376 Crestview Rd., Columbus 2, Ohio
FORT WAYNE	—	—	—	—
MILWAUKEE	—	P. B. Laeser	E. L. Cordes	3304 N. Oakland Ave., Milwaukee, Wis.
MONMOUTH	—	L. J. Giacioletto	C. D. Samuelson	5 Russel Ave., Ft. Monmouth, N. J.
PRINCETON	—	W. C. Johnson	J. G. Barry	Princeton University, Princeton, N. J.
SOUTH BEND	December 20	H. E. Ellithorn	J. E. Willson	1002 S. Lombardy Dr., South Bend, Ind.

I. R. E. Members, Their Institute, and Their PROCEEDINGS

It may be stated with propriety that the membership of The Institute of Radio Engineers includes a thoroughly competent group of communication and electronic engineers in the active practice of their profession at this time. The Institute is the agency through which their collective activities are stimulated and their professional viewpoints collected, co-ordinated, and disseminated. The PROCEEDINGS of the I.R.E. is the chosen instrument whereby the work of each Institute member reaches his professional associates. And as a result of the activities of the membership of the Institute, and of the publication of their PROCEEDINGS, the electronic and communication arts and sciences are notably advanced. Applications of engineering knowledge to the benefit of mankind are increased in number and importance. The industries based upon the devices and techniques developed by the I.R.E. membership are stimulated in their growth and led to greater usefulness and prosperity. And the engineering members of the Institute are themselves benefitted and encouraged by the progress and expansion of their art and the increasing public esteem in which they are held.

The founders of the Institute and the long line of competent and devoted executives, Section officers, Committee Chairmen, Committee members, and Institute employees have contributed in great measure to the growth of the Institute, not only numerically or quantitatively but also in the quality and merit of its contributions. In the last analysis, nevertheless, it is the membership of the Institute who in the past have made the Institute possible and who in the future must continue to maintain and enhance its standing. The solidarity of the Institute membership with their professional society is in fact the keystone not only of future I.R.E. accomplishments but also of the standing and prosperity of the engineers who are its members and of the industries in which they work.

It may be gladly acknowledged that the industries in question have demonstrated their understanding of the constructive and mutually beneficial relationship between themselves and the Institute. The Building-Fund campaign has shown that most of the industrial leaders already understood the purposes and accomplishments of the Institute. And those who at first did not fully appreciate its worth were soon convinced and became, like their colleagues, its friends and supporters.

It is not only inevitable but desirable that the great expansion in the membership and activities of the Institute should require the expansion of its employed staff through the addition of skilled individuals who are capable of carrying, year in and year out, many of the burdens of administration and operation. Policy decisions of major professional import should and will remain in the hands of the engineering executive officers and directors of the Institute, selected to that end by the Institute membership. But daily operations and the corresponding decisions can no longer be handled by active professional engineers engrossed in their own technical activities and able to devote to the Institute no more than limited periods of time at certain intervals. The Institute requires continuous supervision and operation, and the burden of such operation is no longer a part-time task.

The Institute membership and directors are well aware of these conditions and have accordingly understood and approved the necessary staff expansions, reorganization, and improved operational methods which have been introduced. Such officers as the Executive Secretary, the Assistant Secretary, and the Technical Secretary, in the Secretarial Department as well as the Associate Editor and the Technical Editor, in the Editorial Department will enable the more efficient and productive handling of the Institute's ever-increasing activities.

It is the obligation of these members of the Institute staff to plan and execute their duties dependably and in the interests of the membership. They merit the support and friendliness of the Institute membership. It is the duty and opportunity of the officers and directors of the Institute to determine the broad policies of the Institute and to guide the employees of the Institute along such major lines as will ensure the advancement of the communication and electronic engineering profession. And it is the privilege and opportunity of the membership of the Institute to aid and guide both of these groups; to express opinions of commendation or criticism freely; to select the policy-forming group of the Institute; to participate in the Committee, Convention, Section, and publication activities of the Institute; and to feel themselves ever more closely associated through a bond of common membership, friendliness, and ideals in one of the great professional organizations of the world of our times.

The Editor



William O. Swinyard

Board of Directors—1945

William O. Swinyard was born on July 17, 1904, at Logan, Utah. He received the B.S. degree in mathematics and physics in 1927 from the Utah State College. From 1927 to 1930 he was an instructor in physics, mathematics, and music in secondary schools in southern Idaho. In the fall of 1930 he was employed in the Bayside, Long Island, laboratory of the Hazeltine Electronics Corporation. During the next four years Mr. Swinyard worked on general engineering problems and later was actively engaged in some of the early work done by the company on high-fidelity broadcast receivers and associated measuring equipment. In 1934 he was transferred to Hazeltine's New York laboratory where he spent three years as a senior engineer working on the design and development of commercial broadcast receivers and the measurement of their performance characteristics. In 1937 he was transferred to the Chicago laboratory, as assistant engineer in charge, and has been engineer in charge of that laboratory since 1942.

He is the author of several technical papers and book reviews which have been published in the PROCEEDINGS and in other technical magazines.

Mr. Swinyard joined the Institute of Radio Engineers as an Associate in 1937 and was transferred to the Senior Member grade in 1939. He has been active in I.R.E. section activities since 1937. At present, he is Chairman of the Chicago Section and a member of the I.R.E. Education Committee and Sections Committee.

Mr. Swinyard is a charter member of the Illinois professional Communications Engineers Association and was chairman from 1942-1944. He is president of the Radio Engineers Club of Chicago. He was a member of the National Electronics Conference Executive Committee in 1944, and is chairman-elect of the Executive Committee for 1945.

Mr. Swinyard also is a member of the Radio Club of America, the Acoustical Society of America, and the Chicago Physics Club.

The Engineer's Place in Naval Research*

WALTER G. SCHINDLER†

IN THE May, 1945, issue of the PROCEEDINGS OF THE I.R.E., a very interesting symposium entitled "The Engineer's Place in the Scheme of Things" is reviewed in brief. Many engineers of Naval Ordnance are in sympathy and agreement with many of the views expressed in the article. There were, however, some remarks appearing as paragraph three, column one, of page 288, with which we of the Naval Ordnance Laboratory wish to take exception. In justice to what might be called the government defense-research services, since the beginning of the national emergency and certainly in the future, it is believed that the impressions created by the paragraph should be corrected.

The paragraph states: "Another interesting matter considered by him was the comparison of government work with industrial work, and correlatively the likely future of an engineer in a government organization. The danger of government-laboratory work, he felt, is that future important developments might never spread out into private industry and would thus be immured in the governmentally organized laboratories. Industry can envisage better peacetime applications of research than can government organizations. Competent men, he feared, might be taken from private industries and placed in government work which would not advance the development of industry and engineering as effectively as if they were in private industries. Thus many engineers might be frozen in their present status and not serve to advance peaceful progress. A government laboratory engineer cannot, in general, be industrially active after the war unless he goes into industry."

In refutation it should first be pointed out that national-defense research and development is so strikingly similar to industrial research and development that much of the force of the statement is lost. Like industrial research, naval research derives from the fruits of the fundamental research of the pure scientist. It starts with basic studies of new fundamental research phenomena with an eye to application. It proceeds through the creative or inventive phase of evolving a device to achieve a technical objective. The device passes through the laboratory or bread-board-model stage, through the design and development phase of an adequately tested working model, through pilot production and mass production stages to introduction into the field by means of technical salesmanship. Like industrial research it is developed under the same conditions of secrecy, or security as it is termed by the military. It is likewise protected by patents in the same fashion as the industrial devices. There are only two respects in which the device developed by the Navy or the government defense agency differs from the device developed by industry. One of these is the degree of secrecy or security maintained. The other lies in the character of the distribution, employment, and the type of technical salesmanship involved in the later use of the device. As regards the security aspect, it must be stated that

even this, as in industry, enjoys a wide scope of security levels. These range all the way from free dissemination through the classifications termed "restricted," "confidential," "secret," and "top secret," depending on the nature of the device and its uses. The industrial devices until safely protected by patents, are usually kept at the confidential or secret level, and no taxpayers' representatives can pry into these secrets. Thereafter, when the sales phase demands publicity, the industrial-research achievement and the device are given wide publicity. Even then, there are certain concealments and reticences referred to as "trade secrets" which prevent complete revelation of all details. While such publicity will not accompany very many of the naval devices, there are relatively few devices in the confidential, secret, or top secret brackets. It is remarkable to what extent even the more highly classified devices leak out into technical journals and magazines. In fact the sustained higher classification applies especially to details of a few specially designed weapons or devices of a critical nature. Needless to say, in time of war the maintenance of security is paramount for national welfare, and therefore it is improper reasoning to project the present security measures into the peacetime future.

As regards the technical salesmanship phase of industry, this is duplicated in naval and military spheres in the accompanying of the device into the fleet or the field by groups of qualified engineers whose function it is to sell the device to the services, to service it in technical employment, and to evaluate and exploit its tactical potentialities. In the armed services this phase is, however, on a classified level and is available only to the services and co-operating engineers from industry.

It should, in passing, also be noted that in naval and military research and development industrial concerns are in a large, in fact preponderating measure, the big brothers or partners of the armed services. It is they who in an overwhelming measure produce the articles and weapons of war in our common defense endeavor. Industry is therefore as much involved in these classified items as are the research laboratories of the armed services. It thus makes little difference whether the engineers are employed by industry for the work on these items or by the armed services. This close co-operation and common interest must be emphasized in answer to the criticism.

Before proceeding further, it is essential to stress the vital importance of technical defense research after the war. For the preservation of our country, our way of life, and of our industries, it is imperative that, in the uncertain peace of the future, we adequately prepare in time of peace for the new weapons of the future and the countermeasures thereto. In the measure that we are prepared, in that measure will we discourage attack by a potential enemy, and in that measure only will we be able to survive. Adequate peacetime national-defense research for the future is as urgent as such research in time of war. It is as much the concern of industry as it is of the engineer, the scientist, and the government defense-research agencies. It behooves our engineering

* Decimal classification: R070. Original manuscript received by The Institute, June 11, 1945.

† Naval Ordnance Laboratory, Washington 25, D.C.

profession in time of peace, as in time of war, to assist and encourage such work, not to discourage it.

The danger that such research laboratories will make serious inroads on industry by taking too many good engineers, as indicated in the paragraph cited, is preposterous for two good reasons. The first is that in the imminent peacetime economy there will be all too few of such agencies. The second reason is that the paragraph cited indicates ignorance of the plans which are contemplated for future government defense agencies, certain portions of which are already in use for the conduct of such research. It is believed that, when such plans are understood, readers will agree that the technical defense-research laboratories will not be the evil predicted, but will do a positive service for the engineering profession.

The agencies which will carry on these researches are:

(a) Research laboratories of the Army and the Navy. There must be such laboratories to carry on certain problems directly connected with weapons, their development, and improvement because of their ability to work closely with the armed services. They will supposedly also handle the more highly classified weapons.

(b) Research units operating under the cognizance of the Research Board for National Security in co-operation with the armed forces. These units will be few and will work in industrial or academic research laboratories under contract for specific projects of limited duration.

(c) Industrial research laboratories engaged in working on devices of interest to the armed forces, or devices which will be of service in national defense.

As regards the conduct of the research laboratories operating under the armed services, the following comments should be made. Before World War II these laboratories were painfully inadequate as to staff, facilities, and funds, and fell heir to the evils resulting from lack of appreciation and support. With the establishment of the national emergency, early in 1940, these laboratories were rapidly and vastly expanded. New ones were established. Research units were set up under the Office of Scientific Research and Development. Contract employment together with the patriotism of our American scientists and engineers, resulted in the employment of the ablest men in this country for work on these problems. Under the stimulus and guidance of these men, what seemed an impossible task of technical achievement for national defense was accomplished in time to bring victory. In the next war the required time may not exist. In this war it was accomplished, but barely in time. These men are still with us. Many, it is hoped, will remain with us after the war. They have seen the difficulties of the past. They plan to avoid them in the future. These plans envisage the following procedures:

(a) To establish such means of hiring by contract and under Civil Service that proper recruiting and selection of personnel comparable to those currently used by industry will be possible.

(b) To establish adequate pay grades comparable with industry.

(c) To establish classification and promotion systems

such that employees may be rated for technical efficiency as well as for administrative efficiency.

(d) To permit of liberal in-grade increase of salaries and to liberalize promotion procedures.

(e) To encourage membership of its technical personnel in technical societies, and to encourage participation in scientific meetings.

(f) To encourage, as far as possible, sound basic research and to permit very much wider publication of results of purely scientific interest. Despite the war conditions still existing, the Naval Ordnance Laboratory has, in the last six months, submitted in excess of a dozen papers for publication in scientific journals. Once the pressure of wartime production is eased, many more papers of considerable engineering value will be published.

(g) To encourage and achieve exchange of technical personnel for periods of the order of months to a year among industrial laboratories, scientific laboratories, and the defense-research laboratories.

(h) To facilitate advanced study of its junior personnel and to have scientific seminars with outside and local speakers.

(i) To organize a technical society on a classified level for all defense-research agencies.

(j) To arrange for work or study by its personnel at appropriate industrial and educational research laboratories.

(k) Not to encourage its personnel to remain too long in work of this character. That is, to hire able, brilliant, and capable young technical men, to train them, advance them as rapidly as possible, and to encourage them to seek outside employment at suitable times after, perhaps, intervals not to exceed ten years.

(l) To place the direction of technical research in the hands of competent technical men, and to reduce to a necessary minimum the administrative supervision of the nontechnical military personnel. On the other hand, to co-operate with them in the achievement of common objectives.

(m) To organize the laboratories in terms of stimulating scientific and technical groups, and to exchange duties within the laboratory, insofar as is consistent with good judgment, to broaden the background and experience of the personnel.

(n) To furnish the best of equipment and material facilities, including libraries, to its personnel.

(o) To encourage originality, genius, and enterprise among the technical employees to the utmost compatible with the accomplishment of the tasks in hand.

It is clear that, if these objectives can be achieved, the engineer engaged in technical defense research for the government will be better off than if employed in many smaller industries, and that in that measure the engineering profession will be benefited. In some directions indicated by this program, the government defense-research laboratories have already achieved material success. There is much more to be done in the future. With the understanding, endorsement, and support of the engineering profession, we stand a good chance of achieving complete success. We hope that we can count on that co-operation.

A Review of Plastic Materials*

HAROLD L. BROUSE†, MEMBER, I.R.E.

Summary—The spectacular growth of the plastics industry to its present state is a direct result of proved ability to meet war demands for critical items on a volume-production basis.

Common plastic materials are classified according to their thermal characteristics and the methods of fabrication.

Typical physical and electrical properties are presented for each of the general class of materials. It is pointed out that such values are average, and do not indicate the range that can be obtained by selection of a specific molding powder.

Common trade names, compositions, and their manufacturers are presented in the form of a cross-index for reference purposes.

Factors governing the performance and the choice of a particular material are discussed.

Expansion coefficients as applied to the use of metal inserts molded into the material, light transmission properties, and the fabrication of laminates are briefly treated in the Appendix.

INTRODUCTION

TREMENDOUS advances have been made during the past several years in all phases of the plastics industry. Briefly, new and improved molding powders have been developed by the basic-materials manufacturers; press equipment has been redesigned so as to afford better control of molding temperatures and pressures; radio-frequency dielectric heating has become an accepted practice; and new techniques in the art of molding have been conceived. Hence, today's production of plastics items for the armed forces typifies the efficient teamwork "behind the scenes" necessary to supply the best-equipped army in the world.

Plastics may be looked upon as an infant member of the large organic family; not new-born, but in a dynamic state of development today. In order to evaluate the qualities of new materials as they become available, one should be able to associate their properties with the characteristics of similar, older materials known from past experience.

CLASSIFICATION OF MATERIALS

While there is a variety of ways in which materials can be classified, the one most generally used is according to whether the material is hardened upon the application of heat; i.e., thermosetting, or whether it can be softened by reheating, viz., thermoplastic. Table I lists the principal types of materials in each of these two groups. Tables X and XI provide a cross-index of manufacturers, trade names, and compositions.

COLD-MOLDING COMPOUNDS

Cold-molding compounds comprise a group of materials which have been used extensively for more than two decades. As indicated by their name, the powder is

* Decimal classification: R281. Original manuscript received by the Institute, April 11, 1945.

† The Crosley Corporation, Cincinnati, Ohio.

TABLE I

PRINCIPAL THERMOSETTING MATERIALS

Allyl Resins	Melamine Formaldehyde
Aniline Formaldehyde	Phenol Formaldehyde
Casein	Phenol Furfural
Lignin	Urea Formaldehyde

PRINCIPAL THERMOPLASTIC MATERIALS

Amides (Nylon)
Cellulose Resins
Cellulose Acetate
Cellulose Acetate-Butyrate
Cellulose Nitrate
Ethyl Cellulose
Methyl Methacrylate
Polyethylene
Polyvinyl Alcohol
Shellac
Silicones
Styrene Resins
Polystyrene
Polystyrene base (Styramic)
Polydichlorostyrene (Styramic HT)
Styrene Copolymers
Cerax
Styraloy
Vinyl Aldehyde Resins
Polyvinyl Acetal
Polyvinyl Butyral
Polyvinyl Formal
Vinyl Ester Resins
Polyvinyl Acetate
Polyvinyl Chloride
Polyvinyl Chloride-Acetate
Vinylidene Chloride (Saran)

cold-pressed to shape in suitable dies, after which the "green" piece is subjected to an oven-baking operation. Owing to the high content of asbestos filler used in the compounds, the molded parts are extremely resistant to heat, and are widely used for such applications as connector plugs and handles, arc shields, and electrical heating-element supports. These compounds may be classified as shown in Table II.

TABLE II

COLD-MOLDING COMPOUNDS

1. Inorganic binder (refractory type)
 - a. Lime-silica cement base
2. Organic binder (nonrefractory type)
 - a. Bituminous base
 - b. Synthetic-resin base (phenolic, etc.)

FILLERS AND BASE MATERIALS

In most instances, a molding powder will contain a number of ingredients in addition to the resin itself, blended so as to facilitate molding and to impart desirable characteristics in the molded piece. Such compounds consist of fillers or extenders, catalysts, solvents, lubricants, plasticisers, etc. A filler may be used to obtain added impact strength, improved electrical properties,

or added heat resistance, depending upon the particular characteristic desired. Fillers become extenders when they are added merely to reduce the cost of the molding material by replacing a portion of the resin with a cheaper, inert material. On the other hand, laminates consist of a base material which is built up using a properly blended natural or synthetic resin as a binder and/or impregnant. Typical fillers used in molding powders and base materials used for laminates are indicated in Table III.

TABLE III
FILLERS AND BASE MATERIALS

Molding Compound Fillers		Laminated Base Materials
Alpha Cellulose	Linen Fabric	Asbestos
Asbestos	Mica	Cotton Fabric
China Clay	Sisal Fiber	Fiber-Glass
Cotton Flock	Silica	Linen
Cotton Fabric	Slate Dust	Macerates
Graphite	Tire Cord	Paper
Wood Flour		Wood Pulp
		Wood Veneers

METHODS OF FABRICATION

Progress in all phases of the industry has made possible new and higher productive methods of fabrication. Table IV shows the methods in use at the present time for handling thermosetting and thermoplastic materials.

TABLE IV
METHODS OF FABRICATION

Material Type	Method	
Thermosetting Materials	Casting	
	Compression Molding	
	Jet Molding	
	Laminates	High pressure, steam cure
		High pressure, radio-frequency cure
		Low pressure, bag molding
		Contact pressure
Macerates and Pulp Molding		
Post Forming of Laminates		
Transfer Molding		
Thermoplastic Materials	Blowing	
	Calendering	
	Compression Molding	
	Deep Drawing	
	Extrusion Molding	
	Film Casting	
	Injection Molding	
	Post Forming	
	Pressing	

Naturally, all of the fabrication methods are not used for any single material since these methods cover those processes which have been developed to meet specific needs. However, certain groupings are evident; e.g., thermosetting materials which are compression molded can, likewise, be transfer molded or jet molded, provided the filler is not too bulky. By the same token, most thermoplastic materials, which can be injection molded, can be extruded.

The more common methods of fabrication applicable to each of the plastics groups are presented in Table V.

TABLE V
FABRICATION METHODS APPLICABLE TO VARIOUS PLASTIC MATERIALS

	Casting	Impregnating Resins	Compression Molding	Injection ¹	Extrusion	Calendering	Blowing	Pressing	Film
<i>Thermosetting Materials</i>									
Allyl Resins	X	X							
Aniline Formaldehyde			X						
Casein			X					X	
Lignin		X	X						
Melamine Formaldehyde		X	X						
Phenol Formaldehyde	X	X	X						
Phenol Furfural	X	X	X						
Silicones		X							
Urea Formaldehyde		X	X						
<i>Thermoplastic Materials</i>									
Amides (Nylon)				X	X				
Cellulose Acetate			X	X	X		X		X
Cellulose Acetate Butyrate			X	X	X		X		X
Cellulose Nitrate			X				X		X
Ethyl Cellulose	X		X	X	X		X		X
Methyl Methacrylate	X		X	X	X		X		
Polvinyl Alcohol	X		X		X				
Polyethylene				X	X				X
Shellac			X					X	
Styrene Polymers			X	X	X		X		
Vinyl Aldehydes			X	X	X		X		
Vinylidene Chloride (Saran)			X	X	X				X
Vinyl Esters			X	X	X		X		

¹ Machines have been developed to permit the injection molding of thermosetting materials, but are not in common use at this time.

CHOICE OF A PLASTIC MATERIAL

A number of factors must be taken into account in order to arrive at the proper choice of a plastic material for a given application. These factors may be combined into four separate groups consisting of physical properties, electrical properties, eye appeal, and cost.

Physical properties, described in handbook form and in manufacturers' literature, have been carefully determined from laboratory samples tested according to the American Society for Testing Materials standards. Values will be found to cover a wide range for each material because of two principal factors:

1. The actual molding of a material under different conditions of temperatures and pressures will produce widely different results. For example, a tensile-strength range of from 5000 to 9000 pounds per square inch may be obtained with polystyrene. It is logical to assume that one should consistently obtain a strength figure of 7000 pounds per square inch in production.

2. Many materials are formulated to meet specific requirements requiring increased moldability, heat resistance, dimensional stability, etc. A handbook presentation of the characteristics for such a material must include all

of those values which can be obtained from each formulation. Cellulose acetate typifies this kind of a material, in that molding powders can be obtained having varying degrees of hardness, temperature resistance, and cold flow after molding.

Hence, variations may appear in the molding of test-specimen bars, from which the physical characteristics are determined. An additional variation appears in a molded item due to flow within the die during molding. It is apparent, therefore, that final judgment of a given material must be reserved for test results on the molded product, particularly if the safety factor is marginal.

Variation in the electrical properties comes about in much the same manner as those found to occur in the physical properties. However, these are of a less serious nature once the proper formulation is selected and the design is based upon its choice, whether such a choice involves dielectric constant, arc-tracking resistance, power factor, or dielectric strength.

The use of a plastic material, because of its beauty, involves an intangible factor in its choice which we have called "eye appeal." Eye appeal, at first sight, becomes sales appeal and results from styling, warmth or coolness of color, and "feel." The last factor can best be described as a finish which imparts life, is pleasant to touch, and is devoid of a dull or greasy luster. Once sales appeal has been effected, eye appeal must be supported by the physical characteristics of the material to maintain its surface finish under service conditions. This involves resistance to scratching, permanence of color, and dimensional stability.

The final determining factor for the use of any material is the cost of the finished product. Cost may be broken down into (1) capital investment, (2) personnel, (3) material cost, (4) hourly production, (5) finishing, and (6) packaging. If the choice lies between a suitable thermosetting material and a comparable thermoplastic purely on the basis of cost, one must pay particular attention to items (3), (4), and (5) above.

Actually, what is taking place today is an attempt to develop thermosetting-material equipment which will give the production obtainable from injection equipment used for thermoplastics and, in turn, thermoplastic-materials manufacturers are trying to approach the more important characteristics found in the thermosetting powders in the form of increased temperature resistance, higher impact values, and price reductions. Postwar production methods are certain to require analysis to be based solely on the particular item in question, and such an analysis must take into account all of those factors previously mentioned in order to obtain a clear-cut picture.

PROPERTIES OF MATERIALS

Tables VI, VII, and VIII indicate the outstanding properties of various materials; their physical properties, and their electrical properties, respectively. Table

IX lists typical characteristics for laminated products. An average figure was chosen from handbook and manufacturers'-test data, and is tabulated as a single value for each characteristic. Since single values cannot indicate the possible range obtainable or available, these values must be used qualitatively.

TABLE VI
OUTSTANDING PROPERTIES FOR VARIOUS
PLASTIC MATERIALS

<i>Material</i>	<i>Properties</i>
Allyl Resins	Clarity, hard surface, excellent optical properties. An impregnant for laminates.
Aniline Formaldehyde	Moisture and chemical resistance, improved dielectric properties.
Casein	Nonflammable, easy to machine and polish.
Lignin	Excellent extender in phenolics. Adhesive for laminates.
Melamine Formaldehyde	Hard surface, solvent resistance, arc-tracking resistance.
Phenol Formaldehyde	High impact, minimum cold flow, heat and chemical resistance.
Phenol Furfural	Initially developed as a substitute for phenol formaldehyde; has excellent molding qualities with heat, chemical, and moisture resistance.
Urea Formaldehyde	Flexural and tensile strength, solvent resistance, hardness and light-diffusion properties.
Amides (Nylon)	Heat resistance, chemical resistance, tough, moldable in very thin sections.
Cellulose Acetate	Good impact strength and mar resistance. Easy to mold.
Cellulose Acetate-Butyrate	Dimensional stability, smooth surface finish. High impact strength.
Cellulose Nitrate	Toughness, water resistance, easily fabricated.
Ethyl Cellulose	High impact strength, widely soluble.
Methyl Methacrylate	Cast sheets, good electrical properties, outdoor aging resistance, excellent optical properties.
Polydichlorostyrene	Characteristics similar to polystyrene plus high heat resistance.
Polyethylene	High impact, flexibility at low temperatures, excellent electrical properties.
Polystyrene	Excellent electrical properties, moisture resistance, optical properties.
Saran	High tensile strength. Chemical resistance.
Shellac	Scratch resistance, resilience, smooth finish.
Silicones	Resin used as impregnant with inorganic insulation. Provides high heat resistance, attendant with good electrical properties.
Styrene Copolymers Cerex	Physical properties equivalent to polystyrene, electrical properties better than most thermosetting materials, high temperature resistance.
Styraloy	Excellent low-temperature flexibility with heat and corona resistance.
Vinyls	Rigid forms to liquid resins. Adhesives, wire coatings, fabric coatings, sheets. Chemical resistance, flexibility at low temperature.

TABLE VII
TYPICAL PHYSICAL PROPERTIES FOR THERMOSETTING MATERIALS

Material	Impact-Izod; foot pounds per inch of notch	Compression strength; pounds per square inch	Tensile strength; pounds per square inch	Flexural strength; pounds per square inch	Maximum deflection; inches	Rockwell hardness; ¹ M-scale	Continuous operating temperature; degrees Fahrenheit	Specific gravity	Approximate cost per pound
Allyl Resin									
Cast Stock	0.35	23,000	5500	9000	—	95	176	1.31	1.00
Aniline Formaldehyde	0.30	22,000	10,000	15,000	—	115	225	1.21	0.35
Casein	1.0	—	9000	—	—	—	160	1.35	—
Melamine Formaldehyde									
Alpha Cellulose	0.26	22,000	7500	14,000	0.062	120	210	1.49	0.52
Cotton Fabric	0.68	23,000	7000	14,000	0.049	110	225	1.40	0.55
Mineral Filled	0.31	20,000	6000	9300	0.021	110	350	1.98	0.53
Phenolics									
General Purpose	0.32	26,000	7000	11,000	0.060	113	250	1.38	0.18
Improved Impact	0.53	26,000	7500	12,000	0.065	100	250	1.36	0.26
Medium Impact	1.30	30,000	7500	12,000	0.068	100	240	1.38	0.31
High Impact	6.00	30,000	6500	13,000	0.095	100	230	1.35	0.43
Electrical	0.35	25,000	6000	9000	0.020	110	300	1.76	0.26
Chemical Resistant	0.20	27,000	6000	10,500	0.065	100	300	1.24	0.19
Heat Resistant	0.30	25,000	4200	7500	0.015	110	450	1.74	0.16
Urea Formaldehyde									
Alpha Cellulose	0.26	22,000	6000	15,000	0.065	120	180	1.45	0.35

¹ ASTM-D-48-39; $\frac{1}{4}$ -inch-diameter ball, 10-kilogram static load, 100-kilogram added load. This value does not indicate surface-scratch resistance.

TYPICAL ELECTRICAL PROPERTIES FOR THERMOSETTING MATERIALS

Material	Volume resistivity; ohm-centimeter	Per cent power factor at 1 megacycle	Dielectric constant at 1 megacycle	Dielectric strength; volts per mil; $\frac{1}{4}$ -inch-thick sample; 60 cycles	Water absorption; per cent 24 hours
Allyl Resin					
Cast Stock	10^{11}	5.6	3.5	450	0.30
Aniline Formaldehyde	10^{12}	0.6	3.5	600	0.08
Casein	—	5.2	6.3	500	12.0
Melamine Formaldehyde					
Alpha Cellulose	10^{12}	2.9	7.0	300	0.7
Cotton Fabric	10^{11}	4.1	7.2	270	1.0
Mineral Filled	10^{13}	2.8	5.8	440	0.07
Phenolics					
General Purpose	10^{11}	4.0	5.0	400	0.7
Improved Impact	10^{10}	4.0	5.0	350	0.7
Medium Impact	10^{10}	6.0	6.0	300	1.0
High Impact	10^9	7.0	7.0	250	1.5
Electrical	10^{13}	0.85	4.0	450	0.03
Chemical Resistant	10^{10}	6.0	5.0	300	0.20
Heat Resistant	10^{10}	5.0	5.0	250	0.24
Urea Formaldehyde					
Alpha Cellulose	10^{10}	2.7	6.6	300	2.0

TABLE VIII
TYPICAL PHYSICAL PROPERTIES FOR THERMOPLASTIC MATERIALS

Material	Impact-Izod; foot-pounds per inch notch	Compression strength; pounds per square inch	Tensile strength; pounds per square inch	Flexural strength; pounds per square inch	Rockwell ¹ hardness; M-scale	Continuous operating temperature; degrees Fahrenheit	Specific gravity	Approximate cost per pound
Amides (Nylon)	0.94	18,000	7000	12,500	90	250	1.14	\$2.60
Cellulose Acetate	4.2	13,000	6000	10,000	40	160	1.3	0.48
Cellulose Acetate-Butyrate	5.0	15,000	6000	8000	30	170	1.2	0.53
Cellulose Nitrate	5.0	25,000	7500	9000	40	140	1.4	0.40
Ethyl Cellulose	6.5	11,000	7500	9500	40	170	1.1	0.70
Methyl Methacrylate	0.6	12,000	7000	15,000	90	155	1.2	0.85
Polyethylene	3.5	3000	1700	1700	29	200	0.92	0.85
Polyvinyl Alcohol	—	—	4000	—	—	200	1.25	—
Shellac	2.7	13,000	1500	—	—	175	1.90	0.15
Styrene Resins								
Polystyrene	0.4	14,000	7000	12,000	85	160	1.06	0.37
Polystyrene Base (Styramic)	0.3	11,000	3300 ²	6500	72	180	1.36	0.70
Polydichlorostyrene (Styramic HT)	—	—	—	—	103	230	1.38	—
Styrene Copolymers								
Cerex	0.46	—	—	13,000	100	215	1.07	5.60
Styroloy	1.5	—	1000	—	—	145	0.96	—
Vinyls ²	—	11,000	9000	12,000	20	130	1.30	0.75
Vinylidene Chloride	6.5	8000	5500	16,000	55	180	1.7	1.00

¹ This value does not indicate surface-scratch resistance.

² These materials are available in rigid to flexible forms, dependent upon compounding. Values given typify the flexible type of material.

TYPICAL ELECTRICAL PROPERTIES OF THERMOPLASTIC MATERIALS

Material	Volume resistivity; ohm-centimeter	Per cent power factor; 1 megacycle	Dielectric constant; 1 megacycle	Dielectric strength; volts per mil $\frac{1}{8}$ -inch section; 60 cycles	Water absorption; per cent in 24 hours
Amides (Nylon)	10 ¹³	5.5	4.0	400	1.5
Cellulose Acetate	10 ⁹	3.0	4.0	375	4.0
Cellulose Acetate-Butyrate	10 ⁹	3.0	4.7	325	1.7
Cellulose Nitrate	10 ¹¹	8.5	6.2	600	1.7
Ethyl Cellulose	10 ¹⁶	2.5	3.2	600	1.5
Methyl Methacrylate	10 ¹⁵	1.5	2.8	500	0.5
Polyethylene	10 ¹⁷	0.03	2.3	900	0.01
Shellac	10 ⁹	5.0	4.5	400	—
Styrene Resins					
Polystyrene	10 ¹⁸	0.02	2.6	600	0.05
Polystyrene Base (Styramic)	—	0.04	2.5	—	0.046
Polydichlorostyrene (Styramic HT)	—	0.02	2.6	—	0.03
Styrene Copolymers					
Cerex	—	0.24	2.7	500	0.30
Styraloy	10 ²⁰	0.07	2.6	700	0.02
Vinylidene Chloride	10 ¹⁵	4.0	4.0	350	0.09

TABLE IX
TYPICAL PHYSICAL PROPERTIES OF LAMINATES

Base material	Impact; foot-pounds per inch of notch	Compression strength; pounds per square inch	Tensile strength; pounds per square inch	Flexural strength; pounds per square inch	Rockwell hardness; M-scale	Water absorption; per cent 24 hours	Specific gravity
		<i>Phenol Formaldehyde Resin</i>					
Paper	1.0	26,000	11,000	18,000	100	2.5	1.34
Cotton Fabric	3.0	33,000	11,000	19,000	100	2.0	1.35
Asbestos Cloth	2.5	38,000	9000	18,000	95	1.5	1.60
Glass Fabric	6.5	44,000	17,000	23,000	110	0.40	1.50

TABLE IX—continued
TYPICAL PHYSICAL PROPERTIES OF LAMINATES

Base material	Impact; foot-pounds per inch of notch	Compression strength; pounds per square inch	Tensile strength; pounds per square inch	Flexural strength; pounds per square inch	Rockwell hardness; M-scale	Water absorption; per cent 24 hours	Specific gravity
Paper	1.0	31,000	<i>Allyl Resin</i> 11,000	16,000	94	2.4	1.40
8-ounce Duck	3.6	29,000	7200	13,000	72	1.5	1.37
Glass Fabric	22.7	60,000	41,000	21,000	96	0.40	1.77
1/45-inch Birch, phenolic film	12.4	<i>Phenol Formaldehyde Bonded Wood Veneers</i> 20,000		6000	—	3.8	1.38
1/16-inch Maple, liquid resin	10.0	10,000	30,000	3700	—	8.8	1.37
1/4-inch Maple, impregnated	6.0	20,000	27,000	4000	—	4.0	1.30
Untreated Birch	—	6200	10,000	2000	—	—	0.63

TABLE X

TRADE NAMES AND MANUFACTURERS

	<i>Allyl Resins</i>	Catalin	<i>Melamine Formaldehyde</i>
Allymer CR-39, CR-149, CR-170	Pittsburgh Plate Glass Company	Melmac	Catalin Corporation
MR-1, MR-1A, MR-17	Marco Chemicals, Inc.	Plaskon Melamine Resimene 803A	American Cyanamid Company
	<i>Amides</i>		Plaskon Company, Inc.
Nylon	E. I. Dupont Company		Monsanto Chemical Company
	<i>Aniline Formaldehyde</i>		<i>Methyl Methacrylate (Acrylics)</i>
Cibanite	Ciba Products Company	Lucite	E. I. DuPont Company
Dilectene	Continental Diamond Fiber Company	Plexiglas	Rohm and Haas Company
	<i>Casein</i>	Plexigum	Rohm and Haas Company
Amercid	American Plastics Corporation	Textolite	General Electric Company
Gala	George Morrell Corporation	Vernonite (Denture)	Rohm and Haas Company
Galorn	George Morrell Corporation		<i>Phenol Formaldehyde</i>
	<i>Cellulose Acetate</i>		<i>Molding Compounds</i>
Bakelite	Bakelite Corporation	Bakelite	Bakelite Corporation
Chemaco	Chemaco Corporation	Co-ro-lite	Columbian Rope Company
Durashield	Plastics Fabricators, Inc.	Durez	Durez Plastics and Chemicals
Fibestos	Monsanto Chemical Company	Durite	Durite Plastics Company
Hercules	Hercules Powder Company	Heresite	Heresite and Chemical Company
Lumapane	Celanese Celluloid Corporation	Indur	Reilly Tar and Chemical Corporation
Lumarith	Celanese Celluloid Corporation	Insurok	Richardson Company
Nixonite	Nixon Nitration Works	Kys-ite	Keyes Fibre Company
Plastacele	E. I. DuPont Company	Makalot	Makalot Corporation
Tenite I	Tennessee Eastman Corporation	Neillite	Watertown Manufacturing Company
Textolite	General Electric Company	Resinox	Monsanto Chemical Company
	<i>Cellulose Acetate-Butyrate</i>	Textolite	General Electric Company
Tenite II	Tennessee Eastman Corporation	<i>Resins</i>	
Textolite	General Electric Company	Amberlite	Resinous Products and Chemical Company
	<i>Cellulose Nitrate</i>	Bakelite	Bakelite Corporation
Celluloid	Celanese Celluloid Corporation	Baker Resin	Baker Oil Tools, Inc.
Herculoid	Hercules Powder Company	Catabond	Catalin Corporation
Nitron	Monsanto Chemical Company	Catalin	Catalin Corporation
Nixonoid	Nixon Nitration Works	Catavar	Catalin Corporation
Pyralin	E. I. DuPont Company	Gemstone	A. Knoedler Company
Vimlite	Celanese Celluloid Corporation	Haveg	Haveg Corporation
	<i>Ethyl Cellulose</i>	Indur Varnish	Reilly Tar and Chemical Corporation
Chemaco	Chemanaco Corporation	Marblette	Marblette Corporation
Ethocel	Dow Chemical Company	Opalon	Monsanto Chemicals Company
Ethofoil	Dow Chemical Company	Prystal	Catalin Corporation
Hercules E C	Hercules Powder Company	Tego	Resinous Products and Chemicals Company
Lumarith E C	Celanese Celluloid Corporation		<i>Phenol Furfural</i>
	<i>Lignin</i>	Durite	Durite Plastics
Benalite	Masonite Corporation	Resin X	Plastics Industry Technical Institute
Catapak	Catalin Corporation		<i>Polyethylene</i>
Lignolite	Marathon Chemical Company	Polythene	E. I. DuPont Company
		Polyethylene	Carbide and Carbon Chemical Company
			<i>Polystyrene and Derivatives</i>
		Amphenol	American Phenolic Corporation
		Bakelite	Bakelite Corporation
		Cerex	Monsanto Chemicals Company
		Chemaco	Chemaco Corporation

TABLE X—continued
TRADE NAMES AND MANUFACTURERS
Polystyrene and Derivatives—continued

Loalin	Catalin Corporation
Lustron	Monsanto Chemical Company
Plax	Plax Corporation
Styramic X214	Monsanto Chemical Company
Styramic HT	Monsanto Chemical Company
Styraloy	Dow Chemical Company
Styrofoam	Dow Chemical Company
Styron	Dow Chemical Company
	<i>Polyvinyl Acetal</i>
Alvar	Shawinigan Products Corporation
	<i>Polyvinyl Acetate</i>
DuPont Polyvinyl	E. I. DuPont Company
Gelva	Shawinigan Products Corporation
Vinylite A	Carbide and Carbon Chemical Company
Vinylseal	Carbide and Carbon Chemical Company
	<i>Polyvinyl Alcohol</i>
Compar	Resistoflex Corporation
PVA	E. I. DuPont Company
Resistoflex	Resistoflex Corporation
	<i>Polyvinyl Butyral</i>
Buticite	E. I. DuPont Company
Butvar	Shawinigan Products Corporation
Saflex	Monsanto Chemical Company
Vinylite X	Carbide and Carbon Chemical Company
	<i>Polyvinyl Chloride</i>
Geon 100 Series (Koro-seal, etc.)	B. F. Goodrich Company
Vinylite Q	Carbide and Carbon Chemical Company
	<i>Polyvinyl Chloride Acetate</i>
Vinylite V	Carbide and Carbon Chemical Company
Vinyon	Carbide and Carbon Chemical Company
	<i>Polyvinyl Formal</i>
Formex	General Electric Company
Formvar	Shawinigan Products Corporation
	<i>Shellac</i>
Complac	Poinsettia, Incorporated
Compo-Site	Compo-Site, Incorporated
Harvite	Siemon Company
Lacanite	Consolidated Molded Products Company
	<i>Silicones</i>
Silicones	Dow-Corning Company
	<i>Urea Formaldehyde</i>
Bakelite	Bakelite Corporation
Beetle	American Cyanamid Company
Insurok	Richardson Company
Makolot	Makolot Corporation
Plaskon	Libby-Owens-Ford Glass Company
Textolite	General Electric Company
Uformite	Resinous Products and Chemicals Company
Urac	American Cyanamid Company
	<i>Vinyls—General</i>
Chemaco	Chemaco Company
Gemflex	Gemloid Corporation
Gemloid	Gemloid Corporation
Synflex	Industrial Synthetics Corporation
Vynate	Monsanto Chemical Company
	<i>Vinyl Vinylidene Chloride</i>
Geon 200 Series	B. F. Goodrich Company

TABLE X—continued
TRADE NAMES AND MANUFACTURERS

	<i>Vinylidene Chloride</i>
Saran	Dow Chemical Company
Vec	Pierce Plastics, Incorporated
Velon	Firestone Rubber and Laytex Company
	<i>Laminates</i>
Aqualite	National Vulcanized Fibre Company
Celoron	Continental-Diamond Fibre Company
Dilecto	Continental-Diamond Fibre Company
Duraloy	Detroit Paper Products Corporation
Farlite	Farley and Loetscher Manufacturing Company
Formica	Formica Insulation Company
Insurok	Richardson Company
Lamicoid	Mica Insulator Company
Lamitex	Franklin Fibre-Lamitex Corporation
Micarta	Westinghouse Manufacturing Corporation
Ohmoid	Wilmington Fibre Specialty Company
Panelyte	St. Regis Paper Company
Papreg	Forest Products Company
Phenol Fibre	Penn Fibre and Specialty Company
Phenolite	National Vulcanized Fibre Company
Plastiply	Haskelite Manufacturing Corporation
Pluswood	Pluswood, Incorporated
Plymetl	Haskelite Manufacturing Corporation
Plymold	Haskelite Manufacturing Corporation
Ply-Tech	Technical Ply-Woods Company
Polyflex	Plax Corporation
Preg-Tech	Technical Ply-Woods Company
Pregwood	Formica Insulation Company
Resnprest	Plylock Corporation
Revolite	Atlas Powder Company
Spauldite	Spaulding Fibre Company
Synthane	Synthane Corporation
Taylor	Taylor Fibre Company
Textolite	General Electric Company
Ucinite	United-Carr Fastener Company

TABLE XI
TRADE NAMES AND COMPOSITION

Allymer CR-39, CR-149, CR-170	Allyl Resin
Alvar	Polyvinyl Acetal
Amberlite	Phenol Formaldehyde
Ameroid	Casein
Amphenol	Polystyrene
Aqualite	Phenolic Laminates
Bakelite	Thermosetting and Thermoplastic Materials
Baker Resin	Phenol Formaldehyde
Beetle	Urea Formaldehyde
Benalite	Lignin Sheet
Butacite	Polyvinyl Butyral
Butvar	Polyvinyl Butyral
Catabond	Phenol Formaldehyde
Catalin	Phenol Formaldehyde, Urea Formaldehyde
Catapak	Lignin
Catavar	Phenol Formaldehyde Varnish
Celluloid	Cellulose Nitrate
Celoron	Thermosetting Laminates
Cerex	Polystyrene Copolymer
Chemaco	Thermoplastic Materials
Cibanite	Aniline Formaldehyde
Compar	Polyvinyl Alcohol Base
Complac	Shellac
Compo-site	Shellac
Co-ro-lite	Phenol Formaldehyde
Dilectene	Aniline Formaldehyde
Dilecto	Phenolic Laminates
DuPont Polyvinyl	Polyvinyl Acetate
Duraloy	Phenolic Laminates

TABLE XI—continued
TRADE NAMES AND COMPOSITION

Durashield	Cellulose Acetate
Durez	Phenolic Laminates
Durite	Phenol Formaldehyde, Phenol Furfural
Ethocel	Ethyl Cellulose
Ethofoil	Ethyl Cellulose
Farlite	Phenolic Laminates
Fibestos	Cellulose Acetate
Formex	Polyvinyl Formal
Formica	Phenolic Laminates
Formvar	Polyvinyl Formal
Gala	Casein
Galorn	Casein
Gelva	Polyvinyl Acetate
Gemflex	Vinyls
Gemloid	Vinyls
Gemstone	Phenol Formaldehyde
Geon 100 Series	Polyvinyl Chloride
Geon 200 Series	Vinyl Vinylidene Chloride
Haveg	Phenol Formaldehyde
Harvite	Shellac
Hercules	Cellulose Acetate, Ethyl Cellulose
Herculoid	Cellulose Nitrate
Heresite	Phenol Formaldehyde
Indur	Phenol Formaldehyde
Insurok	Phenolic and Urea Laminates
Koroseal (Geon 100 Series)	Polyvinyl Chloride
Korogel (Geon 100 Series)	Polyvinyl Chloride
Kys-ite	Phenol Formaldehyde
Lacanite	Shellac
Lamicoid	Phenolic Laminates
Lamitex	Phenolic Laminates
Lignolite	Lignin
Loalir	Polystyrene
Lucite	Methyl Methacrylate
Lumapane	Cellulose Acetate
Lumarith	Cellulose Acetate, Ethyl Cellulose
Lustron	Polystyrene
Makalot	Phenol Formaldehyde, Urea Formaldehyde
Marblette	Phenol Formaldehyde
Melmac	Melamine Formaldehyde
Melurac	Melamine-Urea Resin
Micarta	Phenolic Laminates
MR1, MR1A, MR-17	Allyn Resin
Neillite	Phenol Formaldehyde
Nitron	Cellulose Nitrate
Nixonoid	Cellulose Nitrate
Nixonite	Cellulose Acetate
Nylon	Polyamide
Ohmoid	Phenolic Laminates
Opalon	Phenol Formaldehyde
Panelyte	Phenolic Laminates
Papreg	Laminated Paper
Phenol Fibre	Phenolic Laminates
Phenolite	Phenolic Laminates
Plaskon	Urea Formaldehyde, Melamine Formaldehyde
Plastacele	Cellulose Acetate
Plastipty	Resin Covered Plywood
Plexiglas	Methyl Methacrylate
Plexigum	Methyl Methacrylate
Plax	Polystyrene
Pluswood	Impregnated Plywood
Plymetl	Metal Bonded to Plywood
Plymold	Resin Bonded Plywood
Ply-Tech	Resin Bonded Plywood
Polyflex	Thermosetting Laminates
Polythene	Polyethylene
Preg Tech	Impregnated Wood
Pregwood	Impregnated Wood
Prystal	Impregnated Wood
PVA	Polyvinyl Alcohol
Pyralin	Cellulose Nitrate

TABLE XI—continued
TRADE NAMES AND COMPOSITION

Resimene 803A	Melamine Formaldehyde
Resin X	Liquid Furfural Resin
Resinox	Phenol Formaldehyde
Resistoflex	Polyvinyl Alcohol
Resnprest	Resin Bonded Plywood
Revolite	Phenolic Laminates
Saflex	Polyvinyl Butyral
Saran	Vinylidene Chloride
Silicons	Organo-Silicon Oxide Polymers
Spauldite	Phenolic Laminates
Styramic HT	Polydichlorostyrene
Styrofoam	Expanded Polystyrene
Styron	Polystyrene
Styraloy	Elastomeric Polystyrene Copolymer
Styramic X214	Polystyrene Base
Synflex	Vinyls
Synthane	Phenolic Laminates
Taylor	Phenolic Laminates
Tego	Phenolic Impregnated Tape
Tenite I	Cellulose Acetate
Tenite II	Cellulose Acetate—Butyrate
Textolite	Thermosetting and Thermoplastic Materials
Ucinite	Phenolic Laminates
Urformite	Urea Formaldehyde
Urac	Urea Formaldehyde
Vec	Vinylidene Chloride Resins
Velon	Vinylidene Chloride Resins
Vernonite	Methyl Metacrylate (Denture)
Vimlite	Cellulose Nitrate
Vinylite	Vinyl Materials
Vinylseal	Polyvinyl Acetate
Vinyon	Polyvinyl Chloride Acetate
Vynate	Vinyl Materials

CONCLUSION¹

No attempt has been made to present a comprehensive review of the plastics field, but, rather, to offer a progressive series of tabulations for the materials in common use today and to show their classifications, one with respect to another. From these general characteristics one can choose those materials which appear to offer possibilities for the application under consideration and obtain their specific characteristics from manufacturers' test information.

In conclusion, plastics should be used only on the basis of their own merits; utility should not be sacrificed for cost. Observance of such a policy will establish a firm footing for their continued use and the public will not come to regard plastics as a group of low-cost substitutes.

APPENDIX

EXPANSION COEFFICIENTS

The use of metal inserts in molded plastics is common practice, wherein the insert is set into position in the die prior to actual molding. The efficiency of such an insert depends upon its function and the type of requirements placed upon the bond between the metal and the plastic.

¹ The trade names or trade-marks and the identity of the products and manufacturers listed herein were developed from the best sources available to the writer. No responsibility is assumed for any error in spelling or in the identity of the product or source, or for any omissions of individual products or manufacturers.

When the bond is one of a mechanical nature, design is confined to the type and amount of serration or perforation to be used on the metal insert in keeping with the flow characteristics of the plastic material. However, if the bond must also withstand liquid or gas pressures, the difference in expansion coefficients existing between the metal and the plastic must be given serious consideration. From the list of coefficients for common materials, given in Table XII, it can be seen that definite limitations exist, and generally, some kind of a third material must be used between the plastic and metal to serve as a compliant, gas tight member.

TABLE XII

EXPANSION COEFFICIENTS PER 100 DEGREES CENTIGRADE

Alluminum	0.0023	Ethyl Cellulose	0.012
Copper	0.0017	Melamine Formaldehyde	0.002
Glass	0.00085	Methyl Methacrylate	0.008
Mercury	0.018	Nylon	0.010
Porcelain	0.00036	Phenol Formaldehyde	0.005
Silver	0.0019	Polyethylene	0.019
Steel	0.0012	Polystyrene	0.007
Cellulose Nitrate	0.011	Saran	0.016
Cellulose Acetate	0.012	Urea Formaldehyde	0.003

LIGHT TRANSMISSION AND OPTICS

Certain members of the thermosetting group have become well recognized for their light-diffusing properties. For example, urea formaldehyde has been used to make lamp reflector-bowls, and marketed in large quantities.

Acetate film lends itself well to the making of color screens, due to the uniformity of color and the ease with which varying shades can be controlled.

Methyl methacrylate and polystyrene have the required clarity to transmit light around curves, which property is utilized in medical instruments, edge-lighted signs, instrument panels, etc.

Edge-lighted dials obtain their effect by the use of offset numerals and designs, which pick up the light to present a controlled illuminated area. Such parts may be compression-molded to avoid stress and flow lines which might be apparent in an injection-molded piece.

Polystyrene is injection-molded into faceted forms for costume jewelry. It is superior to methacrylate for such items because of its greater scratch resistance and surface hardness.

The most critical of all applications involves the manufacture of optical lenses. Injection-molding is satisfactory for the manufacture of common magnifying glasses; whereas, compression-molding techniques must be used for higher-quality lenses because of the greater freedom from internal stress. Multiple-element lens systems which must meet rigid optical specifications are made either by the grinding of the lens from cast blanks or the direct casting of the lens, using optically ground molds. The most common materials for these applications are the methacrylates and the polystyrenes. Allyl resins offer excellent possibilities for the casting of lenses

when the material becomes available, since it provides greater abrasion resistance.

The principal precautions that must be observed in the manufacture and the use of plastic lenses involve (1) stress relief and complete polymerization; (2) parts must be mounted so as to allow for expansion and contraction with temperature; (3) housings for the lens assemblies should be dust-proof; and (4) extreme care must be exercised if cleaning of a particular surface is necessary.

The use of the methacrylates or polystyrene for reflecting mirrors falls into the same category of equipment as lenses. Such pieces can be readily molded or cast, using an optical surface on the male part of the die. The current problem involves deposition of the reflecting metal film on the plastic. Once this is accomplished economically, quantity-production reflector costs can be reduced below the cost for large, all-metal, plated reflectors or silvered-glass mirrors in use today.

LAMINATES

Flat sheets, rods, and tubes built up from paper, fabric, and wood veneers, using various animal and vegetable glues, have been available for some years. However, during the past several years, new synthetic-resin binders, new base materials, and new methods of fabrication have resulted in vastly improved products.

Generally speaking, the fabrication of laminated products makes use of one of the following methods: (1) high pressure (1500 to 3000 pounds per square inch), 300 degrees Fahrenheit, steam heat, press cure; (2) high pressure, radio-frequency heat cure; (3) low pressure (15 to 75 pounds per square inch), bag molding, steam autoclave-cure, 300 degrees Fahrenheit; (4) contact pressure (15 pounds per square inch or less), 140 to 250 degrees Fahrenheit oven cure.

In the use of the high-pressure method, materials may be resin bonded and/or resin impregnated. Wood veneers 1/80- to 1/30-inch thick are bonded by resin film placed between the layers of ply; veneers 1/30- to 1/16-inch in thickness are usually coated with a liquid resin; whereas, thicknesses of 1/16- to 1/8-inch must be impregnated by complete immersion. The technique is, therefore, dictated by the amount of resin that can be forced into a given thickness of material.

After stacking the veneers between the press platens, thermocouples are placed between the plies throughout the stack height, to permit temperature control on the outer surfaces and to determine when the proper temperature is reached at the center of the stack. When the resin has cured, the press temperature must be reduced so as to permit the center of the stack to reach approximately 140 degrees Fahrenheit before the pressure can be released. Curing time approximates one hour per inch of thickness. Radio-frequency heating must be used for sections greater than two inches thick.

Low-pressure and contact-pressure molding have been

made feasible by the development of resins which have higher penetrating power and will set up with or without the application of external heat. The reduction of time, temperature, and pressure has resulted in the economical production of large, laminated, curved structures approaching the strengths of sheet metals. Complete boat hulls and plane sections made in this manner have given excellent service in battle engagements.

In the bag-molding method, any of the resin impregnated materials previously indicated in Table III may be formed around a male core or within a female die. The die may be made from wood, metal, cast resin, or plaster, depending upon expected service life. A rubber bag or "blanket" is then used to act as the mating member of the die, either as the female or the male part, respectively. Upon evacuation of the air between the "blanket" and the material being formed, the bag serves to transmit a uniform pressure over the surface of the material to be formed and cured, and, furthermore, prevents contact of the resin with live steam in the autoclave, when used. Other methods of holding the wrapped material in place without the use of the bag process have been developed.

Low-pressure and contact molding have been developed during the past several years, and their use has been confined to war applications. They offer possibilities in the furniture field sufficient to cause considerable concern among the furniture manufacturers at this time, and it is certain that future applications depend only upon the ingenuity of the molder.

Bibliography

- (1) Herbert R. Simonds and Carleton Ellis, "Handbook of Plastics," D. Van Nostrand Company, Inc., New York, N. Y., 1943.
- (2) "Technical Data on Plastic Materials," Plastics Materials Manufacturers' Association, Washington, D. C., May, 1943.
- (3) George K. Scribner, "A Ready Reference for Plastics," Boonton Molding Company, Boonton, N. J., 1944.
- (4) "Plastics Catalog," Plastics Catalog Corporation, New York, N. Y., 1944.
- (5) "Rapid, continuous injection of thermosetting materials," *Modern Plastics*, vol. 21, pp. 90-91; January, 1944.
- (6) C. L. Jones, "A new series of thermoplastic resins," *Modern Plastics*, vol. 21, pp. 83-168; July, 1944.
- (7) Carrol C. Sachs, "High-, low- and no-pressure laminates," *Modern Plastics*, vol. 21, pp. 80-174; July, 1944.
- (8) C. L. Jones and M. A. Brown, "A new high temperature styrene," *Modern Plastics*, vol. 21, pp. 93-168; August, 1944.
- (9) "Continuous injection molding and extruding," *Plastics*, vol. 1, pp. 74-108; October, 1944.
- (10) "Machine Design, Directory of Materials." The Penton Publishing Company, Cleveland, Ohio, October, 1944.

Effect of Surface Finish and Wall Thickness on the Operating Temperature of Graphite Radio-Tube Anodes*

L. L. WINTER†, MEMBER, I.R.E., AND H. G. MACPHERSON†

Summary—The effect of rough and smooth surfaces and variable wall thicknesses on the operating temperature of radio-tube graphite anodes has been determined. Simultaneous measurements of internal and external temperatures were made with two optical pyrometers on rough and polished hollow graphite cylinders with variable wall thicknesses. Because of the ideal black-body conditions inside the graphite tubes, true internal temperatures were obtained. The optical pyrometer sighted on the outside of the cylinder measured the radiation at a wave length of 6530 angstrom units in terms of brightness temperature. From these data, calculations were made showing the true temperature differences and differences in emis-

sivity and in radiation of the various graphite cylinders.

Observations made show that varying the wall thickness of these graphite cylinders from 0.07 to 0.10 inch gave a difference of not more than 20 degrees centigrade in operating temperature. Polishing the surface of the graphite reduced the emissivity by 8 per cent, and increased the surface temperature by 25 degrees centigrade over that obtained for the rough-surface cylinder at 1000 degrees centigrade. Radiation from these surfaces indicates that a roughened anode surface at 1000 degrees centigrade has a radiation capacity increased over that of the polished anode by 1.1 watts per square centimeter.

GRAPHITE anodes for some recent radio-tube applications require a smooth surface finish in order to eliminate surface irregularities and remove loosely held particles.

In this connection, it became desirable to measure and to evaluate the effects of smooth and rough anode finishes and of varying anode wall thicknesses on the operating temperatures. Because of the favorable radia-

tion characteristics of graphite, and since few anodes operate at temperatures higher than 1000 degrees centigrade, measurements were made between 850 and 1075 degrees centigrade, a range in which optical measurements are quite reliable. The general procedure followed was to heat a graphite cylinder in a vacuum to incandescence by passing current through it and make simultaneous measurements of both internal and external brightness temperatures at an effective wave length of 6530 angstrom units.

Graphite cylinders 12 inches long by 1-inch outside diameter were polished to give a shiny surface, and

* Decimal classification: R253X R282. Original manuscript received by the Institute, March 2, 1945; revised manuscript received, June 25, 1945.

† Research Laboratories, National Carbon Co., Inc., Cleveland, Ohio.

similar-size cylinders were sanded to give as dull a surface as possible. Cylinders having the desired surface characteristic were machined to wall thicknesses of 0.100 and 0.070 inch. The photograph in Fig. 1 shows the difference in surface smoothness and in wall thickness of the cylinders.

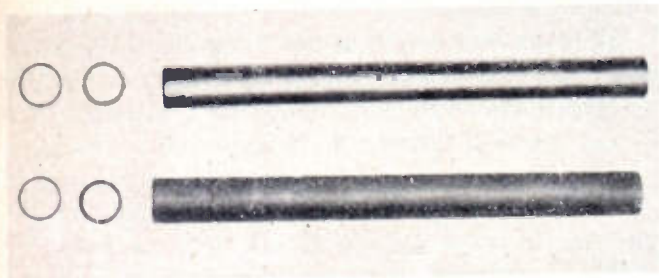

Fig. 1—Comparison of graphite cylinders having smooth and rough surfaces and thick and thin walls.

The graphite cylinders were mounted axially in the pyrex chamber shown in Fig. 2, which was evacuated to a pressure of less than 5 microns to eliminate any oxidation of the graphite and reduce convection heat losses. The other details of the arrangement are indicated in the diagram. The power input was adjusted so that the cylinder came up to operating temperature in 80 to 100 seconds.

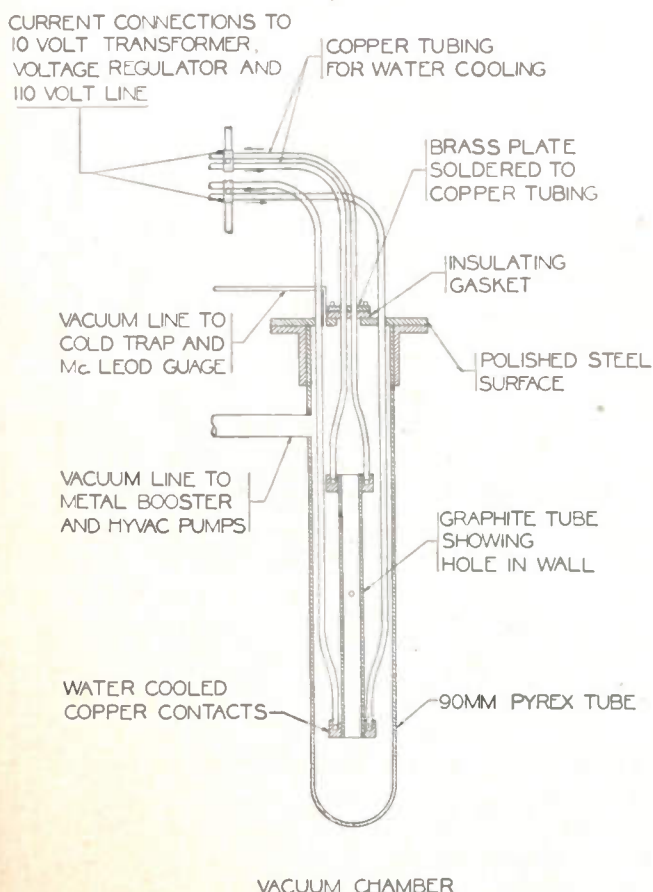

Fig. 2—Vacuum-chamber assembly showing the graphite cylinder held in position inside the pyrex tubes by means of water-cooled current conductors.

The temperature inside of the graphite cylinder was measured by an optical pyrometer sighted through a 0.16-inch-diameter hole drilled in the cylinder wall. A simultaneous measurement was made of the brightness temperature of the outside of the cylinder with a pyrometer sighted on the outside wall opposite the hole. The radiation coming through the hole was very nearly black-body radiation, since the cylinder is heated to a uniform temperature for about 6 inches of its length. The optical pyrometers were calibrated over the temperature range 750 to 1075 degrees centigrade against a standard chromel-alumel thermocouple.

The results of the temperature measurements on the graphite cylinders are plotted in Fig. 3, where the difference between the inside and outside temperatures is

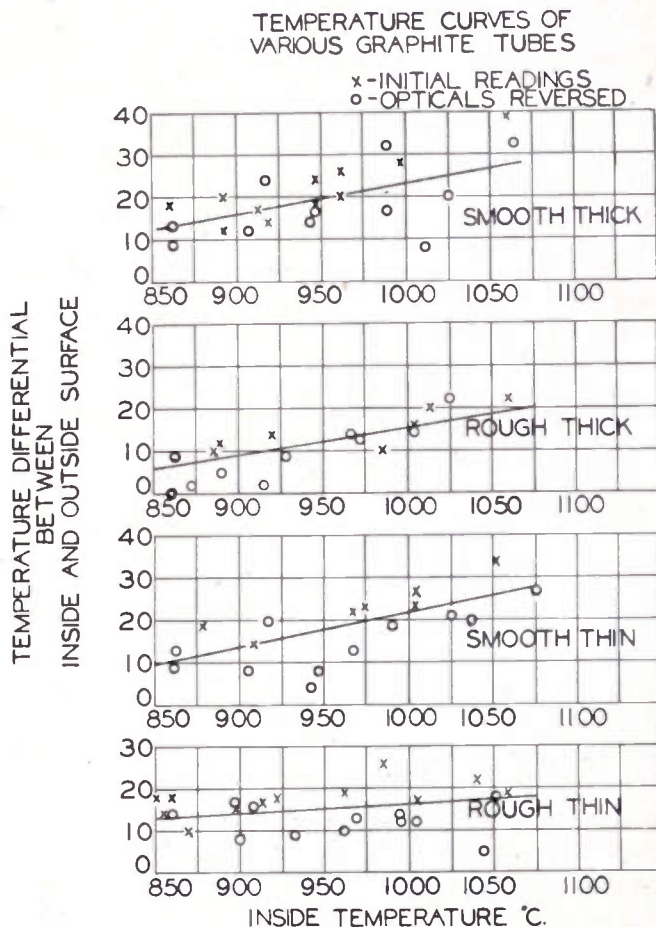

Fig. 3—These curves indicate the temperature differential between the inside and outside surface of the various graphite cylinders over an inside temperature range of 850 to 1075 degrees centigrade.

indicated as a function of the inside temperature of the cylinder. The optical pyrometers were interchanged once during each set of measurements to insure that the temperature differences observed would be independent of any differences in the calibrations of the two instruments. The circles represent temperatures obtained with one arrangement of the optical pyrometers, and the crosses those determined with the other arrangement. It is apparent that there is a systematic difference between the readings with the two pyrometers,

due to a slight error in calibration. However, this does not enter into the final results, because the method of interchanging the pyrometers eliminates this error. When plotted on this expanded scale, the temperature measurements show a considerable spread. However, the probable error of any one temperature-difference measurement is estimated to be not more than 5 degrees centigrade, so that when a number of points are averaged, the accuracy is sufficient to permit pointing out the differences between the cylinders. In general, the difference in temperature between the inside and outside surface increases with the temperature level but the maximum difference, even at 1050 degrees centigrade with the thickest of the cylinders, is only about 30 degrees centigrade.

Table I gives the average temperature differences obtained from the various cylinders and selected regions of temperature. These average values are probably the most objective means of judging the differences between the samples, since they represent fairly large groups of measurements. In obtaining the averages, the points for each pyrometer arrangement were averaged separately and the mean of the two averages was taken

TABLE I

	Average Temperature Difference	
	In Range 850°-950° C.	In Range 950°-1050° C.
Rough dull surface		
Thin wall (0.066 inch)	14.0° C.	16.0° C.
Thick wall (0.102 inch)	8.4° C.	14.6° C.
Smooth shiny surface		
Thin wall (0.070 inch)	13.4° C.	21.1° C.
Thick wall (0.102 inch)	16.1° C.	22.6° C.

The effect of the thickness of the cylinder walls can be evaluated readily. In the 850-to-950-degree temperature region, the average difference of temperature for the thin-wall cylinders was 13.7 degrees, and for the thick-wall cylinders, 12.3 degrees. In the 950-to-1050-degree range, the value for the thin wall was 18.5 degrees and for the thick wall, 18.6 degrees. The indicated difference between the two wall thicknesses is less than the error of measurement, and in one case is in the reverse direction from that expected, so it is obvious that there is no appreciable difference in the temperature drop for the two wall thicknesses.

Calculations of the temperature differences based on heat conduction check this observation. In our experiment, the temperature difference between the outside and the inside of the cylinder is approximately one half of the value which would obtain in a radio-tube anode. This is due to the difference in the mode of heating employed. With our method of heating by the I^2R loss in the cylinder, the heat is generated uniformly throughout the entire graphite wall and is, on the average, conducted only halfway through the cylinder wall. In the operation of a radio tube, on the other hand, the heat is introduced at the inside surface and must all be conducted through the entire thickness of the graphite.

The temperature differences between the inside and outside surfaces were calculated for both cases, (1) that of uniform heating and (2) that of heating at the inside surface, from the following formulas:

$$\Delta T = (Qr_2/k)(1/2 - r_1^2/(r_2^2 - r_1^2) \ln r_2/r_1) \quad (1)$$

$$\Delta T = (Qr_2/k) \ln r_2/r_1 \quad (2)$$

In these formulas

ΔT = the true temperature difference between the inside and outside surface of the cylinder.

Q = the heat to be dissipated per unit area of the outside surface of the cylinder.

k = the thermal conductivity of graphite at the operating temperature of the cylinder.

r_1 and r_2 = the inner and outer radii of the cylinder.

Table II gives the calculated temperature differences between the inner and outer surfaces at various operating temperatures of the cylinder. In the calculation, it was assumed that the heat dissipated from the outside surface of the cylinder was equal to the radiation of a body with an emissivity of 0.9 at its operating temperature. The values of thermal conductivity used were 0.080, 0.071, and 0.062 gram calories per second per centimeter squared per degree centigrade per centimeter, for the three temperatures, 800 degrees centigrade, 900 degrees centigrade, and 1000 degrees centigrade, respectively. These values are estimated as probable values for the transverse thermal conductivity of the graphite used. The conductivity at 800 degrees centigrade is approximately 50 per cent of the longitudinal value given by Powell.¹

TABLE II
Calculated Temperature Difference between Inner and Outer Surfaces

	Operating Temperature of Cylinder		
	800° C.	900° C.	1000° C.
A. Heat generated within the walls by resistance heating			
Thin wall (0.070 inch)	1.8° C.	3.0° C.	4.7° C.
Thick wall (0.100 inch)	2.8° C.	4.4° C.	7.0° C.
B. Heat generated at inside surface			
Thin wall (0.070 inch)	3.9° C.	6.1° C.	9.7° C.
Thick wall (0.100 inch)	5.7° C.	9.1° C.	14.5° C.

From Table II it can be seen that, in this experiment, the maximum difference to be expected between the thin- and thick-wall cylinders is 2.3 degrees at 1000 degrees centigrade. This calculation is therefore in agreement with our observation that the temperature difference is small. Even though the temperature difference in the case of a radio-tube anode would be approximately twice this, it is still too small to be important.

Examination of Table I shows that there is a real difference between the operation of the bright- and dull-finish cylinders. This difference can best be evaluated by calculating an emissivity for the two surfaces. First, however, we must subtract the real temperature difference between the inside and outside of the tube

¹ R. W. Powell, "The thermal and electrical conductivities of a sample of acheson graphite from 0° to 800° C.," *Proc. Phys. Soc. (London)*, vol. 49, pp. 419-426; 1937.

walls, due to the conduction of heat from the inside to the outside, and then the remaining temperature difference will be only an apparent difference, due to the fact that the emissivity of the surface is less than 1.0. We have used the calculated values of the true temperature difference given in Table II for making this subtraction because they are more accurate than any values that could be calculated from the data. Table III gives the values of the apparent temperature difference after the real temperature difference has been subtracted. Values for the thin- and thick-wall cylinders are averaged together since the effect of the wall thickness has been eliminated by the subtraction.

TABLE III
Apparent- or Brightness-Temperature Difference between the Inside and Outside of Cylinders Due to Emissivity Value

	In Range 850°-950° C.		In Range 950°-1050° C.	
		Average		Average
Rough dull surface				
Thin wall	11.0	7.5	11.3	9.5
Thick wall	4.0		7.6	
Smooth shiny surface				
Thin wall	10.4	11.0	16.4	16.0
Thick wall	11.7		15.6	

For each value of this apparent-temperature difference, an emissivity was calculated from the following equation:

$$\log_{10} e = 0.4343c_2\Delta T/\lambda T^2.$$

In this equation

e = the emissivity

c_2 = the second radiation constant which has a value of 1.432 centimeter—degree centigrade

λ = the wave length in centimeters of the radiation used for the brightness measurement

ΔT = the apparent difference in temperature

T = the operating temperature of the cylinder.

Values of the emissivity calculated in this way are given in Table IV.

TABLE IV
Calculated Emissivities

	Data at		Average
	900° C.	1000° C.	
Rough dull surface	0.90	0.88	0.89
Smooth shiny surface	0.84	0.805	0.82

The average calculated value of the emissivity for the sanded-graphite surface is about 0.89, and for the shiny surface about 0.82. Although these emissivities are not claimed to be very accurate, the values are quite reasonable in view of previous experience with graphite. The emissivities calculated in this way are spectral emissivities for radiation of effective wavelength 0.653 microns. However, there is every reason to believe that carbon is a true grey body having the same emissivity at all wave lengths and temperature, so that spectral and total emissivities can be used interchangeably.²

The difference in emissivity of the two surfaces can be used to calculate the difference in operating temperature that would result from the use of the two types of surface. By the Stefan-Boltzmann radiation law, the energy radiated is proportional to the product of the emissivity and the fourth power of the absolute temperature. For example, the roughened, dull-finish-graphite surface will radiate 6.7 watts per square centimeter of surface if it operates at a temperature of 800 degrees centigrade. To radiate the same heat energy, the smooth shiny-surface anodes would operate at a temperature of 822 degrees centigrade, or 22 degrees higher. Similarly, to radiate the same amount of heat as the rough-surface anode at 1000 degrees centigrade, the smooth shiny anode would have to operate at a temperature of 1025 degrees centigrade.

Table V gives the radiation from rough- and polished-graphite cylinder surfaces at 900 degrees and 1000 degrees centigrade.

TABLE V

Surface condition	Emissivity	Temperature	Radiation watts per square centimeter
Smooth polished surface	0.82	900° C.	8.8
Rough dull surface	0.89	900° C.	9.6
Smooth polished surface	0.82	1000° C.	12.2
Rough dull surface	0.89	1000° C.	13.3

From these experiments, it is evident that differences of not more than 30 degrees centigrade will be found in radio-tube anodes operating at about 1000 degrees centigrade as a result of differences in type of surface and wall thicknesses of 0.070 to 0.100 inch.

² American Institute of Physics, "Temperature, Its Measurement and Control in Science and Industry," Reinhold Publishing Corp., New York, N. Y., 1941; comment by H. T. Wensel, p. 1149.

A Coil-Neutralized Vacuum-Tube Amplifier at Very-High Frequencies*

R. J. KIRCHER†, SENIOR MEMBER, I.R.E.

Summary—This paper describes a two-stage single-side coil-neutralized amplifier employing an experimental triode operating in the vicinity of 140 megacycles. Circuit features are described and typical operating conditions are indicated. Typical distortion characteristics at low power levels are also included.

PART I. INTRODUCTORY CONSIDERATION OF THE PROPERTIES OF THIS TYPE OF NEUTRALIZATION

WELL KNOWN are the usual methods employed in the neutralization of vacuum-tube amplifiers such as the "capacitance bridge," the Rice, and the Hazeltine arrangements. These methods use the general principle of neutralizing the voltage fed back from the output circuit to the input circuit through an inherent branch circuit by the addition of an auxiliary branch circuit which returns to the same input point an equal voltage of opposite phase.

A less familiar method using a variation of his principle was proposed by H. W. Nichols^{1,2} nearly two decades ago. In this method the grid-to-plate capacitance of a vacuum tube was antiresonated with a suitable inductance at the operating frequency, thereby greatly reducing the admittance coupling the output and the input circuits. For convenience, we shall refer to this method as "coil neutralization." Because of a steadily increasing demand for power-amplifier stages in the ultra-high-frequency range, for which no adequately neutralized power tube was available,³ and because of the greater technical difficulties encountered in applying conventional neutralizing schemes at ultra-high frequencies, an experimental study was begun to determine the operating characteristics of coil-neutralized triodes at very-high frequencies.

A qualitative consideration of the advantages and disadvantages of this method of neutralization may serve to orient the reader who is not familiar with the method. Coil neutralization has the disadvantage that careful adjustments must be made for each operating frequency. These adjustments, when made, are, however, reliable and duplicable at will. Minor readjustments are required only occasionally to maintain optimum neutralization, and this is true even for tube replacements. This inherent drawback loses significance

in fixed-frequency services for which the ultra-high frequencies are particularly applicable. One important advantage of this method is the increased simplicity in circuit arrangement which may be achieved for either single-side or push-pull applications. The use of triodes with grid and plate terminals adjacent to each other greatly simplifies the mechanical layout of the circuit elements.

It is appreciated in a qualitative way that the capacitance to be antiresonated between the grid and plate elements includes not only the direct interelectrode capacitance, but also the total stray capacitance between these elements as well. Furthermore, the inherent inductance in plate and grid leads merely contributes to the total inductance required to antiresonate the total grid-to-plate capacitance. In this method, therefore, two factors which disturb conventional neutralizing technique have been put to service. At very-high frequencies the inductances and capacitances inadvertently introduced into a neutralizing circuit by an element such as a capacitor often result in unsatisfactory or just tolerable neutralization, and may also contribute to the establishment of parasitic oscillations. The ultimate high-frequency application of coil neutralization takes the form of a short transmission line, either of the open $1/2\lambda$ type, or the closed $1/4\lambda$ type, between the grid and plate elements. No blocking capacitor is required if the $1/2\lambda$ line is used. In general, in the very-high- and ultra-high-frequency region, less stray capacitance will be added to the circuit with coil neutralization than with conventional neutralizing means. Such direct benefits as less capacitance current, a broader transmission band, and a higher frequency of operation result.

When coil neutralization is applied to a tuned-grid, tuned-plate triode, a sufficient condition for nonoscillation is that at any frequency the impedances of the three circuits must be of like nature, resistive, inductive, or capacitive. At the particular frequency for which the coil and the grid-to-plate capacitance antiresonate, the impedance between the output and the input circuits becomes very high. For example, if the total grid-to-plate capacitance of a triode is 2 micromicrofarads, the reactance of this capacitance at 150 megacycles is approximately -530 ohms. Antiresonating this capacitance with an external coil of $+530$ ohms at 150 megacycles, and assuming a Q of 95, the grid-to-plate impedance would be raised to approximately 50,500 ohms. The result is a corresponding decoupling between the plate and grid circuits. This impedance is in series with the grid-to-cathode impedance and the plate-to-

* Decimal classification: R355.7. Original manuscript received by the Institute, February 9, 1945; revised manuscript received, June 5, 1945. This paper is a thesis submitted as a partial requirement for the M.S. degree from Stevens Institute of Technology, Hoboken, N. J.

† Bell Telephone Laboratories, 463 West Street, New York, N. Y.

¹ United States No. 1,325,879, H. W. Nichols.

² United States No. 1,558,909, H. W. Nichols.

³ A. L. Samuel and N. E. Sowers, "A power amplifier for ultra-high frequencies," *Proc. I.R.E.*, vol. 24, pp. 1464-1483; November, 1936.

cathode impedance. From this relationship it follows that the magnitude of the voltage returned to the grid circuit from the plate circuit depends on the ratio of the grid-circuit impedance to the sum of the grid-to-plate impedance and the grid-circuit impedance. A similar relationship exists for the magnitude of the voltage fed through from grid to plate, in which, however, the plate-circuit impedance replaces the grid-circuit impedance. With zero plate voltage and a small radio-frequency voltage on the grid, the ratio of the grid voltage to the plate voltage is noted as the neutralizing circuit is brought into resonance and the grid and plate circuits are kept in tune. Following this procedure, a minimum value of the ratio of the plate voltage to the grid voltage may be obtained. This voltage ratio was observed by means of vacuum-tube voltmeters attached as closely as possible to the grid and plate elements of the coil-neutralized tube. Experimental observations verified the conditions expected, and there was realized in all of the models, for a good neutralizing condition, a feed-through plate voltage of approximately 4 or 5 per cent of the grid voltage.

When all three circuits had been brought simultaneously into tune, it was noted that almost complete isolation was effected between the grid and plate circuits so far as interaction on the grid circuit due to plate-circuit tuning was concerned. At this point, it is interesting to note that the equivalent capacitance between the grid and plate of a pentode or tetrode for a capacitive reactance of 50,000 ohms at 150 megacycles is 0.021 micro-microfarads, a value realized only in small commercial pentodes. The pentode or tetrode has the disadvantage of the screen-lead inductance, the reactance of which may seriously affect the satisfactory operation of the tube at very-high frequencies. Qualitatively, the decoupling achieved by coil neutralization is comparable with that obtainable with the best small pentodes, and, since it is applicable to tubes rated for transmitters, its advantages become more apparent.

Upon applying plate voltage to the neutralized triode, a change in the interelectrode impedances usually occurred, and vernier readjustments of all three circuits were required to obtain optimum neutralization as indicated by a minimum reaction on the grid voltage as the plate-circuit tuning capacitor was varied. Normal coupling to the plate-circuit load was maintained for both preliminary and final adjustments. The reaction noted above was but one third to one fourth the reaction usually observed with conventionally neutralized triodes, or with the available tetrode or pentode tubes when operated in this frequency range as single-side amplifiers.

With this qualitative discussion on the general properties of a coil-neutralized amplifier, our attention will now be turned to a description of the experimental apparatus used, and some phases of the experimental technique employed.

PART II. EXPERIMENTAL APPARATUS AND TECHNIQUE USED

Three push-pull coil-neutralized experimental amplifiers were built in succession using Western Electric 304A, 316A, and 226Y vacuum tubes. The performance of these amplifiers equaled, and, in some ways excelled, that of similar amplifiers using the bridge-capacitance type of neutralization. It was noted that the plate efficiency of the amplifiers was, to a large extent, a function of the frequency of operation, and the quality of the high-frequency design of the tube used. In this respect, efficiencies of 33 per cent were obtained with the 316A and the 226Y stages when operating as class B amplifiers at 150 megacycles. We will consider in detail the design of still another experimental model, as it is of greater technical interest.

With the development of the Western Electric 299Y triode,⁴ which is capable of dissipating 100 watts under an air blast, a two-stage single-side coil-neutralized amplifier was constructed. Each tube was mounted in a removable frame on which the high-frequency circuits were built as compactly as possible. Simple shunt-resonant circuits were used in the grid, plate, and neutralizing circuits. Series-tuned circuits could be used, provided all three circuits were so designed and ganged together as to have the same type of reactance at any frequency, since this is the criterion for nonoscillation. In order more readily to effect neutralization, a vernier variable capacitor was placed between the grid and plate elements. This adjustment was made by means of a screw thread on a shaft which translated a metal plate relative to two fixed plates connected to the grid and plate elements respectively. Plate and grid diode voltmeters were integral parts of each unit. The power and measuring circuits were completed when the unit was seated in position, the two units being placed side by side in an aluminum box. Each tube was cooled by an air blast supplied by a blower through a duct in the rear of the assembly. Inductive coupling was used between the two stages, and between the second-stage plate circuit and the 320-ohm output load.

An exposed view of this two-stage model appears in Fig. 1. The bottom view of one unit appears in Fig. 2, in which the grid and plate circuits and diode voltmeters may be seen quite clearly on either side of a central longitudinal partition. The opposite side of this unit appears in Fig. 3, in which is shown the placement of the 299Y tube, and the coil and vernier tuning capacitor required in the neutralizing circuit. This tube, which is shown in Fig. 4, is provided with a pair of grid and plate terminals on diametrically opposite surfaces of the envelope, the advantages of which are apparent.

To set up two coil-neutralized amplifier stages in

⁴ A. L. Samuel, "A negative grid triode oscillator and amplifier for ultra-high frequencies," *Proc. I.R.E.*, vol. 25, pp. 1243-1252; October, 1937.

tandem, the first stage was neutralized as described above, using a high-frequency oscillator to supply the driving voltage. After neutralization, the plate power was applied and optimum neutralizing adjustments made. Using the excitation voltage provided from the first stage, the second stage was neutralized for mini-

linear relationship between the driving voltage and the output voltage.

The second, or power-amplifier stage, is the more interesting of the two stages, since the first stage is merely a linear voltage amplifier which provides the necessary driving voltage. It was noted that in this stage the active grid shunting impedance⁶ appeared to be many

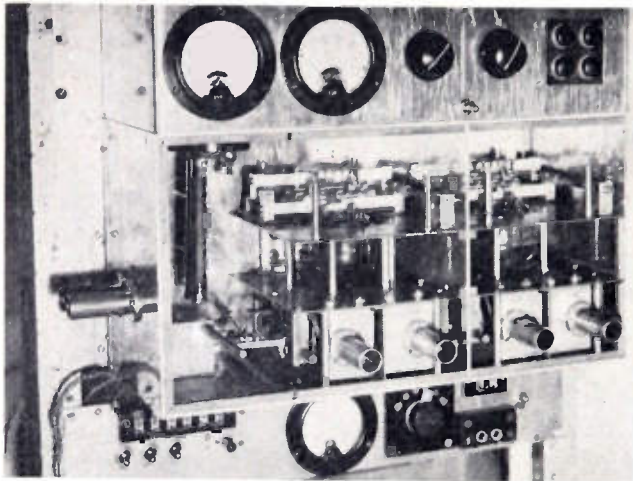

Fig. 1—Experimental two-stage coil-neutralized amplifier.

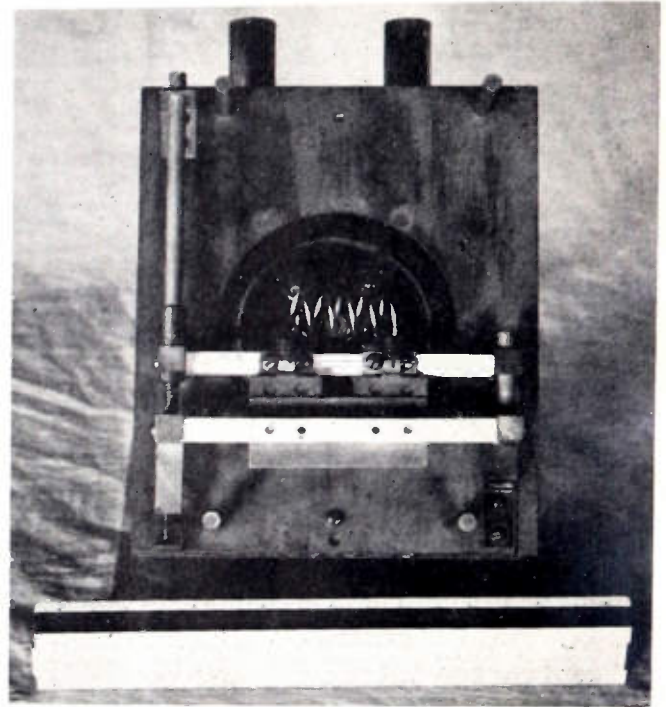

Fig. 3—Top view of a unit of the amplifier.

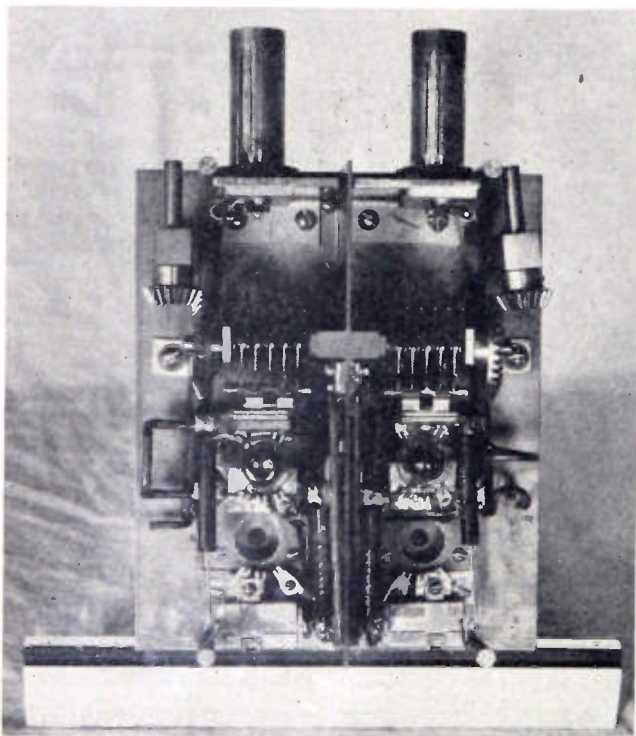

Fig. 2—Bottom view of a unit of the amplifier.

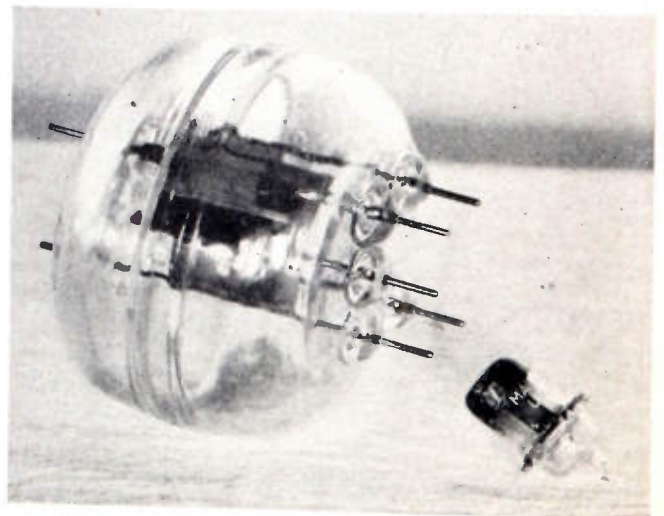

Fig. 4—The 299Y tube and the 955 monitor tube.

mum feed-through voltage when the load resistance was coupled to the plate circuit. Plate power was then applied and optimum output coupling effected. Readjustments were then made on the neutralizing control to obtain optimum neutralization. The direct-current bias voltage on each amplifier stage was adjusted to obtain a

times greater than the impedance of the grid circuit, which was of the order of 10,000 ohms. This property is a measure of the effectiveness of the high-frequency design of the vacuum tube.

⁶ M. J. O. Strutt and A. van der Ziel, "The causes for the increase of the admittances of modern high-frequency amplifier tubes on short waves," *Proc. I.R.E.*, vol. 26, pp. 1011-1032; August, 1938.

The bandwidth of the output circuit when properly coupled to the load is of interest since this factor determines the extent of the frequency band which may be transmitted uniformly. This characteristic, given in Fig. 5(a), was obtained by applying a voltage of variable

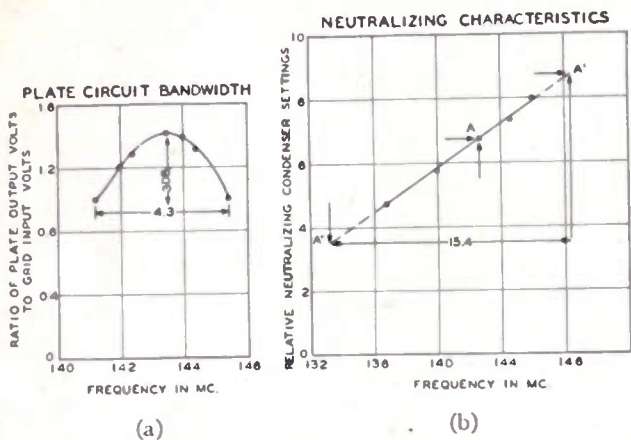

Fig. 5—(a) Plate-circuit bandwidth characteristic of the power stage. (b) Nonoscillating frequency interval of the power stage.

frequency but constant amplitude to the grid of the power tube and measuring the resulting voltage developed across the plate circuit. The grid and plate diode voltmeters were ideal for this purpose.

When testing an amplifier with a view to discovering its weaknesses or limitations as well as its strong points, it is good engineering practice to establish a criterion by which the stability of the amplifier may be described. In particular, the extent of maladjustment permitted in the neutralizing control before oscillations will occur is a useful guide to the stability of an amplifier. In bridge-capacitance neutralized circuits this latitude may be readily stated in terms of the micromicrofarads of capacitance variation permitted on either side of the optimum value of neutralizing capacitance. In the case of a coil-neutralized amplifier, the neutralizing is effected by the adjustment of a shunt-resonant circuit of high Q , and therefore a somewhat less direct method was used to obtain a criterion for the stability of the amplifier.

The technique of this method was as follows: The relationship between the vernier neutralizing-capacitor control and the frequency of operation of the amplifier was plotted as the operating frequency was varied from 135 to 150 megacycles. This relationship appears in Fig. 5(b). The amplifier was then set up to operate at 142.8 megacycles (point A on the curve of Fig. 5(b)). The excitation was removed and the neutralizing-capacitor control varied above and below the reference value until tuned-grid, tuned-plate oscillations occurred. These limits are indicated by the point A' and A'' on the curve. In this way, the relationship between the neutralizing-capacitor control range and the nonoscillating frequency interval was determined. Thus, a criterion for the stability of the amplifier may be established. We will now consider in detail typical operating characteristics of this coil-neutralized amplifier.

PART III. OPERATING CHARACTERISTICS OF THE COIL-NEUTRALIZED AMPLIFIER

Typical operating characteristics for the power stage operated as a class B amplifier at 144 megacycles are shown in Fig. 6. It is noted from curves D , B , and A

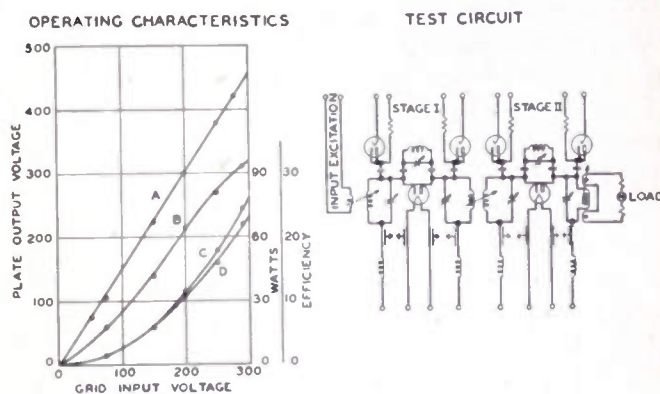

Fig. 6—Typical operating characteristics of the power stage. Curve A , input-voltage versus output-voltage linearity characteristic. Curve B , useful-load power-efficiency characteristic. Curve C , power delivered to the circuit and the load. Curve D , useful power delivered to the 320-ohm load.

that a useful output power of 65 watts was obtained at 31 per cent efficiency with a substantially linear characteristic between the input and the output voltage. The total power delivered by the tube is indicated by curve C . Some interest is attached to the measurement of power at this frequency and so the means employed will be briefly considered.

From the plate-circuit bandwidth determination (see Fig. 5(a)) the resonant step-up of the circuit Q is, to a good approximation, given by

$$Q = 144/4.3 = 33.5.$$

The plate-circuit inductance was determined to be

$$L = 0.043 \text{ microhenry.}$$

From these values, the antiresonant impedance of the loaded plate circuit was given by

$$Z = Q\omega L = 1300 \text{ (ohms).}$$

The radio-frequency plate voltage was accurately given by the diode voltmeter. Therefore, the total power delivered by the tube as indicated by curve C is given by

$$W = (E^2/2)(1/Z)$$

where E is the diode peak voltage. The power delivered to the useful load was determined from the load current, and the value of the load resistance. The radio-frequency current-meter readings were corrected for the frequency of operation according to the manufacturer's calibration. In previous work it had been determined that the value of the load resistances was practically the same at this frequency as at power frequencies. These resistances were thin-walled isolantite tubes with a high temperature deposit of carbon on the external surface.

The power dissipated in the load was given by RI^2 and is indicated by curve *D*. The plate-circuit losses were given by the difference between curves *C* and *D*.

The curve of Fig. 5(b) indicates that a frequency interval of 15.4 megacycles was realized for the possible settings of the neutralizing control for which no oscillation would occur. About six tenths of this interval was below the operating frequency designated by point *A* on the curve. This appears to offer a reasonable margin of safety against maladjustments of the neutralizing-capacitor control. Independent variations of the plate and grid-circuit capacitors throughout their range indicated that no oscillatory condition could be produced from such adjustments.

No apparent increase in radio-frequency loading due to a shunting impedance resulting from electron transit-time effect in the tube was observed. There remained the possibility, however, that the not-readily observable variation of the transit angle,⁶ which occurs during the radio-frequency cycle, might contribute to an increase in the normal nonlinear distortion generated in the amplifier. Should this effect be of significant proportions, it was expected that a systematic study of the distortion characteristics might reveal its contribution at least to a qualitative degree. In any event, the actual capabilities of the amplifier with regard to signal level, power output, and distortion, were of fundamental interest.

The amplifier brought to this stage of development appeared promising, and it became of interest to determine the distortion characteristics under conditions simulating those encountered in an actual communication system. The highlights of such a study and some typical results obtained will be presented in the following subdivision of this paper.

PART IV. DISTORTION CHARACTERISTICS OF THE COIL-NEUTRALIZED AMPLIFIER

In order to study as rigorously as possible the distortion characteristics of the coil-neutralized amplifier, it was decided to use a two-frequency generator and associated harmonic analyzer which had been developed with this purpose in view by associates working in the same frequency region. It will suffice to indicate the general principles used in this apparatus.

The twin-frequency generator consisted of two highly stabilized very-high-frequency oscillators of moderate power, differing in frequency by approximately 50 kilocycles, at a final frequency of approximately 144 megacycles. Great care was taken to prevent intermodulation of the two oscillators. This was realized to the extent that the dominant distortion products were 70 decibels below either fundamental frequency. Equal amplitudes were maintained for the two frequencies. The twin frequencies were supplied to the first circuit of the two

stage coil-neutralized amplifier through a pair of shielded coaxial transmission lines.

The harmonic-distortion analyzer consisted of a high-frequency push-pull square-law detector with special input and intermediate-frequency circuits to provide the necessary selectivity to separate harmonic frequencies differing by but 50 kilocycles. An accurately calibrated, manually operated attenuator with a range of 100 decibels was used at the intermediate frequency in conjunction with a second-detector output meter also calibrated in decibels. Flexible shielded concentric-conductor transmission lines were used exclusively to connect the distortion analyzer to either amplifier stage through the short tubes evident in Fig. 1.

When two such pure frequencies are passed through a nonlinear device, such as a vacuum-tube amplifier, an intermodulation occurs which is evidenced by the appearance of a large number of new frequencies in the output which were not present in the input. This constitutes a distortion of the original input signal. We will be concerned only with the third- and fifth-order distortion products which arise in the following manner. Designate the two input frequencies by p and q . Then the dom-

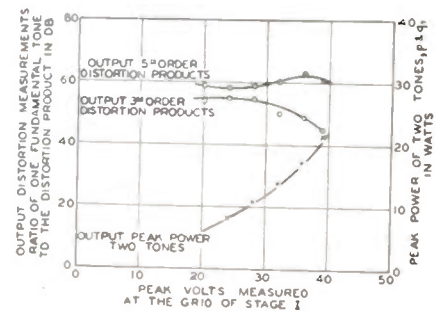

Fig. 7—Over-all distortion characteristics versus peak-power output. Two-tone distortion characteristics.
 $p = 144.000$ megacycles
 $q = 144.050$ megacycles
 p and q are equal in amplitude.

inant contributions to the third-order distortion in a reasonably linear amplifier are given by the terms $(2p-q)$ and $(2q-p)$. If, for example, p is 144.000 megacycles, and q is 144.050 megacycles, the third-order-distortion frequencies are 143.950 and 144.100 megacycles, respectively. These spurious frequencies appear but 50 kilocycles on each side of the pair of original frequencies.

In a similar manner, it can be shown that the dominant fifth-order products which result are given by the terms $(3p-2q)$ and $(3q-2p)$ which, for the given values of p and q , appear as frequencies of 143.900 and 144.150 megacycles, respectively. These are in turn removed but 50 kilocycles from the third-order terms. Still other orders of distortion products appear and add their terms at precise intervals of 50 kilocycles. The calibrated attenuator of the analyzer permitted the ratio of the distortion-product amplitude to fundamental amplitude to be obtained directly in decibels.

Using optimum distortion ratios as the criterion, the best value for the grid bias and for the inductive

⁶ F. B. Llewellyn, "Phase angle of vacuum-tube transconductance at very high frequencies," Proc. I.R.E., vol. 22, pp. 947-956; August, 1934.

coupling between each tube and its load was determined, with the reservation that the minimum acceptable distortion ratio in the output of the second stage would be 40 decibels. This restriction limited the allowable power output of the second stage in a marked manner as would be expected. Typical results obtained are indicated in Fig. 7, and may be summarized as follows.

The peak-power output of the second stage occurred for the instantaneous coincidences of the maximum amplitude of the two input frequencies which were of equal amplitude, at which time, four times the power of a single frequency was developed. For a peak-power output of 23 watts, the third-order distortion-product amplitude was approximately 44 decibels below the amplitude of either fundamental. The fifth-order distortion-product amplitudes were better than 60 decibels below the amplitude of either fundamental. A voltage ratio of one hundred to one is the equivalent of a 40-decibel ratio in these measurements. In making distortion measurements, the monitoring diode filaments were turned off.

These observations on typical distortion characteristics, of which a number were made, seem to indicate that the dominant mechanism for the production of distortion may be attributed to the usual source; viz., the nonlinear properties of the tube, and that the effect of the electron transit time does not contribute appreciably to the distortion. With these results obtained, the objectives motivating the study of the coil-neutralized amplifier were, to a certain degree, attained, and while the data presented apply only to this model, there does not appear to be any reason to believe that the results given are not indicative of what may be realized with other tubes of similar type when operated in a similar manner.

Additional References

- (1) United States No. 1,489,228, L. A. Hazeltine.
- (2) United States No. 1,533,858, L. A. Hazeltine.
- (3) United States No. 1,577,421, L. A. Hazeltine.
- (4) United States No. 1,763,015, G. H. Stevenson.
- (5) United States No. 1,832,261, G. H. Stevenson.
- (6) W. H. Doherty, "Neutralization of radio frequency power amplifiers," *Pick-ups* (Western Electric Company), December, 1939.

Cathode-Follower Circuits*

KURT SCHLESINGER†, ASSOCIATE, I.R.E.

Summary—The cathode follower is a circuit of increasing importance for television and ultra-high-frequency applications, and has therefore received much attention in technical literature. Most of the publications deal with the cathode-output amplifier, a three-terminal device. In this paper, such systems are treated briefly along with applications of the cathode follower for voltage amplification and signal mixing. This is preceded by a graphical diagram of the cathode-follower characteristic, which may be used for the determination of the direct-current components of such circuits.

Cathode followers with a complex load are subsequently considered. These circuits show characteristic feedback phenomena from the cathode into the grid system in which the interelectrode

capacitance acts as a coupling element. Most circuits of this nature are two-terminal devices, with action observed in the input circuit, and no external output derived from the cathode. The cathode-follower oscillator is perhaps the most important application of this group. Cathode-follower circuits with one or more resonant circuits in the cathode arm may be used as detectors or filters in connection with frequency modulation.

In presenting a variety of cathode-follower applications in the light of a general theory, this paper indicates the wide scope of possible applications with no intention of being exhaustive in every detail. In order to facilitate reading, most of the mathematical derivations have been put into the Appendix.

I. THE CATHODE FOLLOWER AS SIGNAL REPEATER

A. A Cathode-Follower Diagram

IN DESIGNING an amplifier circuit, the first step is to establish an appropriate working point along the direct-current characteristic of the tube. This demands the determination of adequate grid bias for given plate voltage and current. Fig. 1 shows a typical cathode-follower amplifier which derives grid bias from

a tap along the cathode resistor. This technique has advantages as compared to bias from a bleeder across the B-supply, in that it tends to keep the plate current constant and relatively independent of plate-voltage variations.

Fig. 2 shows a graphical method of securing information about circuit design and signal transmission at low frequencies. This cathode-follower diagram is based upon a conventional triode characteristic, showing plate current versus grid voltage.

$$i_p = f(E_g). \quad (1)$$

This curve for a triode with grounded cathode and constant plate voltage E_b is plotted as c in Fig. 2.

* Decimal classification: R139.21. Original manuscript received by the Institute, November 24, 1944; revised manuscript received, August 20, 1945.

† Columbia Broadcasting System, New York, N. Y. Work covered in this paper was done while the author was a member of RCA Laboratories, Purdue University, Lafayette, Indiana; material presented in a lecture, Purdue University, September 21, 1944.

The cathode-follower characteristic f for the circuit of Fig. 1 may be derived from this curve by reason of

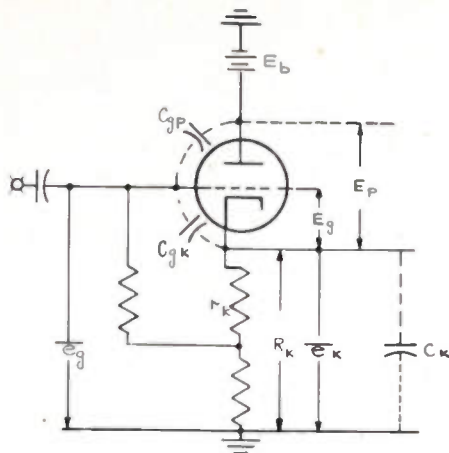

Fig. 1—Typical cathode-follower amplifier.

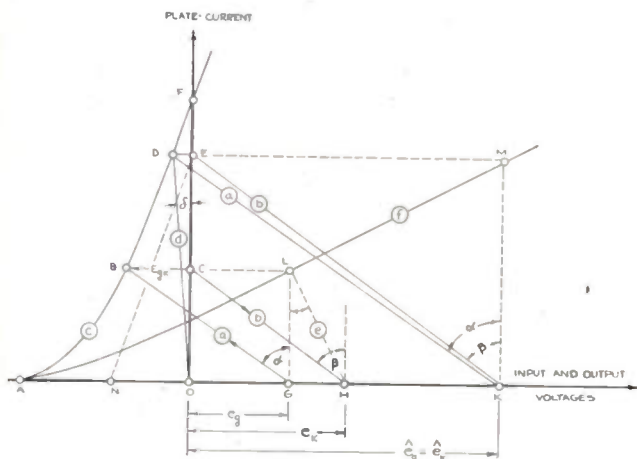

Fig. 2—Cathode-follower characteristic. Angle $GLH = \gamma$.

the fact that the plate current in a triode remains unchanged as long as the voltage sum $E_g + (1/\mu)E_p$ is kept constant. In this expression, E_g and E_p are voltages measured between the tube electrodes. This expression may be rewritten in terms of input and output voltages, e_g and e_k , respectively:

$$E_g = e_g - e_k \tag{2}$$

$$E_p = E_b - e_k \tag{3}$$

$$E_g + \frac{1}{\mu} E_p = e_g - e_k \left(1 + \frac{1}{\mu} \right) + E_b/\mu. \tag{4}$$

The same plate current,

$$i_p = e_k/R_k \tag{5}$$

is then found to flow under the influence of a plate voltage E_b and a grid bias of

$$E_g = e_g - i_p R_k \left(1 + \frac{1}{\mu} \right). \tag{6}$$

In Fig. 2, the plate current may then be read from the point of intersection B, where the characteristic c ,

given by equation (1), meets the load line a , given by equation (6).

In this way, the output voltage $e_k = OH$ may be obtained for each input voltage $e_g = OG$ by constructing the quadrilateral $GBCII$ with BC parallel to the abscissa and with the load lines a and b having slopes, respectively, of

$$\tan \alpha = R_k \left(1 + \frac{1}{\mu} \right) \tag{7}$$

$$\tan \beta = R_k. \tag{8}$$

The actual cathode-follower characteristic f showing the plate current $OC = GL$ versus input voltage $OG = CL$ may then be constructed point by point. If the working point L is to be established by a cathode-resistor tap, r_k , Fig. 1, its value may be deduced from the angle $\gamma = GLH$

$$\tan \gamma = r_k \tag{9}$$

according to equation (2).

From Fig. 2 it is seen that the cathode-to-ground voltage OH is more positive than the grid-to-ground voltage for all working points below M . At this point, grid current begins to flow.

To find the peak plate current, $OE = i_{p(max)}$, a load line d may be drawn through the origin O at the angle δ

$$\tan \delta = \tan \alpha - \tan \beta = R_k/\mu. \tag{10}$$

The peak output voltage $OK = i_{p(max)} \cdot R_k$ is then found to be μ times DE , which indicates the desirability of using a large cathode resistor R_k .

As a by-product of these considerations, a convenient method of finding amplification factors is available. From inspection of the triangles ODE and KDM , it is apparent that the same plate current will flow in a triode which has: (a) the grid at ground and r_1 ohms between cathode and ground; or (b) grid and cathode connected and r_2 ohms between cathode and ground. The amplification factor for that plate-current value is then given by the equation

$$\mu = r_2/r_1 - 1. \tag{11}$$

B. A Multistage System for Signal Synthesis

The preceding section has shown that the signal output from a cathode follower differs from the input in two ways: (1) by a slight reduction in amplitude, and (2) by the addition of a positive-voltage bias. These properties may be used in signal transmission systems where it is desired to combine a plurality of signals at definite amplitude levels.

A typical problem of that kind occurs in television transmission where synchronizing pulses are to be added to the picture signal. Shortly before these pulses are transmitted, the signal is supposed to reach the black level and to hold it for some time, regardless of the instantaneous level of the video modulation. This problem may be solved by the use of several cathode-follower tetrodes in cascade, as shown schematically in Fig. 3. This circuit functions as a mixer for video, direct-current,

blanking, and synchronizing signals.¹ Each stage has its inner grid directly connected to the cathode of the preceding stage, while negative pulses are applied to the screen grids from the blanking and synchronizing-pulse generators 7 and 8, respectively.

The graphs (a) through (f) in Fig. 3 explain the synthesis of the final television signal, step by step. Graph (a) shows the alternating-current component of the video signal V , obtained from the pickup tube 1, and the video amplifier 2. This signal reaches a direct-current restorer 3, through a coupling capacitor, and leaves it with the negative peaks raised to zero level, as shown in graph (b) of Fig. 3. Graph (c) illustrates the function of the first keying tetrode 5. The output from this stage stays above zero level even at those instants when the signal input is zero. The output from stage 5 reaches zero level, however, if negative pulses arrive at the screen grid and key the plate current. This brings the signal to a definite level or blanking pedestal, as shown in graph (d) of Fig. 3, regardless of the video voltage at the time. This action is repeated in the second cathode-follower tetrode 6, and is explained by another application of the cathode-follower diagram shown is graph (e), with the resulting signal output of graph (f). In this final form, the television signal exhibits synchronizing pulses of the amplitude S super-

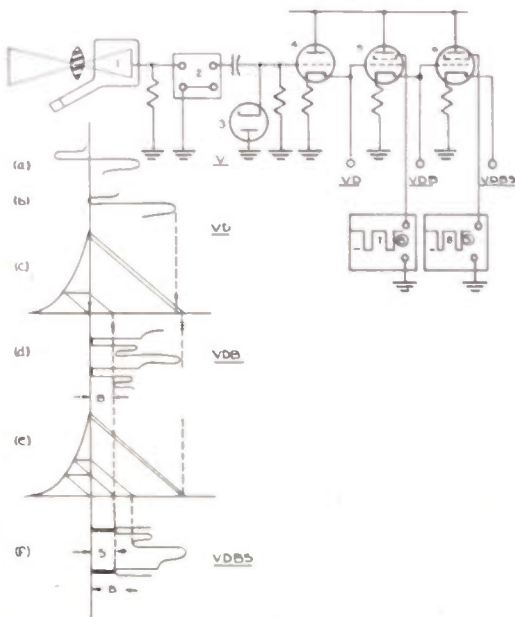

Fig. 3—Cathode-follower cascade for television transmission.

imposed on a constant black level B which is maintained throughout the transmission. In spite of the loss in signal amplitude at each stage, the signal output is of the same order as the input because each stage adds a pulse component to the original signal. There is no particular difficulty in transmitting a wide band of frequencies through the cathode-follower cascade since the output impedance of each stage is sufficiently low.

¹ The circuit description and diagram, Fig. 3, are simplified to explain the general idea of operation. Further details regarding a practical form of the circuit may be found in U. S. Patent No. 2,366,358, January 2, 1945, issued to Kurt Schlesinger, assignor to RCA.

II. CATHODE-OUTPUT AMPLIFIERS

As long as there is no appreciable phase lag between cathode and grid, the cathode follower exhibits low input admittance and low output impedance. These qualities are utilized in well-known amplifier applications, particularly in connection with video amplifiers. In such circuits a cathode-follower stage is commonly used either to match the high output impedance of a television pickup tube,² or to match the low input impedance of a cable.³⁻⁵ Cathode-follower action is frequently employed to correct falling frequency response of video amplifiers and to expand their bandwidth (Section II, C). The cathode follower may also be used as an inter-stage coupling element in video amplifiers.^{6,7} Although

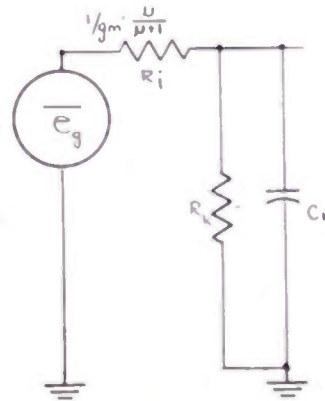

Fig. 4—Equivalent circuit of cathode-output amplifier of Fig. 1. Generator electromotive force, shown as e_g , is equal to $e_0 \cdot \mu / \mu + 1$.

the gain per stage may be more than doubled by this method, such a circuit is not widely used, because it is less economical than modern methods of network coupling. Another cathode-output amplifier which yields a gain greater than unity consists of a step-up transformer at the output of a cathode follower (Section II, D). This combination may be used in audio amplifiers.

A. Gain and Bandwidth

The behavior of a cathode-output amplifier, such as Fig. 1, may be readily deduced from the equivalent circuit of Fig. 4. This shows the triode as a generator with the electromotive force $e_0 \mu / (\mu + 1)$ and with the source impedance⁸

$$R_i = 1/g_m \frac{\mu}{\mu + 1} \tag{12}$$

From Thevenin's theorem, it follows that the gain and

² A. A. Barco, "Iconoscope preamplifier," *RCA Rev.*, vol. 4, pp. 89-107; July, 1939.

³ Albert Preisman, "Some notes on video amplifier design," *RCA Rev.*, vol. 2, pp. 421-432; April, 1938.

⁴ F. E. Terman, "Radio Engineers' Handbook," McGraw-Hill Book Company, New York, N. Y., 1943, p. 431.

⁵ V. K. Zworykin and G. A. Morton, "Television," John Wiley and Sons, New York, N. Y., third edition, pp. 438-439.

⁶ J. G. Brainerd, G. Koehler, Herbert J. Reich, and L. F. Woodruff, "Ultra-High-Frequency Techniques," D. van Nostrand Company, New York, N. Y., 1942, pp. 221-223.

⁷ H. J. Reich, "Features of cathode-follower amplifiers," *Elec. Ind.*, vol. 4, pp. 74-77; July, 1945.

⁸ See Appendix I.

TABLE I

Tube Type	Amplification Factor	Transconductance g_m (micromhos)	Capacitance C_k (microfarads)	Load Resistance R_k eq. (19) (ohms)	Cutoff Frequencies Internal f_i eq. (15) (megacycles)	External f_e eq. (16) (megacycles)	Total Bandwidth b eq. (18) megacycles	Gain a eq. (17)	Maximum Signal Output for 10-Megacycle Bandwidth and 10-Milliampere Plate Current e_k eq. (21) Volts
6J5	20	3000	16	10,000	30	1.0	31.0	0.92	9.95
			80	497	6	4.0	10.0	0.57	9.85
			160	143	3	7.0	10.0	0.28	0.82
6AC7	50	8000	16	10,000	80	1.0	81.0	0.97	9.95
			80	10,000	16	0.2	16.2	0.96	2.0
			160	500	8	2.0	10.0	0.78	0.98
6J4	55	12,000	16	10,000	120	1.0	121.0	0.97	9.95
			80	10,000	24	0.2	24.2	0.91	9.95
			160	10,000	12	0.1	13.0	0.91	9.95

frequency response of the cathode follower are the same as that of an equivalent pentode with grounded cathode which has the same load capacitance C_k and a plate resistor of

$$r_p = \frac{1}{g_m(1 + 1/\mu) + 1/R_k} \text{ ohms.} \quad (13)$$

This is the value of the parallel connection of source resistance R_i (equation (12)) and load resistance R_k . The angular frequency at which the gain of the equivalent amplifier falls off 3 decibels from its value for low frequencies is the reciprocal of the time constant $r_p C_p$ of the equivalent plate circuit.

The bandwidth of a cathode-output amplifier may thus be found from equation (13).

$$b = \frac{g_m(1 + 1/\mu)}{2\pi C_k} + \frac{1}{2\pi C_k R_k} \quad (14)$$

In this form, the cathode-follower bandwidth is seen to be the sum of two separate cutoff frequencies

$$\frac{g_m(1 + 1/\mu)}{2\pi C_k} = f_i \quad (15)$$

$$1/2\pi R_k C_k = f_e \quad (16)$$

These may be termed "internal" and "external" cutoff frequencies because, with a given load capacitance, the first depends on the parameter g_m of the tube, and the second depends on the resistor R_k in the external circuit. In these terms the amplification factor becomes

$$a = \frac{f_i}{f_i + f_e} \cdot \frac{\mu}{\mu + 1} \quad (17)$$

and this gain will be 3 decibels down at the bandwidth

$$b = f_i + f_e \quad (18)$$

In many cases this bandwidth is more than adequate to cover the spectrum f_s of signal frequencies. (See Table I.) If this is not true in a given case, however, the cathode-follower bandwidth may be expanded by increasing the external cutoff frequency. This is done by decreasing the value of the cathode resistor according to the equation

$$R_k \leq 1/g_m \cdot \frac{f_i}{f_s - f_i} \text{ for } f_s > f_i. \quad (19)$$

This extension of the bandwidth is achieved, however, at the expense of amplification.

Multiplying (17) and (18) there results

$$a \cdot b = f_i \cdot \frac{\mu}{\mu + 1} = \text{constant} \quad (20)$$

which indicates that the product of gain and bandwidth remains constant. A similar rule is known to hold for plate-loaded amplifiers, with the difference, however, that in the case of the cathode follower, a reduction of the signal band below the internal cutoff frequency (equation (15)) cannot be exchanged for amplification factors greater than one.

In Table I, the internal cutoff frequencies are listed for tubes with medium and high transconductance and for large and small load capacitances. The cathode-resistor values are computed for a signal bandwidth of $f_s = 10$ megacycles.

It is possible to compensate cathode-output amplifiers at high frequencies by methods similar to those used for plate-loaded amplifiers. At the cathode-follower output, series peaking is quite successful. Fig. 5 shows such a

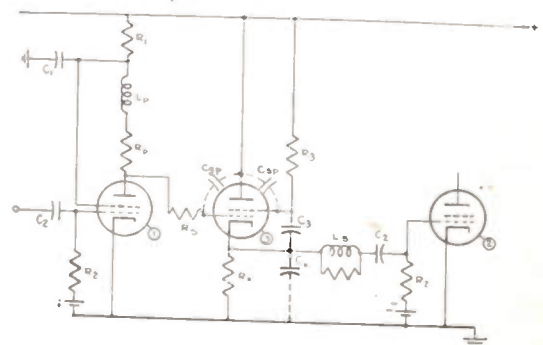

Fig. 5—Cathode-follower tetrode as an interstage coupling tube.

peaking coil L_p , with shunt resistor which is frequently needed to avoid overshoot. No such damping resistor is required if the peaking inductance is kept small enough so that the circuit composed of L_p , C_p , and $1/g_m$, has a Q factor of less than 0.6. This condition is satisfied if series resonance between L_p and C_p occurs at or above a frequency of 1.5 times the cutoff frequency. If this

* Heinz E. Kallman, Rolf E. Spencer, and C. P. Singer, "Transient response," PROC. I.R.E., vol. 33, pp. 169-195; March, 1945.

is done, the cathode follower is compensated over the entire bandwidth and shows good transient response.

In the cathode-follower amplifiers, only a portion of the cathode bias voltage is available as signal output over a given bandwidth. Unlike the plate-loaded amplifier with low plate impedance, a cathode follower may be designed with a high cathode impedance R_k , and still be able to cover a wide band of frequencies, including the internal cutoff frequency. In this design, however, larger amplitudes may be handled at low frequencies than at high frequencies, with a given plate current and without distortion. With a system as shown in Fig. 1, the peak-to-peak output voltage $|2e_k|$, available up to a frequency f_s , may be written in terms of the crest plate current, I_o , which is represented as OE in Fig. 2.

$$|2e_k| = \frac{I_o R_k}{\sqrt{1 + (f_o/f_s)^2}} < I_o R_k \cdot \frac{f_s}{f_o} \quad (21)$$

This output swing obviously decreases with increasing frequency. If the cathode follower is to be used over its entire bandwidth (equations (14) and (18)), the signal swing reduces to

$$|2e_k| = \frac{I_o}{g_m + 1/R_k} < \frac{I_o}{g_m} \quad (22)$$

This is represented in Fig. 2 as the distance ON . Measurement of frequency response in cathode-follower circuits may be in error if made with amplitudes in excess of those indicated. Moreover, the low source impedance of the cathode-follower cannot be guaranteed for amplitudes beyond those limits. If this output is too small, several tubes have to be connected in parallel, in order to increase the crest current I_o .

B. Interstage Coupling by Cathode Followers

In Fig. 5, a tetrode is used as a coupling element in cathode-follower connection. The screen grid of this stage is connected to the cathode through by-pass capacitor C_3 , rather than to ground. This capacitor is so designed that its susceptance matches the tube transconductance in midband. It then prevents low frequencies from the plate supply from reaching the output, but it connects screen and cathode in parallel for the higher signal frequencies. As a result, the grid-to-plate capacitance C_{gp} of the coupling tube is effectively removed from the plate output of the driver stage 1. In return, an additional load capacitance C_{sp} appears across the cathode output, but this is readily disposed of by the low output impedance of the cathode follower.¹⁰ A tetrode as coupling tube yields about 24 per cent more gain at the higher frequencies than a triode connection of the same tube. This gain is obtained, however, at the expense of a somewhat higher noise level, due to random current distribution between screen grid and plate.^{11,12}

The plate of the driver stage 1 may be directly connected to the grid of the coupling tube 3, provided that sufficient voltage drop is established across the filter resistor R_1 . This leaves the circuit with only two resistance-capacitance systems of opposite frequency response between which low-frequency correction may be obtained ($R_p C_1 = R_2 C_2$). High-frequency compensation may be accomplished by a series inductance L_s at the

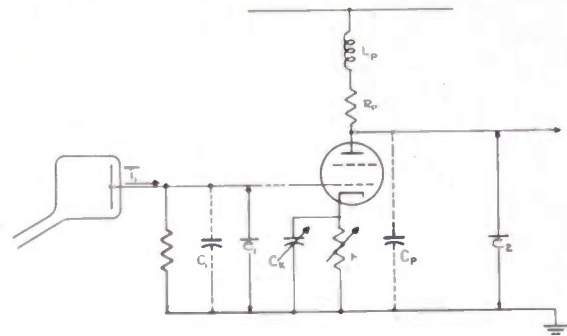

Fig. 6—Frequency-band expansion by cathode-follower amplifier.

output of the coupling stage. In addition to this, the input signal may be compensated by a shunt peaking coil L_p in the plate circuit of the driver stage. The grid resistor r_s in Fig. 5 acts as a feedback-suppressor without which regeneration is likely to occur, due to the negative input resistance of the cathode-follower coupling stage with capacitive load. (See Section III.)

Voltage-amplification factors of 30:1 may be obtained over a 6-megacycle band by using this circuit arrangement with 6AC7 tubes as amplifier and coupling tetrode.

C. Frequency-Band Expansion by Cathode-Follower Action

Fig. 6 shows another application of the cathode follower for video amplification. In this case, the cathode-to-ground voltage is not connected to any external output; instead, it is used to modify, in a predetermined way, the grid control in an equalizer stage. The practical problem consists in equalizing over a wide band f_2 a signal input \bar{e}_1 with insufficient amplitude at high frequencies. Suppose the signal is obtained across an input circuit $r_1 C_1$ from a constant-current generator. The input voltage,

$$\bar{e}_1 = \frac{i_1 r_1}{1 + p r_1 C_1}; \quad p = j\omega, \quad (23)$$

exhibits a drop of 3 decibels at the bandwidth f_1

$$f_1 = 1/2\pi r_1 C_1. \quad (24)$$

It is desired to expand this band s times

$$s = f_2/f_1. \quad (25)$$

In the equalizer stage with cathode degeneration, the plate current becomes

$$i_p = g_m(\bar{e}_1 - \bar{e}_k) = \frac{\bar{e}_1 g_m}{1 + \frac{g_m r_k}{1 + p r_k C_k}} = \bar{e}_1 g_m \frac{1 + p r_k C_k}{1 + p \frac{r_k C_k}{1 + g_m r_k}} \quad (26)$$

¹⁰ See Appendix I, equation (12).

¹¹ D. O. North, "Fluctuations in space-charge currents," *RCA Rev.*, vol. 5, pp. 244-260; October, 1940.

¹² W. A. Harris, "Fluctuations in space-charge currents," *RCA Rev.*, vol. 5, pp. 505-524; April, 1941.

By combination of (26) and (23) and multiplication by the plate impedance, the over-all amplification of the system is obtained.

$$\frac{e_2}{i_1 r_1} = \frac{g_m r_p}{1 + g_m r_k} \cdot \frac{1 + \mu r_k C_k}{1 + \mu r_1 C_1} \cdot \frac{1 + \mu L_p / r_p}{1 + \mu r_k C_k / (1 + g_m r_k)} \quad (27)$$

From this expression it may be seen that the bandwidth over which constant gain is available may be expanded s times (equation (25)) if the following three conditions are fulfilled:

$$r_k C_k = r_1 C_1 \quad (28a)$$

$$1 + g_m r_k = s \quad (28b)$$

$$L_p / r_p = 1 / 2\pi f_2 \quad (28c)$$

The first two equations define a cathode circuit in which both the resistance r_k and the by-pass capacitance C_k are unique¹³

$$\begin{aligned} r_k &= 1 / g_m \cdot (s - 1) \\ C_k &= g_m / 2\pi f_1 (s - 1). \end{aligned} \quad (29)$$

With no plate inductance L_p , the output will then be 3 decibels down at the frequency f_2 . Perfect compensation requires a plate circuit with "peaking coil" and with a time constant as specified by equation (28c). It may be shown that, in this design, the plate resistor must be limited to

$$r_p = 1 / 4\pi f_2 C_p \quad (30)$$

in order to avoid overshoot. This is one half of the resistance value for conventional amplifiers with shunt peaking. The over-all gain is then

$$a = \frac{e_2}{i_1 r_1} = \frac{g_m r_p}{s} \quad (31)$$

so that the product of gain by bandwidth is once more found to be constant. This method of bandwidth expansion by cathode-follower action has been used with success in amplifiers for television pickup tubes.¹⁴

D. Cathode-Follower Amplifier with Output Transformer

If the load resistance is considerably higher than the output impedance of the cathode follower, voltage amplification may be obtained by the use of a step-up transformer between the cathode output and the load. Such a circuit, as shown in Fig. 7, may be used as a driver for audio amplifiers. Throughout the audio bandwidth of 10,000 cycles, a gain of 7:1 may be obtained with tubes of high transconductance, and a gain of 4:1 with ordinary triodes of the type¹⁵ 6J5.

The over-all fidelity of this circuit may be much improved by tuning the primary of the transformer to a low frequency, using an appropriate coupling capacitor C_k . The low output impedance of the cathode follower

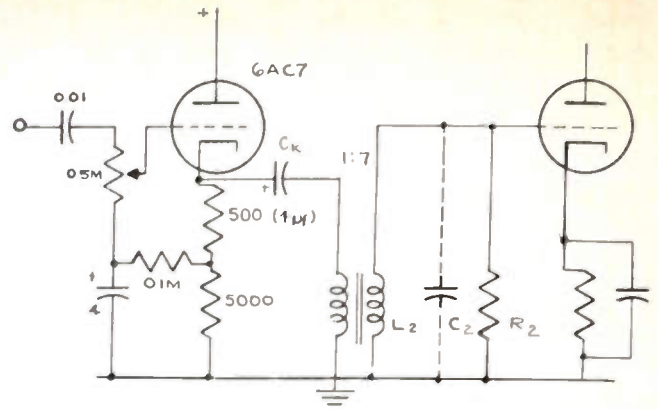

Fig. 7—Cathode-follower audio amplifier with a step-up transformer.

facilitates series resonance between the coupling capacitor and the transformer primary. This effect may be used to emphasize the low audio frequencies, or to extend the transmission band toward very low frequencies. Fig. 8 shows the influence of various values of the coupling capacitance on low-frequency response. The high-frequency peak is due to resonance in the transformer secondary.

The circuit of Fig. 7 has less gain than plate-loaded amplifiers,¹⁶ but it offers a number of advantages. Since it is a negative feedback circuit, it shows little harmonic distortion even at large amplitudes. Transformer distortion is also reduced because direct current is blocked from the primary. Furthermore, the cathode follower acts as an efficient filter¹⁷ to remove the hum and low-frequency fluctuations from the power supply.

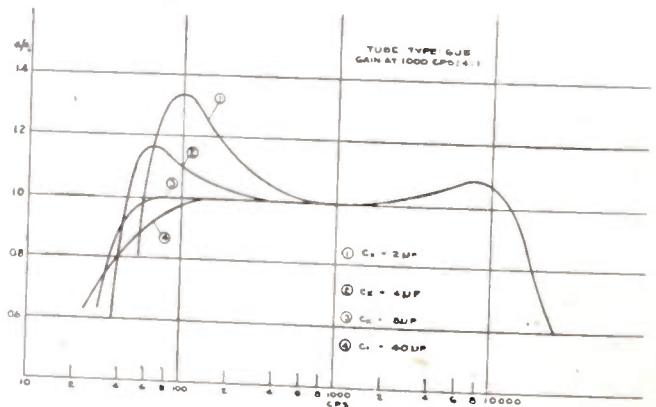

Fig. 8—Low-frequency response of the circuit of Fig. 7.

III. TWO-TERMINAL CATHODE-FOLLOWER DEVICES

A. Complex Cathode Impedance

Cathode-follower systems with a complex cathode impedance may be called complex cathode followers. In such systems, cathode and grid voltages may be considerably out of phase, and characteristic feedback phenomena occur through the grid-cathode capacitance as a coupling element. Fig. 9 shows three prototypes of such circuits. Circuits a and b each have only one

¹³ Due to the current distribution between plate and screen grid, the transconductance of a pentode is 10 to 20 per cent higher in the cathode circuit than it is in the plate circuit.

¹⁴ U. S. Patent No. 2-378-797, issued to Otto H. Schade, assignor to RCA, June 19, 1945. See also U. S. Patent No. 2-384-263.

¹⁵ Derivation, see Appendix.

¹⁶ The gain inferiority is of the order of $1/\sqrt{\mu}$.

¹⁷ Filtering factor = $1/\mu + 1$.

reactance element in the cathode arm; it is negative in circuit *a* and positive in circuit *b*. Circuit *c* has two cathode reactances of opposite sign, forming a series-resonant circuit. The total cathode reactance then becomes a function of frequency and may change from negative values below resonance to positive values above resonance. More complex cathode networks with three or more reactances may be reduced to one of these prototypes over limited frequency ranges.¹⁸ A study of these prototypes therefore gives a fairly general picture of what may be obtained from such circuits in actual practice.

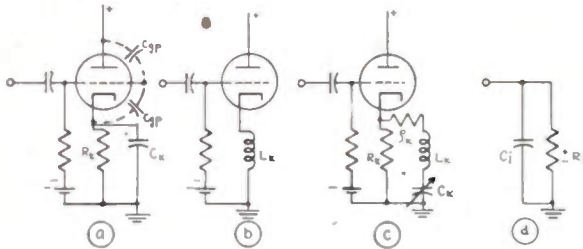

Fig. 9—Cathode-follower with complex load.

Analysis¹⁹ shows that in all three cases the input impedance of the complex cathode follower appears to be a capacitance C_i shunted by a resistance R_i (circuit *d*, Fig. 9). This general behavior of the complex cathode follower is illustrated by the vector diagram of Fig. 10.

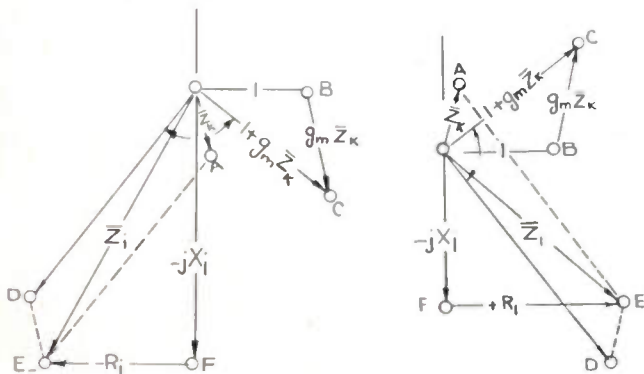

Fig. 10—Vector diagram of complex cathode follower.

It shows how the input impedance OE may be derived from a given cathode load vector OA . OB is the real unit, and OD is obtained by a clockwise rotation of 90 degrees from OC as a base. To obtain the input impedance vector OE , the cathode load DE is added to OD . In Fig. 10 is shown a capacitive-resistive cathode load, and an inductive-resistive cathode load with equal impedance and opposite phase angle. The resulting input impedances both have a capacitive-reactance OF and almost equal resistive components EF . However, the polarity of the input resistance is negative for capacitive load and positive for inductive load. Accordingly, degeneration is caused by inductance and regeneration by capacitance in the cathode branch.

¹⁸ T. E. Shea, "Transmission Networks and wave filters," D. van Nostrand Company, New York, N. Y., 1929; part 1, chapter 5, pp. 124-167.

¹⁹ See Appendix III, equation (53).

More information is obtained from Fig. 11, which shows both input parameters C_i and R_i as functions of the cathode reactance for a complex cathode follower with tuned-cathode circuit, such as circuit *c* of Fig. 9. For such systems, the cathode reactance may be written

$$X_k = \sqrt{\frac{L_k}{C_k}} (x - 1/x); \quad x = f/f_{res} \quad (32)$$

where x is the detuning factor. It is seen that the cathode reactance near resonance ($x=1$) is proportional to the frequency deviation from resonance, so that the abscissa $g_m X_k$ may be interpreted as a frequency scale.

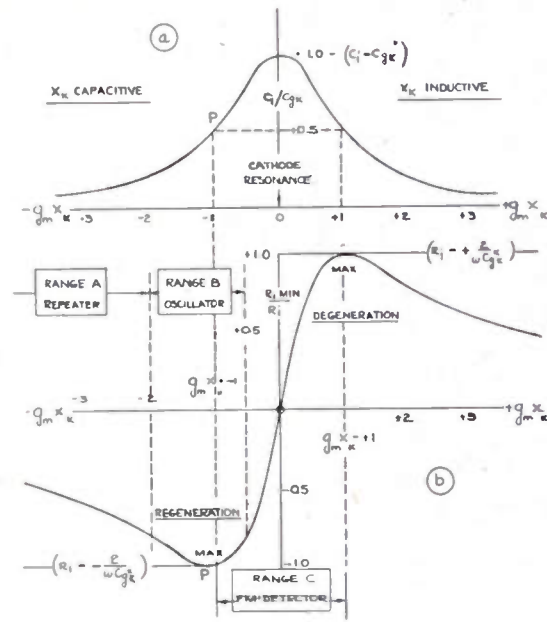

Fig. 11—Input parameters of the complex cathode follower as functions of frequency.

At resonance, the input capacitance reaches a maximum equal to the grid-cathode capacitance. The frequency deviations on either side of resonance have relatively little influence, and the capacitance variations are almost symmetrical. On the other hand, the resistive component of input admittance changes sign as the frequency passes through cathode resonance. To the left of $X_k=0$; (i.e., frequencies below resonance), the input conductance becomes negative, and regeneration results. To the right of $X_k=0$; (i.e., for frequencies above cathode resonance) there is degeneration in the input circuit.

The feedback actions increase on either side of cathode resonance, and reach their maxima for two frequencies, ω_1 and ω_2 , where²⁰

$$g_m X_k = \pm 1. \quad (33)$$

At these points the input conductance assumes a positive or negative maximum. Analysis shows that the minimum value of the input resistance amounts to twice the reactance of the grid-cathode capacitance at those frequencies.

²⁰ In (33) and (34) it is assumed that $\omega Cg < g_m$, which excludes very high frequencies. For more complete expressions see Appendix III.

$$|R_i|_{\min} = \frac{2}{\omega_2 C_{\theta k}} \quad (34)$$

For greater frequency deviations from cathode resonance, the feedback action decreases again. Equation (34) is important for the design of cathode-follower oscillators.

The technical applications of the complex cathode follower may be broadly classified into three groups: signal repeater, oscillator, and detector for frequency modulation. These are shown in Fig. 10, as ranges *A*, *B*, and *C*, respectively, along the frequency scale.

It was shown in Section II, *A*, that repeater action occupies a bandwidth from zero frequency up to the internal cutoff frequency. Low input capacitance and negligible feedback into the grid circuit are characteristic for this mode of operation. Range *A*, or the repeater range, is indicated as including all negative values of cathode reactance up to approximately $g_m X_k = -2$, where repeater action gives way to oscillator action. Range *B* is represented for oscillator applications. It lies on either side of the point *P*, where the input conductance reaches its negative peak. The third range, *C*, is centered around cathode resonance. In this range, the feedback into the grid circuit alternates from regeneration for positive frequency excursions to degeneration for negative frequency excursions. By reason of this fact, the complex cathode follower may be used as a frequency discriminator; some such applications will be described in Sections III, *C*, and IV, of this paper.

B. The Oscillating Cathode Follower

It was shown in the preceding section that the complex cathode follower with a capacitive load has negative input resistance. Analysis and experience lead therefore, to the expectation that oscillations may be generated in a tuned circuit connected between grid and ground, such as that of Fig. 12. By diagramming the

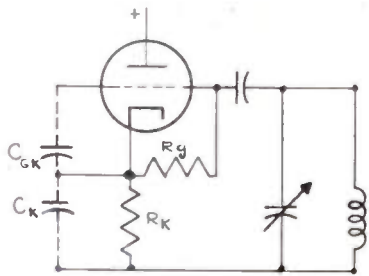

Fig. 12—Cathode-follower oscillator system. Note that tuned circuit is connected between grid and ground.

electrode capacitance $C_{\theta k}$, the circuit becomes similar to a Colpitts-type oscillator. Analysis of this oscillator by methods developed in the theory of the complex cathode follower yields valuable data regarding design factors and performance.

The system of Fig. 12 has a negative cathode reactance

$$X_k = -1/\omega C_k \quad (35)$$

There is practically no equivalent resistance in series

with X_k , especially if chokes are employed in the cathode supply. Under these conditions, the system exhibits a negative input resistance²¹ of

$$R_i = -\frac{1}{2\pi f} \left[\frac{1}{C_\theta} + \frac{1}{C_k} \right] \cdot \left[\frac{f}{f_0} + \frac{f_0}{f} \right] \quad (36)$$

It is evident from this equation that the input conductance reaches a negative peak value at a frequency f_0 which is found as

$$f_0 = \frac{g_m}{2\pi[C_\theta + C_k]} \quad (37)$$

At this preferred frequency, the input resistance becomes

$$R_{i0} = -\frac{1}{\pi f_0} \left[\frac{1}{C_\theta} + \frac{1}{C_k} \right] \quad (36a)$$

This is just twice the value of the reactance offered by the capacitive voltage divider between grid and ground.

At any frequency f other than the preferred one f_0 , the input resistance is obtained by multiplying R_{i0} by the factor

$$R_i/R_{i0} = \frac{1}{2} [f/f_0 + f_0/f]$$

By combining equations (36) and (37), the minimum input resistance may also be written in the form

$$R_{i0} = -\frac{2}{g_m} \frac{(C_\theta + C_k)^2}{C_\theta C_k} \quad (38)$$

This yields the important result that an optimum of design is obtained if the capacitances on either side of the cathode are made equal, $C_\theta = C_k$. If this is done, the negative input resistance is reduced to its lowest possible value

$$R_{i\min} = -\frac{8}{g_m} \quad (38a)$$

This may be realized at any frequency f , provided that the coupling capacitances are chosen as follows:

$$C_\theta = C_k = \frac{g_m}{4\pi f} \quad (39)$$

The result of this theory may be summarized as follows: *The cathode-follower oscillator has a preferred range of operation at or around a frequency where the susceptances of the cathode-to-ground and cathode-to-grid capacitances combined are equal to the transconductance of the tube. At this frequency, the negative input resistance of the oscillator assumes a minimum value equal to twice the capacitive reactance between grid and ground. The maximum of the negative input conductance is 1/8 of the transconductance of the tube. This is obtained at the preferred frequency and with equal capacitances on either side of the cathode.*

This theory answers one or both of the following questions: (1) What is the best load capacitance for oscillator operation at some predetermined frequency? (2) Which

²¹ Derivation given in Appendix III, equation (54).

TABLE II

Type	Transconductance g_m (mhos)	Grid-Cathode C_p (micromicrofarads)	Cathode-Ground C_k (micromicrofarads)	Preferred Frequency f_o (megacycles) eq. (37)	Input Resistance at Preferred Frequency R_{i_o} (ohms) eq. (36a)	Smallest Possible Input Resistance $R_{i_{opt}}$ eq. (38a)	Input Resistance at Frequencies of		
							5 mega-cycles	50 mega-cycles	500 mega-cycles
6J5	3000	3.0	8.0	43.5	-3070	-2670	-13,500	-3370	-17,700
6AC7	9000	11.0	9.0	71.5	-900	-890	-6460	-960	-3230
6AG7	11,000	5.2	10.7	110.0	-830	-726	-9000	-1100	-1980
6F4	5800	2.0	3.0	185.0	-1440	-1380	-26,600	-2850	-2200
6J4	12,000	5.5	2.8	230.0	-750	-667	-17,300	-1810	-990

is the preferred frequency range for an oscillating cathode follower with a given load? This latter question is of particular interest if the tube is to oscillate with only its natural cathode-to-ground capacitance as load.

In Table II, numerical data are listed for cathode-follower oscillators at various frequencies and for tubes of medium and high transconductance. It is assumed that there is no feedback path other than the interelectrode capacitances. Both the negative input conductance and the tendency to oscillate increase with increasing frequency until the preferred range is reached. At broadcast frequencies the input resistance keeps well above -100,000 ohms. This is hardly sufficient to start oscillations in practical circuits with losses. It becomes necessary, therefore, to connect additional external capacitance between grid and cathode. As the frequency increases, the input resistance drops until values as low as -10,000 ohms are available at 10 megacycles, and less than -1000 ohms at 100 megacycles and above. At the same time, however, the optimum cathode-to-ground capacitance decreases to a value which eventually become comparable to, or even smaller than, the cathode-electrode capacitance itself. (See equation (39).) In designing cathode-follower oscillators for still higher frequencies, the cathode load capacitances for optimum design become so small that a serious mismatch cannot be avoided. Fig. 13 presents a balanced cathode follower

oscillations with lagging phase and are loaded by their natural electrode capacitance only.²² Feedback occurs solely through the grid-cathode interelectrode capaci-

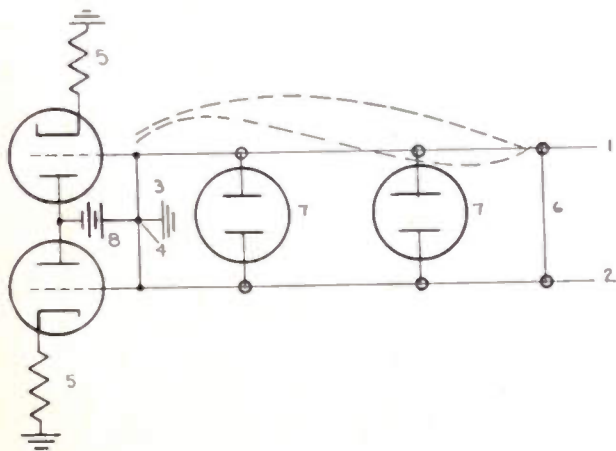

Fig. 13—An ultra-high-frequency cathode-follower oscillator.

oscillator for ultra-high frequencies which is particularly suited for demonstration purposes. It has two 6AG7's in triode connection, and a total plate input of about 10 watts. The Lecher-wire system, (parts 1 and 2), is connected to a coupling rod 3, about 1 inch long, which is grounded at the center tap 4. The plates of the tubes are grounded through the plate battery 8 and bypass capacitors, while the cathodes follow the grid

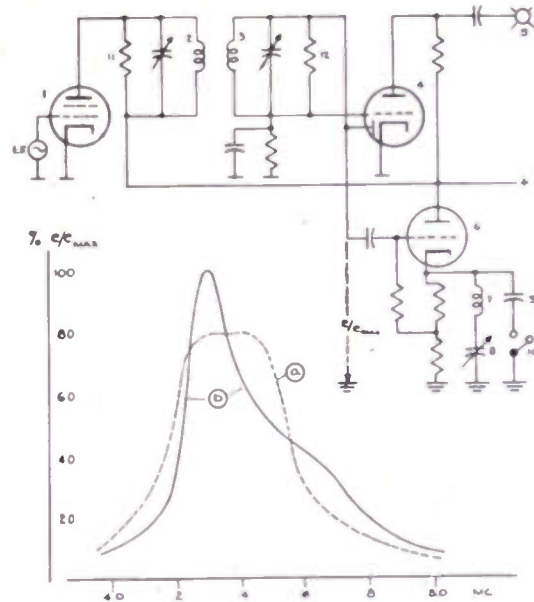

Fig. 14—Band-pass filter with cathode-follower termination.

tance. The wavelength of the system is substantially determined by the grid circuit, 3 and 4, while the Lecher system, 1 and 2, acts chiefly as a voltage transformer. At resonance, i.e., when the distance between bridge 6, and grid connector 3, measures one or more half waves, standing waves of frequencies up to 200 megacycles may readily be demonstrated by neon indicators, 7.

Still higher frequencies (700 megacycles and above) have been obtained with acorn tubes as oscillating cathode followers. The grid circuit was a concentric tuning stub, and the cathode was loaded only by its own electrode capacitance. At very high frequencies the most serious limitation was found to be the inductance of the plate-to-ground connections and of the plate leads within the tube.²³

C. Filter with Cathode-Follower Termination

It was shown in Section III, A, that a cathode follower with a series-resonant circuit in the cathode branch suppresses frequencies below and enhances frequencies above cathode resonance. This may be demonstrated in a circuit such as Fig. 14. This is an ordinary

²² The grid-bias resistors 5, of 150 ohms are large as compared to the reactance of the cathode capacitance at these very high frequencies. This condition may be assured by the use of cathode chokes.

²³ Eduard Karplus, "Wide-range tuned circuits and oscillators for high frequencies," PROC. I.R.E., vol. 33, pp. 426-441; July, 1945.

receiver circuit for amplitude modulation which has an intermediate-frequency output stage 1, a band-pass filter 2 and 3, and damping resistors 11 and 12, as well as a second detector 4, of the diode type. Audio frequency is thus available at 5 and the over-all characteristic would be symmetrical around center frequency as shown in curve *a* of Fig. 14, if tube 6 were omitted.

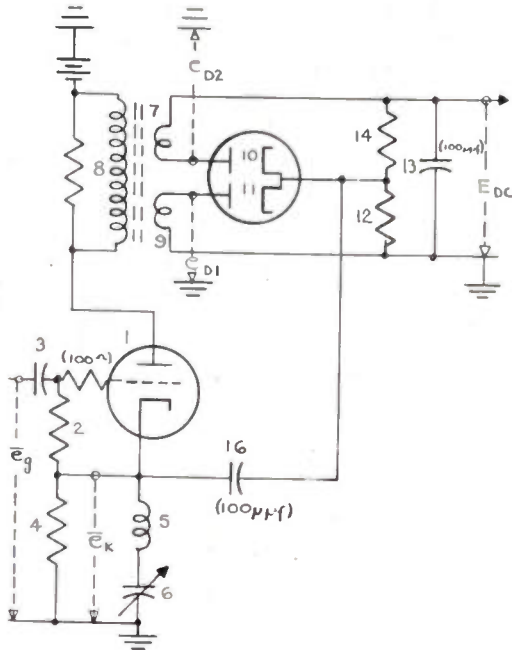

Fig. 15—Cathode-follower detector for frequency modulation.

The complex cathode follower 6 is connected in parallel to the filter output and its cathode circuit 7 and 8 is tuned to the center frequency. The symmetrical band-pass filter characteristic of Fig. 14a, is thereby transformed into a sloping filter characteristic of curve *b*, with the center frequency as the turning point. As a result, it becomes possible to receive frequency-modulated signals with detectors for amplitude modulation.

The circuit is reconverted into an amplitude-modulation receiver either by the switch 10, which connects a large by-pass capacitor 9 across the cathode circuit, or else by breaking the heater circuit of the cathode-follower stage. In both cases there is no change in the cathode-follower input capacitance and thus no detuning of the band-pass filter.

IV. A CATHODE-FOLLOWER DETECTOR FOR FREQUENCY MODULATION

Another application of the complex cathode follower for frequency modulation is shown in Fig. 15. It presents a frequency discriminator²⁴ which compares favorably with more conventional systems, as it combines detector and limiter action. The circuit is basically a complex cathode follower with tuned load 5 and 6, the output voltage of which is rectified through a double diode 10 and 11, in differential arrangement. Two equal and opposite exciter voltages e_{D1} and e_{D2} are induced in se-

²⁴ United States Patent pending.

ries with the diodes by an aperiodic radio-frequency plate transformer 7, 8, and 9. The audio output voltage across resistor 12-14 is then zero at cathode resonance and is proportional to frequency excursions below and above that frequency.

The operation of the system is illustrated in the form of a vector diagram in Fig. 16. *OA* is the input voltage to the cathode-follower grid and is assumed to be 1 volt. Cathode voltage and plate current may then be found for any frequency by plotting the product $g_m X_k$ along a horizontal line through point *B*, 1 volt above the origin ($BD = g_m X_k$). The line *OD* then intersects at *E*, the circle having *OA* as diameter. This yields immediately the cathode voltage $\bar{e}_k = OE$. The plate current, $i_p = OF$, is obtained by locating a point *F* diametrically opposite to *E*. The exciter voltages *OH* and *OG* appear at right angles to the plate current since they are induced in the plate transformer (7, 8, and 9, of Fig. 15), which operates far below resonance. It may be shown that the amplitudes of the diode voltages, e_{D1} and e_{D2} , have no influence on the output of the system so long as they exceed the input amplitudes; i.e., so long as points *G* and *H* lies at or beyond the circle with center *O* and radius *OA*. The form of the discriminator characteristic for 1-volt input may then be found by laying off twice the length *OE*, vertically through *D*, giving the ordinate *LK*. This yields a curve of the type²⁵

$$y = 2x/\sqrt{1 + x^2} \tag{40}$$

which is linear and symmetrical with respect to center

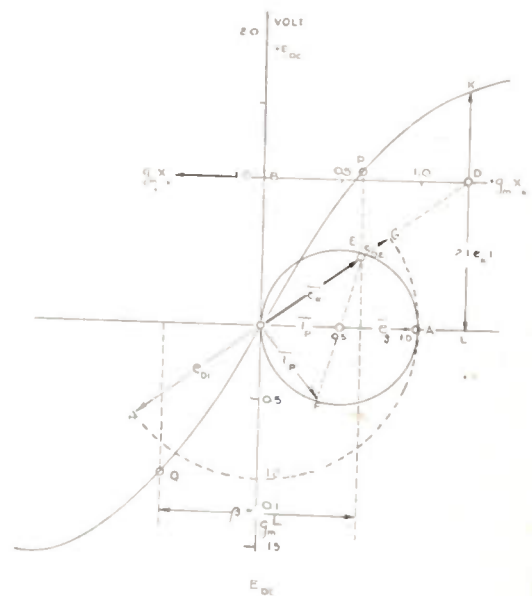

Fig. 16—Vector diagram for cathode-follower detector.

frequency over a range *P*–*Q*, where output and input amplitudes are equal. Above that value, output saturation begins, but there is no reversal of the characteristic as found in conventional discriminator circuits.

The limiter action of the system may be explained by the fact that the output depends on the cathode swing rather than on the exciter voltages for the diode plates.

²⁵ See Appendix V, equation (64).

From the cathode-follower diagram of Fig. 2 it is apparent that the amplitudes between cathode and ground are confined between the points **O** and **N**. This presumes that the grid-leak resistor 2; is high enough to allow for additional grid bias for strong signals. In actual tests, constant output was obtained for input voltages ranging from less than one volt to several volts.

A disadvantage of the circuit of Fig. 15 is the excessive bandwidth necessary to cover fully the linear output range. For a simple two-reactance arm with a cathode inductance L_k , the bandwidth²⁶ is

$$b = 160/L_k \cdot g_m. \tag{41}$$

This is listed in Table III for various tubes and for a center frequency of 4.2 megacycles, to which is tuned a resonant circuit with $L_k = 71$ microhenrys, $C_k = 20$ microfarads, and negligible series resistance.

TABLE III
CATHODE-FOLLOWER DETECTOR FOR FREQUENCY MODULATION

Tube Type	Transconductance g_m (milliamperes per volt)	Bandwidth b (kilocycles) eq. (41)	Type of Circuit
6Q7	1.2	1840	Internal diode-electrodes
6R7	1.9	1180	
6J5	3.0	750	Separate double-diode necessary
6AC7	8.0	280	
6J4	12.0	188	

With ordinary diode-triodes, (type 6R7) with $g_m = 2$ milliamperes per volt, it is difficult to obtain better selectivity than about 1 megacycle. There are two possible ways of improving the selectivity of the discriminator and obtaining bandwidths of 300 kilocycles or less: either a tube with high transconductance, or a more complex network may be used. Tubes with transcon-

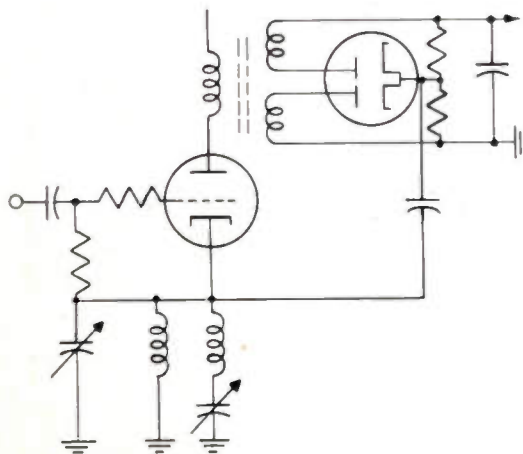

Fig. 17—Equivalent cathode-follower discriminator with four-reactance network.

ductances of 8000 micromhos and more are listed in Table III with the resultant selectivities for a two-reactance cathode arm, as computed from equation (41). The bandwidth may be expanded by the use of resistor in series with the cathode arm. The other alternative uses a four-reactance network as shown in Fig. 17 as

complex load for a standard triode. This circuit yields high selectivity and adjustable bandwidths down to 200 kilocycles in connection with tubes of moderate transconductance. Fig. 18 shows experimental data obtained with a 6J5 tube in the circuits of Fig. 15 and Fig. 17. Curve *a* of Fig. 18 shows the response of the simple detector circuit with only two reactance elements; its bandwidth is 800 kilocycles. In the system with four reactances, the bandwidth can be adjusted between 400

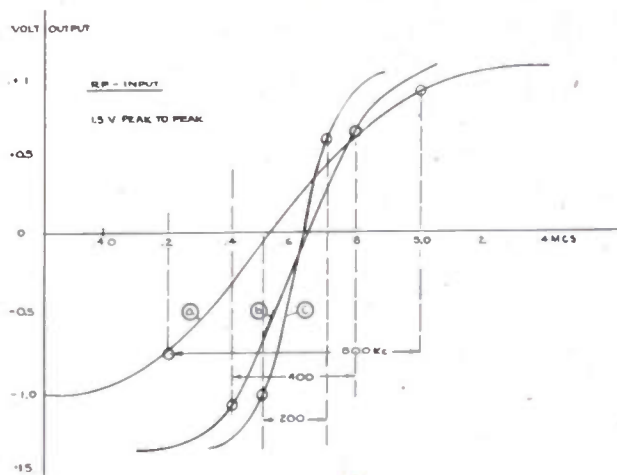

Fig. 18—Selectivity and bandwidth for the circuits of Figs. 15 and 17.

and 200 kilocycles by reducing the separation between the two antiresonant frequencies of the cathode network. (Curves *b* and *c* of Fig. 18.) In actual practice, the circuit of Fig. 15 may be more attractive because it has only one tuning element for adjustment to center frequency.

This frequency-modulation detector circuit is somewhat more involved than the conventional double-diode discriminator, but it has, in addition to limiter action, the advantage of higher input impedance and lower output impedance. The former permits higher gain from the output stage of the intermediate-frequency amplifier and the latter allows for the transmission of higher modulation frequencies. In addition to this, the cathode-follower circuit provides efficient filtering of the plate power supply, and thereby a beneficial reduction of background noise.

CONCLUSION

In this paper, cathode-follower circuits have been presented in various technical applications. The cathode-output amplifier is firmly established as impedance transformer and signal equalizer for wide-band transmission. It may also be used with output transformer in an audio amplifier to yield a gain of about 7:1 with good fidelity. As an interstage coupling element, the cathode follower is less attractive since equivalent gain may be more economically obtained by conventional coupling networks. A cascade of several cathode-follower tetrodes may be used to advantage for signal synthesis in transmitters for television and multiplex communication.

²⁶ See Appendix IV, equation (57).

rule-of-thumb formula which is developed in the last section of the paper. In spite of the lack of quantitative experimental confirmation, it was thought that this subject would be of general interest in television circles.

Fig. 1 shows two cycles of a train of waves which are of particular interest in television problems. This wave has been called variously by many names, among

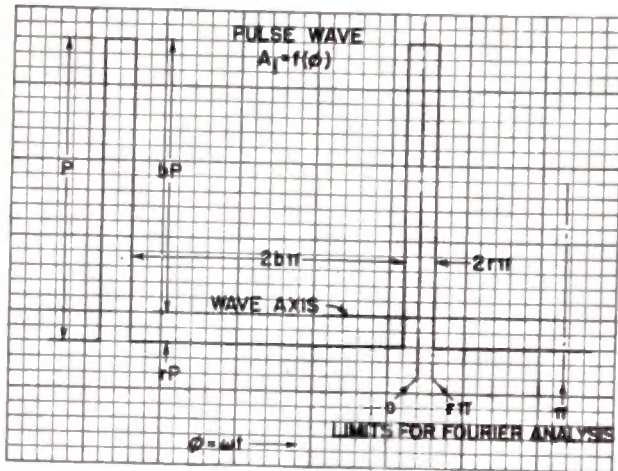

Fig. 1—Graph of a finite rectangular pulse.

which the more prominent are pulse, blanking-signal, and pedestal. Although the wave diagram of Fig. 1 is a mathematically ideal representation, electric waves of potential, which are closely approximate to this ideal may be generated.¹⁻⁷ It is the purpose of this paper to present some useful computations in regard to Fig. 1, and concerning image resolution.

The pulse wave has three distinguishing characteristics: amplitude, duration, and frequency of repetition. It will be noted that the positive and negative excursions of the wave are different in amplitude, and also that the durations of the positive and negative portions are different.⁸ The ratio of these durations is inversely proportional to their amplitudes because of the equality of areas. The ratio of the time-of-least-duration to the time-of-the-entire-cycle will be defined by the symbol r (the fraction of the cycle for which the positive peak

endures, in Fig. 1). The ratio of the time-of-greatest-duration to the period of the cycle will be defined by the symbol b . Thus, $b+r=1$. The " r index" is a "duration index" of the wave, and waves will be described by reference to this r index, where r is a fraction always less than unity.

The equation of the pulse wave may be obtained by the methods of Fourier analysis.^{9,10}

The equation of an infinite train of pulse waves, in the steady state, at any instant of time, is (see Appendix A for derivation)

$$A_i = 2rP \sum_{n=1}^{\infty} \frac{\text{Sin } nr\pi}{nr\pi} \cdot \text{Cos } n\omega t. \quad (1)$$

It will be observed that there are three factors composing this equation. In the order of their occurrence in (1), these factors are:

- (1) The constant term, the magnitude of which has been properly chosen so that the sum of the infinite number of harmonic components will always add (at the proper phase point) to give the proper peak value to the wave.
- (2) The harmonic-amplitude-adjusting coefficient, which is independent of the time, but is a transcendental function of nr .
- (3) The functional component, which is dependent upon the time.

II. AMPLITUDE OF HARMONIC COMPONENTS

A pulse wave defined by (1), having a duration index r , will be referred to as an r -type wave. The second factor, $\text{Sin } nr\pi/nr\pi$, under column II of (1), has the property of modulating the amplitudes of the harmonic components. It will be noticed that this factor is of a peculiar form. It is zero at every value of n which is an integral multiple of $1/r$, since $nr\pi$ is then an integral multiple of π . These zero points are called the elided frequencies of the wave. They represent points at which the amplitudes of the harmonic components fall to zero. The similarity to discussions on the effect of finite aperture widths will be apparent.¹¹ In fact, the width of the pulse and the width of an aperture are identical as mathematical concepts.

The first, second, and third zero frequencies of an r -type wave occur at $n=1/r, 2/r, 3/r$. Because of the fact that the harmonic amplitudes are positive in the angular interval up to the first zero, and negative in the interval from the first zero to the second zero, then if only those components up to the first zero frequency are present, the resultant wave form will overshoot the actual wave form which it simulates (see curve a of Fig. 2).

⁹ Manfred von Ardenne, "Frequency spectrum of sawtooth waves," *Telev. and Short-Wave World*, January, 1938.

¹⁰ R. A. Monfort and F. J. Somers, "Measurement of the slope and duration of television synchronizing impulses," *RCA Rev.*, vol. 6, pp. 370-389; January, 1942.

¹¹ Mertz and Gray, "A theory of scanning," *Bell Sys. Tech. Jour.*, p. 464; July, 1934.

¹ H. Abraham and E. Bloch, "Multivibrator," *Ann. de Physique*, vol. 12, p. 237; 1919.

² B. van der Pol, "On relaxation oscillators," *Phil. Mag.*, and *Jour. Sci.*, vol. 2, pp. 978-992; November, 1926.

³ B. van der Pol and van der Mark, "Some experiments with triodes and relaxation oscillation," *L'Onde Electrique*, vol. 6, p. 69; September, 1927.

⁴ R. M. Page and W. F. Curtis, "The van der Pol four-electrode tube-relaxation oscillation circuit," *Proc. I.R.E.*, vol. 18, pp. 1921-1930; November, 1930.

⁵ "Impulse generator circuit," *Electronics*, p. 221; July, 1932.

⁶ "Television bibliography," *Electronics*, p. 265; August, 1932.

⁷ J. L. Potter, "Sweep circuit," *Proc. I.R.E.*, vol. 26, pp. 713-719; June, 1938.

⁸ Mathematically, a wave motion is a cyclical disturbance-with-time, in some form of space (energy space, momentum space, etc.). This occurs in such fashion that there is no net change in displacement from cycle to cycle. The locus of zero displacement is the axis of the wave. This divides the wave into positive and negative portions in which the time-integral-of-displacement in each cycle is zero; i.e., the positive and negative areas are equal. Electrically, the displacement of charge is involved, and the rule of equality-of-areas may be interpreted to mean that there is no net transfer of charge, in an alternating circuit, from one cycle to another.

In Fig. 3 there has been plotted curve 1, which represents the amplitudes of the harmonic components of the pulse wave of (1) for the first two angular intervals. The product $n\pi$ is a pure number, and may be represented as an angle: $n\pi = \phi$ radians. The function

$$S_1 = \text{Sin } \phi / \phi \quad (2)$$

is a discontinuous function when ϕ is defined in this manner.¹² Graph 1 of Fig. 3 is a plot of the envelope of the discontinuous function S_1 .

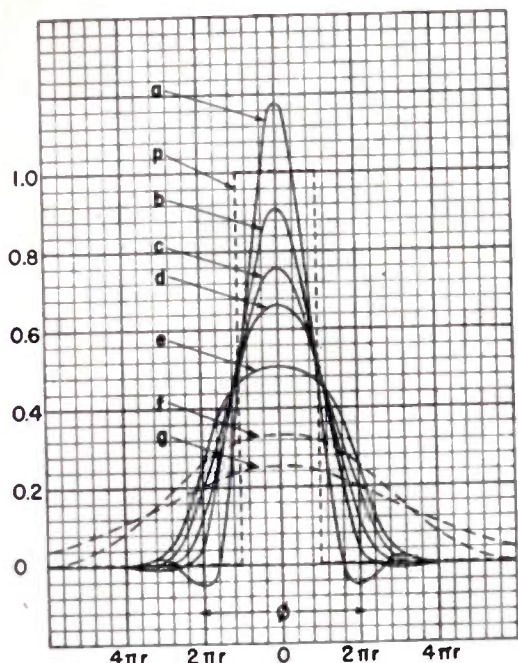

Fig. 2—Finite pulse shapes. Synthesis of harmonics of a finite pulse, with cutoff at 1st elided frequency.

ρ = rectangular pulse for infinite number of harmonics (neglecting Gibb's phenomenon). Electrical signal will have this pulse form, if a finite illuminated area of width index r is scanned by a photocell having an infinitesimal aperture. This is the graph of (1) for $N = \infty$.

a = shape of the pulse P for a finite number of harmonics. This is the graph of (1) for $N = 1/r$.

b = electrical signal will have this pulse form if a finite, illuminated area is scanned by a photocell having a finite aperture of the same width, and if electrical cutoff is at first elided frequency. This is the pulse shape from a picture element scanned by one aperture of element width.

c = pulse shape from a picture element scanned by two apertures in tandem, each of element width.

d = pulse shape from a picture element scanned by three apertures in tandem, each of element width.

e = pulse shape from a picture element scanned by one aperture of twice element width.

f = pulse shape from a picture element scanned by one aperture of three times element width.

g = pulse shape from a picture element scanned by one aperture of four times element width.

The function S_1 approaches a continuous function as a limit, when r , the index of pulse width, approaches zero. The integral of S_1 , as a continuous function, is known as the sine integral.¹³ Fig. 3 (graph 1) is a graph of the integrand of the sine integral, which is the envelope of the amplitudes of the n harmonic components of a finite, pulse wave. It will be noted that the ampli-

¹² According to this definition, ϕ is not a continuous variable but has only a discrete number of values, depending upon the number of values which n can assume (up to $n = 1/r$), in each interval.

¹³ Ernst A. Guillemin, "Communication Networks," vol. 2, John Wiley and Sons, Inc., New York, N. Y., 1935, p. 478.

tude of S_1 goes through zero many times, and reverses sign as it does so, and also that the successive maxima of S_1 diminish steadily as ϕ increases, ϕ being proportional to n .

For each width of the pulse; i.e., for each value of r there is only a finite number of harmonics in each interval of S_1 . The number of these harmonics is determined by the equation $n r = 1$. As the duration index r approaches zero; that is, as the duration of the pulses becomes very short, the parameter $\phi = n r \pi$ may be considered as a continuous variable. Actually, ϕ is a "quantized" variable which changes its value in discrete jumps, each of magnitude $\Delta\phi = r\pi$. The value of ϕ at any harmonic frequency will be determined by the number of these jumps, which number is equal to n , the order of the harmonic.

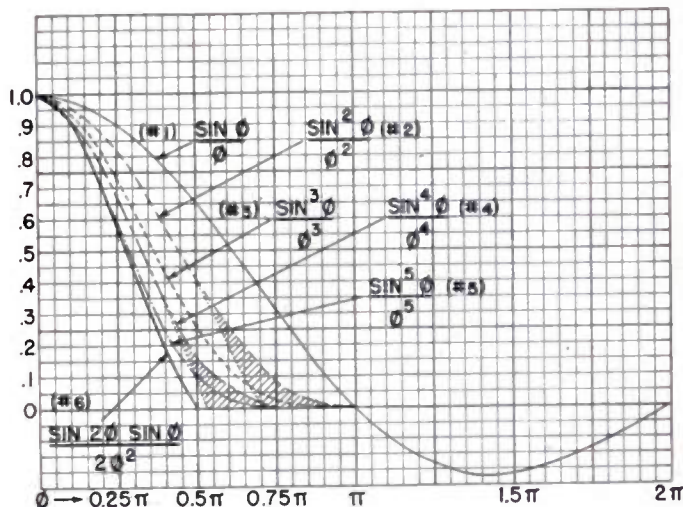

Fig. 3—Graphs of the function S_1 and related functions describing the harmonic contents of pulses subjected to successive aperture processes.

- 1 = relation of harmonics in a rectangular pulse, up to the second zero frequency. (One aperture process.)
- 2 to 5 = relation of harmonics, up to the first zero frequency, for 2, 3, 4, and 5 in tandem aperture processes.
- 6 = approximation for S_1 when two aperture processes are involved, having a ratio of 1:2.

The areas of the sine integral have been tabulated for many values of $\phi = n r \pi$ and may be interpolated from tables for other values.^{14,15} The abscissa scale to which Fig. 3 has been plotted is such that zero frequencies occur whenever the values of $n r$ are integral; i.e., whenever ϕ is a multiple of π .

The units of abscissa may be converted rapidly to frequency, in case the periodicity of the wave and its duration index are known. For example, if it is desired to know the first zero frequency of a 60-cycle pulse wave of 0.1 duration ($r = 0.1$), choose $n = 1/r = 10$ such that the first zero frequency occurs at the 10th harmonic of the fundamental; i.e., at 600 cycles. The harmonic amplitude of any component can be found immediately

¹⁴ Federal Works Agency, Work Projects Administration for the City of New York, "Tables of Sine, Cosine and Exponential Integrals," vol. 2, 1940.

¹⁵ See also N. R. Jørgensen, "Undersøgelser over Frekvensflader og Korrelation," A. Busck, København, 1916, pp. 157-175, for table of $1/\pi Si(nx)$.

for the 10 values of ϕ , at which harmonics exist, by dividing each interval into 10 equal parts. The amplitudes of the harmonics are read from the curve at these points. It will be appreciated that, since harmonics are always integral multiples of the fundamental, there are only discrete points along the curve within each interval which are useful for any particular value of r . The reciprocal of the value of r for a pulse wave denotes the number of points from zero to the first zero-frequency and between zero frequencies, where harmonics actually exist. The units of abscissa in the diagram of Fig. 3 are units of $r\pi$, for any particular wave. The smaller the value of $r\pi$, the more points along the curve are needed to describe its harmonic content.

In Fig. 2a the synthesis of the pulse wave is shown for a finite sum of harmonics, added up to the first zero frequency. "Plotting" cutoff is, in this case, at $1/r$ harmonics. The curve holds approximately for any value of r smaller than 0.1, i.e., for narrow pulse width relative to the spacing between the pulses. The curve becomes more exact, the smaller the value of r . Thus Fig. 2a is approximately a plot of a single cycle of an 0.1 pulse wave, which would be obtained by adding up all the components to the 10th harmonic, at every phase point, and neglecting all other components. The pulse wave of Fig. 2a represents the output of an imaginary electrical system with flat transmission and linear phase characteristic up to the first zero frequency, whether this frequency be at the 10th or 10,000th harmonic frequency, when the input wave is of the form shown in Fig. 1, (or Fig. 2p). Since neither the input wave nor the filter can exist, the pulse shape of Fig. 2a is confined to theoretical interest and has been developed as an aid to the discussion to be undertaken in Section III.

III. SYNTHESIS OF WAVES FROM THEIR HARMONIC COMPONENTS

The factor of the form $\sin \phi / \phi$ is a function of $\phi = nr\pi$. When r is small, $r\pi$ may be treated as an increment. Let $r\pi = \Delta\phi$. Multiplying (1) by unity $= \Delta\phi / \Delta\phi = \Delta\phi / r\pi$.

$$A_i = \frac{2P}{\pi} \sum_{n=1}^{\infty} \frac{\sin \phi}{\phi} \cdot \Delta\phi \cos n\omega t. \quad (3)$$

This equation represents the pulse wave for infinite bandwidth. Such form of the equation suggests that the amplitude of the wave could be found for any finite number of harmonics by expressing ωt in terms of ϕ , and integrating, or adding areas under the summation sign, up to a finite number of harmonics ($n = N$). This is a substitute for the laborious process of actually adding N harmonic components, where N is a very large number.

Since ϕ is proportional to n , the limits must be changed from units of n to units of ϕ ; i.e., from $n = 1$ and $n = N$, to $\phi = 0$ and $\phi = \phi_1$. The summation, then, represented in (3) may be replaced by an integral. ($\Delta\phi$ may be replaced by $d\phi$ when r is small.)

$$A_i \text{ (finite cutoff)} = \frac{2P}{\pi} \int_0^{\phi_1} \frac{\sin \phi \cos n\omega t d\phi}{\phi} \quad (4)$$

where $\phi_1 = Nr\pi$.

Equation (4) is not in condition for simple integration. It will be necessary to determine ωt in terms of $r\pi$ and to set the limits of integration, according to the number of harmonic terms it is desired to add. There are only a few values of ωt for which it is necessary that the amplitude of the wave be determined, in order to plot its general shape. It will be sufficient to plot the curve at six points: (a) $\omega t = 0$; (b) $\omega t = r\pi/2$; (c) $\omega t = r\pi$; (d) $\omega t = 3r\pi/2$; (e) $\omega t = 2r\pi$; and (f) $\omega t = 3r\pi$. (Calculations for curves of Fig. 2 are shown in Appendix B.)

This number of points is believed to be sufficient to indicate the shape of a universal, synthetic pulse wave, having any large number of harmonic components up to the 1st elided frequency. Integration limits are determined by the cutoff frequency (at the N th harmonic). In substituting the values for ωt in (4), six integrals are obtained.

$$A_a = \frac{2P}{\pi} \int_0^{\pi} \frac{\sin \phi}{\phi} d\phi \quad (5a)$$

$$A_b = \frac{2P}{\pi} \int_0^{\pi} \frac{\sin \phi}{\phi} \cdot \cos \phi/2 d\phi \\ = \frac{4P}{\pi} \int_0^{\pi/2} \left(\frac{\sin \phi}{\phi} - \frac{\sin^3 \phi}{\phi} \right) d\phi \quad (5b)$$

$$A_c = \frac{2P}{\pi} \int_0^{\pi} \frac{\sin \phi \cos \phi}{\phi} d\phi = \frac{P}{\pi} \int_0^{2\pi} \frac{\sin \phi}{\phi} d\phi \quad (5c)$$

$$A_d = \frac{2P}{\pi} \int_0^{\pi} \frac{\sin \phi \cos 3\phi/2}{\phi} d\phi \\ = \frac{4P}{\pi} \int_0^{\pi/2} \left(\frac{\sin \phi}{\phi} - \frac{5 \sin^3 \phi}{\phi} + \frac{4 \sin^5 \phi}{\phi} \right) d\phi \quad (5d)$$

$$A_e = \frac{2P}{\pi} \int_0^{\pi} \frac{\sin \phi \cos 2\phi}{\phi} d\phi \\ = \frac{2P}{\pi} \int_0^{\pi} \left(\frac{\sin \phi}{\phi} - \frac{2 \sin^3 \phi}{\phi} \right) d\phi \quad (5e)$$

$$A_f = \frac{2P}{\pi} \int_0^{\pi} \frac{\sin \phi \cos 3\phi}{\phi} d\phi \\ = \frac{P}{\pi} \left[\int_0^{4\pi} \frac{\sin \phi}{\phi} d\phi - \int_0^{2\pi} \frac{\sin \phi}{\phi} d\phi \right]. \quad (5f)$$

If $N = 1/r$, $\phi_1 = \pi$; and the values calculated from (5) correspond to those which would be obtained by adding N harmonics. If $N = 2/r$, $\phi_1 = 2\pi$. Using $\phi_1 = 2\pi$ in (4) corresponds to adding harmonic components up to the second elided frequency. Calculations for $\phi_1 = \pi$, in (5), are shown in Appendix B, and plotted in Fig. 2 as pulse a .

As an example of the error which is introduced by using an integral method for values of r as large as 0.1, the negative overshoot for the universal wave of Fig. 2a' at the points $\pm r\pi$, is 5 per cent of the total amplitude

of the wave when computed by (5); whereas, the actual addition of the ten Fourier components at this point would give a 6 per cent negative overshoot.

For the theoretical case where $r=0$ (of academic interest only) the equation of the infinitesimal pulse may be obtained from (1) by letting r approach zero, in which case the $\text{Sin } \phi/\phi$ factor becomes unity. The shape of the *infinitesimal* pulse, obtained by adding a *finite* number of harmonic components $N=1/r$ is shown in Fig. 4 (see Appendix D).

IV. PULSE SIGNALS THROUGH APERTURES

A television system is an optical system for the transmission of images through moving apertures. The finite size of the aperture causes degradation of the image, as is well known.¹¹

An analysis of the shape of an electrical pulse, from an illuminated point in the image on a television pick-up tube, is of interest in regard to aperture distortion. Since a true mathematical point has no reality, that is, no shape and no dimensions, it is best to define the shape and dimensions of the points of light in the image to be discussed, and thus avoid a philosophical impasse. The shape of a point (a picture element) will be defined as "square." If an image is divided into parallel lines

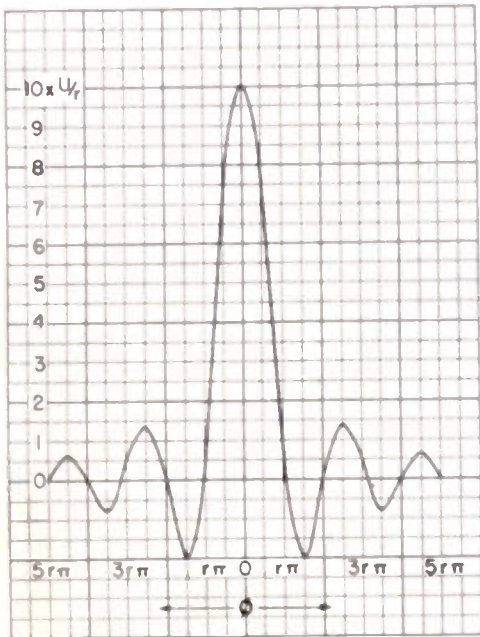

Fig. 4—Infinitesimal pulse for finite cutoff. Finite width of an infinitesimal pulse after transmission through a filter with sharp cutoff at a harmonic defined by $N=1/r$.

or strips and these lines are strung out end to end, the light intensities of picture elements across the strip image have an order of spacial distribution, which may be converted to an order of time distribution, by means of the repetitive scanning process. This implies that observation of the image is made through a small, square window which moves uniformly along the line. The uniform motion along the line corresponds to scanning speed, and the small window corresponds to the scanning aperture.

Consider the image to be made up of points of light and consider a device (an infinitesimal window) which would transform these points of light into instantaneous electrical potentials, as it traverses them. Light radiation will "pulse" through this window, at the frequency of scanning repetition. For the purpose of the analysis, it will be sufficient to consider only a single point of light in the entire picture: all other points could be con-

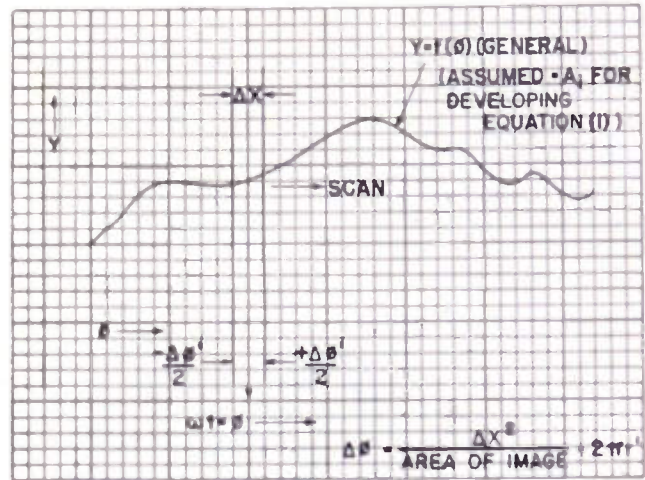

Fig. 5—Graph of Y , which is intensity of light along scanning line, in its relation to the width of aperture, ΔX . ($Y=A_i$ for developing (1) of text.)

sidered on the same basis, having different relative phase and amplitude. The pulses of light have the wave form of Fig. 1.

Thus, (1) describes the electrical components (in a photocell circuit) which come into being from each square point of light, during the scanning process (assuming an infinitesimal width of aperture). A finite scanning aperture has the effect of integrating (averaging) these components across its dimensions, in the direction of the scanning. Thus, to obtain the electrical output from a scanning system with a finite aperture, it is necessary to integrate (1) along the aperture in the direction of scanning. Let the dimensions of the aperture be $\Delta\phi' \times \Delta\phi'$ (Fig. 5). Then the integration must be performed between the limits $(\phi - \Delta\phi'/2)$, and $(\phi + \Delta\phi'/2)$. Let E_a = the electrical signal at field-scansion frequency, from the photo surface behind the finite aperture.

$$E_a = K' \int_{(\phi - \Delta\phi'/2)}^{(\phi + \Delta\phi'/2)} A_i' \cdot d\phi \quad (K' \text{ is a constant of the photocell}). \quad (6)$$

Integration and simplification of (6) yields (see Appendix C)

$$E_a = A' \sum_{n=1}^{\infty} \frac{\text{Sin } nr\pi}{nr\pi} \frac{\text{Sin } nr'\pi}{nr'\pi} \text{Cos } n\omega t. \quad (7)$$

Examination of (7) reveals that the only effect of a finite aperture is to introduce another factor of the form $\text{Sin } \phi'/\phi'$ into the original harmonic composition of the pulse. The index of the aperture is r' , the ratio of $\Delta\phi'$

to the total angular length (2π) of field-scanning-path across the entire strip image. The finite aperture, then, modifies the frequency spectrum which would be obtained through an infinitesimal aperture, during the scanning act, in the same manner that the *finiteness* of a pulse modifies the frequency spectrum of an infinitesimal pulse.

When the aperture index has the same value as the r index of the electrical pulses generated from image picture elements; that is, when the spot size is comparable to the picture element size which it is desired to reproduce, the modulating factor of the harmonic amplitudes in the frequency spectrum has a $\text{Sin}^2 \phi/\phi^2$ form, as shown in curve 2 of Fig. 3. This is obvious from examination of (7) (substitute r for r'). It will be noticed that the first zero frequency of the aperture signal is identical

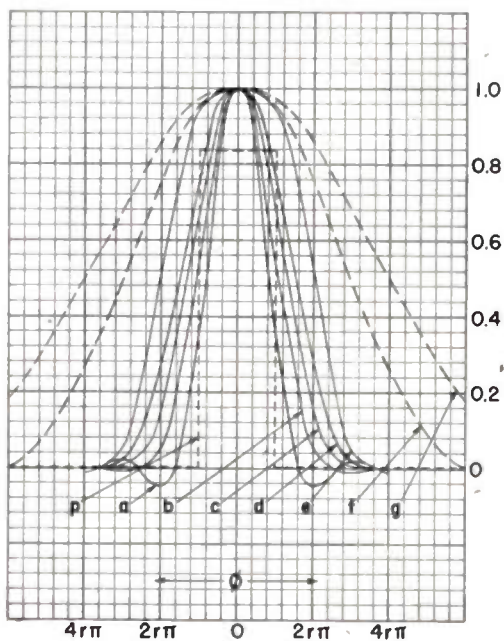

Fig. 6—Pulse shapes of Fig. 2. Equalized in amplitude.

to that of a finite picture element having the same size as the aperture (curve 1, Fig. 3). Curves 1 and 2 of Fig. 3 do not differ greatly from one another; only the higher-frequency components of the electrical spectrum have been modified by the finite aperture. For this reason, it is frequently stated that the quality of television pictures can be improved by aperture compensations; i.e., a rising frequency characteristic in the ratio of curve 1 to curve 2 in Fig. 3, up to the first zero frequency.

The pulse shape shown in Fig. 2 as curve *a* is an idealized shape, for two reasons: the first of these is that it represents the output of an infinitesimal aperture, which cannot exist in practice but can be approximated; and the second is that it represents this output up to only the first zero frequency of the pulse, which implies that a sharp cutoff filter having perfectly linear phase shift up to cutoff has been inserted in the electrical circuit. This latter device does not exist, but can be approximated. The closer these two ideal conditions are real-

ized, the more nearly the output wave form will be as shown in curve *a*, Fig. 2.

If the aperture has the same width as the structure of the image, that is, the width of the dotted rectangle shown as $2\pi r$ in Fig. 2, then the harmonic content is described by curve 2 of Fig. 3 and the shape of the electrical output will be as shown in curve *b* of Fig. 2. This shape is computed by methods similar to those used in (5) (see Appendix B), substituting $\text{Sin}^2 \phi/\phi^2$ for $\text{Sin} \phi/\phi$. If, in addition, the filter has a cutoff characteristic $\text{Sin} \phi/\phi$, then the harmonic content is described by curve 3 of Fig. 3, and the output wave shape will be as shown in curve *c* of Fig. 2, which is computed according to the theory by substituting $\text{Sin}^3 \phi/\phi^3$ for $\text{Sin} \phi/\phi$ in (5).

Should the scanning aperture have a width of twice that shown in Fig. 2; that is, a width of $4\pi r$, the output for a sharp cutoff filter (no frequency limitation below the first zero frequency) would be as shown in curve *e* of Fig. 2 (harmonic content as in curve 6 of Fig. 3). All the curves of Fig. 2 have one common characteristic: the area of the original, dotted rectangle is conserved. This may be proved by integration (planimeter), or by theoretical reasoning beyond the scope of this paper. Should all these curves be equalized in amplitude by insertion of electrical amplifiers, they would appear as shown in Fig. 6, which gives a basis for calculating the widening effect of successive aperture processes. The effective width of a pulse will be defined in the usual manner, as the width of an equivalent rectangle. Since the areas of the curves in Fig. 2 were equal (before equalizing the amplitudes), the areas of the curves in Fig. 6 must be inversely proportional to the amplitudes of the curves of Fig. 2, which means that the effective widths of the pulses are inversely proportional to their amplitudes, as calculated from (5).

V. SIGNIFICANCE, AS APPLIED TO RESOLUTION OF IMAGES¹⁶⁻¹⁸

Manufacturers rate film at 45 lines per millimeter, for fast film, or 70 lines per millimeter for slow, high-definition film. A 16-millimeter frame is 8 millimeters in height, and a 35-millimeter frame is 16 millimeters in height; thus, the manufacturer's rating of resolution for fast 16-millimeter film would be $8 \times 45 = 360$ lines (720 television lines). In television practice, a line is defined as a scanning line, either black or white; whereas, it seems to be representative of optical practice to define resolution in terms of *distinguishable* lines; i.e., as black-and-white pairs. Thus, some film manufacturers define the resolution as one half of the value used in television.

If the quality of an image is defined by defining the number of "television lines" of resolution n_i , (such as

¹⁶ E. W. Engstrom, "A study of television image characteristics," Part I, Proc. I.R.E., vol. 21, pp. 1631-1652; December, 1933; Part II, vol. 23, pp. 295-311; April, 1935.

¹⁷ A. V. Bedford, "Figure of merit for television performance," RCA Rev.; July, 1938.

¹⁸ H. A. Wheeler and A. V. Loughren, "The fine structure of television images," Proc. I.R.E., vol. 26, pp. 540-576; May, 1938.

$n_i = 800$, which is fairly representative of 16-millimeter film) and if the image has an effective¹⁹ aspect ratio of A , then there are $A(n_i)^2$ picture elements. Each of these elements has, for scanning purposes, an electrical width (an r index) of

$$r = 1/A(n_i)^2. \quad (8)$$

(This value of r is the ratio of duration between one picture element in the picture, and the period of reproduction of a frame.)

The first, elided frequency of the electrical image, viewed through an infinitesimal aperture, is at the N th harmonic of the frame frequency. If it were possible to produce electrical transmission filters with sharp cut-off at this frequency, the act of scanning would produce an electrical signal of the form shown in Fig. 2a.

If, however, the scanning aperture is square and of picture-element width (electrical index equal to r), then both the shape and the width of the pulse reproduced through the aperture will be modified from the shape of Fig. 2a. Mathematically, the modification could be plotted by performing the integrations in (5), substituting²⁰ the $\text{Sin}^2 \phi/\phi^2$ curve for $\text{Sin} \phi/\phi$. This involves a great deal of work which can be avoided by another method of approximations.

It can be shown from Fig. 3 that the $\text{Sin}^2 \phi/\phi^2$ curve, if extended, as in dot, to intersect the axis at 0.72π , would have a shape closely approximate to $\text{Sin} \phi/\phi$, with the exception of the cross-hatch area. The scale of plotting in electrical degrees is, however, contracted in the ratio $0.72/1$, which corresponds to a decrease in the value of N , or to an increase in the value of r , to a new value $r'' = r/0.72 \doteq \sqrt{2} \cdot r$.

The case in which two tandem scans of a finite image are made by apertures which are finite and of width r indicates that the harmonic content is modified by a $\text{Sin}^3 \phi/\phi^3$ curve (curve 3), which is approximately a $\text{Sin} \phi/\phi$ curve intersecting the axis at 0.62π . This corresponds to an over-all width index of $r''' \doteq \sqrt{3} \cdot r$. For two apertures of width r , a filter²¹ of width r , and an image of structure r , the curve is $\text{Sin}^4 \phi/\phi^4$, and the approximate equivalent (four-in-tandem) aperture is $r'''' \doteq \sqrt{4} \cdot r$.

It is submitted that the finite structure of the original picture to be transmitted by electrical means imposes a restriction on the frequency band arising from the scanning process, which restriction is equivalent to that imposed by the scanning of a picture having infinite detail (if such could exist) by a finite aperture. This restriction will be defined as an "aperture process." Thus, to be explicit, *the finiteness of the structure of the picture itself in tandem with the finiteness of the aperture which scans it, is equivalent to the scanning of a perfect image by two apertures in tandem.*

¹⁹ D. B. Smith, "Notes on the optimum number of lines for a television system," Panel 7, National Television Systems Committee.

²⁰ Figs. 2b to 2e and the curves of Fig. 6 are plotted in this manner. Plotting data are calculated in Appendix B.

²¹ A filter of width r is defined as one which has a cutoff characteristic similar to that of an aperture of width r , as shown in curve 1 on Fig. 3, to the first elided frequency.

By the method of mathematical induction, a rule of thumb may be evolved as to the "widening" effect, on a picture element, in subjecting the picture to any number of aperture processes. The transmission of frequency components up to the first elided frequency only is itself an aperture process, as stated in the preceding paragraph. Observation through an aperture of twice the width of picture element modifies the harmonic-adjusting coefficient of the frequency spectrum of a finite picture element as in curve 6 of Fig. 3 (pulse shape is plotted in Fig. 2e)

$$\text{Sin} \phi/\phi \text{ Sin } 2\phi/2\phi = \text{Sin}^2 \phi/\phi^2 \text{ Cos } \phi. \quad (9)$$

Equation (9) is approximately of the form $\text{Sin}^5 \phi/\phi^5$, and has almost exactly the form $\text{Sin} \phi/\phi$, if the scale in electrical degrees is adjusted for $r'''''' = \sqrt{5} \cdot r$.

Thus, it may be induced as a working approximation, that aperture processes involving r indexes having values k times r , where r is the width index of the original picture element, are equivalent to a number of identical aperture processes, which number is approximately equal to k^2 . Thus, scanning by a $2r$ aperture is equivalent to four successive scans by an r aperture.

If the number of identical aperture processes is K , then the rule of thumb is that the width index of the reproduced pulse is approximately

$$Kr = \sqrt{k_1^2 + k_1^2 + k_2^2 + \dots + k_p^2} \cdot r \quad (10)$$

where r is the width index of the original picture element, and $k_1, k_1 \dots k_p$ are the ratios of aperture widths (in each aperture process) to picture-element width. (k_1 is in itself equal to unity, by definition.)

Equation (10) is mathematically empirical, based on approximating a $(\text{Sin} \phi/\phi)^K$ curve with a $\text{Sin} \phi/\phi$ curve, plotted to a scale in electrical degrees, which scale has been contracted by the factor $1/K$.

The following theory assumes that optical systems are always composed of apertures which can be considered as a multitude of pinholes in parallel, each inclined to the other so that the transmitted images are coincident. The size of the pinholes (apertures) depends on the degree of optical excellence in grinding. The pinhole-aperture size would be difficult to specify, so it is more convenient to define resolution in terms of number of lines (usually, lines per millimeter, but in television practice, lines per frame).

In general, if an image of n_i lines is projected through successive optical systems having a resolving power of n_1, n_2 , etc. lines, the over-all, approximate resolution of the reproduced image will be obtained by calculating the width index from (10) and converting this to a quality index, expressed as number of lines n_r in the reproduced image.

From (8) and (10) the quality formula may be obtained. Starting with an image of n_i line resolution, suppose that p different aperture processes, either scanning spot sizes or lens systems, are applied to obtain a reproduced image of n_r -lines resolution.

Then

$$\begin{aligned}
 k_{i,r} &= 1/An_i^2 \\
 k_{1,r} &= 1/An_1^2 \\
 &\dots\dots\dots \\
 k_{p,r} &= 1/An_p^2
 \end{aligned}
 \tag{11}$$

and the reproduced resolution is

$$K_r = 1/An_r^2. \tag{12}$$

Equations (11) and (12) express the relation between the number of lines of resolution and the width of pulse for the optimum condition where the vertical and horizontal resolution are equal. This assumes that the number of lines is changed for the optimum condition each time the image passes through an aperture, which condition, of course, does not hold. Actually, the number of scanning lines is maintained constant at a value of n' lines per frame, so that the equations expressing the relationship between pulse width and the number of lines of resolution should be

(let $1/n'A = B$)

$$\begin{aligned}
 k_i &= B/n_i \\
 k_1 &= B/n_1 \\
 &\dots\dots\dots \\
 k_p &= B/n_p
 \end{aligned}
 \tag{13}$$

and

$$K = B/n_r. \tag{14}$$

K is calculated by substituting from (13) in (10). Substitution for this value of K in (14) yields the approximate rule-of-thumb formula for over-all resolution

$$n_r = 1/\sqrt{1/n_i^2 + 1/n_1^2 + \dots + 1/n_p^2}. \tag{15}$$

An empirical formula for the peak values in Fig. 2 (or Appendix B) of the pulse shapes derived from the square pulse by subjecting it to x identical aperture processes is

$$\text{peak} = 1.18/\sqrt[4]{x(x+1)/2}. \tag{16}$$

Since the structure of the image itself is considered as one aperture process, the relative widening of a picture element after x -in-tandem aperture processes is the inverse ratio of (16) for values of $x=1$ and $x=x$ (inverse because width of pulse is inversely proportional to peak). The resolution of the reproduced image in terms of lines in the original image, for x identical aperture processes, thus may be expressed very accurately by

$$n_r = n_i/\sqrt[4]{x(x+1)/2}. \tag{17}$$

As an example, suppose $n_i=800$ for a certain piece of film, $n_1=1500$ (30 lines per millimeter) for the projection lens on the camera photo-pickup tube, $n_2=600$ for the pickup-tube aperture, $n_3=\infty$ for transmission filters (flat response in transmitter and receiver), $n_4=600$ for the projection-tube aperture (0.003-inch spot and 1.8-inch picture height), and $n_5=1000$ for the projection lens to the viewing screen. Substitution in (15) shows that the resolution on the viewing screen will be

(without filters) $n_r = 342$ lines. (18)

If the transmission filters are limited ($n_3=525$ lines instead of $n_3=\infty$) the resolution will be degraded, and the line-structure will be

(with filters) $n_r = 287$ lines. (18a)

If 35-millimeter film is used, n_i becomes 1600, and the line structures become

(without filters) $n_r = 368$ (19)

(with filters) $n_r = 302.$ (19a)

A comparison of (19) with (18) indicates, in the main, why 35-millimeter film has been found to give superior resolution to that given by 16-millimeter film in television practice. This superiority of 35-millimeter film over 16-millimeter film for television broadcasts can be expected to increase as the number of scanning lines is increased.

VI. CONCLUSIONS

It was shown in the last paragraph of Section IV that the widening effect of an aperture process, on an exact basis (integral method), is inversely proportional to the peak amplitude of the signal transmitted through the aperture. Thus, from the data given in Appendix B in regard to peak signals (values $A_{a1}, A_{2a}, \dots, A_{a4}$) the effects of successive aperture processes on the line structure of the reproduced image can be calculated in terms of per cent of original line structure. The last column

TABLE I

Aperture Processes	Reproduced Lines n_r in Per Cent of Original	(From Rule of Thumb) n_r in Per Cent of Original
	Per Cent	Per Cent
Two identical	76.5	70.7
Three identical	64.2	57.7
Four identical	56.3	50.0
Five identical	42.8	44.4
Two processes, one twice the other		44.4
Two processes, one three times the other	28.1	31.6
Two processes, one four times the other	21.3	24.2

in Table I was calculated according to the rule of thumb given in (15), whereby successive aperture processes will degrade the line structure of the original image such that the reproduced image will exhibit a certain percentage of the original structure.

It can be seen that the percentage error introduced by the rule of thumb is of the order of ± 10 per cent as compared to the more exact integral method, or the empirical formula (17) which is valid only for identical aperture processes.

In regard to the relative excellence of 35-millimeter film versus 16-millimeter film the resolution capability (line structure) of the film itself is undoubtedly a contributing factor of some importance, as shown by the calculations (18) and (19). There is another factor, beyond the scope of this paper, which affects the resolution in favor of 35-millimeter film. This factor is concerned with mechanical tolerances in regard to printing of film, registry of frames, projector jump, etc. These tolerances are more severe for 35-millimeter than for 16-millimeter film, which fact results in a still further improvement of resolution for 35-millimeter tele-motion pictures.

APPENDIX A

The Fourier analysis may be performed on any half cycle of the wave of Fig. 1, choosing the origin of coordinates at the center of a pulse, as shown.

Computation of the coefficients of the cosinusoidal terms in the Fourier series representing a finite pulse (sinusoidal terms are zero) is made as follows:

$$f(\phi) = bP \quad \text{from } \phi = 0 \quad \text{to } \phi = r\pi$$

$$f(\phi) = -rP \quad \text{from } \phi = r\pi \quad \text{to } \phi = \pi.$$

The coefficient of the N th harmonic term is

$$b_n = \frac{2}{\pi} \int_0^{r\pi} bP \cos n\phi \, d\phi + \frac{2}{\pi} \int_{r\pi}^{\pi} (-rP) \cos n\phi \, d\phi. \quad (20)$$

n is an integer, and represents the order of a harmonic. By integration, and substitution of limits, (20) becomes

$$b_n = \frac{2P}{n\pi} (b \sin nr\pi - r \sin n\pi + r \sin nr\pi) \quad (21)$$

so that

$$b_n = \frac{2P}{n\pi} (b+r) \sin nr\pi = \frac{2P}{n\pi} \sin nr\pi \quad (\text{since } b+r=1). \quad (22)$$

Hence, the series is

$$A_i = 2rP \sum_{n=1}^{\infty} \frac{\sin nr\pi}{nr\pi} \cos n\omega t \quad (23)$$

where A_i defines the amplitude of the wave at any instant of time t .

It can be shown that the double-peak amplitude of (23) is

$$P = I\omega/br\pi \quad (24)$$

where the constant I represents the single-peak amplitude of the saw-tooth wave,²² which is the integral of A_i .

APPENDIX B

PLOTTING DATA FOR FIG. 2a

Substitution of values of ϕ from tables in (5a) to (5f) will yield data which are sufficient to plot the curve of Fig. 2a for cutoff at first elided frequency where $N=1/r$. It will be noticed that the periodicity of the overshoots corresponds to the cutoff frequency.

$$A_a = \frac{2P}{\pi} \text{Si}(\pi) = 1.179P$$

$$A_b = \frac{P}{\pi} [\text{Si}(\pi/2) + \text{Si}(3\pi/2)] = 0.948P$$

$$A_c = \frac{P}{\pi} \text{Si}(2\pi) = 0.451$$

$$A_d = \frac{P}{\pi} [\text{Si}(5\pi/2) - \text{Si}(\pi/2)] = 0.059P$$

$$A_e = \frac{P}{\pi} [\text{Si}(3\pi) - \text{Si}(\pi)] = -0.056P$$

$$A_f = \frac{P}{\pi} [\text{Si}(4\pi) - \text{Si}(2\pi)] = 0.023P.$$

Extrapolation from these formulas shows that for $\omega t = n\pi$, A_n can be generalized

$$A_n = \frac{P}{\pi} [\text{Si}(n+1)\pi - \text{Si}(n-1)\pi].$$

PLOTTING DATA FOR OTHER CURVES OF FIG. 2

(I) For two identical aperture processes (Fig. 2b):

$$A_{2a} = \frac{2P}{\pi} \text{Si}(2\pi) = 0.903P$$

$$A_{2b} = \frac{P}{4\pi} [5 \text{Si}(5\pi/2) + 3 \text{Si}(3\pi/2) - 2 \text{Si}(\pi/2)]$$

$$= 0.783P$$

$$A_{2c} = \frac{P}{2\pi} [3 \text{Si}(3\pi) - \text{Si}(\pi)] = 0.505P$$

A_{2d} (Not computed)

$$A_{2e} = \frac{2P}{\pi} [\text{Si}(4\pi) - \text{Si}(2\pi)] = 0.050P$$

$$A_{2f} = \frac{P}{2\pi} [5 \text{Si}(5\pi) - 6 \text{Si}(3\pi) + \text{Si}(\pi)] = -0.006P.$$

(II) For three identical aperture processes (Fig. 2c):

$$A_{3a} = \frac{3P}{4\pi} [3 \text{Si}(3\pi) - \text{Si}(\pi)] = 0.758P$$

$$A_{3c} = \frac{P}{2\pi} [4 \text{Si}(4\pi) - 2 \text{Si}(2\pi)] = 0.498P$$

$$A_{3e} = \frac{P}{8\pi} [25 \text{Si}(5\pi) - 27 \text{Si}(3\pi) + 4 \text{Si}(\pi)] = 0.121P$$

(III) For four identical aperture processes (Fig. 2d):

$$A_{4a} = \frac{2P}{3\pi} [4 \text{Si}(4\pi) - 2 \text{Si}(2\pi)] = 0.665P$$

(IV) For two aperture processes; one of width $2\pi r$; and one of width $4\pi r$ (corresponds to scanning with an aperture of twice the width of image picture element) (Fig. 2e):

$$A_{a2} = \frac{P}{2\pi} [3 \text{Si}(3\pi) - \text{Si}(\pi)] = 0.505P$$

$$A_{c2} = \frac{P}{\pi} \text{Si}(4\pi) = 0.475P$$

$$A_{e2} = \frac{P}{4\pi} [5 \text{Si}(5\pi) - 3 \text{Si}(3\pi)] = 0.251P$$

$$A_{f2} = \frac{P}{2\pi} [3 \text{Si}(6\pi) - 2 \text{Si}(4\pi) - \text{Si}(2\pi)] = 0.023P$$

(V) For two aperture processes; one of width $2\pi r$; and one of width $6\pi r$; (corresponds to scanning with aperture three times width of image picture element) (Fig. 2f):

$$A_{a3} = \frac{2P}{3\pi} [2 \text{Si}(4\pi) - \text{Si}(2\pi)] = 0.332P.$$

²² T. E. Shea, "Transmission Networks and Wave Filters." D. van Nostrand Co., Inc., New York, N. Y., 1929.

(VI) For two aperture processes; one of width $2\pi r$; and one of width $8\pi r$ (corresponds to scanning with aperture four times width of image picture element) (Fig. 2g):

$$A_{a4} = \frac{P}{4\pi} [5 \text{ Si}(5\pi) - 3 \text{ Si}(3\pi)] = 0.251P.$$

Peak values of A_{xa} for any number of identical aperture processes x can be calculated approximately from the empirical formula (16)

$$A_{xa} = 1.18/\sqrt{x(x+1)/2}.$$

APPENDIX C

In order that E_a of (6) should represent the *instantaneous* electrical response from the photocell, due to the motion of the aperture, it is necessary that the constant K' , which includes the sensitivity of the photo surface and the impedance of the load, contain also the width of the aperture as a divisor. That is, the integrated response from A_i over the aperture, divided by the aperture width, represents the instantaneous signal. Thus

$$K' = \frac{K''}{\Delta\phi'} \quad (25)$$

The width of the aperture divided by the total length of scanning path (2π radians) will be called the index of the aperture in relation to the scanning cycle

$$r' = \frac{\Delta\phi'}{2\pi} \quad K' = \frac{K''}{2\pi r'} \quad (26)$$

Let the phase of the pulse in the cycle be $\omega t = \phi$. Substitute K' , ωt , and A_i in (6).

$$E_a = \frac{2K''rP}{2\pi r'} \int_{n(\phi-\Delta\phi'/2)}^{n(\phi+\Delta\phi'/2)} \sum_{n=1}^{\infty} \frac{\sin nr\pi}{nr\pi} \cos(n\phi) \frac{d(n\phi)}{n} \quad (27)$$

(The variable of integration is $(n\phi)$). The integration of the cosine function is obtained easily, as

$$E_a = \frac{A'}{2\pi r'} \sum_{n=1}^{\infty} \frac{\sin nr\pi}{nr\pi} \left[\frac{\sin(n\phi)}{n} \right]_{n(\phi-\Delta\phi'/2)}^{n(\phi+\Delta\phi'/2)} \quad (28)$$

(Where $A' = 2K''rP$).

Substituting limits

$$E_a = A' \sum_{n=1}^{\infty} \frac{\sin nr\pi}{nr\pi} \frac{2 \cos n\phi \sin \frac{n\Delta\phi'}{2}}{2\pi r' n} \quad (29)$$

Substitute for $\Delta\phi'$ and ϕ : ($\Delta\phi' = 2\pi r'$, $\phi = \omega t$)

$$E_a = A' \sum_{n=1}^{\infty} \frac{\sin nr\pi}{nr\pi} \frac{\sin nr'\pi}{nr'\pi} \cos n\omega t \quad (30)$$

which is (7) of the text.

APPENDIX D

To find the equation of the infinitesimal pulse, let r approach zero in (1).

$$A_i' = \lim_{r \rightarrow 0} A_i \quad (31)$$

Since r is contained explicitly in P , it will be necessary to substitute for P in (31). (See (24), Appendix A).

$$A_i' = \lim_{r \rightarrow 0} \frac{2I\omega}{\pi} \sum_{n=1}^{\infty} \frac{\sin nr\pi}{nr\pi(1-r)} \cos n\omega t \quad (32)$$

Differentiate the numerator and denominator of (32)

$$A_i' = \frac{2I\omega}{\pi} \sum_{n=1}^{\infty} \frac{n\pi \cos nr\pi}{n\pi(-r + (1-r))} \cos n\omega t \quad (33)$$

At the limit $r=0$, the coefficient of $\cos n\omega t$ becomes unity, and the series becomes divergent.

$$A_i' = \frac{2I\omega}{\pi} \sum_{n=1}^{\infty} \cos n\omega t \quad (34)$$

The method of Section III may be applied to (34) in order to obtain the shape of A_i' when only a finite number of harmonics represented by $N = 1/r$ is plotted. Multiply (34) by $\Delta\phi/r\pi$ (=unity), and replace the summation by an integral (this is allowable if r is small).

$$(A_i) \text{ finite} = \frac{2I\omega}{r\pi^2} \int_0^{\phi_1} \cos n\omega t \, d\phi \quad (35)$$

where $\phi_1 = Nr\pi$. (This is equivalent to summation from 1 to N instead of 1 to infinity. Limits are changed from n to ϕ . See Section III.)

At the center of the pulse, $\omega t = 0$, so

$$(A_i')_0 = \frac{2I\omega}{r\pi^2} \int_0^{\pi} d\phi = \frac{2I\omega}{r\pi} = U/r \quad (36)$$

At $\omega t = r\pi/2$

$$(A_i')_{r/2} = \frac{2U}{\pi r} \int_0^{\pi} \cos(\phi/2) d(\phi/2) = 2U/\pi r = 0.636U/r \quad (37)$$

At $\omega t = r\pi$

$$(A_i')_r = \frac{U}{\pi r} \int_0^{\pi} \cos \phi \, d\phi = 0 \quad (38)$$

At $\omega t = 3r\pi/2$

$$(A_i')_{3r/2} = \frac{2U}{3\pi r} \int_0^{\pi} \cos(3\phi/2) d(3\phi/2) = -2U/3\pi r = -0.212U/r \quad (39)$$

Thus, by expressing ωt in terms of $r\pi$, the amplitude of the infinitesimal pulse with finite cutoff at $1/r$ harmonics can be calculated at any phase point desired (see Fig. 4).

ACKNOWLEDGMENT

Grateful acknowledgment is made to Dr. Hans W. Salinger for his assistance in performing the integrations and in deriving some of the more difficult mathematical formulas of Appendix B.

Loop-Antenna Coupling-Transformer Design*

W. S. BACHMAN†, MEMBER, I.R.E.

Summary—The low-impedance loop coupling-transformer circuit is analyzed, expressing the transformer parameters in terms of the circuit and transformer coupling coefficients. Equations are developed which yield optimum design values for the transformer. It is shown that an ideal transformer-coupled loop has 38.4 per cent of the gain realizable from a direct-connected loop of the same area, assuming the same Q in the transformer secondary as in the direct-connected loop.

BUILT-IN loop antennas are widely used in broadcast receivers because of their convenience and simplicity from the consumer's point of view. In order to make them most effective, it is usual to shield them electrostatically against local disturbances. Considerable simplification is possible, if, instead of an electrostatically shielded high-impedance loop, a low-impedance loop with coupling transformer is used. This alternative permits greater tuning range because of the lower distributed capacitance of the system, and gives more flexibility in the choice of size and location of the loop.

A further simplification would be effected in all-wave receivers if the short-wave loop were also used as the low-impedance broadcast-band loop. This fixes the inductance of the loop at the necessary value for the short-wave band to be covered. Since the range of the tuning capacitor is also fixed, it is necessary to design a transformer to couple the loop to the tuning capacitor, and to specify optimum values for its parameters.

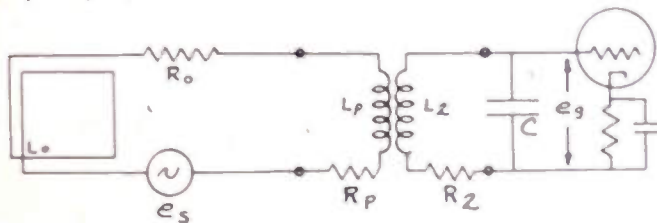

Fig. 1—Low-impedance loop coupling-transformer circuit.

In the circuit of Fig. 1, it is necessary to specify the values for L_p , the primary-winding inductance; L_2 , the secondary inductance; and M , the mutual inductance.

Let

$$\begin{aligned} L_1 &= L_0 + L_p \\ R_1 &= R_0 + R_p \\ K &= \frac{M}{\sqrt{L_1 L_2}} \end{aligned} \quad (1)$$

$$K_1 = \frac{M}{\sqrt{L_p L_2}} \quad (2)$$

where K is the coupling coefficient between the entire primary circuit and the secondary, and K_1 is that between the primary winding only and the secondary. By

* Decimal classification: R382.1×R325.3. Original manuscript received by the Institute, June 20, 1945.

† General Electric Company, Bridgeport, Conn.

expressing the unknowns in terms of K and K_1 , and finding the optimum values for these coefficients, it is possible to specify the optimum values for the transformer parameters.

Analyzing the circuit of Fig. 1,

$$\begin{aligned} Z_1 &= R_1 + jX_{L_1} \\ Z_2 &= R_2 + j(X_{L_2} - X_c) \end{aligned}$$

Then

$$\begin{aligned} I_1 &= \frac{e_s}{Z_1 + \frac{X_m^2}{Z_2}}; & e_s &= I_1 \left(Z_1 + \frac{X_m^2}{Z_2} \right) \\ I_2 &= \frac{jX_m I_1}{Z_2}; & e_s &= -jX_c I_2 = \frac{X_c X_m I_1}{Z_2} \end{aligned}$$

The gain A is

$$A = \frac{e_s}{e_s} = \frac{\frac{X_c X_m}{Z_2}}{Z_1 + \frac{X_m^2}{Z_2}} = \frac{X_c X_m}{Z_1 Z_2 + X_m^2} \quad (3)$$

Referring to the secondary circuit, in addition to X_{L_2}

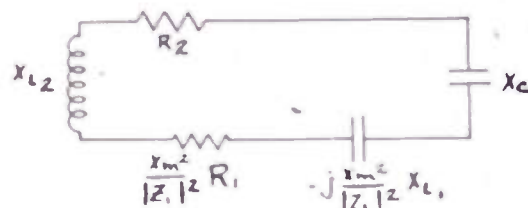

Fig. 2—Equivalent circuit, referred to the secondary, of the low-impedance loop coupling transformer.

and X_c , there will be coupled in impedance from the primary as shown in Fig. 2.

At resonance the reactances balance out, so that

$$jX_{L_2} - j \frac{X_m^2}{|Z_1|^2} X_{L_1} - jX_c = 0 \quad (4)$$

Now if the primary Q is reasonably high,

$$X_{L_1} \gg R_1 \text{ and } |Z_1|^2 \text{ is very nearly equal to } |X_{L_1}|^2.$$

Therefore (4) becomes

$$\begin{aligned} jX_{L_2} - j \frac{X_m^2}{X_{L_1}} - jX_c &= 0 \\ X_m^2 &= X_{L_1}(X_{L_2} - X_c) \end{aligned} \quad (5)$$

Expanding the expression for gain (3) and substituting (5) for X_m^2 , we obtain

$$A = \frac{X_c X_m}{R_1 R_2 + j[R_1(X_{L_2} - X_c) + R_2 X_{L_1}]}$$

For reasonably high values of Q this reduces to

$$A = \frac{X_c X_m}{R_1(X_{L_2} - X_c) + R_2 X_{L_1}} \tag{6}$$

If

$$Q_1 = \frac{X_{L_1}}{R_1} \quad \text{and} \quad Q_2 = \frac{X_{L_2}}{R_2}$$

(6) becomes

$$A = \frac{X_c X_m Q_1 Q_2}{Q_2 X_{L_1} (X_{L_2} - X_c) + Q_1 X_{L_1} X_{L_2}} \tag{7}$$

From (1) we may write

$$X_m^2 = K^2 X_{L_1} X_{L_2} \tag{8}$$

Equating (5) and (8)

$$X_{L_1} (X_{L_2} - X_c) = K^2 X_{L_1} X_{L_2} \tag{9}$$

Substituting (9) in (7)

$$A = \frac{X_c X_m Q_1 Q_2}{(Q_1 + K^2 Q_2) X_{L_1} X_{L_2}} \tag{10}$$

Substituting the value of X_m from (8) in (10)

$$A = \frac{X_c K}{\sqrt{X_{L_1} X_{L_2}}} \left(\frac{Q_1 Q_2}{Q_1 + K^2 Q_2} \right) \tag{11}$$

From (1) and (2) we obtain

$$X_{L_1} = \frac{X_{L_0}}{\left(1 - \frac{K^2}{K_1^2}\right)} \tag{13}$$

Solving (9) for X_{L_2}

$$X_{L_2} = \frac{X_c}{(1 - K^2)} \tag{14}$$

Substituting (13) and (14) in (11)

$$A = \frac{X_c K}{\sqrt{\left(\frac{X_{L_0}}{\left(1 - \frac{K^2}{K_1^2}\right)}\right) \left(\frac{X_c}{(1 - K^2)}\right)}} \left(\frac{Q_1 Q_2}{Q_1 + K^2 Q_2} \right)$$

$$A = \sqrt{\frac{X_c}{X_{L_0}}} \left(\frac{Q_1 Q_2}{Q_1 + K^2 Q_2} \right) \left[K^2 (1 - K^2) \left(1 - \frac{K^2}{K_1^2}\right) \right]^{1/2} \tag{15}$$

Equation (15) expresses the gain of the transformer in terms of two variables K and K_1 and the circuit Q 's, and the unknown constants of the transformer are related to these values of K and K_1 by (13) and (14).

As an experimental verification of the theory, the following measurements were made on a developmental transformer:

$L_0 = 7.0$ microhenries	} 1000-cycle measurements
$L_p = 3.6$ microhenries	
$L_2 = 244.4$ microhenries	
$L_p + L_2 + 2M = 284.9$ microhenries	
$Q_0 = 82$	} 1000-kilocycle measurements.
$Q_2 = 153$	
$C = 118$ micromicrofarads	

These inductance measurements yield values of 0.625 for K_1 , and 0.364 for K .

$$X_c = \frac{1}{2\pi f C} = 1350 \text{ ohms at 1000 kilocycles}$$

$$X_{L_0} = 2\pi f L_0 = 44 \text{ ohms at 1000 kilocycles.}$$

Substituting in (15)

$$A = \sqrt{\frac{1350}{44}} \left(\frac{82 \times 153}{82 + 0.132 \times 153} \right) [0.132(0.868)(0.663)]^{1/2}$$

$$= 5.54 \times 123 \times 0.276 = 188.$$

This checks very closely with the measured gain of 190. The circuit gain was measured by inserting the source voltage of a Q meter in series with the primary circuit, and connecting the secondary across its capacitor terminals. The Q reading indicates the gain of the circuit, provided that the source impedance of the Q meter is small compared to the primary-circuit impedance. In this case, the source was 0.04 ohms, and the resistance in the primary circuit must be greater than 0.497 ohms, which is known to be the radio-frequency resistance of the loop itself at 1000 kilocycles. This indicates an error of something less than 7 per cent in the measured value.

Examination of (15) shows that the variable K_1 appears only once, and that it should be as large as possible for maximum gain. It should be noted that K must always be smaller than K_1 , for, if they were equal, all of the primary-circuit inductance would be in the primary winding, leaving no inductance in the loop, and, hence, no signal pickup would be obtained.

Knowing that K_1 should be as large as possible, it is necessary to determine experimentally what value of K_1 may be practically attained. Values in the order of 0.9 have been readily attained in iron-cored transformers for this service.

As is seen from (15), the circuit Q has some effect on the best value of K . In order to simplify the Q parenthesis, it would be convenient to express Q_1 in terms of Q_2 .

Let

$$a = \frac{Q_1}{Q_2}; \quad Q_1 = aQ_2.$$

Substituting this in (15)

$$A = \sqrt{\frac{X_c}{X_L}} Q_2 \left(\frac{a}{a + K^2} \right) \left[K^2 (1 - K^2) \left(1 - \frac{K^2}{K_1^2}\right) \right]^{1/2} \tag{16}$$

Having this equation, it is necessary only to substitute known values to yield all of the necessary design information. The gain is directly proportional to Q_2 , so the highest value practically realizable should be used. Having chosen Q_2 , the ratio a may be estimated readily, since Q_1 is largely determined by the Q_0 of the loop itself. The value for K_1 has already been discussed. It is then possible to differentiate (16) with respect to K , and equate to zero, to find the optimum value for K .

Knowing the optimum K , it may be substituted in (13) and (14) to determine the required values of primary and secondary inductance.

Having arrived at the optimum design of the loop coupling transformer, it is of interest to compare the low-impedance transformer-coupled loop with a high-impedance loop connected directly to the tuning capacitor. The voltage induced into a loop is

$$e_s = \frac{2\pi NA}{\lambda} H \quad (17)$$

- where N = the number of turns
- A = the area of the loop
- λ = the wavelength of the signal
- H = the field strength.

The product $e_s \sqrt{X_c/X_{L_0}}$ may be shown to be independent of the number of turns, since

$$X_{L_0} = \omega L_0 = \omega N^2 P \quad (18)$$

where P is the permeance of the magnetic path. Substituting (18) and (17),

$$e_s \sqrt{\frac{X_c}{X_{L_0}}} = \frac{2\pi NAH}{\lambda} \sqrt{\frac{X_c}{\omega N^2 P}}$$

In the case of the direct-connected high-impedance loop, $X_c = X_{L_0}$ hence the voltage at the grid is

$$e_g = \sqrt{\frac{X_c}{X_{L_0}}} e_s Q_2 = e_s Q_2$$

In the low-impedance transformer-coupled loop

$$e_g = \sqrt{\frac{X_c}{X_{L_0}}} e_s Q_2 \left(\frac{a}{a+K^2} \right) \left[K^2(1-K^2) \left(1 - \frac{K^2}{K_1^2} \right) \right]^{1/2}$$

Since the term $\sqrt{(X_c/X_{L_0})} e_s$ has been shown to be independent of the number of turns, the expression

$$\left(\frac{a}{a+K^2} \right) \left[K^2(1-K^2) \left(1 - \frac{K^2}{K_1^2} \right) \right]^{1/2} = \text{gain factor.}$$

This gain factor is the ratio of the gain of a transformer-coupled loop to a direct-connected loop working into the same tuning capacitance. This is always less than unity, and varies between 0.25 and 0.30 in practical cases.

In Fig. 3 are plotted several curves of gain factor versus K , for various combinations of primary Q and K_1 . They show that the optimum value of K is not critical, and that it is not violently affected by the value of primary Q .

Of particular interest is the case of an infinite primary-circuit Q and a transformer coupling coefficient of unity. These values yield an optimum K of 0.576 ($K^2 = \frac{1}{3}$). Using this value in (13), it is found that L_0 , the loop inductance, is $\frac{2}{3}$ of L_1 , the primary-circuit inductance. The other $\frac{1}{3}$ is in the primary-winding inductance.

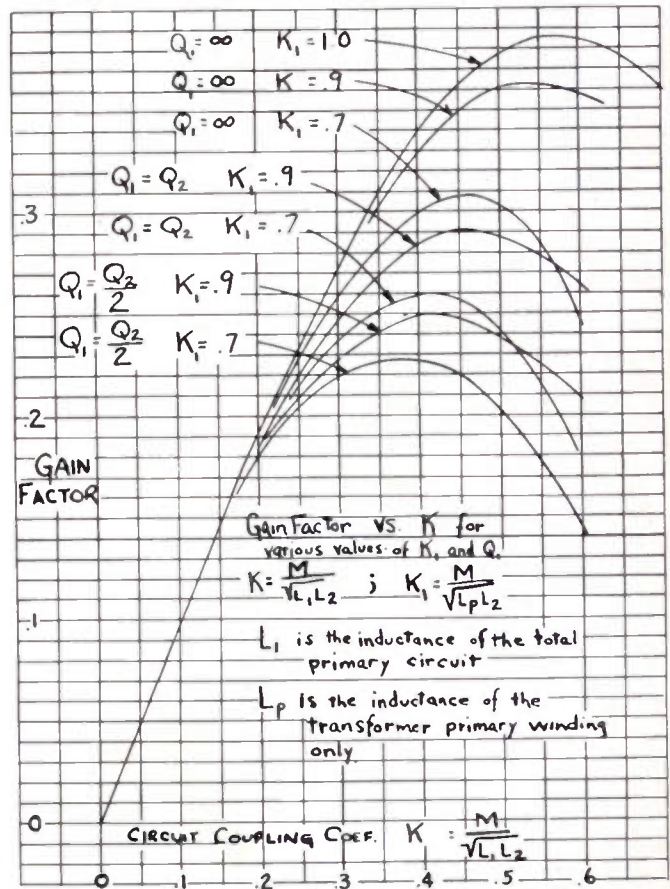

Fig. 3—Gain factor (ratio of the gain of a transformer-coupled loop working into the same tuning capacitance) versus circuit-coupling coefficient, for various values of primary circuit Q and transformer-coupling coefficient.

The gain factor, using this value of K , is 0.384, which is numerically equal to $\frac{2}{3} \times 0.576$. The physical significance of this is that only $\frac{2}{3}$ of the primary inductance provides the signal pickup, and since K is 0.576, only this fraction of the primary voltage would appear in the secondary of a 1:1 transformer. Thus, an ideal transformer-coupled loop antenna is capable of only 38.4 per cent of the gain of a direct-connected loop, assuming the secondary Q to be equal to the direct-connected loop Q , and equal loop areas in both cases. The distributed capacitance limits the usable size of direct-connected loops, so the low-impedance transformer-coupled loop may gain a considerable advantage in area. Also, it is quite often possible to obtain higher transformer-secondary Q than may be obtained in a high-impedance loop.

On the Theory of the Progressive Universal Winding*

A. W. SIMON†

Summary—The rigorous theory previously developed by the author for the ordinary or stationary universal winding is extended to the progressive universal winding; in particular, an exact formula for calculating the gear ratio to be employed in winding a progressive universal coil is deduced, and, by neglecting certain terms therein, formulas representing various degrees of approximation of the same are derived and shown to be equivalent of those previously given by the author, by Joyner and Landon, and by Hershey. The theory of the spiral ridges and close-packed layers of progressive universal coils is developed, and formulas giving the slope of the spiral ridge and the dimensions of the close-packed layers are deduced. The principles underlying the selection of the optimum number of crossovers per turn are discussed, and an example of the application of the formulas to the design of a progressive universal coil is given.

I. THEORY OF THE PROGRESSIVE UNIVERSAL WINDING

THE METHOD of winding a progressive universal coil is such that, as the dowel or tube on which the coil is wound rotates, the wire is guided back and forth by a shuttle, which displaces the wire in linear proportion to the angle of rotation of the dowel, while *simultaneously* the dowel is given a uniform linear motion in a direction parallel to its axis.

TABLE OF SYMBOLS

A, B, C = constants appearing in the gear-ratio formulas; defined a, b, c specifically in terms of the basic parameters by (9), (10), (11), (12), (13), and (14).
 c = cam throw; i.e., maximum shuttle displacement produced by the cam.
 δ = nominal diameter of the wire (including the insulation).
 d = diameter of the dowel on which the coil is wound.
 f = spacing factor; i.e., the ratio of the distance between centers of adjacent wires to the nominal wire diameter. ($f = s/\delta$)
 h = circumferential advance per crossover; in particular, the distance which the point of crossover gains, or loses, over a line drawn, on the developed surface, at a distance from the starting line equal to the circumference divided by the approximate number of crossovers per turn. This can be easily seen in Figs. 1 and 2.
 k = axial advance per crossover; the distance which the dowel moves in an axial direction during the time of one crossover.
 n = approximate (integral) number of crossovers per turn of the dowel.
 n' = exact number of crossovers per turn; equal to the exact number of half cam turns per turn of the dowel.
 s_1 = spacing between centers of adjacent wires produced on the *forward* stroke.
 s_2 = spacing between centers of adjacent wires produced on the *backward* stroke.
 s_m = spacing of the points of maximum displacement of the wire in the direction of the spiral ridge.
 s_r = spacing between successive turns of the (same) spiral ridge.
 $t = \tan \phi$ (used in appendix only).
 l = turns per inch (in general) when not otherwise indicated.
 w_l = width of the close-packed layer.
 w_o = width of the opening between close-packed layers.
 x = linear displacement of a point of the wire on the developed surface in a direction *parallel* to the axis of the dowel.
 y = linear displacement of a point of the wire on the developed surface in a direction *perpendicular* to the axis of the dowel.

* Decimal classification: R 382. Original manuscript received by the Institute, April 25, 1945; revised manuscript received, August 3, 1945.

† Edwin I. Guthman and Company, Inc., Chicago, Illinois.

θ_C = angle in radians through which the cam has turned.
 θ_D = angle in radians through which the dowel has turned.
 ϕ_1 = angle which the axis of the wire makes with the axis of the dowel on the *forward* stroke.
 ϕ_2 = same for the *backward* stroke.
 ψ = angle which the direction of the spiral ridge makes with the axis of the dowel.
 ψ_0 = value of ψ for zero opening between close-packed layers.

Since the longitudinal motion or "progression" of the dowel alternately aids and opposes the cam motion, it is necessary in setting up the equations to consider the conditions obtaining both on the forward stroke (motions aiding) and on the backward stroke (motions opposing).

GLOSSARY

Cam throw: the shuttle displacement produced by one full stroke of the cam in one direction.

Crossover: a journey of the wire from a point of maximum displacement in one direction to that in the other, corresponding to one full stroke of the cam in one direction. One crossover corresponds also to *one-half* revolution of the cam.

Point of crossover: the point at which the wire reaches its maximum displacement in either direction (point corresponding to maximum shuttle displacement, point of reversal).

Progressive layering: the case where the point of crossover *advances* over a line drawn at a distance from the starting point equal to the length of the developed surface πd divided by the approximate number n of crossovers per turn ($h > 0$, Fig. 1).

Retrgressive layering: the case where the point of crossover falls *behind* the line defined under progressive layering. ($h < 0$, Fig. 2.)

Forward stroke: that corresponding to the case where the motion of the shuttle and the axial motion of the dowel are in the *same* direction.

Backward stroke: that corresponding to the case where the motion of the shuttle and the axial motion of the dowel are in *opposite* directions.

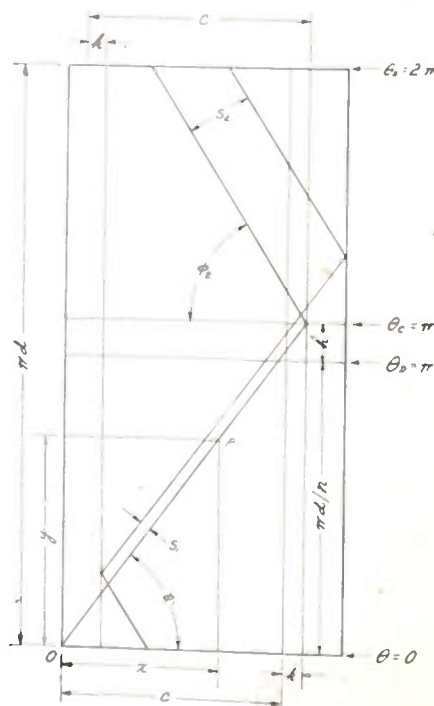

Fig. 1—Developed diagram of progressive universal winding with progressive layering. Two crossovers per turn.

Accordingly (Figs. 1 and 2), if we focus attention on the linear displacement of a point P of the wire, on the developed surface, in a direction first parallel and then perpendicular to the axis of the dowel, we have

$$x/(c \pm k) = \theta_c/\pi \tag{1}$$

$$y/\pi d = \theta_D/2\pi \tag{2}$$

where the upper sign is taken for the forward stroke, and the lower for the backward stroke.

If we divide (2) by (1), and note that the quotient θ_D/θ_c is equal to the gear ratio r , there results

$$y/x = \pi dr/2(c \pm k). \tag{3}$$

If, next, we focus attention on the angles ϕ_1 and ϕ_2 which the wire makes with the axis of the dowel on the forward stroke and the backward stroke, respectively, we have

$$\tan \phi_1 = y/x = \pi dr/2(c + k) \tag{4a}$$

$$\tan \phi_2 = y/x = \pi dr/2(c - k). \tag{4b}$$

However, from Figs. 1 and 2, it is readily seen that these angles also satisfy the relations

$$(c + k) \tan \phi_1 = (\pi d/n) \pm h \tag{5a}$$

$$(c - k) \tan \phi_2 = (\pi d/n) \pm h \tag{5b}$$

where the upper sign is now taken for progressive layering,¹ and the lower for retrogressive layering, a convention which will be adhered to in all that follows.

As regards the spacing of adjacent wires (Fig. 3) we have

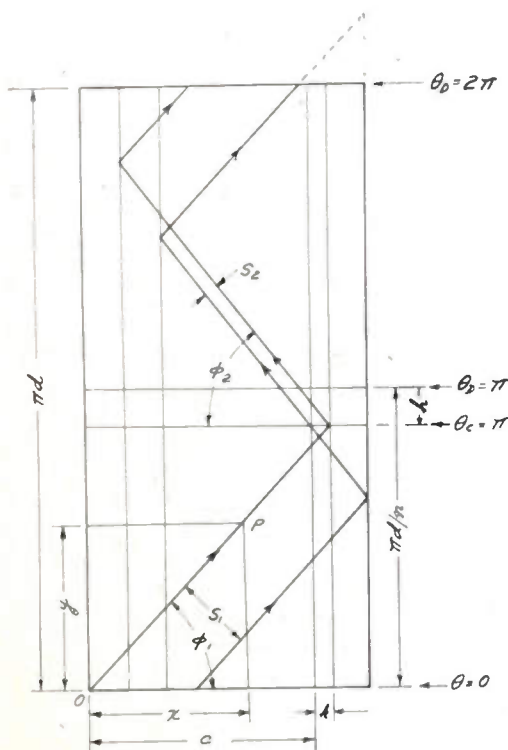

Fig. 2—Developed diagram of progressive universal winding with retrogressive layering. Two crossovers per turn.

¹ The use of the word "progressive" to describe the direction in which the layering proceeds should not be confused with its use to describe the type of winding.

$$s_1 = qh \cos \phi_1 \mp qk \sin \phi_1 \tag{6a}$$

$$s_2 = qh \cos \phi_2 \pm qk \sin \phi_2. \tag{6b}$$

In addition, the axial advance per crossover, the pitch of the progression, the exact number of crossovers per turn, and the gear ratio, are related according to the equations

$$k = p/n' = pr/2. \tag{7}$$

Since support is attained for progressive layering on the forward stroke and for retrogressive layering on the backward stroke, the elimination of ϕ_1 for the first and ϕ_2 for the second, from (4) and (6), after substituting therein for h and k their values as given by (5) and (7), respectively, yields the quadratic equation.

$$Ar^2 + Br + C = 0 \tag{8}$$

where the coefficients A , B , and C , are defined by

$$A = (1 - a^2) \mp 2e + (1 - b^2)e^2 \tag{9}$$

$$B = - (4/n)[1 \mp (1 - b^2)e] \tag{10}$$

$$C = (4/n^2)(1 - b^2) \tag{11}$$

and the constants a , b , and e , in turn by

$$a = s/qc \tag{12}$$

$$b = ns/q\pi d \tag{13}$$

$$e = p/nc. \tag{14}$$

Rigorous solution of (8) yields²

$$r = (2/n) \frac{[1 \pm (1 - b^2)e \pm \sqrt{a^2 + b^2 - a^2b^2}]}{[(1 - a^2) \mp 2e + (1 - b^2)e^2]} \tag{15}$$

Since a , b , and e are small quantities, the formula for r can be rewritten with a high degree of accuracy

$$r = (2/n)[1 \pm e \pm \sqrt{a^2 + b^2 + a^2 - e^2}] \tag{16}$$

and with still a fair degree of accuracy

$$r = (2/n)[1 \pm e \pm \sqrt{a^2 + b^2}]. \tag{17}$$

Finally, since b ordinarily will be small compared with a , we can set approximately

$$r = (2/n)[1 \pm (e + a)]. \tag{18}$$

The last equation is, in fact, the exact equivalent of that given by Joyner and Landon,³ and if we set therein $e=0$, that of Hershey.⁴

Finally, if we set $e=0$ in (16), we obtain the accurate formula previously given by the present author for ordinary or "stationary" universal coils.^{5,6}

² The details of the mathematical solution are outlined in the Appendix.

³ A. A. Joyner and V. D. Landon, "Theory and design of progressive universal coils," *Communications*, vol. 18, pp. 5-8; September, 1938.

⁴ L. M. Hershey, "The design of the universal winding," *Proc. I.R.E.*, vol. 29, pp. 442-446; August, 1941.

⁵ A. W. Simon, "Winding the universal coil," *Electronics*, vol. 9, pp. 22-24; October, 1936; Errata, p. 52; November, 1936.

⁶ A. W. Simon, "On the winding of the universal coil," *Proc. I.R.E.*, vol. 33, pp. 35-37; January, 1945.

II. GEOMETRY OF THE SPIRAL RIDGES AND LAYERS

As pointed out by Joyner and Landon, the locus of the points of maximum displacement of the wire forms a ridge traveling in the shape of a spiral around the coil, the direction of the spiral being that of a left-hand screw for progressive layering, and of a right-hand screw for retrogressive layering (compare Figs. 1, 2, and 3).

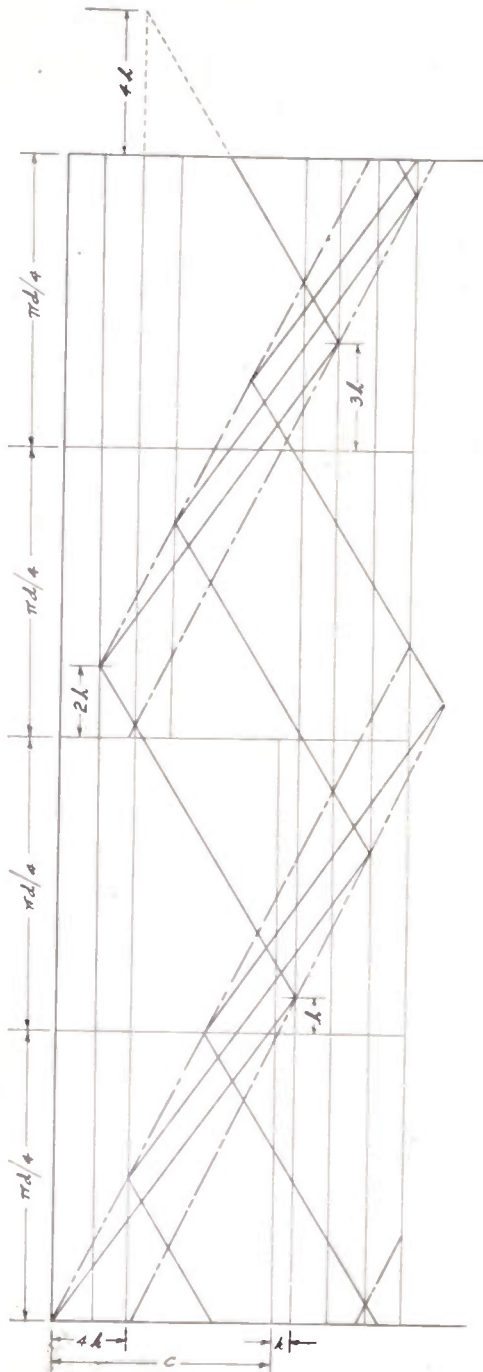

Fig. 3—Developed diagram of progressive universal winding with progressive layering. Four crossovers per turn. Two distinct close-packed layers.

If we denote by ψ the angle which the direction of this ridge makes with the axis of the coil, we have from Fig. 4 directly

$$\tan \psi = \pm h/k \tag{19}$$

or, in view of (7)

$$\tan \psi = \pm 2h/pr. \tag{20}$$

If next we eliminate h , from (4) and (6) we have

$$\pm h = \pi d(nr - 2)/2n \tag{21}$$

which value substituted in (20) yields

$$\tan \psi = \pm \pi d(1 - 2/nr)/p. \tag{22}$$

The last equation enables the calculation of the slope of the spiral ridge, provided the gear ratio r and the progression p are given.

Also, it is readily seen from Fig. 4 that the spacing s_m of the points of maximum displacement of the wire in the direction of the ridge is given by the simple formula

$$s_m = q\sqrt{h^2 + k^2} \tag{23}$$

while from Fig. 5 the spacing s_r between successive turns



Fig. 4—Geometry of the wire spacing. Progressive layering.

of the (same) ridge is given by

$$s_r = \pi d \cos \psi \tag{24}$$

and the width w_c of the close-packed layer is given by

$$w_c = c \sin \psi - (\pi d/n) \cos \psi; \tag{25}$$

consequently, the width w_o of the opening between close-packed layers is

$$w_o = (1 + 1/n)\pi d \cos \psi - c \sin \psi. \tag{26}$$

Theoretically, then, the amount of this opening becomes zero when the ratio h/k is so chosen that

$$\tan \psi_o = h/k_o = (1 + 1/n)\pi d/c. \tag{27}$$

III. SELECTION OF THE NUMBER OF CROSSOVERS PER TURN

It should be pointed out that all the symbols used in the present paper have exactly the same significance as those used in the previous papers by the author, the only new concepts introduced being those relating to the progression; namely, the quantities k , p , t , and e . Hence

we can take over, with only slight modification, the principles developed for the ordinary universal winding and apply the same to the progressive universal winding.

In particular, this holds for the selection of the number of crossovers per turn, which, as pointed out in a previous paper by the author, is selected on the basis that the winding angle ϕ have its minimum permissible value at the surface of the dowel, for the purpose of building up the coil as high as possible. Since the latter is not a necessary condition in the case of a progressive universal coil, the number of crossovers per turn can be

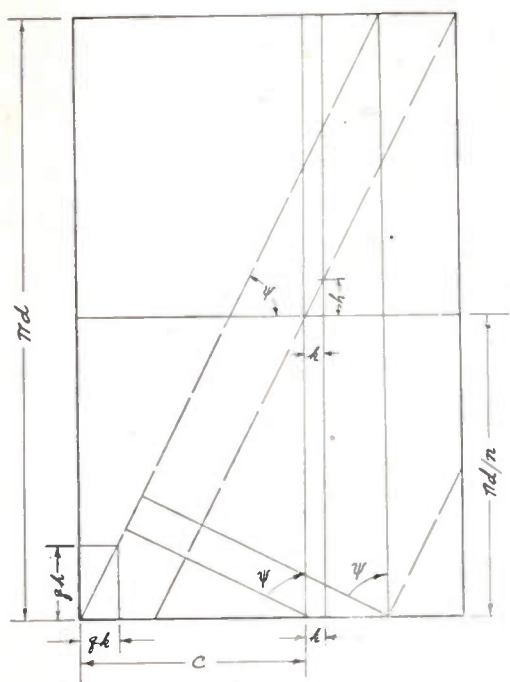

Fig. 5—Developed diagram of the spiral ridges and layers.

selected so that the angle ϕ has a value which will assure absolutely no slippage. According to Joyner and Landon, this condition is attained when n satisfies the formula

$$n = 2d/5c. \quad (28a)$$

The maximum number of crossovers per turn that can safely be used is given by

$$n = 2d/3c. \quad (28b)$$

IV. AN EXAMPLE OF THE APPLICATION OF THE FORMULAS

Let it be desired to wind a progressive universal coil with No. 32 S.S.E. wire ($\delta=0.0106$), on a $\frac{7}{8}$ -inch form ($d=0.875$), using a $\frac{1}{8}$ -inch cam ($c=0.125$), 120.5 turns per inch ($t=120.5$, $p=0.0083$), a spacing factor of 1.25, and retrogressive layering.

The maximum number of crossovers which can safely be used is

$$n = \frac{2 \times (\frac{7}{8})}{3 \times (\frac{1}{8})} = \frac{14}{3} \times \frac{8}{3} = 4\frac{2}{3}$$

while the condition of no slippage would give

$$n = \frac{2 \times (\frac{7}{8})}{5 \times (\frac{1}{8})} = \frac{14}{5} \times \frac{8}{5} = 2\frac{2}{5}$$

hence four crossovers per turn ($n=4$), corresponding to four crossovers per winding cycle ($q=4$) would constitute good design.

The parameters a^2 , b^2 , e , and e^2 are

$$a^2 = (1.25 \times 0.0106/4 \times 0.125)^2 = 7.02 \times 10^{-4}$$

$$b^2 = (4 \times 1.25 \times 0.0106/4 \times \pi \times 0.875)^2 = 2.32 \times 10^{-5}$$

$$e = (0.0083/4 \times 0.125) = 1.66 \times 10^{-2}$$

$$e^2 = (1.66 \times 10^{-2})^2 = 2.76 \times 10^{-5}$$

$$\sqrt{a^2 + b^2} = 2.69 \times 10^{-2}.$$

The accurate formula (16) then gives for r

$$r = (2/4)(1.000 - 1.66 \times 10^{-2} - 2.69 \times 10^{-2} + 7.02 \times 10^{-4} - 2.76 \times 10^{-4})$$

$$r = (1/2)(1.000 - 4.3 \times 10^{-2}).$$

The nearest integral ratio satisfying this equation is

$$r = (1/2)(1 - 1/23) = 22/46 = 44/92.$$

Hence a drive gear with 92 teeth and a cam gear with 44 teeth should be used.

APPENDIX

METHOD OF SOLUTION OF THE BASIC EQUATIONS

If we denote $\tan \phi$ by t , we have from (4) and (7)

$$t = \pi dr / (2c \pm pr) \quad (29)$$

while from trigonometry we have

$$\sin \phi = t / \sqrt{1 + t^2} \quad (30)$$

$$\cos \phi = 1 / \sqrt{1 + t^2}. \quad (31)$$

Solving next (4) and (5) for h we obtain

$$\pm h = \pi d(nr - 2) / 2n \quad (32)$$

while for k we have from (7)

$$k = pr/2. \quad (33)$$

If now in the basic (6) we substitute for $\sin \phi$, $\cos \phi$, h , and k , their values as given by (30) to (33) inclusive, we obtain

$$(2ns/q\pi d)\sqrt{1 + t^2} = (nr - 2) \mp nprt/\pi d. \quad (34)$$

If, finally, we substitute in (34) for t its value as given by (29), square, and rearrange terms, we obtain the basic quadratic (8), which is solved by the standard method.

Concerning Hallén's Integral Equation for Cylindrical Antennas*

S. A. SCHELKUNOFF†, FELLOW, I.R.E.

Summary—The main purpose of this paper is to explain the substantial quantitative discrepancy between Hallén's formula for the impedance of cylindrical antennas, and ours. Hallén's first approximation involves a tacit assumption that the antenna is short compared with the wavelength. Since the subsequent approximations depend on the first, they are degraded by this initial assumption.

The approximations involved in his integral equation itself are justified; and, if properly handled, the equation yields results in much better agreement with ours. The last section of the paper is devoted to infinitely long antennas. Such antennas can be treated by at least three very different methods and a comparison is instructive. In practice, the solution for this case is an approximation to a long antenna designed to carry progressive waves.

INTRODUCTION

IN A previous paper,¹ attention has been called to substantial discrepancies between the values of the impedance of cylindrical antennas as calculated from our formula² on the one hand, and from Hallén's formula on the other.³ Since our results enjoy experimental support, it has been suggested,⁴ tentatively, that the approximations involved in Hallén's integral equation from which his formula was obtained might account for the inaccuracy of his results. Our analysis shows, however, that these approximations are permissible under the contemplated conditions, and cannot account for the large discrepancies under consideration. On the other hand, Gray's solution⁵ of Hallén's integral equation leads to an impedance formula which agrees far better with our formula than with Hallén's, see Table I.

All solutions under consideration, aside from mathematical details, are in the form of sequences of successive approximations, each term depending on the preceding. The goodness of the first approximation affects the goodness of the n -th. In all three solutions, only the first two approximations have actually been expressed in terms of known and tabulated functions. We find that the leading term of Hallén's series is obtained on a tacit assumption that the antenna is short compared with the wavelength. Hallén assumes explicitly that the parameter $\Omega = 2 \log(2l/a)$ is large (l is the length of one arm of the antenna and a is the radius); but in obtaining

the magnitude of the leading term, he also assumes that l/λ is small and thus places a greater burden on the following correction terms. It is for this reason that Hallén's second approximation is inferior to ours, which does not assume that l/λ is small. By numerical integra-

TABLE I
TABLE OF MAXIMUM RESISTANCE OF A FULL-WAVE ANTENNA IN FREE SPACE ($l \geq \lambda/2$)
 $\Omega = 2 \log(2l/a) = K_0 \cdot 60 + 2$

K_0	$l/2a$	Ω	Theoretical				Experimental
			1	2	3	4	5
480	37.1	10	1620	1150	882*	680	860
780	452.0	15	3770	2900	2340	2220	2450
1080	5507.0	20	6820	5500	4840	4650	4840

- (1) Ronald King and F. G. Blake, from two terms of Hallén's series;
- (2) C. J. Bouwkamp, from three terms of Hallén's series;
- (3) S. A. Schelkunoff, from two terms of his series;
- (4) M. C. Gray, from two terms of her series;
- (5) From an experimental* curve.

* In obtaining this value, the capacitance of the flat ends of the cylinder was estimated as explained in S. A. Schelkunoff, "Electromagnetic Waves," D. Van Nostrand and Co., Inc., New York, N. Y., 1943, p. 465. The curves in footnote reference 2 do not include this capacitance, which is negligible when $\Omega = 15$ or greater. The latter is concentrated near the rim and the removal of the flat ends would not appreciably alter the "end capacitance," particularly because the inner surface of the cylinder will become exposed. The same conclusion was reached experimentally by George H. Brown and O. M. Woodward, Jr., "Experimentally determined impedance characteristics of cylindrical antennas," Proc. I.R.E., vol. 33, pp. 257-262, April, 1945.

tion, Bouwkamp obtained⁶ the third term of Hallén's expansion and then computed a few values of the anti-resonant impedance ($l \cong \lambda/2$) of center-fed cylindrical antennas in free space. Table I presents a comparison between various experimental and theoretical values. It is to be noted that the addition of the third term of Hallén's series alters the results by a large percentage in the direction of our values. There is no assurance, however, that the higher-order approximations will ever yield as good results for antennas of practicable dimensions as the first two terms of either Gray's formula or ours. Thus, Bouwkamp observes that the coefficients of the third term are already much larger than those of the second, and there is every indication that the trend will persist and that the series is not convergent but asymptotic. The added terms would not then improve the results unless the parameter Ω is much larger than it can possibly be for practical antennas. An antenna in Copenhagen is perhaps the "thinnest" tower on record; for this antenna, $\Omega = 20$. The diameter of the thinnest antenna measured, by Feldman, at the Bell Telephone Laboratories, was 10 mils, and the length of one arm was about 30 feet; for this antenna, $\Omega = 23.8$. Doubling the length

* Decimal classification: R120. Original manuscript received by the Institute, June 18, 1945.

† Bell Telephone Laboratories, New York, N. Y.

¹ S. A. Schelkunoff, "Antenna theory and experiment," *Jour. Appl. Phys.*, vol. 15, pp. 54-60; January, 1944.

² S. A. Schelkunoff, "Theory of antennas of arbitrary size and shape," Proc. I.R.E., vol. 29, pp. 493-521; September, 1941.

³ E. Hallén, "Theoretical investigations into the transmitting and receiving qualities of antennas," *Nova Acta (Uppsala)* [4] vol. 11, pp. 1-44; November, 1938.

⁴ L. Brillouin, "The antenna problem," *Quart. Appl. Math.*, vol. 1, pp. 201-214; October, 1943.

⁵ Marion C. Gray, "A modification of Hallén's solution of the antenna problem," *Jour. Appl. Phys.*, vol. 15, pp. 61-65; January, 1944.

⁶ C. J. Bouwkamp, "Hallén's theory for a straight perfectly conducting wire, used as a transmitting or receiving aerial," *Physica*, vol. 9, pp. 609-631; July, 1942.

or halving the diameter would increase Ω by only 1.4; even $\Omega = 30$, a value which does not appear to be excessively large, can be of academic interest only since a 10-mil wire would have to be 1362 feet long.

In dealing with asymptotic series for relatively small values of the independent variable, it is quite possible to encounter a situation which is best illustrated by an example. The following two series belong to the same function

$$f(x) = \frac{10}{x} - (105 + \frac{5}{8}) \frac{1}{x^2} + \left(1118 + \frac{23}{64}\right) \frac{1}{x^3} - \dots \quad (\text{A})$$

$$= \frac{10}{x+10} - \frac{45}{8(x+10)^2} + \frac{375}{64(x+10)^3} - \dots \quad (\text{B})$$

Both series are asymptotic in the sense that as x becomes larger and larger, any fixed number of terms will approximate $f(x)$ better and better; on the other hand, if x is not sufficiently large, the two series behave quite differently. Thus, if $x = 2$, the first three terms of series (B) yield $f(2) = 0.79766$, while the exact value of $f(2)$ is known to be 0.79728; but series (A) breaks down altogether. The exact value happens to be known because series (B) was obtained from

$$f(x) = 80 - 80e^{x+10} \sqrt{2(x+10)/\pi} K_0(x+10)$$

with the aid of the well-known asymptotic expansion for the modified Bessel function. Series (A) is nothing but (B), when the latter is expanded in powers of $1/x$ in place of $1/(x+10)$.

For the purposes of illustration, we have deliberately exaggerated the phenomenon which is actually encountered in the antenna theory. Nevertheless, the choice of the parameter in reciprocal powers of which the solution is expanded is much more important than is realized by some students of the theory.

DERIVATION OF THE INTEGRAL EQUATION FOR ANTENNAS

Hallén's approximate integral equation for a cylindrical antenna is

$$\int_{-l}^l \frac{I(\xi) e^{-i\beta r}}{4\pi r} d\xi = A \cos \beta z + B \sin \beta |z|, \quad (1)$$

$$r = \sqrt{(\xi - z)^2 + a^2}, \quad \beta = \omega \sqrt{\mu \epsilon} = 2\pi/\lambda,$$

where $I(z)$ is the current, l is the length of one arm of the antenna, a is the radius, and z is measured along the antenna from the generator. It should be emphasized that the above equation is for a cylindrical antenna, and that the equation changes with any change in the shape of the antenna. A recent suggestion⁷ by King and Harrison that Hallén's solution of (1) actually applies to a pair of ellipsoids placed end to end, does not seem to take this fact into consideration.

⁷ Ronold King and C. W. Harrison, Jr., "The impedance of short, long, and capacitively loaded antennas with a critical discussion of the antenna problem," *Jour. Appl. Phys.*, vol. 15, pp. 170-185; February, 1944.

The constants A and B are calculated from the impressed voltage and the condition imposed on the current at the ends of the antenna; but first, let us compare this equation with the exact equation for hollow, perfectly conducting cylindrical antennas. In order to obtain the exact equation, we need only observe that *if the currents on one or more parallel conductors are longitudinal, then on the surface of any conductor the retarded scalar and vector potentials are sinusoidal functions of the distance along the conductor.*⁸ On a single cylinder, the longitudinal current flow is insured if the cylinder has no flat ends and if the impressed voltage is independent of the angular co-ordinate. For thin cylinders, the effects of the capacitance of these ends are small (of order a/l), and we are justified in neglecting them. Those who are interested in the exact equation for cylinders with the flat ends are referred to a paper by L. Brillouin.⁴

If V is the scalar retarded potential and Π the only nonvanishing component of the vector potential, then on the surface of the antenna and in the region free from the applied voltage, we have

$$\frac{dV}{dz} = -i\omega\mu\Pi, \quad \frac{d\Pi}{dz} = -i\omega\epsilon V, \quad (2)$$

where z is the axial co-ordinate. In the region of the impressed voltage the first equation becomes

$$\frac{dV}{dz} = -i\omega\mu\Pi + E'(z), \quad (3)$$

where $E'(z)$ is the impressed voltage per unit length. Eliminating V , we obtain

$$\frac{d^2\Pi}{dz^2} = -\beta^2\Pi - i\omega\epsilon E'(z). \quad (4)$$

Let us now apply these equations to a pair of conducting cylinders, separated by a gap of length s , Fig. 1. Under the influence of the impressed voltage, the charge surges back and forth between the cylinders. This is not precisely the way antennas are operated, but the results can be adapted to the actual method of feeding shown in Fig. 2. Outside the gap, Π is sinusoidal, and we have

$$\Pi = \int_0^{2\pi} \int_{-l}^l \frac{I(\xi) e^{-i\beta r}}{8\pi^2 r} d\xi d\phi$$

$$= A \cos \beta z + B \sin \beta |z|, \quad |z| > s/2, \quad (5)$$

where $I(z)$ is the current; also

$$r = \sqrt{(\xi - z)^2 + \rho^2}, \quad \rho = 2a \sin(\phi/2), \quad (6)$$

where a is the radius of the cylinder. It has been assumed that the impressed voltage is symmetric about the center; otherwise, we should have two equations of form (5), one for each arm of the antenna, with different values of A and B .

For a uniform impressed intensity across the gap on the continuation of the antenna surface we have⁸

⁸ This assumes that the internal impedance of the "generator" is zero. There is no loss in generality in this since the generator impedance is simply in series with the antenna impedance.

$$\Pi = C \cos \beta z + V'/i\omega\mu s, \tag{7}$$

where $V' = E's$. The retarded scalar potential is obtained by differentiation

$$\begin{aligned} V &= -\frac{1}{i\omega\epsilon} \frac{d\Pi}{dz} = -i\eta A \sin \beta z + i\eta B \cos \beta z, \quad z > s/2; \\ &= -i\eta C \sin \beta z, \quad -s/2 < z < s/2; \\ &= -i\eta A \sin \beta z - i\eta B \cos \beta z, \quad z < -s/2; \end{aligned} \tag{8}$$

where

$$\eta = \sqrt{\mu/\epsilon}.$$

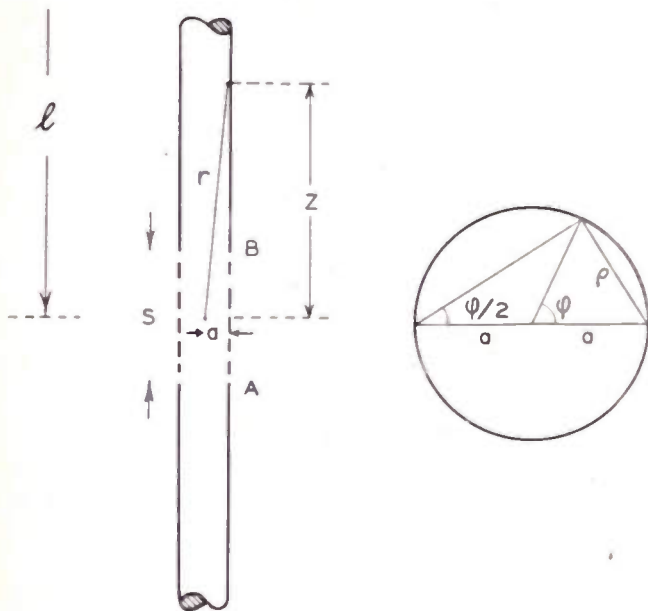

Fig. 1—A portion of a cylindrical antenna in the vicinity of the gap across which the electric charge is forced to flow back and forth between the two arms of the antenna.

The continuity of V and Π at $z = s/2$ gives two equations for determination of the constants of integration A, B, C . The continuity at $z = -s/2$ is automatically provided by the symmetry of the equations. At the ends of the antenna the current vanishes

$$I(\pm l) = 0. \tag{9}$$

Hence we have enough equations for obtaining the constants of integration. The ratio

$$Z_i = V'/I(s/2) \tag{10}$$

is the input impedance of the antenna.

The input impedance depends, to a slight extent, on the distribution of the impressed voltage. This ambiguity is inevitable for a finite gap. For an infinitesimal gap the ambiguity is removed but the impedance necessarily vanishes, unless the "terminals" of the antenna are tapered as a pair of cones. In the immediate vicinity of an infinitesimal gap between two cylinders, the dominant term in the expression² for the current is $4i\omega\epsilon a V' \log(a/z) + \text{const.} = (ia/15\lambda) V' \log(a/z) + \text{const.}$ The first term is large only so long as z is very much smaller than a ; still at $z=0$, the current is infinite and in impedance calculations we must assume a finite gap unless a approaches zero together with z sufficiently fast.

An alternative to assuming a distribution of impressed voltage is to assume a constant current I between the terminals A and B and to calculate the voltage necessary to produce it. In this case, we have to solve (5), (9) and

$$I(\pm s/2) = I. \tag{11}$$

Constants A and B will thus be obtained from (9) and

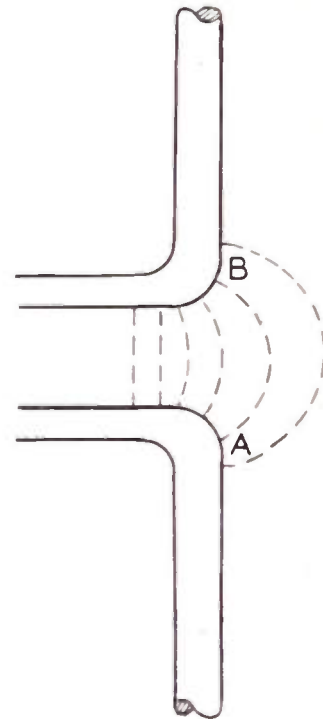

Fig. 2—A portion of a cylindrical antenna receiving its power from a two-wire transmission line.

(11). The necessary impressed voltage is then obtained by integration of (3)

$$\begin{aligned} V' &= \int_{-s/2}^{s/2} E'(z) dz = V'(s/2) - V'(-s/2) + i\omega\mu \int_{-s/2}^{s/2} \Pi(z) dz \\ &= 2V'(s/2) + i\omega\mu \int_{-s/2}^{s/2} \Pi(z) dz \end{aligned} \tag{12}$$

with a subsequent substitution from (8). The main part of the last term is contributed by the vector potential of the current in the filament AB ; hence, the ratio of this term to the current I represents largely the impedance of the filament. In order to obtain the impedance of the antenna as seen from the terminals A, B , this ratio should be subtracted from V'/I ; thus

$$Z_i = 2V'(s/2)/I. \tag{13}$$

This is a better expression for the antenna impedance than (10), but usually there will be little numerical difference between the two.

CONCERNING THE SOLUTION OF THE INTEGRAL EQUATION FOR ANTENNAS

Let us now apply to the left side of (5) a transformation analogous to that employed by Hallén in connection with (1); thus we write

$$\int_0^{2\pi} \int_{-l}^l \frac{I(\xi)e^{-i\beta r}}{2\pi r} d\xi d\phi = I(z) \int_0^{2\pi} \int_{-l}^l \frac{d\xi d\phi}{2\pi r} + \int_0^{2\pi} \int_{-l}^l \frac{I(\xi)e^{-i\beta r} - I(z)}{2\pi r} d\xi d\phi. \quad (14)$$

The purpose of this resolution is to set the stage for successive approximations. If a is small and ξ is in the vicinity of $\xi = z$, r is also small; hence, as a approaches zero the first term on the right becomes infinite while the second remains bounded. Neglecting the second term, we obtain the first approximation for $I(z)$ by substitution in (5). Successive corrections are obtained by substituting each preceding approximation to $I(z)$ in the second term of (14). The integral

$$\Omega(z) = \int_0^{2\pi} \int_{-l}^l \frac{d\xi d\phi}{2\pi r} \quad (15)$$

itself is a fairly complicated function of z , and since we have to divide the right-hand side of (5) by this function, subsequent integrations of the second term in (14) would be complicated. To simplify the calculations, Hallén writes

$$\Omega(z) = \Omega(0) + [\Omega(z) - \Omega(0)]. \quad (16)$$

Instead of $\Omega(0)$ one could use the mean value of $\Omega(z)$, but the difference between these values turns out to be small. With the aid of (14) and (16), (5) becomes

$$I(z) = \frac{4\pi[A \cos \beta z + B \sin \beta |z|]}{\Omega(0)} + \left[1 - \frac{\Omega(z)}{\Omega(0)}\right] I(z) + \frac{1}{\Omega(0)} \int_0^{2\pi} \int_{-l}^l \frac{I(\xi)e^{-i\beta r} - I(z)}{2\pi r} d\xi d\phi. \quad (17)$$

Letting

$$I_0(z) = \frac{4\pi[A \cos \beta z + B \sin \beta |z|]}{\Omega(0)}, \quad (18)$$

substituting in the two last terms of (17), and continuing the process, we obtain

$$I(z) = I_0(z) + I_1(z) + I_2(z) + \dots \quad (19)$$

Evidently, this is a series in descending powers of $\Omega(0)$. In Hallén's analysis

$$\Omega(0) = 2 \log (2l/a), \quad (20)$$

because he uses (1) rather than (5) and thus assumes in effect that $\rho = a$ in (15). It is this approximation that was criticized by Brillouin. It can be shown, however, that the error is of the order $(a/l)^2$. Integrating (15) with respect to ξ , we have

At points far enough from the ends we have

$$\begin{aligned} \Omega(z) &= \frac{1}{2\pi} \int_0^{2\pi} \log \frac{l^2 - z^2}{a^2 \sin^2 (\phi/2)} d\phi \\ &+ \frac{1}{2\pi} \int_0^{2\pi} \left[\frac{a^2}{(l+z)^2} + \frac{a^2}{(l-z)^2} \right] \sin^2 (\phi/2) d\phi + \dots \\ &= \log \frac{4(l^2 - z^2)}{a^2} + \frac{1}{2} \left[\frac{a^2}{(l+z)^2} + \frac{a^2}{(l-z)^2} \right] + \dots \quad (22) \end{aligned}$$

where the omitted terms are of the order of a^4 . At $z=0$ this equation differs from (20) by a^2/l^2 . On the surface, it may appear that Hallén's approximation is not justified near the ends of the wire; but it is. At $z=l$, we have

$$\begin{aligned} \Omega(l) &= \frac{1}{2\pi} \int_0^{2\pi} \log \frac{2l + \sqrt{4l^2 + \rho^2}}{\rho} d\phi \\ &= \frac{1}{2\pi} \int_0^{2\pi} \log [2l/a \sin (\phi/2)] d\phi \\ &+ (a^2/8\pi l^2) \int_0^{2\pi} \sin^2 (\phi/2) d\phi + \dots \\ &= \log (4l/a) + a^2/8l^2 + \dots \quad (23) \end{aligned}$$

The error is still of the order of a^2/l^2 and Hallén's approximation of the double integral by the simple integral is justified for many practical antennas.

Thus, Brillouin's suggestion that Hallén's formula for the input impedance yields poor results on account of the approximations in (1) is not borne out by the above analysis. On the other hand, we are now in a position to call attention to several points which, so far, seem to have been overlooked. Equation (14) is an identity only so long as $I(z)$ is not infinite. The integral equation itself gives no indication with regard to finiteness of $I(z)$; but from other considerations it is known that for an infinitesimal gap, $I(0)$ is infinite. Hence, infinitesimal gaps must certainly be excluded from consideration if we are to use (14). Furthermore, the first term on the right of (14) cannot be a good approximation to the integral on the left if $I(\xi)$ varies rapidly at $\xi = z$; this is precisely the case in the vicinity of $z=0$ when $s \ll a$. Hence, transformation (14) requires s to be sufficiently large to insure that $I(z)$ does not vary too rapidly.

Finally, the first term on the right of (14) is a better approximation to the integral on the left if βr is small; that is, if $2\pi l/\lambda$ is small. It will be recalled that $\Omega(z)$ as given by (15) is proportional to the direct-current inductance per unit length of a uniform current filament extending from $z = -l$ to $z = l$. If we multiply (5) by $i\omega\mu$, we should find, by comparing with Maxwell's equations, that the right-hand side represents the dynamic component of the voltage per unit length along the antenna. Hallén's first approximation, $I_0(z)$ to the

$$\Omega(z) = \frac{1}{2\pi} \int_0^{2\pi} \log \frac{[(l+z) + \sqrt{(l+z)^2 + \rho^2}][l-z + \sqrt{(l-z)^2 + \rho^2}]}{\rho^2} d\phi. \quad (21)$$

current is obtained in effect by dividing this voltage by $i\omega L$, where L is the direct-current inductance of the wire. It would have been better to use the "alternating-current inductance." Mathematically this would correspond to the following transformation:

$$\int_0^{2\pi} \int_{-l}^l \frac{I(\xi)e^{-i\beta r}}{2\pi r} d\xi d\phi = I(z) \int_0^{2\pi} \int_{-l}^l \frac{\cos \beta r}{2\pi r} d\xi d\phi + \int_0^{2\pi} \int_{-l}^l \frac{I(\xi) - I(z)}{2\pi r} \cos \beta r d\xi d\phi - i \int_0^{2\pi} \int_{-l}^l \frac{I(\xi)}{2\pi r} \sin \beta r d\xi d\phi \quad (24)$$

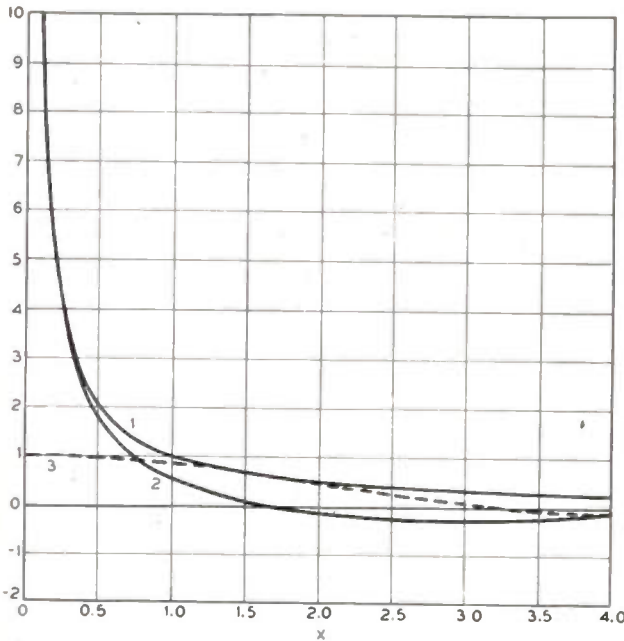

Fig. 3—Curves 1, 2, and 3 represent respectively $1/x$, $\cos x/x$ and $\sin x/x$.

in place of (14). This is precisely the transformation employed by Gray. Instead of $\Omega(z)$ we now have

$$P(z) = \int_0^{2\pi} \int_{-l}^l \frac{\cos \beta r}{2\pi r} d\xi d\phi \simeq 2 \log (\lambda/\pi a) - 2C + Ci \beta(l+z) + Ci \beta(l-z), \quad (25)$$

where $C=0.577 \dots$ is Euler's constant. At $z=0$, we have

$$P(0) = 2 \log (\lambda/\pi a) - 2C + 2 Ci \beta l. \quad (26)$$

With the exception of this modification, there is no reason why the process of successive approximation should not be carried on as suggested by Hallén. In (17) we replace Ω by P and r by $|\xi-z|$. Gray improves the first correction term by using *under the integral sign* the average value of $P(z)$, rather than $P(0)$; but this is not obligatory, and one could use $P(0)$ throughout, relying on the higher-order terms for greater accuracy.

Another possible transformation, preferable to (14), is

$$\int_0^{2\pi} \int_{-l}^l \frac{I(\xi)e^{-i\beta r}}{2\pi r} d\xi d\phi = I(z) \int_0^{2\pi} \int_{-l}^l \frac{e^{-i\beta r}}{2\pi r} d\xi d\phi + \int_0^{2\pi} \int_{-l}^l \frac{[I(\xi) - I(z)]}{2\pi r} e^{-i\beta r} d\xi d\phi. \quad (27)$$

The function corresponding to $P(z)$ is now

$$\hat{P}(z) = P(z) - i[\text{Si } \beta(l+z) + \text{Si } \beta(l-z)]. \quad (28)$$

Fig. 3 illustrates the reason why (14) does not yield as good a series for $I(z)$ as (24), particularly when $\lambda/4 < l < \lambda/2$. The real part of the integrand contains the factor $\cos \beta r/\beta r$, which vanishes when $r=\lambda/4$. When $l=\lambda/2$, this factor vanishes almost where $I(\xi)$ is maximum; hence, the region in the vicinity of $r=\lambda/4$ contributes little to the real part of the integral, and this feature is reflected in the first term on the right-hand side of (24). On the other hand, the corresponding region contributes a substantial amount to the first term on the right-hand side of (14). This difference is particularly important because the region $r < 0.03\lambda$, where $\cos \beta r/\beta r$ is large and nearly equal to $1/\beta r$, contributes little to the integral in question on account of smallness of $I(\xi)$. Fig. 3 also shows that (27) will not be as good as (24) as the basis for successive approximations. Since $\cos \beta r/r$ is large only when $\xi=z$, the real part of the integral on the left is nearly proportional to the current $I(z)$ at $\xi=z$; on the other hand, $\sin \beta r/r$ is of the same order of magnitude in a large interval about $\xi=z$; and the imaginary part is not even approximately proportional to $I(z)$.

AN INFINITELY LONG ANTENNA

Infinitely long antennas are of interest to us primarily because they can be treated in at least three quite different ways, and a comparison will be instructive. In order to approximate an infinitely long antenna in a laboratory, one should make it several wavelengths long and attempt to terminate so as to produce substantially progressive waves for several wavelengths on both sides of the generator.

If the radius is small compared with $\lambda/4$, the simplest method is the one which takes advantage of the fact that in an infinitely long antenna we have to consider only the principal progressive waves.⁹ Thus when z/a is large, we have

$$I(z) = Ae^{-i\beta z/\sqrt{K(z)}}, \quad K(z) = 120 \log (2z/a), \quad (29)$$

where A is a constant and $K(z)$ is the nominal characteristic impedance. The input impedance is found to be approximately¹⁰

$$Z_i = 120 \left(\log \frac{\lambda}{2\pi a} - C - i \text{Si } 2\pi \right) = 120 \log (\lambda/2a) - 207 - i172. \quad (30)$$

⁹ S. A. Schelkunoff, "Principal and complementary waves in antennas," to be published in Proc. I.R.E., January, 1946.

¹⁰ J. Stratton and L. J. Chu, "Steady-state solutions of electromagnetic field problems, I. Forced oscillations of a cylindrical conductor," Jour. Appl. Phys., vol. 12, pp. 230-235; March, 1941.

From conservation of energy we obtain

$$A^2 = R_i [I(0)]^2, \tag{31}$$

where R_i is the input resistance; therefore,

$$I(z) = \frac{I(0)\sqrt{R_i}e^{-\alpha z}}{\sqrt{K(z)}} \simeq \frac{Ve^{-\alpha z}}{\sqrt{R_i K(z)}}, \tag{32}$$

except for a possible constant phase shift, unobtainable from the energy equation.

Several years ago, we tried to solve this problem for any radius. It is relatively easy to express the current in the following form:

$$I(z) = \frac{V(0)a}{30\lambda s} \int_{(C)} \frac{\sinh(\gamma s/2) K_1(a\sqrt{-\gamma^2 - \beta^2}) e^{\gamma z}}{\gamma \sqrt{-\gamma^2 - \beta^2} K_0(a\sqrt{-\gamma^2 - \beta^2})} d\gamma \tag{33}$$

where s is the length of the gap and (C) is the imaginary axis indented to the right of the branch point $\gamma = -i\beta$ and to the left of $\gamma = i\beta$. The admittance is then $I(s/2)/V(0)$. The chief difficulty is the evaluation of the integral. If a is small, we succeeded in approximating the real part of the admittance²

$$G_1 = \frac{1}{120M} \left[1 + \frac{\log 2}{2M} - \frac{3}{4} \pi^2 - \frac{(\log 2)^2}{4M^2} + \dots \right],$$

$$M = \log(\lambda/2\pi a) + \frac{1}{2} \log 2 - C, \quad C = 0.577 \dots \tag{34}$$

It is to be noted that, if we retain only the first two terms of this equation, the reciprocal of G_1 is equal to the real part of Z_i in (30). When a is large, the real part of the integral can be evaluated numerically; by this method a previous curve¹¹ was obtained.

Finally when a is small, we were successful in obtaining from (33) the following approximation:

$$I(z) = \frac{V(0)}{120[\log(\lambda/2\pi a) - C]} \left[1 - \frac{\log(2\pi z/\lambda) + \log 2 + C}{2[\log(\lambda/2\pi a) - C]} \right] e^{-\alpha z}, \tag{35}$$

except for a term in quadrature with $V(0)$. The approximation assumes that z/a is large but z/λ is small enough to make the second term in brackets fairly small. This equation agrees with (32), as may be verified by using

$$K(z) = 120 \log(2z/a)$$

$$= 120 \left[\left(\log \frac{\lambda}{2\pi a} - C \right) + \left(\log \frac{2\pi z}{\lambda} + \log 2 + C \right) \right] \tag{36}$$

and expanding $\sqrt{K(z)}$ in a power series. Equation (32), however, is good for all large values of z/a .

All these results are at variance with those obtained¹⁰ by Stratton and Chu, from an equation which is equivalent to (33) with $s=0$. These authors find that the cur-

rent in an infinitely long, perfectly conducting cylinder vanishes and that nonzero current exists only in imperfect wires. The discrepancy is explained by the incomplete evaluation of the integral; they evaluate only the contributions from the poles of the integrand, and for perfectly conducting wires the latter has no poles.

Let us now consider the integral equation for an infinitely long wire. The exact equation is

$$60 \int_{-\infty}^{\infty} \int_0^{2\pi} \frac{I(\xi) e^{-\alpha r}}{2\pi r} d\phi d\xi = V e^{-\alpha|z|}, \quad |z| > s/2;$$

$$r = \sqrt{(\xi - z)^2 + \rho^2}, \quad \rho = 2a \sin(\phi/2). \tag{37}$$

The approximate equation, when a is small, is

$$60 \int_{-\infty}^{\infty} \frac{I(\xi) e^{-\alpha r}}{r} d\xi = V e^{-\alpha|z|}, \quad |z| > s/2;$$

$$r = \sqrt{(\xi - z)^2 + a^2}. \tag{38}$$

Identity (14) breaks down, this time because $\Omega = 2 \log(2l/a)$ becomes infinite. On the other hand, (24) is still valid and we write

$$I(z) = \frac{V e^{-\alpha|z|}}{K} + \frac{60}{K} \int_{-\infty}^{\infty} \frac{I(\xi) - I(z)}{|\xi - z|} \cos \beta(\xi - z) d\xi$$

$$+ \frac{i60}{K} \int_{-\infty}^{\infty} \frac{\sin \beta(\xi - z)}{\xi - z} I(\xi) d\xi, \tag{39}$$

where

$$K = 60 \int_{-\infty}^{\infty} \frac{\cos \beta r}{r} d\xi = 120 \left(\log \frac{\lambda}{\pi a} - C \right). \tag{40}$$

In the first approximation we have

$$I(z) = (V/K) e^{-\alpha|z|}. \tag{41}$$

Substituting this in (39), we have the second approximation for positive values of z

$$I(z) = (V/K) e^{-\alpha z} \left[1 - \frac{60}{K} \left(\log \beta z + C - \log 2 - \frac{i\pi}{2} \right) - \frac{60}{K} \left(-\text{Ci } 2\beta z + i \text{Si } 2\beta z - \frac{i\pi}{2} \right) e^{\alpha z} \right]. \tag{42}$$

When z is nearly zero, we have

$$I(0) = \frac{V}{K} \left[1 + \frac{120 \log 2}{K} + i \frac{60\pi}{K} \right]. \tag{43}$$

From this we obtain the input impedance

$$Z_i = K - 120 \log 2 - i60\pi$$

$$= 120 \left(\log \frac{\lambda}{2\pi a} - C \right) - i60\pi. \tag{44}$$

Comparing this to (30), we find the real parts in agreement; the imaginary parts are 172 and 188 ohms, respectively.

If βz is fairly large, then (42) becomes

¹¹ See Fig. 22 of footnote reference 2.

$$I(z) = (V/K)e^{-i\theta z} \left[1 - \frac{60}{K} \left(\log \frac{2\pi z}{\lambda} + C - \log 2 - \frac{i\pi}{2} \right) \right]. \quad (45)$$

This equation checks (32) and (35), except for a phase shift which was not included in the previous equations.

CONCLUSION

Our general conclusion is that there is no disagreement between the antenna theories developed directly from Maxwell's equations and Hallén's theory based on the integral equation *provided the latter is treated with sufficient care*. On the surface, the solution of the integral equation seems to require only elementary algebra and rudiments of integral calculus, but appearances are sometimes deceptive. Just to give substance to the warning, let us return to the exact equation (37) for the infinitely long cylinder. Among its solutions is to be found the internal wave as well as the external; that is, the well-known guided wave inside a hollow-cylindrical shell. Once this solution has been determined by other methods, it is easy to verify that it satisfies (37); but it would be easy to overlook this particular solution, let alone obtain it.

Similarly, the equation for natural oscillations on a closed, perfectly conducting surface is satisfied by the *internal undamped* oscillations as well as by the external damped oscillations. This is true, for instance, in the

case of Brillouin's equation for natural oscillations on a cylinder. We have in mind the equation which is obtained when we equate to zero the tangential electric intensity calculated by the retarded potential method from the current distribution on the surface. This equation is not the equation for the natural oscillations on a perfectly conducting *solid* or in a cavity imbedded in a perfectly conducting solid. For the solid, the restrictions on the electric intensity are more stringent since it must vanish everywhere within the solid.

Thus we have shown that the approximations involved in Hallén's integral equation are justified, so long as the square of the ratio of the length of the antenna to its diameter is large compared with the natural logarithm of this ratio; but his method of successive approximations to the solution and his impedance formula are based on a tacit initial assumption that the antenna is short compared with the wavelength, and due to the nature of his series, the higher-order approximations fail to correct this initial assumption even for thinnest practicable antennas. This method has been relied upon in several recent papers on antennas, and the conclusions contained in them would be similarly affected. On the other hand, the solution of Hallén's equation as given by Gray does not involve the above-mentioned stringent assumption, and for this reason is more satisfactory. Her method can thus be recommended as an alternative to the method presented in our previous paper.²

Frequency-Modulation Distortion Caused by Multipath Transmission*

MURLAN S. CORRINGTON†

Summary—When a frequency-modulated wave is received by more than one path, so that two or more of the voltages which are induced in the antenna have nearly the same amplitude, considerable distortion can result. Large objects, such as hills or high buildings, can reflect and absorb the waves and thus cause interference. Two interfering waves will be in phase part of the time and out of phase part of the time during modulation. This causes amplitude modulation on the resultant carrier, and a sharp irregularity in the instantaneous frequency, corresponding to each hole in the carrier caused by the interference.

INTRODUCTION

DURING a demonstration of a frequency-modulation receiver in New York in the spring of 1942, difficulty was experienced in locating an antenna in the RCA Building which would produce a signal of

* Decimal classification: R113.6×R148.1×R414. Original manuscript received by the Institute, March 9, 1945; revised manuscript received, April 30, 1945.

† RCA Victor Division, Radio Corporation of America, Camden, N. J.

The distortion can often be greatly reduced by detuning the receiver or discriminator until the hole in the carrier coincides with the zero-balance point of the discriminator. Directional antennas are helpful when the signals from the desired station are not coming from the same direction.

Formulas are derived for the modulated envelope and for the distortion. A Fourier-series analysis of the distorted audio output makes it possible to calculate the effects of de-emphasis networks and other audio selectivity.

quality comparable with that known to be transmitted by station W2XWG. The antenna was located in a room in this steel building on the side away from the transmitter. The distortion was present even on relatively small deviations.

The tests were repeated in an apartment house on 93rd Street, and similar distortion was encountered. Further tests were made later with a second frequency-modulation receiver to determine whether the distortion

was caused by a defective receiver or was introduced during the transmission of the signal. Both receivers produced the same type of distorted output. Since intermediate-frequency amplifier selectivity would not cause this effect, it was suggested that it might be caused by multipath reception. During July and August of 1942, further observations on a qualitative basis were made on the eighty-fifth floor of the Empire State Building. Path differences due to reflections were encountered which were of sufficient magnitude to cause partial or complete cancellation of the waves at one or more frequencies in a 150-kilocycle-wide channel as used by frequency-modulation broadcast stations. A large number of field tests have been made since that time, and they show that this trouble can occur in nearly any location in Manhattan as well as in many of the surrounding towns in northern New Jersey.

In midtown Manhattan there are many steel buildings which cause multipath transmission. If the receiver is inside such a structure, an outside antenna is desirable. If such an antenna is not practicable, it probably will be necessary to use more than one inside receiving antenna in order to obtain full performance on the high-fidelity programs from all the New York frequency-modulation stations. This will be true even if the receiver has the best performance characteristics now commercially available. For a single stationary antenna, distortion will probably be noticed in many locations on at least one of the stations.

Cases have been observed where the movement of a person around in the room near the receiving antenna has changed the relative field strengths enough so that, when the person was in some parts of the room, the reception was satisfactory, and when he was in other parts it was unsatisfactory. A parasitic element such as a metal rod or dipole can sometimes be moved around in a room to produce the same effect. Maximum distortion occurs at the time of cancellation of the two waves. This causes a great reduction in the voltage in the intermediate-frequency channel and it may fall below the threshold of limiting in the receiver.

If the cancellation occurs near one edge of the band, the signal may sound fairly good during the soft passages but it becomes distorted on the loud passages. It will then sound like an overloaded audio-amplifier stage. If the cancellation occurs near the middle of the channel, the entire output may be so distorted that it becomes almost unintelligible; it then sounds somewhat like severe selective fading in amplitude modulation. Since high-order harmonics are produced, the distortion may appear as buzzes, rattles, or swishes, and if it occurs during the playing of a phonograph record, one may think the pickup is not tracking properly. The high frequencies often tend to become irritating due to intermodulation.

Two amateurs¹ have reported distortion of the

¹ A. D. Mayo and Charles W. Sumner, "F. M. distortion in mountainous terrain," *QST*, vol. 28, pp. 34-36; March, 1944.

programs from WMIT when the receiver is in the mountainous region near Asheville, N. C. At times they found that the audio signal was badly distorted to the point of becoming unintelligible, even for strong signals, and that the distortion is a constant phenomenon over periods of weeks in those spots where it occurs. DuMont and Goldsmith² found that multipath conditions are common in which two signals of approximately equal strength arrive at a receiving antenna, and therefore this type of distortion with frequency-modulation sound transmission can be expected to occur frequently.

A similar type of distortion had previously been encountered in long-distance transmission. In 1930, Eckersley³ was working with amplitude-modulation transmitters which had incidental frequency modulation. Because of this frequency shift he found "most appalling distortion" resulting from delayed echoes caused by reflections from the Heaviside layer. He found that it was necessary to use special precautions to keep any frequency shift from getting into the amplitude-modulation transmitters. The distortion when frequency modulation and amplitude modulation were both present was worse than that for amplitude modulation only.

A study of frequency-modulation propagation over long distances was made by Crosby.⁴ A transmitter was set up in Bolinas, California, and the transmissions were observed on receivers at the Riverhead, New York, station. He found that there was considerable distortion, and that in some cases a signal which gave fair intelligibility on amplitude modulation was practically unintelligible on frequency modulation. He stated, "The general conclusion derived from the tests and theory is that, on circuits where multipath transmission is encountered, frequency modulation is impracticable." In a later paper,⁵ he again reported similar distortion. Other studies^{6,7} have shown that reflections from the ground and nearby buildings cause multipath transmission, for both horizontal and vertical polarization, which can introduce distortion. Reflections from airplanes flying overhead sometimes cause interference for short intervals.

The same difficulty is encountered in television reception. The higher frequencies used tend to increase the difficulty, since the phase changes encountered are greater. This causes light and dark bands in the picture

² Allen B. DuMont and Thomas T. Goldsmith, Jr., "Television broadcast coverage," *PROC. I.R.E.*, vol. 32, pp. 192-205; April, 1944.

³ T. L. Eckersley, "Frequency modulation and distortion," *Exp. Wireless and the Wireless Eng.*, vol. 7, pp. 482-484; September, 1930.

⁴ Murray G. Crosby, "Frequency-modulation propagation characteristics," *PROC. I.R.E.*, vol. 24, pp. 898-913; June, 1936.

⁵ Murray G. Crosby, "Observations of frequency-modulation propagation on 26 megacycles," *PROC. I.R.E.*, vol. 29, pp. 398-403; July, 1941.

⁶ P. S. Carter and G. S. Wickizer, "Ultra-high-frequency transmission between the RCA building and the Empire State Building in New York City," *PROC. I.R.E.*, vol. 24, pp. 1082-1094; August, 1936.

⁷ R. W. George, "A study of ultra-high-frequency wide-band propagation characteristics," *PROC. I.R.E.*, vol. 27, pp. 28-35; January, 1939.

and results in synchronization difficulties when frequency modulation is used on video or synchronizing signals.

Since field tests have demonstrated the possibility of encountering distortion due to multipath propagation even though the distance from the transmitter to the receiver is relatively short, a theoretical and experimental study was made to determine the factors contributing to this type of distortion. It is the purpose of this paper to present the results of this investigation.

THEORETICAL CONSIDERATIONS

Suppose that one frequency-modulated wave is delayed with respect to the second by a time interval t_0 because of two-path transmission. The equations for the instantaneous voltages of the two waves are

$$e_1 = E_1 \sin \left\{ \omega t + \frac{D}{\mu} \sin 2\pi\mu t \right\} \tag{1}$$

$$e_2 = E_2 \sin \left\{ \omega(t - t_0) + \frac{D}{\mu} \sin 2\pi\mu(t - t_0) \right\} \tag{2}$$

- where ω = unmodulated-carrier angular frequency
- D = maximum frequency deviation
- μ = audio frequency
- t_0 = time delay of the second wave with respect to the first
- E_1 = amplitude of first wave
- E_2 = amplitude of second wave,

By combining these two waves by the parallelogram law, the equation for the resultant voltage becomes, as shown in Appendix I, equation (22),

$$e_1 + e_2 = E_1 \sqrt{1 + x^2 + 2x \cos \{z \cos (2\pi\mu t - \pi\mu t_0) + \omega t_0\}} \sin \left[\omega t + \frac{D}{\mu} \sin 2\pi\mu t - \tan^{-1} \frac{x \sin \{z \cos (2\pi\mu t - \pi\mu t_0) + \omega t_0\}}{1 + x \cos \{z \cos (2\pi\mu t - \pi\mu t_0) + \omega t_0\}} \right] \tag{3}$$

where

$$z = 2 \frac{D}{\mu} \sin \pi\mu t_0 \tag{4}$$

and

$$x = \frac{E_2}{E_1} \tag{5}$$

The first part of this expression (that under the radical sign) gives the variations in amplitude of the resultant carrier, and the argument of the sine function shows the variations in phase of the signal. There is considerable amplitude modulation introduced, and the frequency-modulated signal is also distorted. The resulting carrier envelope will be considered now, and the distortion in the audio output will be discussed later.

Effect of Interference on the Envelope of the Radio-Frequency Wave

The resultant amplitude of the radio-frequency carrier is given by

$$|e_1 + e_2| = E_1 \sqrt{1 + x^2 + 2x \cos \{z \cos (2\pi\mu t - \pi\mu t_0) + \omega t_0\}} \tag{6}$$

The amplitude is a function of the ratio of the two signal voltages x , the maximum deviation D , the time delay t_0 , and the audio frequency μ . The only effect of the carrier frequency ω is to determine the initial phase angle ωt_0 .

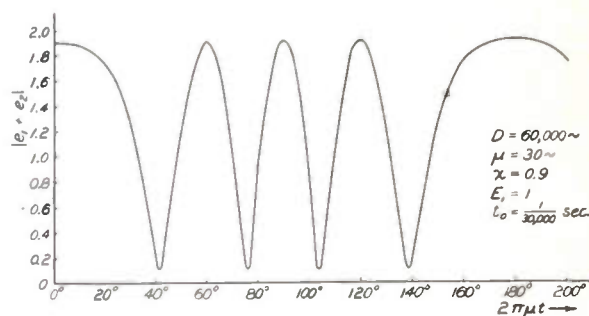

Fig. 1—Carrier envelope.

Fig. 1 shows the carrier envelope for a deviation of 60,000 cycles per second from a mean carrier frequency of 45 megacycles per second. E_1 was assumed to be one volt and E_2 was taken as 0.9 volt, so the voltages are nearly equal. The conditions were chosen so that the two radio-frequency signal voltages were in phase at the undeviated position corresponding to $2\pi\mu t = 90$ degrees. The equation of the envelope becomes

$$|e_1 + e_2| = \sqrt{1.81 + 1.80 \cos \{4\pi \cos (2\pi\mu t - 0.18^\circ)\}} \tag{7}$$

The path difference corresponding to t_0 is 6.2 miles. Zero

degrees correspond to full deviation on one side.

Since the audio signal is a cosine function, it varies slowly at first, then more rapidly as it goes through 90 degrees, and then slows down as it approaches 180 degrees. Fig. 1 shows how the spacing of the peaks and dips of the carrier envelope corresponds to this variation. Zero degrees corresponds to the slowest rate of change, and the peak is very wide; at 90 degrees, the variation is most rapid, and the peak is narrow. The amplitude can be represented by the resultant of two rotating vectors R as shown by Fig. 2. If E_2 were to rotate at a uniform rate, the resultant R (which corresponds to the instantaneous value of the envelope), would go through identical cycles, and the peaks of Fig. 1 would be evenly spaced. When the carrier wave is modulated sinusoidally,

however, the vector E_2 does not rotate uniformly, but rocks back and forth, with a sinusoidal variation of the angle θ . Under the conditions represented by Fig. 1, the vector E_2 starts with $\theta = 0.18$ degrees and makes two

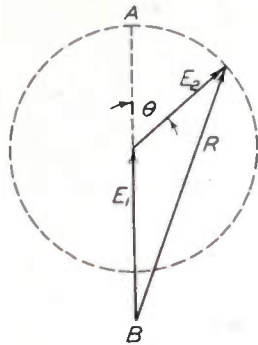

Fig. 2—Resultant of two signals.

revolutions (4π radians) while the carrier frequency varies from maximum deviation to the mean undeviated frequency. Each time it goes past point B it gives a hole in the carrier envelope, and when it goes through A it gives a peak.

Fig. 3 shows what happens when the frequency is increased from 30 cycles per second to 5000 cycles per second. The equation of this envelope is

$$|e_1 + e_2| = \sqrt{1.81 + 1.80 \cos \{ 12 \cos (2\pi\mu t - 30^\circ) \}} \quad (8)$$

Since $\pi\mu t_0 = \pi/6$ radians = 30 degrees, the curve is shifted over approximately 30 degrees from that in Fig. 1, corresponding to one half the fraction of the audio cycle by which one wave is lagging behind the other.

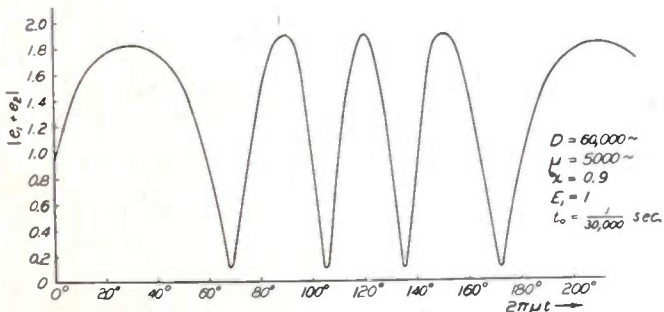

Fig. 3—Carrier envelope.

Another interesting difference is that the two voltages come almost, but not quite, into phase at 30 degrees. This peak is therefore slightly lower than the others. The difference is caused by the fact that the sine of an angle is not linear, but departs from a straight line for larger angles. The maximum angle through which the one vector of Fig. 2 rotates with respect to the other is given by

$$z = 2 \frac{D}{\mu} \sin \pi\mu t_0 \text{ radians} \quad (9)$$

and this sine function introduces the nonlinearity. Further changes of the frequency merely move the curve along the axis, but effect slight changes in shape.

Variation of the Envelope with Deviation

Fig. 4 shows the effect of changes of the maximum deviation D . The constants were chosen such that the two voltages are always in phase when $2\pi\mu t = 0$ degrees. For a small deviation, say $D = 15,000$ cycles per second,

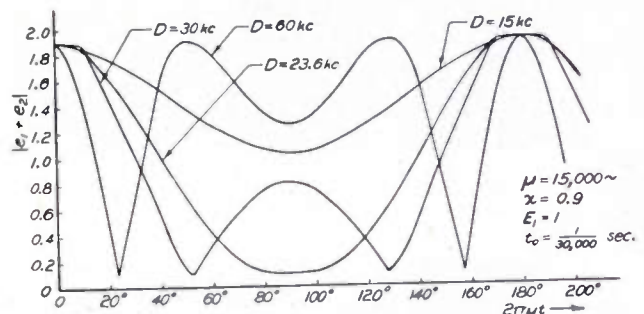

Fig. 4—Variation of carrier envelope with D .

the two voltages start to go out of phase as $2\pi\mu t$ increases, but do not go completely out of phase. The maximum angle between the vectors in this case is

$$\begin{aligned} z &= 2 \frac{D}{\mu} \sin \pi\mu t_0 \\ &= 2 \frac{15,000}{15,000} \sin \frac{\pi(15,000)}{30,000} \\ &= 2 \text{ radians.} \end{aligned}$$

The vector E_2 rotates clockwise 2 radians, then reverses and goes 2 radians counterclockwise, as shown by Fig. 5. This process gives the envelope shown in Fig. 4.

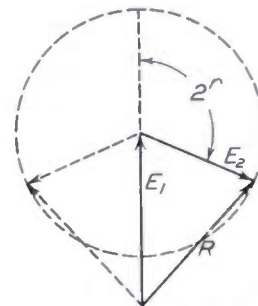
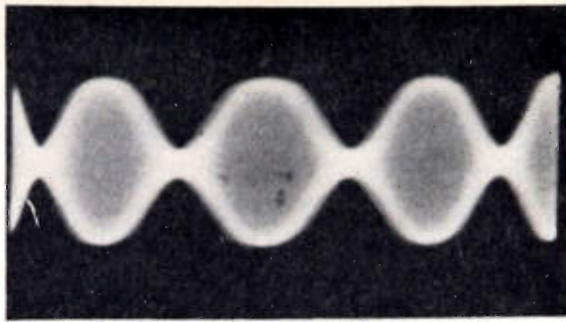

Fig. 5—Variation of resultant.

If the maximum deviation D is increased to 23,600 cycles per second, the two voltages go just out of phase in the mean position. A further increase in D causes them to start to come into phase again, as shown by the curve for $D = 30,000$ cycles per second. Further increases in D increase the number of peaks and holes in the envelope.

Variation of the Envelope with Path Difference

A change in the path difference for the two waves will also change the number of peaks and holes. Fig. 6 shows the envelopes for different path differences from 1.0 mile to 6.2 miles. The curves are very similar to those of



$D=30,000\sim$

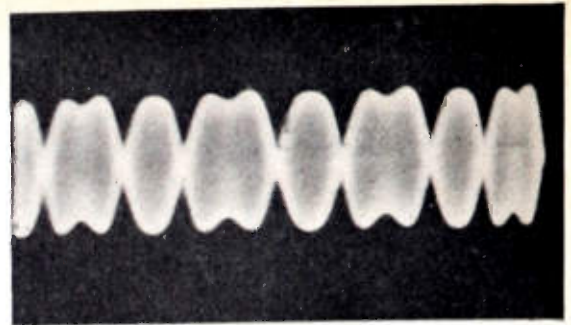

$D=35,000\sim$

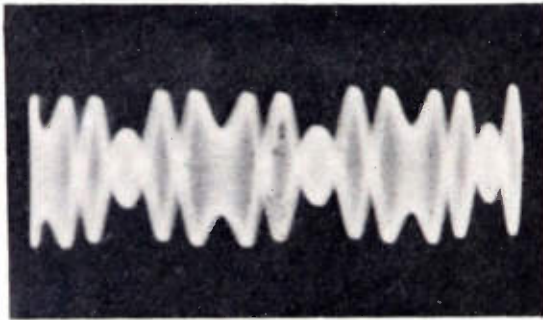

$D=60,000\sim$

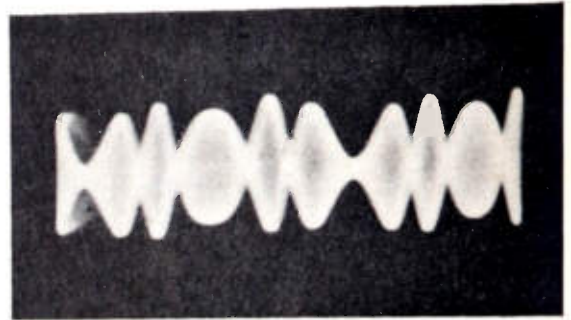

$D=75,000\sim$

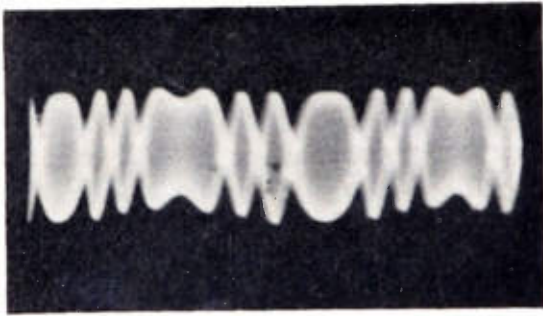

$D=100,000\sim$

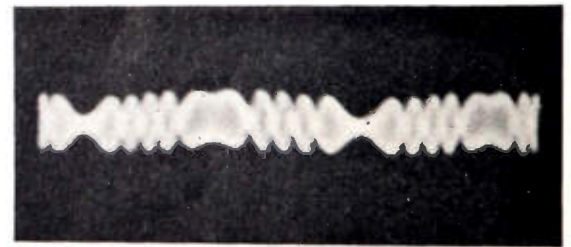

$D=150,000\sim$

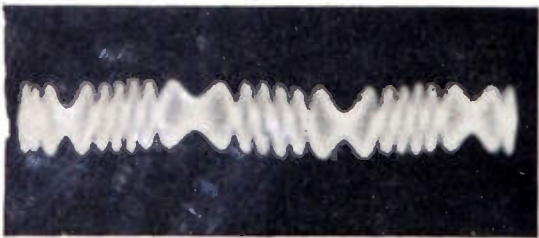

$D=175,000\sim$



$D=200,000\sim$

Fig. 9—Oscillograms of carrier envelopes.

Fig. 4. The shapes can be changed further by adjusting the initial phase of the two waves.

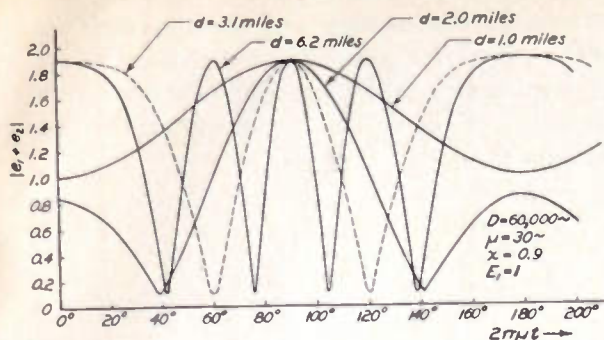

Fig. 6—Variation of carrier envelope with path difference.

Variation of the Amplitude with Deviation.

When the wave is modulated sinusoidally, the variation of the frequency deviation is not linear, and this causes the unequal spacing of the peaks and dips as shown in Fig. 1. If the same set of conditions is used, and

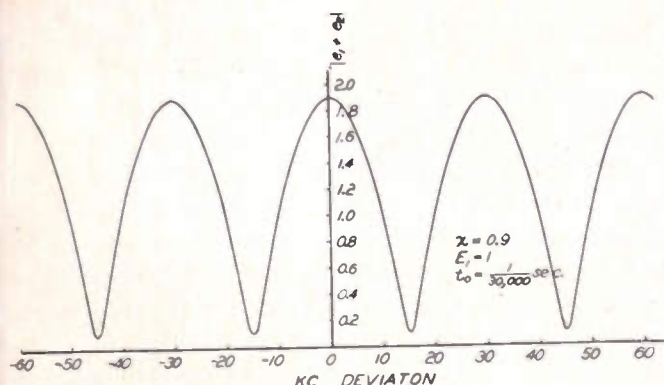

Fig. 7—Variation of amplitude with deviation.

the variation of amplitude is plotted against the deviation, the spacing of the peaks and dips will be uniform as shown by Fig. 7. A further increase in deviation will cause more peaks, but will not alter the spacing if the time delay is unchanged.

The equation of the amplitude is

$$|e_1 + e_2| = \sqrt{1.81 + 1.80 \cos\left(\frac{2\pi D}{30,000}\right)} \quad (10)$$

if the waves start out in phase.

Experimental Study of Carrier Envelope

An artificial time delay was obtained by passing the signal through 10,500 feet of high-frequency cable, and then combining it with a signal from the same source which had traveled only a short distance. The circuit is shown in Fig. 8.

The frequency-modulation signal generator was modulated by a sinusoidal audio tone, and the potentiometer *P* was adjusted until the two voltages on the oscilloscope were nearly equal. The maximum deviation *D* was adjustable, and the initial phase could be adjusted by shifting slightly the mean carrier frequency. A series of

oscillograms was taken that showed the carriers beating together for different deviations *D*. It took approximately 30,000 cycles per second deviation to cause the carrier to go from in-phase to out-of-phase.

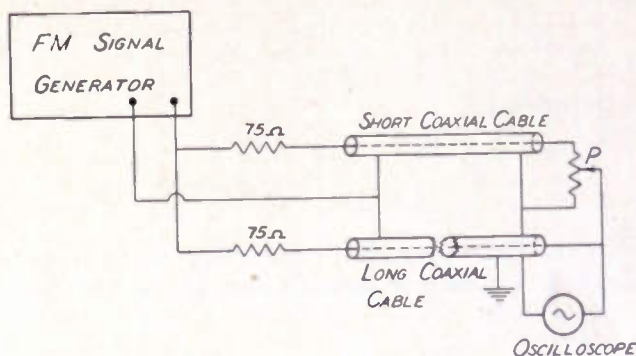

Fig. 8—Circuit for studying interference.

The oscillograms of Fig. 9 show how the number of peaks and holes varies with the deviation *D*. They are seen to be very similar to those of Figs. 1, 3, 4, and 6. In each one, the two voltages were nearly equal.

Fig. 10 shows an oscillogram in which one signal is about 3.5 times as strong as the second. The general shape is the same as those of Fig. 9, but the holes do not

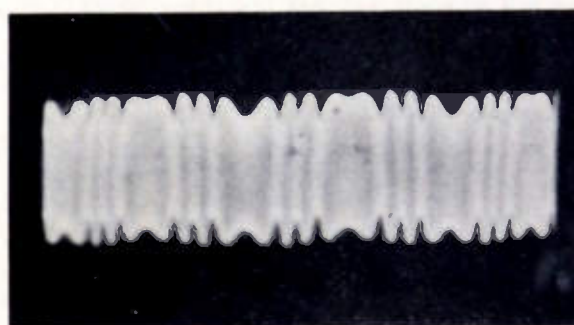

Fig. 10—Oscilloscope of carrier envelope.

go nearly so deep. The velocity of propagation in the cable was 66 per cent of that in free space; therefore, the effective path difference was 15,900 feet. This corresponds to a time delay of 16.2 microseconds.

Determination of Time Delay

Let the path difference be *d* and the time delay corresponding to this difference be *t*₀. The unmodulated carrier frequency is ω . Let λ_1 be the wavelength corresponding to ω , and let λ_2 equal the wavelength corresponding to $\omega + D$, where *D* is the frequency deviation required to increase by one the number of wavelengths in *d*.

Then

$$d = N\lambda_1 = (N + 1)\lambda_2 \quad (11)$$

and

$$d = N \frac{3 \times 10^8}{\omega} = (N + 1) \frac{3 \times 10^8}{\omega + D} \text{ meters} \quad (12)$$

where $\omega\lambda_1 = 3 \times 10^8$ meters per second, the free-space

velocity of the wave, and $(\omega + D)\lambda_2 = 3 \times 10^8$ meters per second. Eliminate N from the second equation

$$d = \frac{d\omega}{\omega + D} + \frac{3 \times 10^8}{\omega + D}$$

and

$$d = \frac{3 \times 10^8}{D} \text{ meters.} \quad (13)$$

The time delay

$$t_0 = \frac{d}{3 \times 10^8} = \frac{1}{D} \text{ seconds.} \quad (14)$$

If D is the frequency shift required to go from out-of-phase, to in-phase, and out-of-phase again, the time delay will be $1/D$.

Field Tests.

To study the distortion encountered in New York City, the NBC transmitter at the Empire State Building was operated with 300-cycle pure-tone modulation and a deviation of ± 75 kilocycles. A medium-priced receiver and an antenna were set up in a room next to the transmitter. The antenna could easily be located to give two-path reception, with a time delay of about seven microseconds. Figs. 11 and 12 show the carrier envelope and the discriminator output. In Fig. 11 the two waves canceled each other near one end of the swing. The resultant

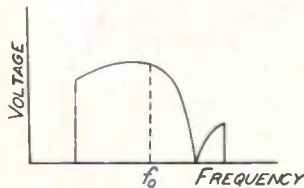

Fig. 11—Carrier envelope.

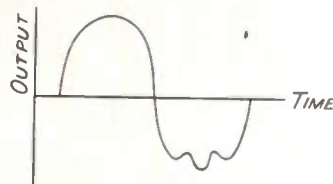

Fig. 12—Discriminator output.

amplitude modulation which passed the limiter, and the coincidental phase modulation gave the result shown in Fig. 12. One half of the cycle is relatively free from distortion, since the two signals did not go out of phase at any part of that swing. The two irregularities in the audio output correspond to the point of cancellation. This distortion could be eliminated by correct antenna location.

In the RCA Building on the side away from the transmitter, the antenna was fairly well shielded from the direct wave from the transmitter, and it received signals which may have been reflected from other buildings. Fig. 13 shows several curves of the audio output and the corresponding variation in the carrier voltage during the cycle. They are all for a 300-cycle audio tone and ± 75 -kilocycle deviation, for various antenna positions. The audio output should be a pure sine wave, and the intermediate-frequency voltage should show the intermediate-frequency selectivity curve, as shown by the dotted lines. Although there were several irregularities along the straighter portions, the most serious distortion occurs at the ends of the swing. The first intermediate-

frequency voltage curve shows that there were several paths of nearly equal voltage. In the second case, the secondary paths were still present, but the relative voltage was much less, as shown by the decreased departure from the selectivity curve. Since the signal strength was fairly low, some of the distortion was probably due to the inability of the limiter to remove all the deep holes in the carrier.

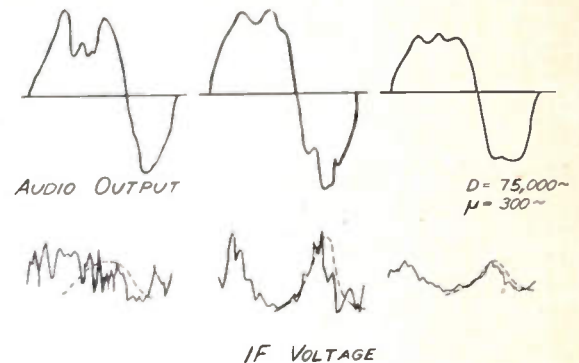

Fig. 13—Distortion for various antenna positions.

Many other field tests in New York City and northern New Jersey have shown this distortion. The time delay is usually about 7 to 12 microseconds. This means that, for two-path transmission, there will be one or two holes in the carrier. Since the limiter tends to fail at these holes, the distortion can often be reduced by detuning the receiver until the hole in the carrier coincides with the discriminator zero-balance frequency. Since the discriminator output is zero at this point, variations in input voltage cause a minimum of distortion. It sometimes happens, when the direct and indirect waves are nearly equal, that severe distortion is encountered in the audio output of the set even though the input signal, as indicated by the voltage developed at the limiter grid, would normally be sufficient to secure limiting.

Effect of Interference on the Audio Output from the Discriminator

As shown in Appendix I, equation (23), the audio output from the discriminator is proportional to

$$D \cos 2\pi\mu t + \frac{2D \sin \pi\mu t_0 \sin (2\pi\mu t - \pi\mu t_0)}{1/x + \cos \{z \cos (2\pi\mu t - \pi\mu t_0) + \omega t_0\} + 1} \quad (15)$$

The first term represents the undistorted output, and the second term shows the distortion introduced by the interference. This result was obtained by assuming that a limiter removes the coincidental amplitude modulation from the wave, and that the discriminator output is proportional to the instantaneous frequency.

General Case—Two Voltages Nearly Equal

The distortion term can be expanded in a Fourier series, as shown in Appendix II. The audio output from the discriminator is proportional to

output = $D \cos 2\pi\mu t$

$$-2\mu \sum_{n=0}^{\infty} (-1)^n C(2n+1, z; x, \omega t_0) (2n+1) \sin (2n+1)\gamma$$

$$-2\mu \sum_{n=1}^{\infty} (-1)^n S(2n, z; x, \omega t_0) (2n) \sin 2n\gamma \quad (16)$$

where

$\gamma = 2\pi\mu t - \pi\mu t_0$ and the C and S functions are defined as follows:

$$C(m, n; x, \theta) = \sum_{s=1}^m \frac{(-x)^s}{s} J_m(sn) \cos s\theta. \quad (17)$$

$$S(m, n; x, \theta) = \sum_{s=1}^m \frac{(-x)^s}{s} J_m(sn) \sin s\theta. \quad (18)$$

The amplitude of each harmonic can be calculated from these equations by assuming the proper value of n . The

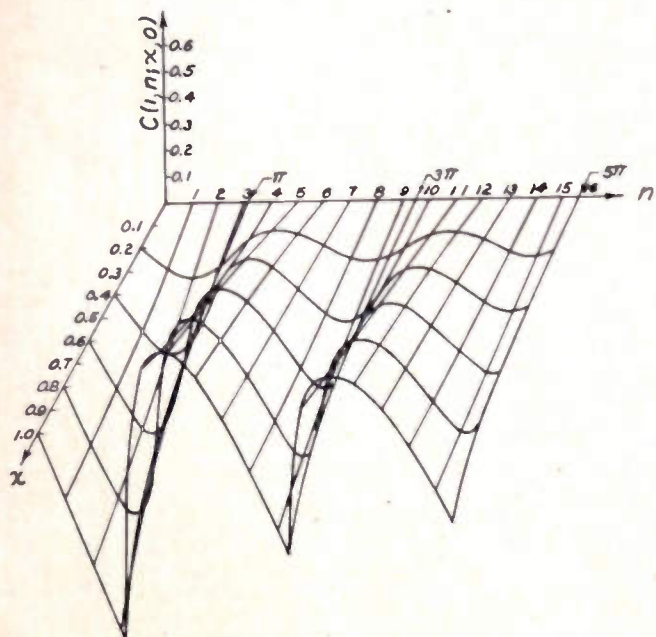

Fig. 14—Graph of $C(1, n; x, 0)$.

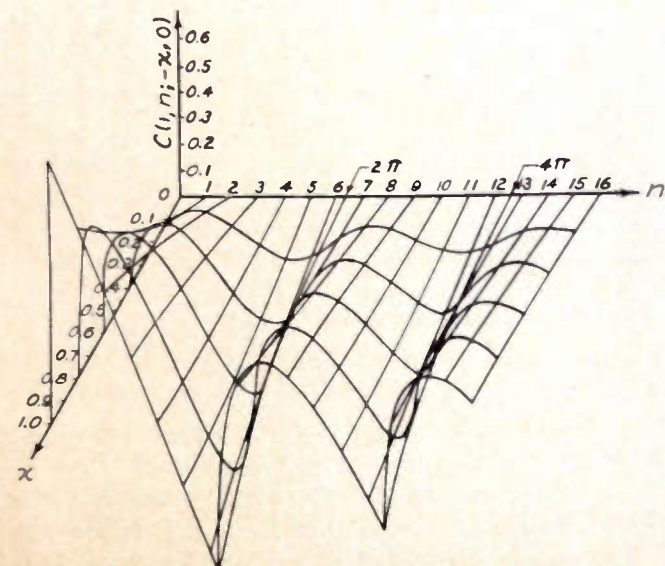

Fig. 15—Graph of $C(1, n; -x, 0)$.

C and S functions can be computed from tables of Bessel functions. Figs. 14, 15, 16, and 17 show some graphs of these functions.

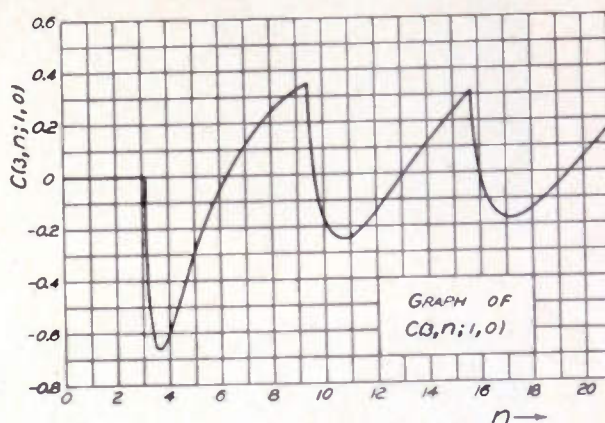

Fig. 16—Graph of $C(3, n; 1, 0)$.

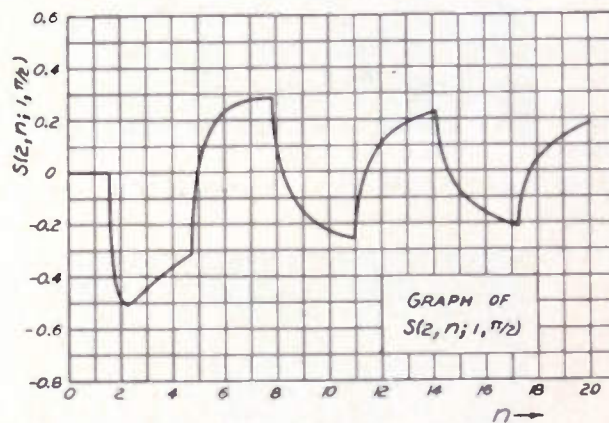

Fig. 17—Graph of $S(2, n; 1, \pi/2)$.

Fig. 18 shows the distortion caused at an audio frequency of 500 cycles per second under the conditions listed. The phase of the two radio-frequency waves was chosen such that they are 180 degrees out of phase at the unmodulated frequency. This gives the maximum of dis-

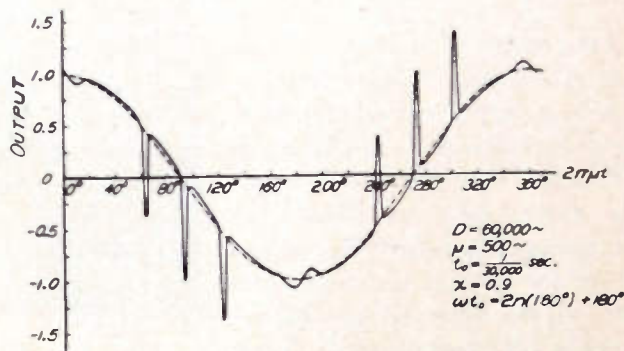

Fig. 18—Distorted audio output.

tortion. The first irregularity comes at about 10 degrees, where the vectors are still rotating relatively slowly with respect to each other. By the time the angle $2\pi\mu t = 63$ degrees, the two vectors are rotating rapidly and a sharp dip is created. A similar effect occurs at 93 degrees and

123 degrees. At 180 degrees the vectors are again rotating slowly, and the peak is small. The process is repeated during the second half of the audio cycle.

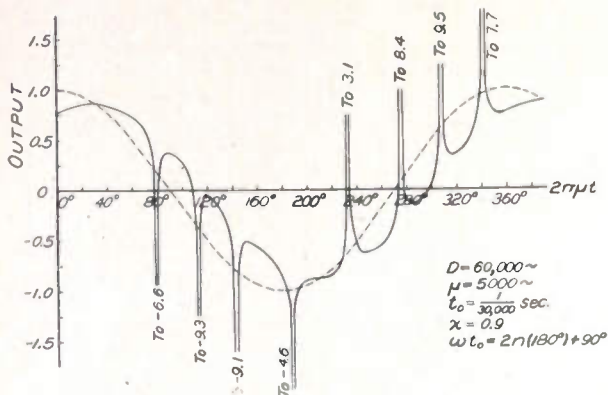

Fig. 19—Distorted audio output.

Fig. 19 shows the distorted audio output when the audio frequency is increased to 5000 cycles per second. The value for ωt_0 was chosen to make the two radio-frequency signals start 90 degrees out of phase.

Fig. 20 shows the two vectors E_1 and E_2 and the angle θ , which is the angle between them. The resultant R makes an angle α with E_1 . The amount the distorted curve of Fig. 19 departs from the pure cosine wave (shown by the dotted line) is proportional to the time

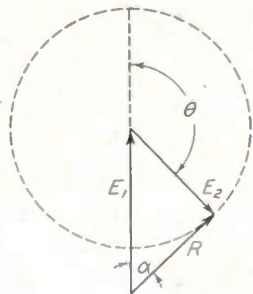

Fig. 20—Variation of α .

rate of change of angle α . It is easy to see from Fig. 20 that, as the angle θ nears and goes through 180 degrees, there is a very great change in α for a relatively small change in θ , when E_1 and E_2 are nearly the same length. This means that the first derivative of α with respect to time is very large, and this causes the deep dips and high peaks. The nearer E_2 comes to E_1 in absolute magnitude, the greater the departure from the undistorted curve. In the limit, as $E_1 = E_2$, $\alpha = +90$ degrees as θ approaches 180 degrees from the right and $\alpha = -90$ degrees as θ passes through 180 degrees. This means a 180-degree change in α as θ passes 180 degrees. The derivative of α with respect to time is therefore infinite at that instant, and the curve representing the audio output becomes a sharp pulse.

This theory assumes an infinite bandwidth and linear phase-shift in the receiver. The very deep and narrow

dips and peaks show the presence of harmonics of high order which are in phase at each peak. Since the receiver has a limited bandwidth, many of these harmonics will be filtered out in the audio system, so the audio output will not be actually as distorted as shown. The effect of nonlinear phase shift and limited bandwidth is to broaden out and shorten the peaks in the output. The undistorted cosine curve is shown for comparison. The

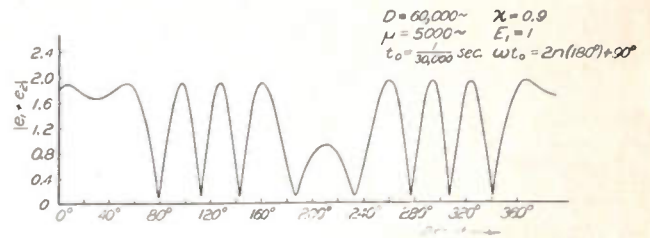

Fig. 21—Carrier envelope.

envelope of the carrier for this set of conditions is shown by Fig. 21. There is one dip or peak corresponding to each hole in the envelope of the carrier.

If the maximum deviation is reduced, such that the two vectors do not go out of phase so often, the distortion will be much less, because the number of peaks will be reduced and the one vector will not rotate so fast

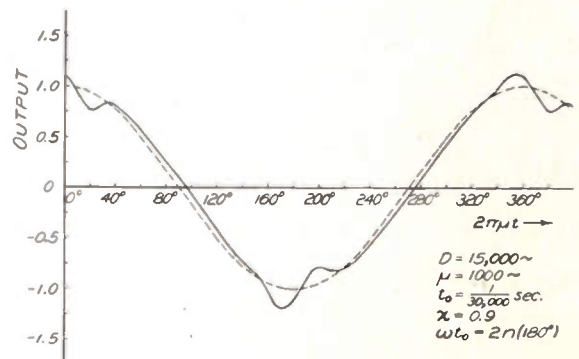
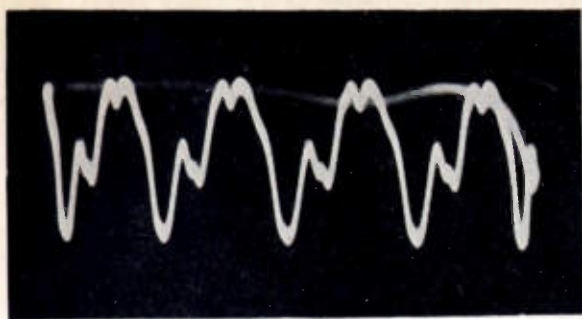

Fig. 22—Distorted audio output.

relative to the second. Fig. 22 shows the output at 1000 cycles per second with a maximum deviation of 15,000 cycles per second. The time delay is 1/30,000 second as before. The phase of the two radio-frequency carriers was chosen such that they were in phase at the undeviated frequency. This assumption also reduces the distortion. Upon reducing the deviation further, or decreasing the time delay of the retarded signal, the irregularities will disappear.

Experimental Study of Distorted Output

The distortion in the audio output from the receiver was studied by using the circuit of Fig. 8 with a frequency-modulation receiver connected just ahead of the oscilloscope. The signal was passed through the intermediate-frequency amplifier, limiter, and discriminator, and the distortion was studied with the oscilloscope. Fig. 23 shows a series of oscillograms taken with different audio frequencies and deviations.



$D = 100,000 \sim \mu = 10,000 \sim$

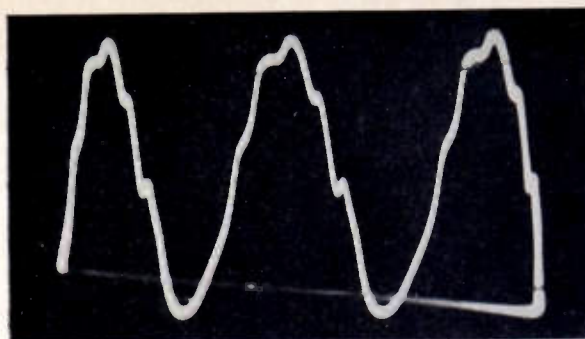

$D = 75,000 \sim \mu = 10,000 \sim$

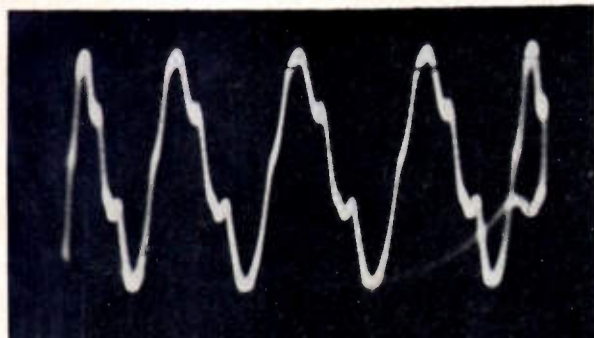

$D = 100,000 \sim \mu = 4000 \sim$

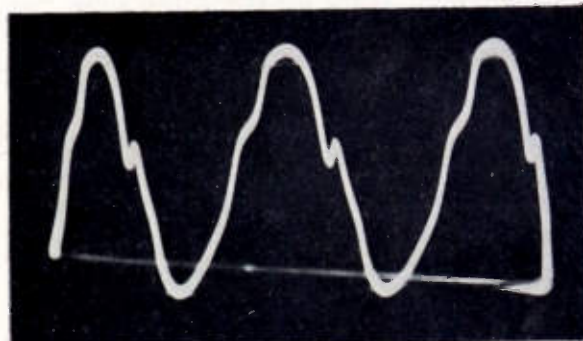

$D = 75,000 \sim \mu = 4000 \sim$

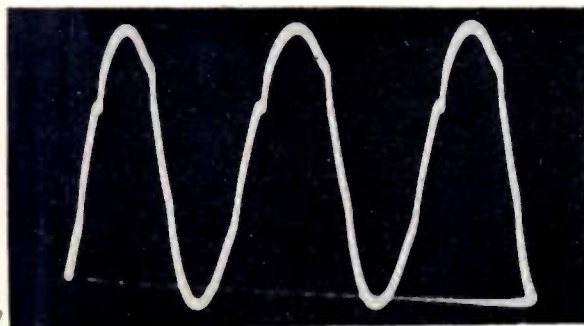

$D = 100,000 \sim \mu = 1000 \sim$

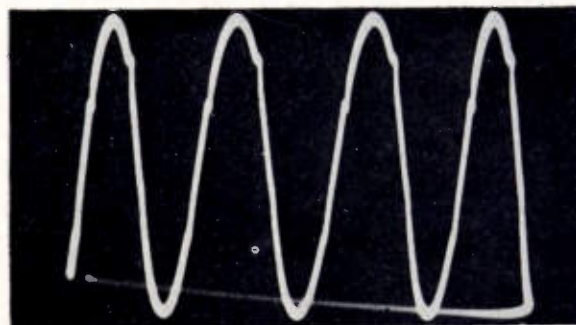

$D = 75,000 \sim \mu = 1000 \sim$

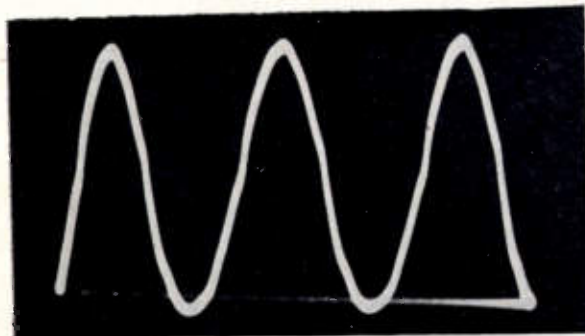

$D = 75,000 \sim \mu = 400 \sim$

Fig. 23—Oscillograms showing distortion.

It is easily seen that high deviations and high audio frequencies cause the most distortion. Reducing either one will decrease the distortion. These curves cannot be compared directly with the theoretical ones previously shown, since the time delay is not the same. The time delay used experimentally was limited to 16.2 microseconds by the available length of cable, while the theoretical curves were based on a time delay of 33.3 microseconds. Naturally, the increased time delay causes the one signal to lag further behind and thus causes greater distortion. Crosby⁸ has also shown many oscillograms of this type of distortion, taken over a path from Kansas City to Riverhead, Long Island. These show the characteristic sharp breaks in the audio output and the effect of noise.

CONCLUSION

The calculations and experimental study show that serious distortion of a frequency-modulation signal can be caused by multipath transmission over relatively short distances. This distortion is liable to be encountered in the vicinity of large buildings or other objects which reflect and absorb the waves and thus cause interference. These buildings or other large objects can be near either the transmitter or the receiver and cause such reflections. The two signals will be in phase part of the time and out of phase part of the time during the audio cycle. If the signals have approximately equal amplitudes, nearly complete cancellation results when they go out of phase. This change in amplitude modulates the resultant carrier since it causes a sudden drop or deep hole in the resultant carrier amplitude, as shown by Figs. 1, 3, 9, etc. If these holes are so deep that the limiter in the conventional receiver cannot hold the output constant, amplitude modulation will be impressed on the discriminator. If the discriminator can respond to these variations in amplitude, the output will be distorted at the part of the cycle which corresponds to the hole in the resultant carrier. If the resultant-carrier amplitude drops below the noise level, the distorted part of the cycle will have noise superimposed on it. Cases have been observed in which the output was undistorted at all parts of the cycle except at one point, and there the output was all noise.

Each time the two nearly-equal carriers go out of phase, there is a very rapid phase shift which causes a peak or dip in the output corresponding to this phase modulation. The worst distortion occurs when the two signals are of nearly equal voltage, and when the two radio-frequency carriers are out of phase when the modulation is removed. The distortion increases with the audio frequency because the higher the audio frequency, the further the retarded wave lags behind, in terms of an audio cycle. An increase in the maximum frequency deviation increases the number of times the two signals go in and out of phase in each audio cycle, and this also increases the distortion. This increase of the distortion

as the deviation is increased is in contrast to the reduction of ordinary noise as the bandwidth of the transmission is increased.

The amplitude of each harmonic can be calculated by the formulas given. From these values, the effect of a low-pass audio filter can be determined. The low frequencies are not distorted very much, and the high frequencies will have their distortion reduced by the audio selectivity. This means that the medium frequencies will be the ones which are distorted the most and they are the ones most needed for intelligibility. For shorter path differences the time delay is less, and the distortion is reduced. If the two signals are approximately in phase at the undeviated position, they cannot go entirely out of phase for path differences less than about one mile with the deviations used today. However, if they are out of phase at the undeviated position, distortion will be produced even for small time delays. For small deviations and low audio frequencies the signals do not get far out of phase; thus there is not much distortion.

The distortion due to multipath transmission of frequency-modulated waves contains many high-order harmonics and is, therefore, different from amplitude-modulation distortion caused by the same process. In amplitude modulation the harmonics are all of low order and are not so disagreeable. Frequency-modulation distortion often sounds like crackles, rattles, swishes, or gurgles and may not be objectionable on low modulation. It sometimes makes one wonder if the transmitter is being operated properly. At times it is noticeable only on the loud passages and may sound somewhat like overloading in an audio-amplifier tube. At other times the distortion may be so bad that the signal is almost unintelligible; it then sounds somewhat like selective fading in amplitude modulation.

It is doubtful whether an increase in selectivity can decrease the distortion. The hole in the resultant carrier and the coincidental phase modulation can occur at any part of the audio cycle, and thus can occur at the carrier frequency as well as any other. This cancellation at the center frequency cannot be eliminated by greater selectivity. An increase in sensitivity usually helps to decrease the distortion, since it helps to maintain sufficient carrier amplitude to operate the limiter at all times. A commercial frequency-modulation receiver designed to reduce multipath distortion should have a sensitivity of at least 10 or 20 microvolts, and for that signal strength should remove all amplitude variations in the signal even at the ends of the swing. The receiver should also remove the holes from the carrier; otherwise, distortion may be noted on some stations that may have much higher signal strengths than others which have no apparent distortion.

A properly oriented directional antenna, such as a dipole, will reduce the distortion if the two signals are coming from different directions, as is likely to be true near large buildings. Such antennas are of limited value

⁸ See page 401 of footnote reference 5.

when the signals are coming from the same direction. A power-line antenna or built-in loop often gives multipath trouble, and little can be done to reduce it since most such antennas are not ordinarily adjustable, and the voltage pickup is usually less than for a dipole.

In some receiving locations, the antenna should preferably be remote from the receiver so the relative field strengths will not be changed appreciably as the occupants of the room move about. Cases have been observed where the signal was either distorted or undistorted depending upon where one stood in the room. For time delays of approximately 6 or 8 microseconds, the distortion can often be greatly reduced by mistuning the receiver or discriminator until the hole in the carrier coincides with the zero-balance point of the discriminator, since any amplitude modulation that passes the limiter then causes very little audio output. However, this may cause an increase in noise. Under these conditions, a tuning meter is of little value.

APPENDIX I

DERIVATION OF EQUATIONS FOR FREQUENCY-MODULATION DISTORTION CAUSED BY MULTIPATH TRANSMISSION

The analysis of this appendix is similar to that developed by Crosby,⁴ and is repeated here for convenience. It will serve as an introduction to the derivation in Appendix II.

Let one frequency-modulated wave be delayed with respect to another by a given time interval t_0 . This condition can be caused by a two-path transmission, where one path is longer than the other by a fixed distance. The equations for the instantaneous voltages of the two signals are

$$e_1 = E_1 \sin \left(\omega t + \frac{D}{\mu} \sin 2\pi\mu t \right) \tag{19}$$

$$e_2 = E_2 \sin \left\{ \omega(t - t_0) + \frac{D}{\mu} \sin 2\pi\mu(t - t_0) \right\} \tag{20}$$

where

- ω = unmodulated-carrier angular frequency
- D = maximum frequency deviation
- μ = audio frequency
- t_0 = time delay of the second signal with respect to the first.

These two waves can be combined by the parallelogram law. In Fig. 24, the law of cosines gives

$$R = \sqrt{E_1^2 + E_2^2 + 2E_1E_2 \cos \theta}$$

The angle θ between the two vectors E_1 and E_2 equals the difference of the two arguments of the sine functions.

$$\theta = \frac{D}{\mu} \sin 2\pi\mu t - \frac{D}{\mu} \sin 2\pi\mu(t - t_0) + \omega t_0$$

The angle α between R and E_1 is given by

$$\tan \alpha = \frac{E_2 \sin \theta}{E_1 + E_2 \cos \theta} = \frac{x \sin \theta}{1 + x \cos \theta}$$

where

$$x = \frac{E_2}{E_1}$$

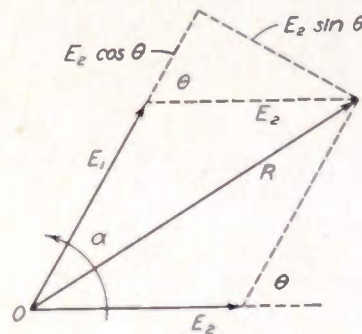

Fig. 24—Composition of two vectors.

The law of cosines gives, therefore

$$e_1 + e_2 = \sqrt{E_1^2 + E_2^2 + 2E_1E_2 \cos \theta} \sin \left(\omega t + \frac{D}{\mu} \sin 2\pi\mu t - \tan^{-1} \frac{x \sin \theta}{1 + x \cos \theta} \right) \tag{21}$$

Since $\sin \alpha - \sin(\alpha - \beta) = +2 \cos(\alpha - \beta/2) \sin \beta/2$,

$$\begin{aligned} \theta &= 2 \frac{D}{\mu} \sin \pi\mu t_0 \cos(2\pi\mu t - \pi\mu t_0) + \omega t_0 \\ &= z \cos(2\pi\mu t - \pi\mu t_0) + \omega t_0 \end{aligned}$$

where $z = 2D/\mu \sin \pi\mu t_0$.

The equation for the resultant voltage becomes

$$\begin{aligned} e_1 + e_2 &= \sqrt{E_1^2 + E_2^2 + 2E_1E_2 \cos \{z \cos(2\pi\mu t - \pi\mu t_0) + \omega t_0\}} \\ &\quad \sin \left[\omega t + \frac{D}{\mu} \sin 2\pi\mu t - \tan^{-1} \frac{x \sin \{z \cos(2\pi\mu t - \pi\mu t_0) + \omega t_0\}}{1 + x \cos \{z \cos(2\pi\mu t - \pi\mu t_0) + \omega t_0\}} \right] \end{aligned} \tag{22}$$

The amplitude term of this expression shows the variation of the resultant carrier amplitude, and the argument of the sine function gives the frequency modulation and resulting distortion. When the signal goes through a perfect limiter the amplitude term is suppressed, and the argument of the sine term is effective at the discriminator.

Calculation of Audio Output

The output from the discriminator is proportional to the instantaneous frequency, where the instantaneous frequency⁹ is defined by

⁹ J. R. Carson, "Notes on the theory of modulation," PROC. I.R.E., vol. 10, pp. 57-64; February, 1922.

$$f = \frac{1}{2\pi} \frac{d}{dt} (\text{argument of sine function})$$

$$= \frac{1}{2\pi} \frac{d}{dt} \left[\omega t + \frac{D}{\mu} \sin 2\pi\mu t - \tan^{-1} \frac{x \sin \{z \cos (2\pi\mu t - \pi\mu t_0) + \omega t_0\}}{1 + x \cos \{z \cos (2\pi\mu t - \pi\mu t_0) + \omega t_0\}} \right]$$

Since and

$$\frac{d}{dx} \tan^{-1} u = \frac{1}{1+u^2} \frac{du}{dx}$$

$$\frac{d}{dx} \left(\frac{u}{v} \right) = \frac{v \frac{du}{dx} - u \frac{dv}{dx}}{v^2}$$

the derivative can be simplified to give

$$f = \frac{\omega}{2\pi} + D \cos 2\pi\mu t + \frac{2D \sin \pi\mu t_0 \sin (2\pi\mu t - \pi\mu t_0)}{1/x + \cos \{z \cos (2\pi\mu t - \pi\mu t_0) + \omega t_0\}} \cdot (23)$$

$$\frac{x + \cos \{z \cos (2\pi\mu t - \pi\mu t_0) + \omega t_0\}}{x + \cos \{z \cos (2\pi\mu t - \pi\mu t_0) + \omega t_0\}} + 1$$

A balanced discriminator is operated so there is no output at the unmodulated carrier frequency ω , and the output is proportional to the deviation from this frequency. The audio output is therefore proportional to the second and third terms of (23). The third term represents the distortion, and it can be serious.

APPENDIX II

FOURIER SERIES ANALYSIS OF DISTORTED AUDIO OUTPUT

The third term of (23) of Appendix I represents the distortion in the audio output from the discriminator. It was obtained by differentiation of the argument of the sine function of (22). Consider this term

$$\frac{d}{dt} \tan^{-1} \frac{x \sin \{z \cos (2\pi\mu t - \pi\mu t_0) + \omega t_0\}}{1 + x \cos \{z \cos (2\pi\mu t - \pi\mu t_0) + \omega t_0\}}$$

$$= \frac{d}{dt} \tan^{-1} \frac{x \sin \theta}{1 + x \cos \theta} \quad (24)$$

where $\theta = z \cos (2\pi\mu t - \pi\mu t_0) + \omega t_0$.

Let $\alpha = \tan^{-1} \frac{x \sin \theta}{1 + x \cos \theta} \quad (25)$

so $\tan \alpha = \frac{x \sin \theta}{1 + x \cos \theta}$.

From Fig. 25

$$k \sin \alpha = x \sin \theta \quad (26)$$

$$k \cos \alpha = 1 + x \cos \theta \quad (27)$$

where

$$k = \sqrt{(1 + x \cos \theta)^2 + (x \sin \theta)^2}$$

$$= \sqrt{1 + x^2 + 2x \cos \theta} \quad (28)$$

Multiply (26) by i and add (27).

$$1 + x \cos \theta + ix \sin \theta = k(\cos \alpha + i \sin \alpha).$$

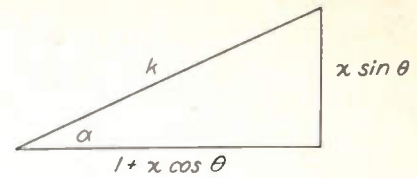

Fig. 25—Determination of k .

Change these complex numbers to the exponential form,

$$1 + xe^{i\theta} = ke^{i\alpha} \quad (29)$$

and take logarithms of both sides,

$$\log (1 + xe^{i\theta}) = \log k + i\alpha. \quad (30)$$

Expand this in a power series by the well-known relation

$$\log (1+x) = x - \frac{x^2}{2} + \frac{x^3}{3} - \frac{x^4}{4} + \dots \quad -1 < x \leq 1 \quad (31)$$

so

$$\log (1 + xe^{i\theta}) = xe^{i\theta} - \frac{x^2}{2} e^{2i\theta} + \frac{x^3}{3} e^{3i\theta} - \frac{x^4}{4} e^{4i\theta} + \dots$$

$$= x(\cos \theta + i \sin \theta) - \frac{x^2}{2} (\cos 2\theta + i \sin 2\theta)$$

$$+ \frac{x^3}{3} (\cos 3\theta + i \sin 3\theta)$$

$$- \frac{x^4}{4} (\cos 4\theta + i \sin 4\theta) + \dots \quad (32)$$

Equate the imaginary terms of (32), and use (30).

$$\alpha = x \sin \theta - \frac{x^2}{2} \sin 2\theta + \frac{x^3}{3} \sin 3\theta - \frac{x^4}{4} \sin 4\theta + \dots \quad (33)$$

Differentiate this expression with respect to time,

$$\frac{d\alpha}{dt} = (x \cos \theta - x^2 \cos 2\theta + x^3 \cos 3\theta - x^4 \cos 4\theta + \dots) \frac{d\theta}{dt}$$

$$= 2\pi\mu z \sum_{n=1}^{\infty} (-x)^n \sin (2\pi\mu t - \pi\mu t_0)$$

$$\cos \{nz \cos (2\pi\mu t - \pi\mu t_0) + n\omega t_0\}. \quad (34)$$

Two lemmas will now be proved.

Lemma α

$$e^{ix \cos \theta} = \sum_{k=-\infty}^{\infty} i^k J_k(x) e^{ik\theta}.$$

Two expansions in series of Bessel coefficients due to Jacobi¹⁰ are

$$\cos (x \cos \theta) = J_0(x) + 2 \sum_{n=1}^{\infty} (-1)^n J_{2n}(x) \cos 2n\theta$$

$$\text{and } \sin (x \cos \theta) = 2 \sum_{n=0}^{\infty} (-1)^n J_{2n+1}(x) \cos (2n + 1)\theta.$$

¹⁰ G. N. Watson, "A treatise on the theory of Bessel functions," The Macmillan Company, New York, N. Y., Second edition, 1944, p. 22.

Multiply the second equation by i and add the first equation. Change the cosine terms to the complex form. This gives

$$\begin{aligned} & \cos(x \cos \theta) + i \sin(x \cos \theta) \\ &= J_0(x) + \sum_{n=1}^{\infty} (-1)^n J_{2n}(x) e^{2in\theta} + \sum_{n=1}^{\infty} (-1)^n J_{2n}(x) e^{-2in\theta} \\ &+ i \sum_{n=0}^{\infty} (-1)^n J_{2n+1}(x) e^{(2n+1)i\theta} \\ &+ i \sum_{n=0}^{\infty} (-1)^n J_{2n+1}(x) e^{-(2n+1)i\theta}. \end{aligned}$$

Since $(-1)^n = i^{2n} = i^{-2n}$ and $J_n(x) = (-1)^n J_{-n}(x)$, this proves the lemma.

Lemma β

$$\begin{aligned} & \sin \theta \cos(a \cos \theta + b) \\ &= 2 \cos b \sum_{m=0}^{\infty} (-1)^m \frac{2m+1}{a} J_{2m+1}(a) \sin(2m+1)\theta \\ &+ 2 \sin b \sum_{m=1}^{\infty} (-1)^m \frac{2m}{a} J_{2m}(a) \sin 2m\theta. \end{aligned}$$

In complex form, using lemma α ,

$$\begin{aligned} & \sin \theta \cos(a \cos \theta + b) \\ &= \frac{1}{4i} \{ e^{i\theta} - e^{-i\theta} \} \{ e^{i(a \cos \theta + b)} + e^{-i(a \cos \theta + b)} \} \\ &= \frac{1}{4i} \left\{ e^{i(\theta+b)} \sum_{k=-\infty}^{\infty} i^k J_k(a) e^{ik\theta} + e^{i(\theta-b)} \sum_{k=-\infty}^{\infty} (-i)^k J_k(a) e^{ik\theta} \right. \\ &\quad \left. - e^{-i(\theta+b)} \sum_{k=-\infty}^{\infty} i^k J_k(a) e^{ik\theta} - e^{-i(\theta-b)} \sum_{k=-\infty}^{\infty} (-i)^k J_k(a) e^{ik\theta} \right\} \\ &= \frac{1}{4i} \left\{ \sum_{k=-\infty}^{\infty} i^k J_k(a) [e^{i(k+1)\theta+ib} - e^{i(k-1)\theta+ib}] \right. \\ &\quad \left. + \sum_{k=-\infty}^{\infty} (-i)^k J_k(a) [e^{i(k+1)\theta-ib} - e^{i(k-1)\theta-ib}] \right\} \\ &= \frac{1}{4i} \sum_{k=-\infty}^{\infty} \{ i^{k-1} J_{k-1}(a) e^{i(k\theta+b)} - i^{k+1} J_{k+1}(a) e^{i(k\theta+b)} \} \\ &\quad + \{ (-i)^{k-1} J_{k-1}(a) e^{i(k\theta-b)} - (-i)^{k+1} J_{k+1}(a) e^{i(k\theta-b)} \} \\ &= -\frac{1}{4} \sum_{k=-\infty}^{\infty} \{ J_{k-1}(a) + J_{k+1}(a) \} \{ i^k e^{i(k\theta+b)} - (-i)^k e^{i(k\theta-b)} \} \\ &= -\frac{1}{2} \sum_{k=-\infty}^{\infty} i^k \frac{k}{a} J_k(a) \{ e^{i(k\theta+b)} - (-1)^k e^{i(k\theta-b)} \} \\ &= -\frac{1}{2} \sum_{k=1}^{\infty} \frac{k}{a} i^k J_k(a) \{ e^{i(k\theta+b)} + (-1)^k e^{-i(k\theta+b)} \} \\ &\quad - (-1)^k e^{i(k\theta-b)} - e^{-i(k\theta-b)} \} \end{aligned}$$

$$\begin{aligned} &= \sum_{m=0}^{\infty} (-1)^m \frac{2m+1}{a} J_{2m+1}(a) \{ \sin [(2m+1)\theta+b] \\ &\quad + \sin [(2m+1)\theta-b] \} \\ &- \sum_{m=1}^{\infty} (-1)^m \frac{2m}{a} J_{2m}(a) \{ \cos(2m\theta+b) - \cos(2m\theta-b) \}. \end{aligned}$$

The identities

$$\sin(x+y) + \sin(x-y) = 2 \sin x \cos y$$

$$\text{and } \cos(x+y) - \cos(x-y) = -2 \sin x \sin y$$

prove the lemma.

An application of lemma β to (34) gives the relation

$$\begin{aligned} \frac{d\alpha}{dt} &= 2\pi\mu z \sum_{n=1}^{\infty} (-x)^n \\ &\left\{ \cos n\omega t_0 \sum_{m=0}^{\infty} (-1)^m \frac{2(2m+1)}{nz} J_{2m+1}(nz) \sin(2m+1)\gamma \right. \\ &\quad \left. + \sin n\omega t_0 \sum_{m=1}^{\infty} (-1)^m \frac{2(2m)}{nz} J_{2m}(nz) \sin 2m\gamma \right\} \\ &= 2\pi\mu \sum_{n=1}^{\infty} \sum_{m=0}^{\infty} (-1)^m (-x)^n \\ &\quad \frac{\cos n\omega t_0}{n} 2(2m+1) J_{2m+1}(nz) \sin(2m+1)\gamma \\ &+ 2\pi\mu \sum_{n=1}^{\infty} \sum_{m=1}^{\infty} (-1)^m (-x)^n \\ &\quad \frac{\sin n\omega t_0}{n} 2(2m) J_{2m}(nz) \sin 2m\gamma \quad (35) \end{aligned}$$

where $\gamma = 2\pi\mu t - \pi\mu t_0$. The audio output from the discriminator is therefore proportional to

$$\text{output} \propto D \cos 2\pi\mu t$$

$$\begin{aligned} &-2\mu \sum_{n=0}^{\infty} (2n+1) (-1)^n C(2n+1, z; x, \omega t_0) \sin(2n+1)\gamma \\ &-2\mu \sum_{n=1}^{\infty} (2n) (-1)^n S(2n, z; x, \omega t_0) \sin 2n\gamma \quad (36) \end{aligned}$$

where the C and S functions are defined as follows:

$$\begin{aligned} C(m, n; x, \theta) &= \sum_{s=1}^{\infty} \frac{(-x)^s}{s} J_m(ns) \cos s\theta \\ S(m, n; x, \theta) &= \sum_{s=1}^{\infty} \frac{(-x)^s}{s} J_m(ns) \sin s\theta. \end{aligned}$$

The graphs of Figs. 14, 15, 16, and 17 show how these functions vary for the particular values of the parameters which were chosen. Other graphs of the functions can be plotted by using tables of Bessel functions¹¹ which were prepared for this purpose.

¹¹ Murlan S. Corrington and William Miehle, "Tables of Bessel functions $J_n(x)$ for large arguments," *Jour. Math. and Phys.* (M.I.T.), vol. 24, pp. 30-50; February, 1945.

Symmetrical Antenna Arrays*

CHARLES W. HARRISON, JR.†, MEMBER, I.R.E.

Summary—A relatively simple method is presented for calculating the impedance properties of antenna arrays consisting of n identical radiators oriented at the vertices of regular polygons. All antennas are required to carry currents of equal magnitude, but not necessarily of the same phase. However, the choice of phase angle must be such that the required electrical symmetry of the array is unimpaired.

The case of a circular array with a central radiator is discussed.

Immediate practical applications of the theory include:

(a) Determination of the driving-point impedance of the primary radiator in a corner-reflector antenna.

(b) Calculation of the power lost through radiation, or conversely the signal pickup, of certain multiple-wire transmission lines, when operated in a resonant condition.

(c) Analyses of problems involving symmetrically disposed fixed antennas for direction-finding purposes.

(d) Ascertaining the effectiveness of circular arrays for transmission.

Several numerical illustrations of the theory are given.

GENERAL THEORY OF SYMMETRICAL ANTENNA ARRAYS

CONSIDER an array consisting of five identical antennas symmetrically disposed on the circumference of a circle, as shown in Fig. 1. Each antenna is of half-length h and radius a . The origin for co-ordinates ($z=0$) is the meridian plane of the array. Let it be assumed that the antennas are driven by identical generators maintaining the flow of equal currents. These currents may differ in phase by an appropriate angle. By direct analogy with antenna theory previously formulated,¹⁻⁵ the distribution of current along antenna (1), for example, is given by

$$I_z = -\frac{j4\pi}{\Omega R_c} \left\{ C_1 \cos \beta z + \frac{1}{2} V_0^e \sin \beta |z| \right\}$$

* Decimal classification: R125. Original manuscript received by the Institute, May 18, 1945.

† U. S. Navy Office, Evans Signal Laboratory, Belmar, N. J.

¹ Ronold King and Charles W. Harrison, Jr., "Mutual and self-impedance for coupled antennas," *Jour. Appl. Phys.*, vol. 15, pp. 481-495; June, 1944.

² Charles W. Harrison, Jr., "Mutual and self-impedance for collinear antennas," *Proc. I.R.E.*, vol. 33, pp. 398-408; June, 1945. The following corrections should be made in this paper: The universal magnetic constant of space II, as defined by (7), should appear in lieu of π in the numerators of (20), (23), (63), (64), and (65). In the latter equation, II occurs twice.

In (13), $z \rightarrow l/2$. The denominator of the first bracketed term of (52) should read $\Omega R_c \cos(\beta l/2)$. Similarly, parenthesis should be used about each factor $1/2$ appearing in (60b) and (62). The negative sign should be removed before jA_1^{II} in (73). Concerning the several tables that appear on page 404: The heading for the first one is $h = \lambda/4$; $\Omega = 10$; ($h/a = 75$). For the second table, the heading is $h = \lambda/2$; $\Omega = 10$; ($h/a = 75$).

In line 12 from the bottom of page 400, right-hand column, $z_1 = 0$.

³ Charles W. Harrison, Jr., "On the calculation of the impedance properties of parasitic antennas array involving elements of finite radius," *Jour. Amer. Soc. Naval Eng.*, vol. 57, pp. 224-239; May, 1945, and p. 435; August, 1945.

⁴ Charles W. Harrison, Jr., "On the distribution of current along asymmetrical antennas," *Jour. Appl. Phys.*, vol. 16, pp. 402-408; July, 1945.

⁵ Charles W. Harrison, Jr., "A theory for three-element broadside arrays," to be published.

$$\begin{aligned} & -\frac{1}{\Omega} \left\{ I_z \ln \left(1 - \frac{z^2}{h^2} \right) + I_z \delta + \int_{-h}^{+h} \frac{I_z' e^{-j\beta r_{11}} - I_z}{r_{11}} dz' \right\} \\ & -\frac{1}{\Omega} \left\{ e^{-j\theta_{12}} \int_{-h}^{+h} \frac{I_z' e^{-j\beta r_{12}}}{r_{12}} dz' + e^{-j\theta_{13}} \int_{-h}^{+h} \frac{I_z' e^{-j\beta r_{13}}}{r_{13}} dz' \right. \\ & \left. + e^{-j\theta_{14}} \int_{-h}^{+h} \frac{I_z' e^{-j\beta r_{14}}}{r_{14}} dz' \right. \\ & \left. + e^{-j\theta_{15}} \int_{-h}^{+h} \frac{I_z' e^{-j\beta r_{15}}}{r_{15}} dz' \right\}. \end{aligned} \quad (1)$$

The following notation is used:

$$\Omega = 2 \ln \frac{2h}{a} \quad (2)$$

R_c is the intrinsic resistance of free space.

$$R_c = 376.7 \approx 120\pi \text{ ohms.} \quad (3)$$

C_1 is an arbitrary constant, to be evaluated from the boundary condition

$$I_h = 0, \quad (z = \pm h).$$

V_0^e is the voltage applied across the input terminals of any radiator.

$$\beta = \frac{2\pi}{\lambda}, \quad (\lambda \text{ is the wavelength}). \quad (4)$$

$$\delta = \ln \left\{ \frac{1}{4} \left[\sqrt{1 + \left(\frac{a}{h-z} \right)^2} + 1 \right] \cdot \left[\sqrt{1 + \left(\frac{a}{h+z} \right)^2} + 1 \right] \right\}. \quad (5)$$

$$r_{11} = \sqrt{(z-z')^2 + a^2} \approx |z-z'|. \quad (6)$$

θ_{1k} ($k=2, 3, 4,$ and 5) is the phase of the current in antenna k referred to the current in antenna (1).

$$r_{1k} = \sqrt{(z-z')^2 + b_{1k}^2}. \quad (7)$$

In (7), b_{1k} is the distance (taken in the meridian plane) between the center of antenna (1) and the center of antenna k .

Clearly, one may write
 {Last four integrals in (1)}

$$= \sum_{k=2}^{k=n} e^{-j\theta_{1k}} \int_{-h}^{+h} \frac{I_z' e^{-j\beta r_{1k}}}{r_{1k}} dz'. \quad (8)$$

Here n is the number of antennas in the array—five in the present case.

Thus, the current in antenna (1) of an n -element symmetrical array becomes

$$\begin{aligned} I_z = & -\frac{j4\pi}{\Omega R_c} \left\{ C_1 \cos \beta z + \frac{1}{2} V_0^e \sin \beta |z| \right\} \\ & -\frac{1}{\Omega} \left\{ I_z \ln \left(1 - \frac{z^2}{h^2} \right) + I_z \delta \right. \\ & \left. + \int_{-h}^{+h} \frac{I_z' e^{-j\beta r_{11}} - I_z}{r_{11}} dz' \right\} \\ & -\frac{1}{\Omega} \sum_{k=2}^{k=n} e^{-j\theta_{1k}} \int_{-h}^{+h} \frac{I_z' e^{-j\beta r_{1k}}}{r_{1k}} dz'. \end{aligned} \quad (9)$$

In solving this equation, a process of iteration is used. For instance, the expression⁶

$$(I_z)_o = -\frac{j4\pi}{\Omega R_c} \{C_1 \cos \beta z + \frac{1}{2} V_o \sin \beta |z|\} \quad (10)$$

is conveniently selected as the zeroth-order approximation for the distribution of current along antenna (1), and this is substituted in the integrals when computing a first-order correction to the current. This procedure may be extended indefinitely, thus building up a series expansion for the current. Convergence of this series is assumed. In the present paper, only two terms in the expansion will be retained, as experience in analyzing numerically other antenna types proves this procedure to be satisfactory.

The current I_o , flowing at the input terminals of antenna (1) may be obtained from (9) by writing $z=0$ throughout. Thus,

$$I_o = -\frac{j4\pi}{\Omega R_c} \{C_1\} - \frac{1}{\Omega} \int_{-h}^{+h} \frac{I_z' e^{-j\beta l_{11}} - I_o}{l_{11}} dz' - \frac{1}{\Omega} \sum_{k=2}^{k=n} e^{-j\theta_{1k}} \int_{-h}^{+h} \frac{I_z' e^{-j\beta l_{1k}}}{l_{1k}} dz'. \quad (11)$$

The current $I_h=0$ for $z=\pm h$. For this condition (9) becomes

$$0 = -\frac{j4\pi}{\Omega R_c} \{C_1 \cos \beta h + \frac{1}{2} V_o \sin \beta h\} - \frac{1}{\Omega} \int_{-h}^{+h} I_z' \frac{e^{-j\beta d_{11}}}{d_{11}} dz' - \frac{1}{\Omega} \sum_{k=2}^{k=n} e^{-j\theta_{1k}} \int_{-h}^{+h} I_z' \frac{e^{-j\beta d_{1k}}}{d_{1k}} dz'. \quad (12)$$

The notation

$$l_{11} = \sqrt{(z')^2 + a^2} \approx |z'| \quad (13)$$

$$l_{1k} = \sqrt{(z')^2 + b_{1k}^2} \quad (14)$$

$$d_{11} = \sqrt{(h-z')^2 + a^2} \approx |h-z'| \quad (15)$$

$$d_{1k} = \sqrt{(h-z')^2 + b_{1k}^2} \quad (16)$$

is used in (11) and (12).

Let the following shorthand be adopted:

$$F_1(o) \approx -\int_{-h}^{+h} \frac{\cos \beta u e^{-j\beta |u|} - 1}{|u|} du \quad (17)$$

$$F_1(h) \approx -\int_{-h}^{+h} \cos \beta u \frac{e^{-j\beta |h-u|}}{|h-u|} du \quad (18)$$

⁶ The limitations of selecting (10) as the leading term in the antenna-current distribution are discussed in footnote reference 5. Readers should see these comments before applying the present theory to the solution of numerical problems.

The integral equation in the current for a symmetrical center-driven antenna is obtained from (9) by dropping the term involving a summation of integrals. If (10) is used in solving this equation, a limited investigation reveals that impedance values tend to be somewhat low for antennas operated in the vicinity of resonance, and high for antennas operated near antiresonance. The choice of (10) to represent the zeroth-order approximation for the current distribution, in lieu of the analytically superior form used in certain other papers, is admittedly an attempt to shorten the analysis at the expense of a some reduction in accuracy.

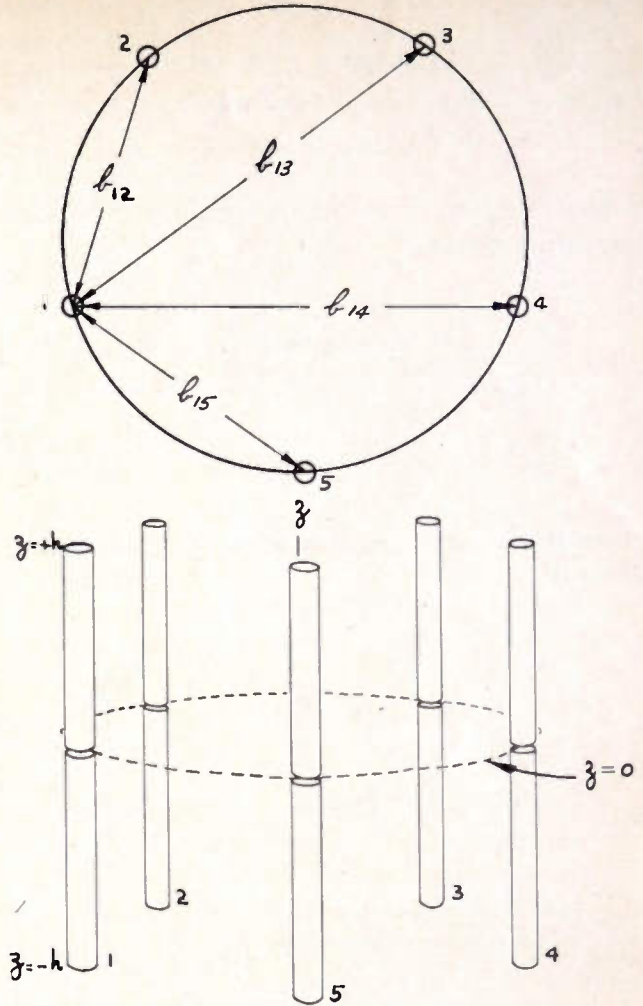

Fig. 1—Five-element circular array. All antennas have identical dimensions. They must be driven such that electrical symmetry obtains for the present theory to apply.

$$G_1(o) \approx -\int_{-h}^{+h} \sin \beta |u| \frac{e^{-j\beta |u|}}{|u|} du \quad (19)$$

$$G_1(h) \approx -\int_{-h}^{+h} \sin \beta |u| \frac{e^{-j\beta |h-u|}}{|h-u|} du \quad (20)$$

$$P_{1n}(o) = -\sum_{k=2}^{k=n} e^{-j\theta_{1k}} \int_{-h}^{+h} \cos \beta u \frac{e^{-j\beta \sqrt{u^2 + b_{1k}^2}}}{\sqrt{u^2 + b_{1k}^2}} du \quad (21)$$

$$P_{1n}(h) = -\sum_{k=2}^{k=n} e^{-j\theta_{1k}} \int_{-h}^{+h} \cos \beta u \frac{e^{-j\beta \sqrt{(h-u)^2 + b_{1k}^2}}}{\sqrt{(h-u)^2 + b_{1k}^2}} du \quad (22)$$

$$Q_{1n}(o) = -\sum_{k=2}^{k=n} e^{-j\theta_{1k}} \int_{-h}^{+h} \sin \beta |u| \frac{e^{-j\beta \sqrt{u^2 + b_{1k}^2}}}{\sqrt{u^2 + b_{1k}^2}} du \quad (23)$$

$$Q_{1n}(h) = -\sum_{k=2}^{k=n} e^{-j\theta_{1k}} \int_{-h}^{+h} \sin \beta |u| \frac{e^{-j\beta \sqrt{(h-u)^2 + b_{1k}^2}}}{\sqrt{(h-u)^2 + b_{1k}^2}} du. \quad (24)$$

(Values for the above integrals are listed in Appendix I.)

Returning now to (11) and (12), and making use of (17) to (24), one obtains

$$I_o = -\frac{j4\pi}{\Omega R_c} \left\{ C_1 \left\{ 1 + \frac{1}{\Omega} (F_1(o) + P_{1n}(o)) \right\} + \frac{1}{2} V_o \frac{1}{\Omega} \{ G_1(o) + Q_{1n}(o) \} \right\} \quad (25)$$

and

$$C_1 = -\frac{1}{2} V_o \left\{ \frac{\sin \beta h + \frac{1}{\Omega} (G_1(h) + Q_{1n}(h))}{\cos \beta h + \frac{1}{\Omega} (F_1(h) + P_{1n}(h))} \right\}. \quad (26)$$

Substituting the value of C_1 from (26) into (25), and neglecting terms in $1/\Omega^2$,

$$I_o = \frac{j2\pi V_o}{\Omega R_o} \left\{ \frac{\sin \beta h + \frac{1}{\Omega} \{ \sin \beta h (F_1(o) + P_{1n}(o)) - \cos \beta h (G_1(o) + Q_{1n}(o)) + G_1(h) + Q_{1n}(h) \}}{\cos \beta h + \frac{1}{\Omega} \{ F_1(h) + P_{1n}(h) \}} \right\}. \quad (27)$$

Since the input impedance Z_o of any antenna in the array is

$$Z_o = V_o / I_o. \quad (28)$$

$$Z_o = -j60\Omega \left\{ \frac{\cos \beta h + \frac{1}{\Omega} \{ F_1(h) + P_{1n}(h) \}}{\sin \beta h + \frac{1}{\Omega} \{ \sin \beta h (F_1(o) + P_{1n}(o)) - \cos \beta h (G_1(o) + Q_{1n}(o)) + G_1(h) + Q_{1n}(h) \}} \right\}. \quad (29)$$

Equation (29), together with values for $F_1(o)$, $F_1(h)$, etc., computed from (30) to (37), enables one to make a complete study of the impedance characteristics of an n -element symmetrical array. To obtain the impedance of base-driven vertical antennas of full length h located over a perfectly conducting plane earth, divide (29) by 2.

As a numerical illustration, assume that the array portrayed in Fig. 1 is to be analyzed. Let the following description apply: $h = \lambda/2$, $\Omega = 20$, ($h/a \approx 11.013$), $b_{12} (= b_{13}) = \lambda/2$, $\theta_{1k} = 0$ degrees (all antennas are driven in phase). The object is to find the input impedance Z_o of antenna (1).

Since $n = 5$, $b_{13} (= b_{14}) = 0.8090\lambda$. From (31) to (37) one obtains

$$\begin{aligned} F_1(h) &= -1.557 - j0.7461 \\ G_1(o) &= -1.418 + j2.438 \\ G_1(h) &= -0.6720 + j0.8810 \\ P_{1n}(h) &= -0.4868 - j0.8692 \\ Q_{1n}(o) &= 1.122 - j2.012 \\ Q_{1n}(h) &= -0.3310 - j1.073. \end{aligned}$$

Substituting these values in (29)

$$Z_o = 4,998 - j19,465 \text{ ohms.}$$

This result, if collaborated by further evidence computed for different values of h and b_{12} , suggests that one property of circular arrays is high driving-point reactance, especially when electrically short radiators are used. If this is true, one would obviously not attempt to

use such an array for long-wave transmission (where physical limitations preclude the use of electrically long antennas) because of the inherently high base voltage encountered for modest radiated powers.

If antennas numbered (2) to (5) are moved into the far zone with respect to antenna (1), so that coupling may be considered negligible, the input impedance of antenna (1), as computed from the present theory,⁶ is

$$Z_{oo} = 5703 - j3320 \text{ ohms.}$$

The theory of symmetrical arrays is of use in analyzing certain multiple-wire transmission lines for radiation

loss.⁷ The present method of solution is more rigorous than methods based on "assumed currents."

Corner-Reflector Antennas^{8,9}

A fundamental problem involved in the design of a corner-reflector antenna is the determination of the driving-point impedance of the primary radiator. Subject to certain approximations, this impedance may be calculated by the method of the previous section, provided the corner angle is π/n radians, where n is any positive integer.

Fig. 2 illustrates a corner-reflector antenna, while Fig. 3 shows the image orientation for several corner angles. The currents in the radiators denoted by $+$ are oppositely directed from those represented by o .

For the theory of symmetrical arrays to apply rigorously, one must assume that the reflecting plates are perfectly conducting and infinite in extent. If the reflectors are constructed of copper or other metal of low resistivity, practically no power will be consumed in heat. Thus the assumption of zero surface impedance is an excellent approximation. Practical experience proves that reflectors having dimensions of several wavelengths on a side may be regarded as "infinite" when one is concerned with the calculation of the terminal impedance of the exciting antenna.

⁷ Charles W. Harrison, Jr., "On the pickup of balanced four-wire lines." *PROC. I.R.E.*, vol. 30, pp. 517-518; November, 1942.

⁸ J. D. Kraus, "The corner reflector antenna," *PROC. I.R.E.*, vol. 28, pp. 513-519; November, 1940.

⁹ S. Ramo and J. R. Whinnery, "Fields and Waves in Modern Radio," John Wiley and Son, New York, N. Y., 1944, p. 145.

As a numerical example of the theory of symmetrical arrays applied to corner-reflector antennas, consider the following system:

Corner angle = 90 degrees.

Primary radiator description: $h = \frac{\lambda}{4}$, $\Omega = 20$.

$D = 0.3535\lambda$. The object is to find Z_o .

Referring to Fig. (3), clearly

$$b_{12} \{ = b_{14} \} = \frac{\lambda}{2}$$

$$b_{13} = 0.7071\lambda$$

$$\theta_{12} = \pi \text{ radians.}$$

$$\theta_{13} = 2\pi \text{ radians.}$$

$$\theta_{14} = 3\pi \text{ radians.}$$

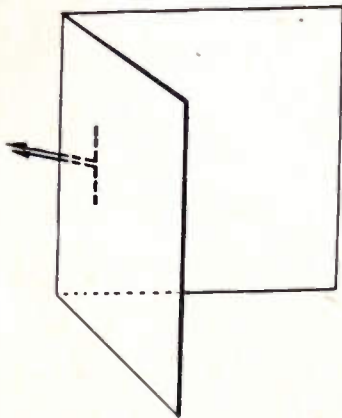

Fig. 2—A representative corner-reflector antenna.

For this case (30) to (37) give

$$F_1(o) = 1.648 + j1.852$$

$$F_1(h) = -0.7090 + j1.219$$

$$G_1(h) = 1.815 + j1.143$$

$$P_{1n}(o) = -1.142 - j0.3457$$

$$P_{1n}(h) = -1.011 + j0.0073$$

$$Q_{1n}(h) = -0.9425 + j0.0326.$$

Substituting these values in (29),

$$Z_o = 79.67 + j86.51 \text{ ohms.}$$

(If the reflecting plates are removed, the self-impedance of the antenna⁶ is $Z_{oo} = 65.92 + j27.86$ ohms.)

The bandwidth of a corner-reflector antenna of fixed dimensions devolves into a study of (29) for appropriate increments in λ .

SYMMETRICAL ARRAY WITH CENTRAL ANTENNA

An interesting modification of the symmetrical array discussed earlier in the paper is achieved by the addition of a central radiator. Several such antenna systems are pictured in Fig. 4. The outer antennas, which lie equally spaced on the circumference of a circle, are identical. Normally they are required to carry currents of equal

amplitude and phase. The dimensions of the central antenna need not correspond to those in the outer ring, and further, no restriction need be placed on the amplitude or phase of the current flowing therein.

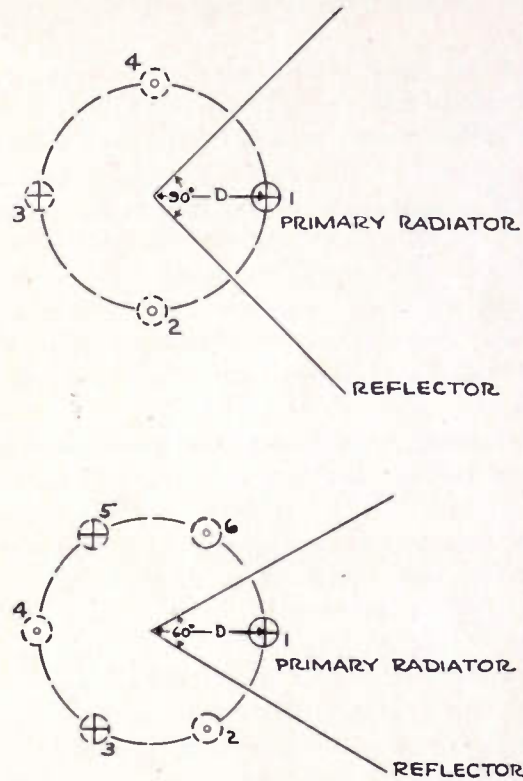

Fig. 3—Corner-reflector antenna showing image configuration for a 90-degree corner, and for a 60-degree corner.

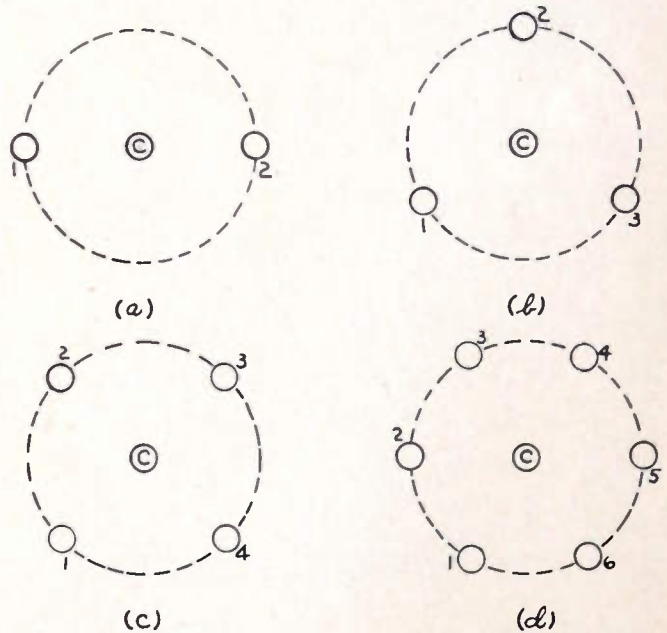

Fig. 4—Some symmetrical arrays with central radiators.

If the vector relationship between the applied voltages is known, one may determine the terminal impedance of any antenna in the array. Conversely, if the complex ratio of the driving-point currents is specified, the required geometrical relationship between the applied voltages is available. Suffice it to say, the solution of this problem is somewhat more involved than a quantitative

discussion of symmetrical arrays, as two arbitrary constants, instead of one, must be determined.⁶ One of these constants is associated with the distribution of current along the central radiator; the other is intrinsic in the expression for the current along any antenna in the outer ring.

Readers interested in analyzing a symmetrical array with central radiator may do so by synthesizing the first part of the present paper with the discussion previously presented.⁶ In this paper, the array depicted in Fig. 4(a) is considered in detail. It is of interest to observe that, in lieu of an antenna at the geometrical center of a circular array, one may interpose another symmetrical array, and thus create two concentric rings of antennas. The increase in complexity of analysis is slight, provided symmetry obtains, both physical and electrical.

In conclusion, the writer wishes to mention an application of symmetrical-array theory to certain types of fixed antenna direction finders.¹⁰ Such systems often consist of four antennas located at the corners of a square, with a fifth antenna erected at the geometrical center. One might be interested in calculating the input impedance of the central antenna, for equal load impedances connected across the terminals of the other antennas. This problem presents no great difficulties. The procedure is to regard the outer antennas as loaded parasites; i.e., a voltage $V_o = -I_o Z_L$ is applied to each, where Z_L is the complex load impedance. One then solves for the current at the center of the fifth antenna. The applied voltage, divided by this current, gives the required input impedance.

APPENDIX I

The integrals (17) to (24) have the following values:

$$F_1(o) \approx \overline{\text{Ci}} 2\beta h + j \text{Si } 2\beta h \quad (30)$$

$$F_1(h) \approx \frac{1}{2} \cos \beta h \{ \overline{\text{Ci}} 4\beta h + j \text{Si } 4\beta h \} \\ - \frac{1}{2} \sin \beta h \{ \text{Si } 4\beta h - j \overline{\text{Ci}} 4\beta h \} \quad (31)$$

$$G_1(o) \approx -\text{Si } 2\beta h + j \overline{\text{Ci}} 2\beta h \quad (32)$$

$$G_1(h) \approx -\frac{1}{2} \cos \beta h \{ \text{Si } 4\beta h - 2 \text{Si } 2\beta h \} \\ - j \overline{\text{Ci}} 4\beta h + j 2 \overline{\text{Ci}} 2\beta h \} \\ - \frac{1}{2} \sin \beta h \{ \overline{\text{Ci}} 4\beta h + j \text{Si } 4\beta h - j 2 \text{Si } 2\beta h \} \\ - 2 \overline{\text{Ci}} 2\beta h - 4 \ln 2 \} \quad (33)$$

¹⁰ T. J. Keary, "Angles of Arrival of Radio Waves," Research Library of Physics, Harvard University, Cambridge, Mass., 1941.

$$P_{1n}(o) = \sum_{k=2}^{k=n} e^{-j\theta_{1k}} \{ -\text{Ci } \beta(x_{1k} + h) + \text{Ci } \beta(x_{1k} - h) \\ - j \text{Si } \beta(x_{1k} - h) + j \text{Si } \beta(x_{1k} + h) \} \quad (34)$$

$$P_{1n}(h) = \sum_{k=2}^{k=n} e^{-j\theta_{1k}} \{ -\frac{1}{2} \cos \beta h \{ \text{Ci } \beta(y_{1k} + 2h) \\ - \text{Ci } \beta(y_{1k} - 2h) - j \text{Si } \beta(y_{1k} + 2h) \\ + j \text{Si } \beta(y_{1k} - 2h) \} + j \frac{1}{2} \sin \beta h \{ 2 \text{Ci } \beta b_{1k} \\ - j 2 \text{Si } \beta b_{1k} - \text{Ci } \beta(y_{1k} - 2h) - \text{Ci } \beta(y_{1k} + 2h) \\ + j \text{Si } \beta(y_{1k} - 2h) + j \text{Si } \beta(y_{1k} + 2h) \} \} \quad (35)$$

$$Q_{1n}(o) = \sum_{k=2}^{k=n} j e^{-j\theta_{1k}} \{ 2 \text{Ci } \beta b_{1k} - j 2 \text{Si } \beta b_{1k} \\ - \text{Ci } \beta(x_{1k} + h) - \text{Ci } \beta(x_{1k} - h) \\ + j \text{Si } \beta(x_{1k} + h) + j \text{Si } \beta(x_{1k} - h) \} \quad (36)$$

$$Q_{1n}(h) = \sum_{k=2}^{k=n} \frac{j}{2} e^{-j\theta_{1k}} [e^{-j\beta h} \{ 2 \text{Ci } \beta(x_{1k} - h) \\ - j 2 \text{Si } \beta(x_{1k} - h) - \text{Ci } \beta(y_{1k} - 2h) \\ + j \text{Si } \beta(y_{1k} - 2h) - \text{Ci } \beta b_{1k} + j \text{Si } \beta b_{1k} \} \\ + e^{j\beta h} \{ 2 \text{Ci } \beta(x_{1k} + h) - j 2 \text{Si } \beta(x_{1k} + h) \\ - \text{Ci } \beta(y_{1k} + 2h) + j \text{Si } \beta(y_{1k} + 2h) \\ - \text{Ci } \beta b_{1k} + j \text{Si } \beta b_{1k} \}]. \quad (37)$$

In the above

$$\text{Ci } z = \int_{\infty}^z \frac{\cos u}{u} du \quad (38)$$

$$\text{Si } z = \int_0^z \frac{\sin u}{u} du \quad (39)$$

$$\overline{\text{Ci}} z = \int_0^z \frac{1 - \cos u}{u} du = 0.5772 + \ln z - \text{Ci } z \quad (40)$$

$$x_{1k} = \sqrt{h^2 + b_{1k}^2} \quad (41)$$

$$y_{1k} = \sqrt{(2h)^2 + b_{1k}^2} \quad (42)$$

ACKNOWLEDGMENT

Professor Ronald W. P. King, of Cruft Laboratory, Graduate School of Engineering, Harvard University, has reviewed the manuscript. The writer hopes to incorporate the material within a thesis at some future date.

General Formulas for "T"- and "Π"-Network Equivalents*

MYRIL B. REED†, ASSOCIATE, I.R.E.

Summary—This paper presents the development of two sets of general formulas which determine a set of "T" or "Π" impedances equivalent to any linear, lumped-constant, four-terminal network.

IN SPITE of the many years that the equivalence of T and Π networks has been known and used, general formulas for the T and Π equivalents of four-terminal networks are not available. Such general formulas will be developed in this paper.

Consider, first, the general voltage equations of the four-terminal network¹ indicated in Fig. 1. In matrix form these equations are

$$\begin{vmatrix} V_1 \\ -V_2 \\ 0 \\ \vdots \\ 0 \end{vmatrix} = \begin{vmatrix} Z_{11} & Z_{12} & \cdots & Z_{1n} \\ Z_{21} & Z_{22} & \cdots & Z_{2n} \\ Z_{31} & Z_{32} & \cdots & Z_{3n} \\ \vdots & \vdots & \ddots & \vdots \\ Z_{n1} & Z_{n2} & \cdots & Z_{nn} \end{vmatrix} \begin{vmatrix} I_1 \\ I_2 \\ I_3 \\ \vdots \\ I_n \end{vmatrix} \quad (1)$$

Inverting this equation leads to

$$\begin{vmatrix} I_1 \\ I_2 \\ I_3 \\ \vdots \\ I_n \end{vmatrix} = \frac{1}{D} \begin{vmatrix} d_{11} & d_{12} & \cdots & d_{1n} \\ d_{21} & d_{22} & \cdots & d_{2n} \\ d_{31} & d_{32} & \cdots & d_{3n} \\ \vdots & \vdots & \ddots & \vdots \\ d_{n1} & d_{n2} & \cdots & d_{nn} \end{vmatrix} \begin{vmatrix} V_1 \\ -V_2 \\ 0 \\ \vdots \\ 0 \end{vmatrix} \quad (2)$$

where D = the determinant of the impedance matrix
 d_{ij} = the cofactor of the j th row and i th column of D .

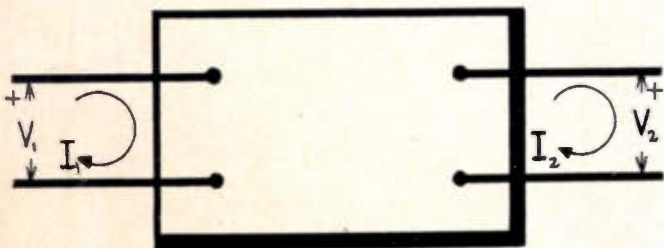

Fig. 1—General four-terminal network.

Because of the zeros appearing in the voltage matrix, the input and output currents of the four-terminal network are

$$\begin{vmatrix} I_1 \\ I_2 \end{vmatrix} = \frac{1}{D} \begin{vmatrix} d_{11} & d_{12} \\ d_{21} & d_{22} \end{vmatrix} \begin{vmatrix} V_1 \\ -V_2 \end{vmatrix} \quad (3)$$

* Decimal classification: R142. Original manuscript received by the Institute, March 20, 1945; revised manuscript received, May 9, 1945.

† Bell Telephone Laboratories, New York, N. Y., on leave of absence from Illinois Institute of Technology.

¹ E. A. Guillemin, "Communication Networks," John Wiley and Sons, New York, N. Y., 1935, Vol. 2, Chapter IV.

If, after multiplying the last of these current equations by -1 , they are viewed as the node equations²⁻⁴ of a

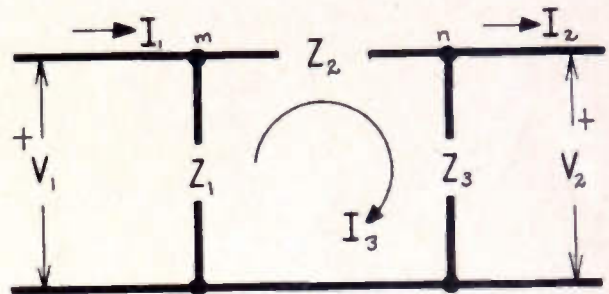

Fig. 2—General π network.

three-node network (see Fig. 2) with the low node as the reference,

$$\begin{aligned} Z_1 &= \frac{D}{d_{11} - d_{12}} \\ Z_2 &= \frac{D}{d_{12}} = \frac{D}{d_{21}} \\ Z_3 &= \frac{D}{d_{22} - d_{21}} \end{aligned} \quad (4)$$

will make I_1 and I_2 of Figs. 1 and 2 the same for the same V_1 and V_2 provided $d_{12} = d_{21}$, as is actually the case. Consequently, the impedances of (4) specify a Π network equivalent to any linear, lumped-constant, four-terminal network.

Formulas for a T equivalent to any linear, lumped-constant, four-terminal network can be established by inverting (3). Thus

$$\begin{vmatrix} V_1 \\ -V_2 \end{vmatrix} = \frac{D}{D'} \begin{vmatrix} d_{22} & -d_{21} \\ -d_{12} & d_{11} \end{vmatrix} \begin{vmatrix} I_1 \\ I_2 \end{vmatrix} \quad (5)$$

where

$$D' = \begin{vmatrix} d_{11} & d_{12} \\ d_{21} & d_{22} \end{vmatrix} \quad (6)$$

But such a determinant consisting of cofactors of another determinant can be expressed as⁵

$$D' = \begin{vmatrix} d_{11} & d_{12} \\ d_{21} & d_{22} \end{vmatrix} = D d_{22}'' \quad (7)$$

² Myril B. Reed, "Node equations," PROC. I.R.E., vol. 32, pp. 355-359; June, 1944.

³ Electrical Engineering Staff, Massachusetts Institute of Technology, "Electric Circuits," John Wiley and Sons, New York, N. Y., 1940, pp. 121-164, 391-398, 420-430.

⁴ Murray F. Gardner and John L. Barnes, "Transients in Linear Systems," John Wiley and Sons, New York, N. Y., 1942, pp. 38 *et sequens*.

⁵ M. Bocher, "Introduction to Higher Algebra," Macmillan Publishing Co., New York, N. Y., 1938, p. 33.

where d_{22}'' = the determinant left after removing the first two rows and first two columns of D .

Equation (5) thus becomes

$$\begin{vmatrix} V_1 \\ -V_2 \end{vmatrix} = \frac{1}{d_{22}''} \begin{vmatrix} d_{22} & -d_{21} \\ -d_{12} & d_{11} \end{vmatrix} \begin{vmatrix} I_1 \\ I_2 \end{vmatrix} \quad (8)$$

If this equation is considered as the two voltage equations of the T network of Fig. 3,

$$\begin{aligned} Z_a &= \frac{d_{11} - d_{12}}{d_{22}''} \\ Z_b &= \frac{d_{12}}{d_{22}''} = \frac{d_{21}}{d_{22}''} \\ Z_c &= \frac{d_{22} - d_{21}}{d_{22}''} \end{aligned} \quad (9)$$

will make I_1 and I_2 of this T network the same as I_1 and I_2 of the four-terminal network from which the cofactors

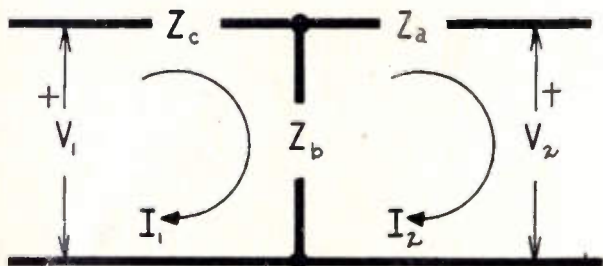

Fig. 3—General T network.

are determined if V_1 and V_2 are the same for both networks. Equations (9) accordingly determine the T network equivalent to any linear, lumped-constant, four-terminal network.

As an example of the use of the general formulas (4) and (9), the Π network equivalent to a T network can be determined from (4) as follows: The voltage equations for a T network (Fig. 3) are

$$\begin{vmatrix} V_1 \\ -V_2 \end{vmatrix} = \begin{vmatrix} Z_c + Z_b & -Z_b \\ -Z_b & Z_a + Z_b \end{vmatrix} \begin{vmatrix} I_1 \\ I_2 \end{vmatrix} \quad (10)$$

and from these equations

$$\begin{aligned} d_{11} &= Z_a + Z_b \\ d_{12} &= d_{21} = Z_b \\ d_{22} &= Z_c + Z_b \\ D &= Z_a Z_b + Z_b Z_c + Z_c Z_a. \end{aligned} \quad (11)$$

Substituting these last relations into (4) gives

$$\begin{aligned} Z_1 &= \frac{Z_a Z_b + Z_b Z_c + Z_c Z_a}{Z_a} \\ Z_2 &= \frac{Z_a Z_b + Z_b Z_c + Z_c Z_a}{Z_b} \\ Z_3 &= \frac{Z_a Z_b + Z_b Z_c + Z_c Z_a}{Z_c} \end{aligned} \quad (12)$$

which are the well-known formulas for the Π impedances equivalent to a T network.

Similarly, for the Π network of Fig. 2, the voltage equations are

$$\begin{vmatrix} V_1 \\ -V_2 \\ 0 \end{vmatrix} = \begin{vmatrix} Z_1 & 0 & -Z_1 \\ 0 & Z_3 & -Z_3 \\ -Z_1 & -Z_3 & Z_1 + Z_2 + Z_3 \end{vmatrix} \begin{vmatrix} I_1 \\ I_2 \\ I_3 \end{vmatrix} \quad (13)$$

from which, as required by (9)

$$\begin{aligned} d_{11} &= \begin{vmatrix} Z_3 & -Z_3 \\ -Z_3 & Z_1 + Z_2 + Z_3 \end{vmatrix} = Z_1 Z_3 + Z_2 Z_3 \\ d_{12} = d_{21} &= - \begin{vmatrix} 0 & -Z_1 \\ -Z_3 & Z_1 + Z_2 + Z_3 \end{vmatrix} = Z_1 Z_3 \\ d_{22} &= \begin{vmatrix} Z_1 & -Z_1 \\ -Z_1 & Z_1 + Z_2 + Z_3 \end{vmatrix} = Z_1 Z_2 + Z_1 Z_3 \\ d_{22}'' &= Z_1 + Z_2 + Z_3. \end{aligned} \quad (14)$$

Substituting these results into (9) gives

$$\begin{aligned} Z_a &= \frac{Z_2 Z_3}{Z_1 + Z_2 + Z_3} \\ Z_b &= \frac{Z_1 Z_3}{Z_1 + Z_2 + Z_3} \\ Z_c &= \frac{Z_1 Z_2}{Z_1 + Z_2 + Z_3} \end{aligned} \quad (15)$$

which are the well-known formulas for the T network equivalent to a Π network.

As a further example of the application of the general formulas (4) and (9), the Π and T equivalents of the network of Fig. 4 will be established. An examination of

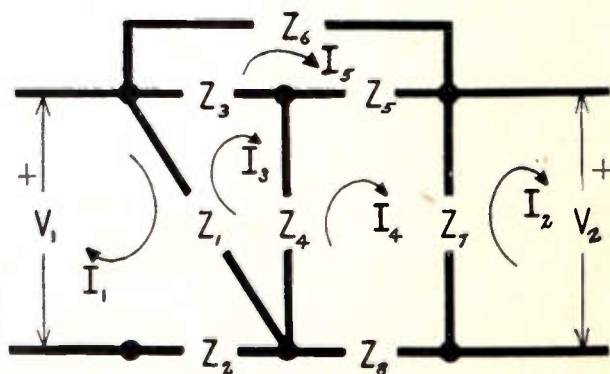

Fig. 4—Four-terminal network.

(4) and (9) shows that the determinant D , three of its cofactors d_{11} , $d_{12} = d_{21}$, and d_{22} , and the special sub-determinant d_{22}'' are required to determine these equations and so the equivalent Π and T networks.

Writing the Kirchhoff equations for the network of Fig. 4 with the variables in the order of their subscripts, their coefficients are seen to give, for the determinant of the circuit,

$$D = \begin{vmatrix} Z_1 + Z_2 & 0 & -Z_1 & 0 & 0 \\ 0 & Z_7 & 0 & -Z_7 & 0 \\ -Z_1 & 0 & Z_1 + Z_3 + Z_4 & -Z_4 & -Z_3 \\ 0 & -Z_7 & -Z_4 & Z_4 + Z_5 + Z_7 + Z_8 & -Z_5 \\ 0 & 0 & -Z_3 & -Z_5 & Z_3 + Z_5 + Z_6 \end{vmatrix} \quad (16)$$

From this determinant

$$d_{11} = \begin{vmatrix} Z_7 & 0 & -Z_7 & 0 \\ 0 & Z_1 + Z_3 + Z_4 & -Z_4 & -Z_3 \\ -Z_7 & -Z_4 & Z_4 + Z_5 + Z_7 + Z_8 & -Z_5 \\ 0 & -Z_3 & -Z_5 & Z_3 + Z_5 + Z_6 \end{vmatrix} \quad (17)$$

$$d_{12} = d_{21} = - \begin{vmatrix} 0 & -Z_1 & 0 & 0 \\ 0 & Z_1 + Z_3 + Z_4 & -Z_4 & -Z_3 \\ -Z_7 & -Z_4 & Z_4 + Z_5 + Z_7 + Z_8 & -Z_5 \\ 0 & -Z_3 & -Z_5 & Z_3 + Z_5 + Z_6 \end{vmatrix} \quad (18)$$

$$d_{22} = \begin{vmatrix} Z_1 + Z_2 & -Z_1 & 0 & 0 \\ -Z_1 & Z_1 + Z_3 + Z_4 & -Z_4 & -Z_3 \\ 0 & -Z_4 & Z_4 + Z_5 + Z_7 + Z_8 & -Z_5 \\ 0 & -Z_3 & -Z_5 & Z_3 + Z_5 + Z_6 \end{vmatrix} \quad (19)$$

$$d_{22}'' = \begin{vmatrix} Z_1 + Z_3 + Z_4 & -Z_4 & -Z_3 \\ -Z_4 & Z_4 + Z_5 + Z_7 + Z_8 & -Z_5 \\ -Z_3 & -Z_5 & Z_3 + Z_5 + Z_6 \end{vmatrix} \quad (20)$$

If these determinants are combined in accordance with equations (4) and (9), the impedance elements of an equivalent II and equivalent T network will result. In particular, if the impedances of Fig. 4 are $Z_1=2+j2$, $Z_2=3+j4$, $Z_3=3-j4$, $Z_4=5-j5$, $Z_5=8+j6$, $Z_6=6-j8$, $Z_7=1-j1$, $Z_8=2-j4$, the determinant is

$$D = \begin{vmatrix} 5+j6 & 0 & -2-j2 & 0 & 0 \\ 0 & 1-j1 & 0 & -1+j1 & 0 \\ -2-j2 & 0 & 10-j7 & -5+j5 & -3+j4 \\ 0 & -1+j1 & -5+j5 & 16-j4 & -8-j6 \\ 0 & 0 & -3+j4 & -8-j6 & 17-j6 \end{vmatrix}$$

$$D = 4704 - j21,472.$$

Similarly,

$$\begin{aligned} d_{11} &= -1456 - j2592 \\ d_{12} = d_{21} &= -412 + j516 \\ d_{22} &= 14,544 - j10,042 \\ d_{22}'' &= 548 - j2314. \end{aligned}$$

The II equivalent of Fig. 4 can now be determined by substituting these last results into (4); i.e.,

$$\begin{aligned} Z_1 &= \frac{D}{d_{11} - d_{12}} = \frac{4704 - j21,472}{-1044 - j3108} = 5.75 + j3.45 \\ Z_2 &= \frac{D}{d_{12}} = \frac{4704 - j21,472}{-412 + j516} = -29.9 + j14.7 \end{aligned}$$

$$Z_3 = \frac{D}{d_{22} - d_{21}} = \frac{4704 - j21,472}{14,956 - j10,558} = 0.884 - j0.809.$$

Placing these impedances in the positions indicated in Fig. 2 establishes the II equivalent of Fig. 4. Note that Z_2 is not physically realizable; consequently, for the numerical impedances specified in the foregoing, Fig. 4 does not have a physically realizable II equivalent.

The T equivalent of Fig. 4 follows from evaluating equations (9) in terms of the numerical values established for d_{11} , d_{12} , d_{22} , and d_{22}'' . Thus,

$$\begin{aligned} Z_a &= \frac{d_{11} - d_{12}}{d_{22}''} = \frac{-1044 - j3108}{548 - j2314} = 1.17 - j0.729 \\ Z_b &= \frac{d_{12}}{d_{22}''} = \frac{-412 + j516}{548 - j2314} = -0.251 - j0.118 \\ Z_c &= \frac{d_{22} - d_{21}}{d_{22}''} = \frac{14,956 - j10,558}{548 - j2314} = 5.74 + j5.09. \end{aligned}$$

Therefore, since R_b is negative, the four-terminal network of Fig. 4, for the numerical values of impedances specified in the foregoing, does not have a physically realizable T equivalent, either. This is often true also, when an equivalent T or II is calculated from open-circuited and short-circuited impedance measurements on an actual circuit. Even physically realizable T or II networks do not always have physically realizable II or T equivalents.

Institute News and Radio Notes

Plans Go Forward for Winter Technical Meeting and Radio Engineering Show

PROGRESS on plans for the first postwar Winter Technical Meeting and Radio Engineering Show of the Institute at the Hotel Astor, New York, January 23 to 26, 1946, are far advanced, and all indications point to one of the largest as well as one of the most significant gatherings of this type ever held.

Last year, more than 3000 members were present and reports this year indicate a substantially greater attendance. Several features in addition to the major highlights of the Meeting are on the schedule of events.

In preparation for the Radio Engineering Show, 132 exhibitors have already taken the total of 168 booths originally planned, including three theater booths, while efforts are being made to obtain additional space to accommodate the waiting list of further exhibitors. This mammoth show is scheduled to open at 4:00 P.M. Wednesday, January 23, and will close promptly at 2:00 P.M. Saturday, January 26.

The annual banquet, on Thursday, January 24, the social highlight of the I.R.E. year, will have places for 2500 members. Mr. Edgar Kobak, president of the Mutual Broadcasting System, will be the toastmaster. The principal speaker at the banquet will be Dr. Frank B. Jewett, president of the National Academy of Sciences.

For the President's Luncheon to be held Friday, January 25, it has been announced that Mr. L. M.

Clement, vice-president in charge of research and engineering of the Crosley Corporation, will be master of ceremonies.

Another enjoyable feature this year will be a cocktail party also scheduled for Friday evening, for members and their friends. A nominal fee will be charged for admission.

An interesting program has been arranged for the women guests at the meeting. This will consist of sight-seeing trips to points of interest in New York City and luncheons at unusual places are planned.

This year the I.R.E. will be host at a joint meeting with the American Institute of Electrical Engineers, scheduled to be held in the Engineering Society's auditorium on Wednesday evening, January 23. Last year, this meeting drew such crowds that many had to be turned away. At this gathering, however, arrangements have been made to install a public-address system and to reserve another large meeting room in the same building to accommodate any overflow attendance. At the joint meeting, there will also be a timely address by a speaker prominent in the electrical and electronics field.

Since the demand for hotel accommodations in New York is still extremely critical, those who have not as yet sent in their reservations for hotel rooms should do so at once.

Board of Directors

October 3 Meeting: At the October 3, 1945, meeting of the Board of Directors, the following were present: W. L. Everitt, president; G. W. Bailey, executive secretary; S. L. Bailey, E. F. Carter, Alfred N. Goldsmith, editor; R. F. Guy, R. A. Hackbusch, R. A. Heising, treasurer; Keith Henney, F. B. Llewellyn, Haraden Pratt, secretary; D. B. Sinclair, W. O. Swinyard, H. M. Turner, H. A. Wheeler, and W. C. White.

Approval of Executive Committee Actions: It was unanimously approved that the actions of the Executive Committee taken at its September 5, 1945, meeting be ratified.

Constitution and Laws Committee: The Board approved the adoption of the following proposed modifications of Article III, Section 2, and Article II, Section 6:

"ARTICLE III, SECTION 2—Applications for admission or transfer to any grade of membership, except Fellow, shall be addressed to the Board of Directors and

submitted to the Institute office. Election or transfer of an applicant to any grade, except Fellow, shall be made by a two-thirds affirmative vote of the Board membership voting, or a two-thirds affirmative vote of a committee of Board members, duly authorized in the By-laws to act for the Board in electing members or transferring their membership grades."

"ARTICLE II, SECTION 6—For admission to the grade of Student, a candidate shall be devoting a major portion of his time as a registered student in engineering or science in a school of recognized standing. Membership in this grade shall not extend more than two and one-half years beyond the termination of his student status as described above. A Student member who for any reason has not transferred to Member grade within the extended period shall be transferred to Associate grade."

ARTICLE IV, SECTION 2: Mr. Guy, chairman of the Constitution and Laws

Committee, moved that the Minutes of the October 3, 1945, Board meeting show that the Board reconsidered Article IV, Section 2, and reiterated its decision as shown at the September 5, 1945, meeting. This was approved.

Section Redistricting: It was unanimously approved that the plan of the Section redistricting be accepted as submitted, with the recommendation that, when the map is published, United States territories only be shown (with a notation to the effect that Canadian territories will be shown at a later date).

During the discussion on the Section redistricting, Mr. R. A. Heising, chairman of the Sections Committee, was instructed to reopen, with the Connecticut Valley and Boston Sections, the discussion on the boundaries.

The change in the Sections territories is to become effective as of January 1, 1946.

Joint Committees: A motion that the Standards Committee and the Technical Committees be instructed to form where

indicated, as speedily as possible, joint committees with other responsible technical organizations or groups dealing within their scope, and to carry forward the activities of such joint committees, was unanimously approved.

Bylaw Section 57: The price of a single annual subscription to the PROCEEDINGS was increased to \$6.00 from \$5.00, and the Constitution and Laws Committee was instructed to modify Bylaw Section 57 in accordance with this increased price.

Annual Meeting: The annual meeting of the Institute will be held on Thursday, January 24, 1946.

Radio Technical Planning Board: Mr. Pratt, Chairman of the RTPB, reported that the Federal Communications Commission was in favor of the continuation of the RTPB functions. Mr. Pratt also stated that it was opinion The Institute should take a leading part in the future activities of the RTPB.

Executive Committee

October 3 Meeting: At the Executive Committee meeting, held on October 3, 1945, the following were present: W. L. Everitt, president; G. W. Bailey, executive secretary; S. L. Bailey, W. H. Crew, assistant secretary; Alfred N. Goldsmith, editor; R. A. Heising, treasurer; and Haraden Pratt, secretary.

Membership Approval was given to the 323 applications for membership in the Institute listed on page 36A of the November, 1945, issue of the PROCEEDINGS. These applications are as follows:

For Transfer to Senior Member grade.....	36
For Admission to Senior Member grade.....	9
For Transfer to Member grade....	62
For Admission to Member grade...	63
For Admission to Associate grade...	109
For Admission to Student grade...	44
Total.....	323

Section Redistricting: It was unanimously approved that the Executive Committee recommend to the Board that the redistricting of the Sections, which has been done by the Sections Committee in compliance with the Board's instructions of March 7, 1945, be accepted.

At the suggestion of Editor Goldsmith, the map showing the redistricting of the Sections will be published in the PROCEEDINGS, together with appropriate explanations. Coincident with the publication of the map, an article covering the procedure by the Sections in handling higher grade membership transfers and admissions will be published.

Winter Technical Meeting: Definite arrangements have been completed with the Astor Hotel for the Winter Technical Meeting, and the budget, as set up, was unanimously approved.

Postwar Publication Fund: Dr. Goldsmith moved that Dr. F. E. Terman, Chairman, Dr. B. E. Shackelford, and Mr. I. S.

Forthcoming Section Meetings

December 13, 1945

CONNECTICUT VALLEY
BRIDGEPORT

Dinner: 6:45 P.M., Stratfield Hotel
Meeting: 8:00 P.M., Stratfield Hotel
Chairman: H. W. Sundius
Speaker: A. E. Harrison, Sperry Gyroscope Company
Title of Paper: The Klystron

December 18, 1945

CINCINNATI

Meeting: Engineering Society of Cincinnati Headquarters
Speaker: H. B. Fancher, General Electric Company
Title of Paper: Microwave Relay Networks

December 21, 1945

CHICAGO

Dinner: 6:00 P.M., Main Dining Room, 38th Floor, Civic Opera Building, 20 Wacker Drive, Chicago, Illinois
Program: Sixth Floor, Civic Opera Building
Chairman: Ralph P. Glover
Speaker: Hugh S. Knowles, Vice-President and Chief Engineer, Jensen Radio Manufacturing Co.
Title of Paper: Receiver Loudspeaker Systems

Summary—Historical data on radio receiver loudspeaker systems will be given which indicate certain prewar trends. Stress is placed on the deliberate use of distortion of various kinds in narrow-band transmission systems and the limitations which similar distortion place on wide-band systems. The limitations of single-channel, wide-band transmission systems will be discussed in relation to the limitations to be expected from the acoustic portions of frequency-modulation systems. War developments in loudspeakers will be included for what light they may shed on their influence on postwar design trends. A demonstration will be included.

January 8, 1946

CONNECTICUT VALLEY
SPRINGFIELD

Dinner: 6:45 P.M., Hotel Sheraton
Meeting: 8:00 P.M., Hotel Sheraton
Chairman: H. W. Sundius
Speaker: H. B. Fancher, General Electric Company
Title of Paper: General Electric-International Business Machines Radio Relay

January 14, 1946

PITTSBURGH

Meeting: 8:00 P.M., Mellon Institute
Students from the University of Pittsburgh and Carnegie Institute of Technology will present papers.

January 15, 1945

CINCINNATI

Meeting: Engineering Society of Cincinnati Headquarters
Speaker: John D. Reid, Crosley Corporation
Title of Paper: Sound and Hearing

January 17, 1946

CONNECTICUT VALLEY
HARTFORD

Dinner: 6:45 P.M., Hotel Bond
Meeting: 8:00 P.M., Hotel Bond
Chairman: H. W. Sundius
Speaker: Daniel E. Noble, Galvin Manufacturing Company
Title of Paper: The Motorola Walkie Talkie, Handie Talkie, and the New 152- to 160-Megacycle Portable Mobile Equipment

NOTE: We are desirous of giving as much publicity as possible to forthcoming Section Meetings, provided that we have the material in sufficient time to include it in the next available issue of the PROCEEDINGS. For the February, 1946, issue, we should have copy not later than December 20, for March, not later than January 20, and so on.

The Editor

Coggeshall be appointed a committee, with whom Dr. Goldsmith will collaborate to secure an addition to the Postwar Publication Fund for further expansion of technical publications.

Election of Officers

On November 13, 1945, the Board of Directors announced that Dr. Frederick B. Llewellyn was elected president of The Institute of Radio Engineers for 1945, and Mr. E. M. Deloraine was elected vice-president. The following directors also were chosen by the membership: Dr. Walter

G. R. Baker, Mr. Virgil M. Graham, and Dr. David B. Sinclair.

Kansas City Technical Societies Council

Seventeen technical and professional societies of Greater Kansas City recently formed the Technical Societies Council of Kansas City. This organization is to be a co-ordinating agency which will further the industrial upbuilding of the region. The Institute of Radio Engineers is represented by R. N. White (S'40-A'41-M'45), engineer and maintenance department, T.W.A., and A. P. Stuhrman (A'39), of the Wilcox Electric Company.

I.R.E. People



J. B. COLEMAN

JOHN B. COLEMAN AND M. C. BATSEL

Appointment of John B. Coleman (A'25-M'29-SM'43) as assistant director of engineering for the RCA Victor Division and the naming of M. C. Batsel (A'21-F'27) as chief engineer of the engineering products have been announced by D. F. Schmit (A'25-M'38-SM'43) director of engineering for the RCA Victor Division.

Mr. Coleman, who will make his headquarters at the company's home office in Camden, N. J., joined RCA in 1930. He progressed through the engineering division holding a series of responsible positions until 1939 when he was appointed chief engineer of the engineering products department, a position he held until his new assignment.

Mr. Batsel is widely known in the radio and motion-picture industry. He became associated with RCA in 1929. Previous to his new assignment, Mr. Batsel was chief engineer at the RCA Victor plant in Indianapolis, Ind.

DONALD G. FINK

Donald G. Fink (A'35-SM'45) spoke before the Radio Club of America on September 13, 1945, on "Radar Theory and War-time Applications." This paper dealt with the fundamental basis of radar detection as derived from simple concepts and expressed in the form of a single equation which expresses the effects of transmitter power and receiver noise, target size and distance from the transmitter, wavelength, and antenna characteristics. The application of the equation to the design of radar equipment was discussed and illustrated with slides of typical military and naval radars, together with the technical background of wartime applications.

Browder J. Thompson Memorial

In the May PROCEEDINGS, an announcement was made of a plan to turn contributions of friends of the late B. J. Thompson over to The Institute of Radio Engineers to establish an annual prize for the outstanding paper in radio and electronics.

Undoubtedly many members of the Institute will be interested in the status of the Browder J. Thompson Memorial Fund. As of October third, contributions totaling over \$4100 have been received.

The Fund is still growing; and inasmuch as only about one fourth of the potential contributors have been heard from, there is every reason to believe that it will continue to grow.

In view of this favorable preliminary result, consideration is being given to investing the money now on hand and taking other appropriate steps in order that the initial award may be made at an early date, possibly at the forthcoming Summer Convention. Naturally, B. J.'s friends are strongly desirous that the fund established in his name shall speedily encourage workers in the field with which he was so closely identified and to which he contributed so greatly.

R. R. LAW
Secretary
Memorial Committee

Mr. Fink is a graduate of the Massachusetts Institute of Technology, and spent a year in graduate study before joining the editorial staff of *Electronics* in 1934. After a four-year leave of absence, Mr. Fink returned to *Electronics*, on September 1, 1945, as executive editor. During his leave of absence, he was associated with the Radiation



DONALD G. FINK



M. C. BATSEL

Laboratory, assigned to development work on the Loran system of long-range navigation. The Loran transmitters now in use are based on his designs, and he is the author of "Microwave Radar," the first radar textbook, written for the use of the laboratory staff and military personnel.

Appointed head of the Loran division of the laboratory in 1943, Mr. Fink served both in European and Pacific areas, and was later transferred to the Washington, D. C., office of the Secretary of War, where he advised the Army Air Forces concerning the use of Loran and related navigational devices. Assigned to the headquarters of the Ground Forces, Mr. Fink advised on the use of radar as applied to gunfire control and the detection of ground targets. He was also appointed a member of the Committee on Air Navigation and Traffic Control, and will continue this government service in conjunction with his new position.

RMA-I.R.E. GOLF TOURNAMENT

The Radio Manufacturers Association of Canada and the Toronto Section of The Institute of Radio Engineers held their first joint golf tournament on September 12, 1945. The I.R.E. trophy for low gross was won by E. O. Swan (A'40-M'44).

The tournament was followed by a dinner, at which J. R. Longstaffe (A'36), chairman of the golf committee, presided. Mr. Longstaffe introduced several representatives of both organizations, including F. H. R. Pounsett (A'26-SM'44), chairman of the Toronto Section, and Alexander Bow (A'43), secretary-treasurer of the Toronto Section. Mr. Pounsett spoke briefly on the great strides which the art of radio had made during the war years, and predicted that radio will be the industry in the future.

Books

The Decibel Notation and Its Applications to Radio Engineering and Acoustics, by V. V. L. Rao

Published (1944) by Addison and Company, Inc., Madras, India. 176 pages+3-page index + xvi pages. 51 illustrations. $8\frac{1}{2} \times 5\frac{1}{2}$ inches. Price, \$3.00.

The decibel notation may be taken to mean the use in engineering of the logarithm of the ratio of two powers, or of their associated quantities, rather than the ratio itself. As such it must pervade any book on communication engineering. The present work however makes it the focal point.

The first part presents the reasons for using logarithms, and develops the concepts underlying those quantities such as loss, power level, etc., which occur in electrical systems and are expressed in decibels. The second part deals with acoustic systems, and includes the concept of the phon, which replaces the decibel when dealing with loudness level. The third and largest part is devoted to specific numerical examples of the calculation, in decibels, of the various quantities which are met in the engineering of radio and acoustic systems. Methods of measuring these are also described. Appendixes include tables and a discussion of the use of logarithmic graphs.

The level of difficulty has been chosen to fit "an average student of electrical engineering." The practicing engineer would find it useful primarily as a reference. It should also meet the needs of those in administrative positions whose duties require a working knowledge of the language of the engineer.

The style is clear and straightforward, and as Professor Chakravarti says in his foreword, "This modest work is packed with much useful and worthwhile information presented with clarity and economy of words."

Reporting as it does the current terminology of communication it illustrates how far the application of the decibel has evolved from its original use as a measure of "transmission loss" which described the change in received power in going from the reference to the test conditions. Also it reflects that looseness in the use of terms which is so prevalent in the literature.

R. V. L. HARTLEY
Bell Telephone Laboratories
Murray Hill, N. J.

On the Propagation of Radio Waves, by Olof E. H. Rydbeck

Published (1944) by Elanders Boktryckeri Aktiebolag, Göteborg, Sweden, 169 pages. 47 illustrations. 7×10 inches. Price, 10.0 kronor.

In this book the author obtains theoretical solutions to several problems connected with the idealized problem of the propagation of radio waves between the earth and a concentric parabolic layer of ionization. The book is addressed primarily to the mathematical physicist and unquestionably con-

Radio Pioneers' Books

Commemorating the Radio Pioneers' Dinner held in New York City on November 8, 1945, at the Hotel Commodore, the New York Section of The Institute of Radio Engineers, prepared a booklet containing historical notes on the I.R.E., Veteran Wireless Operators' Association, Radio Club of America, and the American Radio Relay League. This volume contains much of interest regarding radio from the mid 1800's through 1925, both chronologically and by eras. In it there are biographical sketches of numerous important personages in radio and a substantial number of photographs of interesting old equipment. The book was prepared by an editorial group under the chairmanship of Harold P. Westman. It contains 64 pages, is $8\frac{1}{2}$ by 11 inches in size, attractively bound in a light-gray cover with blue printing, and is priced at \$1.00 per copy. Copies of this book may be ordered from the chairman of the New York Section, Professor G. B. Hoadley, 85 Livingston St., Brooklyn 2, New York. Remittances should accompany orders.

stitutes a contribution in this field by presenting explicit solutions of many interesting problems encountered in studying the transmission of radio waves in inhomogeneous media. The exact solution of the problem of determining the intensities of radio waves at large distances from the transmitting antenna in the presence of an ideally smooth earth and upper atmosphere should provide a useful guide to the calculation of the expected intensities of ionospheric waves as actually propagated around the earth. Previous attempts to solve this problem have almost always used the methods of geometrical optics and this paper indicates in what frequency and distance ranges such methods may be expected to be applicable.

In addition formulas are given for the expected sky-wave (and ground-wave) field intensities to be expected (in the presence of the idealized earth and atmosphere) in many cases where the methods of geometrical optics would not be applicable. In one case, i.e., transmission on a frequency of 60 kilocycles over sea water, these solutions are actually reduced to the form of a curve showing the attenuation factor as a function of distance. This curve indicates that the field intensities to be expected oscillate up and down with increasing distance in a very irregular way. Unfortunately no experimental data were given to confirm this rather unexpected behavior and it is the belief of the reviewer that the actual transmission on this frequency is not characterized by any such oscillations. Probably much additional theoretical work of the type contained in this book will be required before suitable theoretical solutions of this wave propagation problem are obtained.

KENNETH A. NORTON
Office of the Chief Signal Officer
Washington 25, D. C.

UHF Radio Simplified, by Milton S. Kiver

Published (1945) by D. Van Nostrand Co., Inc., 250 Fourth Ave., New York, N. Y. 236 pages+2-page index+viii pages. 157 illustrations. $5\frac{1}{2} \times 8\frac{1}{2}$ inches. Price, \$3.25.

In this book the author attempts a simplified, nonmathematical treatment of ultra-high-frequency radio, intended apparently for the use of radio amateurs; laboratory and technical assistants; technical, sales, and commercial representatives; executives; and others who have some technical knowledge and experience, who would profit by a simple descriptive treatment of the subject. The author assumes that the reader has some knowledge and experience with lower-frequency radio circuits, as, for example, broadcast transmitters and receivers, and attempts to explain the generation and transmission of ultra-high-frequency radiations, by pointing out similarities and analogies and indicating logical extensions of the lower-frequency techniques to the ultra-high-frequency region. Attempts are made to visualize the mechanism of electron flow and in other ways to develop physical concepts of phenomena in ultra-high-frequency generators and transmission lines.

On the whole, the author has been successful in accomplishing his stated purpose, namely, "to point out the underlying equality of all radio." The book undoubtedly will be of interest and value to the readers for which it is designed. It would be expected that the avoidance of mathematical analysis and the attempts to make the explanation easily comprehended would result in glaring omissions and a sense of incompleteness. These would, however, be felt more keenly by serious and thorough students in the field, for whom the book is not intended and to whom it is not recommended. These simplifications and the brevity of the text likewise cause the author to include categorical statements without indicating the basis for them or deriving them mathematically.

Following an introductory chapter, in which the transition from the lower- to the higher-frequency techniques is explained, the book describes the operation and use of generators of high-frequency oscillations; the transmission of high-frequency currents from the generator to the antenna; antennas; the propagation of high-frequency electromagnetic waves; and the instruments and methods of measurement of wavelengths, potential difference, and power. There is no adequate treatment of transmitter stations nor of receivers.

Advances in this field during the war have been rapid on account of the development of radar and special communication systems for military purposes. This new knowledge, as yet not released from military security, could not be included in the book. However, the ideas developed and the techniques described will continue to be important as an introduction to the more advanced ideas and techniques that will become available when military security permits.

O. S. DUFFENDACK
North American Philips Company, Inc.
Irvington, N. Y.

Correspondence

Correspondence on both technical and nontechnical subjects from readers of the PROCEEDINGS OF THE I.R.E. is invited subject to the following conditions: All rights are reserved by the Institute. Statements in letters are expressly understood to be the individual opinion of the writer, and endorsement or recognition by the I.R.E. is not implied by publication. All letters are to be submitted as typewritten, double-spaced, original copies. Any illustrations are to be submitted as inked drawings. Captions are to be supplied for all illustrations.

Iron Powder Cores and Coils

When working with iron-core direction-finding loop antennas some time ago, the writer was greatly assisted in his understanding of the related permeability phenomena by the paper by R. M. Bozorth and D. M. Chapin.¹

A perusal of articles which have since been published in various journals does not show any reference to this paper but many repeat earlier "rule-of-thumb" methods. To this writer the paper seems worthy of some elaboration in respect to its application to the design of iron powder cores and coils for radio sets.

Formula (1) for the effective permeability of a core and coil combination is derived from fundamental principles

$$\mu_e = \frac{L_i}{L_a} = \frac{d^2}{D^2}(\mu - 1) + 1 \quad (1)$$

$$\frac{1}{\mu} = \frac{1}{\mu'} + \frac{N}{4\pi} \quad (2)$$

¹ R. M. Bozorth and D. M. Chapin, "Demagnetizing factors of rods," *Jour. Appl. Phys.*, p. 320; May, 1942.

² Dudley E. Foster and Arthur E. Newlon, "Measurements of iron cores at radio frequencies," *Proc. I.R.E.*, vol. 29, pp. 266-277; May, 1941.

Change of Member Address for 1946 Yearbook

If you have made any changes in your address or position since you sent in your YEARBOOK postcard questionnaire, will you please inform I.R.E. Headquarters promptly. It would be helpful in that case if you would make a statement to the effect that your YEARBOOK listing should be changed as follows: (Here insert the proper changes.) No YEARBOOK corrections in address or position can be made after January 1, 1946. Kindly address your communications to

The Institute of Radio Engineers, Inc.
330 West 42nd Street
New York 18, New York

and is accurate for an infinite coil and core length.²

SYMBOLS

μ_e = effective permeability of coil and core combination

μ = apparent permeability of cylindrical core

μ' = ring permeability of core material³

$N/4\pi$ = demagnetizing factor

L_i = inductance of coil with core

L_a = inductance of coil less core

$$D = \frac{D_1 + D_2}{2}$$

D_1 = outer diameter of the winding

D_2 = inner diameter of the winding

d = diameter of core.

l = length of core.

What to do when finite lengths and small length-to-diameter ratios are encountered is the problem constantly facing the designer. The usual method is to allow certain empirical factors known from experience or from scant preliminary references to

At the same density.

obtain the apparent permeability of various geometrical core configurations.

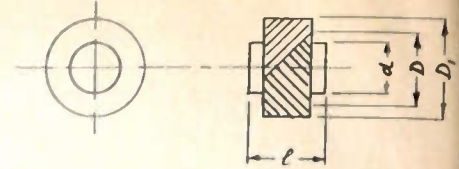

Fig. 1

The abovementioned article appears to clear this matter up for the so called "open construction" shown in Fig. 1. Using (2) which is rewritten from reference 1 and picking values from the curves for cylindrical rods in Fig. 2 on page 322 the following table is obtained.

m	ring permeability			
	5	10	100	infinity
1	2.25	2.90	3.2	3.5
2	3.29	4.65	6.5	7.6
3	3.85	5.92	10.08	12.3
4	4.22	6.94	15.0	17.7
5	4.46	7.69	20.0	24.0
6	4.59	8.15	25.0	31.0
8	4.74	8.75	34.0	46.0
10	4.83	9.14	41.6	62.5

The apparent permeability is found at the intersection of the column for the ring permeability of the material and the row for the appropriate core length-to-diameter ratio.

This table confirms some of the empirical figures used for the popular short cores with an m in the neighborhood⁴ of 2. It is also quite evident that it is not economical to use high-permeability materials when m is small.

Thus this table, when used in conjunction with (1) rounds out the picture for the designer.

Conversely, it is possible to make measurements of the material permeability using ordinary coils and cores.

⁴ m = ratio of core length to diameter.

H. W. JADERHOLM
Montreal, Que., Canada

Contributors



W. S. BACHMAN

W. S. Bachman (S'32-A'36-M'45) was born at Williamsport, Pa., on October 29, 1908. He received the degree of Electrical Engineer from Cornell University in 1932, and joined the radio-receiver engineering department of the General Electric Company in 1934. His work has included the design and development of loudspeakers, receivers, electromechanical devices, and magnetic circuits.

Mr. Bachman is a member of Tau Beta Pi and Eta Kappa Nu.



Harold L. Brouse (A'43-M'44) was born on July 16, 1907, at Akron, Ohio. He received the B.S. degree in electrical engineering from Case School of Applied Science, in 1930. From 1930 to 1933 he was a graduate



HAROLD L. BROUSE



MADISON CAWEIN



teaching assistant at Rutgers University and received the M.S. degree in 1932.

From 1933 to 1937 he was associated with the B. F. Goodrich Company, as electrical engineer. In 1937 Mr. Brouse joined the Ohio Brass Company, where he was engaged in the development of high-voltage bushings until 1942. Since August, 1942, he has been with the Crosley Corporation as a member of their research staff.

Mr. Brouse is a member of the American Institute of Electrical Engineers, a registered professional engineer of Ohio, and is a member of Sigma Xi, Tau Beta Pi, and Eta Kappa Nu.



Madison Cawein (M'36-SM'43) was born at Louisville, Kentucky, on March 18, 1904. He received a B.S. degree in physics from the University of Kentucky in 1924, and did graduate work at Cornell University in 1925, and at the University of Kentucky from 1926 to 1928.

In 1925 and 1926 Mr. Cawein was employed by the Westinghouse Lamp Company, in Bloomfield, New Jersey, in the physics laboratory, and later in 1926, was associated with the research department at the Brooklyn Edison Company. From 1928 to 1930 he was an instructor in physics at



Thomas Studios

MURLAN S. CORRINGTON

the University of Kentucky, a post which he left to accept a position as assistant in the astronomical observatory at Princeton University, but accepted a position at Hazeltine instead.

Mr. Cawein was employed by the Hazeltine Corporation from 1930 to 1938, and served as a television consultant for the Andrea Corporation in 1938 and 1939. He joined the staff of the Farnsworth Television and Radio Corporation in 1939, and until 1942 was engaged in television-receiver development with that organization in Marion, Indiana. Since 1942 he has been manager of research at the Fort Wayne, Indiana, plant of the Farnsworth corporation.



Murlan S. Corrington was born at Bristol, South Dakota, on May 26, 1913. He received the B.S. degree in electrical engineering in 1934, from the South Dakota



H. G. MACPHERSON



School of Mines and Technology, and the M.Sc. degree in 1936, from Ohio State University.

From 1935 to 1937 Mr. Corrington was a graduate assistant in the physics department of Ohio State University. In 1937 he joined the Rochester Institute of Technology, and taught mathematics, mechanics, and related subjects. Since 1942 he has been engaged in mathematical engineering in the advanced-development section of the RCA Victor Division of the Radio Corporation of America. He is the author of "Applied Mathematics for Technical Students," and co-author of "Machine Shop Practice and Instrument Making."



H. G. MacPherson was born at Victorville, California, on November 2, 1911. He received the A.B. degree in 1932 and the Ph.D. degree in physics in 1937, from the University of California. He has been employed as a research physicist in the research laboratories of the National Carbon Co., Inc., since 1937, engaged in research on the carbon arc and on fundamental properties of carbon.



MYRIL B. REED

Myril B. Reed (A'41) was born in Woodruff, Utah, on February 14, 1902. He received the B.S. degree in electrical engineering from the University of Colorado in 1926, the M.S. degree in electrical engineering in 1931, and the Ph.D. degree in physics in 1935, both of the latter from the University of Texas. During 1924 and 1925, he worked in the meter department of the Public Service Company of Colorado. For a year after receiving his Bachelor's Degree, he worked as operator in hydro plants of the Utah Power and Light Company. In 1927 Dr. Reed became an instructor in electrical engineering at the University of Texas, and in 1938 he became assistant professor at Illinois Institute of Technology (at that time Armour Institute of Technology) where he is at the present time a professor in electrical engineering, on leave of absence to work with the Bell Telephone Laboratories in New York City. He is a member of Tau Beta Pi, Eta Kappa Nu, and Sigma Xi.

Dr. Reed published "Fundamentals of Electrical Engineering" in 1938 and has a second book, "Fundamentals of A.C. Circuit Theory," ready for publication. He also has published several papers on circuit theory.



S. A. Schelkunoff (A'40-F'44) received the B.A. and M.A. degrees in mathematics from the State College of Washington in



S. A. SCHELKUNOFF



WALTER G. SCHINDLER

1923, and the Ph.D. degree in mathematics from Columbia University in 1928. He was in the engineering department of the Western Electric Company from 1923 to 1925; the Bell Telephone Laboratories from 1925 to 1926; the department of mathematics of the State College of Washington, 1926 to 1929; and Bell Telephone Laboratories, 1929 to date. Dr. Schelkunoff has been engaged in mathematical research, especially in the field of electromagnetic theory.

Walter G. Schindler was born at New Glarus, Wisconsin, on December 10, 1897. He attended St. Johns Military Academy and the University of Wisconsin, and was graduated from the United States Naval Academy in 1921. He also took a graduate course in ordnance at the same institution.

During his career in the Navy, Captain



KURT SCHLESINGER

Schindler has specialized in ordnance, serving both at sea and in the Bureau of Ordnance. During the early part of World War II, he served in the Pacific area as gunnery officer and chief of staff for a task force commander. Since 1943 he has served as officer in charge of the Naval Ordnance Laboratory, and has had a leading part in planning the plant now under construction for this laboratory, at White Oak, Maryland.

Kurt Schlesinger (A'41) was born on April 20, 1906, in Berlin, Germany. In 1928 he received the engineer's diploma, and in 1929 the degree of Doctor of Applied Physics, both from Technische Hochschule in Berlin. From 1929 to 1930 he was research physicist in Ardenne Research Laboratory, Berlin, and from 1931 to 1937 was chief engineer in the television department of Loewe Radio Company, also in Berlin. In 1938 Dr. Schlesinger became affiliated with the Radio and Cables-Grammont in Paris, France. From 1941 to 1944 he was research engineer for RCA Laboratories. Since that time he has been a member of the research department of the Columbia Broadcasting System, specializing in color television.

Alfred W. Simon was born in Chicago, Illinois, on September 16, 1897. He studied physics and mathematics at the University of Chicago, receiving the degrees of B.S. in 1921 and Ph.D. in 1925. Subsequently, as a National Research Fellow in Physics at the California Institute of Technology, he carried on researches on electrostatic generators. Entering the industrial field in 1927, he was appointed director of the Cottrell Research Laboratory of the Tennessee Coal, Iron and Railroad Company, a subsidiary of the United States Steel Corporation, and held this position until 1932. From 1935 to 1937 he was employed as research physicist in the radio laboratory of the Stewart Warner Corporation, where he specialized in the design of coils for radio receivers; from 1937 to 1939 he was employed as a geophysicist by the Geophysical Research Corporation and the Stanolind Oil and Gas Company of Tulsa, Oklahoma; and from 1939 to 1941 he was chief engineer of the American Harmonica Company in Chicago. At the outbreak of the war, Dr. Simon transferred to the Naval Ordnance Laboratory of the United States Navy Yard in Washington, D. C., where he stayed until 1943 when he was appointed instructor in mathematics and communication engineering in the Army Specialized Training Program at Washington University in St. Louis. He was employed as chief engineer with John Luel-len and Company at Hazel Crest, Illinois from June to December, 1944, and since



ALFRED W. SIMON

January 1, 1945, he has been director of research with Edwin I. Guthman and Company, Chicago, Illinois, engaged in research on coils and wire.

L. L. Winter (M'45) was born in Vancouver, Washington, on September 18, 1911. He received the Ph.D. degree in chemistry from the State College of Washington in 1939. Since leaving college he has been employed as a chemist in the research laboratories of the National Carbon Co., Inc., in Cleveland, studying fundamental properties of graphite with particular emphasis on improvement of graphite for electronic applications.

For a photograph and biographical sketch of Charles W. Harrison, Jr., see the June, 1945, issue of the PROCEEDINGS; for R. J. Kircher, see the February, 1945, issue of the PROCEEDINGS.



L. L. WINTER

**YOU'LL SELL *MORE*
HOME APPLIANCES
IF THEY'RE NOISE-FREE**



SOLAR

Elim-o-Stats

CUT RADIO NOISE IN:

- ★ *Vacuum cleaners*
- ★ *Refrigerators*
- ★ *Power tools*
- ★ *Electric shavers*
- ★ *Washing machines*
- ★ *Vibrators*
- ★ *Sewing machines*
- ★ *Food mixers*
- ★ *Floor waxers*
- ★ *Electric trains*
- ★ *Kitchen ventilators*
- ★ *Oil burners*
- ★ *Stokers*

NO QUESTION about it — your big money in sales is coming from appliances that won't set up local interference in radio and television receivers.

When the big rush for the new radios begins, your customers—better informed than ever before—are going to demand noise-free performance in shavers, vacuum cleaners, oil burners, refrigerators, mixers — in *all* motorized appliances. You can count on *that*.

And you can count, too, on *your* share of the long pent-up appliance business by making sure every motorized appliance you sell is equipped with a Solar Elim-O-Stat. Submit your particular appliance problem *now* to the Filter Division, Engineering Dept.



WEST N. Y. BAYONNE
PLANT PLANT

A TOTAL OF TEN
ARMY-NAVY EXCELLENCE AWARDS

SOLAR MANUFACTURING CORP.
285 Madison Avenue • New York 17, N. Y.

Ⓜ 106

SHALLCROSS

ENGINEERING SPECIALISTS

CHECK YOUR NEEDS
AGAINST THIS LIST

TEAR OUT AND MAIL

- | | |
|--|--|
| <input type="checkbox"/> 1. "Akra-Ohm" Accurate Fixed Wire-Wound Resistors | <input type="checkbox"/> 20. Low-Resistance Test Sets |
| <input type="checkbox"/> 2. Hermetically-Sealed Resistors | <input type="checkbox"/> 21. High-Voltage Measuring Apparatus |
| <input type="checkbox"/> 3. High-Voltage Corona-Protected Resistors | <input type="checkbox"/> 22. Kilovoltmeter Multipliers |
| <input type="checkbox"/> 4. Compensated Decade Units | <input type="checkbox"/> 23. Solid Silver Contact Rotary Selector Switches |
| <input type="checkbox"/> 5. Ayrton Universal Shunts | <input type="checkbox"/> 24. Special Switches |
| <input type="checkbox"/> 6. Ratio Arm Boxes | <input type="checkbox"/> 25. Unmounted Decade Resistances |
| <input type="checkbox"/> 7. Secondary Resistance Standards | <input type="checkbox"/> 26. Binding Posts |
| <input type="checkbox"/> 8. Multi-Resistance Standards | <input type="checkbox"/> 27. Attenuation Pads |
| <input type="checkbox"/> 9. Megohm Decade Standards | <input type="checkbox"/> 28. Logarithmic Decade Boxes |
| <input type="checkbox"/> 10. Decade Resistance Boxes | <input type="checkbox"/> 29. Portable Galvanometers |
| <input type="checkbox"/> 11. Decade Potentiometers (Voltage Dividers) | <input type="checkbox"/> 30. CONSULTANTS ON: |
| <input type="checkbox"/> 12. Heavy Duty Resistance Decades | High-Voltage Measurements |
| <input type="checkbox"/> 13. Megohm Bridges | Low-Resistance Measurements |
| <input type="checkbox"/> 14. Percent Limit Bridges | Special Resistors for High Frequency Applications |
| <input type="checkbox"/> 15. Decibel Meters | Tropicalization of Resistors, Switches and Instruments |
| <input type="checkbox"/> 16. Telephone Transmission Testing Equipment | Other Electrical and Mechanical Engineering Problems |
| <input type="checkbox"/> 17. Wheatstone Bridges | |
| <input type="checkbox"/> 18. Fault Location Bridges | |
| <input type="checkbox"/> 19. Kelvin-Wheatstone Bridges | |

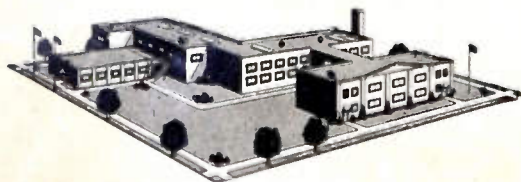

SHALLCROSS MFG. CO.

Engineers • Designers • Manufacturers

DEPT. 1R-12b, COLLINGDALE, PA.



BOSTON

"The Anatomy of Atomic Nuclei," by Robley D. Evans, Massachusetts Institute of Technology; October 19, 1945.

CHICAGO

"Behavior of Dielectrics Over Wide Ranges of Frequency, Temperature, and Humidity," by R. F. Field, General Radio Company; September 21, 1945.

"Late Developments in Wire Recording," by Hugh Davis, J. P. Seeburg Corporation; September 21, 1945.

DALLAS-Ft. WORTH

"A Discussion of Quartz Crystals, Their Use and Care," by Merrill Eidson, Eidson's Commercial Crystals and Mountings; August 24, 1945.

DAYTON

"Microwave Communications," by Vincent Learned, Sperry Gyroscope Company; October 18, 1945.

DETROIT

"Microwave Electronics," by J. A. Hutcheson, Westinghouse Electric Corporation; September 21, 1945.

"Squelch Circuits in Frequency-Modulation and Amplitude-Modulation Receivers," by F. M. Hartz, Detroit Edison Company; October 19, 1945.

EMPORIUM

"The Story of the Proximity Fuze," by W. R. Jones, Sylvania Electric Products, Inc.; October 11, 1945.

KANSAS CITY

"The Behavior of Dielectrics Over Wide Ranges of Frequency, Temperature, and Humidity," by R. F. Field, General Radio Company; September 24, 1945.

"A High-Quality Loudspeaker System of Small Dimensions," by P. W. Klipsch, United States Army; October 9, 1945.

LONDON (Canada)

"Radar in World War II," by K. R. Patrick, RCA Victor; October 5, 1945.

LOS ANGELES

"Pulse-Position Modulation in Army Communication," by F. J. Altman, United States Army Air Forces, G. M. Snow, and S. A. Voelker, United States Army Signal Corps; October 16, 1945.

MONTREAL

"The Application of Radio-Frequency Dielectric Heating to the Dehydration of Penicillin," by G. H. Brown, RCA Laboratories; October 17, 1945.

NEW YORK

"Frequency-Modulation Circular Antenna," by M. W. Scheldorf, General Electric Company; July 11, 1945.

(Continued on page 36A)

Proceedings of the I.R.E. December, 1945

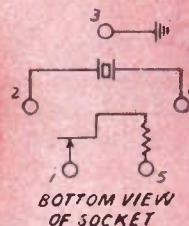
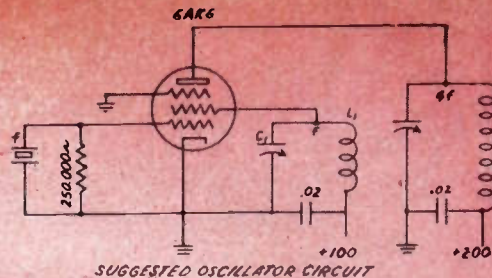
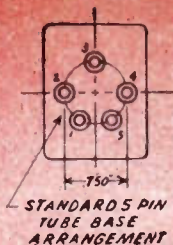
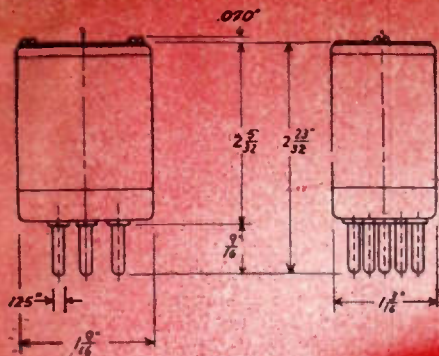

Announcing the **BLILEY** type ART crystal unit for maximum VHF stability

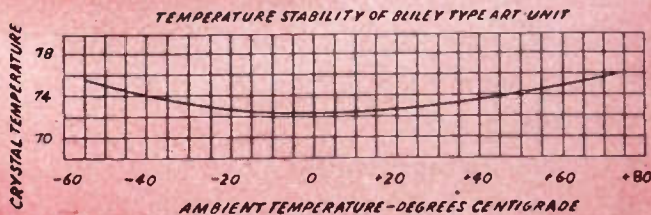

This new Type ART acid-etched*, crystal unit is another Bliley "first", designed for VHF services, such as police and railway communications, where frequency stability must be maintained over temperatures ranging from -55°C. to +75°C. With a built in heater operating on 6.3 V. at 1 amp. crystal temperature is held within $\pm 2^\circ\text{C}$. The unit will maintain an overall frequency tolerance of $\pm 0.005\%$ or better including variations due to temperature change and tolerances required for crystal production. This rugged, compact crystal assembly is available for any frequency between 3500 kc. and 11,000kc.



A schematic diagram of the oscillator circuit and tolerance to be maintained should accompany requests for quotations. See above design for efficient frequency multiplication.

*Acid etching quartz crystals to frequency is a patented Bliley process.

Bliley CRYSTALS

Radio Engineers —
write for temporary
Bulletin P-26

BLILEY ELECTRIC COMPANY • UNION STATION BUILDING, ERIE, PENNSYLVANIA

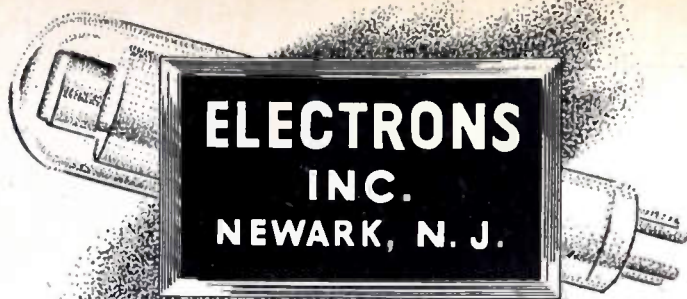

Specialized Research

... SINCE 1928

- Specialization invariably results in better functioning. For over 17 years we have concentrated on continuous, systematic research in the development of hot-cathode, gaseous-discharge Rectifier and Control Rectifier Tubes, which would satisfy the demand for power tubes of outstanding reliability.

- EL Rectifier Tubes have a unique, tough cathode coating, devised to withstand the particularly heavy ion bombardment experienced by gas-filled tubes for industrial use. This is characteristic of the many details of design and manufacture which result in rectifier tubes of longer life, with the ability to handle short circuits and momentary overloads in the critical interval that occurs before the fuse is cleared.

- EL Rectifier Tubes have met with widespread acceptance, not only by industry but for Government use, as evidenced by the fact that several of our Rectifier Tubes are on the Army-Navy Preferred List. We invite you to contact us regarding your Rectifier and Control Rectifier Tube requirements and suggest that you . . .

Write for Descriptive Literature

ELECTRONS, INCORPORATED
127 SUSSEX AVENUE NEWARK 4, N. J.

EL *Rectifier* 
TUBES



(Continued from page 34A)

"The Application of Cathode-Ray Tubes," by W. J. Knoop, Jr., Allen B. Dumont Laboratories; July 11, 1945.

"Radar in the United States Army," by R. B. Colton, United States Army Air Forces; September 5, 1945.

"The Gun Director's Conquest of the Robot Bomb," by C. A. Lovell, Bell Telephone Laboratories; September 19, 1945.

"Ratio Detectors for Frequency-Modulation Receivers," by S. M. Seeley, RCA Laboratories; October 3, 1945.

PHILADELPHIA

"The Federal Communications Commission—Its Consideration of Technical Matters Relating to the Various Communication Services," by V. R. Simpson, Federal Communications Commission; October 4, 1945.

PITTSBURGH

■ "The Radio Sonde and Associated Meteorological Equipment," by L. D. Whitelock, Bureau of Ships; October 8, 1945.

PORTLAND

Discussion on Frequency Modulation; October 1, 1945.

ST. LOUIS

"A High-Quality Loudspeaker System of Small Dimensions," by P. W. Klipsch, United States Army; October 24, 1945.

SAN DIEGO

"Radio-Frequency Curing of Conolon," by B. D. Abramis, Consolidated-Vultee Aircraft Corporation; October 9, 1945.

TWIN CITIES

"The Behavior of Dielectrics Over Wide Ranges of Frequency, Temperature, and Humidity," by R. F. Field, General Radio Company; September 25, 1945.

WASHINGTON

"Very-High-Frequency Train Communication Systems," by J. W. Hammond, Bendix Aviation Corporation; October 9, 1945.

"Inductive Train Communication," by L. O. Grondahl, Union Switch and Signal Company; October 9, 1945.

WILLIAMSPORT

"New Amplitude-Modulation, Frequency-Modulation and Television Studios at WHAM-WHFM," by K. J. Gardner, Radio Station WHAM-WHFM; October 3, 1945.

SUBSECTIONS

COLUMBUS

"A Fundamental Pulse Radar System," by D. A. Newberry, United States Navy; September 14, 1945.

"Industrial Electronic Control," by K. H. Keller, General Electric Company; October 12, 1945.

(Continued on page 38A)

HERE'S PROOF...

How Federal H-F Cable
Quality is Controlled by

Actual Test

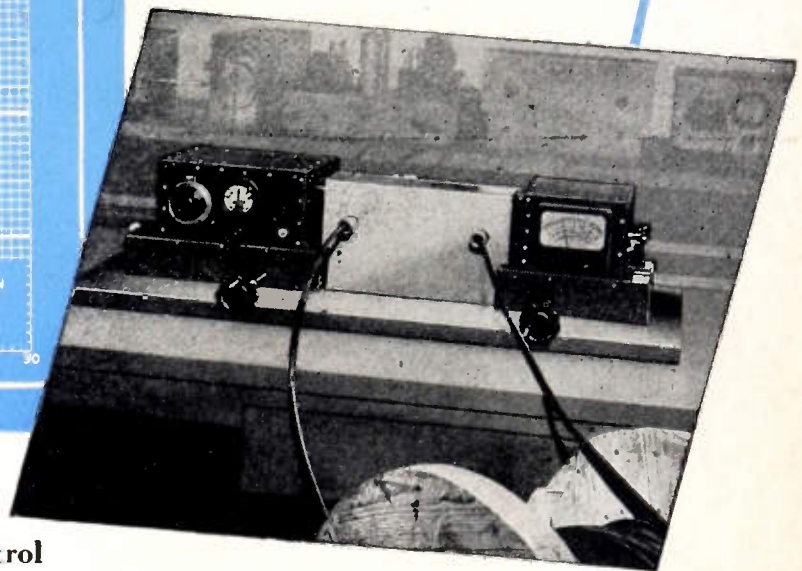

Precision engineering—plus careful control of all manufacturing operations . . . from raw materials to finished product—mean complete reproducibility in any given Intelin Cable type . . . and overall superior cables.

Take Intelin RG-8/U for instance . . . general purpose “work-horse” of high-frequency cables. Its characteristics are shown in curves obtained—not from nominal design values—but from thousands of actual measurements on cable samples, with special equipment developed and used exclusively by Federal’s Intelin Product Line.



Intelin’s Attenuation Meter is an example of such equipment. It’s a precision instrument . . . accurate to .1 db . . . developed by Intelin to provide a constant check on production quality and “measured” data for the equipment designer.

For additional information regarding Intelin RG-8/U . . . write *today* for Report E-53 —and for cable you can count on . . . *always* specify INTELIN.

Federal Telephone and Radio Corporation

Newark 1, N. J.

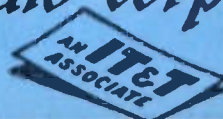

Thanks!

- TO YOU!

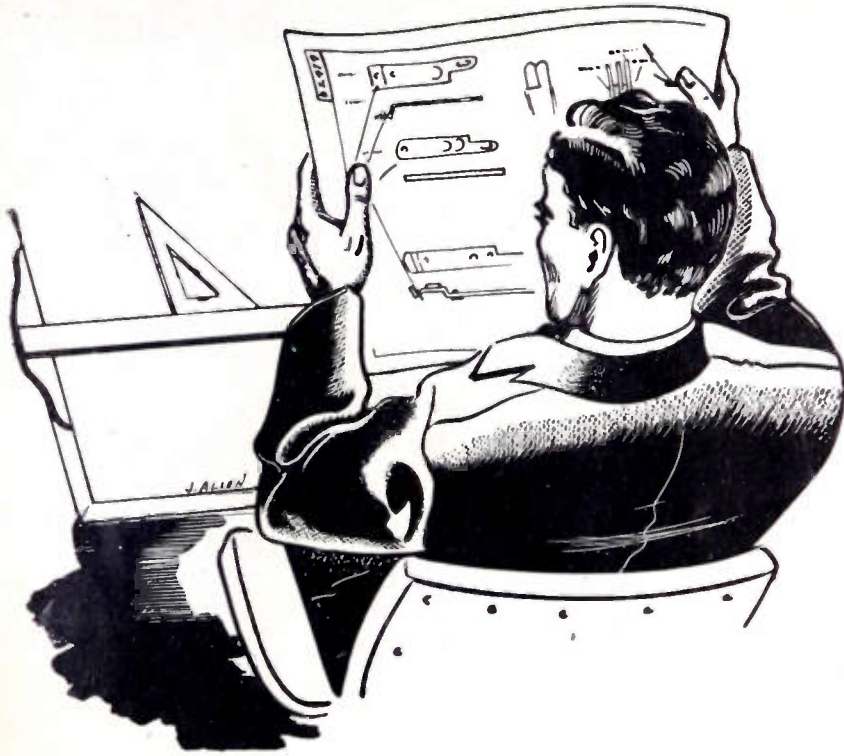

Yes... thanks to all of you whose cooperation during the past ten years has helped us to grow and expand. As a result of your faith in our ability to engineer and manufacture according to your most exacting requirements, we can celebrate our tenth anniversary. In these ten short years, it has been our pleasure to work with many of the leaders in the various electronic and communication fields.

Airborne Instruments Laboratory, Inc.
 Aireon Manufacturing Corporation
 Brush Development Company
 Civil Aeronautics Administration
 Columbia Broadcasting System, Inc.
 Gates Radio Company
 Northwest Airlines, Inc.

Presto Recording Corporation
 Radio Corporation of America
 Schuttig & Company
 Sylvania Electric Products Inc.
 University of Minnesota
 Western Union Telegraph Co.
 Wilcox-Gay Corporation

are a few of the many friends to whom we say...

... thanks again!



Audio Development Co.
 2833 13th Ave. S., Minneapolis, Minn.
"Audio Develops the Finest"

SECTION MEETINGS

(Continued from page 36A)

MILWAUKEE

"Behavior of Dielectrics Over Wide Ranges of Frequency, Temperature, and Humidity," by R. F. Field, General Radio Company; September 21, 1945.

PRINCETON

"Radar Sets and How They Grew," by L. A. Turner, Radiation Laboratory, Massachusetts Institute of Technology; October 12, 1945.

SOUTH BEND

"The Behavior of Dielectrics Over Wide Ranges of Frequency Temperature and Humidity," by R. F. Field, General Radio Company; September 27, 1945.

MEMBERSHIP

The following transfers and admissions were approved on November 7, 1945:

Transfer to Senior Member

- Beach, A. R., 307 Poplar Dr., Falls Church, Va.
- Briggs, T. H., Superior Tube Co., Norristown, Pa.
- Burroughs, H. A., 2124 Key Blvd., Arlington, Va.
- Carroll, M. J., 589 E. Illinois St., Chicago 11, Ill.
- Dondanville, R. V., 3909 Johnson Ave., Western Springs, Ill.
- East, L. A. W., 204 Hospital St., Montreal 1, P. Q., Canada
- Freundlich, M. M., 9 W. 87 St., New York 24, N. Y.
- Gardiner, P. C., 210 James St., Scotia, N. Y.
- Hastings, T. M., Jr., 530 Commonwealth Ave., Boston, Mass.
- Heller, J. I., 905 Ditmas Ave., Brooklyn, N. Y.
- Herbstreit, J. W., 1420 N. Longfellow St., Arlington, Va.
- Higgy, R. C., 2032 Indianola Ave., Columbus 1, Ohio
- Holt, A. C., 442 Stevens Ave., Ridgewood, N. J.
- Janes, C. W., 1 Allen Ave., Fort Monmouth, N. J.
- Kersta, L. G., Bell Telephone Laboratories, Whippany, N. J.
- Kolo, R. E., 50 Lockwood Ave., Fort Thomas, Ky.
- McLoughlin, R. P., Sucre 2525-2do. A., Buenos Aires, Argentina
- Morrison, H., 4 Glen Rd., Morristown, N. J.
- Morton, P. L., Engineering Dept., University of California Berkeley 4, Calif.
- Okress, E. C., 16 Forest St., Montclair, N. J.
- Peterson, D. A., 15 Brattle Circle, Cambridge, Mass.

(Continued on page 40A)

For Eimac's

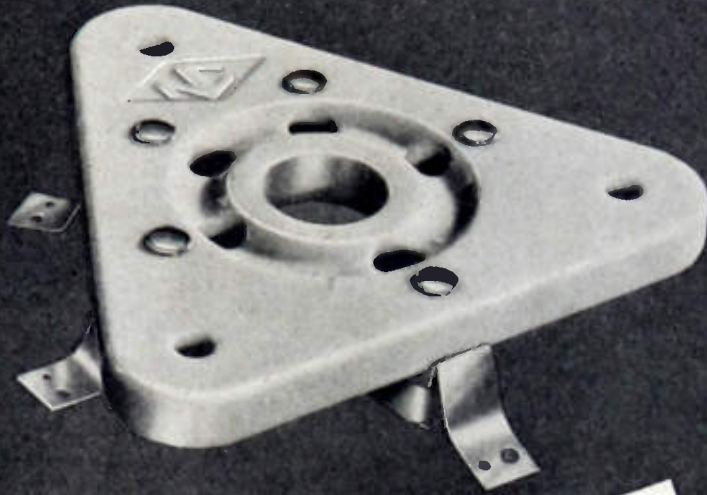

FOR EIMAC TETRODES 4-125-A, 4-250-A AND OTHERS

The HX-100 is a husky low-loss socket that will handle any tube using the "Giant" 5-pin base, including the Eimac 4-125-A and the Eimac 4-250-A. The HX-100 is of the wafer type with a low-loss ceramic body. Contacts are of the heavy duty type with auxiliary springs to provide ample contact pressure. In every detail, HX-100 is designed to contribute top performance through a long, trouble-free life.

Deliveries to dealers will begin about the time this issue appears.

HX-100 Socket List Price, \$3.30.

HX-100S Socket with three stand-off insulators, List Price, \$4.25.

NATIONAL COMPANY, INC.
MALDEN, MASS., U.S.A.





(Continued from page 38A)

- Ryder, J. D., Dept. of Electrical Engineering, Iowa State College, Ames, Iowa
- Wing, A. H., Jr., Cruft Laboratory, Harvard University, Cambridge, Mass.
- Yuan, L. C., RCA Laboratories, Princeton, N. J.
- Yunker, E. A., 277 Cross St., Belmont, Mass.

Admission to Senior Member

- Bash, F. E., Driver Harris Co., Harrison, N. J.
- Baughman, G. W., Union Switch & Signal Co., Pittsburgh 18, Pa.
- Bower, J. L., 238 Union St., Schenectady 5, N. Y.
- Frink, O., Jr., 706 Sunset Rd., State College, Pa.
- Gainsborough, G. F., B.C.S.O., Dupont Circle Bldg., Washington, D. C.
- Harris, D. B., 72 Prince St., Needham, Mass.
- Nobles, C. E., 200 W. Baltimore St., Baltimore 1, Md.
- Phillips, W. E., Natal University College, P. O. Box 1525, Durban, South Africa
- Schuttig, L. A., Schuttig and Co., 9 and Kearny Sts., N.E., Washington 17, D. C.
- Shoupp, W. E., 941 S. Braddock Ave., Wilkensburg, Pa.
- Stull, R. J., 341 Market St., San Francisco, Calif.
- Veatch, J. P., 1810 N. Cleveland St., Arlington, Va.

Transfer to Member

- Alden, E. E., c/o Radio Station WIRE, Indianapolis 6, Indiana
- Anderson, L. T., 194 Bryant Ave., Springfield, N. J.
- Ashbrook, F. M., 12 Ware St., Cambridge 38, Mass.
- Balter, L. M., 139 Atlantic Ave., Long Branch, N. J.
- Bangs, J. R., National Broadcasting Co., 30, Rockefeller Plaza, New York 20, N. Y.
- Beaulieu, J. W. R., Station CBV, Charlesburg, P.Q., Canada
- Bennett, S. R., 1308 Locust St., Williamsport 13, Pa.
- Berge, R. G., 86-12-138 St., Jamaica 2, N. Y.
- Bolenbaugh, R. K., 73 Oliver Rd., Wyoming 15, Ohio
- Booth, A. A., Canadian Marconi Co., Ltd., Trenton and Canora Rds., Town of Mount Royal, P. Q., Canada
- Bourne, J. D., 1472 Mackay St., Montreal, P. Q., Canada
- Brudwig, A. H., 4010 Mountain View Dr., Bremerton, Wash.
- Bushnan, S. F., 1411 N. Central Ave., Chicago 51, Ill.
- Caton, W. A., 132 Faraday St., Ottawa, Ont., Canada
- Colander, R. E., 2600 B Ave., N. E., Cedar Rapids, Iowa
- Cordes, E. L., 3304 N. Oakland Ave., Milwaukee, Wis.

(Continued on page 42A)

More Adaptable
**TO YOUR
PARTICULAR NEEDS**

**BUILT TO YOUR
SPECIFICATIONS FOR
THE LIFE OF
YOUR PRODUCTS**

THE know-how gained in engineering transformers to war's exacting specifications is now available to solve your peacetime transformer needs. Stancor engineers are ready to study and master the toughest problems you can set them. Production men trained to exacting standards, with modern equipment and precision winding machinery, assure that highest specifications will be met in the finished product.

When you have a transformer problem, think first of Stancor. Competent sales engineers are ready to satisfy your most exacting transformer requirements.



STANCOR
STANDARD TRANSFORMER CORPORATION
1500 NORTH HALSTED STREET CHICAGO 22, ILLINOIS

MYCALEX 410

... PERFECT
INSULATION PARTNER FOR
METALS

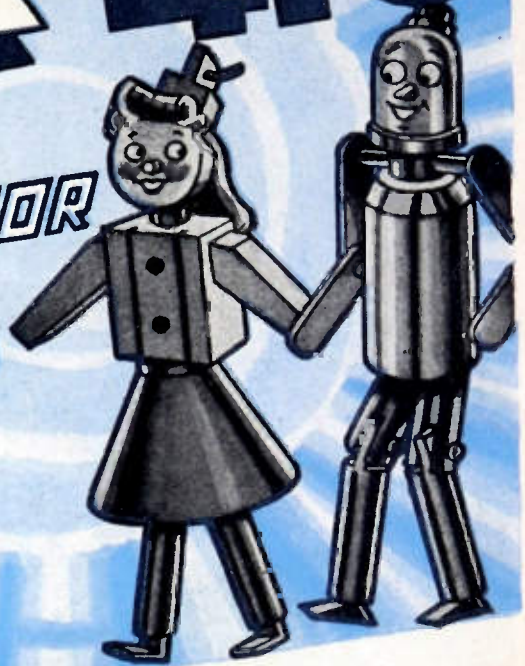

Where the need is for the most modern insulating material—of high dielectric strength and very low loss factor, the first thought of design engineers is MYCALEX. In applications requiring the incorporation of metal electrodes or inserts in the closest possible union with the insulation, the answer is new, advanced precision-molded MYCALEX 410.

Important new advancements in technique and process—exclusive with MYCALEX CORPORATION OF AMERICA—now make possible the nearest approach to theoretical "perfection" in bonding or sealing combinations of MYCALEX and metals into completely integrated units. We have the special facilities, the pioneering "know-how" and the plant capacity to mold your MYCALEX-METAL component parts—with a totally new (and heretofore impossible) degree of precision. The finished product will meet the most exacting electrical and mechanical requirements.* Ask us for complete details. Tell us your product needs.

*Withstands temperatures above 400°—Inorganic, no carbonization—Impervious to moisture and gases—Close tolerances.

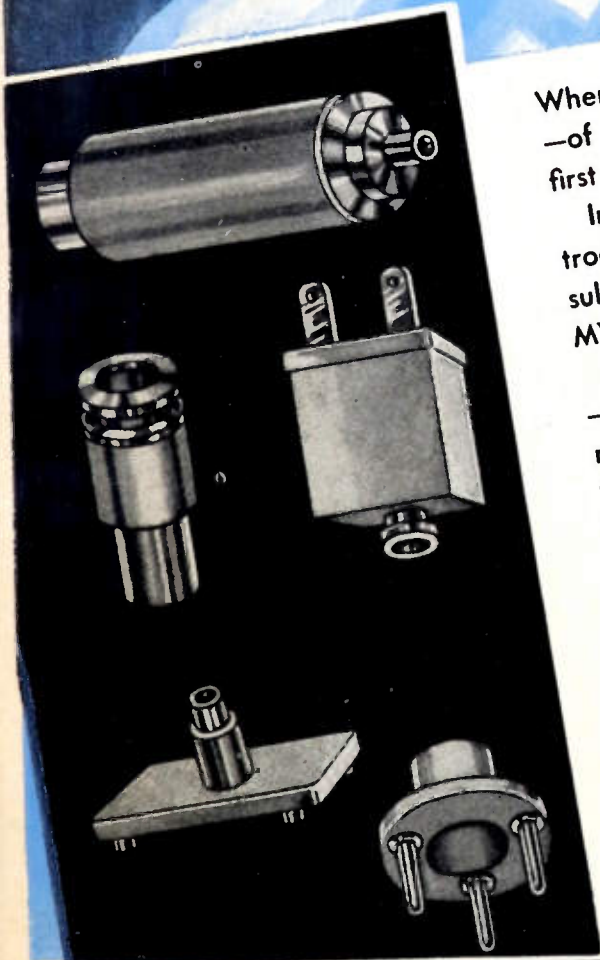

MYCALEX CORPORATION OF AMERICA

"Owners of 'MYCALEX' Patents"

Plant and General Offices, CLIFTON, N. J.

Executive Offices, 30 ROCKEFELLER PLAZA, NEW YORK 20, N. Y.



(Continued from page 40A)



**IF IT'S ELECTRICAL
... AND IF IT ROTATES**

Check with **EICOR**

A roster of all Eicor products, in their various types and sizes, shows an astonishing number and diversity. But of special interest to users of rotary electrical equipment is our ability to produce units unusual in design or performance ... and do it quickly, accurately, and at reasonable cost.

Serving in an endless list of special applications, these developments include ... the smallest commercially produced dynamotor, for 10 watts continuous output, in a 2-5/16" diameter frame and weighing only 34 ounces ... a motor rated 1/5 hp at 3800 rpm for intermittent duty, 2-5/16" in diameter, weight 38 ounces ... an aircraft inverter to supply output of 100 va, 400 cycle, single or three phase, in a 3" frame and unit weight of 5 3/4 lbs. ... a .6 hp, 4000 rpm, intermittent duty motor, 4" in diameter and 9 1/2 lbs. weight ... a dynamotor 4-1/16" in diameter which supplies 32 watts continuous output per pound weight ... a 12 vdc motor rated 1/4 hp at 1700 rpm with 150 in. lbs. lock torque in a 5 1/4" frame.

These highlights are an indication of what EICOR has done in the past. In the days to come our creative engineering will solve similarly difficult problems involving motors, dynamotors, and generating equipment for industry. Your inquiry is invited.



EICOR, INC. 1501 W. Congress St., Chicago, U.S.A.

DYNAMOTORS • D. C. MOTORS • POWER PLANTS • CONVERTERS

Export: Ad Auriema, 89 Broad St., New York, U.S.A. Cable: Auriema, New York

- D'heedene, A. R., 463 West St., New York 14, N. Y.
- Earp, J. A., 3311 E. 36 St., Kansas City, 3, Mo.
- Edwards, C. M., 35-36-83 St., Jackson Heights, L. I., N. Y.
- Emmett, R. A., Jr., 2552 Southern Ave., S. E., Washington, 20, D. C.
- Ensall, T., R.F.D. 8, P. O. Box 3, Dayton, Ohio
- Ferry, R. N., 8607 Cedar St., Silver Spring, Md.
- Foster, C. L., 1701 W. 73 Terrace, Kansas City 5, Mo.
- Gibson, G. B., 2108-31 St., S. E., Washington 20, D. C.
- Glan, G., 306 Iowa St., Urbana, Ill.
- Glovitsky, S. V., 832 W. 102 St., Los Angeles 44, Calif.
- Goodwin, P. S., 100 Huntington Rd., Garden City, L. I., N. Y.
- Gowdey, M. V., 1138 Haywood Ave., Manette Station, Bremerton, Wash.
- Graham, R. E., Bell Telephone Laboratories, 463 West St., New York, N. Y.
- Hale, N. H., 1295 Elmhurst Dr., N. E., Cedar Rapids, Iowa
- Hall, T. C., 2533 Yale Ave., N., Seattle 2, Wash.
- Hallaway, A. B., 6101 France Ave., S., Minneapolis 10, Minn.
- Jennions, A. E., 16 Henry St., Newport Man., England
- Katz, L., Natal Technical College, Durban, South Africa
- Keck, A., 68 Dalton Rd., Belmont 78, Mass.
- Kendall, P. R., 2220 Mt. Vernon Rd., S.E., Cedar Rapids, Iowa
- Kinsman, W. D., 4502 Frederick Ave., Baltimore 29, Md.
- Knox, M. E., 4309-44 Ave., S., Minneapolis 6, Minn.
- Kulberg, L. E., 6413 Buchanan St., Washington 19, D. C.
- Limpel, E. J., 3533 N. 27 St., Milwaukee 1, Wisc.
- Lindner, H. G., 208 E. Madison Ave., Collingswood, N. J.
- Lockwood, E. C., 1677 Cedar Ave., Cincinnati 24, Ohio
- Longacre, H. C. M., 117 Eldred St., Williamsport, Pa.
- Margolis, S., Sylvania Electric Products, Williamsport, Pa.
- Marino, J. L., 313-46 St., Brooklyn 20, N. Y.
- May, H. E., 4452 Washington Blvd., Chicago 24, Ill.
- McClellan, J. F., P. O. Box 291, Goshen, N. Y.
- Middleton, D., 51 Brattle St., Cambridge 38, Mass.
- Munson, L. J., 17 Crescent Park, Chattanooga 4, Tenn.
- Orba, A., Rose Cottage, Moorgreen, West-end, Southampton, England
- Pike, B. W., 58 Wilson Ave., Watertown, Mass.

(Continued on page 44A)

METAL ASSEMBLIES AND COMPONENTS FOR ELECTRONIC AND MECHANICAL DEVICES

●
ENGINEERING

●
DEVELOPING

●
FABRICATING

●
ELECTRO-FORMING

●
PLATING

●
FINISHING
●

BERNARD **R**ICE'S **S**ONS

I N C O R P O R A T E D

MANUFACTURERS OF QUALITY METAL PRODUCTS SINCE 1867

OFFICE: 325 FIFTH AVENUE, NEW YORK 16, N. Y.

WORKS: 139-145 NORTH TENTH STREET, BROOKLYN 11, N. Y.

Matched MIDGET CONTROLS

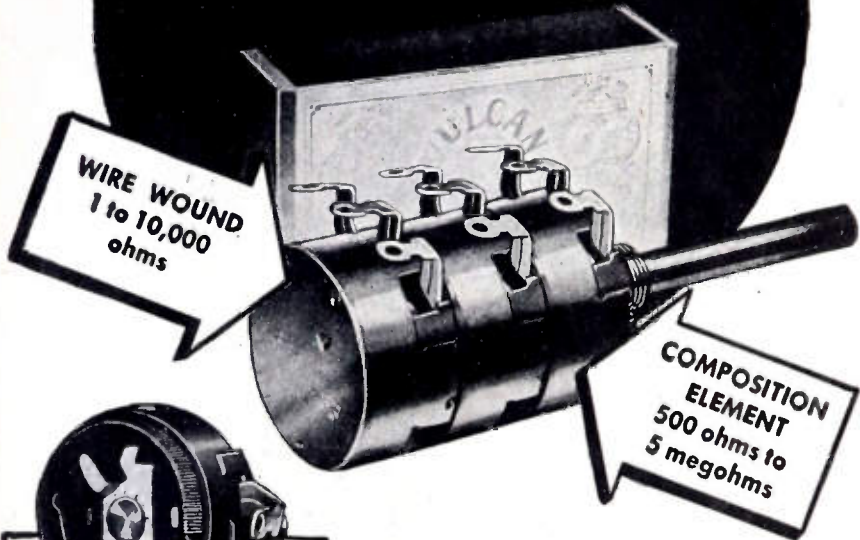

New

Clarostat Type 43 WIRE-WOUND MIDGET

Smallest unit now available of that rating.

Rated at 2 watts. 1 to 10,000 ohms.

Matches Clarostat Type 37 midget composition-element control—in appearance, dimensions, rotation, switch.

Available with or without power switch.

Available in tandem assemblies—suitable combinations of wire-wound and composition-element controls.

Type 37 composition-element controls rated at $\frac{1}{2}$ watt. 500 ohms to 5 megohms.

★ They look, measure and operate the same—these Clarostat wire-wound and composition-element midget controls. Fully interchangeable, mechanically. Can be made up in various tandem assemblies.

Clarostat Type 37 midget composition-element controls have been available for several years past. Their *stabilized element* has established new standards for accurate resistance values, exceptional immunity to humidity and other climatic conditions, and long trouble-proof service.

And now the Clarostat Type 43 midget wire-wound control is also available, to match Type 37—matched in appearance, dimensions, rotation, switch.

For neatness, compactness, convenience, trouble-free operation—just specify these Clarostat matched midget controls.

★ Write for literature. Submit that resistance or control problem. Let us quote on your requirements.

CLAROSTAT



Controls and Resistors

CLAROSTAT MFG. CO., Inc. · 285-7 N. 6th St., Brooklyn, N. Y.



(Continued from page 42A)

- Reed, P. B., RCA Victor Div., 1625 K St., N.W., Washington, D. C.
- Reedy, C. W., P. O. Box 955, Oakland 4, Calif.
- Reid, O. W., c/o S. A. Airways, Rand Airport, Germiston, South Africa
- Relson, M., 118-11—84 Ave., Richmond Hill 18, L. I., N. Y.
- Roake, W. C., 1007 Remington Rd., Philadelphia 31, Pa.
- Rugg, H. H., National Research Council, Radio Branch, Ottawa, Ont., Canada
- Rystedt, T., Gillette, N. J.
- Scott, J. E., Jr., 4859—68 St., San Diego 5, Calif.
- Seabrook, H. B., 5325 Victoria Ave., Montreal 26, P. Q., Canada
- Sears, P. R., 1115 Gary Ave., Baltimore 28, Md.
- Sheppard, C. B., Jenkintown and Ashbourne Rds., Cheltenham, Pa.
- Shoemaker, J. R., 1 Elmira St., S. E., Washington 20, D. C.
- Slougher, W. J., 11 Park Pl., Bloomfield, N. J.
- Smith, I. F., c/o G.P.O., London, E. C. 1, England
- Steelman, R. J., 3 Twain Pl., Dayton 10, Ohio
- Thomas, E. U., Specialties, Inc., Syosset, L. I., N. Y.
- Trevor, J. B., Jr., Naval Research Laboratory, Washington 20, D. C.
- Tuller, W. G., 4 Solon St., Wellesley 81, Mass.
- Vogel, V. H., 119—38 St., N. E., Cedar Rapids, Iowa
- Wahl, A. C., R.F.D. 3, P. O. Box 83, Cincinnati 11, Ohio
- Wallace, R. J., Canadian Marconi Co., Town of Mount Royal, P. Q., Canada
- Ware, L. A., Dept. of Electrical Engineering, State University of Iowa, Iowa City, Iowa
- Watson, A. D., High St., Clinton, Ont., Canada
- Wheeler, H. T., 628 Harvard St., Houston 7, Texas
- Wileman, R. A., 1308 W. Albanus St., Philadelphia 41, Pa.
- Woodward, T. M., Jr., 203 E. 5 St., Emporium, Pa.
- Admission to Member**
- Adamson, A. A., Bell Telephone Laboratories, Whippany, N. J.
- Affanasiev, K. J., 12 Hamilton Pl., Garden City, L. I., N. Y.
- Arnett, R. A., 114 Jackson Ave., Schenectady 4, N. Y.
- Aron, M., 1262—49 St., Brooklyn 19, N. Y.
- Baucum, P. G., 458 Wisconsin Ave., Mobile 19, Ala.
- Beckwith, J. R., 115 N. Parkside Ave., Chicago 13, Ill.
- Bernard, H. S., 157 Cedarhill Ave., Belleville, N. J.
- Beyer, C. M., 1739—31 St., San Diego 2, Calif.

(Continued on page 46A)

Down to fundamentals...

IN TRANSFORMER DESIGN FOR POST-WAR



★ The product illustrated typifies N-Y-T compact designs incepted by N-Y-T for mobile, airborne and portable equipment.

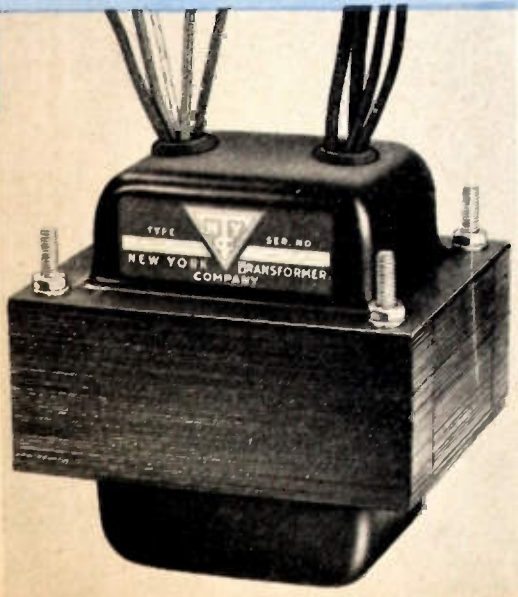

A consideration of time and cost factors!

N-Y-T engineers are now in a position to extend close collaboration in the solution of transformer, choke and filter problems—from blueprint to finished product. They are prepared to design special components for specific applications and produce them promptly at low unit cost. This unique service is made possible by the specialized engineering and production facilities of N-Y-T. Our engineers are available for consultation.

Address inquiries to Dept. P

NEW YORK TRANSFORMER CO
26 WAVERLY PLACE, NEW YORK 3, N. Y.

T-725 *an* unequaled Phenolic Laminate AS FAR AS WE KNOW!

Superior insulation resistance, low moisture absorption and good hot punching qualities—that's INSUROK T-725—a plastic that's really worth shouting about!

For parts made of INSUROK T-725 can be "sanded down" to meet very close thickness and surface parallelism requirements—yet retaining their superior insulation resistance, punching and low moisture absorption qualities, which are *unequaled by any other phenolic laminated material we know about.*

INSUROK T-725 is an improvement on T-640 and therefore has uniformly superior electrical values and mechanical characteristics. Altogether, we think it adds up to important news for those working with electronics applications. Richardson Plastics are waiting to give you the full story. Write today—there's no obligation.

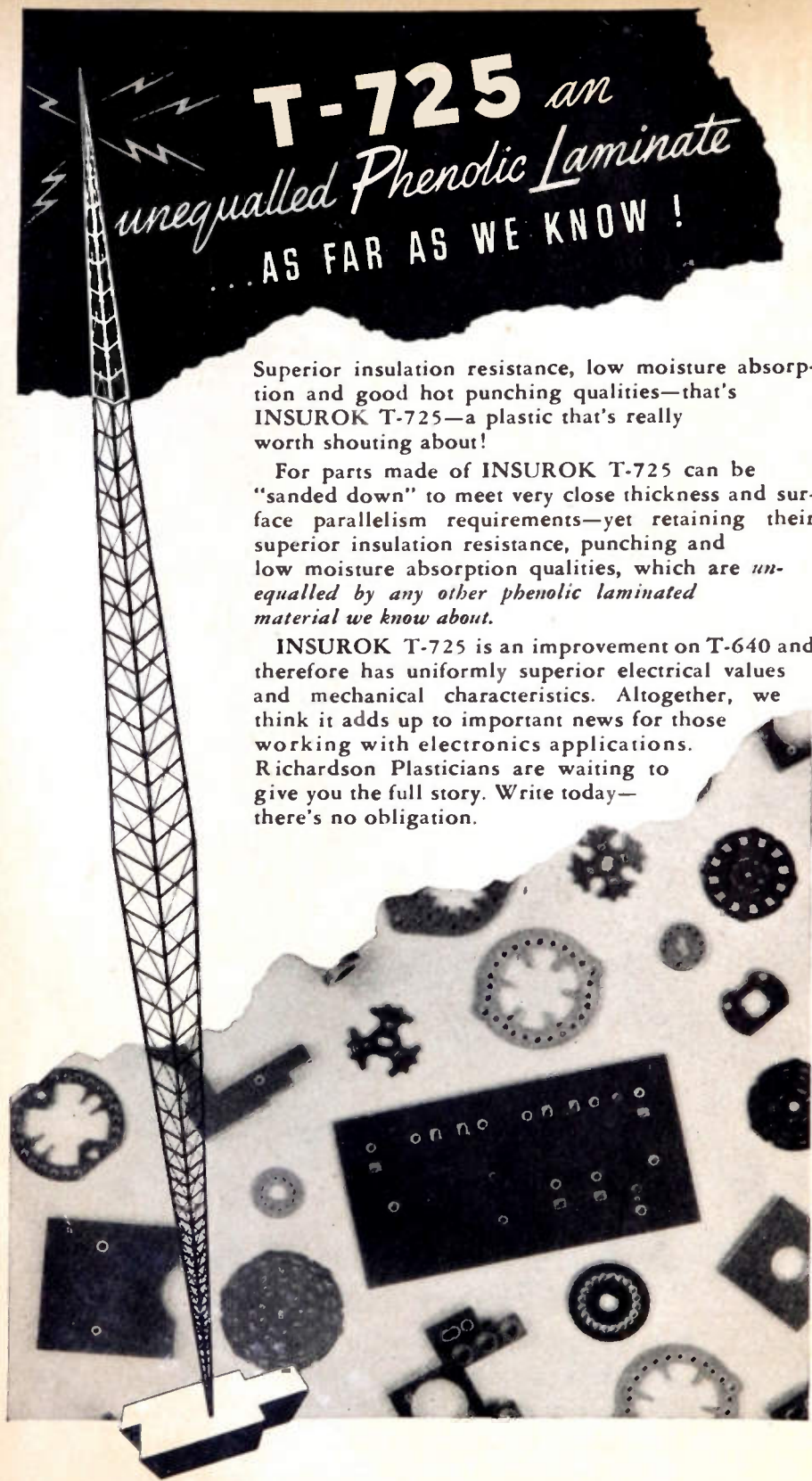

INSUROK *Precision Plastics*

The RICHARDSON COMPANY

LOCKLAND, CINCINNATI 15, OHIO FOUNDED 1858 Sales Headquarters: MELROSE PARK, ILL.

Sales Offices: NEW YORK 6 • CLEVELAND 15 • DETROIT 2

Factories: MELROSE PARK, ILL. NEW BRUNSWICK, N. J. INDIANAPOLIS, IND.



(Continued from page 44A)

- Bradley, C. F., 1657 Sunset Cliffs Blvd., San Diego 7, Calif.
 Brinster, J. F., Palmer Physical Laboratory, Princeton, N. J.
 Brownell, G. T., c/o Majestic Radio and Television Corp., St. Charles, Ill.
 Bruns, R. A., Radio Research Laboratory, Harvard University, Cambridge, Mass.
 Bryden, E. W. J., 8, Elgin Rd. Seven Kings, Essex, England
 Burden, B. C., P. O. Box 931, Lincoln, Nebr.
 Campbell, R. L., 229—23 St. Dr., S. E., Cedar Rapids, Iowa
 Chamberlain, J. E., 135 Union St., Xenia, Ohio
 Chandler, G. E., 130 Forest St., Winchester, Mass.
 Chen, N., 14 W. 3 St., Kansas City, Mo.
 Clifford, D. G., 381 Dana Ave., Palo Alto, Calif.
 Cook, F. S., 198 W. Como Ave., Columbus 2, Ohio
 Cooke-Yarborough, E. H., Bracken Bank, Wells Rd., Malvern Wells, Worcs., England
 Cooley, R. M., 516 Poplar St., Emporium, Pa.
 DePew, R. T., 2924 Woodway Ave., Dayton 5, Ohio
 Dorris, R. C., 135 S. Harrison St., East Orange, N. J.
 Drake, H. B., 31 Concord Ave., Cambridge 38, Mass.
 Dunlap, H. B., c/o Fleet Post Office, San Francisco, Calif.
 Eaden, N., 6244—29 St., N. E., Seattle 5, Wash.
 Elsea, I. W., 60 Hudson St., Room 1811, New York, N. Y.
 Fenske, O. E., Jr., 2741 Logan Blvd., Chicago 47, Ill.
 Fleming, H. A., 3214—32 Ave., W., Seattle 99, Wash.
 Folsom, D. E., P. O. Box 2072, Anchorage, Alaska
 Foltz, H. M., Jr., 811 W. Cottage St., Houston 9, Texas
 Frantz, W. P., 72 Roosevelt St., Garden City, L. I., N. Y.
 Gannaway, R. R., 411 S. Harvey St., Oak Park, Ill.
 Gehman, J. B., 3131 N. Capitol St., Indianapolis, Ind.
 Gomberg, H. J., 2932 Southern Ave., S. E., Washington 20, D. C.
 Good, W. E., Westinghouse Research Laboratories, East Pittsburgh, Pa.
 Goodship, G., D.A./S.M., Admiralty, Bath, England
 Gottfried, N. J., Federal Telephone and Radio Corp., 67 Broad St., New York 4, N. Y.
 Hanson, R. O., P. O. Box 271, Columbia Univ., New London, Conn.
 Harper, R. B., 362 Henry St., East Hempstead, L. I., N. Y.

(Continued on page 48A)



Switches

Shown above are a few of the many types of micro-switches, toggle switches, knife switches, rotary switches, band switches, etc., now available through the Hallicrafters Co., Chicago, agent for the Reconstruction Finance Corporation under contract SIA-3-24.

Other radio and electronic components such as resistors and condensers are also available in large quantities. Send the coupon for further details.

hallicrafters RADIO

THE HALLICRAFTERS CO., AGENT FOR RFC UNDER CONTRACT SIA-3-24
MANUFACTURERS OF RADIO AND ELECTRONIC EQUIPMENT

THESE VALUABLE ITEMS *Available Now*
or very soon. Write, wire or phone for further information.

• head phones • test equipment • component parts •
marine transmitters and receivers • code practice equip-
ment • sound detecting equipment • vehicular operation
police and command sets • radio beacons and airborne
landing equipment.

CLIP THIS COUPON NOW

RFC DEPARTMENT 307, HALLICRAFTERS
5025 West 65th Street • Chicago 38, Illinois

Send further details and price on Switches and component parts

Send listings of other available items

Especially interested in.....

NAME.....

ADDRESS.....

CITY..... ZONE.....

STATE.....



An Announcement To Those Who Require The Best

THIS advertisement is addressed to the manufacturers of electronic equipment whose product demands the best in component parts—who will want the best in transformers, if “the best” is offered at a price that will fit the cost specifications of their finished product.

By adapting to peace-time use the major features of the Hermetically-Sealed transformer construction that won war-time leadership, Chicago Transformer is prepared to provide the best in transformers to those who require them. Fully developed basic mounting parts, when utilized on a mass production basis, will provide the element of economy in manufacture.

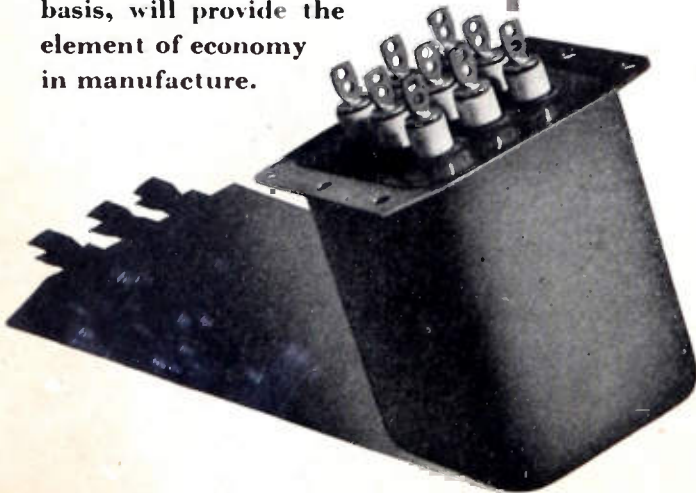

CHICAGO TRANSFORMER

DIVISION OF ESSEX WIRE CORPORATION

3501 WEST ADDISON STREET

CHICAGO, ILL.



(Continued from page 46A)

- Harrell, D. H., 4618 Chester Ave., Philadelphia 43, Pa.
 Haselton, M. L., 1 Roseld Ave., Deal, N. J.
 Hathaway, S. W., 56 Concord Ave., Cambridge 38, Mass.
 Henry, W. E., Radiation Laboratory, Massachusetts Institute of Technology, Cambridge 39, Mass.
 Hoehn, A. J., Jr., 302 Barrington St., Rochester 7, N. Y.
 Hope, D. L., 1944 Tennyson St., Kansas City, Kan.
 House, L. G., 23 Highview Ave., Wethersfield 9, Conn.
 Hunter, J. L., 2513 Maclay Ave., Bronx, N. Y.
 Iskenderian, H. P., Hudson View Gardens Apts., 183 and Pinehurst Aves., New York 33, N. Y.
 Kao, C., Chung-Chin Kao Laboratories, 220 E. 42 St., New York 17, N. Y.
 Kauffman, H. C., 960 King Ave., Lorain, Ohio
 Kent, H. A., 114 Wyatt Rd., Garden City, L. I., N. Y.
 Lambert, J. S., 317 E. Emerson Ave., Osborn, Ohio
 Larson, H. G., 3212 Georgia Ave., St. Louis Park 16, Minn.
 Leas, J. W., Naval Research Laboratory, Washington 20, D. C.
 Line, G. D., 113 Avila Rd., San Mateo, Calif.
 Lyngstad, E. O., R.F.D. 3, P. O. Box 574, Bremerton, Wash.
 Mager, I., 1910 Griffiss Ave., Baltimore 30, Md.
 Maninger, R. C., 870 S. Euclid Ave., Pasadena 5, Calif.
 Mansur, F., 4339 Bowen Rd., S. E., Washington 19, D. C.
 Meader, R. O., 34 Thaxter Rd., Newtonville 60, Mass.
 Nichols, F. J., 1808 Ferguson Dr., Montebello, Calif.
 Olson, N. K., 4204—11 St., N. E., Seattle, 5, Wash.
 Parcinski, H. J., 33 Heil Ave., Trenton 8, N. J.
 Parker, M. L., Jr., 5720 N. Washington Blvd., Arlington, Va.
 Parrott, R. D., 21—19 St., West New York, N. J.
 Pollard, J., Y. M. C. A. Hostel, Wormley, Godalming, Surrey, England
 Queen, W. H., 450—26 Ave., San Mateo, Calif.
 Ridings, G. H., 60 Hudson St., New York, N. Y.
 Rosch, W. J., 20 Chesapeake St., S.W., Washington 20, D. C.
 Roshon, A. H., Jr., 4820 Cape May Ave., San Diego 7, Calif.
 Shamos, M. H., New York University, Washington Square, New York 3, N. Y.
 Smith, H. H., Watson Laboratories, ATSC, Red Bank, N. J.
 Speller, J. T., 3846 N. 17 St., Philadelphia 40, Pa.

(Continued on page 56A)

Start **RIGHT**
AND YOU *End*
RIGHT!



**with WESTONS ON ALL PRODUCTION
 TEST-STANDS AND INSPECTION EQUIPMENT!**

With the race for markets in full swing, electrical manufacturers are eliminating costly production bottlenecks by providing uniform dependability in testing procedure all along the line. From the inspection of purchased components right through to final product inspection, they insure accurate testing by using instruments they can trust.

And it's easy to insure measurement dependability at every step, because there are WESTONS for every testing need . . . including types for all special test-stand requirements, as well as a broad line of multi-range, multi-purpose test instruments. These compact, multi-purpose testers often afford new simplicity and economies in testing procedure, while assuring the dependability for which WESTONS are renowned.

Literature describing the complete line of WESTON panel and test instruments is freely offered . . . Weston Electrical Instrument Corporation, 578 Frelinghuysen Avenue, Newark 5, New Jersey.



Weston *Instruments*

ALBANY • ATLANTA • BOSTON • BUFFALO • CHICAGO • CINCINNATI • CLEVELAND • DALLAS • DENVER • DETROIT • JACKSONVILLE • KNOXVILLE • LOS ANGELES • MERIDEN
 MINNEAPOLIS • NEWARK • NEW ORLEANS • NEW YORK • PHILADELPHIA • PHOENIX • PITTSBURGH • ROCHESTER • SAN FRANCISCO • SEATTLE • ST. LOUIS • SYRACUSE
 In Canada, Northern Electric Co., Ltd., Powerlite Devices, Ltd.

Draftsman Wanted

Also

**Designer
Detailer
Tracer and
Engineer**

We are one of the largest manufacturers of a wide variety of communication and electronic equipment in the world, fully prepared and ready to go ahead with a very ambitious, expansion program as quickly as we are permitted. There will be unlimited possibilities for creative, ambitious men to advance to key positions both in research development and production field.

At present, we are producing vital equipment for our fighting forces.

Good Starting Salaries
Exceptionally fine working conditions.

Apply Personnel Office
8 A.M. to 5 P.M.

**FEDERAL TELEPHONE &
RADIO CORP.**

the Mfg. unit of the International
Tel. & Tel. Corp.
591 Broad St., Newark, N.J.
WMC Rules Observed



The following positions of interest to I.R.E. members have been reported as open. Apply in writing, addressing reply to company mentioned or to Box No. . . .

The Institute reserves the right to refuse any announcement without giving a reason for the refusal.

PROCEEDINGS of the I.R.E.
330 West 42nd Street, New York 18, N.Y.

RADIO ENGINEERS

For design and development of home radio receivers. Can use men with experience in design laboratories on communications and entertainment receiving sets. Call or write Mr. Frank A. Hinners, Vice President in Charge of Engineering, Air King Products, 1523 63rd St., Brooklyn 19, N.Y.

SENIOR ENGINEER

Expanding New York radio and television manufacturer, requires man with several years thorough experience in design and production of home radio receivers. Not a temporary but a permanent opportunity. High pay. Excellent future. U. S. Television Manufacturing Corp., 106 Seventh Ave., New York 11, N.Y.

ENGINEERS

A large midwest manufacturer has immediate openings for the following engineers:

Senior Development Engineers. Openings in domestic radio and television receiver development for two Senior Radio Project Engineers and one Mechanical Engineer.

Assistant Chief Engineer. To assume complete supervision of household and auto radio receiver development. Extensive prewar experience in above lines imperative. Television receivers will be in our line.

Research Engineers. Two research men with prewar development experience in the radio receiver or television field.

All inquiries will be treated as confidential. Reply to Box 406.

ENGINEERS

With experience in audio circuit work for engineering development on hearing aids and associated devices. Experience on hearing aids not actually necessary. Apply to Chief Engineer, Zenith Radio Corporation, 6001 West Dickens Avenue, Chicago 39, Illinois, giving details of education, age and experience. Excellent opportunities for interested personnel.

ENGINEER OR TECHNICIAN

To write articles on radio (particularly FM) and television, including maintenance. Fee basis. Collaboration possible for beginners. Lieutenant Myron Eddy, 295 Broadway, New York 7, N.Y.

(Continued on page 52A)

ENGINEERS

*For Design Work
on Radio Receivers,
Audio Amplifiers,
Television*

Men with substantial commercial experience wanted, preferably those having Degrees in Electrical or Communications Engineering. Write, giving details of experience and salary expected, to:

FREED RADIO CORPORATION

*Makers of the Famous Freed-
Eisemann Radio-Phonograph*

**200 Hudson Street
New York 13, N.Y.**

IF YOU ARE A SENIOR ELECTRONIC ENGINEER

Who Can Design
For Production
YOU WILL LIKE
THIS POSITION

If you have a thorough working knowledge of tubes and circuits in frequencies to 100 kc. and would like a permanent position with an alert Chicago firm, this may be your opportunity. We will pay from \$5000 to \$6000 a year for a man under forty who can design low frequency equipment, and who wants responsibility. There is plenty of room and opportunity for advancement. Please tell us all about yourself in your first letter—state your age, experience, education, etc. Enclose a small snapshot of yourself.

BOX 407

The Institute of Radio Engineers
330 West 42nd Street
New York 18, N.Y.



TRANSPORTATION



PETROLEUM



CONSERVATION



PROTECTION



MOTION PICTURES



UTILITIES



NEWSPAPERS



The New Bendix-Pacific

VHF MOBILE RADIO COMMUNICATION SYSTEMS

Bendix—famous for many recent new developments in radio for industry and home—now announces advanced VHF radio communication systems for mobile use.

The new systems, which offer greatly improved performance characteristics and economy of operation, are available for use in three of the Very High Frequency bands—30-44 megacycles, 72-76 megacycles and 152-162 megacycles.

All the equipment has been designed to use low input power. Any extended service can be provided with relay facilities.

For five years Pacific Division's radio research group has been working with military experts on advanced designs of VHF

communication and control systems, and the new equipment embodies the latest developments for commercial application. In addition to new performance characteristics, the Bendix-Pacific equipment has been designed for compactness, long life and for easier service and maintenance.

Whatever application of radio voice communication you are planning, Pacific Division is interested in explaining the advantages of the new equipment to you. Pacific Division, Bendix Aviation Corporation, 11676 Sherman Way, North Hollywood, California.

Sales Engineering offices in New York and St. Louis.



One of the new VHF communication units combining transmitter and receiver in a single cabinet for either mobile or fixed station installation.

Pacific Division
 Bendix Aviation Corporation
COMMUNICATION SYSTEMS

★ **CREI Offers**
A Planned Program
of
GROUP
TRAINING

To Modernize the Technical Knowledge of Your Employees Through Modern Training for Professional Self-Improvement

If your organization is engaged in any phase of radio-electronics, your technical personnel must know FM—television — Ultra High Frequency Techniques, and all other phases of war-developed electronics technology; and, of course, a thorough and complete knowledge of the fundamentals of practical radio-electronics engineering.

The CREI "Employers' Plan" for group training will:

1. Increase the technical abilities of your radio-electronics personnel.
2. Enable them to perform their duties more efficiently and in less time.
3. Increase the value of their services to your organization.

No company time is required for this training . . . It is accomplished by spare-time, home study, and is tailored to meet each individual organizations requirements.

The CREI "Employers' Plan" is useful for the up-grading of technical personnel in manufacturing, AM, FM, and television broadcasting, communications, industrial electronics, including the following:

Engineers	Testers
Engineering Aides	Technicians
Laboratory Assistants	Field Servicemen
Inspectors	Installers
	Maintenance Men

Your request will promptly bring an outline of the plan, as now in use with other organizations, and intimate details will follow when your particular needs are known. No obligation or cost, of course.

CAPITOL RADIO
Engineering Institute

E. H. RIETZKE, President

Home Study Courses in Practical Radio-Electronics Engineering for Professional Self-Improvement

Dept. PR-10, 3224—16th St., N.W.
WASHINGTON 10, D.C.

Contractors to the U. S. Navy—U. S. Coast Guard — Canadian Broadcasting Corp. Producers of Well-trained Technical Radiomen for Industry.



(Continued from page 50A)

RADIO ENGINEER

Several years experience on radio receivers and associated equipment desirable. Circuit development and mechanical design. Knowledge of production test procedure and test equipment. Opportunity in new division in established firm. Premier Crystal Laboratories, Inc., 63 Park Row, New York 7, N.Y.

ACOUSTICAL ENGINEER

Preferably with E.E. degree to work in the field of microphones, phones, and supersonics. Our employees know of this advertisement. Box 399.

SEVERAL ENGINEERING POSITIONS

Progressive midwestern capacitor manufacturer has permanent key positions for top notch executive calibre men as follows:

Electrolytic Development Engineer

Capable of designing and supervising installation of equipment. To take complete charge of laboratory and supervise production quality control. Must have previous experience with etching and formation processes.

Electrical Engineer

Should have broad background of theory and practice in small electrical parts or equipment manufacturing. Position at present that of coordinating engineering problems of field sales with laboratory, engineering and manufacturing departments. Will have wide latitude of authority and report directly to management. To the right man, position will lead to that of Chief Electrical Engineer. Experience in capacitor field is advisable.

Electrical Engineer Power Factor Improvement

This key position for a new department requires an electrical engineer with specific experience in power factor improvement problems. Technical writing ability is important. The right man probably would have gained his experience with a public utility or manufacturer of heavy power equipment. He must be qualified to create and supervise an entire department for sales of capacitors used in power factor improvement. He will be given assistance of a competent staff of capacitor engineers but will be required to design and arrange for manufacture of associated power factor equipment. Sales experience will be helpful but not essential.

Applicants are requested to outline experience, education, present and previous earnings and salary requirements. All replies will be held in strictest confidence. Our own engineers know of this advertisement. Address Box 401, Proceedings of the I.R.E., 330 West 42nd Street, New York 18, New York.

(Continued on page 54A)

Quality Phosphors

FOR A VARIETY OF NEEDS

Patterson high-grade phosphors, produced singly or in blends, meet a variety of specific needs. For more than thirty years, the Patterson Screen Division of the Du Pont Company has manufactured superior fluorescent materials. Principal component of world-famed Patterson Screens for precision x-ray work, these phosphors facilitate important radiographic diagnosis.

Manufactured under exacting conditions, Patterson phosphors are distinguished for uniformity of emission, color and grain size. Shades, grain structures and life of afterglow are assured.

Throughout the war period, Patterson Luminescent Chemicals served makers of cathode ray tubes for television and radar equipment. Now they are available for similar applications and research work. A descriptive booklet sent upon request. Patterson Screen Division of E. I. du Pont de Nemours & Co. (Inc.), Towanda, Pa.



Patterson Luminescent Chemicals



BETTER THINGS FOR BETTER LIVING
...THROUGH CHEMISTRY

250 Watts of
Broadcast
Satisfaction

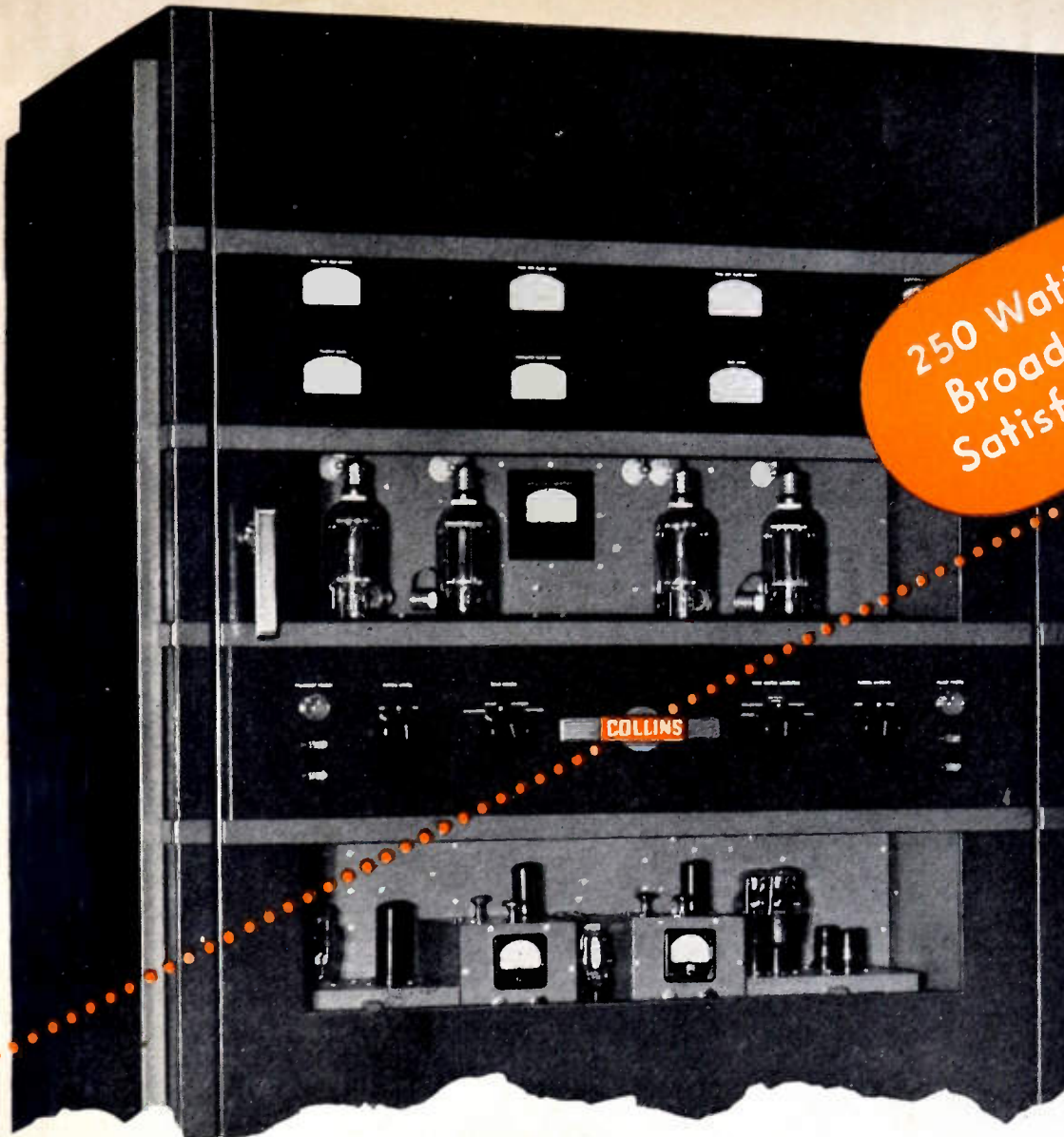

**Collins 12Z
Remote Amplifier**

A high quality four channel remote amplifier, a.c.-d.c. powered. The d.c. source consists of self-contained batteries which take the load automatically in case of a.c. line failure. Gain, approximately 95 db. Frequency response, 30-12,000 c.p.s. ± 1 db. Power output, 50 milliwatts. Weight, with batteries and carrying case, 32 pounds.



The new Collins 300G-1 AM broadcast transmitter is an operator's ideal. Its components are the finest available, with very high safety factors, *and all are completely and immediately accessible.* Replacements, if necessary, are just a quick, simple one-man job!

Circuit design, physical arrangement, and workmanship throughout, meet the superior standards which station engineers have come to expect of Collins engineering.

The nominal power output of the 300G-1, 250 watts, can be reduced to 100 watts by means of a switch on the control panel. The response is flat within ± 1.0 db from 30 to 10,000 cycles. Distortion is less than 3% up to 100% modulation.

Tell us about your plans. We will be glad to study them with you and make recommendations covering requirements for your entire station, AM or FM, and of any power. Collins Radio Company, Cedar Rapids, Iowa; 11 West 42nd Street, New York 18, N. Y. In Canada, Collins equipment is sold by Collins-Fisher Limited, Montreal.

FOR BROADCAST QUALITY, IT'S . . .

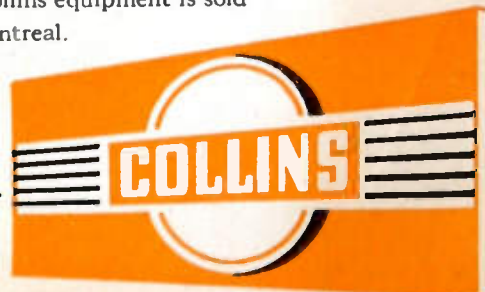

CARDWELL

skill and facilities
responsible for this
"SPECIAL ORDER" Equipment
are available for your design
and production problems . . .



Rack Mounted Metrodyne Frequency Meter, Type 221 — Complete with A.C. power supply, ranges: 125 kc. to 20,000 kc.

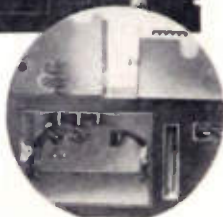

Similar Frequency Meter in Portable Case—Battery operated (or A.C. power supply can be substituted); ranges of various Frequency Meters:

Type 221	125 kc. to	20 Mc.
Type 173	90 Mc. to	450 Mc.
Type 174	20 Mc. to	250 Mc.
Type 175	85 Mc. to	1000 Mc.



These are instruments of accuracy and precision as manufactured for government service by the makers of Cardwell variable and fixed air capacitors, which have long been a "Standard of Comparison."

The Cardwell engineering and manufacturing personnel and facilities, so skillfully employed on this equipment, are available for any production or design problem in the field of electronics.

Address inquiries to:

DEPT. M, CONTRACT MANUFACTURING DIVISION



**THE ALLEN D. CARDWELL
MANUFACTURING CORP.**

Main Office: 81 Prospect St., Brooklyn 1, N. Y.
Factories: Plainville, Conn. — Brooklyn, N. Y.



(Continued from page 52A)

TELEVISION ENGINEERS

Design experience in the development of television cameras, terminal equipment or transmitters. State experience and salary desired. Apply in person or in writing to Personnel Department, Raytheon Manufacturing Company, Inc., Communications Division, 60 E. 42nd St., New York 17, N.Y.

SALES ENGINEER

For sale of new and interesting electronic device. Must have had previous sales experience in radio or other electronic equipment. A real opportunity for right man with large international organization. Write qualifications in detail to Box 400.

DIRECTOR OF ENGINEERING

Smaller firm with national organization and established post-war business in electronic, audio and electro-acoustic fields has opening for engineer in charge of development and design. Salary liberal. Must have engineering degree and practical experience. Design of audio and electro-acoustic systems. Replies confidential. State education, experience record, patents, etc. Photograph if available. Box 398.

SALES ENGINEER

Manufacturer of materials for radio components needs sales engineer with good technical background to appraise and work on technical details in the sales of their products. Headquarters New York. Box 402, Proceedings of the I.R.E., 330 West 42nd Street, New York 18, New York.

ENGINEERS

Opportunities are offered by an expanding, progressive engineering organization to first-class Development, Communication and Radio Engineers with extensive prewar experience. Write: Maguire Industries, Inc., Electronics Division, Personnel Dept., 342 W. Putnam Ave., Greenwich, Conn.

RADIO PARTS OF "TAYLOR LAMINATED PLASTICS"

WHETHER OR NOT your

Post-war radio has the

Tone, selectivity and quality

Appearance to give it a head start

On competition depends to a large

Extent upon how closely the

ENGINEERS who design it follow

Modern developments, especially

In the field of LAMINATED PLASTICS

Where great strides have been made

During the WAR YEARS in the

Development of new and better

Materials and methods.

Like to KNOW MORE? Write us today.

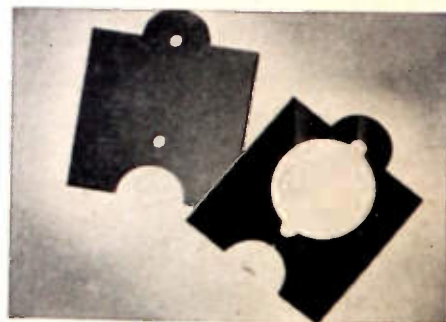

This two-part radio insulator is typical of Taylor's ability to mass-produce accurate parts. Each is stamped in a single operation, one from Vulcanized Fibre and the other from a grade of Phenol Fibre noted for its high dielectric strength. Whatever combination of qualities you may need, it's a good bet that Taylor can give it to you.

TAYLOR FIBRE COMPANY

LAMINATED PLASTICS: PHENOL FIBRE-VULCANIZED FIBRE
Sheets, Rods, Tubes, and Fabricated Parts
NORRISTOWN, PENNSYLVANIA
OFFICES IN PRINCIPAL CITIES

Pacific Coast Headquarters:
544 S. SAN PEDRO STREET, LOS ANGELES

Proceedings of the I.R.E. December, 1945

TRANSMITTERS

by

PRESS WIRELESS



RADIO TRANSMITTER PW-981-A

This compact 2500 watt, remote-control, air-cooled, radio transmitter is engineered to the same precision standards that characterize all Press Wireless communication equipment. Operating frequencies from 2.5 to 23 megacycles are available for radio-telegraph, radio-teleprinter, radio-photos and facsimile.

Amplitude ON-OFF keying speeds to 150 w.p.m. may be employed. A Frequency Shift Unit built into the transmitter permits the important advantages of high-speed frequency shift keying.

Radio transmitter PW-981-A combines simplicity of operation with carefully integrated design to occupy a floor space less than one square yard. The unit operates from a 3-phase, 220/230 volt, 50/60 cycle, 8-kilowatt power source.

Write for free engineering bulletin.

PRESS WIRELESS, INC.

Executive and Sales Office, 1475 BROADWAY, NEW YORK 18



Awarded to our Hicksville, L. I. plant for outstanding achievement in war production.

PARIS · BUENOS AIRES · RIO DE JANEIRO · MONTEVIDEO · MANILA · BERNE · SANTIAGO DE CHILE · NEW YORK · CHICAGO · LOS ANGELES · LONDON · HAVANA

THE FEATHEROAK?

THERE'S NO SUCH THING... BUT

Skydyne

SANDWICH CONSTRUCTION

IS

**LIGHT AS A FEATHER...
STRONG AS AN OAK...**



... a long-sought combination correctly engineered into "SKYPLY"—the miracle material now available for your electronics cabinet needs.

Rigidly tested on fighting fronts throughout the world, where "SKYPLY" radar and radio cabinets proved their resistance to heat, cold, moisture, vibration and sound—this modern Skydyne Sandwich Construction is the perfect

answer to your product housing requirements.

Results of the "Drop Test" show that "SKYPLY" is twice as strong with half the weight, thereby reducing dead weight and lowering shipping costs.

Adaptable to all types of designs because "SKYPLY" is form-moulded, this Skydyne Sandwich Construction offers a beautiful, smooth surface, with curvatures easily attained.

Get the full story of this and many other "SKYPLY" uses.

WRITE TODAY FOR OUR FREE BROCHURE

Skydyne Inc

PORT JERVIS, NEW YORK



"SKYPLY"

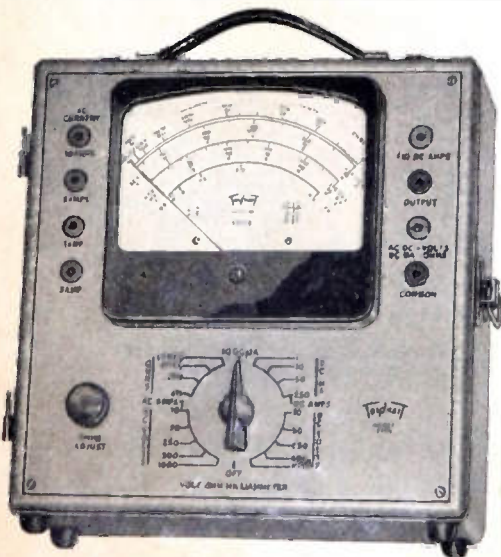

MODEL 2405

**Volt · Ohm
Milliammeter**

25,000 OHMS PER VOLT D. C.

STANDARDS ARE SET BY



SPECIFICATIONS

NEW "SQUARE LINE" metal case, attractive tan "hammered" baked-on enamel, brown trim.

■ **PLUG-IN RECTIFIER**—replacement in case of overloading is as simple as changing radio tube.

■ **READABILITY**—the most readable of all Volt-Ohm-Milliammeter scales—5.6 inches long at top arc.

Model 2400 is similar but has D. C. volts Ranges at 5000 ohms per volt.

Write for complete description

Triplet

ELECTRICAL INSTRUMENT CO.

BLUFFTON OHIO

**NEW ENGINEERING
NEW DESIGN • NEW RANGES
50 RANGES**

Voltage: 5 D.C. 0-10-50-250-500-1000 at 25000 ohms per volt.
5 A.C. 0-10-50-250-500-1000 at 1000 ohms per volt.

Current: 4 A.C. 0-.5-1-5-10 amp.
6 D.C. 0-50 microamperes—0-1-10-50-250 milliampers—0-10 amperes.

4 Resistance 0-4000-40,000 ohms—4-40 megohms

6 Decibel -10 to +15, +29, +43, +49, +55

Output Condenser in series with A.C. volt ranges



(Continued from page 48A)

- Steinhauser, H. B., 119 Harrison Ave., Montclair, N. J.
- Stephenson, R. G., P. O. Box 1663, Santa Fe, N. M.
- Thatcher, W. H., Bell Telephone Laboratories, Whippany, N. J.
- Thompson, W. E., 125-38 St., N. E., Cedar Rapids, Iowa
- Todd, W., 95 Riverview Ave., Neptune City, N. J.
- Van Raalte, C., 19 Erindale Ave., Toronto, Ont., Canada
- Wanner, L. R., 4700 Stenton Ave., Philadelphia 44, Pa.
- Wearth, A. W., 6006 El Monte St., Mission, Kansas
- Weimer, F. C., Dept. of Electrical Engineering, Ohio State University, Columbus 10, Ohio
- Weppler, H. E., 7412 Dexter Blvd., Detroit 6 Mich
- Wilbur, E. T., R.F.D. 2 Miamisburg Ohio
- Williams, G. V., R.F.D. 1, P. O. Box 186d Bremerton Wash
- Witschner, Y., P. O. Box 6 Overland Park Kansas
- Wojciechowski, B. M., 530 Riverside Dr., New York 27, N. Y.

Admission to Associate

- Aldrich, A. J., c/o Postmaster, Miami, Fla.
- Arand, E. M., 3125 N. Emerson St., Franklin Park, Ill.
- Bain, R. K., 15 Odell Ave., Beverly, Mass.
- Beaman, W. G., 511 N. Howard St., Akron, Ohio
- Beardsley, C., 163 Tooker Ave., Springfield, N. J.
- Bennett, L. C., 116 E. 12 Ave., Columbus 1, Ohio
- Bennison, G. K., 399 W. Park Ave., Oakhurst, N. J.
- Betros, L. A., 605 E. 69 St., Kansas City 5, Mo.
- Bhatt, V. J., J. D. Bhatt and Co., Napier Rd., Karachi 2, India
- Blackwood, J. E., Box 149, Mason, Ohio
- Boehner, C. H., 121 W. Frambes Ave., Cincinnati 1, Ohio
- Boggioni, A. J., 291 E. 9 Ave., Columbus 1, Ohio
- Bown, H. T., 5104 Nall Ave., Mission, Kan.
- Brockway, B. W., 2103 Willow St., Yakima, Wash.
- Brown, T. H., 106 State St., New Haven 4, Conn.
- Brubaker, R. J., 2812 E. 73 St., Kansas City 5, Mo.
- Buffington, L. R., 1850-1 Ave. N.W., Cedar Rapids, Iowa
- Cacheris, J. C., Princeton University, Palmer Laboratory, Princeton, N.J.
- Canning, R. G., 2908 Victoria Ave., Cincinnati 8, Ohio
- Cerwin, F. J., Box 17, Hangar 116, Naval Air Station, Jacksonville, Fla.
- Chamberlin, E. W., 4919 Troost Ave., Kansas City 4, Mo.

(Continued on page 58A)

LARGE OR SMALL ... AmerTran!



**SPECIFY
AMERTRAN
Components
in your
NEW
TRANSMITTER**

Rating: 74DB, Class B, Modulation Transformer .03-15KC; 12 KV D.C. Operating 51 K.V. Hi-potential.

- Modulation Transformers and Reactors
- Oil or Abestol Immersed Plate Transformers
- W Type Transmitter Transformers
- Transtat A. C. Voltage Regulators (Manual, Motor and Automatic Operation)
- Radio components
- Wave filters
- Rectifiers
- Transformers for Electronic Applications
- Air borne Transformers
- General Purpose Lighting and Power Transformers

There is an AmerTran Transformer for practically every transformer symbol in all electronic circuits. They range from units to fit in a microphone to the huge modulation and plate transformers used by large broadcasting stations. Whatever their size, they have one thing in common—the quality construction that has made AmerTran the leader in transformer manufacture for forty-four years. When writing for Bulletin state product in which you are interested.

AMERICAN TRANSFORMER COMPANY
178 EMMET STREET, NEWARK 5, N. J.

AMERTRAN
MANUFACTURING SINCE 1901 AT NEWARK N. J.

Pioneer Manufacturers of Transformers, Reactors and Rectifiers for Electronics and Power Transmission



Quiet • POWERFUL SM Fractional H. P. Motor

*The Home Power Servant
also handles many other
jobs efficiently, dependably*



For quiet operation, dependable performance, long life, maximum

power per ounce of weight and per inch of space, use SM Fractional H.P. Motors. Models from 1/10th to 1/200th H.P. Speeds of 3,000 to 20,000 R.P.M. Voltage from 6 to 220 AC-DC Large volume production to your exact specifications.

Small Motors, Inc.

DEPT. 31

1308 ELSTON AVE. • CHICAGO 22

Manufacturers of special small universal, fractional H. P. motors, dynamometers, shaded pole motors, heater motors, generators.

Design, Engineering, Production



(Continued from page 56A)

- Chesterman, A. R., 80 Coates Ave., Orakei S.E. 2, Auckland, N. Z.
 Chi, M., International Training Administration, 1419 H St., Washington, D. C.
 Christensen, A. O., Naval Training School, (Radio Material), Treasure Island, San Francisco, Calif.
 Criddle, C. B., Commodore Hotel, Breerton, Wash.
 Crockett, D. W., 654 Myrtle Ave., San Francisco, Calif.
 Dahlman, H. E., 1113 E. 11 St., Kansas City 6, Mo.
 Davies, J. D., 633 Broadway, Hastings-on-Hudson, N. Y.
 Davis, H. C., 321 E. Gregory, Kansas City 5, Mo.
 Davis, H. B. O., 40 Edwards Pl., Princeton, N. J.
 Deister, W. A., Rua Visconde de Parnaiba 1316, Sao Paulo, Brazil
 De Jonghe, J. J., R.F.D. 1, Danville, Ill.
 Delhorbe, W. E., 19127 Hanna St., Melvindale, Mich.
 de Malignon, R. G., 4553 Walnut St., Kansas City 2, Mo.
 Donovan, R. J., 128 Paine St., Worcester 5, Mass.
 Doriot, K. E., 558 Celeron St., Pittsburgh 21, Pa.
 Dowden, C. B., 49 Walnut St., Halifax, N.S., Canada
 Drechsler, F. P., 85-47-67 Dr., Forest Hills, L. I., N. Y.
 Du Berger, P., Box 59, Matane, P.Q., Canada
 Eastwood, G. C., 16 The Aberdeens, 100 Bain Ave., Toronto 6, Ont., Canada
 Egbert, L. L., 38 E. Frambes Ave., Columbus 1, Ohio
 Elliott, F. J., Squadron H, CK 4, Morrison Field, West Palm Beach, Fla.
 Filmer, J. C., 39 Boulder Brook Rd., Wellesley 81, Mass.
 Forst, W. D., Box 9, Mundare, Alberta, Canada
 Fozard, B., 36, Harbour Crescent, Wibsey, Bradford, Yorkshire, England
 Fryer, E. M., 77 Martin St., Cambridge 38, Mass.
 Garn, A. A., 420 Madison Ave., Toledo 4, Ohio
 Gaylord, R. E., Naval Research Laboratory Bldg. 46, Washington 20, D. C.
 Granard, C. H., 2535-2 Ave. W., Seattle 99, Wash.
 Grimm, E. M., 206 Oak St., Boonton, N. J.
 Gschaar, J., Jr., 3548 Tryon Ave., New York 67, N. Y.
 Haggerty, P. E., 930-17 St. South, Arlington, Va.
 Halbach, E., 267 Franklin Ave., Cliffside Park 9, N. J.
 Hale, I., 1701 N. 33 St., Philadelphia 21, Pa.
 Handley, D. J., 34½ Olin St., Ocean Grove, N. J.
 Henderson, J. P., 9 Mayfield St., Port Talbot, Glam., England
 Herb, A. P., 2705 Lawndale Ave., Cincinnati 13, Ohio

(Continued on page 60A)

EBY SADDLE TYPE MINIATURE TUBE SOCKETS

AVAILABLE IN



GENERAL PURPOSE
PHENOLIC (EBY #8100) →



LOW LOSS PHENOLIC
(EBY #8082) →



STEATITE
(EBY #8083) →

The castings and beryllium copper contacts are identical with JAN S-28 Types SO 10M and SO 10C except that the shield base is replaced with a saddle. These EBY sockets meet the need for quality replacement of sockets of the saddle type. Write today for prices and samples.

LONG LIFE CONTACTS

The self-aligning beryllium copper contacts have been especially designed and Micro-processed to assure constant, even pressure on all parts of the socket pin without fatigue in contacts after continuous use.

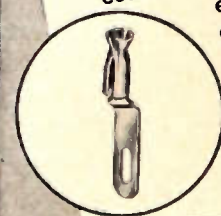

IF IT'S IN A CIRCUIT
... EBY COMPONENTS
AND SERVICES WILL
HELP YOU DO IT BETTER

HUGH H.
EBY
INCORPORATED
18 W. CHELSEA AVE.
PHILADELPHIA, PA.

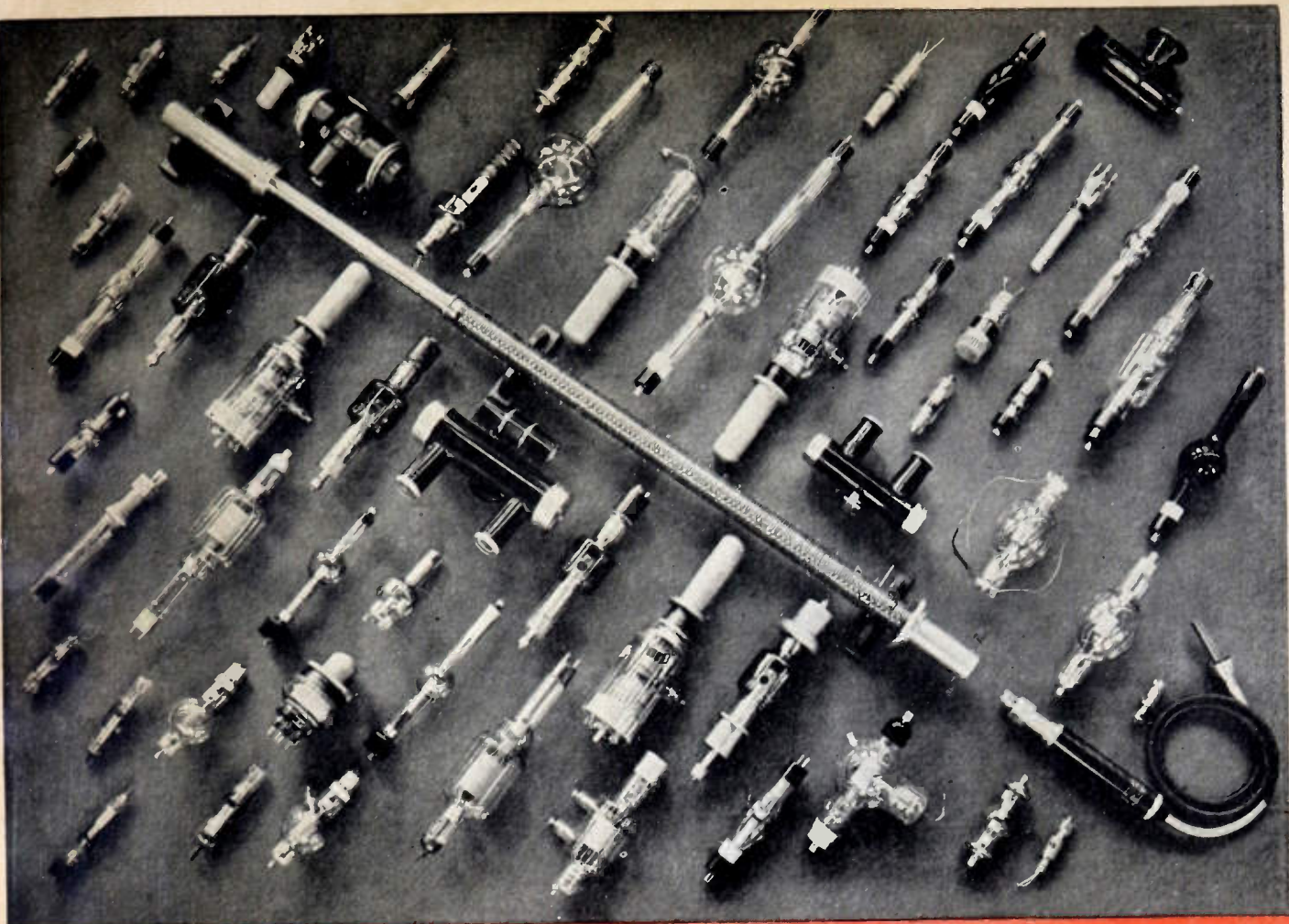

GROUPED about the widely acclaimed Two-million-Volt Precision X-ray Tube are other Machlett tubes for medical, industrial and radio purposes. In each of these tubes are incorporated the inherent skills employed by Machlett in the development of this unique tube. They are your assurance of long life, ruggedness and dependability in whatever field they are used. Machlett Laboratories, Inc., Springdale, Connecticut.



APPLIES TO RADIO AND INDUSTRIAL USES
ITS **48** YEARS OF ELECTRON-TUBE EXPERIENCE

EASTERN HEAT DISSIPATING UNIT

The Eastern Heat Dissipating Unit is used in connection with television, radar, short wave radio communications, high pressure mercury lamps, X-Ray tubes, induction heating units, and many other applications. It was developed for military requirements in conjunction with radar and electronic tube cooling problems. Units were designed in various sizes and capacities, some with the close heat control range of 2 degrees C. Used successfully for ground, water and airborne service, they combine rugged construction, compactness and light weight.

The model illustrated will dissipate up to 1200 watts with a constant controlled temperature, irrespective of surrounding temperatures, within 2 degrees C. It is complete with Thermostat control, Thermostatic valves and flow switch. Eastern has built airborne units of much smaller sizes and industrial units of much larger sizes and capacities. The specifications for the unit shown are: SIZE: 16" x 7½" x 7½"; METALS: Steel, Bronze, or Aluminum. Other models can be designed to dissipate up to 5000 watts.



Closed View

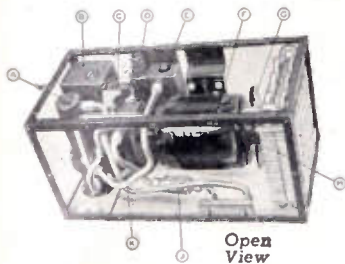

Open View

- | | |
|--------------------------|-------------|
| A. Thermo flow-regulator | F. Motor |
| B. Reservoir | G. Fan |
| C. Flow Switch | H. Radiator |
| D. Thermostat | I. Filter |
| E. Auxiliary Heater | K. Pump |

Eastern's experience in solving heat control problems, especially where compactness and light weight are necessary, makes them the logical people with whom to discuss heat control applications. If you are designing or planning to build equipment that calls for heat dissipation or the close control of operating temperatures, Eastern will design and build the entire unit for you to meet your specific requirements.

An inquiry about your heat dissipating needs will not obligate you in the slightest.

A large part of Eastern's business is the designing and building of special pumps, in quantities ranging from 25 to several thousand for the aviation, electronic, chemical, machine and other special fields. Eastern builds over 600 models, both centrifugal and positive pressure, ranging in size from 1/100 H.P. to ¼ H.P. as standard units.

Eastern Engineering Co.

86 FOX STREET, NEW HAVEN 6, CONN.



(Continued from page 58A)

- Hold, H. W., 320 Roselle St., Linden, N. J.
 Huberty, R. M., 4501 N. Malden Ave., Chicago 40, Ill.
 Hunter, J. B., 17 Edgewood Crescent, Toronto, Ont., Canada
 Hutton, S. A., 285 Schenectady Ave., Brooklyn 13, N. Y.
 Irminger, R. E., 117 N. Lightburne St., Liberty, Mo.
 Irvin, J. L., 23, Longfield Rd., Chelmsford, Essex, England
 Jaberg, A., Jr., 4556 Walnut St., Kansas City 2, Mo.
 Jakowatz, C. V., 1843 Anderson Ave., Manhattan, Kan.
 Johnson, W. W., 8203 Dallas Ave., Seattle 8, Wash.
 Kamys, J. E., 3847 N. Spaulding Ave., Chicago 18, Ill.
 Kao, D., c/o Major M. S. Hu, 2110 Leroy Pl. N.W., Washington 8, D. C.
 Kimbrel, G. M., 6235 Orchard Lane, Cincinnati, Ohio
 Lang, E. T., 518 W. Palmetto St., Florence, S. C.
 Lewis, J. R., 1575 S. 6 St., Camden, N. J.
 Lundstedt, H. E., 2240 Mariendale Ave., Los Angeles 32, Calif.
 MacLeod, J. P., 915 Times Ave., Bremerton, Wash.
 Mahland, E. W., 131-16-109 Ave., South Ozone Park 20, L. I., N. Y.
 Markantes, P. N., 215-01-111 Rd., Queens Village 9, L. I., N. Y.
 Massey, M. M., 16 N. Main St., Liberty, Mo.
 Mauer, D. J., 829 Washington St., El Monte, Calif.
 Maynard, H. M., 4 Jewett Pkwy., Buffalo 14, N. Y.
 McLarren, R., 610 Shoreham Bldg., Washington 5, D. C.
 Mehr, A., 101-28-80 St., Ozone Park, Queens, L. I., N. Y.
 Mendes, J. A., 2406-106 Ave., Oakland 3, Calif.
 Miller, C. B., 7524 Girard Ave., S., Minneapolis, Minn.
 Moro-Lin, H., 1565 Odell St., Bronx, N. Y.
 Morrison, I. E., 104 Greenridge Court, Towson 4, Md.
 Morse, C., Box 159, Mason, Ohio
 Newell, S. E., 2550-12 St. W., Seattle 99, Wash.
 Nickerson, F. B., 4321 N. 8 St., Philadelphia 40, Pa.
 Nigh, L. O., 609 W. 77 St., Kansas City 5, Mo.
 Ogden, B., 1645 Hill Dr., Eagle Rock, Los Angeles 41, Calif.
 Olyphant, M., Jr., 17 Edwards Pl., Princeton, N. J.
 Ostberg, O. S., c/o Postmaster, New York, N. Y.
 Perez, C. P., Calle 60, No. 510, La Plata, Argentina
 Petraglia, F. A., 56-7 Ave., New York 11, N. Y.

(Continued on page 62A)

Engineered and built by

Doolittle

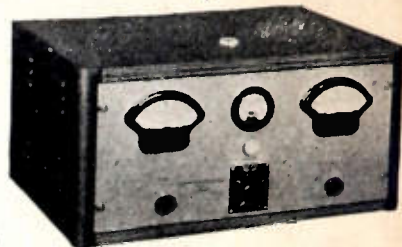

FM and AM FREQUENCY MONITORS

Direct reading. No charts or complicated calculations necessary. Models available for 110 volt A.C. or battery operated portable use. Meet FCC requirements.



DISTORTION METER

Direct reading device which indicates as a percentage of the fundamental frequency, the square root of the sum of the squares of the harmonic components. It is used for audio frequency measurements in any audio device in the usual range of voice or musical notes from 150 to 15,000 cycles.

• Utilize the many advantages of these units now. They are sturdily built, self-contained, moderately priced. Remember . . . equipment pioneered by DOOLITTLE years ago, still serves efficiently today!

SEND FOR FULL DETAILS

Doolittle

RADIO, INC.

7421 SOUTH LOOMIS BOULEVARD
 CHICAGO 36, ILLINOIS

**BUILDERS OF PRECISION
 RADIO EQUIPMENT**

IRON SLEEVE CORES

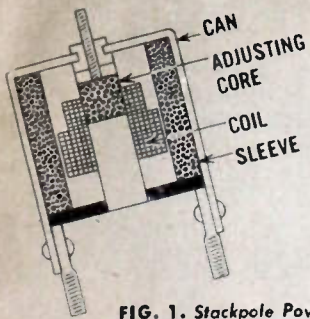

FIG. 1. Stackpole Powdered Iron Sleeve and Core used for Diode Transformer (I-F); Antenna, Oscillator, or Filter Coils, etc.

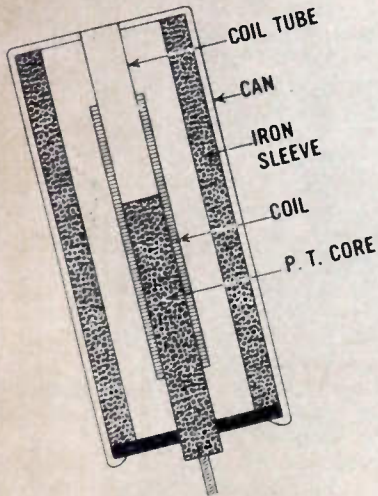

FIG. 2. Grade SK1 core and powdered iron sleeve (.790 O. D. x 1 1/2" long) used with permeability tuning in auto radio receiver.

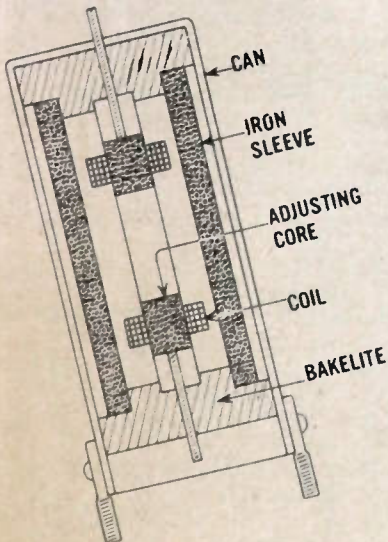

FIG. 3. Two Stackpole cores and powdered iron sleeve used in a double tuned I-F transformer application.



The Modern Answer to Better Coils in Less Space

BY USE of Stackpole Sleeve Cores, much smaller cans of any material may be used to provide Q that is equal to or better than that of conventional coils and cans. Thus they pave the way to an exceptionally high order of tuning unit efficiency in greatly reduced size. A few of many design possibilities are indicated in the accompanying sketches.

Beside supplying additional electrostatic and electromagnetic protection over that provided by the can alone, sleeve cores result in making the can itself smaller, less critical and less costly. Inexpensive die cast lead cans, for instance, may be used instead of aluminum. In some cases, it may not even be necessary to use a can.

STACKPOLE CARBON COMPANY, ST. MARYS, PA.

EXPORT: Stackpole Carbon Co., 254 W. 34th St., New York 1, N. Y., U. S. A.

STACKPOLE

ELECTRICAL BRUSHES AND CONTACTS (All carbon, graphite, metal and composition types) • RARE METAL CONTACTS • WELDING CARBONS • BRAZING TIPS AND BLOCKS • PACKING, PISTON, AND SEAL RINGS • CARBON REGULATOR DISCS • MOLDED METAL COMPONENTS, ETC.

MAKE IT

MOVE



WITH ALLIANCE

Thousands of little motors leave the high speed production lines of Alliance . . . every day. Where will they go? Wherever you need compact, condensed power sources . . . power controlled from a central point.

It will pay you to investigate Alliance motors . . . they will make your product MOVE . . . bring it to life.

Long experience in the advanced design and manufacture of miniature electric motors makes for high quantity, low cost production!

WHEN YOU DESIGN—KEEP

alliance

IN MIND

ALLIANCE MANUFACTURING CO. • ALLIANCE, OHIO



(Continued from page 60A)

- Parsons, K. L., 80 S. 4 St., Old Town, Me.
Payne, H. B., Fleet Post Office, San Francisco, Calif.
Pereyra, L. A., 5 de Julio 369, Vicente Lopez—F.C.C.A., Argentina
Ransom, R. A., 4657 A—36 St. S., Arlington, Va.
Racine, R. F., 10 Dana St., Cambridge, Mass.
Ray, H. A., Jr., Burton, Wash.
Rea, L. W., 2422 S. 27 St., Arlington, Va.
Reitz, H. W., 129 N. 5 St., Sunbury, Pa.
Riemitis, C. F., 91 Exchange St., Lawrence, Mass.
Rogers, A. J., 34 W. McPherson St., Dayton 5, Ohio
Rosenberg, H. W., 278 Chestnut St., Chelsea, Mass.
Rund, L., 1340 Morris Ave., Bronx 56, N. Y.
Rutherford, C. E., 39 N. Bedford St., Arlington, Va.
Salisbury, W. R., 2026 Delaware St., Berkeley 4, Calif.
Salles, J., 1623½ S. Burlington Ave., Los Angeles 6, Calif.
Santangelo, J., 107 Mt. Vernon Ave., Mt. Vernon, N. Y.
Schneeberger, R. J., Westinghouse Research Laboratories, East Pittsburgh, Pa.
Schoedinger, R. G., 713 S. Broadleigh Rd., Columbus 9, Ohio
Schwarz-Rexach, W., 13 State St., Schenectady 5, N. Y.
Sides, J. D., 8 Summitt Lane, Skyway Park, Osborn, Ohio
Siek, J. R., 1308½ N. Lowry Ave., Springfield, Ohio
Skeeters, R. N., 1661 Rose Villa, Pasadena, 4, Calif.
Smith, J. M., Macamor, MacLean, Va.
Smith, W. E., 617 Derstine Ave., Lansdale, Pa.
Spuhler, H. A., 1805 Ave. S., Lubbock, Texas
Swenson, W. J., 15 Oxford St., Montclair, N. J.
Tanner, H. A. J., 614—11 St., Glenwood Springs, Colo.
Thornhill, J. R., 81 Balmoral Ave., Toronto, Ont., Canada
Ting, P. P., c/o T. Wang, 1601 V St. N.W., Washington, D. C.
Watson, M. R., 39 Murray Pl., Princeton, N. J.
Wilken, B. W., 1149 W. Pine St., Walla Walla, Wash.
Williams, J. M., 163 N. Euclid Ave., Westfield, N. J.
Wilson, G. L., The Clarendon Laboratory, Parks Rd., Oxford, England
Wirth, V. A., 5056 S. Leamington St., Chicago 38, Ill.
Woodard, T. C., 1802½ N. Western Ave., Los Angeles 27, Calif.
Worster, J. R., 1511 Lincoln Ave., New Hyde Park, N. Y.
Zimmer, E. C., 52 Union St., Hamburg, N. Y.

RCA Tube Plant, Lancaster, Penna.
RCA manufactures cathode-ray tubes, as well
as power tubes, in this modern plant.

Last year the production of

POWER TUBES

by the Tube Division of RCA

was greater than that of
any other manufacturer in the world

THE FOUNTAINHEAD OF MODERN
TUBE DEVELOPMENT IS RCA



42-4134-37

RADIO CORPORATION OF AMERICA

TUBE DIVISION • HARRISON, N. J.

**Industrial Condenser
Corporation's
NEW HOME**



**THE WORLD'S MOST
MODERN CONDENSER PLANT**
with these outstanding features

- ★ 1,000,000 VOLT RESEARCH LABORATORY
- ★ VERY LATEST PRODUCTION EQUIPMENT
- ★ SPECIALIZED WAR-LEARNED TECHNIQUES

From this new ultra-modern factory come capacitors carefully engineered and accurately produced. Staffed by skilled engineers and backed by 16 years of technical progress, Industrial Condenser Corp. is supplying capacitors for every application. If your specifications call for Electrolytic, Paper, Oil, or Motor capacitors, look to Industrial Condenser Corporation.

**INDUSTRIAL CONDENSER
CORPORATION**

3243-65 NORTH CALIFORNIA AVENUE, CHICAGO 18, U. S. A.
District Offices In Principal Cities

PAPER, OIL AND ELECTROLYTIC MOTOR CAPACITORS

**WIRE SO FINE
IT MUST BE
Magnified
TO BE SEEN**



WOLLASTON PROCESS
Wire as small as

$\frac{1}{100,000}$ } OF AN INCH
IN DIAMETER

... available in Platinum
and some other Metals

.00001" is less than 1/30 the
diameter of the smallest wire
die commercially available.
Yet our Wollaston Process
wire (drawn in a silver jacket)
closely meets your specifica-
tions for diameter, resistance
and other characteristics.

This organization specializes
in wire and ribbon of smaller
than commercial sizes and
closer than commercial toler-
ances. Write for List of Products.

SIGMUND COHN & CO.



44 GOLD STREET NEW YORK 7

Why **OHMITE** Resistors PERFORM SO DEPENDABLY

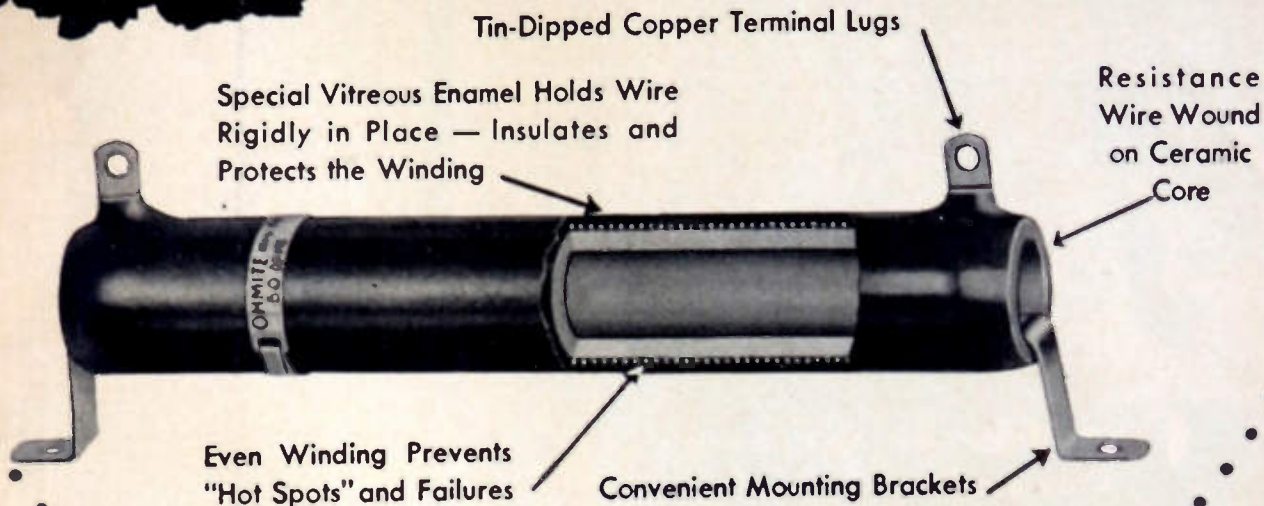

Here you see a few of the important features that insure long life and trouble-free service in every Ohmite Resistor. In the lug type illustrated above, the resistance wire is both mechanically locked and brazed to copper terminal lugs to assure perfect electrical connection. Time-proved Ohmite vitreous enamel construction dissipates heat rapidly . . . withstands humidity. Today, Ohmite Resistors are extensively used in the Armed Forces, Industry, Communications, Research. *Made in a wide range of types and sizes in stock and special units for every need. Consult Ohmite engineers on your resistor problem.*

OHMITE MANUFACTURING COMPANY

4861 FLOURNOY ST., CHICAGO 44, U. S. A.



Be Right with **OHMITE**
RHEOSTATS • RESISTORS • TAP SWITCHES

ALNICO-5

"MIRACLE METAL"

for
SPEAKERS

Cinaudagraph Speakers are known the world over for tone, stamina, engineering perfection and design. Consider the use of Alnico 5, newest miracle metal that gives 4 times the performance without weight or size increase, add this to scores of other Cinaudagraph Speaker achievements and you have the reasons why Cinaudagraph Speakers are "The Finest Speakers in all the World."

Cinaudagraph Speakers
A DIVISION OF **Aireon**
3911 SOUTH MICHIGAN AVENUE, CHICAGO
"The Finest Speaker in all the World"



Complete Your Files of the Proceedings of the I.R.E.

Some back issues available
Each issue is priced at \$1.00 but members of I.R.E. are given a 25% discount and accredited public and college libraries a 50% discount. The following issues are offered subject to prior sale.

- 1913-1915 Volumes 1-3**
Quarterly
1913 Vol. 1 January (a reprint)
- 1916-1926 Volumes 4-14**
Bimonthly
1917 Vol. 5 April, June, August, October
1918 Vol. 6 None
1919 Vol. 7 December
1920 Vol. 8 April, June, August, October, December
1921 Vol. 9 All 6 issues
1922 Vol. 10 All 6 issues
1923 Vol. 11 February, April, June, August, December
1924 Vol. 12 August, October, December
1925 Vol. 13 April, June, August, October, December
1926 Vol. 14 All 6 issues
- 1927-1938 Volumes 15-26**
Monthly
1927 Vol. 15 April, May, June, October, December
1928 Vol. 16 February to December, inc.
1929 Vol. 17 April, May, June, November
1930 Vol. 18 January, April to December, inc.
1931 Vol. 19 All 12 issues
1932 Vol. 20 January, March to December, inc.
1933 Vol. 21 All 12 issues
1934 Vol. 22 All 12 issues
1935 Vol. 23 All 12 issues
1936 Vol. 24 January to April, inc., June
1937 Vol. 25 February to December, inc.
1938 Vol. 26 All 12 issues
- 1939-1945 Volumes 27-33**
Monthly
New Format—Large Size
1939 Vol. 27 All 12 issues
1940 Vol. 28 All 12 issues
1941 Vol. 29 All 12 issues
1942 Vol. 30 January, February, April, October to Dec., inc.
1943 Vol. 31 February to December, inc.
1944 Vol. 32 January, February, July to December, inc.
1945 Vol. 33 All issues
- Remittance should accompany your order.*
Please do not send cash except by registered mail
- THE INSTITUTE OF
RADIO ENGINEERS, INC.**
330 West 42nd Street,
New York 18, N.Y.

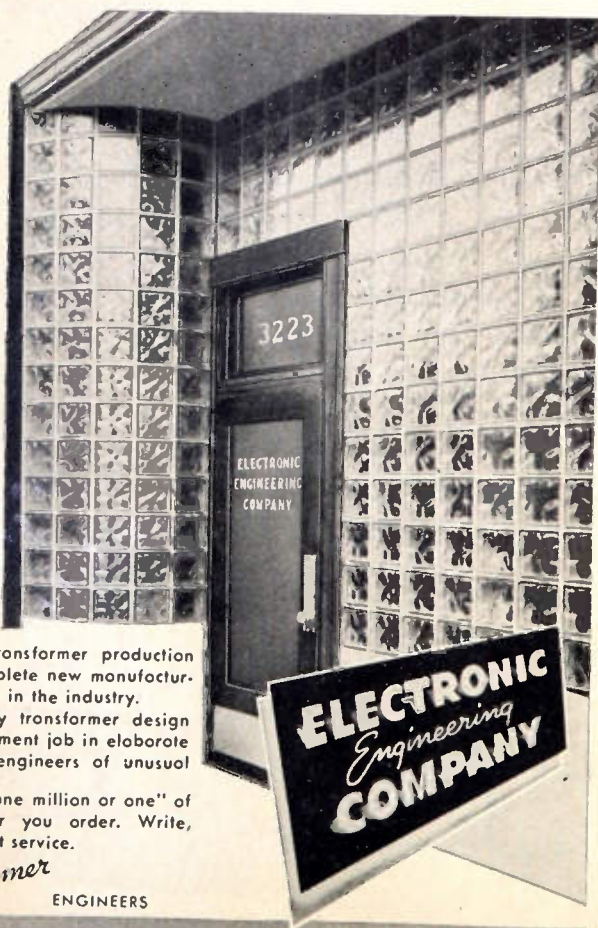

*Ready...
Willing...
Able...*

Ready to take on any transformer production job... our complete new manufacturing facilities are second to none in the industry.
Willing to handle any transformer design or development job in elaborate new laboratories staffed with engineers of unusual experience.
Able to ship, quickly, "one million or one" of any transformer you order. Write, wire or phone us for fast efficient service.

SPECIALIZED *Transformer* ENGINEERS

3223-9 WEST ARMITAGE AVENUE • CHICAGO 47, ILLINOIS



CLAIM STAKING

Hallicrafters and Very High Frequency

Based on the facts in the case, Hallicrafters can stake out a very strong claim to leadership in the very high frequency field. The facts include such things as the Model S-37, FM-AM receiver for very high frequency work. The Model S-37 operates from 130 to 210 Mc.—the highest frequency range of any general coverage commercial type receiver.

Hallicrafters further supports its claim to domination in the high frequency field with the Model S-36A, FM-A M-CW receiver. The 36A operates from 27.8 to 143 Mc., covers both old and new FM bands and is the only commercially built receiver covering this range.

Further developments in this direction can soon be revealed—adding further support to Hallicrafters claim to continued supremacy in the high frequency field.

HALLICRAFTERS NEW \$600,000 HOME NOW UNDER CONSTRUCTION.



hallicrafters RADIO

THE HALLICRAFTERS CO., MANUFACTURERS OF RADIO AND ELECTRONIC EQUIPMENT • CHICAGO 16, U. S. A.

COPYRIGHT 1945 THE HALLICRAFTERS CO.

Start with any **1** Jackson Instrument to Build a Balanced Testing **TEAM!**



Condenser Tester
Model 650A—Measures Capacity, Power Factor and Leakage



Sensitive Multimeter
Model 642—20,000 ohms per volt—complete ranges



Electronic Multimeter
Model 645—A new Jackson instrument of advanced design

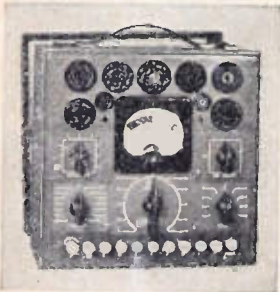

Tube Tester
Model 634—Uses exclusive Jackson "Dynamic" Test Method



Multimeter
Model 643—1000 ohms per volt. Push key range selection



Test Oscillator
Model 640—Accurate to 1/2%, covers full frequency range

It's A PLUS VALUE of the Jackson line. Each instrument is engineered and manufactured for long accurate life, as today's users know—but every one is carefully matched in appearance, dimensions and finish as well.

Start with whichever Jackson instrument you need first. Add to it as occasion demands. Your foresight will be repaid with a matched and balanced set of instruments built to give you testing results that you just can't get with hit-or-miss assemblies. Plan now to equip your shop with these Jackson instruments. See your distributor.



Service Lab
Assembly of
Standard Size
Jackson
Instruments

DEPENDABLE PERFORMANCE

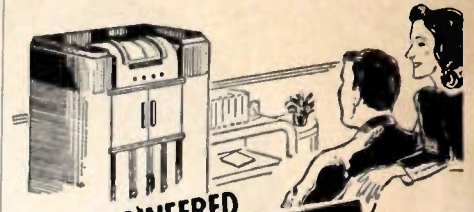

IT'S ENGINEERED
WITH

HI-Q

COMPONENTS

Dependable performance in any electronic equipment is the sum of little things. And when those "little things" are Hi-Q components you can rest assured that performance will be thoroughly dependable. Hi-Q components are available in any desired quantities to your specifications. Send for samples and complete data.



CERAMIC CAPACITORS

CI Type: axial leads

CN Type: parallel leads

Made of titanium dioxide (for temperature compensating types). Tested for physical dimensions, temperature coefficients, power factor and dielectric strength.



WIRE WOUND RESISTORS

Fixed Type

Immediately available in standard ratings or precision built to any tolerance or value.



CHOKE COILS

Sturdy construction. Insulated or uninsulated. Quantity production available at once.

BUY WAR BONDS AND STAMPS TODAY

JACKSON

Fine Electrical Testing Instruments

JACKSON ELECTRICAL INSTRUMENT COMPANY, DAYTON, OHIO

**ELECTRICAL REACTANCE
CORPORATION**
FRANKLINVILLE, N. Y.



How SKILSAW Protects Equipment "in-the-Package"

Moisture "in-the-package" causes vast damage to precision equipment.

Skil saw, Inc. prevents this damage by means of Jay Cee Silica Gel, the ideal drying agent. A few small bags of the Jay Cee Gel are included within tightly sealed packages of electric handsaws, drills, and other tools. The gel has amazing power to absorb and hold moisture. Thus the air in the package is kept thoroughly dry and damage from rust or corrosion is avoided.

This practice is being followed by more and more manufacturers of metal products. The cost

of the gel is a mere trifle in comparison with the possible damage from rust or corrosion.

Jay Cee Silica Gel has wide application in the Air Conditioning, Refrigeration, and Chemical industries. It is clear white; passes a rigid section test; meets exacting Government specifications; is strictly a quality product.

A few excellent Jay Cee Silica Gel sales territories are still open to jobbers. Write for details.



JAY CEE CHEMICALS, LTD., INDUSTRY AVENUE, JOLIET, ILLINOIS

SILICA GEL

A superior dehydrant

Have you a High
Temperature
Capacitor
Application?

PLASTICONS Operate at **256° F.**

Plasticon Types AS are silicone impregnated plastic film dielectric capacitors. They will operate from -80°F. to $+256^{\circ}\text{F.}$ with less than 10% capacitance change. Plasticons are small in size as they are not "voltage derated."



Condenser Products Company

1375 NORTH BRANCH STREET • CHICAGO 22, ILLINOIS

How **STAMPING**
DRAWING and
BRAZING
Can Reduce
Costs!

You, too, can save by
**GOAT PRECISE-FORMED
METAL STAMPINGS**

Induction brazing and machining operations can save you money by replacing many types of machine parts, castings and assemblies. New techniques in deep drawing eliminate the necessity of in-between annealing. As a result, we can produce stampings, as well as assemblies of stampings, that would have been regarded as impossible prior to the war.



Samples or Prints
analyzed without obligation

GOAT METAL STAMPINGS, INC.
Affiliate of The Fred Goat Co., Inc.
314 DEAN STREET
BROOKLYN, N. Y.



Compare the costs! Formerly the part shown below was machined from tubing, an expensive operation involving the time-taking removal and waste of a large amount of stock.

1.



This deep-drawn shell, $1\frac{13}{16}''$ d x $4\frac{3}{8}''$ is drawn without expensive annealing, by the Goat Precise-Formed Process.

2.



Stamped thread rings shown above is induction brazed to the shell.

3.



A thread is cut on the ring, completing the product.

Binders

for the Proceedings
Protect your file
of copies against
damage and loss



Binders are available for those who desire to protect their copies of the PROCEEDINGS with stiff covers. Each binder will accommodate the twelve monthly issues published during the year. These binders are of blue Spanish grain fabricoid with gold lettering and will serve either as temporary transfers or as permanent binders. They are so constructed that each individual copy of the PROCEEDINGS will lie flat when the pages are turned. Copies can be removed from the binder in a few seconds and are not damaged by their insertion.

Available for both the old, small size PROCEEDINGS or the new, large size (1939 to date).



Price: \$1.50

either size (specify which)
Postpaid to all countries

You may have a volume number or your name stamped in gold for 50 cents additional.

Remittance should accompany
your order

THE INSTITUTE OF
RADIO ENGINEERS, INC.
330 West 42nd Street,
New York, N.Y.

**Build the competitive advantages of longer life,
better performance into your products...with**

SPERTI HERMETIC SEALS



BUYERS who have waited through the war years will be looking for big improvements in your products. You'll have to meet civilians' expectations...just as you have met military specifications.

You can do it by building longer life, better performance, more trouble-free operation into your products. That calls for Sperti Hermetic Seals, the rugged, dependable, war-proved seals that effectively shut out dust, moisture and deteriorating agents.

Sperti Hermetic Seals are durable, one-piece units, easily soldered-in at less expense. Because of Sperti's advanced manufacturing methods, plus exhaustive tests and inspections, you'll get "true" seals that cut down production delays and costly rejects in the inspection line.

WRITE, TODAY. Get the facts. Find out about the many product applications of Sperti Hermetic Seals and their performance advantages.



Sperti

Incorporated, Dept. PIR-125, Cincinnati 12, Ohio

RESEARCH • DEVELOPMENT • MANUFACTURING

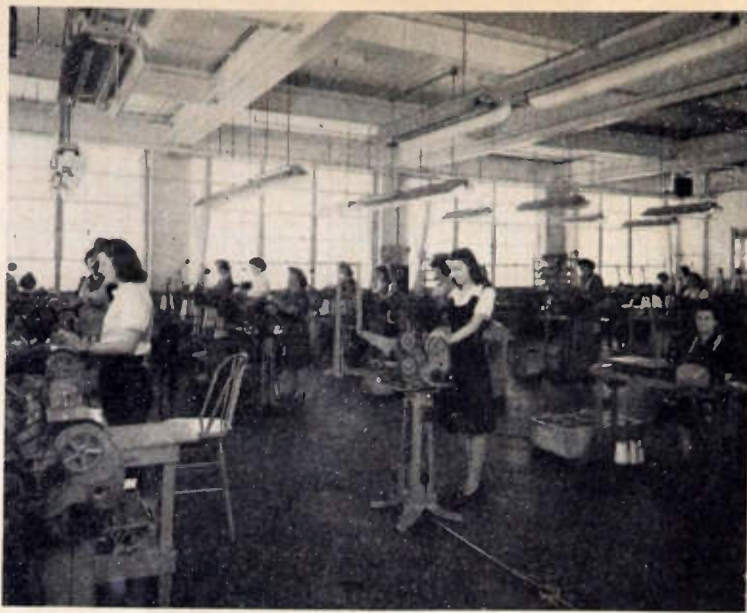

No. 6 of a Series

MODERN COIL WINDINGS

Partial View of Automatic Coil Winding Department

Coto-Coil Electric Coil Windings have pioneered in the industry since its infancy. Coto-Coil engineering skill and products have met all demands of two world conflicts and the intervening years of peace.

Now, in a modern plant, equipped with every facility for producing coil windings which may be depended on to meet all requirements, Coto-Coil is busy meeting the increasing demands of peacetime production.

Our 28 years of experience in coil design and production are at your service.

COTO-COIL, INC.

COIL SPECIALISTS SINCE 1917

65 PAVILION AVE.

PROVIDENCE 5, R.I.

CML SERVES THE ELECTRONIC INDUSTRY

Designed to meet the most rigorous specifications for precision, every CML unit is equipment of accredited performance.

- 1** **ROTOBRIDGE** . . . This automatic inspector checks for proper wiring, correct resistance, capacity and inductance values in all types of electronic equipment.
- 2** **MODEL 1100, MODEL 1110** . . . Voltage regulated power supply units; with extremely low noise level and excellent regulation.
- 3** **MODEL 1420 GENERATOR** . . . Furnishes test power over a wide frequency range; may also be employed in 3-phase circuits.
- 4** **MODEL 1200 STROBOSCOPE** . . . Stops motion within range of 600 to 600,000 R.P.M.

WRITE FOR DESCRIPTIVE BULLETINS

**COMMUNICATION
MEASUREMENTS
LABORATORY**
120 GREENWICH ST., NEW YORK 6, N. Y.

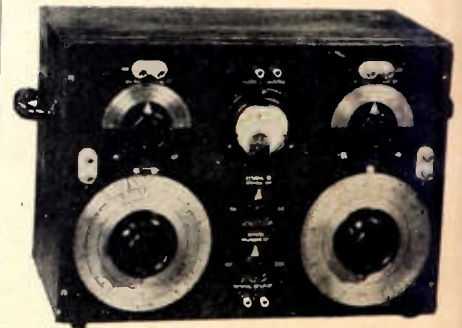

High Accuracy

In Measuring:

- CAPACITANCE—RESISTANCE—IN INDUCTANCE
- STORAGE FACTOR (Q) OF COILS
- DISSIPATION FACTOR OF CONDENSERS

• **MODEL 200-A IMPEDANCE BRIDGE** is a portable, self contained instrument of highest quality used extensively by the Army, Navy, and many manufacturers.

The range of measurement for capacitance is 1 micro microfarad to 100 microfarads; for resistance, 1 milliohm to 1 megohm; for inductance, 1 microhenry to 100 microhenrys. The accuracy on the main decade is 1% for capacitance or resistance measurements and 2% for inductance tests.

Reading obtained from 6 inch direct reading dials. All controls and connections plainly marked and conveniently located on the panel. 35-page book gives methods for many types of measurements.

IMMEDIATE DELIVERIES

Our factory is in a position to make fast deliveries on Model 200-A and other products including precision mica condensers, binding posts, several types of AWS rheostat-potentiometers and decade and low capacity switches.

Brown Engineering Co.

4635 S. E. Hawthorne Blvd. Portland 15, Oregon

Jennings
RADIO
VACUUM ELECTRONIC COMPONENTS

Vacuum Variable **CONDENSER!**

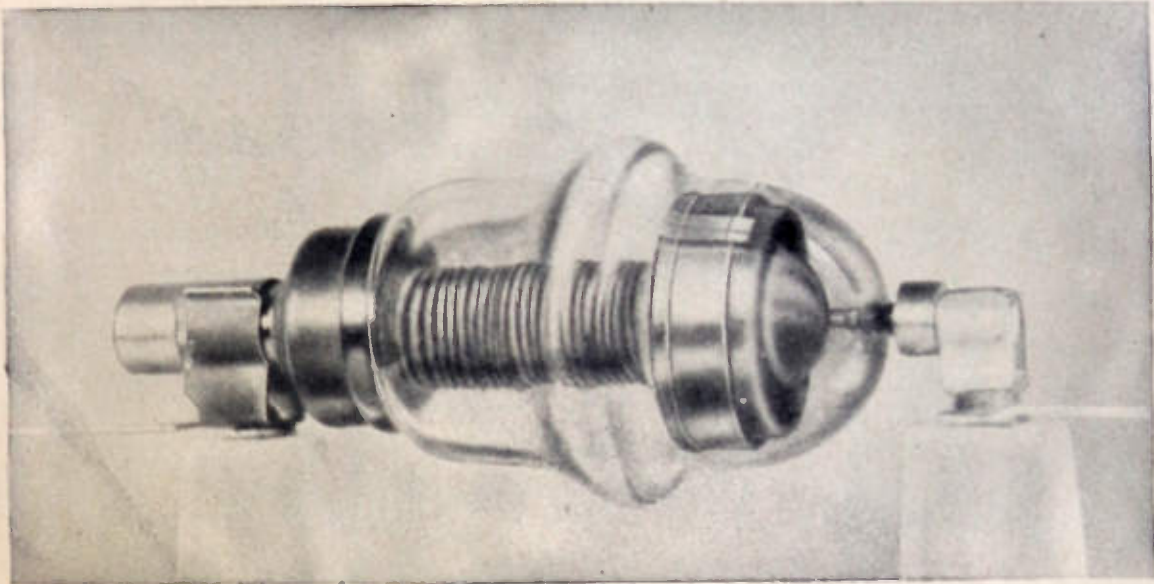

Potent Applied for

at Last—

After three years of development, Jennings has brought the **first** successful **Vacuum Variable Condenser** to the Electronic field.

For improved efficiency, reduced size and weight, these units should be used in tank, neutralizing or antenna tuning circuits in FM, AM and Television stations. Write for further details on this remarkable unit and other Jennings High Voltage Vacuum Capacitors in a wide range of sizes and capacities.

We welcome your inquiry and the opportunity to serve you.

WATCH JENNINGS FOR NEW DEVELOPMENTS IN THE FIELD OF SPECIALIZED VACUUM ELECTRONIC COMPONENTS.

WRITE FOR BULLETIN IR

JENNINGS RADIO MANUFACTURING COMPANY • 1098 E. WILLIAM ST. • SAN JOSE 12, CALIFORNIA

HIGH VACUUM!

Our complete and modern equipped high-vacuum and glass-working laboratory is now available for conducting work on special research and experimental problems or for the manufacture of special high-vacuum devices of all kinds to your specifications.

Experienced technicians are available for work on:

HIGH VACUUM AND GASEOUS DISCHARGE TUBES

Ionization Gauges, Pirani Type Gauges, Vacuum Thermocouples and T.C. Gauges, Bolometers, using Wollaston or Fine Wires, Spectroscopic Research Discharge Tubes, Geiger Counters, Mass Spectograph Tubes, Etc.

EVAPORATING AND SPUTTERING TECHNIQUES

SCIENTIFIC AND LABORATORY GLASS APPARATUS

In Soft Glass, Pyrex and Quartz.

We Welcome Your Inquiries

BALLANTINE LABORATORIES, INC.
Boonton, New Jersey

FILTER CONDENSER Bargains!



Thousands of rugged, oil-filled, oil-impregnated condensers at ridiculously low prices. Write for list! New Time Payment Plan if desired.

BIG NEW CATALOG!

By mailing us your name and address, you will be among the first to get a copy of our own big new catalog, plus latest announcements of new and bargain components and equipment. Write today! Address Dept. IR of nearest Newark branch.



CHICAGO
Newark ELECTRIC Company
115-117 W. 45th St. NEW YORK 19 323 W. Madison St. CHICAGO 6

Attention Associate Members!

Many Associate Members can qualify for higher membership grades and should certainly do so. Members are urged to keep membership grade up in pace with their present development.

An Associate over 24 years of age who is occupied as a radio engineer or scientist, and is in this active practice three years may qualify for Member Grade.

An Associate who has taught college radio or allied subjects for three years may qualify.

Some may possibly qualify for Senior Grade. But transfers can be made only upon your application. For fuller details request transfer application-form in writing or by using the coupon below.



Coupon

Institute of Radio Engineers
330 W. 42nd St.
New York 18, N.Y. 12-45

Please send me the Transfer Application Membership-Form.

Name

Address

Place

State

Present Grade

Immediate Delivery! WIDE RANGE VACUUM TUBE VOLTMETERS

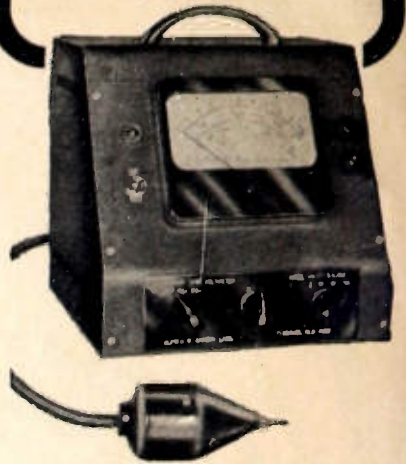

- High input impedance for both AC and DC measurements.
- Convenient, low capacity "Probe" especially adapted to high frequency radio use—100 megacycles and over.
- Self-regulating operation from power line; no batteries.
- Multiple voltage ranges—accurate and stable.

BULLETIN ON REQUEST

ALFRED W. BARBER LABORATORIES

34-04 Francis Lewis Blvd. Flushing, N.Y.

Easy to Erect

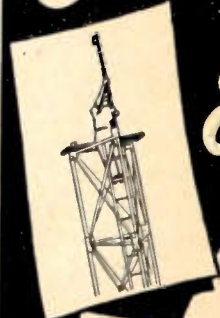

MASTS AND TOWERS

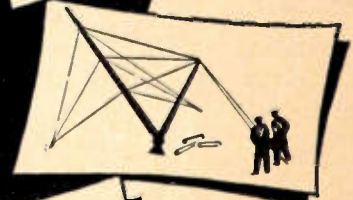

Catalog will be sent to engineers and executives writing on their business letter-head.

Address Dept. AG

HARCO TOWER INC.

Elizabeth 4, N. J.

USE STANDARD PARTS—SAVE TIME AND MONEY

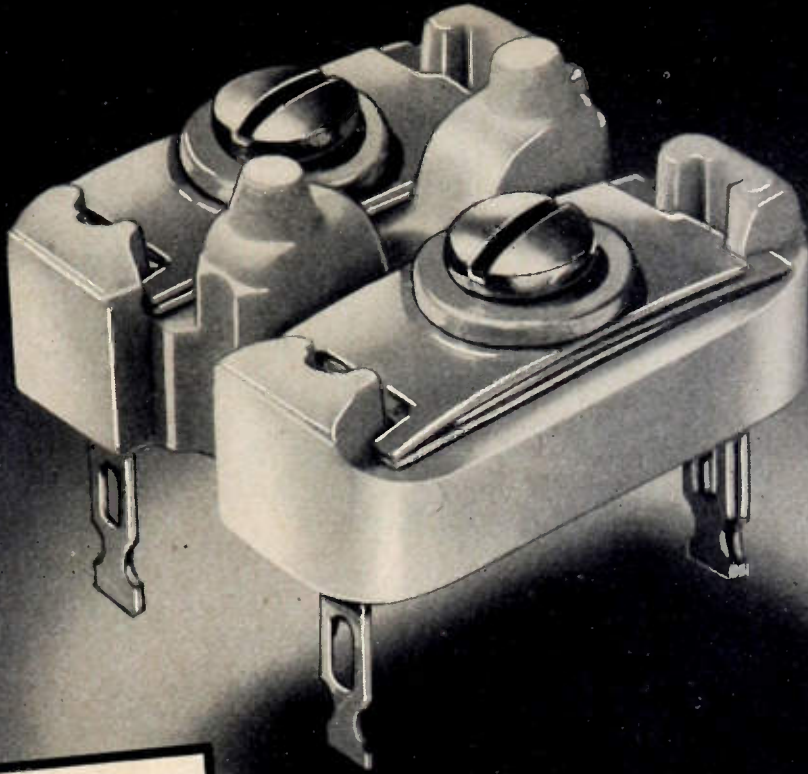

SAVE

For many years

*Automatic has manufactured
Coils and Trimmers for manufacturers.*

*Our mass-production methods
will save you money and headaches.*

*Order your Coils and Trimmers from
people who "know how".*



AUTOMATIC
MANUFACTURING
CORPORATION

MASS PRODUCTION COILS & MICA TRIMMER CONDENSERS

900 PASSAIC AVE.

EAST NEWARK, N. J.

New FOLDED UNIPOLE ANTENNA

Another Example of ANDREW Ingenuity in Engineering

Concentrating on electrical performance, Andrew engineers have designed a unique Folded Unipole Antenna which—according to comparative tests—easily outperforms other antennas at several times the price.

Used for transmitting and receiving at frequencies from 30 to 40 MC and for powers up to 5,000 watts, this antenna has proved so successful that similar models for higher frequencies are now being designed.

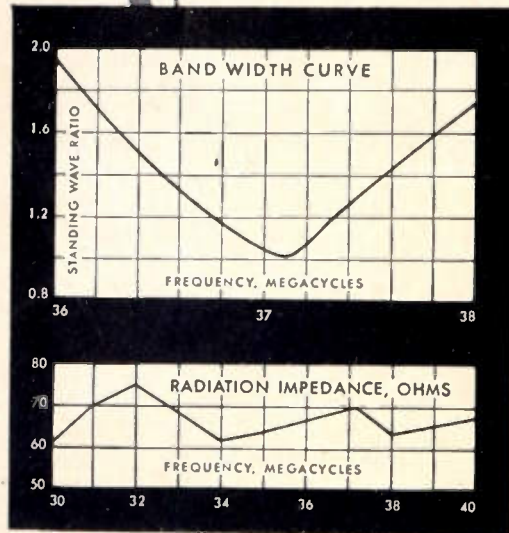

FEATURES:

- Light weight — only 15 pounds — simplifies installation.
- Lightning hazard minimized by grounded vertical element.
- "Slide trambone" calibration permits exact adjustment for any frequency between 30 and 40 MC, using only a wrench. Optimum performance for that frequency is guaranteed without "cut and try" methods.
- Proper termination of coaxial transmission line. Unlike other "70-ohm" antennas, the Folded Unipole actually provides a non-reactive impedance with a resistive component varying between 62 and 75 ohms (see lower curve).
- Excellent band width, ideal for FM (see upper curve).

Andrew Co. specializes in the solution of antenna problems. For designing, engineering and building of antenna equipment, consult Andrew Co.

ANDREW CO.

363 EAST 75th ST., CHICAGO 19, ILL.



WRITE FOR FULL INFORMATION

POSTWAR RADIO TRANSFORMERS

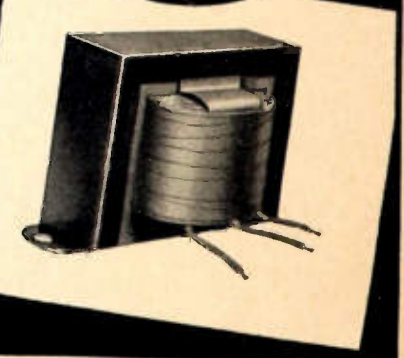
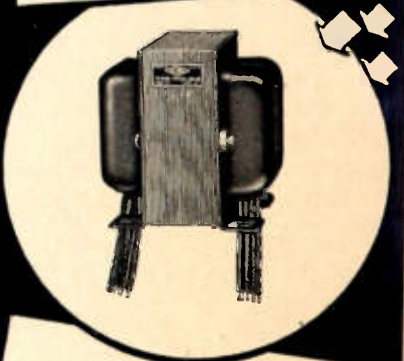
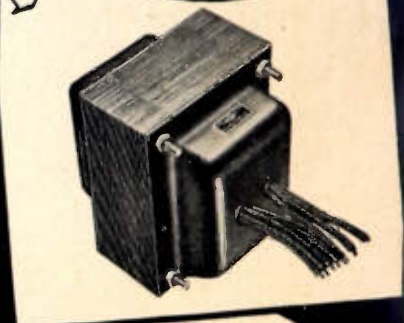
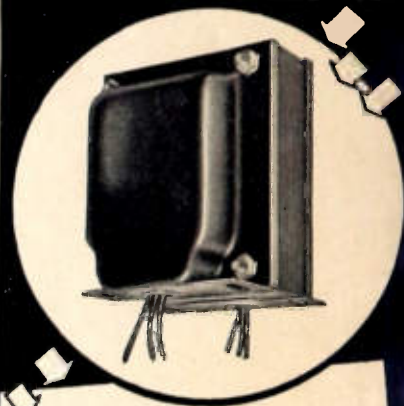

THE ACME ELECTRIC & MFG. CO.
CUBA, N. Y.

Acme  Electric

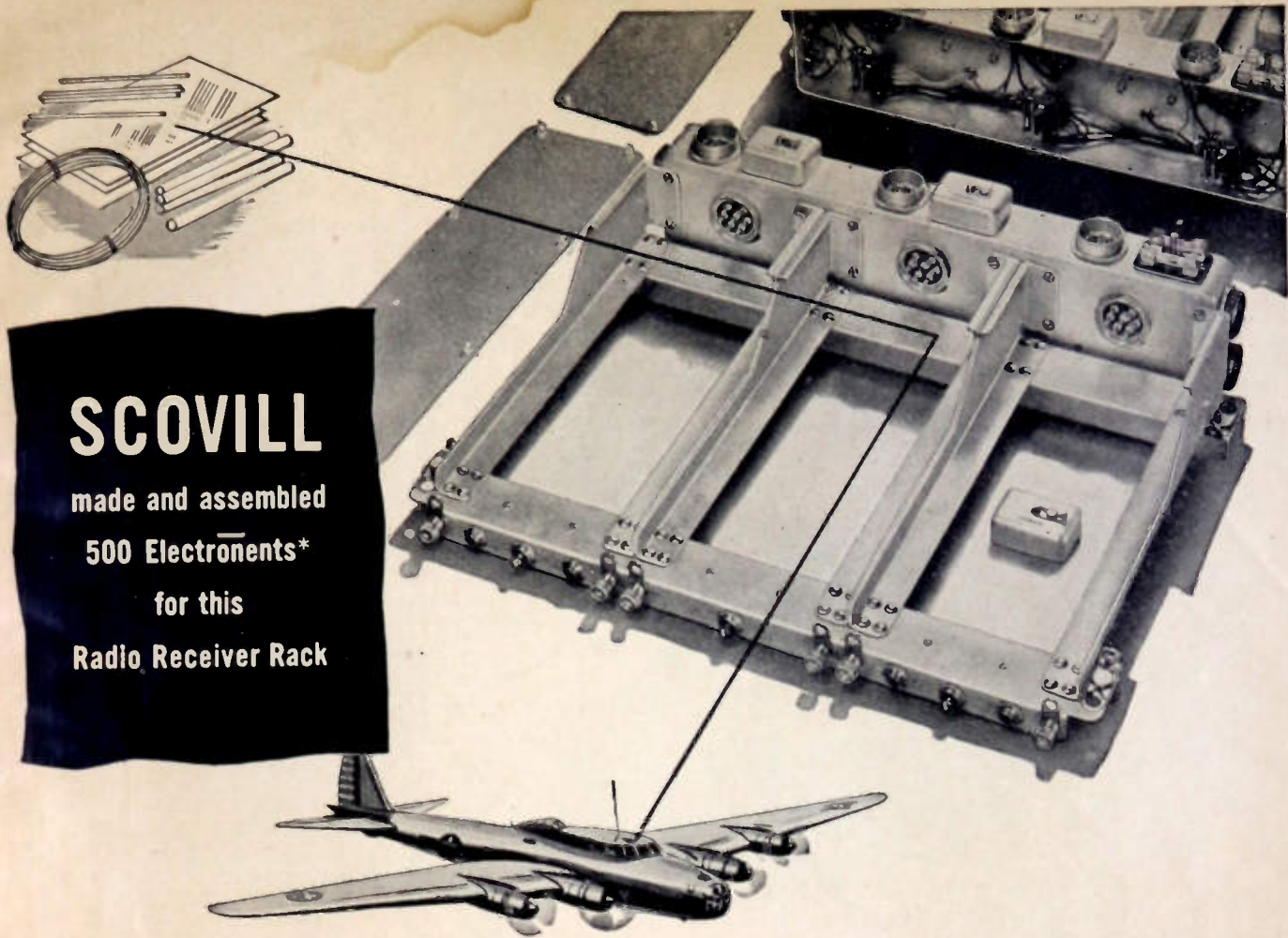

SCOVILL

made and assembled
500 Electronents*
for this
Radio Receiver Rack

*Demonstrating how Scovill can reduce your overhead
on small parts or complete assemblies*

Put yourself in the shoes of the prime contractor who needed this three-position, high-frequency radio receiver rack for big bombers in a hurry. He could have undertaken to make in his own plant the more than 500 individual parts required, or . . . made some and purchased the remainder, then assembled the complete unit himself. Instead he turned the complete responsibility over to Scovill . . . and saved time, space, trouble and money.

Here's what Scovill did: made all the metal parts of sheet, rod, wire and tube stock using such metal-working

methods as forging, stamping, drawing, heading, machining and wire forming . . . cut all wires to length, stripped and soldered them into position . . . manufactured, tested and adjusted re-lays . . . assembled the entire rack as illustrated.

Investigate how Scovill's versatile production setup, as exemplified above, can improve the quality or lower the cost of your small electronic components or complete assemblies. Learn how Scovill's designing and metal-working experience and facilities will make you sure of getting the

one *right* solution to your metal-parts problems. For proof of Scovill's ability to help you, write for literature. Fill in the coupon below and mail it today.

*Electronents = Electronic Components



Please send me a free copy of "Masters of Metal" booklet describing your facilities. I am interested in the ELECTRONENT* applications checked.

- | | | |
|--|--------------------------------------|--|
| <input type="checkbox"/> Batteries | <input type="checkbox"/> Dials | <input type="checkbox"/> Panels |
| <input type="checkbox"/> Record Changers | <input type="checkbox"/> Escutcheons | <input type="checkbox"/> Sockets |
| <input type="checkbox"/> Clips | <input type="checkbox"/> Jacks | <input type="checkbox"/> Stampings (misc.) |
| <input type="checkbox"/> Condensers | <input type="checkbox"/> Lugs | <input type="checkbox"/> Tubes |

Other applications

SCOVILL MANUFACTURING COMPANY

Electronic Division
26 Mill Street, Waterbury 91, Connecticut

Name

Company

Address

NEW!

A complete,
24 page
Illustrated
Manual

on *Permanent Magnets*

**PERMANENT
MAGNETS**
for Industry

THE ARNOLD ENGINEERING COMPANY
147 EAST ONTARIO STREET, CHICAGO 11, ILLINOIS

**WRITE TODAY,
on your letterhead,
for your free copy.**

This unusual Arnold manual on permanent magnets is the product of many months of careful research and planning.

It is devoted entirely to the consideration of the factors affecting the design, fabrication and application of Alnico permanent magnets. Written entirely by Arnold engineers, its purpose is to help engineers in industry to better utilize the magnetic and physical characteristics of the Alnico alloys in arriving at efficient design.

Write today, on your letterhead, for your free copy.



THE ARNOLD ENGINEERING COMPANY

147 EAST ONTARIO STREET, CHICAGO 11, ILLINOIS

Specialists in the Manufacture of ALNICO PERMANENT MAGNETS

T
E
E
T
R
O
D
E
E

✓ these tube characteristics to meet the most exacting requirements of fine instrumentation.

They are intended primarily for service where ordinary commercial tubes are not suitable.



*Actual
Size*

Series VW-41 Characteristics

Filament Current	0.015 amperes
Filament Voltage	1.5 volts
MU G-1	18
Transconductance	65 micromhos
Plate Resistance	275000 ohms

Especially suitable for measuring very small currents or voltages in very high resistance circuits particularly where input resistance may be of the order of 10^{12} ohms or greater.

Also available as . . .
Electrometers Triodes
Pentodes Diodes



Hi-Meg Resistors

Designed for high precision instrumentation where ranges of 10 millivolts to 10 volts are used. The same physical size is maintained for all values from 1 megohm to 1,000,000 megohms. Vacuum sealed in special treated glass—size of envelope $1\frac{7}{8}$ inches long $\frac{3}{16}$ inches in diameter.



THE VICTOREEN INSTRUMENT CO.
5806 HOUGH AVENUE
CLEVELAND 3, OHIO

Laboratory Standards

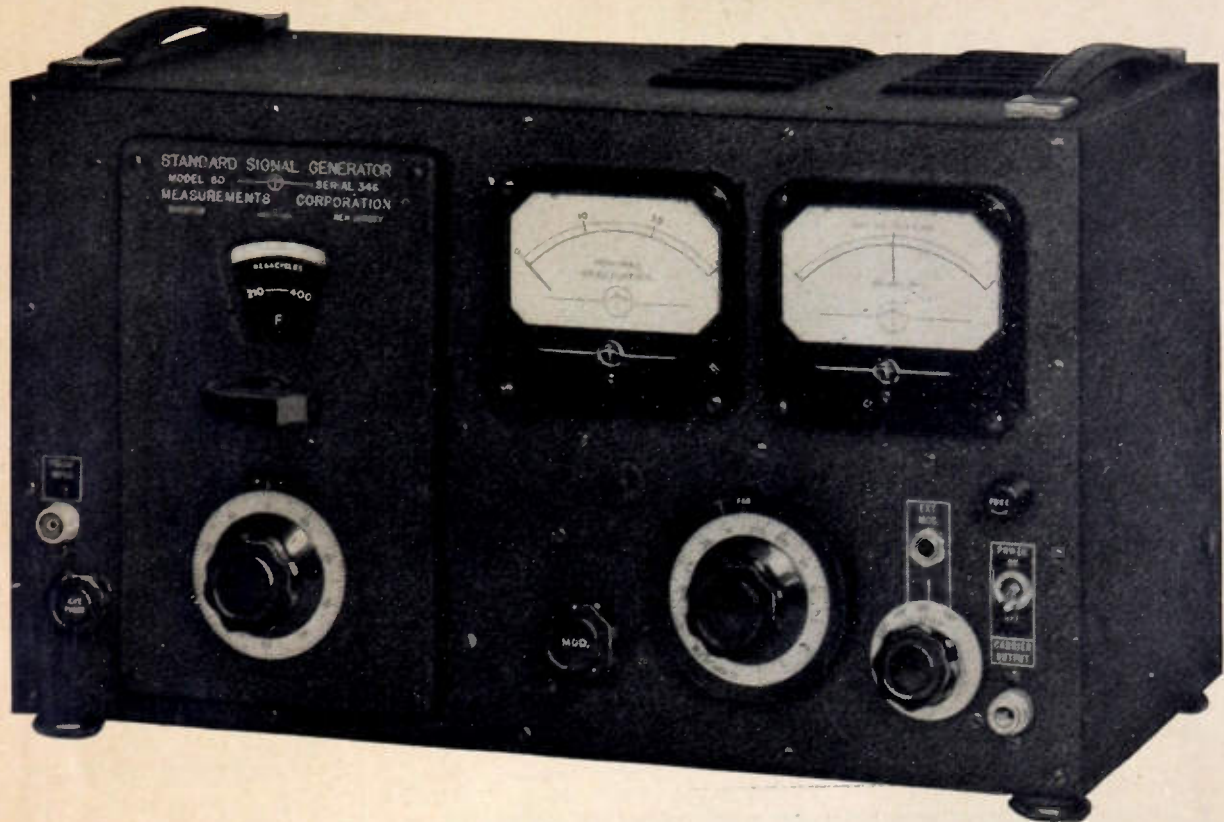

Model 80 STANDARD SIGNAL GENERATOR

Specifications

CARRIER FREQUENCY RANGE:

2 to 400 megacycles.

Individually calibrated dial with six overlapping bands. Automatic range indication eliminates error in selection of the correct frequency scale. Embodies a highly stable, low drift oscillator of thoroughly coordinated design.

OUTPUT SYSTEM:

Continuously variable from 0.1 to 100,000 microvolts. The output metering system incorporates a precision barretter bridge for continuous monitoring of the carrier oscillator. The carrier leakage is held to less than 0.1 microvolt.

OUTPUT IMPEDANCE:

Fixed at 50 ohms. Optional 6 db. external pads are available to reduce reflection errors from lines of uncertain characteristics.

MODULATION:

Amplitude Modulation from a self-contained modulator and oscillator providing 400 to 1,000 cycle. Provision for external audio modulation. Video Modulation jack is provided for connecting an external pulse generator (such as our 79-B) directly to the oscillator plate circuit. Pulses of one microsecond can be obtained at higher carrier frequencies.

DIMENSIONS:

Width 19", Height 10 $\frac{3}{4}$ ", Depth 9 $\frac{1}{2}$ "

Power Supply: 117 volts, 50-60 cycle

Weight: Approximately 35 pounds

Fuses: One type 8-AG-1 one ampere

Prompt delivery

MEASUREMENTS CORPORATION
BOONTON  **CORPORATION**
NEW JERSEY

Use C. T. C.'s NEW TIME-SAVING All-Set TERMINAL BOARDS

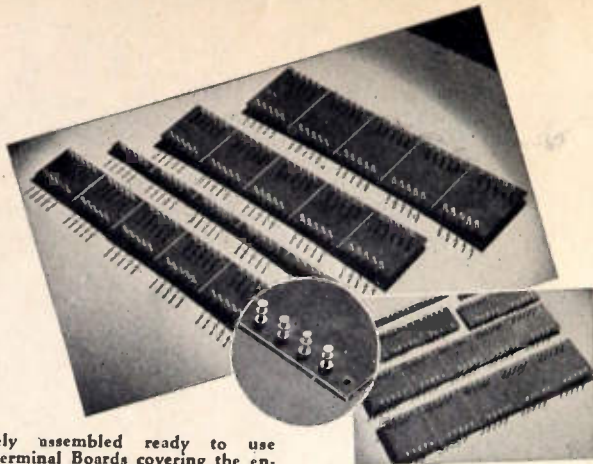

Completely assembled ready to use Mounted Terminal Boards covering the entire range of standard resistors and condensers. Specially designed for experimental laboratories and manufacturers to speed development of model equipment and assembly of established products.

C.T.C. All-Set Terminal Boards are made of 3/32", 1/8" and 3/16" linen bakelite only and are available in four widths 1/2"; 2" (lug row spacing 1 1/2"); 2 1/2" (lug row spacing 2"); 3" (lug row spacing 2 1/2").

Made in five-section boards which can

be broken into fifths by bending back on scribed line. Each fifth is drilled for twelve lugs.

Available in sets of four widths, or in lots of 6 or multiples of 6 in any single width. Extra lugs and stand-offs supplied.

C.T.C.'s new All-Set Terminal Boards can be supplied with any size C.T.C. Turret Terminal Lug—as listed in catalog #100, drawing #1724.

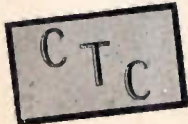

WRITE FOR C.T.C. CATALOG No. 100

CAMBRIDGE THERMIONIC CORPORATION

456 Concord Avenue

Cambridge 38, Mass.

Remler Appointed as Agent for R.F.C.

... to handle and sell government owned electronic equipment released for civilian use.

Write for Bulletin Z-1 listing a wide variety of equipment covering entire electronic field.

Remler Co., Ltd. · 2101 Bryant St.
San Francisco 11, Calif.

REMLER

SINCE 1918

Communications · Electronics

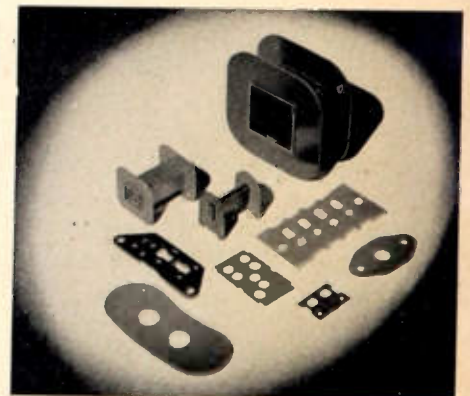

Serving the Radio
Industry with dependable
laminated plastics

**NATIONAL
VULCANIZED
FIBRE**

PHENOLITE
Laminated BAKELITE

—because of their lightness in weight, high dielectric strength, ready machineability, exceptional wearing and other qualities—are playing a vital part.

**NATIONAL VULCANIZED
FIBRE CO.**

Offices in Principal Cities
WILMINGTON, DELAWARE

MADE BY *Engineers*

FOR *Engineers*

CORWICO

WIRES

JOB AHEAD!

... and we are equal to it!
Each day we'll be shipping
MORE for civilian use

cornish

WIRE COMPANY, INC.

15 Park Row, New York City, New York

SYLVANIA NEWS

ELECTRONIC EQUIPMENT EDITION

DEC.

Published by SYLVANIA ELECTRIC PRODUCTS INC., Emporium, Pa.

1945

NEW, SENSATIONALLY SMALL SYLVANIA TUBE WILL PERMIT RADIOS OF CIGARETTE-PACK SIZE

Fuze-Type Tube Adaptable To All Battery Sets

Sylvania Electric announces a revolutionary new radio tube, the size of a peanut, which is as significant to the development of sets as the famous Sylvania Lock-In Tube.

Originally designed as the T-3 fuze-type tube, this tiny electronic unit is the commercial version of the radio proximity fuze tube developed by Sylvania. These tubes are being made

in low-drain filament types. They have long life and are so rugged that they won't break when dropped. Their low-drain characteristics take advantage of a new miniature battery developed during the war — permitting the design of radios ranging from the size of a package of cigarettes up to a deluxe farm receiver.

The new, tiny, complete electronic

unit will provide electrically and mechanically superior features similar to the Sylvania Lock-In Tube. Since the T-3 type of tube was originally designed to withstand the shock of travelling inside a spinning artillery shell, it will be even more rugged than the Lock-In, which has become known for its superiority for all types of sets.

THE T-3 TUBE LINES UP WITH OTHER FAMOUS SYLVANIA TUBES

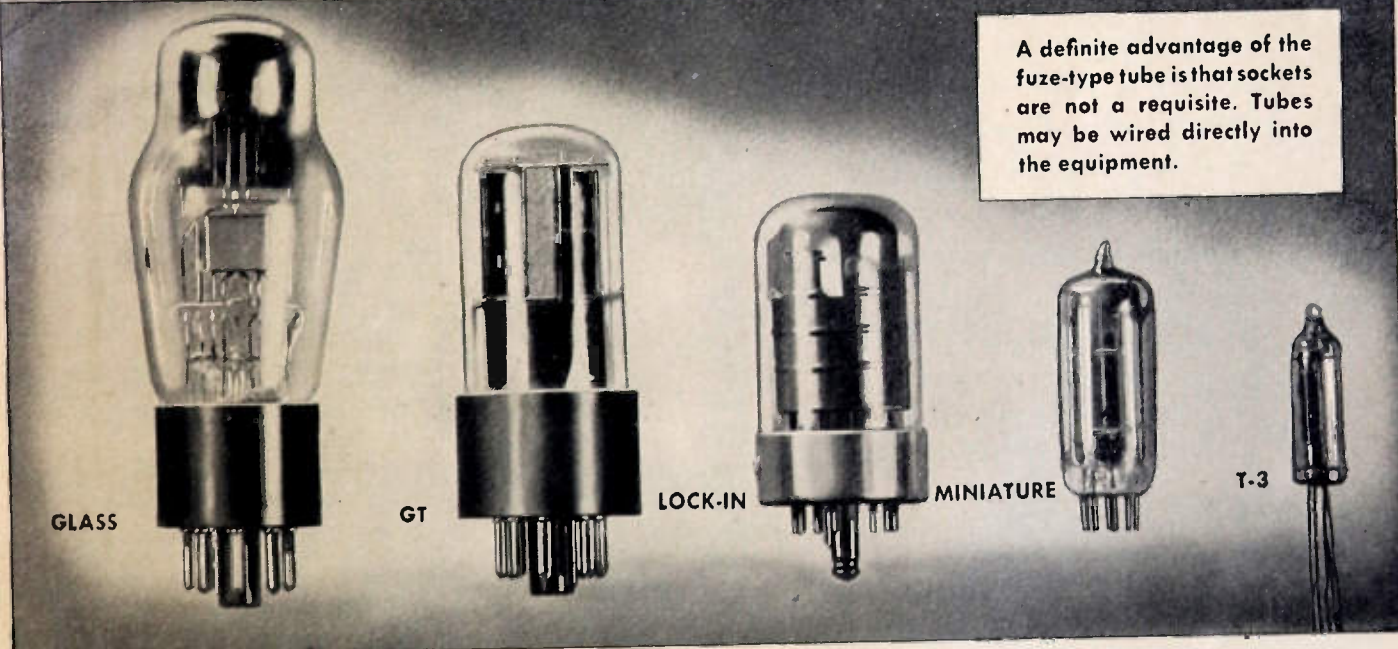

SYLVANIA ELECTRIC

Emporium, Pa.

MAKERS OF RADIO TUBES; CATHODE RAY TUBES; ELECTRONIC DEVICES; FLUORESCENT LAMPS, FIXTURES, WIRING DEVICES; ELECTRIC LIGHT BULBS

How High?

Should future developments in electronic communications (either audio or video) require vertical radiators of extreme height look to Blaw-Knox for the kind of structural engineering which will assure the success of such towers.

Thousands of installations, ranging from 66 ft. to 1000 ft., are ample proof that you can rely on Blaw-Knox for complete responsibility in the fabrication, erection and testing of complete antenna systems.

BLAW-KNOX DIVISION
OF BLAW-KNOX COMPANY
2038 FARMERS BANK BLDG.
PITTSBURGH • PENNSYLVANIA

BLAW-KNOX VERTICAL RADIATORS

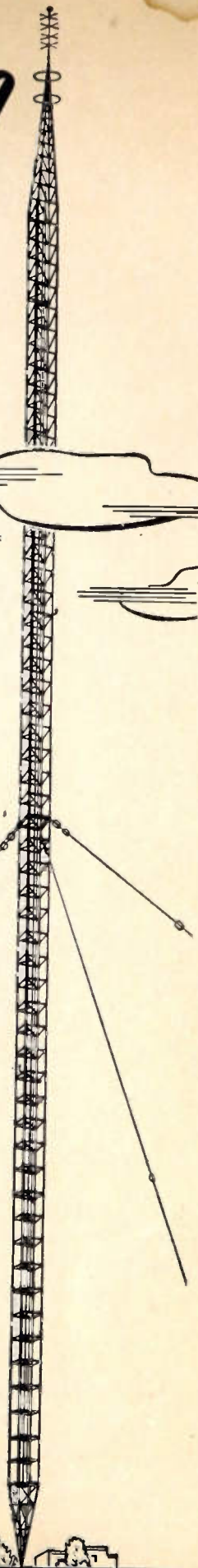

AVAILABLE I.R.E. STANDARDS

	Price
Standards on Electroacoustics, 1938	\$.50
Definitions of Terms, Letter and Graphical Symbols, Methods of Testing Loudspeakers. (vi + 37 pages, 6 × 9 inches.)	
Standards on Electronics: Definitions of Terms, Symbols, 1938	\$.20
A Reprint (1943) of the like-named section of "Standards on Electronics, 1938." (viii + 8 pages, 8½ × 11 inches.)	
Standards on Electronics: Methods of Testing Vacuum Tubes, 1938	\$.50
Standards on Transmitters and Antennas: Definitions of Terms, 1938	\$.20
A Reprint (1942) of the like-named section of "Standards on Transmitters and Antennas, 1938." (vi + 8 pages, 8½ × 11 inches.)	
Standards on Transmitters and Antennas: Methods of Testing, 1938	\$.50
A Reprint (1942) of the like-named section of "Standards on Transmitters and Antennas, 1938." (vi + 10 pages, 8½ × 11 inches.)	
Standards on Radio Receivers: Definitions of Terms, 1938	\$.20
A Reprint (1942) of the like-named section of "Standards on Radio Receivers, 1938." (vi + 6 pages, 8½ × 11 inches.)	
Standards on Radio Receivers: Methods of Testing Broadcast Radio Receivers, 1938	\$.50
A Reprint (1942) of the like-named section of "Standards on Radio Receivers, 1938." (vi + 20 pages, 8½ × 11 inches.)	
Standards on Radio Wave Propagation: Definitions of Terms, 1942	\$.20
(vi + 8 pages, 8½ × 11 inches.)	
Standards on Radio Wave Propagation: Measuring Methods, 1942	\$.50
Methods of Measuring Radio Field Intensity, Methods of Measuring Power Radiated from an Antenna, Methods of Measuring Noise Field Intensity. (vi + 16 pages, 8½ × 11 inches.)	
Standards on Facsimile: Definitions of Terms, 1942	\$.20
(vi + 16 pages, 8½ × 11 inches.)	
Standards on Facsimile: Temporary Test Standards, 1943	\$.20
(iv + 8 pages, 8½ × 11 inches.)	
ASA STANDARDS (Sponsored by the I.R.E.)	
American Standard: Standard Vacuum-Tube Base and Socket Dimensions (ASA C16.2 — 1939). (8 pages, 7¾ × 10¾ inches.)	\$.20
American Standard: Manufacturing Standards Applying to Broadcast Receivers (ASA C16.3—1939). (16 pages, 7¾ × 10¾ inches.)	\$.20
American Standard: Loudspeaker Testing (ASA C16.4—1942). (12 pages, 7¾ × 10¾ inches.)	\$.25
American Standard: Volume Measurements of Electrical Speech and Program Waves (ASA C16.5—1942). (8 pages, 7¾ × 10¾ inches.)	\$.20

Prices are net and include postage to any country. Include remittance with order, and address:

**THE INSTITUTE OF
RADIO ENGINEERS, Inc.**
330 West 42nd Street, New York 18, N.Y.

Picture Performance

THAT REALLY "SELLS"

TELEVISION RECEIVERS



THE **DUMONT**
Type 7EP4

GIVES A CLEAR
EASY-ON-THE-EYES PICTURE
...YET IS PRICED FOR
LOW COST RECEIVERS

Check these **DUMONT Type 7EP4 Features!**

- ✓ special DuMont "EYE COMFORT", soft quality screen (formerly only available in more expensive tubes)
- ✓ high level of light output at low accelerating potential
- ✓ short length for shorter cabinets
- ✓ designed by DuMont for low cost television receivers at the specific request of manufacturers
- ✓ backed by the DuMont reputation for dependability and quality

Now available in production quantities!!! . . .

Order samples NOW and let us quote on quantity orders!

DUMONT

Precision Electronics & Television

ALLEN B. DUMONT LABORATORIES, INC., PASSAIC, NEW JERSEY • CABLE ADDRESS: ALBEEDU, PASSAIC, N. J., U. S. A.

Here is how you can acquire a better knowledge of electronics without trying to be a radio engineer . . .

. . . SEND FOR

Elementary Engineering Electronics

With Special Reference to Measurement and Control

by Andrew W. Kramer,

Managing Editor "Power Plant Engineering,"
Member American Institute of Electrical Engineers,
Associate Member Institute of Radio Engineers

Cloth, 344 pages, 259 illustrations
\$2.00 postpaid

This is a PRACTICAL treatment of principles and applications. It is NON-MATHEMATICAL—no equations beyond elementary-algebra level in the text—fewer than a dozen of these to be learned.

ORDER HIS UNIQUE BOOK NOW

Check, money order or cash must accompany order.

Instruments Publishing Co.,
1128 Wolfendale St., Pgh. 12, Pa.

Enclosed is \$..... for copies
of Kramer's ELEMENTARY ENGINEERING
ELECTRONICS (at \$2.00 each).

Name
Address

Instruments

THE MAGAZINE OF
Measurement and Control

This unique magazine offers a BALANCED DIET of articles and special features appealing to production men as well as to research men—to executives and apprentices! It covers all subjects within the growing fields of Measurements, Inspection, Testing, Automatic Control, Metering, etc.

Many important methods have been disclosed for the first time in exclusive *Instruments* articles; many more will be disclosed through its pages.

Several outstanding books appeared first as serials in *Instruments*. The one advertised above is but one example.

SUBSCRIBE NOW!

Instruments Publishing Co.,
1128 Wolfendale St., Pgh. 12, Pa.

Enclosed is \$2.00 for which send me
Instruments for ONE YEAR.

Name
Position
Company
Products
ADDRESS

ATTENUATORS

by
TECH LABS



STANDARD
TYPE
700



MIDGET
TYPE
600

"Midget" model is especially designed for crowded apparatus or portable equipment.

- Solid silver contacts and stainless silver alloy wiper arms.
- Rotor hub pinned to shaft prevents unauthorized tampering and keeps wiper arms in perfect adjustment.
- Can be furnished in any practical impedance and db. loss per step upon request.
- TECH LABS can furnish a unit for every purpose.
- Write for bulletin No. 431.



Manufacturers of Precision Electrical Resistance Instruments
337 CENTRAL AVE. • JERSEY CITY 7, N. J.

JUST PUBLISHED!

The Most Indispensable Reference in Radio-Electronics!

Electronic Engineering Master Index

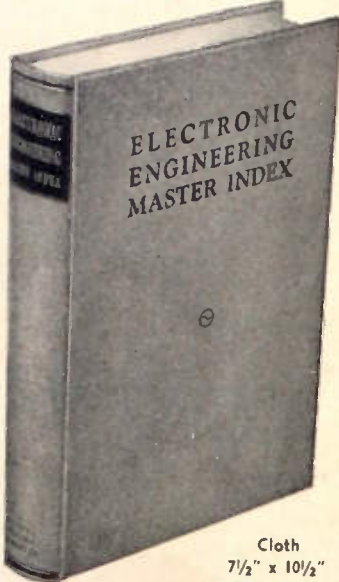

Cloth
7 1/2" x 10 1/2"
320 pages

A master compilation of over 15,000 titles of texts and articles selected for their value to the research engineer, this INDEX covers the years 1925-1945 and enables you to survey twenty years of research literature on any subject in a matter of minutes!

Vitally Needed in Every Laboratory and Library

COMPLETE IN ONE VOLUME

PART I	PART II
January 1925 to December 1934	January 1935 to June 1945

★

PARTIAL LIST OF PERIODICALS INDEXED

Bell Laboratories Record	General Electric Review
Bell System Technical Journal	Journal of Applied Physics
Communications	Proceedings I.R.E.
Electrical Communication	Transactions of A.I.E.E.
Electronics	Radio News
Electronic Industries	R.C.A. Review
Journal of I.E.E.	Wireless Engineer
	Wireless World

A \$500 Reference Library in One Volume for \$17.50

Descriptive circular on request.

ELECTRONICS RESEARCH PUBLISHING COMPANY
238 East 44th Street • New York 17, N.Y.

PRIORITIES NO LONGER NECESSARY

You Can Now Purchase SECO Products on Unrated Orders

To obtain any SECO product is now an easy task. By merely calling or mailing your order to the factory results in prompt shipment of the correct voltage control apparatus for your particular application. Your order does not have to wait its turn because a higher priority job has pushed it aside.

The majority of the standard POWER-STAT variable transformers are carried in stock for immediate shipment. For instance; if a smooth continuously adjustable output voltage is required from a 115 volt line, POWERSTAT type 116 is available with an output range of 0 to 135 volts. Its current rating is 7.5 amperes.

For control of POWERSTATS from push-button stations or automatic controllers, motor-driven POWERSTATS are offered in the same capacities as manually-operated units. Only a few days is necessary to make delivery of any standard model.

SECO'S increased production of SECO Automatic Voltage Regulators means that the unequalled performance of the SECO Regulator in maintaining a constant output voltage regardless of variations in input voltage or output load current is available for all requirements in the range of 1 to 100 KVA.

When space is limited or the atmosphere is hazardous, Oil-cooled POWERSTATS can be run at increased ratings with no danger involved.

Whether production testing or laboratory use is the demand, the VOLTBOX a-c power supply provides an ideal portable source of variable voltage. Regulated and unregulated models are obtainable from stock.

Send for Bulletin ER

SUPERIOR ELECTRIC COMPANY

490 LAUREL STREET,

BRISTOL, CONNECTICUT

ADVERTISERS' INDEX

Section Meetings	34A	Electrons, Inc.	36A	Sperti, Inc.	71A
Membership	38A	Erie Resistor Corp.	25A	Sprague Electric Co.	18A
Positions Open	50A	Federal Tel. & Radio Corp.	15A, 37A, 50A	Stackpole Carbon Co.	61A
Acme Electric & Mfg. Co.	76A	Freed Radio Corporation	50A	Standard Transformer Corp.	40A
Aerovox Corp.	24A	General Electric Co.	8A	Stupakoff Ceramic & Mfg. Co.	22A
Aireon Mfg. Corp.	1A	General Radio Company	Cover IV	Superior Electric Co.	85A
Allen-Bradley Co.	14A	Goat Metal Stampings, Inc.	70A	Sylvania Electric Products Inc.	81A
Alliance Mfg. Co.	62A	General Instrument Corp.	11A	Taylor Fibre Co.	54A
American Lava Corp.	9A	Hammarlund Mfg. Co., Inc.	12A	Tech Laboratories	84A
American Tel. & Tel. Co.	16A	Hallicrafters Co.	47A, 67A	Thordarson Electrical Mfg. Co.	28A
American Transformer Co.	57A	Harco Tower Inc.	74A	Triplett Electrical Instrument Co.	56A
Amperex Electronic Corp.	17A	Heintz & Kaufman, Ltd.	6A	Tung-Sol Lamp Works, Inc.	10A
Andrew Company	76A	Hewlett-Packard Co.	26A	United Transformer Corp.	Cover II
Arnold Engineering Co.	78A	Hytron Radio & Electronics Corporation	29A	Victoreen Instrument Co.	78A
Audio Development Co.	38A	Industrial Condenser Corp.	64A	Western Electric Co.	2A, 3A
Automatic Manufacturing Corporation	75A	International Resistance Company	23A	Westinghouse Electric Corp.	5A
Ballantine Laboratories, Inc.	74A	International Tel. & Tel. Corp.	15A, 37A, 50A	Weston Electrical Instrument Corp.	49A
Alfred W. Barber Laboratories	74A	Instruments Publishing Co.	84A	Paul D. Zottu	86A
Bendix Aviation Corp. (Pacific Div.)	51A	Jackson Electrical Instrument Co.	68A	Professional Service	
Blaw-Knox Co.	82A	Jennings Radio Mfg. Co.	73A	M. F. M. Osborne Associates	
Bliley Electric Co.	35A	Joliet Chemicals, Ltd.	69A	Consulting Physicists	
W. J. Brown	86A	Kaar Engineering Company	19A	Fluid Dynamics, Mechanics, Electronic Design, Electromagnetic and Acoustic Wave Propagation, Mathematical Analysis.	
Brown Engineering Company	72A	Lewis Electronics	32A	703 Albee Bldg., Washington 5, D.C.	
Cambridge Thermionic Corp.	80A	Machlett Laboratories, Inc.	59A	ATlantic 9084	
Capitol Radio Engineering Institute	52A	Frank Massa	86A	FRANK MASSA	
Allen D. Cardwell Mfg. Corp.	54A	Measurements Corp.	79A	<i>Electro-Acoustic Consultant</i>	
Centralab	30A	Carl H. Miller Engr. Co.	86A	DEVELOPMENT PRODUCTION DESIGN	
Chicago Transformer Corp.	48A	Mycalex Corporation of America	41A	PATENT ADVISOR	
Ginaudagraph Speakers, Inc.	66A	National Carbon Company, Inc.	21A	ELECTRO-ACOUSTIC & ELECTRO-MECHANICAL	
Clarostat Mfg. Co., Inc.	44A	National Co., Inc.	39A	VIBRATING SYSTEMS	
Sigmund Cohn & Co.	64A	National Union Radio Corp.	27A	SUPERSONIC GENERATORS & RECEIVERS	
Collins Radio Co.	53A	National Vulcanized Fibre Co.	80A	3393 Dellwood Rd., Cleveland Heights 18, Ohio	
Communication Measurements Laboratory	72A	Newark Electric Co., Inc.	74A	W. J. BROWN	
Condenser Products Co.	70A	New York Transformer Co.	45A	<i>Electronic & Radio Engineering Consultant</i>	
Continental-Diamond Fibre Co.	7A	Ohmite Mfg. Co.	65A	Electronic Industrial Applications, Commercial and Broadcasting Transmitter and Receiver Design, Test Equipment, etc.	
Cornell-Dubilier Electric Corp.	Cover III	M. F. M. Osborne	86A	23 years experience in electronic development	
Corning Glass Works	13A	Albert Preisman	86A	2879 Coleridge Rd., Cleveland Hts., Ohio	
Cornish Wire Co., Inc.	80A	Press Wireless, Inc.	55A	Fairmount 0030	
Coto-Coil Co., Inc.	72A	Radio Corp. of America	32B, 32C, 63A	STANLEY D. EILENBERGER	
Tobe Deutschmann Corp.	87A	Rauland Corp.	31A	<i>Consulting Engineer</i>	
Doolittle Radio, Inc.	60A	Raytheon Mfg. Co.	20A	INDUSTRIAL ELECTRONICS	
Allen B. DuMont Labs., Inc.	83A	Remler Co., Ltd.	80A	Design—Development—Models	
E. I. du Pont de Nemours & Co. (Inc.)	52A	Bernard Rice's Sons, Inc.	43A	Complete Laboratory and Shop Facilities	
Eastern Engineering Co.	60A	Richardson Company	46A	6309-13—27th Ave.	
Hugh H. Eby, Inc.	58A	Scovill Manufacturing Company	77A	Kenosha, Wis. Telephone 2-4213	
Eicor, Inc.	42A	Shallcross Mfg. Co.	34A	ALBERT PREISMAN	
Stanley D. Eilenberger	86A	Skydyne Inc.	56A	<i>Consulting Engineer</i>	
Eitel-McCullough, Inc.	88A	Small Motors, Inc.	58A	Specializing in Television and Pulse Techniques, Video Amplifiers, Industrial Applications.	
Electrical Reactance Corporation	68A	Solar Mfg. Corp.	33A	616 St. Andrews Lane Silver Spring, Md.	
Electronic Engineering Co.	66A			Paul D. Zottu	
Electronics Research Publishing Co.	84A			Consulting Engineer	

CARL H. MILLER ENGR. CO.

Design, Development and Production Engr.

WE ARE ESPECIALLY QUALIFIED TO HANDLE WORK IN THE AIRCRAFT AND ELECTRONICS FIELDS. OUR EXPERIENCE PREVIOUS TO AND DURING THE WAR EFFORT HAS BEEN IN THE DEVELOPMENT OF PRECISE MECHANICAL AIRCRAFT AND ELECTRONIC EQUIPMENT. QUOTATION OR TIME ESTIMATES GIVEN—PHONE OR WRITE.

716 5TH ST. N.W., WASHINGTON (1), D.C.
TEL. NATIONAL 3023 or 3073



DIAGNOSIS *by a Specialist*

THE CURE OF RADIO NOISE is a highly specialized task that involves much more than simply "hooking a condenser across the line". It requires exact knowledge of the proper size and type of capacitor to use . . . of the correct place to add it to the noise-making circuit . . . of the necessary length or positioning of connecting leads . . . and of many other seemingly trivial, but actually vital, bits of information that cannot rightfully be expected of the electrical design engineer.

This exact knowledge is available to you when you must provide radio silence for electrical apparatus. Just send us the offending equipment and we will measure its radio noise output according to standard specifications, will design the most efficient Filterette to cure the noise, will specify the proper means of installing it, and, upon your adoption of our recommendations, will authorize your use of the FILTERIZED label that tells buyers your apparatus will not interfere with radio reception. This service is free to users of Tobe Filterettes . . . write for details.

TOBE DEUTSCHMANN CORPORATION-CANTON, MASSACHUSETTS

ORIGINATORS OF FILTERETTES . . . THE ACCEPTED CURE FOR RADIO NOISE



Tests Prove Eimac Vacuum Condensers Far Superior in Operating Efficiency

Ability to handle high current at high frequencies is the true measure of the performance of a capacitor. A high peak voltage rating based on low frequency measurements does not tell the whole story.

The chart on this page shows the results of tests at 50 Mc. conducted on a standard Eimac VC50-32 Vacuum Capacitor and three other 50 mmfd. vacuum capacitors, designated on the chart by "A," "B" and "C." At just over 17 amps. (approximately 1525 peak volts across the capacitor) Unit "A" (rated at many times the applied voltage) became sufficiently heated to melt the solder on the end caps. Under this same test, the Eimac VC50-32 operates at less than 70°.

Eimac introduced the vacuum capacitor in 1938. It is interesting to note that the original Eimac capacitor design is still outperforming all comers. Such outstanding performance is typical of all Eimac products, which is one of the reasons why they are first choice of leading electronic engineers throughout the world.

Follow the leaders to



1113

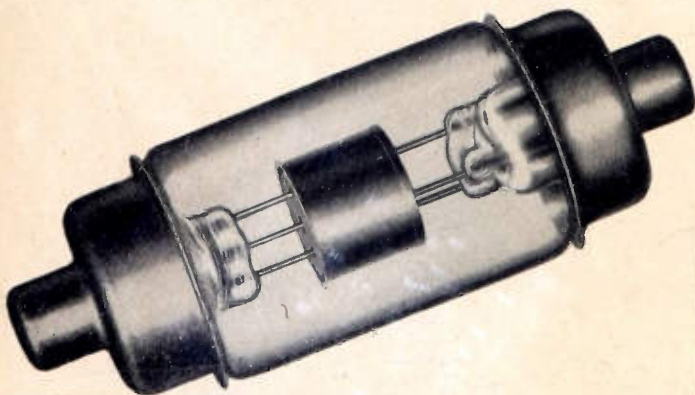

EIMAC VACUUM CAPACITOR TYPE VC50-32
General Characteristics

Mechanical:

Maximum Overall Dimensions
Length 6.531 inches
Diameter 2.281 inches

Electrical:

Maximum Peak Voltage 32,000 volts
Maximum RMS Current 28 amps.

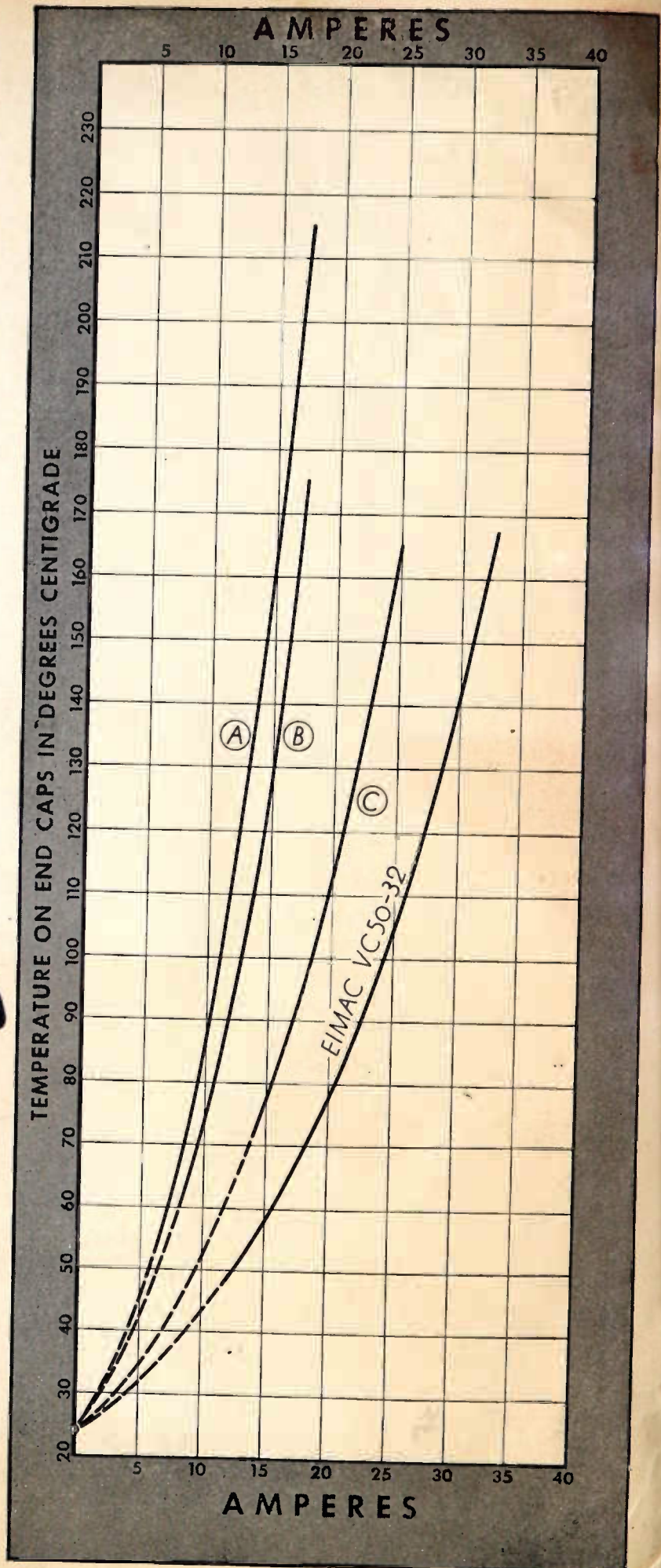

C-D's Skilled Craftsmen, Backed by Expert Engineers, Build High Voltage Capacitors for the Nation's key installations . . .

From the smallest to the largest . . . no requirement is overlooked in C-D's complete range of capacitors. Outstanding examples of C-D's advanced engineering are high voltage capacitors for plate circuit filter and power-factor improvement.

Recognized by the country's leading public utilities, C-D has given them invaluable aid in meeting ever-mounting demands for more power without adding new equipment. Notable among C-D's many contributions to the power field are such installations as those

at Bonneville Dam. Industry knows C-D's helping hand in keeping production up and costs down.

Cornell-Dubilier engineering is available whenever capacitor problems confront you. Write to Cornell-Dubilier Electric Corporation, South Plainfield, New Jersey.

★ ★ ★ Other plants at New Bedford, Brookline, Worcester, Mass. and Providence, R. I.

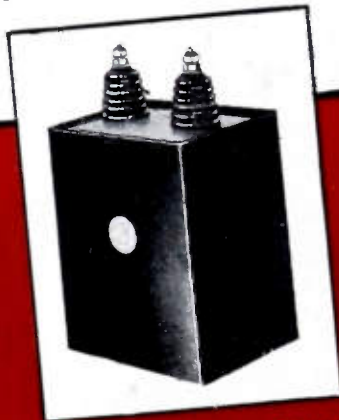

TYPE 14 DYKANOL FILTER CAPACITORS — High grade, multi-terminated bulk capacitors, high purity electrolytic fluid, vacuum de-aired, hermetically sealed steel cases for high capacity and high voltage in an air-cooled, steady, regulated



CORNELL-DUBILIER CAPACITORS

MICA · DYKANOL
PAPER · ELECTROLYTICS



1910

1945

FIRST IN QUALITY — FIRST IN CAPACITOR DEVELOPMENT



TYPE 566-A
0.5 — 150 Mc
Accuracy: 2 — 3%
\$45



TYPE 758-A
55 — 400 Mc
Accuracy:
2% — 5%



TYPE 724-A 0.016 — 50 Mc
Accuracy: 0.25 — 1% \$100

WAVEMETERS for the ENTIRE COMMUNICATIONS SPECTRUM

NEW TYPE 1140-A 240 — 1200 Mc

This is the latest addition to the G-R wavemeter line, with a butterfly-type tuned circuit in which the capacitive and inductive elements are built integrally and tuning is effected by simultaneously varying both. The rectifier is a sensitive and rugged silicon crystal detector with a microammeter for resonance indication. The scale on the frequency indicator drum is 9 inches long. The tuning unit and indicating meter are mounted in a plastic housing which can be held conveniently in one hand. The instrument is accurate to 2% of the indicated frequency. Price: \$65

• Simple, tuned-circuit wavemeters, either with or without resonance indicators, always will find wide application in the laboratory. Direct reading, compact, lightweight, rugged, easy to use, and with accuracy more than ample for many uses, these meters effectively supplement the highly accurate heterodyne frequency meter for many types of measurement.

Wavemeters will always be useful for approximate measurements of coil ranges, oscillator spans, preliminary lining up of transmitters, locating and naming harmonics in either the receiver or the transmitter, and for general experimental work.

For almost thirty years General Radio Company has pioneered in the design and manufacture of accurate wavemeters. General Radio's frequency measurement program, which

has resulted in the finest primary standard of frequency to be obtained anywhere, has always had as a concurrent project the development of a line of wavemeters to cover as much of the useful radio spectrum as the art required.

The four instruments depicted cover the entire frequency range from 16 kc to 1,200 Mc. All of these meters are calibrated in our Calibration Laboratory in terms of the G-R Primary Standard of Frequency. All are built to the same standard of G-R quality as is found in the most precise frequency measuring assembly we manufacture.

G-R wavemeters are correctly designed, skillfully engineered, carefully manufactured and accurately calibrated. Write for detailed information.

GENERAL RADIO COMPANY

Cambridge 39,
Massachusetts

90 West St., New York 6

920 S. Michigan Ave., Chicago 5

1000 N. Seward St., Los Angeles 38