

Proceedings



of the

I·R·E

A JOURNAL of the Theory, Practice, and Applications of Electronics and Electrical Communication

- Radio Communication • Sound Broadcasting • Television • Marine and Aerial Guidance •
- Tubes • Radio-Frequency Measurements • Engineering Education • Electron Optics •
- Sound and Picture Electrical Recording and Reproduction •
- Power and Manufacturing Applications of Radio-and-Electronic Technique •
- Industrial Electronic Control and Processes • Medical Electrical Research and Applications •



RCA Victor

ELECTRONIC RIVET DETONATOR
HIGH-FREQUENCY HEATING OF EXPLOSIVE RIVETS MODERNIZES AN OLD ART

AUGUST, 1945

Volume 33 Number 8

Interdepartment Radio Advisory
Committee

Engineering Training

Army Radio-Relay Systems

Automatic Direction Finder

Electrolytic Tank Impedance-Function
Determination

Multivibrator Circuits

Reactance Theorem for a Resona-
tor

"N"-Phase R-C Oscillators

The Institute of Radio Engineers



FOR INDUCTORS

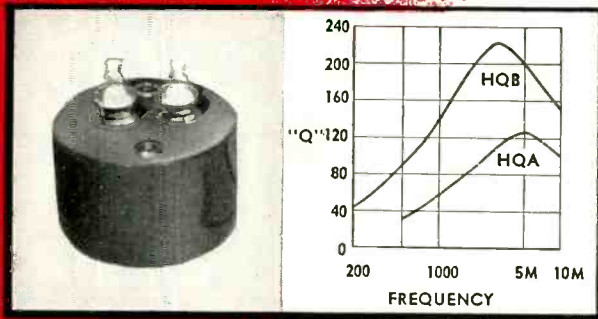

HQA AND HQB HIGH Q INDUCTORS

This series of toroid wound high stability inductors are available from 5 Mhy. to 2 Hys. Voltage stability is excellent, hum pickup is very low. Temperature effects are negligible. HQA units 1-13/16" in diameter by 1-3/16" high.

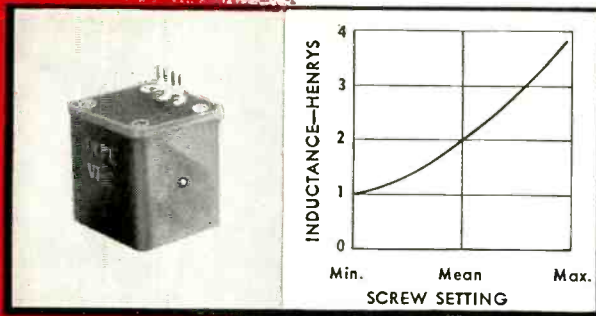

TYPE VI-C VARIABLE INDUCTORS

These inductors are available in optimum values from 10 Mhy. to 10 Hys. They are tunable over a wide range by inserting an Allen Head wrench in the adjusting screw. Units measure 1 1/4" x 1-7/16" x 1-7/16".

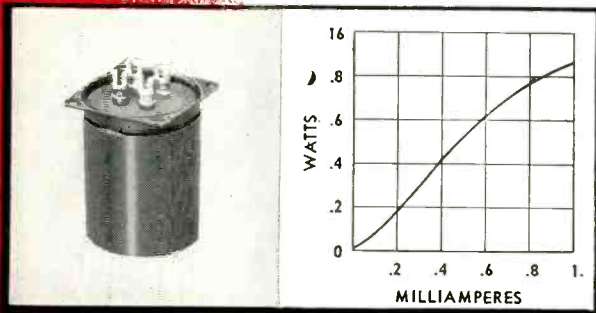

SENSITIVE SATURABLE INDUCTORS

UTC Saturable Inductors cover a wide range of application for magnetic amplification and control. These units are supplied to specific requirements. The curve shown illustrates a high sensitive type, showing DC saturation vs. AC watts into load.

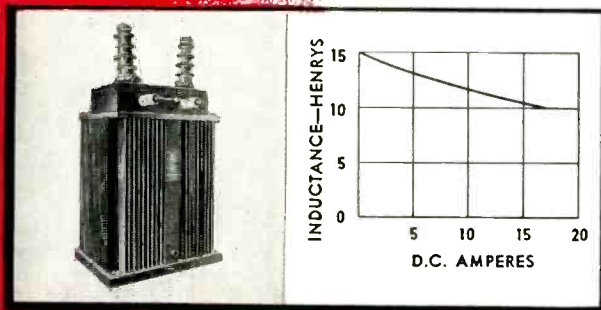

POWER SUPPLY INDUCTORS

UTC supplies power supply components for every type of application, ranging from a one-third ounce reactor, which measures 5/8" x 7/16" x 3/4", to the 10,000 pound, broadcast station, plate supply reactor, illustrated.

May we cooperate with you on design savings for your applications...war or postwar?

ALL PLANTS



United Transformer Corp.

120 VARICK STREET

NEW YORK 13, N. Y.

EXPORT DIVISION, 13 EAST 40th STREET, NEW YORK 16, N. Y.,

CABLES: "ARLAB"

HIGH VACUUM NOW CONTROLLED TO ONE-BILLIONTH OF AN ATMOSPHERE

HIGH on the list of important recent electron tube developments in the National Union Research Laboratories is this ultra sensitive N. U. Ionization Gauge.

Used as a control device in the evacuation of other electron tubes, this gauge reads pressures of .00001 of a micron! High vacuum is assured with resulting uniform high performance characteristics of all N. U. Tubes it helps to manufacture.

Having no grid element, this gauge is completely free from Barkhausen oscillations. Construction is simple, rugged, dependable—and, of course, economical to manufacture.

Here again is an example of the many contributions National Union engineers are making to the advance of electronics. For progress through research—count on National Union. *National Union Radio Corporation, Newark 2, New Jersey.*

N. U. IONIZATION GAUGE

Typical Operation

- Filament voltage—3.0 volts
- Filament current—1.8 A.
- Electron collector voltage—13 volts
- Electron current—20 Ma.
- Ion collector voltage—200 volts
- Sensitivity—Ten times the ion current in amperes equals the pressure in mms. of mercury.

It is possible to expose the hot filament of this gauge to air at atmospheric pressure and later have it function efficiently under vacuum conditions.



NATIONAL UNION RADIO AND ELECTRON TUBES

Transmitting, Cathode Ray, Receiving, Special Purpose Tubes • Condensers • Volume Controls • Photo Electric Cells • Panel Lamps • Flashlight Bulbs

NATIONAL RECEIVERS ARE THE EARS OF THE FLEET

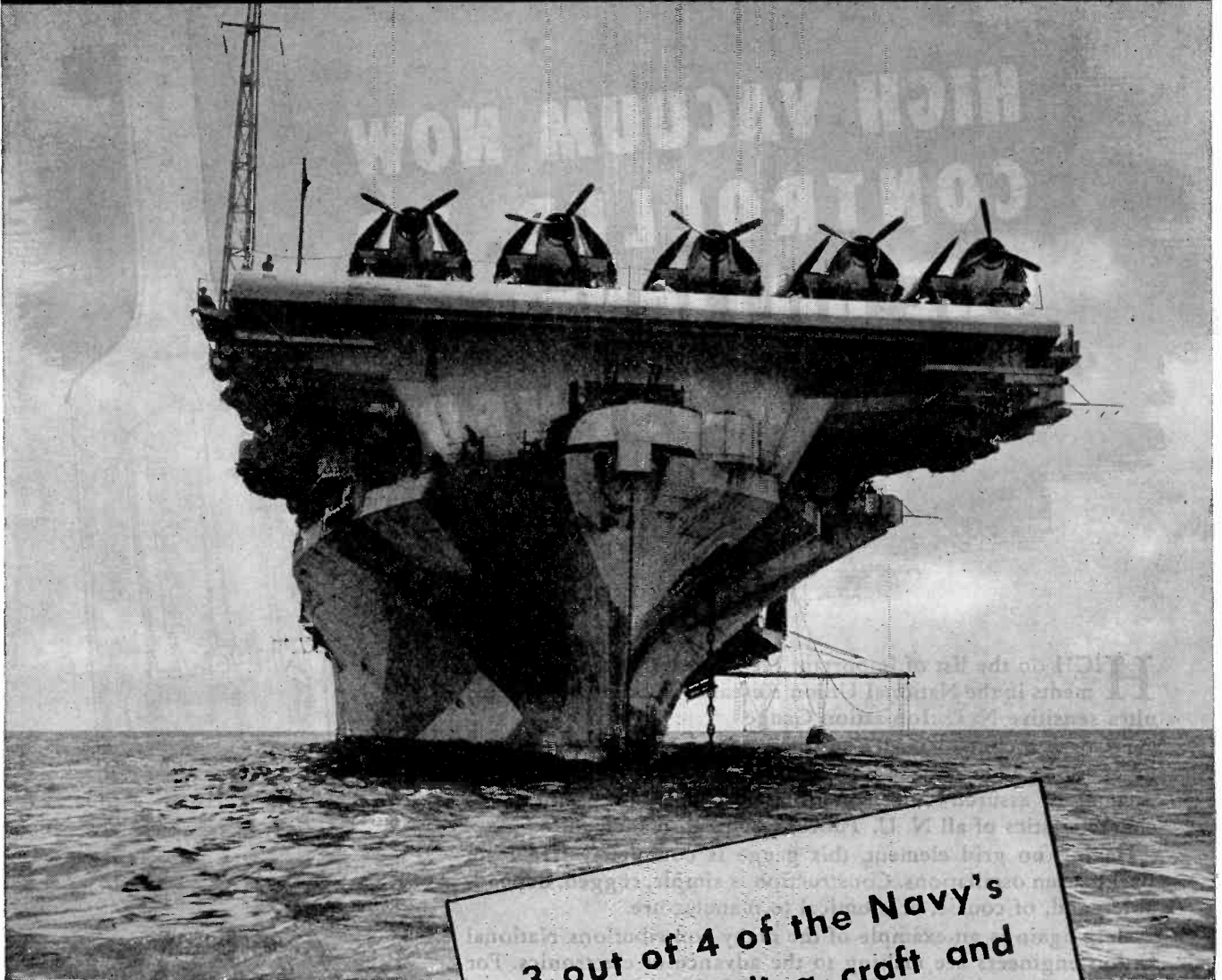

U.S.S. HORNET OFFICIAL U. S. NAVY PHOTOGRAPH

3 out of 4 of the Navy's
ships — landing craft and
larger — use receivers
designed by National.

A capital ship is no place
to use anything but the
finest in radio equipment.



HRO

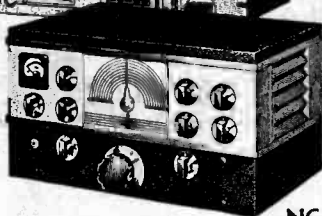

NC-200

NATIONAL COMPANY

MALDEN



MASS, U. S. A.

NATIONAL RECEIVERS ARE IN SERVICE THROUGHOUT THE WORLD

HERE'S PROOF...

How Federal H-F Cable
Quality is Controlled by

Actual Test

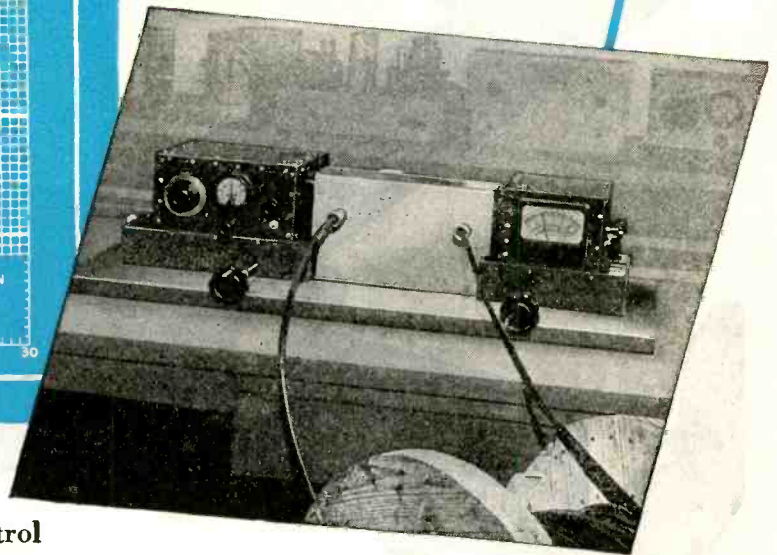
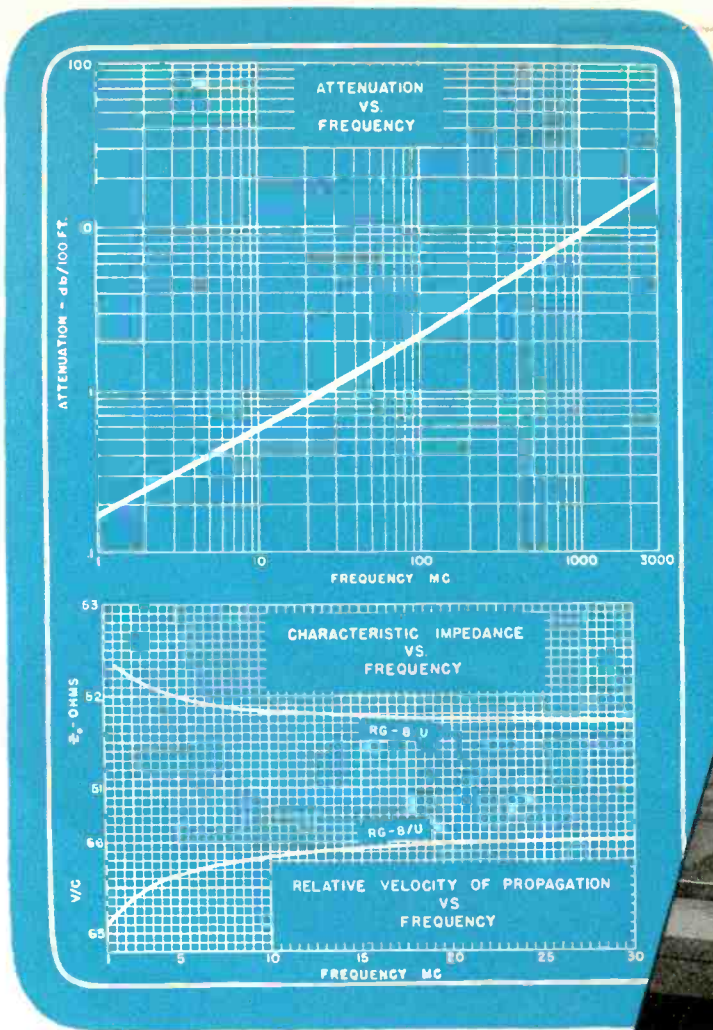

Precision engineering—plus careful control of all manufacturing operations . . . from raw materials to finished product—mean complete reproducibility in any given Intelin Cable type . . . and overall superior cables.

Take Intelin RG-8/U for instance . . . general purpose "work-horse" of high-frequency cables. Its characteristics are shown in curves obtained—not from nominal design values—but from thousands of actual measurements on cable samples, with special equipment developed and used exclusively by Federal's Intelin Product Line.

Intelin's Attenuation Meter is an example of such equipment. It's a precision instrument . . . accurate to .1 db . . . developed by Intelin to provide a constant check on production quality and "measured" data for the equipment designer.

For additional information regarding Intelin RG-8/U . . . write *today* for Report E-53 —and for cable you can count on . . . always specify INTELIN.



Federal Telephone and Radio Corporation



Newark 1, N. J.

THIS SEA-GULL LIVES ON THE GROUND

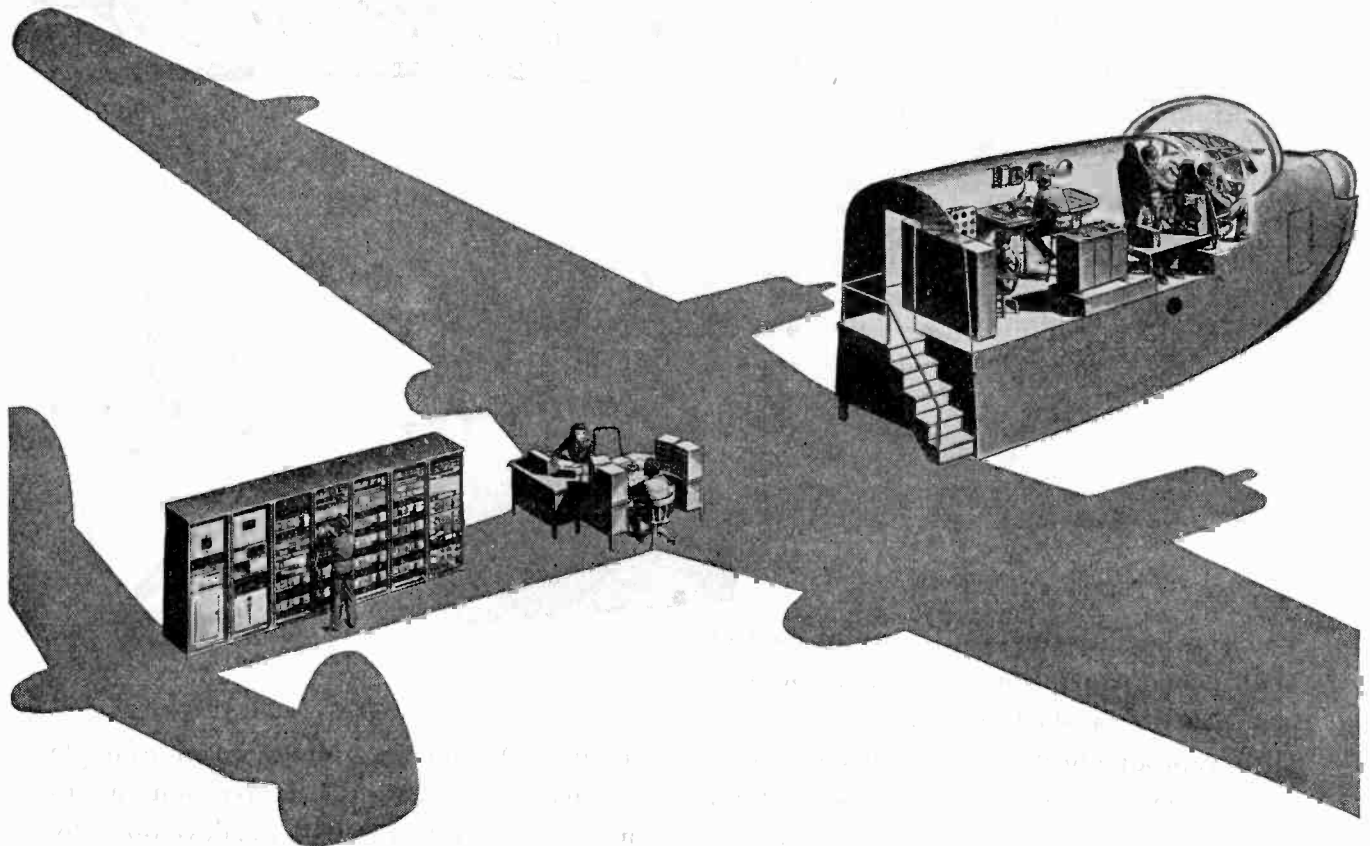

This is a "flight trainer"—an electronically operated replica of the PBM-3 flying boat. It was conceived by the Bureau of Aeronautics and developed by Bell Telephone Laboratories to train Navy bomber crews on the ground.

The new crew climb a few steps to get in and from then on it is like being in a big plane at night. Controls tug against the pilot's grasp and "engines" roar in response to the throttle. From his desk, the instructor creates every situation of real flight—even to iced-up wings, conked-out engines and sudden air-pockets. The novice pilot and his crew get the feel of danger without the hazard.

Once the control dials are set, the various effects are automatically organized and set in motion by concealed machinery which includes 200 vacuum tubes, 60 motors, loudspeakers and hundreds of associated parts. Twenty Laboratories engineers worked more than a year developing the project. Drawings covered an area equal to 15,000 square feet.

This is only one of the 1200 projects in which our experience has been able to help the Armed Forces. What we have learned in devising electronic circuits to train flyers will help build better telephones.



BELL TELEPHONE LABORATORIES

Exploring and inventing, devising and perfecting for the Armed Forces at war and for continued economies and improvements in telephone service.

SMOOTH COMMUTATION!

A.C. VOLTAGE CONTROL with TH 2½A TRANSTAT

Brush Arm Assembly

One piece die casting permits good heat dissipation, provides a simple means of replacing the brush and protects the commutator against contact with brush holder if brush should break or loosen.

Core and Coil Impregnated FOR Long Service

Each turn of vinyl acetate insulated wire is PERMANENTLY anchored by impregnation of whole core and coil with phenolic resin, followed by baking.

Broad Commutating Surface

Ground from parallel wires on outer periphery of coil, forms long even segments with solid insulation necessary to avoid shorted turns. Greater contact area results in a lower operating temperature. Smooth, mirror-like finish provides a practically frictionless brush track.

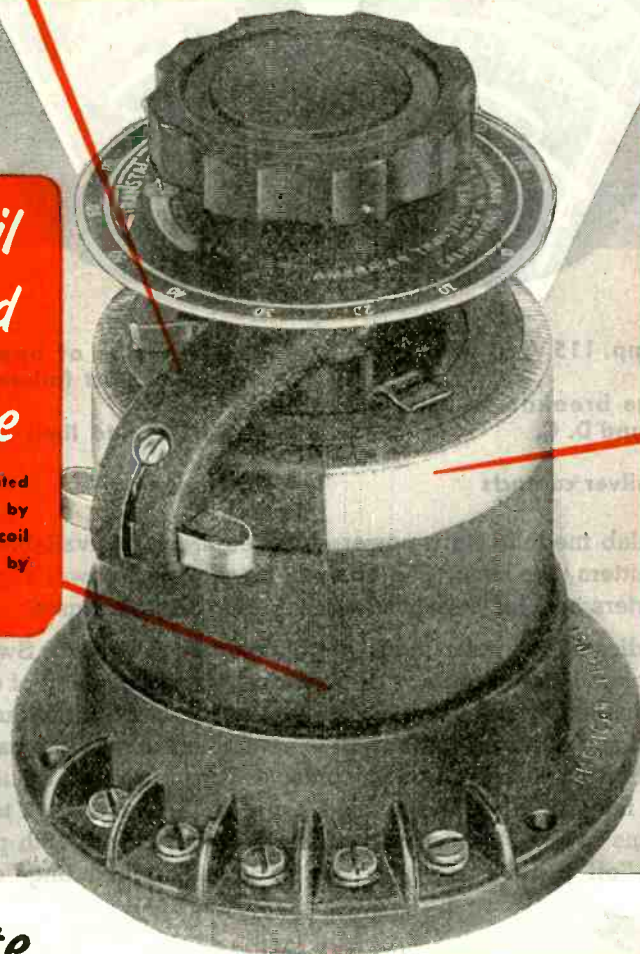

Write
FOR THIS
NEW FOLDER!

Complete description, including construction details, performance curves, wiring diagrams, ratings, electrical data and applications covered. Ask for Bulletin No. 171-01.

AMERICAN TRANSFORMER COMPANY
178 Emmet Street, Newark 5, N. J.

Proceedings of the I.R.E. August, 1945

AMERTRAN

MANUFACTURING SINCE 1901 AT NEWARK, N. J.

Pioneer Manufacturers of Transformers, Reactors and
Rectifiers for Electronics and Power Transmission



Centralab

Medium Duty Power Switches



- 7½ amp. 115 V. 60 cycle A. C.
- Voltage breakdown 2500 V to ground D. C.
- Solid silver contacts
- 25,000 cycles of operation without contact failure
- Fixed stops to limit rotation
- 20° indexing

Centralab medium duty power switches are now available for transmitters (has been used up to 20 megacycles) power supply converters and for certain industrial and electronic uses.

It is indicated in applications where the average Selector Switch is not of sufficient accuracy or power rating. Its accuracy of contact is gained by a square shaft, sleeve fit rotor, and individually aligned and adjusted contacts. It is assembled in multiple gangs with shorting or non-shorting contacts. Torque can be adjusted to suit individual requirements. Furnished in 1 pole . . . 2 to 17 positions (with 18th position continuous rotation with 18th position as "off"); and 2 or 3 pole . . . 2 to 6 position including "off".

Centralab

Division of GLOBE-UNION INC., Milwaukee

PRODUCERS OF Variable Resistors • Selector Switches • Ceramic Capacitors • Fixed and Variable • Steatite Insulators and Silver Mica Capacitors

TWO NEW GASEOUS VOLTAGE REGULATORS

In Miniature

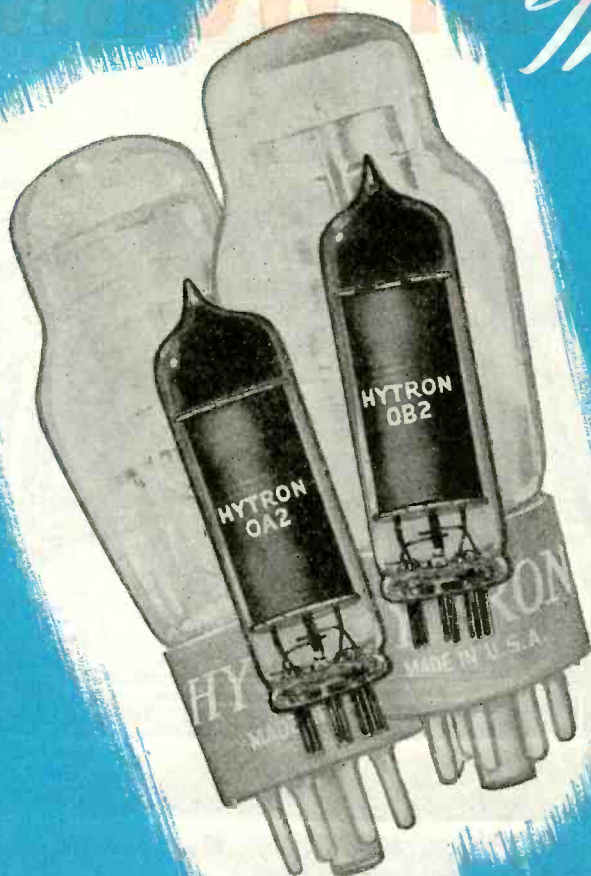

The list of Hytron's customers for the standard OC3/VR105 and OD3/VR150 reads like the social register of electronics. Proved quality products, these Hytron tubes are found literally by the millions in military radar, communications, and electronic equipment.

Now in space-saving miniature bulbs, the new Hytron OA2 and OB2 offer the same careful engineering design, rigid control of processing and assembly, and adherence to tight factory specifications which have made the standard Hytron regulators famous. Life and performance of the miniature OA2 and OB2 equal those of the standard tubes, except that maximum operating current is 30 ma. for the miniatures. Construction is both simple and rugged. Note, for example, use of both top and bottom mica supports and the heavy stem leads. Compare the characteristic data given. Consider the possible space economies. Order your engineering samples today.

COMPARATIVE DATA

HYTRON MINIATURE AND STANDARD GASEOUS VOLTAGE REGULATOR TUBES

TYPE	PHYSICAL CHARACTERISTICS				AVERAGE OPERATING CONDITIONS			
	Max. Length (inches)	Max. Diam. (inches)	Bulb	Base	Supply Voltage† (min.)	Operating Voltage (approx.)	Regulation $E_{50} - E_{5} \dagger$ (volts)	Operating Current* (ma.)
OA2	2 $\frac{5}{8}$	$\frac{3}{4}$	T-5 $\frac{1}{2}$	7-pin Min.	185	150	2	5-30
OD3/VR150	4 $\frac{1}{8}$	1 $\frac{1}{16}$	ST-12	6-pin Octal				5-40
OB2	2 $\frac{5}{8}$	$\frac{3}{4}$	T-5 $\frac{1}{2}$	7-pin Min.	133	108	1	5-30
OC3/VR105	4 $\frac{1}{8}$	1 $\frac{1}{16}$	ST-12	6-pin Octal				5-40

†Sufficient resistance must always be used in series with the tube to limit current through it as follows: OA2 and OB2, 30 ma.; OD3/VR150 and OC3/VR105, 40 ma.

‡Regulation (either positive or negative polarity) is defined as the difference in voltage when the current is varied from 5 ma. to 30 ma.

*Operation for extended periods of time at low current will temporarily increase regulation of tube.

OLDEST MANUFACTURER SPECIALIZING IN RADIO RECEIVING TUBES



HYTRON

RADIO AND ELECTRONICS CORP.



BUY
ANOTHER
WAR BOND

MAIN OFFICE: SALEM, MASSACHUSETTS
PLANTS: SALEM, NEWBURYPORT, BEVERLY & LAWRENCE

MEN AT WORK

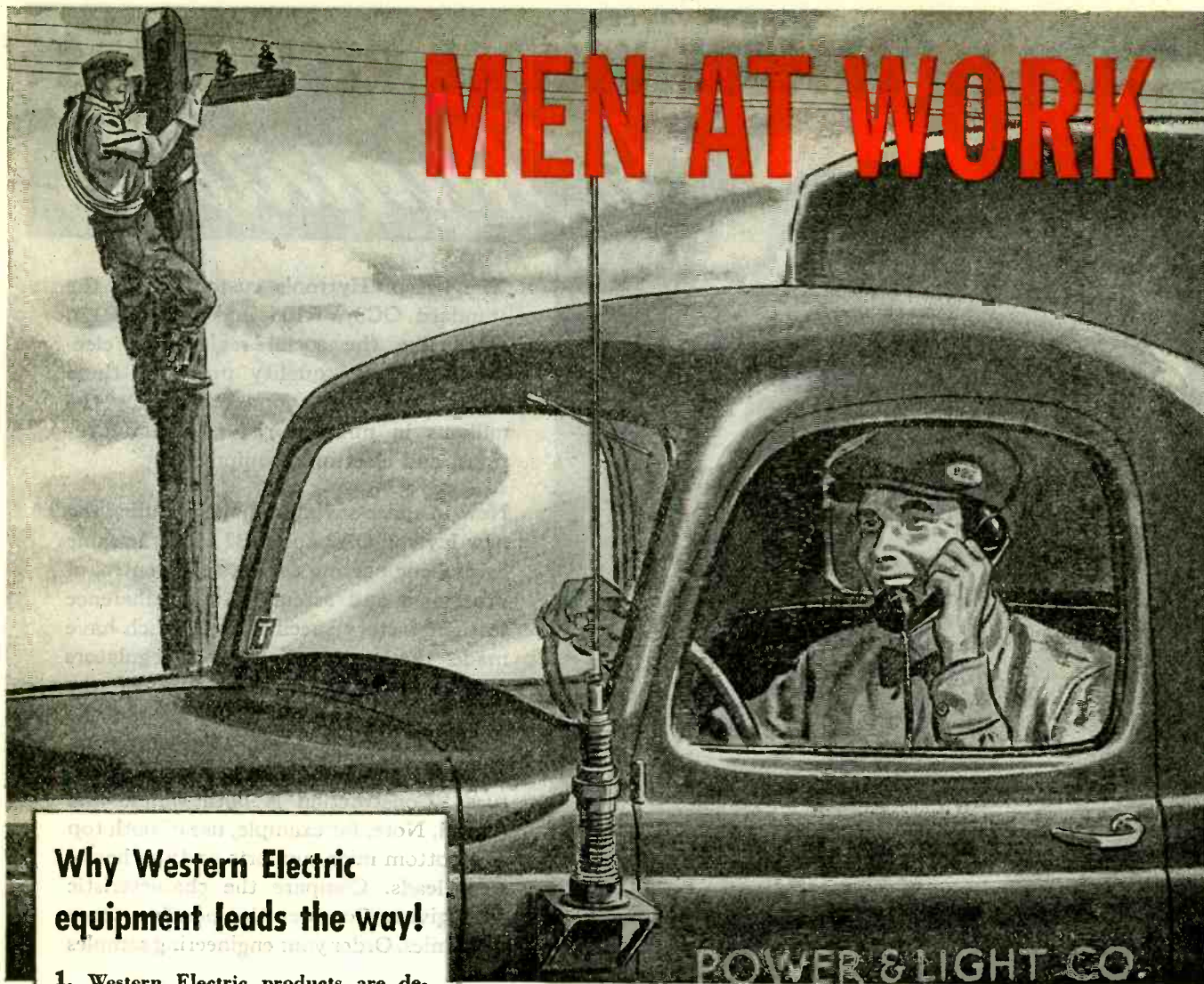

Why Western Electric equipment leads the way!

1. Western Electric products are designed by Bell Telephone Laboratories—world's largest organization devoted exclusively to research and development in all phases of electrical communication.

2. Since 1869, Western Electric has been the leading maker of communications apparatus. Today this company is the nation's largest producer of electronic and communications equipment.

3. The outstanding quality of Western Electric equipment is being proved daily on land, at sea, in the air, under every extreme of climate. No other company has supplied so much equipment of so many different kinds for military communications.

Western Electric

Global war has spotlighted and proved to all the world the tremendous value of instantaneous communication by mobile radio telephone. In the air on land and at sea, it has helped to get the job done faster and to save countless lives.

Men at work or men at play, in the years ahead, will find mobile radio telephone an equally efficient means of keeping

Western Electric has specialized



AM • BROADCASTING • FM



MARINE RADIO



AVIATION RADIO



MOBILE RADIO

or MEN AT PLAY

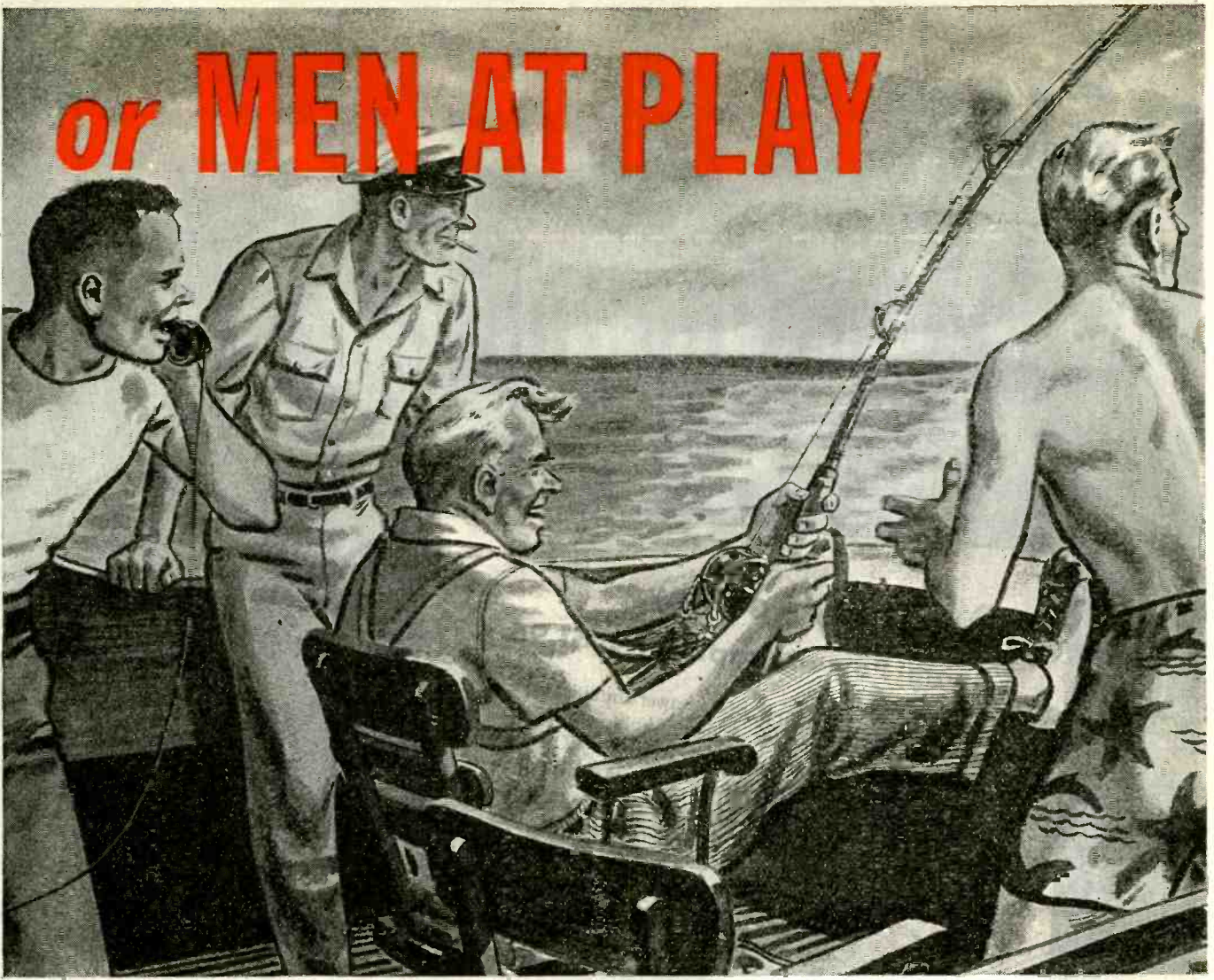

equipment leads the way!

in quick, easy contact with business headquarters or with home.

For more than a quarter of a century, Bell Telephone Laboratories and Western Electric have pioneered in the field of mobile radio. When manpower and materials become available, count on Western Electric for the finest equipment for mobile communications services.



*Buy all the War Bonds you can
... and keep all you buy!*

knowledge in all of these fields

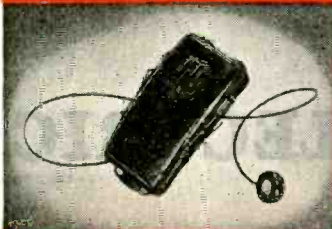

HEARING AIDS



SOUND SYSTEMS



VACUUM TUBES



COMPONENT PARTS



Most popular transmitting tube

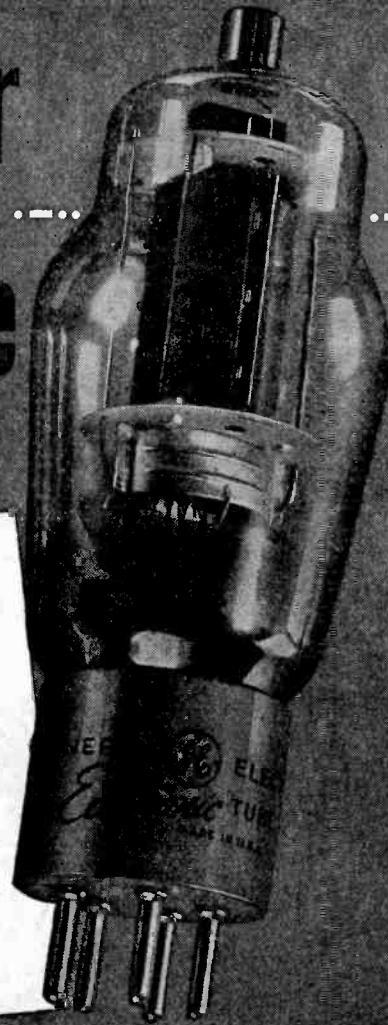

TYPE GL-807 Beam Power Amplifier . \$1.95

High-vacuum, 4-electrode, beam-power-amplifier tube, with heater-type filament. Filament voltage and current, 6.3 v and 0.90 amp. Max plate ratings (CCS) are: voltage 600 v, current 0.10 amp; input 60 w, dissipation 25 w. Max plate ratings (ICAS) are: voltage 750 v, current 0.10 amp; input 75 w, dissipation 30 w. Frequency at max ratings 60 megacycles; at reduced ratings 125 megacycles. Gm 6,000.

EVERY type of transmitter uses this versatile Type GL-807 G-E tube—broadcasting, communications, police, amateur. The tube is employed as a power amplifier in smaller sets; large trans-

mitters use it for service in their low-power stages.

Continuous improvement has enabled Type GL-807 to meet the ever more rigid requirements of the armed forces. Especially is this true of the screen current limits, which now are lower than before. As a result, the commercial usefulness of the tube and its application-range are further broadened.

Basic ratings above give evidence of Type GL-807's adaptability to transmitter service of varying types. A low price of \$1.95 reflects economies that stem from wide demand and large-scale factory output. For complete ratings and performance data see your nearest G-E office or distributor, or write to *Electronics Department, General Electric, Schenectady 5, N. Y.*

When amateur tubes again are available in quantities, General Electric will offer a complete line meeting every requirement.

GENERAL ELECTRIC

161-08-8890

TRANSMITTING, RECEIVING, INDUSTRIAL, SPECIAL PURPOSE
TUBES • VACUUM SWITCHES AND CAPACITORS

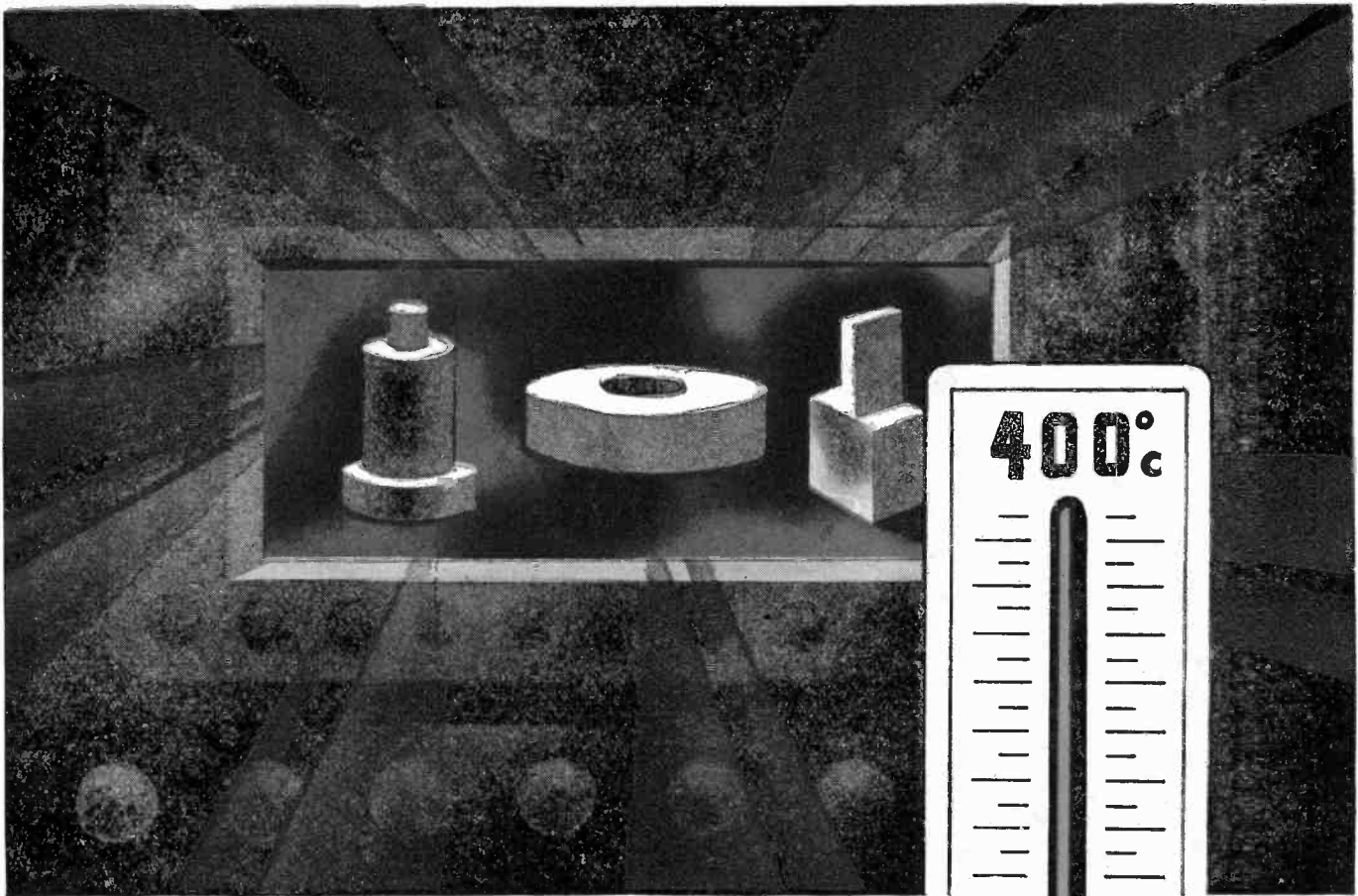

MYCALEX 400

WITHSTANDS HIGH TEMPERATURES

An outstanding characteristic of MYCALEX 400 is that it can withstand temperatures above 400° C. without softening or any permanent change in dimensions or properties.

Thus MYCALEX 400 has proved of great value as a low loss insulator in communications and other high frequency apparatus intended for use at elevated operating temperatures.

MYCALEX 400 is inorganic, free of carbonization... impervious to oil and water... not subject to cold flow. It meets all Army and Navy specifications as Grade L-4 material (JAN-I-10). It combines low loss factor with machinability to close tolerances. In sheets and rods. Fabricated to specifications.



OTHER MYCALEX CORPORATION PRODUCTS

MYCALEX K

A series of ceramic capacitor dielectrics, with dielectric constant selectable from 8 to 19. Low power factor, high dielectric strength. Meets Army and Navy requirements as Class H material (JAN-I-12). To specifications.

MOLDED MYCALEX

Low loss, high temperature injection molded insulation. Molded in union with metals in irregular shapes. High production rates result in economical prices.

MYCALEX K and MOLDED MYCALEX will also withstand 400° C.

MYCALEX CORPORATION OF AMERICA

"Owners of 'MYCALEX' Patents"

Plant and General Offices, CLIFTON, N. J.

Executive Offices, 30 ROCKEFELLER PLAZA, NEW YORK 20, N. Y.

COMMUNICATIONS

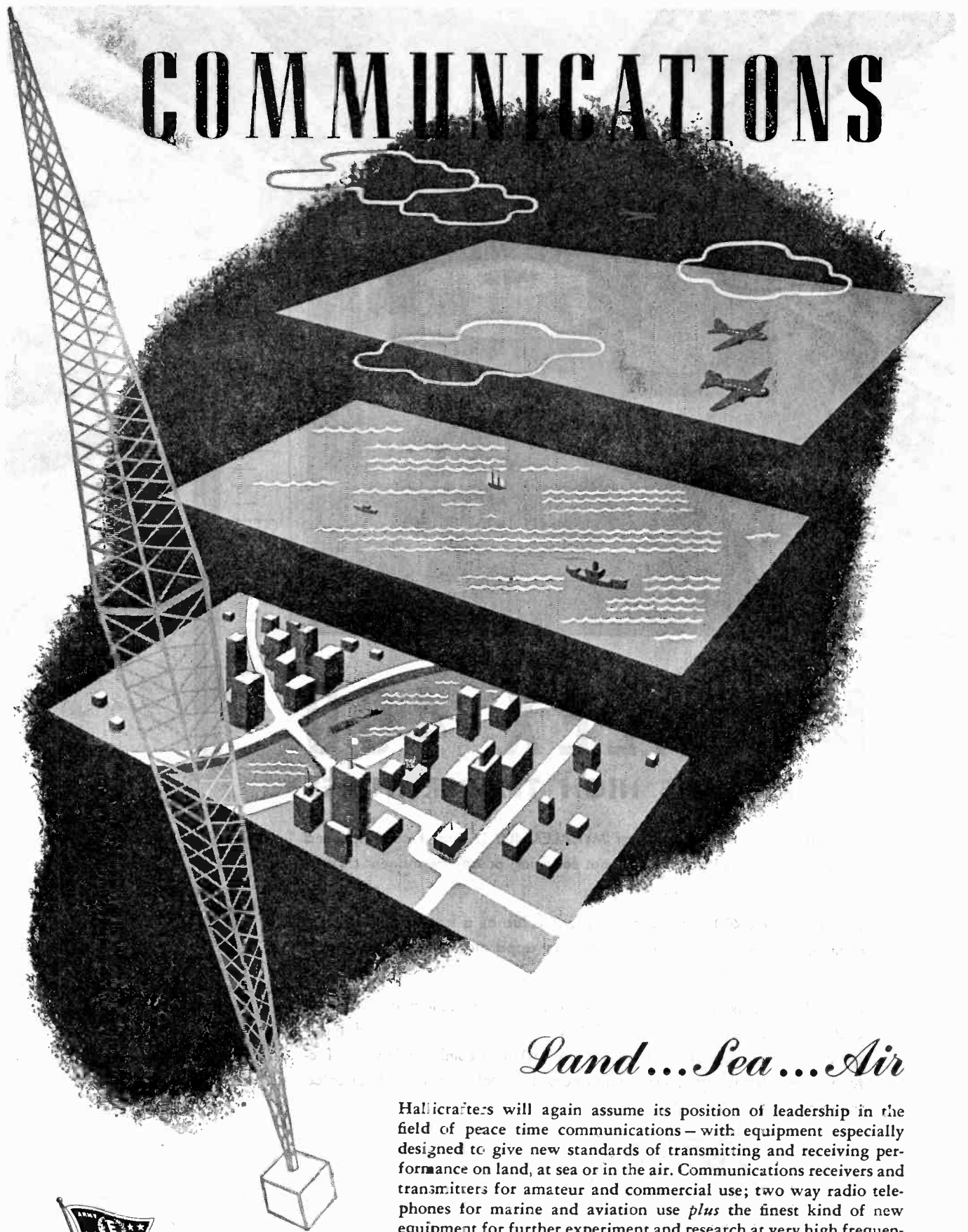

Land... Sea... Air

Hallicrafters will again assume its position of leadership in the field of peace time communications—with equipment especially designed to give new standards of transmitting and receiving performance on land, at sea or in the air. Communications receivers and transmitters for amateur and commercial use; two way radio telephones for marine and aviation use *plus* the finest kind of new equipment for further experiment and research at very high frequencies will all be included in Hallicrafters postwar production plans.



BUY A WAR
BOND TODAY!

COPYRIGHT 1945
THE HALLICTRAFTERS CO.

hallicrafters RADIO



THE HALLICTRAFTERS CO., WORLD'S LARGEST EXCLUSIVE MANUFACTURERS OF SHORT WAVE RADIO COMMUNICATIONS EQUIPMENT, CHICAGO 16, U. S. A.

THE AMPEREXTRA FACTOR in INDUCTION HEATING

The Amperextra Factor is the longer operating life and lower maintenance cost of Amperex air and water cooled transmitting and rectifying tubes. In induction heating, a field in which our engineers have pioneered, this Factor adds considerably to the general efficiency of equipment using Amperex tubes.



LONGER LIFE . . .

. . . since the life of a tube is influenced by the equipment in which it is used, as well as by the inherent characteristics of the tube itself, we maintain a Special Engineering Application Department which constantly applies our tubes in actual circuits, and determines which conditions are conducive to prolonged life. Their findings are freely available to you.



FIGURED . . .

. . . on the basis of the hours of maximum tube life, Amperex tubes are by far your best and most economical "buy."



LOWER MAINTENANCE COST . . .

. . . Amperex tubes offer more value per dollar invested. Down time is noticeably decreased, number of replacements minimized, overall costs reduced.

AMPEREX

. . . the high

performance tube

The Amperex Special Application Engineering Department, another "Amperextra," will be glad to work with you on present or postwar problems.



Amperex Type 575-A Mercury Vapor Rectifier. Filament AC voltage, 5.0 volts. Filament current, 10.0 amperes. Preheating period, before plate voltage is applied, 30 seconds. \$30.00, list price.

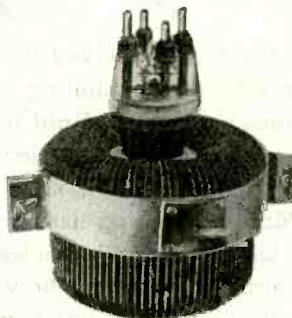

Amperex Type 889-R Transmitting Tube. Filament voltage, 11 volts. Filament current, 125 amperes. Amplification factor, 21. Direct interelectrode capacitance: Grid to plate, 20.7 μf : Grid to filament, 19.5 μf : Plate to filament, 2.5 μf . \$260.00, list price.

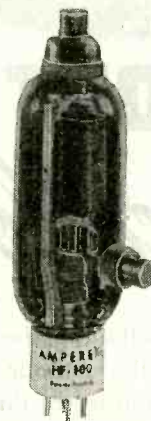

Amperex Type HF-100 Transmitting Tube. Filament Voltage, 10-10.5 volts. Filament current, 2.5 amperes. Amplification factor, 23. Grid to plate transconductance at 100 ma., 4200. Direct interelectrode capacitance: Grid to plate, 4.5 μf : grid to filament, 3.5 μf : plate to filament, 1.4 μf . \$12.50, list price.

AMPEREX TUBES . . .

. . . for induction heating applications range from small 50 watt types to "big boys" of 100,000 watts. Many of these tube types are now available through leading radio equipment distributors.

AMPEREX ELECTRONIC CORPORATION

25 Washington St., Brooklyn 1, N.Y., Export Division: 13 E. 40th St., New York 16, N.Y., Cables: "Arlab"

Canadian Distributor: Rogers Electronic Tubes, Limited • 622 Fleet Street West, Toronto

Pioneering- continued

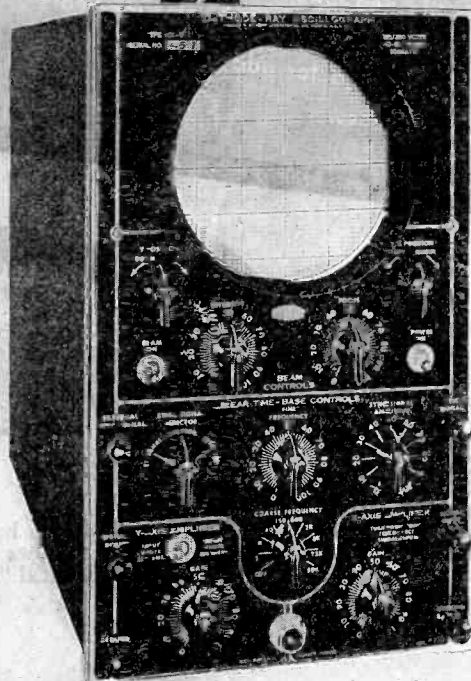

Du MONT

Oscillography

◆ A decade and a half ago Allen B. DuMont conceived the idea of commercializing the cathode-ray tube and exploiting to the full the many possibilities of this amazing device. Until then it had been a scientific curiosity limited to a few laboratories with lavish budgets.

In the few intervening years DuMont pioneering has evolved many types of cathode-ray tubes. Likewise oscillographs and allied equipment. And the DuMont application "know-how" has grown apace. Since 1941 the DuMont organization has engaged 100% in the war effort. Plans are now ready for the coming peace. Such is DuMont pioneering—past, present, continued.

© ALLEN B. DUMONT LABORATORIES, INC.

TYPICAL DUMONT

Pioneering-

◆ The first low-priced commercialized cathode-ray tubes for general use.

◆ Self-contained single-unit low-priced cathode-ray oscillographs.

◆ Oscillographs facilitating the investigation of transient as well as recurrent phenomena over a wide frequency range.

◆ Cathode-ray modulation monitor for checking and maintaining highest broadcast standards.

◆ Large-screen oscillographs such as DuMont 20" Type 233 for detailed analysis of fine-structure wave forms and for lecture demonstrations.

◆ Intensified electroc in tubes for maximum sensitivity and increased brilliance.

◆ DuMont powder-testing oscillographs for evaluating explosives and meeting set standards.

◆ The exclusive DuMont Cyclograph for the non-destructive inspection of ferrous and non-ferrous materials and products compared with known standards, and providing a 100% quality-of-production control.

◆ The electronic switch which places the oscillograms of two signals on a single oscillograph screen for direct comparison or simultaneous study.

◆ The Resonoscope—the only visual method of determining the correct pitch of musical instruments or voice.

◆ Simplified television equipment from camera and control room to transmitting antenna, making telecasting service available even to the smaller population centers.

◆ DuMont Station WABD in New York which has an enviable record for scheduled programs and for the evolution of commercialized television.

DUMONT

Precision Electronics & Television

ALLEN B. DUMONT LABORATORIES, INC., PASSAIC, NEW JERSEY.

Assembling the filament stem of a 50 kilowatt vacuum tube at the Federal Telephone and Radio Corporation plant at Clifton, New Jersey. Ten five, seven jet Litton burners.

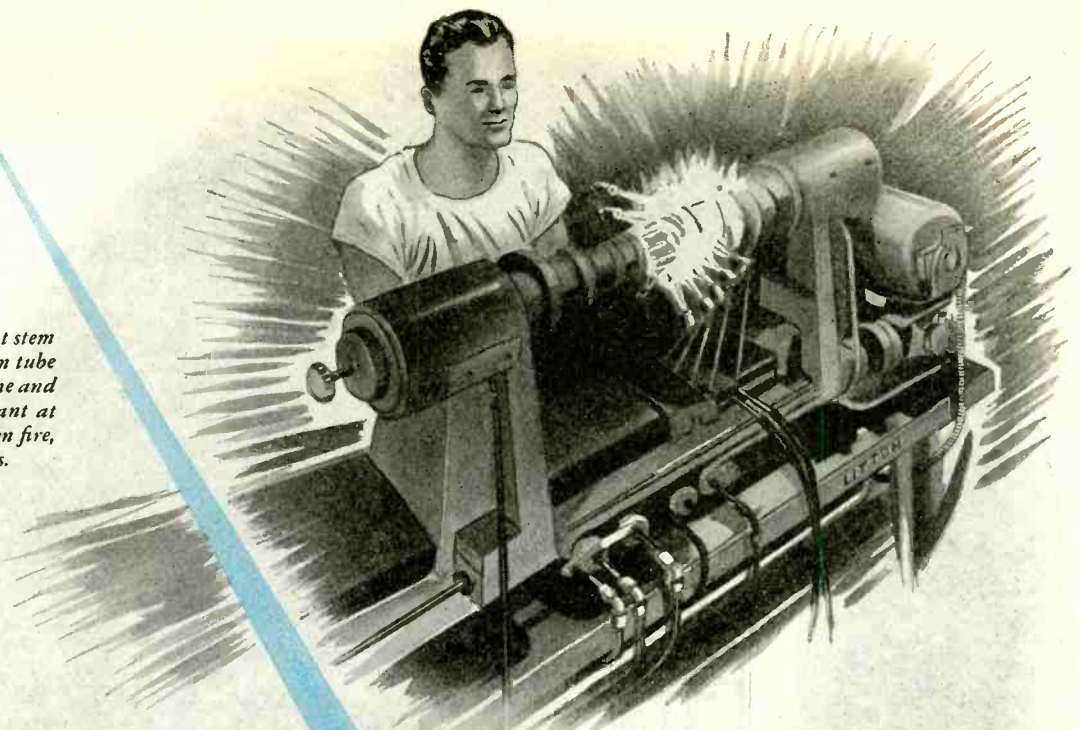

What you may expect from LITTON

JET MIX BURNERS. Litton engineered Jet Mix Burners, proved by 13 years of practical industrial performance, have stepped up production in a number of urgent war industry operations — spectacularly so in vital vacuum tube output.

Compact in size, Litton burners are designed to achieve almost complete carburetion thus eliminating the intense light so injurious to eyes, while permitting low volume operation with complete absence of pop outs — explosions due to rapid change of fire size. Other features of Litton burners include low cost, use of oxygen-gas or oxygen-hydrogen at low and non-critical pressures, uniform size of high temperature flame. They articulate at both head and base, are quickly replaceable, and maintain oxidizing conditions permitting work close to burner tips. Models available are: single jet, two to twelve fire assemblies; large size, seven jet, six or ten fire assemblies; Annealing Burner for bench mounting or with handle. Also hand torches with single or seven jet burners. Complete catalog listings may be had on request.



Litton

ENGINEERING LABORATORIES

REDWOOD CITY, CALIFORNIA, U. S. A.



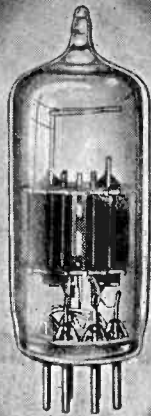

RAYTHEON

TYPE 6J6

Miniature Dual Triode

For a considerable time Raytheon has been assigned a major role in supplying the essential requirements for a versatile, miniature, dual triode tube, type 6J6.

The precise manufacturing techniques which must be maintained are obvious when the physical structure of this tube is considered. Two high transconductance triodes are obtained from a single relatively large flat cathode, which also acts as a shield to prevent interaction between two separate half-grids. These are wound with extremely fine wire and are accurately spaced a few thousandths of an inch on either side of the cathode. Two individual half-plates complete the tube.

Applications utilizing Raytheon Type 6J6 are varied and numerous, ranging from a diode detector to an ultra high frequency push-pull oscillator capable of producing useful energy at frequencies of several hundred megacycles. Its unique construction lends itself to connection as a high performance diode, a single very high transconductance triode, or a dual triode with a common cathode. The 6J6 is also used in cathode follower service and high frequency mixer applications.

Raytheon's continuing development work and long manufacturing experience means *better tubes*. Use Raytheon High-Fidelity Tubes in your postwar products!

SPECIFICATIONS OF 6J6			
DIMENSIONS:			
Maximum Over-all Length	2 1/8	inches	
Maximum Seated Height	1 7/8	inches	
Maximum Diameter	3/4	inches	
RATINGS:			
Heater Voltage	6.3	volts	
Heater Current	0.45	amperes	
Maximum Plate Voltage	300	volts	
Maximum Plate Dissipation (per unit)	1.5	watts	
DIRECT INTERELECTRODE CAPACITANCES (Approx. for each unit) — Unshielded:			
Grid to Plate	1.6	μft	
Input	2.2	μft	
Output	0.4	μft	
CLASS A₁ CHARACTERISTICS (Each triode):			
Plate Voltage	100	volts	
Cathode Bias Resistor — Both units operating	50	ohms	
Plate Current	8.5	ma	
Transconductance	5300	μmhos	
Amplification Factor	38		
Plate Resistance (Approx.)	7100	ohms	

Listen to
"MEET YOUR NAVY"
AMERICAN BROADCASTING CO.
Every Monday Night
Coast to Coast
181 Stations

All Four Divisions Have
Been Awarded Army-Navy
"E" with Stars

RAYTHEON

MANUFACTURING COMPANY
RADIO RECEIVING TUBE DIVISION
NEWTON, MASSACHUSETTS — LOS ANGELES
NEW YORK — CHICAGO — ATLANTA

DEVOTED TO RESEARCH AND THE MANUFACTURE OF TUBES AND EQUIPMENT FOR THE NEW ERA OF ELECTRONICS

READ THE LATEST NEWS!...

About **IRC** Type **BT** and **BW** RESISTORS

Here's a brand new file size Engineering Bulletin, just off the press! It offers you essential authentic information on IRC Type BT (Insulated Metallized) and BW (Insulated Wire Wound) Resistors. Concise, easy-to-read and an excellent ready-reference source, it contains eight pages of "meaty" material that will save you valuable time by quickly answering many of your resistance problems. Interesting construction facts, characteristics data, JAN Type Numbers, dimensional drawings, as well as a complete list of resistance values are compactly presented in this new BT-BW Bulletin. It should be in every Engineering and Design file. Write for your copy today. Address Dept. 10-H



INTERNATIONAL RESISTANCE CO.

401 N. Broad St. Phila. 8, Pa.

IRC makes more types of resistance units, in more shapes, for more applications than any other manufacturer in the world.

Aerovox Standard Types *Plus* Aerovox Engineering Ingenuity Meet High-Altitude Operation Requirements

PILLAR-TERMINAL "Bathtubs"

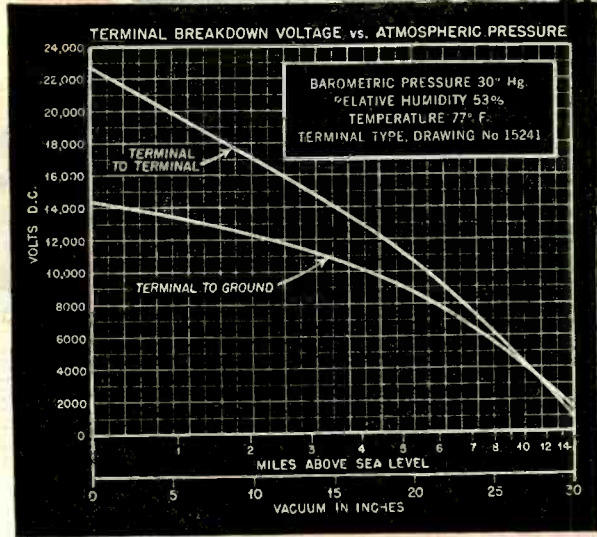
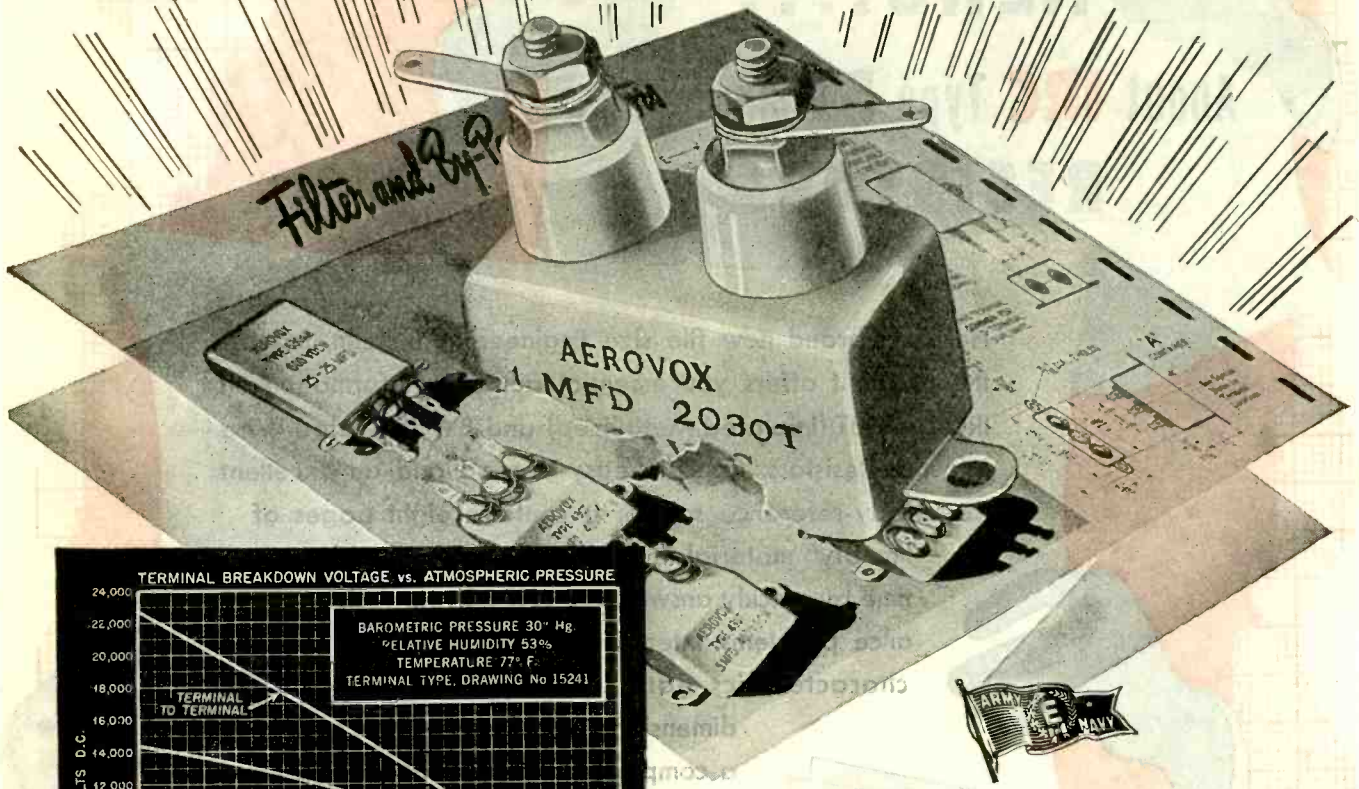

oil-filled capacitors to operate at high altitudes, Aerovox engineers fitted high-voltage pillar terminals to the well-known Type 30 "bathtubs". The result is the unit here shown. The small pillar terminals of feed-through design are normally rated at 3500 V. D.C.W. maximum. At this rating they can be used at altitudes corresponding to 35,000 feet or almost 7 miles. At 50,000 these terminals could be used on capacitors rated at 2000 V. or less. The accompanying chart tells the story.

● Aerovox "know-how" is multiplying the outstanding choice of standard Aerovox capacitors countless fold in meeting extraordinary needs. For instance: To meet certain aircraft requirements for compact

Just another example of that outstanding Aerovox "know-how" that is saving time, money, headaches, for more and more critical capacitor buyers.

● Submit your problem.



Capacitors

INDIVIDUALLY TESTED

AEROVOX CORPORATION, NEW BEDFORD, MASS., U. S. A. **SALES OFFICES IN ALL PRINCIPAL CITIES**
Export: 13 E. 40 St., New York 16, N. Y. • Cable: 'ARLAB' • In Canada: AEROVOX CANADA LTD., HAMILTON, ONT.

THOROUGHbred - j.g.

THE BENDIX TG-16 FIXED STATION TRANSMITTER

**Traditional Bendix quality in the
low power field.**

**The latest addition to the Bendix
line of ground station equipment**

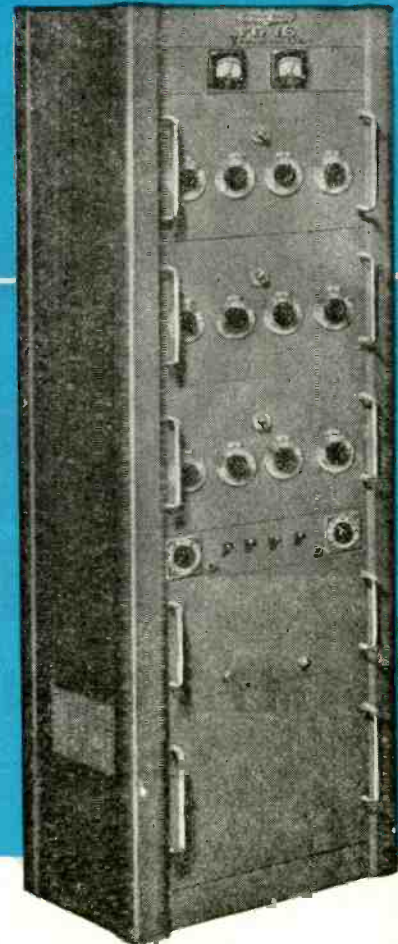

A worthy companion to higher powered Bendix equipment, the TG-16 transmitter is designed to the same standards of performance that have made Bendix Radio equipment "STANDARD FOR THE AVIATION INDUSTRY." Characterized by straightforward design, conservative ratings, and low power consumption, it is ideally suited for installation at secondary airfields where simple, reliable operation is a necessity.

The TG-16 is a unit-type, multi-channel transmitter for airways communication and point-to-point operation at

high frequency and V.H.F. A low frequency RF channel for control tower or automatic radio beacon service can be supplied where required. The output of the transmitter is 100 watts at V.H.F. At lower frequencies it supplies 190 watts for radio telegraph and 160 watts for radio telephone. Simple remote control facilities are available for distances up to 1000 feet.

For further information on the new Bendix TG-16 Fixed Station Transmitter, write for your copy of our catalogue.

Listen to "MEN OF VISION" Sundays 7 P.M. E.W.T. CBS.

Bendix Radio DIVISION

BALTIMORE 4 BENDIX RADIO MARYLAND

STANDARD FOR THE AVIATION INDUSTRY



Behind Push Button Tuning...

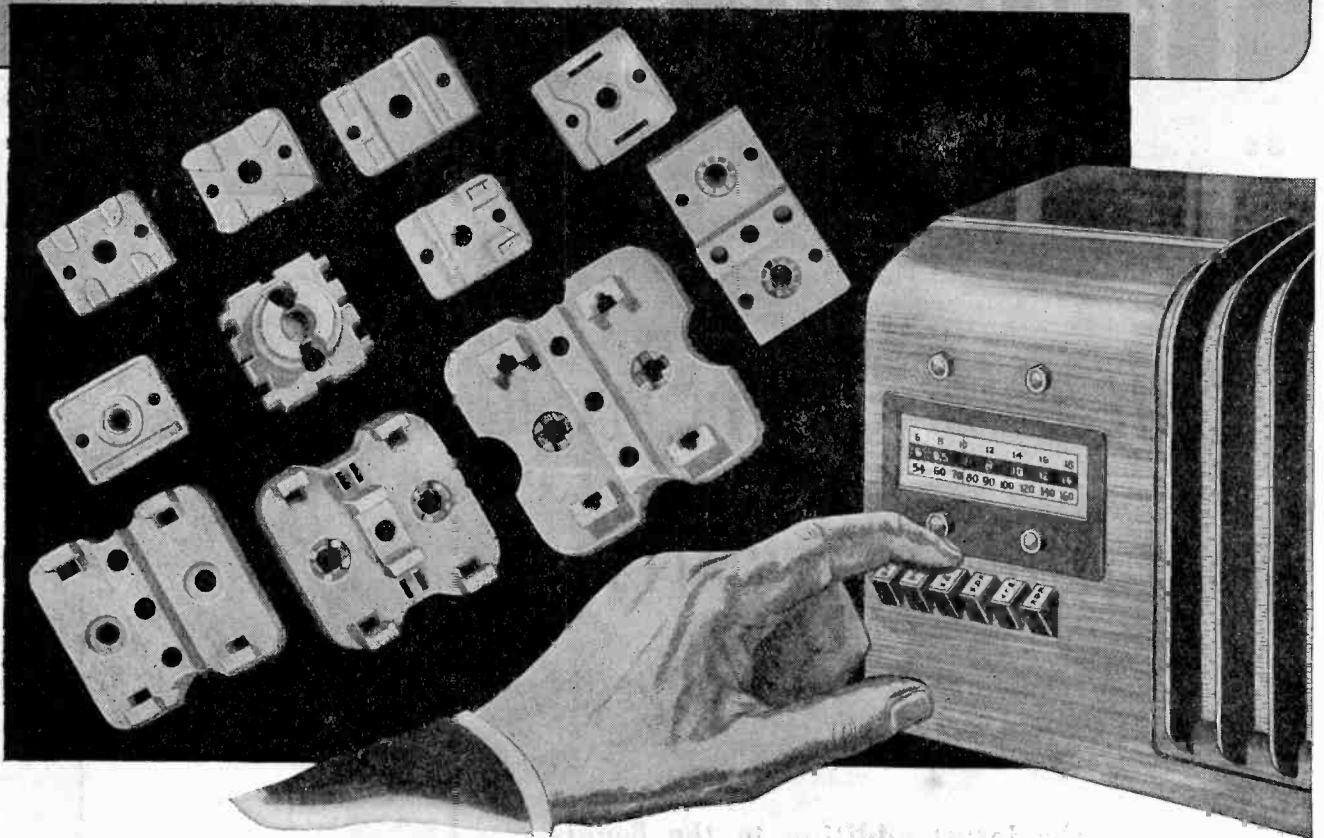

STEATITE CONDENSER BASES **... strong - accurate - stable** **by STUPAKOFF**

STUPAKOFF steatite bases for padder and trimmer condensers provide stable insulation within the circuit—are precision built and withstand rapid assembly operations. They are made of fully vitrified, dense, hard and non-hygroscopic inorganic materials, resulting in low electrical losses and accurate tuning in complete assemblies. They go through riveting operations with little cracking or breaking, and once assembled, "stay put" because of their rigidity and permanence under changing conditions of atmosphere and temperature.

Dimensional accuracy—vitaly important to rapid assembly lines—is obtained by absolute control over every factor in the Stupakoff method of manufacture. Precision is the watchword with Stupakoff—and precision on a mass production scale.

During the past twenty years Stupakoff has supplied hundreds of millions of ceramic parts to the radio industry. It is suggested that you bring your insulation problems to Stupakoff—specialists in developing insulators to satisfy the most exacting standards and requirements.

BUY MORE WAR BONDS



STUPAKOFF CERAMIC AND MANUFACTURING CO., LATROBE, PA.

Products for the World of Electronics



GIRDER CONSTRUCTION...

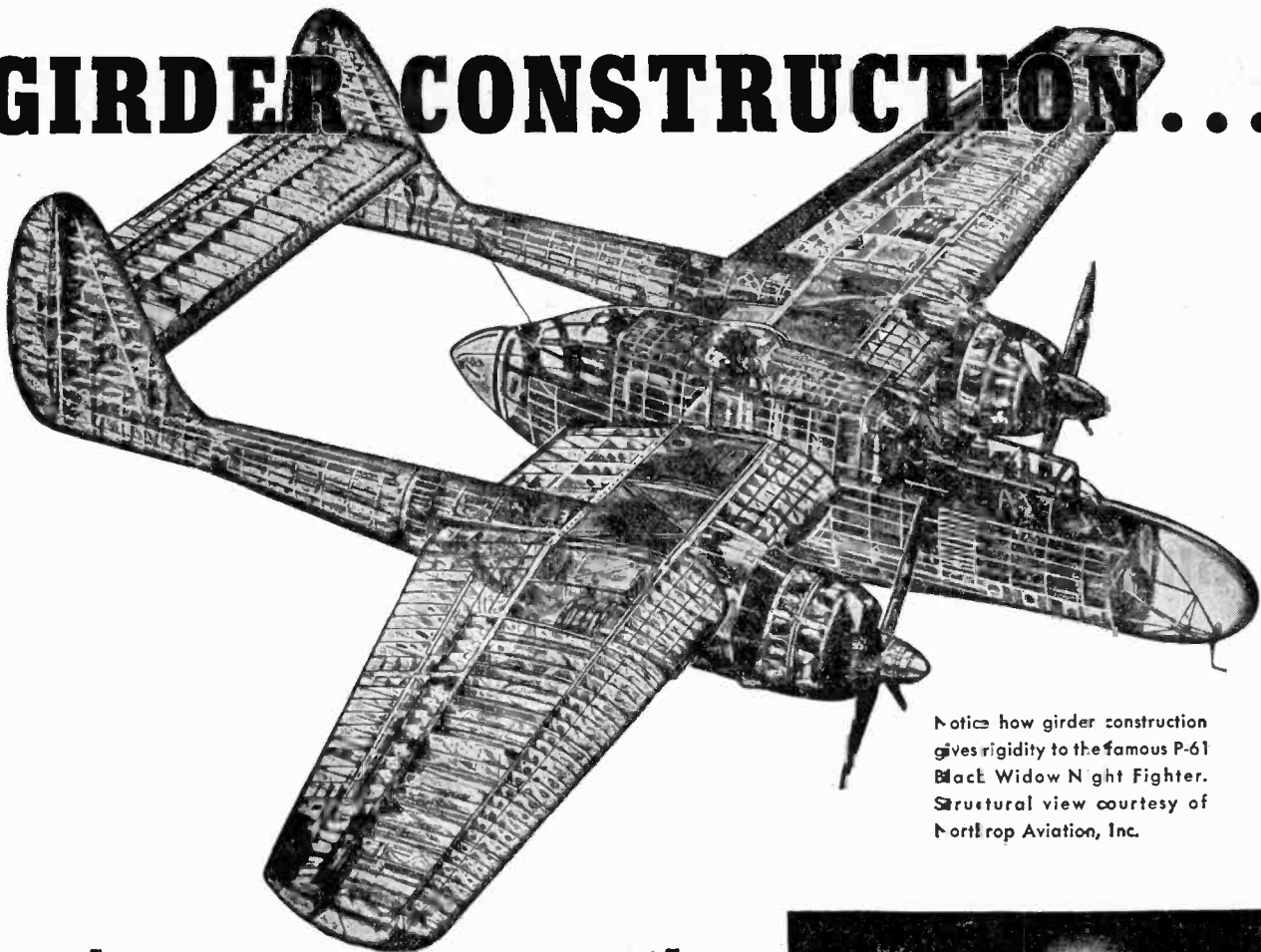

Notice how girder construction gives rigidity to the famous P-61 Black Widow Night Fighter. Structural view courtesy of Northrop Aviation, Inc.

gives greater strength to *Gammatron Tubes*

The same type of construction which gives strength and rigidity to a modern airplane, skyscraper, or bridge has been successfully incorporated into the design of the HK-854 and HK-1054 triodes. Compare the girder construction of the P-61 with the plate and grid supports of the HK-1054—the structural principles are identical! Note particularly how the heavy tripod plate support is welded to large diameter tubing, which in turn is firmly secured to the copper plate cup.

Because of their girder construction, HK-854 and HK-1054 Gammatrons stand up exceptionally well even when subjected to the vibration and stresses which usually accompany their use in such industrial applications as dielectric heating.

This superior internal strength is important since it prevents internal shorts, and variations in the characteristics of the tubes due to movement of the elements.

NEW LOW PRICES NOW IN EFFECT

TUBE TYPE	NEW LIST PRICE
HK 854-H (High amplification factor) . .	Now only \$60.00
HK 854-L (Low amplification factor) . .	Now only 60.00
HK 1054-L (Low amplification factor) . .	Now only 135.00

KEEP BUYING  WAR BONDS

HEINTZ AND KAUFMAN LTD.
SOUTH SAN FRANCISCO · CALIFORNIA

EXPORT AGENTS: M. SIMONS & SON,
25 WARREN STREET, NEW YORK CITY, U. S. A.

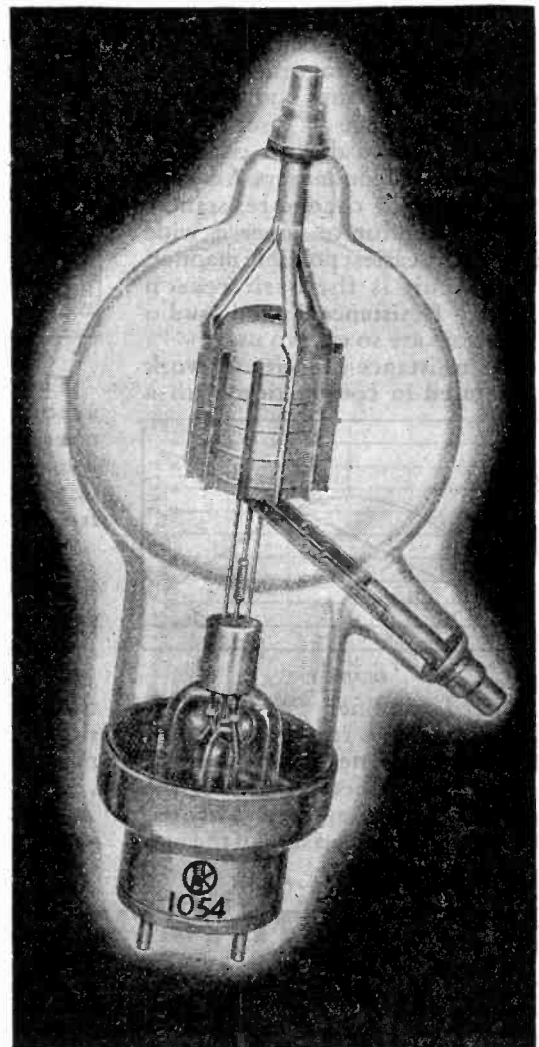



This fundamental circuit is the key to -hp- audio oscillator efficiency

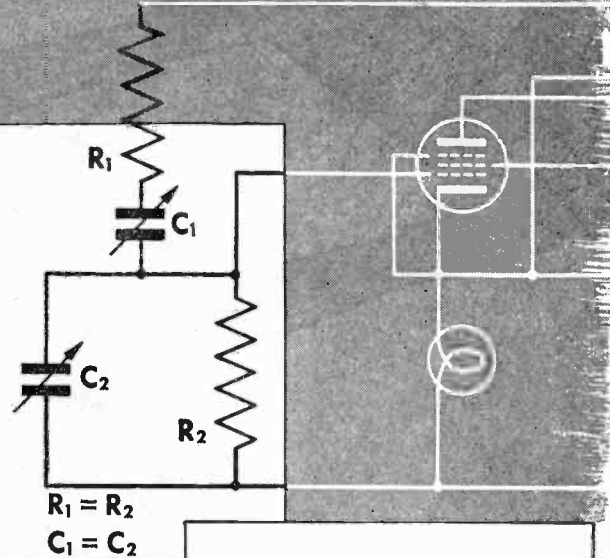

$$f = \frac{1}{2\pi RC}$$

The resonant frequency of this network is inversely proportional to the product of resistance and capacity. Thus wide change in resonant frequency is practical with commercially available condensers. A decade gang switch to change resistances enables operator to cover a wide range in the easiest possible manner. This circuit is the basic reason why -hp- Resistance-Tuned Audio Oscillators are so easy to use.

This resistance-capacity network is operated in conjunction with a

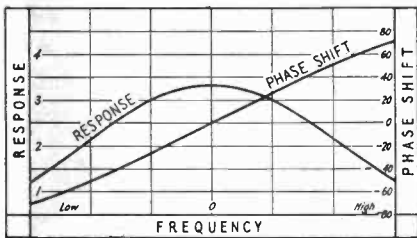

FIGURE 1

stabilized amplifier. Positive feedback is applied to this amplifier through the R-C network. The result is a very high effective "Q" for the circuit, which, combined with the phase shift characteristics of the net-

work, provides an extremely stable output frequency. See Figure 1.

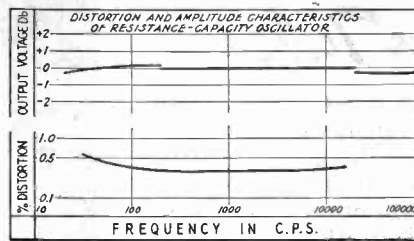
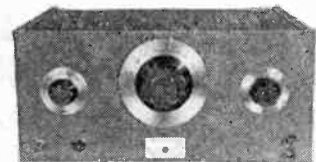

FIGURE 2

The unique balancing circuit automatically selects the proper operating point, keeps distortion at a remarkably low level, and maintains uniform output over the entire frequency spectrum. See Figure 2.

-hp- Audio Frequency Oscillators require no zero setting

It's just such engineered features as these that have made -hp- the outstanding laboratory instruments in the field today. Simplicity of operation... speed in making measurements without sacrifice of accuracy... that's the keynote of all -hp- instruments. Write for information... -hp- engineers are at your service.



-hp- Resistance-Tuned AUDIO OSCILLATORS cover a wide range

-hp- Model 200-A

Frequency range, 35 cps to 35 kc. In 3 ranges: 35 to 350 cps, 350 to 3500 cps, 3500 cps to 35 kc.

-hp- Model 200-B

Frequency range, 20 cps to 20 kc. In 3 ranges: 20 to 200 cps, 200 to 2000 cps, 2000 cps to 20 kc.

-hp- Model 200-C

Frequency range, 20 cps to 200 kc. In 4 ranges: 20 to 200 cps, 200 to 2000 cps, 2000 cps to 20 kc, 20 kc to 200 kc.

-hp- Model 200-D

Frequency range, 7 cps to 70 kc. In 4 ranges: 7 to 70 cps, 70 to 700 cps, 700 to 7000 cps, 7000 cps to 70 kc.

-hp- Model 202-D

Frequency range, 2 cps to 70 kc. The Model 202-D is similar to the Model 200-D, with the addition of a 2-50 cps band covering approximately 200 degrees on the main tuning dial.

-hp- Model 200-1

Frequency range, 6 cps to 6000 cps. In 6 ranges: 6 to 20, 20 to 60, 60 to 200, 200 to 600, 600 to 2000 and 2000 to 6000 cps.

All the above models are available in cabinets or for relay rack mounting.

HEWLETT-PACKARD COMPANY

BOX 1042D • STATION A • PALO ALTO, CALIFORNIA

- | | | |
|--------------------------------|---------------------|------------------------|
| Audio Frequency Oscillators | Signal Generators | Vacuum Tube Voltmeters |
| Noise and Distortion Analyzers | Wave Analyzers | Frequency Meters |
| Square Wave Generators | Frequency Standards | Attenuators |
| | | Electronic Tachometers |



INSTRUMENT OF THE NEW INDUSTRIAL REVOLUTION

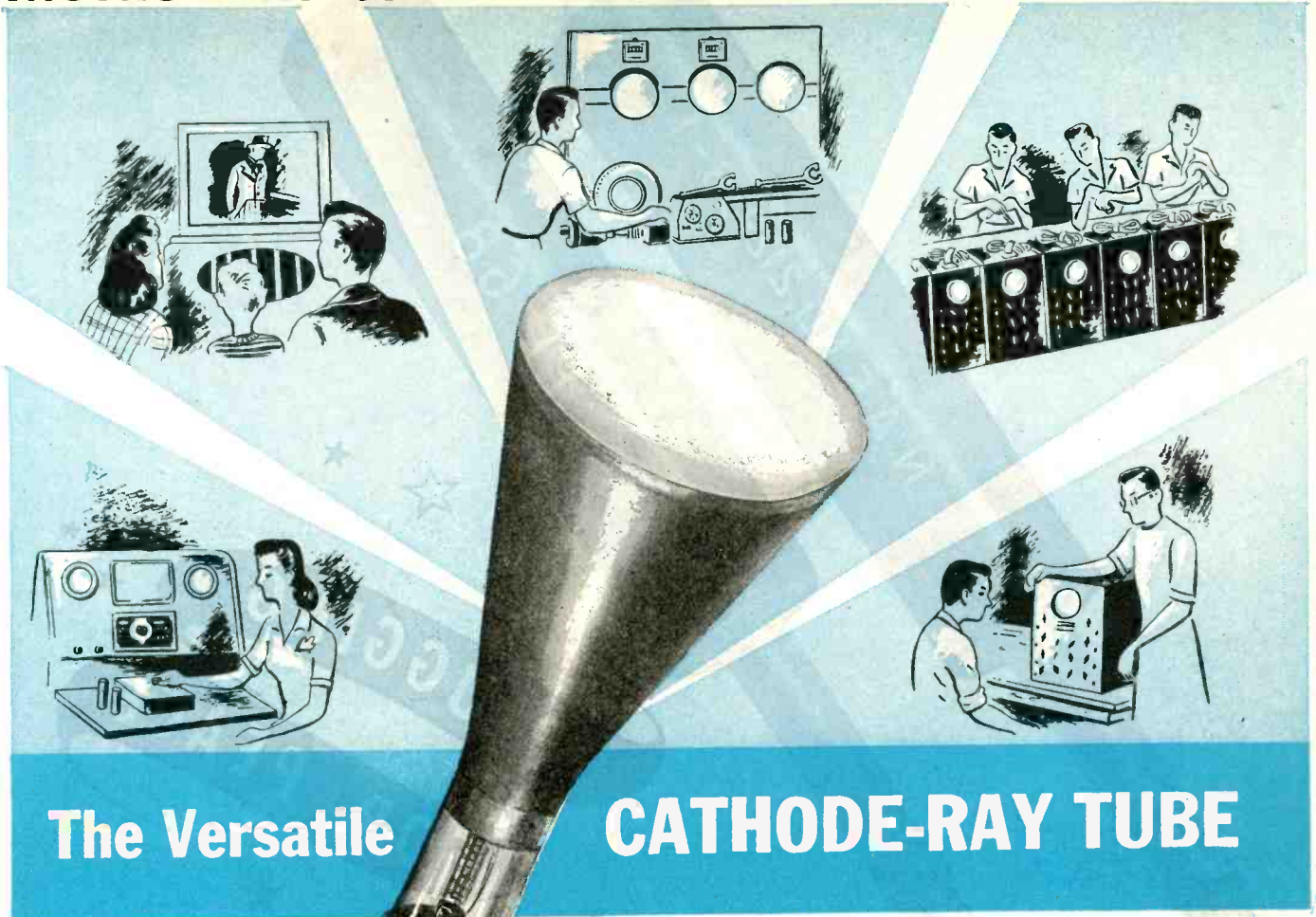

The Versatile

CATHODE-RAY TUBE

Among the more important applications of the Cathode-Ray Tube are the following:

TELEVISION

- Kinescope — Iconoscopes
- Monitors for television signals

ELECTRICAL LABORATORY PRECISION MEASUREMENTS

- Oscilloscopes
- Comparison of Wave Shapes
- Frequency Response
- Power Distortions

MEDICAL

- Electrocardiograph
- Reaction of nerve stimuli

MECHANICAL

- Measurement and visual indication of Tension
- Stress analysis
- Compression of engines
- Vibrations
- Uniformity of gear cuts, cams, etc.
- Regulation of spring movements

GENERAL

- Musical tones study
- Measuring efficiency of operations
- Speed measurements

The part that the cathode-ray tube is destined to play in the industrial picture of tomorrow is dramatically suggested in its wartime applications.

The term "picture" is used advisedly. For the performance of the cathode-ray tube is pictorial. Thanks to its magical powers, hidden secrets are made to materialize . . . elusive phenomena are captured and crystallized so that they may be viewed and studied.

Today, the cathode-ray tube is a weapon of war. In the tomorrow of peacetime progress, it will demonstrate its versatility in industry, in medicine, in countless

fields, and in wondrous ways . . .

As manufacturers of electronic testing equipment, we of Sherron Electronics have a first-hand familiarity with cathode-ray tubes.

In our research and development departments, we have produced equipment for the inspection of the cathode-ray tube, as well as equipment in which the cathode-ray tube has served as a measuring device.

Already, the cathode-ray tube figures importantly in the postwar projects of many manufacturers. For information regarding the adaptability of the cathode-ray tube to your own manufacturing processes, write to:

Sherron
Electronics

SHERRON ELECTRONICS CO.

Division of Sherron Metallic Corporation

1201 FLUSHING AVENUE, BROOKLYN 6, N. Y.

"Where The Ideal Is The Standard, Sherron Units Are Standard Equipment"



★
★
PLUGGING
FOR PEACE
★
★

Telephone Type Plugs

Signal Corps • Navy Specifications

PLUG NUMBER	NUMBER CONTACTS	TYPE SLEEVE	SEE NOTE
PL47	2	Long	
PL54	2	Short	1
PL55	2	Long	2
PL55K	2	Shoulder	
PL68	3	Long	3
PL124	2	Short	1
PL125	2	Long	2
PL155	2	Off Set	2
PL354	2	Short	1
PL540	2	Short	1
B-180207	2	(Lock-Nut)	2
CAU-49109	2	Long	2
CRL-49007A	3	Long	3
NAF-1136-1	2	Long	2
NAF-212938-1	3	Long	3
NAF-215285-2	2	Short	1

Note 1 — Interchangeable with others Note 1.
Note 2 — Interchangeable with others Note 2.
Note 3 — Interchangeable with others Note 3.

OTHER DESIGNS TO ORDER

Simple things—these humble plugs, but Remler found a way to make them better, faster. Production has been doubled while man hours were reduced fifty per cent. This precision efficiency has been made possible by ingenious machines designed by Remler engineers to combine several operations.

The facilities of this organization, backed by 27 years of experience in radio, electronics and plastics will soon be available to sub-contract the manufacture of your peace time parts and components in metal and plastics.

Inquiries invited, write—

REMLER COMPANY, LTD. • 2101 Bryant St. • San Francisco, 10, Calif.

REMLER

SINCE 1918

Announcing & Communication Equipment



CATHODE RAY TUBES THAT MEET EXACTING SPECIFICATIONS

NORTH AMERICAN PHILIPS is one of the few manufacturers of electronic tubes endowed with the skill and experience required for the mass production of the 5JPI and similar cathode ray tubes.

The deflection-plate terminals of these tubes are brought out at the neck of the glass envelope to provide higher insulation and lower lead capacitance at very high frequencies.

In the manufacturing procedure the tubes are cracked at the neck, the deflection-plate leads bent out, and the envelope sections rejoined on a glass-sealing lathe, as illustrated. During this operation the tubes are maintained at a high temperature to prevent the formation of water vapor on the fluorescent screens. The ability to produce, in volume, NORELCO cathode

ray tubes that meet exacting specifications is the result of experience gained by an organization with a background of over half a century of research and development in the electrical field.

The facilities which North American Philips has applied to the manufacture of electronic tubes in wartime will be immediately available for the post-war production of cathode ray tubes for direct viewing and projection television.

Write today for interesting booklet on "How and Why Cathode-Ray Tubes Work."

When in New York, be sure to visit our Industrial Electronics Showroom.

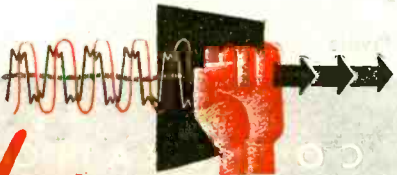

Norelco Electronic Products by
Reg. U. S. Pat. Off.

OTHER PRODUCTS: Quartz Oscillator Plates; Search-ray (Industrial X-ray) Apparatus, X-ray Diffraction Apparatus; Medical X-ray Equipment, Tubes and Accessories; Tungsten and Molybdenum Products; Fine Wires; Diamond Dies.

NORTH AMERICAN PHILIPS COMPANY, INC.

Dept. F-8, 100 East 42nd Street, New York 17, N. Y.
Factories in Dobbs Ferry, N. Y.; Mount Vernon, N. Y. (Metalix Div.); Lewiston, Me. (Elmet Div.)

Meet TWO LITTLE METERS THAT DO A GREAT BIG JOB!

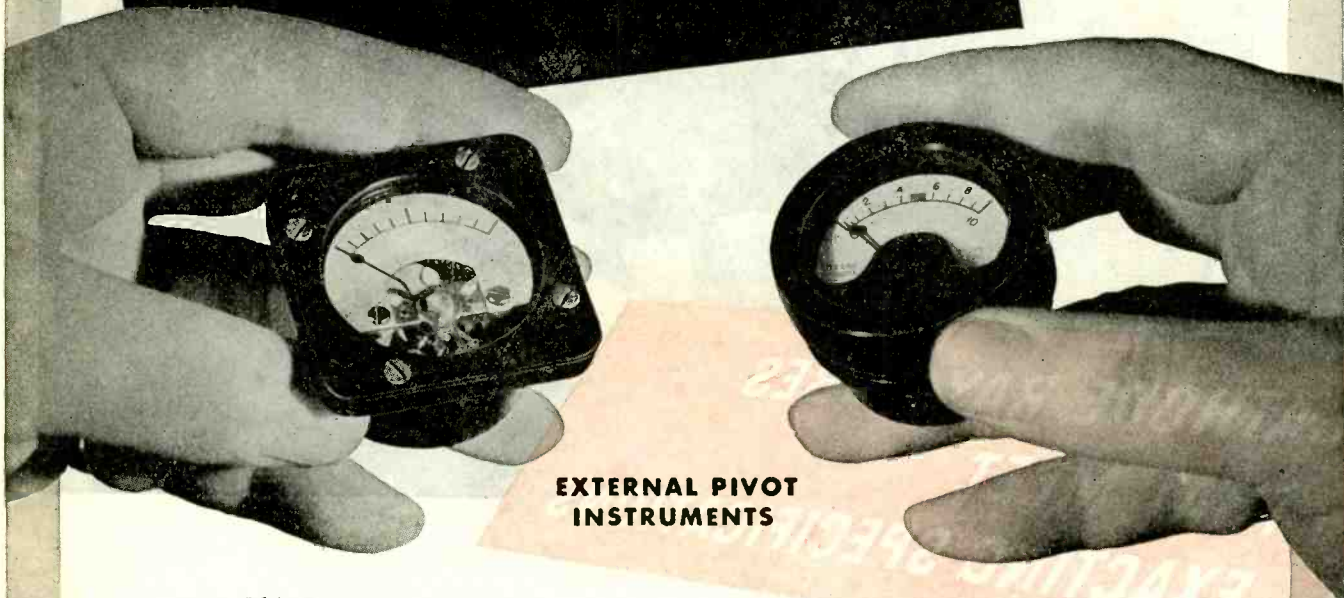

EXTERNAL PIVOT INSTRUMENTS

1½" Square Model 112

Measuring only 1¾" square by 25/32" deep, the 112 is capable of performing a full-scale task in a variety of applications. Made with the precision of all DeJUR larger instruments. It can be immersed in water at a depth of 30 feet for seven days without harm to mechanism. Movement built to forthcoming JAN-I-6 specification for 1½ inch instruments. Quickly and easily installed. Additional information upon request.

1½" Round Model 120

Another good friend to know. It also is capable of doing a man-sized job in many applications where space is at a minimum. Performs with high efficiency. Uses basically the same carefully designed components as large DeJUR instruments. Built with fine precision. Entirely self-contained, with built-in resistors and shunts. Also, immersion-proof throughout. Conforms to forthcoming JAN-I-6 specifications for 1½ inch instruments. Write for catalog.

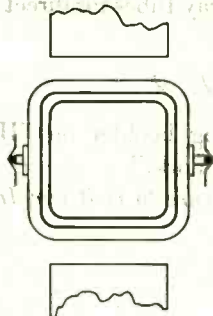

External Pivots

EXTERNAL PIVOTS—used in the design of DeJUR 1½ inch Meters provide greater accuracy in mounting the moving element between the jewel bearings. For this reason internal pivots are not used in DeJUR instruments.

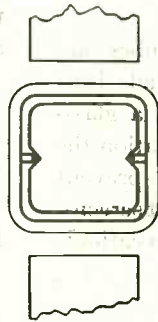

Internal Pivots

DeJUR engineers are prepared to work with you on special models of DeJUR Products for your present and postwar applications.



DeJUR AMSCO CORPORATION

GENERAL OFFICE: NORTHERN BLVD. AT 45th STREET, LONG ISLAND CITY 1, N. Y.

NEW YORK TRANSFORMER CO. 26 WAVERLY PL NEW YORK, N.Y.		COIL SPECIFICATION
COIL #	G-4113-C	
TYPE	9915	
DATE	2-2-45	CHECKED
WRITTEN W.E.O.		
DATE	1-17-45	CHECKED
TURN	1	
TAPS	42.11	
WIRE	#35	
WINDING LENGTH	1.17	
TURN PER LAYER	7/8	
MINIMUM MARGIN	0.33	2.00
TUBE	0.10	
LAYER INSULATION	1.14	
WRAPPER	5CC	
POUNDS OF WIRE	2.3	
D.C. RESISTANCE	9.2	
KIND OF TERMINAL	C	
TERMINAL LENGTH	1.14	
MARK		
TREATMENT		
TESTS		
COME		
REMARKS		

The New Plant of N·Y·T..your **TRANSFORMER DEPARTMENT**

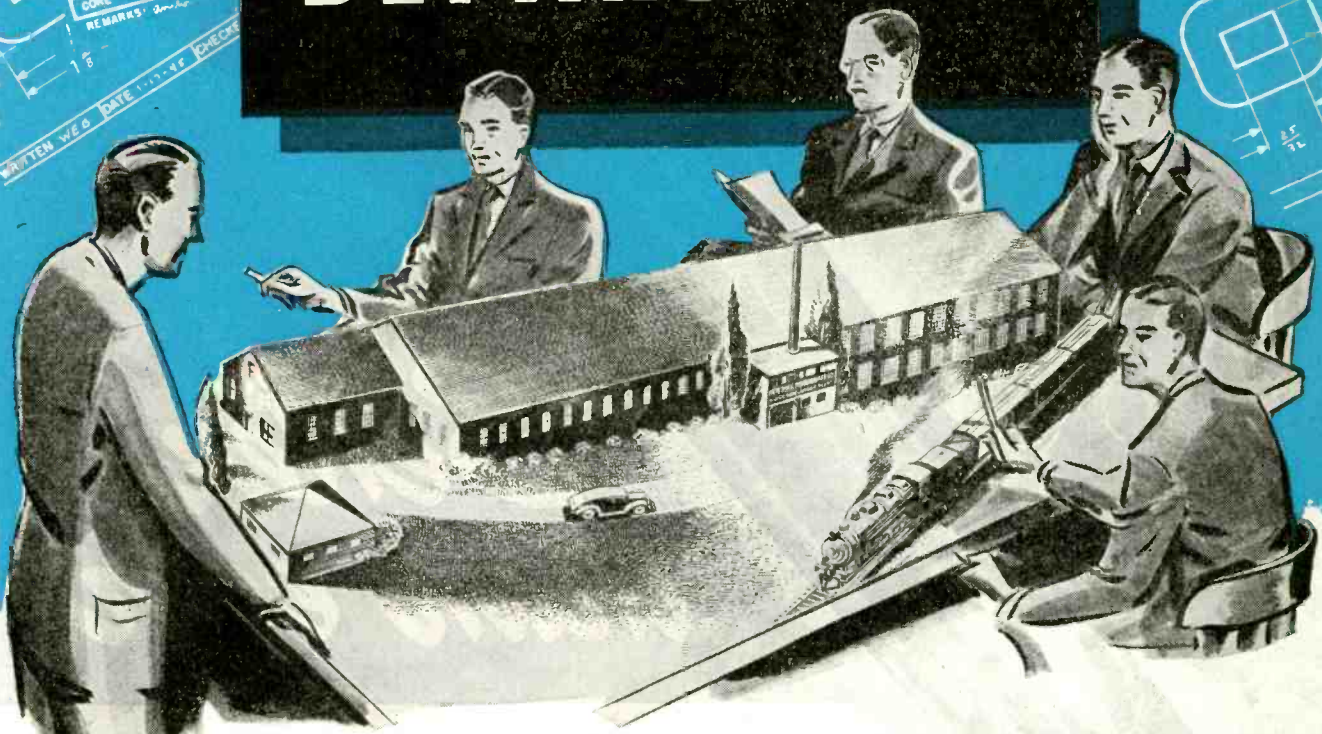

Complete engineering and production facilities for **TRANSFORMERS, CHOKES and FILTERS**

N·Y·T HERMETICALLY-SEALED TRANSFORMERS



The product illustrated typifies N·Y·T hermetically-sealed components — transformers, chokes and filters—designed to meet unusual operating conditions for every type of application.

Tooled up and geared for full production, the latest addition to N·Y·T facilities is rapidly assuming the role of "Transformer Department" to leading electronic and electrical manufacturers.

Complete in every phase of manufacture, the Alpha Division is one of the most modernly equipped plants in the East.

Important, too, is N·Y·T engineering collaboration—offering valuable assistance to engineers responsible for the design of electronic equipment. Close cooperation in this early phase of design inception results in better component suitability. It frequently effects over all economies and improvements. Inquiries are invited; there is no obligation.

Address Inquiries to Dept. P

NEW YORK TRANSFORMER CO.
26 WAVERLY PLACE, NEW YORK 3, N. Y.



KEN-RAD

CATHODE-RAY TUBES

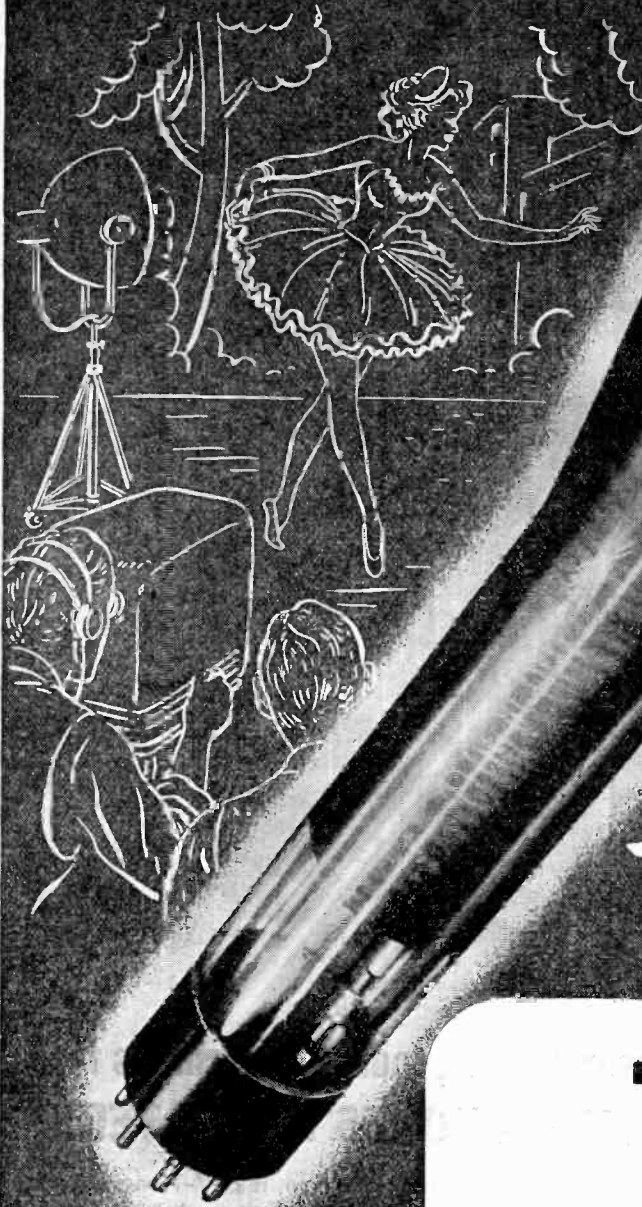

*Better
than ever*

► Television, oscillograph, and other images are bright, clear, and sharp when projected by Ken-Rad Cathode Ray Tubes . . . Now new research, new engineering facilities assure further advancement in Ken-Rad quality and efficiency . . . benefiting equipment designers and builders by tube performance that is *better than ever*.

✕
● Write for your copy of
"Essential Characteristics"
the most complete digest of
tube information available.

178-D4-8E 50

KEN-RAD

OWENSBORO, KENTUCKY



HERE'S THAT NEW
TRIPLITT
625-N

LONG SCALE, WIDE RANGE VOLT-OHM-MILLIAMMETER

DOUBLE SENSITIVITY D. C. VOLT RANGES

0-1.25-5-25-125-500-2500 Volts,
 at 20,000 ohms per volt for greater accuracy on
 Television and other high resistance D.C. circuits.
 0-2.5-10-50-250-1000-5000 Volts,
 at 10,000 ohms per volt.

A. C. VOLT RANGES

0-2.5-10-50-250-1000-5000 Volts,
 at 10,000 ohms per volt.

OHM-MEGOHMS

0-400 ohms (60 ohms center scale)
 0-50,000 ohms (300 ohms center scale)
 0-10 megohms (60,000 ohms center scale)

DIRECT READING OUTPUT LEVEL DECIBEL RANGES

-30 to +3, +15, +29, +43, +55, +69 DB

TEMPERATURE COMPENSATED CIRCUIT FOR
 ALL CURRENT RANGES D. C. MICROAMPERES
 0-50 Microamperes, at 250 M.V.

D. C. MILLIAMPERES

0-1-10-100-1000 Milliamperes, at 250 M.V.

D. C. AMPERES

0-10 Amperes, at 250 M.V.

OUTPUT READINGS

Condenser in series with A.C. Volts for output
 readings.

ATTRACTIVE COMPACT CASE

Size: 2½" x 5½" x 6". A readily portable, completely
 insulated, black, molded case, with strap handle.
 A suitable black, leather carrying case (No. 629)
 also available, with strap handle.

LONG 5" SCALE ARC

For greater reading accuracy on the Triplet
 RED • DOT Lifetime Guaranteed meter,

SIMPLIFIED SWITCHING CIRCUIT

Greater ease in changing ranges.

Write for descriptive folder giving full technical details



Triplet

ELECTRICAL INSTRUMENT CO. BLUFFTON, OHIO

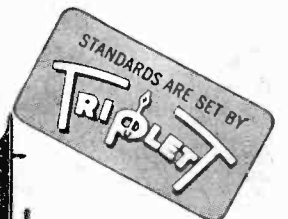

MODERNIZE YOUR PRODUCT

at Low Cost



WITH THESE INEXPENSIVE, HIGHLY ADAPTABLE SWITCHES

Up-to-the-minute switches add efficiency to the electrical product, that means greater sales appeal to the ultimate consumer. Stackpole line, slide, and rotary-action switches are highly adaptable to the individual needs of a wide variety of electrical equipment and cost but

little. Eighteen standard units include 3-position types and 1-, 2-, 3-, and 4-pole switches with or without spring return, detent, covers and other optional features. Each can be adapted mechanically or electrically to meet a wide variety of specific requirements.

OTHER STACKPOLE PRODUCTS

Brushes and Contacts
Carbon Regulator Discs
Bearings—Pipe
Anodes and Electrodes
Packing, Piston and
Seal Rings
Welding Carbons, etc.

WRITE FOR ELECTRONIC COMPONENTS CATALOG

... for complete details on Stackpole Switches, also Fixed and Variable Resistors, and molded iron cores.

STACKPOLE CARBON COMPANY, St. Marys, Pa.



STACKPOLE

Federal

presents

COMPLETE FM TRANSMITTERS. 1-3-10-50 KW



ALL NEW — incorporating new techniques, new circuits, new tubes.

NEW TRANSMITTERS . . . with impressive high fidelity, low harmonic distortion, low hum level . . . with outputs of 1, 3, 10 and 50 kilowatts . . . plus ample operating safeguards.

The basic unit is the exciter, generating 250 watts of RF power. Its design permits adding power units as desired . . . at any time . . . in selected steps that make possible the different outputs.

NEW ANTENNAS . . . of two or more loops with two or more half-wave elements, are factory tuned for easy installation. Standard coaxial lines feed them.

NEW POWER TUBES . . . highly efficient, incorporate notable Federal achievements in design and production. They assure long, dependable performance in FM broadcasting.

Look to Federal for the finest in FM equipment.



Federal Telephone and Radio Corporation



Newark 1, N. J.

First

with **GRADE 1, CLASS 1 RESISTORS**

(First produced Dec. 1941—Millions made to date)

First with **RESISTORS WOUND
with CERAMIC INSULATED WIRE**
(Pioneered and perfected by Sprague many years ago)

First with **GLASS-TO-METAL SEALED
RESISTORS** (Pioneered by Sprague in 1941, now
produced commercially at the rate of thousands of
seals per day)

First with **GLAZED CERAMIC SHELLS
and New Style End Seals for 5-, 10-, 25-, 50- and
120-watt resistors.** (One type of Koolohm—the stand-
ard type—does the job under any climatic condition,
anywhere in the world)

First and **STILL EXCLUSIVE** with **MEGOMAX**
(The high-resistance, high-voltage resistors. Megohms
of resistance operated at thousands of volts!)

One after another, Sprague Koolohm Resistors have established new performance records as proved indisputably by the record. One after another Koolohm Resistors have revolutionized traditional limitations to wire wound resistor usage—because radically different Koolohm construction permits a higher degree of physical protection, better electrical characteristics, smaller sizes, and easier mounting arrangements than are possible with conventional resistor types. Write for catalog.



SPRAGUE KOOLOHM

(Trademark Reg. U. S. Patent Office)

WIRE WOUND RESISTORS

SPRAGUE ELECTRIC COMPANY
(Resistor Division) North Adams, Mass.

Proceedings of the I.R.E. August, 1945

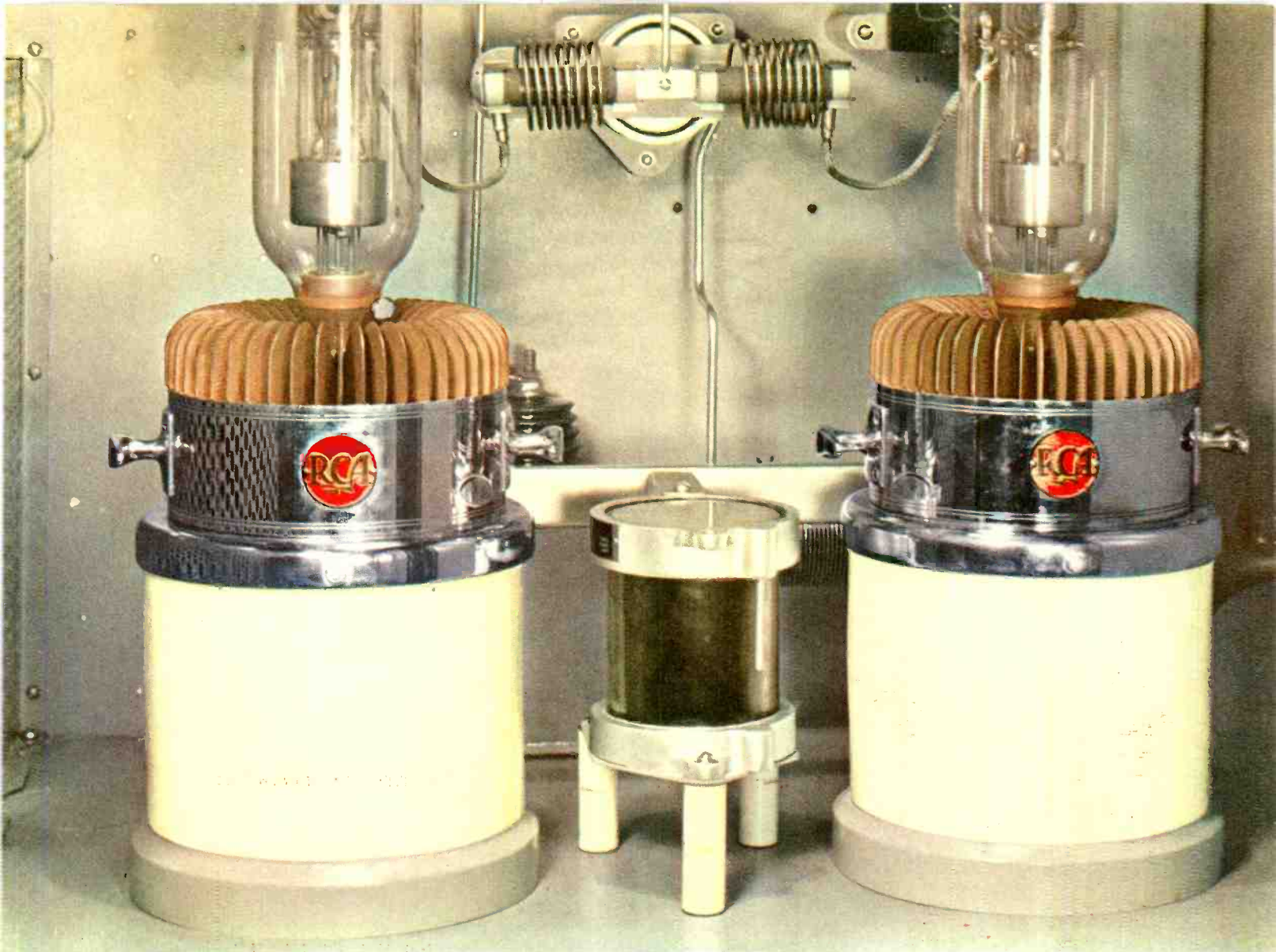

FARADON Capacitors for Industrial Oscillators

FOR 25 years, Faradon Capacitors have been used in outstanding communication and broadcast equipment built by RCA and other well-known manufacturers. Today, capacitors are finding new uses in electronic power generators, which are serving industry in many ways.

The reliability of Faradon Condensers, the wide range of sizes available, and the facility with which they can be adapted to design requirements, make

them a natural choice for all such applications.

For information on Faradon Capacitors for any purpose, write to Faradon Condenser Section, Dept. BB125, Radio Corporation of America, Camden, New Jersey.

At right. RCA 15-B Electronic Power Generator, used for preheating of plastic materials, gluing of laminated propellers, the processing of rayon yarns and for numerous other purposes.



BUY MORE WAR BONDS



RADIO CORPORATION OF AMERICA

RCA VICTOR DIVISION • CAMDEN, N. J.

In Canada, RCA VICTOR COMPANY LIMITED, Montreal

**For dependability, compactness,
simplicity, economy—consider
RCA Beam-Power Tubes
when designing transmitters**



**Beam-power tubes provide simple, compact equipment —
a wide range of power output — high power-sensitivity —
over-all efficiency and economy.**



IN AM TRANSMITTERS: Beam-power transmitting tubes provide high output with low driving-power. They enable you to design more compact, simpler, more economical broadcast transmitters than other types of tubes.

Transmitters designed around beam-power tubes are *more compact* because fewer stages are required and because neutralizing circuits are eliminated; they are *more simple* because the transmitter does not have to be re-neutralized each time tubes are replaced; they are *more economical* because fewer tubes and fewer stages can be used for a given power-output.

IN FM TRANSMITTERS: The self-neutralizing property of beam-power tubes provides a simple, efficient means of obtaining stable operation in wide-band FM circuits without complex auxiliary circuits.

IN TELEVISION TRANSMITTERS: The high-gain and self-neutralizing properties of beam-power tubes make possible stable, efficient wide-band video and r-f amplifiers, with a minimum of tubes and without neutralizing circuits.

LOOK TO RCA FOR YOUR TUBES: In beam-power transmitting tubes, RCA has developed a whole family of high-performance champions such as the RCA-807, 813, 814, 815, 828, 829B, and 832A—the *most complete line offered by any manufacturer!*

For complete technical information on RCA beam-power tubes, see the RCA HB-3 Handbook. If you do not have a copy of this handbook, or if you have questions on the application of beam-power tubes, write to RCA, Commercial Engineering Department, Section 62-33P, Harrison, N. J.

**The Fountainhead of Modern
Tube Development is RCA**



62-6136-33

RADIO CORPORATION OF AMERICA

RCA VICTOR DIVISION · CAMDEN, N. J.

Buy War Bonds!

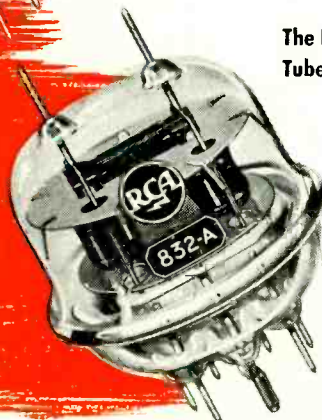

BOARD OF

DIRECTORS

1945

William L. Everitt
President

Hendrik J. van der Bijl
Vice-President

Raymond A. Heising
Treasurer

Haraden Pratt
Secretary

Alfred N. Goldsmith
Editor

Lynde P. Wheeler
Senior Past President

Hubert M. Turner
Junior Past President

1943-1945

Wilmer L. Barrow
F. B. Llewellyn
Harold A. Wheeler

1944-1946

Raymond F. Guy
Lawrence C. F. Horle
William C. White

1945-1947

Stuart L. Bailey
Keith Henney
Benjamin E. Shackelford

1945

E. Finley Carter
Lewis M. Clement
Ralph A. Hackbusch
Donald B. Sinclair
William O. Swinyard

●
Harold R. Zeamans
General Counsel

BOARD OF EDITORS

Alfred N. Goldsmith
Editor

Ralph R. Batcher
Robert S. Burnap
Philip S. Carter
Lewis M. Clement
William G. Dow
Elmer W. Engstrom
William L. Everitt
William G. H. Finch
George W. Gilman
Peter C. Goldmark
Frederick W. Grover
Lewis B. Headrick
C. M. Jansky, Jr.
Hugh S. Knowles
John D. Kraus
Donald G. Little

Frederick B. Llewellyn
Nathan Marchand
Samuel S. Mackeown
Edward L. Nelson
Harry F. Olson
Harold O. Peterson
Greenleaf W. Pickard
Ralph A. Powers
Haraden Pratt
Conan A. Priest
Herbert J. Reich
Peter C. Sandretto
Vernon W. Sherman
Lyne C. Smeby
E. C. Wentz

Harold A. Wheeler
William C. White
Laurens E. Whittemore
Gerald W. Willard
William Wilson
Charles J. Young
Vladimir K. Zworykin

Proceedings

of the I·R·E

Published Monthly by

The Institute of Radio Engineers, Inc.

VOLUME 33

August, 1945

NUMBER 8

Section Meetings.....	492
The Sections and Institute Affairs..... Hugh B. Okeson	493
Arthur Van Dyck.....	494
The Interdepartment Radio Advisory Committee..... E. M. Webster	495
Some Aids to Facilitate the Engineer's Academic Training.. B. Dudley	499
Radio-Relay Communication Systems in the United States Army....	
William S. Marks, Jr., Oliver D. Perkins, and Willard R. Clark	502
A New Type of Automatic Radio Direction Finder..... C. C. Pine	522
Experimental Determination of Impedance Functions by the Use of an Electrolytic Tank..... W. W. Hansen and O. C. Lundstrom	528
Multivibrator Circuits..... M. V. Kiebert and A. F. Inglis	534
The Reactance Theorem for a Resonator..... W. R. MacLean	539
"N"-Phase Resistance-Capacitance Oscillators..... R. M. Barrett	541
Institute News and Radio Notes.....	546
Board of Directors.....	546
Executive Committee.....	546
Standards Committee Report.....	548
Correspondence:	
"Radio-Noise-Meter Performance"..... Philip Eisenberg	550
"Professional Status of the Engineer"..... Henry W. Kaufmann	550
I.R.E. People.....	552
Books:	
"The Radio Amateur's Handbook, Twenty-Second Edition," The American Radio Relay League, Inc. Harold P. Westman	555
"Alignment Charts—Construction and Use," by Maurice Krait- chik..... Nathan Marchand	555
"Resistance Welding Control," Westinghouse Electric and Man- ufacturing Co..... Ralph R. Batcher	555
Report of the Secretary—1944.....	556
Contributors.....	560
Section Meetings.....	34A
Membership.....	38A
Positions Open.....	50A
Advertising Index.....	70A

Helen M. Stote, Associate Editor ● William C. Copp, Advertising Manager

Responsibility for the contents of papers published in the PROCEEDINGS rests upon the authors. Statements made in papers are not binding on the Institute or its members.



Changes of address (with advance notice of fifteen days) and communications regarding subscriptions and payments should be mailed to the Secretary of the Institute, at 330 West 42nd Street, New York 18, N. Y. All rights of republication, including translation into foreign languages, are reserved by the Institute. Abstracts of papers, with mention of their source, may be printed. Requests for republication privileges should be addressed to The Institute of Radio Engineers.

Copyright, 1945, by The Institute of Radio Engineers, Inc.

PAPERS COMMITTEE

Frederick B. Llewellyn
Chairman

Herman A. Affel
Wilmer L. Barrow
Howard A. Chinn
James K. Clapp
Ivan S. Coggeshall
Seymour Cohn

Edward J. Content
Clifford W. Corbett
Murray G. Crosby

Frederick W. Cunningham

Robert B. Dome
Enoch B. Ferrell
Donald G. Fink
Howard S. Frazier

Robert L. Freeman
Stanford Goldman
Frederick W. Grover

O. B. Hanson

Thomas J. Henry
Edward W. Herold
John V. L. Hogan

Frederick V. Hunt
Harley Iams
Loren F. Jones

John G. Kreer, Jr.
Emil Labin
Frederick R. Lack

Hugo C. Leuteritz
Charles V. Litton
Knox McIlwain

Harry R. Mimno
Iliia E. Mouromtseff
G. G. Muller

Albert F. Murray
Dwight O. North
Allen F. Pomeroy

Jack R. Poppele
Simon Ramo
Francis X. Rettenmeyer

Sergei A. Schelkunoff
Donald B. Sinclair
Dayton Ulrey

A. P. Upton
Karl S. Van Dyke
E. K. Van Tassel

John R. Whinnery
Irving Wolff
J. Warren Wright
Harold R. Zeamans

PAPERS

PROCUREMENT COMMITTEE

Dorman D. Israel
General Chairman
Edward T. Dickey

Vice General Chairman

GROUP CHAIRMEN
Arthur B. Bronwell
Nelson P. Case

Madison Cawein
Ivan S. Coggeshall
Murray G. Crosby

Alfred Crossley
Harry Diamond
Arthur E. Harrison

Theodore A. Hunter
James R. Nelson
Harry F. Olson

Donald B. Sinclair
Howard J. Tyzzer
Wilbur L. Webb

William C. White
Karl S. Van Dyke

●
George W. Bailey
Executive Secretary

William H. Crew
Assistant Secretary



THE INSTITUTE OF RADIO ENGINEERS

INCORPORATED



SECTIONS MEETINGS

ATLANTA September 21	BUFFALO-NIAGARA September 19	CEDAR RAPIDS September 20	CHICAGO September 21	CLEVELAND September 25
CONNECTICUT VALLEY September 20	DAYTON September 20	DETROIT September 21	LOS ANGELES September 18	NEW YORK September 5
PHILADELPHIA September 6	PITTSBURGH September 10	PORTLAND September 10	WASHINGTON September 10	WILLIAMSPORT September 5

SECTIONS

- ATLANTA**—Chairman, R. A. Holbrook; Secretary, I. M. Miles, State Engineering Experimental Station, Georgia School of Technology, Atlanta, Ga.
- BALTIMORE**—Chairman, W. L. Webb; Secretary, H. L. Spencer, Box 6760, Towson 4, Md.
- BOSTON**—Chairman, C. C. Harris; Secretary, Corwin Crosby, 16 Chauncy St., Cambridge, Mass.
- BUENOS AIRES**—Chairman, A. DiMarco; Secretary, H. Krahenbuhl, Transradio Internacional, San Martin 379, Buenos Aires, Argentina
- BUFFALO-NIAGARA**—Chairman, A. G. Skrivseth; Secretary, H. W. Staderman, 264 Loring Ave., Buffalo, N. Y.
- CEDAR RAPIDS**—Chairman, F. M. Davis; Secretary, J. A. Green, Collins Radio Co., 855—35th St., N.E., Cedar Rapids, Iowa
- CHICAGO**—Chairman, Cullen Moore; Secretary, L. E. Packard, General Radio Co., 920 S. Michigan Ave., Chicago 5, Ill.
- CINCINNATI**—Chairman, L. M. Clement; Secretary, J. F. Jordan, The Baldwin Co., 1801 Gilbert Ave., Cincinnati 2, Ohio
- CLEVELAND**—Chairman, H. B. Okeson; Secretary, A. J. Kres, 16911 Valleyview Ave., Cleveland 11, Ohio
- CONNECTICUT VALLEY**—Chairman, H. W. Sundius; Secretary, L. A. Reilly, 989 Roosevelt Ave., Springfield, Mass.
- DALLAS-FORT WORTH**—Chairman, J. D. Mathis; Secretary, B. B. Honeycutt, 9025 Roanoak, Dallas 18, Texas
- DAYTON**—Chairman, L. B. Hallman; Secretary, Joseph General, 411 E. Bruce Ave., Dayton 5, Ohio
- DETROIT**—Chairman, L. H. Larime; Secretary, R. R. Barnes, 1411 Harvard Ave., Berkley, Mich.
- EMPORIUM**—Chairman, W. A. Dickinson; Secretary, H. E. Ackman, West Creek, R. D. 2, Emporium, Pa.
- INDIANAPOLIS**—Chairman, H. I. Metz; Secretary, E. E. Alden, 4225 Guilford Ave., Indianapolis, Ind.
- KANSAS CITY**—Chairman, R. N. White; Secretary, Mrs. G. L. Curtis, 6003 El Monte, Mission, Kans.
- LONDON**—Chairman, B. S. Graham; Secretary, C. H. Langford, Langford Radio Co., 246 Dundas St., London, Ont., Canada
- LOS ANGELES**—Chairman, R. C. Moody; Secretary, R. G. Denechaud, Blue Network Co., 6285 Sunset Blvd. Hollywood 28, Calif.
- MONTREAL**—Chairman, L. A. W. East; Secretary, R. R. Desaulniers, Canadian Marconi Co., 2440 Trenton Rd., Town of Mt. Royal, Que., Canada
- NEW YORK**—Chairman, G. B. Hoadley; Secretary, J. T. Cimorelli, RCA Manufacturing Co., 415 S. Fifth St., Harrison, N. J.
- OTTAWA**—Chairman, W. A. Steel; Secretary, L. F. Millett, 33 Regent St., Ottawa, Ont., Canada
- PHILADELPHIA**—Chairman, D. B. Smith; Secretary, P. M. Craig, Philco Corp., Philadelphia 34, Pa.
- PITTSBURGH**—Chairman, J. A. Hutcheson; Secretary, C. W. Gilbert, 52 Hathaway Ct., R.F.D. 1, Wilkesburg, Pa.
- PORTLAND**—Chairman, Kenneth Johnson; Secretary, C. W. Lund, Route 4, Box 858, Portland, Ore.
- ROCHESTER**—Chairman, G. R. Town; Secretary, A. E. Newlon, Research Dept., Stromberg-Carlson Co., Rochester 3, N. Y.
- ST. LOUIS**—Chairman, B. B. Miller; Secretary, N. J. Zehr, KWK, St. Louis, Mo.
- SAN DIEGO**—Chairman, F. A. Everest; Secretary, Clyde Tirrell, United States Navy Radio and Sound Laboratory, San Diego 52, Calif.
- SAN FRANCISCO**—Chairman, David Packard; Secretary, William Barclay, Stanford University, Palo Alto, Calif.
- SEATTLE**—Chairman, G. L. Hoard; Secretary, K. A. Moore, 5102 Findlay St., Seattle 8, Wash.
- TORONTO**—Chairman, S. H. R. Pounsett; Secretary, Alexander Bow, Copper Wire Products, Ltd., 137 Roncesvalles Ave., Toronto, Ont., Canada
- TWIN CITIES**—Chairman, Ross Hilker; Secretary, Merle Ludwig, Minneapolis-Honeywell Regulator Co., Minneapolis, Minn.
- WASHINGTON**—Chairman, H. A. Burroughs; Secretary, L. C. Smeby, 4801 Connecticut Ave., N.W., Washington, D. C.
- WILLIAMSPORT**—Chairman, L. E. West; Secretary, F. L. Burroughs, 2030 Reed St., Williamsport 34, Pa.

The Sections of The Institute of Radio Engineers, taken together, *are* the Institute. Accordingly, whatever binds each Section more closely to the other Sections and to the directors, officers, and staff of the Institute is greatly to the benefit of every member of the Institute.

With this aim in view, the Chairmen of the Sections of the Institute have been invited to present their views to the entire membership through guest editorials appearing in the PROCEEDINGS. The following stimulating and encouraging statements by the Chairman of the Cleveland Section are here presented.

The Editor

The Sections and Institute Affairs

HUGH B. OKESON

The Institute of Radio Engineers accepted the challenge of war in 1941 and the records of the radio and electronics industries in the war are ample proof that the Institute and its membership have measured up to the challenge. The record is nothing short of phenomenal.

As the war has progressed it has become apparent that the Institute would progressively face new problems as the various phases of the war are won and we move on into the postwar period. These new tasks include measuring up to the new responsibilities, obligations, and opportunities of service to industry and the radio and electronics art, all resulting from the great achievements and expansion of that art during the war.

The Officers and Directors of the Institute are fully aware of the challenge the Institute faces. The vision and judgment shown in the steps that have already been taken in the Building-Fund Campaign to provide a National Headquarters and the other plans for expansion of the Institute activities are proof of this fact. We may be assured that Institute Affairs are being handled in an orderly and constructive manner. The stage is set for an impressive expansion of the Institute, possibly far beyond the expectations of some of the membership.

This brings us to the responsibilities and obligations of the Sections and the membership in general in this expansion program. I believe that we will agree that the Officers, Directors, and Management of the Institute are pointing out to us an adequate program for the future. It logically follows then that it is our obligation and opportunity as individuals to aid the new program in any way possible, in order that it may be brought to a successful conclusion. The Building-Fund Campaign is most encouragingly moving forward. Industry has responded in a splendid manner, showing appreciation of the service I.R.E. has put at the disposal of the radio and electronics industry. Membership can do no less, and I am sure that the membership-gifts quota will be oversubscribed if each individual will only ask himself how great his loss would be if I.R.E. were not here and functioning for his good.

At the present time a vote *for* the proposed amendment to increase the dues structure would appear to be a *must* for all of us in order that the proposed expanded services of the Institute may be made to function.

We also have an opportunity to increase our membership simply by presenting the facts concerning the real value of Institute membership to the vast number of qualified nonmembers waiting for this information. We must follow up these invitations and see that the membership applications are properly filled out and placed in the hands of the Membership Committee, or mailed to the Institute Secretary.

We may increase our benefits and those of the entire membership of I.R.E. by entering into expanded Section activities, attending meetings, working on Committees, and accepting elective office in the Sections and the Institute as these honors come to us. After we have done this for a short time, we shall be looking for new opportunities of service and not counting up how much we are getting out of I.R.E. The latter will take care of itself and our benefits will be many.

Let us all be more active in Section affairs than we have been in the past. By doing this, we shall be a factor in promoting the general interests of the Sections, The Institute of Radio Engineers, and the radio and electronics art.



Arthur Van Dyck

Commander A. F. Van Dyck was born on May 20, 1891, in New York State. During high-school and college years, he entered radio the hard, but the most interesting way, as an amateur. During vacations, he worked as wireless operator at sea, cruising to South America and England. He was graduated from the electrical engineering course at Yale University in 1911, and joined the National Electric Signalling Company (Fessenden) in research work at Brant Rock, Massachusetts. Upon the termination of that company's activities, he went to the research department of the Westinghouse Company, East Pittsburgh, for general development work, specializing in high-voltage, high-frequency problems.

From 1914 to 1917, Commander Van Dyck was an instructor in electrical engineering at the Carnegie Institute of Technology, a position which he left, upon our entry into World War I, in order to join the United States Navy as Expert Radio Aide. Then, as before World War II, the Navy had prepared for war, and the radio plans for World War I included the bringing in of civilian experts, of whom there were not so many in those days, to head technical work at the Navy Yards and Bureaus.

In 1919, he left the Navy to join the Marconi Wireless Telegraph

Company of America, and was in charge of the factory engineering department of that company when it was absorbed in the formation of the Radio Corporation of America. For two years, he was in the Schenectady radio department of the General Electric Company, then the manufacturer of radio apparatus for RCA, and remained with that company in various capacities connected with its broadcast development and manufacturing activities until 1942, when he was called to active duty in the United States Naval Reserve, and was granted a leave of absence.

From 1930 to 1942, Commander Van Dyck was manager of the RCA license laboratory, which became widely known in the industry for its consultation service to radio companies, and for its output of useful developments. That laboratory has now become the industry service division of RCA Laboratories.

Commander Van Dyck is in the Office of the Chief of Naval Operations, Electronics Division, Washington, D. C., and has made several trips overseas in connection with electronic planning. He is a charter member of The Institute of Radio Engineers and has served on the Board of Directors from 1930 through 1935. He was President of the Institute in 1942.

The Interdepartment Radio Advisory Committee*

Its History, Mode of Operation, and Relationship to Other Agencies

E. M. WEBSTER†, FELLOW, I.R.E.

THE INTERDEPARTMENT Radio Advisory Committee, an organization of the Federal government, more commonly referred to as the IRAC, will have been in active continuous existence for 23 years this summer. It is composed of the representatives of twelve government agencies, their alternates, and a small secretariat. Five of these agencies are represented on the organization's technical subcommittee, its only standing committee. The IRAC came into existence June 1, 1922.

Under the law it is the responsibility of the President to assign frequencies to government stations, which he does periodically by means of Executive Orders. The IRAC, as his advisory agency, makes assignment recommendations for insertion in the Executive Order and by his authority makes interim assignments which are included when appropriate in the next Order. Stripped of its legalistic form, the function of the IRAC is, in actual practice, to assign frequencies to government radio stations, in which respect it bears much the same relation to government departments as the Federal Communications Commission to the nongovernment interests. In addition, it assists and advises the President and the various federal agencies on related technical radio problems of interagency interest, and on other questions as may be referred to the Committee from time to time by the President.

First official recognition of the authority of the IRAC in connection with allocations came about in 1927 when, in a letter to the Secretary of Commerce, the President justified the action of the Committee in assuming the responsibility for advising him in regard to frequency assignments for the government. This responsibility has come down unchanged to the present.

The IRAC is unique among government agencies in that it came into being, not as the result of action by either the executive or legislative branches of the government, but spontaneously through a demand of the interested government agencies. It has continued because it fills an essential need and because, throughout its existence, it has been careful to confine its activities to filling that need. In the process, it has furnished a conspicuous example of voluntary self-regulation resulting from a realization of the necessity for co-operation and co-ordination in the common good.

* Decimal classification: R005×R060. Original manuscript received by the Institute, February 1, 1945. Presented, 1945 Winter Technical Meeting, January 26, 1945, New York, N. Y.

† Captain, United States Coast Guard; Chairman (formerly Vice-Chairman), Interdepartment Radio Advisory Committee, Washington, D. C.

The First National Radio Conference, combining both government and industry representatives, was held in Washington in 1922 to discuss regulation and control of the fast-growing radio services. This conference awakened several of the government departments to the necessity for co-operative action in solving the problems arising from the federal government's interest in broadcasting, especially since the Navy Department had established broadcasting facilities at the Washington Navy Yard and made them available to other government departments. It was proposed that the Committee assist in regulating and guiding the operation of this station and any others that might be established by the government. At the suggestion of Dr. S. W. Stratton, Chairman of the conference, Secretary of Commerce Herbert Hoover, under whose department radio was regulated in these early days, invited interested government departments to designate representatives for a special government radio committee. The Secretary's invitation was answered by seven government departments, whose representatives first met in April, 1922. The genuineness of their interest may be judged by the fact that all seven, Agriculture, Commerce, Navy, Post Office, State, Treasury, and War, are still numbered among the twelve government agencies now represented on IRAC. The five added later are the Departments of Interior, Justice and Labor, the Federal Communications Commission, and the United States Maritime Commission. On April 17, 1922, the original seven representatives recommended that a permanent interdepartment committee be formed; their recommendation was approved and the first meeting of the new committee was held on June 1, 1922, with Dr. Stratton as chairman and Dr. J. H. Dellinger, who was to be continuously associated with IRAC from that date to the present, as secretary.

The name first taken by the new group was the "Interdepartment Advisory Committee on Government Radio Broadcasting." Despite the name originally chosen, it was apparent from the first to most of the members that their interests in radio would not be confined to broadcasting. At the first meeting, in fact, a proposal was submitted to extend the committee's scope to general radio communications. Within the year, this point of view became general and the name was changed to "Interdepartment Radio Advisory Committee" which name it still bears.

Less than two months after its formal creation, the committee found the field to which it was eventually to devote most of its efforts. The minutes of July 27,

1922, indicate a discussion with respect to the assignment of a wave length. Steadily from that time on, allocations occupied an increasing proportion of the committee's time, with interest rapidly diminishing in aspects of radio not closely allied.

To those interested in the early days of radio, the minutes of the IRAC are interesting reading. Some of the items have their amusing aspects, as for instance, the discussion at several of the first meetings on a proposal that the government install radio receivers in the public parks of Washington for the reception of Navy band concerts. Nothing came of it, it might be added, since the War Department, after trial, reported that the quality of the music was not sufficiently good to justify a permanent system. Since the matter was then referred to the technical subcommittee, we may assume that the poor quality involved the radio system and not the Navy's music.

Aside from such items, however, the minutes not only trace the growth of the entire field of radio communications but indicate IRAC's close contact with its problems. One of the earliest actions of the technical subcommittee was a recommendation that trials be conducted to determine the relative merits of tube versus arc transmitters. The same year, 1922, saw the opening moves that were later to culminate in the international radio conference held at Washington, in 1927; it was apparent to the government departments involved that the newly formed IRAC was an ideal body for the discussion of government problems in connection with such matters, and it was recommended that the technical subcommittee hold the necessary preparatory meetings.

The disposal of obsolete surplus government radio equipment is already looming as one of the major problems to follow World War II, just as it was after World War I. It is interesting to note that, after the previous war, it was the IRAC which, in 1925, requested the Navy and the United States Shipping Board to discontinue the sale of discarded spark transmitters so that interference from that type of equipment might be curbed. Today, the postwar problems posed by the impact on the spectrum of such surplus gear as walkie-talkies, with their unstable frequency characteristics, and certain electronic devices, with their wide bands of emission, will be a matter of deep concern to all of us.

All this seems so long ago as to have little connection with present-day radio. Yet, as early as 1928, the IRAC first took up the problem of frequency allocations for television and for the aeronautical service. The outgrowth of these studies with respect to television resulted in a recommendation by the late Federal Radio Commission that the service be given a 200-kilocycle band running from 2750 to 2950 kilocycles, exactly one thirtieth of the spectrum space now employed for a single television channel. Its studies in connection with aviation were prompted by a desire to bring about uniformity of aircraft communications and navigational aids, and to avoid duplication of stations and frequen-

cies. The report pointed out that extensive use of radio for aviation had not yet materialized, but observed that when it did, the band of 35 kilocycles then available for this service would probably prove to be inadequate. Beginning in 1935, aviation needs assumed a prominent place on the IRAC agenda when the federal government began installing air navigation, air-ground, and point-to-point facilities on a large scale.

During the troubled period of the past few years, the IRAC's agenda has reflected the successive phases of national emergency and war. The years 1940 and 1941 show a steadily increasing number of applications from the Army and Navy, particularly for domestic aviation use. In 1942, there was a corresponding demand for overseas communications facilities. Still further expansion is noted in 1943, as the tide of war swung in our favor and larger land and sea areas were involved. The extent of the radio-communications facilities required by our operations in Europe and the Pacific is almost beyond comprehension. The resultant situation was responsible, in 1943, for a significant landmark in the field of frequency allocations. In that year, an important agency of the United States Government found its request for radio facilities denied in part by IRAC because of the impossibility of finding sufficient usable frequencies. Since then, the expanding requirements of radio communications have been met with progressively greater difficulty, and then only by acceptance of increasing amounts of interference on the part of existing services.

To speak of present-day frequency allocations touches on a situation that few anticipated. That is, that as a practical matter, the government does not have unlimited use of the spectrum in time of war. To many, this will be hard to believe. After all, it has been accepted as axiomatic that all radio facilities become available to the government in an emergency, and even the communications act so provides. Even in the IRAC, as late as 1928, we find this assumption reflected when a proposal for special wartime military assignments was objected to as unnecessary in view of the availability of the entire spectrum to the government in time of war. Theoretically, it may be; actually, it is not. War today is not a matter of armies and navies alone; it involves all the people. Radio is necessarily associated with many other aspects of the war effort than the purely military. We could not suspend domestic broadcasting; we have found it necessary not only to continue international broadcasting but to augment it; our airlines must continue to operate, and their complex and extensive network of communications and airport control facilities are essential to their operation; navigational aids for both air and marine use have to be maintained; point-to-point circuits to our allies and to neutral nations cannot be appreciably curtailed; our municipal and state police radio systems must continue; the radio facilities required for the protection of our forests have to be kept in operation. Of course, a number of frequencies were

nevertheless made available by the point-to-point, coastal, and amateur interests. It is perhaps appropriate at this point to acknowledge this co-operation of the amateurs in relinquishing their bands, and of the commercial interests in rearranging their services and accepting interference which in normal times would be considered intolerable.

Early in 1943, the IRAC realized that the end of the war would bring with it a tremendous demand for frequencies, not only from the activities which have been curtailed during the war, but from enormously expanded commercial aviation and new activities. It was obvious, too, that the military establishment would not shrink to its prewar level. Accordingly, the IRAC appointed a special subcommittee to consider postwar frequency allocations. During the subsequent ten-months' study by this committee, many radio experts of the industry were called in for private informal meetings in order that the members of IRAC would have the benefit of their knowledge. Finally, under date of June 15, 1944, the committee issued its now well-known proposals for postwar spectrum allocations.

It may be asked why the IRAC, spokesman only for government needs, presumed to propose a general allocations table. Part of the answer is found in the fact that international allocations do not differentiate between government and nongovernment, so that any plan must eventually assume the shape of a general allocations table. Further, the postwar allocations problem below 25 megacycles represents mainly a matter of adjustment to accommodate increased navigation aids, permanent military establishments, and aviation. The first two are government subjects, while the third finds its counterpart in our wartime military air transport services. Above 25 megacycles, certain allocation landmarks exist in the shape of vast quantities of equipment in world-wide use, much of which will find commercial postwar use. No one can seriously hope to draft an allocation table for this region without full knowledge of these landmarks. At the moment that knowledge is confined largely to the government and is subject to security restrictions. The IRAC indicated these landmarks, and also insisted that the amateur bands be placed where they would be useful for wartime military expansion, but beyond that, suggested only a division of spectrum space between government and nongovernment.

It may be added that currently the IRAC is modifying its original proposals as a result of continued discussions with the Federal Communications Commission, taking into account the Commission's findings resulting from its recent hearing "In the Matter of the Allocation of Frequencies to the Various Classes of Nongovernment Services in the Radio Spectrum from 10 kilocycles to 30,000,000 kilocycles."

RELATION OF IRAC TO OTHER AGENCIES

The IRAC's authority to allocate frequencies to government radio stations makes it an important body; it is

worth while to examine carefully its relation to other agencies.

It is desirable from the start not to confuse IRAC with other agencies. This frequently occurs. The specialized nature of frequency allocations work requires that such matters within each agency be centralized in a small group, usually only one or two individuals. These people represent their respective agencies whenever frequencies are involved, but it should be emphasized that, while each is acting to some extent as an individual, he is primarily the medium of policy expression for his organization. At times there may be several committees working on frequency allocation matters, particularly when, as at present, preparations for telecommunications conferences are in progress. Regardless of the number of committees, the people on them are for the most part the same, thereby insuring continuity and co-ordination.

The agency with which the IRAC is perhaps most closely associated is the Federal Communications Commission. As previously indicated, the IRAC assigns frequencies to government stations while the FCC assigns frequencies to nongovernment radio stations. However, while the scope of their operations can be clearly distinguished, their activities cannot be wholly separated, since the assignment of any frequency may affect the users of other frequencies. Separate agencies such as IRAC and FCC, therefore, cannot both allocate frequencies without complete co-ordination. In this instance, the co-ordination is very simply achieved: the FCC is one of the members of the IRAC. To summarize the relations of IRAC and FCC: they are independent bodies, having equal authority to make frequency assignments in their respective fields, and they co-ordinate their day-to-day activities through the medium of FCC's membership on IRAC.

After the outbreak of war in Europe, the President created the Defense Communications Board, now the Board of War Communications. It was given broad powers of policy-making nature with respect to the placement of United States communication facilities on a war footing. The IRAC was designated as Committee V of the Board to advise on frequency matters involving government radio stations. Thus, the IRAC has direct connection with the Board of War Communications, as a committee of that Board. However, it is important to keep clearly in mind that the IRAC still carries on certain activities separate and distinct from its function as Committee V of the Board of War Communications, particularly with respect to postwar matters. This dual nature was emphasized last summer when the IRAC, acting as such and not as a committee of the Board, prepared its postwar frequency allocation plan. This plan was forwarded by IRAC direct to the Department of State, the agency charged with the responsibility of preparing United States proposals for international telecommunications conferences. In this connection, care should be taken not to confuse the IRAC with special

committees created by the Department of State from time to time to centralize such preparations.

With its extensive records and the increasing complexity and volume of the minutes of its meetings, the IRAC maintains a modest permanent secretariat. In 1928, the subject of funds for an IRAC secretariat was discussed, but it appeared that the small sum involved did not warrant a separate appropriation by Congress. It has been found more practicable for the FCC to include funds for the purpose in its own budget and to furnish office space. Under this arrangement, it is logical for the FCC representative or alternate to be elected as the secretary of the IRAC. This physical connection between the FCC and the IRAC secretariat is a matter of convenience, inasmuch as the records of both agencies are thus centralized, and readily available to each other.

ORGANIZATION

The organization of the Committee follows a rather simple form: a chairman, a vice-chairman, a secretary, and one standing committee; i.e., the technical subcommittee, with its chairman. Special subcommittees are appointed when required for specific purposes.

The method of selection of the chairman and vice-chairman may be of interest, as it solves the frequently recurring problem of equality of opportunity and recognition. Both officers automatically take office in alphabetical order of the member agencies for a term of one year, except that any member agency has the option of declining, in which event the office is automatically offered to the next member agency in alphabetical order. Currently, the Navy Department holds the chairmanship, and as the result of the declinations of both the Post Office and State Departments, the next in alphabetical order, the Treasury Department, holds the vice-chairmanship.

The secretary is elected by the Committee for a term of two years, and must be a representative or alternate of one of the member agencies.

The technical subcommittee, whose chairman is elected by the IRAC for a two-year term, considers specific technical problems assigned to it by the main committee.

The regularity of IRAC meetings is not only required from the point of view of the importance of the mission of the Committee, but is necessary to the expeditious accomplishment of its work. Meetings are held on the first Thursday of each month, with ten meetings a year specified as a minimum. Special meetings are held at the call of the chairman. Parliamentary procedure governs the conduct of meetings, a majority constitutes a quorum, and all members and alternates may participate in debate or call upon technical assistants to present information.

The value of any committee rests not only upon the soundness and wisdom of its decisions but upon the processes of arriving at those decisions. The importance

of the latter was considered so vital that the IRAC provided in its by-laws that the Committee shall endeavor to reach unanimous agreement on all questions discussed. However, upon request of any member agency a record vote may be taken. Each member agency has but one vote, no proxies are permitted, and motions and elections are carried by majority vote. The IRAC is proud of its record in carrying out these democratic principles.

To those who have had experience in the complicated problems of frequency allocations, it is understandable that it would be impossible to make assignments which are just, fair, and equitable to all concerned without a mutually satisfactory set of principles. The present principles governing the assignment and use of radio frequencies by the IRAC are the culmination of over twenty years of molding and are so fundamental and important that they should be mentioned with some exactness.

Applications by a government agency for authority to use a radio frequency must be justifiable under reasons such as the following: specific legislative directives; international commitments, such as treaty obligations; national-defense requirements; protection of national resources; safety services; essential mobile communications; emergency communications affecting safety of life or property; research and experimental services; absence, inadequacy, or impracticability of establishment or use of other means of communication.

Recognizing that the demand for radio frequencies greatly exceeds the supply, and to make the most efficient and orderly use of the spectrum in the national interest, action by the IRAC is predicated on consideration of all available data, including international regulations, national laws, established government policies, national interest, availability of other possible communication facilities, and technical aspects.

The Committee examines the data submitted in the light of good engineering practice for conformity with respect to frequency and geographical separation, and endeavors to insure that the frequency selected, insofar as possible, is one having transmission characteristics best suited to the proposed use; that national and international allocation plans are recognized; that the frequency stability is the best which the state of the art and service requirements permit; that minimum power consistent with satisfactory performance is employed; and that the frequency band width of emission is the most restricted consistent with satisfactory communication. Assignments are made with due engineering consideration of the probabilities of adjacent channel interference, and after careful study of the possible effect of the assignment on frequency assignments and uses. If an assignment is made where there is a possibility of interference, appropriate restrictions are placed on the assignment.

The extensive sharing of frequencies between agencies together with ever-smaller frequency separations have

required IRAC to develop an intricate system of priorities which, because of its timeliness and possible future application in other jurisdictions, warrants examination.

The Committee defines priority as the right to occupy a specified frequency for authorized uses, free of harmful interference from stations of other agencies; in questions involving precedence in the use of radio-frequency assignments, the term indicates the superior rights of one agency over another. It depends upon considerations such as:

(a) Agreements and records, as set forth in national laws, Executive Orders, IRAC minutes and records, international and interagency agreements;

(b) National interest, wherein consideration is given to relative need for the frequency in question and to the degree of utilization by the agencies involved;

(c) Necessity for using radio, taking into consideration the availability of other means of communication;

(d) Expansion. Here, in the interest of planned and orderly utilization of the radio spectrum, the Committee recognizes the desirability of providing for normal expansion of a service where it is shown by the applicant that expansion will occur, and where its trend and magnitude can be estimated;

(e) Geographical priority, which, as applied to mobile stations, is construed to extend only to the geographical area specified at the time the frequency was assigned; as applied to a fixed station, it extends only to the geo-

graphical location of the points of communication designated in the authorization;

(f) Dates of assignment and first use, where other considerations are substantially equal, establish the priority as between stations unless by the terms of an agreement it is specifically provided otherwise.

To the end that there be most efficient utilization of the radio spectrum, acceptance of a radio-frequency assignment imposes definite obligations on the assignee with respect both to equipment and to use. Some of these are specified in treaties and laws. Among the important obligations are:

(a) To use the best and most selective radio apparatus the state of the art and service operating requirements permit;

(b) To use frequencies economically by avoiding unnecessary emissions and conducting operations on a minimum number of frequencies;

(c) To share frequencies between agencies as a recognized and necessary expedient for the fullest utilization of the radio spectrum.

You have now been told something regarding the history of the IRAC, its relationship to other agencies, its internal organization, and the principles it follows in the conduct of its work. We are proud of that history and of our harmonious relations with other agencies, and we believe that our organization is both business-like and democratic. We feel this is the way in which you, as engineers, would wish to have us operate.

Some Aids to Facilitate the Engineer's Academic Training*

B. DUDLEY†, SENIOR MEMBER, I.R.E.

Summary—The rapidly increasing complexity of radio engineering practice and the employment of very-high frequencies necessitates more thorough and intensive training of radio-engineering students. Greater facility in mathematics will be required, but should be accompanied by adequate correlation between the mathematics and the physics of the problem. The use of animated motion-picture films, working models, or static models and diagrams suitable for textbook use, are discussed as one means of improving educational methods.

INTRODUCTION

AS A RESULT of the technical developments which the war has accelerated, and the exposure of large groups of men to at least the elements of engineering thinking and training, some rather im-

portant revisions of engineering education may be required in the postwar period. This appears especially true in communication engineering as a result of vastly expanded techniques and the need for a more general and fundamental educational approach. It is certainly now necessary to teach radio-engineering students the fundamentals of nonsinusoidal recurrent and transient phenomena. It is necessary to develop concepts of the electromagnetic field in three spatial dimensions as well as of time, and to replace the simpler and more familiar circuit concepts in which time variations of voltage and current alone were sufficient to specify the behavior of communication equipment.

If the engineering profession is to maintain a high standard of excellence, the increased scope of engineering topics which it seems desirable to teach must lead, it would seem, to one or both of the following procedures: (1) More effective and powerful teaching

* Decimal classification: R070. Original manuscript received by the Institute, February 6, 1945. Presented, Chicago Section, November 17, 1944.

† Formerly, Western editor, *Electronics*, McGraw-Hill Publishing Company, Chicago, Ill.; now, editor, *Technology Review*, Massachusetts Institute of Technology, Cambridge, Mass.

methods must be employed to provide the student with a sound foundation of generalized engineering principles; and (2) the length of training required for professional proficiency must be increased.

NEED FOR MORE MATHEMATICS

Undoubtedly there are many opportunities for increasing the effectiveness of teaching methods, particularly in mathematical subjects. Science and engineering are based on quantitative relationships which can best be expressed through the employment of mathematics. While the simpler problems can be treated adequately with the simpler branches of mathematics, radio-communication engineering is now sufficiently complex that, as minimum professional requirements in mathematics, every electrical-engineering graduate should possess facility in the setting up, solution, and use of linear partial-differential equations. He should be able to "think" in terms of three-dimensional time-varying quantities.

Consequently, a greater and more effective training in mathematics for undergraduate engineering students appears to be imperative. In contrast with the mathematician, the engineer is interested in mathematics as a useful working tool. His mathematics is applied mathematics. Every term, every coefficient, every exponent in his equation must, of necessity, have physical significance. Such mathematics becomes and should represent very much more than a mere "crank-turning" process. It is, in fact, a concise, compact method of quantitative thinking, and expresses the physical relations between those engineering quantities in which the engineer is vitally interested. Therefore, the physical interpretation of mathematics should be particularly emphasized. Textbook authors can aid by dissecting the important equations indicating those portions of the equation which represent amplitude, frequency, phase, initial and reflected components, and the like.

METHODS OF OBTAINING MORE EFFECTIVE INTERPRETATION

Undoubtedly much more than has already been achieved can be accomplished in the physical interpretation of mathematics, through the judicious use of animated motion pictures, models, and more effective textbook illustrations. For example, the fundamental processes of modulation and detection, or of radiation of electromagnetic waves, are complicated operations, frequently requiring a sizable sprinkling of mathematics for a proper elucidation. But, if these topics were illustrated by means of accurately drawn and correctly produced animated drawings, and these drawings were, in turn, properly co-ordinated with the mathematics of the problem they represent, no electrical-engineering student could fail to grasp the fundamental problem the first time he was exposed to the topic.

As an indication of what could be achieved in this direction, imagine a Walt Disney creation, executed somewhat in the manner of "Fantasia," but in which

there are portrayed accurately the correlation between the mathematical and physical interpretation of problems which students do not perceive readily. How quickly the student's grasp of fundamentals could be improved if such a method were applied to topics such as the production of beats, the behavior of nonlinear amplifiers having reactive loads, the fundamentals of amplitude- or frequency- and phase-modulation, the establishment of the electromagnetic field by a radiating system, or the transient behavior of networks!

In industrial electronics, these films might deal with timing, differentiating, integrating, or clipping circuits, but the real opportunity lies in the elucidation of field phenomena or mathematical concepts which can be represented in three-dimensional space.

REQUIREMENTS FOR FILMS ON ENGINEERING PRINCIPLES

Of course, such an invigorating film must extend considerably beyond those films, produced at about the trade-school level, whose primary objective has been the picturization of qualitative relations. The complete and precise correlation between the mathematics and the physics of the problem is the essential element of the desirable engineering-educational film.

We can hardly afford to overlook the economic factors in producing films such as those suggested. The potential audience will be, numerically, relatively small, and the cost of the animated films will be high. Therefore, it will probably be necessary to produce a relatively small number of films on different topics, and to distribute these as widely as possible. This procedure, in turn, would necessitate a certain amount of standardization in courses in communication and electronics. The Institute of Radio Engineers might well take the lead in making concrete suggestions in this direction.

Animated motion-picture films are not the only means of clarifying an understanding of fundamentals. For example, working models, in motion, a series of static three-dimensional models, or, failing these, a group of three-dimensional drawings in some form of perspective will help make clear the spatial relationship encountered in field problems. Such drawings or models can be made of inestimable aid in teaching a subject as complicated as radio engineering. To a very limited extent, three-dimensional drawings have begun to be employed in the treatment of wave guides, and the use of such diagrams is to be commended.

However, such diagrams should not be restricted to wave guides or to radiation problems. They lend themselves admirably to any problems in which a family of curves connecting three variables may be used to represent quantitative relationships.

PERSPECTIVE REPRESENTATION FOR RESONANT CIRCUIT

Consider, for example, the behavior of a simple series circuit, composed of linear-lumped elements of R , L , and C and energized by a voltage source E of variable

frequency. It has been customary to graph the variations of capacitive and inductive reactances as a function of frequency, and by algebraic addition of these two curves to show the absolute value of the net reactance as a sort of V-shaped diagram. The resistance component cannot properly be included on such a diagram,

circuit resistance represented by the real term in circuit equations is evident. Finally, by looking at the resistance-reactance plane, giving the vector relations for the circuit, as by viewing from outside of the model from the extreme left, we see the locus of the impedance vector as a straight line, since the circuit resistance is assumed to be constant and independent of frequency in this case.

All of these quantities are correlated in the impedance plane which shows that at low frequencies the impedance vector is large and negative, becoming a minimum, equal to the resistance of the circuit, at the resonant frequency, and then increasing to larger and positive value as the frequency is increased beyond resonance.

If, as is known to be the case, the circuit resistance varies with frequency, this can be shown easily in the three-dimensional drawing. For the usual case, the resistance is proportional to the square root of the frequency. The impedance plane now becomes somewhat curved and the locus of the impedance vector is a sloping and slightly curved line on the resistance-reactance plane.

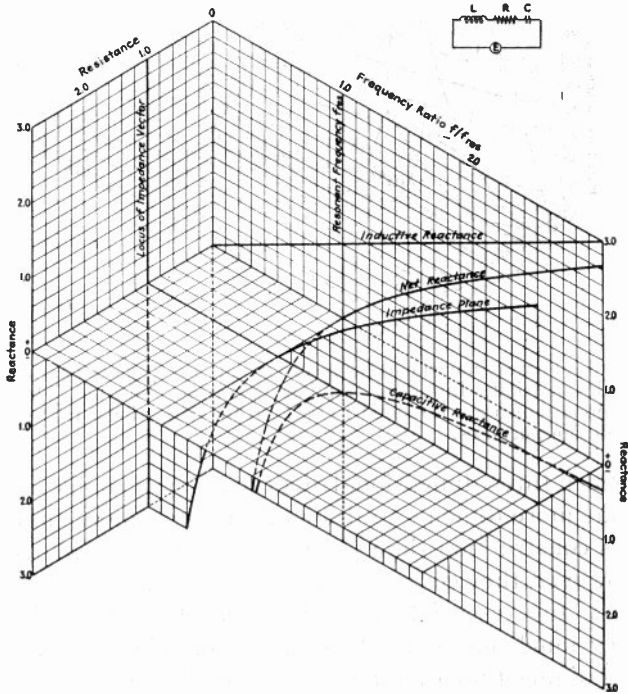

Fig. 1—Isometric drawing showing the relations between reactance, resistance, impedance, and frequency for single series R, L, C circuit, constant resistance.

OTHER EXAMPLES OF THREE-DIMENSIONAL DRAWINGS

We may employ the same general type of drawing to represent the behavior of a parallel or antiresonant circuit, as in Fig. 2. This illustration shows the behavior of the usual type of antiresonant circuit in which the series resistance in the capacitive arm is assumed to

even though a separate set of ordinates may be provided for its inclusion. If it is desired to show the vector relations of such a circuit, a completely new and separate diagram is required. Yet all of these data, and more, can be shown quite easily by a three-dimensional drawing as shown in Fig. 1. For several years, such a diagram has been used in teaching classes in radio engineering, with very satisfactory results. The construction of such a drawing, while readily apparent, nevertheless does not seem to have received attention previously.

In Fig. 1 we have three separate planes, each of which represents a certain physical concept. The vertical frequency-reactance plane at the right represents the circuit reactance, while the vertical resistance-reactance plane represents the vector relations of the circuit. It will be noted that the resistance-frequency plane has been shown horizontal and at 90 degrees to the reactance-frequency plane, as required by the familiar j notation and vector diagrams. Furthermore, both the resistance and the reactance components are properly shown as depending upon frequency.

By looking to the right at the reactance-frequency plane, the net reactance of the circuit, as well as that of its components, is readily determined for any frequency. By looking down on the resistance-frequency plane, the

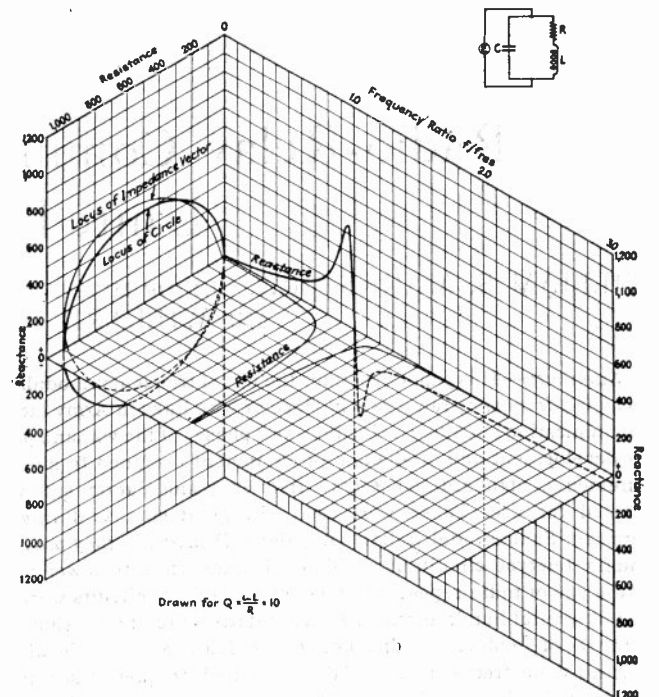

Fig. 2—Isometric drawing giving reactive and resistive components of impedance of parallel R, L, C circuit. The impedance plane has not been drawn, since it would obstruct important portions of the diagram.

be zero, and in which the coil is represented by an ideal inductor in series with a fixed resistor. In this case the coil resistance has been assumed to be constant, but only a very slight modification of this diagrammatic model would be obtained for a coil whose resistance varies as the square root of the frequency.

To illustrate some of the points which such a drawing brings out, the drawing is plotted for a coil having the rather low Q of 10. Careful study of this diagram will show the two different resonant frequencies, one for zero net reactance, and one for which the capacitive and inductive reactances are equal. The diagram has been drawn for the latter case. The diagram also shows that, in the case of the low- Q coils, the locus of the impedance vector may differ quite appreciably from that of a circle which is usually considered to apply for parallel-resonant circuits. In this drawing the impedance plane has not been included since it would obstruct important parts of the diagram; only the resistive and reactive components appear.

The concept of such three-dimensional diagrams may be applied to vacuum-tube characteristics, as in Fig. 3. On such a diagram it is possible, as shown here, to designate the operating limits of the tube, as given by the tube manufacturer. It is also possible to indicate graphically all of the variational parameters of the electrode circuit for which the diagram applies. Usually, as in this case, the plate characteristics are given, and consequently the amplification factor, internal plate resistance, and transconductance are derivable. However, three-dimensional diagrams of grid characteristics have also been plotted from which the equivalent variational parameters for the grid circuit may be determined.

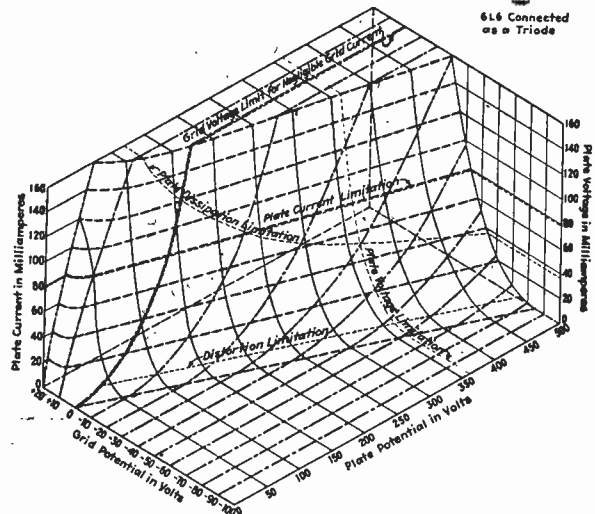
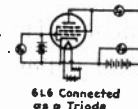

Fig. 3—Three-dimensional perspective diagram of plate characteristics of triode. Limits of amplifier operation indicated. The relations shown are intended to be used for educational rather than design purposes.

Such three-dimensional diagrams are, of course, somewhat more difficult to draw and require more time for this construction than the usual plane representations. However, they convey very much more information and show the essential and fundamental relationships so very much more clearly than is possible with the old techniques that they have very definite advantages for educational purposes. Such drawings lend themselves to reproduction on the printed page. For laboratory or classroom instruction, suitable models might be constructed of lucite sheet or plaster of Paris.

Radio-Relay Communication Systems in the United States Army*

WILLIAM S. MARKS, JR.†, SENIOR MEMBER, I.R.E., OLIVER D. PERKINS†, SENIOR MEMBER, I.R.E.
AND WILLARD R. CLARK†, MEMBER, I.R.E.

Summary—This paper describes the use of frequency-modulated, very-high-frequency radio sets in place of wire lines in Army tactical communication circuits. During the early phases of the war and pending development and production of equipment designed to meet requirements, standard police-type frequency-modulation sets were adapted for use. These were used with great success during the Tunisian, Sicilian, and Italian campaigns. Principally they provided simplex teletype circuits from higher headquarters to lower units. By the use of radio-repeater or relay stations these circuits were extended several hundred miles. Representative circuits are shown illustrative of employment, distances covered, and antenna elevations. A broad-band frequency-modulated very-high-frequency set designated AN/TRC-1 was developed for use in conjunction with voice-

frequency-carrier equipment CF-1 and CF-2 to provide multichannel voice and teletype circuits over a single radio frequency. This has met with great success and was a most important communication factor in the Normandy invasion and battle of France. It marks the first real marriage of wire and radio communications in the Army and provides an integrated communication system. The advantages of a radio system over conventional wire lines under certain conditions are pointed out, such as a saving in men and material, establishment and maintenance of communications in a fast-moving situation, use over water, enemy territory, and rugged or mountainous terrain. Expanding and wider application of the principle is indicated.

I. INTRODUCTION

BEFORE describing the Army's very-high-frequency radio-relay system and the several representative applications made of it in actual

* Decimal classification: R561X R414. Original manuscript received by the Institute, January 29, 1945. Presented, Winter Technical Meeting, New York, N. Y., January 27, 1945.

† Signal Corps Ground Signal Agency, Bradley Beach, N. J.

operations, it is well to take a brief look at military communications in general and review some of the problems and experiences which have influenced the development and increasing use of radio-relay equipment, thus making it possible to remove radio communications from their usual separate and isolated nets and place them together with wire circuits in a single communication system.

It has been said many times that this is a war of machines. One can well believe this when production figures are given for the thousands of airplanes, tanks, tank destroyers, trucks, heavy guns, and many other like items required to carry on this global war. It requires little imagination on the part of the communication engineer to envision the tremendously increased importance placed upon communications to co-ordinate the use of these high-speed weapons of war, and thus make their effective utilization possible. From the infantry soldier in the foxhole, from the commander in the tank, and from the pilot in the airplane to headquarters in Washington, there lies a vast and intricate communications network.

Fig. 1 gives some idea how military communications work. As indicated therein, the two means of transmission for these communications are wire and radio. Since World War I, the Army has always considered wire to be the primary means of communication, and radio the emergency means. This is still the basic policy of the Army, although the very nature of this war has placed ever-increasing emphasis on radio in many cases as the primary means. In fact, in this war, radio is the only means by which highly mobile elements, such as aircraft, tanks, amphibious vehicles, and assault troops can be controlled or co-ordinated effectively. It is the only means of communication across enemy-held territory, over water and terrain inaccessible for wire-line construction. This fact was well demonstrated during the Allied invasion of Normandy, General Patton's 3rd Army dash across France, and during General MacArthur's many amphibious operations in returning to the Philippines. More emphasis has also been placed on radio as an emergency means, due to the greatly increased hazards to wire from enemy bombs, shells, sabotage, and from friendly vehicular traffic.

The vital importance of radio communication poses a serious challenge to this nation to pioneer new fields of application and to design and produce equipment that will give superior performance in the hands of our fighting men. The Signal Corps Ground Signal Agency, through its various laboratories at Fort Monmouth, New Jersey, is responsible for the development of ground-radio equipment for combat troops of the Army and has been fully conscious of this challenge. That it has been well met is attested to in the many reports received from responsible field commanders citing superior performance of Signal Corps equipment.

This superiority is attributed in large measure to the extensive use of frequency-modulation equipment in the

frequency band of 20 to 100 megacycles. In fact, all radio-communication equipment used in this band by the Army ground forces, representing a large proportion of their total complement of equipment, is exclusively frequency modulated. Those familiar with the amount of interference that existed in prewar-radio amateur bands have observed a small sample of the interference problem in the high-frequency band below 20 megacycles that exists in a combat zone. The removal from this band of many thousands of tactical radio sets was a major contribution to the efficiency of military communications.

Exploitation of this very-high-frequency band for ground-radio communication, and the adoption of a comprehensive line of frequency-modulation tactical radio sets, is due principally to the early pioneering and vision of Signal Corps officers and engineers at the Signal Corps laboratories under the direction of Major-General Roger B. Colton (then Colonel), and to the several radio manufacturers who assisted in the early frequency-modulation-development program.

There are two good reasons why the Army relies on wire as the primary means of communication. First, it brings to the ordinary user in the Army the same type of operation and service he has always been accustomed to in his home and business life, so that it has the very real advantage of familiarity. Second, it is considered inherently more secure. Therefore, if radio is to compete with wire, regardless of any tactical or economical advantages it may have, it must provide the same services equally well. The question of security is a problem all its own and will not be discussed here. This discussion will be confined to the problem of providing the Army with the familiar telephone, telegraph, teletype, and facsimile communication facilities by means of radio circuits instead of the conventional wire-line circuits.

In solving this problem the goal of the Signal Corps, and more particularly the Signal Corps Ground Signal Agency, has been to provide the Army with an integrated communication system, where, in the words of one Army Signal officer, "we have a marriage of wire and radio." Although integrated radio-and-wire communication systems of various types have been satisfactorily employed on a commercial basis for several years, the design and operating features of these systems are vastly different from those required to satisfy the tactical requirements for military systems. For example, the commercial systems are normally designed to operate in a fixed-plant type of installation under carefully controlled operating conditions, whereas military systems must incorporate certain peculiar features essential to flexibility of tactical employment in the combat zone, and still retain features essential to reliable operation as a fixed type of installation in the communication zone, pending the establishment of permanent wire-line facilities.

In the light of early experience in the successful development of tactical ground-radio equipment, it was

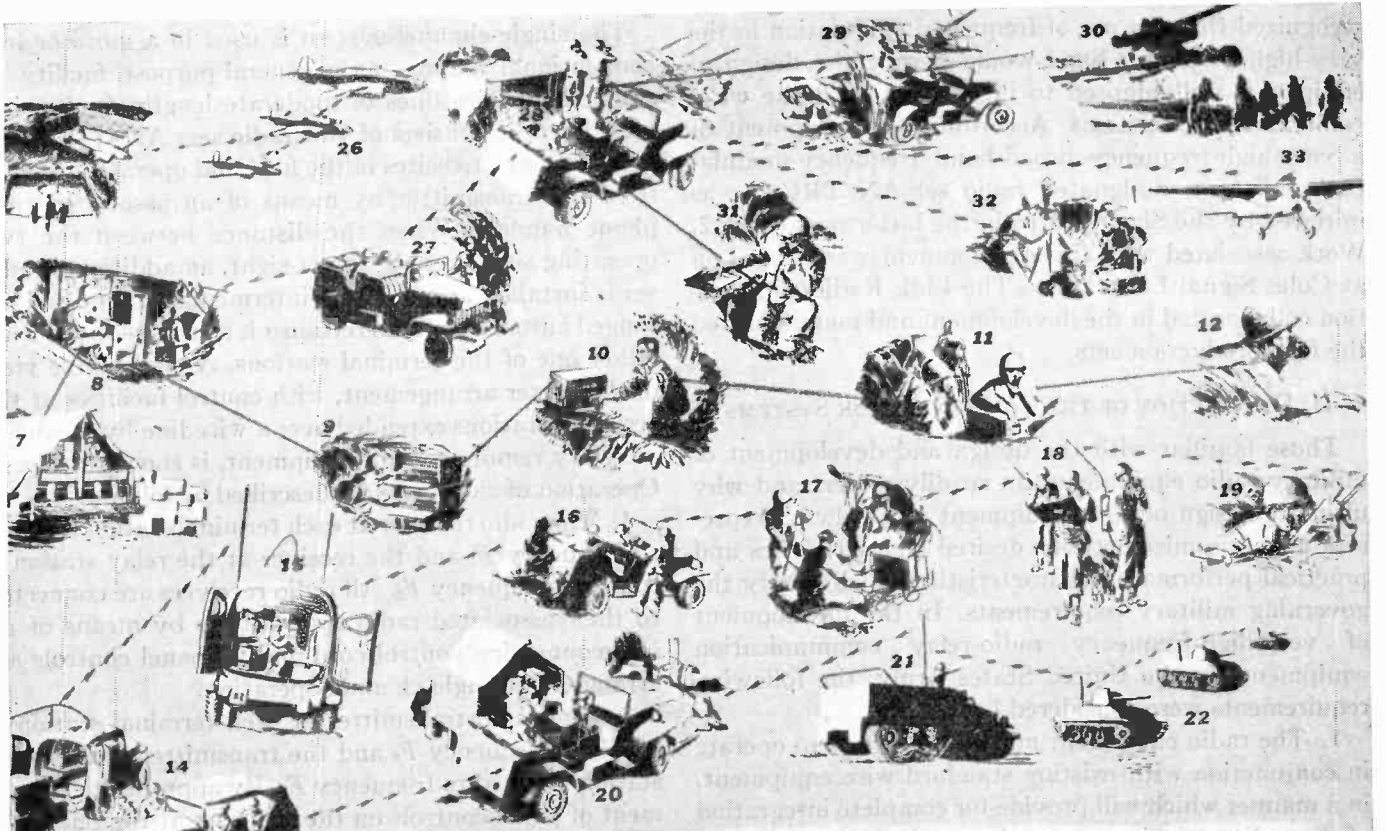

HOW MILITARY COMMUNICATIONS WORKS

Here in highly simplified, graphic form are charted the primary channels of military communications operating in every war theatre where American troops are fighting. Starting in the War and Navy GHQs in Washington, telephone and radio transmission arteries, join echelon to echelon, right down to the Army or Marine private in the forefront of

battle. Secondary and lateral lines of communication—too varied and intricate to be shown—are woven across this primary pattern and interconnect all branches and services, to make up the military communications network of the U. S. fighting forces—the largest and most complex communications system the world has ever seen.

KEY: TELEPHONE LINES

RADIO LINKS

ARMY

- 1 GHQ, Washington, D.C.
- 2 Teletype machines
- 3 Long range radio equipment
- 4 Supreme headquarters, AEF
- 5 Expeditionary force field headquarters

INFANTRY

Telephone System

- 6 Army headquarters
- 7 Corps command post
- 8 Division command post
- 9 Regiment command post
- 10 Battalion command post
- 11 Company command post
- 12 Front line observer

Radio Network

- 13 Army headquarters
- 14 Corps command post
- 15 Division command post
- 16 Regiment command post
- 17 Battalion command post
- 18 Company command post
- 19 Front line observer

ARMORED FORCES

- 20 Divisional commander
- 21 Battalion commander
- 22 Advanced tank companies

AIR FORCES

- 23 Commander, air forces
- 24 Permanent air base
- 25 Advanced air field

FIELD ARTILLERY

- 26 Planes in flight
- 27 Divisional commander
- 28 Battalion commander
- 29 Battery commander
- 30 Gun crews
- 31 Observer, telephone
- 32 Observer, radio
- 33 Observation plane

NAVY

- 1 GHQ, Washington, D. C.
- 2 Long range radio equipment
- 3 Commander-in-Chief, Naval area
- 4 Long range air reconnaissance

5 Supply ships

AMPHIBIOUS ASSAULT TASK FORCE

- 6 Amphibious force flagship
- 7 Warships protecting transports
- 8 Bombardment force flagship
- 9 Carrier-based attack planes
- 10 Warships for bombardment
- 11 Commander, transport group
- 12 Landing craft with troops
- 13 Beachmaster command post
- 14 Commander, shore party of Marines
- 15 Commander, landing party inland
- 16 Front line observer, radio
- 17 Front line observer, telephone
- 18 Shore fire control party
- 19 Bombardment observation planes

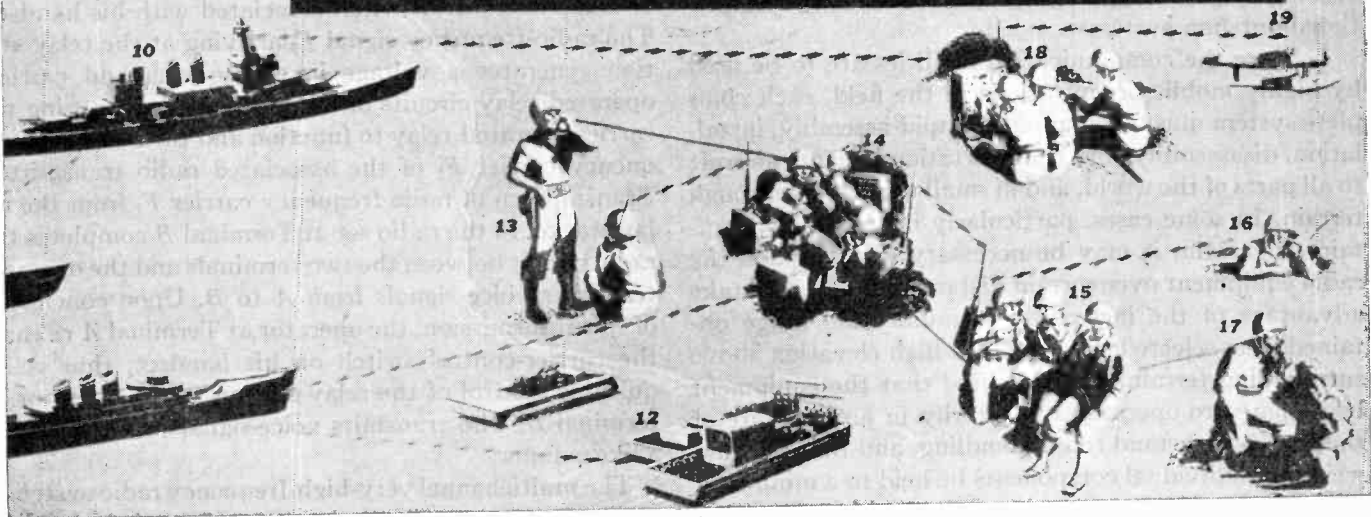

(Courtesy Western Electric Company)

recognized that the use of frequency modulation in the very-high-frequency band would permit the design of equipment well-adapted to integration with the wire-communication systems. Accordingly, development of a very-high-frequency broad-band frequency-modulation radio set, designated radio set AN/TRC-1, was initiated by the Signal Corps in the latter part of 1942. Work associated with this development was carried on at Coles Signal Laboratory. The Link Radio Corporation collaborated in the development and manufactured the first production sets.

II. DESCRIPTION OF THE COMMUNICATION SYSTEMS

Those familiar with the design and development of military radio equipment can readily understand why ultimate design of such equipment must always represent a compromise between desired characteristics and practical performance characteristics which satisfy the governing military requirements. In the development of very-high-frequency radio-relay communication equipment for the United States Army, the following requirements were considered basic:

1. The radio equipment must be designed to operate in conjunction with existing standard wire equipment, in a manner which will provide for complete integration of the radio and wire systems into a single tactical communication system. Since the related wire systems included field-wire lines of moderate length, as well as cable lines capable of extending carrier-telephone facilities over distances in excess of 100 miles, this requirement indicated the need for a "single-channel" system, to operate over moderate distances, and a "multichannel" system, to provide for multiplex radio transmission of the carrier-telephone facilities over extended distances.
2. The operating frequency band used must be satisfactory for reliable day and night communication, relatively free of interference, and consistent with the provision of reasonably compact and easily erected directional-antenna systems.
3. Since the communication facilities are to be used by highly mobile organizations in the field, each complete system must be adapted to rapid assembly, installation, disassembly, and transportation in cargo aircraft to all parts of the world, and in small vehicles over rough terrain. In some cases, particularly in jungle or mountainous terrain, it may be necessary to man-pack the radio equipment over certain distances, in order to take advantage of the increased communication range obtained from selected sites having a high elevation above surrounding terrain. This required that the equipment be designed to operate satisfactorily in any climate of the world, withstand rough handling, and that size and weight of individual components be held to a minimum.
4. The equipment must be well adapted to installation, operation, and maintenance by a small number of military personnel having a minimum amount of specialized training.

The single-channel system is used in a more or less conventional manner as a general-purpose facility to supplement wire lines of moderate length. In its simplest form, it consists of two radio sets AN/TRC-1 installed at selected sites in the field and operated directly from the transmitter by means of an associated telephone handset. When the distance between the two operating sites exceeds line-of-sight, an additional radio set is installed at a suitable intermediate point and arranged automatically to retransmit signals received from either one of the terminal stations. A perspective view of this latter arrangement, with control facilities at the terminal stations extended over a wire line by means of auxiliary remote-control equipment, is shown in Fig. 2. Operation of the system is described as follows:

1. The radio receiver at each terminal station is tuned to frequency F_1 and the receiver at the relay station is tuned to frequency F_2 . All radio receivers are connected to their associated radio transmitters by means of an interconnecting control cord and all panel controls are arranged for single-channel operation.
2. The radio transmitter at each terminal station is tuned to frequency F_2 and the transmitter at the relay station is tuned to frequency F_1 . By appropriate adjustment of panel controls on the radio set at the relay station, circuit arrangements are made whereby the radio-frequency carrier transmitted from this station is turned on by the action of the squelch relay in the associated receiver when a radio-frequency signal is received from either one of the terminal stations.
3. Extension of the headset, microphone, and carrier-control circuits of the terminal stations to the remote operating positions is provided in addition to the local handset and control facilities, so that each terminal station may be operated from either the local or remote position.
4. Operator at terminal *A* turns on the radio-frequency carrier F_2 of the associated radio set by means of a carrier-control switch associated with his handset. The radio-frequency signal F_2 arriving at the relay station generates a voltage in the squelch and carrier-operated relay circuits of the receiver, thus causing the carrier-operated relay to function and turn on radio-frequency carrier F_1 of the associated radio transmitter. Transmission of radio-frequency carrier F_1 from the relay station to the radio set at Terminal *B* completes the radio circuit between the two terminals and the operator transmits voice signals from *A* to *B*. Upon conclusion of this transmission, the operator at Terminal *A* releases the carrier-control switch on his handset, thus relinquishing control of the relay station to the operator at terminal *B*, who transmits voice signals from *B* to *A* in a like manner.

The multichannel very-high-frequency radio system is designed to operate in conjunction with tactical carrier telephone and telegraph terminal equipment to replace or supplement the telephone cable used as the transmitting medium. (See Fig. 3.) This terminal equipment

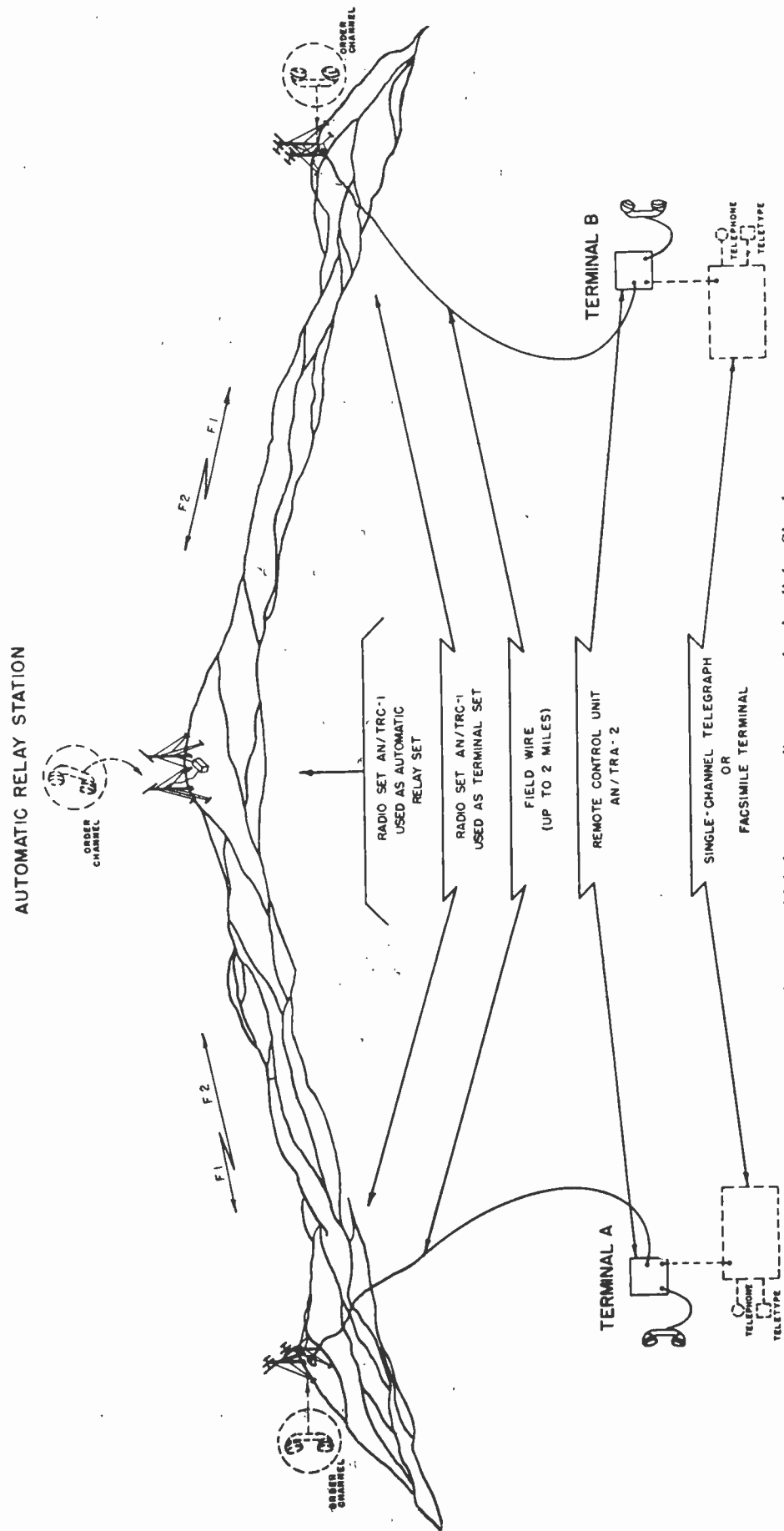

Fig. 2.—Perspective view of two very-high-frequency radio-communication links. Simplex two-way system.

is common to the two systems and provides four telephone circuits, one of which is ordinarily used for voice-frequency telegraph operation to obtain four full or half duplex telegraph or teletype circuits. The telephone cable used is a four-wire, rubber-insulated spiral-four cable with loading coils at the junction points of the cable sections, and is made up in quarter-mile lengths.

vals, depending upon the amount of prevailing noise and atmospheric static, and are adjusted manually at periodic intervals to compensate for variations in the cable attenuation caused by changes in temperature. With this order of repeater spacing and with good maintenance, system lengths up to three- or four-hundred miles may be employed when the cable is all buried. The radio

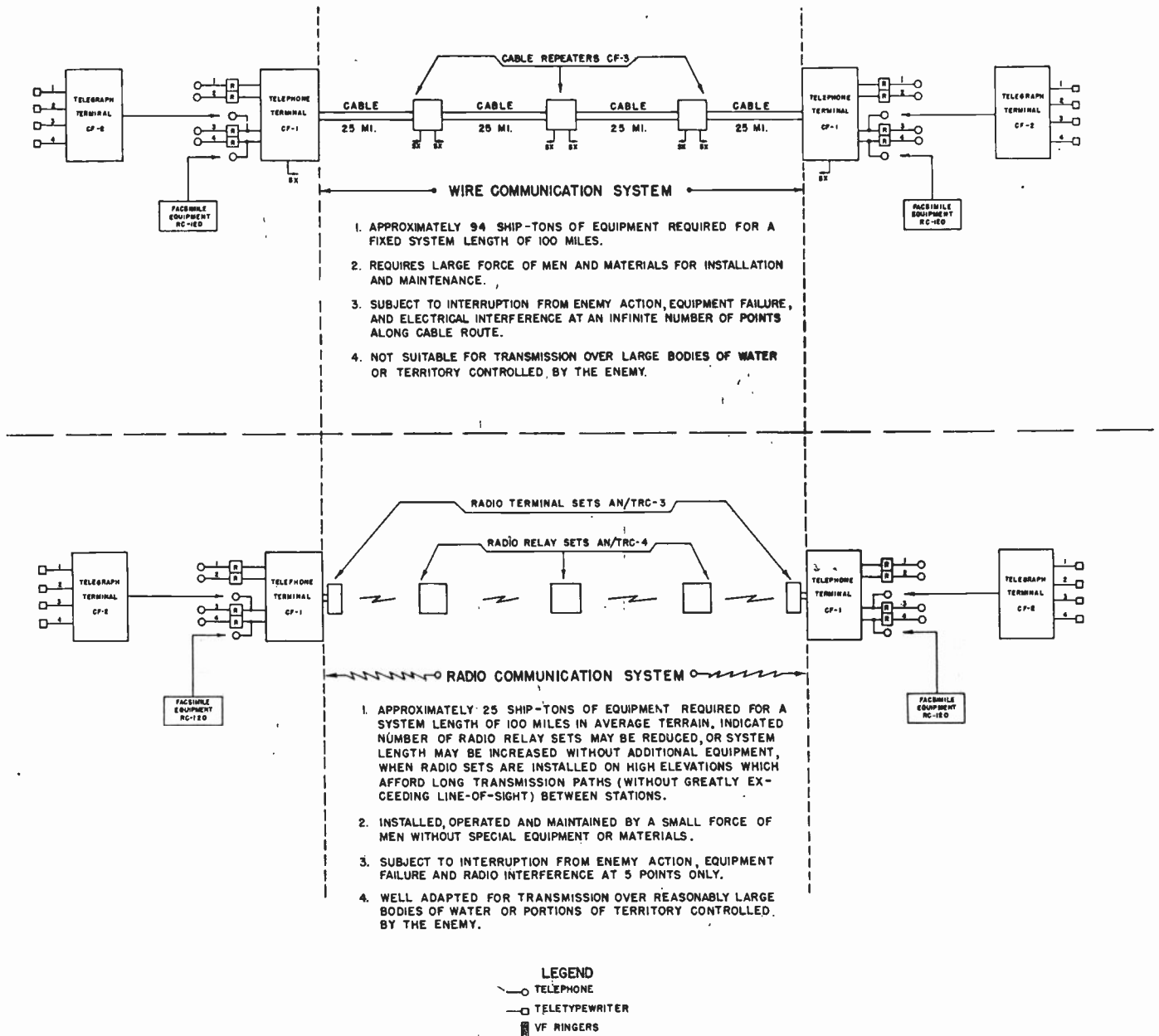

Fig. 3—United States Army tactical multichannel communication systems. Comparison of wire and very-high-frequency radio-transmission facilities.

One pair of conductors serves to transmit in one direction and the other pair in the opposite direction. The cable may be strung aurally, laid on the ground, or buried in the ground by means of a cable plow. In long systems, most of the cable is ordinarily buried to minimize line trouble and the variations in loss or attenuation due to temperature changes. Intermediate cable repeaters are installed at approximately 25-mile inter-

system provides a transmitting medium which may be used to bridge gaps in the cable sections, replace the cable between the repeaters, or replace both the cable and the repeaters between the two terminals. Unlike the cable systems, the spacing between the radio-relay sets or radio-terminal sets depends primarily on the nature of the terrain along the radio-transmission path and the availability of installation sites for the radio equipment

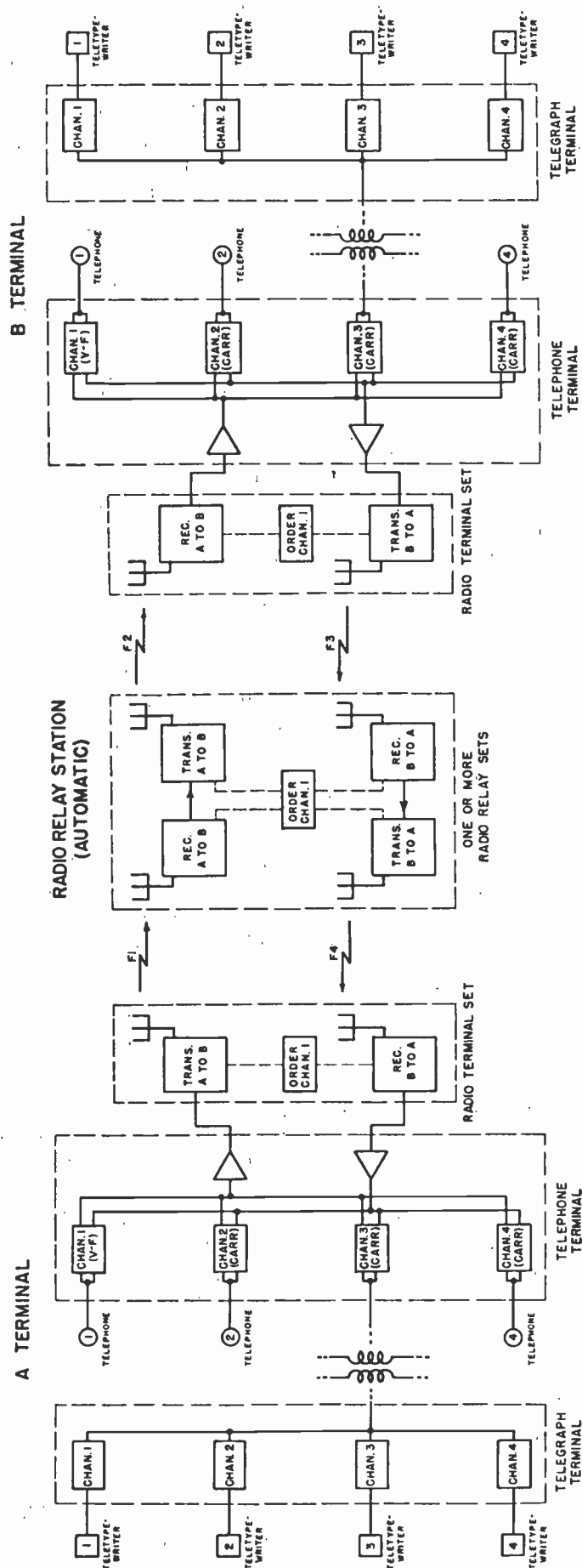

Fig. 4—Simplified functional diagram of United States Army multichannel very-high-frequency radio-relay communication system.

Very-high-frequency radio systems exceeding 100 miles in length may be satisfactorily employed without the use of intermediate relay sets when the terminal sets are installed on natural elevations of suitable height.

Fig. 4 shows a simplified functional diagram of the terminal-station equipment together with the very-high-frequency radio-relay station equipment. The basic component of the system is the telephone terminal which utilizes an audio-frequency band of approximately 200 to 12,000 cycles, divided into four separate telephone channels by means of the single-sideband suppressed-carrier technique. Channel 1 covers the voice-frequency band and is monitored by all stations in the system, thus serving as an "order channel" for supervisory control of the system. Channels 2, 3, and 4 are shifted by modulation into the carrier-frequency range and are used in a normal manner for telephone communication, or for voice-frequency telegraph or teletype communication by means of an associated telegraph terminal. Each of the four telephone channels passes frequencies between 200 and 2800 cycles to the modulator. The three lower sidebands from channels 2, 3, and 4, together with the voice frequencies from channel 1 are passed together to the common transmitting amplifier, and thence through a center-tapped repeating coil to the transmitting pair of the cable, or the input to the radio transmitter. In the cable system the center-tapped coil is used to provide an additional simplex circuit for signaling throughout the system. The receiving side of the telephone terminal, associated with the incoming pair of the cable, or output of the radio receiver, includes a simplex repeating coil, a receiving amplifier common to all four channels, and an equalizer for controlling the receiving gain. The four telephone circuits which the system provides are accessible for connection to a switchboard or individual telephones. Not shown in this diagram, but ordinarily associated with each telephone channel, is an auxiliary set of voice-frequency ringing equipment. In this equipment a 1000-cycle current, interrupted about 20 times per second, is generated and transmitted over the carrier circuit. At the receiving end of the system the low-frequency ringing current is sent toward the switchboard or telephone by means of another set of ringing equipment.

The voice-frequency telegraph terminal ordinarily is connected to the two-wire terminals of one carrier telephone channel. If necessary, additional telegraph terminals may be connected to the other telephone channels. The four telegraph or teletype channels are arranged for simultaneous two-way operation. Transmission between these terminals utilizes voice-frequency carrier currents of eight different frequencies between 595 and 1955 cycles. The local side of each telegraph channel is arranged to operate to outlying teletypewriter stations, telegraph repeaters, or switchboards over direct-current extensions or loop circuits. At the sending end, the signals received from the four direct-current telegraph circuits connected to the telegraph terminals are con-

verted to voice frequencies; and at the receiving end the latter are reconverted to direct-current telegraph signals in the respective four connected circuits. Different carrier frequencies are employed in each direction of transmission for each telegraph channel. The terminals for the two ends of the telegraph channel are alike and are convertible by means of a switch to serve as either west or east terminals. The carrier telephone terminals require no change to make them suitable for use at either end of the system, since the transmission bands are the same in both directions.

Any one of the telephone channels may be used for facsimile transmission by means of suitable auxiliary equipment. Facsimile equipment RC-120 is ordinarily used for this purpose, and provides for the transmission of maps, photographs, and miscellaneous written material.

The combined output of the transmitting amplifier of the telephone terminal, occupying a frequency band of about 200 to 12,000 cycles, is connected to the input of the radio transmitter and thus modulates radio-frequency carrier F_1 . This radio-frequency carrier is received at the relay station, demodulated, and connected to the input of an associated transmitter which retransmits the received signal on radio-frequency carrier F_2 to the next relay or radio-terminal station in the system. The output of the radio receiver at the terminal station is connected to the receiving telephone terminal where it is amplified, filtered, and demodulated into the individual telephone channels. The four radio-frequency carrier frequency channels at the relay stations are selected for simultaneous two-way operation. Channel 1 (voice-frequency) is monitored at each radio station and provision is made for the operators at these stations to utilize this channel as an "order channel" for supervisory control. This is accomplished without interference to communication on the other carrier channels.

The radio sets customarily are located at selected sites on high natural elevations and connected to the associated telephone terminals by means of spiral-four telephone cable. Fig. 5 shows the principal components of the terminal station arranged for operation in the field.

In order to provide a basis upon which to issue equipment for the different methods of employment, three basic sets of equipment were established which differ from one another only in the total number of components provided, and the use of certain auxiliary components to provide for different methods of operation. These sets of equipment and their principal operating components are designated and briefly described as follows:

1. *Radio Set AN/TRC-1* (Fig. 6): Consists of one radio receiver and one radio transmitter, separately housed and shock mounted in weatherproof wooden carrying cases of identical size and shape, each being provided with a portable directional-antenna system. Also included are a portable gas-engine-driven power unit and a set of maintenance equipment. Each radio

set is normally issued to provide single-channel voice communication on a simplex basis in intermittent service, and includes provision for operation as an automatic radio-relay set when installed at an intermediate point in a radio-relay communication system. All components

are readily transportable in a standard military two-and-one-half-ton truck and may be installed as a complete radio station by a crew of four men, in approximately one hour after arrival at the operating site.

3. *Radio-Relay Set AN/TRC-4*: Consists of two radio

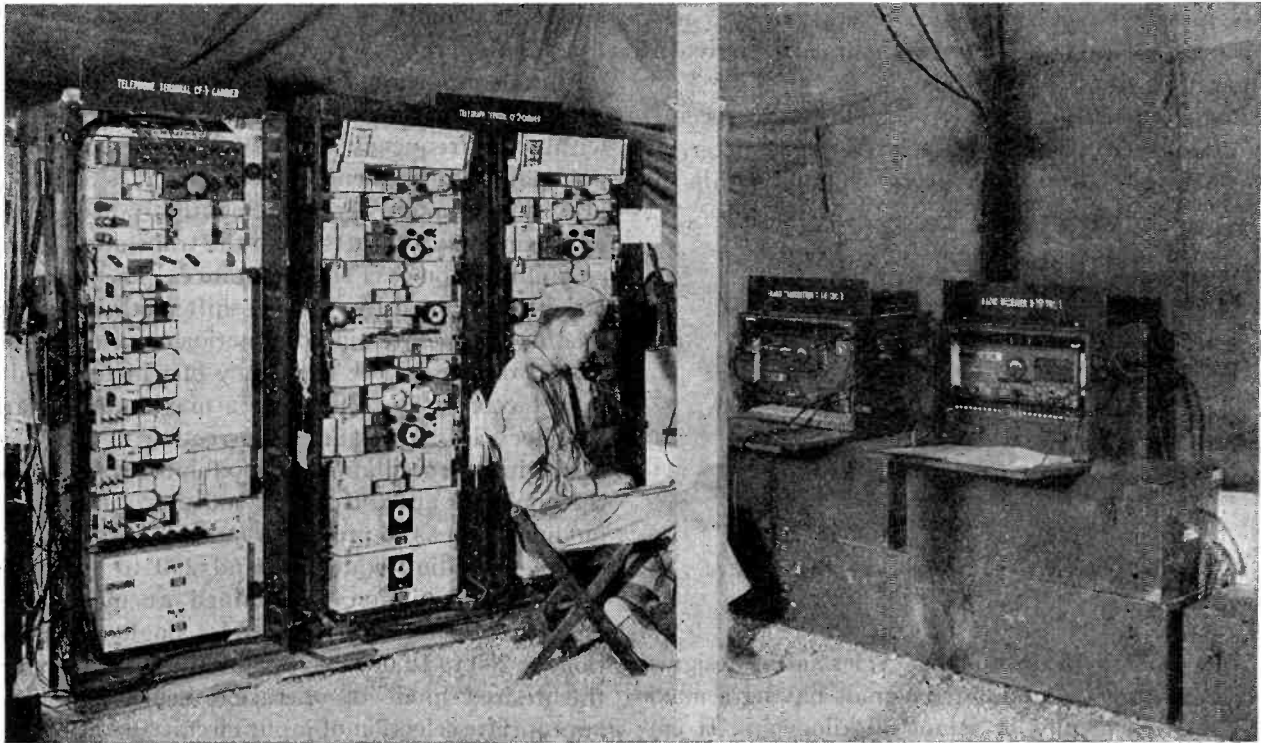

Fig. 5—Radio-relay-system terminal station.

are readily transportable in a standard military three-quarter-ton truck, and may be installed as a complete radio station by a crew of four men, in approximately one hour after arrival at the operating site.

2. *Radio Terminal Set AN/TRC-3*: Consists of one radio receiver, one radio transmitter, two antenna systems, and associated power and maintenance equipment. The basic components are identical and the method of operation is similar to radio set AN/TRC-1, except that radio terminal set AN/TRC-3 is intended for use under conditions of continuous operation at the terminals of a radio-relay communication system where uninterrupted service is a prime requisite. Although it may be used in the same manner as radio set AN/TRC-1, it is normally operated in conjunction with telephone terminal CF-1 and associated auxiliary equipment to provide a duplex radio circuit for the transmission of multichannel-telephone, voice-frequency telegraph (teletype), and facsimile-message traffic, thus providing a means for integrating the radio and wire systems into a single communication system. In order to assure continued operation with minimum interruption of service, an extra receiver, transmitter, and power unit are provided with each radio-terminal set for use as unit replacements in the event of failure of these components. All components

receivers, two radio transmitters, four antenna systems, and associated power and maintenance equipment. The basic components are identical to those used with radio set AN/TRC-1, from which set it differs only in the

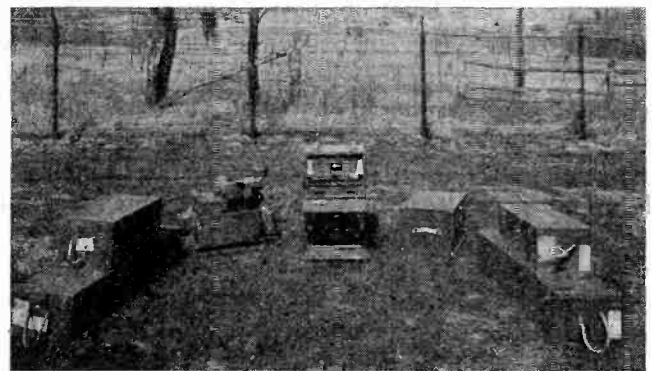

Fig. 6—Components of radio set AN/TRC-1.

total number of such components provided, and the method of interconnection and operation. The complete radio-relay set is primarily intended for use as an automatic duplex radio-relay station interposed between two radio-terminal sets AN/TRC-3 or other radio-relay sets AN-TRC-4, at appropriate intervals to extend the length of the radio circuit between the two radio-terminal

stations. Since the radio-relay set forms an integral part of a radio circuit where uninterrupted service is a prime requisite, an extra receiver, transmitter, and power unit are provided with each set for use as unit replacements. All components are readily transportable in a standard military two-and-one-half-ton truck and may be installed as a complete radio station, by a crew of four men, in approximately two hours after arrival at the operating site.

4. *Radio Receiver R-19/TRC-1*: The radio receiver shown, together with its associated transmitter, in Fig. 7 operates on any single preset channel within the

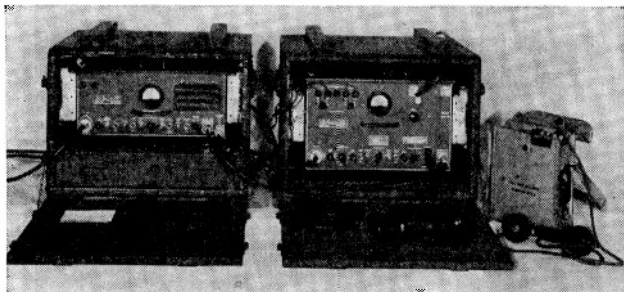

Fig. 7—Radio receiver and transmitter with associated field telephone.

frequency band of 70 to 100 megacycles and is designed to receive frequency-modulated signals having a maximum deviation of plus or minus 30 kilocycles. It employs 17 vacuum tubes in a crystal-controlled double-conversion superheterodyne circuit.

Notable features of this receiver are the dual audio system and "carrier-operated" relay. The audio system includes a low-pass filter which may be inserted by throwing a panel switch to the position marked "single channel." This filter is used to restrict the received audio frequencies to a band of 200 to 3000 cycles when the radio set is used in a single-channel communication system. When the panel switch is thrown to the "multichannel" position, the filter is short-circuited out of the circuit and the audio system provides uniform output of the complete audio-frequency band 200 to 12,000 cycles required for multichannel transmission when the radio set is operated in conjunction with telephone terminal CF-1. The carrier-operated relay associated with the audio system is actuated by a squelch circuit, the sensitivity of which may be adjusted to trip the relay when the desired radio-frequency signal is received. The relay and associated squelch circuit are thus adjusted to control automatically the radio-frequency carrier of an associated transmitter when the receiver and transmitter are interconnected by means of a control circuit, and are used as an automatic radio-relay set. A meter and associated selector switch are also provided on the front panel for checking the operation of individual stages in the receiver.

The complete receiver includes a self-contained loudspeaker and power supply. The loudspeaker is used for

monitoring purposes and the power supply is designed for operation from a 115 volt, 60 cycle, alternating-current power source. When prepared for operation it is connected to its associated antenna, power source, and radio transmitter by means of interconnecting cords. When prepared for transport in its carrying case it weighs 95 pounds.

5. *Radio Transmitter T-14/TRC-1*: The radio transmitter also shown in Fig. 7 is frequency modulated and operates on any single present crystal-controlled channel within the frequency band 70 to 100 megacycles. The nominal radio-frequency power output is 50 watts, and provision is made for reducing this power output to approximately 10 watts when the transmitter is used for communication over short distances. Frequency modulation is obtained by a phase-shift method wherein the modulator operates in conjunction with a crystal-controlled oscillator, the frequency of which is multiplied by a factor of 96 to produce a maximum deviation of 30 kilocycles. A frequency-correcting network, associated with the oscillator and modulator circuits, corrects the nonlinear audio-frequency output of the phase-shift modulator so as to provide a uniform response over the complete audio-frequency band 200 to 12,000 cycles. Maximum deviation is obtained at modulating frequencies of 200 to 3000 cycles, for single-channel operation, or 200 to 12,000 cycles, for multichannel operation, the desired mode of operation being established by appropriate selection of input circuit and adjustment of associated control switches. When the transmitter is operated in conjunction with telephone terminal CF-1 to provide multichannel transmission, the complete audio-frequency band 200 to 12,000 cycles is placed across the cable input terminals and is used to modulate the transmitter fully. Under this condition, four telephone conversations may be transmitted simultaneously, and the input to the modulator is adjusted so that each telephone conversation contributes 9 kilocycles deviation toward the maximum system deviation. Although this would appear to exceed the maximum deviation of 30 kilocycles, the peak voice levels rarely occur on all channels simultaneously, so that in practice the maximum deviation is never exceeded. A low-pass filter in the microphone input circuit restricts the modulating frequencies to a band of 200 to 3000 cycles when the transmitter is modulated with the local handset. By means of an associated control switch, the microphone input circuit may be arranged so as to modulate the transmitter to its full capability for single-channel operation, or at a level corresponding to channel 1 in the wide-band or multichannel system. This latter arrangement permits the local operator at the radio set to utilize the order channel (channel 1) for communication with associated radio stations in the circuit without interfering with transmission on the carrier channels in the system. Also associated with the audio-frequency input circuit to the modulator is a "cable compensator" or attenuator which may be adjusted from the front panel

to increase the audio-frequency input level to the transmitter and thus compensate for loss suffered in transmission over the telephone cable normally used to interconnect the transmitter with its associated telephone terminal. A meter and selector switch are also provided on the front panel for checking the operation of individual stages in the transmitter. The complete transmitter includes a self-contained power supply, and weighs approximately 108 pounds when installed in its carrying case. When prepared for operation it is connected to its associated antenna, power source, and radio receiver by means of interconnecting cords. Fig. 8 shows a functional diagram of the radio receiver and transmitter and Table I shows the principal electrical characteristics of these two components.

TABLE I
Radio Set AN/TRC-1 Characteristics

Frequency-Modulation Transmitter	Frequency-Modulation Receiver
Power Supply: 115 V-60 cycles (built-in) Power Output: 50 Watts Nominal 10 Watts Reduced	Power Supply: 115 V-60 cycles (built-in) Type: Double conversion superheterodyne
Frequency Control: Crystal Preset Frequencies: 1	Frequency Control: Crystal Preset Frequencies: 1
Available Frequency Assignments: 300 Frequency Range: 70 to 100 megacycles Crystal Frequency: 730 to 1040 kilocycles (approximate)	Available Frequency Assignments: 300 Frequency Range: 70 to 100 megacycles Crystal Frequency: 7500 to 8740 kilocycles (approximate)
Multiplication Factor: 96	Special Features: Squelch-operated relay. Built-in loudspeaker.
Modulation: Phase shift	Sensitivity: 5 microvolts for 23 decibels signal plus noise to noise ratio, 50 per cent full deviation multichannel.
Deviation: ± 30 kilocycles maximum	Radio-Frequency Band Width: 108 kilocycles for 30 decibels signal plus noise to noise ratio, 25 microvolts input, 50 per cent full deviation multichannel.
Audio Band Width: 200 to 3000 cycles single channel 200 to 12,000 cycles multichannel	Audio Band Width: 200 to 3000 cycles single channel 200 to 12,000 cycles multichannel
Weight in Carrying Case: 108 pounds	Weight in Carrying Case: 95 pounds.

6. *Antenna System AS-19/TRC-1* (Fig. 9): The antenna system consists of a 3-element horizontally polarized array supported on a steel mast which is mounted on a mast base in such a manner that the complete antenna system may be rotated to orient the array in the desired direction of transmission. The mast is made up of 5-foot tubular-steel sections which are easily assembled together to provide different antenna heights up to a maximum height of 40 feet above ground, and the complete system is held in place by means of rope guys. The antenna array consists of a directly excited horizontal dipole, with parasitically excited director dipole and reflector dipole, both of which are spaced a quarter wave length from the driven dipole, by means of adjustable support members. All elements are calibrated and are adjustable to any operating frequency in the band 70 to 100 megacycles. The dipole elements are all interchangeable and the parasitic-element support members are demountable from a common mast head in such a manner that the antenna may be used as a one-, two-, or three-element system, the latter system having a forward power gain of approximately 6 decibels above a dipole antenna at the same height. Although the beam width of this antenna is quite wide and affords little privacy, it is considered to be the minimum practicable, consistent with the requirements of portability and flexi-

bility of employment. The antenna is connected to its associated radio receiver or transmitter by means of a flexible solid-dielectric radio-frequency transmission line having a characteristic impedance of 50 ohms.

7. *Power Unit PE-75*: The power unit consists of a 2500-watt gasoline-engine-drive alternating-current generating set designed to generate a 120-volt single-phase

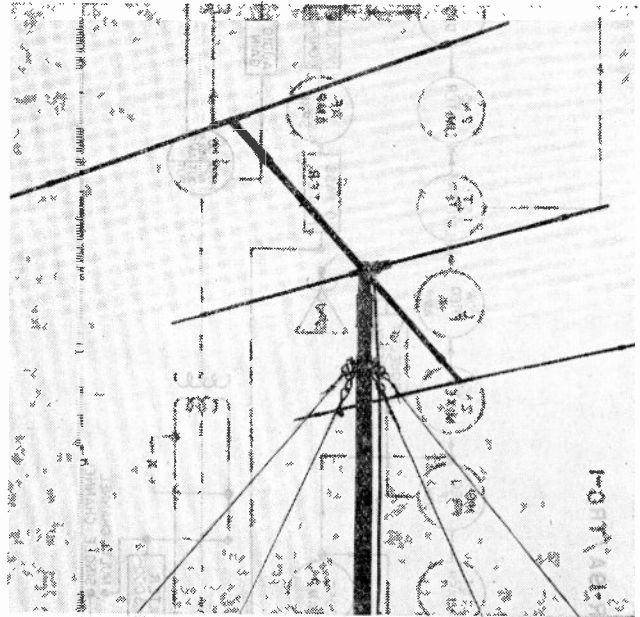

Fig. 9—Close-up of antenna array.

60-cycle current. A single-cylinder gasoline engine of the manual-starting type drives the single-phase generator by means of two V belts. The speed of the engine is automatically controlled by a built-in fully enclosed governor. The complete power unit is mounted on a steel skid base and weighs 325 pounds when assembled for operation. This unit is shown with associated radio components in Fig. 6.

8. *Amplifier Equipment AN/TRA-1* (Fig. 10): This equipment is furnished as auxiliary equipment for use in

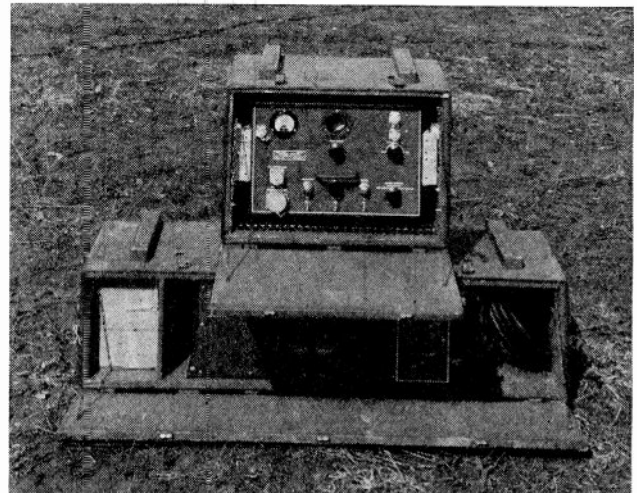

Fig. 10—Amplifier equipment AN/TRA-1.

conjunction with the radio transmitter to increase the radio-frequency power output when increased power is required to improve signal strength on unusually long or noisy circuits. It consists of a push-pull class C radio-frequency amplifier, designed to provide a maximum power output of 250 watts, and is furnished with a separate power supply. The amplifier weighs 90 pounds and the power supply weighs 195 pounds when installed in their respective carrying cases.

III. EMPLOYMENT IN TUNISIAN, SICILIAN, AND ITALIAN CAMPAIGNS

In December, 1942, Allied Force Headquarters, North Africa, placed before the War Department the first de facto field requirement for a radio-relay communication system. This system was to extend from Allied Force Headquarters to subordinate headquarters in the forward combat areas providing facilities whereby commanders in these forward areas could maintain reliable and rapid communication with the rear. Drawing upon its experiences in the Carolina maneuvers of 1941, Coles Signal Laboratory was able to establish the major technical characteristics of the proposed North African System and, with the close co-operation of manufacturers, make available commercial very-high-frequency frequency-modulation police-type radio equipment.

After a number of weeks of preparation in the North African Theater of Operations, during which techniques for the application of two-tone teletype to the radio equipment were developed and tests conducted to verify the suitability of the equipment for the task at hand, a simplex single-channel radio-teletype system was placed in operation on April 20, 1943, extending from a semi-fixed 250-watt terminal station in Algiers, through three successive 250-watt radio-relay stations into Tunisia. (See Fig. 11.) A mobile 50-watt terminal station was attached to the American Combat Headquarters consisting of the Second Corps, reinforced, to complete the circuit from Algiers and provide the only direct communication with this headquarters throughout the ensuing phase of the Tunisian Campaign. This circuit carried the bulk of all operational and administrative traffic to and from Second Corps. The terminal moved with the Corps Headquarters from Beja to Sidi Nsir and thence to Mateur, providing communication immediately upon establishment of each position. A fourth relay station was held in readiness during this advance until the famous assault upon Hill 609 permitted its installation upon an adjacent promontory, whereupon it was placed in operation to provide an additional relay section to the mobile terminal as the latter proceeded beyond range of the third relay station. The resulting over-all system length was 379 miles. This operation represented the first employment of radio-relay systems and of radio teletype in tactical operations by Allied Military Forces.

As the campaign progressed, two additional mobile terminal stations were placed in service, moving with their respective headquarters to Bizerte and vicinities

about Tunis. The three terminal stations operated alternately with the Algiers terminal and with each other through the relay station near Hill 609. The traffic load reached a maximum of 16,000 word groups per day, 12,000 groups being handled with Algiers, and 4,000 groups between the forward terminals. Pending the establishment of wire lines, a task greatly magnified by the rapidity of movement of the terminal headquarters and by the incidence of enemy action, these radio circuits provided vital communication facilities at critical moments during, and immediately after, the campaign remaining in operation until the middle of August, 1943. The total system length during this period reached a maximum of 418 miles over rugged terrain, representative samples of which are indicated.

Fig. 12 shows the transmitter site of one of the relay stations. The radio receivers were located a few hundred yards to the right. A mobile power unit also was located approximately 100 feet from this site serving both receiving and transmitting equipment.



Fig. 12—Transmitter site of radio-relay station in North Africa.

In the installation of this system, some map studies and preliminary reconnaissance of locations were made to predetermine the relay-station sites.

From the opening of the Sicilian Campaign on July 7, 1943, until August 9, 1943 a duplex radio circuit shown in Fig. 13 was operated between Sidi-bou-Said, near Tunis, and Malta, with relay stations on Cape Bon and Pantelleria, a total distance of 243 miles, all over water. Facilities were made available for the manual relay of traffic from this system to the simplex Algiers-Tunis radio system and also to a wire-teletype circuit over a parallel route which, by this time, had been placed in operation. Although operating teams had been dispatched to Malta and Pantelleria considerably prior to the date of the invasion of Sicily, the necessity for observing radio silence precluded preliminary testing of the circuit other than continuous listening at these points. Consequently, there was no certainty that the circuit would be operable. However, when operations began, signal levels were consistently above marginal limits despite the relatively great distance, 148 miles,

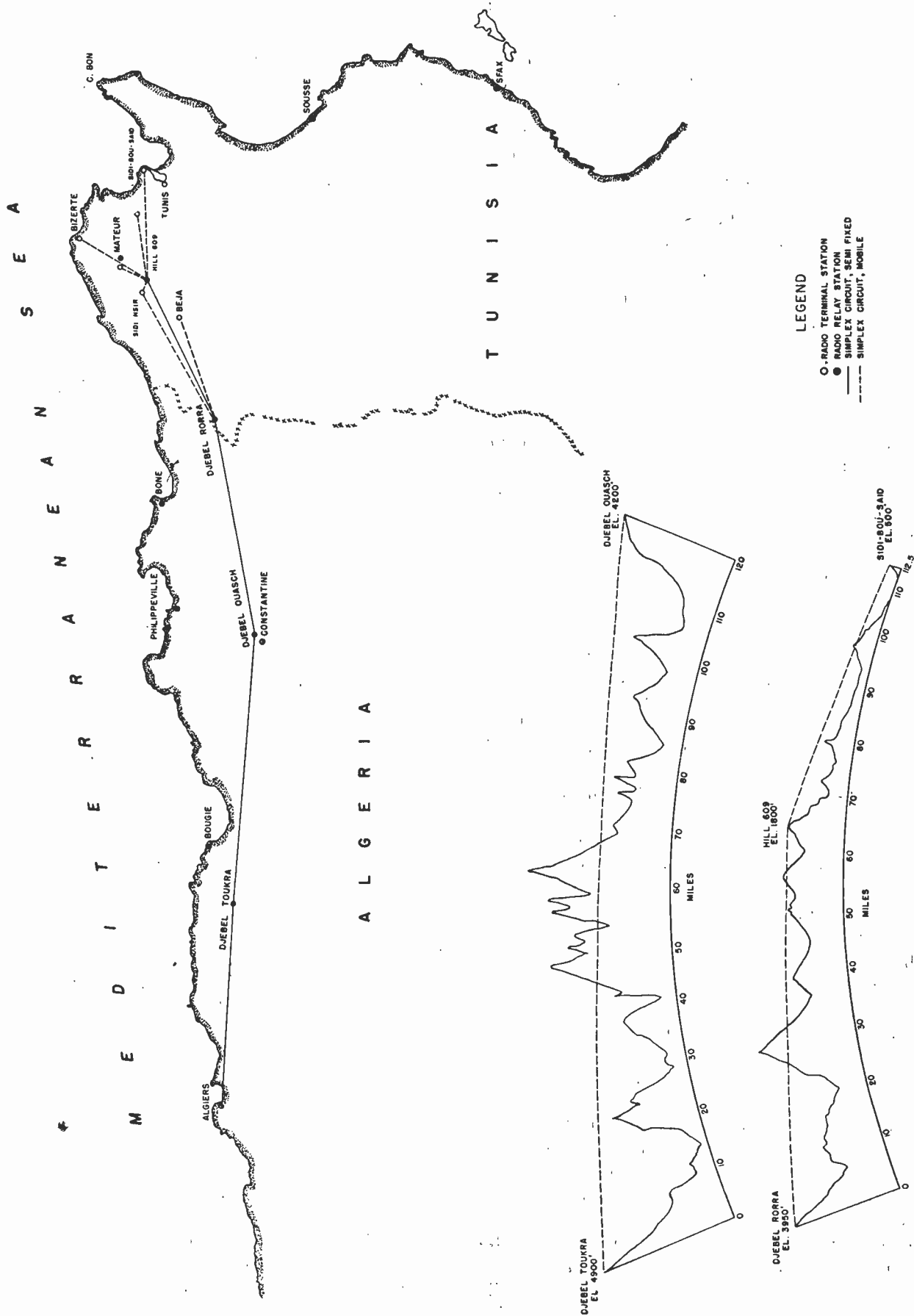

Fig. 11—Single-channel very-high-frequency radio-relay circuits used during Tunisian campaign (April to August, 1943).

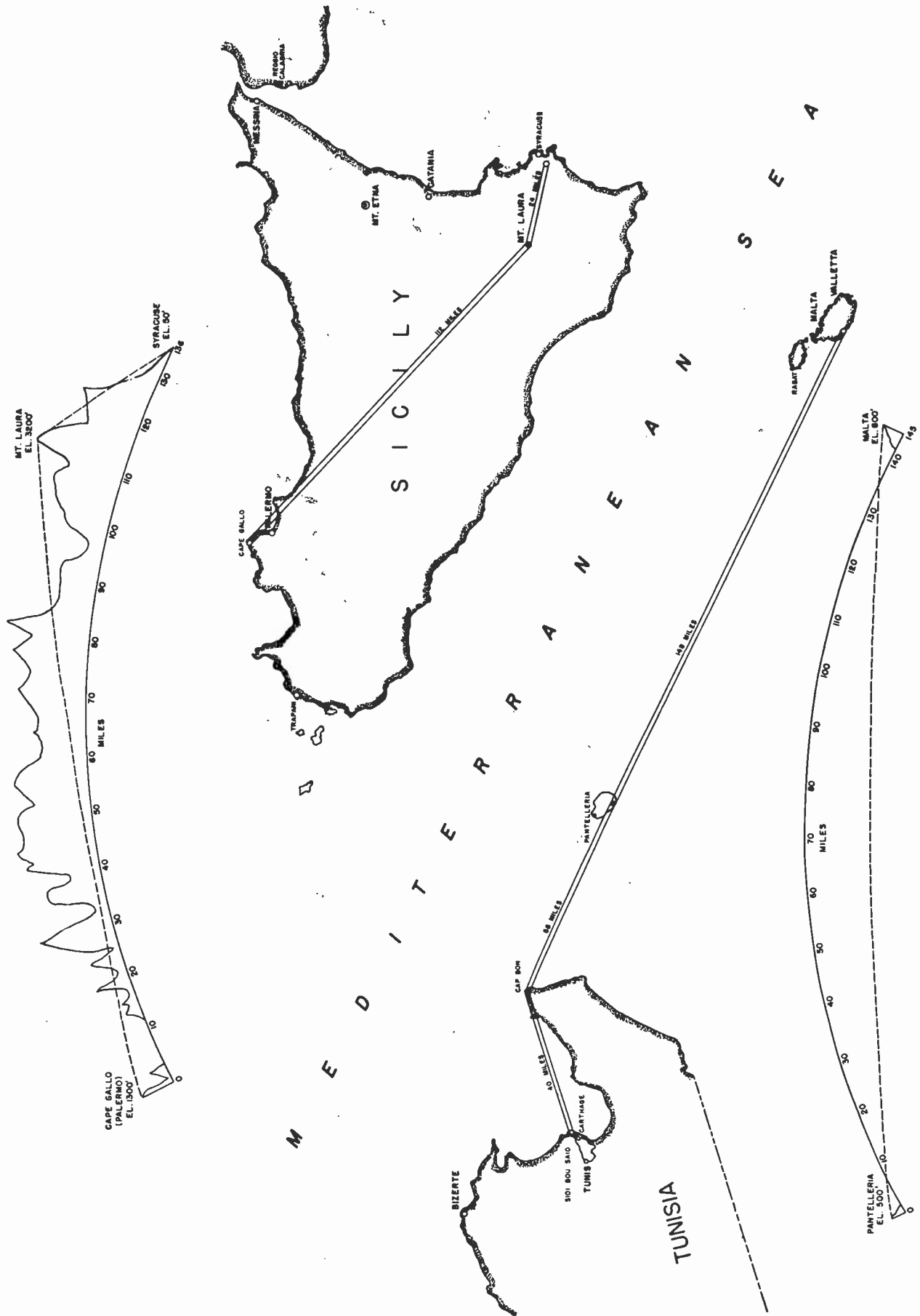

Fig. 13—Single-channel very-high-frequency radio-relay circuits used during Sicilian campaign (July to September, 1943).

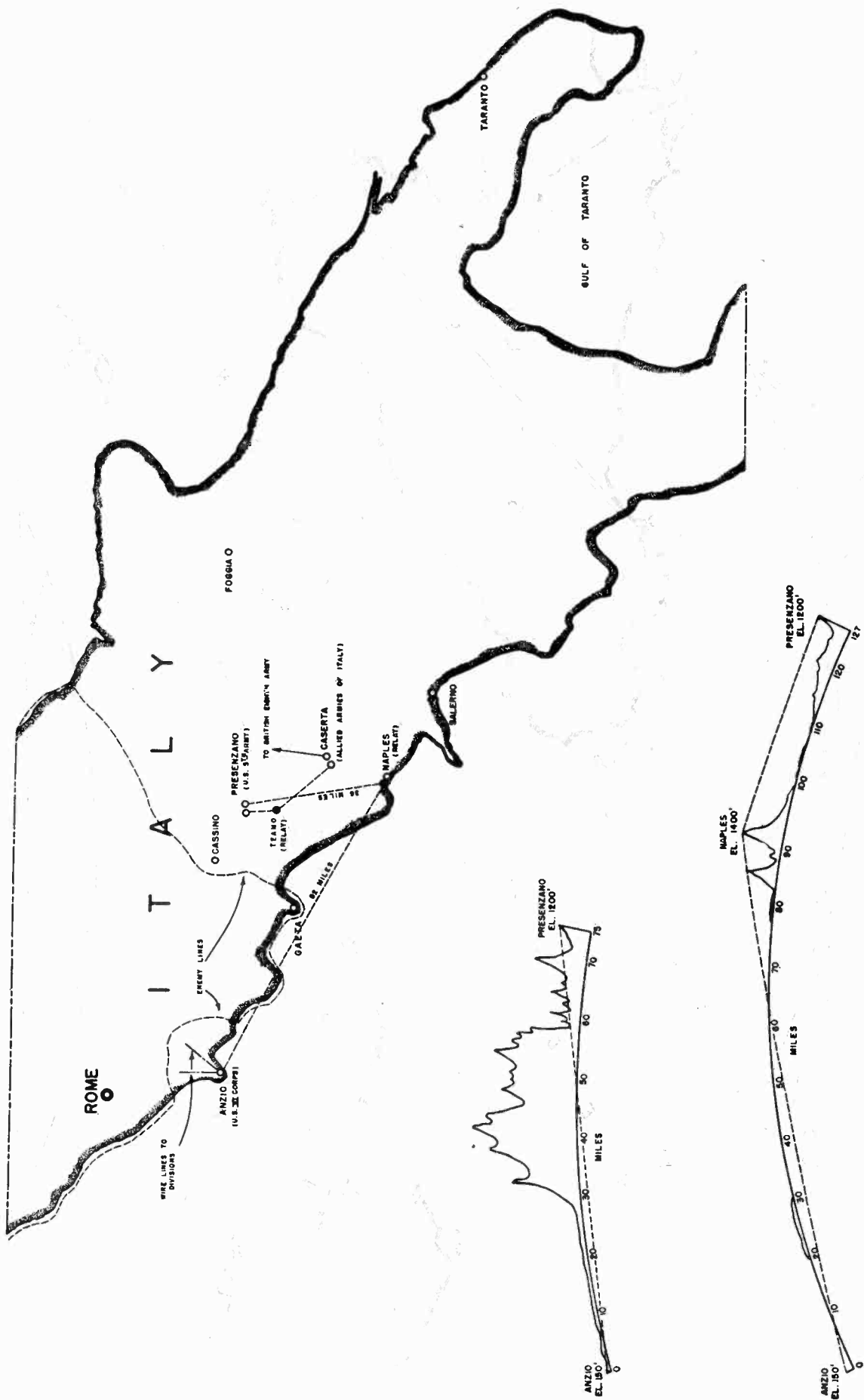

Fig. 14—Single-channel very-high-frequency radio-relay circuits used in Anzio sector during Italian campaign (February, 1944).

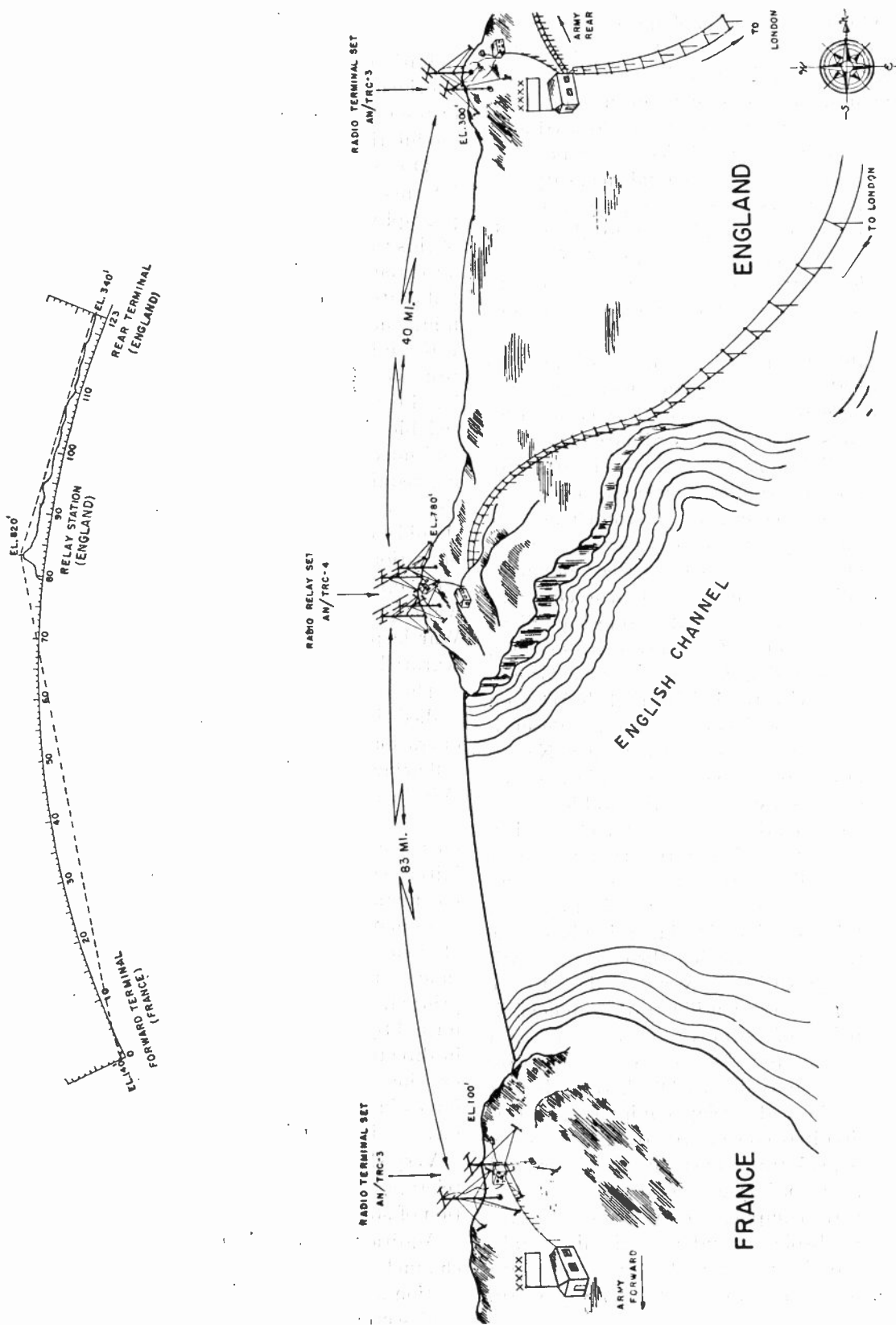

Fig. 15—Perspective view of first United States Army multichannel very-high-frequency radio-relay communication system across English Channel (June, 1944)

between Pantelleria and Malta and the below line-of-sight locations of these stations as indicated in the profile.

Subsequently, a duplex system, also shown in Fig. 13, was operated on Sicily for a period of approximately one month, linking Headquarters of the American Seventh Army at Palermo with Fifteenth Army Group, near Syracuse, commanding the American Seventh and British Eighth Armies. One relay station was located atop Mt. Laura. There was little or no choice of sites possible, the locations being dictated by tactical necessity. Although the profile indicates a relatively poor transmission path between Mt. Laura and Palermo, the circuit operated satisfactorily and provided valuable facilities because of the prior destruction by the enemy of trunk-line wire circuits over appreciable distance throughout the island.

During the Italian Campaign, a variety of missions was executed with this radio-relay equipment operating in simplex circuits, generally between Fifteenth Army Group Headquarters and the subordinate American Fifth and British Eighth Armies. These circuits provided highly important communication facilities between the headquarters concerned, inasmuch as wire lines were subject to frequent outages by enemy action. One illustration of the very important need of radio-relay facilities is illustrated in Fig. 14, wherein communication was maintained from the American Sixth Corps at Anzio beachhead to Fifth Army at Presenzano, thence to the Commanding Fifteenth Army Group, which also was linked with the British Eighth Army on the Adriatic side of the peninsula. As the profile indicates, the location of the relay station near Naples routed the radio circuit over favorable terrain between Anzio and Presenzano to avoid the unfavorable terrain in the direct path between these two points. The facility thus provided bridged enemy-held territory in a manner impossible of accomplishment with wire lines, and furnished the primary means of communication with Anzio for this vital operation. During this phase, the radio-teletype service was extended through the Sixth Corps teletype switchboard and over wire lines to the combat divisions. This operation illustrates the flexibility and important use of radio-relay equipment as a primary means of communication when equivalent wire circuits cannot be made available. Of all the missions accomplished with the radio-relay equipment to this time, the Anzio circuit is considered to have been the most valuable. The peak traffic over this circuit reached a maximum of 20,000 word groups per day.

Subsequently, as the campaign progressed northward, these circuits were displaced and new circuits established, extending to the island of Corsica, the south coast of France, and thence northward in the drive toward Germany.

The preceding examples are indicative of the tasks which tactical communication equipment may be called upon to accomplish in comparison with the missions of

carefully engineered and permanently located fixed equipment.

IV. EMPLOYMENT IN NORMANDY INVASION AND BATTLE OF FRANCE

Early in 1944, plans for the invasion of the European continent across the English Channel included the use of the newly developed very-high-frequency frequency-modulation multichannel AN/TRC-1 equipment. Prior to D day, the Signal Corps in Great Britain forwarded information to the War Department concerning the topography of the proposed cross-channel route. A replica of this route was selected along the coast of Maine, and an extensive series of tests performed by Coles Signal Laboratory with models of the new equipment to determine and solve any technical problems of propagation which might be involved in the coming operation. These tests verified the propriety of the choice of frequency band for operation over moderately long distances with reliable signal strengths permitting teletype operation and maximum signal-to-noise ratio consistent with siting requirements which in many cases would preclude the use of true line-of-sight transmission paths. It should be noted that these tests, as well as subsequent operations over water, covered distances considered most optimistic by engineering experts. Accordingly, a wide application of the equipment was foreseen by the War Department in establishing extensive plans for integrated multichannel wire-and-radio circuits.

The dawn of D day, June 6, 1944, saw facilities installed in England and ready for the cross-channel operation, and equipment on its way to Normandy following closely behind the first wave of the invasion. Within two hours after arrival of the terminal station (at a site on the beachhead) in France, June 8, 1944, the cross-channel circuit (Fig. 15) began operation. The initial service provided was the transmission of vital air-reconnaissance information from a tactical air-command headquarters to the invasion forces. Aerial photographs of enemy positions which had been made by reconnaissance aircraft, flown back to England, developed, printed, and marked for military objectives, were transmitted by facsimile back to the invasion forces and used in directing appropriate offensive action. This was the first instance of facsimile transmission to United States forces in France. A reproduction of a typical facsimile message is shown in Fig. 16.

Very shortly thereafter, multichannel-telephone-and-teletype facilities were made available by the installation of standard army carrier terminal equipments.

Additional terminal equipment was bridged across the channel-coast relay station to permit operation of this station as a radio terminal in event of failure of the inland section or of the necessity to route traffic to other points in England served by existing British wire lines from the relay site. Illustrative of the flexibility of the communication circuits was the integration with British

wire-terminal equipment. Thus the cross-channel facilities could be extended to points throughout Great Britain in addition to the original air base, and did provide telephone talking circuits from General Eisenhower and his associates at Central Headquarters in England to the field commanders of First United States Army on the continent, as well as teletype service between the respective command echelons.

The site of the channel-coast relay station is shown in Fig. 17. Although the vertical rhombic antennas depicted therein were provided as insurance against weak signals across the channel, the three-element horizontal arrays proved to be entirely satisfactory with the normal mast height of 40 feet. In the opposite direction, toward the inland terminal, the three-element arrays also were used, but with reduced height to improve security. In this photograph, the antenna wires are re-touched for clarity.

As the details of the initial use of radio-relay equipment became known, urgent requirements were presented by other combat organizations and services of the Armed Forces. The First United States Army, in accomplishing the initial invasion on the Normandy coast, achieved considerable distinction in this employment by controlling this circuit and having obtained and oper-

through at St. Lô, this Army relied upon these radio circuits for communication back to its commanding Twelfth Army Group, and forward to its respective Corps, and in several instances to its Divisions. Initially, these circuits comprised single sections between the respective terminal headquarters. Then, as these elements moved forward, extending their lines of communication, radio-relay sets were interposed to extend the lengths of

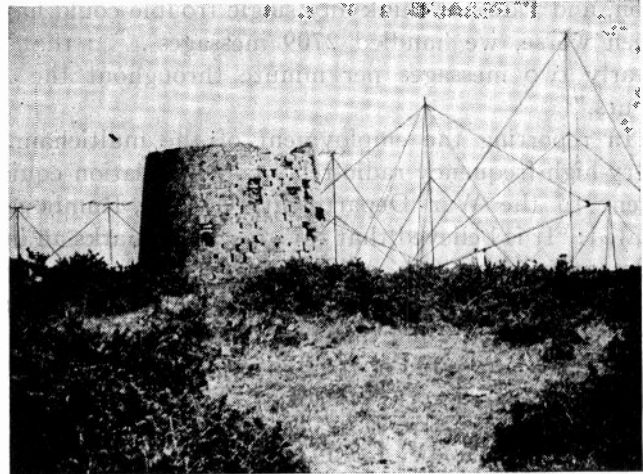

Fig. 17—Operating site of first radio-relay set AN/TRC-4 used in United States Army very-high-frequency radio-relay circuit across English Channel.

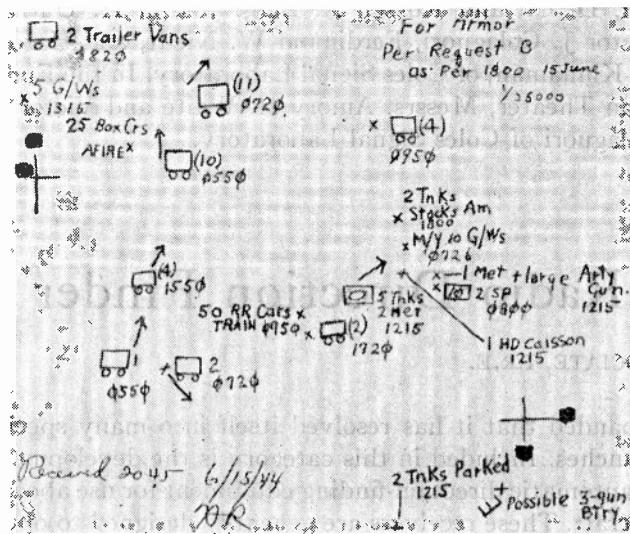

Fig. 16—Teledeltos recording of map overlay sent to American Expeditionary Forces.

ated additional equipment to extend facilities on the continent from Army Headquarters to Corps, and Corps to Divisions, and between Corps within the Army. Following these outstanding uses, other armies were quick to follow suit as they became operational by equipping their units similarly. Air Force base establishments also availed themselves of the opportunities to provide early multichannel-radio circuits pending establishment of equivalent wire facilities.

A typical employment of the radio-relay equipment by the Third United States Army occurred during General Patton's dash across France. After the break

the systems. Later, as wire circuits followed through, relay stations became terminals by direct connection to the wire circuits and the rear radio installations then were either removed from service or continued in operation as emergency facilities in the event of failure or overload of the wire facilities.

As the Armed Forces progressed across France to the Siegfried Line, additional radio-relay facilities were established for both tactical requirements in the forward areas and administrative purposes in the communications zone to the rear. Additional cross-channel radio-relay systems were installed from Paris to London, other types of radio circuits activated, existing wire lines throughout the occupied area rehabilitated, new wire lines installed, and the whole integrated into a comprehensive telephone, teletype, and telegraph network covering an area in Europe equivalent in size to that from New York to Chicago and from Detroit to Atlanta.

Many examples occurred during this campaign to demonstrate the outstanding value of multichannel radio-relay communication facilities to military operations both as a primary means to cross territory held by the enemy in situations similar to that at Anzio beachhead, or rendered impassable by enemy action or terrain characteristics, and as a supplementary facility to wire and other radio circuits. River crossings were established under enemy fire which imposed prohibitive losses in men and material during attempted installations of wire circuits. Emergency facilities were provided, when the main French underground-cable system failed as a result

of combat operations, whereby the Continental Headquarters was furnished direct telephone and teletype communication to England and thence to the United States by interconnection with transatlantic communication facilities. The importance of this emergency operation is illustrated by the quotation of Major-General W. Rumbough, Chief Signal Officer, European Theater of Operations, in a Commanding Generals' conference: "In spite of this very serious cable interruption, and I do not think any single trouble could have been worse, we handled 2709 messages . . . ; that is nearly two messages per minute throughout the 24 hours."

In reporting the employment of the multichannel very-high-frequency radio-relay communication equipment to the War Department, General Rumbough stated: "It is believed that this operation marks an important milestone in military radio communication. Tactical field-radio equipment has been successfully integrated with wire-line and terminal equipment to form a system comparable in reliability and traffic capacity to all-wire systems."

V. CONCLUSIONS

The favorable reception and praise given to very-high-frequency radio-relay systems is due principally to the inherent advantages from a military point of view of such systems. These are briefly summarized in Fig. 3. Since logistics are of prime importance in military operations, the large saving in shipping space and tonnage as well as installation and maintenance personnel by the use of very-high-frequency radio relay is a major con-

tribution in relieving the strain on transportation facilities and the Signal officers' resources.

The successful employment of this system in the Army under difficult conditions indicates greatly increased commercial use of such systems where full advantage may be taken of the unlimited design possibilities opened up by new techniques for such services as point-to-point relaying and multiple use of single radio-frequency channels and facilities.

VI. ACKNOWLEDGMENT

The authors wish to express sincere thanks and appreciation to all their associates of the War Department, Signal Corps Ground Signal Agency, and Industry, through whose close co-operation and tireless efforts the development and production of the frequency-modulation radio-relay equipment was made possible and who contributed valuable information for the preparation of this paper. Particular credit is extended to Mr. Walter E. Bonham, of Coles Signal Laboratory, for his persevering efforts, and to the following civilian employees of the Signal Corps for outstanding duty in combat zones in placing equipment in operation and instructing troops in its use:

In the North African Theater, Messrs. John J. Kelleher, Office of the Chief Signal Officer, Washington, D. C.; and Russell A. Berg, Joseph H. Durrer, Victor J. Colaguori, Ferdinand W. Niedt, and Harold H. Kinnaman, of Coles Signal Laboratory. In the European Theater, Messrs. Amory H. Waite and Victor J. Colaguori of Coles Signal Laboratory.

A New Type of Automatic Radio Direction Finder*

C. C. PINE†, ASSOCIATE, I.R.E.

Summary—A system of automatic radio direction finding is described that operates on the principle of effectively converting the radio-frequency currents developed in two low-impedance loops into direct currents of proportional amplitude and having the same relative polarity as the instantaneous values of the radio-frequency currents developed. By utilizing the two fixed loops in space quadrature, direct currents are obtained which can be applied to an indicating meter or cathode-ray tube in such a manner as to give a continuous visual indication of the angle, in the horizontal plane, at which an incident wave is striking the loop assembly.

INTRODUCTION

THE USE of radio-wave transmission and reception for direction-finding purposes is well known and has been developed into a highly specialized field.¹ However, in recent years this field has been so

expanded that it has resolved itself into many special branches. Included in this category is the development of automatic direction-finding equipment for use aboard aircraft. These receivers are generally designed to operate on frequencies from 200 to 1800 kilocycles, and make use of the normally polarized ground wave radiated from transmitters operating in this band. This paper is devoted to describing an automatic direction-finding system developed primarily for such use.

There are many requirements that must be met if a system of automatic direction finding is to be accepted by the aircraft industry. Among these requirements are reliability, simplicity, and light weight. All of these factors have been considered in the system here described.

THEORY

Let us consider for a moment a crossed-loop assembly connected to a radio goniometer, as in Fig. 1. As an incident wave strikes the loop assembly at angle θ (Fig.

* Decimal classification: R325.31. Original manuscript received by the Institute, July 24, 1944; revised manuscript received, February 28, 1945.

† 166 Bryant Ave., Floral Park, L. I., N. Y.

¹ C. T. Solt, "The development and application of marine radio direction finding by the United States Coast Guard," *Proc. I.R.E.*, vol. 20, pp. 228-260; February, 1932.

2a), with reference to loop *A*, currents will be induced in each loop as may be calculated by the following trigonometric equation.²

$$I_{Ia} = I_{Ia}^{\max} \cos \theta \quad (1)$$

$$I_{Ib} = I_{Ib}^{\max} \sin \theta \quad (2)$$

where *Ia* indicates loop *A*

Ib indicates loop *B*

θ is the angle loop *A* makes with the incident wave in the horizontal plane.

Obviously, the currents in the crossed windings of the goniometer (Fig. 1) will have a direct relationship to those of the loops, and the resultant magnetic field will have the same space relationship with reference to winding *A* as the incident wave has to loop *A*. This may be shown as follows:

$$\tan \phi = I_b/I_a = (I_{Ib}^{\max} \sin \theta)/(I_{Ia}^{\max} \cos \theta) = \tan \theta \quad (3)$$

where $I_{Ia}^{\max} = I_{Ib}^{\max}$ due to identical electrical characteristics of loop *A* and loop *B*

I_a = current in winding *A*

I_b = current in winding *B*

ϕ = angle of resultant magnetic field set up in windings of goniometer.

If a search coil is introduced into the center of this resultant field, the coil can be rotated so as to pick up the maximum or minimum values of the field. By connecting the search coil to a properly constructed receiver, an aural indication of the maximums and minimums can be heard in the receiver output. To measure the angle ϕ , a pointer is attached to the search coil, and the position of the coil is noted on a 360-degree scale as it is rotated to one of the null positions. Of course, this system of aural direction finding is bidirectional, due to the fact that two maxima and two nulls will be heard as the search coil is rotated through 360 degrees.

For a purely imaginative illustration, let us assume that the currents applied to the windings *A* and *B* of the goniometer are direct currents, the values of which follow the same expressions as were derived for the radio-frequency currents. Now, by replacing the search coil with a magnetic armature such as a very small compass needle, it readily can be seen that the armature will align itself with the major axis of the magnetic field and therefore indicate the angle ϕ . Further, as the wind-

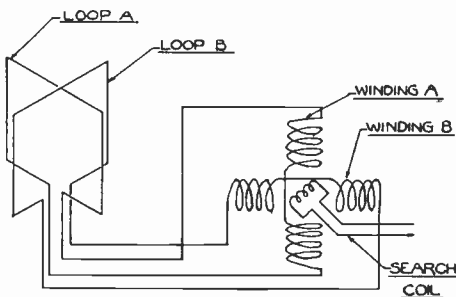

Fig. 1—Simplified circuit of crossed loops connected to a goniometer.

² R. Keen, "Wireless Direction Finding," Iliffe and Sons, London, England, 1938, chapter 15.

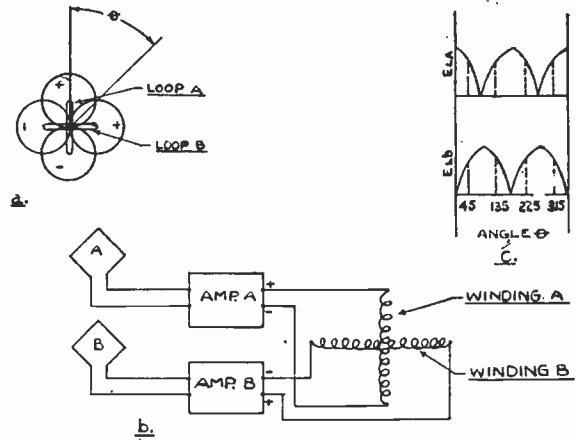

Fig. 2—Quadridirectional indication with a crossed-winding indicator.

ing currents are slowly changed relative to each other, in the same manner as the loop currents would be changed as a wave source is moved around the loop assembly, the armature will continue to indicate the angle because it has the ability to recognize the polarity as well as the angle of the flux field. Thus, we would have an indicating device which would give a continuous reading of the angle at which a wave is striking the crossed-loop assembly.

Many problems present themselves when attempting to put the above theory into practical use. Not only must the method of development be met, but in order to make this system practical for aircraft usage, the requirements set forth previously in the introduction must be given every consideration.

INDICATOR DEVELOPMENT

Simplicity demands that the loop assembly be composed of two small aperiodic loops, and that these loops be placed in a fixed position, that is, nonrotatable. Fig. 2a shows the pattern of the voltages developed in the crossed loops as a source of propagation is moved around them through 360 degrees. Now, if each of these loops is connected to a separate radio-frequency amplifier, as in Fig. 2b, the radio-frequency voltage output of each can be written

$$E_{Ia}' = \mu(E_{Ia}^{\max} \cos \theta) \quad (4)$$

$$E_{Ib}' = \mu(E_{Ib}^{\max} \sin \theta) \quad (5)$$

where μ is the total amplification factor of each radio-frequency unit. It is to be understood that the characteristics of each amplifier are identical.

When these voltages are rectified, the resulting direct-current output voltages, E_{LA} and E_{LB} , for different values of θ may be represented as shown in Fig. 2c. When these direct-current voltages are applied to the respective windings of a crossed-winding indicator, in the center of which is placed a small polarized magnetic armature, the armature will be acted upon in such a manner as to give a quadridirectional indication of the angle θ . This may be illustrated as follows. Let the angle θ of the incident wave be some such value as 45

degrees with reference to the plane of loop *A*. From Fig. 2c we may obtain values which, when substituted in (3), will show that the angle ϕ is equal to 45 degrees. Now, should the source of the radio wave be moved around the loop assembly so that it is being received from an angle of 135 degrees, it will be evident that the currents flowing in the windings *A* and *B* will be of the same amplitude and polarity as those flowing at 45 degrees. (See Fig. 2c.) Therefore, the angle ϕ will again be 45 degrees. This will also hold true for reception from 225 and 315 degrees. Thus by calculation it may be shown that the armature of the indicator will traverse the angles from 0 to 90 degrees and back twice, as a complete rotation of the radio-wave source is made around the loop assembly.

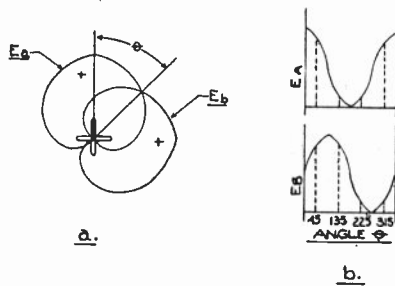

Fig. 3—*a.* Cardioid pattern obtained when a sense antenna voltage is combined with the loop voltages.
b. Rectified output of amplifiers with cardioid-pattern input.

The above condition of quadrirectional indication can be traced to the fact that the radio-frequency expressions, as set forth previously, are not valid for all angles of θ when applied to the above specific case, but are interrupted abruptly as the sine and cosine values become negative. This is, of course, due to the characteristics of rectification.

As can be seen readily from the foregoing, the indications obtained are of no value as far as automatic direction finding is concerned. The indication obtained from the crossed-winding type of meter can, however, be made unidirectional by the addition of suitable components to the system.

If a nondirectional radio-wave pickup, such as that obtained from a "whip" or "T" antenna commonly used on aircraft, is combined in proper phase with the patterns of Fig. 2a for the crossed loops, the following results are obtained.³

$$E_a = E_{I_a}^{\max} \cos \theta + E_s \quad (6)$$

$$\text{and } E_b = E_{I_b}^{\max} \sin \theta + E_s \quad (7)$$

where E_a is the effective value of the loop voltage plus the sense voltage.

In the case where $E_{I_a}^{\max} = E_{I_b}^{\max} = E_s$, the resulting pattern can be shown as in Fig. 3a. Now, if these voltages are applied to separate amplifiers, the rectified output voltages for various values of θ may be shown as in Fig. 3b. It is interesting to note that, by adding a sense

voltage to each of the loop voltages, we have succeeded in amplifying and rectifying the loop-voltage components without change. That is, the rectification process does not affect the polarity of the loop voltages as long as the results of (6) and (7) are positive values.

We may now write the following equation of proportionality

$$E_A/E_B = E_a/E_b(E_{I_a}^{\max} \cos \theta + E_s)/(E_{I_b}^{\max} \sin \theta + E_s) \quad (8)$$

where E_A and E_B are the rectified direct voltages. If the rectified voltages are considered to be made up of two components, as follows:

$$E_A = E_{LA}^{\max} \cos \theta + E_s \quad (9)$$

$$\text{and } E_B = E_{LB}^{\max} \sin \theta + E_s \quad (10)$$

where E_s = the direct-current component resulting from the sense voltage

$E_{LA}^{\max} \cos \theta$ = the direct-current component resulting from the loop *A* voltage

$E_{LB}^{\max} \sin \theta$ = the direct-current component resulting from loop *B*.

Then, the value of E_s might be subtracted from E_A and E_B to allow the following expression to be written.

$$\frac{E_{LA}}{E_{LB}} = \frac{E_{LA}^{\max} \cos \theta}{E_{LB}^{\max} \sin \theta} = \frac{E_{I_a}^{\max} \cos \theta}{E_{I_b}^{\max} \sin \theta} = \frac{E_{I_a}}{E_{I_b}} \quad (11)$$

This gives us direct voltages which are proportional to the original loop voltages in amplitude and have the same relative polarities as the loop voltages for all values of θ .

The above results can be accomplished in practice in the following manner. First, an additional amplified sense voltage must be made available; and second, two additional windings must be incorporated in the indication device. Fig. 4 gives an illustration of the basic system. Windings *C* and *D* of Fig. 4 are wound with unity

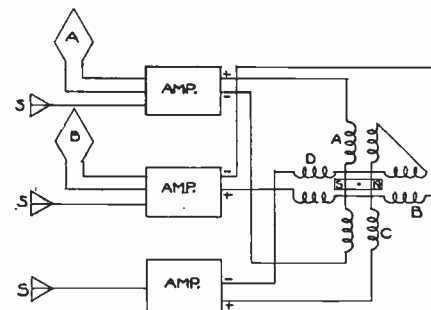

Fig. 4—Basic circuit for unidirectional indication with crossed-winding meter.

coupling to windings *A* and *B* respectively, and the voltage E_s is so applied as to cause the flux set up by these windings to oppose the flux set up by windings *A* and *B*. Now, if the angle ϕ is calculated, it is found to be equal to the angle θ . The magnetic armature is acted upon in such a manner as to seek an angle relative to the angle at which the incident wave is striking the loop assembly, and thus we have a visual indication of the bearing which will be unidirectional.

Three important factors must be kept in mind if the above results are to be achieved satisfactorily in

³ Donald S. Bond, "Radio Direction Finders," McGraw-Hill Book Company, New York, N. Y., 1944, Chapter 5.

practice. The sense voltage must always be equal to, or greater than the maximum loop voltage, the gain of the three amplifiers must be equal, and the design must be such as to obtain linear-gain characteristics throughout the required operating range.

RECEIVER DEVELOPMENT

The method of developing an appropriate indicator has been analyzed, but the problem of obtaining overall simplicity is far from being overcome. The system as described up to this point demands the use of three separate amplifier systems.

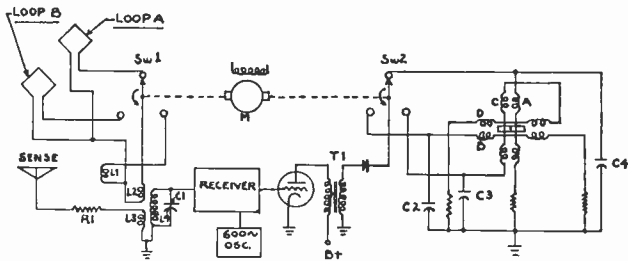

Fig. 5—Simplified circuit of automatic radio direction-finding system.

To simplify the system further, a single receiver must be made to do the work of the three described previously, and must do it with a minimum of auxiliary components. Another point not to be overlooked is the avoidance of circuits that require critical balancing in order to achieve satisfactory results. It is obvious that the three input voltages cannot be applied to the input of a single receiver simultaneously to obtain output voltages which would be of any value as far as this system is concerned. The possibility of applying the voltages successively to the input of the receiver by means of a pulsing method was investigated and found to be satisfactory.

Two receivers have been built, one using an electronic pulsing system and one using a mechanical pulsing system. In the interest of conserving space, and also because of the simplicity of the illustration, the mechanically switched receiver will be described.

Fig. 5 gives a simplified diagram of the circuit, and the following is a brief description of its operation. For illustration, let us assume the signal to be striking the forward edge of the loop A and let this be the reference point, or zero angle. The sense antenna is connected to L3 through R1 at all times. R1 is in the circuit to give the proper phase relationship between the sense and loop voltage. Motor M is connected to Sw1 and Sw2 so as to rotate their poles at a speed of approximately six revolutions per second. The desired signal is tuned in by means of L4 and C1 and the motor is turned on. Now, for the first 120 degrees of rotation of Sw1, loop A is connected to L2 and will apply a voltage in combination with the sense voltage to the receiver input which may be shown as E_a in Fig. 6 for θ equals zero degrees. As Sw1 is rotated through the second 120 degrees, loop B is connected to L2; there-

fore, a pulse is introduced into the receiver consisting of this voltage in combination with the sense voltage. For the case where θ equals zero, the loop B voltage is zero, and therefore only the sense voltage is applied to the input. This is shown in Fig. 6, for θ equals zero, as E_b . For the third 120 degrees of rotation of Sw1, the dummy-loop coil L1 is connected to L2. This is merely to keep the input properly loaded when the loops are switched out of the circuit. This last pulse consists of sense voltage only, and is shown in Fig. 6 as E_s . As stated previously, the cycle is repeated approximately six times per second.

The sequence of input voltages is amplified by the radio-frequency amplifier and converted to an intermediate frequency as in a conventional receiver. As the voltages pass through the intermediate-frequency stages, a 600-cycle component is added. This is done to insure a modulated output at the detector for all incoming signals. This modulation is necessary in this particular receiver, and will be discussed later.

The amplified and modulated signal voltages are then rectified and applied to the grid of a zero-biased amplifier, the output of which is fed through transformer T to the indicator rectifier. Here the output voltages are rectified and the resulting direct voltages are introduced into the rotor of Sw2. Sw2 is synchronized with Sw1 so that indicator winding A is connected to the output as loop A is connected to the input, and winding B is

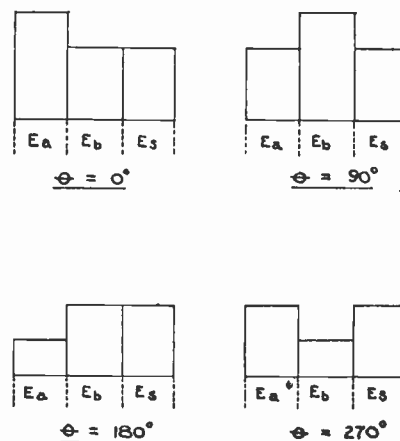

Fig. 6—Pulse input to receiver in the special case where $E_s/E_{1a} = E_s/E_{1b} = 2$.

connected to the output as loop B is connected to the input. Windings C and D are connected to the output when the sense voltage only is applied to the input. It should be noted that windings C and D are so connected that their currents flow in opposition to the currents flowing through windings A and B.

The respective windings of the indicator each receive one pulse of rectified voltage per revolution of Sw2. Therefore, we have a pulsating direct current flowing through each winding that is a function of the switching frequency. In order to convert this pulsating current into a steady direct current, the windings are shunted

by the large filter capacitors $C2$, $C3$, and $C4$ (Fig. 5).

For the value of θ equals zero degrees, the fields set up by windings B and D cancel, and the fields of windings A and C are such as to cancel the portion contributed by the sense voltage, leaving only the field set up by the excess of current in winding A , due to the voltage of loop A , to act upon the armature. We will now call this the zero position of the armature. If the signal is striking the loop A on the rear edge where θ equals 180 degrees, the input pulses may be shown as in Fig. 6, for θ equals 180 degrees. By following the same line of thought as previously used, we find that once again the fields set up by windings B and D cancel, and that the resulting field set up by windings A and C is from the difference of the values of currents due to E_A and E_S . This leaves a field of the same amplitude as

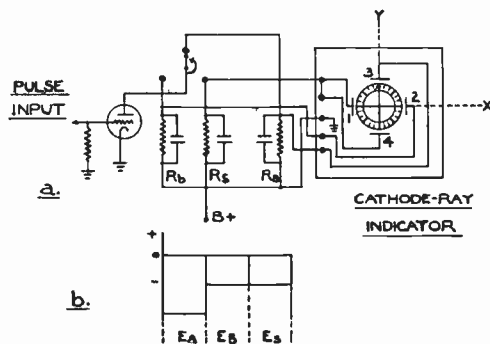

Fig. 7—Circuit arrangement of cathode-ray-tube indicator.

before, but of opposite polarity. This again agrees in direction with the voltage developed by loop A , and the armature will be displaced by an angle ϕ equal to θ . Examination of the resulting indicator fields for any angle of reception will show that the armature will indicate the true value of θ within the limits of the linearity of the component parts which make up the system.

One of the requirements stated in the introduction was that of reliability of operation of the system. Therefore, some visual indication should be present that would assure the operator that the system is functioning normally when a signal is being received. Of course, this could be done by continual aural monitoring, but in practice this is not the most convenient method. In this system a visual indication of proper operation is included. Referring to Fig. 5, the input and output switching is carried on at a frequency that will cause a slight fluctuation in the resultant field set up by the currents flowing in the indicator windings. When a signal is tuned in, the intermediate-frequency component is modulated, and the resulting modulated pulses are passed through the output transformer to the indicator, which will seek the proper position and then continue to hunt or vibrate around this point. If the station to which the system is tuned should suddenly go off the air, no power would be supplied to the indicator, and the armature would immediately cease to hunt. Also, if the receiver should fail, the same nonoperating indication

would be present, and a check could be made to determine the source of trouble.

Tests have been made on the completed receiver whereby the indicator windings were inserted directly in the plate circuit of an indicating tube, and the voltages developed by the input pulses were applied to the grid of this tube as a negative bias. In this case it is obvious that the 600-cycle modulation is not necessary, as either modulated or unmodulated signals would develop the operating bias for the indicator tube. The results obtained were satisfactory, but the hunting characteristics of the indicator were present at all times, regardless of the signal input. This was explained by the fact that tube plate current was flowing through the meter windings at all times, even though no pulse voltage was present on the grid. If filter condensers were chosen so as to give a slight ripple, and the tube operated at cutoff with no signal applied, the indicator armature could probably be made to have a desired hunting characteristic.

ELECTRONIC INDICATOR

An electronic indicator such as the cathode-ray tube would have advantages in some special installations. The writer visualizes the possibility of using one cathode-ray tube as a combined indicator for several functions, such as automatic direction finding, blind landing, and possibly an horizon indicator. With this in mind, experiments were carried out with a view towards developing such an indicator for the system herein described. Fig. 7 shows a possible circuit and an explanation of its operation follows.

As the train of voltage pulses, shown in Fig. 7b, is impressed on the grid of the indicator tube, a similar variation will be observed in the output voltage of this tube. Now, so that these pulses may be separated, the output section of the rotary switch is synchronized to connect each of the load resistors to the plate of the tube at the instant the plate current changes from one value to another. This gives three values of plate voltage across the respective load resistors which are designated as E_A' , E_B' , and E_S' . The voltages are completely filtered by relatively large capacitors. The load resistor R_s is connected to plates 1 and 4 of the cathode-ray tube. R_a and R_b are connected to plates 2 and 3 respectively. This effectively applies the voltages E_A' and E_B' to the plates of the indicator tube with E_S' as zero reference.

The next step is to adjust the electron stream of the cathode-ray tube until a small dot appears on the screen. Now, when the voltages on plates 1 and 2 are equal, a condition existing when the incident wave is striking the forward edge of loop A , the dot will be held in the center of the X axis. But, as has been pointed out previously, the voltage picked up on the loop A is at a maximum at this instant and is polarized so as to add to the sense voltage. Thus, due to the circuit arrangement, a voltage is applied to plate 3 that is more

positive than the voltage applied to plate 4, and therefore the dot moves up on the Y axis as indicated in Fig. 7a. The voltage values may be computed for various angles of wave reception to show that the results are such as to cause the dot to seek an angle with reference to the Y axis, which is equal to the angle of reception with reference to loop A .

By the use of automatic volume control, the signal strength of the received wave can be adjusted so as to keep the dot well out on the edge of the screen. This allows a more accurate reading to be taken on the bearing. In the case of a manual volume control, the distance from the dot to the center of the tube will give an indication of the received signal strength. This might be used to give an additional check on the operation of the system in cases where a homing maneuver is being executed. In such a case, the dot would fall on the upper portion of the Y axis, and by observing whether it progressed toward the center, or away from the center of the ray tube, as the homing course was continued, an indication of the true direction of the station is present.

As in the case of the mechanical indicator, the electronic type also gives a visual monitoring of the operation of the system, including the assurance of the presence of signal input. Should the dot suddenly come to rest in the center of the screen or shift erratically, the operator would be warned of malfunction and an investigation could be made to determine the trouble.

CONCLUSION

There are many features of this system that would make it suited for light airplane installations. A mechanically pulsed receiver, together with a mechanical type indicator might be made very compactly, and would be extremely simple to operate. One unit that has been constructed consists of a six-tube receiver, and the complete system has a total weight of under 25 pounds. However, this is an experimental model and this weight should not be taken as a final minimum.

Another interesting feature of the system is evident when the full advantages of the crossed-loop assembly are considered. Aural direction finding may be realized with the use of a goniometer of the conventional type. It is also possible properly to phase the loop voltages so as to obtain a null or "homing" pattern, and then,

merely by reversing the polarity of one of the loops by a switch on the control panel, to obtain an antistatic "range" loop pattern. These latter type patterns are in much evidence on small aircraft, but in most cases are obtained by rotating manually a single loop to either its null or maximum pickup position. Some tests have been made and it seems entirely practical that the loop voltages can be phased so as to give nondirectional antistatic reception, which would be of great advantage to any type of aircraft radio installation.

It is feasible, by using the system herein described, to construct a dual automatic direction-finding installation with a minimum of component parts. For instance, if a six-point commutation were used, the same loop assembly and sense antenna might be used for both receivers, each of which would be tuned to a different frequency. The output thus obtained could be amplified through a common audio channel and then be separated for distribution to respective indicators for visual analysis. Or still another conservation of components might be realized by using a single cathode-ray tube as a dual indicator. This could be accomplished by switching the plates of the cathode-ray tube alternately from one to the other of two receivers. If the switching frequency is properly chosen, two dots will appear on the screen of the tube, each dot representing the bearing of the respective received signals.

It is realized that very precise engineering must be built into a system such as the one here described in order to obtain accuracy comparable to that of most systems now in use; however, by the use of a single receiver, to amplify the necessary voltages, an advantage is gained over other similar systems requiring three separate balanced receivers for proper operation. This is due to the fact that any minor voltage change or shifting of the tube characteristics will have an equal effect on all three input voltages, and will therefore have little effect on the accuracy of the system.

The material presented in this paper is based on laboratory experimentation and is, therefore, inadequate as far as definite predictions are concerned. However, the postwar period will surely demand a simple, light-weight, automatic direction finder, and a departure from the present-day design is inevitable if this demand is to be met.

Experimental Determination of Impedance Functions by the Use of an Electrolytic Tank*

W. W. HANSEN†, ASSOCIATE, I.R.E., AND O. C. LUNDSTROM†, STUDENT, I.R.E.

Summary—It is shown that impedance and gain functions can be determined by the use of an electrolytic tank. The method is amply accurate and is rapid and convenient when the locations of the poles and zeros of the function to be determined are known. Full details of the theory are given, a suitable experimental setup is described, and typical results are shown.

INTRODUCTION

THE FUNCTIONS giving the impedance of a network, the gain of an amplifier, etc., in terms of the frequency are often exceedingly complicated, making it a tedious process to produce plots of amplitude and phase by direct calculation from these functions.

The method to be described was devised to avoid this tedium by substituting for the slide-rule work a rather simple experiment using an electrolytic tank.

As will appear presently, the location of the electrodes in the tank depends on the positions of the various poles and zeros of the impedance or gain function in the complex frequency plane. The method is, therefore, convenient only when the pole and zero positions are easily found. This is the usual condition in amplifiers where the individual interstage-coupling networks are ordinarily quite simple, and the tubes cause the impedances of the networks to combine in a multiplicative manner. The saving in labor is especially great when there are a number of nonidentical stages. On the other hand there are cases in which the discovery of the pole and zero positions is difficult; in these cases, much of the effectiveness of the present method disappears.

In addition to possible savings in time, the procedure to be described has other important advantages; for it is based on an analogy between electrostatics and function theory, and thus the highly developed mechanism of potential theory becomes available for the solution of circuit problems. Similarly, the common and easily developed "feeling" for electrostatic problems may be applied to give useful qualitative results in circuit theory.

In what follows, then, we will give the needed theory and a brief description of some typical experimental results. The theory may be divided roughly into a general formulation of the problem, the introduction of suitable scale factors, the precise statement of the electrolytic-tank analogy, the methods of evaluating the various constants experimentally, and finally, methods of correcting for the finite size of practical tanks.

* Decimal classification: R240. Original manuscript received by the Institute, January 16, 1945.

† Sperry Gyroscope Company, Inc., Garden City, Long Island, N. Y.

THEORY

As is well known, impedance Z is a rational function of the radian¹ frequency ω . It is, therefore, an analytic function of the complex variable ω and it is often useful to consider complex values of ω , even though experimental results usually apply only to real values of ω . The above is also true of the gain function of an amplifier $G(\omega)$, and since the present method seems likely to be most useful in connection with amplifiers, the notation, etc., will be chosen to facilitate application to amplifiers. The slight modifications needed for other applications will be quite apparent.

To proceed, then, the gain of an amplifier can be written

$$G(\omega) = a(\Pi(\omega - \omega_z)/\Pi(\omega - \omega_p)) \quad (1)$$

where the continued product in the numerator is over l zeros ω_z , and that in denominator over m poles ω_p . We note that the zeros and poles occur in pairs with symmetry about the imaginary axis.

Also, there is a relation between $m-l$ and the number of stages, which we shall call n . Thus let us assume that the plate of any tube and the grid of the following tube are connected together; i.e., that we have two-terminal coupling. Then the coupling impedance consists of a capacitance in parallel with an arbitrary impedance, the least possible value of this capacitance, which we shall call C , being the sum of the plate and grid capacitances. Now as $\omega \rightarrow \infty$ the capacitive admittance will dominate, and therefore the gain must decrease as $1/\omega$ for one stage, or for the whole amplifier as $(1/\omega)^n$, and so $m-l=n$. If the grid and plate capacitances are separated (four-terminal coupling) then $(m-l) \geq 2n$. Our method works equally well in this case, and the slight modifications in notation needed will not be discussed.

To proceed further, we need to know the constant a , and it is also useful to introduce scale factors so that suitable dimensionless variables may be employed.

Thus we write the identity

$$G(\omega) = a \frac{\Pi(\omega - \omega_z)}{\Pi(\omega - \omega_p)} = G(0) \frac{a}{G(0)} \frac{\Pi(\omega - \omega_z)}{\Pi(\omega - \omega_p)} \quad (2)$$

with the idea of measuring gain in terms of $G(0)$, the gain at zero frequency. However, this gain, if evaluated from (1), also involves a , and therefore the second factor in (2) may be simplified by the introduction of a scale factor ω_0 defined by

$$\omega_0^n = \Pi |\omega_p| / \Pi |\omega_z| \quad (3)$$

¹ We use the time factor $e^{i\omega t}$. Those who prefer the e^{pt} notation may make the translation by writing $-jp$ for ω everywhere, and rotating all maps in the complex plane by 90 degrees.

$$\begin{aligned} \text{whereupon } G &= G(0)(-j\omega_0)^n \frac{\Pi(\omega - \omega_z)}{\Pi(\omega - \omega_p)} \\ &= G(0)(-j)^n \frac{\Pi(w - w_z)}{\Pi(w - w_p)} \end{aligned} \quad (4)$$

where $w = \omega/\omega_0$; i.e., we measure frequency in terms of ω_0 .

The above definition of ω_0 assumes that none of the ω_z is zero. Rigorously, there usually is at least one zero per stage at the origin because of the necessity of direct-current isolation of plate and grid as, for example, by blocking capacitors, mutual-inductance coupling, etc. Practically, these may usually be neglected. In the low-pass case the zero at the origin is accompanied by a pole a very short distance up the imaginary axis, and except at nearly zero frequency their effects cancel. In the band-pass case it is usually expedient, for other reasons, to adopt a new origin centered on the pass band, and to count the poles and zeros near this pass band but to neglect those near $\omega = 0$ and near the negative pass-band frequency.

It is also useful to write G and ω_0 in terms of various circuit constants and, incidentally, to give an interpretation to ω_0 . Plainly, the needed constants are the g_m of the tube, and some two constants of the coupling network. These latter two are most simply taken as C , which controls the gain at $\omega \rightarrow \infty$ and R , the resistive impedance of the coupling network for direct current, which controls the gain at $\omega = 0$. Then R determines $G(0)$ as $(g_m R)^n$ and the product RC establishes a time scale. As to this time scale, we can write the a of (1) either as $(-jg_m R \omega_0)^n$ from (4) or as $(-jg_m/C)^n$ by consideration of the behavior of (1) at $\omega \rightarrow \infty$. Comparing the two expressions we see that $\omega_0 = 1/RC$. Also, one may write $G(0)$ in terms of C and ω_0 instead of R , thus obtaining $G(0) = (g_m/C\omega_0)^n$.

In computing the gain-bandwidth product, the fact that altering R changes $G^{1/n}$ and the frequency equally and in opposite directions is easily utilized by the employment of these variables. Specifically, if the bandwidth is found to be w_0 , the gain-bandwidth product is $(g_m/2\pi C)\omega_0$.

All of the above tacitly assumes that R is the same for all stages. Often this is not true, in which case we simply take R to be the geometric mean of the various coupling resistances.

One further transformation that is often useful introduces a normalized gain $g(\omega) = G(\omega)/G(0)$, thus measuring gain in terms of the zero-frequency gain. Also, it is sometimes convenient to consider $g^{1/n}$ which is the stage gain if the stages are identical and a sort of mean stage gain if they are not.

Having disposed of the above preliminaries, we may begin on the main problem by remarking that we usually want not the real and imaginary parts of G but the absolute magnitude and the phase thereof. The separation in this form may be achieved by taking the logarithm. Thus

$$\log |G| = \log |a| + \sum \log |\omega - \omega_z| - \sum \log |\omega - \omega_p| \quad (5)$$

and

$$\arg G = -n\pi/2 + \sum \arg(\omega - \omega_z) - \sum \arg(\omega - \omega_p). \quad (6)$$

Now (5) at once suggests potential theory. Specifically, if we put l equal negative line charges at positions corresponding to the zeros and m similar positive charges at the poles, the resulting potential distribution on a plane normal to the line charges would correspond, with suitable choice of constants, to the amplification function $|G|$ on the ω plane. Also, it is well known that, if we plot the equipotential lines and then construct an orthogonal set of curves, then this orthogonal set will correspond to the lines of constant $\arg G$.

There is nothing new in the above, of course. In less specific form it has probably been stated in every complex-variable course ever given. Nor is there anything new in the additional remark that one may equally well use, in forming the analogy, the current flow in a uniform two-dimensional medium, for example, an electrolytic tank.

But, surprisingly enough, it has not become common practice to exploit this analogy. We wish to suggest here that the analogue is a useful one, and to give instructions for its experimental realization.

The two main questions that arise are the following. First, how do we arrange the apparatus and reduce the experimental data in order to get the proper values of the various constants; and second, what is the effect of using a tank of finite size as must, of course, be done in practice?

As to the first question, we note that there must be two free constants, since we certainly need a scale factor to convert the measured voltage in volts to gain in nepers; and we also need to specify the zero of potential. These constants are easily fixed, as follows. If the measured voltage be called V and we wish to find $\log |g|$ we must divide by a constant, call it V_0 , such that, as $r \rightarrow \infty$ V/V_0 will vary as $(m-l) \log |r|$ as $\log |g|$ varies; and then we must add a constant chosen so as to give $g(0) = 1$.

The constant V_0 is most easily determined by making an auxiliary experiment in which a single probe, corresponding to a single pole, feeds current into the electrolytic tank. No error will arise due to finite tank size if it is bounded by a circle centered on the wire or probe. The potential is measured as a function of radial distance from the probe. We then plot this potential V against $\log |r|$, whereupon we should obtain a line whose slope we shall call V_0 . Plainly enough, then, if V be measured for some other arrangement of probes, i.e., poles and zeros, the quantity V/V_0 will be similar to $(m-l) \log r$ at infinity and therefore will correspond to $\log |g|$.

As to the second constant we have only to choose our zero of potential to be the potential at the origin. This makes $V/V_0 = 0$ at $w = 0$ which is correct, since $|g| = 1$, $\log |g| = 0$.

Thus, if we measure potential difference between any point and the origin and call it V and divide this by V_0 ; as determined in the above-described experiment, then the quantity V/V_0 will be identical with $\log |g|$.

We come now to the question of the effect of the use of a finite tank which we will take to be of circular form with the circle centered on the origin. The needed results are easily found from standard results of potential theory.

Thus, if we take (5) and express the various logarithms appearing in terms of the well-known expansion of $\log r_{12}$ we find

$$\begin{aligned} \log |g| &= \sum \log |w - w_z| - \sum \log |w - w_p| \\ &= (l-m) \log r - \sum \frac{a_k}{r^k} \cos k\theta - \sum \frac{b_k}{r^k} \sin k\theta \end{aligned} \quad (7)$$

where r and θ are polar co-ordinates in the w plane, as is illustrated in Fig. 1, and the summations are over k . Here

$$a_k = \frac{1}{k} \left[\sum r_z^k \cos k\theta_z - \sum r_p^k \cos k\theta_p \right] \quad (8)$$

$$b_k = \frac{1}{k} \left[\sum r_z^k \sin k\theta_z - \sum r_p^k \sin k\theta_p \right] \quad (9)$$

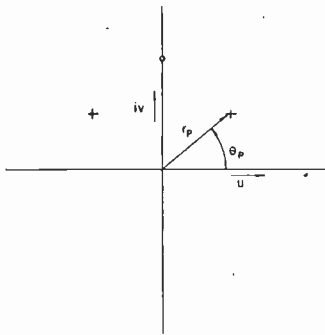

Fig. 1—Location of a point in the $w = u + iv$ plane shown in this figure is determined by co-ordinates u and iv . Also used are polar co-ordinates r and θ which are illustrated defining the position of the pole indicated by a cross, a zero being designated by a circle.

with r_z, θ_z and r_p, θ_p the polar co-ordinates of the various zeros and poles and with the summation over p and z . The expansion is valid only when r is larger than the radius corresponding to the pole or zero most distant from the origin. Other expansions can be written for other ranges of r but are not of interest at the moment.

Since impedance functions always have poles and zeros symmetrically distributed about the imaginary axis, it follows that only the even a_k and the odd b_k are nonzero. Moreover, since one wants only $|g|$ on the real axis, and the sine terms are zero there, we see that in using this series to find $|g|$ only the even cosine terms survive.

The above gives the value of $\log |g|$ and also the value of V/V_0 that would be found in an infinite electrolytic tank with electrodes corresponding to the poles and zeros and with each electrode carrying a current equal in magnitude to that used in determining V_0 .

But in a tank of finite radius, which we shall call r_0 , we must subtract from (7) a potential function which

satisfies Laplace's equation, has no singularities inside r_0 , and makes the potential constant on the circle $r = r_0$. If we call this subtracted function ΔV it is plain that

$$\log |g| = 1/V_0 [V(\text{measured}) + \Delta V] \quad (10)$$

and hereafter we shall denote the measured value of V by V_m . The form of ΔV is obtained by standard methods of potential theory from the above specifications; so we have

$$\log |g| = \frac{V_m}{V_0} - \sum a_k \frac{r^k}{r_0^{2k}} \cos k\theta - \sum b_k \frac{r^k}{r_0^{2k}} \sin k\theta \quad (11)$$

or on the real axis

$$\log |g| = \frac{V_m}{V_0} - \sum a_k \frac{r^k}{r_0^{2k}} \quad (12)$$

For reasons to be explained later, the derivative of $\log |g|$ in the imaginary direction is also of interest and on the real axis this has the value

$$\frac{d \log |g|}{dv} = \frac{1}{V_0} \left(\frac{dV_m}{dv} \right) - \sum k b_k \frac{r^{k-1}}{r_0^{2k}} \quad (13)$$

As to the corrections arising from finite tank size, two things can be done. First, by making the tank large, the corrections may be made small or even negligible. Second, we may, if necessary, apply the corrections. In this connection it is important in principle to understand that after the corrections are applied the results are exact, regardless of tank size. That is, decreasing the tank size does not change the attainable accuracy, which is always perfect, but merely requires use of more terms in the correction formula. Practically, of course, one uses a tank large enough to make the corrections small, for if many terms in the series for ΔV must be used, the main advantage of our method, its simplicity, disappears.

Ordinarily, there is little difficulty in making the corrections small, as may perhaps be well illustrated by an example. Consider a single resistance-capacitance coupled stage which gives a single pole unit distance up the imaginary axis. Then all nonzero a_k and b_k have numerical value $1/k$. The tank we have used has $r_0 = 8$. Thus at $r = 8$ the first nonvanishing term in the series on the right of (12) is $1/128$ for $k = 2$ and the next is 128 times smaller. So if we omitted the correction entirely the error in $|g|$ would be about 1 per cent. Thus it is not hard to make the first term rather small, and if we do this, following terms are certainly negligible. Moreover, the correction becomes smaller quadratically as we go in from the edge of the tank.

Although the corrections can be made small, and are very easy to apply when the a_k and b_k are known, some simplification in the methods of finding these coefficients would be of help. They can be found rapidly, as follows. We note first that only b_1 and a_2 are ever of practical significance, and that, since the total correction is small, no great percentage of accuracy is required in computing the coefficients. We can therefore obtain sufficient accuracy by using contour maps of the functions $r \sin \theta$ and $(r^2/2) \cos 2\theta$ to evaluate b_1 and a_2 by (8) and (9).

The lines $r \sin \theta = \text{constant}$ are, of course, simply straight lines parallel to the real axis, and this seems too simple to justify a figure. The second function is illustrated in Fig. 2, where it will be seen that the contour lines are hyperbolas, as may easily be shown directly. To use such a map to find a_2 one simply locates the zeros and poles on the map and adds corresponding values read from the contours, using positive signs for zeros and negative for poles. In this way b_1 and a_2 may be evaluated rapidly and with more than sufficient accuracy.

We turn now to the question of determining the phase. We have found three methods of doing this and will describe each of them, although the first two are more instructive than practical. The third method appears to be quite satisfactory, and the first two will merely be sketched, many details being omitted.

According to the first method we observe that since $\log |G|$ is an analytic function of ω the lines of constant $\phi = \arg G$ must be everywhere orthogonal to the lines of constant $\log |G|$. We therefore plot contours of $\log |G|$ as explained above, except that now we must cover the whole plane instead of merely the real axis. Lines orthogonal to these contours are then drawn in and, if suitably spaced, these lines give the values of ϕ . The disadvantages are that determining a complete map of $\log |G|$ is tedious work and that the accuracy of constructing the orthogonal lines is open to doubt unless complicated calculations are introduced.

To proceed according to the second method, one first connects the various zeros and poles by a series of curves, each of which goes in the direction of the electric field. At each pole or zero two of these lines intersect: the angle of intersection is to be 180 degrees. The shape of these lines is found either from the electrolytic tank or from a rubber model. We then bend strips of metal to correspond to these lines and use these strips as electrodes which set up a new problem in the electrolytic tank. At each pole or zero there will be a gap between two strips. Across each gap we place π volts with the right-hand side positive for a zero, and vice versa for a pole. The effect is to set up a new potential problem in which lines of potential and lines of force are interchanged. The lines of constant ϕ then become equipotentials and ϕ can be measured directly. This method is probably less work than the first, but its accuracy is doubtful as it would seem to depend on having the electrodes of the right shape, which takes us back to the first method.

According to the third method we determine $d\phi/du$ first and then find ϕ by an integration. This sounds tedious but actually is not, since the "integration" can be a simple summation. As a whole, the method seems quite satisfactory because (a) for many purposes $d\phi/d\omega$ is the quantity actually desired; (b) the integration is not difficult; and (c) the integration introduces at least as great a degree of accuracy.

To determine $d\phi/du$ we note that since $\log |G| + j\phi$

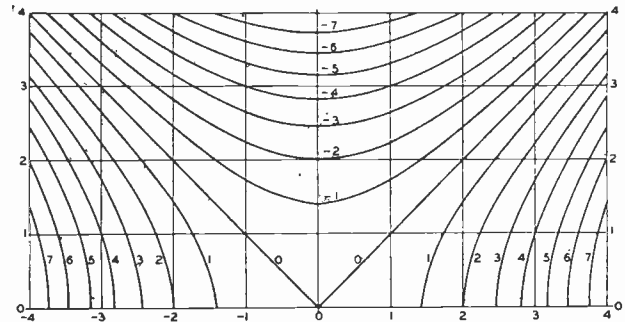

Fig. 2—Plots of $(r^2/2) \cos 2\theta = (u^2 - v^2)/2 = \text{constant}$. For use in evaluating a_2 .

is an analytic function of $w = u + jv$ there is a relation between $\partial\phi/\partial u$ and $\partial \log |g|/\partial v$: The latter quantity is then easily determined experimentally.

The needed relation is easily found directly from one of the Cauchy-Riemann equations. Thus we have

$$\partial\phi/\partial u = \partial \log g/\partial v. \quad (14)$$

Experimentally we can measure the difference in potential $\Delta_1 V$ between two probes spaced a distance Δv whereupon

$$\partial\phi/\partial u = \Delta_1 V/V_0 \Delta v. \quad (15)$$

Finally, if we wish ϕ we can conveniently make the integration element equal to Δv . Then

$$\phi(k\Delta v) = \frac{1}{V_0} \sum_0^{k-1} \Delta_1 V \quad (16)$$

where the $\Delta_1 V$ are observed at $u = \Delta v/2, 3\Delta v/2$, etc. Starting at $\phi = 0$ at $u = 0$, ϕ will reach $(m-l)\pi/2$ at $u \rightarrow \infty$.

The absolute values of the residues at the various poles may also be found without difficulty, although they are not of great interest from the present point of view.

Perhaps the best procedure is to open the circuit to the probe corresponding to the pole in question and then measure the value of the potential on the probe. This potential is reduced in the same way as $\log |G|$ value is obtained by dividing by V_0 and subtracting a suitable constant. The result is then the log of the absolute value of the residue.

The same result may be obtained, in principle, by leaving all probes connected and measuring the potential of one of them. From this is subtracted the previously determined potential of a single probe fed with the same current. The resulting voltage is then treated as described above. The last method is probably not very satisfactory in practice, because the two measured voltages will be nearly equal, and therefore the loss of accuracy due to subtraction will be severe.

No simple method of electrically determining the arguments of the residues is apparent.

EXPERIMENT

We have experimented with the above-suggested procedure, obtaining results which will now be described briefly.

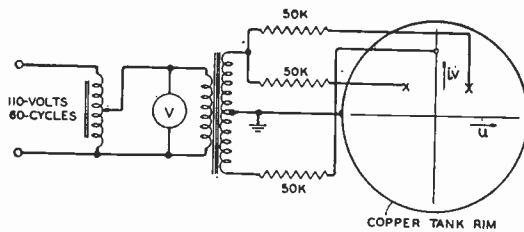

Fig. 3—Diagrammatic representation of apparatus for measuring g by means of an electrolytic tank. The arrangement of probes shown corresponds to the two poles and one zero characteristic of the common shunt-peaking circuit.

The apparatus is shown diagrammatically in Fig. 3. The electrolytic tank is circular, of eight-inch radius, and having the rim and all other electrodes of copper, the electrolyte being a dilute-copper-sulphate solution. The electrolyte is about $\frac{3}{8}$ inch deep and, with the concentration used, the impedance of one probe is a few hundred ohms. The probes corresponding to the poles and zeros are supplied with current from the opposite ends of an ordinary plate-supply transformer with grounded center tap. In series with each probe is a 50,000-ohm resistor. Voltages are measured with a Hewlett-Packard vacuum-tube voltmeter having an input resistance of two megohms. A variac and primary voltmeter maintain constant input.

The first procedure is to measure V_0 . To do this one, probe is put at the origin and the voltage on the u axis measured as a function of u . The voltage is plotted against $\log u$ and the slope gives V_0 . Two representative plots are shown in Fig. 4.

It will be seen that this plot is accurately linear. It should also be noted, however, that the end point, corresponding to the tank radius, does not fall on the straight line. This is also true of the point corresponding to the probe radius, though this point is not shown on the graph. This deviation indicates an electrode effect of some sort. We have not investigated this at all since its presence can have no effect on our method, provided the electrode whose potential is being measured carries substantially zero current, as is, of course, the case when using a vacuum-tube voltmeter.

Next, one measures V for an arrangement of probes corresponding to the location of poles and zeros in the gain function desired. Two points arise here.

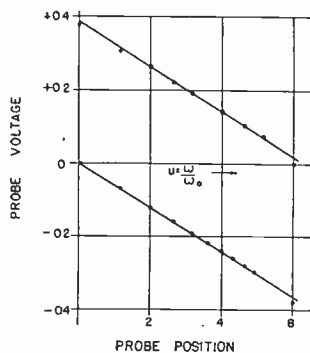

Fig. 4—Plot of probe voltage versus log of radius as used in determining V_0 .

In the first place, we note that, by placing a second set of probes below the real axis in positions that are mirror images of those above, we can practically eliminate errors due to the measuring probe not being exactly on the real axis. This precaution seems well worth while. To illustrate this by example, suppose we are measuring $|g|$ for a single resistance-capacitance coupled stage, which corresponds to a single pole at $v=1$. Then if we use only this one pole a displacement of the measuring probe by only 0.010 inch (for one inch = one unit of v) will give a 1 per cent error in $|g|$. If, on the other hand, we introduce an image pole at $v=-1$ the error due to 0.010 inch displacement is $\frac{1}{2} \times 10^{-4}$. Or, to put it in another way, a displacement of 0.14 inch is required to give an error of 1 per cent. Thus, the use of a set of images reduces the requirements on the slider carrying the measuring probe from fairly severe to quite negligible. Of course, the extra set of poles and zeros doubles the voltmeter readings.

TABLE I
Sample Data
Determination of Amplitude

u	V_m	V_m/V_0	$2.41 u^2/r_0^2$	V/V_0	$ g = 0^V/V_0$
0	0	0	0	0	1.000
0.5	-0.0010	-0.0058	+0.0001	-0.0057	0.994
0.75	-0.0045	-0.0262	+0.0003	-0.0259	0.974
1.00	-0.0120	-0.0698	+0.0006	-0.0692	0.933
1.25	-0.0245	-0.1425	+0.0009	-0.1416	0.869
1.50	-0.0415	-0.2410	+0.0013	-0.2397	0.786
2.00	-0.0820	-0.477	+0.0024	-0.475	0.622
2.50	-0.1230	-0.715	+0.0037	-0.711	0.491
3.00	-0.155	-0.901	+0.0053	-0.896	0.393
4.00	-0.213	-1.238	+0.0094	-1.229	0.292
5.00	-0.255	-1.483	+0.0148	-1.468	0.230
6.00	-0.293	-1.705	+0.0213	-1.684	0.186

The other point relates to the choice of the zero of potential. The most convenient thing to do is to connect the ground side of the voltmeter to the tank edge. The difficulty is that, since the percentage of error in the voltmeter readings is approximately constant, the absolute error is relatively large near the origin and small near the tank edge. Then, when the exponential is taken, we find ourselves knowing $|g|$ very accurately for large u and rather poorly near $u=0$. This is just the reverse of the usual order of interest. It is therefore obviously suggested that the "ground" end of the voltmeter be connected to a potential divider across one side of the transformer and adjustments made such that the voltmeter reads zero when the probe is at the origin. We have actually done this but have found, in our setup, that a zero voltmeter reading could not be obtained simply by adjusting the potentiometer. No doubt this could be remedied by careful shielding but we found it satisfactory to add two capacitors, one from the low side of the voltmeter to ground, and one across the voltmeter itself. These capacitors are adjusted by trial. At first sight such pickup may seem surprising in view of the low impedance offered by the probe. But it must be remembered that the voltmeter is expected to read down to around 10^{-8} volt while there are 250 volts present on the wires leading to the probes. (The probes themselves carry only a volt or so, most of the voltage

being lost in the 50-kilohm resistors which insure constant current.)

The results of a typical measurement are shown in Table I. These results are for a shunt-peaked amplifier with $L=0.414R^2C$ which gives the flattest amplitude response. This corresponds to a zero at $v=2.42$ and two poles at $u = \pm 0.98$ and $v=1.21$. This table shows measured values of V_m , the resulting V_m/V_0 , the correction which comes out at $2.41u^2/r_0^4$, the resulting $\log |g|$ and finally $|g|$. The value of V_0 was 0.172. These results are given graphically in Fig. 5 where the points are experimental data and the curve is from the theoretical formula. It will be seen that the agreement is quite close.

To measure $d\phi/du$ we must, first of all, reverse the polarity of the connections to the "image" poles and

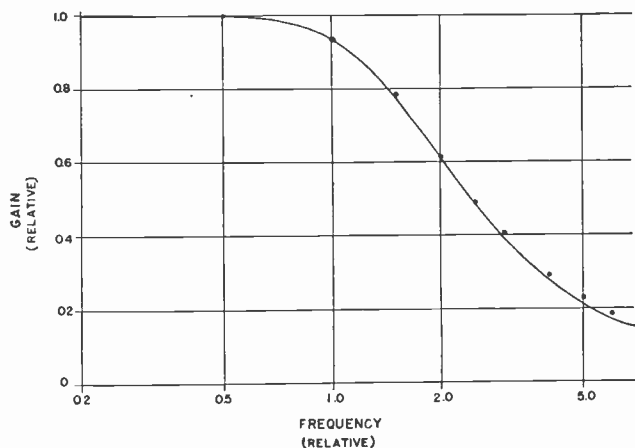

Fig. 5—Gain versus frequency of a shunt-peaked amplifier. $L=0.414 R^2C$. — calculated values; experimental values.

zeros below the real axis. This makes the potential an odd function of v so that the measurements of dV/dv are only slightly affected by displacement in the v direction. The measured value of dV/dv will, of course, be doubled by the addition of the images.

Second, we must provide a pair of probes spaced at a fixed distance Δv and capable of motion along the u axis. Moreover, instead of measuring the voltage between these probes directly, it is convenient to connect the ground end of the voltmeter to the tank rim, which is at zero potential, measure the potentials of the two probes separately, and then add.

A complete set of data and its reduction are tabulated in Table II. In this case Δv was 0.52, $V_0=0.179$ and the setup, as before, was to represent the case of a shunt-peaked amplifier. For this particular case b_1 is identically zero so no tank correction is required. The results are also presented graphically in Figs. 6 and 7, where $d\phi/du$ and ϕ are plotted as functions of u . It will be seen that the agreement between theory and experiment is satisfactory. It should be pointed out that, to achieve such agreement, some care must be used in measuring Δv . Thus if, as here, $\Delta v = \frac{1}{2}$ inch the probe spacing must be measured to 0.005 inch to get 1 per cent accuracy. This is easily possible with a traveling microscope but

TABLE II
Sample Data
Determination of Phase Shift

u	$\Delta_1 V_m$	$\Delta_1 V_m/V_0$	$\Delta\phi$	$\frac{\Delta\phi}{\Delta u}$	$\phi = \Sigma\Delta\phi$
0					
0.25	0.0255	0.143	0.273	0.546	0.273
0.50					
0.75	0.0301	0.168	0.322	0.644	0.595
1.00					
1.25	0.0288	0.161	0.308	0.616	0.903
1.50					
1.75	0.0201	0.122	0.215	0.430	1.118
2.00					
2.25	0.0122	0.068	0.131	0.262	1.249
2.50					
2.75	0.0072	0.040	0.077	0.154	1.326
3.00					
3.25	0.0046	0.026	0.049	0.098	1.375
3.50					
3.75	0.0030	0.017	0.032	0.064	1.407
4.00					
4.25	0.0020	0.011	0.021	0.042	1.428
4.50					
4.75	0.0013	0.007	0.014	0.028	1.442
5.00					
5.25	0.0008	0.004	0.009	0.018	1.451
5.50					

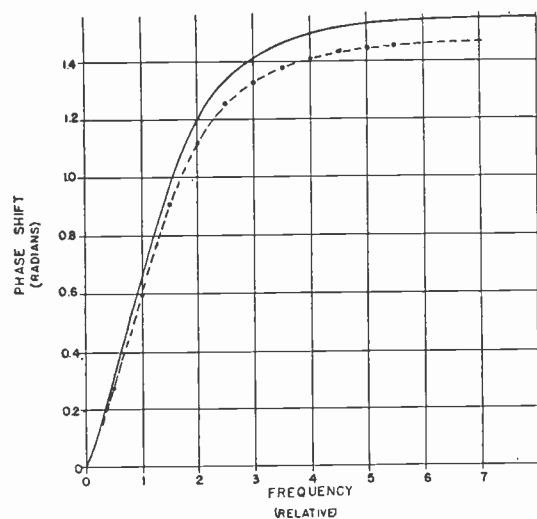

Fig. 6—Phase shift versus frequency of a shunt-peaked amplifier. $L=0.414 R^2C$. — calculated values; experimental values.

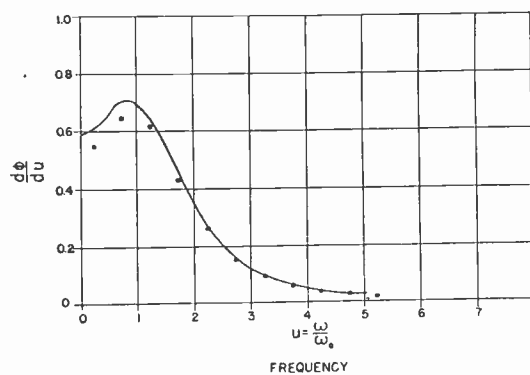

Fig. 7— $d\phi/du$ versus frequency of a shunt-peaked amplifier. $L=0.414 R^2C$. — calculated values; experimental values.

for most purposes it would probably be simpler and just as satisfactory, or possibly more so, to adjust Δv to give the known proper value of $\phi = \pi/2$ at $u \rightarrow \infty$.

CONCLUSION

In conclusion, it is our belief that the method described and illustrated above is a rapid and adequately

accurate method of evaluating gain functions when, as is usual, the location of the poles and zeros is easily found. Even more useful, to us, has been the new point of view coming with the introduction of the electrostatic

problem, for a number of new and useful circuit-theory results have been suggested by well-known ideas in potential theory. Some of these we hope to describe at a later date.

Multivibrator Circuits*

MARTIN V. KIEBERT, JR.†, SENIOR MEMBER, I.R.E., AND
ANDREW F. INGLIS‡, ASSOCIATE, I.R.E.

Summary—A simplified method is presented for the calculation of the voltage wave forms of nonsinusoidal voltage generators in which the circuit action is dependent upon the exponential charging and discharging of capacitors. A number of multivibrator circuits are then discussed and analyzed in accordance with this method.

INTRODUCTION

THE ADVENT of television and allied communication systems has brought into use a large number of electronic nonsinusoidal voltage generators of which the most important is probably the multivibrator. Because the wave forms encountered in these circuits are not sinusoidal, and because the grid-voltage variations are so great that the tube seldom acts as a linear amplifier, conventional methods of circuit analysis are of little value. In the multivibrator, as well as in many other nonsinusoidal voltage generators, the wave forms must be calculated by the methods of transient analysis, and the vacuum tube can be most accurately represented as a resistor in series with a switch. As an introduction to the study of multivibrators, this paper presents a simple method of resistance-capacitance circuit analysis and a discussion of the representation of a vacuum tube by a resistor and switch. These methods are then applied to a number of typical multivibrator circuits.

THE RESISTANCE-CAPACITANCE CIRCUIT

The voltage variations in all circuits which contain one capacitor and any number of resistors and sources of direct-current potential always follow exponential curves. Three quantities fix these curves uniquely: the voltage at any time, the time constant resistance-capacitance, and the voltage which the exponential is approaching. If these three are known the entire curve can be drawn. In one time constant the voltage rises (or falls) approximately 63 per cent of the way between its value at the beginning of the time constant and the value which it is approaching. This is true of any part of the exponential curve. The curve, therefore, gets

closer and closer to the value which it approaches but, from a mathematical standpoint, never reaches it. From an engineering standpoint, however, the difference eventually becomes so small as to be negligible. In four time constants the voltage rises (or falls) more than 98 per cent of the way between its initial value and the value which it is approaching. For many purposes, therefore, the voltage may be said to have reached an equilibrium value after four time constants.

The equations describing exponential curves are quite simple. If it is desired to know how long it takes the voltage to change from one value to another, the time can be found from the following equation

$$t = RC \log_e E_A/E_B. \quad (1)$$

E_A is the difference between the voltage at the beginning of the interval and the voltage which the exponential is approaching. Similarly, E_B is the difference at the end of the interval. These are illustrated in Fig. 1. Note

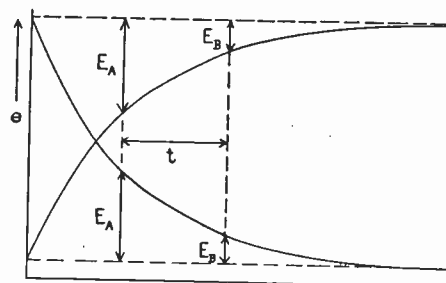

Fig. 1—Relationships on exponential curves.

that it is equally applicable to rising and falling exponentials. Equation (1) can also be written in exponential form if t and E_A are known and it is desired to find E_B

$$E_B = E_A e^{-t/RC}. \quad (2)$$

The technique of solving transients in resistance-capacitance circuits is summarized in the following three rules.

Rule 1: When a sudden change occurs in a resistance-capacitance circuit containing one capacitor and any number of resistors, the voltage between any two points in the circuit can be plotted by determining the voltage between the points just after the change occurs, the voltage between the points after the circuit again reaches equilibrium, and connecting these points with

* Decimal classification: R146.2. Original manuscript received by the Institute, October 16, 1944; revised manuscript received, January 16, 1945.

† Bureau of Aeronautics, Navy Department, Washington, D. C.
‡ Prerad Naval Training School, Bowdoin College, Brunswick, Maine.

an exponential curve having the proper time constant. The time constant can be found by reducing the network connected to the terminals of the capacitor to a Thevenin generator. The product of the resistance of the generator and the capacitance of the capacitor is the time constant.

Rule 2: To determine the voltages in the circuit just after the sudden change, find the voltage across the capacitor just before the change. Because of the fact that the voltage cannot change instantly across a capacitor, to find the other voltages in the circuit is a simple direct-current problem.

Rule 3: Equilibrium conditions can be determined by considering the capacitor to be an open circuit.

The application of these rules to the equivalent circuit of a multivibrator is shown in Fig. 2. Assume that at t_1 switch 1 has been open and switch 2 closed a long

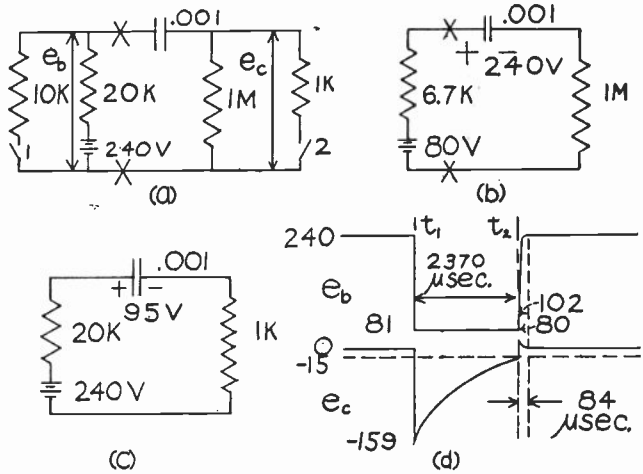

Fig. 2—Determination of the output wave forms of a resistance-capacitance circuit.
 (a) Circuit.
 (b) Equivalent circuit at t_1 ; switch 1 has just closed and switch 2 opened.
 (c) Equivalent circuit at t_2 .
 (d) Wave forms.

time. The switch positions are then reversed. Evidently the capacitor is charged to 240 volts, and this will not change as the switch positions are reversed. If the portion of the circuit to the left of $X-X$ in Fig. 2(a) is reduced to a Thevenin generator, the equivalent circuit shown in Fig. 2(b) is obtained. The voltages e_b and e_c can be determined easily as 81 and -159 volts respectively. Evidently e_b will relax toward 80 volts and e_c toward zero volts as the capacitor discharges. The time constant is approximately: $(1,007,000) (0.001 \text{ microfarad}) = 1007$ microseconds. Assume that when e_c has relaxed to -15 volts (equivalent to the grid of a multivibrator reaching cutoff) switch 1 opens and switch 2 closes. The time required for e_c to rise to -15 volts can be determined from (1).

$$t = 1007 \log_e 159/15 = 2370 \text{ microseconds.}$$

The capacitor has now discharged to 95 volts. Since the $1K$ resistor is now in parallel with the $1M$, the effect of the latter can be ignored and the equivalent circuit is

shown in Fig. 2(c). By inspection it can now be determined that e_b has jumped to 102 volts and e_c to 7 volts. As the capacitor recharges, e_c will relax to zero and e_b to 240 volts. The time constant is 21 seconds, and in 4 time constants this relaxation will be substantially complete.

THE VACUUM TUBE AS A SWITCH

In a large number of nonsinusoidal generators the grid voltage alternates between two values, one of which is below cutoff and the other in the conducting region, usually zero. Under these conditions the tube can be represented as a switch in series with a resistor and battery. Suppose, for example, that the grid voltage of the tube shown in Fig. 3(a) is held constant at -5 volts.

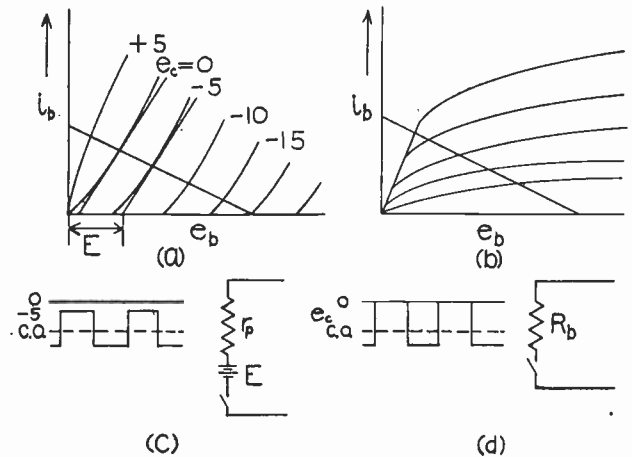

Fig. 3—Vacuum-tube plate characteristics and equivalent circuits.
 (a) Typical triode characteristic.
 (b) Typical pentode characteristic.
 (c) and (d) Grid wave forms and corresponding equivalent circuits for triode.

Then the tube appears to external circuits as a resistor r_p , in series with a voltage E . E is determined by drawing a tangent to the curve of constant grid voltage at the point where it crosses the static load line and finding where it intersects the voltage axis. (See Fig. 3(a).) This equivalent circuit is quite accurate provided that the plate voltage does not vary too much from the value determined by the intersection of the static load line. When the grid voltage is below cutoff, the tube is evidently an open circuit. Thus, if a square wave is applied to the grid which alternates between -5 volts and any value below cutoff, the behavior of the tube can be predicted by alternately opening and closing the switch. This is illustrated in Fig. 3(c).

When the grid voltage of a triode is zero (or positive) the tangent intersects the voltage axis approximately at zero. Furthermore, the dynamic plate resistance is approximately equal to the static or direct-current value R_b . Without making a serious error, therefore, the tube can be represented by a resistor R_b and switch which is open when the grid voltage is below cutoff and closed when the grid voltage is zero. This is shown in Fig. 3(d).

With pentodes, a similar method can be followed. When the pentode is operating above the "knee" of the characteristic curves, the tangent to the characteristic intersects the voltage axis at a large negative voltage. The equivalent circuit of the tube is, therefore, a very large resistance r_p , in series with a very large battery, the positive pole of which is at cathode potential. If the tube is operating below the knee of the curves, the pentode has the properties of a rather small resistance. (Typical values: 6SJ7 = 3000 ohms, 6AC7 = 3000 ohms, 6AG7 = 800 ohms.)

The wave forms of the multivibrator are greatly affected by grid conduction, since this puts a heavy load on the plate circuit of the tube which drives the grid. When the grid is positive there is a reasonably linear relationship between grid voltage and grid current, the ratio for most small receiver-type tubes ranging from 500 to 2000 ohms. Thus the grid can be represented by a resistor and switch, the switch being open when the grid is negative and closed when the grid is positive. The exact value of this resistor makes little difference in the circuit calculations so long as it is of the right order of magnitude. It is usually safe, therefore, to assume a value of 1000 ohms as the grid resistance while conducting.

THE BASIC MULTIVIBRATOR

The circuit, equivalent circuit, and wave forms of a typical multivibrator are shown in Fig. 4. It can readily

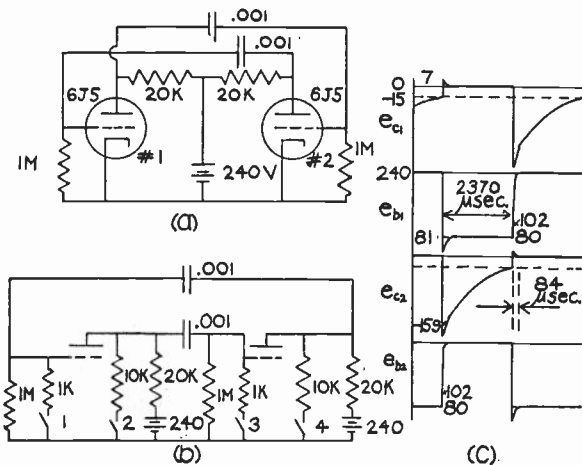

Fig. 4—Basic multivibrator circuit and wave forms. (a) Multivibrator. (b) Equivalent circuit; at t_1 : switches 1 and 2 close, switches 3 and 4 open; at t_2 : switches 1 and 2 open, switches 3 and 4 close. (c) Wave forms.

be seen from the wave forms that the grid voltage is always either at zero or below cutoff with the exception of the short positive "pip" at the beginning of each cycle. This is a case, therefore, where the tube should be represented by a resistor and switch. A 20,000-ohm load line intersects the characteristic for $e_c = 0$ at $e_b = 80$ volts and $i_b = 8$ milliamperes. This gives $R_b = 10K$. Likewise, the grid can be represented by a 1000-ohm resistor and switch.

The cycle of operation is as follows. Consider the conditions in the circuit just before t_1 . The grid of Tube 1 is just approaching cutoff, and the plate is at the supply potential. The grid of Tube 2 is at zero, and its plate is at 80 volts, due to the heavy flow of plate current. In the equivalent circuits, then, switches 1 and 2 are open and 3 and 4 are closed. When the grid of Tube 1 reaches cutoff, plate current starts to flow, dropping the plate voltage. This pulls down the grid of Tube 2 and thus causes its plate voltage to rise. This, in turn, pulls up the grid of Tube 1 and thus causes a further drop in its plate voltage. This repeated amplification and feedback continues until the grid of Tube 1 is driven positive and the grid of Tube 2 is driven far below cutoff. All this takes place very rapidly, the limiting factor being the rate at which the interelectrode capacitances can be charged and discharged. For many purposes it may be regarded as happening instantaneously.

This action is represented in the equivalent circuits by the reversing of all four switches. Switches 1 and 2 now close, and 3 and 4 open. They remain in this condition until the grid of Tube 2 relaxes to cutoff, at which time the procedure is repeated with the roles of the two tubes reversed. Switches 1 and 2 now open, and 3 and 4 close. When the grid of Tube 1 relaxes to cutoff the cycle is complete.

The analysis of the equivalent circuits has been given previously. With one exception, the multivibrator wave forms are identical with those computed for the equivalent

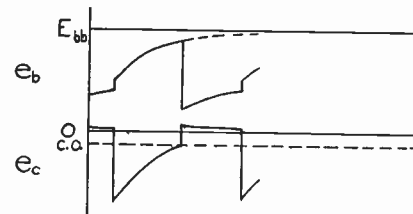

Fig. 5—Plate- and grid-voltage wave forms of one tube of multivibrator in which the plate relaxation is slower than the grid.

lent circuit. In drawing the equivalent circuit it is assumed that the grid voltage is zero at all times while the tube is conducting. As has been pointed out, this is true with the exception of the positive "pip" which occurs when the tube is first driven to conduction. This appears in the plate as an amplified negative peak. Because of the coupling capacitor the peak also appears on the grid of the nonconducting tube where it is superimposed on the exponential rise. If, as is usually the case, the time duration of the peak is small compared with the half-period, this will have little effect on the relaxation time and can be neglected in the calculations. In Fig. 4(c) the actual wave forms are shown as solid lines while the computed wave forms, where different, are shown as dotted lines.

(In case the time constant of the circuit involving the nonconducting plate is comparable with that involving the nonconducting grid, the wave forms may be quite

different). The nonconducting plate will not have time to relax to E_{bb} , and the conducting grid will not have time to relax to zero. The resulting wave forms will then be as shown in Fig. 5. An exact calculation of the wave form in this case is impossible. This is because the cutoff voltage on the nonconducting tube is constantly changing, due to the changing plate voltage, and the grid voltage of the nonconducting tube does not follow an exponential curve. Aside from the difficulties in calculating the wave forms in this case, it is usually undesirable to design the multivibrator so that the plate relaxation time is slower than that of the grid, since the resulting wave forms are not as useful as those shown in Fig. 4.

THE BIASED MULTIVIBRATOR

A modification of the basic multivibrator is shown in Fig. 6. Instead of returning the grid resistors to the cathode they are returned to a point which is held positive with respect to cathode. This modification is of particular value in high speed circuits and in circuits where good frequency stability is desirable.

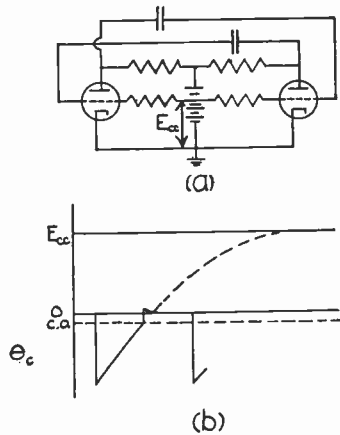

Fig. 6—Biased multivibrator.
(a) Schematic circuit.
(b) Grid-voltage wave forms.

Since the effective grid-to-cathode resistance is small compared with that of the grid resistor, the grid voltage is affected very little by this modification during the part of the cycle when the grid is conducting. The plate wave forms are likewise very little affected. However, during the part of the cycle when the grid is negative, it relaxes toward E_{cc} instead of toward zero, as shown in Fig. 6(b). This has two important effects: it shortens the relaxation time, thus increasing the frequency of the multivibrator; and it increases the rate of change of grid voltage at the time cutoff is reached, thus improving the frequency stability. If in the circuit of Fig. 4 the grid resistors had been returned to a potential of +240 volts, E_A would equal $(159+240)=399$ volts and E_B would equal $(159+15)=174$ volts. From (1) the half period would then be $1007 \log_e 399/174=834$ microseconds. The frequency is almost tripled, therefore, by this change. A simple calculation likewise shows that the frequency is stabilized by this modification. Suppose

that, due to the substitution of another tube, the cut-off value were changed from -15 to -16 volts. In the unbiased case the new half period would be $1007 \log_e 159/16=2310$ microseconds which is a change of about 2.5 per cent. In the biased case the new frequency would be $1007 \log_e 399/175=830$ microseconds, a change of only about 0.5 per cent.

The dependence of frequency upon the bias value provides a very convenient method of frequency control. By suitable design, the frequency can be varied over as great a range as 10 to 1 by adjustment of the bias.

SPECIAL MULTIVIBRATORS FOR PRODUCING SQUARE WAVES

There are a number of applications in which the plate-voltage wave form of the basic multivibrator is unsuitable because the leading edge of the positive portion of the cycle is an exponential, rather than an instantaneous rise. The plate voltage cannot rise immediately to E_{bb} when the grid is driven below cutoff, because the plate

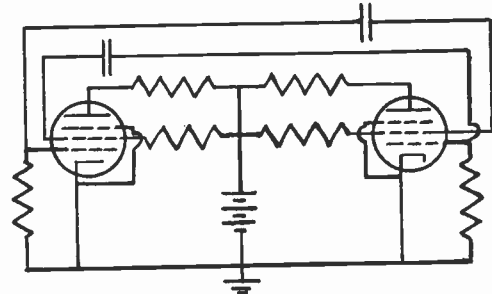

Fig. 7—Pentode multivibrator.

is coupled to the grid of the other tube. Since the grid of the other tube is conducting its effective resistance to cathode is very low, and nearly all the resistance drop due to the charging current of the capacitor appears across the plate load resistor. The plate voltage cannot rise to E_{bb} , therefore, until the capacitor is fully charged. This difficulty can be avoided in two ways: by utilizing pentodes or by adding resistors in series with the grids in the triode circuit.

A pentode multivibrator circuit is shown in Fig. 7. In this circuit use is made of the fact that the cathode, control grid, and screen grid have triode characteristics which are little affected by the plate voltage, provided that it does not fall too low. By connecting these elements in the two tubes as a multivibrator, oscillations will occur just as in the basic multivibrator, and the wave forms can be calculated in the same way if the screen characteristics are known. Since the plate load consists only of a resistor, the plate voltage depends only on the plate current. Thus when the grid is driven below cutoff, the plate voltage rises instantly to E_{bb} , and a very square leading edge results. This circuit is very similar to the ordinary electron-coupled oscillator, in that the load is isolated from the oscillatory circuit.

The leading edge of the plate-voltage wave form of the

triode multivibrator can be made more nearly square by adding resistors in series with the grids. This circuit is shown in Fig. 8(a). The effect of this modification is to reduce the charging current into the coupling capacitor, thus allowing the plate voltage of the nonconducting tube to rise instantly much nearer to E_{bb} when the tube is cut off. The effect is illustrated in Fig. 8(b). Note that

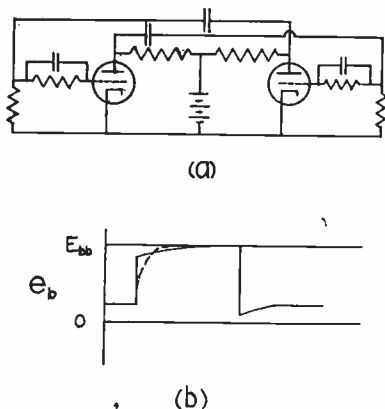

Fig. 8—Square-wave multivibrator.

(a) Schematic circuit.

(b) Plate-voltage wave forms. The dotted curve shows the wave form of the basic multivibrator.

the time constant of the charging circuit is increased, so that the exponential portion of the rise is slower than in the basic multivibrator. The plate wave form can be calculated readily by the method previously described. If, for example, 100-kilocycle resistors are added in series with the grids of the circuit shown in Fig. 4, the plate voltage will rise instantly to 211 volts, instead of to 102 as was the case with the basic multivibrator.

(The series grid resistors are usually by-passed with small capacitor (10 to 50 micromicrofarads) as shown in Fig. 8(a). This is done to provide a low-impedance charging path for the interelectrode capacitances. Since the speed with which the electrode voltages can change is limited by the rate at which the voltages on the interelectrode capacitances can be charged and discharged, this circuit detail is necessary to produce sharp leading and trailing edges on the output wave forms.)

An incidental effect of this modification is to reduce the amount by which the grid is driven positive, which likewise reduces the size of the negative dip in the plate voltage. This, however, is seldom of any practical importance.

"ONE-SHOT" MULTIVIBRATORS

There are a number of important applications in which it is desired that the multivibrator remain quiescent until its action is initiated by a voltage pulse or "trigger." The circuit then goes through one cycle of operation, at the end of which it reverts to the original quiescent state where it remains until triggered again. Such a circuit is called a one-shot multivibrator.

Any of the circuits previously discussed can be modified to make a one-shot multivibrator by biasing one of the grids below cutoff. In the quiescent condition this

tube remains cut off and the other one conducting. To initiate the cycle, the grid of the nonconducting tube must be brought above cutoff. This can be accomplished by means of a positive trigger applied directly to the grid of the nonconducting tube, or a negative trigger to the grid of the conducting tube. In the latter case, the trigger is amplified and its polarity inverted. It is then transmitted by means of the coupling capacitor to the grid of the nonconducting tube.

Typical one-shot multivibrators are shown in Fig. 9. The circuit of Fig. 9(a) is the basic multivibrator modified by placing sufficient negative bias on the grid of tube 1 to hold it below cutoff. After triggering, the wave forms of this circuit are very similar to those of the basic circuit with a positive pulse appearing on the plate of tube 2, and a negative pulse of the same duration on the plate of tube 1. The duration of these pulses is determined primarily by the time constant of the circuit coupling the plate of tube 1 to the grid of tube 2.

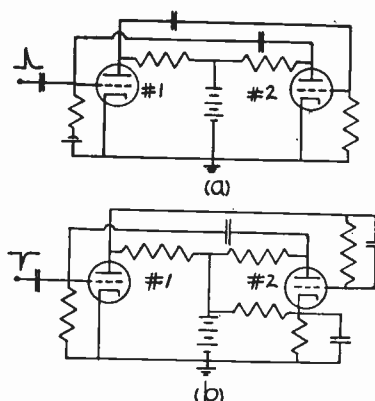

Fig. 9—One-shot multivibrator.

Another one-shot circuit is shown in Fig. 9(b). This differs from the other circuits discussed in this paper in that the coupling between the plate of tube 1 and the grid of tube 2 are through a resistor rather than a capacitor. The small capacitor by-passing the resistor is not essential, but aids in charging and discharging the input capacitance of tube 2, thus improving the rapidity of operation of the circuit. Sufficient positive bias is placed on the cathode of tube 2 to hold it cut off, even though the grid is held positive with respect to ground by an amount equal to the plate voltage of tube 1. When the circuit is triggered by bringing the grid of tube 2 above cutoff, this grid is driven slightly positive and the other grid is driven far below cutoff. The circuit remains in this condition until the grid of tube 1 relaxes to cutoff, at which time the circuit immediately reverts to its quiescent condition. Thus a positive pulse appears on the plate of tube 1 and a negative pulse on the plate of tube 2. The duration of the pulse is controlled by the time constant of the coupling network between the grid of tube 1 and the plate of tube 2. This circuit is particularly useful, since the leading edge of the positive pulse appearing on the plate of the left-hand tube



Check feeding signal
with square wave
you again. Make sure

cut-off isn't taking place
on ~~neg~~ ^{neg} cycle.

consists of an instantaneous jump to the final value instead of an exponential rise.

The coupling capacitor which couples the triggering circuit to the multivibrator should be made as small as possible in most cases. This will insure a short trigger pulse and will minimize the loading of the multivibrator by the triggering circuit.

HIGH-FREQUENCY CHARACTERISTICS OF MULTIVIBRATORS

In the simplified analysis given previously, the inter-electrode and wiring capacitances were neglected, and under these conditions instantaneous voltage changes occur on both the plate and grid wave forms. In practice these capacitances are present, of course, and as with any capacitance it is impossible for the voltage across them to change instantly. Although instantaneous changes are impossible, in many recent applications of the multivibrator it is of great importance that they be very rapid, and the problem of accomplishing this is often a serious one in multivibrator design. (As in the case of a video amplifier, the rapidity with which the electrode voltages can be changed is proportional to the upper frequency limit of the circuit, and the same design factors are involved.) Although a rigorous determination of the time of rise and fall of voltage is practically impossible because of the complexity of the circuit and the nonlinear characteristics of the tubes, a few important generalizations can be made.

At the point in the cycle when the plate voltage on one of the tubes suddenly drops from E_{bb} , the voltage must change across the output capacitance of the tube, the input capacitance of the other tube, and the wiring capacitance. The resistance effectively in series with these capacitances is the load resistor in parallel with the dynamic plate resistance of the tube. It is apparent, therefore, that for greatest speed of operation it is necessary in order that all capacitances, the load resistor, and

the plate resistance be as small as possible. For this reason low- μ triodes which have a low plate resistance are preferred to high- μ tubes. In certain applications which demand an extremely rapid voltage change, power-amplifier tubes, especially beam-power tubes, are sometimes used. Since these tubes can be operated with a small load resistor their high-frequency characteristics are excellent. The exact calculation of the time required for the voltage to drop is complicated by the fact that the grid voltage is not driven instantly from cutoff to its positive value. Also, the effective input capacitance of the other tube cannot readily be calculated; (the ordinary Miller-effect equation cannot be used because the tube is not operating as a linear amplifier). Experimental results show, however, that this time is of the order of one fourth the reciprocal of the upper-half power frequency of one of the tubes operated as an ordinary linear amplifier.

The rounding of the leading edge of the positive portion of the plate wave form in the basic multivibrator is due primarily to the charging of the coupling capacitor, since this is normally much larger than the interelectrode capacitances. In the case of the special multivibrator circuits previously discussed, which were designed to have a square leading edge, the rise time will be determined by the same factors that determined the time of fall. In this case, however, the plate resistance is no longer in parallel with the load resistor, since the tube is cut off at this time. For this reason the time of rise is usually slower, especially with triodes, where the plate resistance is often lower than the load resistor. (A very square wave form can be obtained by taking the output across a small (50 to 1000 ohms) resistor inserted in the cathode circuit of one of the tubes. The output impedance of this circuit is very low, which makes the high-frequency characteristics excellent. This arrangement is particularly suitable for feeding a low-impedance load such as a transmission line.)

The Reactance Theorem for a Resonator*

W. R. MACLEAN†, ASSOCIATE, I.R.E.

Summary—The Foster reactance theorem which states that in any loss-free network, $dX/d\omega$ is positive, is here proved for any loss-free resonator. However, to establish the existence of an input impedance, the author feeds the resonator with a coaxial (or other suitable) transmission line. The proof is based upon an extension of Helmholtz's theorem of adiabatic invariants. The variation of frequency is attained by a slow (adiabatic) movement of a short-circuiting plug in the transmission line while the cavity is oscillating.

* Decimal classification: R145. Original manuscript received by the Institute, November 20, 1944; revised manuscript received, February 13, 1945. Presented, Rochester Fall Meeting, Rochester, N. Y., November 13, 1944.

† Graduate Electrical Engineering Department, Polytechnic Institute of Brooklyn, Brooklyn, N. Y.

INTRODUCTION

FOSTER'S reaction theorem¹ states that the driving-point reactance of any nondissipative network is an odd rational function of the frequency with an always positive slope. The usual proof is based on network theory and limits its validity to configurations of a finite number of degrees of freedom. The principle can and has been extended to certain systems of distributed parameters such as transmission

¹ R. M. Foster, "A reactance theorem," *Bell Sys. Tech. Jour.*, vol. 3, pp. 259-268; April, 1924.

lines.² Such extensions, however, are made to systems for which the impedance function can be determined explicitly; They have then always been found to obey Foster's principle, if one merely allows the impedance function to become meromorphic instead of just rational. It has long been assumed that the theorem was valid for any non-dissipative system whatever, but it has not been proved, so far as the author is aware, for the general case of an unrestricted electromagnetic configuration. It is the purpose of this paper to extend the theorem to a configuration which is specialized only insofar as needed to establish the existence of a driving-point impedance.

To have an impedance in the first place, it is necessary to have a definable voltage and current whose ratio can be taken. In the completely general case, since no scalar-potential function exists, there is no such thing as voltage and hence no impedance. Therefore, the input to the system must be so arranged that a voltage exists at some point, or the theorem has no meaning. Also, if the system is to have no resistance component of input impedance it must be not only nondissipative but also nonradiative. Hence, it must be considered to be made of perfect conductors and to be completely surrounded with a perfectly conducting shield.

Suppose, then, that one has such an enclosure whose internal configuration is any whatever, but which is fed through an attached concentric transmission line, or simply a grounded, shielded, and uniform line. If the frequency is below that required for the propagation of higher modes within the line, and if the line is of sufficient length and fed in any manner whatever at the far end, there will exist at any point which is some diameter distant from the resonator and also from the far end, a field pattern which is purely that of the principal mode. For this mode, the curl of the electric field lies in the transverse planes, and hence in these planes a scalar potential exists. This defines a difference of potential between the outer and inner conductor which is the ordinary "voltage on the line."

A value of current can be defined as the net flow through the center conductor toward the resonator that crosses the same transverse plane used for the voltage. The ratio of these two gives the input impedance to the resonator at a fixed point on the transmission line which needs be a few diameters distant from the resonator. This definition is valid from direct current up to frequencies whose wave lengths become comparable with the diameter of the transmission line, and coincides with the usual concept of impedance.

Since with a given apparatus there is a limit to the region of frequency in which the impedance is defined, we cannot hope to be able to evaluate the function by a knowledge of its poles and roots. But it is possible to show that, within the range of definition, the reactance function is odd, and has a positive slope.

² Dah-You Maa, "A general reactance theorem for electrical, mechanical, and acoustical systems," *PROC. I.R.E.*, vol. 31, pp. 365-371; July, 1943.

I. THE REACTANCE FUNCTION IS ODD

Having decided on a certain concentric feeder, and having picked a transverse plane O through this line at which the impedance is to be determined, one considers the cavity bounded by the perfectly conducting metal surfaces and by an annular ring cut out of O by the transmission line. Within this region, the theorem

$$-\int_s \bar{N} \cdot dS = j2\omega(T - U) \quad (1)$$

can be applied.³

In (1), \bar{N} is the complex poynting vector, T is the total (time-averaged) magnetic energy, and U is the total (time-averaged) electric energy. The integral is taken over the bounding surface with outwardly directed normal. Due to the perfectly conducting metal, the integral vanishes except over the annular ring. If ω is less than the value ω^0 at which the impedance definition breaks down, the integral can be evaluated over the ring since the mode is known to be the principal one. A little computation leads to

$$\bar{V}I = j2\omega(T - U) \quad (2)$$

where \bar{V} and \bar{I} are the complex voltage and current at O . Instead we could write

$$Z = j2\omega(T - U)/I^2 \quad (3)$$

$$\text{or} \quad X = 2\omega(T - U)/I^2 \quad (4)$$

where X is the input reactance.

Substituting $-\omega$ for ω will produce no change in the energies (since there is no physical change involved).

$$\text{Hence} \quad X(-\omega) = -X(\omega) \quad (5)$$

and we see that the function is odd.

II. THE SLOPE IS ALWAYS POSITIVE

To demonstrate this property of the reactance function, we first imagine the concentric feeder extended indefinitely behind the plane O and finally closed with a frictionless plug at a distance ζ from O . This is shown schematically in Fig. 1. We then pick a starting fre-

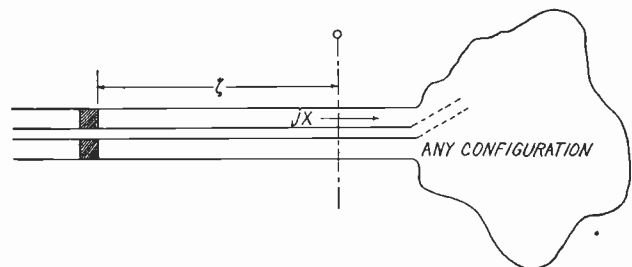

Fig. 1—A general resonator with concentric feeder.

quency, ν , as low as we please and determine the reactance X , at O of the resonator for this frequency. ζ is then adjusted so that

$$X = -R_0 \tan(2\pi\nu\zeta/c) \quad (6)$$

where R_0 is the characteristic resistance of the concentric line. As a result, there is a conjugate match at O at this frequency. Consequently the system, resonator,

³ J. A. Stratton, "Electromagnetic Theory," McGraw-Hill Book Co., Inc., New York, N. Y., 1941, p. 137.

and line out to the plug, has a natural mode at this frequency, and if started in oscillation would continue indefinitely since there is no dissipation.

We now start it oscillating at this lowest frequency, and then move the plug with infinite uniform slowness toward the resonator. This movement will take place against the radiation pressure. Hence it will increase the energy of the mode; but it will also change the frequency. The frequency will always be such that a conjugate match exists at every point on the line where an impedance exists. By this principle, the impedance of the resonator at O will be given by (6) even when ν , X , and ζ have been modified from their starting values.

As a result of the infinitely slow deformation, ν will be a function of ζ and vice versa, and X will be a function of either ν or ζ . Hence

$$dX/d\nu = -R_0 \sec^2(2\pi\nu\zeta/c)(2\pi/c)(\nu d\zeta/d\nu + \zeta). \quad (7)$$

To prove the stated proposition, we must show that the right-hand side of (7) is positive. All the quantities are intrinsically positive except the minus sign and the final bracket. Information concerning the sign of this bracket can be obtained by relating the change in frequency to the change in energy of the mode.

Such a relation is given by the fact that the action of a resonator is an adiabatic invariant. By this is meant that, if W is the energy and τ the period, the product τW cannot be changed by a deformation (slow compared to the period). In symbols⁴

$$\delta(\tau W) = 0. \quad (8)$$

Another formulation would be

⁴ J. H. Jeans, "Dynamical Theory of Gases," Cambridge Press, London, England, 1925, pp. 410-417. This theorem is proved for a machine of a finite number of degrees of freedom. A proof for an electromagnetic resonator is given by the author in *Quart. Appl. Math.*, vol. 2, pp. 329-335; January, 1945.

$$\delta W/W = \delta\nu/\nu \quad (8a)$$

and since one is putting in energy in moving the plug towards the resonator, the frequency is thereby continually increased. $\nu(\zeta)$ is hence monotonic and $\zeta(\nu)$ single-valued.

Now, however, the radiation pressure gives us information concerning the change in energy and leads to the desired result. First, it can be shown by a variety of means that the electromagnetic force F on the plug is equal to the linear density of time-averaged energy w along the line

$$F = w. \quad (9)$$

Hence

$$-dW/d\zeta = w \quad (10)$$

which with (8a) leads to

$$(1/\nu)(d\nu/d\zeta) = (1/W)(dW/d\zeta) = -w/W \quad (11)$$

or

$$\nu(d\zeta/d\nu) = -W/w. \quad (12)$$

Substituting this result in (7) one has

$$dX/d\nu = R_0 \sec^2(2\pi\nu\zeta/c)(2\pi/c)((W - w\zeta)/w). \quad (13)$$

$w\zeta$ is only the energy contained in part of the transmission line, whereas W is the entire energy of the oscillating cavity. Hence $dX/d\nu$ is always positive while the plug moves from its original position up to the plane O .

When the plug has reached O , the frequency has risen to a value say ν_1 . We then stop the oscillation and move the plug back some large whole number of wave lengths of this frequency ν_1 . In this new position, the system has a mode of this same frequency since the conjugate match principle at O is maintained. We create this mode and again push the plug toward the resonator. Hence it is seen that the slope of the reactance curve is always positive up to those frequencies for which the impedance is no longer defined.

"N"-Phase Resistance-Capacitance Oscillators*

R. M. BARRETT†, ASSOCIATE, I.R.E.

Summary—This paper describes the design of a series of resistance-capacitance tuned oscillators of the polyphase type. A single-mesh phase-shift network is used for coupling the N tubes of the oscillator which are arranged in a feedback ring. Limiting the discussion to oscillators of odd phases, the author has developed design formulas and has analyzed typical circuits. Experimental results are shown to check closely those predicted by theory.

I. INTRODUCTION

A VACUUM-TUBE oscillator is, essentially, a converter that changes direct-current plate power into alternating-current energy. This converter consists of a vacuum-tube amplifier and a coupling network, so arranged that an exciting voltage of the proper

magnitude and phase to produce the amplified output is obtained from this output.

The feeding of a signal back to the grid circuit in phase with the input voltage so that it aids oscillations is called positive feedback. The feeding back of a signal out of phase with the input signal in such a way as to hinder and reduce the oscillations is called negative feedback. Since the tube normally produces a phase shift of 180 degrees, the feedback network must provide another shift of approximately 180 degrees to make the voltage being fed back in phase with the initial grid voltage. The coupling network must also provide a frequency-selective characteristic so as to maintain single-frequency operation.

In common with the recently popularized resistance-capacitance oscillators, the N -phase oscillators described in this paper use a resistance-capacitance phase-shift

* Decimal classification: R355.9. Original manuscript received by the Institute, September 30, 1944; revised manuscript received, March 5, 1945.

† Radio Maintenance Section, 1103rd Army Air Forces Base Unit, Morrison Field, Florida.

network to provide positive feedback at the selected frequency. This coupling network is so designed that it not only causes positive feedback, with its accompanying amplification at the selected frequency, but it also provides negative feedback for the harmonic frequencies of the oscillator, thus assuring a distortion-free type of oscillation.

This paper is mainly concerned with N -phase oscillators of the resistance-capacitance phase-shift type. The author has found that, although inductive circuits can be used, they are, on the whole, unsatisfactory and usually are of a more complex nature. The oscillators described herein have the advantages of simplicity, stability, and unusually pure wave form. The design follows closely the single-tube phase-shift oscillator recently described in the literature.¹ The phase-shift network has been divided into N symmetrical sections coupled by single-stage amplifiers. This necessitates a

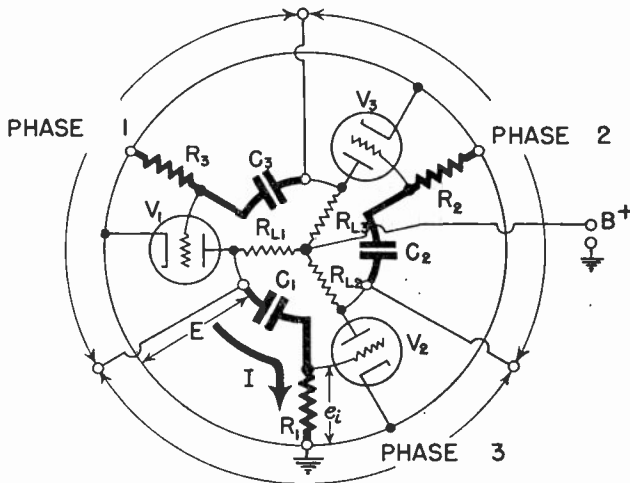

Fig. 1—The three-phase oscillator.

total phase shift of $\pi(n+1)$, for n odd, the phase shift $n\pi$ being taken care of by the N coupling amplifiers, leaving a 180-degree phase shift to be accomplished by the N interstage coupling networks. It is evident that as the number of phases increases, the phase shift per stage decreases, and, in all cases, the simple resistance-capacitance coupling network of the resistance-coupled amplifier produces sufficient phase shift for oscillation.

The following analysis is limited to the discussion of amplifiers of odd phases as the resistance-capacitance-type phase-shift network discussed in this paper is unsuitable for use with sine-wave oscillators where the number of phases generated is even.

II. BASIC CIRCUIT ANALYSIS²

In order to produce self-sustaining N -phase oscillations in a multistage amplifier, three conditions must be satisfied. First, the stages must have identical characteristics; second, the output of the amplifier must be in phase with its input; and third, the over-all gain of the

¹ E. L. Ginzton and L. M. Hollingsworth, "Phase-shift oscillators," PROC. I.R.E., vol. 29, pp. 43-49; February, 1941.

² The analyses of this paper adapt those of Ginzton and Hollingsworth to the N -phase case.

network must be equal to or greater than unity. That is, if A_k = amplification parameter of an amplifier stage B_k = fraction of the output voltage of an amplifier stage introduced into the input of the next stage then,

$$A_1 B_1 \times A_2 B_2 \times A_3 B_3 \times \cdots \times A_n B_n = \prod_{k=1}^{k=n} A_k B_k \geq 1. \quad (1)$$

Thus, if

$$A_1 \times A_2 \times A_3 \times \cdots \times A_n = |A_1| / \theta_1 \times |A_2| / \theta_2 \times \cdots \times |A_n| / \theta_n = \prod_{k=1}^{k=n} |A_k| / \theta_k \quad (2)$$

$$B_1 \times B_2 \times B_3 \times \cdots \times B_n = |B_1| / \phi_1 \times |B_2| / \phi_2 \times \cdots \times |B_n| / \phi_n = \prod_{k=1}^{k=n} |B_k| / \phi_k \quad (3)$$

then,

$$|A_1| |B_1| \times |A_2| |B_2| \times \cdots \times |A_n| |B_n| = \prod_{k=1}^{k=n} |A_k| |B_k| \geq 1 \quad (4)$$

$$(\theta_1 + \phi_1) + (\theta_2 + \phi_2) + \cdots + (\theta_n + \phi_n) = \sum_{k=1}^{k=n} (\theta_k + \phi_k) = \text{zero or any integral multiple of } 2\pi. \quad (5)$$

From these equations it can be seen that an N -phase oscillator must consist of an amplifier capable of developing a voltage amplification of $1 / \prod_{k=1}^{k=n} |B_k|$ and a phase-shifting network that will satisfy the phase equation (5).

The requirements for individual stages of an N -phase oscillator are slightly different. The amplification of the stage must still be greater than, or equal to unity, but the stage output will have a definite phase shift with relation to its input, depending upon the number of phases being produced by the oscillator.

In this case,

$$A_k B_k \geq 1 / \pi(n+1)/n. \quad (6)$$

Thus, if

$$A_k = |A_k| / \theta_k \quad (7)$$

$$B_k = |B_k| / \phi_k \quad (8)$$

then

$$|A_k| |B_k| \geq 1 \quad (9)$$

$$\theta_k + \phi_k = [\pi(n+1)/n] \quad (\text{when } n \text{ is an odd integer}). \quad (10)$$

$$\text{In the usual case } \theta = \pi \quad (11)$$

$$\phi = [(\pi(n+1)/n) - \pi] = \pi/n \quad (\text{when } n \text{ is an odd integer}). \quad (12)$$

The circuit shown in Fig. 1 is that of a three-phase, resistance-capacitance coupled amplifier and its phase-shifting networks. To a close approximation we can assume that the amplifier stages have a phase shift of 180 degrees. In order to satisfy (10) and (12), the interstage coupling networks must be able to produce a phase shift of π/n or in the case of a three-phase oscillator [$+60$ degrees]. As will be seen, the ordinary resistance-capacitance coupling network is capable of accomplishing this for the N -phase case, although more complex networks must be used for single-phase oscillators.

The voltage amplification required by each stage depends critically on the type of phase-shift network used, being equal, numerically, to the attenuation of the coupling circuit at the frequency which produces a phase shift that is equal to π/n .

The second and higher-order harmonics occur at frequencies where the reactance of the coupling capacitor C_c is low and the phase shift through the coupling network approaches zero. Thus, the total phase shift of the three stages for harmonic frequencies will be approximately $[n\pi]$ (540 degrees for the three-phase case). This means that the harmonics will introduce a voltage almost 180 degrees out of phase into the amplifier input, reducing the output, thus effectively producing a negative-feedback amplifier with 100 per cent negative feedback and a zero output, at these frequencies. This tends to maintain a harmonic-free, pure sine-wave type of oscillation. This is especially true when the gain of the circuit is adjusted to a value that barely allows oscillations to be maintained. As a result of this linear operation of the amplifier, the generated harmonics are very low.

As in any multistage negative-feedback amplifier, care must be taken in the amplifier design to prevent unwanted oscillations at the edges of the pass band of the amplifier. In such amplifiers, the relative phase shift approaches 180 degrees near both the upper and lower edges of the pass band. To prevent oscillation at these points, it is necessary to insure that, at the extreme band limits, where the phase shift is high, the amplification has fallen off sufficiently so that the feedback factor of the amplifier is less than unity.

In the case of the *N*-phase oscillator, the phase-shift characteristics at the lower edge of the pass band are used to produce oscillations whose frequency is determined by the lower pass-band characteristics. Thus, it is necessary only to suppress the spurious oscillations at the extremely high frequencies.³ Oscillations at the upper edge of the pass band are best avoided by controlling the rate of cutoff; for example, by connecting a large shunt capacitor across one stage so as to reduce its gain to such an extent that the feedback factor will be less than unity at the point where the total phase shift of the *N* stages is 180 degrees.

III. THEORETICAL ANALYSIS OF THE THREE-PHASE CASE

Fig. 2(a) illustrates a single stage of the three-phase oscillator of Fig. 1. This can be represented by the equivalent circuit of Fig. 2(b), which may be further simplified by the use of Thevenin's theorem, to that of Fig. 2(c). The frequency of oscillation may be computed by finding the total amplification of the circuit, $|A_k| |B_k|$, and finding the frequency at which the phase shift of the coupling network, is equal to π/n .

From Fig. 2(c) the following set of equations may be written for the stage network.

³ In some cases there will be more than one condition at which the phase shift at the lower edge of the pass band will total 180 degrees. For example, if $n=7$ then $\phi=25.5/7$ or $\phi=77.1/7$. If this condition causes spurious oscillations, it may be necessary to control the rate of cutoff, at the lower edge of the pass band, in such a way that the feedback factor will be less than unity for the larger phase shift.

In the normal oscillator this is not necessary, as the gain has dropped off to such an extent, at this point, that oscillations cannot occur.

$$I(R_1 + R - jXc) = E \tag{13}$$

$$e_0/E = \alpha + j\beta = \sqrt{\alpha^2 + \beta^2} \tan^{-1} \beta/\alpha \tag{14}$$

$$\tan^{-1} \beta/\alpha = \pi/n. \tag{15}$$

Solving for I , $I = E/R_1 + R - jXc$.

Since $e_0 = IR$,

$$e_0/E = R/(R_1 + R - jXc) = (R(R + R_1)/(R + R_1)^2 + Xc^2) + (jRXc/(R + R_1)^2 + Xc^2) = \alpha + j\beta.$$

Or, since $\tan^{-1} \beta/\alpha = \pi/n = 60$ degrees,

$$\beta/\alpha = \sqrt{3} = RXc/R(R + R_1) = (1/2\pi fC/(R + R_1)).$$

Therefore, $f = 1/2\pi C\sqrt{3}(R + R_1)$. (16)

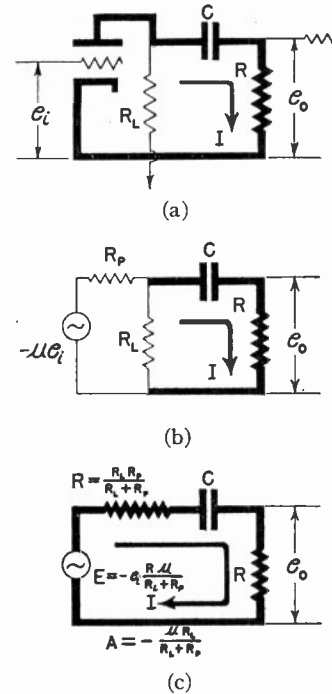

Fig. 2—Single stage of fundamental phase-shift oscillator.

The minimum gain necessary for oscillation may be determined from (14), since the scalar part of this equation determines the attenuation of the coupling network. But $E = Ae_i$, in order to produce oscillations e_i must equal e_0 , therefore

$$e_0 = e_i \quad E = Ae_i \quad \text{or} \quad e_0/E = 1/A.$$

$$E/e_0 = [(R + R_1) - jXc]/R = A \quad (\text{from (13)})$$

$$A = |A| / \phi = \sqrt{[R + R_1/R]^2 + [1/\omega RC]^2} \cdot \tan^{-1} Xc/(R + R_1)$$

$$= \sqrt{[1 + (R_1/R)]^2 + [\sqrt{3}(R + R_1)/\sqrt{3}(R + R_1) \times 1/\omega RC]^2} / \tan^{-1} \sqrt{3}/\sqrt{3} [1/\omega C(R + R_1)]$$

$$A = |A| / \phi = \sqrt{[1 + (R_1/R)]^2 + [3(f_0/f)^2 \{1 + (R_1/R)\}^2]} \cdot \tan^{-1} [\sqrt{3}(f_0/f)].$$

At resonance $f = f_0$ this reduces to

$$|A| = 2[1 + (R_1/R)]. \tag{17}$$

Fig. 3 presents the characteristics of the coupling networks for several different *N*-phase oscillators. It will be noted that, with the exception of the single-phase case, all of the oscillators use the simple coupling network of the resistance-coupled amplifier.

IV. FREQUENCY STABILITY

Unfortunately the frequency of oscillation is determined not only by the phase-shifting network but also by the value of R_1 which varies with operating conditions of the oscillator.

The greatest variation of R_1 is caused by the change in plate resistance R_p of the tube, due to plate-voltage vari-

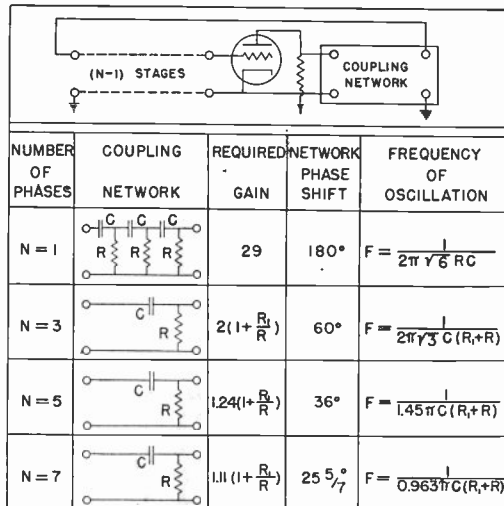

Fig. 3—Characteristics of coupling networks.

ations. It is, therefore, instructive to compute the frequency stability with reference to plate-resistance variations.

Let df be a small change in the frequency f due to the change in the resistance dR_1 resulting from a plate-voltage variation.

Frequency stability is defined as

Incremental change in oscillator frequency

$$\frac{\text{Frequency of the oscillator}}{\text{Incremental change in } (R_1 + R)} = -K_1'$$

$$\text{or } \Delta f/f = -K_1'(\Delta(R_1 + R)/(R_1 + R)).$$

$df/f = -K_1'(dR_1/(R_1 + R)) = -K_1(dR_1/R_1)$ where K_1 is the coefficient of stability. By a change in variables, this equation becomes

$$df/f = -K_2(dR_p/R_p). \quad (18)$$

The frequency stability of a three-phase oscillator is computed below.

$$f = 1/2\pi C\sqrt{3}(R + R_1) \quad R_1 = (R_L R_p / R_L + R_p).$$

Differentiating with respect to R_p

$$df = [1/2\pi C\sqrt{3}]^{(-1)}(R_1 + R)^{-2} dR_1$$

$$= (-1/2\pi C\sqrt{3}) \times (R_L^2 dR_p / (R_1 + R)^2 (1 + R_L/R_p)^2 R_p^2,$$

$$df/f = -R_L^2 / [R_L + R_p] [R_L + R(1 + R_L/R_p)] \times (dR_p/R_p).$$

Therefore

$$K_2 = +R_L^2 / [R_L + R(1 + R_L/R_p)] [R_L + R_p]. \quad (19)$$

For example, a typical design has the following set of constants.

$$R_L = 10,000 \text{ ohms} \quad R = 1,000,000 \text{ ohms}$$

$$R_p = 1,000,000 \text{ ohms} \quad f = 1000 \text{ cycles per second}$$

Substituting these values in (19), one finds that $K_2 = +9.7 \times 10^{-5}$. Thus a 10 per cent change in plate resistance of the amplifier tubes would result in a frequency change of 9.7×10^{-4} per cent or 0.0097 cycles per second. The frequency stability of this three-phase oscillator compares favorably with that of a regular single-phase phase-shift oscillator. Using the same constants, a single-phase oscillator would have a frequency shift of 0.0033 cycle per second, one third the shift of the three-phase case.

V. EXPERIMENTAL RESULTS

Single-phase oscillators of the phase-shift type are often sluggish in starting, due to the high gain needed to produce sufficient feedback for oscillation. This is especially true in variable-frequency oscillators where the attenuation of the phase-shifting network varies with frequency. In the polyphase case, however, the network attenuation is low, eliminating the need for high-gain tubes and thus insuring quick, positive starting oscillators.

Experience has shown that best sine-wave production is obtained where oscillations are barely sustained. Therefore, where purity of wave form is important, automatic amplitude control is indicated. Such arrangements are of especial value in variable oscillators covering an extended frequency range. When properly adjusted, this type of phase-shift oscillator generates high-precision sine waves with less than 0.1 per cent harmonic distortion.

One of the principal difficulties encountered in adapting the circuit of Fig. 1 to practical operation is in the application of variable-amplification control to the circuit. The most obvious means of using sharp cutoff tubes, biased near cutoff, to obtain variable-amplification-factor control of the amplitude of oscillations, is unsatisfactory as it generates unwanted harmonics and gives a very low output voltage. Although this type of control could be improved by using variable- μ tubes rather than sharp cutoff types, working as variable μ by excessive bias, some variable-amplification-control arrangement not involving variational tube characteristics is desirable. With this type of control, it would be possible to operate on the linear portion of the tube characteristic and obtain larger outputs without the accompanying distortion.

The method of amplitude control finally selected is patterned after that of Meacham,⁴ in that a thermal element (thermistor) is used as an amplitude control. This gives a type of amplitude limitation which allows the oscillator to operate on the linear portion of its characteristic, thus allowing a considerable amount of undistorted output to be obtained. The thermistor-controlled bridge, in contrast with the usual variable-amplification-control circuits, has several interesting and important properties. It has an infinite cutoff, at balance, whereas ordinary variable-amplification-control.

⁴ L. A. Meacham, "The bridge-stabilized oscillator," Proc. I.R.E., vol. 26, pp. 1278-1294; October, 1938.

Circuits have restricted ranges. Also, since the thermistor resistance cannot change materially over the time of one cycle of oscillation frequency (due to thermal inertia), the thermistor-controlled bridge introduces no distortion, or phase shift, with its consequent alterations of the frequency of oscillation as regulation takes place.

Fig. 4 shows the adaption of the negative-feedback thermistor bridge to a three-phase oscillator. It will be noted that the fundamental circuit has been modified by the addition of a cathode follower to each amplifier stage. These cathode followers supply the feedback voltage for the thermistor bridge and also allow push-pull output to be obtained from the individual stages.

For the oscillator to be satisfactory, this two-stage resistance-coupled amplifier must have a phase shift that is constant and independent of changes in supply voltages, etc. In addition, the means by which the amplitude of oscillation is controlled, so that the tubes will operate as class A amplifiers, must not depend on, or affect, the tube characteristics.

Constant amplifier phase shift is necessary in order to insure a stable frequency. This is because the phase shift of the interstage transfer impedances of the resistance-capacitance networks vary slowly with frequency. Hence, small changes in amplifier phase shift, as could be brought about by a variation in supply voltage, require a large change in oscillator frequency to produce a compensating phase shift in the resistance-capacitance system.

A stable phase characteristic, such as is obtained in this circuit by means of the negative-feedback thermis-

tion) is obtained by the nonlinear action of the negative-feedback thermistor bridge which prevents oscillations from building up to such a large amplitude that distortion occurs. The cathode bias of V_1 is supplied by the

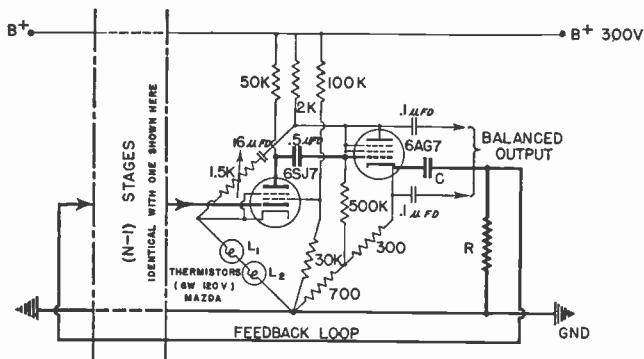

Fig. 4—One stage of the experimental oscillator.

tor bridge, can be obtained readily in the amplifier by using a large amount of negative feedback. This large amount of negative-voltage feedback, plus the use of the second tube as a cathode follower, reduces and stabilizes the output impedance of the tubes to such an extent that the frequency of oscillation is practically independent of changes in the supply voltages or the characteristics of the amplifier tubes. The output impedance of the cathode follower is so low that in formula for frequency (16), it is possible to neglect the term R_1 .

Amplitude control (variable-amplification-control ac-

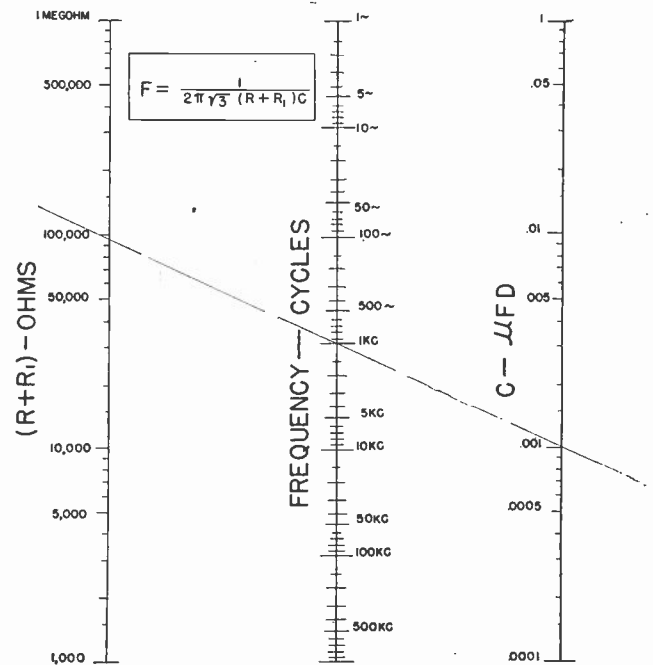

Fig. 5—Nomograph for the design of three-phase oscillators.

voltage across the thermistor, the resistance of which varies rapidly with current at the temperature at which they operate in the circuit. Thus, an increase in oscillation amplitude increases the thermistor resistance. This makes the negative feedback larger and decreases the gain of the amplifier, reducing its tendency to oscillate. Similarly, as the oscillations decrease in amplitude, the current through the thermistor is reduced, lowering its resistance and thus reducing the negative feedback and increasing the oscillator's tendency to oscillate. The resultant effect is that a constant amplitude of oscillation is maintained with no tendency to distort the wave shape. The absolute amplitude of oscillation can be varied by adjusting the resistance arm R_3 of the feedback bridge.

Although the circuits discussed in this article are directly applicable only to the generation of oscillations of odd phases, that does not preclude the possibility of using them as components of networks developing even-phase voltages. For example, with the addition of a phase inverter to each stage of a three-phase oscillator, a six-phase output can be obtained (see Fig. 4). The common methods of phase changing such as the Scott-T connection may also be used.

The nomograph of Fig. 5 is very convenient for use during the preliminary design of three-phase oscillators. This nomograph is accurate enough for ordinary work where the greatest errors arise from the relatively large tolerances in commercial components.

Institute News and Radio Notes

Board of Directors

June 6 Meeting: At the June 6, 1945, meeting of the Board of Directors, the following were present: W. L. Everitt, president; G. W. Bailey, executive secretary; S. L. Bailey, W. L. Barrow, E. F. Carter, L. M. Clement, W. H. Crew, assistant secretary; Alfred N. Goldsmith, editor; R. F. Guy, R. A. Hackbusch, R. A. Heising, treasurer; Keith Henney, L. C. F. Horle, F. B. Llewellyn, Haraden Pratt, secretary; W. O. Swinyard, H. M. Turner, H. A. Wheeler, L. P. Wheeler, and W. C. White.

Executive Committee Actions: The actions of the Executive Committee, taken at its June 6, 1945, meeting, were unanimously approved.

Membership Approval: It was unanimously agreed that Section 25 of the By-laws be altered so as to empower the Executive Committee to give final approval to applications for transfers and admissions to any grade of membership, with the exception of Fellow.

Constitutional Changes Regarding Membership Period: Unanimous approval was given to the recommendation that the Constitution and Laws Committee be instructed to prepare changes in the Constitution which will permit the dating of a member's period of membership, when approved, back to the first of the month after the receipt of his application; which will cause the member's annual dues period to run correspondingly; and will cause his receipt of the publications of the Institute to run concurrently with his membership period.

Constitutional Voting on Suggested Changes: Approval was given to the recommendation that the Constitution and Laws Committee, if possible, arrange for the submission of the constitutional amendments proposed in Minute 160 to the membership at a time to permit the voting thereon to be received and recorded before the end of 1945.

Canadian Council: The recommendation to transmit to the Canadian Council a fund of a specific amount deemed suitable to cover operating expenses for 1945 was unanimously approved.

Committees and Appointments

Constitution and Laws: The following, proposed constitutional amendments were submitted:

- "Article II, Section 1b: Senior Members, who shall be entitled to all rights and privileges of the Institute."
- "Article II, Section 1d: Associates, who shall be entitled to all rights and privileges of the Institute except the right to hold any office, including those of the Sections, the Chairmanship of any Standing Committee, and the right to vote. However, Associates of record on March 31, 1939, shall have the right to vote so long as a continuous membership

since that date is maintained. Furthermore, the restriction on holding the Sections' offices other than Chairman and the Chairmanship of the Standing Committees of Sections shall not be operative until January 1, 1947."

It was unanimously approved that (b), as here submitted, be delayed in submission to the voting membership pending further advice from the Chairman of the Sections Committee. Approval was given to the proposal that (a) be submitted with the ballot to the voting membership.

Membership Solicitation Policy: A report was presented which included the following recommendation:

That the Sections be queried on the question of indicating in the YEARBOOK where a person had been a member at intervals of time, rather than indicating the last period of membership. It was unanimously approved that this recommendation be left to the Executive Committee for action.

The committee stated that it had discussed at length the question of broadening the base of the Institute to include technicians. Following the discussion, the committee had decided to inform the Board that the committee declined to make a recommendation on this question.

After a discussion by the Board on broadening the membership base of the Institute, it was moved that the Board ask the Membership Solicitation Policy Committee to consider, though not necessarily to adopt, a proposal that it is the policy of the Institute

(a) To add to its membership such technicians and other engineering workers as will readily derive benefit from the technically sound presentation of historical, tutorial, or current engineering data, and

(b) To endeavor to provide such Section and other activities, and publications, to the membership, as will be of assistance to the above-mentioned types of members.

This proposal was unanimously approved.

During the discussion of the broadening of the base, Mr. G. W. Bailey stated that, due to the small attendance at the committee meeting, and the many factors involved, he felt that the ground had not been adequately covered, and he accordingly advocated further consideration on the whole subject by a large group of the Board.

New Membership Solicitation Policy: The following appointments to the New Membership Solicitation Policy Committee were unanimously approved:

F. B. Llewellyn, *Chairman*
Alfred N. Goldsmith Keith Henney
R. A. Heising L. C. F. Horle
L. P. Wheeler

Nominations: It was unanimously approved that the Board proceed to ballot on the nominations proposed by the Nominations Committee.

The Board thereupon proceeded to ballot, with the following nomination result:

President: F. R. Llewellyn

Vice-President: E. M. Deloraine

Upon conclusion of balloting, the President declared the following six members nominated for Directorships: W. R. G. Baker, Walter Evans, R. A. Hackbusch, F. R. Lack, D. B. Sinclair, and W. O. Swinyard.

Professional Recognition: Chairman White presented the following recommendation, which was unanimously approved:

"Our Committee recommends that, for the present, the Institute confine its activities on collective bargaining to further study and the advising of its membership of the best available information on the subject, either sent in response to requests, or through publication of certain items in the PROCEEDINGS, or both. It also recommends that a committee continue actively to study the subject so that the Board may be informed or advised of any new developments that might make it desirable for the Institute to participate.

"It is further recommended that the Institute accept or seek representation on any committee studying the problem jointly in behalf of a group of recognized engineering societies."

Special Committee on Board Meetings: Mr. Heising, at the request of Mr. H. A. Wheeler, presented the recommendation, which also was unanimously approved.

"That the Special Committee on Board Meetings be authorized to send to the Board of Directors and to the Constitution and Laws Committee a draft of proposed amendments embodying the plan for regional representation, and the Constitution and Laws Committee be requested to prepare and to submit to the Board a final draft of the proposed amendments in a form suitable for action by the Board."

Executive Committee

June 6 Meeting: The Executive Committee meeting, held on June 6, 1945, was attended by W. L. Everitt, president; G. W. Bailey, executive secretary; S. L. Bailey, W. L. Barrow, W. H. Crew, assistant secretary and acting technical secretary; Alfred N. Goldsmith, editor; E. Finley Carter, R. A. Heising, treasurer; and Haraden Pratt, secretary.

Membership: The following actions were taken on matters presented by the Admissions Committee:

Test Case: It was unanimously approved that the policy with respect to applications for transfer or admission to membership from applicants dealing with the legal or related technical aspects of patents be as follows: Inasmuch as the proper public expression and legal protection of the technical advances originated by engineers do contribute to engineering and engineering welfare, and accordingly to the advancement

of engineering and science, the work of a patent attorney of suitable advanced grade and proved competence falls within the provisions of the Constitution covering the grade of Senior Member.

The following transfers and applications for membership were unanimously approved: For transfer to Senior Member grade, R. B. Albright, J. R. Bach, F. J. Bleil, W. R. Dresser, D. G. Fink, W. E. Gilbert, T. S. Gray, J. C. Herber, R. W. Hickman, J. B. H. Kuper, W. S. Lemmon, Roger McSweeney, Louis Malter, E. C. Manderfeld, G. H. Munro, J. A. Rado, D. S. Rau, H. E. Rice, J. B. Russell, F. W. Schor, M. L. Thompson, J. A. Wood, Jr., and J. D. Woodward; for admission to Senior Member grade, J. F. Byrne, R. V. Coles, R. H. Davies, W. E. Koch, and G. H. Phelps; for transfer to Member grade, George Abraham, D. E. Arnold, R. E. Bailey, G. E. Beggs, Jr., Robert Biedenbender, E. L. Brown, V. C. Campbell, W. S. Carley, H. J. Carter, E. L. Cave, J. H. Copp, S. C. Coroniti, G. F. Craig, R. P. Dimmer, G. F. Elston, F. J. Gaffney, George Glinski, A. L. Goepfinger, P. E. Grandmont, D. A. Heisner, C. F. Hobbs, K. B. Hoffman, R. H. Jones, Jr., M. J. Kobilsky, J. W. Koch, P. H. Kreager, R. P. Lett, Clair Lewis, B. T. McNeil, W. D. Montgomery, L. H. Naum, R. P. Owen, R. K. Phatak, J. W. Rabb, A. E. Richmond, A. J. Rohner, H. H. Schwartz, J. B. Sherr, C. E. Sturtevant, M. J. Werry, R. N. White, E. W. Yetter, and L. W. Zabel; for admission to Member grade, M. E. Ames, Jr., A. M. Bacon, H. L. Barney, L. E. Bessemer, I. S. Boak, E. S. Brotzman, H. R. Callahan, R. T. Capodanno, W. T. Carnes, Jr., Haing-Pao Chung, Nicholas Chako, R. A. Clark, Jr., W. P. Cole, R. W. Cushman, M. F. Davis, R. H. Edmonds, F. S. Fisher, Kenneth Glace, R. K. Haines, N. E. Handel, D. E. Hannum, M. T. Harges, Bernard Hecht, J. H. Henninger, D. F. Holshouser, H. N. Jacobs, Jack Kline, Shao-hsiung Kung, J. R. Lamgham, J. F. Lorber, Dah-You Maa, T. J. Mann, R. L. Mattingly, A. H. McRae, A. F. Miller, E. G. Miller, Jr., Sidney Moskowitz, Reuben Nathan, A. M. Okun, H. J. Oosterling, Ernest Pappenfus, W. E. Phillips, Jr., W. L. Pitts, J. H. Pomerene, S. J. Reisman, B. E. Schnitzer, W. E. Schuyler, Jr., Abe Shulman, R. R. Simons, S. S. Smith, D. H. Strangways, S. J. Sysko, C. C. Taylor, L. W. Thomas, R. L. Trent, F. R. Wagner, H. K. Warner, R. P. Watson, S. A. Westwood, and Bert Zarky; Associate grade, 158; and Student grade, 92.

Amendment to Sections Constitution: It was unanimously approved that Article II, Section 2, be amended to read as follows:

"Sec. 2—All Fellows (Senior Members) Members, and Associates of the Institute residing within the territory of the Section shall be entitled to attend meetings, vote, and hold office, except that only members of Member or higher grade can hold the office of Chairman."

Committees and Appointments

New Technical Committees: It was unanimously approved that the following new Technical Committees be appointed:

Research Committee: —

Handbook Committee: H. A. Wheeler, *chairman*

I.R.E.-I.E.E. Co-operation

The Institute of Radio Engineers will be interested to learn of the plans of any of its members who expect to visit England. The Institution of Electrical Engineers, in London, has kindly expressed its willingness to arrange for members of the Institution to meet with I.R.E. members in England in cases where such individuals have interests in common. It is thus hoped to ensure, from the point of view of two societies, the most fruitful outcome of the opportunities afforded by these visits for a general interchange of views.

Members of the I.R.E. planning to visit England and desiring to make such arrangements should send the appropriate information to the Executive Secretary of the I.R.E., Mr. George W. Bailey at 330 West 42nd Street, New York 18, N. Y., for transmission to The Institution of Electrical Engineers in England. If possible, four weeks notice should be given.

Medical Electronics Committee: G. W. Horton, *chairman*

Railroad and Vehicular Communications: W. T. Cooke, *chairman*

Industrial Electronics: —

and that the Constitution and Laws Committee be instructed to revise the third paragraph of the Bylaws, Section 46, to include these additional Committees.

Unanimous approval was given to the proposal that the name of the Radio Wave Propagation Committee be changed to "Radio Wave Propagation and Utilization Committee," and that the Constitution and Laws Committee be instructed to prepare an amended bylaw to be submitted to the Board.

Proposed Committee Personnel: The following appointments were unanimously approved:

ADMISSIONS

H. A. Chinn J. C. Stroebel
A. R. Morton F. D. Webster

ORGANIZATIONAL RESEARCH

S. L. Bailey Saul Dushman
Ralph Bennett E. W. Engstrom
Earl Cullum J. W. McRae
L. A. DuBridge D. B. Sinclair

PUBLIC RELATIONS

F. W. Albertson E. M. Webster

NORTHWESTERN UNIVERSITY REPRESENTATIVE

R. E. Beam

SOUTHERN METHODIST UNIVERSITY REPRESENTATIVE

A. V. Stanton

Canadian Council: It was unanimously approved that the Executive Committee

recommend to the Board that a certain, appropriate sum be transmitted to the Canadian Council to cover operating expenses for 1945.

Proceedings: Dr. Alfred N. Goldsmith reported that a further extensive study on the paper situation has been prepared for presentation to the WPB as an appeal and is in the hands of the General Counsel.

The papers bank for the PROCEEDINGS is in excellent condition. A report on the returns from the membership survey on papers has been turned over to the Papers Procurement Committee and indicates a satisfactory anticipated supply of papers.

Committee Personnel: The following appointments were unanimously approved for the Board of Editors:

Radio and Nonradio Law: A. W. Graf
Electronics, Methods, and Definitions: E. D. McArthur

The following appointments were unanimously approved:

Papers Procurement Committee; Subcommittee on Microwaves of Electron-Tube Group: R. M. Bowie

Home Receiver (Sound) Group: John Reid
Publication of "Standard Frequency Ranges": Mr. H. A. Wheeler requested the publication of "Standard Frequency Ranges" in the PROCEEDINGS, with the request for expressions from the membership, and this was approved. (See page 548.)

1946 Winter Technical Meeting: Mr. S. L. Bailey reported that Mr. E. J. Content had accepted the Chairmanship of the 1946 Winter Technical Meeting and already has most of his committee chairmanship acceptances; that because of a six months' definite limit, no application can be made to the Office of Defense Transportation until July; that reservations had been made at the Hotel Commodore for the ballroom floor for January 23-26, 1946, as a tentative action depending upon later approval of the Office of Defense Transportation.

New Patent Office Service

Commencing June 1, 1945, the United States Patent Office has put in operation a new service to industry and inventors. The purpose of the service is to bring to the attention of the nation patented inventions under which the owners are willing to grant licenses on reasonable terms; it is hoped that such information will lead to greater employment opportunities in the reconversion period, as well as permit industry to become acquainted with what is being done in various fields.

To accomplish the purposes set out above, a Register of Patents Available for Licensing is now being established, and will be maintained in the United States Patent Office. Patents recorded on this register will be available to the public for inspection in Washington, D. C. Lists of such patents will be published in the Official Gazette of the Patent Office; and it is hoped that engineering periodicals will be able, from time to time to publish selected lists applicable to their fields.

The viewpoint of the I.R.E. membership relative to such publication would be of interest to the Institute's Editorial Department.

Report of the Standards Committee Relating to Standard Frequency Ranges

During the past few years, the increasing use of higher radio frequencies has made it desirable to divide the frequency spectrum into frequency ranges with standard designations, in order to obviate the use of such indefinite terms as "short-wave," "long-wave," etc. There have been several suggestions for the required terminology. These have been reviewed by the Standards Committee and the accompanying table entitled "Standard Frequency Ranges" is submitted as a reasonable solution to the problem.

that the wave velocity is 300,000,000 meters per second. In any case where the required precision makes this assumption inadequate, the exact boundaries of the ranges should be based on the frequency range, not the wavelength range.

This table has been adopted as a standard of the I.R.E. As such it is recommended for general use. At the same time, any comments by way of criticisms or further suggestions relating to this problem are welcome. They should be addressed to the Chairman of the Standards Committee in care of the Institute of Radio Engineers, 330 West 42nd Street, New York 18, N. Y.

HAROLD A. WHEELER
Chairman, Standards Committee 1944-1945

STANDARD FREQUENCY RANGES

Range Number N	Frequency Range		Wavelength Range		Wavelength Range Designations	Frequency-Range Designations
	Lower Limit (exclusive)	Upper Limit (inclusive)	Lower Limit (inclusive)	Upper Limit (exclusive)		
0	0.3 c	3 c				
1	3 c	30 c				
2	30 c	300 c				
3	300 c	3 kc				
4	3 kc	30 kc	10 km	100 km	ten-kilometer	very-low-frequency (v-l-f)
5	30 kc	300 kc	1 km	10 km	kilometer	low-frequency (l-f)
6	300 kc	3 Mc	1 hm	10 hm	hectometer	medium-frequency (m-f)
7	3 Mc	30 Mc	1 dkm	10 dkm	dekameter	high-frequency (h-f)
8	30 Mc	300 Mc	1 m	10 m	meter	very-high-frequency (v-h-f)
9	300 Mc	3 kMc	1 dm	10 dm	decimeter	ultra-high-frequency (u-h-f)
10	3 kMc	30 kMc	1 cm	10 cm	centimeter	super-high-frequency (s-h-f)
11	30 kMc	300 kMc	1 mm	10 mm	millimeter	

Adjective for Nth range = Nth-range frequency.

A few years ago, the Armed Forces adopted a series of names and abbreviations covering seven decades of the radio-frequency spectrum. These appear in the last column of the accompanying table. These were in turn adopted by the Interdepartment Radio Advisory Committee and the Federal Communications Commission. They have been used in many publications.

In October and November, 1943, the Standards Committee considered these terms and, by a large majority, voted that they were not considered suitable for adoption by The Institute of Radio Engineers.

Recently this subject has been reconsidered by the Standards Committee with due attention to this and other terms for designating the various ranges of the frequency spectrum. There was general agreement that a decade system of frequency ranges is a logical and satisfactory method of subdividing the frequency spectrum. There was no unanimity favoring any one set of terms for these ranges. The accompanying table gives the two sets of terms which were considered satisfactory by a majority of the committee. Other designations which were proposed met with considerable disfavor within the committee and therefore were discarded.

The proposed system divides the frequency spectrum into decade ranges with boundaries which are convenient numbers expressed in terms of frequency and wavelength. The designation of each wavelength range is merely the name of the metric unit of length which is equal to the wavelength at the lower limit of the range. The designation of each frequency range is the term adopted by the Armed Forces. In addition, each decade is given a range number which may be used as a short designation.

The table is based on the approximation

Frequency-Modulation Committee of FCC

The United States Federal Communications Commission, through its chief engineer, George P. Adair, recently invited a group of engineers to serve as a committee to work with the Federal Communications Commission staff in conducting further tests on frequency-modulation transmission in the 44- to 108-megacycle band throughout the summer months, preliminary to a final allocation of frequencies to this service. Among those invited to serve on the committee were the following members of The Institute of Radio Engineers:

Major Edwin H. Armstrong (A'14-F'27)
Professor of Electrical Engineering
Columbia University
New York, N. Y.

Dr. D. E. Noble (A'25-SM'44)
Director of Research and Communications
Galvin Manufacturing Corporation
Chicago, Ill.

Dr. W. R. G. Baker (A'19-F'28)
Vice-President
General Electric Company
Bridgeport, Conn.

Dr. T. T. Goldsmith (A'38)
Allen B. Du Mont Laboratories, Inc.
Passaic, N. J.

Raymond Guy (A'25-M'31-F'39)
National Broadcasting Company
New York, N. Y.

Dr. William B. Lodge (A'34-M'37-SM'43)
Columbia Broadcasting System
New York, N. Y.

David B. Smith (A'35-SM'44)
Director of Research
Philco Radio and Television Corporation
Philadelphia, Pa.

C. M. Jansky, Jr. (A'18-M'25-F'28)
Jansky and Bailey
Washington, D. C.

Everett Dillard (A'38)
Commercial Radio Equipment Company
Washington, D. C.

Dr. Harold H. Beverage (A'15-M'26-F'28)
R.C.A. Communications, Inc.
New York, N. Y.

Dr. Charles R. Burrows (A'24-M'38-SM'43-F'43)
Civil Committee on Propagation
National Defense Research Committee
New York, N. Y.

G. F. Leydord (A'36-SM'44)
Crosley Corporation
Cincinnati, Ohio

Cyrus T. Read (A'43)
The Hallicrafters Company
Chicago, Ill.

D. C. Summerford (A'39-M'44)
Assistant Technical Director, WHAS
Louisville, Ky.

J. R. Poppele (A'30-M'39-SM'43)
WOR, Bamberger Broadcasting Company
New York, N. Y.

Frank Marx (A'41)
The Blue Network
New York, N. Y.

Dr. H. W. Wells (A'36-M'36-SM'43)
Carnegie Institute of Washington
Washington, D. C.

G. E. Gustafson (A'27-M'38-F'40)
Vice-President in Charge of Engineering
Zenith Radio Corporation
Chicago, Ill.

Frank A. Gunther (A'25-M'30-SM'43)
Vice-President in Charge of Engineering
Radio Engineering Laboratories, Inc.
Long Island City, L. I., N. Y.

Robert Higgy (A'26)
WOSU
Columbus, Ohio

Carl H. Wesser (A'41-M'42-SM'43)
Chief Engineer, WENA
Detroit, Mich.

Public Relations Committee

The Public Relations Committee of the Institute held a meeting in Washington on Monday, May 7, 1945 in the offices of Jansky and Bailey, there being present: I. S. Coggeshall, chairman; O. B. Hanson; G. W. Bailey, executive secretary; C. M. Jansky, Jr.; Commissioner E. K. Jett; A. F. Van Dyck; S. P. McMinn, representing O. H. Caldwell; and R. F. Guy, guest.

The Committee acted, by request of the Board of Directors, in recommending a legislative program for the Institute.

It was the consensus that the bestowal of the Institute's War Service Awards should be deferred until a more propitious time for the selection of those to be honored.

The need was stressed for the Institute office to undertake, as soon as professional talent is engaged in connection with the society's expanding program, the release of publicity items and photographs to the press. The Committee voted to recommend that technical items be made a prominent feature of such releases, following the plan so successfully used by the National Geographic Society in its series:

"According to the National Geographic ..."

A suggestion was made that it would be appropriate for the Institute, from the viewpoint of its public relations, to take a technical position in connection with the use of frequencies for low-power devices, devices on the border line of radio transmission and inductive coupling, diathermy, inductive heating, and the like, with regard to licensing as a control against interference with other services.

The Committee will give further attention to a project of popular lectures, to be sponsored by Institute's Sections, designed to tie the Institute more closely to the public.

First I.R.E. International Convention Fifteen Years Ago

On August 18-21, 1930, the first international convention of The Institute of Radio Engineers was held in Toronto, Canada. This was also the fifth annual convention of the Institute. During that year, the President of the Institute was Dr. Lee de Forest.

The meeting was also of major interest in that there was conducted a joint meeting of the I.R.E. and of the engineering division of the Radio Manufacturers Association. A number of instructive papers dealing with manufacturing problems were presented at the time. The Toronto Section of the Institute had already been active for five years.

Among the prominent members of the Institute who were active in the first International Convention were, on the Convention Committee, R. A. Hackbusch, A. B. Oxley, and K. S. Van Dyke; on the Exhibition Committee, Virgil M. Graham and I. G. Maloff; on the Ladies' Committee, Mrs. R. A. Hackbusch; on the Membership and Fellowship Committee, C. P. Edwards and L. C. F. Horle; on the Publicity Committee R. A. Hackbusch, O. E. Dunlap, and Donald McNicol; and on the Banquet and Entertainment Committee, A. B. Oxley and F. P. Guthrie.

DANA BACON

Friends of Dana Bacon were saddened to learn of his death on May 24, 1945. He was held in deep affection by all those who worked with him and was consulted on personal problems as well as technical ones. Mr. Bacon gave advice freely to all who requested it and carried on a large correspondence with amateurs all over the country.



DANA BACON

He was born on December 23, 1905, and was graduated from Northeastern University in 1926 with the B.E.E. degree. He was with the Boston Edison Company in their instrument testing laboratory before going to the National Company in Malden, Massachusetts, where he was for the past twenty years and where he was chief electrical engineer at the time of his death. He was an active radio amateur and developed many radio circuit features including crystal filters, radio-frequency coupling circuits, noise limiters, etc.

Mr. Bacon joined the Institute as an Associate in 1931. He was a member of the Papers Committee for one year and vice-chairman of the Boston Section one year.

In the fifteen years following the first I.R.E. International Convention in Toronto, additional Sections of the Institute have been formed in Canada, and the membership has multiplied greatly. An important new group, the Canadian I.R.E. Council, has been formed to represent the I.R.E. membership in Canada in matters affecting their relationship with the Canadian Government and in certain similar matters. The growth of the Canadian I.R.E. activities, and their steady increase in scope and value to the profession, have been a source of added strength to the Institute. The essential solidarity of the Canadian membership of the Institute and its other membership groups is a fortunate indication of the international nature of science and of the friendly relationships existing between these groups.

Wallace B. Caufield, Jr.

By direction of the President of the United States, a Bronze Star Medal for meritorious achievement in connection with military operations against an enemy of the United States during the period indicated has been awarded posthumously by the War Department to Wallace B. Caufield, Jr., an American civilian.

The citation reads as follows:

"During the period from November, 1944, to January, 1945, Mr. Caufield served with the Headquarters Ninth Air Force, Advanced, as civilian advisor on matters pertaining to radio counter measures. He also served in both the Mediterranean and European Theaters of Operation, often in forward combat areas in order to obtain first-hand information and to advise the commanders of advanced units on matters relating to radio counter measures. Although a civilian, and not required to expose himself to the hardships of field conditions, he lived in the field during a large part of his association with the Ninth Air Force, and, of his own volition, subjected himself to all the dangers of combat. By accepting such additional risks he was able to obtain valuable information and to offer more significant advice than would have been possible otherwise. His efforts contributed materially to the planning, training, and execution of an important technical program of the Ninth Air Force.

Date of the award 30 April 1945, European Theater."

Mr. Caufield was an Associate Member of the Institute.



Engineer Talks on Crystals

In a paper delivered before the Rochester, New York, Section of I.R.E. on April 19, 1945, A. A. Leonard (A'41) of North American Philips Company, Inc., covered some interesting points concerning present and future problems in quartz crystal application.

A few matters discussed were piezoelectric effect, electromechanical coupling, lattice, axes (including imaginary Y), coupling between modes of vibration, manufacturing tolerances, equivalent circuits, "Miller" effect, frequency standards, and a suggested "figure of merit."

Speaking of the future, Mr. Leonard said, "Peacetime requirements may also be very large. At least two manufacturers of receivers for the broadcast band are much interested in using crystals to stabilize push-button tuning. Frequency-modulation receivers, crystal-tuned, have been built, and crystals appear to be a very practical way to solve the difficult problem of tuning. Television receivers will probably be crystal tuned."

"Since the crystal moves mechanically, it can be used to generate mechanical vibrations at radio frequencies, or 'supersonic' waves. They will be used to emulsify, demulsify, and homogenize chemicals and foods and to control bacterial and crystal growth."

Correspondence

Correspondence on both technical and nontechnical subjects from readers of the PROCEEDINGS OF THE I.R.E. is invited subject to the following conditions: All rights are reserved by the Institute. Statements in letters are expressly understood to be the individual opinion of the writer, and endorsement or recognition by the I.R.E. is not implied by publication. All letters are to be submitted as typewritten, double-spaced, original copies. Any illustrations are to be submitted as inked drawings. Captions are to be supplied for all illustrations.

Radio-Noise-Meter Performance

Since radio-noise-meter performance is a matter of keen current interest, and since many people have attached considerable weight to the results of Mr. Charles M. Burrill's tests, I should like to raise some questions concerning his study, "An Evaluation of Radio-Noise-Meter Performance in Terms of Listening Experience" in the October, 1942, issue of the PROCEEDINGS.

These remarks are meant to point to certain pitfalls in conducting listener tests, and not to reflect on the quality of Mr. Burrill's research. In fact, Mr. Burrill is to be commended for using psychological techniques and especially for his fruitful application of statistical methods to a problem in engineering research.

Mr. Burrill has found a high degree of relationship between noise-meter measurement and listener judgment of disagreeableness of sound. In so doing, he used a six-point rating scale, on which listeners could register their feelings. The scale ranged from *A* (entirely satisfactory) to *F* (speech unintelligible). On the basis of his finding, he implies that the meter can be substituted for subjective experience, or in other words, that subjective feeling can be predicted from meter readings. This is a valid conclusion provided that predictions of subjective experience from the meter readings are made only in terms of the six-point scale used in the research.

Recently, however, engineers have attempted to apply the meter to a use which goes beyond the limitations of Mr. Burrill's research, that is, to determine the exact amount of interfering noise where agreeableness ends and disagreeableness begins. Such an extension cannot be made from Mr. Burrill's data because his rating scale does not define such a point. The threshold of just noticeable disagreeableness may lie on his scale anywhere between *B* (very good, background unobtrusive) and *D* (background very evident, but speech easily understood). How much of the background listeners will tolerate still remains an open question.

Additional research is required to answer this question. The rating scale may be useful to establish general relationships but it cannot be used for certain specific problems like the one cited above. Instead, once the rela-

tionship has been established, other techniques must be employed to determine the point of disagreeableness. For this purpose, two standard methods used in experimental psychology are available:

(1) *Paired comparisons*—Different noise conditions are presented to the listener in alternate pairs. All the listener has to do is indicate which of the two conditions he prefers, or finds less objectionable. The experimenter introduces enough different paired conditions so that he can determine the exact point at which interference becomes just noticeably disagreeable (or any other criterion desired).

(2) *The method of limits*—A radio program can be played at a relatively constant sound intensity, while the listener controls a dial which introduces more or less interfering noise at will. The listener is instructed to turn the dial back and forth until he reaches the point of just noticeable disagreeableness. Research with this technique has shown that while the listener will not always arrive exactly at the same point each time, he usually comes pretty close. An average of several readings proves to be rather reliable. This is probably a better technique than the first because it is likely to yield a more accurate statement of the threshold of disagreeableness. In addition, for a completely satisfactory test certain other requirements must be met: (1) A larger number of subjects than the 30 used by Mr. Burrill is needed to assure an adequate sample and to study individual variation. (2) The subjects should be a cross section of radio listeners, since engineers and technical people, because of their specialized training, often react quite differently from average listeners. (3) A larger variety of interfering noises, as well as types of radio material should be used, since the point of disagreeableness may vary with type of noise and with program content.

It is noteworthy that engineers are becoming more aware of the need to study listener reaction, and that they are using psychological techniques in their research. However, just as different meters are suitable for different purposes, psychological instruments vary in their usefulness. Subjective feeling must be as carefully measured as the physical characteristics of sound. In listener tests, the listener must be given an opportunity to make an objective judgment. The situation must be so arranged that the listener can make a decision with ease and with complete self-confidence.

PHILIP EISENBERG,
Research Psychologist
Columbia Broadcasting System
New York 22, N. Y.

Professional Status of the Engineer

The following comments are intended in connection with the several stimulating articles on the professional status of the engineer which appeared in the May, 1945, PROCEEDINGS.

Too close a comparison between the status of the lawyer, the doctor, and the clergyman and that of the engineer cannot properly be made, since the former meet problems which are not uniform in nature and must be solved individually, the solution

also being unique, so far as the client is able to determine. Furthermore, there are often strong subjective motives which lead the client to seek expert advice. The engineer is frequently called upon to solve the same problem for several million people; his solution, when given, is often capable of unlimited application and is subject to objective criticism. The linen of the engineering profession is almost inevitably on exhibition to the public while that of the doctor and the lawyer is carefully kept in the laundry as a matter of custom and principle. It thus appears impossible and is probably undesirable that the engineering profession ever enjoy the uncritical respect which is accorded the others. Accurate but simple interpretation of the engineering profession to the public seems the prime essential to its elevation in public esteem. Despite the sincere efforts by many of the larger journals to maintain a reasonable standard of accuracy in writing on technical subjects, active co-operation by local units of national professional organizations could do much to reduce misinterpretation of legitimate news and to permit appropriate evaluation and disposition of the inflated claims to glory which even organizations having outstanding commercial research laboratories frequently release through publicity channels. The Executive Secretary of the Institute should be able to offer helpful comment in this connection.

If, as a preliminary to a formal appearance before the public, the profession requires a definition of engineering, I suggest the one originally sponsored, I believe, by the United Engineering Trustees: "Engineering is the science of controlling the forces and utilizing the materials of nature for the benefit of man, and the art of organizing and directing human activity in connection therewith." The use of the word "science" prevents this definition from including too much; no man is a scientist who does not know the boundaries which differentiate the experimentally demonstrable facts which he knows, from the empirically acquired rules which must be employed only subject to experimental confirmation of their adequacy in the particular case.

If engineering is to achieve general recognition as a profession, the best possible methods for selecting engineering students will be no more than adequate. I consider it unfortunate that the choice of engineering as a curriculum is frequently made when the student is still in the process of adjusting himself to the obligations of maturity. To some youths the immutability of physical laws appears to offer a tempting refuge from the vagaries of human behavior. He enters upon a course of engineering studies, and graduates to find that success in engineering requires just as much skill in the conduct of personal relationships as does any other field of endeavor, or that his clarified view of his environment enables him to see that his true interest is in another direction. Such men too frequently become the Micawbers of the profession. They constitute a definite problem whose solution will probably baffle directors of admission to engineering schools for some time to come.

HENRY W. KAUFMANN
1636 Abingdon Drive
Alexandria, Virginia

Growth of Electronics in the Fleet Personnel of Electronics Division Bureau of Ships*

(A Communication from the United States Navy Department)

As an index of the growth in importance of electronics to our fleet, an interesting comparison recently came to light of the personnel engaged in planning the design, procurement, production, distribution, installation, and maintenance of electronic equipment in the current war and in World War I.

At the time of the World War I armistice, the total staff of the then "Radio Division" which was established in 1910 numbered 75 officers and 25 civilians. As of April 1, 1945, the staff of the Electronics Division now under the direction of Commodore (then Captain) J. B. Dow, United States Navy, has grown to 1160, composed of 459 officers, 487 civilians, and 214 WAVES. Just prior to December 7, 1941, the total division personnel number was 107. In other words, the present personnel is sixteen times as large as the World War I group, and over eleven times as large as the personnel in the period just before our entry into the war in 1941.

It is also interesting to note that the World War I organization included three primary sections, Ship, Shore, and *Aircraft*. The emphasis on aircraft as early as 1917 indicates the Navy's strong interest in aviation as applied to naval science, and explains why the United States Navy has always led the way in the development of Naval aviation. The tremendous accomplishments of our naval air arm of today are possible in large measure as a result of the interest and pioneering work of naval personnel at the time of World War I and during the "twenties." Airborne electronics have kept pace with the communication and other military requirements of modern naval aircraft. Our planes are equipped with the finest and most versatile electronic equipment in the world.

The scene is laid off the coast of a tropical island in the Pacific Ocean. A vast fleet of battleships, cruisers, destroyers, and carrier planes has just completed the initial bombardment of enemy installations on the island and the moment has arrived for the first assault waves to move in. For several miles opposite the island may be seen dozens of specially designed attack transports, for brevity labeled merely "APA," and "LST," which the Navy translates as "Landing Ship Tank," all unloading their cargoes of smaller landing craft. Among these are numbered hundreds of LCT's which are to carry troops and tanks to the beach. The operation proceeds like clockwork, the LCT's moving in perfect formation through the choppy water and the surf until they hit the beach. They have all the appearance of being guided in every movement from some central location and this is actually the case. The LCT's are being controlled and directed by means of two-way voice radio equipment installed in each one and at the control point in one of the larger transports or LST's.

An operation of this magnitude requires the closest co-ordination of movement. If the

fleet of LCT's heading for the beach should be attacked by dive bombers, those under attack will radio for assistance and carrier-based fighter planes will be promptly sent in to drive off the attacking enemy planes. If one of the LCT's should unfortunately strike coral rock or some other type of shoal, it becomes a vulnerable target for the enemy's island gun emplacements. The radio can be used in a case of this kind to call for prompt assistance. If there are any injuries among the personnel of the LCT during the run to the beach, radio is used to call for another vessel to come along side and take off the wounded. Upon lowering the ramp at the time of hitting the beach, the LCT group commander may order the vessel by radio to return to the transport to pick up another load. The two-way radio used in this vast fleet of LCT's, LST's, APA's to maintain such close immediate radio communication is known as a TCS, a very versatile standard Navy transmitter-receiver.

It is well to stop and think a minute about how this large fleet of landing craft came to be equipped with this fine radio equipment; by what means were these thousands of TCS equipments produced and installed so that at this precise moment of invasion in the far reaches of the Pacific, thousands of miles from the points of their manufacture, they would be ready to serve so usefully and to add so materially in the conquest of an enemy-held island?

As explained by Commander Palmer K. Leberman, United States Naval Reserve, who directs the Navy's electronic-equipment production and distribution organization, the steps involved in the supply of electronic equipment are generally as follows:

The story begins in a consideration of the strategy of the Pacific war when it has been determined by the Commander-in-Chief that the operation just described is necessary. The operation is evaluated in terms of the number and types of ships required to put the estimated number of troops and equipment ashore at a certain time on a certain date. The Navy then requests authorization from Congress for the construction, where necessary, of additional vessels and the necessary landing craft to carry out the operation. In the case under consideration, the Bureau of Ships would receive authorization for the construction of a large number of LCT's. It would then arrange with a shipbuilding concern, or several, to construct the required number of LCT's on a carefully arranged schedule of completions each month so that the total number will be ready when needed. At about this time the Chief of Naval Operations would direct the Bureau of Ships to produce and install on each of the required LCT's one 25-watt radiotelephone transmitter and suitable receiver capable of providing two-way voice communication while en route from the transport to the beach. This directive would set forth the act that the required radio equipment should provide reliable communication even when used under adverse weather conditions, heavy static, and rough seas. The Electronics Division of the Bureau of Ships studies the directive and determines that the model "TCS" equipment, a standard design in the Navy for years, will meet the desired military characteristics as

set forth by the Chief of Naval Operations. The Electronics Division then determines the number of TCS's required and the production rate per month to meet the authorized shipbuilding schedule. Procurement is requested and the Contract Division of the Bureau of Ships arranges with one or more manufacturers to produce the required number of TCS's. The manufacturers, if unable to meet the desired production schedule due to difficulty in obtaining required components, such as resistors and capacitors, requests assistance of the Electronics Division, which assigns production specialists to the job of expediting delivery of components from supplies to the TCS manufacturers.

If the completion date for the landing craft approaches, the Inspector of Naval Material arranges for shipment of the TCS's in accordance with instructions from the Electronics Division to the desired destination. The Resident Inspector of Naval Material, at the manufacturer's plant, is supplied full information which permits him to deliver equipments where and when they are needed so that sufficient interval will be available to complete installation of the equipment at the same time the LCT is completed. The equipment is shipped by railway express and arrives at the warehouse of the Radio Materiel Officer in charge of the activity at which the ship is being constructed. Meantime, the Radio Materiel Officer has completed all cabling and mechanical mounting for the installation of the equipment. Upon delivery of the TCS to the spot where the LCT is building, the Radio Materiel Officer has his staff of radio technicians make the installation and test it during the shakedown run of the vessel. After rigorous testing and indoctrination of the crew members who are to operate the equipment, the LCT, complete in every detail, is delivered to a sea-coast port where it is loaded aboard LST's or APA's for transport across the ocean.

It will be seen from this description of the administrative work involved, that the presence of these TCS's aboard the LCT's at the moment of invasion is not due to accident or happenstance but is the end result of a tremendous amount of careful planning and close co-ordination.

Incidentally, the LCT if not too seriously damaged will be used in many other landing operations on near-by islands and beaches. Its TCS equipment must be maintained in tiptop operating condition at all times. To accomplish this the LCT carries a set of equipment spares consisting of all of the small replaceable items such as tubes, resistors, and capacitors. Should its quota of equipment spares be used up, the LCT requests replacements from a tender or repair ship. The tender or repair ship in turn replaces its spares from the nearest larger land base or supply depot. The advanced supply depots, of course, replenish their stocks from the West Coast mainland stock pool at the Naval Supply Depot, Oakland, California. By means of careful planning, the Electronics Division of the Bureau of Ships is able to determine the required rate of flow of maintenance parts and replacement equipments so that the electronic equipment used by the fleet is maintained in constant efficient operating condition and ready for instant use.

* Received by the Institute, April 23, 1945.

I.R.E. People

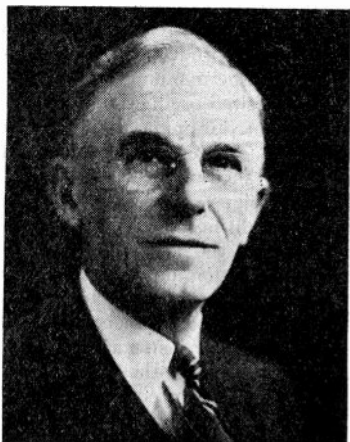

RAY H. MANSON

STROMBERG-CARLSON APPOINTMENTS

At the annual meeting of the Board of Directors of the Stromberg-Carlson Company, held on April 18, 1945, Ray H. Manson (M'23-F'30) was appointed president; George R. Town (A'37-SM'44) assistant secretary and manager of engineering and research; and Lee McCanne (A'36) vice-president and general manager of the organization.

Dr. Manson was born in Bath, Maine, on August 25, 1877, and was graduated from the University of Maine in 1898. He was awarded the degree of Doctor of Engineering in 1933. He was associated with the Western Electric Company, the Kellogg Switchboard and Supply Company, both in Chicago, and the Dean Electric Company, and Garford Manufacturing Company, in Elyria, Ohio, before he joined the staff of the Stromberg-Carlson in 1916, as chief engineer. In 1920 he was elected a director of his firm, becoming vice-president in charge of engineering in 1924, and general manager in 1940. He is one of the nation's leading au-



GEORGE R. TOWN

thorities in the field of communications, and creator of more than 100 inventions in this field. He was President of The Institute of Radio Engineers in 1931. He is a director of the Radio Manufacturers Association, and executive committee member of the association's set division and representative of that organization on the administrative committee of the Radio Technical Planning Board. Dr. Manson is also a Fellow of the American Institute of Electrical Engineers, a Fellow of the Radio Club of America, a Member of the Acoustical Society of America, the Rochester Engineering Society, and the American branch of the Newcomen Society of England.

Dr. Town was graduated from Rensselaer Polytechnic Institute in 1926, receiving his doctorate from the same institution in 1929. Before beginning his association with Stromberg-Carlson, he worked as research and development engineer at Leeds and Northrup Company, in Philadelphia, Pa., and at the Arma Engineering Company, in Brooklyn, N. Y. From 1933 to 1936, he was instructor in electrical engineering at Rensselaer Polytechnic Institute. In 1936 Dr. Town became an engineer in the research laboratory of the Stromberg-Carlson Company, and in 1940, was made engineer in charge of the company's television laboratory. He was appointed assistant director of research in 1941, and manager of research and engineering in 1944. Dr. Town has represented his organization on various television standardization committees of the National Television System Committee and the Radio Technical Planning Board. He is secretary of the television panel of that Board, and chairman of the television standards committee, in addition to filling the post of chairman of the frequency-modulation systems committee of the Radio Manufacturers Association. He is chairman of the Rochester Section of The Institute of Radio Engineers, and treasurer of the Rochester section of the American Institute of Electrical Engineers.

Mr. McCanne was born in St. Louis, Missouri, in May, 1905, and was graduated from Massachusetts Institute of Technology in 1927. Upon receiving his B.S. degree he joined the staff of the Stromberg-Carlson Company as a radio engineer. He transferred to the sales department in 1931, becoming radio sales manager in 1934. He was appointed a director and secretary in 1934, and assistant manager in 1940.

Mr. McCanne is vice-chairman of the Committee for Economic Development in the Second District of New York State, regional director for the National Federation of Sales Executives, vice-president of the Electrical Association of Rochester, a trustee of the Rochester Chamber of Commerce, vice-chairman of the School Sound Systems Committee of the Radio Manufacturers Association, and is active in civic and social



LEE McCANNE

organizations. He is a member of the Rochester Engineering Society and the Independent Pioneer Telephone Association.



ROYAL V. HOWARD

Royal V. Howard (M'41-SM'43), who has recently returned to San Francisco after a year's leave of absence for overseas duty in the European Theatre of Operations for the United States Army, has been elected vice-president in charge of engineering for both the Associated Broadcasters, Inc., and the Universal Broadcasting Company of San Francisco, California. Announcement of his appointment was made on May 17, 1945.

Mr. Howard headed a special scientific staff in London and Paris, working through the Office of Scientific Research and Development. He was hospitalized as a result of enemy action, and returned to the United States the first of this year.



ROYAL V. HOWARD



O. S. DUFFENDACK

One of the early pioneers in short-wave and aircraft communications, Mr. Howard's participation in radio dates back 20 years. During the last 12 years, he has been director of engineering for KSFO, KWID (a 100,000-watt international broadcast station), and KWIX, a 50,000-watt international broadcast station. Since his return from the Armed Forces, he has been elected director of engineering for the 10,000-watt station KPAS, in Pasadena, California. During the past 10 years he has been active in the radio industry. One of his most recently granted patents is for a robot monitoring system for radio stations, in use on KSFO for several years.

Mr. Howard is vice-chairman of the San Francisco section of The Institute of Radio Engineers, radio representative for the combined engineering societies, a member of the International Committee of the Board of War Communications, and former district engineering director for the National Association of Broadcasters. He is also a member of the national Radio Technical Planning Board's Panel 8, on International Broadcasting, and its Panel 4, on Standard Broadcasting.

O. S. DUFFENDACK

O. S. Duffendack (SM'44), director of research of the North American Philips Company, Inc., was appointed vice-president and director of engineering of that company on June 15, 1945. Dr. Duffendack who will be responsible for all research and engineering activities, formerly was professor of physics at the University of Michigan. During the war, he was a director of research with the National Defense Research Committee and serves as chief of one of its sections.

MURRAY G. CROSBY

Murray G. Crosby (A'25-M'38-SM'43-F'43) has joined the firm of The Paul Godley Company, Consulting Radio Engineers, Upper Montclair, New Jersey. He will specialize in radio-communication systems, including frequency-modulation problems, development projects, point-to-point mobile and air-borne communications, relay transmission, and satellite stations.

Mr. Crosby has been a research engineer for the communications division of RCA Laboratories for the past 20 years. In that position he specialized in frequency modulation and has over 100 patents, among them being the reactance-tube automatic-frequency-control type of frequency modulator used in frequency-modulation transmitters. He is the author of a considerable number of basic technical articles on the subjects of frequency and phase modulation.

Born in Elroy, Wisconsin, in 1903, he attended the University of Wisconsin receiving the B.S. degree in 1927 and his professional electrical engineering degree in 1943.

In 1940 he received a Modern Pioneer Award from the National Association of Manufacturers for contributions which improved the American standard of living. In 1943 he was vice-chairman of the New York Section of the Institute of Radio Engineers. He is a member of the 1945 Papers Committee, the Papers Procurement Committee, the Admissions Committee, and the Technical Committee on Frequency Modulation. He is also a Fellow of the Radio Club of America and a Member of the American Institute of Electrical Engineers.

In 1943 and 1944, Mr. Crosby served as expert technical consultant to the Secretary of War and received official commendations for his work.

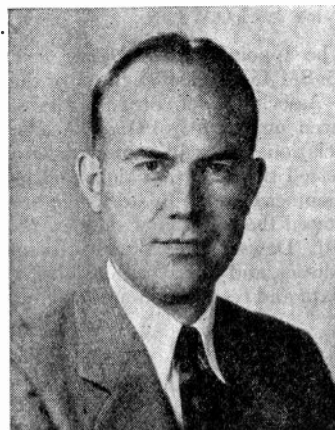

MURRAY G. CROSBY



HOWARD S. FRAZIER

OFFICIAL CITATION FOR HOWARD S. FRAZIER

Elmer Davis, Director of the Office of War Information, in a letter sent during the week of June 8, 1945, to Howard S. Frazier (M'43-SM'43), NAB Director of Engineering, who has been on part-time loan to OWI since November, 1944, commended the latter for his services in the recruitment and training of technical personnel for OWI overseas radio operations.

Employed by OWI only after release from broadcast stations, necessary experienced supervisory personnel were given advanced training at Bethany, Ohio, where several OWI international transmitters are located. Here they were put through a course of indoctrination and gained actual experience on high-powered transmitters. Many of the men were recruited from radio manufacturers. Extensive training of new personnel provided manpower without drawing heavily on domestic broadcast stations. Mr. Davis' letter follows:

"I wish to express my thanks to you for the very valuable services you have rendered this agency in helping us to solve one of our most difficult recruitment problems. With your co-operation and that of the National Association of Broadcasters, which has made your services available, the recruitment of technical personnel for our radio operations overseas has been greatly speeded up.

"I am glad that we shall continue to profit by your advice and counsel as we continue the job of meeting our overseas requirements."

I.R.E. People



JAMES D. McLEAN

PAUL CHAMBERLAIN AND JAMES D. McLEAN

Paul L. Chamberlain (A'43) was recently appointed manager of sales for the receiver division of the General Electric Company's electronics department, according to an announcement by I. J. Kaar (J'22-A'24-M'29-F'41), division manager; and James D. McLean (A'43) was appointed manager of sales for the transmitter division of the same organization, by C. A. Priest (A'24-M'38-SM'43), division manager. Mr. Chamberlain and Mr. McLean will have their headquarters at Bridgeport, Conn., and Schenectady, N. Y., respectively.

Mr. Chamberlain attended Washington University, St. Louis, Mo., and was first employed by the Century Electric Company of that city, where he became manager of the home office. He then engaged in laboratory and sales work for the Colin B. Kennedy Corporation, and later was employed by the Brunswick Phonograph Company as district manager. For the next ten years, Mr. Chamberlain supervised district sales of radio receivers for a number of firms, eventually becoming radio sales manager for the Ochlitree Electric Company, General Electric distributor at Pittsburgh.

In 1942 he entered the electronics department of the General Electric Company, and was placed in charge of the Army aircraft section of the government division, transferring in 1943 to the position of manager of sales for the transmitter division.

Mr. McLean is a graduate of the Massachusetts Institute of Technology, where he received the B.S. and M.S. degrees in electrical engineering. He became associated with the General Electric Company in 1935,

as a student engineer. In 1936 he was engaged as radio engineer by the Republican National Committee during the presidential campaign, and in 1938 returned to the General Electric Company as a development engineer in the laboratory of that organization. Mr. McLean transferred to the electronics department in 1939, first as a design engineer in the transmitter division and later as co-ordinator of Army radio and radar equipment in the government division.



R. EDWARD STEM M

R. Edward Stemm (M'44) will direct the sales activities of Communication Parts, Chicago, Illinois, according to a recent announcement. The organization will produce radio coils, solenoids, and other radio and electronic components, and carry out original design and consultation work.



R. EDWARD STEM M



HENRY S. DAWSON

The appointment of Henry S. Dawson (A'35-SM'45) as chief engineer of the Canadian Association of Broadcasters was announced on May 3, 1945. Officials of the Association, at their annual meeting, had expressed the view that the rapid technical development of the broadcast industry necessitated the creation of the new post.

Mr. Dawson has already assumed his new duties, and will be responsible for studying data and research on national and inter-

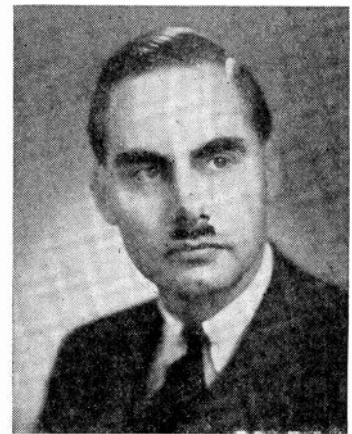

John Palmer

HENRY S. DAWSON

national activities in the broadcast industry. He will advise the Association on all technical matters connected with the present broadcast structure, together with developments in frequency modulation and television. Mr. Dawson will also be the technical member representing the Canadian Association of Broadcasters on the Canadian Radio Technical Planning Board.

Mr. Dawson is a graduate of Cornell University in electrical engineering, and has previously been associated with the Canadian Marconi Company, Rogers Radio Tubes, Ltd., and station CFRB. Since November, 1940, he has served with Research Enterprises, Ltd., as project engineer and, later, as assistant chief engineer.

He is a member of the Association of Professional Engineers of Ontario, and was chairman of the Toronto section of the Institute of Radio Engineers in 1940 and 1941.



GOMER L. DAVIES

Gomer L. Davies (M'33-SM'43) has announced his entrance into the field of consulting radio engineering. He offers a consulting service for broadcast stations on standard, high-frequency (frequency-modulation), and television problems, as well as some phases of electronics and aviation radio.

Mr. Davies has a background of twenty-three years of training and experience in antennas, directional arrays, and wave-propagation work, and in development, design, and production of specialized radio and electronic equipment in the aviation field.

Books

The Radio Amateur's Handbook (Twenty-Second Edition)

Published (1945) by The American Radio Relay League, Inc., West Hartford, Conn. 504 pages+200-page catalogue+12-page index+viii pages. 2107 figures. $6\frac{1}{2} \times 9\frac{1}{2}$ inches. Price, \$1.00.

Such changes as have been made in the twenty-second edition of the Radio Amateur's Handbook are the further impacts of the war on the fields of higher frequencies. While basically the previous edition, certain additions have resulted from the slight rearrangement of the outermost ruffles on the curtains of censorship which have become the technical horizons of citizen radio.

Notable preparatory material that has been added is that on wave guides, cavity resonators, pot tanks, and butterfly circuits in the chapter on fundamentals. The section on vacuum tubes now includes compensation for low- and high-frequency deficiencies in amplifiers, cathode followers, grounded-grid operation, Franklin oscillator, vacuum-tube switches, pulse technic, inductive-output tubes, velocity modulation (velocity variation), Klystrons, and positive-grid oscillators.

Under antennas, we now find the Alford loop, bazooka balancer, and conical structures. To receivers have been added a complex crystal-filter set and a panoramic receiver.

The chapter on The War Emergency Radio Service has been substantially revised with much new equipment including receivers, transmitters, transceivers, and walkie-and-handie-talkie sets.

The measurements chapter has been expanded to include signal generators for amplitude- and frequency-modulated waves. Audio-frequency, phase-shift, and intermodulation measurements are now treated.

The increase of about thirty pages from the previous edition is misleading. A large number of the figures have been reduced in size and great care is evident in the mechanical preparation of the book to conserve every possible bit of space. Much more than thirty pages of material has been added.

In mid 1944, differences of many years standing between the communications and power engineers on some of the fundamental graphical symbols were compromised at a conference called by the American Standards Association. This agreement affects the communication engineer chiefly in that the capacitor symbol will have one of the parallel lines slightly curved. The *Handbook* is probably the first major revision of a radio text to adopt the new symbol. Every figure using a capacitor symbol, fixed or variable—meaning almost every figure in the book—has been redone to comply with the new standard. Once more the amateur leads the way!

Known for almost two decades for its up-

to-date clear presentation of high- and higher-frequency radio fundamentals and practice, the *Handbook* continues to be the greatest compilation of radio information for your dollar.

HAROLD P. WESTMAN
Electrical Communication
International Telephone and
Telegraph Corporation
New York, N. Y.

Alignment Charts— Construction and Use, by Maurice Kraitchik

Published (1944) by D. Van Nostrand Co., Inc., 250 Fourth Avenue, New York, N. Y. 91 pages+2-page index+vi pages. 48 illustrations. $6\frac{1}{2} \times 9\frac{1}{2}$ inches. Price, \$2.50.

The author defines an alignment chart as follows: An alignment chart for a function of three variables, $F(a, b, c) = 0$, consists of an a scale, b scale, and c scale so constructed that any straight line connecting three points one on each scale determines a triple of values (a, b, c) satisfying the given function. This definition immediately suggests two problems: Given an alignment chart, in the sense of being given three curves to serve as basis curves for the (a), (b), and (c) scales, what functions can so be represented? Given a function, what are the best alignment charts, if any, available for the function? This book succeeds in presenting in a concise manner the practical solution to the above problems.

The first four chapters constitute an introduction covering a review of the mathematical terminology, an introduction to determinants, a short discussion of the broad field of nomographic charts (which the author defines as a diagram or combination of diagrams for the representation of mathematical laws), a review of graduated scales, and a short discussion of conversion scales. The fifth chapter describes a general background of the book showing how an equation may be disjuncted into a determinant equation in rectangular co-ordinates so that a nomographic chart can immediately be constructed on rectangular co-ordinate paper. The following three chapters discuss in turn the commonest and most practical nomographic charts, namely, equidistant parallel scales, parallel scales not equidistant, and a combination of two parallel and one curved scale. The various types of equations which can be so represented are clearly illustrated with profuse examples of substitution into the given formulas.

The ninth chapter of this book illustrates how the methods of alignment charts for three variables can be adapted to the construction of alignment charts for the solutions of functions involving more than three variables. The last section of the book contains a discussion of the choice among different types of representations (since very often more than one representation of an equation

can be made), and a discussion of special charts.

The author makes no attempt to give an extended or theoretical study of the subject and he refers the reader to d'Ocagne's work "Traité de Nomographie" (Paris, 1921) for further information. The book is written concisely and to the point. It is well organized and numerous examples are given so that the methods expounded may be employed with a minimum of confusion by the reader.

NATHAN MARCHAND
Federal Telephone and
Radio Laboratories
New York, N. Y.

Resistance Welding Control (Set of Seven Lesson Books and One Quiz Book)

Published (1944) by Westinghouse Electric and Manufacturing Company, 40 Wall Street, New York, N. Y. 85 pages. 324 illustrations. $7\frac{1}{2} \times 5\frac{1}{2}$ inches. Price, \$1.60 per set.

These eight booklets comprise a complete series of blackboard talks on the practical aspects of resistance welding control. The books are styled for use by practical workers in this field and for the use of others who are purchasing or setting up resistance welding equipment to do specific jobs. These booklets each contain ten (or more) pages of specific information accompanied by twenty-five or more illustrations or photographs, specifically selected to illustrate the details of this art.

Book 1 defines the terms of welding technology and illustrates the various types of welds that can be handled with this type of equipment. Book 2 entitled "Types of Resistance Welding Work," gives details as to the requirements of each class of work, and includes several excellent tables of values based on various types of metals and alloys that can be handled. Book 3 gives a description of the ignitron and the thyatron tubes, illustrating in a nontechnical manner their operating principles. Book 4 illustrates how the flow of current is started and stopped in resistance welding work, including details as to several of the circuits in use. Book 5 illustrates how the amplitude of the current is controlled in resistance welding. Book 6 gives more details as to electronic timing controls and Book 7 takes up the basic principles of the energy storage systems using systems of both types, the magnetic type of energy storage and the capacitor type of energy storage.

The last book of the series is a questionnaire giving a number of questions enabling the reader to test himself as to his knowledge of this article as it was outlined in the series of text.

RALPH R. BATCHER
Caldwell-Clements, Inc.
New York, N. Y.

Report of the Secretary—1944

Membership

The total of 13,137 paid members at the end of 1944 represents a new high in Institute membership. This increase of 2058 paid members over the 1943 figure shows a gain of 18.6 per cent. The membership trend since the establishment of the Institute in 1912 is plotted in Fig. 1. Resignations were received from 21 members.

The proportion of the membership outside of the United States and its possessions reached its maximum in the period 1934-1938 when it varied between 23.2 and 24.2 per cent. The trend was downward from 1939 through 1943 as a result of the war. However, an interesting note is that the foreign members comprised 11.7 per cent of the total membership at the end of 1944 as compared with 10.7 per cent the previous year. This is due mainly to the large rise in membership in Canada and England which is included in the figure. Increases of 17.2 per cent in the domestic membership and 29.8 per cent in the foreign membership, despite wartime conditions, were shown at the end of 1944.

The number of members in the British Empire increased by 303 as compared with the addition of 191 members the previous year. The gain in England was largely responsible for the increase of 111 members in the European area. The South American membership increased by 55 members.

There was a marked increase in the number of applications submitted for Senior Member and Member grades during the year. The Admissions Committee considered 655 applications for election or transfer to those grades, of which 497 were approved.

There were 2721 new members elected to the Institute in 1944 which represents a

slight decrease of 0.9 per cent in comparison with the previous year's elections.

The proportion of newly elected members having had some college training was 69 per cent as compared with 74 per cent in 1943. The proportion of those doing radio-engineering work decreased from 47 per cent in 1943 to 38 per cent in 1944. The sales and service personnel increased from 13 to 22 per cent. These analyses exclude Student members. It should be noted that, because of the secret nature of the war work a number of the newly elected members were performing, it was difficult to make an accurate analysis of their work.

During 1944, 2712 applications for admission were received, representing a loss of 3 per cent since 1943 when 2783 applications were received. However, there was a gain of 22 per cent in the number of applications for all elective grades received. The number of Student applications decreased by 36 per cent.

Total Applications Received

The effective work during the year of the Admissions Committee under Chairman G. T. Royden and the Membership Committee under Chairman E. D. Cook is reflected in the high membership figures at the end of 1944.

A large number of applications was received through the efforts of the Sections and the Institute office and many individual members.

Deaths

During 1944, the deaths of three Fellows, four Senior Members, 22 Associates, and two Students, whose names are listed below, were reported.

FELLOWS

Ballantine, Stuart (A'16-F'28)
Hill, Guy (M'13-F'15)
Thompson, B. J. (A'29-M'32-F'38)

SENIOR MEMBERS

Cose, J. H. (M'43-SM'43)
Guilfoyle, T. J. (M'35-SM'43)
Harper, A. E. (A'19-M'26-SM'43)
Winterbottom, W. A. (A'15-M'28-SM'43)

ASSOCIATES*

Davis, K. E. (A'43)
Elliott, D. A. (A'35)
Foil, W. P. (A'42)
Gibson, Robert (S'40-A'42)
Grimes, W. F. (VA'16)
Jinks, C. C. (VA'36)
Kaunitz, F. M. (VA'37)
Knowles, J. G. (VA'26)
Koenigsberg, Seymour (A'43)
McLain, W. W. (S'37-A'40)
Newbold, W. H. (A'28)
Novak, J. J. (VA'16)
Paleschuck, M. H. (S'41-A'42)
Parry, R. C. (VA'36)
Pensyl, D. S. (S'37-A'41)
Peterson, C. U. (VA'36)
Robb, J. D. (A'39)
Rosenthal, M. L. (A'44)
Slezskinsky, G. N. (A'35)
Watson, P. E. (VA'28)
White, M. W. (A'43)
Zwald, J. J. (VA'37)

STUDENTS

Mills, E. H. (S'42)
Wright, G. W. (S'43)

* Those designated "VA" were Voting Associates.

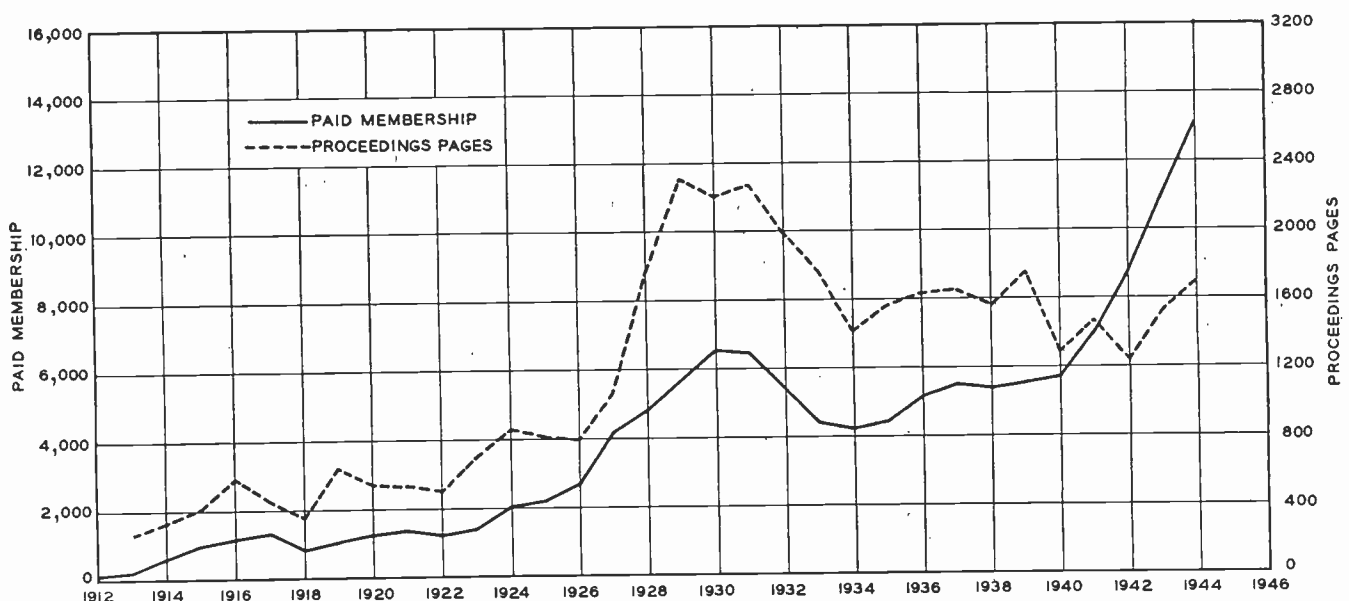

Fig. 1—The variation in paid membership is shown by the solid graph. The dotted line shows the number of pages of technical and editorial material in the PROCEEDINGS. Starting in 1939, a larger format was used. The number of pages indicated in the graph corresponds to the older format, and must be divided by 2.2 to give the corresponding number of pages of equal content in the present format.

Editorial Department

The twelve issues of the PROCEEDINGS OF THE I.R.E., published during the year 1944, contained 98 papers, the 125 authors of which included 7 with no business affiliation, and 118 from 32 colleges and organizations. Of these 125 authors, all but 21 were members of the Institute, and 3 of these 21 were previous members.

The PROCEEDINGS contained 774 numbered pages of editorial material plus 30 unnumbered pages, and 796 pages of advertising plus 36 advertising pages on covers.

Close co-operation with the National Electronics Conference will make it possible for the PROCEEDINGS to present in its pages many of the papers presented before that Conference in Chicago. One of this number was published in 1944, and many others were received, accepted, and scheduled for publication in 1945.

Illustrations with descriptive captions continued to be used on the front covers. Special emphasis was laid on Bond Drives. The June cover promoted the United States Fifth War Loan, and the October cover was devoted to the Seventh Canadian Victory Loan.

Towards the end of the year, it was decided to issue a YEARBOOK as soon as possible. Much thoughtful planning was done in this connection, although no actual work was started on this publication in 1944.

An appeal for a moderate increase in paper allocated to the PROCEEDINGS was made to the War Production Board on May 25, 1944. This appeal was granted on July 13. On October 27, an appeal was made for the

proportionate continuance of this paper allocation for the year 1945. This appeal was denied on November 8.

Lightweight paper stock caused numerous printing difficulties in that the paper had a tendency to fly off the presses and cause trouble in handling. This resulted in a loss of paper and a surcharge for handling. The resulting printed page was far from satisfactory since the printed matter showed through. In the case of charts and diagrams, there was considerable confusion to the reader; in the case of advertisements, some dissatisfaction was evidenced by advertisers.

The Papers Procurement Committee, under the able and active guidance of Mr. Dorman D. Israel, was responsible for the obtaining for the PROCEEDINGS many papers which otherwise would not have been made available. This Committee was reorganized into 16 groups, each one under the capable leadership of an outstanding authority in his field. These groups, in turn, solicited manuscripts from recognized workers in their particular fields.

The Papers Committee continued under the thoughtful and effective direction of Dr. F. B. Llewellyn. Its duties involved the reading of the submitted manuscripts and the detailed and analytic criticism of them. The Board of Editors functioning in a judicial manner, studied, and co-ordinated the reports of the members of the Papers Committee. The conscientious work performed by the members of the Papers Committee and the Board of Editors is directly responsible for the high quality of the papers accepted and published in the PROCEEDINGS.

In spite of wartime restrictions, there

was an adequate supply of excellent manuscripts submitted for publication. A decided trend was noticed in the emphasis laid on electronic and industrial engineering, broad communications problems, and analytical papers dealing with educational problems and professional engineering welfare.

In December, a new cover was introduced. This was imperative because of the growing trend in the PROCEEDINGS towards papers on electronics and electronic devices and a general enlargement over a long period of years of the fields covered by the PROCEEDINGS.

Because of the splendid co-operation of everyone concerned with the production of the PROCEEDINGS, it was possible, even under wartime conditions, to publish useful and constructive volumes. Sincere thanks should go to Dr. Alfred N. Goldsmith, who devoted fully a third of his time to PROCEEDINGS and Institute activities; who was ever on the alert for new trends; and whose sympathetic and helpful guidance was always an inspiration to those working with and for him; to Mr. Dorman D. Israel for his constructive and painstaking efforts on behalf of the Papers Procurement Committee; to Dr. Frederick B. Llewellyn for his able guidance as Chairman of the Papers Committee; to the membership of the Papers Procurement Committee, the Papers Committee, and the Board of Editors for their unflinching willingness to devote much time and energy to their duties for the Institute; and to the editorial staff attached to the Institute, Miss Helen M. Stote, associate editor, and Miss Winifred Carrière, assistant editor, for their enthusiastic

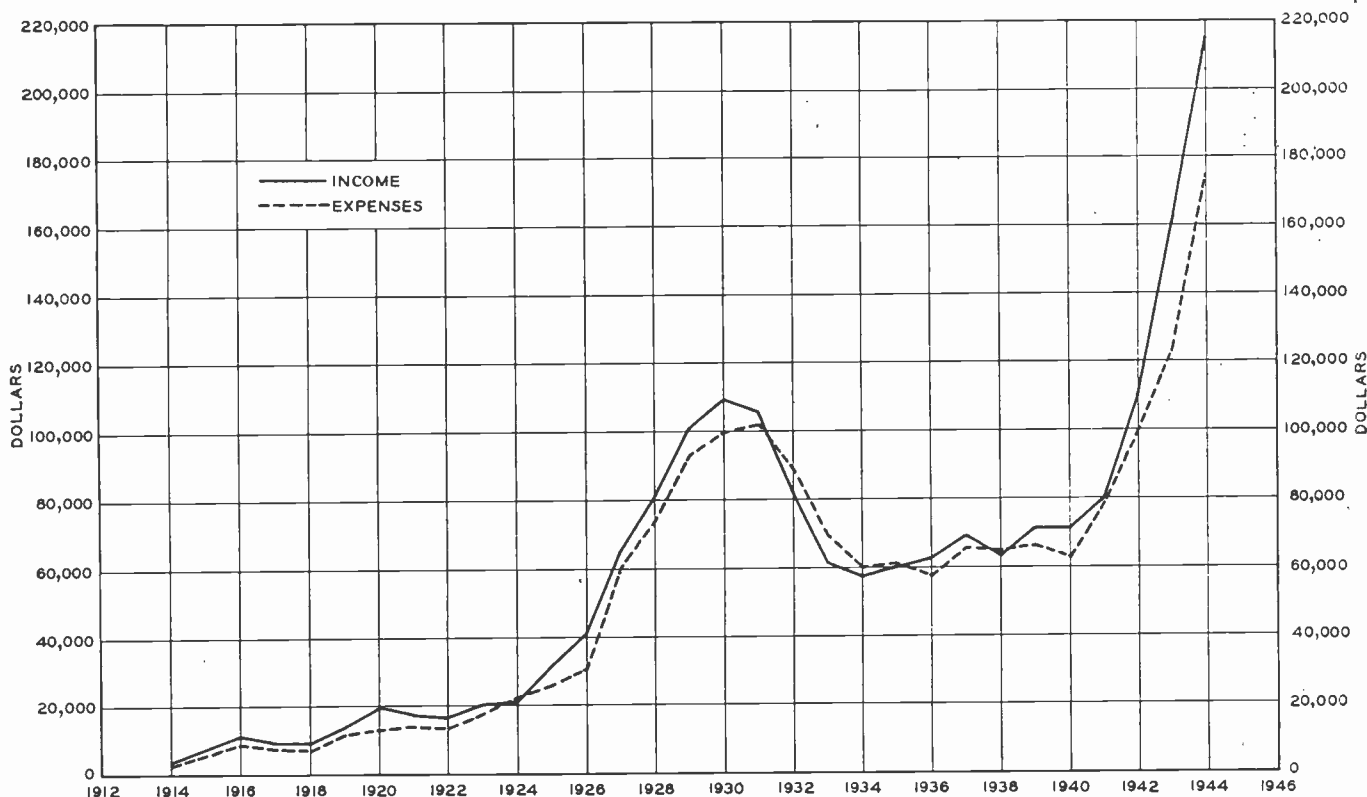

Fig. 2—Income and expenses are plotted for the life of the Institute.

cooperation and effective work in carrying out the wishes of the editorial groups. The George Banta Publishing Company, printer of the PROCEEDINGS, successfully carried out its assignments under unusually difficult wartime conditions involving shortages of manpower and materials.

Advertising

Advertising Manager W. C. Copp, and his efficient staff, produced a record volume of advertising.

Sections

The Sections Committee, under Chairman R. A. Heising, was very active throughout the year.

Several new Sections were established during the year, bringing the total to 33 Sections at the end of 1944. There were 278 Section meetings held during 1944, representing an increase of 32 per cent over the number held in 1943.

All Sections in operation during the entire year met the minimum requirements of 5 meetings and 25 members. The proportion of the membership in Section territories rose from 76 per cent in 1943 to 77 per cent in 1944. Numerically, the total membership in Sections rose from 8421 to 10,101 at the end of 1944.

During the year, President Turner visited the Boston, Chicago, Cincinnati, Connecticut Valley, Dayton, Philadelphia, Pittsburgh, Rochester, and St. Louis Sections.

Conventions and Conferences

The 1944 Winter Technical Meeting was held on January 28 and 29 in New York City and was considered to be one of the most successful of its kind held by the Institute, and Dr. B. E. Shackelford and his committeemen were complimented for their outstanding work in directing the affairs of the meeting. There were 22 technical papers presented. The banquet was attended by 808, while the total attendance at the two-day meeting was 1704.

The Rochester Fall Meeting was held on November 13 and 14 in Rochester, New York. During the two-day session, there were 12 technical papers presented. Some 300 persons attended the banquet and the total attendance was 707.

Meetings

BOARD OF DIRECTORS

The Board of Directors held 12 meetings during 1944.

EXECUTIVE COMMITTEE

Members of the Executive Committee carried unusually heavy burdens during 1944, due to the increasing burden of activities of the Institute, under wartime conditions. In addition to the Institute's officers on this Committee, the other members were Mr. E. F. Carter, Dr. F. B. Llewellyn, and Mr. H. A. Wheeler. Mr. Carter was respons-

ible for the committees on Admissions, Membership, and Public Relations; Dr. Llewellyn, the activities of the Technical Committees; and Mr. Wheeler guided the activities covering Sections, Conventions, Meetings, and Advertising.

Thirteen meetings were held during the year.

ADMINISTRATIVE COMMITTEES

Twenty-five meetings were held by the administrative committees during 1944.

Attention is called to the fact that, in addition to the meetings mentioned above, a large volume of work was accomplished through correspondence and the use of the telephone.

SPECIAL COMMITTEES

Realizing the urgent need for a home for the Institute and taking into consideration the reports of Chairman Heising of the Office Quarters Committee, which had been diligently searching for increased office space to house the present staff and provide adequate room for expansion, the Board of Directors appointed the Building-Fund Committee with Dr. Shackelford as Chairman and Mr. I. S. Coggeshall as Vice-Chairman to raise funds to be used for the purchase of a suitable building. Toward the end of the

year, the Building Fund campaign with a goal of \$500,000 was inaugurated.

TECHNICAL COMMITTEES

The technical committees held 27 meetings during the year in comparison with 10 in 1943. Correspondence played an important part in expediting the work of these committees when no meetings were held.

SUMMARY OF MEETINGS

The following table summarizes the meetings held during 1944.

Meetings Held During 1944

12 Board of Directors
13 Executive Committee
25 Administrative Committees
17 Special Committees
27 Technical Committees

108

Constitution and Laws

Chairman Heising of the Constitution and Laws Committee offered a number of proposed constitutional amendments for consideration of the membership. Those adopted involved a broadening of the power of the Board of Directors in organizing Institute activities, minor changes in language to

COMPARATIVE STATEMENT OF INCOME AND EXPENSES FOR THE YEARS ENDED DECEMBER 31, 1944, AND 1943

INCOME	1944	1943	Increase Decrease
Current Year's Dues			
Student.....	\$ 6,451.00	\$ 5,809.00	\$ 642.00
Junior.....	—	341.00	341.00
Associate.....	55,175.25	43,052.25	12,123.00
Member.....	247.75	8,487.50	8,239.75
Senior Member.....	8,948.00	—	8,948.00
Fellow.....	1,870.00	1,760.00	110.00
Entrance Fee.....	5,999.00	4,654.00	1,345.00
Transfer Fee.....	258.00	164.00	94.00
TOTAL DUES INCOME.....	\$ 78,949.00	\$ 64,267.75	\$ 14,681.25
Dues of Prior Years.....	493.80	416.30	77.50
Advertising in PROCEEDINGS.....	98,911.40	77,858.27	21,053.13
Subscriptions to PROCEEDINGS.....	15,122.15	12,123.37	2,998.78
Sale of Emblems.....	1,968.58	1,800.35	168.23
Sale of Reprints.....	1,730.11	998.20	731.91
Sale of Bound Volumes.....	480.50	376.75	103.75
Sale of Binders.....	1,865.81	1,064.02	801.79
Sale of Standardization Reports.....	1,023.56	652.59	370.97
Income from Investments—I.R.E. Securities..	1,288.09	1,410.37	122.28
Income from Winter Technical Meeting.....	12,704.55	—	12,704.55
Miscellaneous (Radio Markets, Index, etc.)...	106.82	64.75	42.07
TOTAL INCOME.....	\$214,644.37	\$161,032.72	\$53,611.65
EXPENSES			
Cost of Printing PROCEEDINGS.....	\$ 39,292.37	\$ 33,085.90	\$ 6,206.47
Cost of Standardization Reports.....	888.42	855.95	32.47
Cost of Miscellaneous Printing—Index, Radio Markets, etc.....	1,950.62	2,526.98	576.36
Cost of Emblems.....	1,237.66	1,077.19	160.47
Cost of Reprints.....	1,436.67	827.21	609.46
Cost of Bound Volumes.....	63.88	132.47	68.59
Cost of Binders.....	1,274.86	926.49	348.37
Salaries and Wages			
General Office.....	35,422.41	24,266.07	11,156.34
Printing PROCEEDINGS.....	7,417.59	5,002.00	2,415.59
FORWARDED.....	\$ 88,984.48	\$ 68,700.26	\$20,284.22

COMPARATIVE BALANCE SHEET DECEMBER 31, 1944, AND 1943

ASSETS	December 31, 1944	December 31, 1943	Increase Decrease
CURRENT ASSETS			
Cash.....	\$127,571.97	\$ 77,319.24	\$50,252.73
Accounts Receivable—Current			
Dues.....	82.36	103.76	21.40
Advertising.....	4,857.20	4,674.12	183.08
Reprints.....	81.03	45.00	36.03
Others—Sections, etc.....	685.00	304.32	380.68
Inventories (As submitted by the Management)			
PROCEEDINGS.....	5,229.60	7,049.04	1,819.44
Bound Volumes.....	231.00	170.00	61.00
Binders.....	680.75	231.01	449.74
Emblems.....	1,360.14	693.66	666.48
Accrued Interest on Investments.....	15.62	57.29	41.67
TOTAL CURRENT ASSETS.....	\$140,794.67	\$ 90,647.44	\$50,147.23
INVESTMENTS—AT COST			
(Market Value—12/31/44—\$43,905.11).....	45,260.15	45,899.54	639.39
MORRIS LIEBMANN MEMORIAL FUND ASSETS			
Investments (Market Value 12/31/44— \$10,465.24).....	10,140.55	10,012.45	128.10
Cash.....	1,079.48	778.00	301.48
TOTAL FUND ASSETS.....	\$ 11,220.03	\$ 10,790.45	\$ 429.58
FURNITURE AND FIXTURES AFTER RESERVE FOR DEPRECIATION.....	4,995.74	5,229.86	234.12
PREPAID EXPENSES AND OTHER ASSETS			
Unexpired Insurance.....	\$ 68.93	\$ 47.86	\$ 21.07
Stationery Inventory—Estimated.....	200.00	200.00	—
Medal of Honor.....	—	50.50	50.50
Winter Technical Meeting Expense.....	1,074.59	287.81	786.78
Medallion Badges and Lapel Bars.....	577.22	667.44	90.22
Investment Service.....	210.78	123.75	87.03
Building-Fund Committee			
Rent—January, 1945.....	225.00	—	225.00
Utility Company Deposit.....	10.00	—	10.00
Rent Deposit.....	225.00	—	225.00
TOTAL PREPAID EXPENSES AND OTHER ASSETS.....	\$ 2,591.52	\$ 1,377.36	\$ 1,214.16
TOTAL ASSETS.....	\$204,862.11	\$153,944.65	\$50,917.46
LIABILITIES AND SURPLUS			
ACCOUNTS PAYABLE.....	\$ 9,028.48	\$ 7,723.52	\$ 1,304.96
ACCRUED SALARIES.....	305.70	104.29	201.41
SECTION REBATES.....	—	203.00	203.00
ADVANCE PAYMENTS			
Dues.....	12,228.84	7,940.14	4,288.70
Subscriptions.....	7,374.77	4,279.94	3,094.83
INCOME TAX WITHHELD FROM EMPLOYEES, ETC..	539.92	899.52	359.60
TOTAL LIABILITIES.....	\$ 29,477.71	\$ 21,150.41	\$ 8,327.30
MORRIS LIEBMANN MEMORIAL FUND			
Investments.....	\$ 10,140.55	\$ 10,012.45	\$ 128.10
Unexpended Income.....	1,079.48	778.00	301.48
TOTAL FUND.....	\$ 11,220.03	\$ 10,790.45	\$ 429.58
DEFERRED INCOME—WINTER TECHNICAL MEET- ING.....	\$ 2,404.50	\$ —	\$ 2,404.50
SURPLUS—DONATED.....	\$ 1,997.80	\$ 1,997.80	\$ —
SURPLUS—EARNED			
Balance—January 1.....	\$120,005.99	\$ 83,713.15	\$36,292.84
Add—Operating Profit for the years (Per Ex- hibit "B").....	39,756.08	36,292.84	3,463.24
TOTAL EARNED SURPLUS.....	\$159,762.07	\$120,005.99	\$39,756.08
TOTAL SURPLUS AND LIABILITIES.....	\$204,862.11	\$153,944.65	\$50,917.46

make the Constitution conform to the charter, correction of a situation in the Institute office resulting from the previous regulations regarding time limits on arrival of petitions and ballots, and clarification of methods of voting on constitutional amendments. Several Bylaws amendments also were adopted.

Awards

The Medal of Honor for 1944 was presented to Haraden Pratt in recognition of his engineering contributions to the development of radio, of his work in the extension of communication facilities to distant lands, and of his constructive leadership in Institute affairs.

The Morris Liebmann Memorial Prize for 1944 was awarded to W. W. Hansen for his application of electromagnetic theory to radiation, antennas, resonators, and electron bunching, and for the development of practical equipment and measurement techniques in the microwave field.

The following 11 members of the Institute were transferred to the Fellow grade.

S. L. Bailey	Keith Henney
C. R. Burrows	D. O. North
M. G. Crosby	K. A. Norton
Harry Diamond	S. W. Seeley
C. B. Feldman	D. B. Sinclair
	L. C. Young

Finances

Copies of the auditor's report for 1944 were distributed to the Board of Directors. The income and expenses for the life of the Institute are plotted in Fig. 2.

Headquarters Office

At the beginning of the year, there were 17 employees on the staff in addition to the Advertising Manager and his staff who were continued on a contractual basis. In May, Miss Elizabeth Lehmann was engaged as Office Manager, and has carried out her assignments with loyalty and industry.

It was necessary for the staff to carry a considerable amount of overtime work. Accordingly, the number of employees was gradually increased until there was a total of 24 at the end of 1944. One of these employees was on a part-time basis, two were temporary employees, and the remaining 21 were permanent full-time employees.

Late in the year, three new positions were established by the Board of Directors; namely, Executive Secretary, Technical Editor, and Technical Secretary. These additions to the executive staff were intended to broaden the future activities of the Institute, to permit the expansion of the publications program, and to provide services required by the increase in membership. It was decided to fill these positions as soon as suitable personnel could be obtained.

Respectfully submitted



HARADEN PRATT¹
Secretary

Contributors

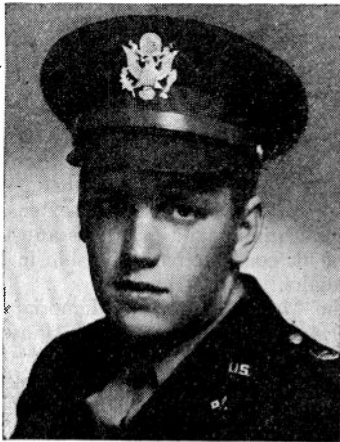

ROBERT M. BARRETT

Robert M. Barrett (S'41-A'43) was born on March 3, 1920, in Farmington, Utah. He received the B.S. degree in electrical engineering from the University of California in 1942.

Since 1942, he has been on active duty with the Army Air Forces as a radar engineering officer.

Captain Barrett is now stationed at Morristown Field, Florida, where he is in charge of installation and maintenance of airborne electronic equipment.



Willard R. Clark (A'36-M'45) was born on May 23, 1911, at Medway, Massachusetts, and has been an amateur radio operator since 1927. He was graduated from Massachusetts Radio and Telegraph School of Boston in 1929, and served an enlistment in the Signal Corps, United States Army, from 1930 to 1933. From 1934 to 1939 he was associated with Tropical Radio and Telegraph Company, Valpey Crystal Corporation, Pan American Airways System, and Eastern Air Lines, Inc. Since 1939 he has been employed by the Signal Corps

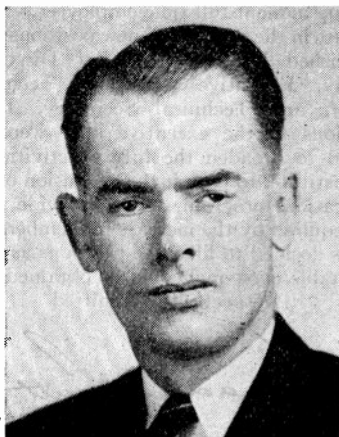

WILLARD R. CLARK

Ground Signal Agency and its predecessor, the Signal Corps Laboratories, at present being a member of the engineering staff of the Coles Signal Laboratory. In 1944 the Commanding General of the Army Service Forces awarded Mr. Clark the War Department Emblem for Meritorious Civilian Service, with a citation for outstanding work in the development of frequency-modulation equipment and in organizing and supervising development of radio-relay communication equipment for the United States Army. He is a member of the Veteran Wireless Operators Association and the American Radio Relay League.



BEVERLY DUDLEY

Beverly Dudley (J'24-A'27-M'43-SM '43) was born on April 2, 1906, at Chicago, Illinois. He attended Armour Institute from 1926 to 1928. In 1935 he received the B.S. degree from Massachusetts Institute of Technology, and from 1935 to 1939 he did graduate work in electrical engineering and physics at Columbia University.

Mr. Dudley was assistant technical editor of *QST* at the American Radio Relay League from 1929 to 1930, and assistant secretary of The Institute of Radio Engineers from 1930 to 1932. He was engaged in technical editorial work at the General Radio Company during the summer of 1934, and in experimental and factory production, test, and specifications on cathode-ray tubes and metal receiving tubes at the RCA Manufacturing Company during 1935 and 1936. In 1936 he became associated with the McGraw-Hill Publishing Company, in New York City, where he remained until 1943, first as associate editor and later as managing editor of *Electronics*.

From 1941 to 1943 Mr. Dudley taught classes in radio communication at the Newark College of Engineering, and from 1943 to 1945 he was located in Chicago, as Western Editor of *Electronics*. During his sojourn in Chicago, he took an active part in the formation and management of the National



W. W. HANSEN



Electronics Conference. He is at present editor of the *Technology Review* of Massachusetts Institute of Technology, while retaining his connection with the McGraw-Hill Book Company as consulting editor for the radio communication series originated in 1942.



W. W. Hansen (A'39) was born in 1909 at Fresno, California. He received the A.B. degree in 1929 and the Ph.D. degree in 1932, from Stanford University. Dr. Hansen was an instructor in physics at Stanford University from 1930 to 1932; National Research Fellow from 1933 to 1934; and successively assistant, associate, and full professor at Stanford University until 1940, when he took leave to go to the Sperry Gyroscope Company as research engineer.



Andrew F. Inglis (A'44) was born at Van, Michigan, on March 17, 1920. He received the B.S. degree in physics from Haverford College in 1941, and spent the following



ANDREW F. INGLIS



MARTIN V. KIEBERT, JR.

year in graduate study in electronics, at the University of Chicago. During the summers of 1940 and 1941, Mr. Inglis was employed by the Eastman Kodak Company, and in the summer of 1942 he was instructor of electronics at the University of Chicago. Following this, he was engaged in the development of radar equipment for the radio division of the Naval Research Laboratory, and in 1943, entered the United States Naval Reserve. He is at present instructor at the Naval Training School (Pre-radar), Bowdoin College, Brunswick, Maine. Mr. Inglis is a member of Phi Beta Kappa.

Martin V. Kiebert, Jr. (A'31-M'38-SM'43) was born on Nov. 27, 1908, at Wallace, Idaho. He attended the University of Idaho from 1928 to 1931, and Reed College, Portland, Oregon in 1933 and 1934, majoring in electrical engineering and physics. In 1929 he was the recipient of the Idaho Edison Scholarship Award. From 1934 to 1937 he was chief engineer at KIRO, Seattle, Washington. In 1937 Mr. Kiebert became radio inspector for the Federal Communications Commission at Seattle, and in 1938 he was transferred to Washington, D. C., where he was associate engineer in the broadcast division. During 1939 he became affiliated



O. C. LUNDSTROM

with Jansky and Bailey, Washington, D. C., as a consulting radio engineer. In 1941 he became a consultant with McNary and Chambers, Washington, D. C. Mr. Kiebert entered the United States Naval Reserve in 1941. In 1942 and 1943 he was senior instructor in the Naval Training School (Pre-radar), Bowdoin College, Brunswick, Maine. In December, 1943, he was transferred to the radio and electrical branch of the Bureau of Aeronautics, United States Navy Department, Washington, D. C. He is stationed there at present with the rank of Lieutenant Commander.

O. C. Lundstrom (S'42) was born at Morrissetown, South Dakota, on September 12, 1917. He was graduated from the University of California in 1941 with the B.S. degree in electrical engineering. From 1942 to 1944 he was a graduate student and acting instructor at Stanford University, from which he received the A.M. and E.E. degrees in electrical engineering. Since 1944 Mr. Lundstrom has been employed by the Sperry Gyroscope Company as an assistant project engineer. He is a member of Tau Beta Pi, Eta Kappa Nu, and Sigma Xi.

William R. MacLean (A'42) was born on July 14, 1908 at Marinette, Wisconsin. He became interested in radio in grade school and operated a spark-coil crystal-detector station in 1921. Later he operated two licensed amateur stations while in high school, and a third at Massachusetts Institute of Technology where he received the B.Sc. degree in electrical engineering in 1929. For the following year he worked in the Bell Telephone Laboratories. Thereafter, during the Weimar republic, he studied physics a semester each at the Universities of Munich and Berlin. This was followed by most of a third semester at the Sorbonne. He did actuarial work from 1932 to 1937. Mr. MacLean returned to electrical engineering in civil service from 1937 to 1941, and then went to the Polytechnic Institute of Brooklyn where he received the M.E.E. degree in 1942 and is now employed as a research associate. He is a member of Sigma Xi and of the Acoustical Society of America.

William S. Marks, Jr. (A'44-SM'44) was born in Nashville, Tennessee, on March 18, 1900. He received the B.S. degree in electrical engineering from the Louisiana State University in 1929, and did post-graduate work at Rutgers University.

He served in World War I as radioman in the United States Naval Reserve after graduating from the Naval Radio School at Harvard University. He was a commercial radio operator for Marconi Wireless and RCA from 1919 to 1925, and in 1929 became associated with the radio engineering department of the General Electric Company in Schenectady, N. Y. In 1930 he accepted an appointment as radio engineer with the Signal Corps Laboratories at Fort Monmouth, New Jersey, and became chief engineer of the vehicular radio branch. Mr. Marks was associated with the original development of Radar in 1936 and 1937, and

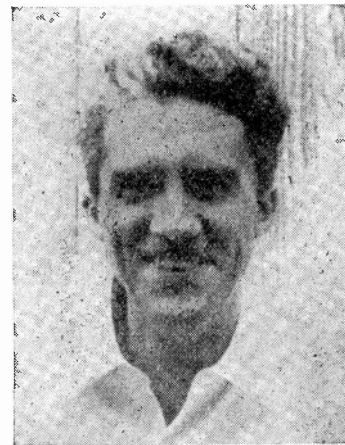

W. R. MACLEAN

pioneered in the development of mobile frequency-modulation equipment for the Army.

In 1942 he accepted a commission as Major in the Signal Corps, and was assigned as officer in charge of the radio communication branch, at Coles Signal Laboratory. In 1944 he served as technical advisor to Major General Roger B. Colton, chief of the engineering and technical service in the Office of the Chief Signal Officer, on a tour of Signal Corps installations in the Italian, European, and North African theater of operations. He received the rank of Lieutenant Colonel in 1944 and he is now assigned to the engineering staff, headquarters, Signal Corps Ground Signal Agency, at Bradley Beach, New Jersey.

He is a member of the Veteran Wireless Operators' Association.

Oliver D. Perkins (A'36-M'38-SM'43) was born at Milwaukie, Oregon, on August 11, 1910. He received the B.S. degree in electrical engineering from Oregon State College in 1931, and the M.S. degree in physics from the same institution in 1933.

During 1928 and 1929, he served as a shipboard radio operator for the Alaska Steamship Company; and from 1931 to 1936 was a member of the technical staffs of

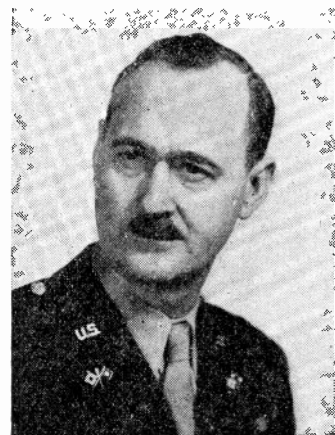

WILLIAM S. MARKS, JR.



Lorstan Studios

OLIVER D. PERKINS

KOAC and KOIN, respectively. Mr. Perkins entered civil service as a radio engineer for the Signal Corps in 1937, serving in Washington, D. C., Fort Sam Houston, Texas, and Fort Shafter, Hawaii. He was transferred to the Signal Corps Laboratories at Fort Monmouth, New Jersey, in 1940.

In 1942 Mr. Perkins entered active military duty as a First Lieutenant, receiving the rank of Captain later in the same year. In 1943, with a group of civilian Signal Corps engineers in the North African Theater of Operations, he developed and supervised the first applications of radio-relay communication systems and radio teletype in tactical operations by the allied military forces, utilizing commercial frequency-modulation radio equipment. In the following year he was associated with the initial planning for use of radio-relay communication systems across the English Channel in the invasion of France, and since that time has been active in further development of radio-relay systems and integrated wire and radio facilities. He is at present a member of the engineering staff Headquarters, Signal Corps Ground Signal Agency.

Captain Perkins is a registered professional engineer, and a member of Eta Kappa Nu, Sigma Pi Sigma, and the American Radio Relay League.



Cecil C. Pine (A '43) was born on February 12, 1910, in Castle Rock, Colorado. His education in radio engineering was obtained through home study courses. He also attended classes in engineering at the University of Washington. He has been active in the radio field since 1929, during which time he maintained his own amateur station. For the past several years he has made a special study of radio direction finding, and at present is employed by the Sperry Gyroscope Company, as engineer in this field. Previous to this he was employed by the Alaska sector of Pan American Airways, at Seattle, Washington.



CECIL C. PINE



E. M. Webster (A'30-M'38-SM'43-F'44) was born in Washington, D. C. in 1889 and was graduated from the United States



E. M. WEBSTER

Coast Guard Academy in 1912, with an appointment as Ensign.

He saw service during World War I, and in 1923 was made Chief Communications Officer of the Coast Guard. In 1934 he was retired because of disability and joined the staff of the Federal Communications Commission as assistant chief engineer. Recalled to active duty in the Coast Guard in 1942, he was reassigned to his former duty as Chief Communications Officer, with the rank of Captain.

He has been active for many years in coordinating communication activities within the government. His association with the Interdepartment Radio Advisory Committee dates from 1923, during the first year of its existence. As a government representative, he has attended many international communications conferences, including the London Safety of Life at Sea Conference in 1929; telecommunications conventions at Washington in 1927, Madrid in 1932, and Cairo in 1938; the International Technical Consulting Committee on Radio Communication at Copenhagen, in 1931; and the International Telegraph Conferences at Paris, in 1925, and Brussels, in 1928.

you can't put the squeeze
on SEALDTITE
CAPACITORS

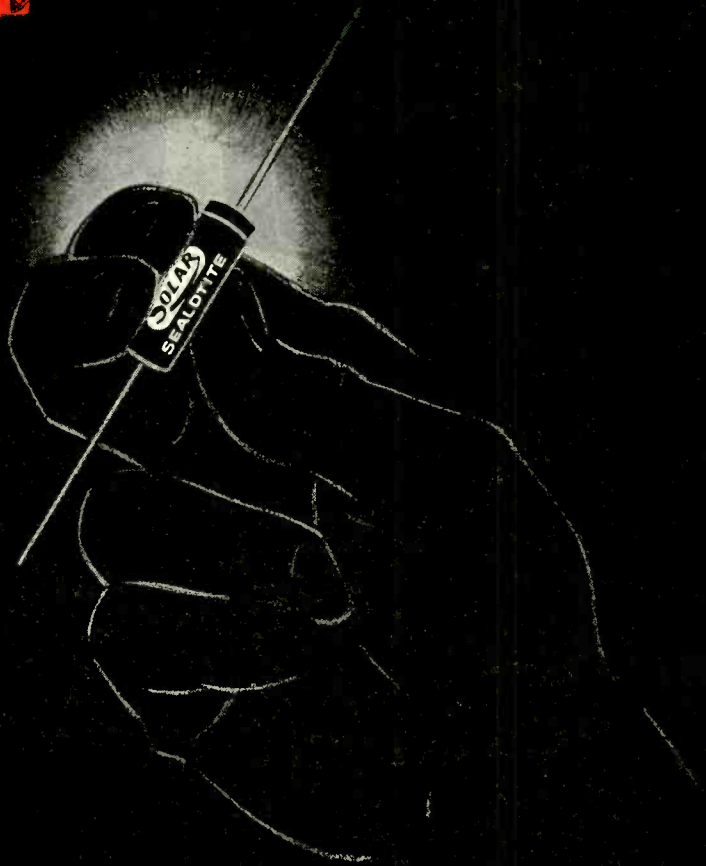

Just try it . . . Take a genuine "Sealdtite" capacitor and try to *squeeze* it. No results. You'll find it has no soft spots, which in ordinary tubulars provide room for moisture, the capacitor's worst enemy, because the Solar capacitor has an internal winding of high quality paper and foil, skillfully *molded* into *solid* plastic.

No moisture can penetrate this protective case and its substantial construction permits rough handling, assures long and *reliable* service. Use "Sealdtite" capacitors. Send for your copy of Catalog V-4. Any Climate—Any Atmosphere—Any Service.



BAYONNE PLANT
WEST N. Y. PLANT
A TOTAL OF EIGHT ARMY-NAVY
EXCELLENCE AWARDS

SOLAR CAPACITOR SALES CORP.
285 MADISON AVENUE, NEW YORK CITY

7567

FOR SPECIALIZED
ELECTRONIC EQUIPMENT
RELY ON ANDREW CO.

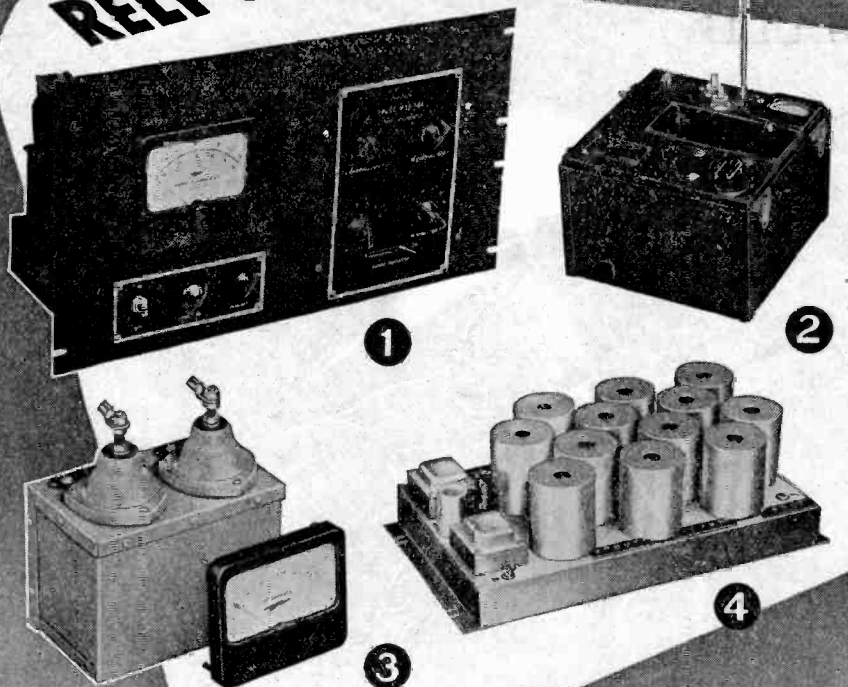

The fine electronic instruments shown above are examples of the precision production that characterizes all ANDREW equipment. Designed and built by skilled engineers, ANDREW CO. electronic equipment is used the world over wherever specialized apparatus is needed.

1 TYPE 40A PHASE METER—This direct reading, precision instrument measures in degrees the phase angle between currents in radiating elements of a directional antenna system. It operates on a signal input of only 200 millivolts and may also be used for general laboratory work.

2 TYPE 291 HF OSCILLATOR—This portable battery operated oscillator is used for checking high frequency receivers, especially aircraft type. The frequency range is from 49 to 154 Mc. with modulation frequencies of 70, 90, 400, 1300 and 3000 cycles. This unit contains a collapsible whip antenna for checking receivers without direct connections, and provides 2 coaxial terminals for low and high level output.

3 TYPE 708 REMOTE ANTENNA AMMETER—This unit contains a diode rectifier with a DC micro-ammeter calibrated in RF amperes, and is used for indicating antenna current at a point remote from the antenna. This instrument is used by hundreds of broadcast stations.

4 TYPE 760 ANTENNA TUNING UNIT—This is used for coupling several antennas into a single receiver, or for coupling a single antenna into a number of receivers. Containing six RF amplifiers with an associated power supply, each amplifier stage in this unit has low impedance input and output circuits. These may be series connected for use with a single receiver or antenna. This equipment is especially useful where antennas are remotely located from receivers.

Send in your orders now so that you may receive early delivery as soon as military restrictions are lifted.

ANDREW CO.

363 East Seventy-fifth Street, Chicago 19, Illinois



Buenos Aires

"The Section's Activities in 1944," by I. C. Grant, Retiring Secretary-Treasurer; April 27, 1945.

"Converter Tubes (Part 1) General Theory and Measurements," by E. Labin, Philips, S. A.; May 4, 1945.

"Converter Tubes (Part 2) Electronic Process and Parasitic Effects," by M. J. Kobilsky; Philips, S. A.; May 18, 1945.

Buffalo-Niagara

"Wartime Developments in Electronics," by W. L. Everitt, President, The Institute of Radio Engineers, Inc.; May 29, 1945.

Election of Officers; May 29, 1945.

Cincinnati

Inspection Trip to Office of War Information and Crosley Transmitters, at Bethany, Ohio; May 10, 1945.

"Radio Broadcasting—Postwar," by J. D. Shouse, Crosley Corporation; June 19, 1945.

Cleveland

"Technical Factors in Microwave Applications," by W. W. Hansen, Sperry Gyroscope Company; May 1, 1945.

"Precision Measuring with Gauge Blocks, Inspection, and Light Waves," by J. M. Beggs and A. B. Erickson, Doall Cleveland Company; May 24, 1945.

Connecticut Valley

"Wartime Developments in Electronics," by W. L. Everitt, President, The Institute of Radio Engineers, Inc.; May 1, 1945.

"Sources of Distortion in Frequency-Modulation Receivers," by D. L. Jaffe, Templeton Radio Company; May 17, 1945.

Election of Officers, May 17, 1945.

Dayton

"Explanation of Radio Station and Inspection," by R. P. Rockwell, Crosley Corporation; May 10, 1945.

"The Design of Broad-Band Aircraft-Antenna Systems," by A. S. Meier, F. D. Bennett, and P. D. Coleman, Aircraft Radio Laboratory; June 14, 1945.

"Instrument Approach and Landing Systems," by F. L. Moseley, Aircraft Radio Laboratory; June 14, 1945.

Emporium

"Wartime Developments in Electronics," by W. L. Everitt, President, The Institute of Radio Engineers, Inc.; June 1, 1945.

Indianapolis

"Heavy-Duty Regulated Vibrator Power Supplies," by Jose Moss, Electronics Laboratories; May 25, 1945.

Business Meeting and Tour of Civil Aeronautics Administration Experimental Station; June 22, 1945.

Kansas City

"Television Operations," by R. D. Compton, KMBC; May 29, 1945.

Election of Officers, May 29, 1945.

Los Angeles

"Automatic Transcription—Playback Radius Equalization," by W. R. Johnson, KFI; June 19, 1945.

"Instantaneous Frequency Runs on Playback Heads," by W. R. Johnson, KFI; June 19, 1945.

"A New High-Frequency Impedance-Measuring Set," by D. S. Henry, Don Lee Network; June 19, 1945.

New York

"Problems in the Manufacture of Ultra-High-Frequency Solid-Dielectric Cables," by A. J. Warner, Federal Telephone and Radio Corporation; February 7, 1945.

"The Transient Response of Wide-Band Amplifiers," by W. W. Hansen, Sperry Gyroscope Company; March 7, 1945.

(Continued on page 36A)

WHAT ARE YOU GOING TO DO ABOUT THE NEW ALLOCATIONS?

HERE'S ONE THING YOU CAN DO ABOUT THEM NOW.

Perhaps by the time you read this, all frequency allocations will have been pretty well settled. You'll be thinking about how your present equipment will fit into the future.

Browning Laboratories have always designed and manufactured soundly engineered and ruggedly built equipment for specific services. Right now every available manhour goes into design and manufacture for the Armed Forces. But, looking ahead, if you'd like Browning to have a converter for your specific needs, tell us how you'd like it.

This applies to both AM and FM receiving equipment. Tear out this page now, as a reminder, or write us a letter.

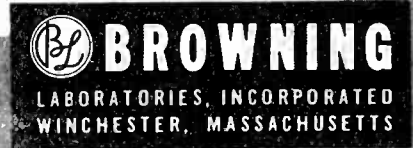

HERE IS A HANDY FORM TO HELP YOU see where you stand. If you mail it to Browning Laboratories, it will give you an opportunity to say exactly what you want by way of conversion equipment.

Browning Laboratories, Inc.
750 Main Street
Winchester, Mass.

Gentlemen:

My present AM receiving equipment has ranges of to to
..... to to to to to

It will be satisfactory in the new allocations without a converter.

It will have to be converted to ranges of to to
..... to to to to to

My present FM receiving equipment has ranges of to to
..... to to to to to

It will be satisfactory in the new allocations without a converter.

It will have to be converted to ranges of to to
..... to to to to to

If a dependable Browning Laboratories converter is available, here are the special features it should have to be most useful to me:

.....
.....
.....

NAME _____

TITLE _____

COMPANY _____

ADDRESS _____

1,001 USES

Condensed Power for Years of Service

VERSATILITY and dependability were paramount when *Alliance* designed these efficient motors — *Multum in Parvo!* . . . They are ideal for operating fans, movie projectors, light home appliances, toys, switches, motion displays, control systems and many other applications . . . providing economical condensed power for years of service.

Alliance Precision

Our long established standards of precision manufacturing from highest grade materials are strictly adhered to in these models to insure long life without breakdowns.

EFFICIENT

Both the new Model "K" Motor and the Model "MS" are the shaded pole induction type — the last word in efficient small motor design. They can be produced in all standard voltages and frequencies with actual measured power outputs ranging upwards to 1/100 H. P. . . Alliance motors also can be furnished, in quantity, with variations to adapt them to specific applications.

DEPENDABLE

Both these models uphold the *Alliance* reputation for all 'round dependability. In the busy post-war period, there will be many "spots" where these Miniature Power Plants will fit requirements . . . Write now for further information.



Remember Alliance!
 —YOUR ALLY IN WAR AS IN PEACE—
ALLIANCE
MANUFACTURING CO.
ALLIANCE . OHIO

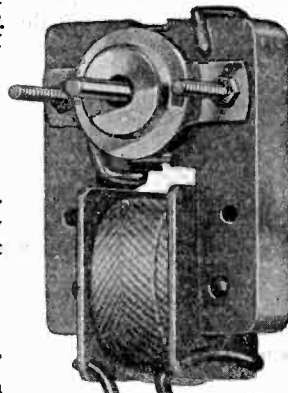

Model "MS" — Full Size
Motor Measures
1 3/4" x 2 x 3 3/8"

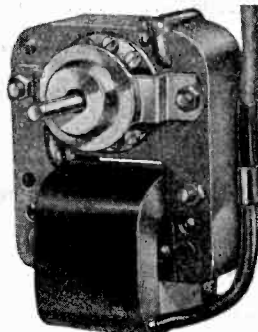

New Model "K" — Full Size
Motor Measures
2 3/8" x 2 3/8" x 3 1/8"

Section Meetings

(Continued from page 34A)

"Wide-Range Tuned Circuits for High Frequencies," by A. Petersen, Bell Telephone Laboratories, Inc.; March 16, 1945.

"The Servo Problem as a Transmission Problem," by E. B. Ferrell, Bell Telephone Laboratories, Inc.; March 16, 1945.

"The Vibratron," by Frank Rieber, Rieber Electronic Laboratories; March 28, 1945.

"Wartime Developments in Electronics," by W. L. Everitt, President, The Institute of Radio Engineers, Inc.; April 4, 1945.

"Precision Methods of Electronic Timing," by J. T. Potter, Potter Instruments Company; April 18, 1945.

"Present and Postwar Aviation-Communication Systems," by D. W. Rentzel, Aeronautical Radio, Inc.; April 26, 1945.

"Some Plane Common Sense About Television," by P. I. Merryman, National Broadcasting Company; May 2, 1945.

"Models of the Motion of Electron and Electro- and Magneto-Static Fields," by J. A. Rajchman, RCA Laboratories; May 11, 1945.

"Field Experiences with the Very-High-Frequency Radio-Relay Equipment in Normandy," by A. H. Waite, Jr., Coles Signal Laboratory; May 11, 1945.

"Frequency Allocations for Television," by G. P. Adair, Federal Communications Commission; June 15, 1945.

"Reflective Optics as Applied to Television," by I. G. Maloff, RCA Victor Division; June 15, 1945.

"Refractive Optics in Television Projection," by Konstantin Pestracov, Bausch and Lomb Optical Company; June 15, 1945.

"Direct Viewing Large Image with a Twenty-Inch Tube," by A. B. DuMont, Allen B. DuMont Laboratories, Inc.; June 15, 1945.

"Pros and Cons of Direct Viewing versus Projection Television," by D. D. Israel, Emerson Radio and Phonograph Corporation; June 15, 1945.

"Color-Television Receivers," by P. C. Goldmark, Columbia Broadcasting System; June 15, 1945.

ROCHESTER

"Wartime Developments in Electronics," by W. L. Everitt, President, The Institute of Radio Engineers, Inc.; May 31, 1945.

ST. LOUIS

"Electronic Heating," by W. D. Wenger, RCA Victor Division; April 26, 1945.

"A Graphical Analysis of Frequency Modulation," by S. H. Van Wambeck, Washington University; May 29, 1945.

Election of Officers, May 29, 1945.
"Graphical Analysis of Frequency Modulation — Part II," by S. H. Van Wambeck, Washington University; June 6, 1945.

SEATTLE

"Kilocycle Cops," by V. A. North, North Pacific Monitoring Area, Federal Communications Commission; June 12, 1945.

WASHINGTON

"Network for Television and Frequency Modulation Broadcasting," by H. S. Osborne, American Telephone and Telegraph Company; February 13, 1945.

"Characteristics and Limitations of the Vacuum-Tube Radio-Frequency Generator," by T. P. Kinn, Westinghouse Electric Corporation; March 12, 1945.

"Wartime Developments in Electronics," by W. L. Everitt, President, The Institute of Radio Engineers, Inc.; April 9, 1945.

"Radio-Relay Communications System in the United States Army," by W. S. Marks, Signal Corps Ground Signal Agency; May 14, 1945.

"High-Frequency Measurements," by Arnold Peterson, General Radio Company; June 11, 1945.

WILLIAMSPORT

"Electrical Glass and Electrical-Glass Working," by E. M. Guyer, Corning Glass Works; June 6, 1945.

Again KAAR is FIRST!

fm



KAAR makes 50 and 100-watt mobile FM practical with instant-heating tubes

Kaar engineers—who pioneered instant-heating AM radiotelephones—have done it again! In presenting the new KAAR FM-50X and FM-100X, they now give you the advantages of FM *plus* instant-heating tubes... greater power and range

with lower battery drain! Standby current is zero. Yet the instant you press the button microphone, you are on the air with a full 50 or 100 watts output, improved voice quality, and minimum distortion—sending out a strong, clear message that insures excellent reception.

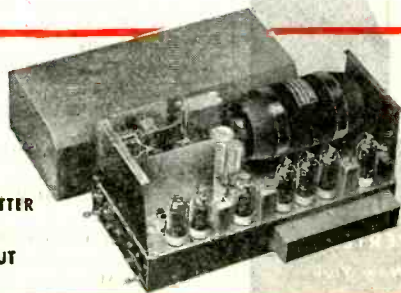

KAAR FM TRANSMITTER
MODEL FM-50X
50 WATTS OUTPUT

KAAR



ENGINEERING CO.

PALO ALTO • CALIFORNIA

Export Agents: FRAZAR & HANSEN • San Francisco, California

MOTOR DATA
No. 126

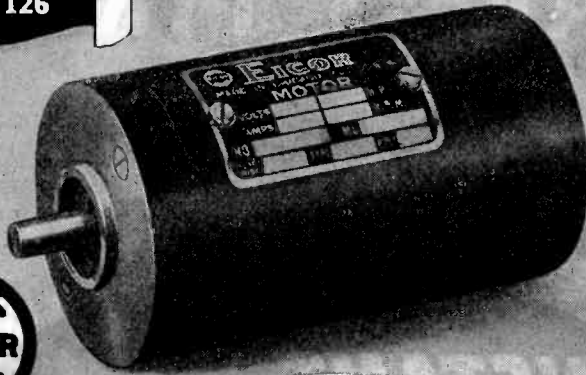

2300 FRAME MOTOR
1/5 HP at 3800 RPM

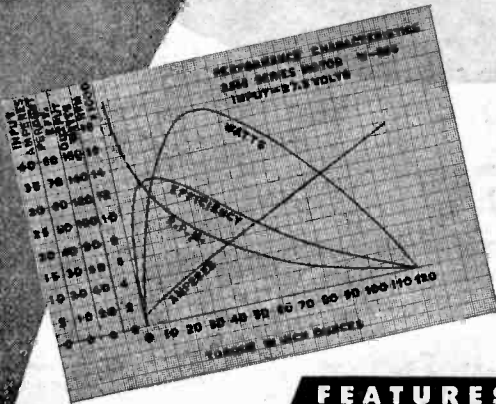

The basic design of the 2300 Frame Motor has been used in scores of individual modifications. Many of these designs are complete and available—others for new equipment can readily be developed.

FEATURES

ELECTRICAL

- Series or shunt wound
- High starting torque
- Low starting current
- High efficiency
- Low RF interference
- Unidirectional or reversible
- Armature and field windings varnish impregnated and baked

MECHANICAL

- Low weight factor
- Unusual compactness
- Completely enclosed
- Base or flange mounting
- Laminated field poles
- Precision ball bearings
- Segment-built commutator
- Permanent end play adjustment

2300 FRAME MOTORS		2318 Series	2310 Shunt
Watts Output, Int.	(max.)	160	50
Torque at 6000 RPM	(in. oz.)	40	10
Torque at 3800 RPM	(in. oz.)	57	—
Lock Torque	(in. oz.)	120	14
Volts Input	(min.)	5	5
Volts Input	(max.)	110	28
Temperature Rise	(int.)	50°C	50°C
Diameter		2 ⁵ / ₁₆ "	2 ⁵ / ₁₆ "
Length less shaft		4 ⁵ / ₃₂ "	2 ³ / ₄ "
Shaft Dia.	(max.)	.312"	.312"
Weight	(lbs.)	2.4	1.5

EICOR INC. 1501 W. Congress St., Chicago, U.S.A.
DYNAMOTORS • D. C. MOTORS • POWER PLANTS • CONVERTERS
Export: Ad Auriema, 89 Broad St., New York, U.S.A. Cable: Auriema, New York



The following transfers and admissions were approved on July 11, 1945:

Transfer to Senior Member

- Allen, J. E., 1611 Lexington Bldg., Baltimore 1, Md.
- Austin, F. M., 3103 Amherst St., Houston 5, Tex.
- Bishop, N., 4375 Congress St., Fairfield, Conn.
- Brodie, LeS., DME (E5) NDHQ, Ottawa, Ont., Canada
- Castle, D. H., White Oak Shade, New Canaan, Conn.
- Curran, G. W., Radiation Laboratory, Massachusetts Institute of Technology, Cambridge, Mass.
- DeWalt, K. C., General Electric Co., Schenectady, N. Y.
- Di Toro, M. J., Hazeltine Corp., 263-89 Grand Central Pkwy., Little Neck, L. I., N. Y.
- Donald, D. D., 3001 Henry Hudson Pkwy., New York 63, N. Y.
- Eltgroth, G. V., 404 Alabama Rd., Towson 4, Md.
- Graf, A. W., 135 S. LaSalle St., Chicago 3, Ill.
- Griffith, R. T., Bell Telephone Co. of Pennsylvania, 416-7 Ave., Pittsburgh 19, Pa.
- Hoyler, C. N., 45 Harold Ave., Princeton, N. J.
- Korman, N. I., 1456 Wildwood Ave., Camden, N. J.
- Lazich, B., 2363 Hollywood Dr., Wilkensburg, Pittsburgh 21, Pa.
- Millar, J. Z., 60 Hudson St., New York 13, N. Y.
- Price, H. J., 2534-30 Ave., S., Seattle, Wash.
- Waldorf, S. K., 5701 Chilham Rd., Baltimore 9, Md.
- Watson, E. F., 15 Sound View Dr., Larchmont, N. Y.

Admission to Senior Member

- Browne, G. C. W., Dept. of Transport, Ottawa, Ont., Canada
- Elder, T. A., 615 Charles St., Scotia, N. Y.
- Lear, W. P., Lear, Inc., 1860 Broadway, New York 23, N. Y.
- Mitchell, T. H., Radio Corporation of America, 66 Broad St., New York, N. Y.
- Moore, V., 105 Smithwood Ave., Catonsville 28, Md.
- Odarenko, T. M., 100 Kingsland Rd., Clifton, N. J.
- Page, H. C., 15 Rutgers Pl., Scarsdale, N. Y.
- Tidd, W. H., 463 West St., New York 14, N. Y.

Transfer to Member

- Becklund, O. A., 841 Diamond St., San Diego 9, Calif.
- Bowditch, F. T., 1259 Bonnie View Ave., Lakewood 7, Ohio
- Butz, A. N., Jr., Harvard University, Underwater Sound Laboratory, Cambridge 38, Mass.
- Clark, D. E., 2501 N. Keeler St., Chicago 39, Ill.
- Currier, M. G., Box 412, Morristown, N. J.
- Duncan, J. R., 7200 Hamilton Ave., Cincinnati, Ohio
- Ellis, A. B., 1017 Keefer Bldg., St. Catherine St., W. Montreal, P. Q., Canada
- Fitzmorris, S. R., General Electric Co., Bldg. 81, Room 203, Schenectady, N. Y.
- Flath, E. H. Jr., University of Cincinnati, Applied Science Research Laboratory, Cincinnati, Ohio
- Floyd, G. H., 1109 South Country Club Dr., Schenectady 8, N. Y.
- Gray, L. F., 337 MacLaren Ave., Ottawa, Ont., Canada
- Hadley, C. F., 303 B Holden Green, Cambridge 38, Mass.
- Hall, F. T., Jr., 231 E. Fairmount Ave., State College, Pa.
- Hammond, R. E., Box 412, Kitchener, Ont., Canada
- Hancock, H. E., 3641 Wilshire Ave., Cincinnati 8, Ohio
- Hardgrave, W. F., University of New Mexico, Dept. of Electrical Engineering, Albuquerque, N. M.

(Continued on page 41A)

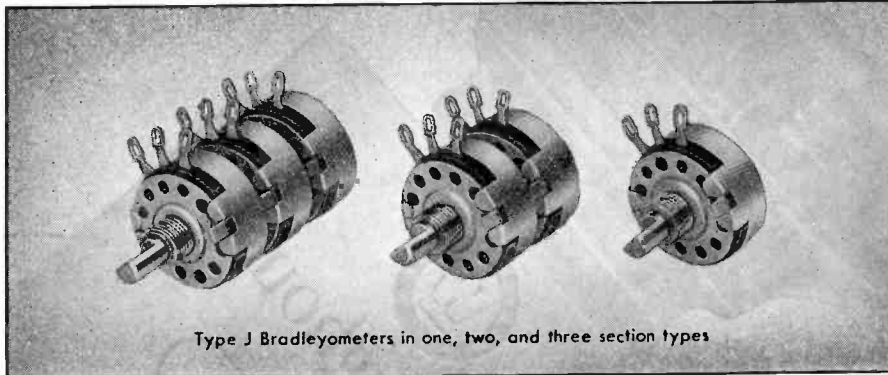
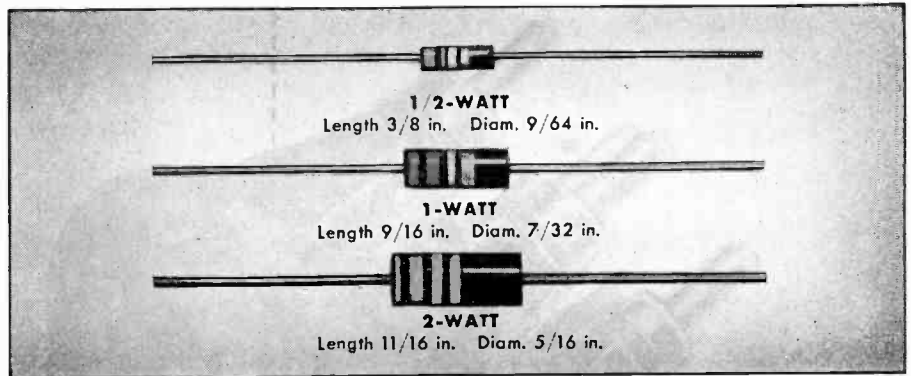
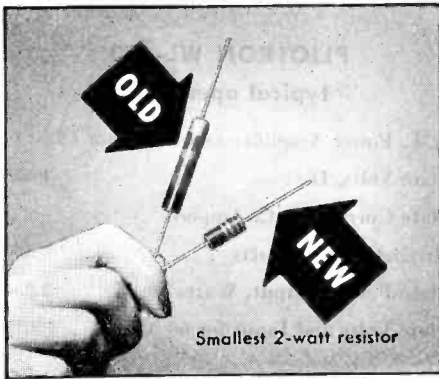

Type J Bradleyometers in one, two, and three section types



Carbon brush makes smooth contact

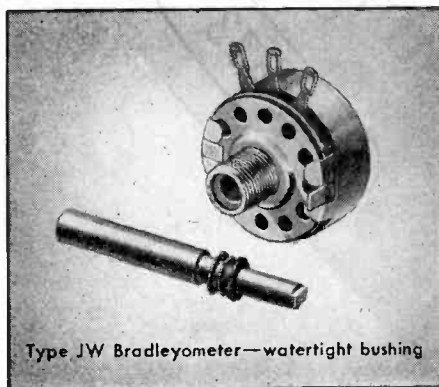

Type JW Bradleyometer—watertight bushing

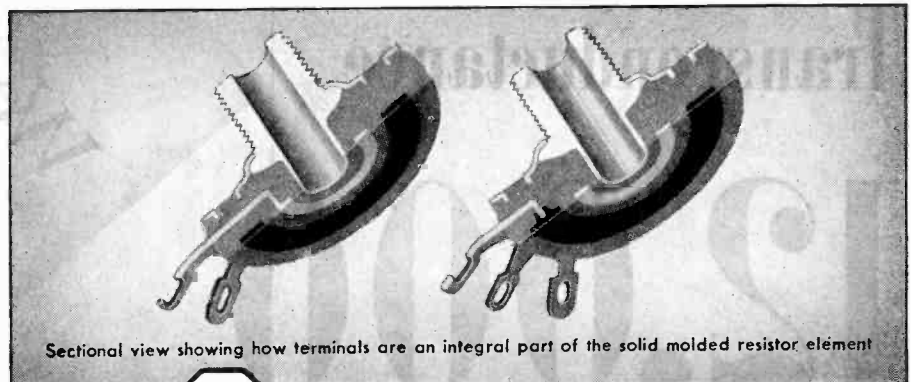

Sectional view showing how terminals are an integral part of the solid molded resistor element



ALLEN-BRADLEY

FIXED & ADJUSTABLE RADIO RESISTORS

QUALITY

FIXED INSULATED RESISTORS—Bradleyunits are available in 1/2-watt, 1-watt, and 2-watt ratings. They will sustain an overload of ten times rating for several minutes without failing. Wax impregnation is not necessary to pass salt water immersion test. The 1/2-watt and 1-watt units are available in all RMA standard values from 10 ohms to 10 megohms. Two-watt units available from 10 ohms to 1 megohm.

ADJUSTABLE RESISTORS—Type J Bradleyometers are the only continuously adjustable composition resistors having a 2-watt rating with good safety factor. Resistor element is solid molded and has substantial thickness. Not a film, paint, or spray type. Molded as single unit complete with insulation, terminals, face plate, and bushing. No rivets or soldered connections. Any resistance-rotation curve can be provided.

Allen-Bradley Company, 114 W. Greenfield Ave., Milwaukee 4, Wis.

WHEN DEPENDABILITY AND PERFORMANCE ARE "MUSTS"... THE EXPERTS SPECIFY ALLEN-BRADLEY



PLIOTRON WL-473
typical operation

R. F. Power Amplifier and Oscillator Class C	
Plate Volts, D-C	3,000
Plate Current, D-C. Amperes	1.4
Driving Power, Watts	330
Plate Power Output, Watts	3,250
Plate Volts and Input for 60 MC	100%

Transconductance

12,000

PLATE OUTPUT:
3,250 WATTS AT 60 MC

PLATE EFFICIENCY:
78%

This exclusive Westinghouse Plotron opens new opportunities for improving design of electronic equipment

©1945, Westinghouse Electric Corporation

Westinghouse

TUNE IN: John Charles Thomas—Sunday, 2:30 P. M., EWT—NBC
 Ted Malone—Mon. through Fri., 11:45 A. M., EWT—Blue Network

The exceptionally high transconductance of the Westinghouse Plotron WL-473 assures high power at low operating plate voltage. This compact, powerful, dependable tube opens new horizons to engineers who are designing dielectric and induction heating equipment and AM and FM transmitters.

For complete technical data on this exclusive Westinghouse tube, consult your nearest Westinghouse office or write Westinghouse Electric Corporation, Electronic Tube Sales Department, Bloomfield, New Jersey.

Electronic Tubes at Work

Membership

(Continued from page 38A)

Herr, M. D., 35 Stanton Blvd., Hempstead, L. I., N. Y.
 Hierath, D. C., Bendix Radio Division, Towson 4, Md.
 Holbrook, R. A., 146 Lawrenceville Rd., Decatur, Ga.
 Hollabaugh, M. G., 35-05—87 St., Jackson Heights 21, L. I., N. Y.
 Johnson, R. M. W., 7818 Truxton Ave., Los Angeles 45, Calif.
 Johnson, R. W., 2713 Ridge Rd., Berkeley 4, Calif.
 Jordan, J. F., 501 Miami Ave., Terrace Park, Ohio
 Levine, M. E., 88 Sheridan St., Irvington 11, N. J.
 Lowery, W. E., 1281 Walnut St., Newton Highlands, Mass.
 Lurch, E. N., 16 Cambridge Ct., Larchmont, N. Y.
 McCachren, W. S., 809 B Windemere Ave., Drexel-Hills, Pa.
 Ming, M. M., RFD 3, Mesquite, Tex.
 Rambo, S. I., 2519 Wilkens Ave., Baltimore 3, Md.
 Shelton, A., 23 Ave. S., Nashville 5, Tenn.
 Warsher, A., 342 Concord Dr., Maywood, N. J.
 Wenk, H. A., Bell Telephone Laboratories, Inc., 180 Varick St., New York 14, N. Y.

Admission to Member

Abate, A., 55 Clark Lane, Waltham 54, Mass.
 Barr, R. L., 1954 Henley St., Glenview, Ill.
 Blythe, R., 460 Beacon St., Boston 15, Mass.
 Brodie, G. H., 715 S. Madison Ave., La Grange, Ill.
 Busse, D. E., TWA Engineering Laboratory, 14 W. 3 St., Kansas City 6, Mo.
 Butler, H., Villa Pj., Eatontown, N. J.
 Carson, G. S., 316 Lee St., Iowa City, Iowa
 Cummings, H., 234 Jackson Ave., Schenectady 4, N. Y.
 Curtis, T. P., 5 Wallace St., Scotia, N. Y.
 Farkas, F. S., 463 West St., New York 14, N. Y.
 Greer, W. M., 504 Munsey Bldg., Washington 4, D. C.
 Kanz, W. J., 75-33—177 St., Flushing, L. I., N. Y.
 Kimbark, E. W., Northwestern University, Dept. of Electrical Engineering, Evanston, Ill.
 Lake, R. E., Pratt Institute, 195 Grand Ave., Brooklyn, S. N. Y.
 Lloyd, C. G., 24 Willard Ave., Ottawa, Ont., Canada
 McCabe, A. P., 3155 Knox St., S. E., Washington 20, D. C.
 Martin, A. C., 157 W. Lanvale St., Baltimore 17, Md.
 Menzer, C. H., State University of Iowa, Radio Station WSUI, Iowa City, Iowa
 Price, J. F., 849 Berkley Rd., Indianapolis 8, Ind.
 Prokes, P. H., 9216 S. Menard Ave., Oak Lawn, Ill.
 Siegel, D. T., 4835 W. Flournoy St., Chicago 44, Ill.
 Smith, E., 6601 Romaine St., Hollywood, Calif.
 Smith, W. B., 311 Daly Ave., Ottawa, Ont., Canada
 Symons, W. E., Box 331, RFD 9, Van Zandt Rd., Cincinnati 24, Ohio
 Taylor, J. M., 5218 E. St. Clair St., Indianapolis 1, Ind.
 Traub, L. A., 2434—31 Ave., W., Seattle 99, Wash.
 Turrell, R. M., 506 Broadway Ave., Harrison, Ohio
 Walsh, H. E., 94 Renfrew Ave., Ottawa, Ont., Canada
 Wells, H. D., Jr., 17 Rosa Rd., Schenectady 8, N. Y.
 White, G. M., 1262 Lowell Rd., Schenectady 8, N. Y.
 Winemiller, H. R., 412 W. Grantley Ave., Elmhurst, Ill.

Admission to Associate

Acerbi, R. S., Monte 1271, Buenos Aires, Argentina
 Alvord, L. H., RFD 2, Brigham, Utah
 Applegate, H. E., Symmes Ct., RFD 1, Cranbury, N. J.
 Ashton, J. J., 2939—16 St., San Francisco 3, Calif.
 Babinchak, J. B., 7803 Dearborn Ave., Cleveland 2, Ohio
 Baird, J. M., RMO1.PSNY, Bremerton, Wash.
 Beasley, E. W., Queen's Rd., Chelmsford, Essex, England.
 Bellis, M. P., 939 Queens Ave., London, Ont., Canada

(Continued on page 42A)

ENGINEERS! DRAFTSMEN! ACCOUNTANTS! STUDENTS!

ORDER TODAY! Sensational NEW

MULTI Slide Rule



Clear, legible print... Tough, durable for long wear... Size 10" x 4"... Fits 3-ring binder... In case... Full instructions... TRANSPARENT PLASTIC INDICATOR...

STANCOR now offers the entire electronic industry the new Multi-Slide Rule. First developed for our own use, it is today made available to all... Greatly simplifies calculation of unlimited range of problems... A genuine professional rule—not a toy. This rule is obtainable ONLY THROUGH STANCOR JOBBERS. PLEASE DO NOT ORDER DIRECT. See your local directory for the name of the Stancor jobber in your city or, write for his name. Price of Stancor Multi-Slide Rule: One Dollar!—America's biggest slide-rule bargain—a service to the trade by Stancor.

STANDARD TRANSFORMER CORPORATION
 1500 N. HALSTED ST. CHICAGO 22, ILL.

ORDER FROM YOUR JOBBER

Note these 8 New Features!

In addition to having ALL the values of the ordinary slide-rule, the new Multi-Slide Rule has:

- 1 Four-place LOGARITHM TABLE
- 2 SIGNS and LIMITS of VALUE assumed by trigonometric functions
- 3 Table of NATURAL TRIGONOMETRIC FUNCTIONS
- 4 Table of TRIGONOMETRIC FORMULAE
- 5 Table of SLIDE-RULE SETTINGS
- 6 Table of GENERAL EQUATIONS
- 7 Long list of common MATHEMATICAL FORMULAE
- 8 DECIMAL equivalents of a fraction

OFFERED AS A SERVICE TO THE TRADE BY

STANCOR

BETTER PERMANENT MAGNETS

for:

**RADIO, SOUND and
COMMUNICATIONS
EQUIPMENT**

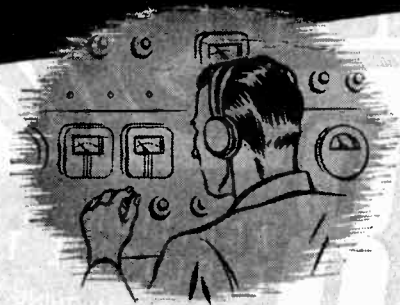

**AUTOMOTIVE
and AVIATION
EQUIPMENT**

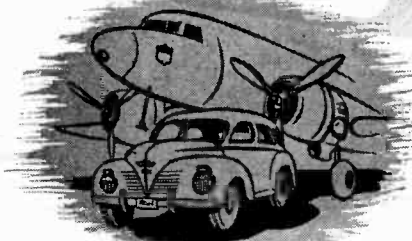

INSTRUMENTS

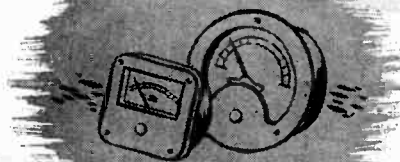

However advanced your own product-development work may be . . . however new or revolutionary the permanent magnets you require . . . Arnold engineers can be of considerable assistance to you in supplying the proper permanent magnets *in volume*. They're precision-built entirely in our own plant, under the closest metallurgical, mechanical and magnetic control to assure peak efficiency at the lowest cost.



Get your copy of this valuable manual on the design, production and application of modern Alnico permanent magnets. Write us, on your company letterhead, today.

Specialists in the manufacture of
ALNICO PERMANENT MAGNETS

THE ARNOLD ENGINEERING COMPANY

147 EAST ONTARIO STREET, CHICAGO 11, ILLINOIS

Membership

(Continued from page 41A)

- Berkley, C., 450 W. 162 St., New York 32, N. Y.
 Berman, R., 204 N. Beechwood Ave., Baltimore 28, Catonsville, Md.
 Blum, G. E., Fleet Post Office, San Francisco, Calif.
 Botha, P. G. E., Hanway Ct., 6, Fisher St., Durban, Natal, Africa
 Brennan, C. E., 3801 S. 56 St., Milwaukee 14, Wisc.
 Broadhead, S. L., Jr., 4132-4 Ave., S., Birmingham 6, Ala.
 Brooks, H. B., Weather Equipment Methods Sub-section, Spring Lake, N. J.
 Brown, R. H., 331 Stanford Ave., West View, Pittsburgh 2, Pa.
 Brown, R. W., 409 Oak St., Columbus, Ohio
 Brown, W. E., 61-20-77 St., Rebo Park, Middle Village Post Office, L. I., N. Y.
 Burmeister, M. A., 2817 Connecticut Ave., N. W., Washington 8, D. C.
 Butler, J. P., 58 W. Greenwood Ave., Columbus, Ohio
 Cook, N. W., 2313 E. 60 St., Kansas City 4, Mo.
 Cox, F. J., 102 O'Connor Dr., Toronto 6, Ont., Canada
 Crouch, E. C., 34 Lords Pl., Orange, N.S.W., Australia
 Darnell, F. W., Eastern Air Command Hq., 17 South St., Halifax, Nova Scotia Canada
 DeWitt, M. H., 614 Sausalito Blvd., Sausalito, Calif.
 Dodd, A. E., 26 McKelvey Rd., Pittsburgh 18, Pa.
 Donneau, P. J., 6 Mt. Auburn St., Cambridge 38, Mass.
 Doshi, K. M., Sheth C. N. Industrial School, Ellisbridge Ahmedabad, India
 Draus, A. R., 5572 W. Gladys St., Chicago 44, Ill.
 Edighoffer, E. A., 27 Parkwood Ave., Kenmore 17, N. Y.
 Ewing, G. W., 201 E. 10 St., San Bernardino, Calif.
 Faust, W. E., 133 Amsterdam Ave., Passaic, N. J.
 Field, F. M., 131 N. Fairfax St., Falls Church, Va.
 Fierman, C., Marconi's Wireless Telegraph Co., Chelmsford Essex, England
 Fincutter, J. P., 2476 Fulton St., San Francisco 18, Calif.
 Gamsa, L., 183, Willesden La., London N. W. 6, England
 Geer, K. E. J., Hotel Syracuse, Syracuse, N. Y.
 Gerdon, E. J., 2514 Baker Ave., Everett, Wash.
 Glass, B. J., 490 Seymour Ave., Columbus 5, Ohio
 Goodell, J. D., 26 W. College Ave., St Paul, 2, Minn.
 Goodwin, A. B., 341 Park Ave., Arlington, Mass.
 Griffin D. C., Navy Pier Ed., Chicago, Ill.
 Grodzinsky, S., Box 83, Scott Field, Ill.
 Grove, L. R., Naval Research Laboratory, Bldg. 1-PH, Washington 20, D. C.
 Guanella, G., Hinterbergstrasse 53, Zurich, Switzerland
 Guenther, P. F., 766 Coney Island Ave., Brooklyn 18, N. Y.
 Gunther-Mohr, G. R., Box 86, Station B, Dayton, Ohio
 Haines, E. D., 1546 Richmond St., Columbus, Ohio
 Hale, R. C., 36 Eden Ave., West Newton 65, Mass.
 Hall, C. T., 415 Penn Ave., Pittsburgh 22, Pa.
 Hammer, F. E., 7257 Holabird Ave., Baltimore 22, Md.
 Hayes, W. L., 573 Grove St., Upper Montclair, N. J.
 Hilsdale, F. A., 992 Memorial Dr., Cambridge, Mass.
 Holmquist, C. A., 1911 London St., New Westminster, B. C., Canada
 Howard, R. D., Army Post Office 237, San Francisco, Calif.
 Huddleston, R. E., R.M.O., Puget Sound Navy Yard, Bremerton, Wash.
 Humphreville, T. N., VAAF, Victorville, Calif.
 Hutchinson, J. M., 926 Blackburn Ave., Ashland, Ky.
 Jara, F. S., 524 W. 162 St., New York 32, N. Y.
 Johnson, R. A., 2312 Lyndale Ave., S., Minneapolis 5, Minn.
 Karaki, L. C., 632 N. Parkside Ave., Chicago 44, Ill.
 Keller, W. P., 6159 W. Eddy St., Chicago 34, Ill.

(Continued on page 46A)



RIGHT

from the start

Because every detail was painstakingly worked out in the early stages of development, this Narrow Band (200 cycles) FM Modulator-Oscillator unit is doing superb wartime service and will be a boon to postwar communications. Let us help you solve your postwar problems.

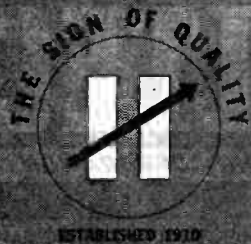
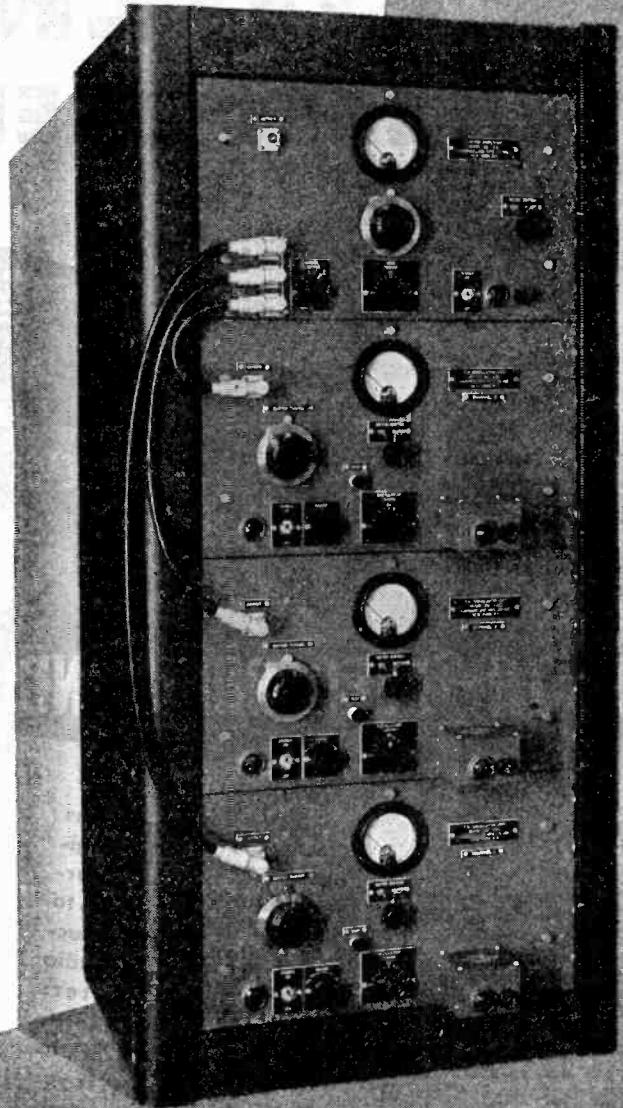

HAMMARLUND

THE HAMMARLUND MFG. CO., INC., 460 W. 34TH ST., NEW YORK 1, N. Y.
MANUFACTURERS OF PRECISION COMMUNICATIONS EQUIPMENT

SPECIALLY DESIGNED
**POWER
 TRANSFORMERS**

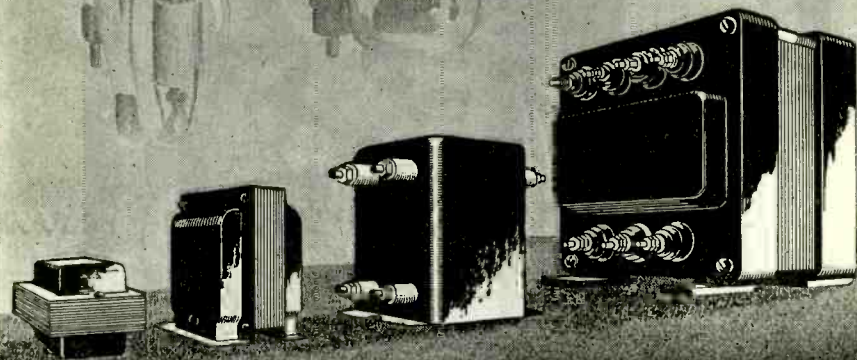

FOR THE ELECTRONIC INDUSTRY

AUDIO INPUT

VIBRATOR POW

CHOKES - AUDI

INSTRUMENT TR

CONTROL TRANS

FLUORESCENT BA

Chicago Transformer has always devoted its engineering and manufacturing facilities primarily to the design and production of Power and Audio Transformers, Filters and Chokes, to fill the specialized needs of the Electronic Industry. If you have a particular problem, let us be of service.

FORMERS

FORMERS

FACTORS

AUTO &

FILTERS

COILS

CHICAGO TRANSFORMER

DIVISION OF ESSEX WIRE CORPORATION

3501 WEST ADDISON STREET

CHICAGO, 18



TRADE MARK REG.



60 DEGREE

Horizontal

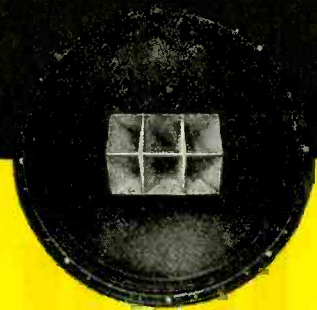

**AREA OF
 DISTRIBUTION**

The new amazing Altec Lansing multi-cellular Duplex Speaker provides up to 1200% increased area of quality sound distribution in the horizontal plane. Horizontally the Duplex delivers a sixty degree angle of distribution, or twelve times the area distribution at high frequencies as compared to single unit speakers of comparable size. Another reason why the DUPLEX is the SPEAKER that REVOLUTIONIZES the methods of sound REPRODUCTION.

SEND FOR BULLETINS

ALTEC

LANSING CORPORATION

1210 TAFT BLDG., HOLLYWOOD 28, CALIF.
 250 WEST 57 STREET, NEW YORK 19, N. Y.
 IN CANADA: NORTHERN ELECTRIC CO.

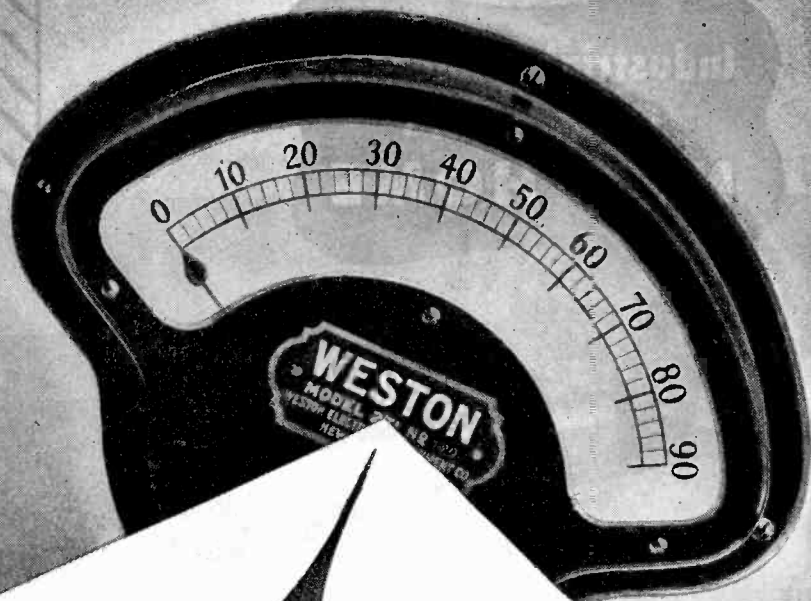

Pointing the way to
BUYER ACCEPTANCE *for tomorrow*

Many a brain-child of far-sighted companies now on the drawing-board, is destined for early birth. Tomorrow, these products will be seeking market acceptance not only at home, but in all corners of the earth.

With postwar markets highly competitive, manufacturers will strive to put into the product the best in materials components, and engineering skill. And if an indicating instrument is essential, it must be one not only of proved dependability, but one which has world-wide preference as well.

Logically, the instrument choice will be WESTON. For a WESTON on the panel gains instant recognition from equipment buyers throughout the world. To them, it is outward evidence of engineering soundness all throughout the device or machine. And to the manufacturer it brings an added sense of security . . . knowing that wherever they are used, his machines have a dependable and trouble free WESTON at the controls.

Before your equipment gets into the manufacturing stage, why not check your instrument needs with WESTON. Complete engineering service is freely offered. Weston Electrical Instrument Corporation, 589 Frelinghuysen Avenue, Newark 5, New Jersey.

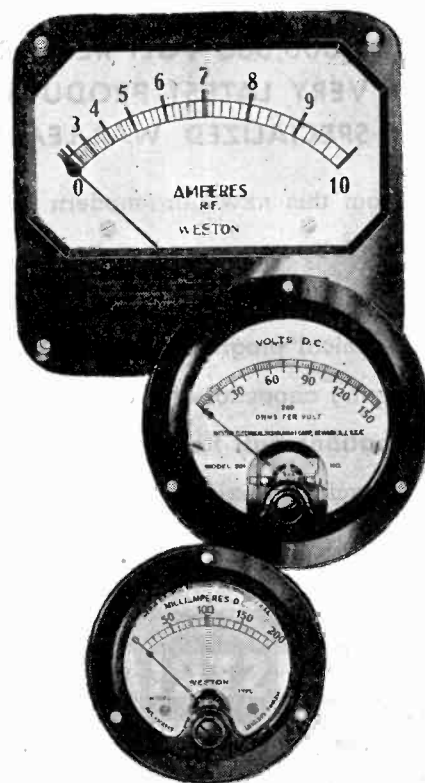

Weston

ALBANY • ATLANTA • BOSTON • BUFFALO • CHICAGO • CINCINNATI • CLEVELAND • DALLAS • DENVER • DETROIT • JACKSONVILLE • KNOXVILLE • LOS ANGELES • MERIDEN
MINNEAPOLIS • NEWARK • NEW ORLEANS • NEW YORK • PHILADELPHIA • PHOENIX • PITTSBURGH • ROCHESTER • SAN FRANCISCO • SEATTLE • ST. LOUIS • SYRACUSE

In Canada, Northern Electric Co., Ltd., Powerlite Devices, Ltd.

Industrial Condenser Corporation's NEW HOME



THE WORLD'S MOST MODERN CONDENSER PLANT with these outstanding features

- ★ 1,000,000 VOLT RESEARCH LABORATORY
- ★ VERY LATEST PRODUCTION EQUIPMENT
- ★ SPECIALIZED WAR-LEARNED TECHNIQUES

From this new ultra-modern factory come capacitors carefully engineered and accurately produced. Staffed by skilled engineers and backed by 16 years of technical progress, Industrial Condenser Corp. is supplying capacitors for every application. If your specifications call for Electrolytic, Paper, Oil, or Motor capacitors, look to Industrial Condenser Corporation.

INDUSTRIAL CONDENSER CORPORATION

3243-65 NORTH CALIFORNIA AVENUE, CHICAGO 18, U. S. A.

District Offices in Principal Cities

PAPER, OIL AND ELECTROLYTIC MOTOR CAPACITORS

Membership

(Continued from page 42A)

- Klein, E. L., 1008 Parkside Dr., Bremerton, Wash.
 Ketchum, D. L., NMRC, Irvington, Calif.
 Kline, J., 2600 N. W. 29 St., Miami 37, Fla.
 Krenzke, P. A., 58-B McNeal Ave., Bremerton, Wash.
 Kreuz, L. B., 2908 1/2 San Gabriel St., Austin 21, Tex.
 Lake, C. J., General Electric Co., Schenectady 5, N. Y.
 Lark, E. J., 5230 Dawes St., San Diego 9, Calif.
 Laurvick, A., 1145 W. Woolman St., Butte, Mont.
 Layton, J. E., 7543 Roosevelt Way, Seattle 5, Wash.
 Leonard, D., DuMont Laboratories, Passaic, N. J.
 Limpel, E. J., 3533 N. 27 St., Milwaukee 1, Wisc.
 Littlewood, W. M., 7359 Bennett Ave., Chicago 49, Ill.
 Lockhart, W. K., 433 Highland Rd., Pittsburgh 21, Pa.
 Luchi, R. D., 45 River Dr., Passaic, N. J.
 Madgett, W. H., 3618 McGraw Ave., Detroit 8, Mich.
 Mandel, M., 1715 Longfellow Ave., New York 60, N. Y.
 Martin, E. E., 11402 Governor Ave., Cleveland 11, Ohio
 Massy, F. M., 128 Post Ave., New York 34, N. Y.
 McMaster, W. J., RFD, Box 74, Terra Bella, Calif.
 Meehan, R. L., 619-3 St., S. W., Puyallup, Wash.
 Meier, W. M., 717 Edmondson Ave., Baltimore 28, Catonsville, Md.
 Metzker, E. R., 2322 1/2 Taft St., Toledo 5, Ohio
 Mihalik, J. J., 283 Hope Ave., Passaic, N. J.
 Mitchell, J. R., RFD 1, Box 332, San Rafael, Calif.
 Mohr, H. F., 49 Lakeview Ave., Lynbrook, N. Y.
 Mumford, E. R., RFD 1, Box 65, Annapolis, Md.
 Munson, J. F., Wolseley, Sask., Canada
 Myers, K. R., 2623 Beulah Rd., Columbus 3, Ohio
 Napier, J. B., 2966-5 Ave., Huntington 2, W. Va.
 Pastor, J., Jr., 266 Pierre Ave., Garfield, N. J.
 Patel, S. N., International House, 1414 E. 59 St., Chicago 37, Ill.
 Pattinson, K., 264, Tamworth Rd., Newcastle-on-Tyne 4, England
 Pearson, J. R. H., 1250 Mackenzie St., Victoria, B. C., Canada
 Pennington, E. T., 1117-9 St., Huntington 1, W. Va.
 Pettit, H. L., 3130-1 Ave., San Diego 3, Calif.
 Poole, J. P., 19 Durban Rd., Mowbray, Cape., South Africa
 Popp, R., 864 Stanton Ave., Millvale 9, Pa.
 Ramakrishnan, P. R., c/o Radha Krishna Mills, Ltd., Coimbatore, Madras, India
 Rawlins, E. F., 4628 Chester Ave., Philadelphia, Pa.
 Reinhart, H. E., RFD 1, Box 442, Meadow Park, San Rafael, Calif.
 Rennenkamp, L. J., 30-16-84 St., Jackson Heights, L. I., N. Y.
 Rhodes, MacL., 190-06 Hollis Ave., Hollis 7, N. Y.
 Rivers, R. A., 4111 Columbus Blvd., Coral Gables 34, Fla.
 Rogers, J. S., RFD 2, Box 479-A, Spring Lake, Mich.
 Romero, E. S., Fleet Post Office, San Francisco, Calif.
 Roselli, D. J., 602-90 St., Brooklyn, N. Y.
 Rutherford, R. E., 93 N. Spring Garden, Nutley, N. J.
 Sanders, R. G., 900 Riverside Dr., New York 32, N. Y.
 Sarli, M. V., General Artigas 4921, Buenos Aires, Argentina
 Sarma, P. H. N. B., Wireless Station, BEZWADA, Madras, South India
 Schoew, F. L., II, 1110-10 St., Huntington 1, W. Va.
 Schroth, L. C., 50 Colby Rd., North Quincy 71, Mass.
 Segaria, N. M., 233 E. Diamond Ave., Hazleton, Pa.
 Selke, G. H., 716 Grafton Ave., Dayton 6, Ohio
 Shapiro, L., Box 36, Scott Field, Ill.
 Silver, B., L.A.A.F., Sqdn Z, Br. 1, Lincoln, Nebr.
 Simon, L., 33 Essex St., New York 2, N. Y.
 Skrypski, E. J., 73 Belsaw Ave., Eatontown, N. J.
 Soich, W. S., 6225 S. Bishop St., Chicago 36, Ill.
 Spooner, L. I., 427 Rutherford Blvd., Passaic, N. J.

(Continued on page 48A)

Proceedings of the I.R.E., August, 1948

SYLVANIA NEWS

ELECTRONIC EQUIPMENT EDITION

AUGUST Published by SYLVANIA ELECTRIC PRODUCTS INC., Emporium, Pa.

1945

HIGH FREQUENCY INDUCTION FURNACE USED IN TUBE PLANT

The bombarder or high frequency induction furnace pictured below is another example of high-precision, modern equipment manufactured at Sylvania Electric's plant in Williamsport, Pa.

Flexible in Application

Used in all radio tube plants where exhaust machines operate, this essential apparatus may also be adapted for use in practically any application that requires high frequency induction heating by the connection of the proper heating coils. Its rated input is 25KVA, uses Type 207 tube as oscillator, frequency about 300KC.

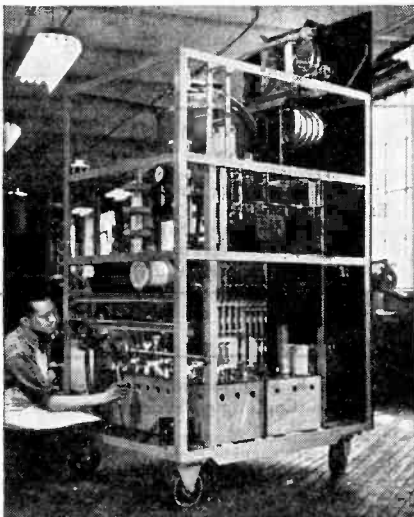

High frequency induction furnace used in all radio tube plants where exhaust machines operate. Made by Sylvania Electric at Williamsport, Pa.

LOCK-IN TUBES PERFECTLY IN LINE WITH RECENT FCC DECISION

*High Frequency Sets (FM) Will
Get Benefit of Tubes' Electrical Superiority*

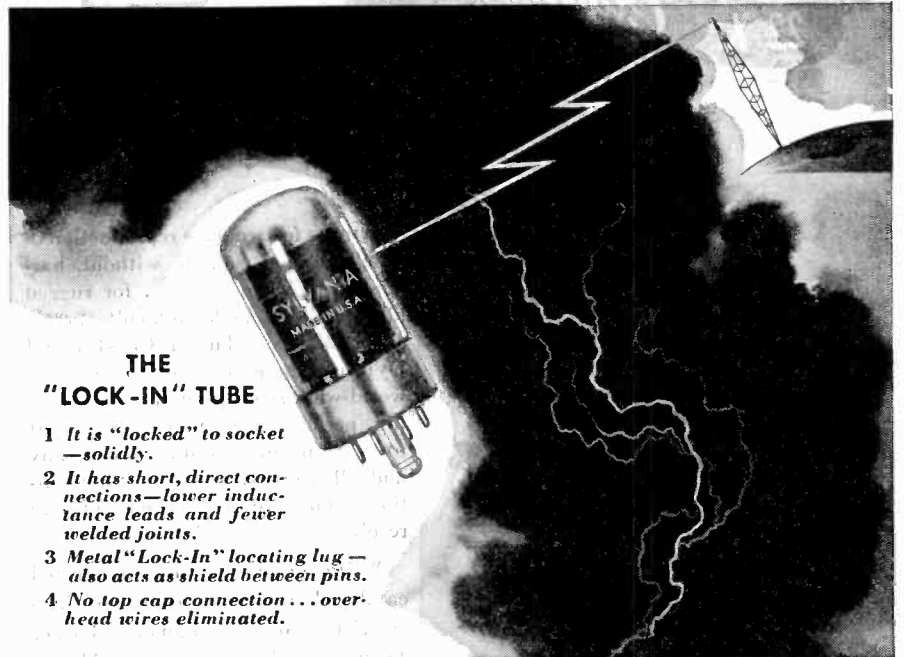

THE "LOCK-IN" TUBE

- 1 It is "locked" to socket—solidly.
- 2 It has short, direct connections—lower inductance leads and fewer welded joints.
- 3 Metal "Lock-In" locating lug—also acts as shield between pins.
- 4 No top cap connection... overhead wires eliminated.

Sylvania Electric's revolutionary type of radio tube—the Lock-In—is so mechanically stronger and electrically more efficient that it takes in its stride the recent FCC decision assigning to frequency modulation the band between 88 and 106 megacycles. The basic electrical advantages of the Lock-In construction are ideally suited to the adoption of higher frequencies.

Mechanically it is more rugged because support rods are stronger and thicker—there are fewer welded joints and no soldered joints—the lock-in lug is metal not molded plastic—the ele-

ments are prevented from warping and weaving.

Electrically, it is more efficient because the element leads are brought directly down through the low loss glass header to become sturdy socket pins—reducing lead inductance—and interelement capacity.

Today, the many special features of the Sylvania Lock-In Tube are even more up-to-date than when they were introduced in 1938—a fact of increasing importance when considering the numerous postwar developments in the field of communications.

SYLVANIA ELECTRIC

Emporium, Pa.

MAKERS OF RADIO TUBES; CATHODE RAY TUBES; ELECTRONIC DEVICES; FLUORESCENT LAMPS; FIXTURES, WIRING DEVICES; ELECTRIC LIGHT BULBS

Famous Turner Twins

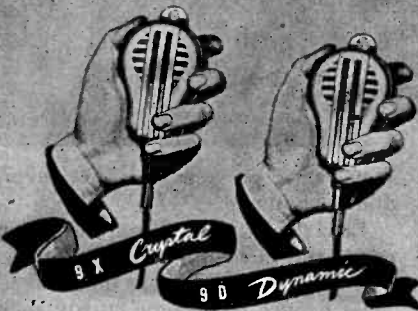
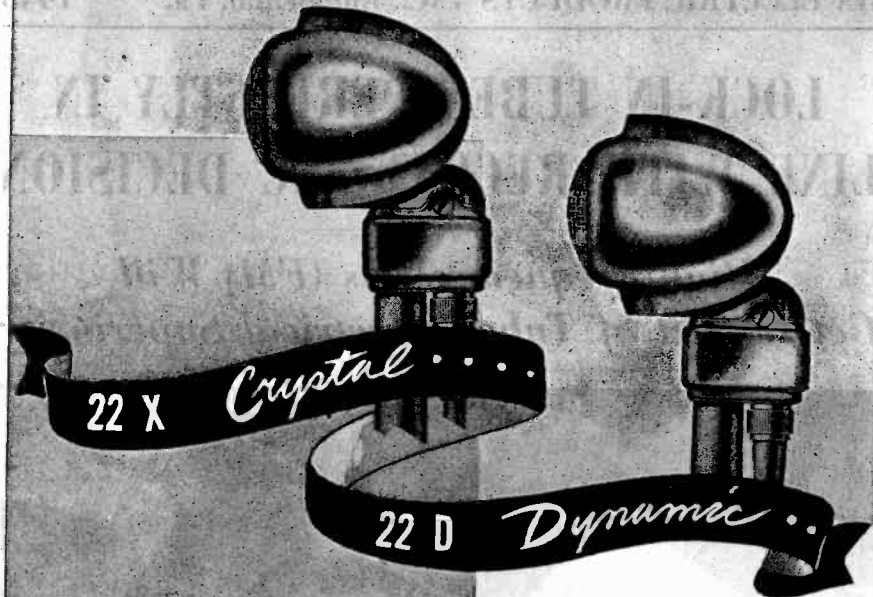

FAMOUS for accurate reproduction of all desired sounds without harmonics or distortion . . . for rugged dependability under difficult operating conditions, Turner Crystal and Dynamic microphones have won world-wide reputations for outstanding performance. When you want utmost in intelligibility under any and all acoustic and climatic conditions, Turn to Turner for sure-fire results.

Write today for free illustrated catalog describing performance characteristics of the Famous Turner Twins as well as all Turner Microphones for recording, P. A., sound system, and commercial and amateur broadcast work.

The Turner Co.
909 17TH STREET N. E.
Cedar Rapids, Iowa

TURNER — Pioneers in the Communications Field

Turner Microphones

Licensed under U.S. Patents of the American Telephone and Telegraph Company and Western Electric Company, Incorporated. Crystals licensed under Patents of the Brush Development Company.

Membership

(Continued from page 46A)

- Stubbins, W. F., AAF Training Aids Div., 1 Park Ave., New York 16, N. Y.
Sullivan, F. R., Sylvania Electric Products, Inc., 1221 W. 3 St., Williamsport, Pa.
Taskin, H., 621 N. 26 St., Milwaukee 3, Wisc.
Tong, E., Fleet-Post Office, New York, N. Y.
Troise, S., 457-11 Ave., Paterson, N. J.
Urdike, A. G., 3425 N. Broad St., Philadelphia, Pa.
Utterback, W. I., Jr., 1810 Kite Ave., Huntington, W. Va.
Van Velsor, C., 174 Lincoln Ave., Little Falls, N. J.
Vencill, G. J., 8421 Colonial La., Clayton 5, Mo.
Volf, C. A., 10 Deshler Ave., Columbus, Ohio
Volz, C., 332 Iris Dr., Pittsburgh 21, Pa.
Ward, O. C., 517 Neilson St., Berkeley 6, Calif.
Wessels, D.H., Press Wireless, Inc., Hicksville, L. I., N. Y.
Wilson, J. H., Jr., 54 W, Blithedale Ave., Mill Valley, Calif.
Wimp, L. F., 7911 Montgall St., Kansas City 5, Mo.
Workman, G. D., 1120 Chestnut St., Kenova, W. Va.
Young, L. L., 1641 K St., N. W., Washington, D. C.
Ziger, A., Bulnes 650, Buenos Aires, Argentina
Zierdt, C. H., Rosedale, Verona, Pa.

ERRATA

The May 2, 1945 Membership Lists, printed in the June issue of the PROCEEDINGS should be corrected as follows:

Page 38A: After J. C. R. Puchard, refer to page 68A beginning with S. D. Robertson, and ending with A. K. Wright for further transfers to Senior Member.

Page 40A: Admissions to Member should end with D. Westwood. Names beginning with R. E. Clinton and ending with C. K. Hadlock should be listed as Associate Members.

Pages 44A, 48A: All names on these pages are Associate Members.

Page 68A: Names beginning with A. W. J. Wessel and ending with R. S. Choate are Associate Members. Names beginning with S. D. Robertson are Transfers to Senior Member as mentioned above.

FRANK MASSA
Electro-Acoustic Consultant
DEVELOPMENT PRODUCTION DESIGN
PATENT ADVISOR
ELECTRO-ACOUSTIC & ELECTRO-MECHANICAL
VIBRATING SYSTEMS
SUPERSONIC GENERATORS & RECEIVERS
3393 Dellwood Rd., Cleveland Heights 18, Ohio

M. F. M. Osborne Associates
Consulting Physicists
Fluid Dynamics, Mechanics, Electronic Design, Electromagnetic and Acoustic Wave Propagation, Mathematical Analysis.
703 Albee Bldg., Washington 5, D.C.
Atlantic 9084

STANLEY D. EILENGERBER
Consulting Engineer
INDUSTRIAL ELECTRONICS
Design—Development—Models
Complete Laboratory and Shop Facilities
6309-13—27th Ave.
Kenosha, Wis. Telephone 2-4213

THEIR FAVORITE BLONDE



THIS IS THE GIBSON GIRL* with her hourglass shape and a bright yellow dress . . . the magic emergency radio transmitter which automatically sends out S-O-S signals by merely turning the hand crank. ☆ Now carried on overwater flights by most military planes, Gibson Girls have snatched back to life many American, Canadian and British crews forced down at sea, ☆ The hand crank generates sufficient power to transmit signals over a 100,000 square mile area, and to light a brilliant signal light. Manual keying on radio transmission is available. The unit is equipped with parachute for release from a rescue plane or before a crash landing. ☆ More than 60,000 Gibson Girls have been produced by Pacific Division since they were developed by this company before Pearl Harbor. Such outstanding radio developments as this demonstrate Pacific Division's unique ability to successfully solve new radio problems.

Our engineers—now specializing in VHF communications systems—are available to assist you with your radio problems.

*Trade Mark Reg. U.S. Pat. Off.

All rescued airmen become members of the most exclusive fraternity in the world—the Order of Gibson Girls. They receive this certificate and a gold lapel pin. If you have been rescued or know someone who has, write today to the Order of Gibson Girls, North Hollywood, California, for membership.

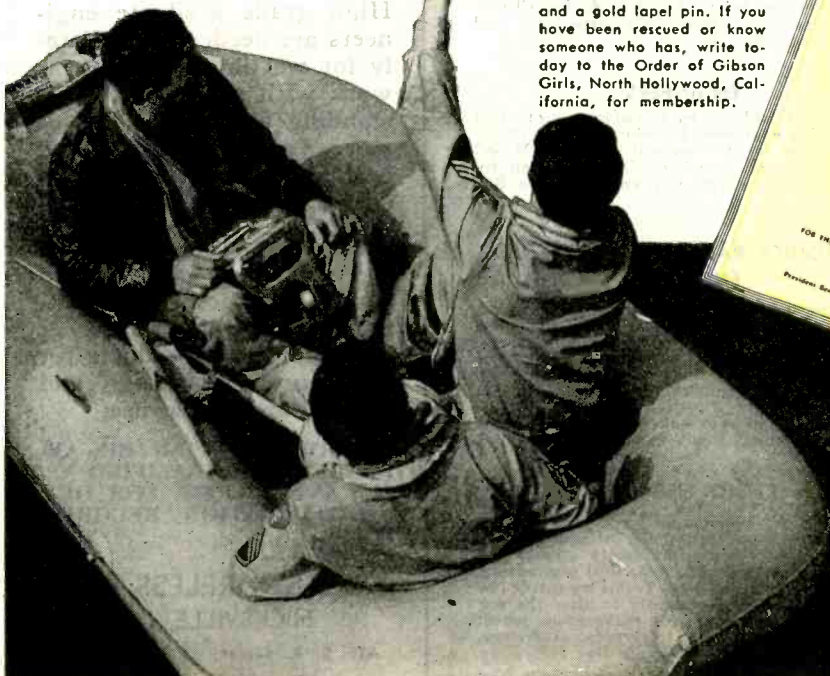
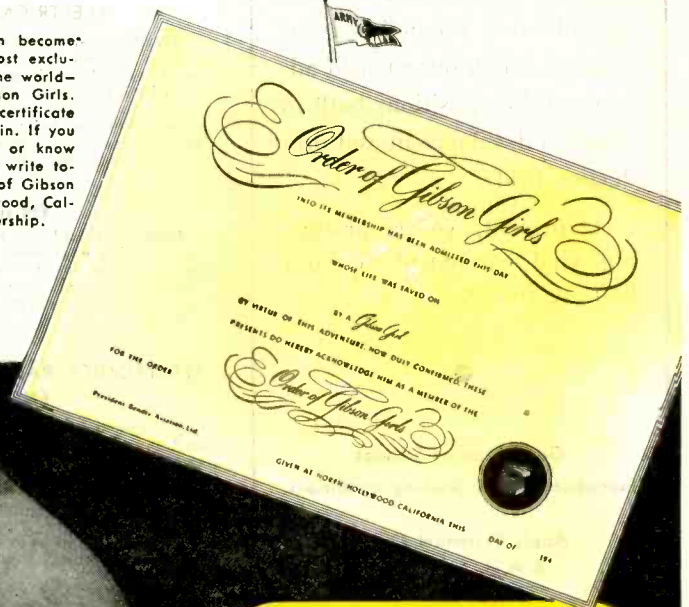

Pacific Division
Bendix Aviation Corporation
NORTH HOLLYWOOD 7, CALIF.

Draftsmen Wanted

Also

Designers

Detailers

Tracers and

Engineers

We are one of the largest manufacturers of a wide variety of communication and electronic equipment in the world, fully prepared and ready to go ahead with a very ambitious expansion program as quickly as we are permitted. There will be unlimited possibilities for creative, ambitious men to advance to key positions both in research development and production field.

At present, we are producing vital equipment for our fighting forces.

Good Starting Salaries
Exceptionally fine working conditions.

Apply Personnel Office
8 A.M. to 5 P.M.

**FEDERAL TELEPHONE &
RADIO CORP.**

the Mfg. unit of the International
Tel. & Tel. Corp.
591 Broad St., Newark, N.J.
WMC Rules Observed

POSITIONS OPEN

The following positions of interest to I.R.E. members have been reported as open. Apply in writing, addressing reply to company mentioned or to Box No.

The Institute reserves the right to refuse any announcement without giving a reason for the refusal.

PROCEEDINGS of the I.R.E.

330 West 42nd Street, New York 18, N.Y.

PROJECT ENGINEERS

With design and development experience capable of assuming complete responsibility of a project and supervision of assistants. Post-war opportunity assured by civilian markets. Reply to Engineering Department, Hallicrafters Company, 2611 S. Indiana Ave., Chicago, Ill.

DESIGN ENGINEER

Experienced in mechanics and optics of motion picture cameras, projectors, and film scanning. Give details. Reply to John H. Martin, Columbia Broadcasting System, Inc., 485 Madison Avenue, New York 22, N.Y.

CUSTOMER ENGINEER

Graduate electronics engineer. Signal Corps experience preferable but not essential. Installation and maintenance radio printers and associated electronic equipment. An opportunity for post-war advancement with large international organization. Write qualifications in detail to Box 388.

MECHANICAL ENGINEER

Steady, post-war opportunity with nationally known old-line company. Knowledge of small rotating machinery electrically driven for constant speed devices. Familiar with wire handling mechanisms and tensions. Possess ability to handle designs of above and assume a project engineer's responsibilities. Salary \$4500 to \$6000. Chance for advancement. State fully experience and qualifications. Box 389.

ELECTRICAL ENGINEER

Steady, post-war opportunity with nationally known old-line company. Knowledge of audio amplifier and equalizer design. Have understanding of electromagnetic component theory. Possess ability to assume project engineer's duties and responsibilities. Salary \$4500 to \$6000. Chance for advancement. State fully experience and qualifications. Box 390.

ENGINEERS

Prominent midwestern manufacturer of radio transmitting equipment is looking for two graduate engineers for development work in AM and FM transmitters. Starting salary good and future for advancement excellent. Reply to Box 384.

ELECTRONICS, RADIO AND MECHANICAL ENGINEERS

An unusual opportunity is offered ambitious and capable engineers who have had qualifying experience in the design, development and preparation for manufacture of radio and industrial electronic equipment. Experience with dielectric and induction heating equipment desirable, but not essential.

Important war work now, with large post-war projects to follow. Reply to Box 385.

RADIO ENGINEER

Thoroughly experienced in ultra-high-frequency theory and technique, with or without patent law experience, preferably young, and with some knowledge of mechanical engineering, desired by established New York City patent law firm for employment presently or after the war as consultant and with view to becoming patent lawyer. State education, references, experience, age, and salary expected. Write Box 387.

(Continued on page 52A)

OPENINGS FOR

RADIO

ENGINEERS

ELECTRICAL

ENGINEERS

MECHANICAL

ENGINEERS

In the development and production of all types of radio receiving and low-power transmitting tubes. Excellent post-war opportunities with an established company in a field having unlimited post-war possibilities.

Apply in person or in writing to:

Personnel Manager

**RAYTHEON
MANUFACTURING CO.**

Radio Receiving Tube Div.
55 Chapel St., Newton, Mass.

OPPORTUNITIES IN PRESENT AND POSTWAR WORK

High grade graduate engineers are needed immediately for wartime and postwar work with a record of outstanding ability and five or more years of design and product engineering experience.

Present activities include design and manufacture of high and medium power transmitters, frequency shifters, other communication products for the Navy, and design and models for postwar use.

INTERVIEWS WILL BE ARRANGED FOR QUALIFIED APPLICANTS. WRITE FOR OUR "QUALIFICATION RECORD" FORM.

**PRESS WIRELESS, INC.
HICKSVILLE, L.I.**

ATT: S. A. Barone, Chief Mfg. Engr.

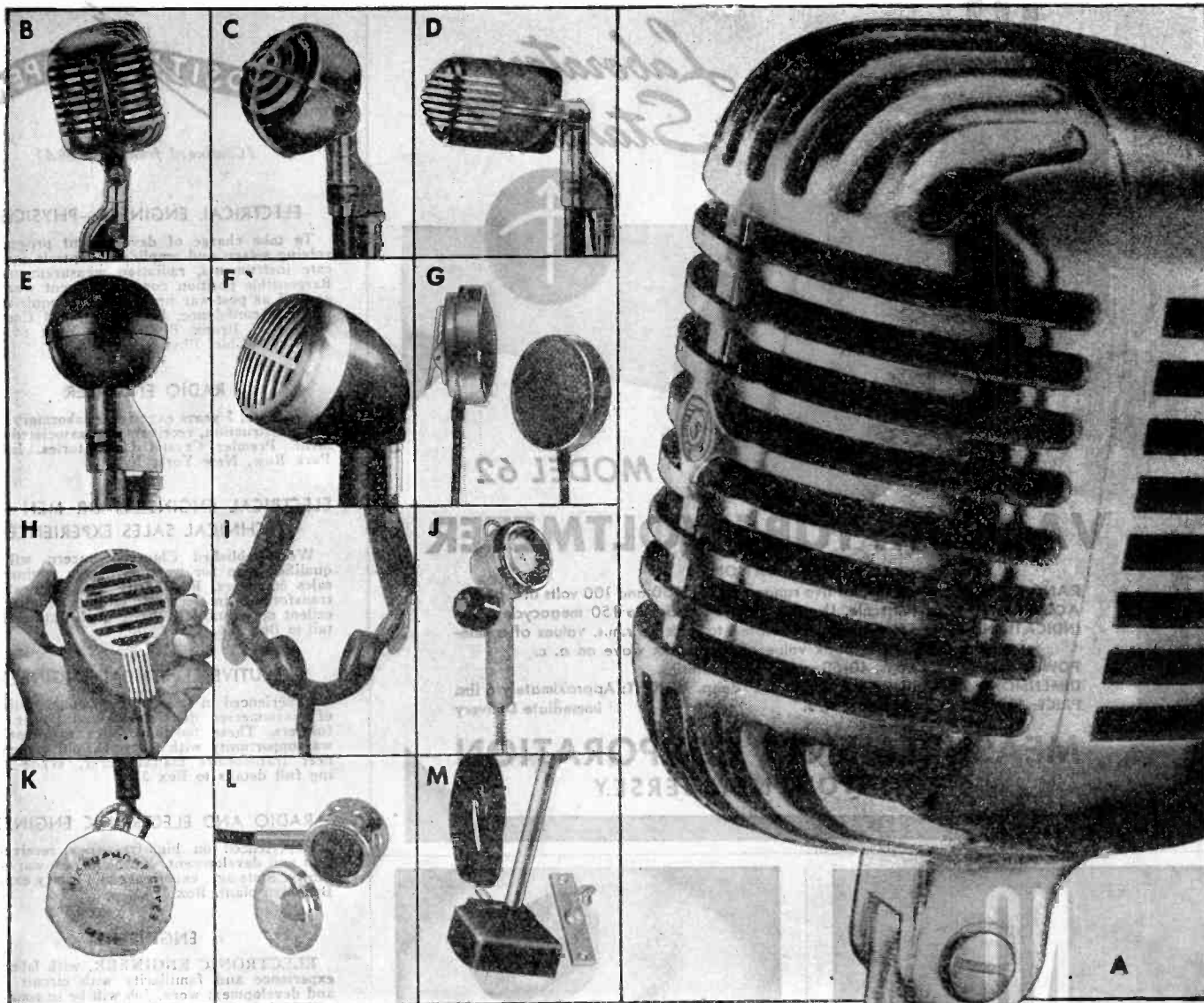

—Your Microphone is here

As outstanding manufacturers of microphones for war —Shure offers a complete microphone line. You will find the proper microphone for every need above. A complete description of any model will be furnished upon request.

- A. Super-Cardioid Broadcast Dynamic
- B. Unidyne Cardioid Dynamic
- C. Uniplex Cardioid Crystal
- D. Stratoliner Dynamic
- E. Laboratory Non-Directional
- F. "Economy" Crystal

- G. Lapel Microphone
- H. Military Carbon
- I. Throat Microphone
- J. Carbon Hand Microphone
- K. Mask Microphone
- L. Stethophone
- M. Vibration Pick-up



SHURE BROTHERS

Designers and Manufacturers of Microphones and Acoustic Devices

225 West Huron Street

Chicago 10, Illinois



Laboratory Standards

MODEL 62

VACUUM TUBE VOLTMETER

SPECIFICATIONS:

RANGE: Push button selection of five ranges—1, 3, 10, 30 and 100 volts a. c. or d. c.
ACCURACY: 2% of full scale. Useable from 50 cycles to 150 megacycles.
INDICATION: Linear for d. c. and calibrated to indicate r.m.s. values of a sine-wave or 71% of the peak value of a complex wave on a. c.
POWER SUPPLY: 115 volts, 40-60 cycles—no batteries.
DIMENSIONS: 4¾" wide, 6" high, and 8½" deep. **WEIGHT:** Approximately 6 lbs.
PRICE: \$135.00 f.o.b. Boonton, N. J. Immediate Delivery

MEASUREMENTS CORPORATION
 BOONTON, NEW JERSEY



(Continued from page 50A)

ELECTRICAL ENGINEER—PHYSICIST

To take charge of development program involving selsyn and amplidyne controls for intricate instruments, radiation measurements, etc. Responsible position covering urgent war work as well as post-war problems. All inquiries held in strict confidence. Farrand Optical Company, Inc., 4401 Bronx Blvd., New York 66, N.Y. Attention: Chief Physicist.

RADIO ENGINEER

Graduate, 5 years experience laboratory design and construction, receivers and associated equipment. Premier Crystal Laboratories, Inc., 63 Park Row, New York, N.Y.

ELECTRICAL ENGINEERS OR MEN WITH TECHNICAL SALES EXPERIENCE

Well-established Chicago concern will hire qualified men for work as design engineers or sales engineers. Familiarity with application of transformers in electronic circuits required. Excellent opportunities. Write qualifications in detail to Box 374.

EXECUTIVE ELECTRICAL ENGINEERS

Experienced in sales, design and manufacture of oil-immersed distribution and power transformers. These positions offer excellent post-war opportunity with forty-year-old eastern pioneer transformer manufacturer. Write outlining full details to Box 375.

RADIO AND ELECTRONIC ENGINEER

Experienced on high-frequency receiver design and development. Excellent post-war opportunity. State age, experience and salary expected. Brooklyn plant. Box 376.

ENGINEERS

ELECTRONIC ENGINEER, with laboratory experience and familiarity with circuit design and development work. Job will be in connection with high frequency heating generators and other industrial applications of electronics. Graduate in electrical or radio engineering.

JUNIOR ENGINEER, preferably engineering graduate, with experience in radio engineering laboratory, factory or engineering department. Job will be in connection with H.F. and A.F. measurements, and general development work.

JUNIOR RADIO ENGINEER OR PHYSICIST, with good mathematical background. In replying give complete information as to experience, education, marital, draft status, and salary expected. Illinois Tool Works, 2501 North Keeler Avenue, Chicago 39, Ill.

RADIO AND ELECTRONIC ENGINEERS

For research and development in the field of radar, radio communications and electrical test equipment, good post-war opportunity, also openings available for draftsmen and junior designers. Allen D. Cardwell Manufacturing Corporation, 81 Prospect Street, Brooklyn, N.Y.

ASSISTANT CHIEF ENGINEER

Mid-west radio-electronics manufacturer, engaged exclusively on electronic war projects at present, requires experienced engineer to assume complete supervision of post-war development of household and auto radio receivers. Television receiver experience desirable but not essential. All inquiries confidential. Write Box 377.

SENIOR DEVELOPMENT ENGINEERS

Large mid-west manufacturer, now exclusively on war radio and radar work, has immediate openings for post-war radio and television development for three senior radio project engineers, two mechanical engineers and one engineer on specifications and standards. Confidential inquiries respected. Write Box 378.

(Continued on page 54A)

NO PRIORITY

For Harco Radio
MASTS & TOWERS

Revocation of Order M-126 permits manufacturing from surplus inventories. We have adequate surplus stocks to make...

IMMEDIATE SHIPMENTS

HARCO
 CO. INC.
 ELIZABETH 4, NEW JERSEY

Catalog mailed on request

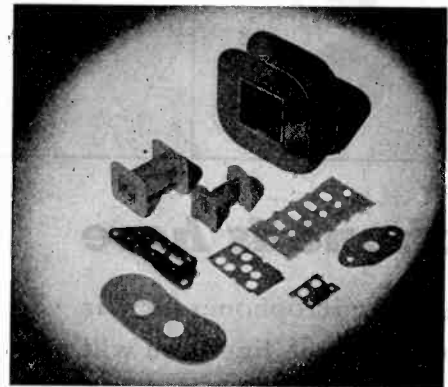

In Everything of Uncle Sam's that "flies, floats or shoots"

NATIONAL VULCANIZED FIBRE

PHENOLITE
 Laminated BAKELITE

—because of their lightness in weight, high dielectric strength, ready machinability, exceptional wearing and other qualities—are playing a vital part.

"BACK THE ATTACK" with WAR BONDS

NATIONAL VULCANIZED FIBRE CO.

Offices in Principal Cities
 WILMINGTON, DELAWARE

The POWER behind the SCR-694...

RAULAND VIBRATOR
JV-0014
used in Vehicular
Power Supply
PE-237



VIBRATOR
POWER SUPPLY
FOR THE SCR-694

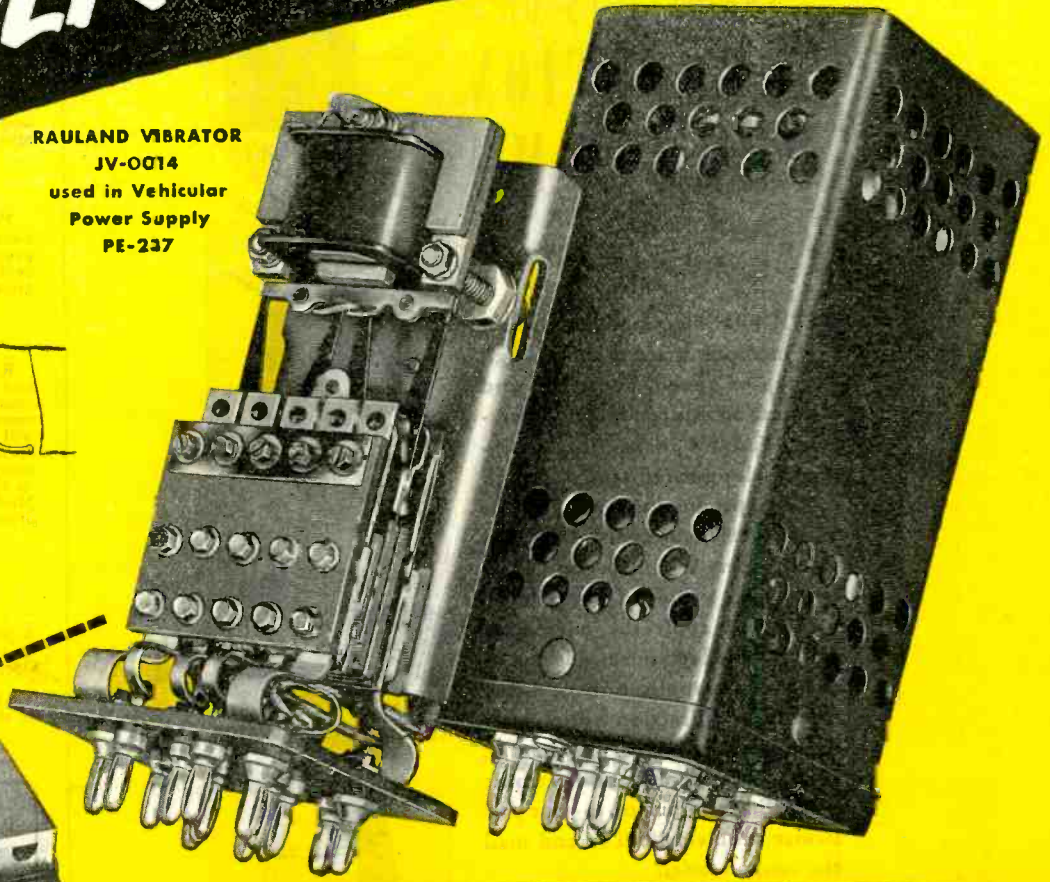

...The "HEART" that made it tick!

Working with the Signal Corps in the creation of the now famous SCR-694, RAULAND Engineers had to solve many a knotty problem. None, however, proved as tough as producing the heart of the Vehicular Power Supply . . . the *Vibrator*. That power supply had to operate from a vehicular battery at 5.4 to 8 volts, 10.8 to 16 volts, or 21.6 to 32 volts while maintaining filament voltage within the limits of $\pm 5\%$ from nominal value. In addition it had to be fully immersion proof! The full story of how they licked a job that "couldn't

be done" packs as dramatic a punch as anything in this man's war, but RAULAND Engineers did it! They designed and built the *highest frequency heavy-duty vibrator ever made* . . . to operate on 200 cycles $\pm 1\%$.

The development of the PE-237 Vehicular Power Supply Unit, and especially the Rauland Vibrator JV-0014, is a typical example of RAULAND engineering thoroughness. . . the kind of electronic planning and craftsmanship that will be available for full cooperation with industry after this war.

A POWER VIBRATOR IN WHICH ARE COMBINED THESE DESIRABLE FEATURES:

- HIGH CURRENT CAPACITY
— 35 amperes continuous duty
- MULTIPLE VOLTAGE
— 6, 12, or 24 volt input to same vibrator
- HIGH FREQUENCY
— 200 cycles
- WIDE TEMPERATURE RANGE
— minus 40 to plus 70°C
- MULTIPLE CONTACT
— 20 power contacts
- MAXIMUM UNIFORMITY OF LOAD DIVISION
— each contact brought out to a separate base pin
- MINIMUM TRANSMISSION OF VIBRATION
— heavy wall extruded case

RADIO • RADAR • SOUND

Rauland

COMMUNICATIONS • TELEVISION

Electroneering is our business

THE RAULAND CORPORATION • CHICAGO 41, ILLINOIS



OUR ENGINEERS ARE SPECIALISTS ON INSPECTION PROBLEMS

MODERN Electronic Inspection methods bring a new, high degree of speed, accuracy, and economy to this production operation. Today's inspection equipment is designed to keep pace with modern production methods. Its amazing efficiency is best employed when expert W-J inspection engineers make a study of *your* requirements and apply the equipment ideally suited to your needs. Let us show you the applications of X-Ray machines, diffraction units, spectrometers, electronic comparators, photo-electric units, and electronic measuring equipment, to your particular problems! Fill in and mail the coupon *today!*



DIFFRACTION UNIT

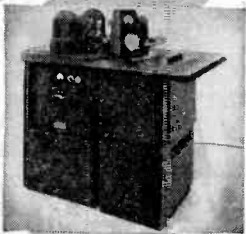

SPECTROMETER

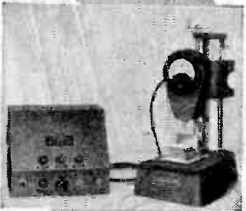

ELECTRONIC COMPARATOR

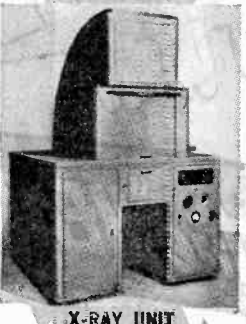

X-RAY UNIT



SEND FOR
THIS NEW
BUYER'S
GUIDE

Please mail me copies of your Inspection Equipment brochure and new catalog.

NAME _____

COMPANY _____

CITY _____ ZONE _____ STATE _____

**WALKER-
JIMIESON, INC.**

311 SOUTH WESTERN AVE., CHICAGO 12, ILL.

Phone **CANal 2525**



POSITIONS OPEN

(Continued from page 52A)

RESEARCH ENGINEERS

Prominent radio and electronics manufacturer located in mid-west has immediate openings for three research men preferably with engineering background, on post-war problems in electrical and electronic fields. Confidential inquiries respected. Write Box 379.

ELECTRICAL ENGINEER

For research and development of automotive electrical systems. General knowledge of suppression of electrical interference to radio reception necessary. Give full particulars—background, experience and availability, Box 380.

RADIO ENGINEERS

Radio, Research and Development Engineers and Draftsman needed for key positions by manufacturer of diversified line of aircraft accessories, small motors, and aircraft radio who will be in the home radio field postwar. Salaries open. Full compliance with WMC regulations necessary. Confidential inquiries respected. Live in the midst of the best hunting and fishing in Michigan. Our employees know of this ad. Address Box 381.

THE OHIO STATE UNIVERSITY

Announces Westinghouse Educational Fellowships in Electron Optics
A post-doctoral fellowship—\$3600 per year. Two pre-doctoral fellowships—\$1000 per year. Open to graduates in Physics, Mathematics or Electrical Engineering. Application forms may be secured from the Dean of the Graduate School, Ohio State University, Columbus 10, Ohio

BROADCAST RECEIVERS

We seek the services of an experienced receiver designer to take charge of our work in the broadcast field. The man must be ingenious, capable of engineering competitive designs and well versed in radio engineering. We will consider a man for work in either our New York or New London laboratories. Write: Templetone Radio Mfg. Corp., New London, Connecticut.



COILS

**Before the war
We made millions of coils each year
For many years.**

Our organization was mass-production minded.

That organization is intact.

We are still mass-production minded.

Be safe.

**Order your mass-production coils and trimmers
from people who "know how".**



**AUTOMATIC
MANUFACTURING
CORPORATION**

MASS PRODUCTION COILS & MICA TRIMMER CONDENSERS

900 PASSAIC AVE.

EAST NEWARK, N. J.



Model 645 A.C.-D.C. Electronic Multimeter

(Vacuum Tube Voltmeter)

Both A.C. and D.C. volt ranges are electronic. This provides the maximum of sensitivity and overload protection for all A.C. ranges as well as D.C. and ohms ranges.

Measures resistance up to one thousand megohms and as low as $2/10$ ohm.

Constant input resistance 12 megohms on all D.C. volts ranges.

Input resistance 4.4 megohms on all A.C. ranges. Flat frequency response between 50 cycles and 10,000 cycles.

Meter cannot be damaged by accidental overload on any electronic range. Electronic overload protection on all A.C. and

D.C. volts, and ohms ranges.

Variations in line voltage do not affect accuracy within the range of 100 to 125 volts. The instrument is equipped with ballast control tube and self-compensating circuits.

Meter Ranges—

A.C. Volts: 0-1/4/10/40/100/400/1000

D.C. Volts: 0-4/10/40/100/400/1000

Ohms: 0-1000/10,000/100,000/1 meg/
10 meg/100 meg/1000 meg

M.A.: 0-1/4/10/40/100/400/1000

Decibels: Minus 30 to minus 5/minus
10 to plus 15/10 to 35/30 to 35

Either positive or negative D.C. voltmeter indications instantly by means of reversal switch. Signal tracing type test lead with isolation resistor in probe. Model 645 is an ultra-modern high sensitivity instrument, with all of the famous Jackson features, including exceptional accuracy and simplicity of use.

MODEL 645

Net Price

\$56.50

Available now on rated orders . . . after war a new regular in the Jackson line . . . a line that shall always live up to a long reputation for INTEGRITY OF DESIGN.

BUY WAR BONDS AND STAMPS TODAY

JACKSON

Fine Electrical Testing Instruments

JACKSON ELECTRICAL INSTRUMENT COMPANY, DAYTON, OHIO

WIRE, RIBBON and other METAL PRODUCTS

- Smaller than Commercial Sizes
- Closer than Commercial Tolerances

PLATINUM · RHODIUM · IRIIDIUM PALLADIUM · RUTHENIUM and ALLOYS

Commercial Purity and High Purity
WIRE, SHEET, FOIL, TUBING

Wire for Resistance Thermometers

Rhodium Electroplating Solutions

Platinum for Electronic Tubes

Rhodium First Surface Mirrors

Alloys for Contact Points

Wires for Detonator Fuses

Dental Metals and Alloys

Wires for Thermocouples

Tubing for Ink Devices

Wire for Pirani Gauges

Spark Plug Electrodes

Wollaston Wire

Duro Palladium

BASE METALS · RARE METALS PRECIOUS METALS and ALLOYS

Galvanometer Suspension Strips

Platinum-Covered Grid Wire

Gold Covered Silver Wire

Gold Cyanide for Plating

Special Melts and Alloys

Gold Covered Grid Wire

Small Spring Ribbon

Electroplated Wires

Ribbon, All Metals

Molybdenum Ribbon

Tungsten Ribbon

Filament Ribbon

Filament Wire

Fuse Wire

Grid Wire

Write for List of Products and Data

SIGMUND COHN & CO.



44 GOLD STREET

NEW YORK 7

METAL ASSEMBLIES AND COMPONENTS FOR ELECTRONIC AND MECHANICAL DEVICES

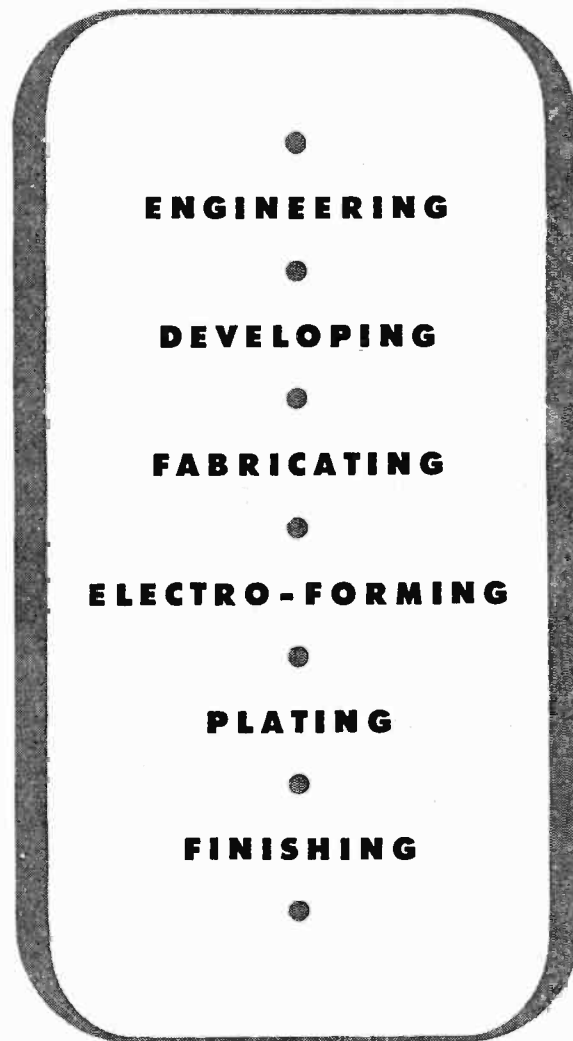

BERNARD **R**ICE'S **S**ONS

I N C O R P O R A T E D

MANUFACTURERS OF QUALITY METAL PRODUCTS SINCE 1867

OFFICE: 325 FIFTH AVENUE, NEW YORK 16, N. Y.

WORKS: 139-145 NORTH TENTH STREET, BROOKLYN 11, N. Y.

GET THIS!



Just off the press, this new C.T.C. Crystal Bulletin shows how and why "mathematical dimensioning," a recent C.T.C. development, assures high activity, constant frequency and

long life in every C.T.C. Crystal. It points out the 21 steps, 15 checks and tests that protect the quality of C.T.C. Crystals from initial inspection to final finishing.

If you're looking for "crystals you can count on" better look this new bulletin over. Ask us to send you C.T.C. BULLETIN NUMBER 015 today.



CAMBRIDGE THERMIONIC CORPORATION

456 Concord Avenue

Cambridge 38, Mass.

NEED SMALL, INTRICATE METAL STAMPINGS TO CLOSE TOLERANCES?

GOAT Precise-Formed METAL STAMPINGS

HOW GOAT SAVES YOU TIME AND MONEY

Goat specializes in the design and fabrication to close tolerances of small, intricate, drawn, formed, stamped metal and alloy parts. Expert tool design, quality control, and modern manufacturing techniques can save you time and money on parts like those illustrated above.

GOAT METAL STAMPINGS, INC.
AN AFFILIATE OF THE FRED GOAT CO., INC.
314 DEAN STREET, BROOKLYN 17, N. Y.

ENGINEERS SEND US YOUR PROBLEMS



★ The ingenious Clarostat Series 60 Hi-Voltage Coupler provides either 3,000 or 10,000 volts breakdown insulation between the control proper and its shaft and mounting.

This coupler is available with Clarostat Midget Controls Series 37 (composition - element) and Series 43 (wire-wound). Also with the large Series 58 wire-wound controls. Likewise with Clarostat multiple controls.

Especially desir-

able for controls used in high-voltage circuits such as television equipment, cathode-ray oscillographs, and many electronic applications.

Neat. Unit mounts as readily as usual control. And SAFE where high voltages are involved.



★ **Submit that problem . .**

If it has to do with resistors, controls or resistance devices, send it to us for engineering aid, suggestions, quotations.



CLAROSTAT MFG. CO., Inc. • 285-7 N. 6th St., Brooklyn, N. Y.

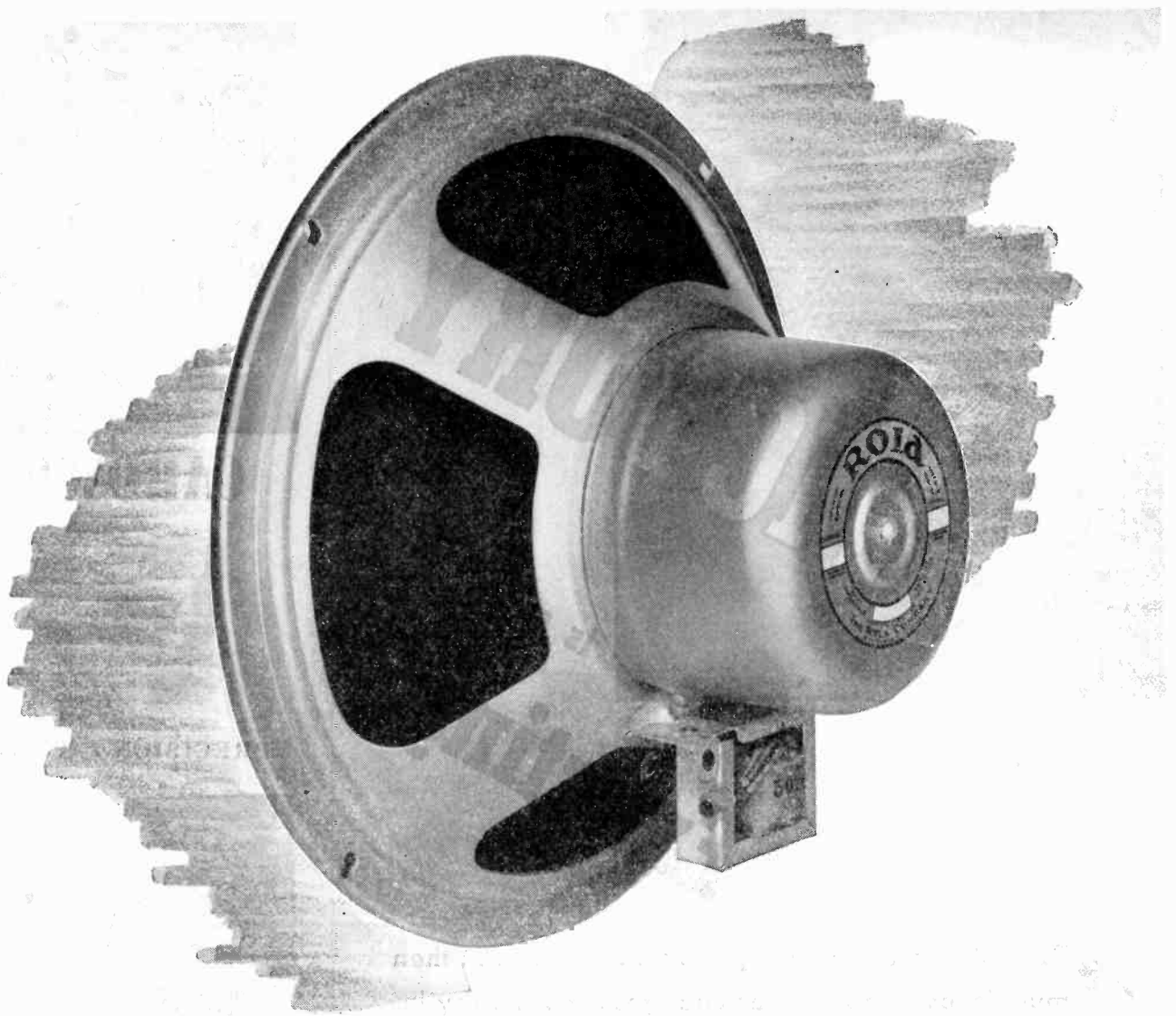

It May Look the Same... *But...*

New Rola speakers may look similar to prewar models. But in performance, fidelity and craftsmanship there will be no comparison! Rola research, intensified by war needs, has paced the swiftly advancing stride of electronic development.

Improvements, exclusive with Rola, will be incorporated in the broadened line of speakers. And the developments and processes that have resulted from exacting wartime tasks will

further guarantee the quality and dependability which, for a quarter of a century, have made Rola a leader.

Rola's greatly expanded production facilities still are absorbed in supplying communication needs of our military forces—but it is possible, now, to provide experimental models and demonstrate to interested manufacturers Rola's improved engineering and performance.

The Rola Company, Inc., 2530 Superior Ave., Cleveland 14, O.



MAKERS OF THE FINEST IN SOUND REPRODUCING AND ELECTRONIC EQUIPMENT

ROLA SPEAKERS NOW AVAILABLE FOR RATED ORDERS

A few weeks ago Rola resumed the manufacture of Speakers in moderate quantities and for rated orders. Inquiries are invited from manufacturers who need quality speakers for priority contracts.

ROLA

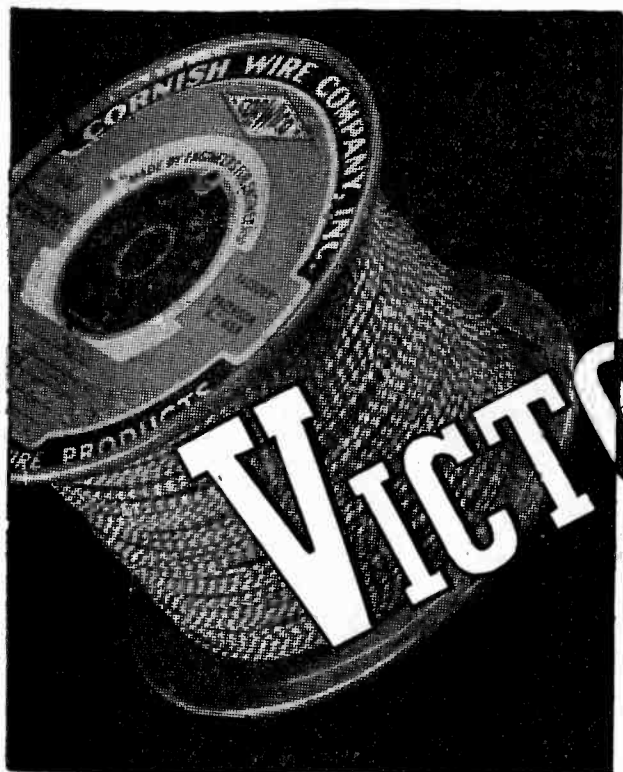

is so

Exacting

AFTER the last enemy lays down his arms . . . then must follow the fabulous changeover whereby industry diverts production for War into production for Peace.

A critical and an exacting phase!

We at CORWICO are already planning for the transition. Soon millions of tons of basic materials formerly required by our armed forces can be diverted to peacetime uses . . . including, you may be sure, the fine CORWICO Wires that civilians have so patiently gone without for so long.

cornish

WIRE COMPANY, INC.

15 Park Row, New York City, New York



"Made by Engineers for Engineers"

**Essential to
PRESENT
AND
FUTURE**

**Radio Communications
Equipment**

CARDWELL

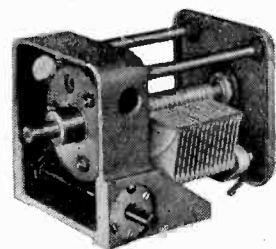

PRECISION CAPACITORS

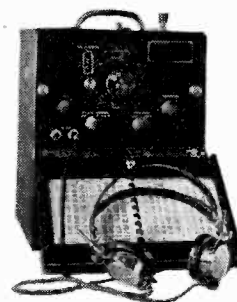

INSTRUMENTS



ELECTRONIC Devices & Accessories

Ready soon!

The new CARDWELL Catalog No. 46, a valuable addition to your files!

Write for your copy now!

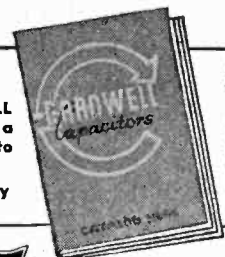

CARDWELL QUALITY PRODUCTS

**THE ALLEN D. CARDWELL
MANUFACTURING CORP.**

Main Office: 81 Prospect St., Brooklyn 1, N. Y.
Factories: Plainville, Conn. — Brooklyn, N. Y.

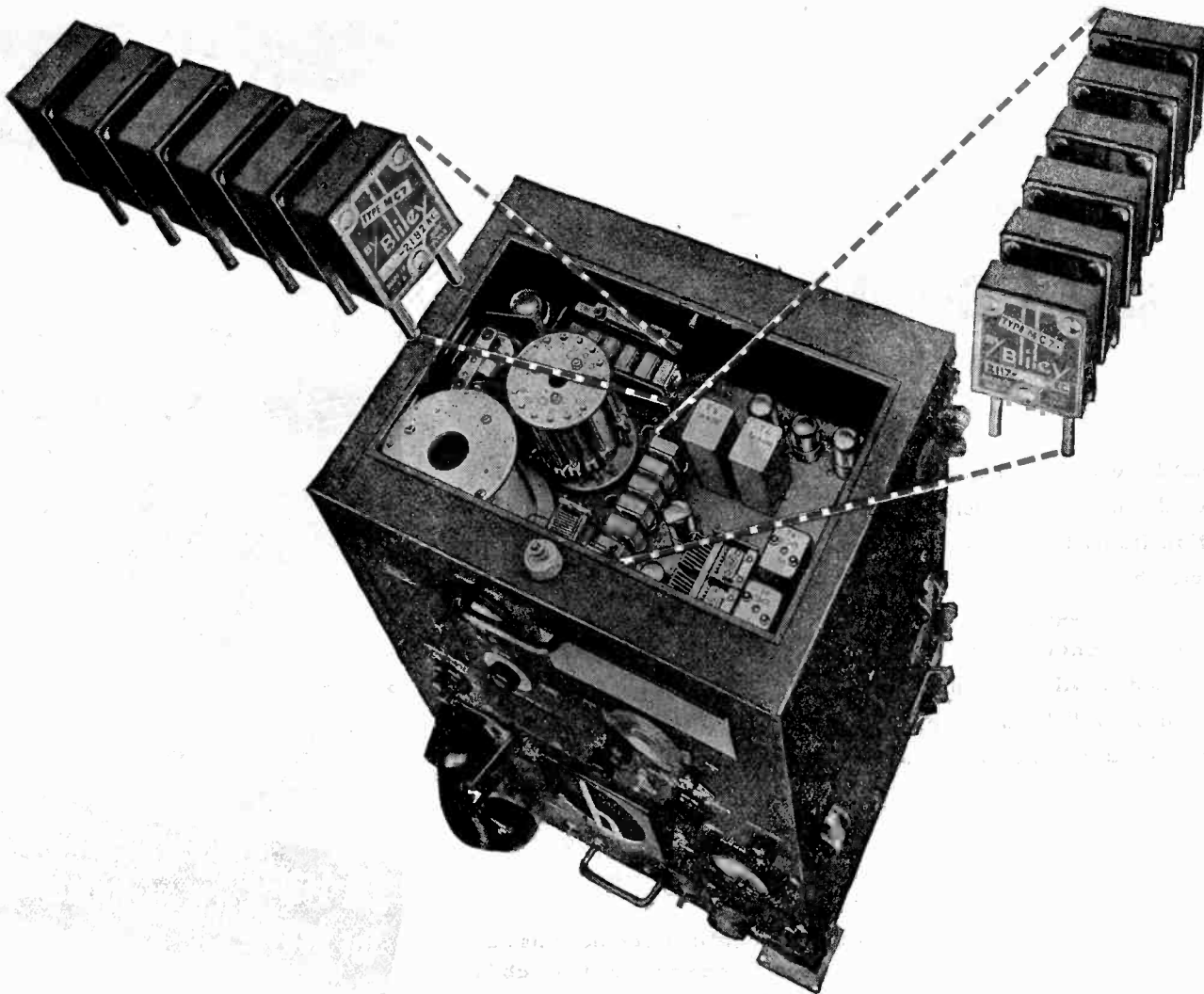

The 6 operating frequencies are **BLILEY CRYSTAL**-controlled

For dependable communications on the high seas here is a battle-tested set incorporating every modern feature that experience has shown to be most desirable for ship-to-shore and ship-to-ship radiotelephone service.

The six Bliley crystal-controlled operating frequencies permit instant and positive channel selection

in both transmitter and receiver. The Bliley *acid etched** Crystals used in this Hallicrafters HT-14 set were designed to meet specific objectives in the operation of two-way radiotelephone communications. They, too, have been battle-tested.

It's a habit with most communications engineers to specify Bliley for all crystal requirements. This is par-

ticularly true today when new applications and complex designs require technical excellence in every component. There is no substitute for the 15 years of experience offered by Bliley craftsmen and engineers.

+ + +

**Acid etching quartz crystals to frequency is a patented Bliley process.*



Bliley CRYSTALS

Do more than before ...

buy extra War Bonds

BLILEY ELECTRIC COMPANY
UNION STATION BUILDING • ERIE, PENN.

Many ADC Standard Catalog Items Will Soon Be Available!

It may not be very long before we can again supply the wide variety of communication items that comprised our line before the war. As the need for specialized battle equipment eases, we will resume manufacture of many urgently needed ADC standard components. These will be made available to you at the earliest possible moment.

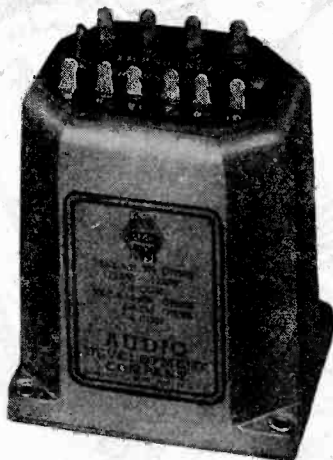

ADC HIGH FIDELITY TRANSFORMERS

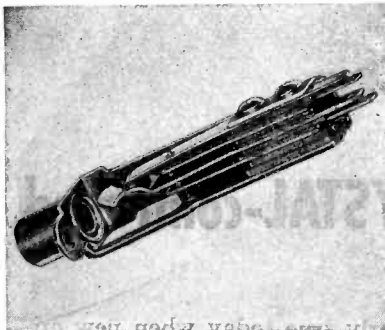

ADC JACKS

ADC communication components have long been recognized for their ability to completely fulfill the highest requirements of reliability and efficiency. Their design is backed by the experience and knowledge acquired through many years of precision manufacturing and painstaking research. You can depend on ADC quality.



ADC PATCH CORDS



ADC JACK PANELS

SEND FOR THE ADC CATALOG



Audio Development Co.

2833 13th Ave. S., Minneapolis 7, Minn.

POWER STAMINA LONG-LIFE



SM Fractional H.P. Motors for dependable performance



With a SM motor, you get a unit designed for a specific job, engineered to your exact performance requirements, precision-built to your specifications, produced in volume for your needs. SM fractional H.P. motors are made to order with speeds from 3,500 to 20,000 R.P.M. — 1/10th to 1/200th H.P. — voltage from 6 to 220 AC/DC. Illustrated is the famous SM-2 Blower Motor; many thousands have been made for military purposes. Other SM motors have been designed and produced in large volume for a wide variety of radio, aircraft and other applications where rugged power, stamina, long life and dependable performance were primary requisites. What are your requirements?

Small Motors, Inc.
1308 ELSTON AVE., CHICAGO 22, ILLINOIS

DEPT. 31

Manufacturers of special small universal, fractional H.P. motors, dynamotors, shaded pole motors, heater motors, generators.

Design • Engineering • Production

**THIS RADIO
RECEIVER
RACK...**

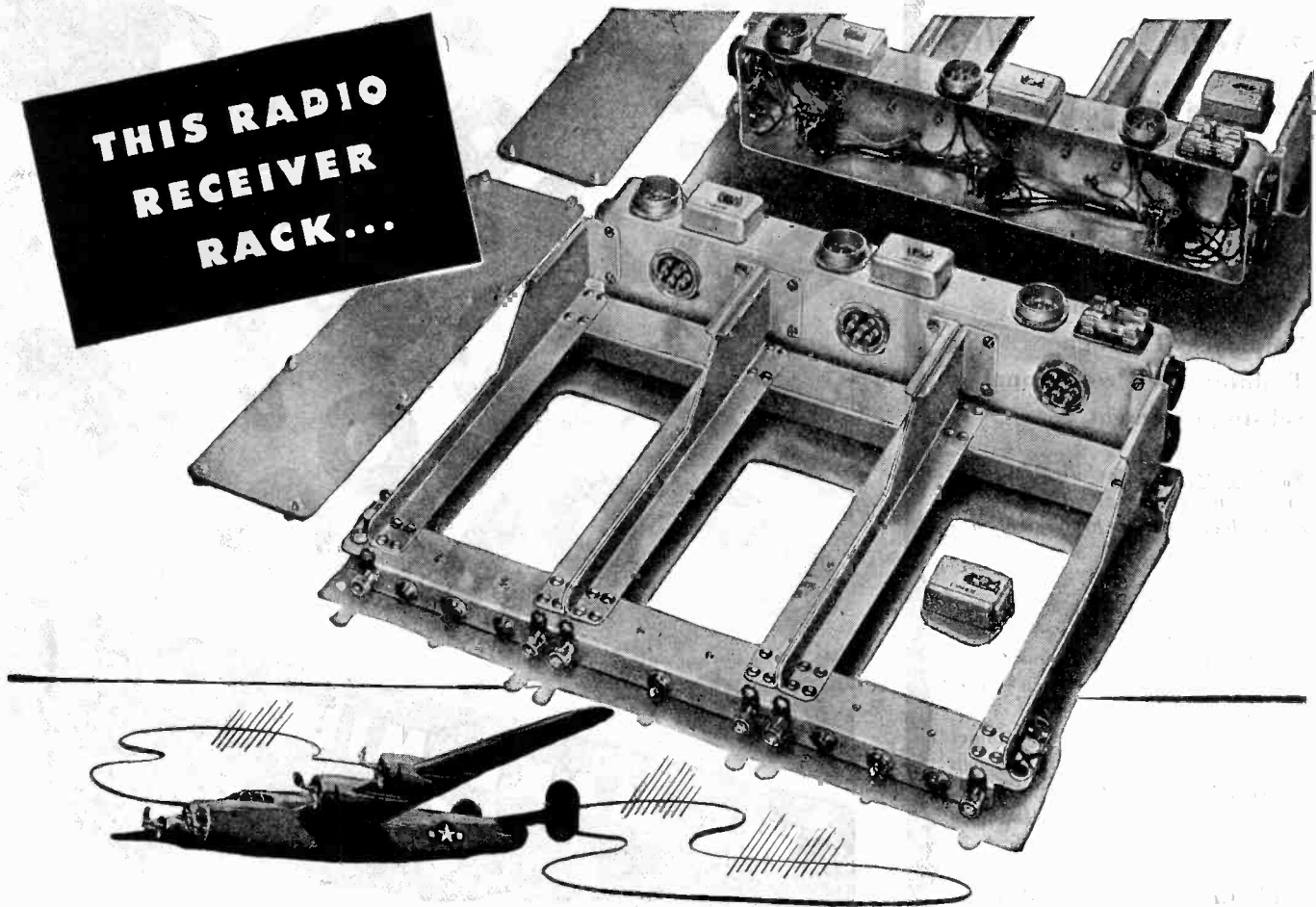

*contains more than 500 Electrōnents**

... all made and assembled by Scovill

This three-position, high-frequency radio receiver rack for big bombers is one of the most intricate manufacturing and assembling problems ever entrusted to Scovill... shows how Scovill's versatile production facilities can meet requirements for electronic components or complete assemblies.

More than 500 individual parts are assembled in this rack. Materials used range from plastics to metal alloys in the form of sheet, rod, wire and tubing. Scovill makes all except glass and plastics components. Methods include

forging, stamping, drawing, heading, machining, and wire forming.

Even complicated wiring does not stump Scovill's production engineers. Every wire is cut to length, stripped and soldered into correct position. Relays are manufactured, tested and adjusted by Scovill technicians.

In other words, Scovill engineered the whole job for assembly-line production... a service that can help you, too, save time, trouble and money on the production of small electronic components as well as large assem-

blies. For further details about the scope of Scovill's ingenuity and facilities, send for literature. Fill in coupon below and mail today.

*Electrōnents = Electronic Components



Please send me a free copy of "Masters of Metal" booklet describing your facilities. I am interested in the ELECTRONENT* applications checked.

- | | | |
|--|--------------------------------------|--|
| <input type="checkbox"/> Batteries | <input type="checkbox"/> Dials | <input type="checkbox"/> Panels |
| <input type="checkbox"/> Record Changers | <input type="checkbox"/> Escutcheons | <input type="checkbox"/> Sockets |
| <input type="checkbox"/> Clips | <input type="checkbox"/> Jacks | <input type="checkbox"/> Stampings (misc.) |
| <input type="checkbox"/> Condensers | <input type="checkbox"/> Lugs | <input type="checkbox"/> Tubes |

Other applications.....

SCOVILL MANUFACTURING COMPANY

Electronic Division
26 Mill Street, Waterbury 91, Connecticut

Name

Company

Address

★ *Now Available:*

CREI Group Training

**A Planned Program to
Modernize the Technical
Knowledge of Your
Employees Through
Training for Professional
Self-Improvement**

★ *Prepare your technical staff to meet the challenge of post-war radio-electronic technological demands.*

If your organization plans engagement in post-war radio-electronics, your technical personnel must know FM—television—Ultra High Frequency Techniques, and all other phases of war-developed electronics technology; and, of course, a thorough and complete knowledge of the fundamentals of practical radio-electronics engineering.

The CREI "Employers' Plan" for group training will:

1. Increase the technical abilities of your radio-electronics personnel.
2. Enable them to perform their duties more efficiently and in less time.
3. Increase the value of their services to your organization.

No company time is required for this training . . . it is accomplished by spare-time, home study.

The CREI "Employers' Plan" is useful for the up-grading of technical personnel in manufacturing, AM, FM, and television broadcasting, communications, industrial electronics, including the following:

Engineers	Testers
Engineering Aides	Technicians
Laboratory Assistants	Field Servicemen
Inspectors	Installers
	Maintenance Men

The CREI "Employers' Plan" for group training is tailored to meet each individual organization's requirements.

Your request will promptly bring an outline of the plan, as now in use with other organizations, and intimate details will follow when your particular needs are known. No obligation or cost, of course.

CAPITOL RADIO Engineering Institute

E. H. RIETZKE, President

Home Study Courses in Practical Radio-Electronics Engineering for Professional Self-Improvement

Dept. PR-8, 3224—16th St., N.W.
WASHINGTON 10, D.C.

Contractors to the U. S. Navy—U. S. Coast Guard—Canadian Broadcasting Corp. Producers of Well-trained Technical Radiomen for Industry.



WE MAKE MILLIONS
Every day!

● This isn't an unusual statement at all—not when you're talking about punched parts made of Laminated INSUROK! For in the electrical insulation field Richardson precision plastics have long been favorite materials . . . used by the millions in all shapes, sizes and thicknesses.

This outstanding preference is easy to understand, for Laminated INSUROK is an easy-to-handle product whose physical characteristics remain commercially uniform. It can be drilled, punched, sawed, turned, planed or milled in your own shop—without special tools—or Richardson Plastics will do it for you. Write today for the full story about INSUROK . . . laminated and molded.

INSUROK Precision Plastics

The RICHARDSON COMPANY

MELROSE PARK ILL. NEW BRUNSWICK, N. J. FOUNDED 1888 INDIANAPOLIS, IND. CLEVELAND, OHIO
DETROIT OFFICE 4-252 G. M. BUILDING, DETROIT 2, MICHIGAN NEW YORK OFFICE 75 WEST STREET, NEW YORK 6, N. Y.
CLEVELAND OFFICE 326-7 FLYMOUTH BLDG. CLEVELAND 15, OHIO



more efficient
...in miniature

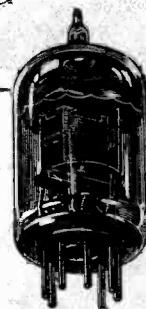

ACTUAL SIZE

When the wind blew hard, it was not unusual to put two husky men on the wheel of an old "wind-jammer." Yet today one man easily steers a vessel ten times the tonnage, in any weather, with a wheel about quarter the size. Modern engineering has made this possible.

So it is with miniature electronic tubes. They are not only smaller, but they offer many other advantages when used in high-frequency circuits. Moreover the shorter elements of miniatures are more rigid and are less prone to distortion as the result of vibration or shock.

Manufacturers of radio sets and other electronic

devices will find the use of miniatures of greatest aid in reducing the size and improving the function of their new equipment. TUNG-SOL engineers will consult with manufacturers in the designing of circuits and in the selection of tubes. Consultations are always held in strictest confidence.

TUNG-SOL
vibration-tested
ELECTRONIC TUBES



TUNG-SOL LAMP WORKS INC., NEWARK 4, NEW JERSEY
Also Manufacturers of Miniature Incandescent Lamps, All-Glass Sealed Beam Headlight Lamps and Current Intermittors

*Clip
the
Coupon*

PEERLESS Electrical Products Co.
6920 McKinley Ave., Los Angeles 1, Calif.

Please mail new 20-page catalog No. 431 to:

Name _____

Firm _____

Position _____

Street _____

City _____ State _____

**FOR YOUR COPY OF THE NEW
PEERLESS TRANSFORMER CATALOG**

Contains latest information and prices on the complete line of Peerless transformers, windings and reactors.



PEERLESS
ELECTRICAL PRODUCTS CO.

6920 McKinley Avenue, Los Angeles 1, California



**New Catalog and
Handbook of Taylor
Laminated Plastics**

Just off the press! A 54-page catalog and handbook containing the latest factual data, standards, and engineering information on Taylor Phenol Fibre and Vulcanized Fibre sheets, rods, tubes, and fabricated parts. An invaluable reference book for purchasing agents, design engineers, and manufacturers whose products contain laminated plastic parts. The scarcity of paper has forced us to make this a "limited edition," so if you want to be sure of getting a copy before the supply is exhausted, write today on your business letterhead.

**TAYLOR FIBRE COMPANY
LAMINATED PLASTICS**

PHENOL FIBRE • VULCANIZED FIBRE
Sheets, Rods, Tubes, and Fabricated Parts

NORRISTOWN, PENNSYLVANIA

OFFICES IN PRINCIPAL CITIES

Pacific Coast Headquarters:

544 S. San Pedro Street • Los Angeles 13



For Perfect Calibration

MONARCH

MEASURING • TESTING • CALIBRATING

EQUIPMENT

For better war production • For finer civilian production

Throughout the war period, Monarch instruments have facilitated production of better equipment, giving more accurate results. As soon as conditions permit, these same dependable instruments will be used to insure finer results in products designed for civilian use.



In the palm of your hand...



An Alert Organization...
**equipped to produce YOUR TUBES
under YOUR BRAND name!**

It's like adding a complete new plant to your own manufacturing facilities when you assign the important job of electronic tube production to Lewis at Los Gatos. Here is every facility . . . machinery, skill of highly trained personnel, engineering brains, and enthusiasm! For efficient and economical production of your tubes, manufactured to your "specs," call Lewis Electronics!

Lewis at Los Gatos

A manufacturing organization . . . the pride of an entire community . . . with an electronic engineering background of 20 years experience! Plus a war-born performance record of meeting huge production demands and exacting technical requirements—on time and economically!

Let us tell you about the war or post-war job Lewis can do for you! Write, phone or wire, and our representative will personally call!

Lewis ★

ELECTRONICS
LOS GATOS • CALIFORNIA

*Immediate
Delivery*

CO-AXIAL CONNECTORS

FOR
50 AND 70 OHM LINES

KINGS Electronics

MANUFACTURERS OF
**ELECTRONIC
EQUIPMENT PARTS**

- TERMINAL STRIP ASSEMBLIES
- ANTENNAE
- TRANSMISSION LINES
- RADAR ASSEMBLIES
- ALIGNMENT TOOLS
- SPECIAL EQUIPMENT
- WAVE GUIDES

For Complete Details
Write for Catalog.



KINGS ELECTRONICS Co.

372 CLASSON AVE.
BROOKLYN 5, N. Y.



MEASURES QUANTITIES

*with greater
sensitivity & range
than ever before
accomplished*



PATS. APP. FOR

TECH LAB MICROHMMETER

... gives direct and instantaneous readings of resistance values down to 5 microhms and up to 1,000,000 megohms. Accuracy in all measurements to better than 2%. Output is sufficient to drive recorder. Entirely AC operated. Furnished in two models. Reasonably prompt deliveries. For complete data regarding other applications write for Bulletin No. 432.

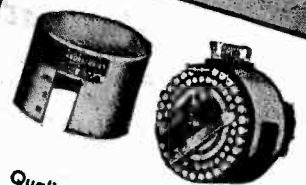

Quality manufacturers of attenuators and other electrical resistance instruments. For complete data write for Bulletin No. 431.

TECH
LABORATORIES

9 LINCOLN STREET
JERSEY CITY 7, N. J.

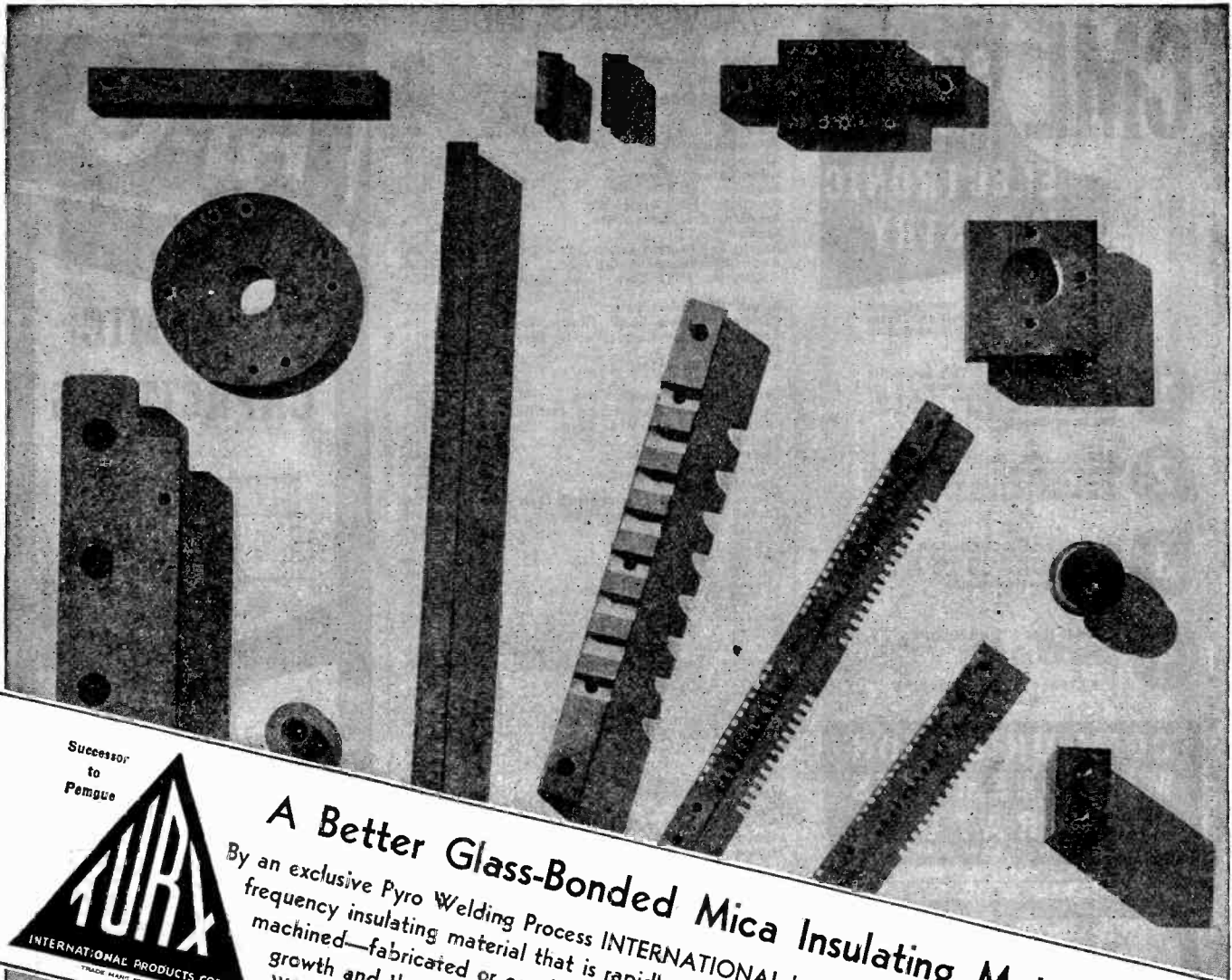

Successor
to
Pemgac



A Better Glass-Bonded Mica Insulating Material

By an exclusive Pyro Welding Process INTERNATIONAL has developed a stone-hard low loss high frequency insulating material that is rapidly reaching the top in the field of electronics. It can be machined—fabricated or can be had in stock sheet sizes. It is moisture proof—resistant to fungi growth and thermal shock. A complete engineering report—sizes and prices available on request. Write for catalogue—NOW.

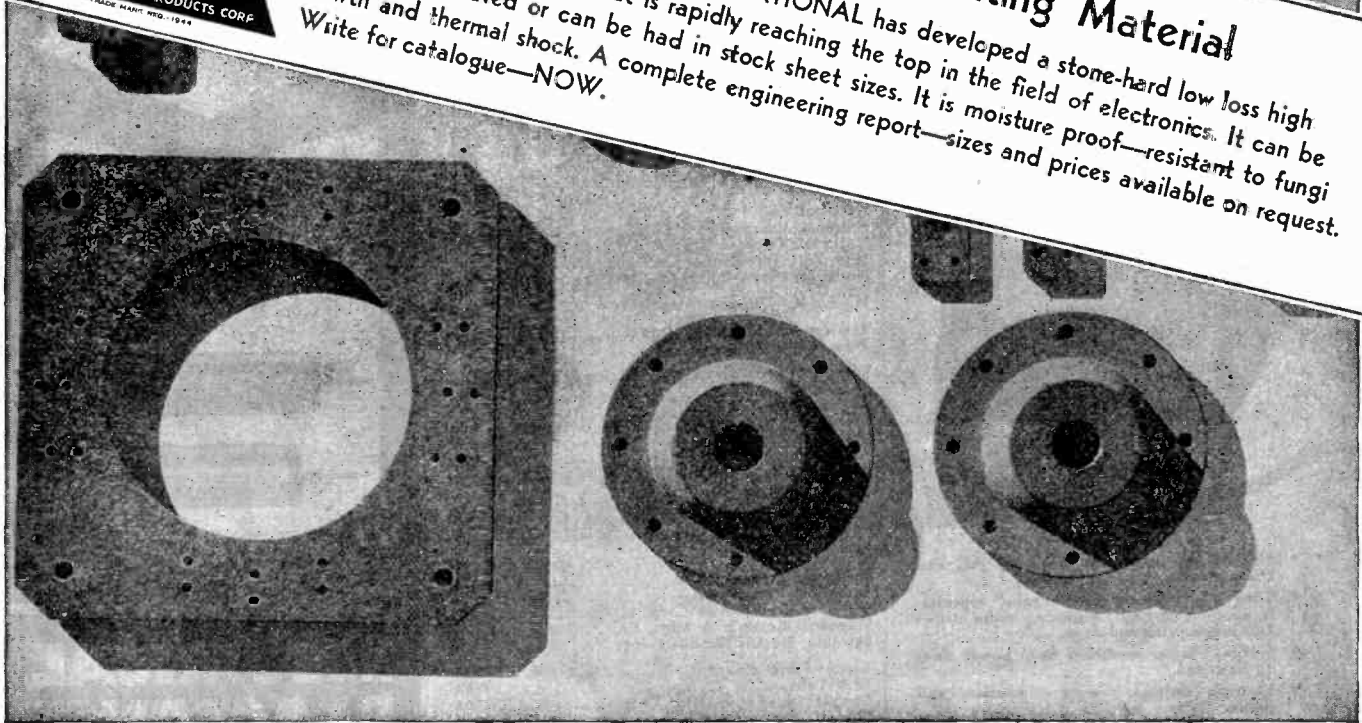

INTERNATIONAL PRODUCTS CORPORATION

BALTIMORE 18

2554 GREENMOUNT AVENUE

MARYLAND

CML SERVES THE ELECTRONIC INDUSTRY

Designed to meet the most rigorous specifications for precision, every CML unit is equipment of accredited performance.

1

ROTOBRIDGE . . . This automatic inspector checks for proper wiring, correct resistance, capacity and inductance values in all types of electronic equipment.

2

MODEL 1100, MODEL 1110 . . . Voltage regulated power supply units; with extremely low noise level and excellent regulation.

3

MODEL 1420 GENERATOR . . . Furnishes test power over a wide frequency range; may also be employed in 3-phase circuits.

4

MODEL 1200 STROBOSCOPE . . . Stops motion within range of 600 to 600,000 R.P.M.

WRITE FOR DESCRIPTIVE BULLETINS

COMMUNICATION MEASUREMENTS LABORATORY

120 GREENWICH ST., NEW YORK 6, N. Y.

Immediate Delivery! WIDE RANGE VACUUM TUBE VOLTMETERS

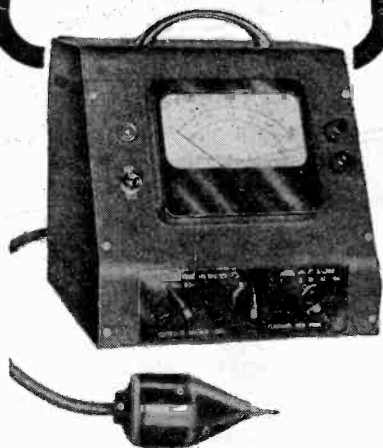

- High input impedance for both AC and DC measurements.
- Convenient, low capacity "Probe" especially adapted to high frequency radio use—100 megacycles and over.
- Self-regulating operation from power line; no batteries.
- Multiple voltage ranges — accurate and stable.

BULLETIN ON REQUEST

**ALFRED W. BARBER
LABORATORIES**

34-04 Francis Lewis Blvd. Flushing, N.Y.

ADVERTISERS' INDEX

Section Meetings	34A
Membership	38A
Positions Open	50A
Aerovox Corp.	18A
Allen-Bradley Co.	39A
Alliance Mfg. Co.	36A
Alltec Lansing Corp.	44A
American Tel. & Tel. Co.	4A
American Transformer Co.	5A
Amperex Electronic Corp.	13A
Andrew Co.	34A
Arnold Engineering Co.	42A
Audio Development Co.	62A
Automatic Mfg. Corp.	55A
Alfred W. Barber Labs.	70A
Bendix Aviation Corp. (Radio Div.)	19A
Bendix Aviation Corp. (Pacific Div.)	49A
Bliley Electric Co.	61A
Browning Labs., Inc.	35A
Cambridge Thermionic Corp.	58A
Capitol Radio Engineering Institute	64A
Allen D. Cardwell Mfg. Corp.	60A
Centralab	6A
Chicago Transformer	44A
Clarostat Mfg. Co.	58A
Sigmund Cohn & Co.	56A
Communication Measurements Lab.	70A
Cornell-Dubilier Electric Corp.	Cover III
Cornish Wire Co.	60A
DeJur-Amsco Corp.	26A
Tope Deutchmann Corp.	71A
Allen B. DuMont Labs., Inc.	14A
Eicor Inc.	38A
Stanley D. Eilenberger	48A
Eitel-McCullough, Inc.	72A
Electrical Reactance Corp.	70A
Federal Tel. & Radio Corp.	3A, 31A, 50A
General Electric Co.	10A
General Radio Co.	Cover IV
Goat Metal Stampings, Inc.	58A
Hallcrafters Co.	12A
Hammerlund Mfg. Co.	43A
Harco Co. Inc.	52A
Heintz & Kaufman, Ltd.	21A
Hewlett-Packard Co.	22A
Hytron Radio & Electronics Corp.	7A
Industrial Condenser Corp.	46A
International Products Corp.	49A
International Resistance Co.	17A
International Tel. & Tel. Corp.	3A, 31A, 50A
Jackson Electrical Instrument Co.	56A
Kaar Engineering Co.	37A
Ken-Rad Tube & Lamp Div.	28A
Kings Electronics Co.	68A
Lewis Electronics	67A
Litton Engineering Labs.	15A
Frank Massa	48A
Measurements Corp.	52A
Monarch Mfg. Co.	66A
Mycalex Corp. of America	11A
National Co., Inc.	2A
National Union Radio Corp.	1A
National Vulcanized Fibre Co.	52A
New York Transformer Co.	27A
North American Philips Co., Inc.	25A
M. F. M. Osborne Associates	48A
Pearless Electrical Products Co.	66A
Press Wireless, Inc.	50A
Radio Corp. of America	facing 32A, facing 32D
Rauland Corp.	53A
Raytheon Mfg. Co.	16A, 50A
Remler Co., Ltd.	24A
Bernard Rice's Sons, Inc.	57A
Richardson Co.	64A
Rola Co.	59A
Scovill Mfg. Co.	63A
Sherron Metallic Corp.	23A
Shure Bros.	51A
Small Motors, Inc.	62A
Solar Mfg., Corp.	33A
Sprague Electric Co.	32A
Stackpole Carbon Co.	30A
Standard Transformer Corp.	41A
Stupakoff Ceramic & Mfg., Co.	20A
Sylvania Electric Products Inc.	47A
Taylor Fibre Co.	66A
Tech Labs.	68A
Templetone Radio Mfg. Corp.	54A
Triplett Electrical Instrument Co.	29A
Tung-Sol Lamp Works, Inc.	65A
Turner Co.	48A
United Transformer Co.	Cover II
Walker-Jimieson, Inc.	54A
Western Electric Co.	8A, 9A
Westinghouse Electric Corp.	40A
Weston Electrical Inst. Corp.	45A

Hi-Q

CERAMIC CAPACITORS

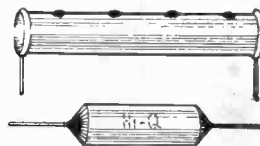

WIRE WOUND RESISTORS



CHOKE COILS

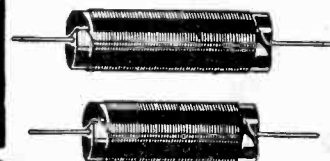

ELECTRICAL REACTANCE CORPORATION

FRANKLINVILLE, N. Y.

Capacity

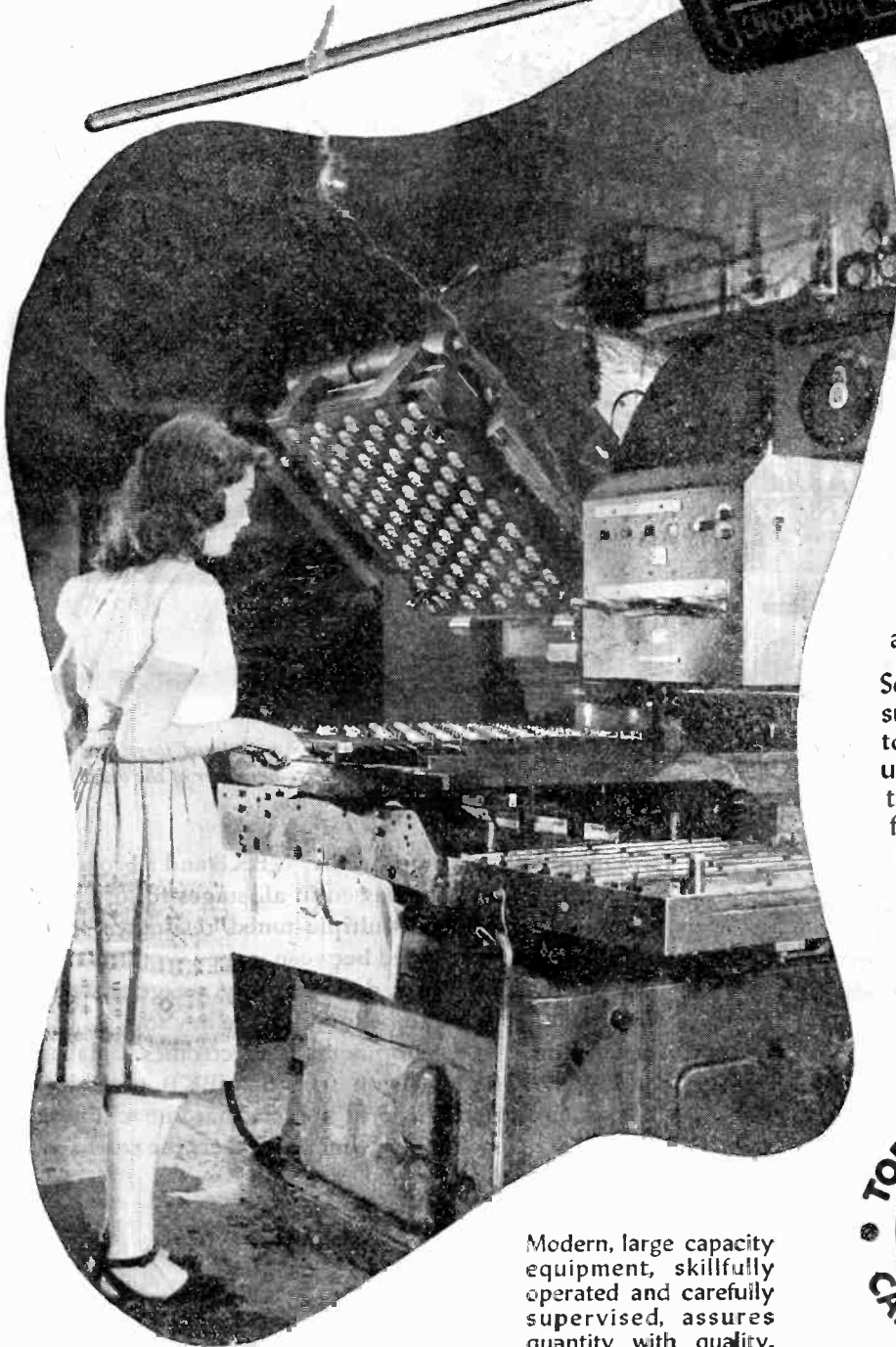
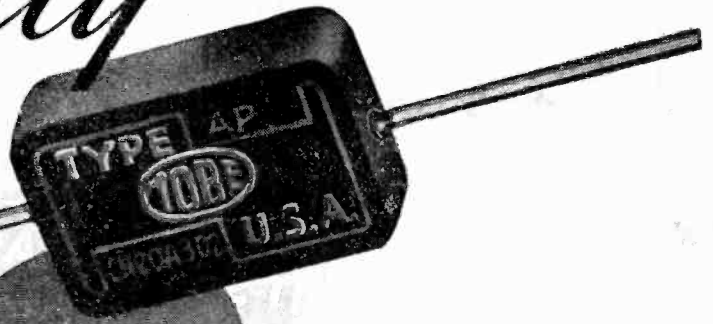

... to deliver molded oil-paper capacitors . . . in quantities more than ample for your needs . . . and in exact agreement with American War Standard C75/221 . . . is afforded by batteries of these dual-77-cavity monsters. Fed with oil-impregnated, aluminum-foil-wound, non-inductive sections and pre-forms of mica-filled phenolic, these huge presses are continually pouring forth capacitors of uniformly high quality with the consistency of characteristics for which Tobe products are famous.

So, however great may be your consumption of molded oil-paper capacitors, Tobe can deliver them in volume. Capacitance ranging from 1000 to 50,000 mmfd: working voltages from 120 to 800 volts d-c: shunt resistance as high as 40,000 megohms at 25°C: power factor as low as 0.004 at 1000 cycles: and moisture seal that meets all thermal cycle, immersion, and humidity requirements.

Modern, large capacity equipment, skillfully operated and carefully supervised, assures quantity with quality.



FIELD OFFICES IN NEW YORK CITY • CHICAGO • DETROIT • GLENDALE, CALIFORNIA



A. H. Brolly . . . Chief Engineer of Television Station WBKB, Chicago, adjusts the grid circuit of the Eimac 304-TL's in the Class B linear stage of the video transmitter.



Mr. Brolly calls attention to the Eimac 1000-T's in the final stage of the Audio FM Transmitter which operates at 65.75 megacycles. It is a very stable amplifier of good efficiency.

**IT'S EIMAC AGAIN!
FIRST CHOICE FOR
THE KEY SOCKETS
AT TELEVISION
STATION WBKB**

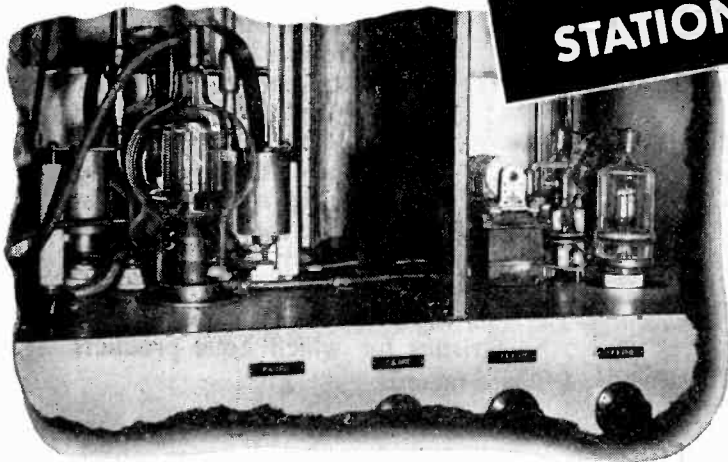

The video transmitter operates at 61.25 megacycles; peak power output is 4 KW which provides a television service throughout metropolitan Chicago and reaches suburbs out to 35 miles or more.

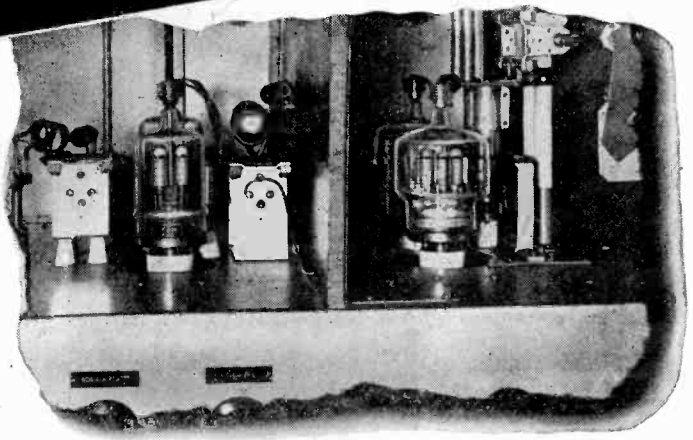

Eimac 152-T's are used in the modulated stage and 304-T's in the first Class B linear amplifier of the video transmitter.

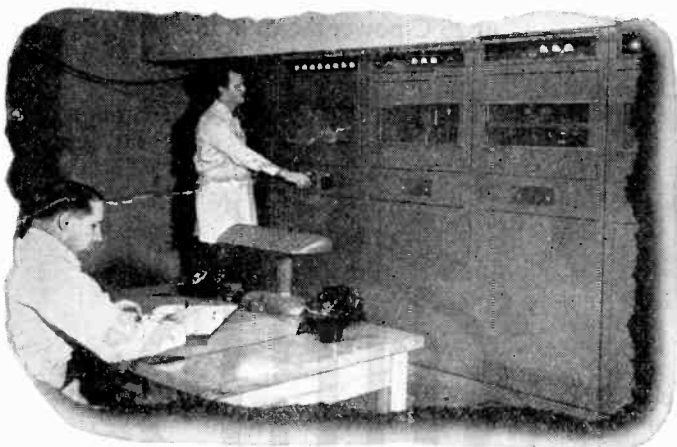

E. F. Cawthon and W. R. Brock are operating the station which has been broadcasting television programs with the present equipment since 1942 and began operation on a commercial schedule in October, 1943.

Grid modulation is employed at WBKB and a broad band of frequencies must be passed in all stages following the modulated amplifier. Multiple-tuned resistance loaded coupling circuits are used between stages.

Performance, stability, dependability are good reasons why Eimac tubes are to be found in the key sockets of the outstanding new developments in Electronics. Balaban & Katz, owners of television station WBKB of Chicago, offer potent confirmation of the fact that Eimac tubes are first choice of leading Electronic Engineers the world over.

FOLLOW THE LEADERS TO

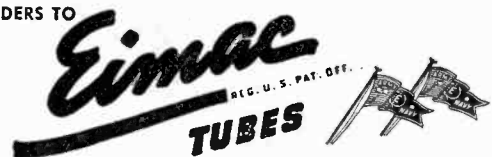

EITEL-McCULLOUGH, INC., 1032 San Mateo Ave., San Bruno, Calif.
Plants located at: San Bruno, California and Salt Lake City, Utah
Export Agents: Frazar & Hansen
301 Clay Street, San Francisco 11, California, U. S. A.

ELECTRONIC TELESIS—fully illustrated.
Send for a copy now. *The Science of Electronics* written in simple language. You'll find it of valuable assistance in explaining electronics to the layman. No obligation.

constant supervision by specialists

Although this operator has long been skilled in the winding of foil and tissue for Cornell-Dubilier capacitors, she looks to her supervisor for pointers when a new job is started. All along the line, production technique keeps pace with new improvements and innovations in our products.

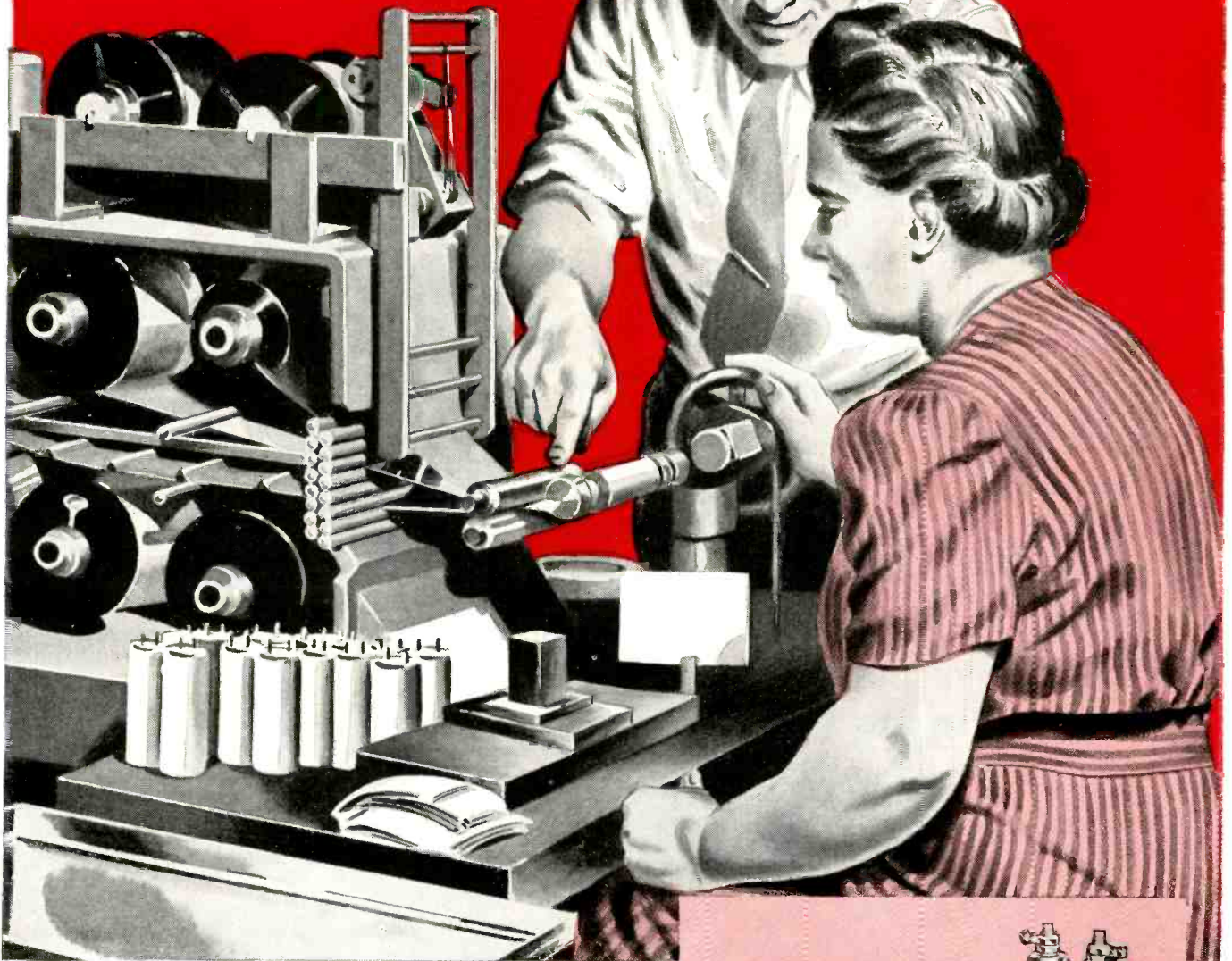

Vigilance in little details is second-nature to C-D craftsmen.

Accuracy is their creed.

With such watchful care, capacitor-building becomes a precise science . . . a science that has earned for Cornell-Dubilier capacitors a world-wide reputation for quality and dependability.

If you have a capacitor problem, you may find the answer in one of our basic innovations in design, engineering or manufacture. Cornell-Dubilier Electric Corporation, So. Plainfield, N. J. Other plants: New Bedford, Brookline, Worcester, Mass., Providence, R. I.

TJU TRANSMITTING CAPACITOR

Hermetically sealed in non-corrosive container. Compact, lightweight, furnished with universal mounting clamp, well-insulated terminals. Extra high dielectric strength. Wide range of voltage ratings.



CORNELL - DUBILIER CAPACITORS



WET AND DRY ELECTROLYTICS MICA • DYKANOL • PAPER •

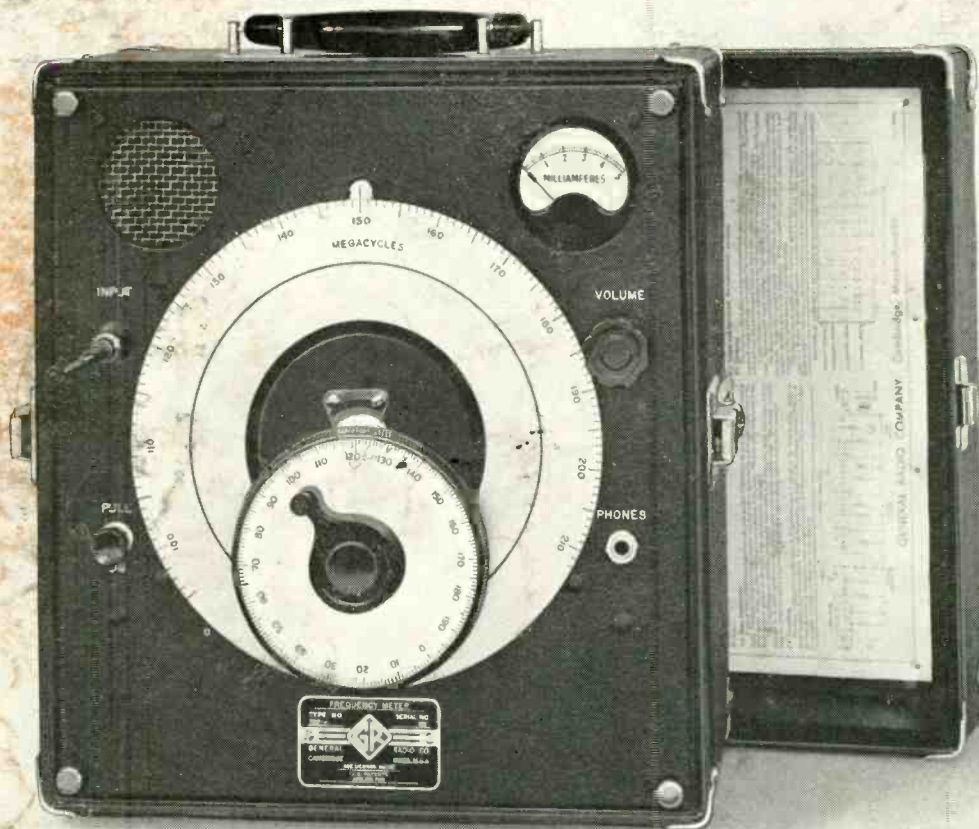

For Measuring Frequencies Between 30 and 3,000 Mc

The new G-R Type 720-A Heterodyne Frequency Meter has all the operating conveniences of a broadcast-band type instrument, with a range of 30 to 3,000 Mc. Heterodyne methods offer several advantages over the conventional resonant type of meter. The fundamental frequency can be low enough to insure stability difficult, or impossible, to obtain with the resonant-circuit instrument. The heterodyne meter has much greater sensitivity and consequently requires much less r-f power to operate.

The fundamental frequency of this new instrument is continuously variable between 100 and 200 Mc. Frequencies above and below this range are measured by the use of harmonics. The tuning element is a butterfly circuit with rotor ball-bearings and no sliding contacts. The fundamental range is direct-reading in megacycles with a dial scale-length of 15 inches. One division of the auxiliary dial corresponds to a frequency change of 100 parts per million.

The built-in detector is a silicon crystal Type 1N21B. Usually no auxiliary pick-up is needed except when frequencies above 1,000 Mc are being measured it may be necessary to adjust the input antenna which is mounted on the front panel.

A three-stage amplifier is provided to produce indication on the panel meter when strong signals are received. Audible beats are simultaneously heard in the small speaker mounted behind the panel. A jack is provided for plugging in headphones for weak beat notes.

The complete instrument is self-contained. Its price, with batteries and spare crystal is \$250.00. At present this meter is available only for top-priority war orders. Reservation orders for future delivery, however, are being accepted.

For complete information see the G-R EXPERIMENTER for July, 1945.



GENERAL RADIO COMPANY

Cambridge 39,
Massachusetts

90 West St., New York 6 920 S. Michigan Ave., Chicago 5 1000 N. Seward St., Los Angeles 38