

Proceedings



of the

I · R · E

VOLUME 32 • JUNE, 1944 • NUMBER 6



Engineering Work of the FCC
Bioelectric-Research Apparatus
Rectifier Study by "Memnoscope"
High-Potential—V-T Voltmeter
Saw-Tooth-Wave Testing
Coupled-Circuit Frequency Modulator
Negative Feedback in Amplifiers
H-F Impedance Measurements
Node Equations
Cavity-Resonance Studies

BUY
MORE
WAR
BONDS



Institute of Radio Engineers

SAVINGS

A FEW TYPICAL SAVINGS
EFFECTED BY UTC REDESIGN
OF WAR COMPONENTS...

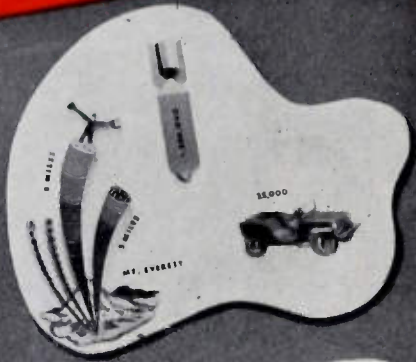

SOME OF THE SAVINGS

- 400,000 ALUMINUM CANT
- 400,000 LOCKWASHERS
- 400,000 BRASS NUTS
- 400,000 TERMINAL BOARDS
- ENOUGH SCREWS TO ASSEMBLE 1,250,000 BOMB FUSES
- ENOUGH TERMINALS TO SUPPLY 25,000 JEEPS



SOME OF THE SAVINGS

- ALLOY STEEL STAMPINGS WOULD BECKY FROM NEW YORK TO ALBANY
- WERE WOULD GO FOUR TIMES AROUND THE WORLD
- ENOUGH SCREWS TO ASSEMBLE 150,000 INCHDIARY BOMBS

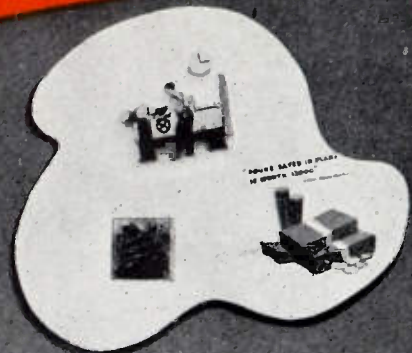

SOME OF THE SAVINGS

- 250,000 MAN HOURS
- 11,000,000 COMPONENT PARTS
- COMPARABLE WEIGHT SAVINGS EQUAL 40,000,000



May we cooperate with you
on design savings for your
application... war or post war

United Transformer Co.

150 VARICK STREET

NEW YORK 13, N. Y.

EXPORT DIVISION: 13 EAST 40th STREET, NEW YORK 16, N. Y., CABLES: "ARLAB"

BOARD OF DIRECTORS
1944

- Hubert M. Turner
President
- Ralph A. Hackbusch
Vice President
- Raymond A. Heising
Treasurer
- Haraden Pratt
Secretary
- Alfred N. Goldsmith
Editor
- Stuart L. Bailey
Wilmer L. Barrow
E. Finley Carter
Adolph B. Chamberlain
Ivan S. Coggeshall
William L. Everitt
Raymond F. Guy
Lawrence C. F. Horle
Charles B. Jolliffe
Frederick B. Llewellyn
Herbert J. Reich
Browder J. Thompson
Arthur F. Van Dyck
Harold A. Wheeler
Lynde P. Wheeler
William C. White

Harold R. Zeamans
General Counsel

BOARD OF EDITORS

- Alfred N. Goldsmith
Editor
- Ralph R. Batcher
Robert S. Burnap
Philip S. Carter
Lewis M. Clement
E. Maurice Deloraine
William G. Dow
Elmer W. Engstrom
William L. Everitt
George W. Gilman
Peter C. Goldmark
Frederick W. Grover
Lewis B. Headrick
C. M. Jansky, Jr.
John D. Kraus
Donald G. Little
Frederick B. Llewellyn
Samuel S. Mackeown
Edward L. Nelson
Harry F. Olson
Harold O. Peterson
Greenleaf W. Pickard
Ralph A. Powers
Haraden Pratt
Conan A. Priest
Herbert J. Reich
Peter C. Sandretto
V. W. Sherman
Lynne C. Smeby
E. C. Wente
Harold A. Wheeler
William C. White
Laurens E. Whittemore
Gerald W. Willard
William Wilson
Charles J. Young
Vladimir K. Zworykin

Proceedings

of the I·R·E

Published Monthly by

The Institute of Radio Engineers, Inc.

VOLUME 32 *June, 1944* NUMBER 6

Foundations for Industrial Success	Paul V. Galvin	315
Charles Byron Jolliffe		316
Engineering Work of the Federal Communications Commission		
I. General Introduction	E. K. Jett	317
II. Timely Broadcast Matters	George Adair	321
III. Police, Aviation, and Maritime Services	W. N. Krebs	324
IV. International Point-to-Point and Allocation Problems	P. F. Siling	326
Bioelectric-Research Apparatus	Harold Goldberg	330
Application of the "Memnoscope" to Rectifier Study	W. E. Pakala and Victor Wouk	336
High-Potential Vacuum-Tube Voltmeter	Paul B. Weisz	338
Steady-State Testing with Saw-Tooth Waves	D. L. Waidelich	339
A Coupled-Circuit Frequency Modulator	Elwin J. O'Brien	348
The Stability Factor of Negative Feedback in Amplifiers	Stewart Becker	351
A Note on Impedance Measurements at High Frequencies with Special Reference to Impedance Matching	P. J. Kibler	354
Node Equations	Myril B. Reed	355
Network Analyzer Studies of Electromagnetic Cavity Resonators	J. R. Whinnery, Jr., C. Concordia, W. Ridgway, and Gabriel Kron	360
Section Meetings		368
Institute News and Radio Notes		369
Constitutional Amendments		369
President Turner to Visit Sections		370
President Turner Greets I.E.E.		370
Board of Directors		371
Executive Committee		371
Technical Committees—1944-1945		372
Correspondence: The Validity of the Equivalent Plate-Circuit Theorem for Power Calculations	Harry Stockman	373
I.R.E. People		373
Books:		
"Bibliography and Abstracts on Electrical Contacts," Published by the American Society for Testing Materials	F. X. Rettenmeyer	374
"Mathematics of Radio Communications," by J. J. Wang	W. O. Swinyard	375
Contributors		375
Section Meetings		34A
Membership		36A
Positions Open		50A
Advertising Index		62A

Responsibility for the contents of papers published in the PROCEEDINGS rests upon the authors. Statements made in papers are not binding on the Institute or its members.



Entered as second-class matter October 26, 1927, at the post office at Menasha, Wisconsin, under the Act of February 28, 1925, embodied in Paragraph 4, Section 538 of the Postal Laws and Regulations. Publication office, 450 Ahnalt Street, Menasha, Wisconsin. Executive, editorial, and advertising offices, 330 West 42nd Street, New York 18, N. Y. Price, \$1.00 a copy. Subscriptions: United States and Canada, \$10.00 a year; foreign countries, \$11.00 a year. Changes of address (with advance notice of fifteen days) and communications regarding subscriptions and payments should be mailed to the Secretary of the Institute, at 330 West 42nd Street, New York 18, N. Y.

Copyright, 1944, by The Institute of Radio Engineers, Inc.

PAPERS COMMITTEE

- Frederick B. Llewellyn
Chairman
- Herman A. Affel
Wilmer L. Barrow
Howard A. Chinn
James K. Clapp
Ivan S. Coggeshall
Murray G. Crosby
Frederick W. Cunningham
Robert B. Dome
Enoch B. Ferrell
Donald G. Fink
H. S. Frazier
Stanford Goldman
Frederick W. Grover
O. B. Hanson
John V. L. Hogan
Frederick V. Hunt
Harley Iams
Loren F. Jones
John G. Kreer, Jr.
Emil Labin
Frederick R. Lack
Hugo C. Leuteritz
De Loss K. Martin
Knox McIlwain
Harry R. Mimno
Ilia E. Mouromtseff
G. G. Muller
Albert F. Murray
Dwight O. North
A. F. Pomeroy
Jack R. Poppele
Simon Ramo
Francis X. Rettenmeyer
Sergei A. Schelkunoff
Donald B. Sinclair
Karl Spangenberg
Hubert M. Turner
Dayton Ulrey
Karl S. Van Dyke
John R. Whinnery
Irving Wolff
J. Warren Wright
Harold R. Zeamans

PAPERS PROCUREMENT COMMITTEE

- Dorman D. Israel
General Chairman
- William L. Everitt
Vice Chairman

GROUP CHAIRMEN

- Jesse E. Brown
Warren B. Burgess
Edward J. Content
Harry Diamond
Edward T. Dickey
J. Kelly Johnson
Carl J. Madsen
Dan H. Moore
Howard J. Tyzzer
William C. White

- Helen M. Stote
Associate Editor
- William C. Copp
Advertising Manager
- William B. Cowilich
Assistant Secretary

**3 in 1
combination**

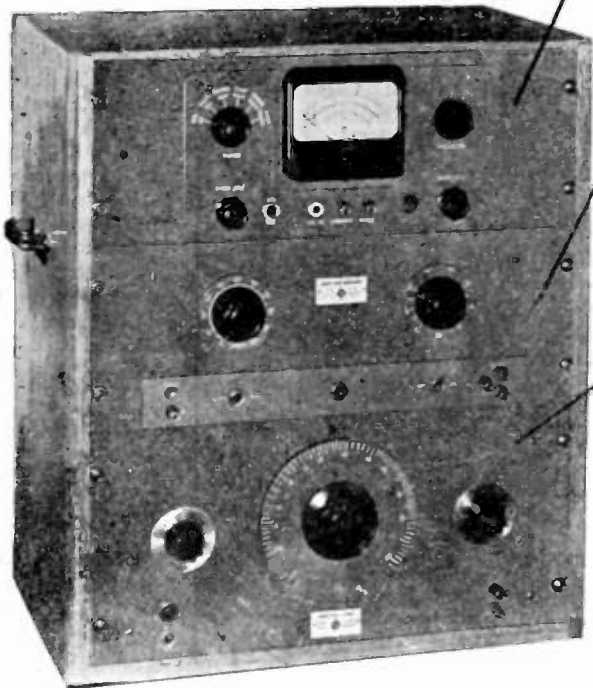
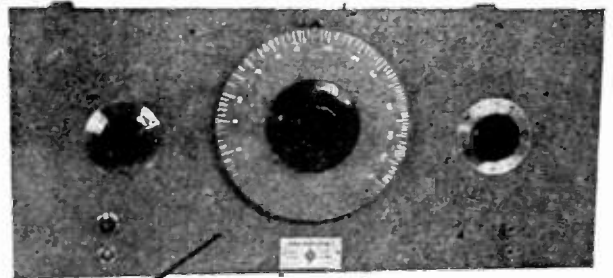
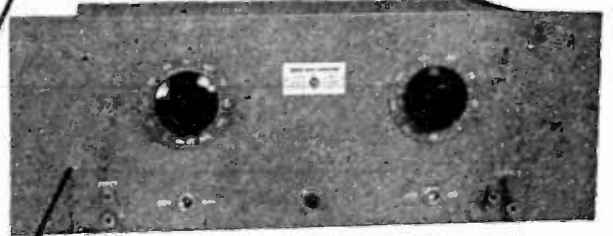
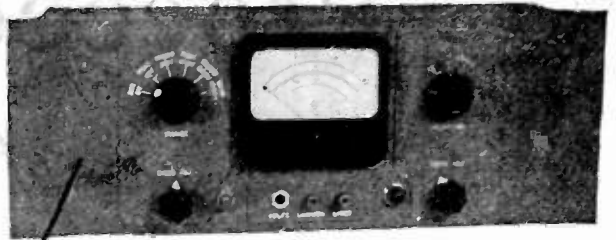

Special Vacuum Tube Voltmeter
Model No. 210 AR Square Wave Generator
Model No. 200 DR Audio Oscillator

Most all *-hp-* instruments are available for standard relay rack mounting. Thus several units may be assembled into a special cabinet to make an ideal combination for production line stations or for equipping a small laboratory. The single unit shown at left combines the three standard *-hp-* instruments shown above. With this combination you can measure volts, apply square wave to measure the response of amplifiers and networks... make distortion measurements

The complete combination in cabinet measuring 21 x 24 x 14 occupies minimum space on the bench. Note lack of great numbers of knobs and dials which is significant of the simplicity and speed of operation.

on audio amplifiers, make accurate bridge measurements and all the valuable tests and measurements possible with *-hp-* resistance tuned audio oscillators. Complete technical data sheets are available on these three units which you may obtain without obligation. * Just drop a post card in the mail. Also ask for your copy of the 24 page *-hp-* catalog which gives much valuable information about electronic test and measuring equipment in addition to data on the *-hp-* instruments.

HEWLETT-PACKARD COMPANY

P. O. Box 783D, Station A, Palo Alto, California

MIDGET OIL-FILLED Capacitors

...used as Mica-Capacitor Alternates
and in Space-Saving Assemblies

• Aerovox tubular oil-filled capacitors combine top performance with extreme compactness. Smaller Type '38 units serve as mica-capacitor alternates, meeting all standard test specifications as such.

These capacitors are hermetically-sealed in tiny metal cans or tubes. The Aerovox double-rubber bakelite terminal insulator assembly is used (or other suitable gasket material, depending on impregnant and fill). Case normally insulated from section, but grounded cases are available. Smaller Type '38 normally supplied without insulating outer tube. Larger Type '89 normally supplied with insulating outer tube and center mounting strap.

Covering a wide range of working voltages and capacitance values, these oil-filled tubulars are contributing notably to still better radio and electronic assemblies.

WRITE FOR
LITERATURE

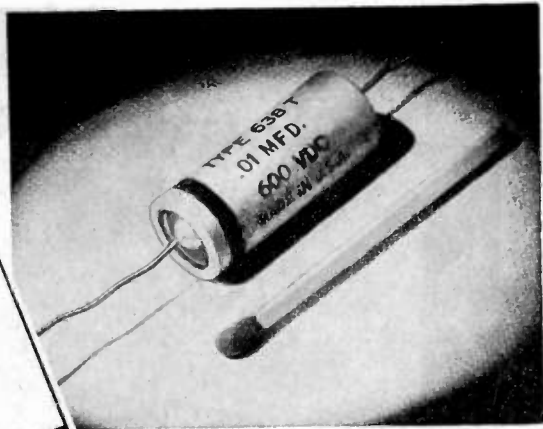

Smaller Type '38: 300, 500 and 600 v. D.C.W., .001 to .01 mfd.; and 800 v., .001 to .005 mfd.

Larger Type '89: 400 v., .015 to .5 mfd.; 600 v., .015 to .25 mfd.; 1000 v., .006 to .1 mfd.; and 2000 v., .006 to .05 mfd.

Unless otherwise specified, units are supplied with Aerovox Hyvol oil impregnant and fill. Available also with mineral oil.

Type '38 tolerances up to but not including .01 mfd., minus 20% plus 50%; .01 mfd., minus 10% plus 40%.

Type '89 tolerances up to .009 mfd., inclusive, minus 20% plus 50%; .01 to .09 mfd., minus 10% plus 40%; higher than .09 mfd., minus 10% plus 20%.



Capacitors

INDIVIDUALLY TESTED

AEROVOX CORPORATION, NEW BEDFORD, MASS., U. S. A.

SALES OFFICES IN ALL PRINCIPAL CITIES

Export: 13 E. 40 ST., NEW YORK 16, N. Y. • Cable: 'ARLAB' • In Canada: AEROVOX CANADA LTD., HAMILTON, ONT.

WELDING CAPACITORS

*for capacitor
discharge-type equipment*



- Uniform voltage stress
- Low max. voltage gradient
- Contacts **SOLDERED** to foil
— internal arcs avoided

Working closely with leading welding equipment manufacturers in the rapid development of Capacitor-Discharge units, Sprague has produced a line of specially-designed capacitors that have proved eminently successful in this exacting application. The dielectric of these Sprague Welding Capacitors is a high-quality

paper impregnated with an oil specially processed to assure a more nearly uniform stress throughout the units and a lower maximum voltage gradient. Longer life is the natural result. A special construction feature wherein contacts are painstakingly *soldered* to the foil minimizes danger of internal arcs with consequent gaseous discharges that might eventually ruin the capacitors.

For the latest developments in this field—whether for original capacitor-discharge welding equipment or replacement purposes—*write Sprague.*

SPRAGUE ELECTRIC CO., North Adams, Mass.
(Formerly Sprague Specialties Co.)



SPRAGUE

CAPACITORS · KOOLOHM RESISTORS

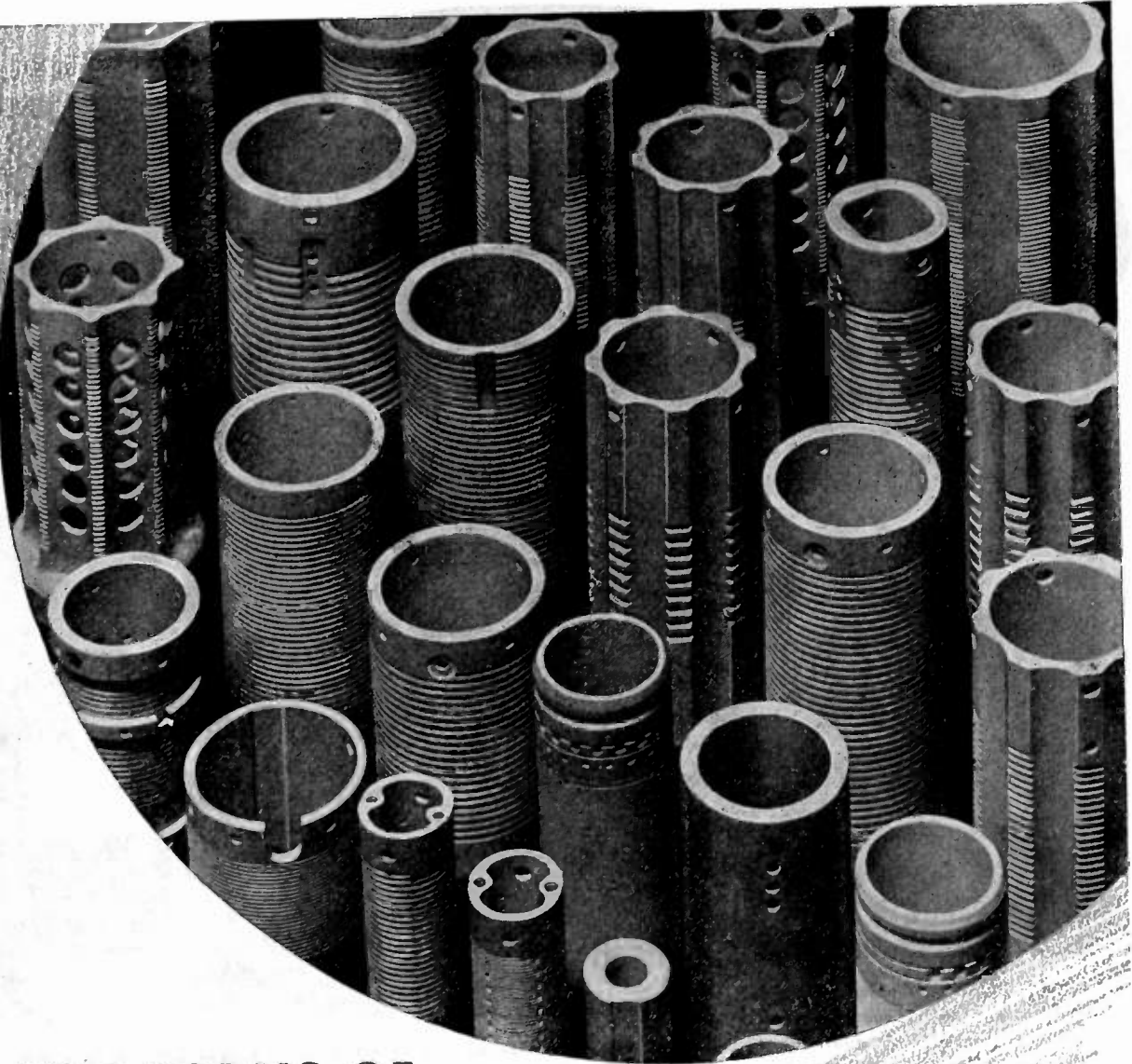

COIL FORMS OF

Steatite

and * *Centradite*

BODY (302)

BODY (400)

An almost endless variety of coil forms (up to 5 inches in diameter) are available, processed to your specifications within reasonable tolerances. We are also able to furnish pressed pieces to approximately 6 inches square. • The facilities of Centralab's engineering and laboratory experience are at your disposal.

Write for Bulletin 720



Centralab
CRL

Division of GLOBE-UNION INC., Milwaukee

PRODUCERS OF VARIABLE RESISTORS • SELECTOR SWITCHES • CERAMIC CAPACITORS, FIXED AND VARIABLE • STEATITE INSULATORS

★ Centradite is especially indicated where Low Thermal Expansion, High Resistance to Heat Shock, Low Porosity and Low Loss Factor are requisites.

38,000 hours
of service from a pair
of HK-54s



JOHN F. IRELAND, technician in charge of the Barnstable (Mass.) County Police Radio System, deserves much credit for the remarkable life of this pair of HK-54 tubes.



FINAL AMPLIFIER of the main station (WRAQ) at the Barnstable County Jail and House of Correction, showing the pair of Gammatrons still on the job after approximately 38,000 hours of operation.

WRAQ REPORTS GAMMATRONS STILL IN CONSTANT OPERATION AFTER 57 MONTHS

Strong proof of the extraordinary life of Gammatron tubes is contained in the following report from the service files of WRAQ as prepared by Technician John F. Ireland:

"Our main station is on the air 24 hours daily, operating on a frequency of 39,900 kcs. The final amplifier of this transmitter uses a pair of HK-54 tubes with 1100 volts on their plates.

"These HK-54s (Serial Nos. 2270 and 2271) were installed in the transmitter on August 3, 1939. Except for shut-downs of short duration for minor repairs and the checking of other tubes, these 54s have been in continuous use since installation, and are still on the job after approximately 38,000 hours.

"To further the life of these tubes the filament voltage, during standby, is dropped from 5.0 volts to slightly under 4.5 volts, a relay shorting the dropping resistor when plate voltage is applied.

"The present modulator tubes, also HK-54s, were installed in the later part of 1939, and from all indications still have a long way to go

before being retired. Filament voltage of these has the same treatment as the above."

Every Gammatron is built of the same materials, is exhausted in the same severe manner, and passes the same rigid tests as those in operation at WRAQ.

BUY AN EXTRA WAR BOND

HEINTZ AND KAUFMAN LTD.

SOUTH SAN FRANCISCO • CALIFORNIA

Army-Navy Production Award bestowed for second time on
 January 15, 1944



Gammatron Tubes

Speed Output

OF ELECTRONIC EQUIPMENT WITH

AMERTRAN

HIGH VOLTAGE RECTIFIERS

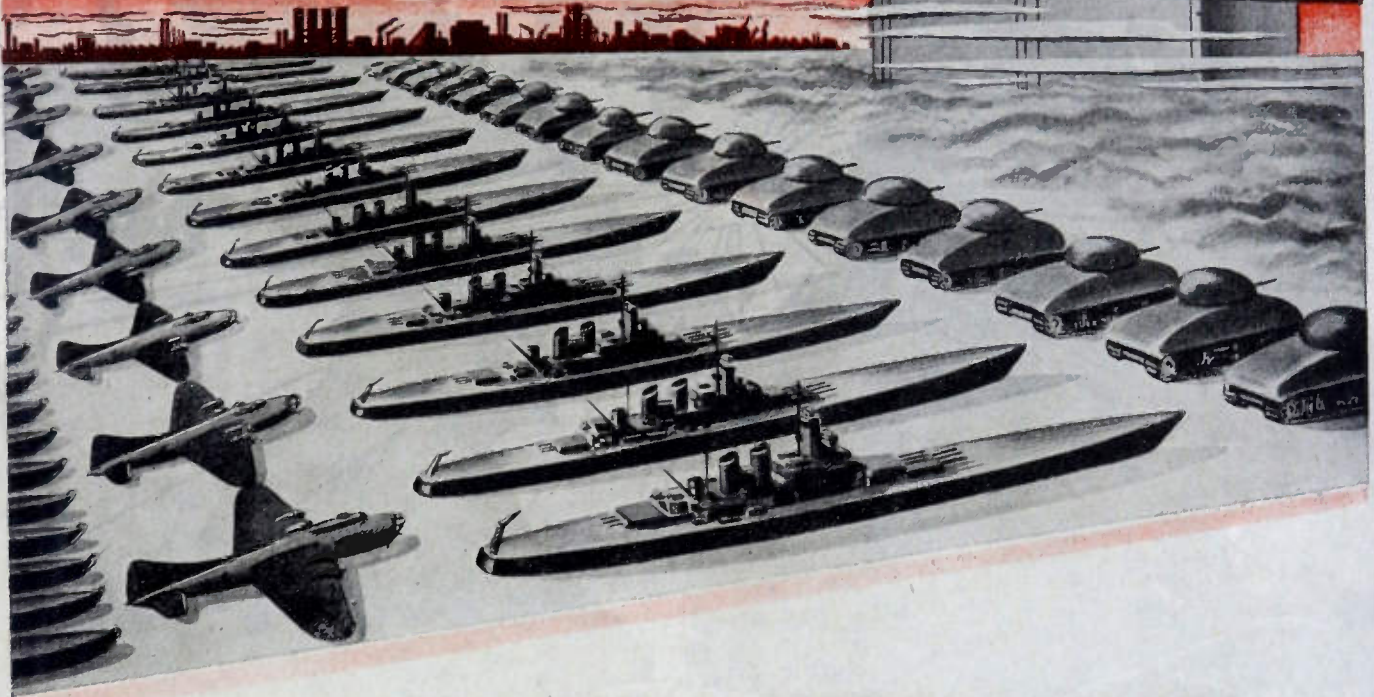
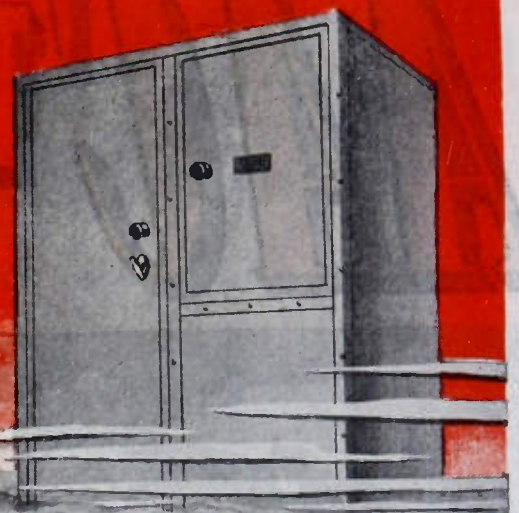

Many manufacturers of naval, aircraft and land communications equipment know that they have better assurance of meeting exacting delivery schedules when the High Voltage Rectifiers are made by AmerTran. Acceptance is also assured through our familiarity with special applications, including navigating and locating devices.

AmerTran Rectifiers can be made to conform in general appearance with other apparatus with which they may be associated.

Delivery is assured by our access to stable mate-

rial sources, plus a proved, fast production system that employs certain recently developed techniques.

In spite of the pressure of war production, AmerTran Rectifiers are built to the same quality standards that have characterized AmerTran products for forty-three years. Quotations will be forwarded promptly upon receipt of your specifications.

AMERICAN TRANSFORMER CO., 178 Emmet St., Newark 5, N.J.



Pioneer Manufacturers
of Transformers, Reactors
and Rectifiers for Electronics
and Power Transmission

AMERTRAN

MANUFACTURING SINCE 1901 AT NEWARK, N. J.

AAC TRANSMITTERS



TYPE 508 TRANSMITTER

(Illustrated at right). Type 508 Transmitter as designed by AAC for Army Airways Communications Service. Power output 450 watts each channel. Types of emission A1, A2, A3 and FM teletype. Five channels can be operated simultaneously. Single or dual modulator can be supplied.



F-34



AIRCRAFT

PRECISION RADIO

Burbank, Calif.



Serving the AIR TRANSPORT COMMAND Along Vital World-Wide Routes

THE Air Transport Command has become the greatest air transportation system in the world . . . delivering planes, materials and personnel to the Allied forces everywhere!

As ATC pilots fly the seven seas and girdle the earth they are served by communications systems of which Aircraft Accessories Transmitters are an important part. These "508 units" are an outstanding example of the engineering skill and production tempo of Aircraft Accessories. Designed specifically to performance requirements of Army Airways Communications Service (AACS), which sets up and operates radio facilities for the ATC, this equipment is now in operation at many of the widespread world outposts maintained by AACS.

This type of AAC equipment can be readily adapted to immediate use by other airlines. Deliveries can be made in remarkably short time, if adequate priority ratings are available.

ELECTRONICS DIVISION KANSAS CITY,
KANSAS



ACCESSORIES **C**ORPORATION

and **ELECTRONICS** • ENGINEERED POWER CONTROLS

City, Kans

New York, N. Y.

Cable Address: AACPRO

QUARTZ CRYSTALS

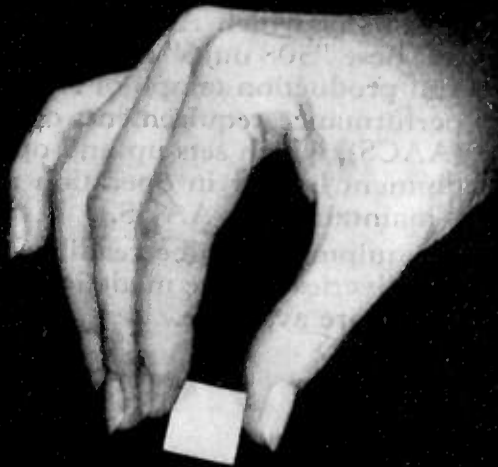

**ANY TYPE, ANY SIZE,
ANY QUANTITY**

OUR PRODUCTION IS GEARED TO MEET
YOUR DELIVERY SCHEDULES AND
SPECIFICATIONS.

WE ARE MAKING THOUSANDS FOR
THE SERVICES. CAN WE HELP YOU?



AVIATION RADIO EQUIPMENT

REX BASSETT

INCORPORATED

FORT LAUDERDALE, FLORIDA



"I think I'd better stop now"

**When Long Distance Says—
"Please limit your call
to 5 minutes"**

That's a good suggestion to follow. It means the lines to war-busy centers are crowded. It's a friendly, thoughtful act that helps the other fellow—and then some day turns right around and helps you.



BELL TELEPHONE SYSTEM



Three attitudes that hamper war production

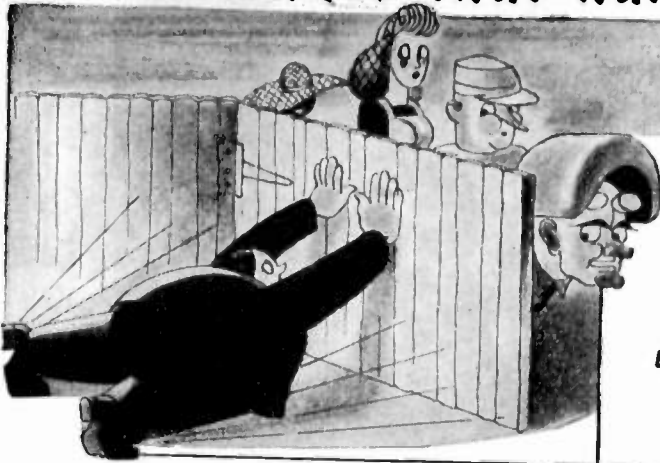

KEEPING LABOR ON LABOR'S SIDE OF THE FENCE

Ignoring successful examples of many progressive plants, some executives still choose to utilize the craftsmanship but not the wholehearted cooperation of labor. Labor appears to be non-essential around the conference table.

ONE EYE SHUT TO WORKING CONDITIONS

A healthy and contented worker is a good worker — but, unfortunately, some men close one eye to this well-established fact. Provisions for maintaining general comfort and morale on the production line are shrugged aside, and then there's wonderment if output lags.

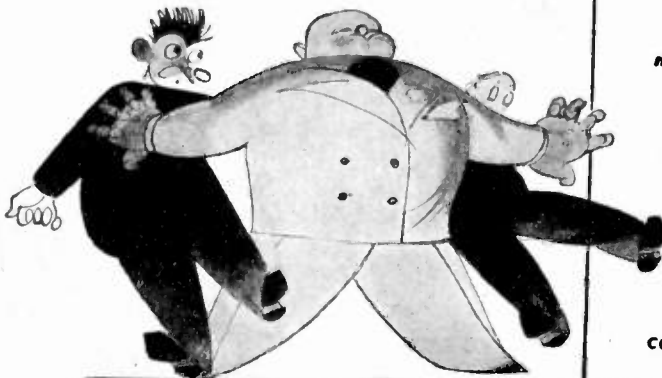

"I'M BETTER THAN HE IS"

While boys of different colors and races and religions fight and die side-by-side, here at home there are those who practice an un-American form of discrimination. Overlooked is the actuality that harmonious relationships of all peoples can, and must, be achieved.

THERE IS NO PLACE IN THIS COUNTRY FOR SUCH ATTITUDES

At ECA, even as in your plant, we have questioned these three attitudes . . . experimented . . . eliminated them. Carrying the fundamental principles of the American dream into our organization, management and labor function as a single democratic unit. Periodic meetings have been established . . . ideas of benefit to both groups are exchanged. Here we gather suggestions for economy and efficiency. Here originate recreational facilities, group insurance and medicine plans, our extensive home front activities. Here developments are born whose value to the country have been effectively demonstrated. Here our policy of assigning jobs on the basis of merit rather than heritage is reaffirmed. Has our plan worked? Efficiency steadily increases and production, for example, today is six times greater than it was twelve months ago. This record gives added support to our proposition that, regardless of color or creed, to advance is the common birthright of all men . . . and that mutual cooperation between the man-in-the-front-office and the man-who-puts-things-together is not only highly desirable but highly essential.

ECA

ELECTRONIC CORP. OF AMERICA

45 WEST 18th STREET • NEW YORK 11, N. Y. WATKINS 9-1870

REPRINTS OF THIS ADVERTISEMENT AVAILABLE.

SHAPPE-WILKES INC.

Proceedings of the I.R.E.

June, 1944

Westinghouse Electronic Tubes . . . doing a job on every front, in every battle, in every war industry

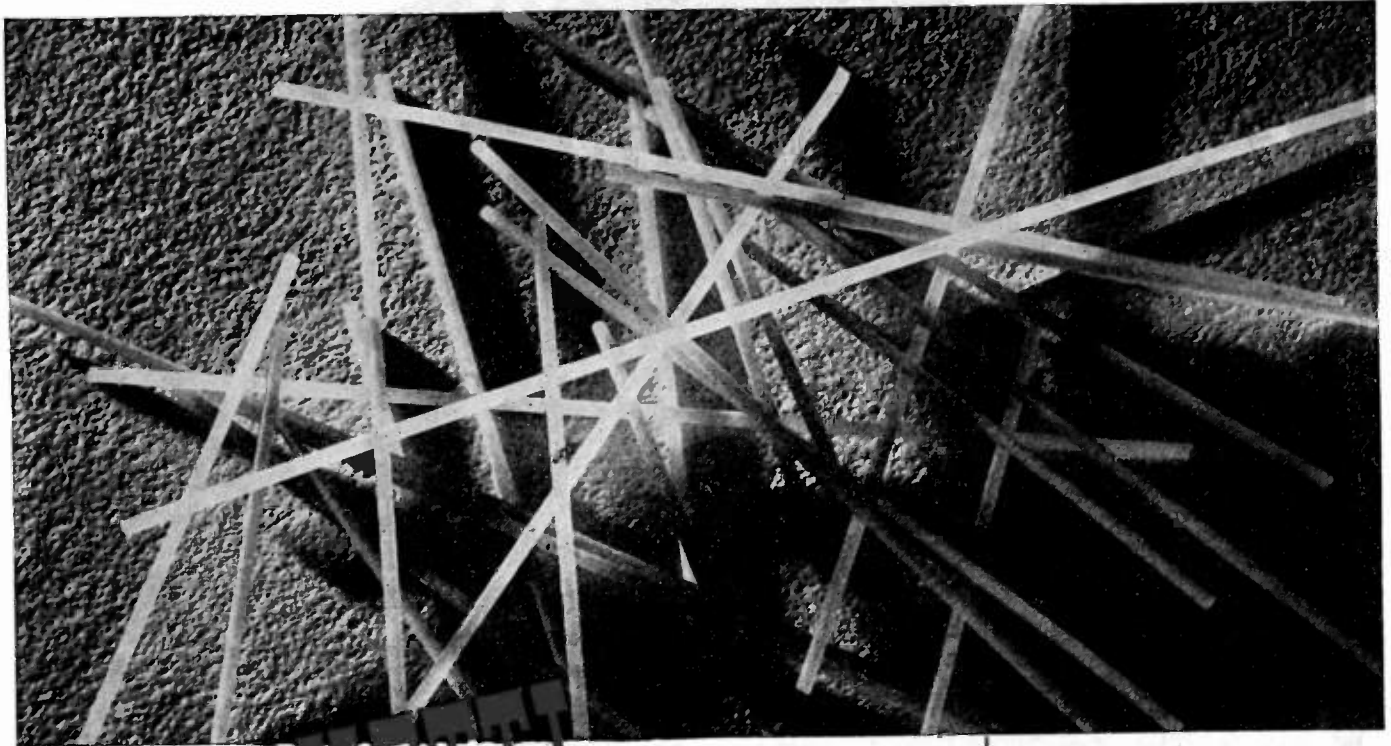

SPAGHETTI
 does a better
 job than steel . . .

To help meet the sky-rocketing demand for Westinghouse Electronic Tubes, Westinghouse has devised a simple but ingenious time-saver. When welding certain filaments, instead of inserting a piece of steel into the filament coil to keep it in alignment, we use a strip of spaghetti. The spaghetti is then burned out and the whole job completed in 1½ minutes instead of 5. This is but one example of how Westinghouse resourcefulness has enabled us to increase production 30 times. Today, we're not only meeting time and quality "musts" on Government contracts—we're also continuing to supply the heavy demands of war industry. Your nearest Westinghouse Office or Distributor will be glad to receive your inquiries for Westinghouse Tubes. Westinghouse Electric & Manufacturing Company, Bloomfield, N. J.

These Westinghouse
 Tubes Now Available
 in Limited Quantities

WL-195	Pliotron
WL-196	Pliotron
WL-463	Pliotron
KU-610	Thyratron
KU-627	Thyratron
KU-628	Thyratron
KU-629	Thyratron
WL-632A	Thyratron
WL-651/656	Ignitron
WL-652/657	Ignitron
WL-655/658	Ignitron
WL-672	Thyratron
KU-676	Thyratron
WL-677	Thyratron
WL-681/686	Ignitron
WL-710	Ballast Tube
WL-788	Ballast Tube
WL-857B	Phanotron
WL-892	Pliotron
WL-895	Pliotron
WL-896	Ballast Tube



Westinghouse
PLANTS IN 25 CITIES . . . OFFICES EVERYWHERE

Quality Controlled **ELECTRONIC TUBES**

soldiers in mufti



One of the most important men on the production front is the electronic engineer. Working long and hard hours, his time is spent devising and planning electronic equipment that will give the Allied forces overwhelming superiority on the battlefield. He was "drafted" early in the war and has devoted his special skills unstintingly to the successful prosecution of the war effort. The electronic engineer is truly a soldier on the homefront.

Raytheon engineers are continually devising new electronic products which contribute to the immeasurably important role that advanced electronic equipment is playing in winning the war. Raytheon electronic tubes and equipment are built to more than meet severe wartime requirements. The "Plus-Extra" quality, dependability and stamina of Raytheon products have established Raytheon as one of the leading manufacturers in the electronic field.



ARMY-NAVY "E" WITH STARS
Awarded All Four Divisions of Raytheon
for Continued Excellence in Production

RAYTHEON

RAYTHEON MANUFACTURING COMPANY
Waltham and Newton, Massachusetts

DEVOTED TO RESEARCH AND THE MANUFACTURE OF TUBES AND EQUIPMENT FOR THE NEW ERA OF ELECTRONICS

NATIONAL LOW-LOSS SOCKETS AND INSULATORS



CIR Series Sockets

Any Type List \$.45

Type CIR Sockets feature low-loss isolantite or steatite insulation, a contact that grips the tube prong for its entire length, and a ring for six position mounting. They are supplied with two metal

AA-3 List \$.60

A low-loss steatite spreader for 6 inch line spacing. (600 ohms impedance with No. 12 wire.)

List \$.50

steatite aircraft-ator.

List \$.90

lose strain In-ss steatite.

st, each \$.20

ite bushing

ten \$.85

Victron.

ten \$.85

the bush-

93 condiam.,

\$.55

.75

0-

0-

XS-1, (1" Hole) List \$ 1.20

XS-2, (1½" Hole) List \$ 1.35

Prices listed are per pair, including metal fittings. Insulation steatite.

XS-3, (2¾" Hole) List \$ 6.00

XS-4, (3¾" Hole) List \$ 7.25

Prices are per pair, including metal fittings. These low-loss steatite bowls are ideal for lead-in purposes at high voltages.

XS-5, Without Fittings List, each \$ 8.25

XS-5F, With Fittings List, per pair \$17.00

These big low-loss bowls have an extremely long leakage path and a 5¼" flange for bolting in place. Insulation steatite.

MEMO

National is still your best bet for high grade parts for H.F. Communication work. Deliveries are good when orders are covered by suitable priority rating.

NATIONAL COMPANY, INC.
MALDEN, MASS.

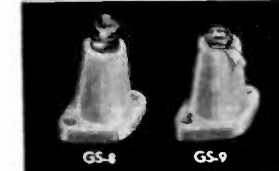
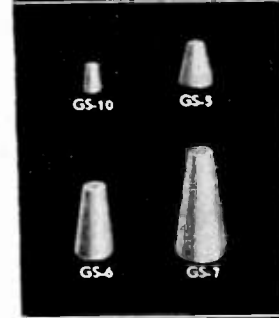
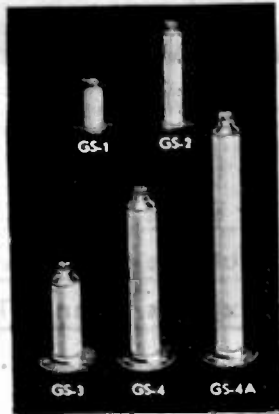
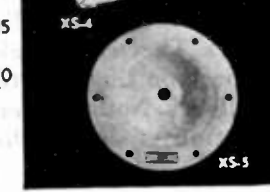
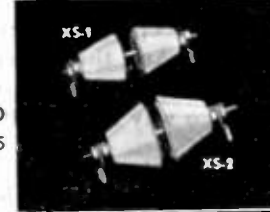
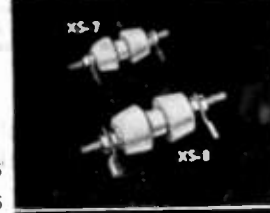
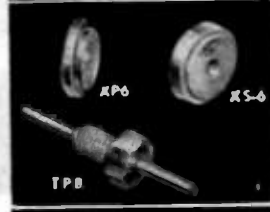
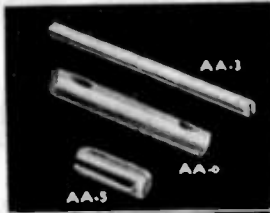

GS-1
GS-2
GS-3
GS-4
GS-4A
Cylindrical standoff plated cap
GSJ, (not in A special top threaded diameter insul & GS-4A.

GS-5, 1¼" List, each \$.40
GS-6, 2" List, each \$.70
GS-7, 3" List, each \$ 1.25
GS-10, ¾", package of 10 List \$.12

These cone type standoff insulators are of low-loss steatite. They have a tapped hole at each end for mounting.

GS-8, with terminal List \$.90
GS-9, with Jack List \$ 1.25

These low-loss steatite stand-off insulators are also useful as lead-through bushings.



HOW TO KEEP 15,000 TRUCKS ON THE GO



These Elastic Stop Nuts are holding the driving flange. Even with frequent starts and stops, and the steady use the wheels of an express truck get, these nuts hold fast.

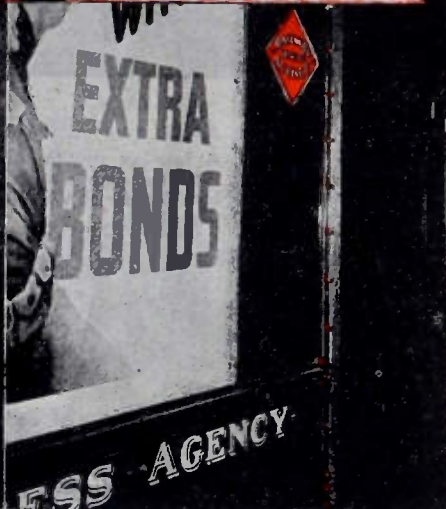

Railway Express truck bodies are completely fastened with Elastic Stop Nuts. Where other fastenings give with the sway and twist of the truck, these nuts hold tight.



Throughout the chassis, Elastic Stop Nuts are used wherever ordinary nuts loosen in service. Here they are fastening the hand-brake drum on the propeller shaft.

ON the road, trucks earn their keep. In the shop they eat their heads off.

The Railway Express Agency knows that well. And they learned one of the answers to keeping trucks on the go way back in 1927.

They use Elastic Stop Nuts — use them on a great many of their 15,000 trucks.

The reasons? These nuts increase safety and cut down mishaps. They reduce maintenance time and up-keep costs.

Elastic Stop Nuts go on like ordinary nuts. They need no auxiliary locking devices. They can be taken off and put back on time and time again and still lock. Nothing — even severe vibration — shakes them loose.

It's the elastic collar in the top that does the trick. It hugs the bolt threads tight. It cushions vibration. The nut can't shiver loose and turn.

Today billions of these nuts with

the ESNA red collar are being used on our aircraft. A bomber takes as many as 50,000 in a single ship.

In the days to come there will be countless fastening problems on all kinds of products. Perhaps you have one now.

If so, we'd like to talk about it. Our engineers are at your service ready to recommend the right Elastic Stop Nut to provide a safer, surer, trouble-free fastening.

Major spots where Elastic Stop Nuts are at work on Railway Express Agency Trucks

Steering post — fasten bracket to cowl • Steering post — hold bracket to chassis • Drive shaft and universals • Master-brake cylinder to bracket • Hand-brake drum to shaft • Gas tank straps • Propeller shaft center carrier • Clutch and brake pedal brackets • Rear wheel hubs • Motor supports on cross member • Shackle bolt lock pin • Front bumper brackets • Cab bolts • Body hinges • Truck bodies — approximately 375 nuts.



ESNA
TRADE MARK OF
ELASTIC STOP NUT CORPORATION
OF AMERICA
ELASTIC STOP NUTS

Look fast to make things last
UNION, NEW JERSEY AND
LINCOLN, NEBRASKA

W. A. PATTERSON, President of United Air Lines



"...YOU SAY VIBRATOR POWER SUPPLIES CAN INCREASE SAFETY AND COMFORT IN PLANES?"

MR. W. A. PATTERSON, President of United Air Lines, recently said—

"It is our belief that the war has advanced public acceptance of the airplane as a mode of transportation by 20 years. The airlines, like every other service that caters to the public, must anticipate their passengers' expectations of new facilities for greater comfort and safety. United will put in service new, huge 44-50 passenger Mainliners offering comforts, conveniences and thoughtful appointments surpassing anything heretofore known, and flying from coast to coast in 11 hours with new devices to assure safe flight."

E-L is ready right now with Vibrator Power Supplies to bring passengers the greater comfort of fluorescent lighting as well as the convenience and safety of radio and radio-telephone. E-L Black Light equipment is available as a safety device for instrument panel illumination at night to eliminate blinding interior glare and to provide clear, sharply defined instrument calibration. Engineered to specific space and voltage requirements, Electronic Laboratories products are used wherever current must be changed in voltage, frequency or type. E-L engineers invite inquiries.

E-L STANDARD POWER SUPPLY MODEL 307

For the operation of standard 110 volt AC equipment, such as radios and small motors, from a 6 volt battery. Characteristics: Input voltage, 6 v. DC; Output voltage, 115 v. AC; Output power, 100 watts; Output frequency, 60 cycles.

Dimensions: 7½x8¼x10¼ in. Weight: 23½ pounds.



Write for further information of this and other models of the extensive E-L line.

Electronic

LABORATORIES INC.
INDIANAPOLIS

VIBRATOR POWER SUPPLIES FOR LIGHTING, COMMUNICATIONS, AND ELECTRIC MOTOR OPERATION • ELECTRIC, ELECTRONIC AND OTHER EQUIPMENT

Serving the Amateur Always-

TAYLOR TUBES

Amateurs today are welding their experience and skill into one of the strongest forces in all history. Taylor Tubes have helped to back them all along the way by producing a mighty flow of the world's finest transmitting tubes. When the Amateur comes home, he will again find a complete line of Taylor Tubes designed especially for his particular requirements — tubes incorporating all of the newer developments that have helped him to carry on so nobly in time of war.

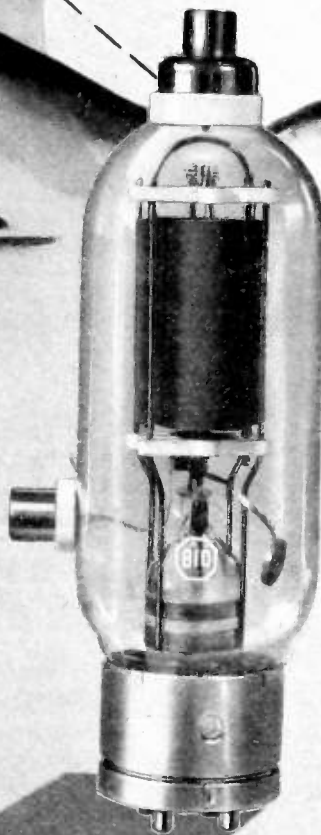

**Buy More WAR BONDS
For Victory!**

Taylor

HEAVY

CUSTOM
BUILT

DUTY

Tubes

TAYLOR TUBES, INC., 2312-18 WABANSIA AVE., CHICAGO, ILLINOIS

WHY AMPEREX

WATER AND AIR COOLED TRANSMITTING and RECTIFYING TUBES

Major developments by Amperex engineers have considerably extended the working hours of our tubes. Out of this one "Amperextra" alone have been affected. Longer life Economies in vital materials have been prolonged. Operating has decreased the number of tube replacements. If you are designing equipment for war or peacetime pursuits, it will pay you to obtain full details of our "Amperextra" engineering service.



One of a series showing Amperex tubes in the making



AMPEREX... the high performance tube
HF-3000

It's easy to give blood... no aches, no pains, no ill after effects. See your local Red Cross.

AMPEREX ELECTRONIC PRODUCTS
79 WASHINGTON STREET • BROOKLYN 1, N. Y.

Official U. S. Navy photograph showing Rear Admiral Alan C. Kirk directing Naval phases of landing operations on Sicily, aided by his staff. Under the arrow is the famous TBY landing set built by Colonial Radio, using Rola Transformers.

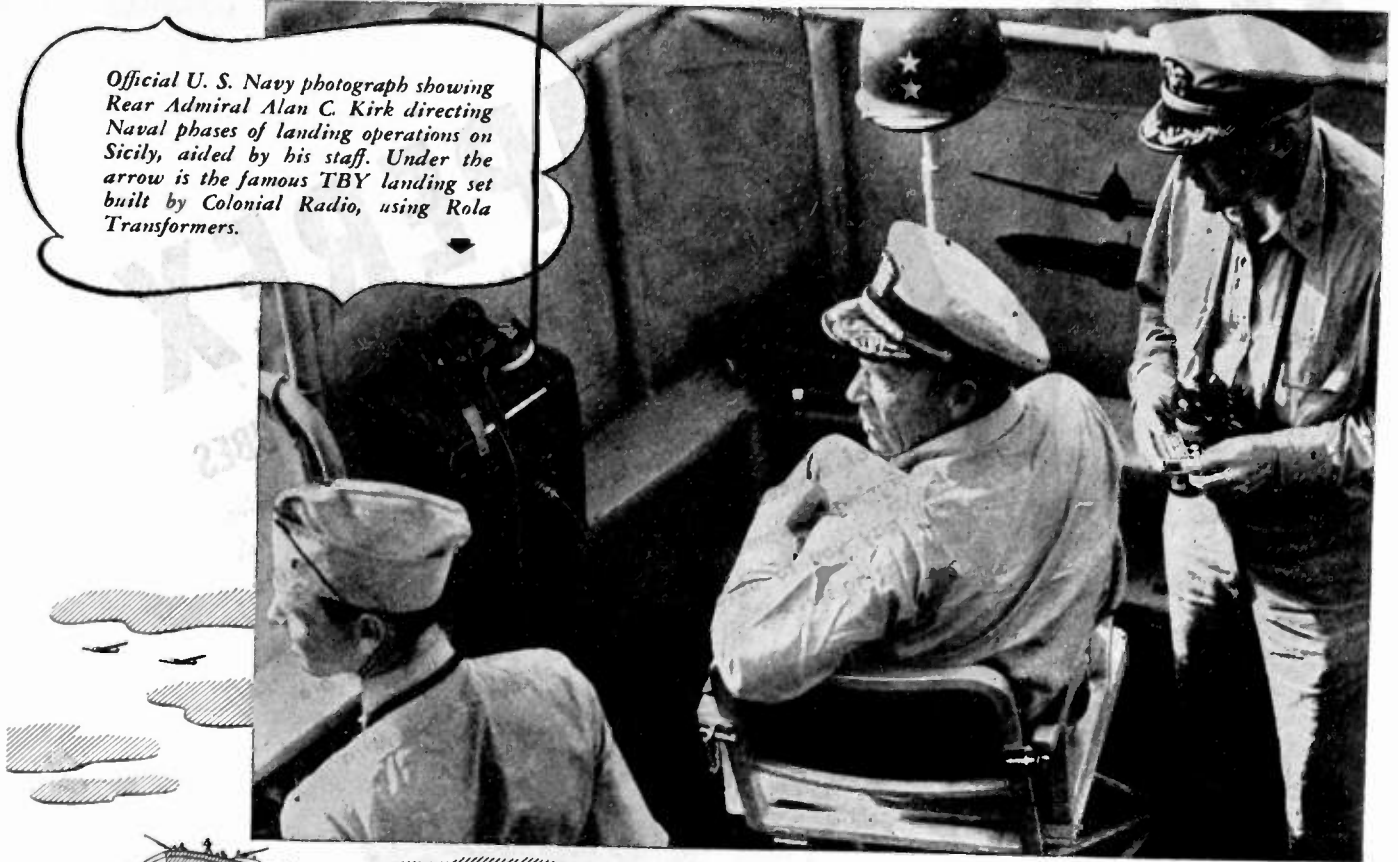

"Design for Invasion"

MONTHS ahead of landing operations the military plans are laid, and often . . . months ahead of that . . . new equipment to serve some new and vital purpose has to be designed and built.

We're now in the invasion phase of the war and with so much staked on the *availability*

and *dependability* of Communications, the makers of this equipment have been asked again to increase their output.

The Electronic Industry has done a good job. Now, it must do a *better* one and Rola will contribute to the full extent of its facilities, its knowledge and its ability.

THE ROLA COMPANY, INC., 2530 SUPERIOR AVENUE, CLEVELAND 14, OHIO

ROLA

Let's do more



in forty-four!

MAKERS OF THE FINEST IN SOUND REPRODUCING AND ELECTRONIC EQUIPMENT

"Right On The Button"

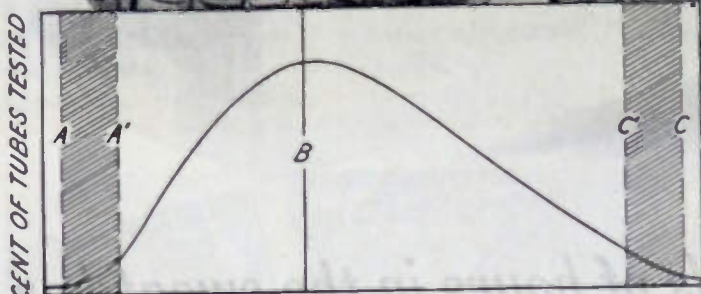

MUTUAL CONDUCTANCE
DISTRIBUTION CURVE—TRANSCONDUCTANCE

Conscientious electronic equipment manufacturers avoid special selection of tubes. When a battlefield tube replacement is made, they want "on the button" performance. They allow for possible additive effects of tolerances for other components—and for the many minor differences of equipment assembly, wiring, and adjustment. Also they realize it is impracticable to manufacture all electronic tubes of a given type exactly alike. Yet they demand and deserve close observance of their tolerances for each tube characteristic. (See A and C on the distribution curve.) Hytron insists on still tighter fac-

tory specifications. (Compare A' and C'.)

Hytron goes still further. Based on past experience—its own and others'—whenever practicable a "bogie", or desired goal, for each characteristic is set. (Compare B.) Controlled design and production aim at producing the majority of tubes with this preferred value, which is not necessarily and arbitrarily midway between tolerances. It is rather the ideal for peak performance—dictated by experience and attainable if exact duplication were possible.

Specify Hytron for tighter specifications— for "bogie"-controlled production— for uniform performance.



OLDEST EXCLUSIVE MANUFACTURER OF RADIO RECEIVING TUBES

HYTRON
CORPORATION

ELECTRONIC AND
RADIO TUBES

SALEM AND NEWBURYPORT, MASS.



BUY
ANOTHER
WAR BOND

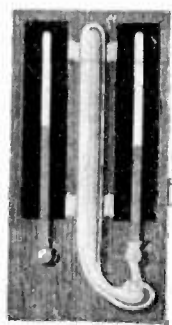
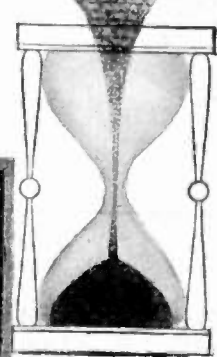
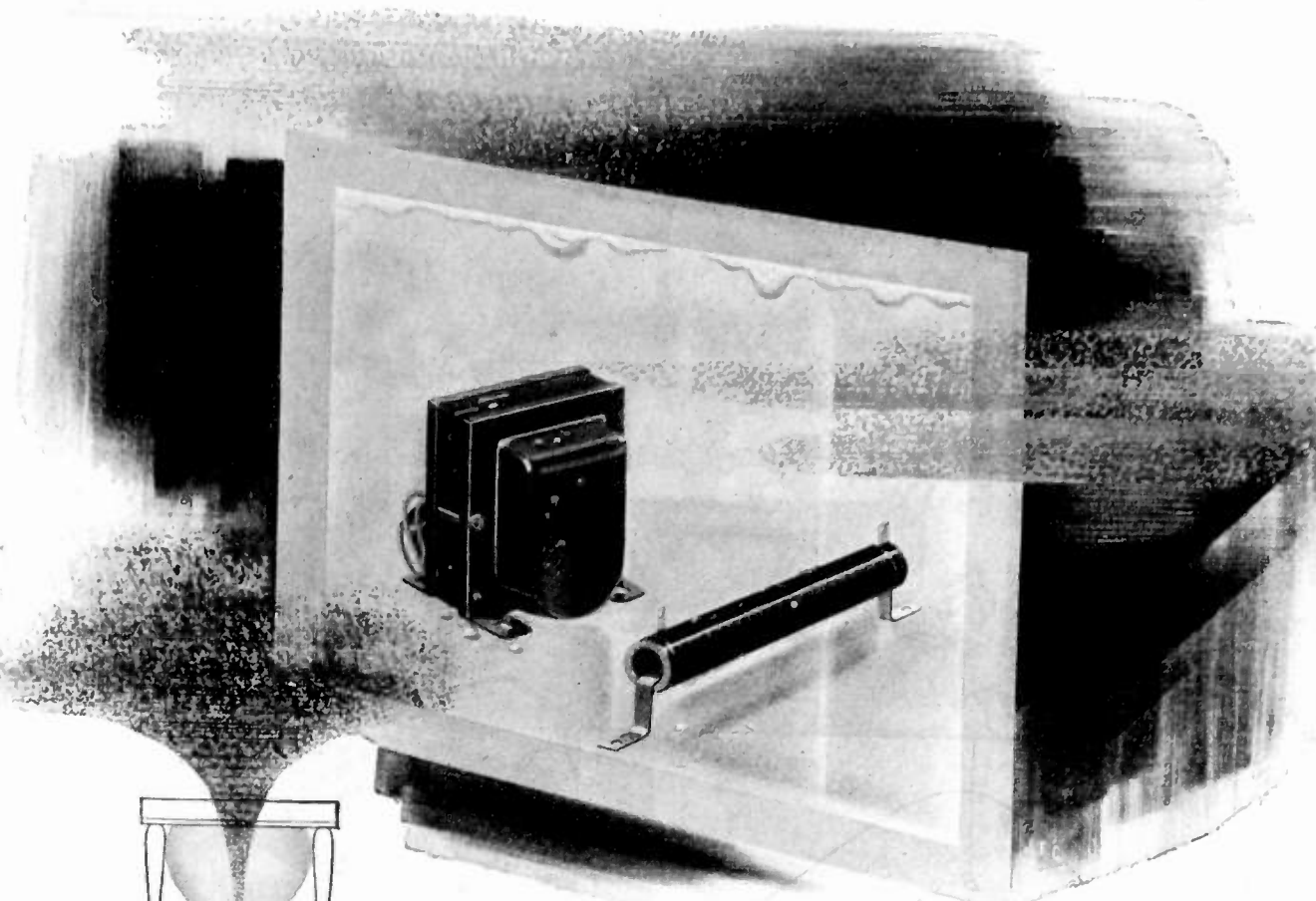

hundreds of hours in the sweat box

The destructive moisture of New Guinea jungles or a London fog is duplicated in this high humidity chamber in the Utah laboratory.

This "sweat" treatment is giving Utah parts being tested the chance to prove that they can take anything that excessive humidity can give them.

As a result, there will be no breakdowns or a lack of efficiency when these parts

encounter actual conditions in the field.

Utah's *complete* testing laboratory is an important aid to Utah engineers in adapting new, war-created radio and electronic developments to military needs today and in making them available for commercial requirements tomorrow.

★ ★ ★

Every Product Made for the Trade, by Utah, Is Thoroughly Tested and Approved

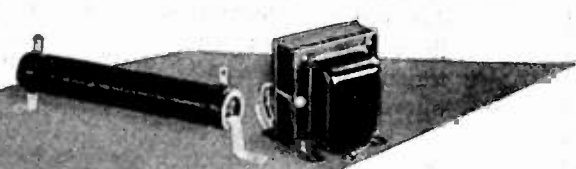

Keyed to "tomorrow's" demands: Utah transformers, speakers, vibrators, vitreous enamel resistors, wirewound controls, plugs, jacks, switches and small electric motors.

utah



Radio Products Company, 818 Orleans Street, Chicago 10, Illinois

CHALLENGE!

As you look through the ads in this magazine...

FIND THE GLASS PARTS NOT MADE AT CORNING

IT'S really not much of a gamble on our part. The truth is that most of the electronic glass equipment built today comes from Corning Glass Works. Bulbs, flares, insulators, transformer bushings, tubing, resistor tubes, coil forms, are just a few of the hundreds of electronic glassware products produced under our Army-Navy "E" flag. Here you will find glasses with high electrical insulating qualities; glasses with an expansion coefficient practically equal to that of fused quartz; glasses extremely resistant to mechanical shock; glasses that can now be made into intricate shapes formerly considered impossible. And be-

hind them all, 75 years of pioneering in glass research and experience gained in the development of more than 25,000 glass formulae.

We hope this doesn't scare you. All it means is this: If you have a problem you think glass might be helpful in solving, feel free to call on Corning! Everything we know about glass is at your service. Just to get started we'd like to send you a copy of an informative new booklet, "There Will Be More Glass Parts In Post-war Electrical Products." If interested, write Electronic Sales Dept. P-6, Bulb and Tubing Division, Corning Glass Works, Corning, New York.



CORNING
means
Research in Glass

Electronic Glassware



"PYREX" and "CORNING" are registered trade-marks of Corning Glass Works

When building their own testing equipment...

Most delicately attuned of all equipment is that used by a manufacturer in testing his products. Many fine names insist upon DeJur precision instruments when building such equipment. For example, the oscilloscope used in the laboratories of the Electronic Corporation of America incorporates one of the various meters bearing the DeJur trademark.

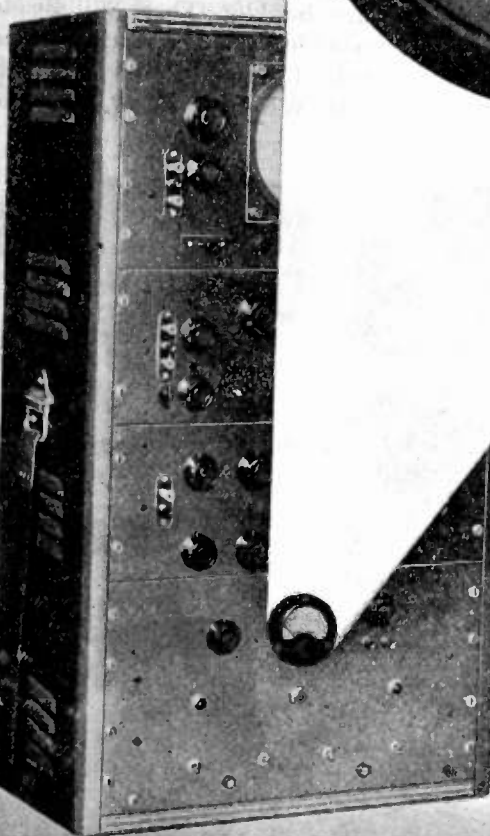
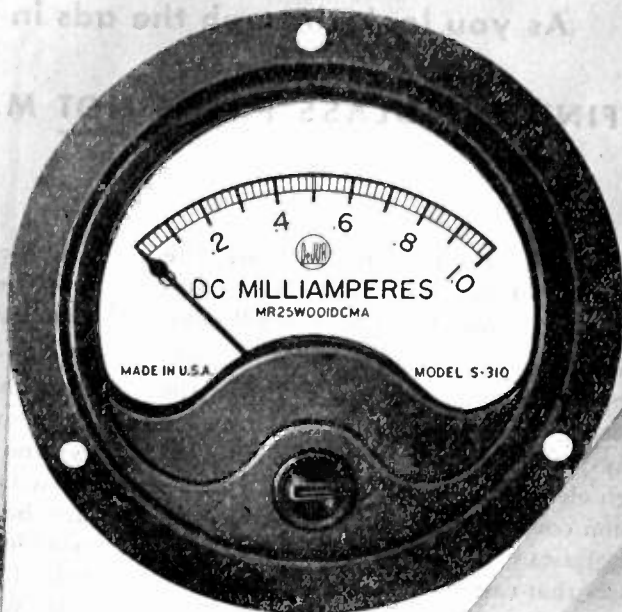

That DeJur instruments are "preferred stock" may be traced to DeJur accuracy, dependability and long life. Refinements in design and construction, growing out of 25 years of distinguished service in the electrical field, give our meters certain definite advantages which become immediately apparent upon application. A DeJur engineer will be glad to assist you . . . whether for your wartime or peacetime program.

The ECA oscilloscope in which a DeJur instrument is an integral component.



Help Shorten the War . . . Buy More War Bonds

De Jur-Amsco Corporation

MANUFACTURERS OF DeJUR METERS, RHEOSTATS, POTENTIOMETERS AND OTHER PRECISION ELECTRONIC COMPONENTS
SHELTON, CONNECTICUT

NEW YORK PLANT: 99 Hudson Street, New York 13, N.Y. • CANADIAN SALES OFFICE: 560 King Street West, Toronto

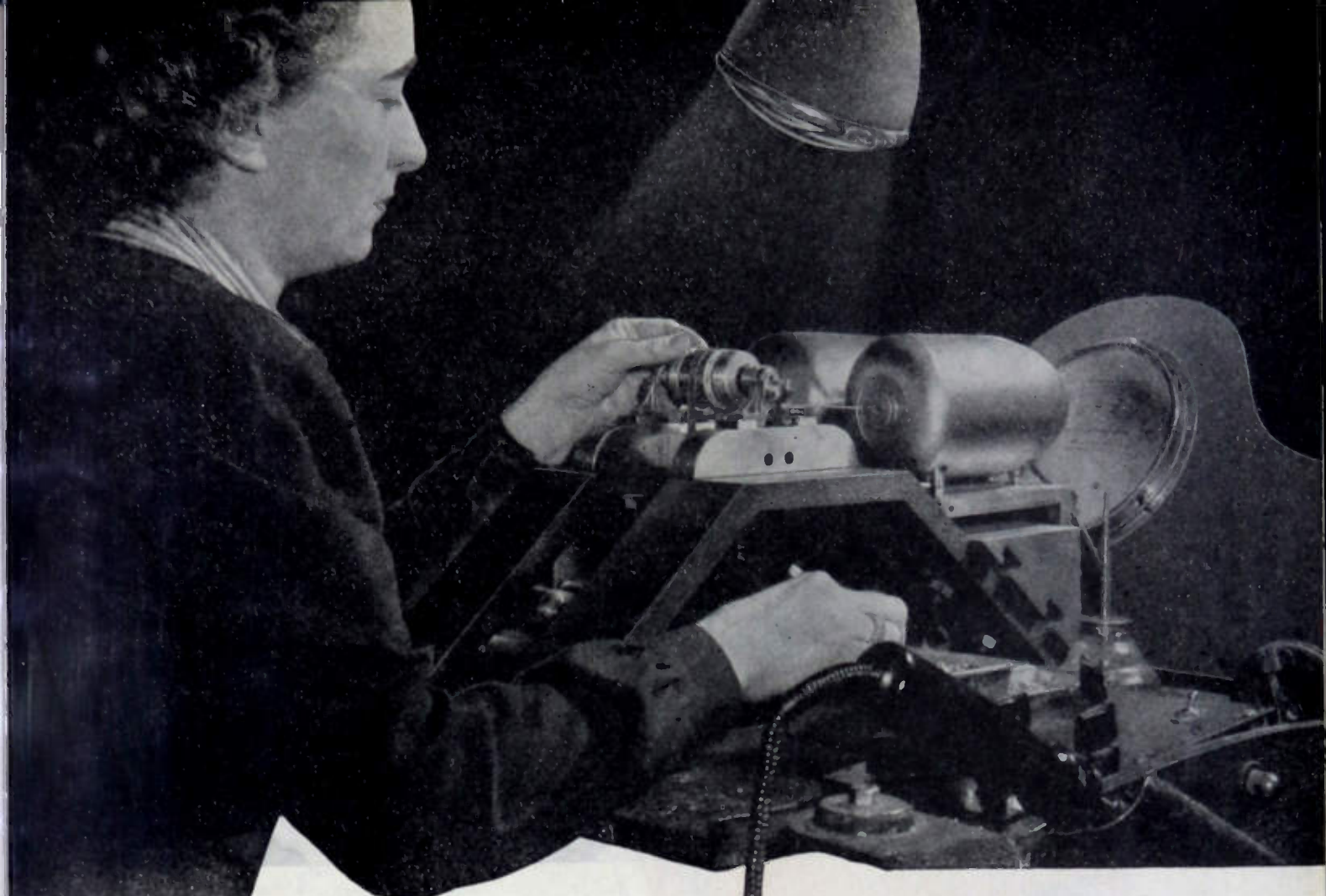

life
Balancing a dynamotor...

Maetta Lambert knows why each armature that goes into the Altair* dynamotors must be patiently balanced. Miss Lambert has two brothers in the service.

Altair* dynamotor armatures are balanced both statically and dynamically as but one of many tests and inspections of this precision product before it is installed in the vital electrical, communication and radio equipment manufactured by Pacific Division.

With a 28-volt input, Model 3971 Altair* Dynamotor has an overall efficiency in excess of 50%. Maintenance has been simplified by the use of interchangeable end-bells and by coding all major components for easy assembly. Service is necessary only each 1000 hours of operation. Write for complete specifications and data. Pacific Division, Bendix Aviation Corporation, North Hollywood, Calif. Sales engineering offices in St. Louis, Dayton and New York.

**The new trade name of Pacific Division, Bendix Aviation Corporation.*



Typical of the use being made of Altair dynamotors is the compact installation being made in Interphone Amplifier equipment which the Pacific Division supplies for many fighting planes.

Pacific Division
Bendix Aviation Corporation
 (Formerly Bendix Aviation, Ltd.)
 NORTH HOLLYWOOD, CALIF.



DESIGNERS AND MANUFACTURERS OF RADIO AND HYDRAULIC EQUIPMENT — OUR PART OF THE INVISIBLE CREW

© 1944, Pacific Division, Bendix Aviation Corp.



TESTING TOMORROW'S RADIO TUBES

• Early in the war, Sylvania engineers stepped up experiment to perfect more rugged and more sensitive radio tubes for vital military communications.

Engineers added to a great array of precision checking instruments. They designed and built special new instruments to detect variations in radio tube characteristics never charted before.

This intensive research program has developed improved radio tubes. Many are now military secrets. But they promise to make postwar radio reception a revelation of clarity and fidelity.

After the war, as in the past, it will pay you to sell Sylvania.

Quality That Serves the War Shall Serve the Peace

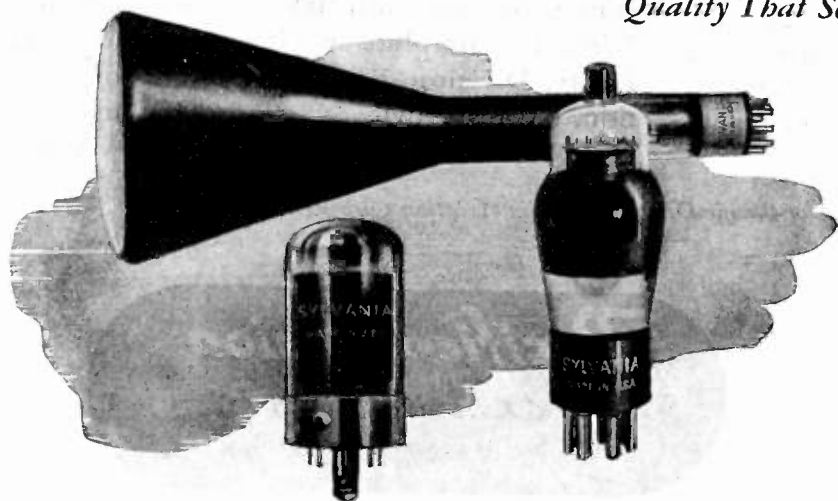

RADIO DIVISION  EMPORIUM, PENNSYLVANIA

SYLVANIA
ELECTRIC PRODUCTS INC.

RADIO TUBES, CATHODE RAY TUBES, ELECTRONIC DEVICES, INCANDESCENT LAMPS, FLUORESCENT LAMPS, FIXTURES AND ACCESSORIES

Proceedings of the I.R.E. June, 1944

When life or death is a matter of Split Seconds,

**"HANDIE-TALKIE"
Delivers**

In a war of vast spaces, swift movement and violent action . . . Radio Communication must not fail. The front line scout, spotting the location and strength of the enemy, gets his vital information back to the command post with split second speed via the Handie-Talkie, the bantam-weight portable two-way radiotelephone. The signalman talks, giving information . . . and listens, receiving instructions.

The Handie-Talkie was conceived and developed by Motorola, makers of Automatic Radios for Home and Car, F-M Police Radiotelephone Systems, and

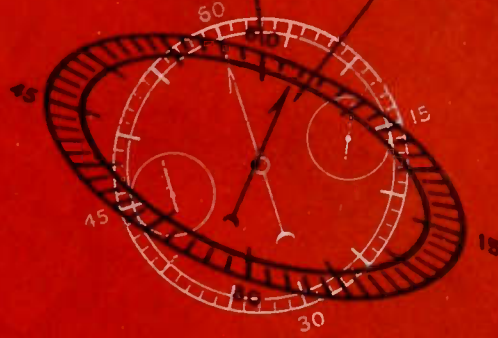

HANDIE-TALKIE
IS ANOTHER
Motorola
Radio
"FIRST"



Real "He Man" Coils IN MINIATURE!

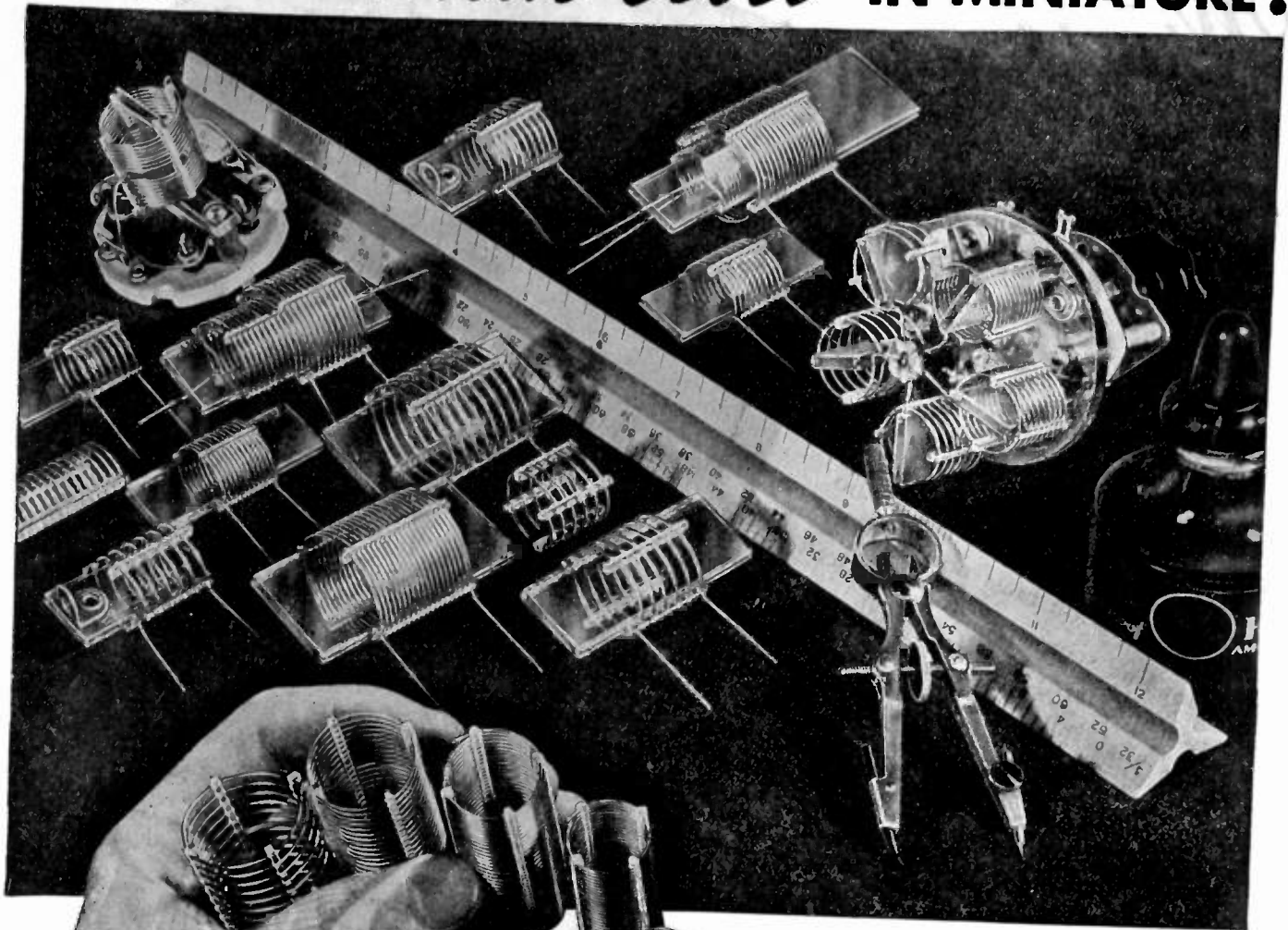

B&W MIDGET AIR-WOUND INDUCTORS

Now, for the first time, you can get B & W Air-Wound Coils in very small sizes from $\frac{1}{2}$ " to $\frac{1}{4}$ " diameter, in $\frac{1}{8}$ " steps, and in winding pitches from 44 to 4 turns or less per inch. Almost any type of mounting can be supplied.

Applications for these tiny coils include: coil switching turret assemblies; intermediate frequency transformers; high-frequency r-f stages (low-powered transmitter or receiver); all types of test equipment involving tuned r-f circuits; high-frequency r-f chokes, and numerous others.

The coils have a high Q, due to the almost total absence of insulating material in the electrical field. They are exceptionally light in weight and extremely rigid. Normally wound with tinned copper wire in sizes from #28 to #14, they can also be supplied with coin silver, coin silver jacketed, bare copper, or phosphor bronze wire. All types may be equipped with either fixed or variable internal or external coupling links, or other non-standard features. Samples on request to quantity users. Send us your specifications!

B&W

BARKER & WILLIAMSON
235 FAIRFIELD AVENUE
UPPER DARBY, PA.

AIR INDUCTORS • VARIABLE CONDENSERS • ELECTRONIC EQUIPMENT ASSEMBLIES

Exclusive Export Representatives: Lindeteves, Inc., 10 Rockefeller Plaza, New York, N. Y., U. S. A.



"Rembrandt in his studio"
by Dou. Gerard 1613-75

The Master Hand

Inspired genius guided the minds and hands of great artists and craftsmen of early days. One comparable, modern day masterpiece of far-reaching electronic influence is the RAULAND High Powered Cathode Ray Tube, heart and brain of Television . . . perfected to project scenes *as they occur* on full size theatre screens!

Other noted results of RAULAND *Electroneering** are Frequency Standards, Precision Tuning Condensers, Two-Way Radio, Intercommunicating and Sound Control Units, all custom-engineered for specific requirements.

**Electroneering* . . . the RAULAND term embracing engineering vision, design and precision manufacture.

RADIO • RADAR • SOUND •

Rauland

COMMUNICATIONS • TELEVISION

Electroneering is our business

THE RAULAND CORPORATION • CHICAGO 41, ILLINOIS

Buy War Bonds and Stamps! Rauland employees are still investing 10% of their salaries in War Bonds

The Inside Story of **OHMITE** Rheostats

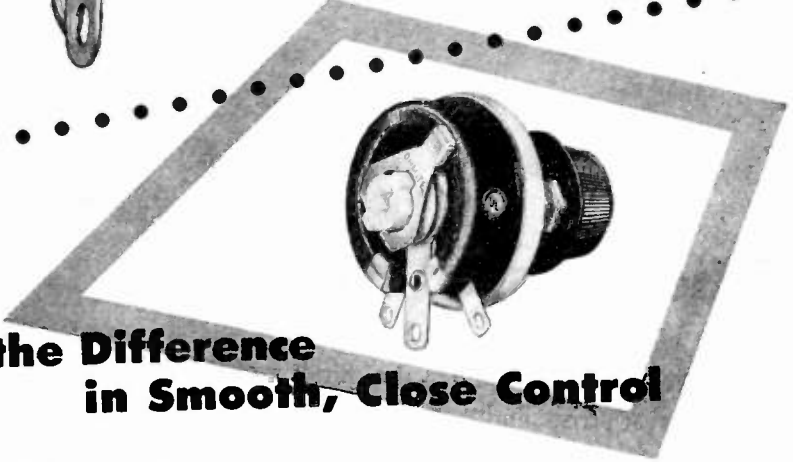
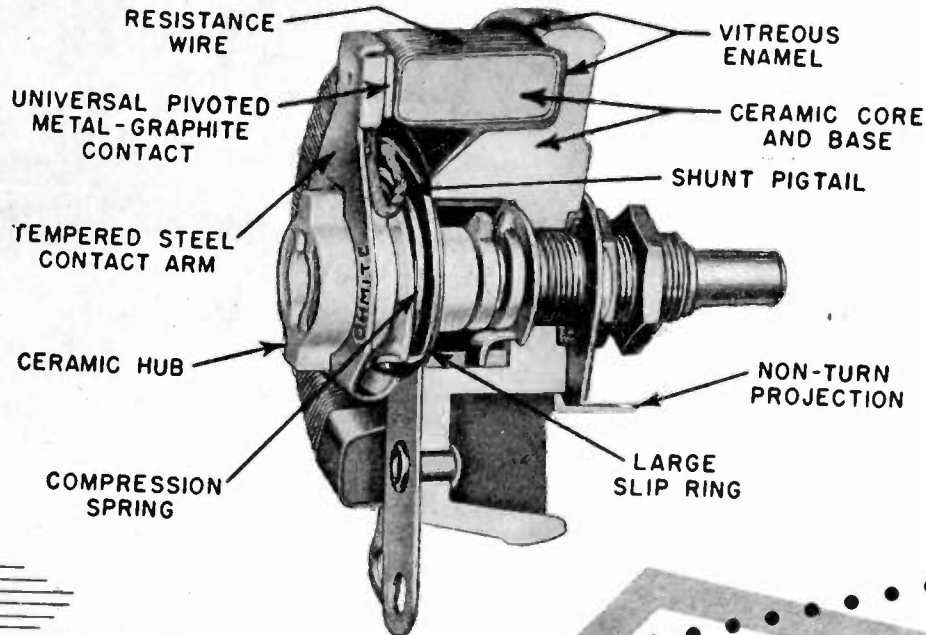

OHMITE Design Makes the Difference in Smooth, Close Control

Everywhere . . . on every battle front . . . and in the tools of Industry . . . you find Ohmite Rheostats doing critical control jobs.

Permanently smooth, close control is built-in . . . to withstand shock, vibration, heat and humidity. Construction is compact . . . all ceramic and metal. There is nothing to shrink, shift or deteriorate.

Illustrated in the cutaway above are many of the features which contribute to the consistent dependability of Ohmite Rheostats.

Widest range of sizes—ten models from 25 to 1000 watts, from 1 $\frac{9}{16}$ " to 12" diameter—in straight or tapered winding, in single or tandem assemblies—to meet every control need in the most advanced electronic devices.

Write on company letterhead for complete, helpful 96-page guide in the selection and application of Rheostats, Resistors, Tap Switches, Chokes and Attenuators.

OHMITE MANUFACTURING COMPANY
4862 W. FLOURNOY STREET, CHICAGO 44, ILLINOIS

Be Right With **OHMITE** Rheostats • Resistors • Tap Switches

OUT OF TODAY'S RESEARCH...
TOMORROW IS ENGINEERED



RECORD BREAKING HEAT WAVE

INDUCTION HEATING through powerful high-frequency radio waves is breaking records in speeding up production of bonded plywoods, tin plating and in other industrial applications.

Of prime importance to the efficiency and stability of such high-frequency circuits is insulation whose composition and strength is master of both power and heat.

Permanent in their hardness, strength and rigidity, ALSIMAG Ceramic Insulators are not subject to distortion, warping or shrinking.

ALSiMAG bodies, each with its particular characteristics, are available to meet all insulating requirements. Our engineering and research people will gladly cooperate in today's design—tomorrow's production.

CHARACTERISTICS OF ALSiMAG INSULATORS

- High Mechanical Strength
- Permanent Rigidity
- High Dielectric Strength
- Low-Loss Factor
- Will Not Absorb Moisture
- Chemically Inert

AMERICAN LAVA CORPORATION
CHATTANOOGA 5, TENNESSEE



Army-Navy "E"
First Awarded July 27, 1942
Second Award: "Star" February
12, 1943
Third Award: "Star" September
25, 1943



CERAMIC INSULATORS



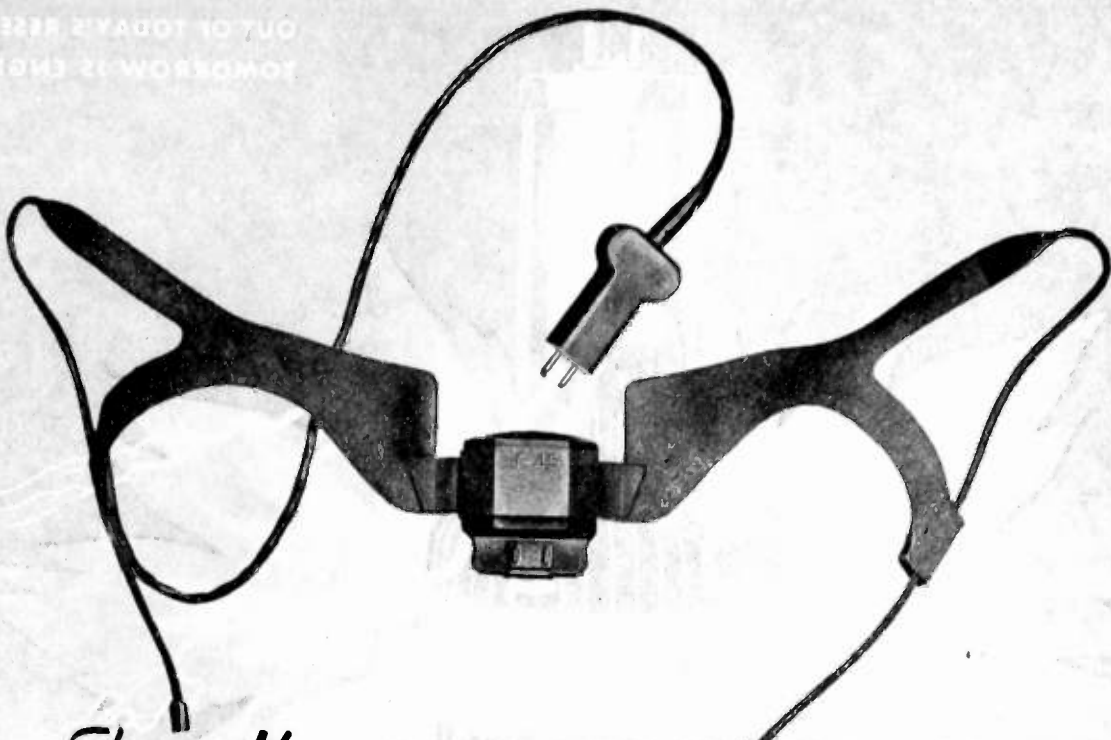

Electro-Voice DIFFERENTIAL MICROPHONE Model T-45 is its U.S. ARMY DESIGNATION

Developed by Electro-Voice engineers in collaboration with the Fort Monmouth Signal Laboratory, this Differential "Lip Mike" carries the voice clearly and distinctly above the roar of battle. Ambient sounds and reverberation are reduced to negligible levels.

- ◆ Frequency response substantially flat from 200-4000 cps.
- ◆ Low harmonic distortion
- ◆ Cancellation of ambient noise, but normal response to user's voice
- ◆ Self-supporting, to free both hands of the operator
- ◆ Uniform response in all positions
- ◆ Usable when gas mask, dust respirator or oxygen mask is required
- ◆ Unaffected by temperature cycles from -40° F. to $+185^{\circ}$ F.
- ◆ Ability to withstand complete immersion in water
- ◆ Physical strength to withstand 10,000 drops
- ◆ Weight, including harness, cord and plug, less than 2 ounces.

Electro-Voice MICROPHONES

Our full line includes Carbon, Dynamic and Velocity models . . . all at popular prices . . . for public address, industrial sound, sound recording and speech transmission applications. Consult your local radio parts jobber.



ELECTRO-VOICE MANUFACTURING CO., INC. • 1239 SOUTH BEND AVENUE • SOUTH BEND 24, INDIANA
Export Division: 13 East 40th Street, New York 16, N. Y. — U. S. A. Cables: ARLAB

STUPAKOFF

FOUNDED IN 1897

Ceramics for the World of Electronics

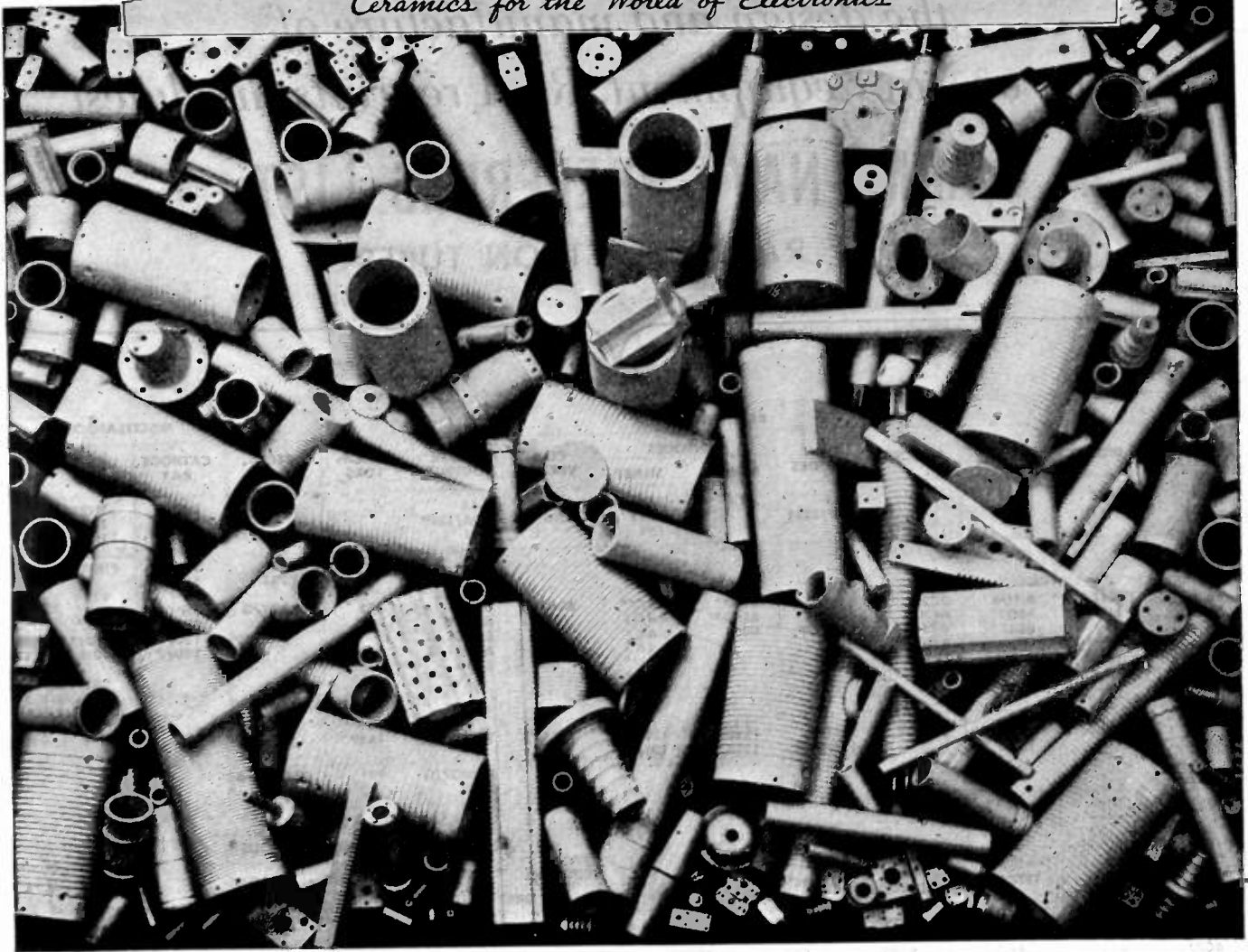

Unlimited Styles and Sizes . . .

PRECISION MADE INSULATORS of Steatite and other materials —

glazed or unglazed—to your exacting specifications.

Years of experience—wide technical and engineering knowledge—modern manufacturing facilities enable STUPAKOFF to produce every type of ceramic for the electronic industry.



Let's All Back The Attack—Buy EXTRA War Bonds

STUPAKOFF CERAMIC AND MANUFACTURING CO., LATROBE, PA.

In the interests of those concerned with
the design and manufacture of
Army or Navy equipment, RCA reprints this latest

ARMY-NAVY PREFERRED LIST OF RADIO ELECTRON TUBES

15 FEBRUARY 1944

FILAMENT VOLTAGE	RECEIVING										MISCELLANEOUS	
	DIODES	DIODE TRIODES	TRIODES	TWIN TRIODES	PENTODES		CONVERTERS	POWER OUTPUT	INDICATORS	RECTIFIERS	CATHODE RAY	CRYSTALS
					REMOTE	SHARP						
1.4	1A3	1LH4	1LE3	3A5 3B7/1291	1T4	1L4 1LNS 1S5	1LC6 1R5	3A4 3D6/1299 3S4			2AP1 3BP1 3DP1 3FP7 3CP1 5CP7 5FP7 5JP1 7BP7 12DP7 12GP7	1N21B 1N23 1N27
8.0										5U4G 5Y3GT	PHOTOTUBES	
4.3	6AL5 6H6° 559 9006	6AQ6 6SQ7° 6SR7°	2C22 6C4 6J4 6J5° 7E5/1201 446A 9002	6J6 6SL7GT 6SN7GT	6SQ7° 6SK7° 9003	6AC7° 6AG5 6AG7° 6AK5 6SH7° 6SJ7° 7W7 9001	6SA7°	6G6G 6L6GA 6N7GT/G 6V6GT/G 6Y6G	6E3	6X5GT/G 1003		918 927
12.6	12H6°	12SQ7° 12SR7°	12J5GT	12SL7GT 12SN7GT	12SQ7° 12SK7°	12SH7° 12SJ7°	12SA7°	12A6°	1629			VOLTAGE REGULATORS 0B3/VR-90 0C3/VR-103 0D3/VR-150
25 and above								25L6GT/G 28D7	991	25Z6GT/G		

TRANSMITTING								MISCELLANEOUS	
TRIODES	TETRODES	TWIN TETRODES	PENTODES	RECTIFIERS			CLIPPER TUBES	GAS SWITCHING	
				VACUUM	GAS	GRID CONTROL			
2C26	801A	5D21	3E29	2E22	2X2	4B25	3C23	1B32/532A	
2C44	809	715B	815	803	3B24	83	3C31/C18	471A	
6C21	811	807	829B	837	5R4GY	866A/866	C5B	532	
15E	826	813	832A		371B	872A/872	884		
VT127A	833A	814			705A		2050		
327B	838	1625			836				
434A	1626				1616				
527	8003				8016				
530	8014A 8023				8020				

*Where direct interchangeability is assured "GT" and "L" counterparts of the preferred metal tubes may be used.

Miniature tubes (shown in Italics) shall be used only when essential to Service requirements.

NOTE: THIS PREFERRED LIST SUPERSEDES THE ARMY-NAVY PREFERRED LIST OF VACUUM TUBES, DATED MARCH 1, 1943.

1. The above Army-Navy Preferred List of Radio Electron Tubes sets up a group of unclassified general purpose tubes selected jointly by the Signal Corps and the Bureau of Ships. The purpose of this list is to effect an eventual reduction in the variety of tubes used in Service equipment.

2. IT IS MANDATORY THAT ALL UNCLASSIFIED TUBES TO BE USED IN ALL FUTURE DESIGNS OF NEW EQUIPMENTS UNDER THE JURISDICTION OF THE SIGNAL CORPS LABORATORIES OR THE RADIO DIVISION OF THE BUREAU OF SHIPS BE CHOSEN FROM THIS LIST. EXCEPTIONS TO THIS RULE ARE HEREINAFTER NOTED.

3. The term "new equipments," as mentioned in Paragraph 2 above, is taken to include:

- Equipments basically new in electrical design, with no similar prototypes.
- Equipments having a similar prototype but completely redesigned as to electrical characteristics.
- New test equipment for operational field use.

4. The term "new equipments," as mentioned in Paragraph 2 above, does not include:

- Equipments either basically new or redesigned, that are likely to be manufactured in very small quantity, such as laboratory measuring instruments.
- Equipments that are solely mechanical redesigns of existing prototypes.
- Equipments that are reorders without change of existing models.

d. Equipments in the design stage before the effective date of adoption of this Preferred List.

Note: The foregoing statements in Paragraphs 3 and 4 above are explanatory in nature and are not intended to be all-inclusive.

5. In the event that it is believed that a tube other than one of those included in this Preferred List should be used in the design of new equipments for either the Signal Corps or Navy, specific approval of the Service concerned must be obtained. Such approval, when Signal Corps equipment is concerned, is to be requested from the Signal Corps Laboratory concerned with such equipment; the said Laboratory will then make known its recommendations in the matter to the Signal Corps Standards Agency where the final decision will be made and returned to the laboratory for transmittal to the party requesting the exception. When Navy equipment is concerned, the request for exception shall be addressed to the Radio Division, Bureau of Ships, Code 930-A, Navy Department.

6. The publication of this list is in no way intended to hamper or restrict development work in the field of radio electron tubes or radio electron tube applications.

7. This list is to take effect immediately.

The Chief of the Bureau of Ships
Navy Department

Office of the Chief Signal Officer
Headquarters, Army Service Forces,
War Department



RADIO CORPORATION OF AMERICA

RCA VICTOR DIVISION • CAMDEN, N. J.

The experiences and viewpoints of those who have contributed substantially to the upbuilding of the radio-and-electronic industry are expressed in a series of guest editorials presented to the readers of the PROCEEDINGS OF THE I.R.E. in the form in which they are received from their writers. Engineers may be able better to appraise their opportunities and problems by consideration of such editorials.

There is commended to the attention of our readers the following statement from the President of the Galvin Manufacturing Corporation, who holds as well the high post of President of the Radio Manufacturers Association.

The Editor

Foundations for Industrial Success

PAUL V. GALVIN

Members of the radio industry, and particularly its planners, are bound to face the questions: What makes for the continued success of a business? What factors must be considered in organizing and conducting a company? What is their relative importance?

Some years ago, confronted with these questions, I answered them to a prominent financial man to the effect that the necessary elements in business organization and operation were capital, management, and engineering. These were presented in the usual order in which they are acquired in a new business.

But, I added, capital is not a serious problem under normal circumstances for a going concern which already commands the confidence of its financial backers. Management problems also failed to trouble me, for methods of sound management and prudent yet broad planning are well understood. Engineering, however, is of major importance and not readily obtainable at highest levels. Accordingly I felt it necessary first and foremost to arrange for a sound engineering organization.

If the engineer is as vital an element in a successful business as I believe him to be, it is doubly important that he shall be understood by the management end of industry and that, in turn, he shall understand management and its problems, appreciate its obligations to its industry, and operate closely in accord with the major needs and policies of the group. There is a mutual-benefit relationship here for, just as management depends on the ingenuity and application of the engineer for its new products and manufacturing methods, so the engineer depends for his livelihood on the commercial success which grows from the salesmanship and executive ability of management.

I for one believe in a great future of our industry. Its manufacturers are the members of its vigorous Radio Manufacturers Association and its engineers are banded together in the leading radio engineering society, The Institute of Radio Engineers. Working for a common purpose, these organizations and their members cannot fail to accomplish great results.



Ray Lee Jackson

Charles Byron Jolliffe

Board of Directors, 1944

Charles Byron Jolliffe was born in Mannington, West Virginia, on November 13, 1894. He received the B.S. degree from West Virginia University in 1915 and the degree of M.S. from the same University in 1920; the degree of Ph.D. from Cornell University in 1922, and the Honorary Degree of LL.D. from West Virginia University in 1942.

From 1917 to 1918 and from 1919 to 1920 he was an instructor in physics at West Virginia University and from 1920 to 1922 at Cornell University. From 1922 to 1930 he was a physicist in the radio section of the National Bureau of Standards and assistant chief of the section. His research was on radio wave propagation and development and maintenance of standards of frequency. This work resulted in several scientific publications. During his connection with the Bureau of Standards he served as representative of that organization on several committees of the Interdepartment Radio Advisory Committee and on many occasions was called into consultation by the Department of Commerce and the Federal Radio Commission.

In 1930, Dr. Jolliffe was appointed chief engineer of the Federal Radio Commission and continued in that capacity when that organization was changed to the Federal Communications Commission in 1934. During this time he had full responsibility for the Commission's engineering work. This involved much of the pioneering work in allocation of frequencies to services and development of service standards for the various types of radio communications which were licensed by the Commission. During this time the first regulations concerning

radio were formulated by the engineering department of the Commission and many new services were undertaken by private corporations under allocations made to those services by the Commission. The present regulations of the Commission with respect to broadcasting and all types of radio communication are the result of pioneering work done by the first engineering department of the Federal Radio Commission, many of which have been changed only in detail.

On November 12, 1935 he resigned from the FCC to accept a position with the Radio Corporation of America, as engineer-in-charge of the RCA Frequency Bureau. Since then he has held other positions with RCA, as chief engineer of RCA Laboratories, and assistant to the president. At present he is chief engineer of the RCA Victor Division.

Dr. Jolliffe has attended many international and other radio conferences as a delegate of the United States or as an expert adviser, including the conferences held in Washington, 1927; The Hague, 1929; Copenhagen, 1931; Madrid, 1932; Mexico City, 1933; Paris, 1936; Bucharest, 1937; Havana, 1937; and Cairo, 1938.

He is chief of the electrical communications division of the National Defense Research Committee and secretary of the Industry Advisory Committee of the Board of War Communications.

He joined the Institute as a Member in 1928 and transferred to the grade of Fellow in 1930. He has served as member of several committees, and in January, 1944, was elected a member of the Board.

Engineering Work of the Federal Communications Commission

I. General Introduction*

E. K. JETT†, FELLOW, I.R.E.

IN THIS symposium group of papers, our engineering members of the Federal Communications Commission will present to you certain aspects of our work and some of the technical problems that lie ahead.

Following me on this program, you will hear from three of the seven Division Chiefs of the Engineering Department, who will cover broadcasting, maritime, aviation, police, point-to-point, and allocation matters. Those who are not represented are Mr. George S. Turner, Chief of the Field Division, who recently succeeded Mr. W. D. Terrell; Mr. George E. Sterling, Chief of the Radio Intelligence Division; Mr. M. K. Toepen, Chief of the Common Carrier Wire Services; and Dr. L. P. Wheeler, Chief of the Technical Information Division. Had it not been for the fact that Dr. Wheeler is occupied in turning over the presidency of the Institute to Professor Turner, we would have asked him to participate and tell us about the work of his Division. However, since his activities are closely co-ordinated with all of the Divisions, it is possible for us to cover some of the ground that he would have handled. We shall also endeavor to cover some field activities.

As many of you know, the Commission is required to classify radio stations and prescribe the nature of the service to be rendered by each class of licensed station. The Communications Act further provides that the Commission shall assign bands of frequencies to the various classes of stations, and assign frequencies to each individual station and determine the power which each station shall use and the time during which it may operate; determine the location of classes of stations or individual stations; regulate the kind of apparatus to be used with respect to its external effects and the purity and sharpness of the emissions from each station; make regulations not inconsistent with law as it may deem necessary to prevent interference between stations; study new uses for radio and provide for experimental uses of frequencies, and generally encourage the larger and more effective use of radio in the public interest; establish areas or zones to be served by any station; and, for the purpose of obtaining maximum effectiveness from the use of radio in connection with safety of life and property, investigate and study all phases of the problem and the best methods of obtaining the co-operation and co-ordination of these systems.

* Decimal classification: R007. Original manuscript received by the Institute, April 5, 1944. Presented, Winter Technical Meeting, New York, N. Y., January 29, 1944.

† Formerly, Chief Engineer, Federal Communications Commission; now, Commissioner, FCC, Washington, D. C.

The President assigns frequencies to stations "belonging to and operated by the United States." The assignment of frequencies for such stations in normal times is done by the President upon the advice of the Interdepartment Radio Advisory Committee. However, when the President created the Defense Communications Board (now known as the Board of War Communications), he directed that IRAC should act as a Committee of the Board, but only in an advisory capacity. While so acting, all of the reports, recommendations, and communications normally prepared for submission to the President are instead submitted to the Board for consideration from the standpoint of national defense and for disposition. The Board has specifically charged this Committee with the responsibility of "making special studies and recommendations regarding frequency allocations, with the requirements of national defense as a primary consideration, but giving due consideration to the needs of governmental agencies, of industry, and of other civilian activities."

It is clear from the foregoing that the important job of allocating frequencies to specific services and for particular purposes must be closely co-ordinated between the Commission and the Interdepartment Radio Advisory Committee. The Commission is represented on this committee by Commissioner Craven who also serves as Chairman, and by Mr. Siling who is Secretary of the Committee. Mr. Siling also serves as Chairman of the Engineering Department's committee on frequency allocation and, in this way, the two engineering groups, namely, the IRAC and the Engineering Department, are able to co-ordinate their work closely.

We heard some very interesting reports at the January 28, 1944, sessions regarding the work of the Radio Technical Planning Board. In this connection, I desire to take this opportunity to commend The Institute of Radio Engineers and the Radio Manufacturers Association for their leadership in organizing the RTPB. In my opinion, it would not have been possible for IRAC and the Commission alone to plan for the needs of industry and other civilian activities in the postwar period. We are, therefore, very fortunate in having the expert advice and assistance of the RTPB and I am confident that it will discharge its responsibilities in a manner which will satisfy all of the services that use radio.

Many of you know that the Commission invited the Board of War Communications, the Interdepartment Radio Advisory Committee, and the Radio Technical

Planning Board to meet informally with the Commission on November 17 for the purpose of discussing organization and procedural matters with respect to plans for the technical future of radio. The Commission stated that it was too early to adopt a policy concerning frequency allocations and systems standardization; therefore, the initial meeting was called with a view to formulating a co-ordinated plan of action between government and industry with the understanding that policy decisions would be deferred until specific recommendations are received from the Board. It was made clear that for security reasons we should not expect the release of certain military information at this time. There is reason to believe, however, that a way will be found whereby certain key persons, both in industry and government, may obtain limited clearance on matters which may have an important bearing upon the design of equipment for use immediately following the war. In any event, it is hoped that we may obtain the latest information with respect to the following matters:

1. *Very-high-frequency, ultra-high-frequency, and super-high-frequency radio-wave-propagation data.*
 - (a) Ground-wave distance ranges versus frequency, power, antenna heights, and polarization.
 - (b) Tropospheric effects versus frequency, polarization and weather conditions; diurnal and annual variations.
 - (c) Burst phenomena versus frequency, diurnal and annual variations.
 - (d) Reflections from structures and natural objects at various frequencies.

The information on propagation may not be in the forms specified but any data on received field strength, distance ranges, etc., where frequency, polarization, power, antenna characteristics, and other transmission conditions are known, will be helpful in compiling our own information on these subjects.

2. *Very-high-frequency, ultra-high-frequency, and super-high-frequency transmitters.*
 - (a) Power (especially maximum steady continuous-wave power output).
 - (b) Frequency stability.
 - (c) Modulation methods and bandwidths.

Although the details of these transmitters may be desirable for purpose of information, they are not necessary to postwar planning of frequency allocation, so long as the essential transmitter characteristics are known. The same comment applies to the receivers and antennas below.

3. *Very-high-frequency, ultra-high-frequency, and super-high-frequency receivers.*
 - (a) Sensitivity.
 - (b) Selectivity.

- (c) Frequency stability—fixed frequency versus tunable receivers.
- (d) First-circuit and ambient-noise levels.
- (e) Radiation levels.

4. *Very-high-frequency, ultra-high-frequency, and super-high-frequency antennas.*
 - (a) Nondirectional.
 - (b) Directional.
 - (c) Wide-frequency band.

There are a few outstanding facts which I believe to be of interest to engineers who have occasion to do business with the Commission. First, it is apparent from the applications we receive that many engineers are not too familiar with the exact nature of the Commission's engineering work and the provisions of its rules, regulations, and technical standards. The Commission's engineers are responsible for reporting to the Commission upon all engineering features of each application filed for construction permit, license, special authorization, or modification of any of the foregoing. These reports primarily are concerned with questions of frequency allocations, possible interference between stations, power, types of emission, points of communication, types of equipment, hours of operation, nature of service, possible duplication of service, and many other factors of a miscellaneous nature. Many of these applications are co-ordinated by telephone, by conference, by correspondence, or by study with the policies and objectives of the Commission and of other Government departments and agencies. In addition, many applications and associated regulatory problems are precedent cases and require engineering studies and reports, looking to the establishment of new policies or regulations. A large proportion of the applications must be reviewed in relation to existing international agreements to which the United States is signatory. When formal hearings before the Commission are conducted, the Commission's engineers must be prepared to provide factual engineering testimony. Rules and regulations pertaining to technical matters frequently are drafted in preliminary form by Federal Communications Commission engineers in consultation with industry, government, and licensee representatives for subsequent consideration by the Commission. As a part of the war effort this work has been extended to include matters coming before the Board of War Communications. In addition, the engineering Department is called upon at times to prepare or supervise the preparation of technical reports, data, or recommendations for the benefit of other departments or agencies of the government, which from time to time request factual information to assist them in carrying on their functions.

It is important that commercial radio engineers and consultants who have business with the Commission have adequate knowledge of the limitations and conditions

imposed by related regulations and by the broader provisions of statute and treaty. We realize, of course, that many scientifically minded and practical engineers have a natural dislike for such administrative details and, accordingly, the Engineering Department has always endeavored to give them as much guidance and assistance as possible in procedural matters and in directing attention to pertinent regulations. In turn, commercial engineers consistently have been of service in keeping the FCC engineers advised of current engineering developments, practical problems encountered in the field, and the engineering treatment of those problems. Since by the very nature of duties performed by the FCC it must devote a majority of its time to desk work, it is necessary that engineers of the Commission depend to a large extent upon continuing liaison with industry and Government agencies using radio apparatus and with the professional consultants for keeping abreast of the latest contributions to the art.

It is our belief that this collaborative exchange of information must continue in the future if we are to achieve a well-rounded engineering development of the various radio services and obtain the maximum use of all available radio frequencies. In this respect, I urge those of you who have responsibility in connection with the filing of applications for radio station authorizations to examine very carefully the Commission's regulations and Standards of Good Engineering Practice. This procedure will eliminate unnecessary paper work for yourself, for your employers, and for us.

Another impression I have obtained is that many applicants for radio authorizations, especially newcomers in this field of activity, often will ask that their applications be acted upon by the Commission within a few hours or a few days from the time that they are filed. In a real emergency, the Commission can and has acted upon applications very soon after receipt. The vast majority of applications, however, are not connected with immediate emergency and we prefer to consider them in their respective order and to give appropriate attention to each item in each application.

Applications for radio and wire authorizations were acted upon prior to Pearl Harbor without having to consider the availability of manpower, materials, and manufacturing facilities. The companies, however, were beginning to realize that materials were becoming scarce and that priorities were needed in order to maintain or complete construction of their facilities. The subsequent picture is well known. Almost from the beginning of the war it has been necessary to limit new construction to facilities which would serve a vital public need or an essential military need. Today, however, the principal difficulty is lack of manpower and manufacturing plant facilities. In checking with Mr. Frank H. McIntosh, Chief of the Domestic and Foreign Branch of the Radio and Radar Division of the War Production Board, just

before I left Washington, he assured me that the situation today is not very different than in 1943. He emphasized that the need for conservation of manpower and manufacturing facilities of radio equipment and maintenance supplies still exists. He also authorized me to say that present indications are that despite the tremendous expansion of radio production that has taken place in the last two years, the requirements of the armed forces in 1944 are half again as large as in 1943. Generally speaking, this large burden on industry will not allow production of equipment for new stations or the expansion of existing facilities unless such facilities are required for war purposes. However, the WPB has always been, and always will be, glad to review any case presented to it and if special circumstances justify unusual action, the WPB will be governed by the circumstances of the case. In view of this information, there is no immediate possibility of the Commission canceling its "freeze" policies. On the other hand, WPB is maintaining day-to-day liaison with the Commission and will keep us advised of current developments so that no time will be lost in relaxing equipment-freeze policies whenever it may be possible to do so.

In some respects, it is fortunate that we cannot proceed with normal licensing at this particular time. For example, there is great interest on the part of the general public in the future of broadcasting, including television, facsimile, and frequency-modulation broadcasting. All of these services are recognized under the Commission's regulations on a commercial basis and were it not for the "freeze" on materials the Commission would be called upon to consider many applications for the construction of new stations. This would require that applications be filed in accordance with engineering standards and allocations which were adopted prior to the war.

Fortunately, we have a limited amount of time to consider and adopt desirable changes and thereby permit industry to offer some worth-while improvements in almost every branch of communications in the immediate postwar era. Let us not be fooled, however, in believing that the manufacturers will hold up production while the Government and engineering profession are considering such changes. For the present and until materials and manpower become available, the manufacturers will be occupied with other tasks. That is why I say we are fortunate in having a temporary respite to do the necessary planning for the technical future of radio.

But you may ask, will there be room enough in the ether for all rival services? Any engineer will be glad to tell you that there is plenty of room in the ether for *his* particular service—and there is. But when you add up all these rival claimants, the picture is not nearly so clear.

It is true, of course, that after the war we shall have a much larger usable spectrum than we had before the

war. And engineers, by pointing to new frequencies above 300 megacycles can make a very plausible case for the view that there will hereafter be more than enough frequencies to go around. But that apparent roominess ceases to look so encouraging when we consider the vast number of channels that will be required for half a million airplanes by 1950, a four-ocean Navy, a huge Army communications system, police radio, harbor radio, frequency modulation, facsimile, etc. And when you consider also the demands of television, which requires a channel at least 6000 kilocycles wide, or wide enough for 100 or more standard-width communication channels, the picture becomes more discouraging. In view of these vast new demands, how can we be sure that when all the claims are added up, there will be channels enough to satisfy everybody?

For these reasons, I shall not go so far as to say that in the postwar world there will be more than enough frequencies to go around. But I shall go so far as to say that, if we do a reasonably good planning job now, there will be room for at least the minimum frequency requirements of all legitimate radio services.

As I have said before, many problems of a technical nature must be solved before we shall be in a position to adopt new standards. In television the allocation problem is foremost in our minds because, in addition to interference problems resulting from multiple transmission paths, we know that the present 18 channels and the standards governing this service are inadequate for an efficient nation-wide competitive system of television broadcasting. In my opinion, we should have at least twice this number of channels. The same is true of frequency-modulation broadcasting in the band from 42 to 50 megacycles, which is sufficient for only 5 noncommercial educational broadcast channels and 35 commercial channels. Considering the problem of adjacent channel interference and the geographical separation required for cochannel operation, it is not unreasonable to ask for at least twice the number of channels for these services.

In considering these postwar broadcasting services we must also plan the necessary relay channels for network programs. It is my understanding that considerable advancement has been made since Pearl Harbor in developing frequencies above 300 megacycles for the distribution of such programs; also, the same networks may just as easily carry telegraph and telephone messages and compete with the services now furnished by the wire carriers. This will involve major questions of policy and may require amendments to the Communications Act. We know, for example, that these relay stations will be installed on towers which will be spaced from 30 to 50 miles apart. The transmitter for each channel of communication will be of very low power, perhaps only a fraction of 1 watt. Interference will be minimized and efficiency increased through the use of directional beams

with the result that the same frequency may be utilized in many sections of the country. There is no reason why this nationwide network should not also carry network programs for standard broadcasting, frequency modulation, facsimile, and private telegraph and telephone circuits for the press, stockbrokers, and agencies that usually lease private-wire facilities. Who should be granted the privilege of operating this system? Should it be competitive with the telephone and telegraph services which now operate as monopolies in their respective fields? Should there be competitive radio networks, thereby necessitating a forest of towers along the same route? Should the company or companies operating the radio network also be permitted to operate terminal facilities at the subscribers' offices? Should the chain broadcasting companies be permitted to own and operate their own networks? These are but a few of the questions which will confront the Commission when, as, and if materials and manpower again become available for the production of civilian equipment.

It has been predicted that these radio networks will be extended internationally to carry television and aural programs and message traffic all over the world. Although we may be fairly certain that such networks will not be extended beyond the Western Hemisphere or even to South America for some time to come, the technical considerations should not be overlooked when planning our own domestic services. There is much to be gained by allocating the same frequency bands to television service on an international basis, and also in adopting international standards for both program broadcasting and network relay systems. If these things are not done, it may be impossible to set aside common bands of frequencies for maritime and air navigational aids. Furthermore, if different bands and technical standards are used in different regions of the world, the sale of apparatus and the exchange of international programs will be greatly retarded.

But I have already digressed too far. The details of these and other problems will be discussed by Messrs. Adair, Krebs, and Siling who follow me on this program. However, I do wish to call attention to the recent hearings which were conducted by the Senate Interstate Commerce Committee on the Wheeler-White Bill, that is, S-814. The transcript of these hearings contains many interesting papers regarding the technical future of radio which were presented by radio engineers and officials who are well known in the industry. If you have not already done so I recommend that you obtain this record as it contains much valuable information.

In closing, I wish again to thank the Institute for inviting the Engineering Department to participate in these meetings. If there is anything that we can do to help solve your individual problems or the problems of any group you need only write, or better still—come to Washington and we shall be glad to talk things over.

II. Timely Broadcast Matters*

GEORGE ADAIR†, SENIOR MEMBER, I.R.E.

BEFORE going to controversial matters, may I take this opportunity to express my appreciation of being permitted to appear before you today representing the Broadcast Division of the Engineering Department of the Federal Communications Commission. In this division we handle all engineering matters relating to radio broadcast stations including standard, frequency-modulation, television, facsimile, international, relay, noncommercial educational, developmental and studio-transmitter-link stations, and experimental operation concerning any of the above classes. We advise the Commission on all technical matters pertaining to broadcasting, examine from a technical standpoint all applications concerning broadcast stations, prepare engineering reports on all such applications and prepare and present expert testimony at hearings. In addition, we prepare technical Rules and Regulations and Standards of Engineering Practice Governing Broadcast Facilities and make studies and reports in regard to propagation conditions and other technical phases looking toward improved application of broadcast technique in the service of the public. We also handle complaints, violations, and other technical matters concerning broadcast stations.

We handle all war-effort engineering matters relating to radio broadcast stations and services, including special studies for the Armed Forces, co-operation with the Fighter Command, the Office of War Information, and the War Production Board, expansion and improvement of international broadcast facilities, and conservation of broadcast equipment including the issuance and maintenance of the Surplus and Salvageable Equipment Catalogue with which many of you are familiar and which I hope has been of some use to you.

In order to carry out these duties, this division is divided into seven sections, namely, the Office of the Chief of the Division, the Administrative Section, the Standard Broadcast Application Section, the Nonstandard Broadcast Application Section, the Hearing Section, the Allocation Section, and the Monitoring and Equipment Section.

While our duties are divided as indicated above and the personnel is assigned to specific sections, it has become more and more necessary that each individual have two or more hats, wearing the hat for the section where the most urgent or greater volume of work at the moment is involved. This is necessary because of the greatly reduced and changing personnel and the rapidly changing nature of the work load during war times. Al-

though it is true that due to the so-called "Freeze Order" the volume of applications has been greatly reduced, the problems of consideration of those remaining have been greatly increased by the scarcity of material and other considerations. It was hoped that the "freezing" of broadcasting would permit the Commission to complete broadcast engineering work which had long been outstanding. However, additional duties arising out of the war effort have almost completely prevented this. Some of the problems which seemed extremely urgent in normal times became of no particular consequence during the war. However, as the postwar period approaches, these problems again arise, accompanied by new and larger problems. For example, prior to Pearl Harbor the Broadcast Division was actively engaged in revising Chapter I of the Standards of Good Engineering Practice with respect to the method of determination of the interference between stations, particularly the combined interference to a desired station from several undesired stations. Under the present standards this is usually referred to as the root-sum-square limitation. This work was abandoned for two reasons. First, urgency of other work in the Commission and second, the fact that it was considered that the Commission should have the advice and counsel of the consulting engineers and other engineering talent in the broadcast industry before promulgating new standards. As much of the engineering talent was engaged in war work, it was considered wise to abandon this project until more deliberate and full consideration could be given to it.

In the postwar planning, it again becomes necessary to consider the revision of the method of determining interference, together with the developments arising out of the war, necessitating study and possible reallocation of all services which give rise to many new problems of allocation in the standard broadcast band as well as in the other broadcast services.

What variation of the root-sum-square method should be made and what allowance should be made for other factors? As I mentioned before, we conducted considerable studies and experimentation on this subject before the war and have now resumed this work. We hope to have some helpful information in this regard for consideration by the industry as well as the Commission in the near future.

A study we made in 1938 showed that during daytime 38.5 per cent of the land area of the United States, in which resided 9,998,747 people or 8.1 per cent of the total population of the United States, was without primary service from even one broadcast station. Further analysis showed that 8,569,788 people or 15.9 per cent of the rural population lived in this area compared to 1,418,959 people or 2.1 per cent of the urban population. The same study showed that during nighttime 56.9 per

* Decimal classification: R550. Original manuscript received by the Institute, April 5, 1944. Presented, Winter Technical Meeting, New York, N. Y., January 29, 1944.

† Chief Engineer and Chief of the Broadcast Division, Engineering Department, Federal Communications Commission, Washington, D. C.

cent of the land area of the United States, in which resided 21,308,453 people or 17.4 per cent of the total population of the United States, was without primary service from even one broadcast station. In this area 17,428,585 people or 32.4 per cent of the rural population and 3,879,368 people or 5.6 per cent of the urban population resided.

Another study made in 1942 showed that the areas not receiving service had been reduced only 3 to 6 per cent and no study was made of the populations, but it is reasonable to assume the ratios were approximately the same.

During the period from May, 1938, to May, 1942, the number of broadcast stations increased from 730 to 924 and in addition the power of many stations had been increased. These studies indicate that there is a greater need to extend primary service to rural listeners than to urban listeners and that changes in facilities in recent years have to a large extent been additional service to areas already receiving service. The nighttime picture is not quite so bad as it appears since secondary, that is, clear-channel sky-wave service is available to every portion of the United States where the noise level is sufficiently low.

How may primary service be extended to areas not now receiving such service, particularly to remote rural areas? There are a number of methods of extending service to these areas, one of which is by the use of so-called superpower. However, this as well as some of the other methods involves social and economic questions. It will be remembered that following the 1938 hearing the experimental license of the only station operating with power in excess of 50 kilowatts was not renewed and that at that time the Senate adopted a resolution against the use of power in excess of 50 kilowatts. Although a number of applications for higher power have been filed, these have all been dismissed as a result of the Commission's Memorandum Opinion of April 27, 1942, with respect to the use of materials.

Another method for improving rural service would be by the more efficient geographical distribution of stations. However, this again involves economic questions since it is apparent that under the competitive system of broadcasting which has grown up stations are located near urban areas in order that they may serve the maximum number of people possible consistent with the facilities available. In most of the areas where no service is available at this time, the density of population is such that a station would be forced to operate at a loss.

The use of very low frequencies has often been suggested for rendering service to wide areas. Here again, while there are distinctive advantages, there are also disadvantages and that again involves serious social and economic questions. In the first place these frequencies are also valuable for other services which are presently occupying them and, furthermore, in order to obtain efficient operation, antennas of heights which involve distinct hazards to air navigation would be required.

The number of receivers in use which would be able to receive such stations is also very limited and would require new receivers or the use of an attachment which would render the desirability of the operation on these frequencies questionable. It should also be noted that since the competition between services for these lower frequencies is so great that at best only a limited number of channels, if any, could be made available. Assuming that even one or two could be so allocated there immediately arises numerous other questions. For example: What classes of stations should be permitted to use them? Who should be the licensees? How can they be allocated so as to provide service in the areas now inadequately served, particularly in those areas where there is inadequate economic support? What treaty difficulties will arise?

Would extension of the standard broadcast band upward be of material aid in expanding the service? Assuming for the moment that such were possible, this question immediately arises: "Are there adequate receivers covering these frequencies in use?" Except for some of the more populous areas where no other assignment of any nature is available, frequencies between 1500 and 1600 kilocycles in general have been given the cold shoulder and undoubtedly frequencies above 1600 kilocycles would be less popular. This is, of course, due to the poorer ground-wave propagation characteristics as well as the receiver situation. It will be noted, however, that several stations operating in the upper portion of the band are providing not only good primary service but excellent secondary service which builds up earlier in the evening and continues longer in the morning than on lower frequencies. These frequencies also have some advantage with respect to atmospheric-static noise. Even if it were determined that these frequencies are needed for broadcast purposes, there are other services now occupying them and their removal would involve many complications. Undoubtedly both the industry and the government will give most careful consideration to the comparative needs of each service, and to the possibility of removing as many services from the more congested portions of the spectrum to the less congested and in many cases to a more desirable portion for the particular service.

Should consideration be given to differences in average static levels in various parts of the country and on different frequencies in determining the normally protected contours of broadcast stations? The Commission has made and is still making recordings of average noise levels in several areas. Lack of personnel and the press of other duties have prevented a full analysis of these recordings. However, preliminary studies indicate that in certain areas the signal strength of the order of 0.2 of a millivolt will render a service equivalent to 1 or 2 millivolts in another area. It must be decided whether the additional service rendered in the areas of low noise level is sufficient to warrant this added complication to national and international allocation and administration

of broadcast facilities. A related problem is what signal strengths are required for satisfactory service to business, industrial, residential, and rural areas? This problem resolves itself considerably on the question as to whether facilities are going to be allocated on the basis of receivers being equipped with built-in antennas or no appreciable antenna or whether with the expectation that listeners will install a reasonable antenna system, or will so locate their receivers in their homes as to be able to obtain satisfactory reception with less signal strength. This question is particularly pertinent with respect to those stations operating in the upper portions of the standard broadcast band as well as to those operating in the frequency-modulation and television bands.

Are the present nighttime propagation curves of the Commission satisfactory or should these be modified, and furthermore, what consideration should be given to F-layer or multiple E reflections in determining sky-wave interference? The Commission has for a number of years engaged in a recording program which it is hoped when analyzed will give a satisfactory answer to these questions. We are proceeding as rapidly as possible to analyze these recordings and it is hoped that before too many months this information may be made available for the consideration of the industry when making its recommendations to the Commission with respect to allocation. We have also prepared a tentative amendment to the standards in this regard which will be placed before the industry for its comments at the same time. One question which has been batted about a great deal lately is "What effect will frequency-modulation broadcasting have on amplitude-modulation?" If you attended the FMBI meetings you undoubtedly found that many felt it would have a great effect. In my opinion to determine the effect and how soon it will occur one would have to have what might be termed a superdeluxe diamond-studded crystal ball. I don't believe the anticipator attachment to the type II B Regretter would be adequate in this case.

There are hundreds of such problems, many of which are contingent on one or more of the others in such fashion that, at times, it would seem almost impossible of resolution and in many cases it may be necessary to make arbitrary decisions or educated guesses due to the inability to foresee the future. In addition to these allocation problems, there are many other problems of administration, including methods of making proofs of performances, equipment requirements, monitoring, etc.

With respect to frequency-modulation, noncommercial educational, television, and facsimile stations, there are several mutual problems. Included among these are: How many channels should be provided for each service and in what frequency band should these be allocated?

Following the hearing in 1940 on allocation of frequencies above 30 megacycles, frequency-modulation and noncommercial educational broadcast stations were allocated to the band 42 to 50 megacycles. In view of the interest shown in these services, there is considerable

doubt as to whether the band provided is adequate for the needs of these services and, in addition, operation of stations in these bands indicate that some difficulties may be anticipated from propagation phenomena including sporadic E-layer reflection and what has been termed "bursts." These bursts of signal, which may be from a fraction of a second to several seconds in duration, are such that, while during normal operation the signal from a distant station is generally of too low an order to interfere with reception of a local station, it may cause interruption to reception of the program, or the program of the undesired station may be heard instead of that of the desired station.

At this time it is not possible to predict the seriousness of this phenomena, its cause, or what may be done to counteract it. The Commission, however, has since last January been engaged in a recording program looking towards a determination of the seriousness of the problem and, if possible, a solution to it. In view of the urgency of reaching a determination in this regard at an early date, the program has been greatly expanded and the Commission is now making recordings at Laurel, Md., Allegan, Mich., Grand Island, Neb., Portland, Ore., and Atlanta, Ga. In addition, several broadcasters are co-operating with the Commission making these studies. Recordings are now being made in the 40- to 50-, 60-, and 70-megacycle bands. It is anticipated that recordings in the 117-megacycle band will be inaugurated within a few days. It is hoped that recordings may be extended to the 140-megacycle band before too long. In addition, every effort is being made to obtain all available data from the industry as well as other government organizations. However, much of this is clothed in military secrecy and may not be released at this time. Tests made in co-operation with Major Armstrong indicate that path differences ranging up to 900 miles occur in transmissions from Alpine, N. J., to Laurel, Md., a distance of only 200 miles. While there may be some question as to the absolute exactness of the determination of the differences in path length there is no doubt that the difference may be very great, indicating reflection is from a very high reflecting medium or is from far to one side of the great-circle path between the transmitter and receiver.

In addition to the recording program we have been endeavoring to determine the actual effect on reception of a local station by bursts of various intensities and duration. Due to the same troubles you have been experiencing, that is, the shortage of personnel, which was not helped by the recent influenza epidemic and transportation difficulties between Washington, D. C., and our Laurel, Md., monitoring station, this work has not progressed as rapidly as desired. The seriousness of sporadic E transmission must also be determined.

There are, of course, many detailed problems in these services including the question of whether trade areas are satisfactory or other means of allocation should be established; what standards of operation should be

adopted; what provisions should be made now for color television; should the aural transmitter of a television station be operated only when the video transmitter is operated, or should it be permitted to operate alone as an aural broadcast station at times; should multiplexing be permitted on frequency-modulation broadcasting, particularly facsimile, or should a separate facsimile service be provided? What and how should relay systems or other means of providing a network of frequency-modulation and television service be established? In what frequency band should these be established?

The solution of these broadcast problems and the many other related problems will require the closest co-operation and much hard work on both the part of the industry and the government. Even after this country is satisfied that the best solutions obtainable have been found, the agreement of other countries must be obtained in order to provide not only the most effective national use of radio facilities but also international use. The present North American Broadcasting Agreement expires March 29, 1946, which will again throw open the question of international allocation.

At this point I should like to emphasize the need for continued conservation of men and materials and to ex-

press our appreciation of the whole-hearted co-operation we have received. I am assured by the War Production Board that except for the conservation efforts extending the life of equipment, particularly tubes, some stations would not now be operating or would be operating with greatly reduced power. Incidentally, the reduction in power by one decibel under the Commission's Order 107 has, as was anticipated, been unnoticed by listeners. The Commission has not received a single complaint in this regard in spite of the fears of some. Prior to placing this order into effect, through co-operation of the engineers of the six stations in Washington, these stations were operated alternately with full and reduced powers for several days. Even those who knew the tests were in progress were unable to tell the difference. In fact, at least one observer in indicating his opinion as to when full or reduced power was used, reported full power at times when actually the power was reduced by approximately $2\frac{1}{2}$ decibels.

In closing, may I again express my appreciation of this opportunity of appearing before this body and also the opportunity of working with the industry and obtaining its assistance in solving some of these perplexing problems.

III. Police, Aviation, and Maritime Services*

W. N. KREBS†, ASSOCIATE, I.R.E.

POLICE, aviation, and maritime services involve very large numbers of radio stations, with the mobile services predominating over point-to-point communication, and with mobile stations or mobile units in the majority. While the scope of police service is mostly domestic, the predominant phases of the aviation and maritime services are international in the fullest sense of the word. The latter two services concern the operation of mobile stations over widespread geographical areas, in fact, world-wide operation. This fact in turn restricts such stations to operation in accordance with the limitations and requirements of international agreements, and while in foreign territory they are further governed by the local regulations of the respective foreign governments having jurisdiction. The international phase of the situation requires the establishment of designated frequencies common to stations of all countries for calling, for the exchange of message traffic, and for aids to navigation. Language problems are encountered which are not conducive to the efficient use of radiotelephony. In the international safety services, it is generally conceded that radiotelegraphy, with the aid of standard international signals and symbols, is more practicable and more reliable. In addition, there must be available to mobile stations in foreign territory or the open sea all necessary documents and information per-

taining to particulars of operation of foreign stations with which they may communicate.

The aviation and maritime services require the sharing of a relatively limited number of frequencies by a large number of radio stations, mostly mobile stations. It is only by providing for the most extensive possible duplication of assignments that any attempt can be made to accommodate the requirements for frequency bands for the mobile services. This duplication of assignments is made possible by the fact that mobile units do not use their transmitters constantly and because many of the mobile service frequencies are in bands below 4000 kilocycles, and above 30,000 kilocycles where duplication is possible. It has been necessary, however, that a rather elaborate set of international regulations be established to avoid intolerable interference and to govern all stations in the international service, to set up the priority of message traffic, to establish international distress signals and procedures, to qualify radio operators on standard operating procedures and communication practices, and to accommodate many other situations characteristic of such operations. In fact, the saving of life or property may depend upon adherence to an individual regulation at a particular time.

There are certain equipment considerations which predominate when groups of frequencies in designated bands are shared by large numbers of land and mobile stations, some of which are in close proximity to each other. Perhaps the most important of these from the point of view of interference are the selectivity of

* Decimal classification: R510×R520×R538. Original manuscript received by the Institute, April 5, 1944. Presented, Winter Technical Meeting, New York, N. Y., January 29, 1944.

† Chief of the Safety and Special Services Division, Engineering Department, Federal Communications Commission, Washington, D.C.

receivers and their radiation properties, the frequency stability and the power of transmitters, the reduction of spurious emissions, and to a certain extent standardization in design.

The police, aviation, and maritime services require large numbers of licensed radio operators, involving matters of citizenship, examination, licensing, and extent of qualifications necessary. Basic requirements in these services are established by international regulations and these represent the absolute minimum requirements which must be imposed by the Commission. It is well to remember that the relative skill of the radio operator in understanding telegraph or telephone communications received through interference, and in continuing to carry on his functions under difficult or hazardous conditions, is a very important factor in the successful operation of a radio circuit in these safety services.

Since the inception of the police service in 1929, there has been a steady growth in the number of stations licensed. In that year there were only 14 police licensees, with 3 frequencies allocated for emergency police service. At the present time, however, there are more than 1700 municipal licensees and 43 state licensees, with the number of licensed transmitters around 18,000. The number of police radio stations and police message traffic in some of the metropolitan areas has increased to such an extent that mutual interference between stations operating on the same or adjacent frequencies is becoming a very serious problem. Since it is rather unlikely that a large number of additional frequencies below 100 megacycles will become available for the police service, the Engineering Department of the Commission is very much interested in the technical characteristics and performance of the frequencies above 100 megacycles which might be allocated to the police. One of the most important questions confronting us, then is "Are these frequencies suitable to provide a satisfactory grade of mobile service for municipal and state police systems using frequency modulation and the most effective antenna systems?"

In regard to aviation radio service, radio engineers associated with government and industry in this field of activity are indeed confronted with some knotty problems which are a challenge to their profession. Those of us who face some of these problems as Commission engineers realize the importance of establishing the correct basic engineering requirements and allocations of frequencies to insure adequate and reliable radio communications and aids to navigation upon which is dependent in considerable degree the safety of commercial and private flying.

Most of the present rules and regulations of the Federal Communications Commission governing aviation radio service are based upon regulatory action of its predecessor, the Federal Radio Commission. In addition to aircraft, aeronautical, and aeronautical point-to-point stations, certain other classes of stations have been recognized and regularly licensed. These are airport control

stations, flying school stations, radio marker stations, and flight test stations. Although provision is made for public-service aircraft and aeronautical stations, there have been no stations licensed for this type of message traffic. To date all stations in the aviation service are authorized to communicate only for maintaining safety of life and property in the air, and for the safe navigation and other flight requirements of aircraft.

There are now eight recognized chain systems governing the existing allocation of frequencies to aeronautical and aircraft stations, including the Hawaiian chain and the intercontinental chain. The latter, which is international in scope, is subdivided on the basis of international agreement into the following routes: Inter-American, Trans-Pacific, Europe-North America, and Europe-Arctic.

Some idea of the scope of aviation radio facilities serving international and overseas routes, at the present time without regard to future requirements, may be obtained from the following brief analysis. Excluding strictly military and naval facilities, the one commercial airline system which is licensed to operate ground radio stations for communication with aircraft flying international routes has a total of 21 aeronautical stations in the United States, including Alaska, Puerto Rico, and Hawaii. The number of frequencies authorized for use by this commercial system total 109. In addition, the Federal Government, excluding the War and Navy Departments, maintains and operates 14 ground stations in the United States and possessions for communication with all types of aircraft flying international routes. These stations employ 20 aeronautical frequencies not shared with commercial stations, 17 aeronautical frequencies on a shared basis, and 42 frequencies for point-to-point communication not shared with commercial stations. In addition these stations regularly guard 5 frequencies established for calling and general safety purposes, and furnish a variety of services, including notices to airmen, weather data, aircraft movements, traffic control, and administrative dispatches. A considerable volume of point-to-point radiotelegraph traffic is handled relative to aircraft movement and exchange of weather information. On these international routes, radiotelegraphy is used for all long-distance communication, and telephony is employed for the exchange of messages directly between the pilot and the airport control towers in connection with the arrivals and departures of aircraft. Numerous radio beacons, instrument landing facilities, radio markers, radio ranges, and direction-finding stations, utilizing additional radio channels, also are operated by the Federal Government. In consequence of these existing facilities and extensive use of frequencies solely by stations of the United States, it is evident that the postwar aviation service on a world-wide basis will demand the use of a large share of the radio spectrum.

It is conceivable that the necessity for air-traffic control can be a serious obstacle to the postwar development of civil aviation unless provision is made for

adequate facilities, including radio-frequency allocations required for communication, radio ranges, anticollision devices, automatic position reporters, and ground-station aircraft detectors. The Radio Technical Commission for Aeronautics, a group of communication engineers representing both government and commercial aviation interests, has these matters under study in coordination with Panel II of the Radio Technical Planning Board, and in due time will submit appropriate reports and recommendations pertaining to the most effective utilization of radio frequencies and apparatus for the benefit of safe air navigation.

Considering now the maritime service, we immediately recall that radio communication to and from ships at sea is the oldest of established radio services and its fundamental aspects are fairly well known. It is well to keep in mind, however, the basic elements of this service which necessarily are reflected in the design of ship station equipment for ocean-going vessels.

First, we must remember that radio facilities are installed aboard ocean vessels for the safety of shipping in general, in addition to embracing safety for the individual ship thus equipped. It is the law of the sea that there is an obligation upon every ship to assist, and be prepared to assist, another vessel in trouble. It may be appropriate today to include aircraft-at-sea also within the maritime service for this purpose. Every ship at sea is a potential lifeboat and, therefore, it should possess the means of intercepting distress calls and be capable of exchanging necessary distress messages. The object of related treaties and statutes, therefore, is to require the installation and use of radio for safety purposes on the largest number of ships as is practicable.

Before the war there were more than 15,000 ships throughout the world fitted with radio installations. In conjunction with coastal stations and connecting point-to-point-systems, these stations are part of a world-wide communication net open to general public message traffic. Hence we have the elements of common-carrier operation, standard international operating procedures, and distribution to each station of the necessary information regarding the technical facilities, hours of opera-

tion, rates, and classes of service of other stations. While this phase of the maritime service is secondary to safety, it nevertheless presents many administrative and regulatory problems.

Coastal stations licensed by the Commission are voluntarily established by commercial interests, and sometimes by municipalities, to provide communication with ships of any nationality or of any licensee. Although concerned primarily with their responsibilities and earnings as common carriers for hire, they are required to answer distress calls and to carry on such communication for the safety of navigation as is necessary in the public interest. In the latter respect, the commercial coast stations have rendered very effective services to many vessels, and their value for safety purposes has uniformly been recognized.

Our most troublesome maritime allocation problem to date, which we share, to some extent, with Canada, is how to provide enough telephone channels for the large number of stations on small craft and coastwise vessels which communicate with coastal-harbor stations and also carry on considerable ship-to-ship telephone communication. This situation is most acute in regions of concentrated ship traffic, such as the Great Lakes, the Pacific Northwest, Alaska, and the intracoastal canals along the Gulf of Mexico. To date there has been practically no use of very high frequencies in this service although it would seem that much short-distance communication could be transferred from medium frequencies to these frequencies, which, under the Commission's rules, have been available for some time. Engineers who have an interest in this service are urged to give more attention to the practical application of frequencies above 30 megacycles for short-distance telephony in the maritime services.

Certain special radio services of importance are forestry, amateur, experimental, geophysical, relay press, mobile press, war-emergency radio service, and intermittent service including provisional stations and motion-picture stations. Within the limitations of this paper, however, it is not possible to mention the many interesting aspects of these fields of activity.

IV. International Point-to-Point and Allocation Problems*

P. F. SILING†, SENIOR MEMBER, I.R.E.

WHILE I plan to lay particular stress on international point-to-point and frequency-allocation problems, it seems to me that for background information, you might be interested in a brief outline of what the International Division of the Engineering Department does. I assure you that I am not going to

* Decimal classification: R007.9. Original manuscript received by the Institute, April 5, 1944. Presented, Winter Technical Meeting, New York, N. Y., January 29, 1944.

† Chief of the International Division Engineering Department, Federal Communications Commission, Washington, D. C.

bore you with a long résumé of functions with which most of you are probably familiar. As the name implies, the International Division deals primarily with international relationships as regards communications and we are particularly interested in the preparatory work in connection with the drawing-up of telecommunication treaties, agreements, and other arrangements, as well as the administrative regulation of these treaties. This means that we must have close liaison with the Department of State and also with industry in order to

insure that the proposals which the United States submits to international conferences represent the ideas and the best interests of the country as a whole. We also, of course, are constantly in touch, through the Department of State, with foreign countries in an effort to reduce international interference to a minimum and to discuss the best practical methods of providing a well-knit international communications system from an engineering basis. At present, as you all doubtless are aware, the major treaties in force affecting communications are: Safety of Life at Sea Convention, London, 1929; International Telecommunications Convention, Madrid, 1932; General Radio Regulations, Cairo, 1938; Inter-American Radio Convention, Havana, 1937; North American Regional Broadcasting Agreement, Havana, 1937; and Inter-American Arrangement, Santiago, 1940. In addition to this list, of course, there are many bilateral agreements which have been effected through an exchange of notes and which bear on certain phases of the telecommunications problems.

As a result of the Inter-American convention, Havana, 1937, there was set up in Cuba an Inter-American Radio Office to centralize and facilitate the interchange and circulation of information relative to radio communications between all the countries in the Western Hemisphere and specifically to act as a central bureau to which all countries, parties to the North American Regional Broadcasting Agreement, notify the frequencies assigned by them to all standard broadcast stations. Therefore, of course, we notify, that Office of all standard broadcast assignments or changes in assignments of stations in the United States and also any objections that we may have to proposed stations in our neighboring countries which would cause interference to our stations in violation of the NARBA.

In the Global Field, as distinguished from the Inter-American, there is also a bureau, the Bureau of the International Telecommunications Union at Berne, Switzerland, to which all frequency assignments are notified and the records of which serve as a basis for determining international priority.

We, of course, are deeply interested, at this time, in the provision of the best possible international broadcast service to all parts of the world consistent with the limited number of transmitters and frequencies available. With this in mind, we co-operate with the Office of War Information and the Co-ordinator of Inter-American Affairs providing them such technical assistance as they require to provide world-wide coverage of their programs. While all international broadcast frequencies are available for assignment to any International Broadcast Station, depending upon the hours of use and the areas which it is expected to cover, from a practical standpoint every effort is made to reduce the number of frequencies that may be assigned to any given station to a minimum. In order to use the limited number of frequencies available to the maximum possible extent, we

maintain a complete record of the schedules of each of the International Broadcast Stations and make such shifts in these schedules, frequencies used, and the antennas employed as are required by the Office of War Information and the Co-ordinator of Inter-American Affairs to provide the service they need at any particular moment. In other words, from a practical standpoint, we are making the best possible use of these frequencies on a shared-time basis.

Our international point-to-point problems are particularly interesting at this time, in that we are having constantly changing conditions as communications to new points are opened up because of their importance as a result of war operations. In the majority of cases, of course, these new direct communications circuits are established with the foreign telecommunications companies which are already equipped to handle traffic to us by indirect routes. Many such new direct circuits have been established within the last two years, such as Sydney, Melbourne, Wellington, and British Guiana. In other cases, it has been necessary to obtain equipment from the United States for the foreign administration, as in the case of India, for example. It is hoped that as a result of the provision of this equipment a direct circuit to this highly important country will be established within the next two months. Then there is also a third case, such as Algiers, where one of our operating communications companies operates the foreign terminal with its own equipment and personnel.

The policies in respect to the establishment of new radio circuits are now determined primarily by the Board of War Communications and the Joint Chiefs of Staff. Usually, these policies dictate that only one company be authorized to establish a circuit to any single point, particularly if that point is in a military area. The Commission, therefore, is faced with the problem of selecting one company from among three applicants. Although the Commission tries to make the best decision possible from the facts presented to it, it is judged to be wrong twice as often as right, since when one company is authorized, two companies must be denied.

From the above brief outline, you can see that it is essential that accurate records be kept of frequency use and the amount of traffic transmitted, and also that the relationship between submarine cables and radio be constantly studied in order to make sure that adequate facilities are available to any given point, that the system as a whole is secure and also flexible, permitting re-routing of traffic when necessary.

In the International Division, we keep the master frequency records of the Commission, consisting of an accurate record of allocated, assigned, and received frequencies, both government and nongovernment, and in so far as possible an up-to-date record of the use of all frequencies by all countries of the world. Therefore, in connection with any new frequency assignment made by the Commission, or by the Government Departments

using radio, we are consulted in order to make sure that the best possible assignment is made. This is by no means an easy job, at this time, for the heavy military demand for radio facilities must, of course, be met. You will readily appreciate that there are no longer any holes in the ether for new services or new assignments except for postwar development of ultra- or superhigh frequencies. Consequently, when there is a request from either commercial companies or the Government Departments for a new assignment to meet an essential war need, or for a vital public or safety service, existing assignments must be juggled either by eliminating a less important service or by making arrangements for a shared-use of certain frequency assignments.

For example, we recently had a request for a frequency in the low 3-megacycle band for an essential war service for point-to-point operations in the early morning hours. Both the Commission and the Interdepartment Radio Advisory Committee, which as Mr. Jett said, is the Committee appointed to advise the Board of War Communications and the President in regard to the assignment of frequencies to Government stations and classes of stations, studied that portion of the spectrum with particular care to see if some shared-time arrangement could be made whereby one frequency could be cleared for this essential service at a particular time each day. After considering many possible solutions, consulting many Government Departments and operating companies, always running into a blind alley, arrangements were finally made for the sharing of one frequency for this purpose. Although we eliminated all red tape by using the telephone for all negotiations in order to expedite the approval of this service, it still took us about three or four days to clear just one frequency for use during a small portion of the day. This example is not unusual and is cited merely to indicate the difficulties involved in obtaining new frequency assignments at the present time.

Also, of course, we must conduct a continuous study of the uses of frequencies by the various services to insure maximum efficiency in the use of the spectrum and to ascertain whether or not any frequencies can be employed by two or more services on a shared-time basis.

Naturally the Commission is at the present time, thinking and looking forward to how the radio spectrum should look after the next International Telecommunications Conference. Doubtless you are all generally familiar with the development of the radio spectrum up to the present time from the first allocation made by the Federal Radio Commission in 1929, when channels were allocated for continuous-wave transmission on a basis of approximately 2/10th of 1 per cent.

Radio-frequency channeling, on a percentage basis, developed in the early days of radio because the transmitter and receiver frequency stability and the receiver selectivity determined the width of a useful channel and both of these quantities could be roughly evaluated on the percentage basis. In 1931, the Commission adopted

a 1/10th of 1 per cent channeling system and for voice combined two telegraph channels in the lower frequencies, assigning the mid-frequency as the carrier frequency for the voice circuit. Since those days, at every international conference, the United States has come out strongly for better equipment, more rigid tolerances, and a reduction of the bandwidth of emissions. Today, more than ever, we are interested in these subjects in order that we may make far greater use of the radio spectrum.

The past system of channeling, on a percentage basis, now may be outmoded. This is due primarily to improvements in methods of transmission and reception such as the development of the superheterodyne receiver wherein the selectivity is practically independent of the frequency being received and means whereby receivers may be automatically tuned to the carrier frequency, thereby eliminating one source of instability. Also, in the lower part of the frequency spectrum, the carrier frequency may be maintained with such accuracy that the remaining frequency deviation does not contribute materially to the total bandwidth for the emissions employed. In the fixed and certain other services, the assigned frequency is more or less a book-keeping convenience and our primary concern is in the over-all stability and bandwidth of emission. Recognizing this, the Commission has been investigating means of licensing and monitoring bandwidths of emission with the thought that in the future, it might be possible to assign for particular purposes a channel whose width would be determined by the requirements of the circuit and adjacent assignments. Such a system would require that the carrier, plus all side frequencies generated, remain within the assigned channel. This arrangement has an obvious advantage in that it would permit the placing of the carrier frequency at one edge of the assigned channel and with the technique of single-sideband or vestigial-sideband transmission, multichannel telegraph, facsimile, or other communication means may be used.

From a cursory examination of the spectrum, it would appear that in order to accommodate some of the expanding needs of the aeronautical services, as well as the continuing needs of certain other mobile services, we shall have to look to portions of the bands now assigned to the fixed and other services. Therefore, we must explore still further methods of utilizing space as efficiently as possible inasmuch as it is also expected that the fixed services will handle an ever-increasing amount of traffic. Obviously, we shall find methods of employing multiplex systems together with single-sideband transmission in the fixed service. There are indications that the two-tone or frequency-modulation type of telegraph signaling, while occupying a greater bandwidth than the usual continuous-wave telegraph system, has certain inherent advantages in radio communication and may well play a part in our future considerations. Even with this system, it appears that a bandwidth of 500 cycles

is capable of containing telegraphic intelligence at speeds of 100 words per minute, and, therefore, that a band 5 kilocycles wide could readily accommodate 9-10 500-cycle telegraph channels with a total communications speed of approximately 900 words per minute.

Some of our present confusion unquestionably is caused by the sharing of certain portions of the spectrum by several services and the mixing of various types of emissions. It is reasonable to expect a great improvement in this regard if these present shared bands would be discontinued and exclusive bands set aside internationally for each service with the further possibility that portions of bands may be limited to certain types of emissions. Where a type of service, such as fixed, employs a number of different bandwidths, depending upon the communication involved, international carriers should be assigned blocks of frequencies in order to provide for the greatest flexibility in bandwidth and type of emission.

Our present hopes that we can find space for every essential service in the radio spectrum are based upon moving out of the high portion of the spectrum those services which can be effectively handled in the very high or ultra-high portion of the spectrum, and similarly those from the very high portion of the spectrum that may be handled effectively and perhaps more efficiently in the ultra-high portion of the spectrum.

Among the difficulties encountered in long-distance radio communication are the effects of ionospheric disturbances which are particularly prevalent in or near the auroral zones. It has long been known that radio paths north and south are much better than those which go east or west. The investigations of propagation conditions throughout the world lead to the conclusion that since we must establish east-west circuits, they will operate with the best propagation characteristics in the equatorial regions. Carrying this thought still further, we might possibly visualize a wide-band multichannel communication system developed between appropriate points around the world at approximately 20 degrees north latitude. This transmission belt could be used as a trunkline system with north-south circuits leading to appropriate terminal points, thence east or west to another terminal and north or south to destination. By this means, an international communications system could be developed utilizing the manual and automatic devices employed in domestic telephone and telegraph systems. Besides providing the greatest possible freedom from interruptions due to poor radio conditions, a long step would be taken in the direction of an economical use of the radio spectrum. At least two of our large communications companies are even now considering an adaptation of this idea by providing for establishment of an automatic relay station at a point in the Western Hemisphere near the equator to handle traffic from New York to European points.

It is interesting to note that even as late as 1938 the international-frequency-allocation table, developed at

Cairo in the International General Radio Regulations, prescribed the bands of services only up to 30 megacycles except for the 56- to 60-megacycle amateur band. Above 30 megacycles, there was included a table which indicated a distribution which would be used on the American continents as a basis for future research and experiments. However, this table did not even visualize anything above 300 megacycles. Now, of course, we are thinking of the possibility of an allocation table up to 30,000 megacycles. We realize that there will be a tremendous demand for frequencies for new services developed as a result of experience in the War, such as anticollision services and to provide for expansion in the aeronautical and maritime services, and, further, that sufficient channels must be made available for television and frequency-modulation broadcasting and to insure methods whereby television and frequency-modulation programs can be distributed throughout the country and possibly even internationally.

It is interesting to note that one of our foremost radio engineers, in 1928, recommended the allocation of 100-kilocycle bands for television as being clearly the minimum bandwidth for true television. Of course, this was based on the status of the then-known art of purely mechanical scanning. If I remember correctly, the Commission did allocate four television channels, 100 kilocycles wide as a result of this testimony. Now we are somewhat dubious as to whether or not with the state of the art as we can possibly foresee it, a band of 6 megacycles is sufficient for postwar commercial television service employing black-and-white pictures; and if we should provide for color television, the bandwidth necessarily will have to be greater for the same number of lines. Indeed there is some question whether the 525-line frame is sufficient for large screens or theater use.

Therefore, the problems now confronting us include the allocation of frequencies with the least possible waste to services whose bandwidth of emission can be measured in cycles, and also to provide space for services which, even under the most optimistic predictions, appear to require a bandwidth of emission of several megacycles. Certainly, it becomes obvious that if we are going to talk about television in terms of providing double the present number of channels, each with a bandwidth of 10 megacycles or more, that service must look beyond the very high portion of the spectrum into the ultra-high. This concerns us deeply because I have heard it said, for example, that the frequencies above 500 or 600 megacycles are not satisfactory for broadcast or other high-powered services and should be used more or less exclusively for highly directional beamed services where lower power can be employed. We must admit that we have very little information about the actual characteristics of frequencies in the ultra-high and super-high portion of the spectrum. Therefore, since we do not know these answers, we particularly welcome the formulation of the Radio Technical Planning Board and the co-ordinated study which is beginning to evolve between the

Board, the Commission, and the Interdepartment Radio Advisory Committee.

I think that the problems facing radio engineers today are greater and their correct solutions will have more far-reaching effects than in any previous time in the history of radio. With the opening up of the ultra-high and super-high portions of the spectrum to commercial services, you must make certain that any service is not frozen by the manufacture of large amounts of equipment in a portion of the spectrum not suitable for that service. In addition, you should be sure that every possible means of efficient spectrum utilization is employed. Some of the problems that face the RTPB and radio engineers today, in addition to the obvious ones (in what portion of the spectrum shall various services be placed and how many channels should be provided for these services), are general equipment and operating problems, such as:

1. Is the use of single-sideband or vestigial-sideband transmission practicable for the mobile services?
2. How about the use of vestigial-sideband transmission for high-speed telegraphy?

3. How can we improve the characteristics of receivers now employed in various services, with particular emphasis placed on stability and discrimination against adjacent-channel interference?
4. What are the lowest practicable tolerances which may be met by equipment manufactured for each service after the war?
5. What means can be employed to reduce radiation outside of the required band of emission?
6. Considering the international communications system as a whole, what practical methods can be found for utilizing to a maximum multiplex systems with single-sideband transmission?

I have not attempted in this paper to outline in detail the problems of frequency allocation which now face us. I could not in the allotted time even if I knew them all. But these are some of the thoughts that are running through our minds so that the final "compromise" that Dr. Baker and Dr. Goldsmith talked about yesterday will provide for as great and efficient use of the spectrum as possible.

Bioelectric-Research Apparatus*

HAROLD GOLDBERG†, MEMBER, I.R.E.

Summary—This paper describes a complete amplifying and cathode-ray-tube system suitable for certain bioelectric-research applications. Three independent amplifying channels, working into a three-trace cathode-ray tube allow the recording of three, independent, simultaneous phenomena. The three traces may be partially or wholly superimposed as desired. Each amplifying channel consists of a battery-operated, three-stage, direct-current amplifier coupled to a power-line-operated, direct-current output stage. All channels operate from a common battery and power-line supply. Cathode-ray-tube sweep circuits are direct-current-coupled and entirely power-line-operated. Individual control of centering and sweep speed for each trace is provided. An associated stimulating circuit, synchronized with the sweep, provides stimuli for biologic specimens under study.

The amplifier input is either single-ended or differential as desired. Response is flat within 1 decibel from 0 to 7000 cycles per second with a maximum voltage gain of 131 decibels. A maximum voltage gain of 125 decibels may be attained with a response flat within 1 decibel from 0 to 14,000 cycles per second. The sweep amplifiers provide an undistorted output of approximately 500 volts, sufficient for full-scale deflection of the Western Electric 330C cathode-ray tube operating at 3 kilovolts accelerating voltage. Sweep frequencies range from 1 per minute to 20,000 per second.

INTRODUCTION

THE FIELD of bioelectric phenomena is largely unknown to the communication engineer. Nevertheless, the thermionic vacuum tube and cathode-ray tube, devices developed in the communications field,

have enabled researchers in the bioelectric field to advance their knowledge of these interesting processes. Some have perhaps had direct contact with one use of this knowledge, the electrocardiogram. But even those who have had this contact have not, perhaps, understood that the electrocardiogram was a record of potential variations with time, between two contacts on the body, and that these potential variations were the result of periodic electromotive forces generated by the heart as it beats. In fact, all muscle and nerve tissue, not only in man, but in the entire animal and insect kingdoms, generate these electromotive forces when active. Other tissues also exhibit electrical phenomena. Plant membranes show characteristic potential changes during certain processes; the processes of metabolism produce electrical phenomena; in fact, probably all the metabolic and katabolic processes of living organic matter produce electrical phenomena.

The apparatus to be described in this paper was designed for the study of action potentials, those electromotive forces which accompany the activity of nerve in conducting pulses, and the activity of muscle in the process of contraction and relaxation. The potential differences set up vary with time. The duration depends on the tissue. A complete cycle of contraction in smooth muscle may take a minute. A nerve impulse may last 1 millisecond. The potential differences led from the heart may have a peak value of 70 or 80 millivolts; cortical potentials led from the brain only 10 or 20 microvolts.

* Decimal classification: 537.87×621.375.1. Original manuscript received by the Institute, December 1, 1941; revised manuscript received, January 26, 1944. Presented, Winter Convention, New York, N. Y., January 12, 1942. The equipment for this apparatus was built at the University of Wisconsin in 1940.

† Stromberg-Carlson Company, Rochester, New York.

three output stages operate from a common power supply and are located with the cathode-ray-tube equipment in a position external to the shielded room.

Fig. 1 shows the circuit for a single channel. The input impedance is 2.5 megohms for normal operation. When desirable, the input may be made single-ended simply by feeding the amplifier between ground and one input lead. The circuit is inherently phase-inverting and converts the single-ended input to push-pull. Small unbalances in the first stage may be compensated by means of the 0.25-megohm potentiometers in the input-grid circuits. A calibrating circuit employing cathode injection provides from 2 to 5000 microvolts. The methods of stabilization, balancing, and differential action used in this circuit and described in the previous paper are carried further in this amplifier. A large effective common-cathode resistance is attained by the use of a 6G6G pentode as a common-cathode resistor. The utilization of the high plate resistance of the pentode for this purpose provides a high effective resistance without a correspondingly high IR drop. The variable resistance in the cathode of this pentode provides a means for adjusting the operating voltages of the first stage and further increases the effective plate resistance of the 6G6G. Type 38 tubes are used as amplifiers with very low plate and screen voltages. When properly balanced, the rejection ratio of the amplifier to in-phase input voltages as compared with out-of-phase voltages is 100,000 to 1. When reduced gain is satisfactory, means is provided for shunting a 25,000-ohm resistor from plate to plate of the first stage. This reduces the gain and the effect of first-stage drift on the output of the channel. Matched tubes are not required for operating balance. Large differences in emission may be balanced by dropping the heater voltage on the tube having the greater emission. A 5-ohm variable resistor is provided for this purpose. Small differences may be balanced by means of the 3000-ohm potentiometer in the plate circuit. Balance is measured by comparing the output of the channel with and without plate-to-plate output in the second stage. Since a reduction in bandwidth is sometimes necessary for certain experiments, capacitance may be shunted from plate to plate for this purpose as shown in Fig. 1.

The second stage is similar to the first except that the operating voltages are higher so that larger signal voltages may be handled. The master gain control of the channel is located in this stage and consists of a 1-megohm variable resistor in series with a 25,000-ohm variable resistor shunted from plate to plate. The two controls provide coarse and fine control of gain, respectively. A circuit providing plate injection of push-pull voltage of either sign and variable amplitude is used in the second stage as a centering control for the output of the channel as applied to the cathode-ray tube.

The third stage does not employ a pentode as a common-cathode resistor since sufficient in-phase degeneration is obtained in the first two stages. Type 1231 tubes

are used as amplifiers. Emission differences may be balanced in this stage by control of heater voltage. Emission balance is not employed in the second stage since operating differences due to this cause may be taken care of by slight unbalancing of the operating output voltage of stage 1. At the loss of some gain, the bandwidth of the amplifier may be increased by the use of the degenerative equalizer in the cathodes of the tubes of this stage.

The final stage is power-line-operated and also employs type 1231 tubes. The output of either side is brought out to a switch for synchronizing purposes.

Adjustment of operating voltages requires a high-resistance voltmeter and is done progressively starting with stage 1 and proceeding towards the output. The adjustable range is limited to that needed to accommodate tube variations. The average operating conditions are necessarily designed into the amplifier. The output stage is designed so its operating average plate voltage to ground is equal to that of the sweep amplifiers in the cathode-ray-tube display circuits. The second anode of the cathode-ray tube is also operated at this voltage and defocusing due to voltage differences between deflecting plates and/or second anode is minimized.

The maximum voltage gain of the amplifier is 131 decibels flat within 1 decibel from 0 to 7 kilocycles. With equalization, the gain is 125 decibels flat within 1 decibel from 0 to 14 kilocycles. The inherent noise referred to the input is 8 microvolts at the maximum bandwidth of the amplifier. The high-frequency components of the noise may be removed by narrowing the response but a flicker component at very low frequencies remains. The limiting factor in the operation of this amplifier is not drift but noise. While there is appreciable drift at maximum gain, it is not such as to mask action potentials. The noise, however, places a lower limit on the magnitude of action potentials that may be satisfactorily amplified.

Because of the stability of the amplifiers, they are operated on a common set of batteries and a common power-line supply for the output stages. Four standard-size, 45-volt batteries supply the first three stages of all three amplifiers. Separate storage batteries are used for the heaters, and separate 22.5-volt C batteries are used for the centering circuits of the three preamplifiers. A power-line-operated supply giving 450 volts is connected in series with the battery supply. Heaters of the output stage are alternating-current-operated. The undistorted output voltage available from the amplifiers is 500 volts, peak to peak.

Construction is of the rack-and-panel type. All battery-operated equipment is located in the shielded workroom. All alternating-current-operated equipment is placed just on the other side of the wire-screen wall of the shielded room with controls brought through the wall on extension shafts. Chassis for the high-gain, direct-current, preamplifiers are spring-mounted from the panel. The period of the mounting is made long. Flexible

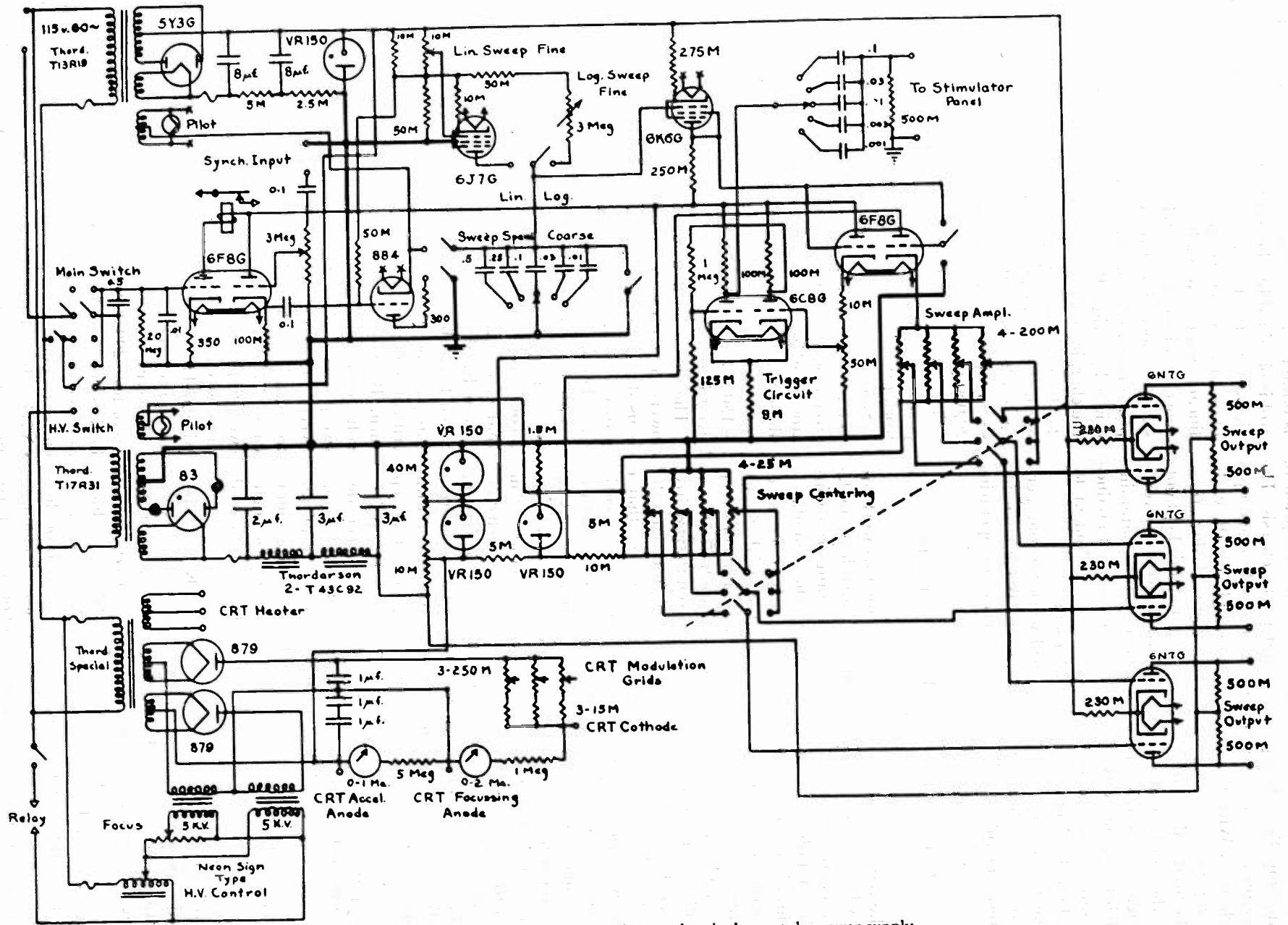

Fig. 2—Sweep generator, synchronizer, and cathode-ray-tube power supply.

leads are used for connections. With the exception of heater supplies, all batteries mount in the chassis. The three output stages and their power supply make up a single unit. With the high-voltage supply for the cathode-ray tube, sweep circuits, and timing flasher, these make up the alternating-current-operated unit kept outside the shielded room. All alternating-current power is brought in through conduit to a shielded box containing a high-frequency wave trap. This is necessary to reduce the interference coming from diathermy equipment located on the floor above the work room.

Once adjusted, the amplifiers will work for long periods of time without further attention. When changing batteries or tubes, it is desirable to check the operating voltages and readjust if necessary.

CATHODE-RAY-TUBE EQUIPMENT AND SWEEP CIRCUITS

The requirements on sweep circuits for this work are somewhat severe. The circuits must be capable of single-sweep operation without long-time-constant transients in the amplifiers. In bioelectric work, the stimulus is synchronized with the sweep so that each sweep is accompanied by a synchronized action potential. Standing-wave patterns produced by rapid repetition of sweep and stimulus are undesirable because rapidly repeated stimuli give rise to a response different from that elicited by a single stimulus in muscle, and tend to fatigue the tissue in a short time. If the writing speed is such that a single sweep produces insufficient exposure of the sensitive recording material, it is necessary that another exposure, made by repeating the sweep and stimulus be made to occur at the same position on the cathode-ray screen as the original. Sweeps are not used, however, in work with automatic tissue such as the heart, which contracts rhythmically without stimulation. In such work, the time axis is supplied by moving the photosensitive recording material at a constant velocity. Work with nonautomatic tissue, however, clearly calls for sweep generators and amplifiers of the direct-current type.

The prototype of the present system has been described recently.² The present system represents a considerably refined and elaborated development of the earlier circuits. Voltage supplies for sweep and stimulator circuits are independent of supplies of the high-gain amplifiers. Stimulator circuits are more flexible and positive in operation.

A low power supply, stabilized by a VR-150 tube, with the positive side grounded, supplies the sweep generator tubes 6J7G and 884 and provides part of the voltage needed by the sweep amplifiers, 6N7G tubes. Sweep voltage is derived from a condenser which charges negatively relative to ground. Logarithmic sweep is obtained by charging the condenser through a resistor; linear sweep, by charging the condenser through a 6J7G pentode. Coarse control of sweep speed

is obtained by switching charging capacitors. Fine control is obtained by the 3-megohm, variable-charging resistance in the logarithmic sweep, and by the 10,000-ohm variable bias control on the charging tube in the linear sweep. Normally, the charging condenser is short-circuited by a switch. When sweep is desired, this switch is opened and the condenser charges to the supply voltage. Closing the switch returns the sweep to its original position. Periodic sweep is obtained by shunting the charging condenser with the 884 gas triode. With the gas triode in the circuit and the short-circuiting switch open, the circuit produces relaxation oscillations which cease when the switch is closed. In this way, both single sweeps and periodic sweeps ranging from 1 per minute to 20,000 per second may be obtained.

The remainder of the power supply provides 500 volts positive to ground with three VR-150 tubes in a network providing stabilized voltages for various purposes.

Since it is desirable, for other circuits in the system, to have a sweep voltage that rises positively relative to ground, i.e., the inverse of that provided by the generator, a 6K6G as a triode is used in a direct-current phase-inverter circuit. The load for the tube is split between cathode and plate, the cathode load going to -150 volts, and the plate load going to +150 volts relative to ground.

The output of the inverter is fed to two cathode followers, 6F8G. One of these, its load returned to ground, is used to drive a trigger circuit 6C8G, whose output provides synchronized pulses for the final stimulator circuit. The first stage is always nonconducting or fully conducting, depending on whether the grid is below or above a certain critical voltage relative to ground. The second stage will be in a state which is the inverse of that of the first stage. If the grid of the first stage is driven by the sweep voltage, a square pulse may be taken from the plate of the second stage. The start of this pulse occurs as the input sweep voltage passes the critical voltage; the finish occurs on the sweep return. By varying the amplitude of the input sweep voltage, the time of the start of the pulse relative to the sweep may be varied from close to the beginning of the sweep, to the end of the sweep. The square pulse is led to an adjustable resistance-capacitance differentiating circuit. The result is a positive pulse of voltage as the sweep input passes the critical voltage, and a negative pulse when the sweep returns. The stimulator circuit is triggered by the positive pulse in various ways for stimulus and rejects the negative pulse.

The second cathode follower, $\frac{1}{2}$ -6F8G, has a load made up of four 200,000-ohm potentiometers in parallel. The load is returned to +22 volts, regulated. The outputs of three of these go to one grid each, of three direct-current, phase-inverting, push-pull sweep amplifiers, 6N7G tubes. These give individual control of sweep amplitude for each of the three traces. Where single control of all three is desired, all three grids are switched to the output of the fourth 200,000-ohm potentiometer.

² Harold Goldberg, "Synchronized voltages for bioelectric research," *Electronics*, vol. 14, p. 30; August, 1941.

The remaining three grids of the sweep amplifiers go to a network which allows them to be varied either individually or in multiple from ground to some 50 volts positive relative to ground. These 25,000-ohm controls provide centering for the sweeps.

The combined controls allow accurate control of both the speed, amplitude, and starting positions of the sweeps on all three traces. If these are made identical, all simultaneous events will lie on a line perpendicular to the sweep traces. By stabilizing the voltages, the adjustment remains stable for long periods of time.

The Western Electric 330C tube is supplied with adjustments for focusing, accelerating voltage, and individual control of beam currents. The power-supply circuits are so arranged that the accelerating voltage may be changed without altering the focusing once the focusing has been done for one accelerating voltage. While the supply will deliver 5 kilovolts, 3 kilovolts is a practical upper limit if long tube life is desired. The sweep amplifiers will deliver sufficient undistorted output for edge to edge deflection and 3-kilovolt operation. A time-delay circuit is incorporated in the high-voltage circuit to keep the high voltage from the tube until the cathode is at operating temperature.

STIMULATING CIRCUIT

The pulses derived from the trigger circuit are fed into a battery-operated stimulator panel. For single stimuli, the pulses are applied to a triode biased beyond cutoff, 1/2-6C8G. This eliminates the undesired negative pulse and clips the tail of the positive pulse. By driving the grid positive, the tip of the positive pulse may also be clipped if desired. Adjustable bias is provided. The output of the tube is fed to the specimen through a potentiometer and shielded transformer GR-578A.

It is sometimes desirable to use a burst of repetitive pulses for a stimulus rather than a single pulse. The length of the burst, amplitude of the pulses, and repeti-

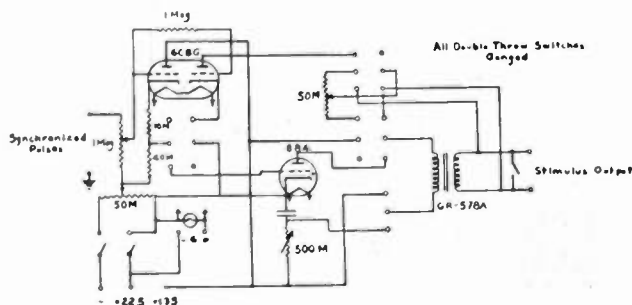

Fig. 3—Stimulator circuits.

tion rate, should be variable. To accomplish this, the condenser pulses are led to a triode acting as a cathode follower, 1/2-6C8G. The output is fed to the grid of an 884 gas triode arranged to act as a relaxation oscillator except that it is normally overbiased. A positive pulse to the grid sufficient to bring the tube to the firing state will cause it to go into oscillation for the duration of the pulse. A negative pulse will have no effect. Thus a burst of repetitive pulses will be obtained during the positive

input pulse. The burst length depends on the pulse length, and the frequency, on the constants of the relaxation circuit. The output is fed through an amplitude control and shielded transformer, GR-578A.

TIMING FLASHER

In applications such as heart research where no sweep is used and the recording material is moved at a constant velocity to provide a time axis, some device that

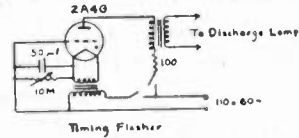

Fig. 4—Timing flasher.

will put accurate timing marks on the record is desirable. The system used is based on the power-line frequency, a primary standard sufficiently accurate for this purpose. The flashing unit itself is a mercury-helium, discharge lamp shaped in the form of a U and made of small-bore tubing. At about 3 kilovolts, and maximum allowable current, it gives a brilliant, highly actinic light. All of the tube is opaqued except a small window about 3/32 of an inch square at the bend of the U. The tube is placed alongside the cathode-ray tube with the window flush with the screen.

The circuit illustrated applies pulses of voltage to the discharge tube every *n*th cycle of power-line frequency, where *n* = 1, 2, 3, etc. The value of *n* is determined by the time constant of the RC network in the cathode of the gas triode. The operation is simple. If the condenser is initially discharged, the tube will fire and charge the condenser at the first positive half cycle. The charge on the condenser prevents further firing of the tube until it

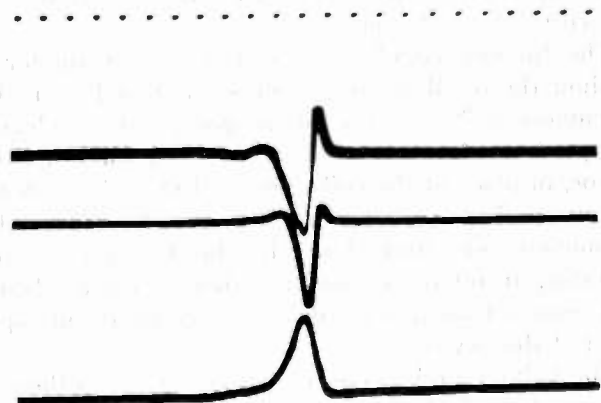

Fig. 5—Record of action potentials from turtle heart.

has leaked off sufficiently for the tube to fire again; an event which will occur at the first positive half cycle following the reestablishment of conditions favorable for firing. Thus the tube can fire only on positive half cycles and will fire only at those half cycles that find the condenser sufficiently discharged to allow the tube to fire. It is evident that by adjusting the time constant of the discharge, the number of cycles intervening between firing half cycles can be chosen. The system is quite

stable for n up to 6. For larger values of n , as would be expected, a random element appears and the firing may occur every n th cycle on the average but may deviate by plus or minus 1 or more cycles.

The apparatus described is the result of a gradual development program aimed at the needs of general electrophysiological research. The equipment is versatile and may be applied to practically any field of biophysics. With auxiliary apparatus it may be applied, for instance, to the hydrodynamics of the heart, or to the dynamics of muscle. The sensitivity, frequency response, and stability are such that it is applicable to all but a very few phenomena. The versatility of the sweep and stimulating circuits makes possible a great variety of experimental procedures. The ability to take three si-

multaneous, independent, records is of great advantage since instantaneous time relations among various phenomena are of great interest and importance in this field. While it is possible to get the time relations between any number of events by recording them in pairs, such procedures require that all events be reproducible. This is only approximately true in biological phenomena and it is, therefore, desirable to take as many simultaneous records as there are events to be compared. Physical limitations, however, set three simultaneous records as a fair upper limit at the present time. By using auxiliary equipment developed in conjunction with the apparatus, combinations of electrical variations, pressure variations, contraction, physical volume, sound, and gross motion have been recorded simultaneously.

Application of the "Memnoscope" to Rectifier Study*

W. E. PAKALA†, NONMEMBER, I.R.E., AND VICTOR WOUK‡, NONMEMBER, I.R.E.

Summary—The "memnoscope" is a device employing rotating condensers for studying randomly occurring electrical phenomena. This paper describes some records obtained with the "memnoscope" when studying arcbacks in shielded mercury-arc rectifiers. It has been found that arcbacks may occur on the shield, without a cathode spot forming on the anode and without resultant disturbances in the external electrical circuits.

THE "memnoscope" is a device for obtaining oscillograms of randomly occurring electrical phenomena, and events immediately preceding and following, by "memorizing" the wave forms for a period of time long enough in which to open a camera shutter. Such a device is of particular value in the study of arcbacks in mercury-arc rectifiers, where the arcbacks are known to occur at random.¹

The "memnoscope" and associated apparatus for recording the oscillogram, are illustrated in Fig. 1. The "memnoscope" consists of a group of condensers mounted in the slots of a rotor of a direct-current motor, in place of the coils. One end of each condenser is connected to a commutator bar, and the other end to a common connection. Three brushes bear on the commutator, an input, output, and short-circuiting brush. The rotor is turned in the direction shown, during operation of the device.

The voltage under consideration charges up the condensers through the input brush. The condensers retain this charge for almost a full revolution of the rotor; and then give it up to the recording circuit connected to the output brush. During the time that the condensers move from the input to the output brush, a camera shutter may be tripped by the randomly occurring

phenomenon, and thus a picture can be taken of events happening a bit before, and as long after the random occurrence, as desired.

In Fig. 1, the phenomenon under study is the voltage wave across the anode and cathode of an Ignitron

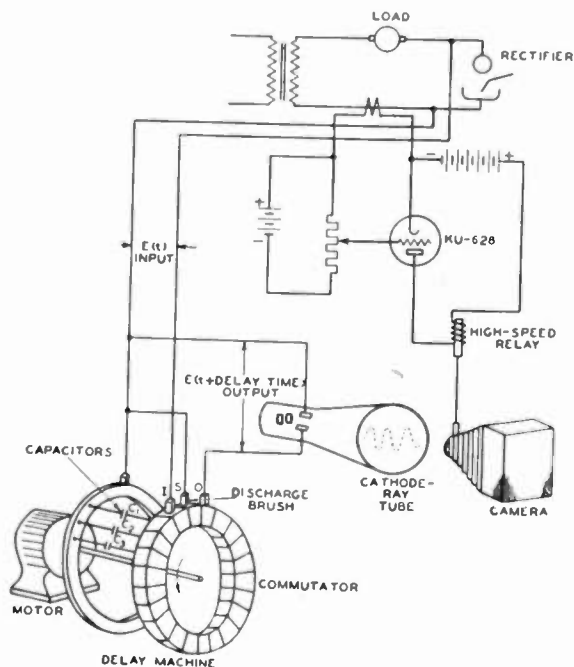

Fig. 1—Memnoscope: A device for obtaining oscillograms of random events.

rectifier during arcbac. An arcbac is accompanied by reverse current in the cathode lead; this reverse current, which exists only when the random arcbac occurs, trips a Thyatron, which in turn opens the shutter of a camera by means of a suitable relay.

It is obvious that the amount of delay, or "memory time," the number of points recorded on each cycle,

* Decimal classification: 621.313.7×R337. Original manuscript received by the Institute, October 28, 1943.

† Westinghouse Electric and Manufacturing Company, East Pittsburgh, Pa.

‡ J. Slepian and R. Ludwig, *Trans. A.I.E.E. (Elec. Eng., October, 1931)*, pp. 793-796; October, 1931.

i.e., the "resolving power" of the "memnoscope," the amount of distortion, etc., all are dependent on the number of condensers used, and the speed of the rotor. These effects, and construction details, are discussed thoroughly in a previous paper.²

VOLTAGES ON THE GRID OF A SHIELDED RECTIFIER

Tests were made to determine the behavior of the voltages on the shield in a large Ignitron rectifier during arcback. For this purpose, not one, but six rotors with condensers were driven by a motor, and a magnetic oscillograph was used instead of a cathode-ray oscilloscope. This necessitated amplifiers in the output circuits of the memnosopes, since the condensers used, of 0.01 microfarad capacitance, were not powerful enough to actuate a magnetic oscillograph element.

Fig. 2 is a block diagram of the connections necessary to obtain an oscillographic record of the current, anode-cathode voltage, anode-shield voltage, and shield-cathode voltage immediately preceding and for a few cycles following an arcback.

Fig. 3 is a typical oscillographic record obtained with this setup. It records an arcback that cleared up before the circuit breaker had a chance to open.

A motor load, with a counter electromotive force of 350 volts, drawing 300 amperes direct current, was run by means of the rectifier. The alternating-current voltage of the supply transformer was 600 volts. This means that the peak inverse voltage applied to the tube was $600 \times \sqrt{2} + 350 = 1198$ volts. Load control was effected by the phasing of the ignitor firing pulse. In the record illustrated, the tube was fired with about 75 degrees de-

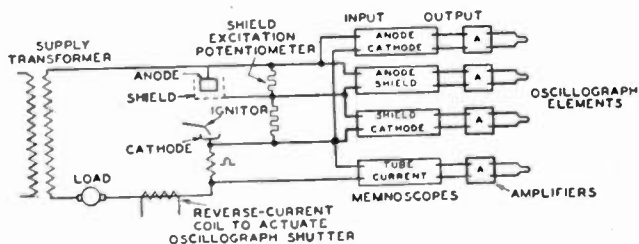

Fig. 2—Connection for obtaining several simultaneous oscillograms of Ignitron voltages.

lay at 60 cycles. The shield was excited by means of a resistance potentiometer connected between the anode and cathode, as shown in Fig. 2.

Analyzing the record in detail, a very interesting course of events is discovered. From the start of the oscillogram at the left, to the point C, there is indicated a cycle of rectification prior to an arcback. During the zero-current portion of the cycle, it is seen that negative voltage is borne by the anode-shield and shield-cathode spaces; the anode-cathode voltage, which is the sum of these two, is normal. Previous to firing, it is seen that positive voltage is borne by all parts of the tube. At A, the ignitor is fired, as is evidenced by the appearance of

load current, and the fall of all the voltages. At B, conduction ceases, and the various spaces start to bear their normal inverse voltage, during the negative portion of the cycle.

At C, an arcback occurs; i.e., a cathode spot forms on the anode, and an arc is struck between what is normally the anode and the mercury pool. This is indicated by the appearance of reverse current, and by the drop of the three inverse voltages. The reverse current seems to rise to a peak value only twice that of the forward current. In reality, the current rises to a value several times greater than this; the distortion of the amplifier accounts for the reduction of the back-current peak.

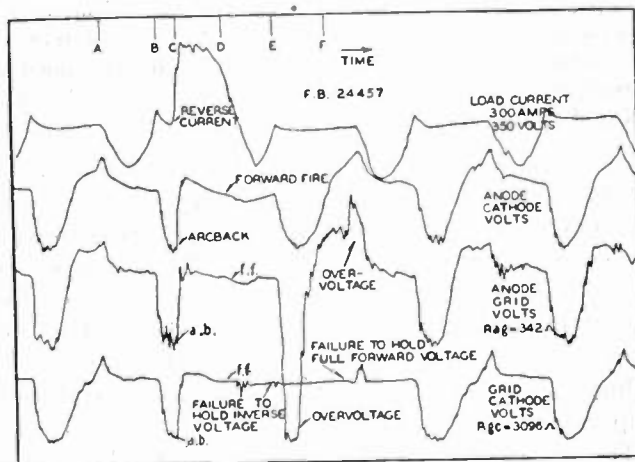

Fig. 3—Oscillogram showing arcback and shield-cathode space collapse without subsequent arcback.

Following the arcback, the tube forward fired, as is seen at D. That is, a cathode spot appeared on the mercury pool before the ignitor fired, and the forward voltage peak, evident at A, is not evident at D.

At the next inverse-voltage period E, a very curious thing is seen to have occurred. A cathode spot appeared on the shield, resulting in a collapse of the voltage between the shield and cathode. However, no cathode spot appeared on the anode. Therefore the full anode-cathode voltage was borne by the anode-shield space, and the large overvoltage is seen on the oscillogram. It is to be noticed that the over-all voltage, the anode-cathode voltage, is normal, and there is no reverse current. The component voltages, though, are not normal.

At F, a similar thing happened in the forward direction. The cathode-shield space failed to hold forward voltage, and the shield-anode space sustained an overvoltage in the forward direction. This resulted in a forward fire a few degrees later, as is evidenced by the fact that the forward current is a little bit larger than normal. After this, though, normal operation of the rectifier was resumed.

(The oscillations in the anode-shield voltage trace are due mainly to poor brush contact in the "memnoscope." The rotors used in these tests held 147 condensers, of which 142 were used to give the "memory" time. The rotor was run at 1500 revolutions per minute, which

² W. E. Pakala, "A memory attachment for oscilloscopes," *Trans. A.I.E.E. (Elec. Eng., 1938)*, vol. 57, pp. 682-684; 1938.

meant that in the 60-cycle wave, there was one condenser point for every 5.9 degrees of the cycle.)

The "memnoscope" has been used extensively to determine the phase occurrence of arbacks.³ Other methods of recording random phenomena with long-persist-

³ W. E. Pakala and W. B. Batten, "Phase occurrence of arbacks in rectifiers," *Trans. A.I.E.E. (Elec. Eng., 1940)*, vol. 59, pp. 345-347; 1940.

ence cathode-ray tubes are used.⁴ For studying more than two or three wave forms simultaneously, and in detail not better than 2 or 3 degrees of a 60-cycle wave is desired, the "memnoscope" is an excellent device for the purpose.

⁴ A. W. Hull, "An oscillograph with a memory," *Gen. Elec. Rev.*, January, 1936.

High-Potential Vacuum-Tube Voltmeter*

PAUL B. WEISZ†, ASSOCIATE, I.R.E.

Summary—A vacuum-tube voltmeter for the measurement of high voltages, with a range of 0 to 2000 volts is described. It utilizes the principle of the inverted vacuum tube; thus the high input impedance of the normal vacuum-tube voltmeter is combined with the ability of measuring high voltages.

IN A great number of applications it is desirable to have available a voltmeter which will measure potentials of the order of one or several kilovolts without drawing an appreciable current. The electrostatic-type of voltmeter often used for this purpose is a rather impractical laboratory instrument because it is mechanically too delicate. Mechanical voltmeters of the ordinary type will draw at least a few tenths of milliamperes, usually more.

The principle of the inverted vacuum tube¹ can be successfully applied to constructing a vacuum-tube voltmeter for high potentials and having large input impedance. Normal receiving tubes are usually capable of handling potentials up to more than 2000 volts between electrodes. For example, the 6C6 and similar types have been used in voltage regulator circuits for such high potentials, even in pentode connection.²

Fig. 1 shows the circuit diagram of a voltmeter for the range 0 to 2000 volts, using a 57-type tube, and cali-

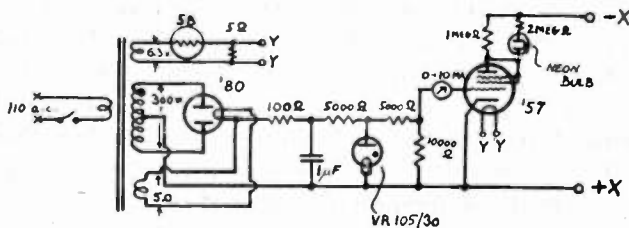

Fig. 1—Complete circuit diagram of vacuum-tube voltmeter for a range of about 0 to 2000 volts.

brating the 0 to 10-milliamper grid-current meter in terms of the unknown voltage which is applied between the cathode and plate with the negative terminal on the plate. Stabilization of the grid potential and fila-

* Decimal classification: R243.1. Original manuscript received by the Institute, August 16, 1943.

† Bartol Research Foundation of the Franklin Institute, Swarthmore, Pennsylvania.

¹ F. E. Terman, "The inverted vacuum tube, a voltage-reducing power amplifier," *Proc. I.R.E.*, vol. 16, pp. 447-462; April, 1928.

² H. V. Neher and W. H. Pickering, "Two voltage regulators," *Rev. Sci. Instr.*, vol. 10, pp. 53-56; February, 1939.

ment current makes the instrument independent of reasonable line-voltage variations. Fig. 2 shows the calibration of the instrument, and the error incurred by a line-voltage change.

The neon-discharge tube in the plate circuit is provided in order to indicate application of the unknown

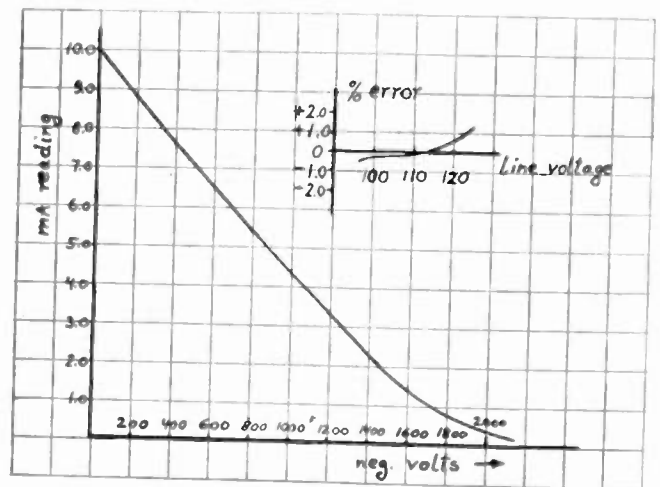

Fig. 2—Calibration curve for high-voltage vacuum-tube voltmeter, and error correction for variation in line voltage.

potential with the polarities reversed, in which case the tube will glow due to the small plate current which will then flow. The latter is limited, however, and conditions are such that the grid current will not increase above the normal rest value (no voltage applied to plate).

It is to be noted that the positive polarity of the unknown potential is applied to the cathode system of the instrument. Therefore we shall derive the full benefit of

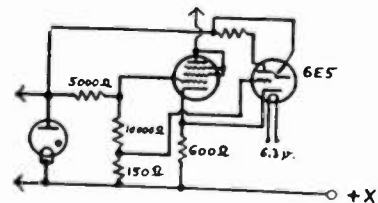

Fig. 3—Variation of the circuit shown in Fig. 1 using a 6E5 indicator tube instead of milliammeter. The remainder of the circuit not drawn is identical with the circuit shown in Fig. 1.

this principle of tube operation only when the positive terminal of the unknown potential is grounded (if any ground is applied). The impedance of the meter will be

lower in case the negative terminal is connected to ground, in which case the impedance will be determined by the insulating properties of the transformer windings against ground, and all other elements of insulation between the cathode side of the circuit and ground.

With the positive terminal of the unknown voltage grounded, or neither one grounded, the impedance of the instrument was measured to be 5×10^9 ohms, with

the negative terminal to ground it was 1.5×10^8 ohms.

Fig. 3 shows how the original circuit may be modified for the use of a 6E5 indicator tube instead of a milli-ampere meter in the grid-current circuit. The accuracy of reading in this case, however, is naturally very poor, but the method may be used for rapidly checking for the presence of high voltages where accuracy is not required.

Steady-State Testing with Saw-Tooth Waves*

D. L. WAIDELICH†, ASSOCIATE, I.R.E.

Summary—The saw-tooth voltage wave has two main advantages over the square voltage wave in the testing of electrical networks. These are (1) the saw-tooth wave tests the response of the network not only to odd harmonic voltages but to even harmonics as well and (2) from the response to the saw-tooth voltage wave, the response to any other voltage of the same period may be obtained without the use of Fourier series. The square wave is also shown to be a special case of the saw-tooth wave. The response curves of several circuits to the saw-tooth wave are also obtained, and several experimental results are included.

INTRODUCTION

SQUARE-WAVE testing has become one of the accepted methods of testing components such as amplifiers and filters and systems of these components. The criterion used mainly in these tests has been a qualitative one in that the output wave shape was judged good if it very nearly resembled the input square-wave shape. Any adjustments made on the apparatus were made in an effort to give an output wave as nearly "square" as possible. The square wave has also been useful in determining the high-frequency response of video amplifiers in television work. In this type of amplifier the square wave was used as a way to obtain readily the response of the amplifier to the fore part of a suddenly applied "unit" or step voltage.

When the response of a network to the square wave is known and the response of the amplifier to any other steady-state wave of the same fundamental frequency is desired, it is necessary to make a tedious Fourier analysis of the output square wave of the amplifier and then a Fourier synthesis of the required output wave. This becomes quite unsatisfactory if the wave has any discontinuity in it. Furthermore, since a square wave contains only odd harmonics of the fundamental frequency, the response of the amplifier to the even harmonics is not known. This is particularly harmful in devices which have resonant circuits incorporated in them, for if the device is resonant at or near an even harmonic of the fundamental frequency, the square-wave response may not indicate this at all. One method of overcoming

this is to use unsymmetrical square waves for testing since these contain both odd and even harmonics.¹

This paper will show that if the response of an amplifier to a saw-tooth wave is known, the response to any other steady-state wave of the same fundamental frequency may be obtained from the saw-tooth response without resorting to a Fourier analysis and synthesis. Furthermore, it is possible to show that in steady-state work the response to a saw-tooth wave has the same significance as the response to the unit function (indicial admittance) has in transient work. The saw-tooth wave has all of the harmonics, both odd and even, present in it, and hence in testing, the response to a saw-tooth wave will give all of the information necessary. The response of the square wave will be shown to be a special case of the response to a saw-tooth wave. If the impressed steady-state voltage has no even harmonics, either the saw-tooth or the square-wave response may be used in obtaining the output wave. If, however, the impressed voltage has some even-harmonic components, the saw-tooth wave must be used. A few typical examples of the response of the simple circuits to the saw-tooth wave are also included. When the period of the saw-tooth wave becomes very large, the wave approaches a unit-step function and hence may be used to simulate a repeated unit function just as has already been done in testing video amplifiers² by the use of square waves for the determination of the high-frequency response. In most television work, only odd harmonics are encountered, and hence the square wave is nearly always adequate. It appears then that the saw-tooth wave will find its greater usefulness in lower-frequency amplifiers, especially those in which waves with even harmonics are encountered. Saw-tooth-wave generators are easily constructed, and it is possible to use, for example, the sweep circuit of an oscilloscope as a source, if necessary.

The square wave is composed of odd harmonics whose

* Decimal classification: R201.7 × R263. Original manuscript received by the Institute, August 30, 1943; revised manuscript received, February 14, 1944.

† University of Missouri, Columbia, Mo.

¹ E. H. B. Bartelink, "A wide-band square-wave generator," *Trans. A.I.E.E. (Elec. Eng., June, 1941)*, vol. 60, pp. 371-376; June, 1941.

² A. V. Bedford and G. L. Fredendall, "Transient response of multistage video-frequency amplifiers," *Proc. I.R.E.*, vol. 27, pp. 277-284; April, 1939.

amplitudes vary inversely as the order of the harmonic. The saw-tooth wave on the other hand contains both even and odd harmonics whose amplitudes vary inversely as the order of the harmonic. The saw-tooth is the more general wave in that it includes both odd and even harmonics, and also the response of a circuit to the saw-tooth wave will include twice as much information as the response of the same circuit to the square wave. In some cases as stated above this additional information is not needed.

In the following analysis of the output voltage of an amplifier for a given input voltage, the first step is to obtain the Laplacian transform of the input voltage. The input-voltage transform is then multiplied by the operational gain of the amplifier, and the product of the two is the Laplacian transform of the amplifier output voltage. The steady-state output voltage is calculated from its transform, and the result is an integral which

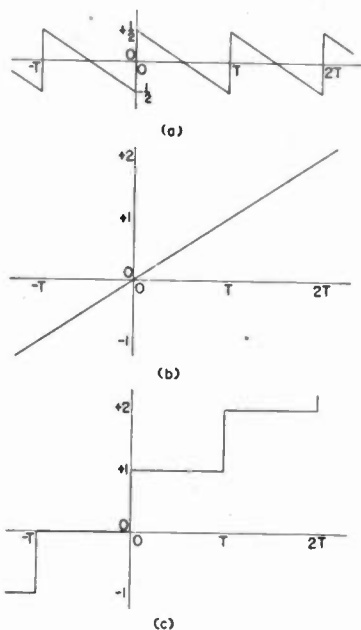

Fig. 1

- (a) The saw-tooth voltage.
- (b) The straight-line voltage.
- (c) The unit-step voltage which is the sum of the saw-tooth and the straight-line voltage.

has to be evaluated. It is then shown that the integrand of this integral is the product of the input voltage to the amplifier and the steady-state response of the amplifier to the step voltage of Fig. 1 (c). Since this step voltage is difficult to generate and the response of the amplifier to it is difficult to observe, the step voltage may be separated into three voltages, the saw-tooth voltage of Fig. 1 (a), the straight-line voltage of Fig. 1 (b), and a $\frac{1}{2}$ unit of direct voltage. The last-named voltage contributes nothing to the output-voltage integral, while the straight-line voltage yields the direct-current part of the output voltage. Since the value of the direct-current part of the output voltage, if there is any, does not affect the wave form, the wave form is determined by the saw-tooth voltage wave alone. If the response of an amplifier to a saw-tooth wave is known, the response of the

amplifier to any other wave of the same period may be determined by evaluating the output voltage integral. As a corollary it immediately follows that if the saw-tooth wave is passed without distortion, any other wave of the same frequency will be passed likewise without distortion. The amount of distortion present in the response of the amplifier to a saw-tooth wave is a measure then of the distortion that will be present in the response of the amplifier to any input wave of the same frequency. Simple circuits will be investigated to determine what types of distortion each produce and to indicate what might be done to lessen the distortion.

It is also shown that if the input wave has no even harmonics, the output wave may be determined from an integral whose integrand is the product of the input voltage to the amplifier and the response of the amplifier to the square wave of Fig. 2(a). The response of the amplifier to a square wave is then a measure of the amount of

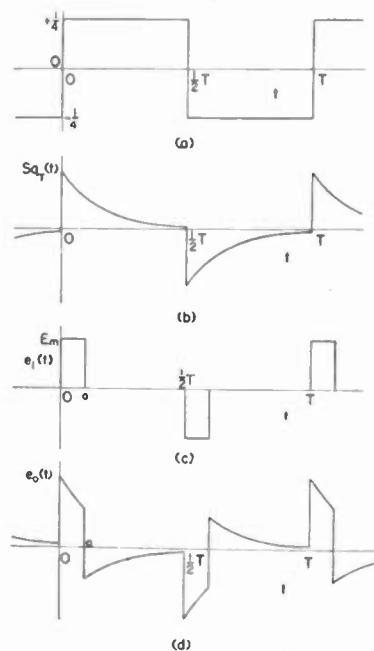

Fig. 2

- (a) The square-wave voltage.
- (b) The output voltage when a square-wave voltage is applied to the resistance-capacitance circuit.
- (c) The input voltage applied to the resistance-capacitance circuit.
- (d) The resulting output voltage.

distortion any input wave with the same frequency and without even harmonics, will encounter as it passes through the amplifier.

SAW-TOOTH WAVE

The first part of this paper will concern itself with showing that once the response of a circuit to a saw-tooth wave of a period T is known, it is possible to calculate from this, without the use of a Fourier series, the response of the same circuit to any periodic wave of the same period T . This statement is true except for the direct-current term which is usually zero in practical cases, but if it is not zero, it may almost always be neglected since it does not affect the wave form. The input

voltage $e_i(t)$ to the circuit has a period T , and its Laplace transform is

$$E_i(p) = p \int_0^{\infty} \epsilon^{-p\tau} e_i(\tau) d\tau = \frac{p}{1 - \epsilon^{-pT}} \int_0^T \epsilon^{-p\tau} e_i(\tau) d\tau. \quad (1)$$

If the operational impedance of the circuit is $Z(p)$, the input steady-state current $i_s(t)$ is^{3,4}

$$i_s(t) = \frac{1}{2\pi j} \int_W \frac{\epsilon^{pt} E_i(p)}{pZ(p)} dp \quad (2)$$

where the curve of integration W is the same as the curve C of the above reference.³ W is a path of integration that includes within it all of the poles of $E_i(p)/p$ but excludes all of the poles of $1/Z(p)$. The function $1/Z(p)$ also must not be an impulsive function and must not have any poles equal to $(jn2\pi/T)$ where n is a positive or negative integer. Similarly if $G(p)$ is the operational gain of the amplifier or other device, i.e., the operational ratio of the output voltage to the input voltage, the output steady-state voltage $e_o(t)$ is

$$e_o(t) = \frac{1}{2\pi j} \int_W \frac{\epsilon^{pt} E_i(p)G(p)}{p} dp \quad (3)$$

where W includes all of the poles of $E_i(p)/p$ but none of $G(p)$, and furthermore none of the poles of $G(p)$ are the same as those of $E_i(p)/p$. The voltage $e_o(t)$ may be re-written

$$\begin{aligned} e_o(t) &= \frac{d}{dt} \left\{ \frac{1}{2\pi j} \int_W \frac{\epsilon^{pt} E_i(p)G(p)dp}{p^2} \right\} \\ &= \frac{d}{dt} \left\{ \frac{1}{2\pi j} \int_W \frac{\epsilon^{pt} G(p)}{p(1 - \epsilon^{-pT})} \left[\int_0^T \epsilon^{-p\tau} e_i(\tau) d\tau \right] dp \right\} \\ &= \frac{d}{dt} \left\{ \int_0^T e_i(\tau) \left[\frac{1}{2\pi j} \int_W \frac{\epsilon^{p(t-\tau)} G(p)}{p(1 - \epsilon^{-pT})} dp \right] d\tau \right\}. \quad (4) \end{aligned}$$

If the part within the brackets is called $S_T(t-\tau)$ in which the subscript T is added to indicate that the function depends upon the length of the period T , then

$$\begin{aligned} S_T(t) &= \frac{1}{2\pi j} \int_W \frac{\epsilon^{pt} G(p)}{p(1 - \epsilon^{-pT})} dp \\ &= \sum_{n=-\infty}^{+\infty} \frac{e^{jn\omega t} G(jn\omega)}{jn\omega T} + \frac{1}{2} G(0) + \frac{t}{T} G(0) + \frac{1}{T} G'(0) \quad (5) \end{aligned}$$

where the sum is taken over all integral values of n except for $n=0$. This expression for $f(t)$ was obtained by evaluating the integral at the simple poles $p=jn\omega = jn(2\pi/T)$ where n is integral but not zero, and at the double pole $p=0$.

From (5) the quantity

$$Sa_T(t) = \sum_{n=-\infty}^{+\infty} \frac{\epsilon^{jn\omega t} G(jn\omega)}{jn\omega T} \quad (6)$$

may be recognized as the steady-state response of the circuit with operational gain $G(p)$ to the saw-tooth voltage of unit height and period T shown in Fig. 1(a). The second term is the steady-state response to a $\frac{1}{2}$ unit direct voltage applied to the circuit. The last two terms of equation (5), i.e.,

³ D. L. Waidelich, "Steady-state currents of electrical networks," *Jour. Appl. Phys.*, vol. 13, pp. 706-712; November, 1942.

⁴ S. Frankel, "Closed-form steady-state response of networks," *Communications*, vol. 23, pp. 30-36; April, 1943.

$$(t/T)G(0) + (1/T)G'(0), \quad (7)$$

may be recognized as the steady-state response of the same circuit to the straight-line voltage with a slope of $(1/T)$ shown in Fig. 1(b). Hence $S_T(t)$ is the steady-state response of the circuit to the unit-step function of Fig. 1(c) composed of the sum of the saw-tooth voltage of Fig. 1(a), the $\frac{1}{2}$ unit direct voltage, and the straight-line voltage of Fig. 1(b). From (4) and (5)

$$e_o(t) = \frac{d}{dt} \int_0^T e_i(\tau) S_T(t-\tau) d\tau, \quad (8)$$

and this equation checks with those of previous papers^{3,5} as shown in Appendix I. These results may also be derived directly from the Fourier-series expression for the output voltage $e_o(t)$. The step voltage of Fig. 1(c) has the same significance in steady-state work that the unit voltage of Heaviside has in transient work. The step voltage is quite impracticable, however, as a means of testing networks because it would be difficult to produce and also the response of the network could not be observed with facility.

The equation (8) for the output voltage of the network may be manipulated into the form

$$e_o(t) = \frac{d}{dt} \int_0^T e_i(\tau) Sa_T(t-\tau) d\tau + \frac{G(0)}{T} \int_0^T e_i(\tau) d\tau \quad (9)$$

where $Sa_T(t)$ is the response of a network to the saw-tooth voltage of Fig. 1(a). The last term on the right of (9) is the steady-state response of the circuit to the average or direct-current value of the applied voltage $e_i(t)$. In many cases this last term is zero because the circuit is such as to pass no direct current, i.e., $G(0)$ is zero or the average value of the applied voltage is zero. In any case the wave form is determined entirely by the first term of (9). Almost all of the amplifiers of cathode-ray oscillographs will eliminate the last term and only the first term will be observable. In almost every case then

$$e_o(t) = \frac{d}{dt} \int_0^T e_i(\tau) Sa_T(t-\tau) d\tau. \quad (10)$$

The last term of (9), which might be called the direct-current term of the output wave, may be obtained if needed by means of two simple measurements. The first measurement is that of $G(0)$ and is obtained as the ratio of the steady-state output direct voltage to the input direct voltage. The average value of the voltage $e_i(t)$ may be measured by means of a suitable direct-current voltmeter. Since both the input voltage $e_i(t)$ and the steady-state circuit response to the saw-tooth wave of Fig. 1(a), $Sa_T(t)$, have the same period T , the limits of the integral of (10) may be changed to any two numbers whose difference is the period T . It is possible to show also that

$$e_o(t) = \frac{d}{dt} \int_0^T e_i(t-\tau) Sa_T(\tau) d\tau \quad (11)$$

where again the limits of the integral may be any two values which differ by the period T . If it is possible then to neglect the direct-current term, the steady-state response of a circuit to any input voltage wave form of

⁵ D. L. Waidelich, "The steady-state response of circuits," *Communications*, vol. 22, pp. 14-18; October, 1942.

period T may be determined from the steady-state response of the circuit to the saw-tooth voltage of Fig. 1(a) with a period T .

As an example, suppose that the saw-tooth wave of Fig. 1(a) is applied to a series circuit of resistance R and capacitance C and that the resistance is equal to the reactance of the capacitance at the fundamental frequency $f = \omega/2\pi = 1/T$ of the saw-tooth wave. The wave form across the resistance is shown in Fig. 2(a) and has the equation

$$S_{aT}(t) = -1/(2\pi\gamma) + (\epsilon^{-\gamma\omega t}/1 - \epsilon^{-2\pi\gamma}) \quad (12)$$

where $\gamma = 1/\omega CR$ and t is the time in seconds. In this case $\gamma = 1$. Then if the input voltage $e_i(t)$ to the series

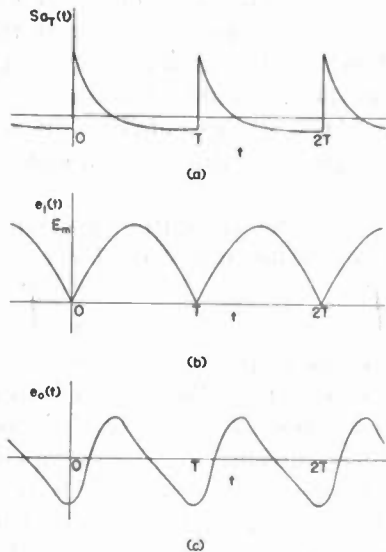

Fig. 3

- (a) The output voltage when a saw-tooth wave is applied to a resistance-capacitance circuit.
 (b) The input voltage applied to the resistance-capacitance circuit.
 (c) The resulting output voltage.

resistance-capacitance circuit is the sine loop voltage of Fig. 3(b), by means of (11) and (12), the output voltage $e_o(t)$ across the resistance R is for $0 < t < T$:

$$\begin{aligned} e_o(t) &= \frac{d}{dt} \left\{ \int_0^t [E_m \sin \frac{1}{2}\omega(t-\tau)] \left[-\frac{1}{2\pi\gamma} + \frac{\epsilon^{-\gamma\omega\tau}}{1-\epsilon^{-2\pi\gamma}} \right] d\tau \right. \\ &\quad \left. + \int_t^T [-E_m \sin \frac{1}{2}\omega(t-\tau)] \left[-\frac{1}{2\pi\gamma} + \frac{\epsilon^{-\gamma\omega\tau}}{1-\epsilon^{-2\pi\gamma}} \right] d\tau \right\} \\ &= \frac{E_m}{1+4\gamma^2} \left[\sin \frac{\omega t}{2} + 2\gamma \cos \frac{\omega t}{2} - \frac{4\gamma\epsilon^{-\gamma\omega t}}{1-\epsilon^{-2\pi\gamma}} \right] \quad (13) \end{aligned}$$

The steady-state output voltage $e_o(t)$ is shown in Fig. 3(c) for the case of $\gamma = 1$.

SQUARE WAVE

A further simplification occurs if the input voltage $e_i(t)$ has no even harmonics present which is a very common case in the waves met in radio engineering. It is possible to show then that the even harmonics in the saw-tooth wave of Fig. 1(a) used to determine the response $S_{aT}(t)$ to this saw-tooth wave, are not needed and may be made zero. The response $S_{aT}(t)$ to the saw-tooth wave then becomes the response $S_{qT}(t)$ to the

square wave of Fig. 2(a) with the same period. If the input voltage $e_i(t)$ has no even harmonics, (9) becomes

$$e_o(t) = \frac{d}{dt} \int_0^T e_i(\tau) S_{qT}(t-\tau) d\tau + \frac{G(0)}{T} \int_0^T e_i(\tau) d\tau \quad (14)$$

and (10) becomes

$$e_o(t) = \frac{d}{dt} \int_0^T e_i(\tau) S_{qT}(t-\tau) d\tau. \quad (15)$$

Similarly (11) becomes

$$e_o(t) = \frac{d}{dt} \int_0^T e_i(t-\tau) S_{qT}(\tau) d\tau \quad (16)$$

and in (14), (15), and (16) any interval T seconds long may be used as the limits of integration.

The same series resistance-capacitance circuit will be used as an example for the case in which the response to a square-wave voltage is used to find the response to another voltage of the same period which has, however, no even harmonic components of voltage. If the square-wave voltage of Fig. 2(a) were applied to the circuit, the wave form across the resistance is shown in Fig. 2(b) and has the equation for $0 < t < T/2$:

$$S_{qT}(t) = (1/2)(\epsilon^{-\gamma\omega t}/1 + \epsilon^{-\gamma\pi}) \quad (17a)$$

and for $T/2 < t < T$:

$$S_{qT}(t) = -(1/2)(\epsilon^{-\gamma(\omega t - \pi)}/1 + \epsilon^{-\gamma\pi}). \quad (17b)$$

The input voltage $e_i(t)$ to the circuit is the pulse voltage of Fig. 2(c) and has odd-harmonic components alone. By the use of (16) and (17) the output voltage $e_o(t)$ across the resistance R is for $0 < t < a$

$$\begin{aligned} e_o(t) &= \frac{d}{dt} \left\{ \int_0^t (E_m) \left(\frac{1}{2} \frac{\epsilon^{-\gamma\omega\tau}}{1 + \epsilon^{-\gamma\pi}} \right) d\tau \right. \\ &\quad \left. + \int_{t+T/2-a}^{T/2} (-E_m) \left(\frac{1}{2} \frac{\epsilon^{-\gamma\omega\tau}}{1 + \epsilon^{-\gamma\pi}} \right) d\tau \right. \\ &\quad \left. + \int_{T/2}^{t+T/2} (-E_m) \left[-\frac{1}{2} \frac{\epsilon^{-\gamma(\omega\tau - \pi)}}{1 + \epsilon^{-\gamma\pi}} \right] d\tau \right. \\ &\quad \left. + \int_{t+T-a}^T (E_m) \left[-\frac{1}{2} \frac{\epsilon^{-\gamma(\omega\tau - \pi)}}{1 + \epsilon^{-\gamma\pi}} \right] d\tau \right\} \\ &= E_m \epsilon^{-\gamma\omega t} \left[\frac{1 + \epsilon^{\gamma(\omega a - \pi)}}{1 + \epsilon^{-\gamma\pi}} \right] \quad (18) \end{aligned}$$

and for $a < t < T/2$

$$\begin{aligned} e_o(t) &= \frac{d}{dt} \left\{ \int_{t-a}^t (E_m) \left(\frac{1}{2} \frac{\epsilon^{-\gamma\omega\tau}}{1 + \epsilon^{-\gamma\pi}} \right) d\tau \right. \\ &\quad \left. + \int_{t+T/2-a}^{t+T/2} (-E_m) \left[-\frac{1}{2} \frac{\epsilon^{-\gamma(\omega\tau - \pi)}}{1 + \epsilon^{-\gamma\pi}} \right] d\tau \right\} \\ &= E_m \epsilon^{-\gamma\omega t} \left(\frac{1 - \epsilon^{\gamma\omega a}}{1 + \epsilon^{-\gamma\pi}} \right). \quad (19) \end{aligned}$$

The steady-state output voltage $e_o(t)$ is shown in Fig. 2(d) for the case of $\gamma = 1$ and $a = (T/10)$.

The square wave which has been used extensively in testing work up till this time, may be regarded therefore as a special case of the saw-tooth wave of Fig. 1(a) and is obtained by making the even harmonics zero. It might be suspected that if the odd harmonics including the fundamental were made zero an equally interesting result would be obtained. Upon reflection, however, it

will be seen that the only effect would be to halve the period of the input voltage, and hence a saw-tooth voltage of half the original period would suffice for this test. The saw-tooth wave then has two important advantages compared to the square wave when used for the testing of linear electrical networks such as amplifiers. These advantages are:

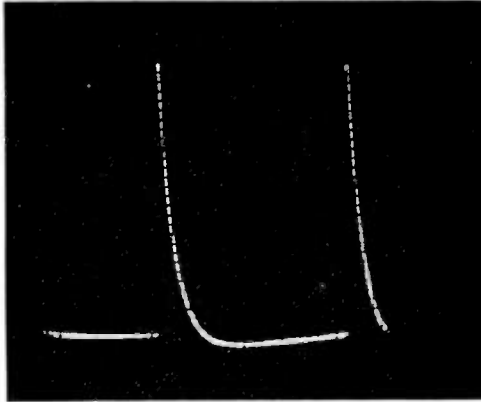

Fig. 4—The response of an amplifier to the saw-tooth wave.

1. It includes the response of the network not only to the odd harmonics of the fundamental frequency but also for the even harmonics.
2. From the response to the saw-tooth wave, the response to any other nonsinusoidal wave of the same fundamental frequency may be determined by the use of (10) or (11).

When using (10) or (11), if the response to the saw-tooth wave is obtained as a trace, say for example on the screen of a cathode-ray oscilloscope, it is desirable to fit an empirical equation to this trace. If the response is known as an analytical expression, however, it may be substituted directly into (10) or (11). In many cases an empirical equation cannot be readily fitted to the ob-

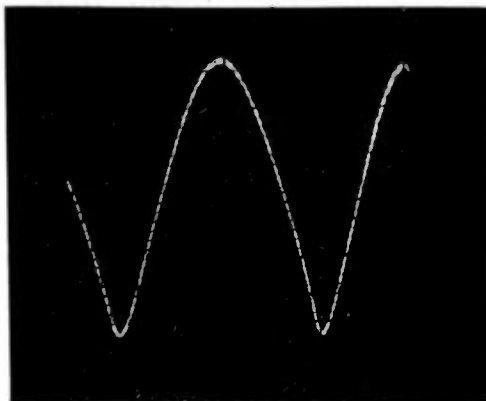

Fig. 5—The input voltage to the amplifier.

served response $S_{aT}(t)$ of the amplifier under test. In that case a numerical evaluation of equations (10) or (11) may be made. An example of such a numerical evaluation is given in Appendix II, and the results are shown in Figs. 4-7. The response $S_{aT}(t)$ of an amplifier is

given in Fig. 4, and the input voltage $e_i(t)$ is shown in Fig. 5. The calculated output voltage $e_o(t)$ is drawn in Fig. 6, and the experimentally obtained output voltage is shown in Fig. 7.

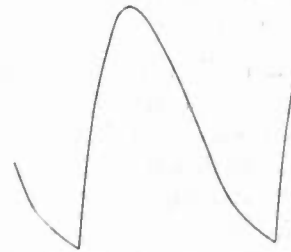

Fig. 6—The calculated output voltage.

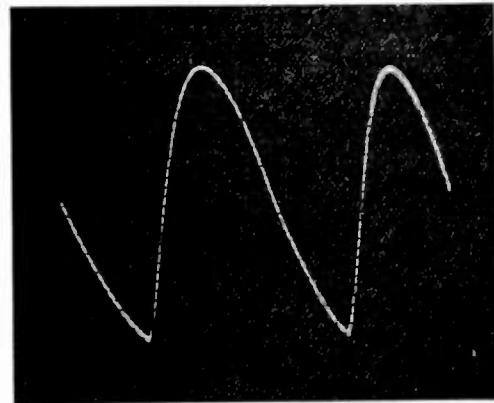

Fig. 7—The experimental output voltage.

SAW-TOOTH RESPONSE CURVES

To use the saw-tooth wave in testing, typical response curves of various simple circuits should be available. This has been done for a square wave⁶ and will be done here for the saw-tooth wave of Fig. 1(a). When the

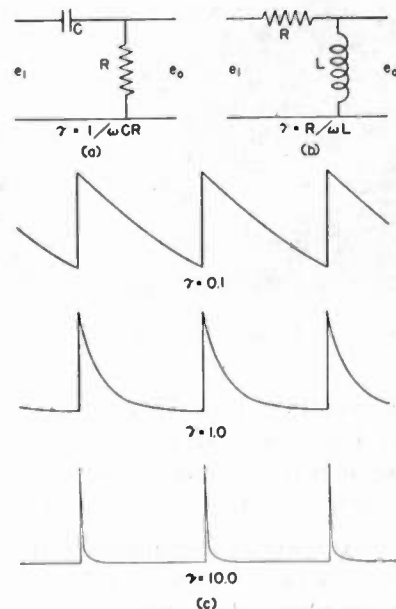

Fig. 8—The response to the saw-tooth wave of resistance-capacitance, and resistance-inductance circuits as differentiators.

⁶ L. B. Arguimbau, "Network testing with square waves," *Gen. Rad. Exp.*, vol. 14, pp. 1-6; December, 1939.

saw-tooth voltage wave e_i is applied to the circuit of Fig. 8(a) where $\gamma = 1/\omega CR$, or to the circuit of Fig. 8(b) where $\gamma = R/\omega L$, the output voltage e_o is that of Fig. 8(c) for the three values of γ equal to 0.1, 1, and 10. This output voltage has the equation

$$e_o(t) = -1/(2\pi\gamma) + (\epsilon^{-\gamma\omega t}/1 - \epsilon^{-2\pi\gamma}). \quad (20)$$

These curves would be similar, for example, to those obtained at the lower end of the pass band of a resistance coupled or a transformer-coupled audio-frequency amplifier. The curve for small values of γ , i.e., for high frequencies resembles the input voltage. The curve for $\gamma = 10$, on the other hand, resembles quite closely the curve for the derivative of $e_i(t)$ and thus when $\gamma = 10$ the circuits act as differentiators. Experimental curves for $\gamma = 1$ and $\gamma = 10$ are shown in Figs. 9 and 10. Similar

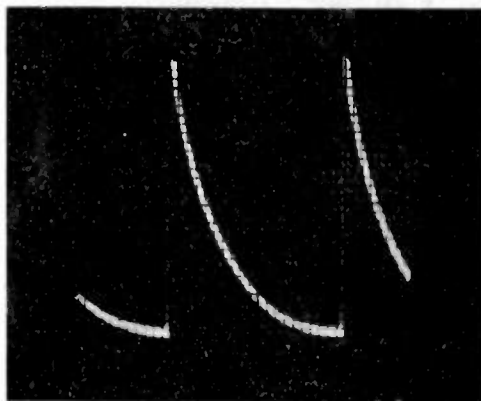

Fig. 9—Experimental curves similar to those of Fig. 8. $\gamma = 1$.

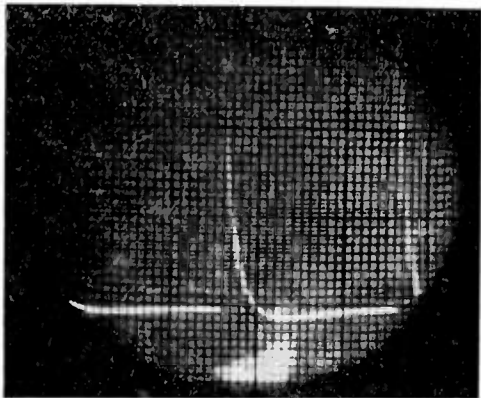

Fig. 10—Experimental curves similar to those of Fig. 8. $\gamma = 10$.

curves for the circuits of Figs. 11(a) and 11(b) are shown in Fig. 11(c). The values of γ are the same as in the preceding case, and the equation of e_o is

$$e_o(t) = 1/2 - (\omega t/2\pi) + (1/2\pi\gamma) - (\epsilon^{-\gamma\omega t}/1 - \epsilon^{-2\pi\gamma}). \quad (21)$$

Again these curves would be similar to those obtained at the higher end of the pass band of a resistance-coupled audio amplifier. The curve for $\gamma = 10.0$, i.e., for low frequencies, resembles closely the input wave form. When γ is small ($\gamma < 0.1$) these circuits act as integrators as is indicated by the curve for $\gamma = 0.1$. Experimental

curves are shown in Figs. 12, 13, and 14 for $\gamma = 0.1, 1,$ and 10.

When the saw-tooth wave is applied to the series inductance L and capacitance C circuit of Fig. 15(a), the output voltage e_o is

$$e_o(t) = - (1/2)(\sin \beta(\omega t - \pi)/\sin \beta\pi) \quad (22)$$

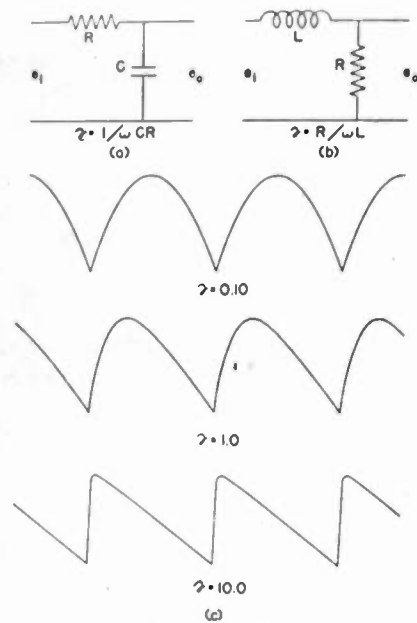

Fig. 11—The response to the saw-tooth wave of resistance-capacitance and resistance-inductance circuits as integrators.

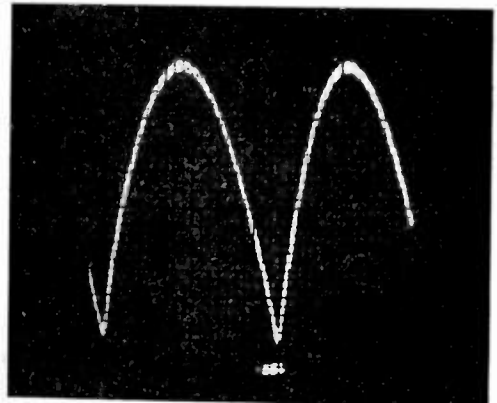

Fig. 12—Experimental curves similar to those of Fig. 11. $\gamma = 0.1$.

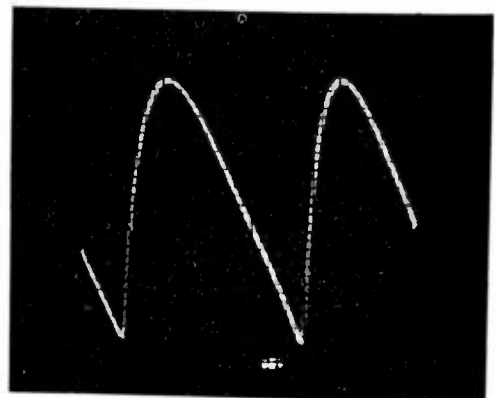

Fig. 13—Experimental curves similar to those of Fig. 11. $\gamma = 1.0$.

where $\beta = 1/\omega\sqrt{LC}$. Resonance occurs when $\beta = n$ where n is any positive integer, and since this circuit contains no resistance, these values must be avoided. When β is small, the output wave form of Fig. 15(b) is very much like the input wave form (see the curve for $\beta = 0.5$). As β

increases, i.e., for lower frequencies, the wave form becomes sinusoidal, and the number β indicates the number of cycles that appear during one period of the applied saw-tooth wave. For example in Fig. 15(b) for $\beta = 2.5$, two and one-half cycles appear during each period of the saw-tooth wave. The corresponding experimentally obtained waves are shown in Figs. 16-19. The wave for $\beta = 0.5$ in Figs. 16-19 shows some slight irregularities at the top caused by the distributed capacitance of the inductor used. The waves for the larger values of β show the effect of the resistance of the inductor in that the amplitudes decrease exponentially.

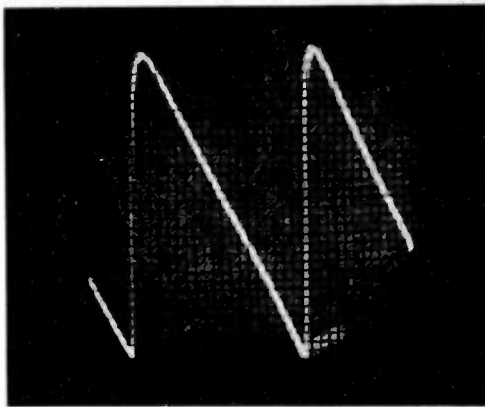

Fig. 14—Experimental curves similar to those of Fig. 11. $\gamma = 10.0$.

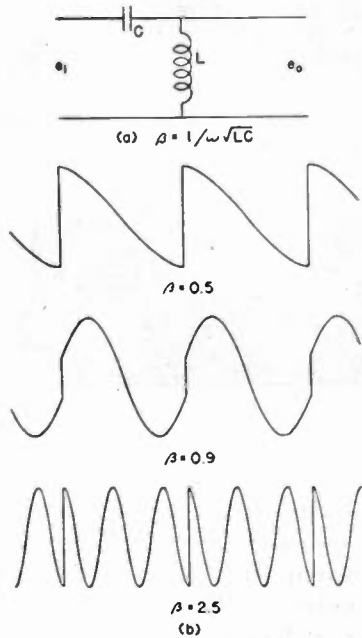

Fig. 15—The response to the saw-tooth wave of an inductance-capacitance circuit. The voltage shown is that across L .

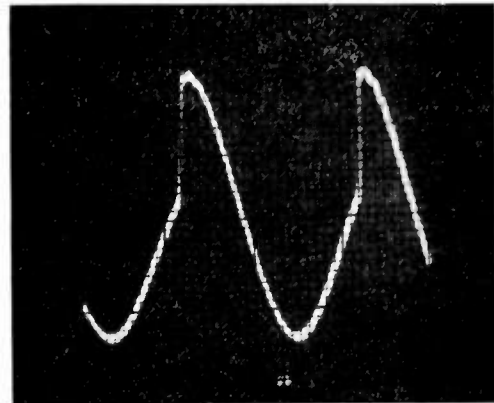

Fig. 17—Experimental curves similar to those of Fig. 15. $\beta = 0.9$.

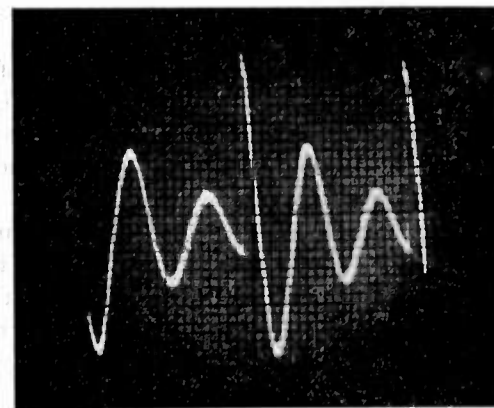

Fig. 18—Experimental curves similar to those of Fig. 15. $\beta = 2.5$.

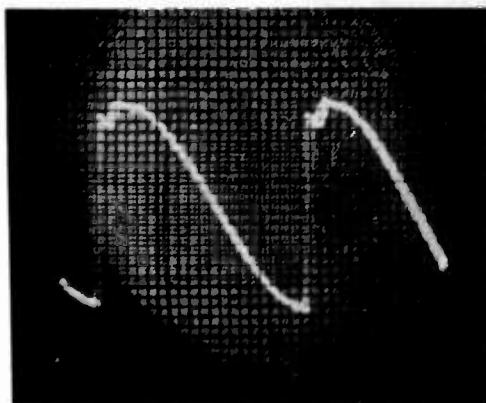

Fig. 16—Experimental curves similar to those of Fig. 15. $\beta = 0.5$.

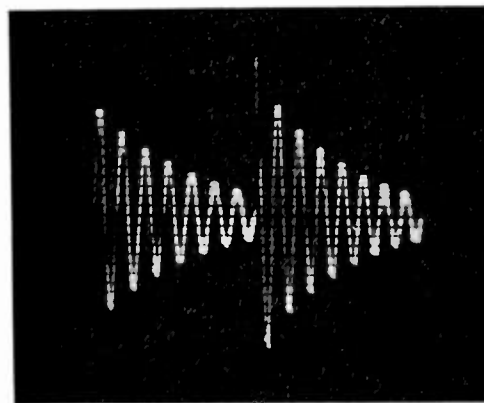

Fig. 19—Experimental curves similar to those of Fig. 15. $\beta = 9.0$, approximately.

The output voltage for the circuit of Fig. 20(a) has the equation

$$e_0(t) = 1/2 - (\omega t/2\pi) + (1/2)(\sin \beta(\omega t - \pi)/\sin \beta\pi). \quad (23)$$

The curves for various values of β appear in Fig. 20(b), and the above remarks concerning the variation with β apply here as well. This case approaches that for the

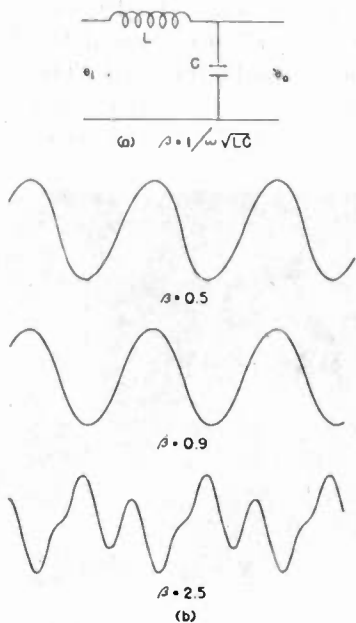

Fig. 20—The response to the saw-tooth wave of an LC circuit. The voltage shown is that across C.

high-frequency end of the pass band of a transformer-coupled audio amplifier and shows that for high frequencies the response becomes almost a sine wave (see the curve for $\beta=0.5$). The experimental wave forms are shown in Figs. 21–23.

A test was made of a transformer-coupled amplifier and the results are shown in Figs. 24–26. Fig. 24 shows the response at a frequency of approximately 40 cycles per second, and it is similar to that of Fig. 8(c) for $\gamma = 1.0$. This is the lower half-power frequency where the response is down 3 decibels and the phase shift is 45 degrees. The response at 1000 cycles is given in Fig. 25, and it shows the effect of distributed capacitance in

the transformers. Fig. 26 was taken at 15,000 cycles and indicates a wave shape somewhat similar to that of Fig. 20(b) for $\beta=0.5$. The trace was broad because of the comparatively large ripple voltage present.

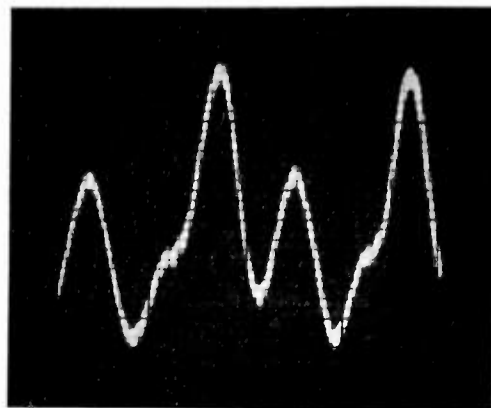

Fig. 22—Experimental curves similar to those of Fig. 20. $\beta=2.5$.

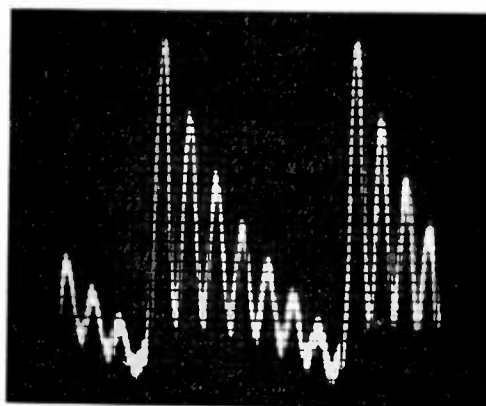

Fig. 23—Experimental curves similar to those of Fig. 20. $\beta=9.0$, approximately.

It should be mentioned here that this saw-tooth wave has a repeated unit step in it and hence may be used in testing the high-frequency response of wide-band amplifiers, such as video amplifiers, just as has the square wave. However, it has no advantages over the square wave in this particular case.

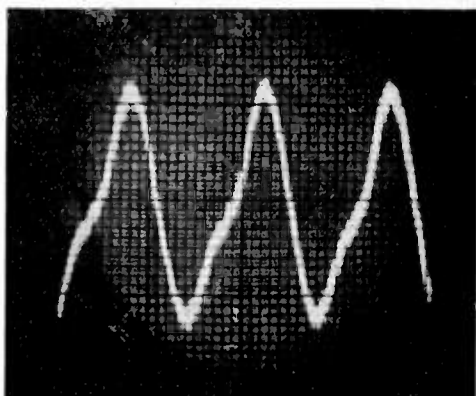

Fig. 21—Experimental curves similar to those of Fig. 20. $\beta=0.5$.

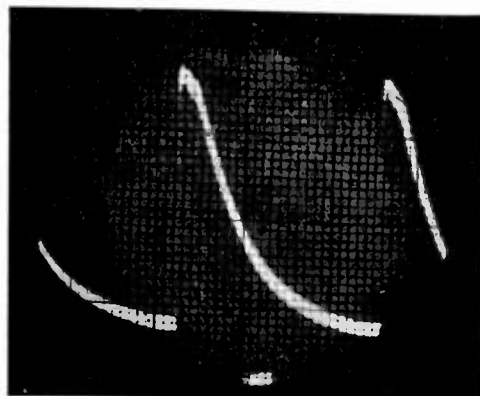

Fig. 24—Amplifier test wave forms for various frequencies. 40 cycles

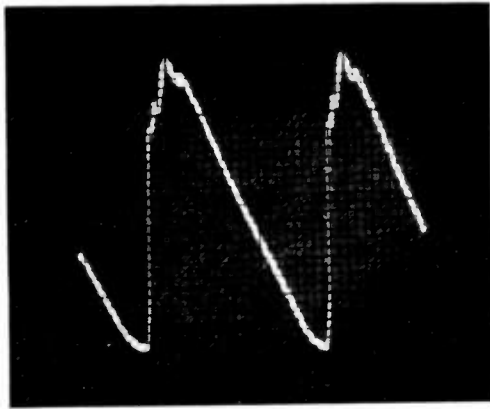

Fig. 25—Amplifier test wave forms for various frequencies. 1000 cycles.

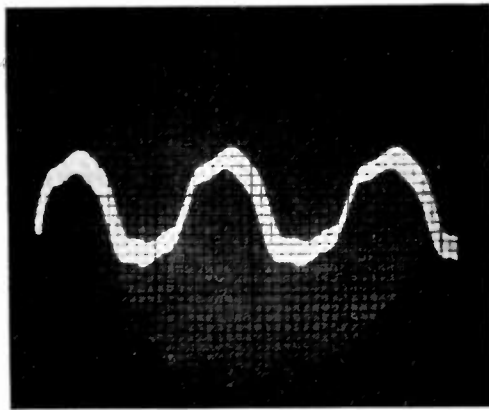

Fig. 26—Amplifier test wave forms for various frequencies. 15,000 cycles.

CONCLUSIONS

1. It has been shown that if the steady-state response $S_{aT}(t)$ of a network to a saw-tooth wave of a frequency $f=1/T$ is known, the steady-state response $e_0(t)$ of that network to any other wave $e_i(t)$ of the same frequency f may be determined by the use of the following equation:

$$e_0(t) = \frac{d}{dt} \int_0^T e_i(\tau) S_{aT}(t - \tau) d\tau. \quad (10)$$

This equation has the same significance in steady-state work that Duhamel's theorem⁷ has in transient studies.

2. The saw-tooth wave of Fig. 1(a) has then the same importance in steady-state work that the unit function has in transient work. Since this saw-tooth wave may be easily produced and observed, it should be invaluable in the testing of the steady-state response of electrical networks. The response of several typical networks to this wave is shown.

3. The square wave now used for steady-state testing is a special case of the saw-tooth wave in that it includes only the response to the odd harmonics while the saw-tooth wave includes the response for both odd and even harmonics. The response to the square wave may be

⁷ V. Bush, "Operational Circuit Analysis," John Wiley and Sons, Inc., New York, N. Y., 1937, p. 56.

used in (15), which is similar to that of (10), if the input voltage has no even harmonics.

APPENDIX I

Agreement with Previous Results

By the use of (5) it can be shown that

$$\int_0^T e_i(\tau) S_T(t - \tau) d\tau = \int_a^{a+T} e_i(\tau) S_T(t - \tau) d\tau + G(0) \int_0^a e_i(\tau) d\tau \quad (24)$$

where a is a real number. When $a = t - T$

$$\int_0^T e_i(\tau) S_T(t - \tau) d\tau = \int_{t-T}^t e_i(\tau) S_T(t - \tau) d\tau + G(0) \int_0^{t-T} e_i(\tau) d\tau, \quad (25)$$

and from (8) and (25)

$$e_0(t) = \frac{d}{dt} \int_{t-T}^t e_i(\tau) S_T(t - \tau) d\tau + G(0)e_i(t). \quad (26)$$

From (5) the steady-state response to the step function $S_T(t)$ may be expressed as

$$\begin{aligned} S_T(t) &= \frac{1}{2\pi j} \int_W \frac{\epsilon^{p^4} G(p)}{p(1 - \epsilon^{-pT})} dp \\ &= \frac{1}{2\pi j} \int_{W_1} \frac{\epsilon^{p^4} G(p)(1 + \epsilon^{-pT} + \epsilon^{-2pT} + \dots)}{p} dp \\ &\quad - \frac{1}{2\pi j} \int_{W_2} \frac{\epsilon^{p^4} G(p)}{p(1 - \epsilon^{-pT})} dp \end{aligned}$$

where W_1 and W_2 are paths of integration and are the same as the paths C_1 and C_2 , respectively, of footnote reference 3. When $0 < t < T$ and if $G(p)$ has no terms involving ϵ^{-pT}

$$\begin{aligned} S_T(t) &= \frac{1}{2\pi j} \int_{W_1} \frac{\epsilon^{p^4} G(p)}{p} dp - \frac{1}{2\pi j} \int_{W_2} \frac{\epsilon^{p^4} G(p)}{p(1 - \epsilon^{-pT})} dp \\ &= G(0) + \frac{1}{2\pi j} \int_{W_2} \frac{\epsilon^{p^4} G(p)}{p(1 - \epsilon^{-pT})} dp \\ &= G(0) + \left[\frac{1}{2\pi j} \int_{W_1} \frac{\epsilon^{p^4} G(p)}{p} dp - \frac{1}{2\pi j} \int_W \frac{\epsilon^{p^4} G(p)}{p} dp \right] \\ &\quad + \left[\frac{1}{2\pi j} \int_{W_1} \frac{\epsilon^{p^4} G(p)}{p} dp - \frac{1}{2\pi j} \int_W \frac{\epsilon^{p^4} G(p)}{p} dp \right] + \dots \end{aligned}$$

$$\text{or } S_T(t) = G(0) + [A(t) - G(0)] + [A(t + T) - G(0)] + [A(t + 2T) - G(0)] + \dots \quad (27)$$

where $A(t)$ is the indicial admittance of the circuit. The expression (27) may be recognized as the response to the step voltage of Fig. 1(c).

By the use of (26) and (27) the following expression for the steady-state response $e_0(t)$ to an applied voltage $e_i(t)$ is obtained:

$$e_0(t) = A(0)e_i(t) + \int_{t-T}^t e_i(\tau) S_T'(t - \tau) d\tau \quad (28)$$

$$\text{where } S_T'(t) = A'(t) + A'(t - T) + A'(t + T) + \dots \quad (29)$$

These last two equations are exactly the same as

expressions obtained previously^{3,5} for the steady-state response of a circuit.

APPENDIX II

The response of an amplifier to the saw-tooth wave is shown in Fig. 4, and the arbitrary response values for each one tenth of the period T are tabulated as $Sa_T(t)$ in Table I. The input wave $e_i(t)$ is shown in Fig. 5 and is

and from the diagonal of Table II extending from top right to bottom left

$$f(0) = 1/10[(-8.72/2) + 67.5 + 24.6 - 9.4 - 19.6 - 17.4 - 13.1 - 6.3 - 2.64 - 0.68 + (0/2)] = 1.867.$$

Similarly from the diagonal to the right of the one used above:

TABLE I

t	0	0.1	0.2	0.3	0.4	0.5	0.6	0.7	0.8	0.9	1.0
$Sa_T(t)$	29	7.5	1.5	-0.4	-0.7	-0.6	-0.5	-0.3	-0.2	-0.1	0
$e_i(t)$	-0.3	6.8	13.2	21	26.2	29	28	23.5	16.4	9	-0.3
$f(t)$	1.867	4.182	18.23	36.91	52.62	62.28	63.35	55.47	40.38	22.56	1.867

similarly tabulated in Table I. The values of $Sa_T(t)$ and $e_i(t)$ are now tabulated at the left-hand side and the top of Table II, and the rest of the table is filled in with the respective products of $Sa_T(t)$ and $e_i(t)$. If

$$f(t) = \int_0^T e_i(t - \tau) Sa_T(\tau) d\tau,$$

then by the use of the trapezoidal rule for integration

$$f(0.1) = 1/10[(196.5/2) - 2.25 + 13.5 - 6.56 - 16.44 - 16.8 - 14.5 - 7.86 - 4.2 - 1.32 + (0/2)] = 4.182.$$

The values of $f(t)$ are tabulated in Table I. The output voltage $e_o(t)$ is obtained by differentiating $f(t)$ and is calculated numerically as follows:

$$e_o(0.05) = [f(0.1) - f(0)]/0.1 = (4.182 - 1.867/0.1) = 23.15.$$

The values of $e_o(t)$ are set down in Table III and are plotted in Fig. 6.

TABLE II

$e_i(t)$	-0.3	6.8	13.2	21	26.2	29	28	23.5	16.4	9	-0.3
$Sa_T(t)$											
29	-8.72	196.5	382	609	761	843	813	682	475	261	-8.72
7.5	-2.25	51	99	157.6	196.5	217.6	210	176.3	122.8	67.5	-2.25
1.5	-0.45	10.18	19.78	31.5	39.3	43.5	42	35.25	24.6	13.5	-0.45
-0.4	+0.12	-2.76	-5.24	-8.4	-10.47	-11.6	-11.2	-9.4	-6.56	-3.6	+0.12
-0.7	+0.21	-4.76	-9.23	-14.7	-18.33	-20.3	-19.6	-16.44	-11.47	-6.3	+0.21
-0.6	+0.18	-4.08	-7.92	-12.6	-15.71	-17.4	-16.8	-14.1	-9.84	-5.4	+0.18
-0.5	+0.15	-3.4	-6.6	-10.5	-13.1	-14.5	-14.0	-11.74	-8.2	-4.5	+0.15
-0.3	+0.09	-2.04	-3.96	-6.3	-7.86	-8.7	-8.4	-7.05	-4.92	-2.7	+0.09
-0.2	+0.06	-1.36	-2.64	-4.2	-5.24	-5.8	-5.6	-4.7	-3.28	-1.8	+0.06
-0.1	+0.03	-0.68	-1.32	-2.1	-2.62	-2.9	-2.8	-2.35	-1.64	-0.9	+0.03
0	0	0	0	0	0	0	0	0	0	0	0

TABLE III

t	0.05	0.15	0.25	0.35	0.45	0.55	0.65	0.75	+0.85	0.95
$e_o(t)$	23.15	140.5	186.8	157.1	96.6	10.75	-78.9	-150.9	-178.2	-206.9

A Coupled-Circuit Frequency Modulator*

ELWIN J. O'BRIEN†, ASSOCIATE, I.R.E.

Summary—The circuit developed in this paper uses a condenser microphone to vary the reactance of an oscillator tank circuit. Using a coupled circuit and a tuning inductance across the condenser microphone, a single-tube wide-band frequency modulator was constructed for use on 40 megacycles.

THE capacitance variation in a condenser microphone, when connected in the tank circuit of an oscillator will produce frequency modulation of an oscillator. In fact, this method has been used to explain

* Decimal classification: R414. Original manuscript received by the Institute, May 7, 1943; revised manuscript received, January 15, 1944.

† Absent on leave from the University of North Dakota, Grand Forks, North Dakota; now, Voice Communication Laboratory, Waco Army Air Field, Waco, Texas.

the theory of operation of a simple frequency modulator. However, since only a small frequency deviation is possible, the method is not practical. This paper shows that by certain circuit modifications, wide-band frequency modulation can be accomplished in a single-tube transmitter, using a signal-operated condenser as a modulator.

When the condenser microphone is employed as the tuning condenser across the tank inductance, the carrier frequency is limited to medium frequencies, and because of the high static capacitance the percentage of frequency variation will be very small. The operating frequency of the oscillator may be increased by

connecting the microphone in series with the tuning condenser, but the effective capacitance change in such an arrangement decreases, and the resultant percentage of frequency deviation also decreases.

Ordinary oscillator circuits will, therefore, not produce appreciable frequency change. However, the condenser microphone will, when used in a simple coupled circuit, produce considerable frequency deviation, the amount being limited by the circuit constants and the operating frequency.

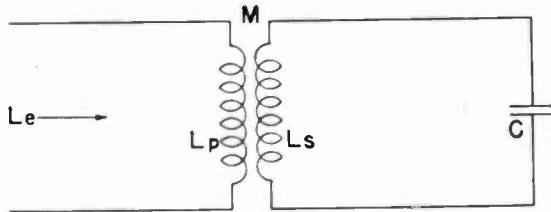

Fig. 1—The fundamental coupled circuit.

When the secondary resistance in the circuit shown in Fig. 1 is assumed to be zero, the effective inductance (L_e) of the coupled circuit will be

$$L_e = L_p - (wM^2/X_s) = L_p - (w^2M^2C/w^2L_sC - 1) \quad (1)$$

where

- L_p = primary inductance
- X_s = secondary reactance
- $w = 2\pi$ times frequency
- L_s = secondary inductance
- M = mutual inductance
- C = secondary capacitance

When the capacitance is varied the greatest change in L_e will occur with a large mutual inductance. This circuit was used as the inductive element in an oscillator circuit by connecting a tuning condenser across the primary and using this combination as an oscillator tank circuit. When operating at a normal carrier frequency of 40 megacycles, a variation of the condenser produced a frequency deviation of several kilocycles; a greater deviation is possible at a still higher operating frequency, providing the mutual inductance is a high value.

The frequency deviation may be greatly increased by reducing or nullifying the static capacitance of the condenser. However, the large static capacitance of the condenser microphone and the amount of L_e required make it impossible by series resonance for $w^2L_sC - 1$ to approach zero and still operate at the ultra-high frequencies. If the condenser microphone is shunted with an inductance and the combination made parallel resonant at or near the normal operating frequency, the greatest change in effective inductance L_e of the coupled circuit is obtained.

Fig. 2 shows a practical push-pull oscillator circuit using the coupled circuit of Fig. 1 and the microphone shunting inductance. This experimental oscillator circuit was built for an operating frequency of 40 megacycles. The primary winding consisted of one-eighth-inch copper tubing with the grid coil of celanese-covered push-back wire inside of the copper tubing, thus providing unity coupling. The secondary was made of the

same push-back wire wound small enough to slip inside the plate winding. A 15-micromicrofarad variable tuning condenser was employed to fix the normal operating frequency. The condenser microphone employed was a

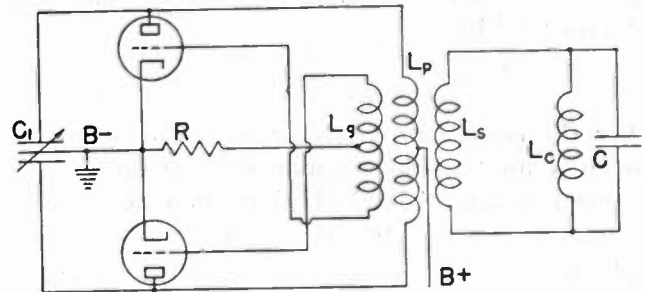

Fig. 2—The circuit for the wide-band frequency-modulation transmitter.

type 394, and the inductance connected in shunt with this microphone was only one-half turn of wire having a total length of approximately 1½ inches. When using a type 19 tube as an oscillator at a carrier frequency of 40 megacycles, a frequency deviation of 15 kilocycles was measured when driving the microphone with an audio-frequency tone. For these measurements the circuit was not adjusted for optimum conditions. Calculations indicate that for the circuit constants given a sufficient microphone capacitance variation can be obtained to produce a frequency deviation of more than 80 kilocycles.

In order to obtain further experimental data, another transmitter was built with a 19 type tube as a push-pull oscillator operating on 22 megacycles with a second 19 type tube as a push-push doubler to 44 megacycles. This unit had a more stable carrier frequency since the antenna was coupled to the doubler. As predicted by theory a larger inductance was used across the condenser microphone, and the frequency deviation was found to be greater than for the single-tube transmitter. It was not measured, but was equivalent to the depth of modulation as received from several frequency-modulation broadcast stations. In fact close talking in the microphone produced considerably more percentage modulation than commercial stations.

An analysis of the circuit shows that the impedance at the terminals of the primary winding of the coupled circuit including the secondary winding, microphone condenser, and shunting inductance will always be inductive in character, and this inductive reactance in combination with the tuning condenser determines the frequency of oscillation at any given instant. Variations in the capacitance of the microphone causes a variation in the effective inductive reactance of the primary winding and therefore varies the frequency of the oscillator.

It can be shown that the effective inductance at the terminals of primary winding in Fig. 2 is represented by the following equation:

$$L_e = L_p - (M^2(w^2L_sC - 1)/L_s(w^2L_sC - 1) - L_c) \quad (2)$$

where L_c is the inductance of the microphone tuning

coil and the other factors are as indicated in Fig. 1.

If the microphone condenser is increased or decreased by an increment C' , then the capacitance of the condenser will be represented by $C \pm C'$, and by substituting this term for C in (2) above, the effective inductance is represented by

$$L_e = L_p - \frac{M^2(w^2L_eC - 1 \pm w^2L_eC')}{L_s(w^2L_eC - 1 \pm w^2L_eC') - L_e} \quad (3)$$

For the condition of resonance of the microphone condenser and the shunting inductance at the operating frequency, $w^2L_eC = 1$, and (3) above becomes

$$L_e = L_p \mp (M^2w^2C' / \pm w^2L_eC' - 1). \quad (4)$$

The term w^2L_eC' in (4) may be neglected since it represents a distortion factor having a very small value, and (4) then becomes

$$L_e \cong L_p \pm w^2M^2C'. \quad (5)$$

Because the frequency is a variable, the w^2M^2C' term will have a greater positive value than the negative value. The percentage unbalance will be small if the carrier frequency is large in comparison to the deviation frequency.

The foregoing equations do not take into consideration the resistance of the primary and secondary circuits but in actual circuits there may be appreciable resistance which will flatten the peak of the resonance curve. Accordingly, it will be found that the maximum variation in the effective inductance will be obtained by tuning the parallel combination involving the microphone condenser and shunting inductance to a frequency somewhat displaced from the normal operating frequency of the oscillator circuit; that is, the parallel combination would be tuned to a point on the steepest portion of its resonance curve at the operating frequency of the oscillator.

The angular frequency for the tuned-plate oscillator of Fig. 2 is

$$w = \sqrt{1 + R_L/r_p/L_eC_1} \quad (6)$$

where R_L is the resistance of the tank circuit, r_p is the plate resistance, and C_1 is the tank capacitance. This equation indicates that the frequency of oscillation is slightly higher than the resonance frequency of the tuned circuit and with a lightly loaded oscillator the approximate equation for the angular frequency

$$w \cong \sqrt{1/L_eC_1} \quad (7)$$

can be used.

Inserting (5) in (7) gives the complete equation for the angular frequency of the transmitter.

$$w \cong \sqrt{1/C_1L_p \pm W^2M^2C_1C'}. \quad (8)$$

Using these formulas the data of Table I were calculated.

With a carrier frequency of 40 megacycles and a deviation frequency of 100 kilocycles in the above equa-

TABLE I

f In Mega- cycles	C' In Micro- microfarads	Per Cent Capacitance Unbalance	f In Mega- cycles	C' In Micro- microfarads	Per Cent Capacitance Unbalance
30	0.010836	0.874	40.01	0.001073	0.09
39.91	0.009743	0.787	40.02	0.002144	0.176
39.92	0.008653	0.698	40.03	0.003214	0.263
39.93	0.007565	0.612	40.04	0.004281	0.343
39.94	0.006479	0.525	40.05	0.005347	0.438
39.95	0.005394	0.438	40.06	0.006411	0.525
39.96	0.004311	0.343	40.07	0.007473	0.612
39.97	0.003231	0.263	40.08	0.008533	0.698
39.98	0.002152	0.176	40.09	0.009591	0.787
39.99	0.001075	0.09	40.10	0.010647	0.874
40.00	0.000000	0.00			

tion, Table I shows the calculated total capacitance to be 0.874 per cent above or below the expected value.

If the frequency term under the radical in (8) is considered constant, which is the equivalent condition for the reactance type of modulator, the calculated capacitance unbalance is 0.375 per cent for the 100-kilocycle deviation. The frequency term in (5) can, therefore, generally be considered a constant.

Solving (8) results in:

$$w = \sqrt{\mp (L_p/2M^2C') \pm \sqrt{(L_p^2/4M^4(C')^2) \pm (1/M^2C_1C')}}.$$

Using the value of C' from Table I for the 40.1-megacycle frequency in the above equation resulted in the calculated frequencies of 40.1 and 39.90172 megacycles, showing nonlinear modulation. If we assume a perfect modulating system and that the modulating frequency contains a second harmonic with the positive maximum in phase with the positive maximum of the fundamental, the same type of nonlinear modulation will result.

The per cent second harmonic distortion may be written as

$$\text{per cent second harmonic} = \frac{\frac{1}{2}(f_{\max} + f_{\min}) - f_{\text{carrier}}}{(f_{\max} - f_{\min})} \times 100.$$

Using these formulas the calculated second-harmonic distortion for the 100-kilocycle deviation is 0.434 per cent.

Therefore, high-fidelity frequency modulation is possible for the coupled-circuit modulator when the microphone has a change in capacitance that is proportional to the sound pressure and independent of the frequency of the signal wave. This condition is met in the ideal microphone and reasonably so for commercial microphones.

While an oscillator of the push-pull type was used in Fig. 2, a single tube can be used. Furthermore, the carrier frequency can be stabilized when necessary by circuits already developed for frequency-modulation transmission.

The Stability Factor of Negative Feedback in Amplifiers*

STEWART BECKER†, SENIOR MEMBER, I.R.E.

Summary—This paper discusses the effect of negative feedback on the gain and stability of an amplifier. A general set of equations for use in designing negative-feedback amplifiers is developed and a discussion of their use is given. With these equations the engineer is able to design an amplifier of given gain and stability, to determine the increase in stability caused by negative feedback when it is known how much gain may be sacrificed, to determine the effect on gain and stability of a given amount of negative feedback in an amplifier, and to determine how much gain must be sacrificed in an amplifier to obtain a certain stability.

GENERAL DISCUSSION

THE FACT that negative feedback increases the stability of an amplifier has been known for some time and practical use of this type of amplifier is rapidly increasing. There are many means of obtaining negative feedback, and since these are adequately covered in the literature,¹⁻³ specific circuits will not be given here. It is intended, rather, to develop a set of equations which will enable the engineer to design negative-feedback amplifiers for various applications.

In brief, the principle employed in negative-feedback amplifiers is as follows.⁴⁻⁶ A fraction of the output voltage of an amplifier is fed back to the input in phase opposition to the signal voltage. This decreases the voltage applied to the first grid and so greater gain is required to produce the same output voltage as before the negative feedback was introduced. The actual input voltage of the amplifier is then the difference between the signal voltage and the feedback voltage and, for great stability, these two voltages are made almost equal, the feedback voltage being the smaller. They should both be large relative to the difference voltage which is applied to the first grid. This feedback should be accomplished through a circuit which is independent of tube constants or supply voltage and thus independent of the gain of the amplifier. If then the gain of the amplifier is lowered because of changes in tube constants or supply voltages, the output voltage of the amplifier is lowered

but the same percentage of it is fed back to the input as before. The feedback voltage is then lowered in accordance with the decrease in gain of the amplifier. Since the signal voltage remains constant but the feedback voltage is lowered, the difference between these two voltages becomes greater and the voltage applied to the grid of the first tube becomes greater thus compensating for the loss in gain of the amplifier.

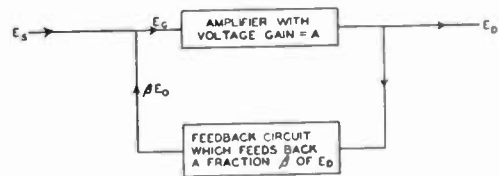

Fig. 1

A = voltage gain of the amplifier without feedback, $\beta = 0$
 A^1 = voltage gain of the amplifier combined with the feedback circuit, β = some finite fraction

$E_g = E_s - \beta E_o$ since E_s and βE_o are out of phase

$$A = E_o / E_g$$

$$A^1 = E_o / E_s$$

Combining these three equations and solving for A^1 ,

$$A^1 = A / (1 + A\beta). \quad (1)$$

When the feedback fraction β becomes large, the term $A\beta$ becomes much greater than unity and the above equation becomes

$$A^1 = 1/\beta. \quad (2)$$

An examination of (1) and (2) shows that as the feedback is increased, the effective amplification of the system A^1 decreases, and when the feedback is very large, as in (2), the effective amplification of the system is entirely independent of the gain of the amplifier without negative feedback and is, therefore, entirely independent of electrode voltages and tube constants. Such performance is, of course, purely theoretical since infinite reduction in gain is necessary for infinite stability and so the engineer must content himself with something less than infinite stability in order to have practical gain. However, stability gains between A^1 and A in the order of 100 to 1 are entirely practical as shown in Fig. 2. For example, if a gain in stability of 100 to 1 is required when A is lowered 20 per cent by changes in the tube constants and supply voltages, A must be 125 times A^1 .

STABILITY FACTOR DEFINED

For the purposes of this article, stability factor is defined as the number of times the stability of an amplifier is increased by the addition of negative feedback.

* Decimal classification: R363.2. Original manuscript received by the Institute, March 29, 1943; revised manuscript received, February 14, 1944.

† Metron Instrument Co., Denver, Colorado.

¹ "Radiotron Designer's Handbook," Third Edition, edited by F. Langford Smith, published by RCA Manufacturing Company, Harrison, N. J., 1942, pp. 34-45.

² F. E. Terman, "Radio Engineers Handbook," First Edition, McGraw-Hill Book Company, New York, N. Y., 1943, pp. 404-406.

³ Pages 399-400 of footnote reference 2.

⁴ H. S. Black, "Feedback amplifiers," *Bell Lab. Rec.*, vol. 12, pp. 290-296; June, 1934.

⁵ H. W. Bode, "Relations between attenuation and phase in feedback amplifier design," *Bell Sys. Tech. Jour.*, vol. 19, pp. 421-454; July, 1940.

⁶ Everitt, "Communication Engineering," pp. 463-471, McGraw-Hill Book Company, New York, N. Y., 1932.

For example, if the gain of an amplifier is lowered 20 per cent by a given change in electrode voltages and tube

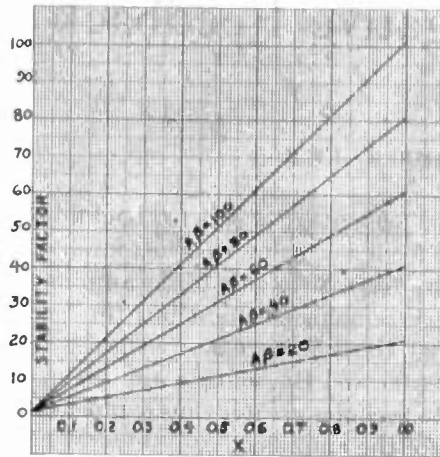

Fig. 2—Variation in stability factor as the value of X varies.
 $SF = 1 + A\beta X$.

constants, and this change in gain is reduced to 2 per cent by the introduction of negative feedback, the stability factor of the negative feedback is 20/2 or 10. The stability of the amplifier is increased ten times by the introduction of negative feedback.

DEVELOPMENT OF STABILITY-FACTOR EQUATIONS

If we could develop an equation expressing this stability factor in terms of the gain of the amplifier and the feedback factor, an amplifier could be designed which would have a given number of times the stability of an amplifier without negative feedback. For this analysis, assume that A varies by some factor X , and it simplifies the analysis if it is assumed that X is a fraction never greater than 1. That is, assume that A is the highest gain which the amplifier without negative feedback ever has when the electrode voltages and tube constants vary over the entire operating range. Then let the gain of the amplifier lower to a fraction X of this highest value so that AX is the lowest gain which the amplifier ever has when the electrode voltages and tube constants vary over the entire operating range.

Thus by definition, we have

A = highest gain of the amplifier without negative feedback

A^1 = highest gain of the amplifier with negative feedback

A_1 = lowest gain of the amplifier without negative feedback when the electrode voltages and tube constants vary over the operating range

A_1^1 = lowest gain of the amplifier with negative feedback when the electrode voltages and tube constants vary over the operating range

SF = stability factor of the negative feedback

SF = per cent change in A / per cent change in A^1

Substituting the following values of per cent change in A and per cent change in A^1 in the above equation,

per cent change in $A = A - A_1 / A$ and per cent change in $A^1 = (A^1 - A_1^1) / A^1$

$$SF = (A^1(A - A_1) / A(A^1 - A_1^1)). \quad (3)$$

Since according to (1), $A^1 = A / (1 + A\beta)$ and by definition $A_1 = AX$ and $A_1^1 = AX / (1 + A\beta X)$. Therefore, substituting the above values in (3)

$$SF = 1 + A\beta X. \quad (4)$$

An inspection of (4) shows that the stability factor depends on X and is greatest for a given amplifier when X approaches its largest possible value which, by definition, is 1. This means that a negative-feedback amplifier compensates a greater percentage for small variations in gain than it does for large variations. Fig. 3 shows this

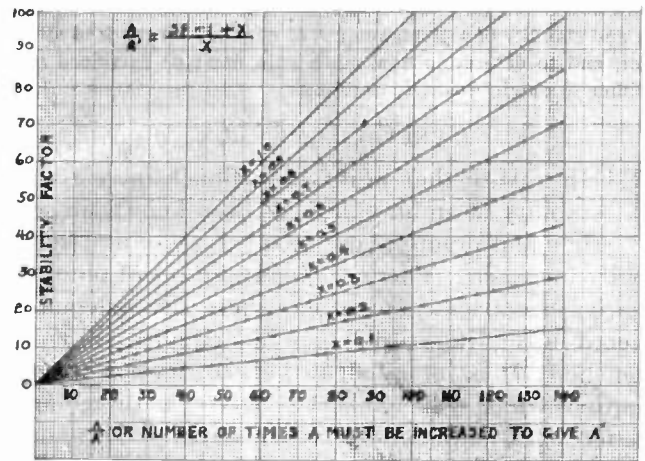

Fig. 3—Increase in gain required for desired increase in stability.

variation for six different amplifiers or rather six different sets of amplifiers because each curve represents a family of amplifiers, each family having a value of $A\beta$ equal to that shown on the curve regardless of the value of A or A^1 .

It would be interesting to know the amount of feedback required to give a certain desired increase in stability and this can be found by combining (1) and (4).

$$A^1 = A / (1 + A\beta) \quad (1)$$

or

$$A = A^1 / (1 - A^1\beta) \quad (5)$$

$$SF = 1 + A\beta X. \quad (4)$$

Substituting (5) in (4) and solving for β

$$\beta = (SF - 1) / A^1(SF - 1 + X). \quad (6)$$

When SF is large compared with either 1 or X , the above equation reduces to $\beta = 1 / A^1$ or $A^1 = 1 / \beta$ which is (2). An interesting fact is brought out by combining (5) and (6). Substituting (6) in (5) and solving for A / A^1

$$A / A^1 = (SF - 1 + X) / X. \quad (7)$$

This is then the expression for the sacrifice in gain which is required to obtain a desired stability and when X approaches 1 and SF is large, this equation reduces to $A / A^1 = SF$. Thus we see that for large values of SF , the loss in gain is equal to the stability factor. Fig. 2 shows how many times the gain must be increased to give a desired value of SF as X varies.

In designing amplifiers for certain applications, it would be convenient to know the feedback which is required for a certain sacrifice in gain and this can be found by solving (1) for β

$$\beta = (A - A^1)/A^1A. \tag{8}$$

In designing amplifiers for certain applications, it would be convenient to know X in terms of SF , A and β and this can be found by solving (4) for X .

$$SF = 1 + AX\beta \tag{4}$$

$$X = (SF - 1)/A\beta. \tag{9}$$

PRACTICAL APPLICATION

Equations have now been developed which enable the engineer to design a negative-feedback amplifier when any of the three following conditions are known:

1. A —the gain of the amplifier without negative feedback.
2. A^1 —the gain of the amplifier with negative feedback.
3. β —the feedback factor—a fraction of the output voltage.
4. SF —The number of times the stability of the amplifier is increased or is to be increased by the addition of negative feedback.
5. X —the fraction of its maximum value which the gain of the amplifier assumes when the electrode voltages and tube constants are varied over the operating range.

Case I. To design an amplifier of given gain and stability.

Known: A^1 , X , SF

Unknown:

$$\beta = (SF - 1)/A^1(SF - 1 + X) \tag{6}$$

$$A = A^1/(1 - A^1\beta). \tag{5}$$

The feedback circuit can now be designed from the value of β and the amplifier itself can be designed from the value of A and the combination should give the value of A^1 which was originally chosen.

Case II. To determine the stability which will be gained by a given feedback circuit when it is known how much gain may be sacrificed.

For example, an amplifier has been designed with more gain than is necessary for a certain application: how much stability can be gained by using negative feedback to lower the gain. Or, how much stability can be gained by adding an additional tube to an amplifier and using negative feedback to lower the gain to the value without the additional tube.

Known: A , A^1 , and X .

$$\text{Unknown: } \beta = (A - A^1)/AA^1 \tag{8}$$

$$SF = 1 + A\beta X. \tag{4}$$

A modification of this case is when SF is known instead of X and it is wished to determine for what value of X this SF is true.

Known: A , A^1 , and SF

Unknown:

$$\beta = (A - A^1)/AA^1 \tag{8}$$

$$X = (SF - 1)/A\beta. \tag{9}$$

In this case, if SF is chosen too large for the gain which can be sacrificed, the solution of (9) will give an answer greater than 1 which means that the variation in A as electrode voltages and tube constants are varied must be less than zero which is obviously impossible. So to give a real solution, either the ratio A/A^1 must be increased or SF must be lowered.

Case III. To determine the effect on gain and stability of a given amount of negative feedback.

Known: A , β , and X

Unknown:

$$A^1 = A/(1 + A\beta) \tag{1}$$

$$SF = 1 + A\beta X \tag{4}$$

as in Case II, the following modification exists:

Known: A , β , and SF

Unknown:

$$A^1 = A/(1 + A\beta) \tag{1}$$

$$X = (SF - 1)/A\beta. \tag{9}$$

Case IV. How much gain must be sacrificed in an amplifier to obtain a certain stability?

Known: A , SF , and X

Unknown:

$$A/A^1 = (SF - 1 + X)/X. \tag{7}$$

This shows how much gain must be sacrificed and from this value, A^1 can be calculated. Then knowing A^1 , β can be calculated from (6).

$$\beta = (SF - 1)/A^1(SF - 1 + X). \tag{6}$$

Note: This article treats only considerations of gain and stability of negative-feedback amplifiers. Other advantages are gained by the introduction of negative feedback into an amplifier, namely: reduction in noise and thus an increase in the signal-to-noise ratio;^{7,8} and reduction in amplitude and phase distortion.^{9,10} By giving a feedback circuit the proper frequency characteristic, the amplifier can be given any desired frequency characteristic and the phase shift in the amplifier can be controlled.

DATA USED IN PLOTTING FIG. 2

$$SF = 1 + A\beta X$$

X	SF	A
1	101	100
0	1	100
1	81	80
0	1	80
1	61	60
0	1	60
1	41	40
0	1	40
1	21	20
0	1	20

DATA USED IN PLOTTING FIG. 3

$$\frac{A}{A^1} = \frac{SF - 1 + X}{X}$$

X	SF	A/A ¹	X	SF	A/A ¹
1.0	100	100	0.5	50.5	100
1.0	0	0	0.5	0	0
0.9	90.1	100	0.4	40.6	100
0.9	0	0	0.4	0	0
0.8	80.2	100	0.3	30.7	100
0.8	0	0	0.3	0	0
0.7	70.3	100	0.2	20.8	100
0.7	0	0	0.2	0	0
0.6	60.4	100	0.1	10.9	100
0.6	0	0	0.1	0	0

⁷ Pages 395-396 of footnote reference 2.

⁸ H. J. Reich, "Theory and Applications of Electron Tubes," First Edition, McGraw-Hill Book Company, New York, N. Y., 1939, pp. 223-225.

⁹ Pages 400-402 of footnote reference 2.

¹⁰ Page 222 of footnote reference 8.

A Note on Impedance Measurements at High Frequencies with Special Reference to Impedance Matching*

P. J. KIBLER†, ASSOCIATE, I.R.E.

Summary—A graphical solution has been developed for the value of the unknown impedance measured by the "three-voltmeter method" of radio-frequency-impedance measurement. The graph is reproduced herewith, together with formulas for computing its counterpart for any desired range of values.

THERE has been developed¹ a method of measuring impedance at radio frequencies in which the unknown impedance Z_r is connected to the output terminals of a transmission line. Voltages or currents are then measured at three points on the line. From these readings the resistive and reactive components of Z_r may be determined from the ratios of the readings and the characteristic impedance of the line. The three points are usually selected $\frac{1}{8}$ wavelength distance apart,

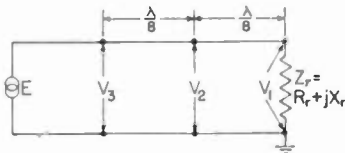

Fig. 1—Schematic diagram of measuring circuit.

measured from the output terminals. In Fig. 1, E may be supplied in any convenient manner. If V_1 is the load voltage, V_2 is the voltage at a distance of $\lambda/8$ from the load, and V_3 is the voltage at a distance of $\lambda/4$ from the load, then²

$$R_r = [A_2(A_1 - A_2 + 1) - 1/4(A_1 - 1)^2]^{1/2} \cdot Z_0 \quad \text{and} \\ X_r = [A_2 - 1/2(A_1 + 1)] \cdot Z_0$$

where $A_1 = |V_1/V_3|^2$; $A_2 = |V_2/V_3|^2$;

Z_0 characteristic impedance of the transmission line.

A_1 and A_2 equal the squares of the absolute magnitudes of the indicated voltage ratios.

The present method is an extension of that previously described by Barrow. At high frequencies, of course, an actual transmission line is used rather than a network simulating a line.

The previous results can be put into somewhat more convenient form as follows: First, hold A_1 constant; that is,

$$A_1 = K = |V_1/V_3|^2. \quad \text{Then}$$

$$R_r^2 = [A_2(K - A_2 + 1) - 1/4(K - 1)^2] \cdot Z_0^2$$

$$X_r^2 = [A_2 - 1/2(K + 1)]^2 \cdot Z_0^2$$

$$R_r^2 + X_r^2 = [KA_2 - A_2^2 + A_2 - 1/4(K^2 - 2K + 1) + A_2^2 \\ + 1/4(K^2 + 2K + 1) - KA_2 - A_2] \cdot Z_0^2 = KZ_0^2.$$

* Decimal classification: R241. Original manuscript received by the Institute, November 1, 1943.

† Farnsworth Television and Radio Corporation, Fort Wayne, Indiana.

¹ W. L. Barrow, "Measurement of radio-frequency impedance with networks simulating lines," *Proc. I.R.E.*, vol. 23, pp. 807-826; July, 1935.

² A typographical error in Barrow's original expression for X_r has been corrected.

That is, if R_r and X_r are plotted in the complex plane, for varying values of A_2 as A_1 is held constant, the loci of the point (R_r, X_r) are circles having their centers at the origin of co-ordinates and having radii $\sqrt{KZ_0} = |V_1/V_3|Z_0$. In like manner, holding A_2 constant, and transferring the origin of co-ordinates to the point $(0, -Z_0)$,

$$A_2 = K = |V_2/V_3|^2; \quad X_r' = X_r + Z_0; \quad R_r' = R_r.$$

(X_r' and R_r' are the new co-ordinates.)

Then

$$R_r'^2 = [K(A_1 - K + 1) - 1/4(A_1 - 1)^2] \cdot Z_0^2$$

$$X_r'^2 = (X_r + Z_0)^2 = X_r^2 + 2X_rZ_0 + Z_0^2$$

$$X_r^2 = [K - 1/2(A_1 + 1)]^2 \cdot Z_0^2$$

$$2X_rZ_0 = 2[K - 1/2(A_1 + 1)] \cdot Z_0^2$$

$$R_r'^2 + X_r'^2 = [KA_1 - K^2 + K - 1/4(A_1^2 - 2A_1 + 1) + K^2 \\ + 1/4(A_1^2 + 2A_1 + 1) - KA_1 - K + 2K - A_1 - 1 + 1] \cdot Z_0^2 \\ = 2KZ_0^2.$$

Thus, for varying values of A_1 as A_2 is held constant, the loci of the point (R_r, X_r) are circles having their centers at the point $(0, -Z_0)$ and having radii $\sqrt{2KZ_0} = \sqrt{2}|V_2/V_3|Z_0$. These results enable us to construct a chart similar to Fig. 2 for any desired range of $|V_1/V_3|$ and $|V_2/V_3|$.

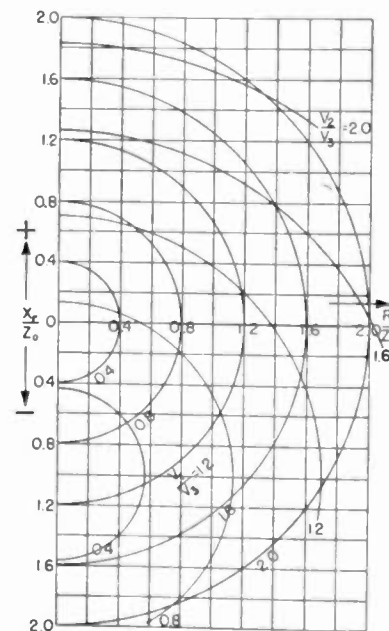

Fig. 2—Chart for determination of unknown impedances.

As an example of the use of Fig. 2, suppose that, in a certain case, V_1 is measured as 4.62 volts; $V_2 = 3.14$ volts; and $V_3 = 3.70$ volts. Then $|V_1/V_3| = 1.25$ and $|V_2/V_3| = 0.85$. From these values, by means of Fig. 2,

it is found that $R_r/Z_0 = 1.12$ and $X_r/Z_0 = -0.58$. If Z_0 is then known to be 70 ohms, $R_r = 78.4$ ohms, and $X_r = -40.6$ ohms; or $Z_r = 78.4 - j40.6$ ohms.

The limited applications of the method, discussed in Barrow's original paper, can be observed immediately from Fig. 2 in the regions where the circles intersect at small angles. Specifically, pure resistances outside the range of about $0.3 Z_0$ to about $2 Z_0$, pure inductances, and pure capacitive reactances far removed in value from Z_0 cannot be measured accurately. The region of greatest accuracy is seen to lie in the region of $Z_r = (0.6 - j.4)Z_0$.

In actual measurement, suitable sections of the same type of coaxial line used to feed the load were used as the measuring-line sections. Appropriate precautions were observed at the voltage-measurement points to avoid undue discontinuities in the transmission line. The voltmeter used was a standard General Radio type 726-A vacuum-tube voltmeter slightly modified. The probe shown in Fig. 3 was fabricated from a piece of half-inch

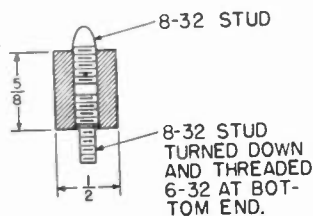

Fig. 3—Special voltmeter multiplier terminal.

polystyrene *A* rod and two 8-32 brass studs. The capacitance between studs was adjusted to about 0.4 micro-

microfarad and this probe was then used in place of the usual "banana plug" on the "high" terminal of the voltmeter. Much more than adequate deflections were obtained using a transmitter capable of 25 watts output into a 50-ohm transmission line. No detectable reaction on the transmitter occurred when the probe terminal was touched to the center conductor of the transmission line. If necessary, of course, the probe capacitance can be still further reduced, at the expense of voltmeter sensitivity.

The value of the unknown impedance is, of course, obtained in terms of the characteristic impedance of the transmission line used for measuring. This impedance is usually known or can be computed with acceptable accuracy. However, where it is desired only to match a load to a given transmission line, Z_0 need not even be known.

No experiments have been made with a view to determining the accuracy of measurement of general impedances, in view of the limitations previously cited; but considerable use has been made of the method in matching various antenna loads to coaxial cables at frequencies from 200 to 350 megacycles per second. It should be noted that, though the initial accuracy of impedance measurement may be poor, as a good match is approached the accuracy improves. The ultimate accuracy is considered entirely adequate for any practical application. The different lengths of measuring line required at various frequencies are inconvenient; but usually work is centered on one or more discrete frequencies in any given range, in which case this disadvantage is not too trying.

Node Equations*

MYRIL B. REED†, ASSOCIATE, I.R.E.

Summary—The node equations are shown to be Kirchhoff's current equations expressed in terms of circuit admittances and voltages from all network junctions or nodes to the reference node (node at which a current equation is not written). A method of writing these node equations directly from a network is presented. This method is given in such a form that it applies to any network, even though mutual magnetic induction, regulated generator voltages, and given input currents are included.

IN RECENT years Kirchhoff's current equations expressed in terms of admittances and voltages between junctions or nodes have assumed a position of importance in network analysis. These current equations have been called *node* equations. The node equations have the property of not changing in number no matter how many branches are added to or subtracted from a certain set of nodes or junctions. Certain types of problems can be most effectively handled by the node

equations and others by the mesh equations. The behavior of networks having specified input currents, or a constant set of nodes with a varying number of branches, is particularly amenable to node-equation treatment. The mesh method, on the other hand, is most effective for networks for which the meshes do not change although the branches do, or for studying mutual-magnetic-induction effects. Furthermore, the system of equations which leads to the least number of equations for a network is usually the one to use because of the greater ease in solving fewer equations.

The fundamental ideas and a technique for writing the node equations which applies to many problems have already been presented elsewhere.^{1,2} However, the methods already presented do not apply if the network

¹ Electrical Engineering Staff, Massachusetts Institute of Technology, "Electric Circuits," John Wiley and Sons, New York, N. Y., 1940, pp. 121-164, 391-398, and 420-430.

² Murray F. Gardner and John L. Barnes, "Transients in Linear Systems," John Wiley and Sons, New York, N. Y., 1942, pp. 38 *et sequens*.

* Decimal classification: R142X510. Original manuscript received by the Institute, August 18, 1943; revised manuscript received, January 6, 1944.

† Illinois Institute of Technology, Chicago, Illinois.

contains an arbitrarily located generator or set of generators of negligible internal impedance or of regulated terminal voltage. In addition the methods already presented do not permit writing node equations *directly from a circuit* containing mutual magnetic coupling, but instead require preliminary calculations.

Until the same ease and assurance are possible in writing the node equations as are possible in writing the mesh equations, the node method will hold a position of minor importance. If these two methods can be used

The inclusion of mutual magnetic coupling in a network adds a certain amount of complexity to both the mesh and node methods. The number of mesh equations is not altered but additional terms appear in these equations. The extra terms are simple in form, however, and so cause no particular difficulty once polarity conventions are accurately formulated. The node equations, on the other hand are definitely and adversely complicated by the inclusion of mutual magnetic induction. It has been shown² that, by certain preliminary calculations, the network can be transformed into a network with new parameters from which the node equations can be written. Many of the new parameters will be complicated expressions of the original parameters if mutual induction involves many of the elements in the network. In the following it will be shown that, as an alternative which is simpler to apply, the network may be altered only slightly and in a very simple manner and the node equations then may be written directly from this altered network. The extra equations required in the method presented here can be readily eliminated by a well-known and routine algebraic process as will be shown.

At the outset it should be noted that the node equations are actually current equations written at a junction or node in compliance with Kirchhoff's current law. These *current equations* are expressed in terms of *voltages and admittances* in contrast with the mesh equations which are Kirchhoff *voltage equations* written in terms of *currents and impedances*. In order to establish the generality of the node method and to formulate general rules for its application, the portions, of a more extensive network, shown in Fig. 1(a) will be considered. This network represents any node *o* coupled electrically and magnetically to other nodes in the same subnetwork as well as magnetically to a second subnetwork.

It will be recalled that independent current equations can be written at all but any one of the nodes of a subnetwork. The one node of a subnetwork at which a current or node equation is not to be written will be designated as the reference node. The two reference nodes of Fig. 1(a) are designated by r_1 and r_2 . The voltages from all nodes of a subnetwork to its one reference node are known as node voltages. These voltages will *all* have an assumed positive polarity away from the reference node as shown by V_3 of Fig. 1. The problem now will be to express the current equation at the arbitrary node *o* in terms of the admittances of the network and the node voltages so polarized by assumption.

Since the node equation is a current equation, it is with the current equation that the development must start. Furthermore in anticipation of the conclusions to be reached subsequently, if the current equations are written with the currents directed away from the nodes, the node equations bear a certain resemblance to the mesh equations which is interesting and is a helpful mnemonic.

The current equation at *o* of Fig. 1(a) is

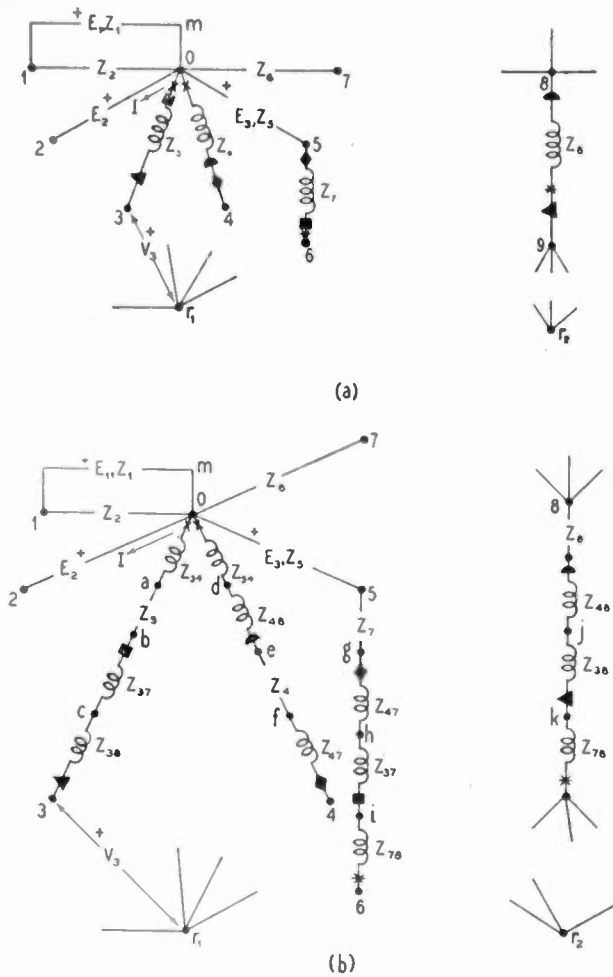

Fig. 1

with equal facility in forming network equations, the decision as to which method to use can be based on the merits of the resulting equations in solving the problem at hand rather than on the fact that the mesh equations can always be written whereas the present form of the node equations cannot. This restriction inevitably has put the node method in second place (even where it is not restricted) because the method that is certain to work in all cases is also certain to be preferred.

This paper presents a node-method technique which makes writing the node equations *directly from the circuit* easy and certain and, therefore, places the node-equation technique where it belongs, on an entirely equal footing with the mesh equations as a complementary scheme of writing network equations.

$$I_{om} + I_{o1} + I_{o2} + I_{o3} + I_{o4} + I_{o5} + I_{o7} = 0. \quad (1)$$

Considering these currents one at a time in terms of Kirchhoff's voltage law, first for branch *om*

$$E_1 = Z_1 I_{om} + V_1 - V_o \quad (2)$$

which if solved for I_{om} gives

$$I_{om} = E_1 Y_1 - V_1 Y_1 + V_o Y_1. \quad (3)$$

Similarly for branch *o5*

$$I_{o5} = -E_3 Y_5 + V_o Y_5 - V_5 Y_5. \quad (4)$$

For branch *o1* immediately,

$$I_{o1} = V_o Y_2 - V_1 Y_2 \quad (5)$$

and likewise for branch *o7*

$$I_{o7} = V_o Y_6 - V_7 Y_6. \quad (6)$$

Consider next branch *o3*. This branch is magnetically coupled to the other three coils shown and in accordance with the various polarity marks shown. The voltage equation is

$$V_o - V_3 = I_{o3} Z_3 + I_{o3} Z_{34} - I_{56} Z_{37} + I_{89} Z_{38}. \quad (7)$$

But this equation is a function not only of I_{o3} but of three other currents and so obviously cannot be solved for I_{o3} in terms of network parameters and node and generator voltages only. Similarly the equation for branch *o4* contains not only I_{o4} but also the three other currents of the branches magnetically coupled to branch *o4*. Consequently I_{o4} cannot be determined in the form desired from this voltage equation. In fact in addition to the voltage equations for branches *o3* and *o4*, two more independent equations, which may be written for branches 56 and 89 in terms of the currents in (7), are required so that the resulting set of 4 equations can be solved simultaneously for the desired currents.

The expressions for I_{o3} and I_{o4} obtained from solving four simultaneous equations will certainly be much too complex to offer any chance whatsoever that they can be determined directly from the circuit with no intermediate computation. But suppose that instead of the foregoing approach, the network portions of Fig. 1(a) are redrawn as in Fig. 1(b). The only difference between these two network sections is indicated in the branches which are magnetically coupled. For example, in branch *o3* of Fig. 1(b) the impedance Z_3 represents the self-impedance of branch *o3* of Fig. 1(a). The mutual-induction voltages of branch *o3* are assumed to be located in the imaginary mutual impedances Z_{34} , Z_{37} , and Z_{38} . These imaginary mutual impedances do not have self-impedance, and each mutual impedance is coupled to only one other such impedance. This modified network is the equivalent of the original network because the same set of voltages appear between nodes *o* and 3, *o* and 4, etc., for both networks.

Now consider the *oa* portion of branch *o3* of Fig. 1(b) magnetically coupled to branch *od*. The equation for the branch *oa* is

$$I_{oa} Z_{34} = V_o - V_d \quad (8)$$

and immediately from this expression the current in branch *oa* is

$$I_{oa} = V_o Y_{34} - V_d Y_{34}. \quad (9)$$

Similarly the current in branch *od*, as a result of magnetic coupling with branch *oa* is

$$I_{od} = V_o Y_{34} - V_d Y_{34}. \quad (10)$$

Except for branch *o2* the expressions for the currents in all the branches connected to node *o* of Fig. 1(b) have now been formulated. Extra nodes over those of the original network have been introduced in the process, but as will be shown, the equations at these extra nodes as well as at the original node can now be written directly from the circuit.

The branch *o2* requires particular although simple treatment. Since this branch represents a source with negligible internal impedance or regulated terminal voltage, a current-impedance relation is impossible. In fact the equation

$$E_2 = V_o - V_2 \quad (11)$$

is the only voltage relation which can be written for branch *o2*. Since this equation cannot be used to determine the current of branch *o2*, it is necessary to assume a current $I = I_{o2}$ in the branch as shown. The current I will be treated as one of the unknown elements which the node equations must determine. Because of the introduction of the extra variable I , the voltage equation (11) must be incorporated into the system of node equations to be written for the network as a whole.

It is now possible to form the equation for node *o* by substituting into (1) the results given in (3), (4), (5), (6), (9), and (10) and $I = I_{o2}$. Hence, at node *o* of Fig. 1(b) after substituting and rearranging,

$$\begin{aligned} \text{node } o: \quad & -E_1 Y_1 + E_3 Y_5 = V_o(Y_1 + Y_2 + Y_5 + Y_6 + 2Y_{34}) \\ & - V_1(Y_1 + Y_2) - V_5 Y_5 - V_7 Y_6 \\ & - V_o Y_{34} - V_d Y_{34} + I. \end{aligned} \quad (12)$$

Without going through all the formalities as in the foregoing, the equations at nodes *a* and *c* will be given, and from the three equations then available, general rules for writing node equations will be formulated. Thus

$$\text{node } a: \quad 0 = V_o Y_3 - V_b Y_3 + V_d Y_{34} - V_o Y_{34} \quad (13)$$

$$\text{node } c: \quad 0 = V_h Y_{37} - V_i Y_{37} + V_j Y_{38} - V_k Y_{38}. \quad (14)$$

The rules for writing node equations at any node, say *A*, may now be stated as follows:

(a) Add the products of all generator voltages (E) and corresponding branch admittances which are in branches connected to node *A*. Use plus signs if the assumed positive polarity of E is at node *A*, i.e., if a generator of the assumed polarity would send a current toward the node—see the two terms on the left of (12). If the generator internal impedance is negligible or the terminal voltage regulated, an unknown current as in branch *o2* of Fig. 1 should be assumed, and this current added on the right of the equality sign if it is assumed away from the node, see (12). An additional equation of the form of (11) must be added to the set of node equations.

(b) The sum of the self-admittances of all the branches connected to node *A* multiplied by V_A should be placed on the right of the equality sign; see the first

term on the right of (12) and (13). The mutual impedance term in this self-coupling term of (12) should be added in correspondence with part (d) following.

(c) Subtract on the right of the equality sign an admittance-voltage product for each self impedance in a branch coupling node *A* to any other node except the reference node; see the second, third, and fourth terms on the right of (12), and the second term on the right of (13). Note that the internal impedance of generators are

$$\begin{aligned}
 \text{node 1:} \quad & E_1 Y_1 = V_1(Y_1 - 2Y_{56}) - I + V_a Y_{56} + V_b Y_{56} \\
 \text{node 2:} \quad & E_4 Y_4 - E_3 Y_3 = V_2(Y_3 + Y_4 + Y_6) + I - V_a Y_6 \\
 & E_2 = -V_1 + V_2 \\
 \text{node a:} \quad & 0 = V_1 Y_{56} - V_2 Y_6 + V_a Y_6 - V_b Y_{56} \\
 \text{node b:} \quad & 0 = V_1 Y_{56} - V_a Y_{56} + V_b Y_6
 \end{aligned} \tag{15}$$

The matrix form of these equations shows most effectively the nature of the relations. Thus

$$\begin{pmatrix} E_1 Y_1 \\ E_4 Y_4 - E_3 Y_3 \\ E_2 \\ 0 \\ 0 \end{pmatrix} = \begin{pmatrix} Y_1 - 2Y_{56} & 0 \\ 0 & Y_3 + Y_4 + Y_6 \\ -1 & 1 \\ Y_{56} & -Y_6 \\ Y_{56} & 0 \end{pmatrix} \begin{pmatrix} V_1 \\ V_2 \\ I \\ V_a \\ V_b \end{pmatrix} \tag{16}$$

to be included in forming these coupling terms. Also note that if node *A* is coupled with the reference node through a self impedance, the coupling term is zero because the coupled voltage (reference node to itself) is zero.

(d) Add on the right of the equality sign, for each mutual-induction element physically connected to node *A* and magnetically coupled by Y_{pq} to the element between nodes *B* and *C*, a product of the form $\pm V_B Y_{pq} \mp V_C Y_{pq}$. These two terms will always be of opposite sign. The positive term will contain the node voltage at the polarity mark corresponding to the polarity mark at node *A*. For example at node *c* of Fig. 1(b), from Z_{37} in branch *cb* magnetically coupled to branch *hi*, the two terms $V_h Y_{37} - V_i Y_{37}$ appear—the plus sign being attached to the voltage V_h which is at the node not polarity-marked in correspondence with the not marked end of Z_{37} at *c*, see (14). Again, at node *o* of Fig. 1(b) the mutual impedance between *o* and *a* introduces the terms $V_o Y_{34} - V_d Y_{34}$ from coupling with branch *od*. The polarity marked end of Z_{34} in *oa* is at *o* and the polarity mark of Z_{34} between *o* and *d* is at *o* hence the plus sign is associated with $V_o Y_{34}$.

In describing a process as in the foregoing it is always difficult to decide when additional words tend to obscure rather than clarify the issue. It is hoped that the discussion already given, together with the following examples will make the node method not too difficult to learn. The reader can be certain that once the node method has been learned, it is as easy to apply as the mesh method.

It may be of interest to note that the theorem suggested by Millman³ is actually a node equation with only passive elements in the branches connected to the node. The method given here, therefore, extends Millman's theorem to any node in any network.

Consider the network shown in Fig. 2(a), modified in Fig. 2(b) as required by magnetic coupling. Assume node 3 as the reference node. Then directly from the circuit in accordance with the foregoing discussion:

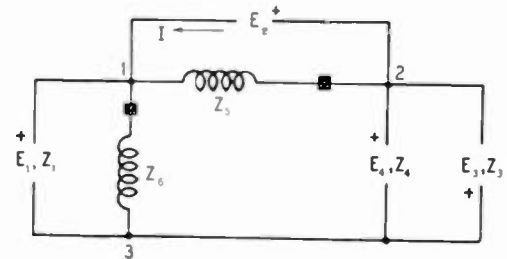

(a)

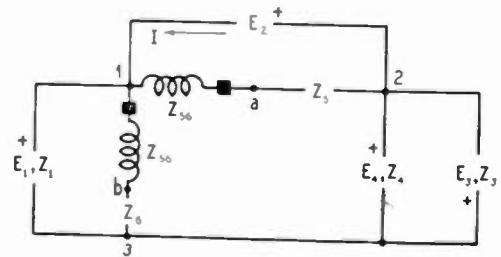

(b)
Fig. 2

Note that the admittance matrix is symmetric, that the self-coupling terms are located on the main diagonal, and that the terms representing coupling with other nodes are off the main diagonal in exact correspondence with the usual impedance matrix of the mesh method.

Node 3 is not the best one to choose as the reference

³ J. A. Millman, "A useful network theorem," Proc. I.R.E., pp. 413-417; September, 1940.

node of Fig. 2(b). It was chosen here merely to illustrate one form of the node equations. If node 1 is chosen as the reference, the regulated voltage E_2 determines the node voltage V_2 so an equation need not be written at node 2, but only at nodes 3, a , and b thus eliminating two equations. The equations required are

$$\begin{aligned} \text{node 3:} & \left(-E_1Y_1 + E_3Y_2 - E_4Y_4 + E_2(Y_3 + Y_4) \right) \\ \text{node } a: & \left(E_2Y_5 \right) \\ \text{node } b: & \left(0 \right) \end{aligned} = \begin{pmatrix} Y_1 + Y_2 + Y_4 + Y_6 & 0 & -Y_6 \\ 0 & Y_5 & -Y_{56} \\ -Y_6 & -Y_{56} & Y_6 \end{pmatrix} \begin{pmatrix} V_3 \\ V_a \\ V_b \end{pmatrix} \quad (17)$$

The term $E_2(Y_4 + Y_2)$ in the equation at node 3 arises from the fact that node 3 is coupled to node 2 through two branches containing Z_4 and Z_3 . The coupling term to be placed on the right of the equation at node 3 is $-V_2(Y_4 + Y_3)$. But since $V_2 = E_2$ and is known, when

$$\begin{aligned} \text{node 2:} & \left(-\mu E_g Y_p + E_g Y_{op} \right) \\ \text{node 3:} & \left(0 \right) \\ \text{node 4:} & \left(0 \right) \\ \text{node 5:} & \left(0 \right) \end{aligned} = \begin{pmatrix} Y_p + Y_{op} + Y_{pk} + Y_a & 0 & -Y_a & 0 \\ 0 & Y + Y_b & 0 & -Y_b \\ 0 & 0 & Y_a & Y_{ab} \\ 0 & -Y_b & Y_{ab} & Y_b \end{pmatrix} \begin{pmatrix} V_2 \\ V_3 \\ V_4 \\ V_5 \end{pmatrix} \quad (18)$$

this relation is used and the coupling term is shifted across the equality sign it becomes $E_2(Y_4 + Y_3)$. Similarly, the term E_2Y_5 on the left in the equation at node a arises as the coupling term between nodes a and 2.

If the last two equations of (16) or (17) are used to solve for V_a and V_b in terms of the remaining node voltages or voltage, and this result substituted into the remaining equations or equation, the result will be the node form of the circuit equations reduced to correspond to the essential nodes of the original network. The next example will show this technique.

$$\begin{pmatrix} -\frac{\mu E_g}{R_p} + E_g j\omega C_{gp} \\ 0 \end{pmatrix} = \begin{pmatrix} \frac{1}{R_p} + j\omega C_{op} + j\omega C_{pk} + Y_a - \frac{Y_a^2 Y_b}{Y_a Y_b - Y_{ab}^2} & \frac{Y_a Y_b Y_{ab}}{Y_a Y_b - Y_{ab}^2} \\ \frac{Y_a Y_b Y_{ab}}{Y_a Y_b - Y_{ab}^2} & Y + Y_b - \frac{Y_a Y_b^2}{Y_a Y_b - Y_{ab}^2} \end{pmatrix} \begin{pmatrix} V_2 \\ V_3 \end{pmatrix} \quad (21)$$

As a final example of the node method of writing circuit equations, consider the equivalent circuit of a triode coupled to a load impedance Z through a transformer, Fig. 3(a) and in modified form Fig. 3(b). Placing the reference node at r of the tube eliminates the necessity of writing an equation at node 1, since the grid voltage determines the node voltage V_1 . The node equations for Fig. 3(b) are

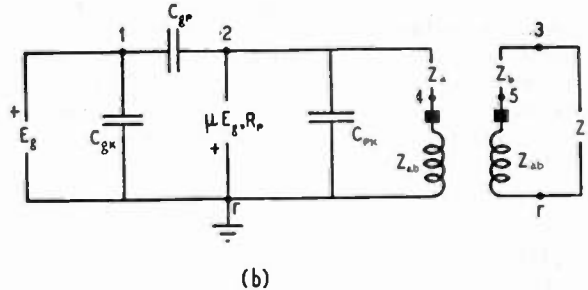
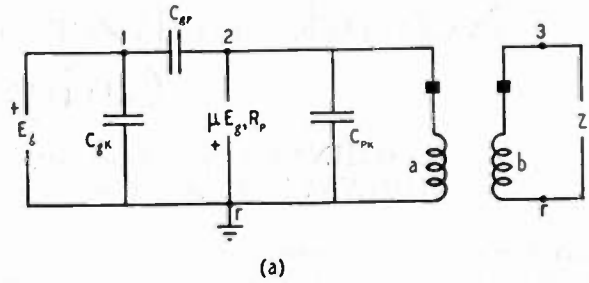

Fig. 3

If, as is usually the case, only the two node voltages V_2 and V_3 are of interest, the last two of equations (18) can be used to determine V_4 and V_5 as

$$V_4 = \frac{V_2 Y_a Y_b - V_3 Y_b Y_{ab}}{Y_a Y_b - Y_{ab}^2} \quad (19)$$

$$V_5 = -\frac{V_2 Y_a Y_{ab} + V_3 Y_a Y_b}{Y_a Y_b - Y_{ab}^2} \quad (20)$$

If these equations are then substituted into the first two equations of (18), the result is

These two equations represent the behavior of the circuit of Fig. 3(a) in terms of the plate-to-cathode voltage and the load voltage. One advantage of the node equations for this circuit is that the interelectrode capacitances may be considered, or not, without doing more than adding or removing a term in the first row and first column element of the admittance matrix.

Network Analyzer Studies of Electromagnetic Cavity Resonators*

J. R. WHINNERY†¹, ASSOCIATE, I.R.E., C. CONCORDIA†², NONMEMBER, I.R.E.,
W. RIDGWAY†², NONMEMBER, I.R.E., AND GABRIEL KRON†³, NONMEMBER, I.R.E.

Summary—Studies are described in which equivalent circuits for the Maxwell field equations, considered in a companion paper, are set up on an alternating-current network analyzer. These correspond to several simple electromagnetic cavities for which results are known. Comparisons made between the known theoretical results and field distributions measured from the equivalent circuits are used for verification of the equivalent circuits, for evaluation of the usefulness of present network analyzers in high-frequency-field problems, and for suggestions of desirable features for analyzers constructed especially for the study of field problems.

I. INTRODUCTION

THIS paper presents the results of a study made on the alternating-current network analyzer to investigate equivalent circuits of the field equations of Maxwell for charge free space. The derivation and proof of the equivalent circuits is given in a companion paper.¹ The significance of the circuits in the study of electromagnetic problems at high frequencies is discussed in a second paper.² It was intended to check the circuits for various configurations for which the theoretical results are known, with the following purposes in mind:

1. To obtain experimental verification of the correctness of the equivalent circuits.
2. To evaluate the usefulness of the present network analyzer for the study of field problems.
3. To determine necessary and desirable features for an analyzer constructed especially for the study of such problems.

The alternating-current network analyzer³ consists of a set of inductance, resistance, and capacitance units, each connected to a pair of flexible cords and plugs. A centrally located set of instruments (voltmeter, ammeter, wattmeter, and varmeter) can be connected to any unit or circuit by a set of key switches. Alternating-current electric power is supplied by a motor-generator set to individual generator units so that several different voltages, independently adjustable in both phase and magnitude, can be inserted in different parts of the net-

work. Connections between impedance units to form any desired network are made by inserting the plugs in adjacent jacks of a jack panel. As many units as desired can be connected to a common point. It was thus easy to set up the previously described¹ equivalent circuits on the analyzer, within the limits of the number of units available. This limitation made it impracticable to study other than the circuits applicable to two-dimensional or axially symmetric configurations.

The number of squares into which a given configuration was divided was restricted by the number of capacitor units available on the alternating-current network analyzer. It was felt at first that the restricted number of units would preclude the possibility of obtaining results which were more than qualitatively correct. However, the results of measurements have checked well enough with theoretical results so that it is evident useful information may be obtained by use of existing equipment for many problems. This is of importance as it suggests that radio engineers might with profit make use of available network analyzers in the solution of certain of their field problems, just as electric-power-system engineers have done with their circuit problems for many years.

Three configurations were studied; a rectangular two-dimensional cavity, a cylindrical cavity, and an L-shaped two-dimensional cavity. Measurements of the components of the electric and magnetic fields were made for each of these circuits and checked against calculated values.

II. CONCLUSIONS

The most important conclusions from the study are listed below.

1. All measurements agreed well enough with theoretical results so that the check of the validity of the particular equivalent circuits used may be considered successful.
2. The analyzer results were close enough to the theoretical results to stress the fact that useful information on certain problems whose results are not known might be obtained on present analyzers. Such problems would presumably have to be either two dimensional or axially symmetric because of the limited number of units.
3. Problems preferably should be set up so that voltages are applied rather than currents (although for certain wave types this means applied magnetic fields rather than electric). If currents are applied, the problem of adjustment becomes very difficult when a large number are required. When currents must be applied, a high series-impedance source should be

* Decimal classification: R116. Original manuscript received by the Institute, December 22, 1943; revised manuscript received, March 1, 1944. Presented, Winter Technical Meeting, New York, N. Y., January 28, 1944.

† General Electric Company, Schenectady, New York.

¹ Electronics Laboratory.

² Central Station Engineering Divisions.

³ Engineering General Division.

¹ Gabriel Kron, "Equivalent circuit of the field equations of Maxwell-I," *PROC. I.R.E.*, vol. 32, pp. 289-299; May, 1944.

² J. R. Whinnery and Simon Ramo, "A new approach to the solution of high-frequency-field problems," *PROC. I.R.E.*, vol. 32, pp. 284-288; May, 1944.

³ H. P. Kuehni and R. G. Lorraine, "A new a-c network analyzer," *Trans. A.I.E.E. (Elec. Eng., February, 1938)*, vol. 57, pp. 67-73; February, 1938.

considered so that generator currents would be essentially independent of load adjustments. A dual of the circuit used in this study exists¹ for which electric and magnetic fields in a *TM* or *E* wave are correlated with voltages and currents, respectively, with the opposite correlation for a *TE* or *H* wave. If applied currents were required in one network, they could thus be avoided by making use of the dual.

4. In these studies, the number of units ranged from about 7 to 12 per wavelength. For certain quantities, accuracy was consistently better than 5 per cent, but for other quantities, particularly in the vicinity of cutoffs or resonances, agreement was much poorer. The required subdivision into units is affected by the size of discontinuities as well as by the wavelength.
5. In the existing alternating-current network analyzer, there is a resistance in the inductances equal to about 4 per cent of the reactance setting, corresponding to a *Q* of 25, while in many actual field problems the *Q* may be in the thousands. The result was a phase shift in measured values different from that predicted by theory, so that the amplitudes only were used for comparison purposes. This of course is a serious handicap if phases are important and unknown, and it does prevent measurements of the actual *Q* due to losses in the dielectric or boundary conductors.
6. The limitations (4) and (5) suggest considerations important for any analyzer constructed especially for the solution of electromagnetic field problems.

III. CIRCUITS AND RESULTS

A. Two-Dimensional Rectangular Cavity

The first problem checked on the analyzer corresponds to a wave of electric type (*E* wave or wave transverse magnetic to the *z* direction) in a region bounded by two parallel conducting planes separated by a distance *h* and connected by a third conducting plane at a distance *l* from the input end, Fig. 1. Currents in the circuit were applied at the input corresponding approximately to a half-cosine wave of E_x in the *x* direction.

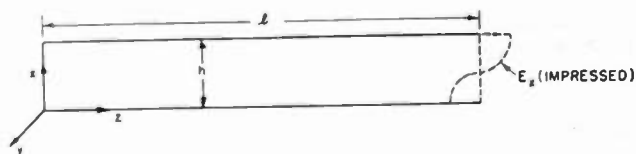

Fig. 1—Rectangular cavity.

It has been shown¹ that an equivalent circuit for representation of a two-dimensional problem with waves of the electric type is as shown in Fig. 2, with the relation between network and field quantities as follows.

Network	Field	
$I_x = E_x$	(1)	$Z_x = Z_x = j\omega\epsilon\Delta l$ (4)
$I_x = -E_x$	(2)	$Y_v = j\omega\mu\Delta l$ (5)
$V_v = H_v$	(3)	

Δl is the size of square of space or dielectric to be repre-

sented by an element of the network, and μ and ϵ are permeability and dielectric constant respectively of the dielectric. (For air or space $\epsilon = (1/36\pi) \cdot 10^{-9}$ farad per meter and $\mu = 4\pi \cdot 10^{-7}$ henry per meter.)

On the network analyzer, per unit quantities are used, so that

$$Z_x = Z_x = jxR_0 \quad (6)$$

$$Y_s = js/R_0 \quad (7)$$

where

R_0 = base ohms for the board

x = per unit reactance settings on inductances

s = per unit susceptance settings on capacitances

By comparing (6) with (4),

$$R_0 = \omega\epsilon\Delta l/x. \quad (8)$$

Equating (5) and (7) and substituting (8), $j\omega\mu\Delta l = js/R_0 = jsx/\omega\epsilon\Delta l$ or $\omega^2\mu\epsilon(\Delta l)^2 = sx$. But in terms of wavelength λ , $\omega\sqrt{\mu\epsilon} = 2\pi/\lambda$ so

$$(\Delta l/\lambda) = \sqrt{sx}/2\pi. \quad (9)$$

The fraction of a wavelength represented by each square is thus determined in terms of per unit reactance and susceptance by (9).

If a wave impedance Z_w is to be determined from the network measurements, where this is a ratio of field quantities, $Z_w = E/H$, it will be obtained from a ratio of current to voltage on the alternating-current network analyzer (see (1) to (3)). If the admittance corresponding to this ratio as read from the alternating-current network analyzer is y per unit, it is an actual admittance of $E/H = Y = y/R_0 = yx/\omega\epsilon\Delta l$ from (8) and substituting (9)

$$E/H = yx2\pi/\omega\epsilon\lambda\sqrt{sx} = \sqrt{\mu/\epsilon}\sqrt{(x/s)}y$$

setting $\sqrt{\mu/\epsilon} = \eta$, intrinsic impedance of this dielectric (for air or space $\eta = 377$ ohms).

$$Z_w/\eta = y\sqrt{x/s}. \quad (10)$$

So from the per unit admittance measurement of y in the network, the corresponding wave impedance is found from (10).

From the above equivalences between field and network quantities, and the theoretical results for the actual field problem as obtained in Appendix A, curves were plotted comparing the calculated field distributions with those measured from the network. The height h was taken as 5 squares, since the zero current $I_x = -E_x$ should apply to the mid-point of the distance represented by its impedance. Thus an extra half square belongs to each side as well as to the short-circuited end. This is indicated in Fig. 2. Table I summarizes the cases set up on the analyzer. Some of the typical plots of field distributions in the longitudinal direction, indicating the degree of agreement between calculated and analyzer results are shown. Fig. 3 is for a case below cutoff, Fig. 4 for one above but near cutoff, and Fig. 5 for one appreciably above cutoff. Calculated curves are referred to the level of E_x on the experimental curve. Typical cross-sectional plots of measured values are shown in Fig. 6. Fig. 7 is typical of plots made showing

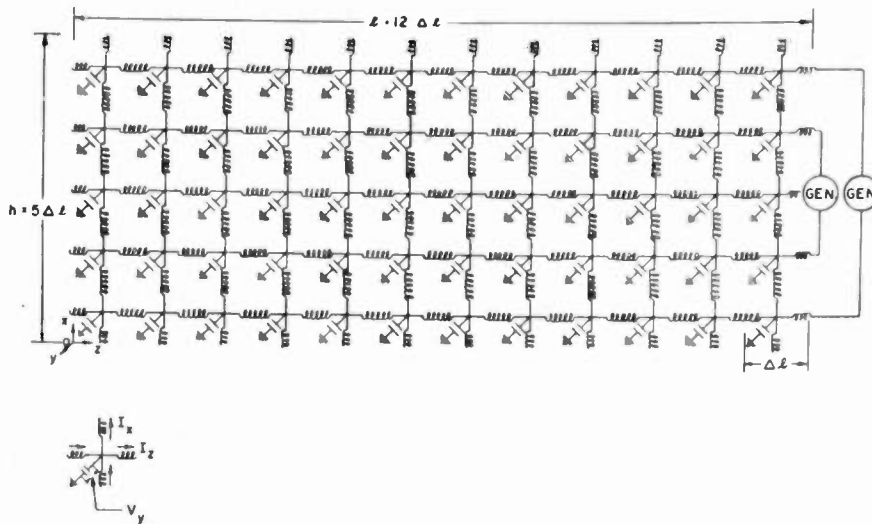

Fig. 2—Network used for rectangular cavity.

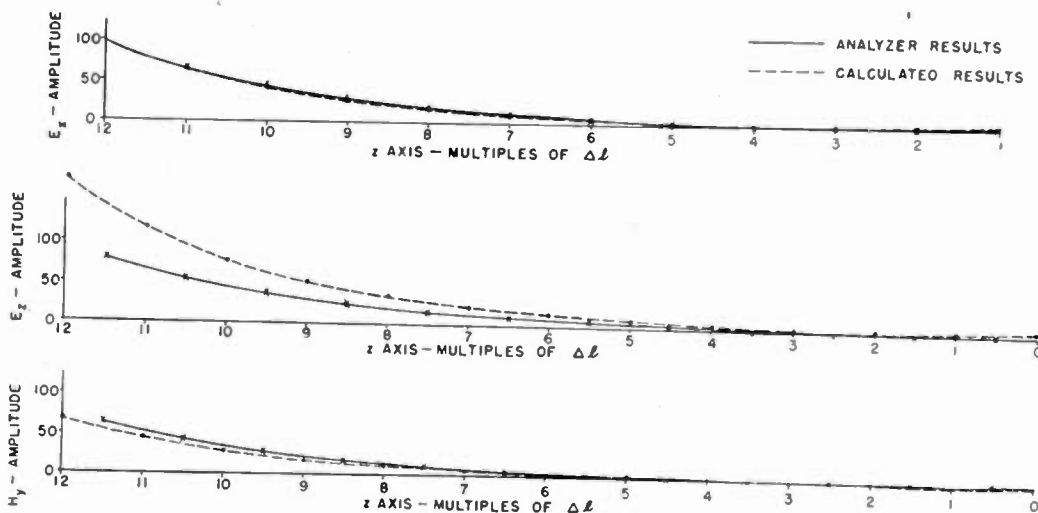

Fig. 3—Longitudinal field distributions for rectangular cavity of Fig. 1; case 10, $h/\lambda = 0.375$.

- (a) E_x along $x = \Delta l/2$ of Fig. 2
- (b) E_z along $x = \Delta l$ of Fig. 2
- (c) H_y along $x = \Delta l/2$ of Fig. 2

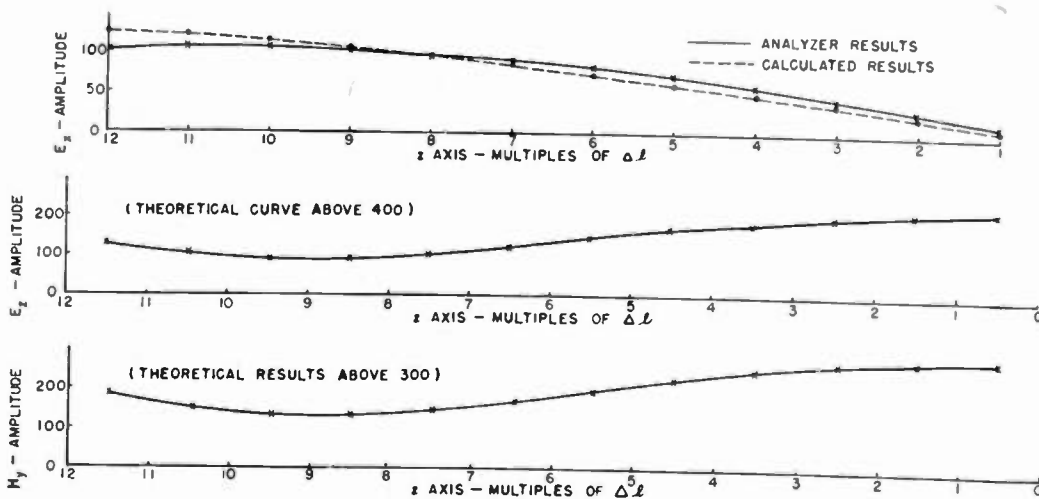

Fig. 4—Longitudinal field distributions for rectangular cavity of Fig. 1; case 6, $h/\lambda = 0.504$.

- (a) E_x along $x = \Delta l/2$ of Fig. 2
- (b) E_z along $x = \Delta l$ of Fig. 2
- (c) H_y along $x = \Delta l/2$ of Fig. 2

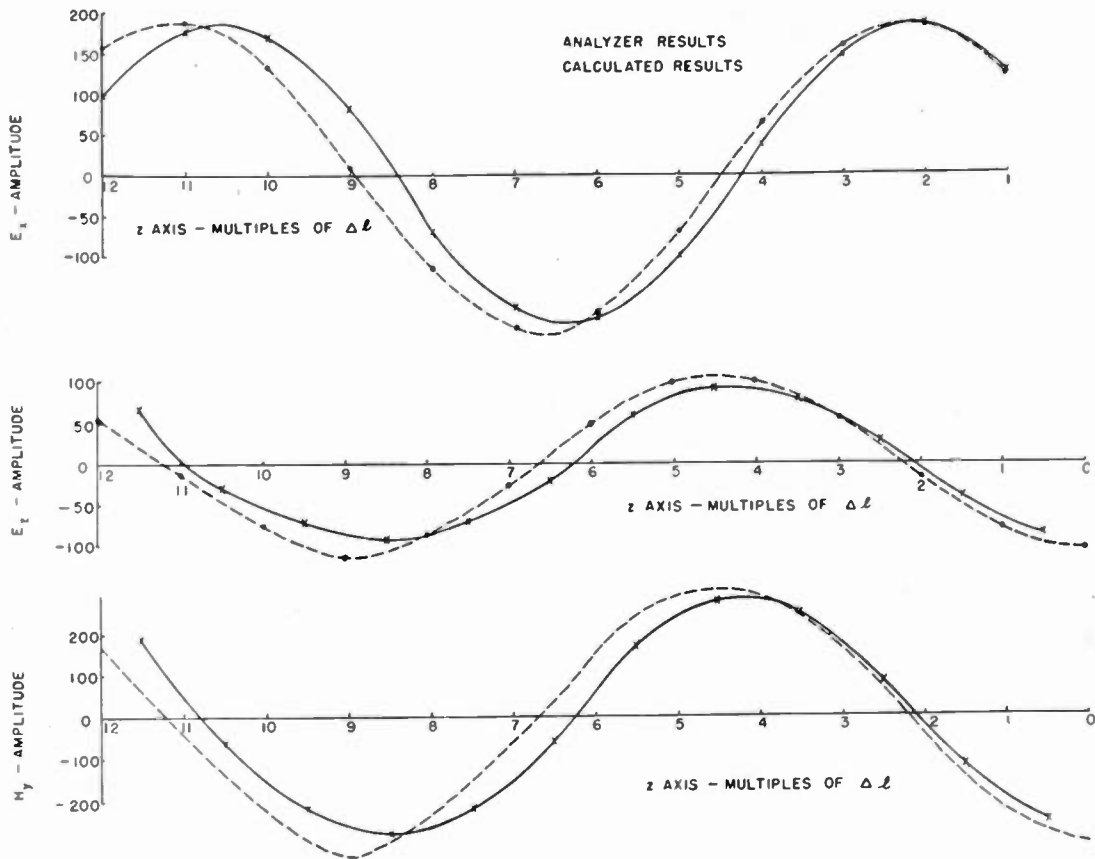

Fig. 5—Longitudinal field distributions for rectangular cavity of Fig. 1; case 3, $h/\lambda=0.75$.

- (a) E_x along $x=\Delta l/2$ of Fig. 2
- (b) E_z along $x=\Delta l$ of Fig. 2
- (c) H_y along $x=\Delta l/2$ of Fig. 2

on one chart longitudinal and cross-sectional distributions for all the network. The plot shown is of E_z for case 2 of Table I.

TABLE I
CASES CHECKED FOR RECTANGULAR CAVITY OF FIG. 1

Case No.	x	s	$\frac{\Delta l}{\lambda}$	$\frac{h}{\lambda} = \frac{1}{2} \frac{f}{f_c}$
10	0.286	0.77	0.0748	0.374
9	0.460	0.77	0.0948	0.474
7	0.504	0.77	0.0993	0.497
1	0.512	0.77	0.100	0.500
6	0.520	0.77	0.1008	0.504
5	0.564	0.77	0.105	0.525
2	0.800	0.77	0.125	0.625
3	1.15	0.77	0.150	0.750
4	1.60	0.77	0.1768	0.885

It is evident that the checks for certain field components are poorest near cutoff ($h/\lambda=0.500$) as might be expected because of the critical nature of the proximity to cutoff factor $1/\sqrt{1-(f_c/f)^2}$ in this region and also the increased importance of losses. It is also evident that in several cases where the checks on wavelength in the z direction and amplitudes of components are very good, the relatively small error in these quantities may amount to a large error in a quantity after several wavelengths. That is, if input impedance or ratios of field components were desired for a line several wavelengths long, the error in merely measuring these quantities on

the equivalent circuit could be large. This means that thought should be given to the measurement and interpretation of quantities from the equivalent circuit to obtain the desired information most accurately.

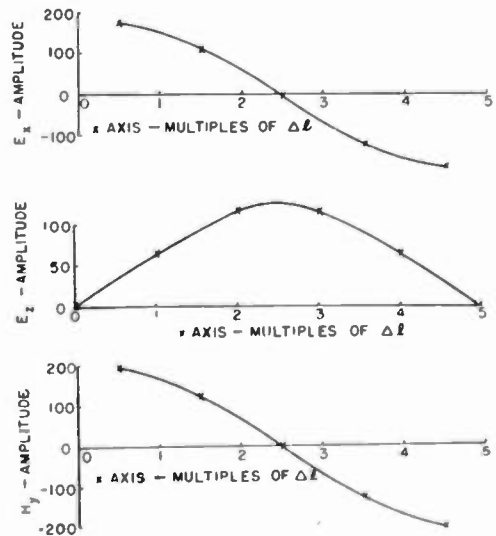

Fig. 6—Typical cross-sectional field distributions in rectangular cavity as measured from analyzer; case 3, $h/\lambda=0.75$.

- (a) E_x along $z=11\Delta l$ of Fig. 2
- (b) E_z along $z=11\frac{1}{2}\Delta l$ of Fig. 2
- (c) H_y along $z=11\frac{1}{2}\Delta l$ of Fig. 2

DOTS INDICATE JUNCTION POINTS
IN NETWORK OF FIGURE 2

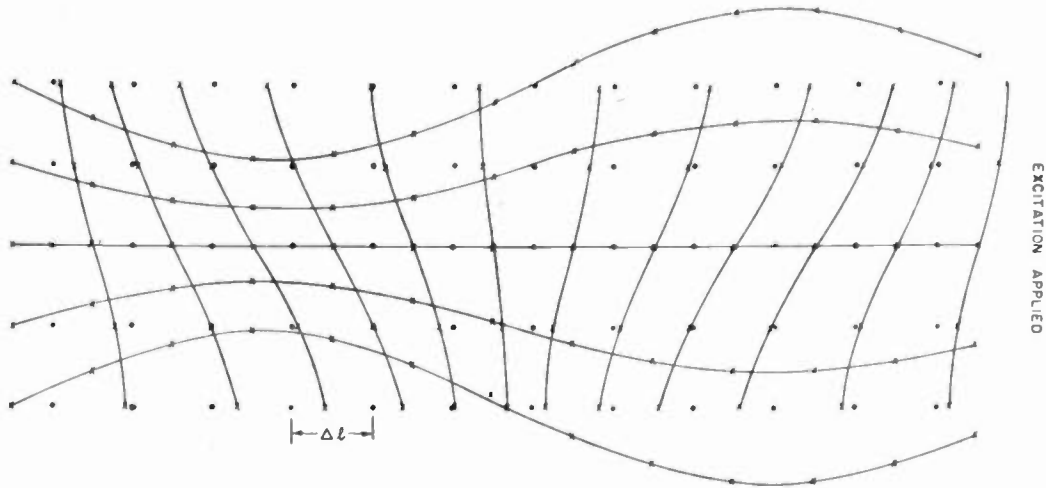

Fig. 7—Typical plot showing measured longitudinal and transverse distributions of a field component throughout the network of Fig. 2. E_z for case 2, $h/\lambda = 0.625$.

B. Cylindrical Cavity

A second problem checked corresponds to a wave of electric type (E wave or wave transverse magnetic to the axis) in a region bounded by a conducting circular cylinder of radius a , closed by a conducting plane at distance l from the input end (Fig. 8). Voltages were applied to the input corresponding approximately to an rJ_1 Bessel function of rH_ψ in the radial direction.



Fig. 8—Cylindrical cavity.

An equivalent circuit has been given¹ for representation of an axially symmetric problem with waves of electric type. This is shown in Fig. 9, with the relation between network and field quantities as follows.

<i>Network</i>	<i>Field</i>	<i>Network</i>	<i>Field</i>
$I_s =$	E_r (11)	$Z_r =$	$j\omega r\Delta l$ (14)
$I_r =$	$-E_z$ (12)	$Z_z =$	$j\omega r\Delta l$ (15)
$V_\psi =$	rH_ψ (13)	$Y_\psi =$	$j\omega\mu\Delta l/r$ (16)

As in Section III, A , Δl is the size of square to be represented by an element of the network, and μ and ϵ are permeability and dielectric constant, respectively, for the dielectric of the field problem to be solved. Here impedances of the network vary directly as the distance from the axis. If base impedance on the analyzer is again R_0 and the per unit reactance set for Z_s at radius $n\Delta l$ from the axis is x_n , the per unit susceptance of Y_ψ is s_n ,

$$Z_s = jx_n R_0 \tag{17}$$

$$Y_\psi = js_n / R_0 \tag{18}$$

By comparing with (15) and (16) respectively and combining the two equations,

$$2\pi\Delta l/\lambda = \sqrt{s_n x_n} = \sqrt{s_1 x_1} \tag{19}$$

So from the product of s and x at any radius $n\Delta l$ from the axis, the fraction of a wavelength to be represented by one square is again determined.

To find the wave impedance E/H from a measurement of a per unit admittance y on the board (ratio of a current I_s or I_z to voltage V_ψ),

$$Z_w = E/H = r(I/V) = r(y/R_0)$$

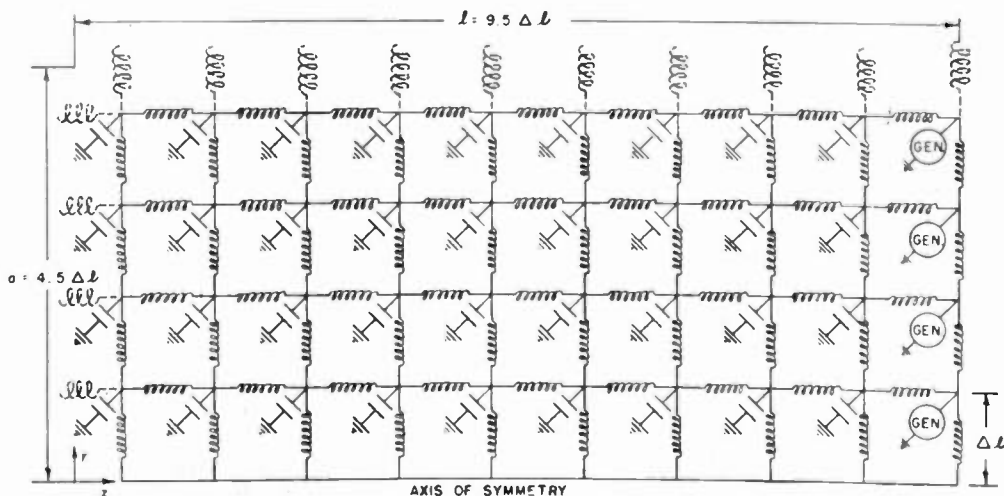

Fig. 9—Network for cylindrical cavity.

R_0 may be obtained by combining say (16), (18), and (19). Then

$$Z_w = (\omega\mu\Delta l/s_n r) y r = \eta\sqrt{(x_n/s_n)} y = \eta n\sqrt{(x_1/s_1)} y. \quad (20)$$

Table II summarizes the cases set up on the board for this axially symmetric example. Figs. 10 and 11 show typical comparisons of analyzer and calculated field-distribution plots in the z direction. Calculated curves are this time referred to the measured level of rH_ψ . Typical plots in the radial direction are shown in Fig. 12.

TABLE II
CASES CHECKED FOR CYLINDRICAL CAVITY OF FIG. 8

Case No.	x_1	s_1	$\Delta l/\lambda$	a/λ	$f/f_c = 2\pi/2.405 a/\lambda$
21	0.232	1.00	0.0767	0.345	0.90
26	0.278	1.00	0.0839	0.378	0.986
23	0.286	1.00	0.0852	0.383	1.0
22	0.362	1.00	0.0958	0.432	1.126
20	0.800	1.00	0.1425	0.641	1.674

Comparison between calculated and measured values again reveals the same general conclusions as in the rectangular case.

C. L-Shaped Two-Dimensional Cavity

Because of the possibility that the previous examples might have given optimistic results regarding the number of units required because of their relative freedom from discontinuities, a two-dimensional region with a corner bend as shown in Fig. 13(a) was taken as a third example. Input impedance may be calculated for such a region as explained in Appendix C. In Table III the calculated values of wave admittance H_ψ/E_z at the input are compared with values measured from the network. Equal voltages were applied to the input terminals in this case representing uniformly applied H_ψ as in the principal or transmission-line wave. The agreement in this table is again much better than was expected.

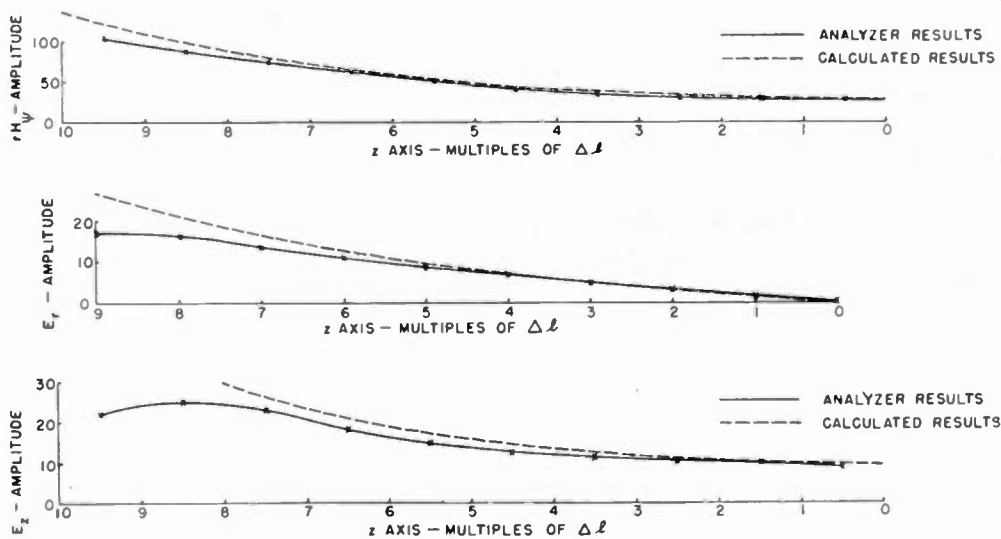

Fig. 10—Longitudinal field distributions for cylindrical cavity of Fig. 8; case 21, $f/f_c = 0.90$.

- (a) rH_ψ along $r = 4 \Delta l$ of Fig. 9
- (v) E_r along $r = 4 \Delta l$ of Fig. 9
- (c) E_z along $r = 3\frac{1}{2} \Delta l$ of Fig. 9

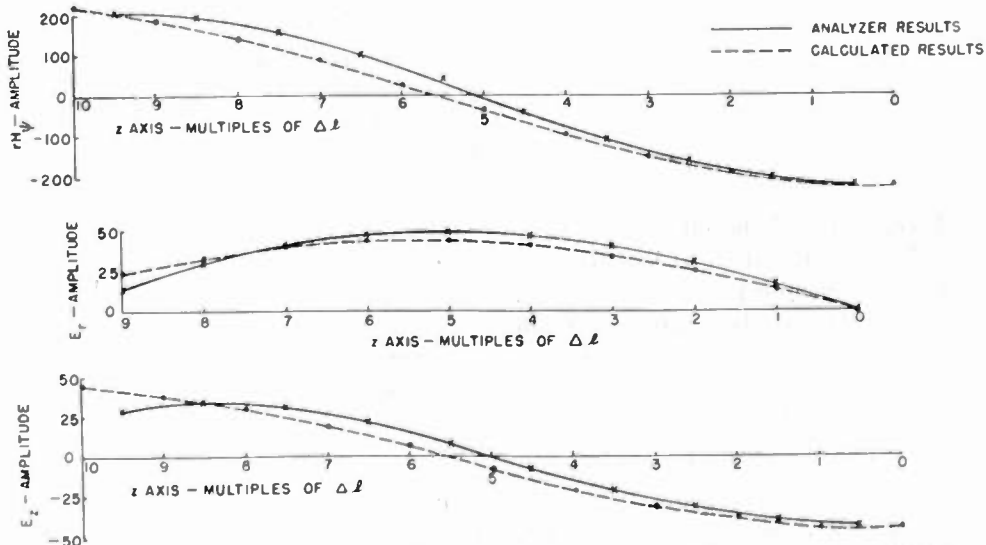

Fig. 11—Longitudinal field distributions for cylindrical cavity of Fig. 8; case 22, $f/f_c = 1.126$.

- (a) rH_ψ along $r = 4 \Delta l$ of Fig. 9
- (b) E_r along $r = 4 \Delta l$ of Fig. 9
- (c) E_z along $r = 3\frac{1}{2} \Delta l$ of Fig. 9

The poorest agreement, case 31, showed a nonuniformity in measured E across the input, where it should be uniform if the transmission wave only is important

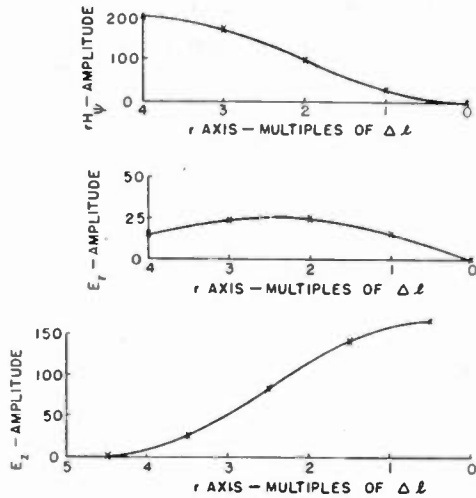

Fig. 12—Typical radial plots of fields in cylindrical cavity as measured from the analyzer.
 (a) rH_ψ along $z = 9\frac{1}{2}\Delta l$ of Fig. 9
 (b) E_r along $z = 9\Delta l$ of Fig. 9
 (c) E_z along $z = 9\frac{1}{2}\Delta l$ of Fig. 9

there as was assumed in the calculation. Plots of the electric-field lines can be made readily from the measurements, since an electric-field line corresponds to a

TABLE III
 CASES CHECKED FOR L-SHAPED CAVITY OF FIG. 13(a)

Case No.	x	s	$\Delta l/\lambda$	a/b	d/b	b/λ	H_y/E_x at input	
							Measured	Calculated
28	0.05	0.77	0.0312	5/9	5/9	0.283	+j 0.647	+j 0.640
29	0.05	0.77	0.0312	5/9	4/9	0.283	+j 0.464	+j 0.443
30	0.05	0.77	0.0312	5/9	3/9	0.283	+j 0.253	+j 0.222
13	0.05	0.77	0.0312	5/9	2/9	0.2808	-j 0.0622	-j 0.0604
31	0.10	0.77	0.0441	5/9	3/9	0.3969	+j 1.78	+j 1.915
32	0.10	0.15	0.0195	5/9	3/9	0.1755	-j 0.488	-j 0.512
27	0.454	0.77	0.0943	5/9	5/9	0.850	—	—

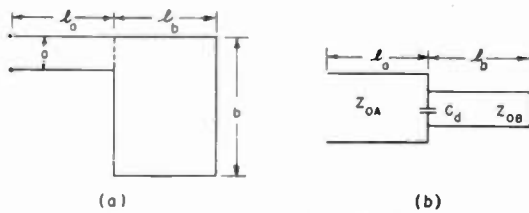

Fig. 13—L-shaped cavity and equivalent circuit.

contour of constant H_y . No calculated checks were made of the electric-field plots, but these at least behave generally as one would expect from physical reasoning. One representative plot corresponding to case 32 of Table III is shown in Fig. 14.

APPENDIX A

Field Relations for Parallel Plane Example

The proper wave solutions for the example of Section III, A, (Fig. 1) are well known and are written below in two forms, one convenient for use below cutoff and the other convenient for use above cutoff.

<p>Below Cutoff ($h < \lambda/2$)</p> <p>$E_x = A \sin k_x x \cosh \alpha z$</p> <p>$E_z = (\alpha A/k_x) \cos k_x x \sinh \alpha z$</p> <p>$H_y = -(j\omega\epsilon A/k_x) \cos k_x x \cosh \alpha z$</p> <p>$k_x = \pi/h$</p> <p>$\alpha = \pi/h \sqrt{1 - (2h/\lambda)^2}$</p>	<p>Above Cutoff ($h > \lambda/2$)</p> <p>$E_x = A \sin k_x x \cos k_z z$</p> <p>$E_z = -(k_z A/k_x) \cos k_x x \sin k_z z$</p> <p>$H_y = -(j\omega\epsilon A/k_x) \cos k_x x \cos k_z z$</p> <p>$k_z = \pi/h$</p> <p>$k_x = 2\pi/\lambda_z$</p> <p>$\lambda_z/\lambda = \frac{1}{\sqrt{1 - (\lambda/2h)^2}}$</p>
--	--

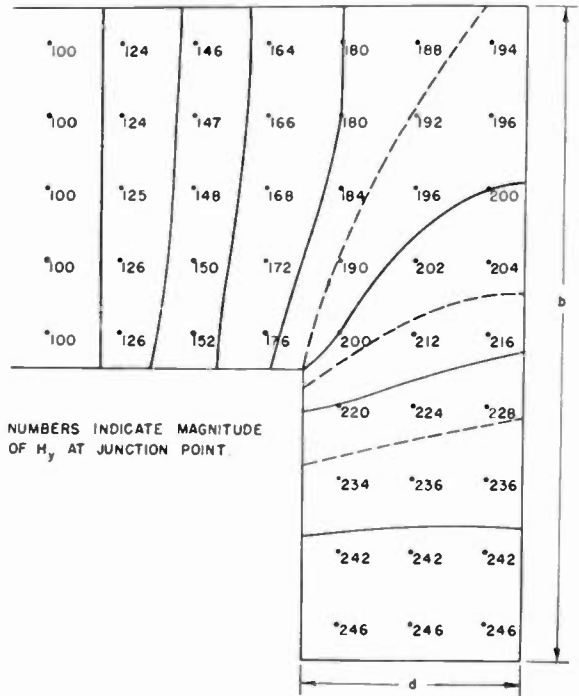

Fig. 14—Typical plot of electric field lines in L-shaped cavity of Fig. 13(a), as measured from the analyzer. Case 32 of Table III.

The above expressions, together with the conversions given in Section III, A, were used to plot the calculated curves with which measured values were compared in Figs. 3 to 5.

APPENDIX B

Field Relations for Axially Symmetric Example

The proper wave solutions for the cylindrical example of Section III, B, (Fig. 8) are also well known, and are written below in two forms, one convenient for use below cutoff and the other convenient for use above cutoff.

<p>Below Cutoff ($a/\lambda < 2.405/2\pi$)</p> <p>$E_z = A J_0(k_r r) \cosh \alpha z$</p> <p>$E_r = -(\alpha A/k_r) J_1(k_r r) \sinh \alpha z$</p> <p>$H_\psi = (j\omega\epsilon A/k_r) J_1(k_r r) \cosh \alpha z$</p> <p>$k_r = 2.405/a$</p> <p>$\alpha = (2.405/a) \sqrt{1 - (2\pi a/2.405\lambda)^2}$</p>	<p>Above Cutoff ($a/\lambda > 2.405/2\pi$)</p> <p>$E_z = A J_0(k_r r) \cos k_z z$</p> <p>$E_r = (k_z A/k_r) J_1(k_r r) \sin k_z z$</p> <p>$H_\psi = (j\omega\epsilon A/k_r) J_1(k_r r) \cos k_z z$</p> <p>$k_r = 2.405/a$</p> <p>$k_z = 2\pi/\lambda_z$</p> <p>$\lambda_z/\lambda = \frac{1}{\sqrt{1 - (2.405\lambda/2\pi a)^2}}$</p>
---	---

These expressions with the conversions given in Section III, B, were used to plot the calculated curves with which measured values were compared in Figs. 10 and 11.

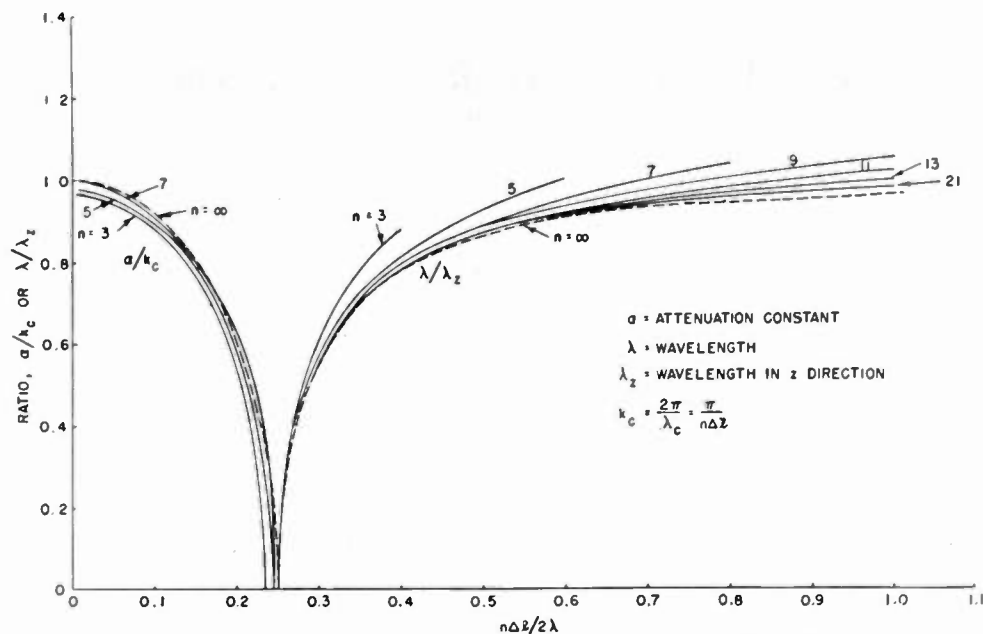

Fig. 15—Effect of different number of elements on simple two-dimensional example, calculated from difference equation.

APPENDIX C

Approximate Calculation of Input Impedance

The input impedance for a region such as Fig. 13(a) may be calculated approximately from equivalent circuits and curves presented in a recent paper,⁴ or more accurately by the complete method described in that paper. The equivalent circuit is that of a short-circuited transmission line of length l_b , characteristic impedance Z_{ob} , connected to one of length l_a , characteristic impedance Z_{oa} , with a discontinuity capacitance C_d shunted between lines at the junction, Fig. 13(b). For a unit width,

$$Z_{oa} = \eta a$$

$$Z_{ob} = \eta b$$

and

$$C_d \cong P(l_b/b)F(b/\lambda)C_d'(a/b)$$

$C_d'(a/b)$ is the fundamental discontinuity capacitance given as a function of the ratio a/b in Fig. 14 of the Whinnery-Jamieson paper; $F(b/\lambda)$ is a frequency-correction factor for dimensions comparable to wavelength obtainable as a function of b/λ from Fig. 16 of that paper; $P(l_b/b)$ is a proximity factor, a function of l_b/b obtainable from Fig. 18 of that paper. The values of C_d used for calculation of the impedances in Table III were actually more accurate values obtained by the complete series method.

APPENDIX D

Effect of Number of Units as Revealed by Difference Equations

The derivation of the equivalent circuits discussed in this paper consists essentially in showing that the difference equations for the network approach the dif-

ferential equations of the field as the divisions become infinitesimal. The important practical question is the required subdivision to attain any desired degree of accuracy in the result. Dr. H. Poritsky has pointed out that the difference equation for the simple two-dimensional example described in Section III, A, has a simple solution, so that the effect of different numbers of units may be calculated for this case. Cutoff, attenuation below cutoff, and wavelength along the guide above cutoff for a first-order wave in this circuit have been calculated for different numbers of elements between the two zero-current boundaries. These results show that essentially the correct cutoff is predicted for even the fewest elements, and that excellent values of attenuation below cutoff are given with only the five elements across the transverse section as used in the analyzer tests. The percentage error with the fewest number of elements may be large in the region of cutoff because of the rapid change in this region, and the error also becomes appreciable with two few elements at high frequencies, that is, when there are too few elements per wavelength.

Curves are plotted in Fig. 15 showing the calculated curves of attenuation constant and wavelength along the guide for different numbers of units across the cross section. The $n=5$ curve corresponds to that studied on the analyzer. Study of such results from difference equations helps to separate inaccuracies in analyzer results due to the finite number of elements from those caused by losses.

⁴ J. R. Whinnery and H. W. Jamieson, "Equivalent circuits for discontinuities in transmission lines," *Proc. I.R.E.*, vol. 32, pp. 98-115; February, 1944.

THE INSTITUTE OF RADIO ENGINEERS

INCORPORATED



SECTION MEETINGS

ATLANTA June 16	CHICAGO September 15	CLEVELAND June 22	DETROIT September 15	LOS ANGELES September 19
NEW YORK October 4	PHILADELPHIA October 5	PITTSBURGH June 12	PORTLAND Aug 14	WASHINGTON June 12

SECTIONS

- ATLANTA**—Chairman, Walter Van Nostrand; Secretary, Ivan Miles, 554—14 St., N. W., Atlanta, Ga.
- BALTIMORE**—Chairman, G. J. Gross; Secretary, A. D. Williams, Bendix Radio Corp., E. Joppa Rd., Towson, Md.
- BOSTON**—Chairman, R. F. Field; Secretary, Corwin Crosby, 16 Chauncy St., Cambridge, Mass.
- BUENOS AIRES**—Chairman, L. C. Simpson; Secretary, I. C. Grant, Venezuela 613, Buenos Aires, Argentina.
- BUFFALO-NIAGARA**—Chairman, Leroy Fiedler; Secretary, H. G. Korts, 51 Kinsey Ave., Kenmore, N. Y.
- CHICAGO**—Chairman, A. B. Bronwell; Secretary, W. O. Swinyard, Hazeltine Electronics Corp., 325 W. Huron St., Chicago, Ill.
- CINCINNATI**—Chairman, J. L. Hollis; Secretary, R. S. Butts, Box 1403, Cincinnati 2, Ohio.
- CLEVELAND**—Chairman, A. S. Nace; Secretary, Lester L. Stoffel, 1095 Kenneth Dr., Lakewood, Ohio
- CONNECTICUT VALLEY**—Chairman, R. E. Moe; Secretary, L. A. Reilly, 989 Roosevelt Ave.; Springfield, Mass.
- DALLAS-FORT WORTH**—Chairman, D. J. Tucker; Secretary, P. C. Barnes, WFAA-WBAP, Grapevine, Texas.
- DAYTON**—Chairman, I. H. Gerks; Secretary, Joseph General, 1319 Superior Ave., Dayton, 7, Ohio.
- DETROIT**—Chairman, R. A. Powers; Secretary, R. R. Barnes, 1411 Harvard Ave., Berkley, Mich.
- EMPORIUM**—Chairman, H. D. Johnson; Secretary, A. Dolnick, Sylvania Electric Products, Inc., Emporium, Pa.
- INDIANAPOLIS**—Chairman, A. N. Curtiss; Secretary, E. E. Alden, WIRE, Indianapolis, Ind.
- KANSAS CITY**—Chairman, A. P. Stuhrman; Secretary, R. N. White, 4800 Jefferson St., Kansas City, Mo.
- LOS ANGELES**—Chairman, L. W. Howard; Secretary, Frederick Ireland, 1000 N. Seward St., Hollywood, 38, Calif.
- MONTREAL**—Chairman, F. S. Howes; Secretary, J. A. Campbell, Northern Electric Co., 1261 Shearer St. Montreal, Que., Canada.
- NEW YORK**—Chairman, Lloyd Espenschied; Secretary, J. E. Shepherd, 111 Courtenay Rd., Hempstead, L. I., N. Y.
- PHILADELPHIA**—Chairman, W. P. West; Secretary, S. Gubin, RCA Victor Division, Radio Corporation of America Bldg. 8-10, Camden, N. J.
- PITTSBURGH**—Chairman, B. R. Teare; Secretary, R. K. Crooks, Box, 2038, Pittsburgh, 30, Pa.
- PORTLAND**—Chairman, W. A. Cutting; Secretary, W. E. Richardson, 5960 S.W. Brugger, Portland, Ore.
- ROCHESTER**—Chairman, O. L. Angevine, Jr.; Secretary, G. R. Town, Stromberg-Carlson Co., Rochester, N. Y.
- ST. LOUIS**—Chairman, N. J. Zehr; Acting Secretary, C. H. Meyer, KFUE, 801 DeMun Ave., St. Louis, Mo.
- SAN FRANCISCO**—Chairman, W. G. Wagener; Secretary, R. V. Howard, 225 Mallorca Way, San Francisco, Calif.
- SEATTLE**—Chairman, F. B. Mossman; Secretary, E. H. Smith, Apt. K, 1620—14 Ave., Seattle, 22, Wash.
- TORONTO**—Chairman, R. G. Anthes; Secretary, J. T. Pfeiffer, Erie Resistor of Canada, Ltd., 128 Peter St., Toronto, Ont., Canada.
- TWIN CITIES**—Chairman, E. S. Heiser; Secretary, B. R. Hilker, KSTP, St. Paul Hotel, St. Paul, Minn.
- WASHINGTON**—Chairman, J. D. Wallace; Secretary, F. W. Albertson, c/o Dow and Lohnes, E St. N. W., between 13th and 14th Sts., Washington, D. C.

Institute News and Radio Notes

Constitutional Amendment Section

COMING CONSTITUTIONAL AMENDMENTS

In the April issue of the PROCEEDINGS there appeared an Institute note mentioning the petition to amend the Constitution, received from the Montreal Section. In the May issue appeared a letter by Chairman L. T. Bird, of the Montreal Section, explaining the scope of these amendments and the reasons for their proposal.

The Constitution and Laws Committee has been busy for some time preparing certain other amendments and some time this summer all these amendments will be submitted to the membership for a vote. In the meantime, in the interest of informing the membership of the nature of the proposed amendments and of giving them an opportunity of expressing their opinions before balloting begins, there will appear in this and several succeeding issues of the PROCEEDINGS a section devoted to the discussion of the proposed amendments. It is highly important that every voting member of the Institute acquaint himself with the nature of these amendments and reasons for their proposal in order that he may express his opinion if he so desires and later intelligently cast his ballot.

MONTREAL AMENDMENTS

The Montreal amendments cover several points, two of which are of minor importance. The third, however, is of importance to the Institute. Members of the Montreal Section were dissatisfied with the new names chosen for grades of membership in the Constitutional ballot of 1943. The Montreal amendments therefore propose substituting grade names of Member, Associate, and Affiliate for the present names, Senior Member, Member, and Associate, respectively. That is, these amendments propose that all Senior Members be called simply Members, all present Members be called Associates, and all present Associates be called Affiliates.

OTHER AMENDMENTS

Other amendments are in process of being drawn up by the Constitution and Laws Committee and the Board. Most of the added amendments are associated with the management of the Institute and will have no direct influence upon the members except through the improved management which should result. An amendment which will be of great interest to the membership, however, involves dues. It is proposed that the dues of all members except those of Student grade be increased.

In the course of the next month or two a full story of the need for the increase in dues will appear in this section. An outline of these reasons will be given herewith in order that the membership may have a bird's-eye view of the reasons necessitating this increase. The

details to support these arguments will appear in succeeding issues.

INCREASED COSTS

A primary reason for increasing dues is that the costs of running the Institute have mounted. It will be nothing new to members to hear that salary levels have increased and that the Institute has had to meet them. Paper costs have gone up. Printing costs have gone up. Rents are rising rapidly in New York and may climb further. The growth of the Institute from a membership of 4400 in 1935 to over 11,000 in 1943 has increased the office work so that more help and more space are needed.

HISTORY

The history of the financial situation will be presented with figures. For eight or ten years the Institute has been operating on a narrow margin, deficits occurring several years, and small surpluses other years. The Board has always tried to operate the Institute within its income and retain a surplus to be saved for a rainy day. That is essential for sound management of the Institute. The effort to keep expenses down and yet to keep the PROCEEDINGS standard up necessitated cutting the services given by the office to committees and to the officers of the Institute. The Editor in many cases has been required to read proof himself and to write or handle much material that could have been written by assistants in the office. The committees were not provided with secretaries so that often no records were kept. Stenography, typing, and mimeograph work which should have been done in the office were often handled by committee chairmen in their own offices. This has turned out to be a burden and it has been increasingly difficult to carry on the work.

About two and one-half years ago when this situation reached a climax the Board of Directors employed an advertising manager and went into an advertising campaign. Fortunately about this time the development of radio for defense, and other special circumstances made it possible to obtain advertising so that for two years the income has been ample. But this income may disappear to some extent with the arrival of peace and a change in financial conditions. The Board will be remiss in its duty if it waits until this advertising diminishes and then takes up the subject of approaching the membership to increase the dues.

INSTITUTE DUES ARE LOW

Information will be presented to show that the Institute dues are extremely low compared to those of comparable societies. Figures will be given showing dues in a

number of other societies for corresponding membership grades.

PLANS

The proposed increase in dues will not prove to be an extravagant or luxurious aid to the management of the Institute. It is believed, however, that the improved service to the members which can be given by the proposed increases will be worth much more than the increase. Some of the proposed plans are given below, though it may not be possible to carry out all of them with the increase, and it may be necessary to select among them.

1. The Institute will be enabled to improve the office situation so as to handle the office work properly and restore services which have been discontinued.

2. The Institute will be in a position to handle the large increase in technical papers that will be released for publication after the war.

3. The Institute hopes to increase the scope of the fields covered by papers in that it will systematically seek and try to publish a paper or two in each field each year rather than depend entirely upon papers submitted by authors who have already determined the subject of their papers.

4. There may be an increase in technical notes and news covering those things which do not justify papers in themselves, and possibly abstracts of publications appearing elsewhere.

5. There may be an increase in rebates to sections.

6. There may be other services such as have been discussed at various times at Section Committee meetings and which the Board of Directors is requested occasionally to supply, but these again will depend upon the income.

President Turner to Visit Sections

Professor H. M. Tunner, president of the Institute of Radio Engineers, plans, the latter part of June, to visit as many Sections in the middle west as time and traveling conditions permit. He will meet with the officials of the Sections to discuss Section and Institute affairs and hopes to meet personally as many members of the Sections as possible. He will welcome the opportunity of closer contact with the Section Officers and membership and hopes to receive their problems and suggestions.

Remarks by H. M. Turner, President, Institute of Radio Engineers

I am very happy to be afforded this opportunity of conveying the warmest greetings and congratulations of the Institute of Radio Engineers to the Wireless Section of

THE DUES

The present dues of the Institute above Student grade are \$6 for Associate and Members, \$10 for Senior Members and Fellows. The Board at present favors increasing the dues of Associates to \$7, Members to \$10, Senior Members and Fellows to \$15, with Associates' dues to increase to \$10 after five years' membership. The Chairman of the Sections Committee, acting upon a resolution passed at the January meeting of the Sections Committee this year, proposed to the Board a membership dues' system which results in equality in dues for all grades, except Student, at a suitable time. In this system the dues of all members, except Students would be \$7 until a member reached 30 years of age, \$10 until a member reached 40 years of age, and \$15 thereafter. This was given consideration by the Board.

It is estimated that the increase in dues received by the Institute from the first system would be about 32 per cent, and from the second about 50 per cent.

COMMENTS INVITED

This section on Constitutional Amendments is open for comments by all members of the Institute. It is hoped that every member having an opinion to express will write to the Secretary and express his opinion in a letter which can be published in this or some other place. It is the intention to give publicity to as many of these opinions as is reasonable and practicable. Publication of all letters cannot be guaranteed, but a diligent effort will be made to see that every idea which is submitted is publicized.

R. A. Heising, *Chairman*
Constitution and Laws Committee

the Institution of Electrical Engineers which is now celebrating the Silver Jubilee of its formation early in 1919. In the intervening 25 years, the science and practice of radio communication have gone through many interesting and revolutionary phases, which I have no doubt have been well described and surveyed by former speakers. In America, we have played our part in these changes, and we have watched with appreciation the part which your Wireless Section has played in this great advance, which has culminated in numerous applications of radio technique in various forms.

Throughout this period, we have noted with great interest the papers published in your *Proceedings*, which have formed a comprehensive and accurate record of the technical progress made in various phases of the communication art. The high standard of the papers published and the spirited nature of the ensuing discussions shows the keen interest taken by your members in their profession.

We were gratified to have as our guests at a recent meeting of the Board of Directors of our Institute of Radio Engineers in New York, Dr. R. L. Smith-Rose, the immediate past chairman of your section; Mr. H. L.

Kirke, your chairman-elect; and Dr. F. S. Barton of the British Air Commission in Washington and junior past-vice-president of the Institute of Radio Engineers, and I hope that as a result of this visit and previous correspondence closer liaison and co-operation between the two bodies may be effected in the future to our mutual advantage.

I understand that Dr. Smith-Rose was to have addressed you in person following the other past chairmen whom you have just heard, but unfortunately his official duties have made it impracticable for him to return to England in time, and the opportunity has, therefore been taken for him to record his contribution to your program for reproduction to you who are present at the meeting in London.

It therefore gives me much pleasure to present your fellow member and immediate past chairman, Dr. Smith-Rose.

EDITOR'S NOTE: The above introductory notes by Professor Turner were recorded as a phonograph transcription and reproduced at the Silver Jubilee of the Wireless Section of the Institution of Electrical Engineers on May 3, 1944.

Board of Directors

April 5 Meeting: At the regular meeting of the Board of Directors, which was held on April 5, 1944, the following were present: H. M. Turner, president; R. A. Hackbusch, vice-president; F. S. Barton, junior past-vice-president (guest); S. L. Bailey, E. F. Carter, I. S. Coggeshall, W. L. Everitt, Alfred N. Goldsmith, editor; R. F. Guy, R. A. Heising, treasurer; L. C. F. Horle, H. L. Kirke (guest); F. B. Llewellyn, Haraden Pratt, secretary; R. L. Smith-Rose (guest); A. F. Van Dyck, H. A. Wheeler, L. P. Wheeler, W. C. White, and W. B. Cowilch, assistant secretary.

Membership: Two applications for transfer to Associate grade, 194 applications for admission to Associate grade, and 111 to Student grade, as recommended for membership by the Executive Committee, were unanimously approved.

Canadian Membership: Vice-President Hackbusch was authorized to represent the Institute members in Canada at meetings with the Canadian Minister of Labour, and to present the viewpoint of the Board in opposition to enforcement of collective bargaining on engineers.

Committees and Appointments

ASA War Committee on Radio: Editor Goldsmith, the Institute's representative on this committee (and chairman of its Subcommittee on Insulating Material Specifications for the Military Services) stated that the work assigned to this group, including the listed Standards which have been approved and published, has now been completed and a set of these Standards given to the Institute.

Ceramic Radio Insulating Materials, Class L
Ceramic Radio Dielectric Materials, Class H
Glass-Bonded Mica Radio Insulators
Glass Radio Insulators
Porcelain Radio Insulators
Steatite Radio Insulators

On recommendation of the Executive Committee, the following members were appointed to the particular committees listed below:

Board of Editors

W. G. Dow P. C. Sandretto
H. O. Peterson W. C. White

Constitution and Laws

S. L. Bailey G. T. Royden
V. N. Graham W. M. Smith

Education

W. H. Campbell Paul de Mars
Fulton Cutting Melville Eastham
J. A. Ouimet

Dr. Everitt, chairman of the Education Committee, described the unanimously approved program for his committee, which will include the following activities:

To publish in the PROCEEDINGS later this year, a paper on the problems confronting the engineering profession, and another on challenging questions for discussion by the membership.

To have each Section devote an entire meeting in November of this year to a discussion on engineering education to be led

by an Institute College Representative, and following such meetings to have the discussions summarized by the committee for publication in the PROCEEDINGS

To approach other engineering societies with the view to having them set up programs similar to that outlined herein.

To have reprints of the papers and discussions available for distribution among colleges, other organizations, and interested individuals.

Institute Representative in College

E. N. Lurch, Manhattan College

Membership

M. M. Ming J. M. Comer, Jr.

Office-Quarters

H. R. Zeamans

Papers

M. G. Crosby D. O. North
Stanford Goldman E. K. Van Tassel

J. R. Whinnery

Papers Procurement

W. B. Burgess R. M. Wise

Technical Committees: Dr. Llewellyn reviewed the personnel of the technical committees, including those for the new Antennas, Circuit, and Radio Transmitters Committees, which had been recommended by the Executive Committee.

Following the discussion, the technical-committee personnel listed on page 372 was unanimously appointed to serve during the annual term beginning May 1, 1944.

Tellers

E. J. Content

Bylaws: A motion was made to adopt the following proposed amendment to Section 40 of the Bylaws:

Amend Section 40 by changing the period to a comma and by adding these words at the end of the present wording: "provided that the amount paid per member shall be increased above fifty cents where necessary by such an amount as, together with an assumption of eight meetings per year, would result in a total compensation of sixty-five cents per member."

National Wartime Conference: Mr. W. C. White was appointed to act as the representative of the Institute on matters concerning the National Wartime Conference, which will be held on June 2 and 3, 1944.

George H. Clark Collection: Secretary Pratt suggested having the title to the Clark collection in the name of the Institute but the collection deposited with the Engineering Societies Library in perpetuity.

This suggestion was discussed and the following motion unanimously approved:

"The Board approves of having the Institute take title to the George H. Clark Collection on the basis that the collection be deposited with the Engineering Societies Library in perpetuity, provided that

"a. The Institute would not be committed to defraying any cost or expenses in connection with the acquisition, cataloguing, or maintenance of the collection,

"b. That the Institute have the privilege of securing from the Library a catalogue file which could be kept at the Institute headquarters,

"c. That, if the collection is not kept intact as a unit in the Library, the Library maintain a separate catalogue listing the collection as a whole and appropriately

labeling it as to its source and the identity of the Institute with regard to it."

I.R.E.-I.E.E.: President Turner introduced Dr. R. L. Smith-Rose and Mr. H. L. Kirke, representing the Wireless Section of the Institution of Electrical Engineers of England, and Mr. F. S. Barton, junior past-vice-president of the Institute, who had been invited to the Board meeting and who there discussed the subject of closer co-operation between the I.E.E. Wireless Section and the Institute.

Mr. Barton explained that the I.E.E. Wireless Section is currently making its facilities available to Institute members in England and has offered its abstracts for use in the PROCEEDINGS. He also expressed the hope that closer co-operation would be possible in the future.

Dr. Smith-Rose, in addition to commenting on co-operation between the two societies, stated that despite the effects of the war, the Silver Jubilee of the I.E.E. Wireless Section would be celebrated on May 3, 1944.

It was unanimously approved to have President Turner write a congratulatory letter for the celebration. It was likewise suggested that a recording be made of an address by President Turner for transmittal to and use at the jubilee.

In his remarks, Mr. Kirke stated that the *Journal of the Wireless Section* is also available on a subscription basis.

In order to foster more extensive co-operation between the two organizations it was suggested that papers be interchanged and that special rates on publications be considered.

Dr. Smith-Rose described an arrangement whereby outstanding papers would be read at meetings of the two societies held simultaneously in the respective countries, and emphasized the desirability of having the I.E.E. conventions patronized to a greater extent by the members of the Institute, and vice versa.

Dr. Wheeler added that broadcasting of conventions of the two societies would stimulate interest among members of both organizations. Mr. Guy remarked that it would be advantageous to have information on the membership requirements of one society published in the journal of the other society.

Dr. Wheeler proposed setting up liaison committees to serve as channels through which matters pertaining to co-operation between the societies would be cleared.

After discussing the proposal, it was unanimously decided to appoint an Institute Liaison Committee which would communicate with a similar group of the I.E.E. Wireless Section.

Our guest indicated that only a small percentage of Institute members are members of the I.E.E. and that the Institute's Standards reports are very useful to I.E.E. members.

Executive Committee

April 4 Meeting: The Executive Committee meeting, held on April 4, 1944, was attended by H. M. Turner, president; E. F. Carter, Alfred N. Goldsmith, editor; F. B. Llewellyn, Haraden Pratt, secretary; H. A.

Wheeler; and W. B. Cowilich, assistant secretary.

1944 Audit: It was recommended that the Board of Directors approve the employment of the firm of Klauser and Todt for the audit of the Institute's 1944 accounting records.

Committees and Appointments

The personnel for the technical committees, including those for the new Circuits

Committee and the separate Committees on Transmitters and Antennas, was unanimously recommended to the Board of Directors for appointment for the annual term beginning May 1, 1944.

Special: It was decided to establish a special committee to study the possibility of obtaining additional personnel for the Institute's technical-committee work, and the following members were appointed to the particular committee: E. F. Carter, chair-

man; Austin Bailey, W. L. Everitt, R. F. Guy, and B. E. Shackelford.

"Radio Markets after the War": Unanimous approval was given to sending 100 additional copies of this publication to the Radio Technical Planning Board, which copies had been stated to be needed by that organization for distribution among their personnel including IRAC members, Canadian representatives, and foreign observers.

Technical Committees

May 1, 1944, to May 1, 1945

ANNUAL REVIEW

L. E. Whittemore, *Chairman*

Andrew Alford	E. A. Guillemin
R. S. Burnap	R. F. Guy
C. R. Burrows	Keith Henney
W. G. Cady	I. J. Kaar
C. C. Chambers	G. G. Muller
I. S. Coggeshall	H. A. Wheeler
L. F. Curtis	C. J. Young

(Plus Member-at-Large)

CIRCUIT COMMITTEE

E. A. Guillemin, *Chairman*

H. W. Bode	Knox McIlwain
W. L. Everitt	A. F. Pomeroy

ELECTROACOUSTICS

G. G. Muller, *Chairman*

S. J. Begun	G. M. Nixon
F. V. Hunt	Benjamin Olney
V. N. James	H. F. Olson
Knox McIlwain	H. H. Scott

L. J. Sivian

ELECTRONICS

R. S. Burnap, *Chairman*

E. L. Chaffee	J. A. Morton
H. P. Corwith	I. E. Mouromtseff
K. C. Dewalt	L. S. Nergaard
W. G. Dow	G. D. O'Neill
R. L. Freeman	H. W. Parker
A. M. Glover	H. J. Reich
T. T. Goldsmith, Jr.	A. C. Rockwood
L. B. Headrick	J. B. Russell, Jr.
D. R. Hull	Bernard Salzberg
S. B. Ingram	A. L. Samuel
Ben Kievit	C. M. Wheeler
D. E. Marshall	J. R. Wilson
J. M. Miller, Jr.	Irving Wolff

Jack Yolles

FACSIMILE

C. J. Young, *Chairman*

Maurice Artzt	H. J. Lavery
E. P. Bancroft	B. V. Magee
J. C. Barnes	Pierre Mertz
F. R. Brick, Jr.	L. D. Prehn
W. A. R. Brown	G. D. Robinson
J. J. Callahan	W. L. Roe
G. V. Dillenback	L. A. Smith
J. V. L. Hogan	R. J. Wise

FREQUENCY MODULATION

C. C. Chambers, *Chairman*

J. E. Brown	V. D. Landon
W. F. Cotter	H. B. Marvin
M. G. Crosby	D. E. Noble
W. L. Everitt	B. E. Shackelford
R. F. Guy	D. B. Smith
C. M. Jansky, Jr.	L. P. Wheeler

W. D. White

RADIO RECEIVERS

L. F. Curtis, *Chairman*

G. L. Beers	C. J. Franks
W. M. Breazeale	A. R. Hodges
W. F. Cotter	J. K. Johnson
Harry Diamond	Garrard Mountjoy
W. L. Dunn	H. O. Peterson
H. B. Fischer	E. K. Stodola
H. C. Forbes	A. E. Thiessen
D. E. Foster	H. P. Westman

R. M. Wilmotte

RADIO WAVE PROPAGATION

C. R. Burrows, *Chairman*

S. L. Bailey	W. C. Lent
J. L. Barnes	H. R. Mimno
J. H. Dellinger	K. A. Norton
W. A. Fitch	H. O. Peterson
G. D. Gillett	H. P. Thomas

W. D. White

STANDARDS

H. A. Wheeler, *Chairman*

Andrew Alford	E. A. Guillemin
R. S. Burnap	R. F. Guy
C. R. Burrows	I. J. Kaar
W. G. Cady	G. G. Muller
C. C. Chambers	C. J. Young
L. F. Curtis	L. E. Whittemore

SYMBOLS

L. E. Whittemore, *Chairman*

R. R. Batcher	E. T. Dickey
M. R. Briggs	H. S. Knowles
R. S. Burnap	O. T. Laube
C. R. Burrows	A. F. Pomeroy
J. H. Dellinger	E. W. Schafer

TELEVISION

I. J. Kaar, *Chairman*

Hollis Baird	L. M. Leeds
J. E. Brown	H. M. Lewis
A. B. DuMont	A. V. Loughren
D. E. Foster	H. T. Lyman, Jr.
P. C. Goldmark	A. F. Murray
T. T. Goldsmith, Jr.	R. E. Shelby
G. W. Fyler	D. B. Sinclair
A. G. Jensen	D. B. Smith

TRANSMITTERS

R. F. Guy, *Chairman*

Andrew Alford	R. W. P. King
M. R. Briggs	W. B. Lodge
G. H. Brown	J. F. Morrison
Harry Diamond	J. C. Schelleng
W. S. Duttera	Robert Serrell
Sidney Frankel	D. B. Sinclair
F. A. Gunther	I. R. Weir
W. E. Jackson	J. E. Young

ANTENNAS

Andrew Alford, *Chairman*

M. R. Briggs	R. W. P. King
G. H. Brown	W. B. Lodge
Harry Diamond	J. F. Morrison
W. S. Duttera	J. C. Schelleng
Sidney Frankel	Robert Serrell
F. A. Gunther	D. B. Sinclair
R. F. Guy	I. R. Weir
W. E. Jackson	J. E. Young

Correspondence

The Validity of the Equivalent Plate-Circuit Theorem for Power Calculations

May the writer call the attention of the readers of this journal to the statement made in some recently published textbooks and by some teachers of elementary tube theory

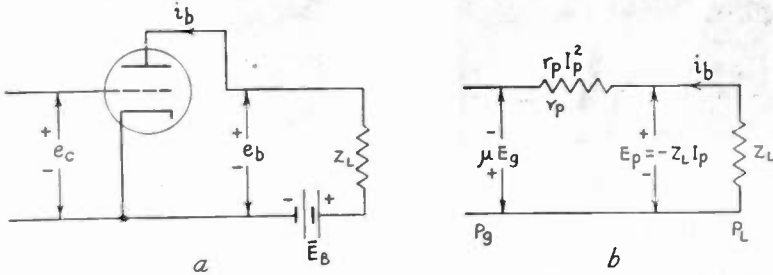

Fig. 1—Physical and equivalent circuits of triode amplifier in linear operation.

that the equivalent plate-circuit equation cannot be used for power calculations, especially when the plate dissipation is concerned. This statement is incorrect as will be shown below. The equivalent plate-circuit equation, multiplied by the variational plate current, actually provides an excellent aid in the teaching of power distribution in the plate circuit.

Generally

$$\Delta i_b = f(\Delta e_c, \Delta e_b) = a\Delta e_c + b\Delta e_b + c\Delta e_c^2 + d\Delta e_b^2 + f\Delta e_c\Delta e_b + g\Delta e_c^3 + \dots \quad (1)$$

where $a = \partial i_b / \partial e_c$ $d = \frac{1}{2}(\partial^2 i_b / \partial e_c^2)$
 $b = \partial i_b / \partial e_b$ $f = \partial^2 i_b / \partial e_c \partial e_b$
 $c = \frac{1}{2}(\partial^2 i_b / \partial e_c^2)$ $g = \frac{1}{6}(\partial^3 i_b / \partial e_c^3)$

If the coefficients a and b are treated as constants, the following coefficients in (1) are zero with the exception of f . Because the product term $f\Delta e_c\Delta e_b$ exists, the tube is nonlinear, but if f is small enough to be negligible in the series expansion, the tube becomes linear and useful for distortion-free amplification. Equation (1) has now the form

$$\Delta i_b = a\Delta e_c + b\Delta e_b \quad (2)$$

If transit-time effects are neglected and complex root-mean-square quantities introduced, the coefficients a and b may be expressed as the transconductance g_m and

the plate conductance $g_p = 1/r_p$, so (2) becomes

$$I_p = g_m E_g + g_p E_p \quad (3)$$

and reads with the substitutions $\mu = g_m/g_p =$ amplification factor, and $E_p = -Z_L I_p$

$$I_p = \mu E_g / (r_p + Z_L) \quad (4)$$

This equation is generally known as the equivalent plate-circuit theorem, but it is doubtful if the term "theorem" is justified. The expression "equivalent plate-circuit equation" is used in the following.

developed in the plate resistance. The equivalent plate-circuit equation of (4) $\mu E_g = r_p I_p + R_L I_p$, multiplied by I_p to become

$$\mu E_g I_p = P_o = r_p I_p^2 + R_L I_p^2 \quad (5)$$

therefore, describes in a perfectly clear way that there is a power $r_p I_p^2$ developed in the tube, heating the plate. If one wants to know the total plate dissipation, it is as described

$$\bar{P}_p = P_o + r_p I_p^2 \quad (6)$$

and there is no breakdown whatsoever in the equivalent plate-circuit "theorem," used for the calculation of plate dissipation.

The above conditions are easily realized from a study of the graph in Fig. 2. As is well known AQ here represents the electromotive force $\sqrt{2} \mu E_g$, the triangle AQC the power $P_o = \mu E_g I_p$, and the vertically shaded triangle ABC the power $r_p I_p^2$. When the signal is applied to the grid, the P_o triangle AQC is taken away, leaving a hole in the rectangular area \bar{P}_b . However, when the alternating-current power is distributed around the equivalent plate circuit, the amount $r_p I_p^2$ is paid back to the tube, so the left side of the hole is filled out, but the area BQC will remain an opening and actually describes the true cooling-down of the tube. This power represented by the triangle BQC is the alternating-current power delivered to the load, so the total rectangular area is the same as it was at the beginning, in other words $P_B = \text{constant}$.

The powers represented by the triangles AQC and ABC are fictitious powers, but it is fully correct to think of the linear circuit as a true physical circuit and treat all powers as real powers.

HARRY STOCKMAN
 Cruft Laboratory
 Harvard University
 Cambridge, Massachusetts

If (4) is read off as a series circuit, it will have the form shown in Fig. 1b. The constant electromotive force μE_g and the constant plate resistance r_p are fictitious quantities, as the action of the tube is merely the action of a systematically varied resistance in a direct-current circuit. The circuit in Fig. 1b may, however, be looked upon as a physical alternating-current circuit, which in case of a resistive load R_L has the dissipative elements r_p and R_L . If now the tube with its power sources is included in a sphere, through which no power transfer can take place, and an alternating voltage on the grid suddenly causes the electromotive force μE_g to deliver the power $P_o = \mu E_g I_p$, this power must have come from somewhere within the sphere. A simple integration shows that it cannot have come from the plate battery, as this source delivers a constant power P_B . Nor can it have been produced by a reduction in the direct-current power \bar{P}_L in the load impedance, as the direct plate current remains constant. P_o has therefore been taken from the direct-current power \bar{P}_p dissipated in the tube, so the tube cools down. However, it will not cool down by an amount determined by P_o alone, for as soon as this power P_o appears in the equivalent plate circuit, it pours some power back into the tube, namely, the amount $r_p I_p^2$

I.R.E. People

ALAN HAZELTINE

Alan Hazeltine has resigned from Stevens Institute of Technology, where he was most recently chairman of the physics department. Dr. Hazeltine organized a physics course in which, by new methods of presentation, he brought down to the Freshman and Sophomore levels various topics that are commonly taken up in upperclass and graduate engineering courses. Examples are rigorous treatments of electric waves, including their propagation along guides and in space and their radiation from simple antennas, by mathematical methods which do not go beyond elementary calculus. Light was treated from the beginning as an electric-wave phenomenon, and the basic laws of optics, including Fresnel's laws, were derived from the laws of electric and magnetic fields.

Dr. Hazeltine joined the Institute of Radio Engineers in 1916 as an Associate Member and transferred to Fellow grade in 1921. He was President of the I.R.E. in 1936 and served on its Board of Directors from 1923 to 1927 and again from 1936 to 1939.

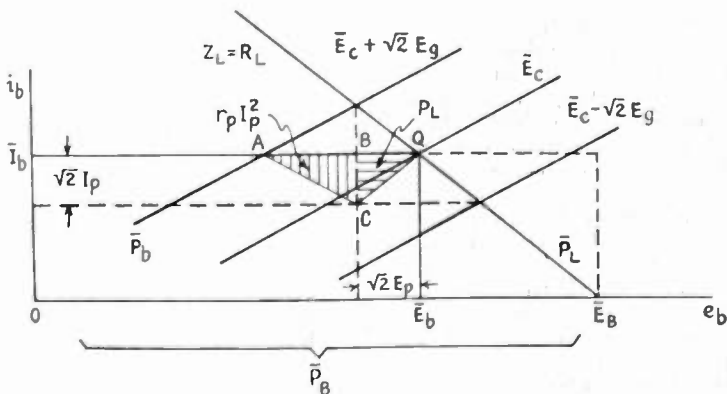

Fig. 2— $i_b e_b$ diagram for triode, illustrating the transfer of direct-current power into alternating-current power.



RICARDO MUNIZ

RICARDO MUNIZ

Ricardo Muniz recently joined the engineering staff of the Espey Manufacturing Company as director.

Until recently Mr. Muniz was chief engineer and plant manager of the Radio Navigational Instrument Corporation, and before that electronic consultant of the Teletor division of International Business Machines Corporation.

He was graduated from Brooklyn Polytechnic Institute in 1930, and he has taught radar at Brooklyn; at Hunter College he directed classes in design, development, and production on electronic medical equipment, radio, and television.

Mr. Muniz is now preparing the text for his new volume, "Radio Maintenance and Repair" to be published by D. Van Nostrand. He has written numerous articles for leading technical publications on radio and television circuits.

He became a Member of the Institute of Radio Engineers in 1943 and he is an Associate Member of the American Institute of Electrical Engineers.

GEORGE R. TOWN

George R. Town recently was appointed as manager of research and engineering of the Stromberg-Carlson Company.

Dr. Town was born in Poultney, Vermont, in 1905. He was graduated from Rensselaer Polytechnic Institute in 1926 and received his doctor's degree from the same



GEORGE R. TOWN

institution in 1929. From 1929 to 1933 Dr. Town was connected with the research department of Leeds and Northrup Company in Philadelphia and was a development engineer for the Arma Engineering Company in Brooklyn. From 1933 to 1936 he taught in the mathematics and electrical engineering departments at Rensselaer Polytechnic Institute. Dr. Town joined Stromberg-Carlson in 1936 as an engineer in the research laboratory. In 1940 he was made engineer-in-charge of the television laboratory, and in 1941, assistant director of research. He has represented Stromberg-Carlson on various television standardization committees of the National Television System Committee and of the Radio Technical Planning Board. Dr. Town became an Associate Member of the Institute of Radio Engineers in 1937 and Senior Member in 1944 and he has been chairman of the Rochester Section since 1942. He is a Member of the American Institute of Electrical Engineers.

MAXWELL HENRY

Professor Maxwell Henry, who died on April 7, 1944, was associated with the College of the City of New York since October, 1924, when he was appointed as an instructor following his graduation from the College.

Born in New York on December 26,



MAXWELL HENRY

1897, he attended Townsend Harris High School and received the degree of Bachelor of Science, in Civil Engineering. He was granted a license as professional engineer by the University of the State of New York in 1932.

While still a college student, Professor Henry taught wounded veterans of the first World War. From 1918 to 1922 he was an electrical and mechanical consultant.

Following his appointment as instructor in electrical engineering at City College in 1924, he was promoted to assistant professor in 1933 and to associate professor in 1941.

Professor Henry was an expert examiner for the New York State Civil Service Commission and supervised the Civilian Pilot Training Program at City College. He was also Selective Service Adviser in charge of deferments for electrical engineering students at the College, a member of the Faculty Board of Higher Education Relations Committee of the General Faculty, and a member of the Committee on Course and Standing of the School of Technology.

Professor Henry was a member of the American Institute of Electrical Engineers, the American Society of Civil Engineers, and was the City College representative of the Institute of Radio Engineers. He was the author of a "Laboratory Manual of the Fundamentals of a Radio Course" and a "Laboratory Manual of Electrical Measurements."

Books

Bibliography and Abstracts on Electrical Contacts, by American Society for Testing Materials

Published (1944) by American Society for Testing Materials, 260 S. Broad St., Philadelphia 2, Pa., 137 pages+iv pages. 6½×9½ inches. Price, \$5.00; \$4.00 to members of A.S.T.M.

This bibliography is the result of work undertaken by Committee B-4 on Electrical-Heating, Electrical-Resistance, and Electric-

cal-Furnace Alloys, of the American Society for Testing Materials, to develop a standard method of testing electrical contact materials and to determine the effect of variables upon the performance. It includes bibliographical references on contact materials, methods of testing, and on the interruption of electrical circuits.

Any bibliography on electrical contacts must necessarily include references on a wide variety of subjects. Such subjects involve the microphysics of the electric arc, metallurgy of the contact materials, the mechanics of the operating mechanism, physical and chemical properties of the materials involved, and ambient conditions. The value of any bibliography lies largely in the choice

and editing of the references and the care with which the synopsis of each reference is prepared.

This work is divided into several sections, which are intended for convenience to the reader. The subject index places the bibliography into groups of references on separate problems and the details involved in the subject of electrical contacts. The author index can be used for the reader interested in the work of any particular individual. The bibliography and abstracts list is set up in chronological order, based on the year in which the article was published. This index starts with the year 1835 and is complete through the year 1943. The titles of most of the foreign references are given both in the

original, and in English. Abstracts appear to be given for all of the more important references.

The Bibliography and Abstracts section of this book are set up in much the same fashion as the Abstracts and References section of the *Wireless Engineer*, which is familiar to most Institute members. The references appear to be well chosen and the Abstracts brief and concise. It is believed that engineers, metallurgists, and others who are interested in the subject of electrical contacts and relays will find this a most convenient bibliography.

Coverage of the subject matter can best be visualized from the titles of the general divisions into which the subject index is divided. These are:

- Electrical Contacts, General
 - Contact Materials
 - Circuit Breaker Design and Testing
 - Relays
 - Stationary Contacts
 - Sliding Contacts
 - Miscellaneous Contact Applications
 - Contact Resistance and Temperature
 - Electric Arc as Applied to Contacts
 - Electric Arc in General
 - Spark Discharge
 - Glow Discharge
 - Low Voltage
 - Contact Wear
 - Circuit and Circuit Parameters as Applied to Contact Operation
- This reviewer has been particularly im-

pressed with the careful editing and convenient arrangement of this book. It brings under one cover some 837 pertinent references, from which anyone interested in the subject matter covered can easily pick out from the abstracts those references with which he is concerned.

F. X. RETTENMEYER
Radio Corporation of America
Camden, New Jersey

Mathematics of Radio Communications, by J. J. Wang

Published (1943) by D. Van Nostrand Co., Inc., 250 Fourth Ave., New York 3, N. Y. 366 pages+6-page index+ix pages. 199 figures. 5½×9½ inches. Price, \$3.00.

This book was written as a mathematics text for use by students of communications. In today's accelerated educational program it is often necessary that these two courses be taken concurrently. The present text provides a high degree of correlation between the two courses.

The first nine chapters cover arithmetical operations, simple equations, graphical representation, practical computations including simple slide-rule operation, algebraic operations, exponents, quadratic equations, and square roots and simultaneous equations, topics such as are required in the

initial class and laboratory work in direct-current theory and circuits.

The next seven chapters cover topics required in alternating-current theory and circuits, namely, trigonometric functions, radian measure of angle and average value, rate of change, solution of triangles, vectors, the rotating vector, and vector forms.

Next follow three chapters covering useful communications tools and concepts, such as common and natural logarithms, the slide rule, trigonometric identities, and elementary analytic geometry.

The last ten chapters present more advanced studies including power and exponential functions, differentiation, applications of derivatives, empirical formulas and expansion of functions, integration, determinants, and Fourier Series.

The material is clearly and concisely presented.

A few typographical errors were noted. For example, on page 131, Fig. 11-10 the letter *B* is omitted on line *AB*; on page 170, Fig. 14-11 the letters *A* and *B* should be interchanged and on page 297 reference is made to "the not entirely vigorous but nevertheless practical monograph."

This book should prove useful not only to that special group for whom it was written but also to persons wishing to review mathematics as applied to communications.

W. O. SWINYARD
Hazeltine Electronics Corporation
Chicago, Illinois

Contributors

George Perrin Adair (A'42-SM'44) was born at Rancho, Texas, on December 8, 1903. He received the B.S. degree in electrical engineering from the Agricultural and Mechanical College of Texas in 1926. While in college he specialized in communication engineering, taking special courses and serving as cadet captain in charge of radio training. From 1921 to 1926 he attended Signal Corps officer training camps and otherwise participated in mathematical and electrical instruction, work, and study.

Upon graduation from college, Mr. Adair

was employed for approximately three and one-half years by the radio engineering department of the General Electric Company, during which time he traveled extensively developing, designing, testing, and installing radio equipment and systems. In 1929 he became associated with Straus Bodenheimer, Texas, electrical distributor, which brought him additional experience in problems of radio interference, service, blanketing, cross modulation, and static.

In 1931, Mr. Adair joined the broadcast engineering staff of the Federal Radio Commission. From April, 1936, to August, 1939, he served as acting assistant chief of the engineering broadcast division of the Federal Communications Commission. In 1939, he was promoted to assistant chief of the broadcast division, and in 1941, he was appointed assistant chief engineer to serve as chief of the Federal Communications Commission's engineering broadcast division, and chief engineer in 1944.

In his official capacity Mr. Adair has made extensive studies of all phases of broadcast allocation, including recommendations and reports on applications, equipment, service and interference, and was active in drafting the Standards of Good Engineering Practice governing broadcast and other radio services.



GEORGE PERRIN ADAIR

Stewart Becker (A'38-M'42-SM'43) was born at Rochelle Park, New Jersey, on October 6, 1904. He received the A.B. degree in physics from Princeton University in 1926. From 1926 until 1928 he was connected with Princeton-in-Peking, Peking, China.

From September, 1928, until November, 1936, Mr. Becker was a radio engineer with the General Electric Company doing development and design work on special types of radio receivers. From 1936 to 1940, he was a member of their general engineering laboratory doing investigational and ad-



STEWART BECKER

ministrative work connected with the development and application in industry of measuring instruments.



CHARLES CONCORDIA



In February, 1940, he left the employ of the General Electric Company to become general manager of the Hathaway Instrument Company in Denver, Colorado, and in November, 1942, he and three other Denver men organized the Metron Instrument Company, Denver, Colorado, of which he now is president and general manager.



Charles Concordia is in the central station engineering division of the General Electric Company in Schenectady. Previous to this, he was in the general engineering laboratory, working on electrical and magnetic measurements, and in the engineering general division. In the latter and in his present position he has been concerned with the analysis of various kinds of electrical and mechanical system problems, principally relating to rotating electrical machinery, automatic control devices, and electric



HAROLD GOLDBERG



power systems. Mr. Concordia is a member of the American Institute of Electrical Engineers and American Society of Mechanical Engineers, and the author of several technical articles.

Harold Goldberg (A'38-M'44) was born in Milwaukee, Wisconsin, on January 31, 1914. He received the B.S. degree in electrical engineering in 1935, the M.S. degree in 1936, and the Ph.D. degree in 1937 from the University of Wisconsin. He served as research Fellow in electrical engineering from 1935 to 1937. After teaching engineering mathematics at the University of Wisconsin during 1937-1938, Dr. Goldberg received an appointment as postdoctorate research Fellow in physiology at this University and conducted biophysical research under this Fellowship until June, 1941. He received the Ph.D. degree in physiology from the University of Wisconsin in March, 1941. Since that time he has been with the Stromberg-Carlson Company research department, in the capacity of senior engineer. He is a member of the American Institute of Electrical Engineers, Sigma Xi, and Panel 10 of the Radio Technical Planning Board.



Ewell K. Jett (A'29-M'38-F'39) was born in Baltimore, Maryland, on March 20, 1893. He entered the United States Naval Service in 1911. Prior to the World War he served as a telegraph operator, and as a radioman on board the battleships *Utah* and *Michigan* and the destroyer *Parker*. From 1914 to 1916 he was assigned to the Arlington radio station and at the Navy's first radio remote-control station in the State, War and Navy Building, Washington, D. C. During this period the Arlington station conducted the first experimental tests in radiotelephony and carried on successful transmission in one-way telephony, employing a vacuum-tube transmitter, with Panama, California, Hawaii, and the Eiffel Tower in Paris.

From 1917 to 1919 he served as radio officer on board Vice-Admiral Gleaves' flagship *Seattle* of the cruiser and transport force, and as radio officer of the battleship *Georgia*.

Permanently commissioned an Ensign in the Navy in 1919 he served as radio officer and officer-in-charge of the Navy Department transatlantic radio-control station until 1922. During a part of this time all transatlantic communication traffic, both government and commercial, was handled through the transatlantic control station utilizing the transmitters of Arlington, Annapolis, Navy Yard Washington, Tucker-ton, N. J., New Brunswick, N. J., and Sayville, N. Y.

In 1922 he became radio officer of the battleship *Texas* of the Pacific battle fleet; and from 1923 to 1926 was aide on the staff of Admirals Chase and Marvell and radio officer of the fleet base force.

He was again transferred to the Navy Department in Washington in 1926 where he served under the director of naval communications as officer-in-charge of the registered publication section, and as assistant Navy Department communication officer and officer-in-charge, radio central.

In 1929 Lieutenant Jett was loaned to the engineering department of the Federal Radio Commission and later, upon being retired from the Navy, he was appointed as senior radio engineer in direct charge of the Commission's engineering work concerning

radio services other than broadcasting. He was named assistant chief engineer in 1931 in which capacity he served until December 31, 1937, when he was named to succeed



EWELL K. JETT

Commissioner T.A.M. Craven, as chief engineer.

Mr. Jett was nominated by President Roosevelt to be a Commissioner and took the oath of office on February 15, 1944.

Mr. Jett was a member of the American Delegation to the North and Central American Radio Conference, Mexico City, 1933; North American Regional Radio Conference, Havana, March, 1937; the International Radio Consulting Committee (C.C.I.R.) Bucharest, May-June, 1937; and the Inter-American Radio Conference, Havana, Cuba, December, 1937. In August, 1937, he represented the Commission at the Governors' Conference in Juneau, Alaska. President Roosevelt named him a delegate to the International Telecommunications Conference which was held at Cairo, Egypt, in 1938. In 1940 he was appointed Technical Advisor on the American Delegation to the Inter-American Radio Conference which was held at Santiago, Chile. Mr. Jett was Chairman of the Interdepartment Radio Advisory Committee from 1939 to 1941 and



PAUL J. KIBLER



has served as Chairman of the Coordinating Committee of the Board of War Communications (formerly Defense Communications Board) since October 25, 1940.

Paul J. Kibler (S'35-A'37) was born on January 8, 1913, at Lakewood, Ohio. He received the B.S. degree in electrical engineering from Case School of Applied Science,

❖



W. N. KREBS

❖

in 1935. From 1935 to 1936 he was a member of the engineering staff of the Muzak Corporation of Ohio and, in 1937, he joined the research and development laboratory of the Washington Institute of Technology. Since 1941, Mr. Kibler has been a member of the research department of the Farnsworth Television and Radio Corporation. Since 1937, his work has been principally concerned with research and development of transmitters, matching networks, and antenna arrays. He is a member of Eta Kappa Nu and Sigma Xi.

❖

W. N. Krebs (A'29) was born on June 23, 1904, at Baltimore, Maryland, and became a licensed amateur and commercial operator in 1919. He was graduated from

❖



ELWIN J. O'BRIEN

❖

the Baltimore Polytechnic Institute in January, 1923, and took special courses in electrical engineering at Johns Hopkins University while employed as testman in the electric research and test department of the Consolidated Gas, Electric Light and Power Company of Baltimore. From Au-

gust, 1924, until October 1925, he assisted in the construction of broadcast station WBAL and became assistant chief operator there. Between October, 1925, and July, 1930, he was engaged in radio engineering work in the research and test laboratory at the Navy Yard, Washington, D. C. During this period he designed and supervised the installation of new radiotelegraph message centers in the War and Navy Departments and broadcast station NAA operated at that time by the Navy Department in connection with programs broadcast from the Weather Bureau, the Library of Congress, and the Pan American Union. In July, 1930, Mr. Krebs joined the engineering staff of the Federal Radio Commission, which in 1934 was superseded by the Federal Communications Commission. During his continuous term of duty in this capacity since 1930, he has been closely associated with the point-to-point, maritime, emergency, aviation, amateur, and other nonbroadcast radio services, and with regulatory problems concerning the licensing of radio operators. During 1938 and 1939, he was in charge of engineering phases of the Great Lakes and Inland Waters Survey conducted by the Commission at the direction of the Congress to ascertain the radio requirements necessary or desirable for vessels navigated on these waters. In June, 1942, Mr. Krebs became chief of the safety and special services division of the Commission's engineering department, which is his present position.

❖

Elwin J. O'Brien (A'27) was born at Center Point, Iowa, on August 11, 1903. He received the B.S. degree in 1933 and the M.S. degree in 1935, both in electrical engineering, from the University of Iowa. From 1925 to 1929 he was in the radio inspection department of the Brenard Manufacturing Company; from 1929 to 1931, in the standards laboratory of the Western Electric Company; in 1931, in the radio design laboratory of the Grigsby Grunow Company; from 1935 to 1936, research assistant at the University of Iowa; from 1936 to 1943, associate professor and radio engineer at the University of North Dakota (absent on leave); since 1943, Voice Communication Laboratory, Waco Army Air Field. Mr. O'Brien is a member of Sigma Xi and an Associate member American Institute of Electrical Engineers.

❖

William E. Pakala was born in Red Lodge, Montana, on July 2, 1901. He received the B.S. degree in electrical engineering from Montana State University in 1927. Following this he did graduate work at the University of Pittsburgh.

Mr. Pakala joined the Westinghouse Electric and Manufacturing Company in 1927 as a radio laboratory engineer; became carrier current engineer in 1933, research engineer in 1936, liaison engineer in 1940, and electronic-tube design engineer in 1942. In his work, he has designed special ignitrons and circuits for firing ignitrons and is now working with arcbacks in rectifier tubes and design of tubes to circumvent the arcback.

He wrote a series of papers on radio interference for the *Electrical Journal* in 1933-1934, and prepared papers on Ignitrons, carrier current, and radio interference for



W. E. PAKALA

the American Institute of Electrical Engineers. Mr. Pakala is an Associate member of the American Institute of Electrical Engineers and belongs to the Tau Beta Pi Fraternity.

❖

Myril B. Reed (A'41) was born in Woodruff, Utah, on February 14, 1902. He received the B.S. degree in electrical engineering from the University of Colorado in 1926, the M.S. degree in electrical engineering in 1931 and the Ph.D. degree in physics in 1935, both of the latter from the University of Texas. During 1924 and 1925, he worked in the meter department of the Public Service Company of Colorado. For a year after receiving his Bachelor's Degree, he worked as operator in hydro plants of the Utah Power and Light Company. In 1927 Dr. Reed became an instructor in electrical engineering



MYRIL B. REED

at the University of Texas and in 1938 he became assistant professor at Illinois Institute of Technology (at that time Armour Institute of Technology) where he is at the present time a professor in electrical engi-



WHITMAN RIDGWAY

neering. He is a member of Tau Beta Pi, Eta Kappa Nu, and Sigma Xi.

Dr. Reed published "Fundamentals of Electrical Engineering" in 1938 and has a second book, "Fundamentals of A.C. Circuit Theory," ready for publication. He also has published several papers on circuit theory.

Whitman Ridgway was born in White Plains, New York, November 24, 1918. He received the B.S. degree in electrical engineering from Princeton University in 1939. He returned for a graduate year and received the degree of Electrical Engineer in 1940. He completed the General Electric Company's test program in 1941 and began work for the central station engineering divisions. At the time the work presented in this paper was done, he was working on the company's alternating-current network analyzer. Since then he has been working on ship power-system analysis.

Philip F. Siling (M'30-SM'43) was born in East Orange, New Jersey on August 14, 1897. He received the Ph.B. degree in electrical engineering and is a member of Sigma Xi. Mr. Siling was with the American Telephone and Telegraph Company, department of operation and engineering from 1917 to 1929. In 1929 he was appointed outside plant engineer and shortly thereafter was made acting plant operations engineer. In



PHILIP F. SILING

this position, he was responsible for outside plant construction and maintenance, central office installation and maintenance, plant extensions and related activities. Mr. Siling was appointed superintendent of materials and supplies for International Telephone and Telegraph Corporation of South America in 1931 with headquarters in Buenos Aires. In 1933 he was appointed assistant deputy administrator of the National Recovery Administration in charge of codes of the electrical manufacturing industry. In 1935 he transferred to the Federal Communications Commission as senior telephone engineer and in February, 1937, was appointed assistant chief of the international division. In April, 1941, he was promoted to head the international division and in February of 1944 he was made assistant chief engineer in charge of the broadcast division of the Commission. In addition to his Commission assignments, Mr. Siling has served as assistant secretary of the Interdepartment Radio Advisory Committee from 1937 to 1941 and as secretary from 1941 to date. He serves as Commissioner Craven's alternate as the Commission's representative on that Committee.



D. L. WAIDELICH

D. L. Waidelich (S'37-A'39) was born on May 3, 1915, at Allentown, Pennsylvania. He received the B.S. degree in electrical engineering in 1936 and the M.S. degree in 1938 from Lehigh University. From 1936 to 1938 he was a teaching assistant at Lehigh University; in 1938, he became an instructor at the University of Missouri and he is now an assistant professor of electrical engineering there. Mr. Waidelich is an associate member of the American Institute of Electrical Engineers and a member of Sigma Xi, Tau Beta Pi, and Eta Kappa Nu.

Paul B. Weisz (A'43) was born in Pilsen, Czechoslovakia, on July 2, 1919. He studied industrial physics at the Polytechnic Institute at Berlin and worked in the field of cosmic rays at the University of Berlin. He received the B.Sc. degree in physics from the Alabama Polytechnic Institute. In 1940 he joined the staff of the Bartol Research Foundation as research assistant to the director, Dr. W. F. G. Swann, and was engaged in cosmic-ray research and the development of electronic instruments. During



PAUL B. WEISZ

1942, on temporary leave, and part-time leave for short periods, taught radio engineering laboratory and pre-radar theory at Swarthmore College for members of the Signal Corps. He is now engaged in research and development of special electronic equipment with the Bartol Foundation. Specializing in electronic applications involving X rays and atomic radiations, Mr. Weisz has served several industries as a consultant, and has several inventions to his credit, as well as numerous research papers. He is a member of the American Physical Society and the National Aeronautic Association.

Victor Wouk was born on April 27, 1919, in New York City. He received the B.A. degree from Columbia University in 1939, the M.S. degree in electrical engineering in 1940, and the Ph.D. in 1942 from the California Institute of Technology.

Dr. Wouk joined the Westinghouse Electric and Manufacturing Company in 1942 as a research engineer. His work since then has been devoted to the study of methods for reducing arcbreak rate in ignitron rectifiers. He has written papers appearing in technical and trade magazines during the past two years. He is a member of the American Institute of Electrical Engineers.

For biographical sketches of J. R. Whinnery and Gabriel Kron see the PROCEEDINGS for May, 1944.



VICTOR WOUK

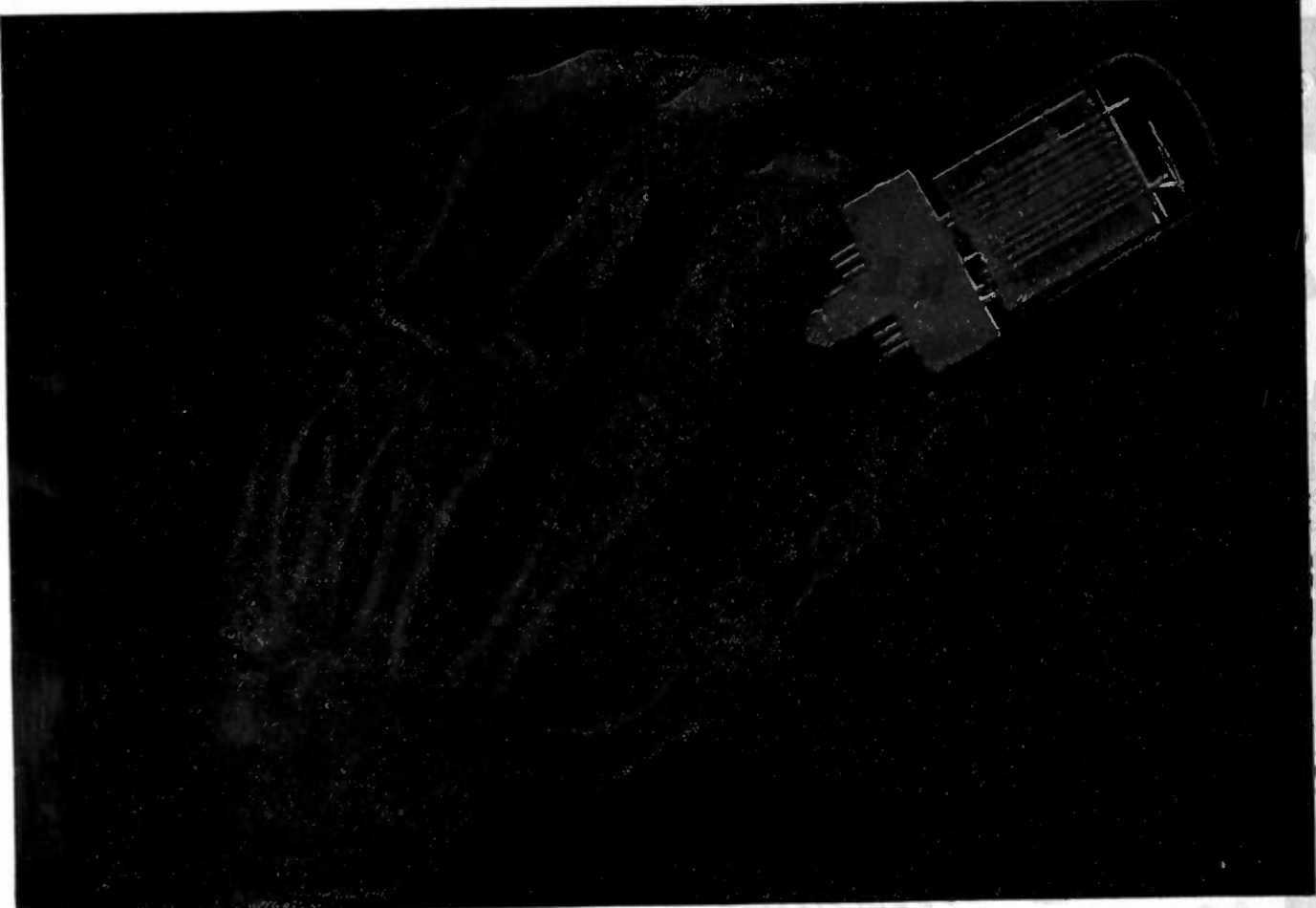

Induction Ceremony

 This is an X-ray photograph of the final step in the stiff pre-induction examination which National Union engineers are giving many of the N. U. Tubes now headed for combat duty.

Why X-ray? Because with great objectives and priceless lives at stake, it is a military necessity to know that critical-type N. U. Tubes are sound through and through—equal in every way to the ordeals they'll face in battle. Even tubes which have passed scores of operational tests with flying colors, are scrutinized by the searching eyes of the X-ray engineer. X-ray examination of the finished tubes—after all

processing has been completed—helps our scientists to know that there is *no* hidden weakness *anywhere*.

This insistence upon leaving nothing to chance typifies the uncompromising scientific standards which prevail at National Union. It is assurance that every tube which carries the N. U. trademark can be counted on to do its duty, always. And for post-war industrial needs, it is a safe and sure guide to electronic tubes of known performance characteristics and dependability. *Count on National Union.*

NATIONAL UNION RADIO CORPORATION, NEWARK, N. J.
Factories: Newark and Maplewood, N. J., Lansdale and Robesonia, Pa.



NATIONAL UNION RADIO AND ELECTRONIC TUBES

Transmitting, Cathode Ray, Receiving, Special Purpose Tubes • Condensers • Volume Controls • Photo Electric Cells • Panel Lamps • Flashlight Bulbs



WIRE-WOUND SURGE RESISTORS

TYPE 290
RANGE: 1000 to
3,000,000 ohms



Developed for the X-Ray and other high-voltage applications, Shallcross Surge Resistors match up-to-the-minute requirements for high-resistance wire-wound resistors capable of handling high voltages, while dissipating normally 200 watts. A typical application is their use in the constant potential DC output of a high voltage Kenetron rectifying system to stabilize the performance of the apparatus to which this high potential is being supplied.

Descriptive data on request

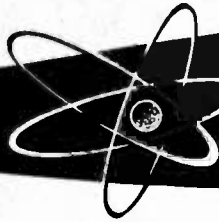

Shallcross ACCURATE, HEAVY-DUTY Wire-Wound Resistors

These sturdy units meet popular favor with instrument manufacturers and others who require small, accurately calibrated resistors capable of handling high currents. They are also widely used as voltmeter multipliers in low-resistance AC or DC instruments. Normally rated at 10 watts, these Shallcross Type RM AKRA-OHMS are supplied to a standard accuracy of 2% and can, of course, be calibrated to closer tolerances where desired. They are water-proof, humidity-tested, and capable of withstanding salt water immersion.

Write for folder

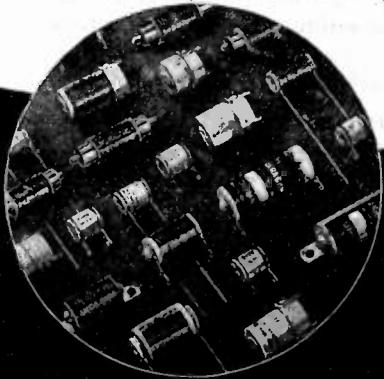

EXACTING RESISTORS FOR EXACTING JOBS

As long-time specialists in the production of close-tolerance resistors, Shallcross offers a complete line covering practically every need. Write for AKRA-OHM Catalog.

SHALLCROSS MFG. CO.

DEPT. IR-64, COLLINGDALE, PA.

ENGINEERING • DESIGNING • MANUFACTURING



ATLANTA

"Electronics in Wartime Production," by J. W. Brisendine, Atlantic Sheet Metal Corporation; March 24, 1944.

BUFFALO-NIAGARA

"Radio Receiver Measurements," by B. E. Atwood and Joseph Van Baalen, Colonial Radio Corporation; April 19, 1944.

"Crystal Frequency-Controlled Circuits used in the Transmitters of WBEN," by H. G. Kortz, Station WBEN, Inc.; April 19, 1944.

"The Sound Scribe," by Frank Marx, Station WKBW; April 19, 1944.

CHICAGO

"Characteristics and Application of Selenium Rectifiers," by Glen Ramsay, Farnsteel Metallurgical Corporation; April 24, 1944.

"Chicago Coastal Harbor Station WAY," by B. Buffo, Illinois, Bell Telephone Company; April 24, 1944.

CONNECTICUT VALLEY

"Coupling Devices for Radio-Frequency Induction Heating," by W. M. Roberts, RCA Manufacturing Company; April 11, 1944.

DALLAS-FORT WORTH

"Acoustical Characteristics and Electrical Details of the WFAA-KGKO Radio Broadcast Studios," by O. S. Brown, Station WFAA-KGKO; April 12, 1944.

DAYTON

"Electron Optics," by V. K. Zworykin, RCA Laboratories; March 22, 1944.

DETROIT

"Ultra-High-Frequency Measurements," by E. D. Cook, General Electric Company; March 21, 1944.

EMPORIUM

"Varied Applications of Quality Control," by Professor Brumbaugh, University of Buffalo; April 6, 1944.

INDIANAPOLIS

"Practical Application of Frequency Modulation in Emergency Services," by B. W. Whaley, Indianapolis Light and Power Company; March 24, 1944.

Motion Pictures, "Aircraft Engine Fire Tests," and "Shooting 15-Pound Birds Through Aircraft Windshields," March 24, 1944.

"Frequency, Power, and Noise in Multichannel Telephone Systems," by J. O. Perrine, American Telephone and Telegraph Company; April 14, 1944.

LOS ANGELES

"Some Applications of Electronics to Telephone Circuits," by H. I. Romnes, American Telephone and Telegraph Company; February 10, 1944.

"Microphones, Their Performance and Calibration," by F. L. Hopper, Western Electric Company; March 21, 1944.

"Radio and Weather's Third Dimension," by C. P. Hedges, University of California; April 18, 1944.

NEW YORK

"Enemy Army Communications Equipment," by R. B. Colton, United States Army Signal Corps; January 27, 1944.

"Air Navigation and Traffic Supervision," by C. I. Stanton; Civil Aeronautics Administration; February 24, 1944.

"A Modern Transcription Processing and Pressing Plant," by K. R. Smith, Muzak Transcriptions, Inc.; April 5, 1944.

PHILADELPHIA

"The Multivibrator," by Eugene Schenk, RCA Laboratories; April 6, 1944.

(Continued on page 36A)

TOP COVER . . .

for Attack at Dawn!

As dawn comes, lean, snarling pursuit planes roar through a lightening sky to become protective patrol above ground operations. It is "top cover" to shield the men below from air-assault, or to blast in low, screaming dives enemy installations that are blocking the advance.

The ever present, Hallicrafters-built SCR-299 Mobile Radio Communications Trucks are often the means of directing the "top cover." Operating under any conditions, these Giants of Military Radio, whether calling for "top cover" or directing the fire of artillery, "get the message through."

BUY MORE BONDS!



hallicrafters RADIO

THE HALLICRAFTERS COMPANY, MANUFACTURERS OF
RADIO AND ELECTRONIC EQUIPMENT, CHICAGO 16, U.S.A.





WINNING THE WAR
ON EVERY
BATTLEFRONT
IN THE
hallicrafters
SCR-299
COMMUNICATIONS
TRUCK

PAPER, OIL AND ELECTROLYTIC CAPACITORS

**INDUSTRIAL
CONDENSER
CORPORATION**

1725 W. NORTH AVE., CHICAGO, U. S. A.

DISTRICT OFFICES IN PRINCIPAL CITIES
QUICK DELIVERY FROM DISTRIBUTOR'S STOCKS

SECTION MEETINGS

(Continued from page 34A)

ROCHESTER

"Radio Progress in Canada," by R. A. Hackbusch, Stromberg-Carlson Company, Ltd.; April 20, 1944.

ST. LOUIS

"The Behavior of Dielectrics over Wide Ranges of Frequencies and Temperatures," by R. F. Field, General Radio Company; March 21, 1944.

"The Electron Microscope, Its Applications and Accomplishments," by M. C. Banca, RCA Victor; March 30, 1944.

SAN FRANCISCO

"Graphical Solution of Transmission-Line Problems," by E. U. Condon, Westinghouse Laboratories; January 26, 1944.

"Comprehensive Survey of Electric Shock," by Charles Dalziel, University of California; March 29, 1944.

SEATTLE

"Analysis of Voltage-Regulator Circuits," by W. R. Hill, University of Washington; March 24, 1944.

TWIN CITIES

"Plastic and Material Selection and Application for Radio Communications," by Glen Woodmark, Maico Company; February 22, 1944.

"Radio-Frequency Heating and Its Application to Industry," by Wiley Wenger, RCA Victor Division; March 28, 1944.

MEMBERSHIP

The following indicated admissions and transfers of membership have been approved by the Admissions Committee. Objections to any of these should reach the Institute by not later than June 30, 1944.

Admission to Member

- Backer, C. M., Biltmore Hotel, Dayton, 2, Ohio
 Bennett, H. W., 143 Rockland Rd., Bridgeport, Conn.
 Bowyer, V. T., B.A.C., 1520 New Hampshire Ave., Washington, D. C.
 Brett, H. M., 166 Mountain Way, Rutherford, N. J.
 Jensen, A. K., 5511 Homeside Ave., Los Angeles, Calif.
 Kintzel, J. D., c/o A. C. Nielsen Co., 2101 W. Howard St., Chicago, Ill.
 Knight, A. R., 1657 Hearthstone Dr. Dayton, 10, Ohio
 Rhein, G. W., Mackay Radio and Telegraph Co., 67 Broad St., New York, 4, N. Y.
 Rudensy, M. B., 15 Walter Pl., Irvington, N. J.
 Sandberg, D. A., 872 Clifton Crest Ter., Cincinnati, Ohio
 Schutz, H., 54 Lyme Rd., Hanover, N. H.
 Stafford, J. W., Apt. 315, 26 Concord Ave., Cambridge, 39, Mass.
 Wright, C. M., 19 Glen Ave., Ottawa, Ont., Canada
 Zink, A. J., Jr., 64 Whittier St., Andover, Mass.

Transfer to Member

- Browder, J. E., 365 Stewart Ave., Garden City L. I., N. Y.
 Cafferata, H., Knotty Ash, Greenways Broomfield Rd., Chelmsford, Essex, England
 Choat, W. F., 38 Grenview Blvd., Toronto, Ont., Canada
 Eubank, R. N., 1227 Windsor Ave., Richmond, 22, Va.
 Fleming, C. C., 173-08-82 Ave., Jamaica, L. I., N. Y.

(Continued on page 38A)

Proceedings of the I.R.E. June, 1944

McELROY designed . . . built

FOR MORE RAPID, MORE ACCURATE, MORE EFFICIENT TRANSMISSION
OF DOTS AND DASHES

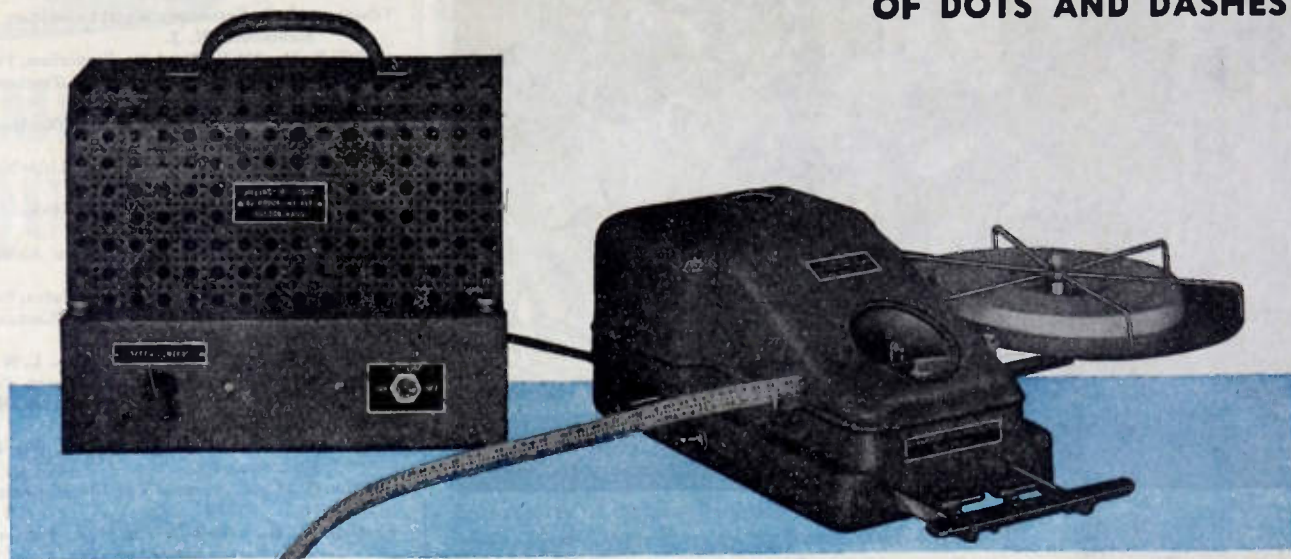

McELROY ELECTRONIC CODE TAPE PERFORATOR PFR-443-A

For improved radiotelegraph communications from ship-to-ship, shore-to-shore, point-to-point. Entirely mechanical, the PFR-443-A comprises two units. The **Keying Unit** which includes an assembly of two keys, space bar and punching mechanism . . . plus the **Electronic Unit** which relieves the keying contacts

of high current voltage, and provides for ease in operation. Experienced operators can easily maintain an accurate speed of more than 40 words per minute . . . in all Morse combinations assigned to the Russian, Turkish, Greek, Arabic and Japanese languages.

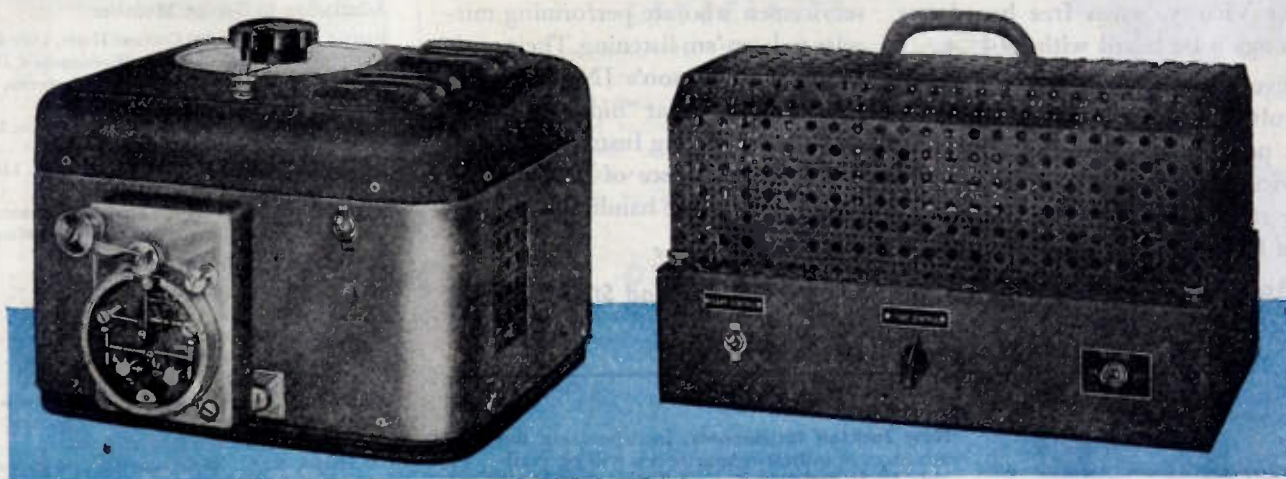

McELROY MODEL XTR-442 BM AUTOMATIC TRANSMITTER

An essential where transmission must be regulated to a given number of words per minute. The **Keying Unit** consists of the McElroy keying head coupled to a newly designed drive. The speed is adjustable at any rate from 10 to 200 words per minute, and at any given setting, the rate cannot vary. The **Electronic Unit** responds to the keying head to produce

either tone for keying a radiotelegraph transmitter, or to key a transmitter through the medium of a heavy duty pivotless relay. The tone can be impressed on a radiofrequency carrier current, sent to a remote transmitting station, filtered and used to operate a transmitter without requiring relay action.

Requests for additional information will be handled promptly

McElroy

MANUFACTURING CORP.
82 BROOKLINE AVE. BOSTON, MASS.



YOU CAN MAKE NO GREATER PERSONAL CONTRIBUTION TO THE WAR EFFORT THAN TO DONATE A PINT OF YOUR BLOOD TO THE RED CROSS



Where Listening calls for Courage

For Europe's enslaved millions, listening to radios today involves *danger*—and will so continue until after Victory, when free broadcasts can again be heard without fear.

Even in America, listening today involves *difficulty*—because, due to the priority of radio and electronic devices for military service, Americans are still using the same equipment that has served us since 1941.

And yet the amazing thing is how **Buy War Bonds and Stamps today**

well—and how many—of America's 59 million radio receivers are still functioning . . . kept in operation by servicemen who are performing miracles to keep 'em listening. Their testimonials to Jackson's INTEGRITY OF DESIGN—that "hidden plus" of all Jackson Testing Instruments—are based on excellence of performance under most severe handicaps.

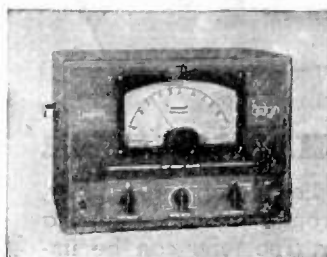

Model 652 Audio Oscillator

New Jackson Instruments, incorporating the advances of military experiences, will be available for the vast post-war radio market. Until then, maintaining Jackson products is a responsibility we shall fulfill as promptly as wartime conditions permit.

JACKSON

Fine Electrical Testing Instruments

JACKSON ELECTRICAL INSTRUMENT COMPANY, DAYTON, OHIO



(Continued from page 36A)

- Glacietto, L. J., Eatontown Signal Laboratory, Ft. Monmouth, N. J.
 Godell, E. M., 224 E. Third St., Emporium, Pa.
 Greene, F. M., Apt. 3, 5311—38 Ave., Hyattsville, Md.
 Haynes, N. M., 1115B., Ninth St., Far Rockaway, L. I., N. Y.
 Holsington, D. B., 48—02 Browvale La., Little Neck, L. I., N. Y.
 Hopkinson, T. W., 600 Bashford La., Alexandria, Va.
 LaPierre, V. M., Pan American-Grace Airways, Inc., Lima, Peru
 McKnight, G. P., 325 Charles St., St. Marys, Pa.
 Talpey, R. G., Stromberg-Carlson Company, Rochester, N. Y.
 Nye, J. H., 4035 Ithaca St., Elmhurst, L. I., N. Y.
 Petts, R. G., 1004 Cherry St., Williamsport, Pa.
 Priebe, F. K., 40 Woodland Dr., Fair Haven, N. J.
 Reash, C. W., Box 11, Emporium, Pa.
 Seidner, J. H., 516 E. Alleghany Ave., Box 401, Emporium, Pa.
 Shultise, Q. M., 64 Avenue of Two Rivers, Rumson, N. J.
 Siemens, R. H., c/o RCA Argentina, Paroissien 3906, Buenos Aires, Argentina
 Summerford, D. C., 3037 Wirth Ave., Louisville, 4, Ky.
 Swan, E. O., CKRL, 444 University Ave., Toronto, Ont., Canada
 Swendson, L. G., 30 Miller Ave., Fairfield, Ohio
 Van Niman, R. T., c/o Motiograph, 4431 W. Lake St., Chicago, Ill.
 Wainwright, R. M., Rm. 30320 Pentagon, OCSIGO, Washington, 25, D. C.
 White, S. D., Bell Telephone Laboratories, 463 West St., New York, N. Y.

Admission to Senior Member

- Barrett, A. B., Rm. 506 Grafton Hotel, 1139 Connecticut Ave., N. W., Washington 6, D. C.
 Benning, H. H., Bell Telephone Laboratories, 463 West St., New York, N. Y.
 Dearle, R. C., University of Western Ontario, London, Canada
 DeBiver, A. M. B., Rua Rodgigo da Fonseca, 135-4, Lisbon, Portugal
 Morrill, K. C., Underwater Sound Laboratory, Harvard University, Cambridge, Mass.

Transfer to Senior Member

- Akerman, B., 2646 Cheshire Bridge Rd., N. E., Atlanta, Ga.
 Avery, R. D., 27 Violet Ave., Mineola, L. I., N. Y.
 Bauer, B. B., 1170 S. Harvey Ave., Oak Park, Ill.
 Callanan, J. A., 6825 N. Olcott Ave., Chicago, Ill.
 Chakravarti, S. P., 8 Camac St., Calcutta, India
 Collision, P. B., Underwater Sound Laboratory, Ft. Trumbull, New London, Conn.
 Corderman, R. C., 45 Clinton Ave., Maplewood, N. J.
 Cotter, W. F., Stromberg-Carlson Company, Rochester, N. Y.
 Curtiss, A. N., 5521 N. Pennsylvania St., Indianapolis, 5, Ind.
 Frankel, S., 72-38—113 St., Forest Hills, L. I., N. Y.
 Gressford, R. K., Sylvania Electric Products, Inc., Emporium, Pa.
 Heiser, E. S., 208 Uptown Post Office, St. Paul, Minn.
 Hendricks, L. A., Aircraft Radio Laboratory, Wright Field, Dayton, Ohio
 Huxtable, C. K., 736 Michigan Ave., Evanston, Ill.
 Kaufman, J., Box 406, Ross, Calif.
 Luttgens, H. C., c/o National Broadcasting Company, Merchandise Mart, 222 N. Bank Dr., Chicago, 54, Ill.
 McNally, J. O., Bell Telephone Laboratories, 463 West St., New York, N. Y.
 Miles, P. D., 707 Berry St., Falls Church, Va.
 Mossman, F. B., 3822—43 Ave., N. E., Seattle, 5, Wash.

(Continued on page 40A)



MEASURES QUANTITIES

with greater sensitivity & range than ever before accomplished



PATS. APP. FOR

TECH LAB MICROHMMETER

... gives direct and instantaneous readings of resistance values down to 5 microhms and up to 1,000,000 megohms. Accuracy in all measurements to better than 2%. Output is sufficient to drive recorder. Entirely AC operated. Furnished in two models. Reasonably prompt deliveries. For complete data regarding other applications write for Bulletin No. 432.

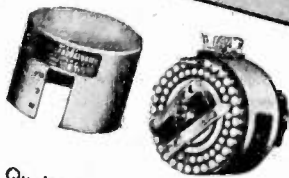

Quality manufacturers of attenuators and other electrical complete instruments. For complete data write for Bulletin No. 431.



9 LINCOLN STREET
JERSEY CITY 7, N. J.

1,001 USES

Condensed Power for Years of Service

VERSATILITY and dependability were paramount when Alliance designed these efficient motors — *Multum in Parvo!* . . . They are ideal for operating fans, movie projectors, light home appliances, toys, switches, motion displays, control systems and many other applications . . . providing economical condensed power for years of service.

Alliance Precision

Our long established standards of precision manufacturing from highest grade materials are strictly adhered to in these models to insure long life without breakdowns.

EFFICIENT

Both the new Model "K" Motor and the Model "MS" are the shaded pole induction type — the last word in efficient small motor design. They can be produced in all standard voltages and frequencies with actual measured power outputs ranging upwards to 1/100 H. P. . . Alliance motors also can be furnished, in quantity, with variations to adapt them to specific applications.

DEPENDABLE

Both these models uphold the Alliance reputation for all 'round dependability. In the busy post-war period, there will be many "spots" where these Miniature Power Plants will fit requirements . . . Write now for further information.

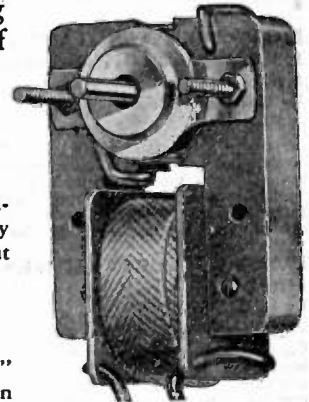

Model "MS" — Full Size Motor Measures 1 3/4" x 2 x 3 1/8"

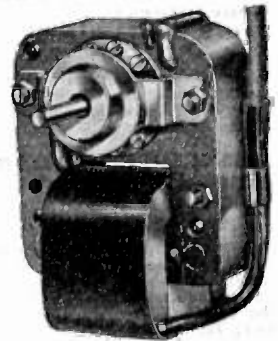

New Model "K" — Full Size Motor Measures 2 1/8" x 2 3/8" x 3 1/8"

Remember Alliance!
—YOUR ALLY IN WAR AS IN PEACE

ALLIANCE MANUFACTURING CO. ALLIANCE, OHIO

WILEY BOOKS IN COMMUNICATIONS-ELECTRONICS



Post-war plans in your field are being made now. Now is the time, then, to step up your knowledge. Be ready for new duties. Look over the important titles listed below. Make your selection and order from the coupon today.

FIELDS AND WAVES IN MODERN RADIO

By Simon Ramo and John R. Whinnery

503 Pages

\$5.00

Authoritative data on high-frequency circuits, skin effect, shielding problems, problems of wave transmission and reflection, transmission lines and wave guides, cavity resonators, and antennas and other radiating systems—with a rigorous account of the technique of applying field and wave theory to the solution of modern radio problems.

HOW TO PASS RADIO LICENSE EXAMINATIONS—Second Edition

By Charles E. Drew

320 Pages

\$3.00

Newly revised and brought up to date, this well-known book, in question-and-answer form, offers much helpful material to amateur radio operators, radiotelephone and telegraph operators, whether interested in broadcasting, marine, aeronautical, or any other field of radio transmission and reception.

RADIO RECEIVER DESIGN—Part I

By K. R. Sturley

435 Pages

\$4.50

Communications engineers will want to own this book, which covers radio frequency amplification and detection. A detailed study, stage by stage, beginning with the aerial and going as far as the detector.

TIME BASES—(Scanning Generators)

By O. S. Puckle

204 Pages

\$2.75

Covers the subject from both the design and the development points of view: assembles more time bases circuits than have heretofore been available in one volume.

PRINCIPLES OF RADIO—Fourth Edition

By Keith Henney

549 Pages

\$3.50

A complete and authoritative presentation of radio, in its fundamentals as well as its recent developments. Partial list of contents includes: Ohm's Law; Inductance; Capacitance; Circuits; Coils; the Vacuum Tube; Amplifiers; Rectifiers; Oscillators; Television; etc. Profusely illustrated.

COMMUNICATION CIRCUITS—Second Edition

By L. A. Ware and H. R. Reed

330 Pages

\$3.50

An expansion of an eminently successful book to include new material on physical aspects of wave guide transmission, impedance matching, solution of circuits, and the theory of rectangular and cylindrical wave guides.

HYPER AND ULTRA-HIGH FREQUENCY ENGINEERING

By Robert I. Sarbacher and William A. Edson

644 Pages

\$5.50

A practical treatment of an important new branch of communications engineering, requiring no special advanced knowledge. Of value to the beginner, as well as those having some familiarity with the subject.

GUIDE TO CATHODE RAY PATTERNS

By Merwyn Bly

30 Pages

\$1.50

Important for technicians and laboratory workers. This book summarizes briefly by means of sketches and captions the cathode-ray pattern types encountered in the usual course of laboratory and test bench work.

FUNDAMENTAL RADIO EXPERIMENTS

By Robert C. Higgy

96 Pages

\$1.50

Thirty-two basic experiments in electricity, electronics and radio, with a full explanation of the principles involved as well as laboratory procedure.

BASIC ELECTRICITY FOR COMMUNICATIONS

By William H. Timbie

603 Pages

\$3.50

A simple, clear presentation of the fundamentals of electricity and their application in the problems of communications and radio. The first twelve chapters illustrate the principles by simple application to communications appliances. The remainder of the book covers the appliances and their operation.

SHORT-WAVE WIRELESS—Fourth Edition

By A. W. Ladner and C. R. Stoner

573 Pages

\$6.00

A book of inestimable value in this field as it contains the latest facts and theory (as far as they may be released now) on the many leading American, English and European developments taking place in short-wave and ultra-short-wave work. 180 new diagrams, plus illustrations and calculations supplement the text.

ON APPROVAL COUPON

JOHN WILEY & SONS, INC.

440 Fourth Avenue
New York 16, N.Y.

Please send me on ten days' approval the books I have checked in this advertisement (or I am attaching to this coupon a separate list of the books desired). At the end of that time, if I decide to keep the books, I will remit indicated price plus postage; otherwise I will return the books postpaid.

Name

Address

City and State

Employed by

IRE-6-44



(Continued from page 38A)

- Pounsett, F. H. R., 23 Parkhurst Blvd., Leaside, Ont., Canada
 Serrell, R., 786 Palmer Rd., Bronxville, N. Y.
 Sussman, H., 1909 Hollingshead Ave., Pennsauken, N. J.
 Wagener, W. G., c/o Heinz and Kaufman, Ltd., South San Francisco, Calif.
 Williams, E. M., Research Division, Aircraft Radio Laboratory, Wright Field, Dayton, Ohio
 Wootton, G. A., 714 Maitland St., London, Ont., Canada

The following admissions and transfers were approved by the Board of Directors on May 3, 1944.

Admission to Member

- Allen, E. W., Jr., 3225 S. Sixth St., Arlington, Va.
 Anton, N. G., 225 Sterling Pl., Brooklyn, N. Y.
 Carroll, T. J., 3067 Ordway St., N. W., Washington, D. C.
 Cronburg, C. I., Jr., Bell Telephone Laboratories, 463 West St., New York, N. Y.
 Daubaras, E. J., 160 Himrod St., Brooklyn, N. Y.
 Evans, C. R., 228 Manhasset Ave., Manhasset, L. I., N. Y.
 Kocher, C. F., 3634 Avalon Rd., Shaker Heights, Cleveland, Ohio
 Liska, R. W., Plant Engineering Agency, Rm. 1303, Architects Bldg., 17 and Sansom Sts., Philadelphia, Pa.
 McDermott, S. J., 35 Longview Rd., Port Washington, L. I., N. Y.

Transfer to Member

- Bailey, R. C., Box 112, Richmond, 1, Va.
 Brunner, G. V., 220 W. Fourth St., Emporium, Pa.
 Burroughs, F. L., 301 E. Alleghany Ave., Emporium, Pa.
 Campbell, C. H., National Broadcasting Company, 30 Rockefeller Plaza, New York, N. Y.
 Dickinson, W., Sylvania Electric Products, Inc., Emporium, Pa.
 Doane, J. E., 317 N. Thomas St., Arlington, Va.
 Eckel, C. B., 1118 Mulberry, Williamsport, Pa.
 Ellefson, B. S., Sylvania Electric Products, Inc., Emporium, Pa.
 Goldberger, E. M., c/o Pilot Radio Corporation, 37-06—36 St., Long Island City, L. I., N. Y.
 Halinton, H., 612 N. Michigan Ave., Chicago, Ill.
 Kinsburg, B. J., Room 1304, 180 Varick St., New York, N. Y.
 Laeser, P. B., 9410 Harding Blvd., Wauwatosa, Wis.
 Marchand, N., 403 W. 115 St., New York, N. Y.
 Overmier, E. E., 20 W. Sixth St., Emporium, Pa.
 Plummer, C. B., Box 3, Alfred, Maine
 Schoen, A. L., 110 Parkdale Ter., Rochester, N. Y.
 Vaughan, E. W., 2284 Neil Ave., Columbus, Ohio
 Weiss, W. A., 333 W. Sixth St., Emporium, Pa.
 Wolfe, H., 10415 McCormick St., North Hollywood, Calif.

Admission to Senior Member

- Brillouin, L. N., 88 Central Park West, New York, N. Y.
 Cooke, W. T., 107 Locust St., Garden City, L. I., N. Y.
 Fruth, H. F., 5032 W. Morse, Skokie, Ill.
 Huber, G. H., 221 Ryder Rd., Munsey Park, Manhasset, L. I., N. Y.
 Richter, W., 5426 N. Kent Ave., Milwaukee, 11, Wis.
 Taylor, M. K., Warwick Lodge, Hale, Cheshire, England
 Willenbecher, J. F., 15 Prospect St., Great Neck, L. I., N. Y.

(Continued on page 42)



Setting her down "on a Dime".....

Federal's Instrument Landing System is Ready to Serve the Great New Air Age



Federal's Instrument Landing Systems are equipped with Intelin Coaxial Cable, also developed and manufactured by Federal. This cable has extreme ruggedness, strength and endurance, and meets all specifications with precision, accuracy, uniformity and dependability.

Through fog, sleet, rain and blackness the science of radio brings the airliner home.

The pilot *knows* his course, position and landing.

Federal's Instrument Landing System guides the homing pilot with unfailing accuracy. He can set his ship down on a dime.

Federal's equipment has made a great contribution to safety in the air. It is dependable and, moreover, is less subject to atmospheric disturbances. It reduces initial, maintenance and operating costs.

Federal—one of the largest manufacturers of instrument landing equipment for ground installations—is prepared now to discuss your plans and probable requirements.

Federal Telephone and Radio Corporation

Newark 1, N. J.



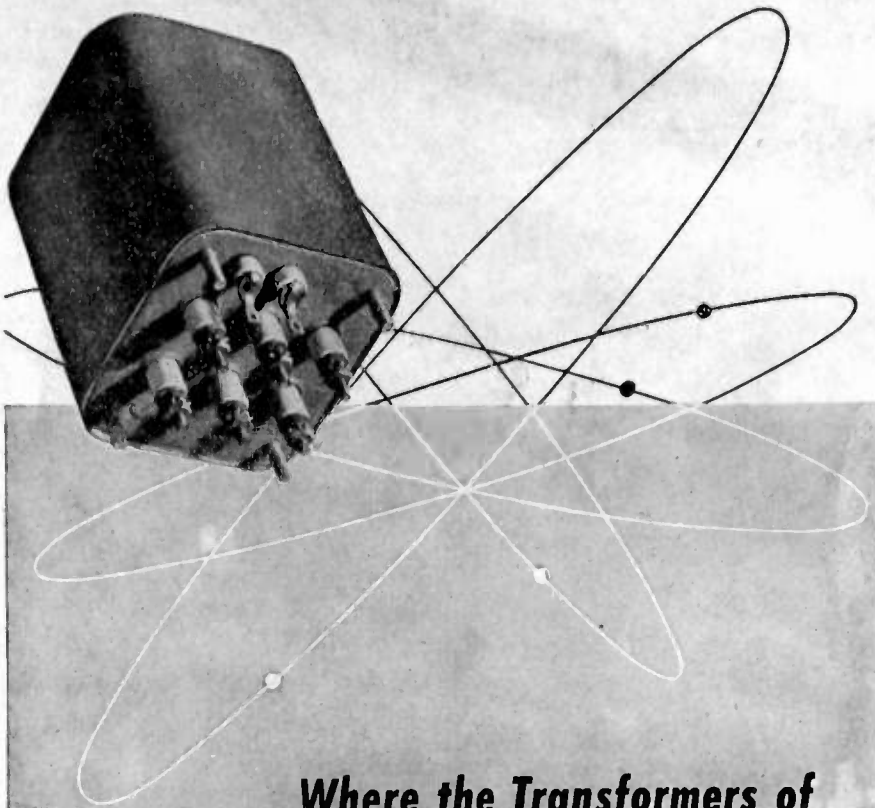

Where the Transformers of Tomorrow are Working Today

In all branches of the service and in all parts of the world Transformers that will play a large part in the homes and industry of tomorrow are being tested today under the most severe conditions.

Chicago Transformer is proud to be manufacturing and designing units of this type.

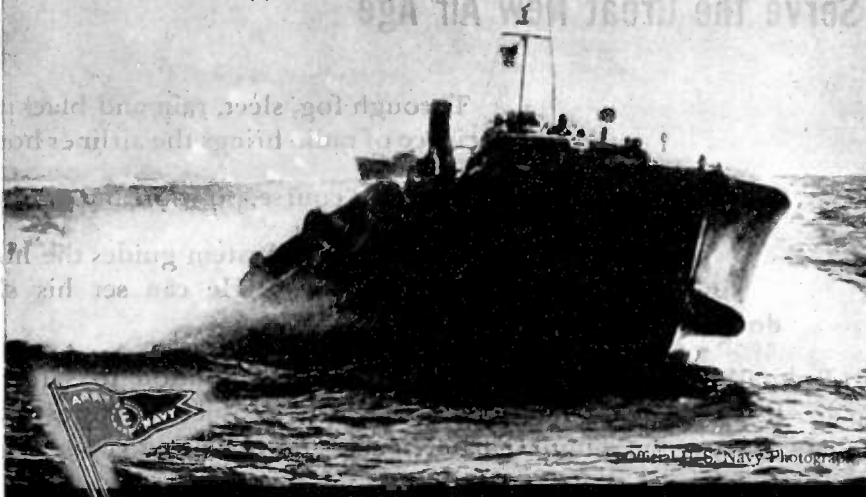

CHICAGO TRANSFORMER

DIVISION OF ESSEX WIRE CORPORATION

3501 WEST ADDISON STREET • CHICAGO, 18



(Continued from page 40A)

Transfer to Senior Member

- Adair, G. P., 101 Allegheny Ave., Takoma Park, Md.
 Dunning, O. M., Hazeltine Electronics Corporation, Little Neck, L. I., N. Y.
 Honaman, R. K., Bell Telephone Laboratories, 463 West St., New York, N. Y.
 Moore, C., 327 Potomac Ave., Lombard, Ill.
 Peterson, A. C., Jr., 15 Inwood Rd., Chatham, N. J.
 Seielstad, H. D., 1017 S. Bend Rd., Webster Groves, 19, Mo.
 Smith, D. B., 9 Rose La., Chestnut Hill, Philadelphia, 18, Pa.

The following admission to Senior Member was approved by the Board of Directors on April 5, 1944.

- Smith-Rose, R. L., National Physical Laboratory, Teddington, Middlesex, England

The following admissions to Associate were approved by the Board of Directors on May 3, 1944.

- Allan, A. H., 6 Devonshire Promenade, Lenton, Nottingham, England
 Allen, G., Box 4056-ATC, Albuquerque, N. M.
 Albee, M. M., 506 S. 41 St., Philadelphia, 4, Pa.
 Alpay, E., Hosnudiye, porsuk sok. 17, Eskischir, Turkey
 Alpert, M., A.E.S. 43 Bks., 215 Marine Corps Air Station, Cherry Point, N. C.
 Alstad, N. J., 42 Hilltop Pl., West Hills, New Haven, Conn.
 Amsler, B. E., 3834 E. 68 Ter., Kansas City, 5, Mo.
 Ander, J., 8019 Austin St., Kew Gardens, L. I., N. Y.
 Archibald, L. H., U. S. Naval Computing Machine Laboratory, Dayton, 9, Ohio
 Atherton, O. L., 312 S. Second St., Olean, N. Y.
 Baganz, A., Colesville Manor-1, Bethlehem, Pa.
 Ballou, H. A., Philco Corporation, 3425 N. Broad St., Philadelphia, Pa.
 Banks, F. A. O., 81 Troy St., Kitchener, Ont., Canada
 Bennett, S. R., Sylvania Electric Products, Inc., Williamsport, Pa.
 Bernstein, A., 2089 Matthews Ave., Bronx, N. Y.
 Bhargave, R. K., Bhargave Trading Company, M Block, Aggarwal Bldg., Connaught Circus, New Delhi, India
 Birt, R. H., 4507 Kugler Mill Rd., Rossmoyne, Ohio
 Blitzer, R., 1205 N. E. Third St., Ft. Lauderdale Fla.
 Bogue, H., 914 W. First St., Santa Ana, Calif.
 Boss, L. J., 370 Samuel Gorton Ave., Warwick Neck, R. I.
 Bosshart, R. F., 23 Collinwood Rd., Maplewood, N. J.
 Bowes, H. J., Victory Heights Housing Project, Apt. 1123-3B, Grand Central and Chemung St., Horseheads, N. Y.
 Boyd, H. W., Jr., 18 Collins La., West Hempstead, L. I., N. Y.
 Briscoe, W. L., Yale University, New Haven, Conn.
 Brooks, J. E., 1270-41 Ave., San Francisco, 22, Calif.
 Butenschon, F., 6 Taranto Pl., Dayton, 4, Ohio
 Butterweck, H. W., 138-02-135 Ave., New York, N. Y.
 Cannon, D. W., 209 N. Reese Pl., Burbank, Calif.
 Chapman, J. K., 216 Jackson Ave., Schenectady, N. Y.
 Clark, N. C., 1318 Taft Rd., Cincinnati, Ohio
 Cohen, M. J., Rm. 20-B-229, 77 Massachusetts Ave., Cambridge, Mass.
 Comegys, C. W., Jr., 1405 N. Stanley Ave., Los Angeles, 46, Calif.
 Culmer, W. J., 5653-19 Ave., S., Minneapolis, 7, Minn.
 Davidson, P., 1901 S. Hamlin Ave., Chicago, 23, Ill.

(Continued on page 44A)

THE "PORCUPINE"

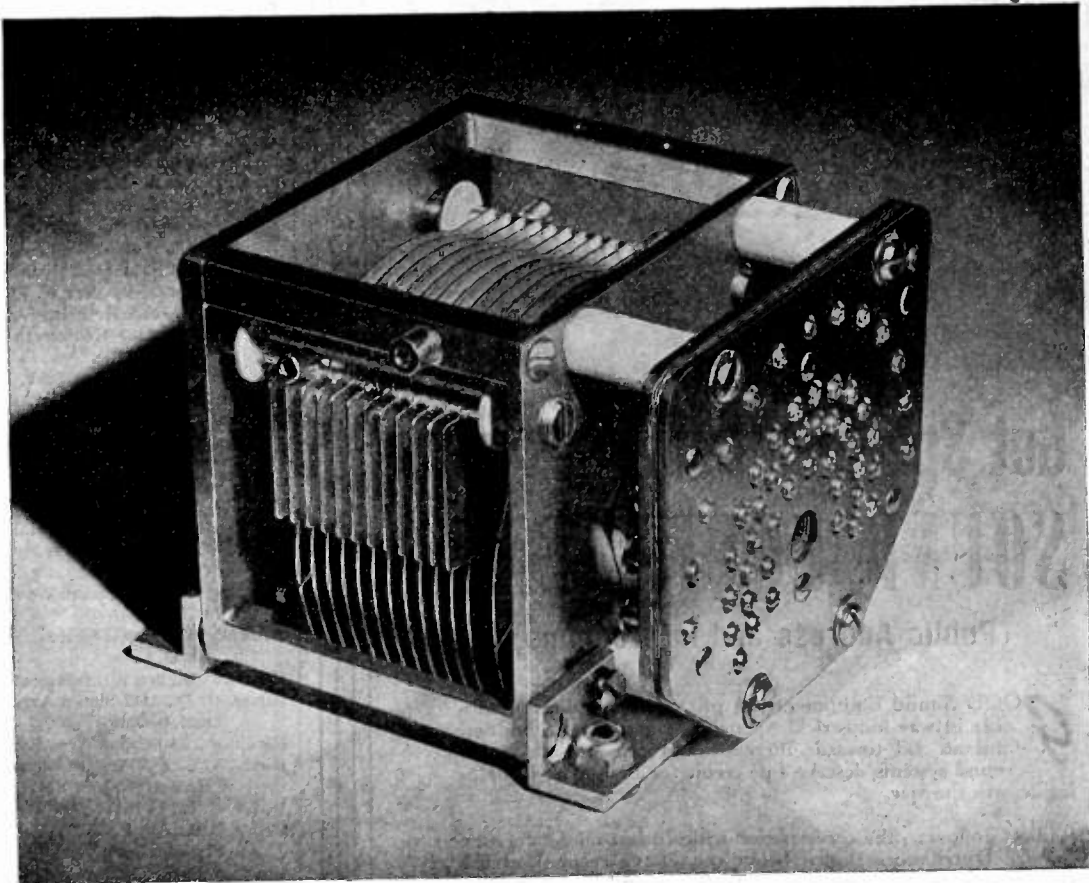

The Porcupine* has 51 trimming adjustments!

NOT LONG ago a variable condenser had just so many rotor and stator plates and that's all there was to it. . . . Today we manufacture hundreds of types complete with all *accessories* to solve many difficult problems.

* So named by the employees who build them.

THE HAMMARLUND MANUFACTURING CO., INC.
460 West 34th Street, New York, N.Y.



HAMMARLUND



Get Speedier Deliveries of SOUND EQUIPMENT

(Public Address and Intercomms)

GOOD Sound Equipment has proved tremendously valuable in war industries. As a time saver, morale builder, and an aid towards increasing production, electronic sound systems deserve full credit for their part in helping to win the war.

Radio Group . . . the three nation-wide *Industrial Emergency Service* Distributors shown below . . . have recognized the vital nature of this equipment. We've maintained generous stocks in ample variety. Orders from war plants and government agencies receive the full benefit of our streamlined emergency service. Deliveries are speedy and efficient in the face of wartime scarcities.

Thousands of plants from coast-to-coast depend on us regularly for all of their Radio and Electronic Supplies. If you're not acquainted with this Emergency Service, write for a Reference Book & Buyer's Guide or send along an order to your nearest distributor, today! Let our skilled electronic engineers, technicians and procurement officers help you get what you want faster than you ever thought possible under war conditions.

*Radio and
Electronic Supplies*

WRITE OR PHONE YOUR NEAREST DISTRIBUTOR

TERMINAL RADIO CORP.

85 Cortlandt St., Phone WOrth 2-4416 NEW YORK 7

WALKER-JIMIESON, INC.

311 S. Western Ave., Phone Canal 2525 CHICAGO 12

RADIO SPECIALTIES CO.

20th & Figueroa, Phone Prospect 7271 LOS ANGELES 7

NATIONAL INDUSTRIAL EMERGENCY SERVICE

Membership

(Continued from page 42A)

- DeShon, H. C., 23 Berkeley Heights Park, Bloomfield, N. J.
- Dillon, F. O., 1421 El Campo Dr., Dallas, 8, Texas
- Dolhar, J. L., 314 Ninth St., S. W., Chisholm, Minn.
- Douglas, J. H., 6043 Bryan Pkwy., Dallas, 6, Texas
- Dunn, J. E., Apt. 12, 82 E. Cliff St., Somerville, N. J.
- Durham, G. E., 1425 C St., San Diego, 2, Calif.
- Ebbeler, J. R., 7030 Ellen Ave., North College Hill, Cincinnati, Ohio
- Ensall, T., R.F.D. 8, Box 3, Dayton, Ohio
- Ercolino, M. D., 907 Bergh St., Asbury Park, N. J.
- Fazio, J. A., 1185 Lebanon St., Bronx, 60, N. Y.
- Featherstone, C. R., Apt. 17, 34 Rosecliffe Ave., Toronto, Ont., Canada
- Fisher, A. H., 1741 N. 60 St., Philadelphia, 31, Pa.
- French, R. M., Main St., Madison, Maine
- Frost, J. D., 4006-24 Ave., W., Seattle, 99, Wash.
- Gary, L. A., 3722 S. Hermitage Ave., Chicago, 9, Ill.
- Gettles, R. A., 363 Kenilworth Ave., Dayton, 5, Ohio
- Gill, C. G., 11640 Asbury Park, Detroit, 27, Mich.
- Gillmor, H. C., 48 Leedale Ave., Leaside, Ont., Canada
- Goodloe, R. R., Twin Trees, Lavergne, 1, Tenn.
- Gordon, J. F., 4218 Fernhill Ave., Baltimore, 15, Md.
- Guess, A. L., 40 Sussex Ave., Toronto, Ont., Canada
- Hase, R. H., 106 Young Ave., Halifax, N.S., Canada
- Henry, D. A. T., 77 Walker Ave., Toronto, Ont., Canada
- Herzberg, R., 3131 Bracken Woods La., Cincinnati, 11, Ohio
- Heusinkveld, M., 3913 First St., S. W., Washington, 20, D. C.
- Hewitt, L. G., Box 101, Jeffersontown, Ky.
- Himes, H. D., 2117 Sinton Ave., Apt. 16, Cincinnati, 6, Ohio
- Hindin, A., 33 Belshaw Ave., Eatontown, N. J.
- Hirsh, W. S., c/o Western Electric Company, 403 Hudson St., New York, 14, N. Y.
- Hodge, G. R., 24 River Bend Dr., Dayton, 5, Ohio
- Hoffer, J. M., A.A.F.T.T.C., Yale University, New Haven, Conn.
- Hopgood, R. C., 277 Bay Ave., Glen Ridge, N. J.
- Hook, C. T., 4626 Miller Rd., Blue Ash, Ohio
- Houghton, W. D., Michigan Ave., Port Jefferson, L. I., N. Y.
- Huffman, J. E., 4137 St. Lawrence, Cincinnati, 5, Ohio
- Inall, E. K., 57 E. Market St., Richmond, New South Wales, Australia
- Keskinen, A. R., 54 Burkleigh Rd., Towson, 4, Md.
- Kocher, J. R., 3429 Berry Ave., Cincinnati, 8, Ohio
- Kmiec, B. W. J., United States Coast Guard Section Base, Box 28, Key West, Fla.
- Kovac, G. M., 100-28-200 St., Hollis, 7, L. I., N. Y.
- Kunz, C. G., Sylvania Electric Products, Inc., Williamsport, Pa.
- Lau, C. B., 402 Alabama Rd., Baltimore, 4, Md.
- Lawson, P. J., 35 Malcolm Rd., Woodside, London, S.E. 25, England
- Lee, W. H., 46 Warwick Gdns., Thornton Heath, Surrey, England
- Lephakis, A. J., 11 Chestnut Ave., Patchogue, L. I., N. Y.
- Levitsky, J., 184 Clarkson Ave., Brooklyn, N. Y.
- Ley, E. W., 626 N. E. 71 St., Portland, 16, Ore.
- Littauer, S. B., Box 6797, Towson, Baltimore, 4, Md.
- Little, E. F., 2724 Erickson St., E. Elmhurst, L. I., N. Y.
- McCarley, H. H., c/o Fleet Post Office, New York, N. Y.
- Miller, J. A., 111, 213 Wall St., Maysville, Ky.
- Milson, W. T., Winrush, Heathway, East Horsley, Surrey, England
- Moll, C. R., 1 Mill Rd., Brookline, Upper Darby, Pa.
- Morris, M., 346 Palmerston Blvd., Toronto, Ont., Canada
- Nakao, G. H., 732 Spencer St., Honolulu, Hawaii
- Nascenzi, R. I., 50 Morton Pl., East Orange, N. J.
- Oravetz, A. S., 201 Clinton Ave., Brooklyn, 5, N. Y.
- Osherow, S. A., 23 Washington Ave., Asbury Park, N. J.

(Continued on page 47A)

Ready in August

ULTRA-HIGH-FREQUENCY RADIO ENGINEERING

By Willis L. Emery

Radio Engineer, Naval Research Laboratory

Both the theory of ultra-high-frequency and the practical operation of ultra-high-frequency equipment are covered in this book. It provides the special training in this field prescribed for the armed forces, and is also an excellent handbook for anyone operating or manufacturing ultra-high-frequency equipment. Laboratory exercises for practical training are included. Techniques of ultra-high-frequency work are stressed. \$3.50 (probable)

The Macmillan Co., 60 5th Ave., N.Y. 11



NERVE CENTER

The primary function of a motor or dynamotor is to produce a specified type of mechanical or electrical energy. In the human body such energy, or muscular activity, is controlled by the nervous system which directs this force into useful work. Similarly, our units are built to be activated and controlled by a set of field coils, wound in each instance to obtain a certain performance.

Field windings in Eicor products may be series, shunt, or compound wound, depending on the desired output characteristics. Such factors as the size of wire, number of turns, and type of insulation, are then carefully calculated so as to produce field strength of optimum efficiency for each design. These coils are unit or gang wound on forms, taped, impregnated and baked, and then protectively sealed to withstand extremes of humidity. These operations produce windings sufficiently flexible for shaping and mounting without strain, assuring trouble-free excitation for the life of the unit.

Properly designed and fabricated field windings represent only one of many important factors in building "specification" motors and dynamotors. *Every detail of every operation* is done with the same painstaking care. That's one more reason why Eicor products are so frequently specified.

EICOR INC. 1501 W. Congress St., Chicago, U.S.A.
DYNAMOTORS • D. C. MOTORS • POWER PLANTS • CONVERTERS
Export: Ad Auriema, 89 Broad St., New York, U. S. A. Cable: Auriema, New York

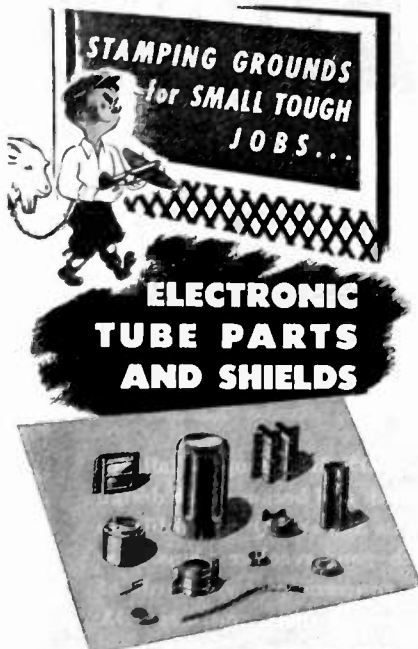

GOAT serves almost every electronic tube manufacturer with a tremendous variety of stock and special parts made of any metal to any degree of accuracy.

GOAT

METAL STAMPINGS, INC.

An Affiliate of THE FRED GOAT CO., INC. Est. 1893
314 DEAN ST., BROOKLYN, 17, N. Y.

TECHNICAL NOTES

Excerpts from New Home Study Lessons Being Prepared under the Direction of the CREI Director of Engineering Texts

The Iconoscope

In this month's issue of the CREI NEWS, appears Part II of the article on Iconoscopes. This section deals with the construction of the Iconoscope and a preliminary discussion of its action when scanned in the dark. In the next issue, the action of the Iconoscope when a scene is imaged on its mosaic will be analyzed.

We believe that this material will be of interest and value to the radio engineer, whether or not he is at present engaged in television, because television promises to be one of the major post-war activities.

Once again, permit us to remind you that the CREI NEWS, the house organ of the Capitol Radio Engineering Institute, publishes each month a technical article of interest to the radio engineer.

Write today for the June issue of the CREI NEWS and the second interesting technical article on "The Iconoscope." You may secure your copy free and without any obligation merely by writing to the Capitol Radio Engineering Institute. We shall be pleased to mail you all future copies thereafter, without cost or obligation.

★ ★ ★

The subject of "The Iconoscope" is but one of many that are being constantly revised and added to CREI lessons by A. Preisman, Director of Engineering Texts, under the personal supervision of CREI President, E. H. Rietzke. CREI home study courses are of college calibre for the professional engineer and technician who recognizes CREI training as a proven program for personal advancement in the field of Radio-Electronics. Complete details of the home study courses sent on request. . . . Ask for 36-page booklet.

CAPITOL RADIO ENGINEERING INSTITUTE

E. H. RIETZKE, President

Home Study Courses in Practical Radio-Electronics Engineering for Professional Self-Improvement

Dept. PR-6, 3224-16th St. N.W.
WASHINGTON 10, D.C.

Contractors to the U. S. Navy—U. S. Coast Guard — Canadian Broadcasting Corp. — Producers of Well-trained Technical Radiomen for Industry.

FILE IN YOUR NOTEBOOK

PUNCH IN HOLES INDICATED



All-Purpose Pocket Size Volt-Ohm-Milliammeter

A new modernistic styled, compact unit that provides an answer to all Volt-Ohm-Milliammeter requirements. Incorporates all the testing facilities of larger, more costly equipment. Self contained batteries. Selector switch control for all ranges. Completely insulated black molded case and panel. (Leather carrying case available for tester and accessories.)



TRIPLET ELECTRICAL INSTRUMENT CO.
BLUFFTON • OHIO

DX ISOSO-LOOPS

are designed for
**Better
Pick-Up**

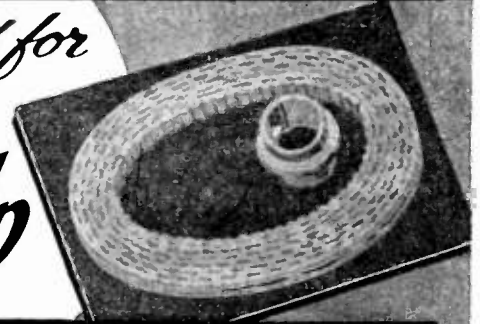

Because every DX Isoso-loop is tailored to fit your circuit and because each design is chosen for its highest "Q"; we'd like to help you with your receiver plans. Our present work concerns new standards of precision in making more and more DX Xtals for our armed forces.



DX CRYSTAL CO.

GENERAL OFFICES: 1200 N. CLAREMONT AVE., CHICAGO 22, ILL., U.S.A.



Membership

(Continued from page 44A)

- Pascual, R. A., c/o Radio Materiel Office, Puget Sound Navy Yard, Bremerton, Wash.
- Petruska, P. C., 1023 Main St., Paterson, 3, N. J.
- Pierce, H. I., 430—18 N., Seattle, 2, Wash.
- Pomeroy, D., Cololo 2437, Pocitos, Montevideo, Uruguay
- Poore, R. D., 230 W. Camino Real St., Arcadia, Calif.
- Pronovost, W. L., 189-10—37 Ave., Flushing, L. I., N. Y.
- Pruks, W. H., 2346 Eastern Ave., Cincinnati, Ohio
- Quist, W. G., 5321—46 Ave., S., Minneapolis, 6, Minn.
- Rawls, H. F., Box 1247, Kingsville, Texas
- Richardson, D., 3981 Delmar Ave., Cincinnati, 11, Ohio
- Richmond, A. E., Box 441 Portland, 7, Ore.
- Rivers, R., 2114 Ninth Ave., Belmar, N. J.
- Rogers, A. Jr., 709 N. Sheridan Rd., Waukegan, Ill.
- Rolston, W. S., 3 Belknap Pl., Greenhills, Ohio
- Rosenberg, B. L., 1346 Park Road Courts, N. W., Washington, 10, D. C.
- Rotsinger, A. H., 2680 Shaffer Ave., Cincinnati, 11, Ohio
- Ryan, J. E., 119 Pebble St., Fall River, Mass.
- Sabin, A. T., 1659 W. Sixth St., Brooklyn, 23, N. Y.
- Schnabolok, H. L., 44 Belshaw Ave., Eatontown, N. J.
- Schramm, M. C., 40 S. Main Ave., Albany, 3, N. Y.
- Schwartz, S., 82 Ave. B., New York, 9, N. Y.
- Secor, D. L., First I and M Unit, Robins Field, Ga.
- Seiler, R. C., 1229 Solita Rd., Pasadena, 3, Calif.
- Shea, H. G., R.F.D. 2, Mount Kisco, N. Y.
- Spellman, W., 1729 Van Ness Ave., Fresno, 1, Calif.
- Spottiswoode, R., National Film Board, John and Sussex Sts., Ottawa, Ont., Canada
- Sprigman, A., 147-18 Jasmine Ave., Flushing, L. I., N. Y.
- Stewart, R. W., 1134 W. 99 St., Los Angeles, 44, Calif.
- Swery, J. S., 42-140 Torat St., Baghdad, Iraq
- Swedlow, S., 1160 Bryant Ave., Bronx, 59, N. Y.
- Sweet, R. E., 425 Grafton Ave., Dayton, 6, Ohio
- Taylor, G. O., R.R. 3, Box 84, Cincinnati, 11, Ohio
- Thaler, G. J., Johns Hopkins University, Baltimore, 18, Md.
- Thompson, W. W., 5 Southlea Ave., Toronto, 12, Ont., Canada
- Thornell, J. H., 6391 Meis Ave., Cincinnati, 24, Ohio
- Tittle, C. W., Massachusetts Institute of Technology, 470 Atlantic Ave., Boston, 10, Mass.
- Tratt, R. J., 3 North St., Rockford, Essex, England
- Trimboli, B. J., 282—22 St., Brooklyn, 15, N. Y.
- Tuckerman, L. S., 395 Essex St., Salem, Mass.
- Tyler, R. S., 1774 N. W. 46 St., Miami, 37, Fla.
- Ulmer, H. W., 184 Concord Ave., Belmont, 78, Mass.
- Vieth, W. G., 527 Garfield Ave., Jersey City, 5, N. J.
- Wahl, A. C., R.F.D. 3, Box 83, Cincinnati, 11, Ohio
- Washbrun, H. H., 1427 E. Pike St., Seattle, 22, Wash.
- Weber, C. E., 8364 Jadwin St., Valleydale, Cincinnati, 15, Ohio
- Weiser, R., Crosley Corporation, Cincinnati, Ohio
- Whelan, F. G., 1812 N. Calvert St., Baltimore, 2, Md.
- White, L. E., 1750 Scranton St., S., St. Petersburg, Fla.
- Wilcox, R. L., Jr., 347 Orange St., S. E., Washington, D. C.
- Winkler, J. L., 4535 W. 18 St., Los Angeles, 6, Calif.
- Wies, G. A., 112 Kingsbury Rd., Garden City, L. I., N. Y.
- Wisleder, D. E., Westinghouse Electric and Manufacturing Company, East Pittsburgh, Pa.
- Worthen, W. L., 238 Whitnall Highway, Burbank, Calif.
- Younger, U. E., 724 N. Rose St., Burbank, Calif.
- Yuen, H. A., 953 Jackson St., San Francisco, 11, Calif.
- Zaslavsky, S., 2879 S. Buchanan St., Fairlington, Arlington, Va.
- Zimov, L. R., 7305 Brookcrest Dr., Cincinnati, 16, Ohio



Solving RESISTANCE WINDING PROBLEMS

★ Just turn that resistance-winding problem over to Clarostat specialists. You'll get two decades of winding experience, outstanding skill, and exclusive winding equipment.

Clarostat winds all wire sizes even down to .0009" dia. Windings as fine as 600 to 700 turns per inch. Round windings up to $1\frac{1}{8}$ " dia. Flat windings to $1\frac{1}{8}$ " wide. Continuous lengths to several feet long. Intricate notched strip windings as shown at left, and also tapered strip and variable pitch windings, for complicated controls. String windings in fibre glass, asbestos, cord.

Solving your winding problems is our business. Just put us to work for you.

Submit Your Problem . . .

Let us quote on your resistance-winding requirements, on resistors, controls and resistance devices.



CLAROSTAT

Controls and Resistors

CLAROSTAT MFG. CO., Inc. · 285-7 N. 6th St., Brooklyn, N. Y.

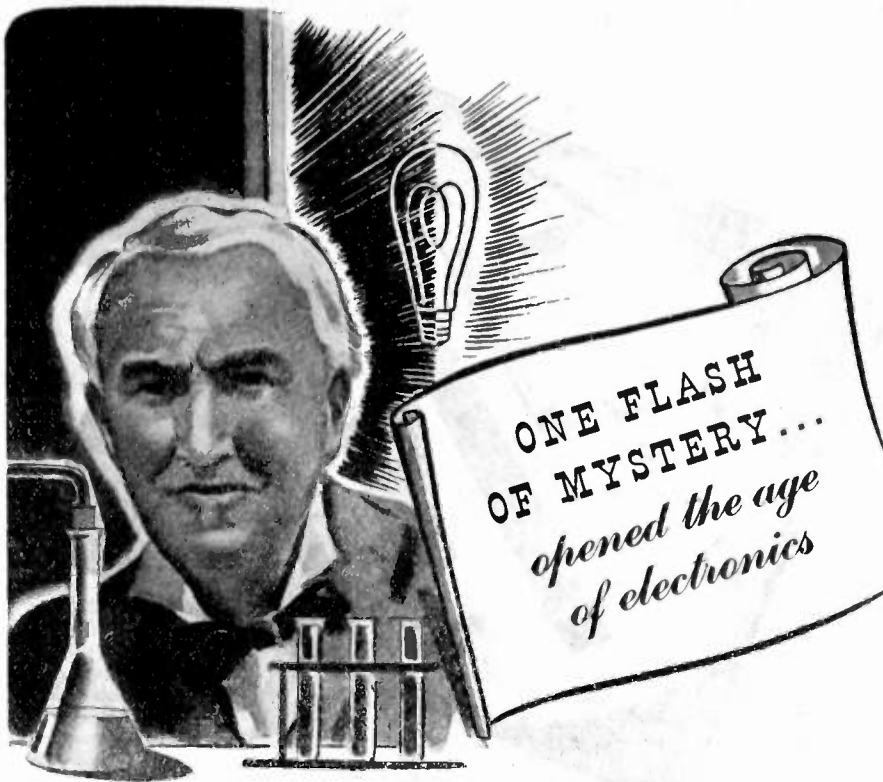

Edison, experimenting with the incandescent lamp in 1883, noted that the hot carbon filament emitted an electric charge. When he put a positively charged electrode in the bulb, negatively charged particles were attracted to it from the filament. Later on, Fleming, intrigued by this mystery, invented the first electronic valve—all of which led to De Forest's invention of the Audion Tube.

Similarly, Stancor Transformer design since its origin, has reflected the refinements of electronic research. This hourly accord with industry's needs and desires is a definite promise always of prime efficiency. . .

SEND FOR NEW COMPLETE CATALOG

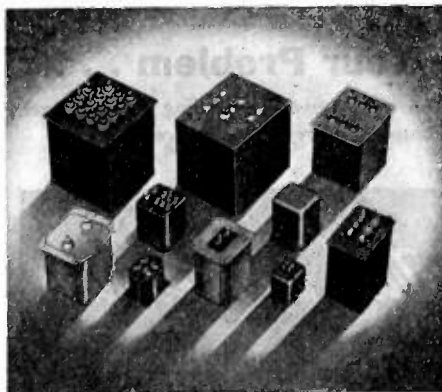

STANCOR

Transformers

STANDARD TRANSFORMER CORPORATION
1500 NORTH HALSTED STREET · CHICAGO



Manufacturers of quality transformers, reactors, power packs and allied products for the electronic industries.

"A million dollar baby"



One of the many condensers going to war is known as our "million dollar baby." Its usage cannot be divulged, but we can say that it is a custom-built job, Cardwell designed and produced. And it serves a most important function.

The experience derived from this particular model will add further to present advanced techniques. On the basis of this and similar "babies," we will be better prepared to meet coming requirements of the electronic age . . . to keep Cardwell the Standard of Comparison.

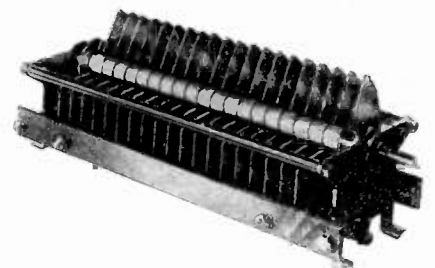

Although this is not the "million dollar baby," thousands of the famous "T" series (illustrated) are helping to—keep 'em rolling, flying and sailing.

Buy a Stake in Tomorrow—Invest in War Bonds Today

CARDWELL CONDENSERS

THE ALLEN D. CARDWELL MANUFACTURING CORPORATION
81 Prospect Street, Brooklyn 1, N. Y.

How we make Cathode Ray Tubes

OF UNIFORM QUALITY
AT WARTIME SPEED

This non-stop rotating oven enables North American Philips to produce cathode ray tubes in assembly line quantities despite the complex heat treatment required for uniformly high quality.

In baking out and rendering inert the binders in the "Aquadag" and fluorescent coating on the inner surfaces of the bulb, heat must be gradually raised and as gradually lowered to prevent damaging residual strains in the glass. The oven illustrated, product of North American Philips ingenuity, accomplishes this by rotating slowly racks of bulbs through zones of increasing and decreasing temperatures within the oven from room temperature to 450C, then down to 200C.

This is but one of the many innovations in engineering and production techniques which assure for NORELCO Cathode Ray Tubes a uniformly high level of performance.

Painstaking concern for perfection and constant striving for improvement characterize all the activities of North American Philips in the development and manufacture of NORELCO electronic products.

Various types of cathode ray, transmitting and amplifying tubes are now being produced for our armed forces, together with quartz crystals for land, sea and air-borne communication equipment.

For our war industries we make Searchray (X-Ray) Apparatus for industrial and research applications; X-Ray Diffraction Apparatus; Direct Reading Frequency Meters; Electronic Measuring Instruments; High Frequency Heating Equipment; Tungsten and Molybdenum in many forms; Fine Wire in many metals and various finishes; Diamond Dies.

And For Victory We Say: Buy More War Bonds



Norelco ELECTRONIC PRODUCTS by NORTH AMERICAN PHILIPS COMPANY, INC.

Executive Offices: 100 East 42nd Street, New York 17, New York
Factories in Dobbs Ferry, New York; Mount Vernon, New York
(Metalix Division); Lewiston, Maine (Elmet Division)

Laboratory
Standards



PULSE GENERATOR

MODEL 79-B

SPECIFICATIONS:

FREQUENCY: continuously variable 60 to 100,000 cycles.

PULSE WIDTH: continuously variable 0.5 to 40 microseconds.

OUTPUT VOLTAGE: Approximately 150 volts positive.

OUTPUT IMPEDANCE: 6Y6G cathode follower with 1000 ohm load.

R. F. MODULATOR: Built-in carrier modulator applies pulse modulation to any r.f. carrier below 100 mc.

MISCELLANEOUS: Displaced sync output, individually calibrated frequency and pulse width dials, 117 volt, 40-60 cycles operation, size 14"x10"x10", wt. 31 lbs.

Price: \$295.00 F.O.B. BOONTON

Delivery on priority

MEASUREMENTS CORPORATION

BOONTON · NEW JERSEY

Coto-Coil

Electrical Coil Windings
Since 1917

... are playing a part in this war, at the controls in planes, tanks and radio communications ... just as they helped win the first world war.

In their new plant, Coto-Coil offers a wealth of engineering experience to design and supervise the winding ... to apply modern methods of impregnation ... to produce a superior coil capable of functioning under the most severe conditions.

Most of our energies are engaged with wartime contracts but allow for a proportion of industrial needs. Phone, wire or write.

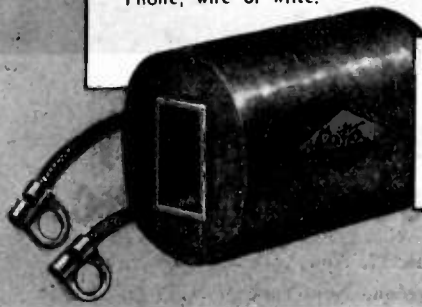

**Coto-Coil
Company Inc.**

65 Pavilion Ave.
Providence 5, R.I.

POSITIONS OPEN

The following positions of interest to I.R.E. members have been reported as open. Apply in writing, addressing reply to company mentioned or to Box No.

The Institute reserves the right to refuse any announcement without giving a reason for the refusal.

PROCEEDINGS of the I.R.E.

330 West 42nd Street, New York 18, N.Y.

ELECTRICAL AND RADIO ENGINEERS

Interesting development work and test equipment design for mass production of electroacoustical devices. Experience in electronics, acoustics or audio desirable.

Excellent working conditions and post-war opportunities with long-established manufacturer.

Call, or write to Chief Engineer, Dictograph Corporation, 95-25 149th Street, Jamaica, L.I., N.Y.

PHYSICISTS AND ELECTRICAL ENGINEERS

Needed in connection with the manufacture of a wide variety of new and advanced types of communications equipment and special electronic products. Apply or write, giving full qualifications, to D. L. R., Employment Dept., Western Electric Company, Hawthorne Station, Chicago 23, Illinois.

ELECTROACOUSTIC OR ELECTRO-MECHANICAL ENGINEER

Must have substantial experience and demonstrated initiative in design and measurement of practical electroacoustic or electromechanical transducers. Must be capable of taking full responsibility for determining the equivalent circuit constants of piezoelectric-crystal plates and assemblies used as transducers, including the development of necessary measuring apparatus and techniques. Position offers opportunity to contribute to the war effort, followed by a continuing program of post-war development. Write to A. L. Williams, President, The Brush Development Company, 3311 Perkins Avenue, Cleveland 14, Ohio.

POST-WAR RADIO ENGINEER

Experienced radio engineer wanted for broadcast-receiver designs, production and detailing. Position open now. Progressive mid-west plant. Salary commensurate with ability and previous experience; starting salary \$6000. Describe former work and background, and enclose a small picture (which will not be returned) if possible. All replies held in strictest confidence. Our employees know of this advertisement. Write to Box 330.

ELECTRONIC ENGINEER

With ability to design audio-amplifier and audio circuits from low-power up to 500 watts. Must be familiar with amplifier circuits and components presently used in this field. Should be familiar with various audio-switching circuits, impedance matching, and filter design, and have a basic knowledge of transformer designs. Should have strong background in fundamentals, as our transmission problems involve both acoustic and audio measurements. Man with practical production experience is desired, in preference to theorist unfamiliar with modern production practices and procedures. Write to Box 331.

SALES ENGINEER

Wartime and post-war opportunity in Chicago territory for a manufacturer whose products are well-known and widely used, especially in the electronic field. Applicant must have engineering training or at least five years of practical experience in engineering or manufacturing. Prefer man between 30 and 35 years of age. Write stating details of education, age, previous connections, experience and salary. If already engaged in war work, require a statement of availability. Address Box 332.

(Continued on page 52A)

Proceedings of the I.R.E. June, 1944

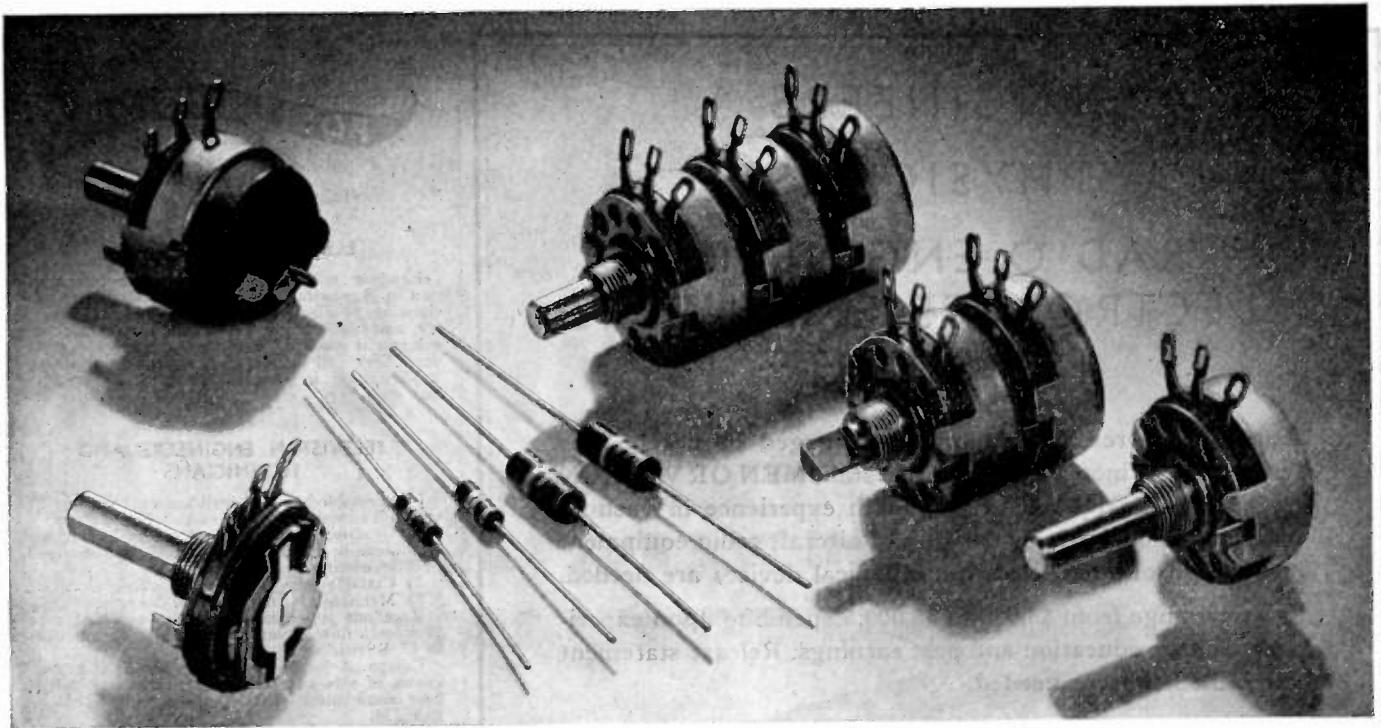

Reliable Resistors for all extremes of service conditions

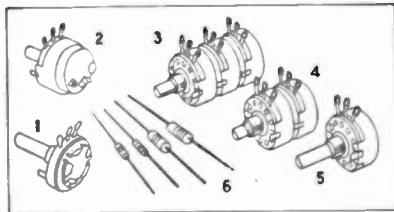

1—Type J Bradleyometer with cover removed. 2—Type JS Bradleyometer with built-in switch. 3—4 Bradleyometers assembled in triple and dual construction to fit particular control needs. 5—Type J Bradleyometer. 6—½ And 1 watt Bradleyunits.

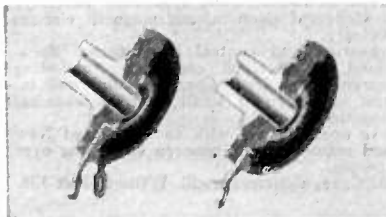

Sectional views of Bradleyometers showing how terminals are imbedded in solid molded resistor element.

These adjustable and fixed resistors are solid, molded units which are not affected by heat, cold, moisture, or hard use.

The Bradleyometers are the only composition type adjustable resistors that will consistently stand up under the Army-Navy AN-QQ-S91 salt spray test. Insulation, resistor material, terminals, face plate, and threaded bushing are molded into a single unit. The resistor element has substantial thickness (approximately 1/32 inch) and can be varied during manufacture to provide practically any resistance-rotation curve. Once the unit has been molded, its performance does not change. Bradleyometers are the only continuously adjustable resistors having a two-watt rating with a good safety factor. Enclosures are dust-proof and splash-proof.

Bradleyunits are molded fixed resistors with lead wires imbedded in the homogeneous resistor material. They will sustain an overload of ten times rating for a considerable period of time without failing. No special wax impregnation is necessary to pass the salt water immersion test. Available in insulated and non-insulated types. Write for details.

Allen-Bradley Company, 114 West Greenfield Ave., Milwaukee 4, Wisconsin



ALLEN-BRADLEY

FIXED & ADJUSTABLE RADIO RESISTORS

QUALITY

**ENGINEERS
PHYSICISTS
RADIO ENGINEERS
ELECTRONICS ENGINEERS
PHYSICISTS**

A non-profit research laboratory engaged in urgent war research must increase its scientific staff. **MEN OR WOMEN (COLLEGE GRADUATES)**, with experience in vacuum tube circuit design, construction of aircraft radio equipment and design of small electro-mechanical devices are needed.

Salaries range from \$3,000 to \$8,000, depending upon experience, ability, education and past earnings. Release statement and **USES** consent needed.

Apply by mail

**AIRBORNE INSTRUMENTS LABORATORY
COLUMBIA UNIVERSITY
DIVISION OF WAR RESEARCH
BOX 231, MINEOLA, N.Y.**

Vacuum and Gaseous Discharge
TUBE ENGINEERS WANTED

for Design • Development • Processing • Testing

This is the chance you've been waiting for to become associated with a company known in the industry and the armed forces for the top quality of its engineering. You'll be 100% in war work now . . . but there's a peace-time future commensurate with your ability and initiative.

If your education, experience and expected salary fit our specifications, you'll be welcomed by our present staff of engineers who not only know about this advertisement but also urge you to join with them in doing big things *better* with electronics.

WRITE TODAY TO

RAYTHEON MANUFACTURING COMPANY

Waltham, Mass.—Att. Chief Engineer Power Tube Division



(Continued from page 50A)

ELECTRONIC ENGINEERS

Leading television and electronics organization in Manhattan needs first-class engineers specializing in electronics, physics, physico-chemistry, and high-vacuum technique, for research development mainly on important post-war products. Give full details of experience and salary. Replies held in strictest confidence. Write to Box 333.

**TELEVISION ENGINEERS AND
TECHNICIANS**

Long-established and well-known company requires Television Engineers and Technicians.

- 1) Graduate engineers and others having had definite experience in the Television field, transmitters or receivers.
- 2) Cathode Ray Tube Research Engineer.
- 3) Mechanical Engineer and Designer.

Excellent opportunity for well qualified men. War work now. Television later. Applicants must be U. S. citizens.

Company located in New York. Our staff knows of this advertisement and replies will be kept confidential. Write, giving all details, to Box 334.

CHIEF MECHANICAL ENGINEER

Mid-west radio-electronics manufacturer has immediate position open. Post-war future for engineer experienced with small parts or in radio-development laboratory. Salary open. Premium for unusual man. Confidence respected. Write to Box 335.

SENIOR RADIO ENGINEERS

Mid-west radio-electronics manufacturer has present and post-war positions for one chief mechanical engineer, and two research, three development, two production, one specifications-and-standards engineers. Salaries open. Confidential inquiries respected. Write Box 336.

RADIO EXECUTIVE

Mid-west radio-electronics manufacturer seeks assistant chief engineer capable of wider responsibilities. Salary open. All queries confidential. Write Box 337.

DEVELOPMENT ENGINEERS

Mechanical and electrical. College degree or equivalent training required for development work in the following branches:

1. Telephone and signaling apparatus. Thorough knowledge of electrical and magnetic circuits necessary.
2. Measuring and control instruments. Background in electrical engineering including electronics required. Creative mind and interest in design of small electro-mechanical apparatus desirable.

Above openings are with an established New England manufacturing concern employing over 1000 people.

W.M.C. regulations prevail. Write to Box 328.

DRAFTSMAN-DESIGNER

On small mechanical and electrical apparatus. Knowledge of die casting and plastic applications desirable.

This position represents a definite opportunity with a Connecticut manufacturer now and after the war.

Statement of availability required. Address reply to Box 329.

ELECTRICAL ENGINEERS AND PHYSICISTS

Need a few men with sound training and some experience in the lighting and electronics fields to work on the design, development, or production of indicated products. The exact type of work will depend upon the individual's interests and experience. Positions offer definite opportunities. Advanced degrees in electrical engineering or physics desirable, but not essential. Openings in Pennsylvania and Salem, Massachusetts.

Write to Sylvania Electric Products, Inc., Industrial Relations Department, 254 Essex Street, Salem, Massachusetts.

(Continued on page 54A)

IRC WILL BE READY

with TYPE BW INSULATED WIRE WOUND RESISTORS

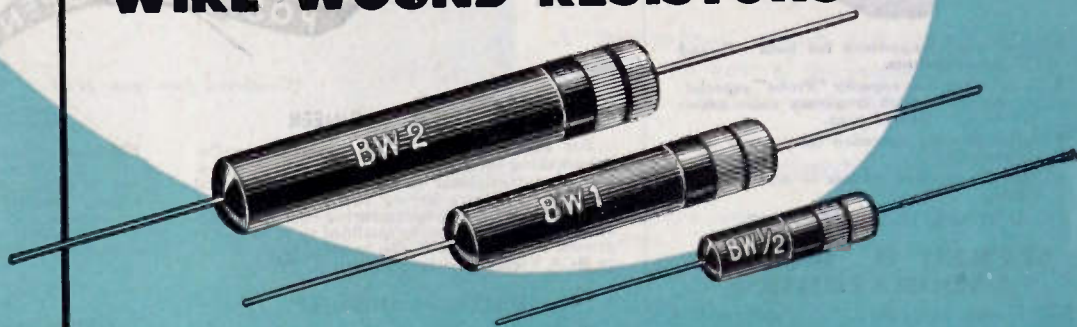

At the first indication of lessened demand by the Armed Services, IRC will be in an excellent position to immediately supply industry's requirements for resistors of *all* types. That IRC units will be available in ample quantities on a favorable price basis is assured because we have developed and are operating on a mass production basis the world's largest resistor plants.

RESISTOR PROBLEMS WELCOME

Feel free at all times to consult with us on your peacetime product design plans involving resistances. You can be certain of unbiased engineering counsel and secure in the knowledge that the subject matter will be held inviolate.

CHECK THESE FEATURES OF TYPE BW WIRE WOUND RESISTORS

1. Completely insulated wire wound of standard $\frac{1}{2}$, 1 and 2 watt sizes.
2. Resistance values: $\frac{1}{2}$ watt—from .24 ohms to 800 ohms; 1 watt—from .5 ohms to 5000 ohms; 2 watt—from 1.0 ohms to 8000 ohms.
3. Have wire wound stability and are physically interchangeable with carbon types.
4. Available in matched pairs to 1% or 2% for close-tolerance, high-stability applications.
5. Element is space wound with copper-nickel or nichrome bare wire securely crimped and molded integrally with leads.



INTERNATIONAL RESISTANCE CO.

401 N. Broad St. Philadelphia 8, Pa.

IRC makes more types of resistance units, in more shapes, for more applications than any other manufacturer in the world.



WIDE RANGE VACUUM TUBE VOLTMETERS



- High input impedance for both AC and DC measurements.
- Convenient, low capacity "Probe" especially adapted to high frequency radio use—100 megacycles and over.
- Self-regulating operation from power line; no batteries.
- Multiple voltage ranges — accurate and stable.

BULLETIN ON REQUEST

ALFRED W. BARBER LABORATORIES

34-04 Francis Lewis Blvd. Flushing, N.Y.

Wanted ENGINEERS

- Radio
- Chemical
- Electrical
- Electronic
- Mechanical
- Metallurgical
- Factory Planning
- Materials Handling
- Manufacturing Planning

To be used in connection with the manufacture of a wide variety of new and advanced types of communications equipment and special electronic products.

Apply (or write), giving full qualifications, to:

C. R. L.
EMPLOYMENT DEPARTMENT

Western Electric Co.

100 CENTRAL AV., KEARNY, N. J.

Applicants must comply with WMC regulations

The Model 610-B MEG-O-METER

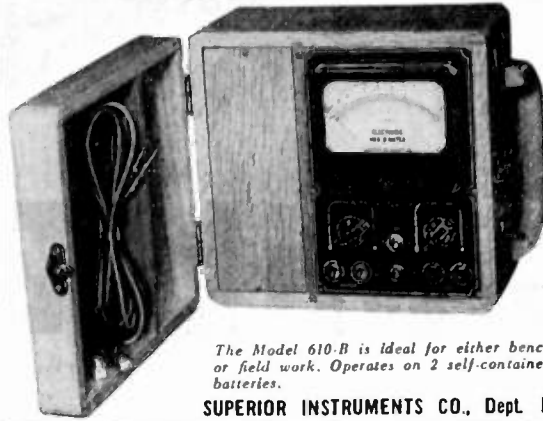

A New Battery Operated
INSULATION TESTER
instantly measures the exact leakage of all insulation from zero up to—200 MEGOHMS at a test potential of 500 VOLTS D.C.

- No Hand Cranking
- Direct Reading
- 3 Ranges: 0-20 M Ohms/2 Meg./200 Meg.

\$62.50

The Model 610-B is ideal for either bench or field work. Operates on 2 self-contained batteries.

SUPERIOR INSTRUMENTS CO., Dept. H, 227 Fulton St., New York 7, N. Y.



(Continued from page 52A)

ELECTRICAL ENGINEER

For experimental work in developing radio-tube-making equipment. Position is that of equipment-design engineer on advanced developmental project. Applicants having previous training in radio-tube or lamp manufacturing equipment preferred. Applicants having qualified technical background and ability will also be considered. Write to RCA Victor Division, Lancaster, Pa.

ELECTRICAL ENGINEERS

Electrical engineers needed with experience in the transformer or rotary-equipment field, either in design, technical, or production work. Company manufactures the smaller types of transformers.

Starting salary range will be between \$4,000 and \$6,000 per year. Write to Box 322.

ELECTRICAL ENGINEERS

Graduate electrical engineers or men with equivalent industrial experience, needed for the development and design of pocket-size radio and audio-frequency equipment. Especially interested in qualified engineers looking to post-war period who, at present, are not being used in their highest skill or capacity. Company is well established in electronic field and located in suburb of a large New England city. Reply to Box 320.

ELECTRONIC-DESIGN ENGINEERS AND ELECTRICAL DESIGNERS

For complex equipment similar to radio transmission apparatus. High priority war work. Must have had all technical training required for bachelors degree in engineering or physics. Two openings demand three or more years responsible research or commercial experience.

Salary open. 48-hour week. Apply, Personnel Office, Radiation Laboratory, University of California, Berkeley, California.

INSTRUCTORS FOR ADVANCED ARMY-NAVY PROJECT

Prominent New England technical institute requires instructors for officer-training project, in modern electronics and applications of ultra high-frequency radio. Exceptional opportunity to acquire advanced knowledge and serve in important war effort. Men having various degrees in electrical engineering, physics, or communications—or long experience in radio engineering—and interested or qualified as teachers, are needed. Salary adjusted to qualifications and experience. Applicants must be U. S. citizens of unimpeachable reputation. Inquiries will be treated as confidential. Please send personal history and small photograph to Box 321.

RADIO ENGINEERS, INSPECTORS, AND DRAFTSMEN

Engineering department of manufacturer, while continuing its war program, is expanding to meet requirements for postwar product development. Well established as a radio-coil and trimmer-condenser manufacturer. Interested in stable men who have an eye to the future. Address reply to Automatic Winding Company, Inc., 900 Passaic Ave., East Newark, N.J.

(Continued on page 56A)

**Sherron
Electronics**

A manufacturer's engineering service organization offering complete Laboratory and Manufacturing facilities. Electronic Test Equipment and Production Devices developed or built to specifications.

In more and more electronic plants—where the ideal is the standard, Sherron Test Units are standard equipment.



SHERRON METALLIC CORP.
1201 FLUSHING AVENUE
BROOKLYN 6, N. Y.

The NEW RCA Type 715-A

Laboratory-type OSCILLOSCOPE Triggered Sweep and Time-Base Marker

A "custom-built" design now available for the first time for general use—especially suited for war work—ideal for post-war problems.

10 Important Features

- 1 Triggered sweep—individually triggered by each signal.
- 2 Time-base marker; one microsecond intervals.
- 3 Sinusoidal horizontal spot deflection at power line frequency with adjustable phase control.
- 4 Extended frequency range — vertical amplifier flat to 10 megacycles.
- 5 High vertical deflection sensitivity (.6 β volts/inch).
- 6 Precisely compensated attenuator for vertical amplifier.
- 7 Calibration meter to permit direct determination of amplitude of any voltage component in signal.
- 8 Low input capacity and high input resistance for vertical amplifier.
- 9 Complete absence of cross-coupling between horizontal and vertical deflection circuits.
- 10 Regulated power supply to insure steady pattern on screen independent of line voltage changes.



RADIO CORPORATION OF AMERICA

RCA VICTOR DIVISION • CAMDEN, N. J.

LEADS THE WAY... In Radio... Television... Tubes...
Phonographs... Records... Electronics

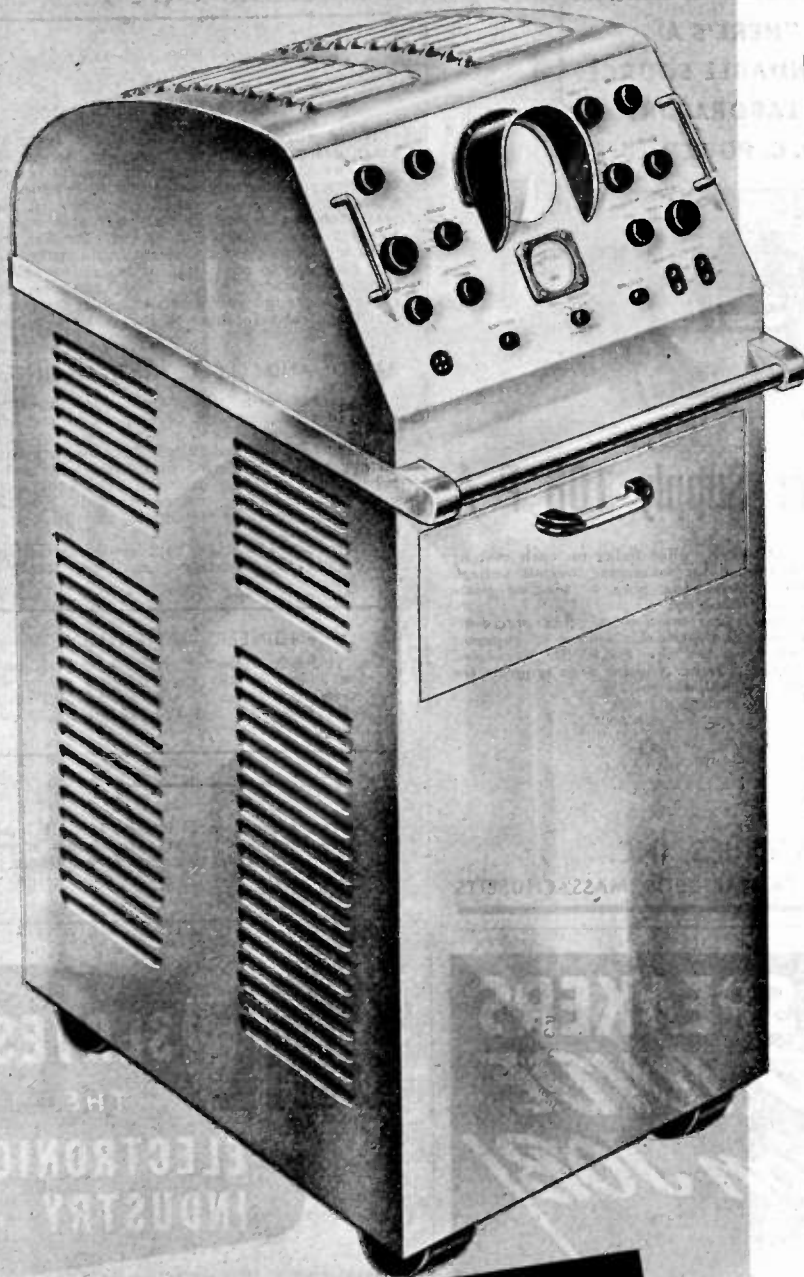

For complete details, send for bulletin

Deliveries of this instrument will be as scheduled by WPB approved Form 3243 under Scheduling Order M-293. Please address inquiries to Test and Measuring Equipment Section, RADIO CORPORATION OF AMERICA, Camden, New Jersey.

1 Sudden condenser charge and subsequent discharge as seen on ordinary oscilloscope.

2 Externally synchronized and expanded 50 times, revealing the true form of one of the charges in Fig. 1.

3 The same charge, expanded 1000 times, permits detailed observation of the wave front.

4 Applying a one-microsecond time-base marker allows determination of time intervals during the cycle.

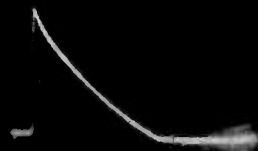
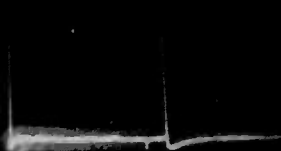

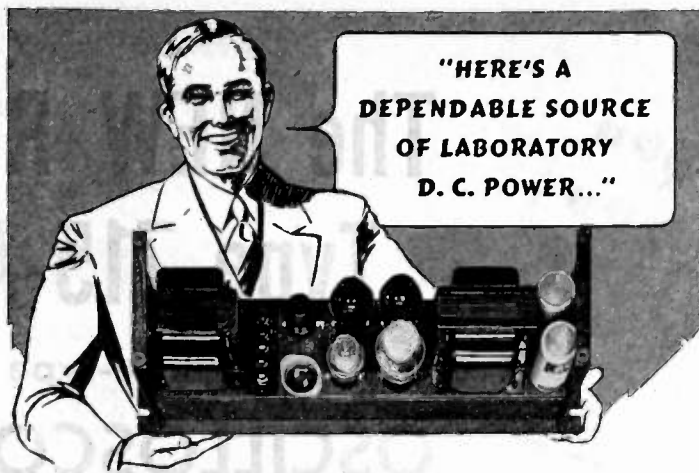

The HARVEY Regulated Power Supply 106 P A

You'll find it ideal for operation with pulse generators, measurement equipment, constant frequency applicators, amplifiers and any other equipment requiring a constant flow of D.C. voltage. Designed to operate from 115 volts A.C., the HARVEY 106 PA has a D.C. voltage output variable from between 200 to 300 volts and accurately controllable to within one percent. A model of efficiency and convenience, it has separate fuses on each transformer primary as well as the

D.C. output circuit: pilot lights on each switch; a D.C. voltmeter for measuring output voltage and a handy two-prong plug or binding posts to permit easy hook-up.

For complete information on this precision-built, thoroughly dependable source of constant voltage, write for the new HARVEY Regulated Power Supply bulletin. Address your requests for this useful new bulletin to

HARVEY
OF CAMBRIDGE

HARVEY RADIO LABORATORIES, INC.

447 CONCORD AVENUE

CAMBRIDGE 38, MASSACHUSETTS

CINAUDAGRAPH SPEAKERS Do a *WORLD WIDE* *Communication JOB!*



If you aren't getting delivery as quickly as you like—remember, the armed forces come first. Watch Cinaudagraph Speakers after Victory!

Cinaudagraph Speakers, Inc.

3911 S. Michigan Ave., Chicago

"No Finer Speaker Made in all the World"



Positions Open

(Continued from page 54A)

RADIO ENGINEERS

Radio engineers wanted with at least two years design and development experience with radio-communications-equipment manufacturer on items subsequently satisfactorily produced in quantity. Knowledge and experience in two-way mobile equipment, low-power transmitters, receivers, and control equipment essential. Permanent position, West Coast manufacturer. Will pay expenses to coast for interview if qualifications satisfactory. Write giving complete past experience, employment record, salary received, and technical references to Box 323.

RADIO AND ELECTRONICS ENGINEERS

Engineers with the ability and experience required to design and develop radio and electronic equipment.

The men who qualify will become permanent members of engineering staff, and will participate in the post-war program of a progressive and well-established company. This firm has excellent laboratory facilities, and is one of the leaders in its field.

All inquiries will be kept confidential. Send all details of experience, etc. with reply to Box 326.

ENGINEERS—ATTENTION

Can you help us locate an RCA 1899 Monoscope Tube? Vitally needed for a war production instrument. Advise Adv. Dept., I.R.E., Rm. 707, 303 West 42nd St., New York 18, N.Y.

The foregoing positions of interest to I.R.E. members have been reported as open. Apply in writing, addressing reply to company mentioned or to Box No.

CML SERVES THE ELECTRONIC INDUSTRY

Designed to meet the most rigorous specifications for precision, every CML unit is equipment of accredited performance.

- 1 **ROTOBRIDGE** . . . This automatic Inspector checks for proper wiring, correct resistance, capacity and inductance values in all types of electronic equipment.
- 2 **MODEL 1100, MODEL 1110** . . . Voltage regulated power supply units; with extremely low noise level and excellent regulation.
- 3 **MODEL 1420 GENERATOR** . . . Furnishes test power over a wide frequency range; may also be employed in 3-phase circuits.
- 4 **MODEL 1200 STROBOSCOPE** . . . Stops motion within range of 600 to 600,000 R.P.M.

WRITE FOR DESCRIPTIVE BULLETINS

**COMMUNICATION
MEASUREMENTS
LABORATORY**
120 GREENWICH ST., NEW YORK 6, N. Y.

FOIL THE SABOTEURS

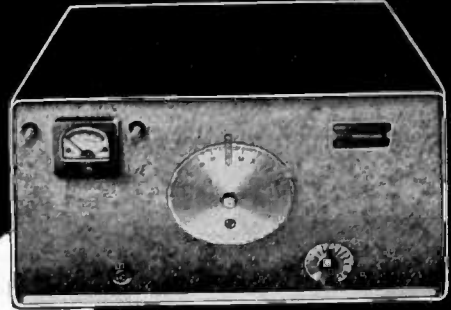

Give critical plants the protection of Browning Signal System with its balanced, capacitance electronic circuit, which saturates vulnerable areas and releases guards for productive duty. Pre-

Pearl Harbor installations have proved efficient, dependable, economical.

Browning Frequency Meters are accurate to .005%. Pre-check public utility and other emergency radio systems. Assure signal clarity.

ILLUSTRATED LITERATURE UPON REQUEST



BROWNING
LABORATORIES, INCORPORATED
WINCHESTER, MASSACHUSETTS



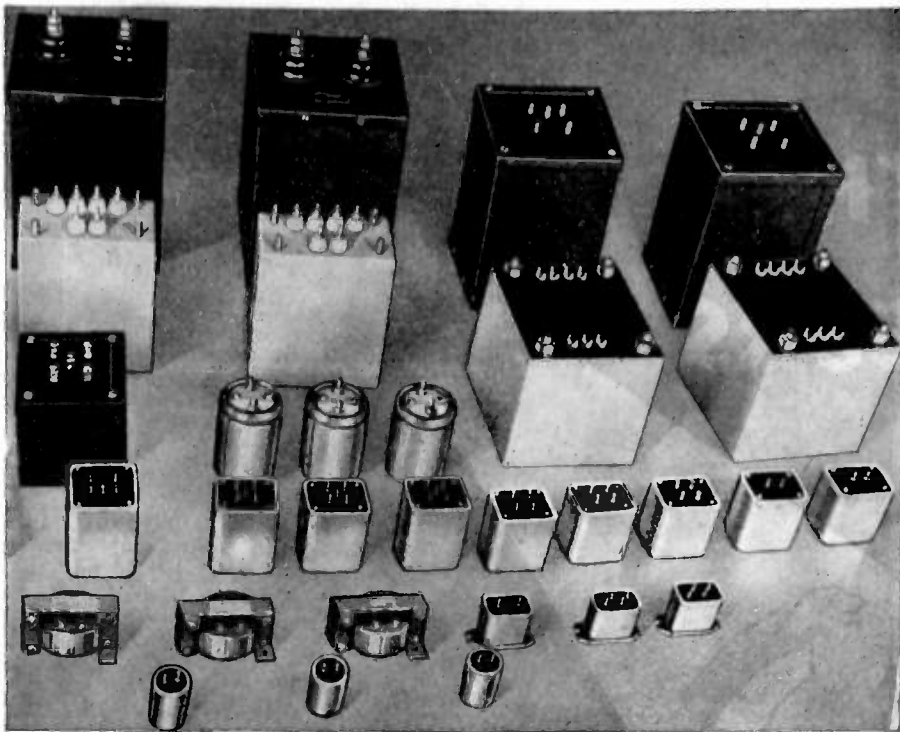

Performance Engineered Electronic Transformers
 THE ACME ELECTRIC & MANUFACTURING CO. • CUBA, N. Y. • CLYDE, N. Y.

Acme  **Electric**

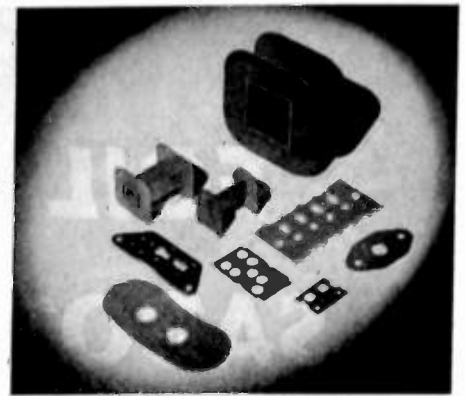

In Everything of Uncle Sam's that "flies, floats or shoots"

NATIONAL VULCANIZED FIBRE **PHENOLITE**
Laminated BAKELITE

—because of their lightness in weight, high dielectric strength, ready machineability, exceptional wearing and other qualities—are playing a vital part.

"BACK THE ATTACK" with WAR BONDS



NATIONAL VULCANIZED FIBRE CO.

Offices in Principal Cities
 WILMINGTON, DELAWARE



mum's the word...NOW

...BUT TIME WILL REVEAL
 THE STORY OF
Doolittle ENGINEERING

Long before Pearl Harbor... "specialized communications equipment by Doolittle" was well and favorably known to aviation, broadcast and police radio engineers.

Since then...Doolittle Engineers have constantly been at work developing and producing vital equipment for the Naval Aircraft Factory and the Bureau of Aeronautics, to hasten Victory.

Their added experience will bring important benefits to future peacetime communications. Look ahead... with Doolittle.

Doolittle

RADIO, INC.

Builders of Precision Radio Communications Equipment
 7421 South Loomis Boulevard, Chicago 36, Illinois

Back the Attack
 ... Buy More
 War Bonds

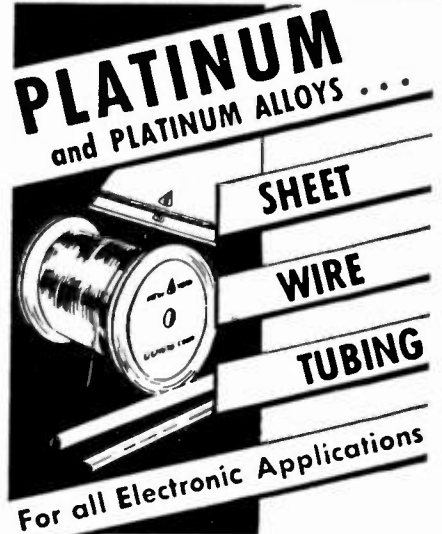

PLATINUM
 and PLATINUM ALLOYS ...

SHEET

WIRE

TUBING

For all Electronic Applications

Platinum metals scrap and residues refined and reworked on toll charges; or purchased outright by us ...

Write for list of Products.
 Discussion of technical problems invited ...

SIGMUND COHN & CO.

44 GOLD ST. NEW YORK
 SINCE 1901

RADIO PARTS OF "TAYLOR LAMINATED PLASTICS"

Many of the problems encountered

DAILY by radio engineers can best

be solved by Phenol Fibre,

Vulcanized Fibre, or Taylor's newest

product — Phenolastic.

Problems of high dielectric strength,

light weight, or MASS production at

economical cost are "duck soup"

to us. Send us your blueprints, tell

us what physical properties are

required, and we'll quickly tell you

whether Laminated Plastics can

serve you.

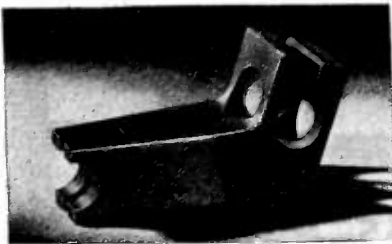

If you think of Phenol Fibre as a plastic that can be used only for the simpler types of insulation, look at this high-finished radio slider that is drilled, slotted, and beveled into just about as complicated a piece of equipment as you'll find in any electrical device. Taylor ingenuity and Taylor equipment turn out such pieces by the thousands at remarkably low cost. Before you decide "it can't be done," Take It to Taylor.

TAYLOR FIBRE COMPANY

LAMINATED PLASTICS: VULCANIZED FIBRE · PHENOL FIBRE
Sheets, Rods, Tubes, and Fabricated Parts
NORRISTOWN, PENNSYLVANIA
OFFICES IN PRINCIPAL CITIES

Proceedings of the I.R.E. June, 1944

ANDREW

No. 83

3/8" COAXIAL TRANSMISSION LINE



Type 83

QUICK DELIVERY can be made on this extremely low loss transmission line. Especially suited for RF transmission at high or ultra-high frequencies, it has wide application (1) as a connector between transmitter and antenna, (2) for interconnecting RF circuits in transmitter and television apparatus, (3) for transmitting standard frequencies from generator to test positions, and (4) for phase sampling purposes.

Andrew type 83 is a 3/8" diameter, air-insulated, coaxial transmission line. The outer conductor material is soft-temper copper tubing, easily bent to shape by hand and strong enough to withstand crushing. Spacers providing adequate mechanical support are made of best available steatite and contribute negligibly to power loss.

Accessory equipment for Coaxial Transmission Line, illustrated:

Type 853 Junction Box: Right angle box required where very sharp right angle turn is necessary.

Type 825 Junction Box: Three way T box for joining three lines at right angles.

Type 1601R Terminal: Gas tight end terminal with exclusive Andrew glass to metal seal. Incorporates small, relief needle valve for discharging gas.

Type 810 Connector: Cast bronze outer connector with copper sleeve for inner conductor.

Andrew Company manufactures all sizes in coaxial transmission lines and all necessary accessories.

Write for Descriptive Catalog

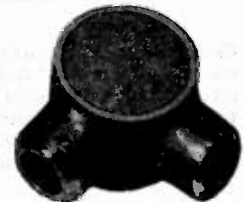

Type 853



Type 825



Type 1601R

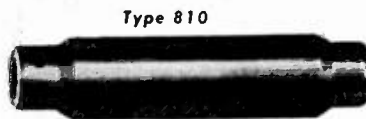

Type 810

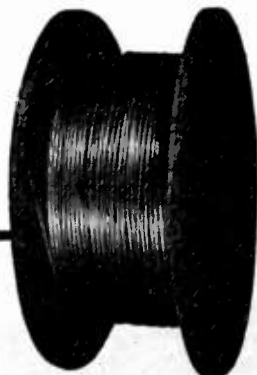

Andrew Type 83 (3/8" diameter) coaxial transmission line is manufactured in 100 foot lengths and may be purchased in coils of this length or in factory spliced coils of any length up to 1/2 mile.

ANDREW CO.



363 EAST 75th STREET
CHICAGO 19, ILLINOIS

A Low Power Factor is Characteristic of Q-Max A-27 Lacquer



Comparison of the curves published in the new Q-Max A-27 Booklet indicates that the power factor of Q-Max, along with its dielectric constant, decreases as the frequency increases. This is a correlation to be expected for it is known that the power factor curve reaches a maximum whenever the material undergoes any form of polarization. The power factor of Q-Max continues to decrease gradually from one megacycle up to 30 megacycles, indicating that probably no further change will take place until atomic polarization of the material occurs. Polarization in Q-Max films, should it occur, would probably take place somewhere in the upper limit of the frequency band.

A new booklet—24 profusely illustrated pages—provides full details of the electrical and mechanical properties of Q-Max A-27 Radio Frequency Lacquer. Send for your copy now.

Other C. P. products available to the communications industry are: a radiation-free copper or aluminum Coaxial Transmission Line, Auto-Dryaire for dehydrating transmission lines, new Sterling Switches, Antennas and Radiating Systems.

Communication PRODUCTS COMPANY, INC.

744 BROAD ST., NEWARK, N. J.
Factory: 346 Bergen Ave.,
Jersey City, N. J.

Communication Products Company, Inc.
744 Broad Street, Newark, New Jersey

Send: Q-Max A-27 Lacquer Booklet

Data on.....

Name.....

Company.....

Address.....

Products of "MERIT" means Fine Radio Parts

... PARTS manufactured exactly to the most precise specifications.

Long manufacturers of component radio parts, MERIT entered the war program as a complete, co-ordinated manufacturing unit of skilled radio engineers, experienced precision workmen and skilled operators with the most modern equipment.

MERIT quickly established its ability to understand difficult requirements, quote intelligently and produce in quantity to the most exacting specifications.

Transformers—Coils—Reactors—Electrical Windings of All Types for the Radio and Radar Trade and other Electronic Applications.

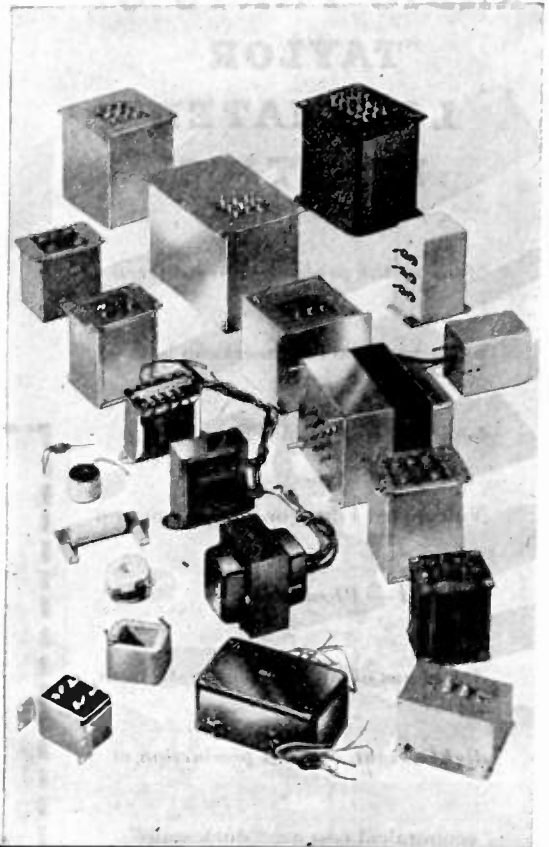

MERIT COIL & TRANSFORMER CORP.

311 North Desplains St.

CHICAGO 6, ILL.

E-Z CODE SYSTEM MARKS EACH AND EVERY WIRE QUICKLY AND EASILY — FOR ASSEMBLIES, MAINTENANCE AND REPAIRS



SIMPLE AS A. B. C.

THERE is an E-Z Code Wire Marker for every circuit. The E-Z Code system speeds production, saves man hours, reduces costs. Of flexible, durable, water-proof material. Ready to apply—no moistening necessary. In standard code or "tailor made" in special symbols and/or colors for specific requirements.

Used by the biggest names in the electrical world. Send for samples and price list. Give priority. MRO, war contract number, End-Use and whether for assembly or maintenance.

WESTERN LITHOGRAPH COMPANY
600 E. SECOND STREET • LOS ANGELES 54, CALIFORNIA
EASTERN SALES OFFICES:
Boyside, L.I., N.Y. • Chicago, Ill. • Kansas City, Mo. • Marion, O.

E-Z Code WIRE MARKERS

QUICK — EASY TO APPLY AND READ

GUARD

Present
Equipment
with
New
Circuit
Protection!

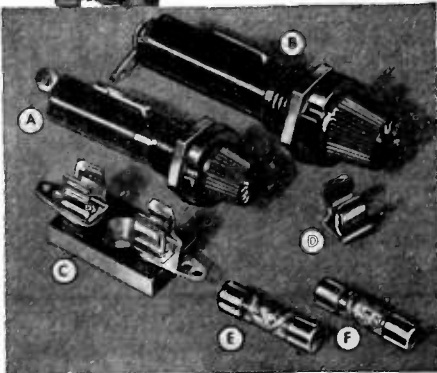

A—1075-F Extractor Post.
B—1212-B 4 AG Fuse Mounting.
C—1010 1 pole, 8 AG Fuse Mounting.
D—1011-B Fuse Clip for 3 AG Fuses, 1/4" dia.
E—1001 8 AG Fuse, 1/100 amp.
F—1004 8 AG Fuse, 1/8 amp.

Littelfuse

"QUICKER THAN A SHORT CIRCUIT"

Littelfuse units for most efficient safeguarding of circuits, machines and instruments have been improved and multiplied. Never before was electrical protection so dependable, or of so wide a range.

NEW FUSING THROUGHOUT

New fusing of all electrical equipment is one of the best supports of present service that must be prolonged. New Littelfuses mean prevention of short circuits, costly burnouts, and damage by inexperienced operators.

Whatever your problem in circuit protection, Littelfuse will be glad to counsel with you.

LITTELFUSE Inc.

263 Ong St., El Monte, California
4793 Ravenswood Ave., Chicago 40, Ill.



IT TAKES

"INSPIRED ENGINEERING"

to build an Amplifier such as this

It is not alone the trim looks and compact convenience of this amplifier which caused it to attain such popularity. Like all Thordarson products, it reflects the right combination of inspired engineering coupled with the highest productive skill, to insure the most in quality at the lowest possible cost.

Thordarson Model T30W20 is a 20-Watt amplifier embodying all of the latest improvements and conveniences which make it adaptable for a wide variety of uses.

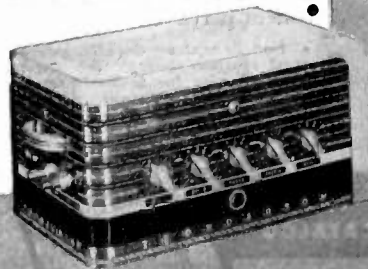

THORDARSON

TRANSFORMER DIVISION
THORDARSON ELECTRIC MFG. CO.
500 WEST HURON ST., CHICAGO, ILL.

Transformer Specialists Since 1895
ORIGINATORS OF TRU-FIDELITY AMPLIFIERS

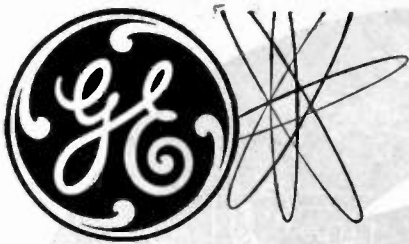

RF CAPACITOMETER

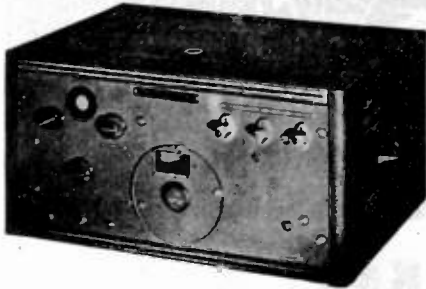

DESIGNED for precision measurements of small capacitance and inductance, the G-E radio frequency capacitometer has found acceptance in colleges and industrial laboratories due to its simplicity and compactness.

Other units in the new General Electric line of ELECTRONIC MEASURING EQUIPMENT include: G-E power supplies, wave meters, wide band oscilloscopes, square wave generators, signal generators and various other instruments in the ultra-high frequency and micro-wave fields for measuring electronic circuits and checking component parts.

• For complete details, please mail coupon below. We invite your inquiry for G-E electronic measuring equipment made to meet your specific requirements.

**FREE
CATALOG**

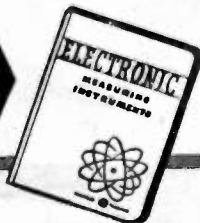

**ELECTRONICS
DEPARTMENT**
General Electric Co.
Schenectady, N. Y.

Please send, without obligation to me, the General Electric Measuring Instrument Catalog, P-6 (loose-leaf), for my information and files.

Name _____
Company _____
Address _____

GENERAL ELECTRIC
184-C3
Electronic Measuring Instruments

INDEX

Section Meetings	34A
Membership	36A
Positions Open	50A

DISPLAY ADVERTISERS

Acme Electric & Mfg. Company	58A
Aerovox Corporation	3A
Airborne Instruments Laboratory	52A
Aircraft Accessories Corp.	8A, 9A
Allen-Bradley Company	51A
Alliance Mfg. Company	39A
American Lava Corporation	29A
American Telephone and Telegraph Co.	11A
American Transformer Company	7A
Ampere Electronic Products	17A
Andrew Company	59A
Alfred W. Barber Laboratories	54A
Barker & Williamson	26A
Rex-Basset, Inc.	10A
Bendix Aviation Corporation	23A
Boonton Radio Corporation	62A
Browning Laboratories, Inc.	57A
Capitol Radio Engineering Institute	46A
Allen D. Cardwell Mfg. Corp.	48A
Centralab	5A
Chicago Transformer Corp.	42A
Cinaudagraph Speakers, Inc.	56A
Clarostat Mfg. Company, Inc.	47A
Sigmund Cohn & Company	58A
Communication Measurements Laboratory	56A
Communication Products Company, Inc.	60A
Cornell-Dubilier Electric Corp.	Cover III
Corning Glass Works	21A
Coto-Coil Company, Inc.	50A
DeJur-Amsco Corporation	22A
Tobe Deutschmann Corporation	63A
Doolittle Radio, Inc.	58A
DX Crystal Company	46A
Eicor Inc.	45A
Eitel-McCullough, Inc.	64A
Elastic Stop Nut Corp. of America	16A
Electronic Corp. of America	12A
Electronic Laboratories, Inc.	Facing 16A
Electro-Voice Mfg. Company, Inc.	30A
Federal Telephone & Radio Corp.	41A

Galvin Manufacturing Corp.	25A
General Electric Company	62A
General Radio Company	Cover IV
Goat Metal Stampings, Inc.	45A
Hallicrafters Company	35A
Hammarlund Mfg. Company	43A
Harvey Radio Laboratories, Inc.	56A
Heintz & Kaufman, Ltd.	6A
Hewlett-Packard Company	2A
Hytron Corporation	19A
Industrial Condenser Corp.	36A
International Resistance Company	53A
International Tel. & Tel. Corp.	41A
Jackson Electrical Instrument Co.	38A
Littelfuse Inc.	61A
Macmillan Company	45A
McElroy Manufacturing Corp.	37A
Measurements Corporation	50A
National Company, Inc.	15A
National Union Radio Corp.	33A
National Vulcanized Fibre Co.	58A
North American Philips Company, Inc.	49A
Ohmite Mfg. Company	28A
Radio Corp. of America, Victor Div.	32A, 55A
Radio Specialties Company	44A
Rauland Corporation	27A
Raytheon Mfg. Company	14A, 52A
Rola Company	18A
Shallcross Mfg. Company	34A
Sherron Metallic Corp.	54A
Sprague Electric Company	4A
Standard Transformer Corp.	48A
Stupakoff Ceramic & Mfg. Company	31A
Superior Instruments Co.	54A
Sylvania Electric Products Inc.	24A
Taylor Fibre Company	59A
Taylor Tubes, Inc.	Facing 17A
Tech Laboratories	39A
Terminal Radio Corporation	44A
Thordarson Elec. Mfg. Co.	61A
Triplet Electrical Instrument Co.	46A
United Transformer Company	Cover II
Utah Radio Products Co.	20A
Walker-Jimieson, Inc.	44A
Western Electric Company	54A
Western Lithograph Company	60A
Westinghouse Elec. & Mfg. Co.	13A
John Wiley & Sons, Inc.	40A



QX CHECKER

TYPE 110-A

A dependable

TEST AND MEASURING INSTRUMENT

The factory counterpart of the Q-Meter. Compares fundamental characteristics of inductance or capacitance and Q under production line conditions with a high degree of accuracy, yet quickly and simply. Insures uniform parts held within close tolerances. Frequency range 100 kc. to 25 mc.



BOONTON RADIO

BOONTON, N. J.

Corporation

DESIGNERS AND MANUFACTURERS OF THE "Q" METER . . . QX-CHECKER . . . FREQUENCY MODULATED SIGNAL GENERATOR . . . BEAT FREQUENCY GENERATOR . . . AND OTHER DIRECT READING TEST INSTRUMENTS

THE GIANT TORTOISE, believed to outlive all vertebrae. Its usual life span is up to 100 years, but records show one to have been at last 152 years old and possibly 200.

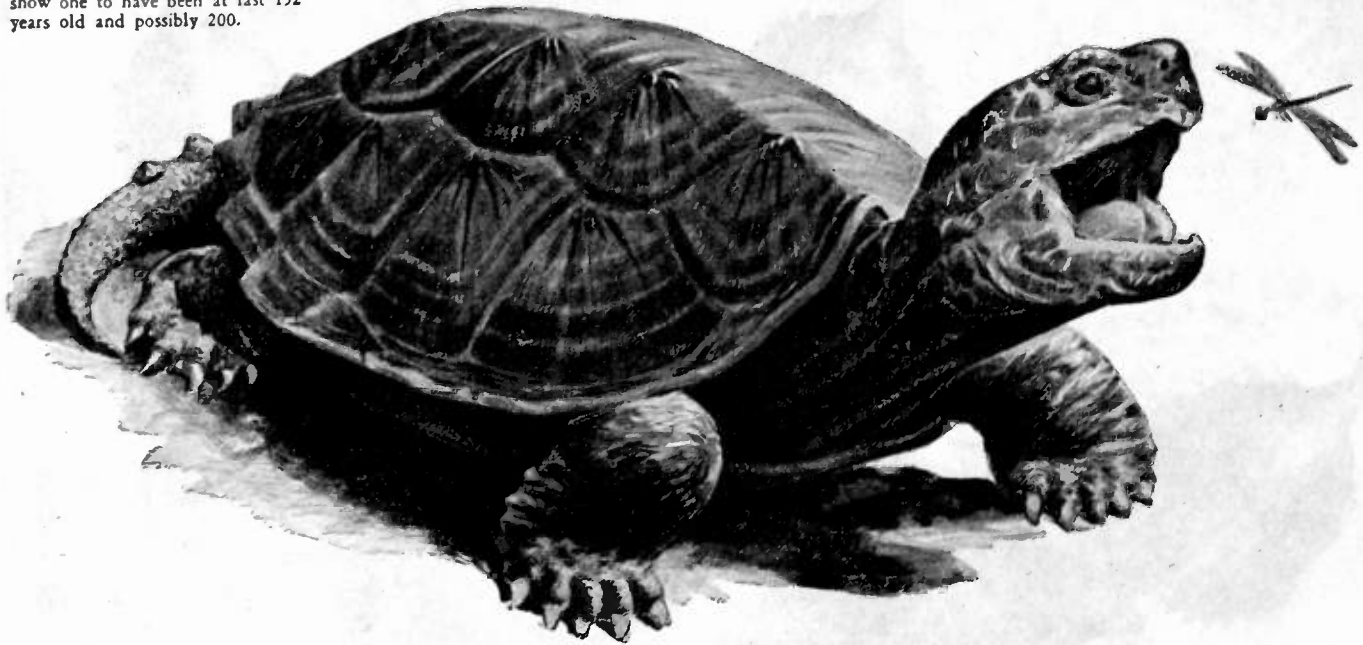

STANDARD OF STAMINA

What you want most in a capacitor is what you are sure of getting in TOBE Capacitors: . . . *long life!* Your proof is in Tobe's enviable record of practically no "returns". Frequent, rigid inspections eliminate uncertainty. Constant research brings constant improvement. The original capacitor with hold-down bracket, Tobe OM-601, offers many definite advantages. This capacitor is strong, compact and space-saving. The hold-down bracket permits the use of either inverted or upright terminals, with wiring underneath or on top of chassis. Write for details and samples (1.0 mfd and 2.0 mfd). Tobe engineers are glad to be of service.

LONG LIFE ASSURED!

SPECIFICATIONS TOBE OM-601 CAPACITORS

TYPE	OM	SHUNT RESISTANCE	.05 to 0.1 mfd. 20,000 megohms
RATINGS .05 to 2.0 mfd. 600 V. D. C.		.25 to 0.5 mfd. 12,000 megohms	
.05 mfd. to 1.0 mfd. 1,000 V. D. C.		1.0 to 2.0 mfd. 12,000 megohms	
STANDARD CAPACITY TOLERANCE	10%	POWER FACTOR	At 1,000 cycles—.002 to .005
TEST VOLTAGE	Twice D. C. rating	CONTAINER SIZE	Width 3/8", length 1 5/16", ht. 2 1/4"
GROUND TEST	2,500 Volts, D. C.	MOUNTING HOLE CENTERS	1 1/2"
OPERATING TEMPERATURE	55°F to 185°F		



A small part in Victory Today . . . A BIG PART IN INDUSTRY TOMORROW

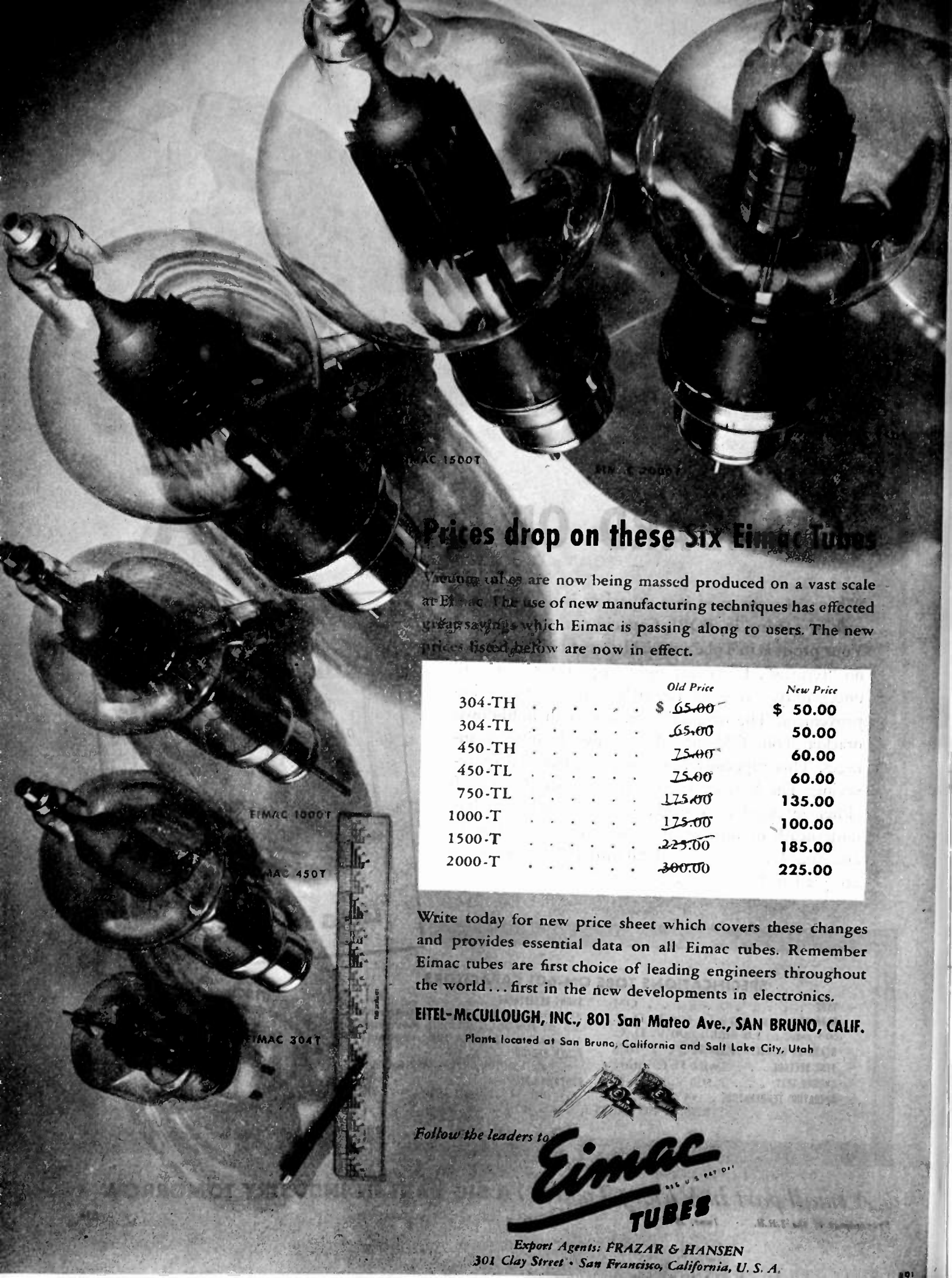

EIMAC 1500T

EIMAC 200T

EIMAC 1000T

EIMAC 450T

EIMAC 304T

Prices drop on these Six Eimac Tubes

Vacuum tubes are now being massed produced on a vast scale at Eimac. The use of new manufacturing techniques has effected great savings which Eimac is passing along to users. The new prices listed below are now in effect.

	Old Price	New Price
304-TH	\$ 65.00	\$ 50.00
304-TL	65.00	50.00
450-TH	75.00	60.00
450-TL	75.00	60.00
750-TL	175.00	135.00
1000-T	175.00	100.00
1500-T	225.00	185.00
2000-T	300.00	225.00

Write today for new price sheet which covers these changes and provides essential data on all Eimac tubes. Remember Eimac tubes are first choice of leading engineers throughout the world... first in the new developments in electronics.

EITEL-McCULLOUGH, INC., 801 San Mateo Ave., SAN BRUNO, CALIF.

Plants located at San Bruno, California and Salt Lake City, Utah

Follow the leaders to



Export Agents: **FRAZAR & HANSEN**
301 Clay Street • San Francisco, California, U. S. A.

*what a
great name
means...*

*on a
little
package*

The meaning of the C-D insignia on a capacitor is strikingly illustrated in the performance of inverted filter type TLA. This little wonder packs the highest insulation resistance, lowest power factor, longest life in the smallest space of any similar filter capacitor. Their dependability springs from a source definite and actual, from specific C-D structural features. You can have this surer security in capacitors by looking for the C-D name. Cornell-Dubilier Electric Corporation, South Plainfield, N.J.

4 OUT OF 5 SAY C-D

In an independent inquiry just completed, 2,000 radio and electrical engineers were asked their first, second and third choice of capacitor make. When all the returns were in, Cornell-Dubilier was far in the lead—receiving almost four times as many “firsts” as its nearest competitor.

TLA FEATURES
Insulated from chassis. Fire-proof—non-inflammable. Enclosed in cylindrical, aluminum container. Efficiently combines long life with small space. Ability to withstand high transient and peak voltages. Designed to operate under continuous full-load duty.

Cornell Dubilier
capacitors

more in use today than any other make



MICA • DYKANOL • PAPER
WET AND DRY
ELECTROLYTIC CAPACITORS

WE'RE TEARING OUR HAIR TOO!



● MANY of our customers have experienced numerous disappointments in changes in delivery dates on orders for G-R equipment; most do not know why deliveries cannot be made sometimes on the date promised.

All orders for electronic test equipment are scheduled by the War Production Board. The scheduled delivery date is based upon the tactical urgency of the order. These dates are changed principally for one of two reasons:

Very frequently the urgency of the order is altered due to the ever-changing war picture; a top-priority order today may be far down on the list tomorrow.

Due to shortages of raw materials, manpower and finished components purchased

from outside suppliers, our production schedule lags at times.

When it becomes necessary for WPB to change a scheduled delivery date, we have no prior knowledge of that fact, nor any information as to the reason for the change. We are required by law to fill all orders in the sequence set up by the WPB schedule. Appeals directly to us to re-shuffle deliveries cannot be acted upon.

The present scheduling system at times results in considerable inconvenience to our customers, we know. The whole purpose of the system, however, is to supply war materials when and where they are most urgently needed at the moment. This after all seems to be the basic aim of war production, doesn't it?



GENERAL RADIO COMPANY

Cambridge 39, Massachusetts
NEW YORK CHICAGO LOS ANGELES