

# Proceedings

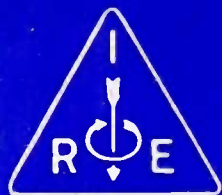

*of the*

# I·R·E

*Hugh Stove*



*Photo: Signal Corps, U. S. Army, Fort Monmouth New Jersey.*

UNBARRED WORDS: THE MICROPHONE RESPONDS TO SPEECH  
THROUGH THE NEW DIAPHRAGM GAS MASK

JULY 1943

VOLUME 31

NUMBER 7

Radio Engineer's Responsibilities  
Beyond Ultra-Short Waves  
High-Power Tubes  
Rectifier Operation  
Vee Antenna Radiation  
General Reactance Theorem  
Impedance-Measurement Charts  
Wartime Radio Production  
Radio Standards Go to War

# Institute of Radio Engineers





## For a full measure of service



Not only are men being tried on battlefronts, the equipment that they employ is being subjected to equally critical tests . . . with the lives of the men as the stakes. We at home, entrusted with war contracts, are overcoming serious raw material shortages through laboratory and production developments, making each individual tube that we produce do more than its planned job . . . and do it better.

Through a series of design refinements, Amperex engineers have developed transmitting and rectifying tubes that are being operated for longer periods of time than hitherto had been practical. These new Amperex radio and Radar tubes present a dual economy . . . many more hours of uninterrupted service . . . and priceless savings of scarce materials.

# AMPEREX ELECTRONIC PRODUCTS

79 WASHINGTON STREET

BROOKLYN, NEW YORK

BOARD OF DIRECTORS

1943

- Lynde P. Wheeler, *President*
- F. Sherbrooke Barton,  
*Vice President*
- Raymond A. Heising, *Treasurer*
- Haraden Pratt, *Secretary*
- Alfred N. Goldsmith, *Editor*
- Stuart L. Bailey
- Wilmer L. Barrow
- E. Finley Carter
- Adolph B. Chamberlain
- Ivan S. Coggeshall
- William L. Everitt
- Harold T. Friis
- Gilbert E. Gustafson
- O. B. Hanson
- Frederick B. Llewellyn
- Frederick E. Terman
- Browder J. Thompson
- Hubert M. Turner
- Arthur F. Van Dyck
- Harold A. Wheeler
- William C. White

Harold R. Zeamans,  
*General Counsel*

BOARD OF EDITORS

- Alfred N. Goldsmith, *Editor*
- Ralph R. Batcher
- Philip S. Carter
- Lewis M. Clement
- Elmer W. Engstrom
- William L. Everitt
- Peter C. Goldmark
- Frederick W. Grover
- C. M. Jansky, Jr.
- John D. Kraus
- Frederick B. Llewellyn
- Samuel S. Mackeown
- Edward L. Nelson
- Harry F. Olson
- Greenleaf W. Pickard
- Haraden Pratt
- Conan A. Priest
- Lynne C. Smeby
- Browder J. Thompson
- Harold A. Wheeler
- Laurens E. Whittemore
- Gerald W. Willard
- William Wilson
- Charles J. Young

Helen M. Stote,  
*Associate Editor*

William C. Copp,  
*Advertising Manager*

William B. Cowilich,  
*Assistant Secretary*

# Proceedings

## of the I·R·E

*Published Monthly by*

The Institute of Radio Engineers, Inc.

VOLUME 31

July, 1943

NUMBER 7

Edwin H. Armstrong .....	315
The Radio Engineer's Responsibilities of Tomorrow..... Haraden Pratt	316
Section Meetings.....	318
Beyond the Ultra-Short Waves..... G. C. Southworth	319
Tubes for High-Power Short-Wave Broadcast Stations	
—Their Characteristics and Use..... G. Chevigny	331
Analysis of Rectifier Operation..... O. H. Schade	341
Radiation from Vee Antennas..... Charles W. Harrison, Jr.	362
A General Reactance Theorem for Electrical, Mechanical, and Acoustical Systems..... Dah-You Maa	365
Charts for Simplifying High-Impedance Measurements with the Radio-Frequency Bridge..... R. L. Nielsen	372
Wartime Radio Production..... Ray C. Ellis	379
Radio Standards Go to War..... Harold P. Westman	381
Corrections to "Loop Antennas for Aircraft," by George F. Levy.....	384
Corrections to "Comparison of Voltage- and Current-Feedback Amplifiers," by E. H. Schulz.....	384
Discussion on "Thermal-Frequency-Drift Compensation," by T. R. W. Bushby..... Herbert Sherman and T. R. W. Bushby	385
Institute News and Radio Notes	
Board of Directors.....	387
Executive Committee.....	387
Correspondence: Proposed Constitutional Amendments.....	388
Books:	
"Electrical Counting," by W. B. Lewis..... W. G. Dow	389
"Alternating-Current Circuits," by E. M. Morecock..... H. A. Wheeler	389
Contributors.....	390
Positions Open.....	xxxvi
Section Meetings.....	xlii
Membership.....	xliv
Advertising Index.....	lxx

Responsibility for the contents of papers published in the PROCEEDINGS rests upon the authors. Statements made in papers are not binding on the Institute or its members.



Entered as second-class matter October 26, 1927, at the post office at Menasha, Wisconsin, under the Act of February 28, 1925, embodied in Paragraph 4, Section 538 of the Postal Laws and Regulations. Publication office, 450 Ahnapp Street, Menasha, Wisconsin. Editorial and advertising offices, 330 West 42nd St., New York, N. Y. Subscription \$10.00 per year; foreign, \$11.00.





## —so we brought the jungle to Chicago

Sweltering jungle heat and ever-dripping moisture is a real test of endurance for our fighting men. But how about the *Communications* equipment upon which their very lives often depend? To find the answer, RAULAND engineers brought the jungle right into our laboratories! They built a large, glass-enclosed, air-tight cabinet . . . provided it with the dripping wetness of saturated, super-heated air and

tropical plants and lush vegetation, deep rooted in mossy loam. Into this "torture chamber" went RAULAND *Communications* equipment . . . to finally emerge with the correct answers to some very vital questions. A typical example of RAULAND engineering thoroughness in making certain that its precision instruments serve dependably under even the most trying conditions.

RADIO . . . SOUND . . .

# Rauland

. . . COMMUNICATIONS

*Electroneering is our business*

THE RAULAND CORPORATION . . . CHICAGO, ILLINOIS

Buy War Bonds and Stamps! Rauland employees are still investing 10% of their salaries in War Bonds



# Mica

## TRANSMITTING CAPACITORS

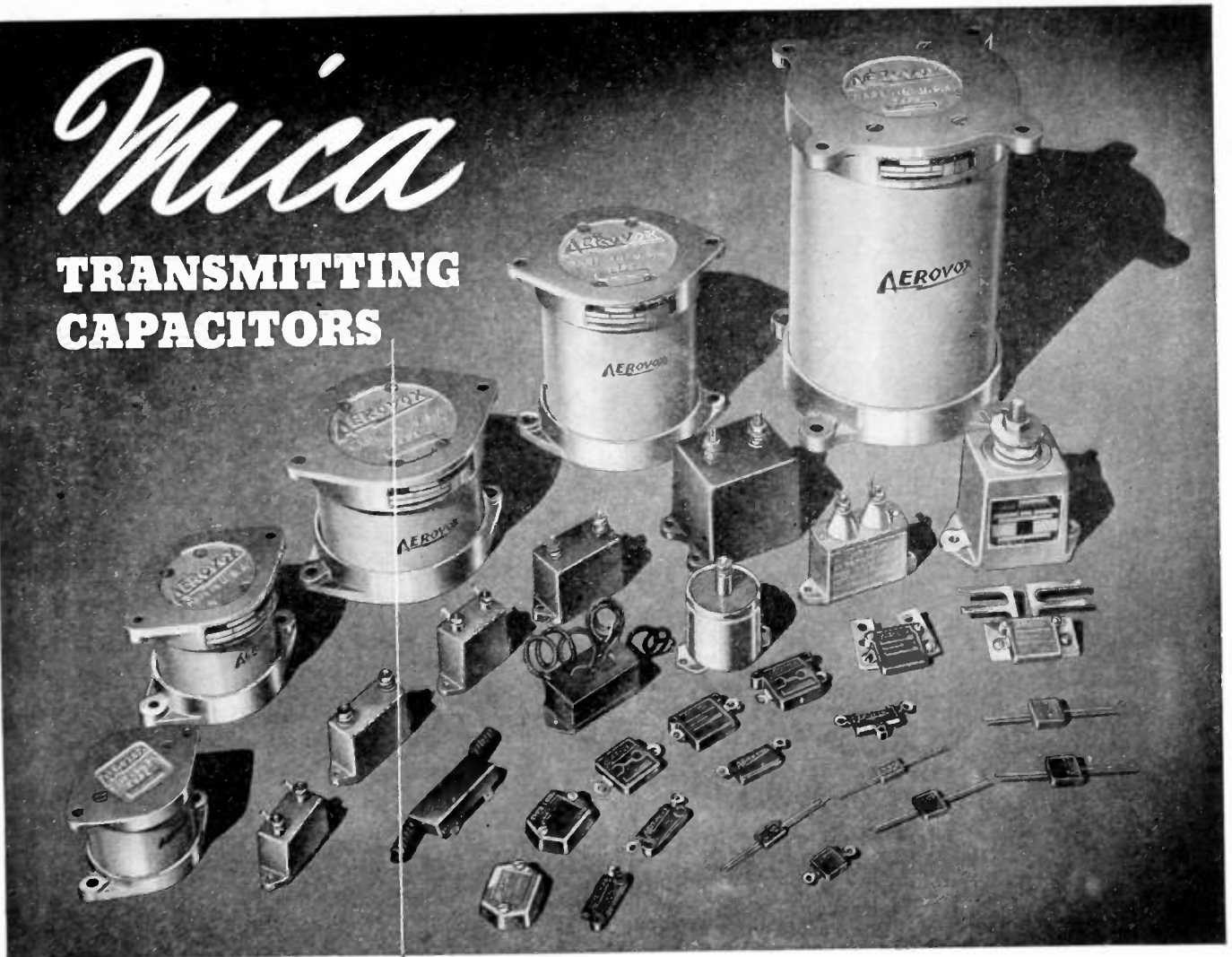

### OUR WAR EFFORT

From January 1941 to December 1942,  
Aerovox . . .

- Stepped up production output 500% for our Armed Forces.
- Increased production floor space 300%.
- Sought, hired, trained, and put to work additional workers—a 300% increase in productive personnel.
- Opened second plant in Taunton, bringing work to available workers there.
- And—doing more and more; growing week by week!

• Be it tiny "postage-stamp" mica capacitor or large stack-mounting unit—regardless, it's a precision product when it bears the Aerovox name.

Only the finest ruby mica is used. Each piece is *individually gauged and inspected*. Uniform thickness means meeting still closer capacitance tolerances. Also, sections are of exceptionally uniform capacitance, vitally essential for those high-voltage series-stack capacitors. Meanwhile, the selection of perfect mica sheets accounts for that extra-generous safety factor so characteristic of ALL Aerovox capacitors.

Our new Transmitting Capacitor Catalog lists the outstanding choice of types. • Write on your business stationery for your registered copy.



# Capacitors

INDIVIDUALLY TESTED

AEROVOX CORPORATION, NEW BEDFORD, MASS., U. S. A. • SALES OFFICES IN ALL PRINCIPAL CITIES  
Export: 100 VARICK ST., N. Y. C. • Cable: 'ARLAB' • In Canada: AEROVOX CANADA LTD., HAMILTON, ONT.

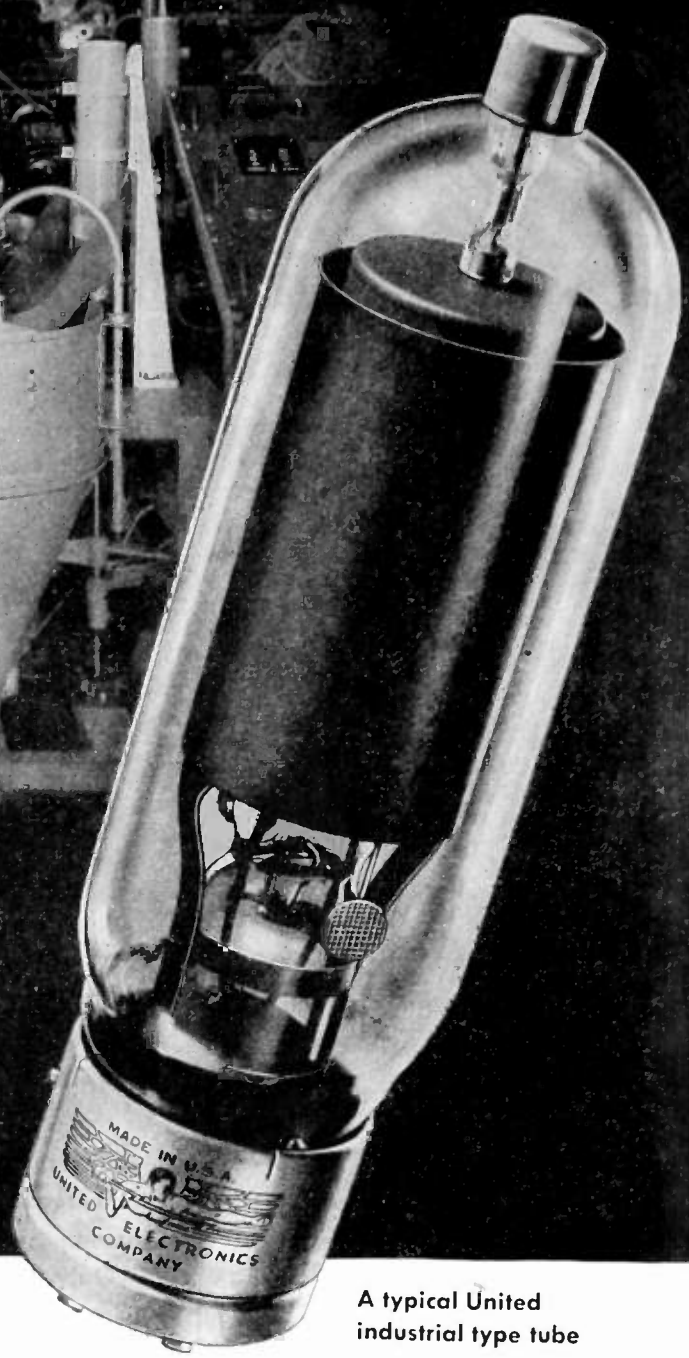
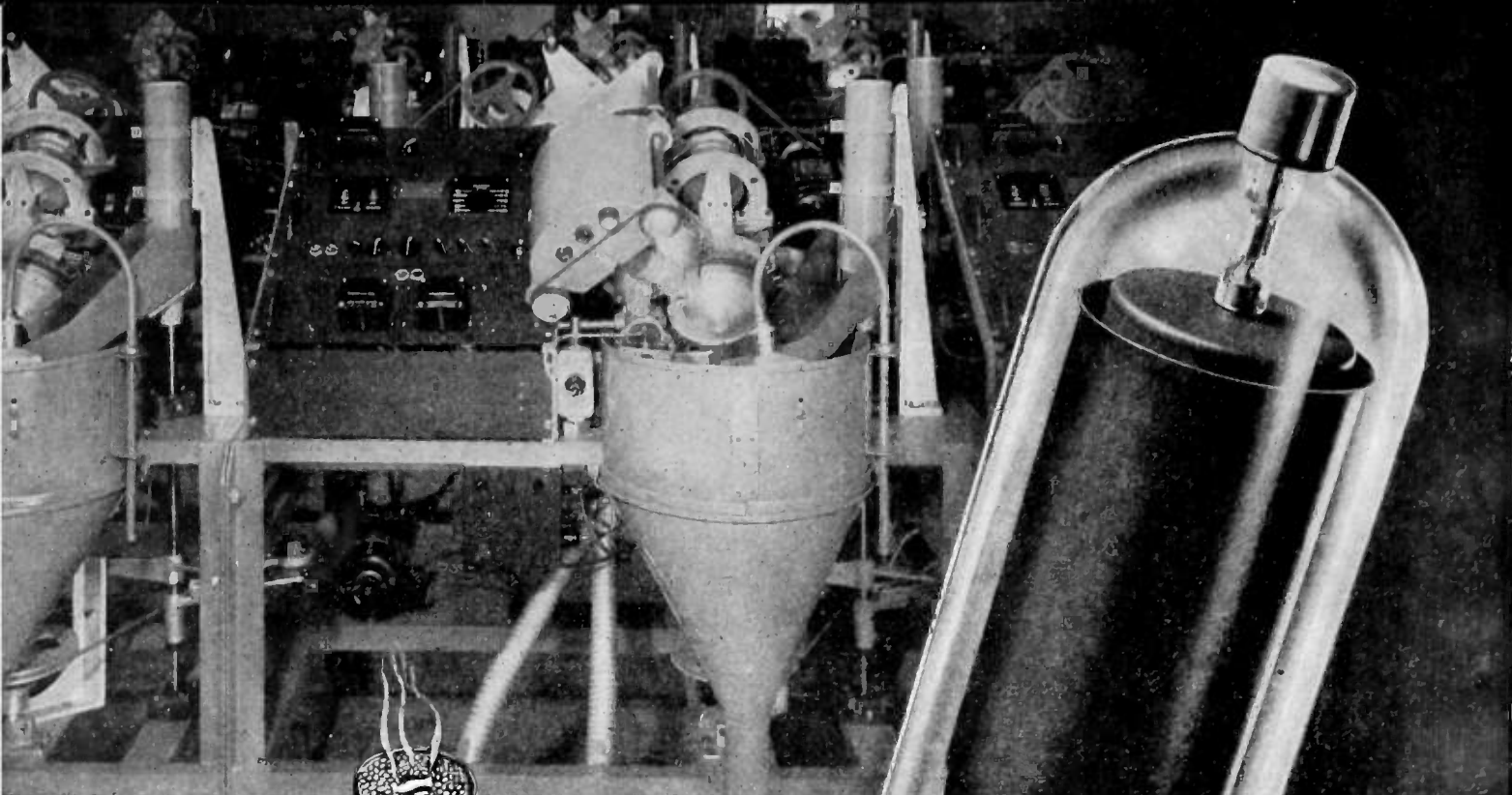

A typical United industrial type tube

# THESE MACHINES KNOW THEIR BEANS

## THEIR HEART IS AN ELECTRONIC TUBE BY **UNITED**

Today, thanks to the miracle of electronics, automatic machines perform intricate tasks which only human hands, eyes and brains could once perform.

One of these remarkable machines is the ELECTRIC SORTING MACHINE, pictured above, made by the company of the same name at Grand Rapids, Michigan. This sensitive device sorts and grades dried beans, peas or peanuts according to size or color . . . separates the perfect from the defective. With unerring

"skill" it rejects foreign objects, such as pebbles, shells, sticks, etc.

The electronic "heart" of this intricate industrial machine is the modern vacuum tube, as perfected by the advanced engineering skill of UNITED. We are proud that the makers of the ELECTRIC SORTING MACHINE are among hundreds of manufacturers who insure maximum efficiency, long service and economy of operation by standardizing on UNITED tubes.

# UNITED ELECTRONICS COMPANY

NEWARK



NEW JERSEY



# LETHAL WEAPON

## IN THE WAR ON U-BOATS



**THE NEW SCIENCE OF ELECTRONICS** has profoundly changed the art of war. On land, in the air, above and below the surface of the sea, our forces fight today with electronic weapons of incredible power, speed, precision. It is satisfying to the men of Radio to know that these weapons have proved so successful on every battlefield where our boys, planes, tanks and ships have come to grips with the enemy.

The revelations concerning RADAR and its part in the war came as no surprise to those whose job is to supply our fighting forces with modern electronic equipment. Since before Pearl Harbor these Americans have been working shoulder to shoulder with our armed forces in applying the power of electronics to the art of war. Out of this united effort have come fighting weapons never before known—on land, at sea or in the air. In this pioneering work it has been National Union's privilege to play a progressively

increasing part. A greater National Union has been built to cope with vastly larger responsibilities. Today, National Union is ready to consult with and assist other manufacturers in the use of electronic tubes. Tomorrow, when peace comes—when the industrial usage of electronics gets the green light—engineers and production men will find at National Union unexcelled service and cooperation in perfecting new electronic applications for the production, testing and packaging of their products.

**NATIONAL UNION RADIO CORPORATION • NEWARK, N. J. • LANSDALE, PA.**

# NATIONAL UNION RADIO AND ELECTRONIC TUBES

Transmitting Tubes • Cathode Ray Tubes • Receiving Tubes • Special Purpose Tubes • Condensers •  
Volume Controls • Photo Electric Cells • Exciter Lamps • Panel Lamps • Flashlight Bulbs



**960 CONTACTS PER SECOND  
PERFECTLY SYNCHRONIZED**

**1/4 WATT OR 1,000 WATTS  VIBRATOR CONVERTERS  
give higher efficiency . . . require no service**

The vibrator is the most efficient means yet developed for changing DC current to AC.

This is an inherent characteristic of the vibrator, because electrical and mechanical losses as well as wear are negligible. Building on this fundamental, Electronic Laboratories have extended the vibrator's field of usefulness by developing vibrator type power supplies which provide extraordinary adaptability, for all types of current conversion, together with unusual efficiency and service life.

Ingenuity of design and precision of manufacture make possible load capacities up to 1,000 watts in *E-L* Vibrator Power Supplies. The 450-watt capacity, 120-cycle vibrator, illustrated above, for instance, has eight sets of contact points. Each of them must make 120 contacts per second, and each synchronized perfectly with every other contact. Adjusted and locked, that is exactly what they do—for life!

Growing use of *E-L* Vibrator Power Supplies in war equipment—land, sea and air—is evidence of their efficiency and reliability under the most severe operating conditions. Wherever you have a problem of current conversion, *E-L* engineers will be glad to work with you to meet it most effectively, and most economically.

**Only *E-L* VIBRATOR POWER SUPPLIES  
Offer All These Advantages:**

1. **CONVERSION**—DC to AC; DC to DC; AC to DC; AC to AC.
2. **CAPACITIES**—Up to 1,000 Watts.
3. **VARIABLE FREQUENCIES**—A power supply may be designed to furnish any frequency from 20 to 280 cycles, or a controlled variable output within a 5% range of the output frequency.
4. **MULTIPLE INPUTS**—For example, one *E-L* Power Supply, in quantity production today, operates from 6, 12, 24, 110 volts DC or 110 volts AC, and 220 volts AC, with a single stable output of 6 volts DC.
5. **MULTIPLE OUTPUTS**—Any number of output voltages may be secured from one power supply to suit individual needs.
6. **WAVE FORMS**—A vibrator power supply can be designed to provide any wave form needed for the equipment to be operated.
7. **FLEXIBLE IN SHAPE, SIZE AND WEIGHT**—The component parts of a vibrator power supply lend themselves to a variety of assembly arrangements which makes them most flexible in meeting space and weight limitations.
8. **HIGHEST EFFICIENCY**—*E-L* Vibrator Power Supplies provide the highest degree of efficiency available in any type power supply.
9. **COMPLETELY RELIABLE**—Use on aircraft, tanks, PT boats, "Walkie-Talkies," jeeps, peeps and other military equipment, under toughest operating conditions has demonstrated that *E-L* units have what it takes!
10. **MINIMUM MAINTENANCE**—There are no brushes, armatures or bearings requiring lubrication or replacement because of wear. The entire unit may be sealed against dust or moisture.

*Electronic*  
**LABORATORIES, INC.**

*E-L* ELECTRICAL PRODUCTS—Vibrator Power Supplies for  
Communications . . . Lighting . . . Electric Motor Operation . . .  
Electric and Electronic Equipment on Land, Sea or in the Air.

INDIANAPOLIS





Here's design help on

# HIGH HUMIDITY PROBLEMS



Protection of sensitive radio parts against the paralyzing destructive forces of tropical high temperature and high humidity no longer need trouble you. Westinghouse engineers have cooperated with many designers to work out a variety of solutions, of which the accompanying illustrations are typical examples. Perhaps these are directly applicable to your problem; or it may be that yours is completely different. In either case, trained and experienced Westinghouse representatives are ready to help you; call them today. Westinghouse Electric & Manufacturing Company, Dept. 7-N, East Pittsburgh, Pennsylvania. J-94560

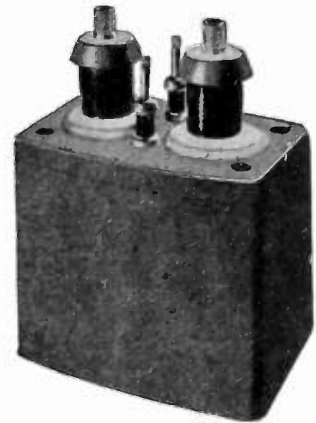

Solder-seal Prestite bushings for hermetically sealed transformers and condensers.



Motor blower for circulating air within radio transmitter, for tropical service.



Space heater and thermostatic control to maintain air temperature within the transmitter above the dew point.



# Westinghouse

PLANTS IN 25 CITIES... OFFICES EVERYWHERE

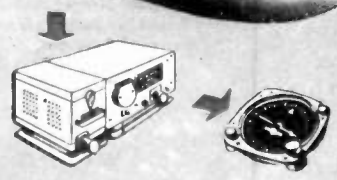
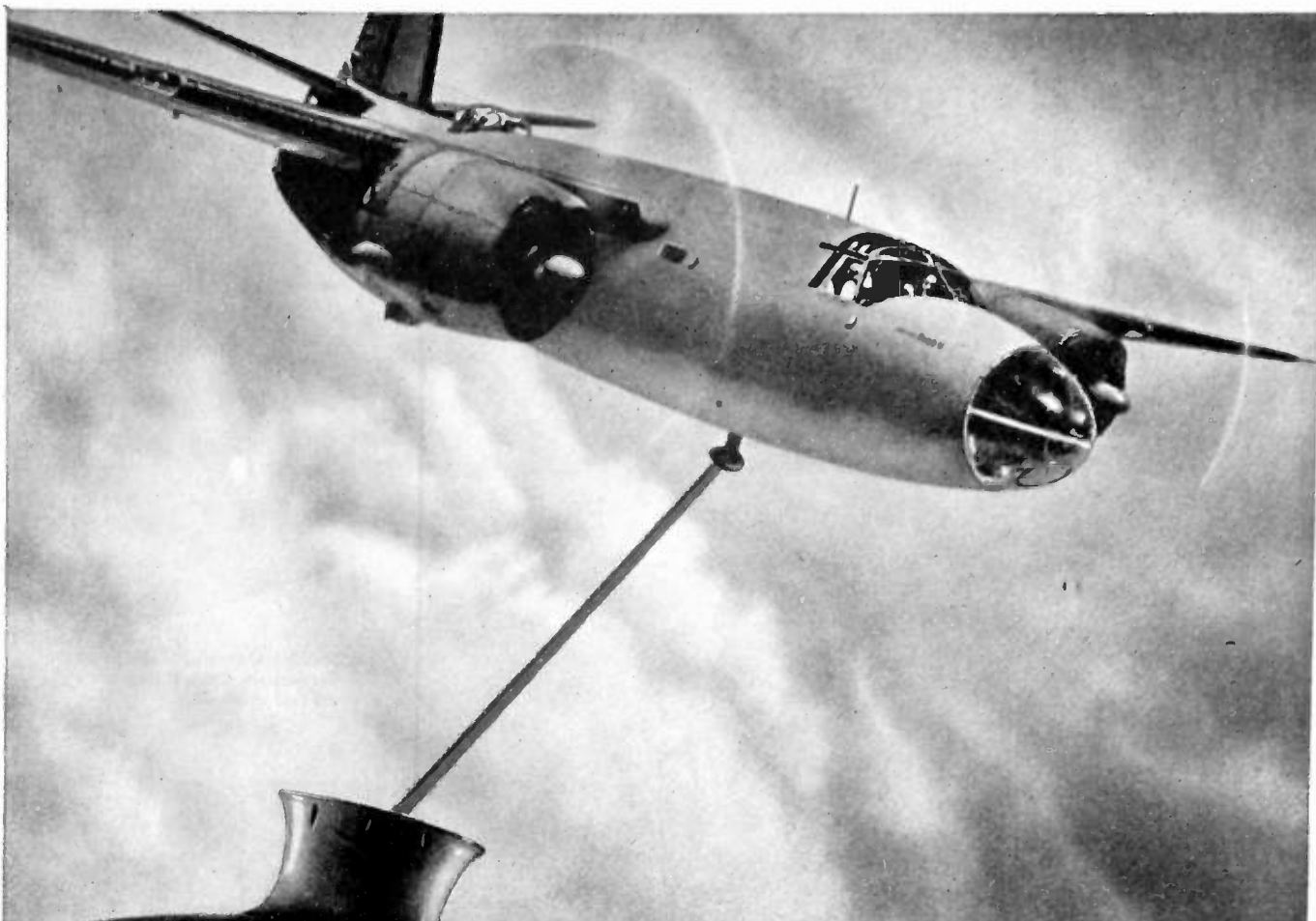

The Bendix Automatic Radio Compass consists of rotating loop antenna in streamlined housing, loop director, compass receiver, bearing indicator and (not shown) remote control unit. This equipment provides continuous indication of the direction of arrival of radio signals . . . without the necessity of computation or correction.



# The "Bomb"

**THAT IS NEVER DROPPED!**

This Streamlined Object is Not a Bomb, but Part of the Bendix\* Automatic Radio Compass!

A highly sensitive receiver is the Bendix Automatic Radio Compass. It operates from a loop antenna inside a streamlined, bomb-like housing. Automatically, in response to a radio signal from any direction, the loop rotates and positions itself. A compass dial connected to it by Bendix Autosyn\* units instantly indicates direction of signal. It puts the pilot "right on the beam" . . . and keeps him there.

A typical member of "The Invisible Crew" of Bendix precision-built instruments, the Automatic Radio Compass is but one of many remarkable electronic devices now turned out in impressive quantities by the men and women of Bendix Radio.

\*Trade Marks of Bendix Aviation Corporation and Subsidiaries

The products of this division are vital members of "The Invisible Crew"—precision equipment, controls and accessories which 25 Bendix plants, coast to coast, are speeding to our fighting crews on world battle fronts.



**B E N D I X   R A D I O   D I V I S I O N**



# MEN OF ELECTRONICS CAN PICK THEIR OWN INDUSTRY IN POSTWAR!

Aviation? When the war is over, giant transport planes will fly almost with the speed of sound, and, through electronics, fly more safely. Radio? To FM will be added the wonders of seeing what is happening miles away, by means of electronic television. Agriculture—steel-making—medical science... Tomorrow the doors to all of these may be open to the electronic engineer.

Almost every day new uses and potentialities for the science of the future unfold, many in the ultra-high frequency ranges where, a few years ago, it was thought electronics could serve no practical purpose. Within the "narrow" 100 to 1000 megacycle range of the spectrum, particularly the former *No Man's Land* beyond 300 MC, a host of applications has been discovered for this new science—for example, in the aircraft industry—itself limitless in peacetime possibilities.

With the opening up of new portions of the frequency spectrum for practical use, men wise in the ways of electronics, or familiar with the theory of harnessing the electron, will be in demand everywhere.

For the practical application of the electronic principle is going to require a new engineering of products, as well as the development of special devices and machines that speed up production...increase accuracy, or measure, control, record and perform the countless other things envisioned in the coming Era of Electronics. And each of these represents opportunity—careers for the men in laboratory and field today hastening this stupendous new age.

Spurred by war's demand for electronic devices, Isolantite is busy preparing for the vastly accelerated application of the electron tube at war's end. For it has been demonstrated in the crucible of war how important is insulation—*high-grade* insulation—to the performance of this equipment designed to accomplish things which man cannot.

## ISOLANTITE

CERAMIC INSULATORS  
ISOLANTITE INC., BELLEVILLE, N. J.

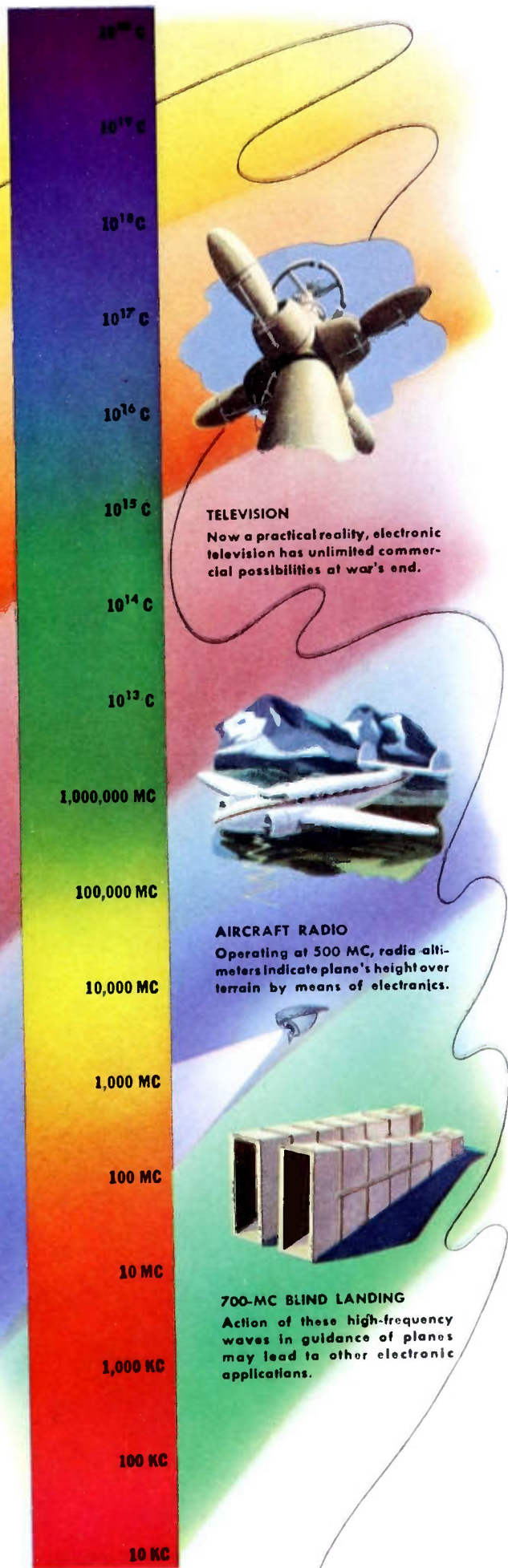

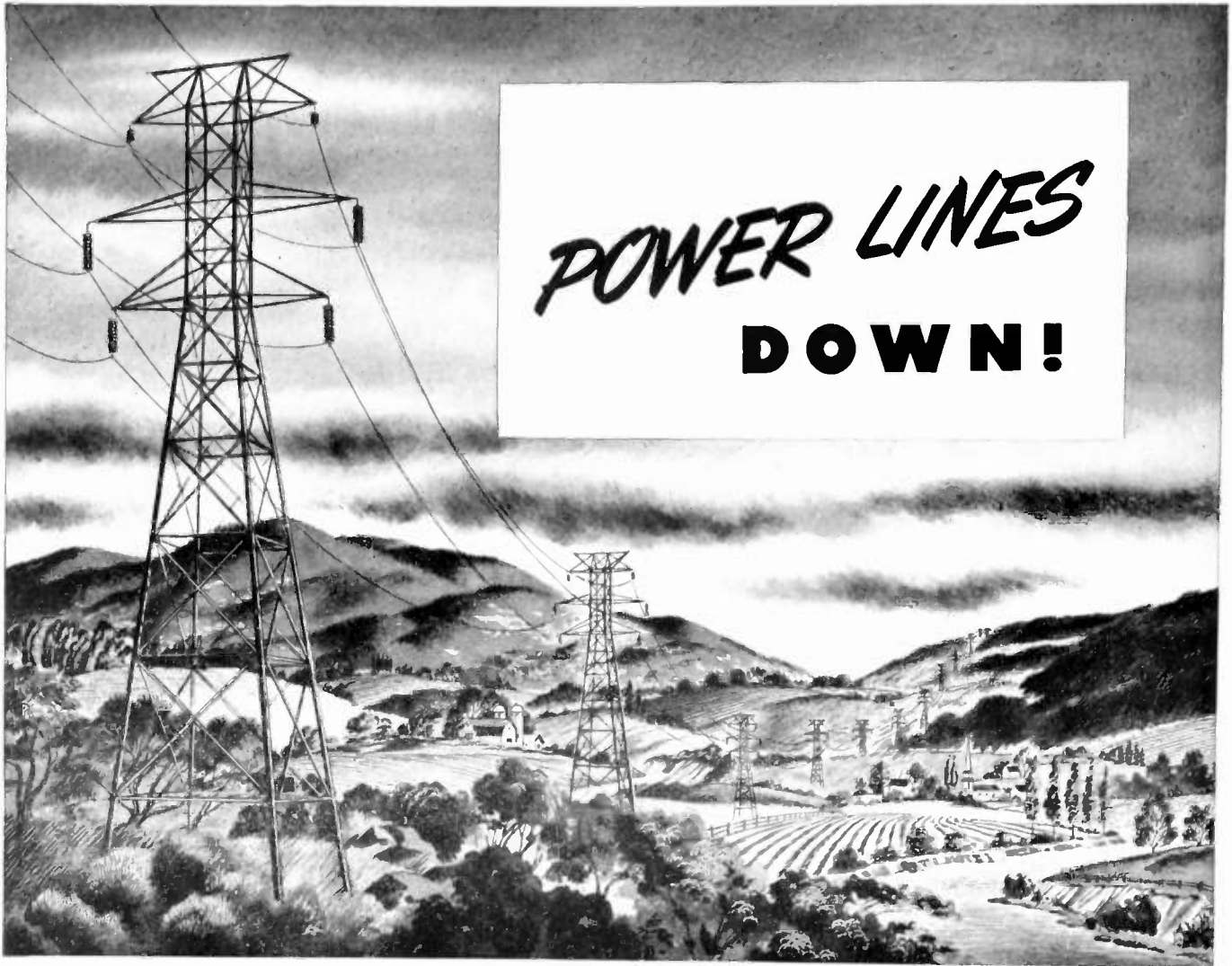

# POWER LINES DOWN!

## IRC RESISTORS Send the Signal

When trouble develops on a high voltage power line, time is of greatest essence. For in our fast-moving electro-mechanical age, minutes quickly translate themselves into countless man-hours. Communications go "dead" . . . lights snuff out . . . vital production grinds to a sudden halt . . . and it's "taps" for a busy world.

### Another IRC Contribution

Until comparatively few years ago, when power transmission interruptions occurred, it often required hours to locate the trouble. Today, thanks in part to the contribution of IRC research engineers, the point of disruption in any electrical circuit—whether power or communications—can readily be spotted in a matter of moments.

*Specially designed, IRC high voltage power resistors dependably dissipate the heavy loads and deliver the voltage required to operate trouble-signalling mechanisms. On receipt of signal, other instruments in which resistors play an important role accurately locate the point of disturbance within a few feet.*

Here at IRC we welcome—and usually solve—unusual problems in the field of resistance devices.

And because IRC makes more types of resistance units, in more shapes, for more applications than any other manufacturer in the world, many leading engineers make it a point to seek our unbiased counsel. There is no obligation, of course.



# INTERNATIONAL RESISTANCE COMPANY

401 N. BROAD STREET • PHILADELPHIA



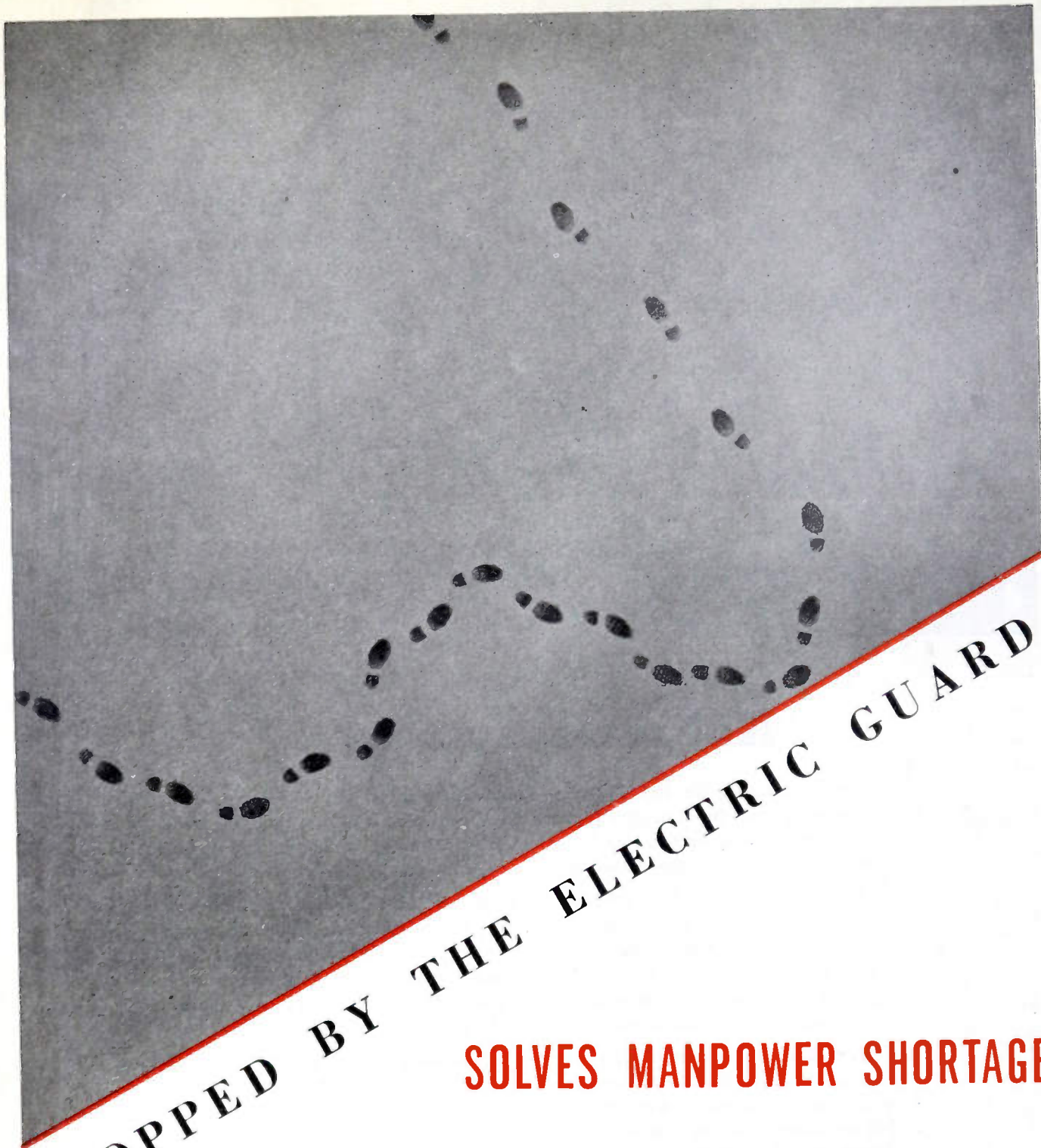

**STOPPED BY THE ELECTRIC GUARD**

**SOLVES MANPOWER SHORTAGE**

## **BROWNING SIGNAL SYSTEM**

A PRODUCT OF  
BROWNING LABORATORIES RESEARCH

The Browning Signal System  
lays down a protective wall, is on the  
job night and day, reduces guarding  
personnel, cuts guarding costs.

**BROWNING LABORATORIES, Inc.**  
751 MAIN STREET, WINCHESTER, MASSACHUSETTS



## Not an easy one . . .

From guarding the law to—yes—delivering babies, a policeman's life is not an easy one. Needed in a thousand different places at one time, his head must remain cool, and his orders must be transmitted quickly, clearly and undistorted by any adjacent noises.

Here, then, is another vital postwar use for Electro-Voice Microphones. It is impossible now to estimate the "good" which will be accomplished with the new Electro-Voice communication microphones for police applications. They are, we believe, incomparable from the standpoint of articulation (we can't tell you the percentage and you wouldn't believe it if we did!) level, reduction of background noise, stability, weight and size.

If you are a contractor, directly serving the war, and are in need of this newest Electro-Voice, we'll gladly send you full particulars. Meanwhile, if your limited quantity needs may be filled by any of our Standard Model Microphones, with or without modifications, contact your local radio parts distributor. He can help solve your problems and speed your smaller orders.

**Note:** *Any model Electro-Voice Microphone may be submitted to your local supplier for TEST and REPAIR at our factory.*



# *Electro-Voice* MICROPHONES

ELECTRO-VOICE MANUFACTURING CO., Inc. • 1239 SOUTH BEND AVENUE • SOUTH BEND, INDIANA



# Designs for War... Hermetic Sealing



The hermetic sealing of transformers covers a wide range of problems, and an equally wide range of applications. The two units illustrated at the left, for example, represent a high voltage transformer for high altitude operation, and an audio unit weighing approximately one ounce.

There is more to hermetic sealing than meets the eye. The illustrations below show some of the factors contributing to the high quality of UTC hermetically sealed units.

May we design a war unit to your application?

*For obvious reasons, the units illustrated are not actual war items.*

## Engineering . . . PRODUCT

Engineering starts with research, continues through the conference table, and then goes through the proving of electrical design, sealing methods, vibration test, etc.



ENGINEERING CONFERENCE



DESIGN PROVING . . . AUDIO



DESIGN PROVING . . . POWER

## Engineering . . . PRODUCTION

The production of war units generally requires precise control. This requires the scientific choice of workers for specific operations . . . the use of modern methods throughout . . . and continuous control of quality and production flow.



APTITUDE TESTING assures worker suited to operation

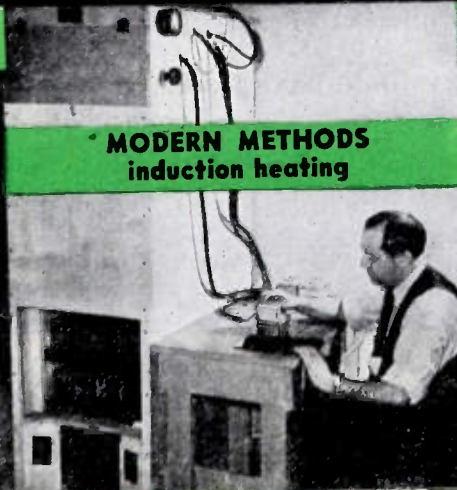

MODERN METHODS induction heating



CONTINUOUS CONTROL for uniformity of production

# UNITED TRANSFORMER CO.

150 VARICK STREET



NEW YORK, N. Y.

EXPORT DIVISION: 100 VARICK STREET NEW YORK, N. Y. CABLES: "ARLAB"

*Today this*



*flag flies over*

From this world headquarters for radio-electronic research flow new weapons, new discoveries and inventions vital to the winning of an Allied victory!

**T**ODAY, over RCA Laboratories, flies a new distinguished battleflag—the coveted Army-Navy “E” Award.

One of the few laboratories in America to receive this award, RCA is at once proud of this distinction, and humbly aware of the responsibilities that it imposes. For much of the progress of the entire radio-electronic industry stems from the work done in these laboratories.

It was perhaps with this thought in mind that—at the dedication of the RCA Laboratories in Princeton—the Chief Signal Officer of the Army called them “The Hidden Battlefront of Research.”

**HIDDEN**—because, for the duration of the war, this magnificent building of 150 separate laboratories must be closed to all but the scientists and research technicians who are working on radio-electronic instruments important to our military effort.

**BATTLEFRONT**—because in the waging of modern warfare, radio-electronics is of first importance. It follows the flag and the fleet—locates the enemy—flashes urgent orders—safeguards the convoy—guides the bombers—directs the artillery—maneuvers the tank. This science fights on every front.

And when that certain day of Victory comes, RCA Laboratories will be devoted to the happier task of making our peacetime world richer, safer, more enjoyable and more productive—through new and finer products of radio, television and electronic research.

#### OTHER SERVICES OF RCA WHICH HAVE EARNED OUR COUNTRY'S HIGHEST WARTIME AWARDS



The Army-Navy “E” flag, with two stars, flies over the RCA Victor Division plant at Camden, New Jersey.



The Army-Navy “E” flag, with one star, has been presented to the RCA Victor Division at Harrison, New Jersey.



The Army-Navy “E” flag, with one star; also the U.S. Maritime Commission “M” Pennant and Victory Fleet Flag have been awarded to the Radiomarine Corporation of America in New York City.

*A Service of  
Radio Corporation of America*



# RCA

## WORLD HEADQUARTERS

*Proceedings of the I.R.E. July, 1943*



*America's Secret Battlefield*  
**RCA Laboratories**



*Laboratories*

**FOR RADIO-ELECTRONIC RESEARCH**



# TAYLOR TUBES

## *Efficiency in Action...*

As always, Taylor is building the finest tubes possible to produce. Every Taylor Tube is designed and engineered to deliver maximum service under strenuous battle conditions. Unfailing, "on the air" performance is their keynote—extra power for vital communications is their heritage. You can rely on Taylor Tubes "More Watts Per Dollar" service in any situation.

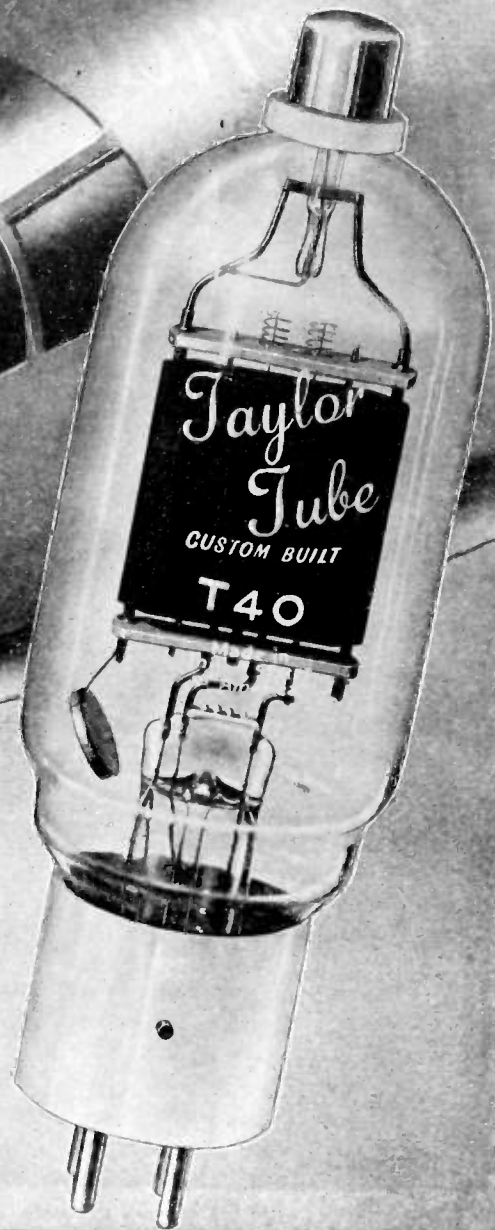

**Taylor** HEAVY **CUSTOM BUILT** DUTY **Tubes**

**TAYLOR TUBES INC., 2312-18 WABANSIA AVE., CHICAGO, ILLINOIS**

as alike . . .

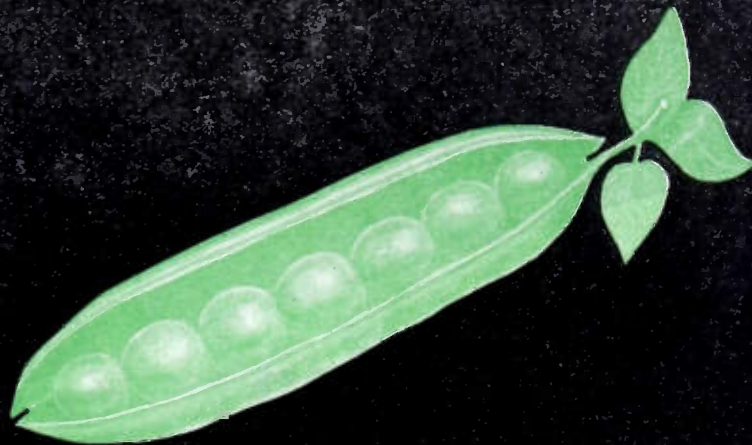

as peas in a pod

## YOUR DETERMINATION AND OURS!

● We both have an identity of purpose—to produce dependable, first-class products on time—*thus help shorten the war!* We know that you depend on us to fulfill our end of the bargain which is the production of uniform special alloys and their delivery on schedule. Our entire mental and physical resources are directed to this end.



**WILBUR B. DRIVER CO.**  
NEWARK • NEW JERSEY





# electronic briefs: television

To produce a moving picture it becomes necessary to break down the action into a series of still pictures. Each still scene is flashed on the screen individually but so rapidly that the human eye sees a smooth action. If the motion picture projector is slowed down the action becomes jerky. Each still picture is called a frame. The conventional movie projector flashes between 24 and 30 frames per second on the screen. Television is based upon the same principle but the problems involved are much more complex.

Television, using the same basis for creating picture action as the movies, breaks down the picture or scene to be broadcast into a series of still pictures called frames. But each frame must also be broken down into approximately 200,000 tiny segments, each segment being broadcast separately and reassembled at the receiving end so rapidly that 30 frames can be flashed on the screen every second. Thus some 6,000,000 separate signals must be transmitted per second. Furthermore each of these signals starts as light, broadcast into an electrical impulse, is converted into an electrical signal, and then reconverted to light again. To make television talk, a conventional sound transmitter must be coordinated and synchronized with the picture broadcast.

As with all things in the field of electronics, vacuum tubes are what make television possible. Remember; Eimac tubes enjoy the enviable distinction of being first choice among leading electronic engineers throughout the world.

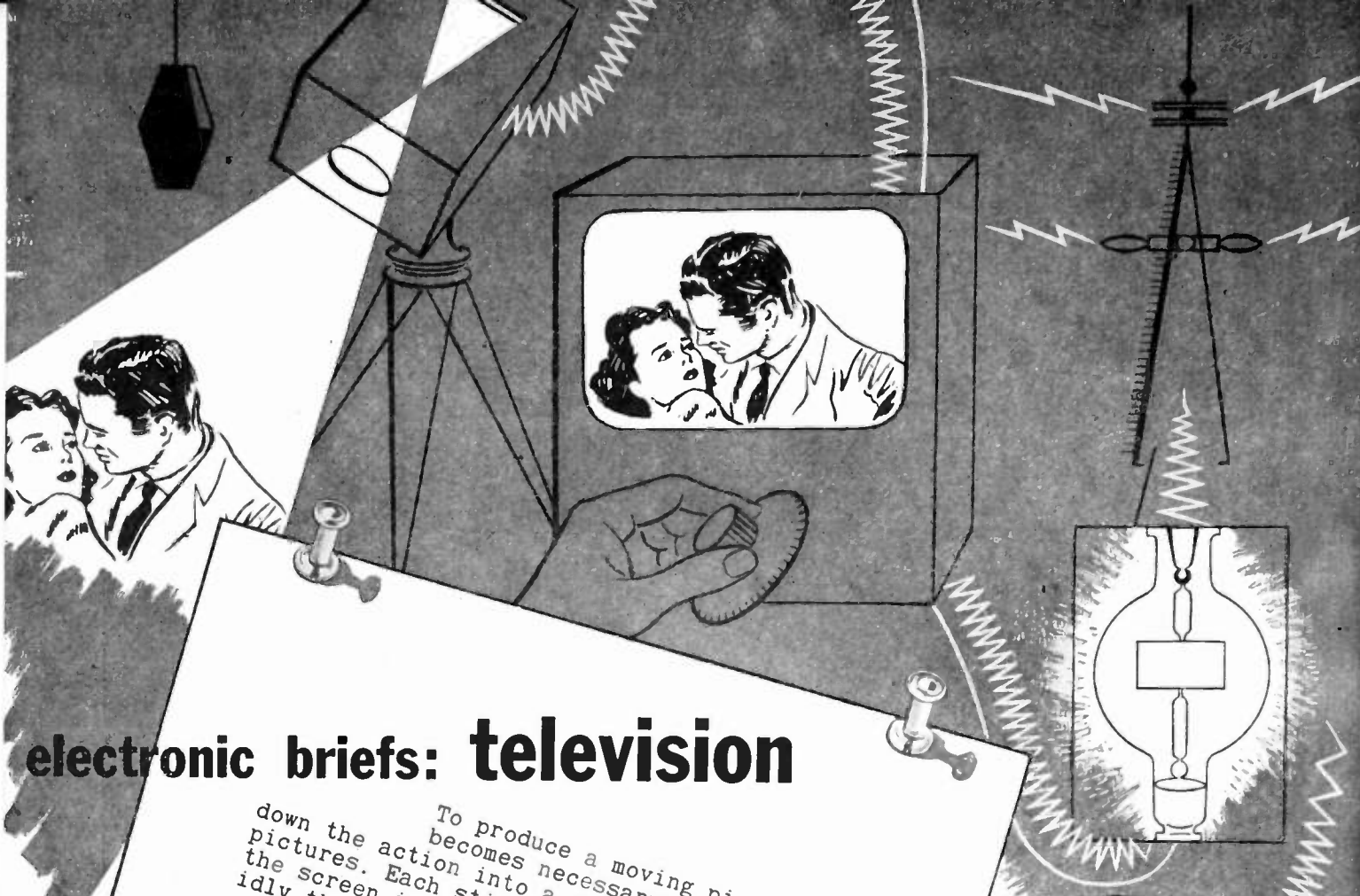

EITEL-McCULLOUGH, INC., SAN BRUNO, CALIFORNIA  
EXPORT AGENTS: FRAZAR & HANSEN, 301 CLAY ST., SAN FRANCISCO, CALIF., U. S. A.

Follow the leaders to



Army-Navy "E" flag awarded for high achievement in the production of war material.

**Eimac**  
REG. U. S. PAT. OFF.  
**TUBES**



EASTERN PLANT NO. 1



EASTERN PLANT NO. 2



MIDWESTERN PLANT NO. 3



## *3 Plants ... 2 Flags ...* **ONE PURPOSE**

To beat the band of Axis bandits, three Solar factories are now operating "round the clock". The men and women of Eastern Plants 1 and 2 were told "Well Done" by the Army and Navy; they proudly wear the Army-Navy "E".

The Midwestern Plant has just started production;

the men and women of this modern air-conditioned factory are ready to help you speed the day of Victory.

If your capacitor or filter problem is made ours, you can be certain of "Quality Above All".

Solar Manufacturing Corporation, General Offices:  
Bayonne, New Jersey.

*Solar* **SOLAR** **CAPACITORS**

CAPACITORS and RADIO NOISE-SUPPRESSION FILTERS



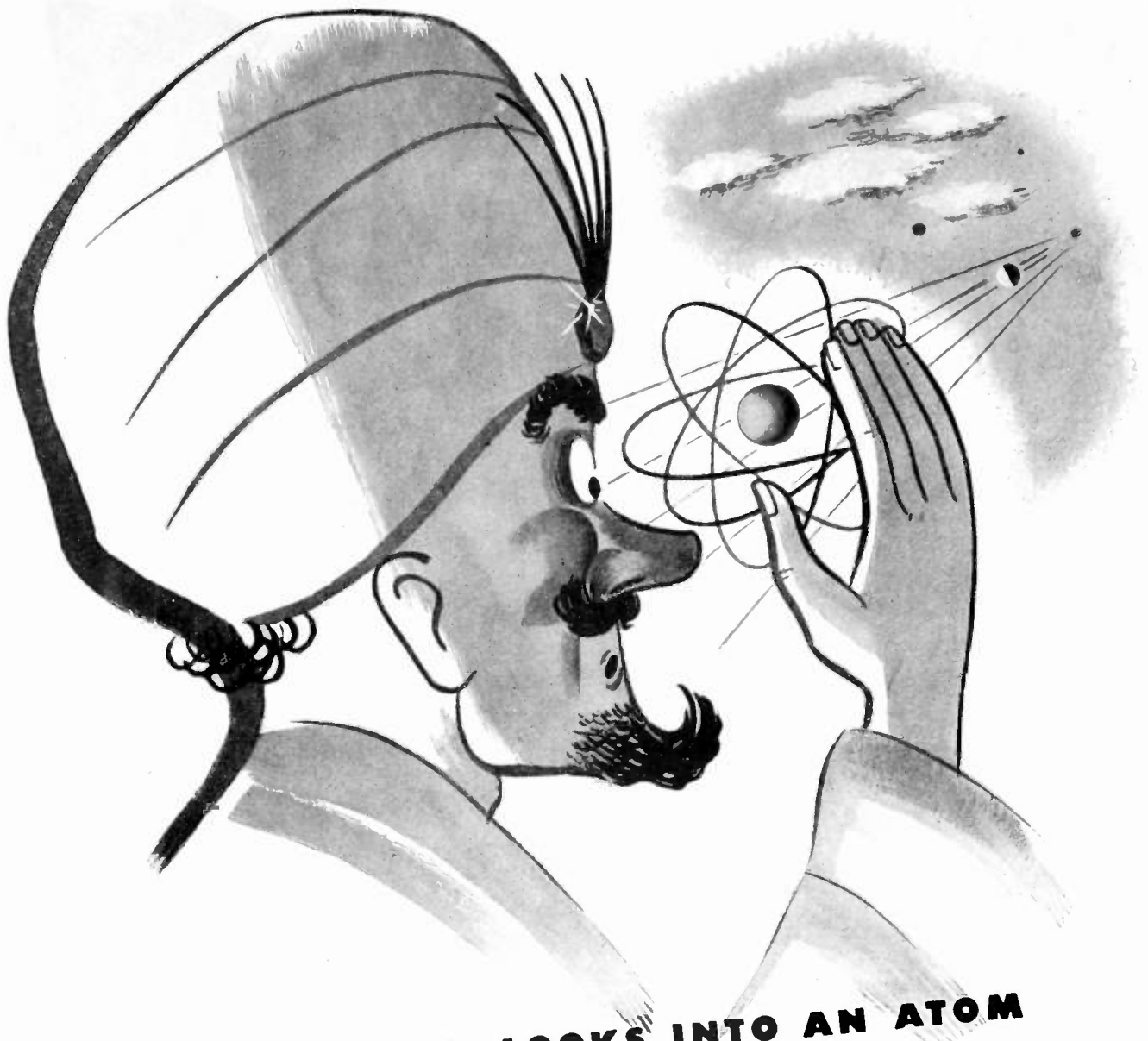

## THE CRYSTAL-GAZER LOOKS INTO AN ATOM

Hocus-pocus with a crystal ball has been replaced by the electron microscope . . . and a host of other devices . . . that really give us a vision of the future. Today's unpublished observations . . . censored by war secrecy . . . will be the basis for tomorrow's industry.

Stancor Transformers are now fighting the war with armies of electrons . . . speeding the energies of military communications. But Stancor engineers are looking ahead . . . through the clearer-than-crystal glass of scientific research . . . to the practical problems of the coming age of electronics.



# STANCOR

STANDARD TRANSFORMER CORPORATION  
1500 NORTH HALSTED STREET - CHICAGO

# Security posted



**M**ANY TIMES every day "surprise attacks" occur along your power line. Some heavy user momentarily stops operation. A sudden overvoltage slams like lightning into delicate machines, precision tools or precious vacuum tubes. You can't see these blitz attacks but you can't escape seeing the results—higher percentage of rejections, damage to sensitive instruments, premature failure of expensive electronic tubes.

*Every unit, however small, is responsible for its own security.* This cardinal rule of combat applies in production too. That is why, everywhere in industry, you will find SOLA CONSTANT VOLTAGE TRANSFORMERS on duty at important "out-guard" posts.

Sola "CVs" are especially designed to protect against surprise overload assaults. They will ab-

sorb voltage sags and surges as great as 30%—and still feed constant, rated voltage to your machines. Sturdy Sola sentinels ask no relief. Day and night, without care or supervision, they stick to their posts—instantaneous in action, without moving parts, self-protecting against short circuit.

Many vital points in your production system are vulnerable to attack. Secure them with Sola "CVs". SOLA CONSTANT VOLTAGE TRANSFORMERS are built in standard units from 10VA to 15KVA capacity, or in special units to your specifications.

**Note to Industrial Executives:** *The problems solved by Sola "CV" transformers in other plants and products may have an exact counterpart in your own. Find out. Ask for bulletin KCV-74.*

## Constant Voltage Transformers

# SOLA

Transformers for: Constant Voltage • Cold Cathode Lighting • Mercury Lamps • Series Lighting • Fluorescent Lighting • X-Ray Equipment • Luminous Tube Signs  
Oil Burner Ignition • Radio • Power • Controls • Signal Systems • Door Bells and Chimes • etc. SOLA ELECTRIC CO., 2525 Clybourn Ave., Chicago, Ill.





# “My Boy Owns This Place!”

*Some time ago I retired, just a good, old fashioned, real-American retirement . . . thought I had served my time and done my share.*

*When the war started I went back to work . . . a good tool maker can do a lot to help lick those fellows, you know. And it is fun to work for my boy. I'm proud of him and proud of America that makes men like him possible. He had the same start I had only now he owns this shop. And that is one of the things we are all fighting for—to preserve that American FREEDOM of opportunity.*

*Pardon me, I've got work to do now. When the war's over look me up—on the front porch.*



## hallicrafters

CHICAGO, U. S. A.



BUY MORE BONDS!

**SCHEDULED FOR DELIVERY  
SOME TIME IN 194?**

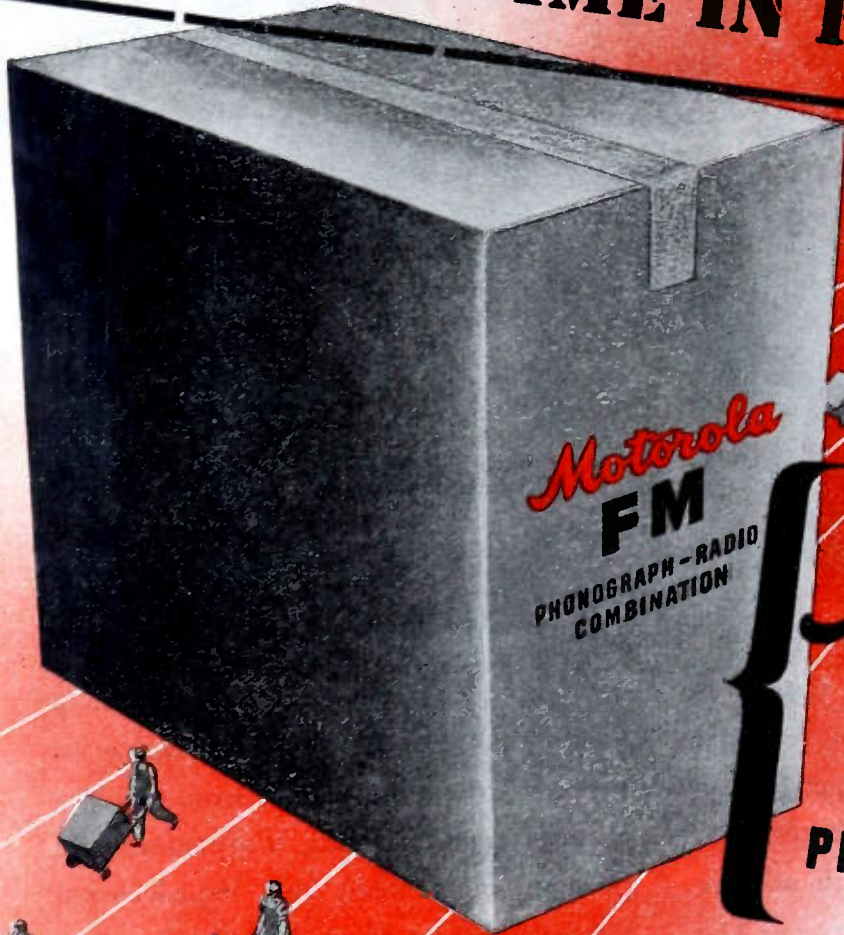

*Motorola*  
**FM**  
PHONOGRAPH-RADIO  
COMBINATION

A GREAT NEW  
*Motorola*  
**FM**  
PHONOGRAPH-RADIO  
COMBINATION

A new and distinctly better type of home radio combination was about ready to make its bow to the American public when war drafted the complete Motorola facilities. Had this static and noise-free F-M receiver been seen and heard by the general public, it would have aroused unqualified enthusiasm . . . whetted an appetite that will have to be satisfied when Peace once again releases electronic talents and

skills war-sharpened for radio's greatest progress and achievement. In the interests of national defense, Motorola is now delivering the finest in F-M emergency broadcast and receiving equipment. You may look for notable scientific developments in F-M radios from Motorola engineers. We can't say when . . . but we can say that no one will be ready sooner.

**Expect big things from Motorola!**



THE ARMY-NAVY "E"—Awarded for excellence in the production of Communications Equipment for America's Armed Forces

**Motorola Radio Communications Systems  
Designed and Engineered to Fit Special Needs**

**GALVIN MFG. CORPORATION • CHICAGO**





Revere, Wisniewski

**THE SKILL** *and* **THE WILL**  
*... today and tomorrow*

**O**nly one American in many thousands is privileged to wear the "E" pin, symbolic of high achievement on the production front. It symbolizes skill and determination above and beyond the high average standard set by American Industry. . . . The men and women of Connecticut Telephone & Electric Division have been honored by the Army-Navy Production Award twice in a period of six months. This symbol

of a job being well done in the cause of Victory is evidence, too, of what may be expected when the war is won. . . . The manufacturer seeking cooperation in product engineering and improvement, the development of production control, or any problem involving the application of advanced electrical or electronic knowledge, is cordially invited to discuss the matter with our engineering staff.



**CONNECTICUT TELEPHONE & ELECTRIC DIVISION**

MERIDEN



CONN.

© 1943 G.A.I., Inc., Meriden, Conn.

**DESIGN, ENGINEERING & PRODUCTION  
 OF PRECISION ELECTRICAL EQUIPMENT**



# CRYSTALS

*Any* **TYPE OF CUT  
AND FREQUENCY**

We have facilities for producing crystals to all temperature co-efficient and absolute frequency specifications. Our engineers have wide experience with all crystal types. In our Special Crystal Division we are ready to undertake NOW the development and production of any special and exacting crystal types that may assist you in the war effort. If it's "Rush" phone!

*Phone* **CRYSTAL SERVICE DIVISION  
PLYMOUTH THREE THREE**

**JOHN MECK INDUSTRIES**  
**PLYMOUTH, INDIANA**

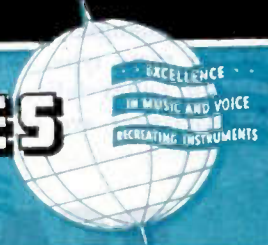

**ON THE JOB... TO KEEP BROADCAST STATIONS OPERATING AT FULL EFFICIENCY**



## **RCA REBUILT TUBES**

**A 100% SERVICE!**

Service facilities in charge of tube experts have been carefully geared to the task of rebuilding old tubes. Each Rebuilt Tube passes the same rigid tests applied to new

RCA Tubes of the same type. To date, it has proved possible to supply rebuilt tubes for 100% of the old tubes returned under the RCA Rebuilt Tube Plan!

### **RCA REBUILT TUBE PRICES\***

<b>RCA-207</b>	<b>RCA-891</b>	<b>RCA-891-R</b>	<b>RCA-892</b>	<b>RCA-892-R</b>
<b>\$233.75</b>	<b>\$242.25</b>	<b>\$298.50**</b>	<b>\$242.25</b>	<b>\$298.50**</b>

Net Sale Prices F.O.B. Shipping Point, Subject to Change or Withdrawal Without Notice.

\*Customer must return an equal quantity of RCA Tubes of similar types.

\*\*Price after allowance of \$50 credit for return of radiator.

From the commercial broadcast station standpoint, "RCA Rebuilds" represent the best news about Transmitting Tubes since war shortages on new tubes first became a threat to continued efficient operation.

Today, thanks to this RCA wartime emergency service to the broadcast profession, an old tube may be "down" but by no means out. If it is one of the five popular types covered by the RCA Rebuilt Tube Plan, it may be exchanged for an RCA Rebuilt Tube of the same type. What's more, these RCA Rebuilt Tubes deliver the watts! Ratings and characteristics are identical with those

of new tubes. RCA Rebuilt Tubes carry a new tube guarantee for workmanship and materials. Since they are sold at 85% of the new tube price, service is adjusted on the basis of 85% of our standard adjustment policy.

If your station uses any of the five listed Tube types, we suggest that you write today for full details on the RCA Rebuilt Tube Plan. Like other stations where many RCA Rebuilt Tubes are already in service, you will find it a logical answer to one of your most pressing wartime operations problems.



# **RCA ELECTRON TUBES**

RCA Victor Division, RADIO CORPORATION OF AMERICA, Camden, N. J.

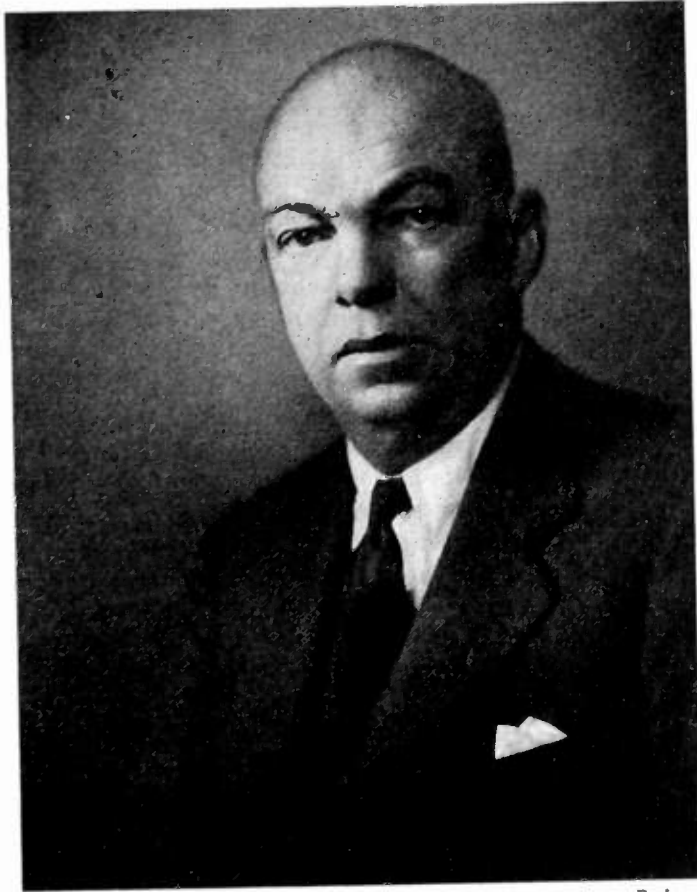

*Bachrach*

## Edwin Howard Armstrong

Edwin Howard Armstrong was born in New York City on December 18, 1890. In 1906 he entered the radio art as an amateur. Becoming a student at Columbia University, he received the degree of E.E. in 1913. This university also conferred the honorary degree of Doctor of Science on him in 1929. He was awarded the same degree from Muhlenberg College in 1941.

His professional career has been based since 1914 at the Marcellus Hartley Research Laboratory at Columbia University. Beginning as an assistant in the Department of Electrical Engineering, he next became a Trowbridge Fellow in 1915. From that date he worked as a collaborator of Professor Michael I. Pupin during the lifetime of that eminent scientist. Since 1934 he has been Professor of Electrical Engineering.

In 1912, while studying the action of the then little-used audio detector (three-element vacuum tube), he discovered the presence of high-frequency currents in its plate circuit. This discovery led to the invention of regeneration and the vacuum-tube oscillator. He then disproved the currently accepted theory of the action of the triode, and published the correct explanation in 1914.

In March, 1915, he presented the results of his work on regeneration before The Institute of Radio Engineers in a classic paper. The next year he presented a further paper describing an investigation which established experimentally the true nature of the detector heterodyne. In 1917, he was awarded the first Medal of Honor of the Institute for his work in regeneration and the generation of oscillations by vacuum tubes. Following an adverse decision by the Supreme Court of the United States on the question of priority of invention of these discoveries, Professor Armstrong returned the Medal to the Institute in 1934. The Board of Directors of the Institute thereupon unanimously declined acceptance of the Medal

and concurrently reaffirmed the original award.

From 1917 to 1919 he served overseas in the Signal Corps, A.E.F., first as Captain and then as Major. He was given the decoration of the Legion d'Honneur in 1919. In 1917 he invented the superheterodyne system of reception. In the same year, he first applied the master-oscillator type of transmitter to military communication. The superregenerative circuit was the next of his discoveries, in 1920.

His principal activity from 1914 to 1922 was a study with Professor Pupin of the problem of static elimination. The outcome of this work was unsuccessful. However, it laid the foundations of the invention of his system for reducing disturbances in radio signaling by means of frequency-modulation transmission and reception—a system described by him in a paper before the Institute in 1935.

He has been the recipient of numerous medals and awards including the Eggleston Medal of Columbia University in 1939, a National Modern Pioneer Plaque from the National Association of Manufacturers in 1940, the Holley Medal of the American Society of Mechanical Engineers in 1940, the Franklin Medal of The Franklin Institute in 1941, the John Scott Medal from the Board of City Trusts of the City of Philadelphia in 1941, and in 1943 the Edison Medal, highest award of the American Institute of Electrical Engineers. In 1935, the Radio Club of America, of which he was president for a number of years, established an award to be known as The Armstrong Medal.

He joined the Institute as an Associate in 1914, transferring to the grade of Fellow in 1927. He has been a member of its Board of Directors at various times, and has served as Chairman of the Awards Committee and as a member of a number of other committees.



POSTWAR PROBLEMS will differ in many respects from those of wartime. And in some ways, peace will bring more difficult and puzzling problems than did war. The conditions of a hard-won peace include more than the provision for a wide diversity and functional perfection of technical devices. These conditions involve as well social, economic, and political elements which are always of importance and sometimes controlling.

Thus the readers of the PROCEEDINGS OF THE I.R.E. will assuredly derive information and benefit from so searching an analysis of the postwar problems in the field of radio-and-electronic engineering as is here presented by one of the Institute's leading members—its present Secretary and its Past President, and Vice President of the Mackay Radio and Telegraph Company and of the Federal Telephone and Radio Corporation. The next step will be for the engineers and their Institute to translate into action the guiding principles and plans here set forth.

*The Editor*

## The Radio Engineer's Responsibilities of Tomorrow

Haraden Pratt

The professional engineer is inclined to be a creature devoted to details. He likes to work with tangible things and to be precise about them. If the factors he encounters in the exercise of his vocation cannot be evaluated in definite forms, he struggles to convert them into tangibles and tries to cancel out all the variables possible. He thus finds himself more often than not, dealing with specific jobs, each one a bit detached from the next, and believes his work well accomplished when a satisfactory result has been achieved allowing him to break off and start afresh on the next perhaps not too closely related problem.

But while busily meeting and overcoming such problems, radio engineers have been neglecting important overlying and contiguous phases of their profession. The proper conception of engineering goes far beyond detailed technical matters, and embraces factors which present very important and fundamental aspects concerning the personal relations of the engineer with his profession, and the relations of his profession with society generally.

Let us look a bit over the past: Radio started in the Maxwellian atmosphere of pure science. After the turn of the century the electron theory seized the stage of scientific fancy leaving the infant radio communication art to struggle on without much skilled assistance either from pure science or from that instrumentality of applied science called engineering. The sudden and tremendous subsequent growth of radio broadcasting and communications

provided the urge toward intensive engineering development of all kinds of equipment, which development signalizes our present-day progress. Very much neglected through these years, among other things, has been one of those important and fundamental aspects that perhaps might well be called, "methods engineering." With the ever-increasing quantity of tangible jobs done, resulting in an array of ingeniously and excellently developed apparatuses, a tremendous stock pile of golden building blocks is accumulating, with few capable available architects to mould them into unified and integrated structures, and still fewer civic planners to arrange aggregations of such structures into well-arranged and self-sufficient communities. The radio engineer very definitely has the job of applying science to practical business and in fulfilling it shoulders the basic responsibility in performing this special mission of bringing the results of technical achievement and business enterprise together, of trying to plan methods whereby future growths will develop in as orderly a manner as possible. If he does not accomplish this, economic forces will tend to control progress; and after large investments become involved, difficulties arise which prevent mankind from enjoying full benefits and a proper logical development becomes precluded.

The engineer cannot stop when he has produced facilities. He must sell the existence of the facts known by him to those that do not know as much about them as he does. The engineer is not so well known as a good salesman. He must now take up a new role and indefatigably point out how future growth and prosperity in his field can only be achieved by utilizing technical attainments to their fullest.

Radio and its allied fields are approaching a critical crossroads point in the continuing process of rapid evolution. The tremendous impetus that present conditions are making possible is causing the production of innumerable quantities of manifold varieties of building blocks, many of which are entirely new to us, both as to form and function, and which are capable of being used for edifices yet to be planned with designs yet to be evolved. Vision and imagination will not be lacking, but to build firmly and well, the engineer must now as never before, bear down resolutely and with determination, on the problem of dealing with variables on top of variables and doing job after job of "methods" and "system" engineering where delicately adjusted balances must be made between factual engineering matters and the more intangible economic and political factors. After all, the forte of the engineer is to "engineer" a proper fusion between science and the life of the people.

Here is where our professional society of the I.R.E. must go to work. The flood of radio-and-electronic instrumentabilities about to pour upon us cannot be dammed. If not controlled and diverted into ordered channels, it will seek its level wreaking along the way a toll of confusion and much disorder. Our Institute is the forum where the radio engineer can reach his brothers, and where all can foregather and forge their strength into an instrumentality of influence upon society. It is an educational institution in a very postgraduate sense. Like all educational organizations, the professional society tends to give primary attention to tangible matters shirking the intangibles, and all must work together, Directors and Officers as well as Members, to curb this tendency and utilize the strength of the Institute and the pages of its PROCEEDINGS to develop larger and broader points of view.

Science has brought powers to man such as he never had before. To a large extent these powers are uncontrolled. The engineer's training of using perceptive thought and the methods of critical planning give him a strength and hope which need only discipline and patience to overcome the existing confusions, and the way will gradually be cleared for further triumphs of control which will lead to the acquisition of still greater powers.

# THE INSTITUTE OF RADIO ENGINEERS

INCORPORATED



## SECTION MEETINGS

<b>ATLANTA</b> September 17	<b>CHICAGO</b> September 17	<b>CLEVELAND</b> September 23	<b>DETROIT</b> September 21	
<b>LOS ANGELES</b> September 21	<b>NEW YORK</b> September 1	<b>PHILADELPHIA</b> September 2	<b>PITTSBURGH</b> September 13	<b>WASHINGTON</b> September 13

## SECTIONS

- ATLANTA**—Chairman, C. F. Daugherty; Secretary, Ivan Miles, 554—14 St., N. W., Atlanta, Ga.
- BALTIMORE**—Chairman, G. J. Gross; Secretary, A. D. Williams, Bendix Radio Corp., E. Joppa Rd., Towson, Md.
- BOSTON**—Chairman, R. F. Field; Secretary, R. O. Oberg, Northeastern Univ., Boston, Mass.
- BUENOS AIRES**—Chairman, J. P. Arnaud; Secretary, Alexander Nadosy, Florida St. 1065, Dept. C-16, Buenos Aires, Argentina.
- BUFFALO-NIAGARA**—Chairman, F. H. Scheer; Secretary, A. J. Dybowski, Dymac Radio, Inc., 1531 Main St., Buffalo, N. Y.
- CHICAGO**—Chairman, A. B. Bronwell; Secretary, W. O. Swinyard, Hazeltine Electronics Corp., 325 W. Huron St., Chicago, Ill.
- CINCINNATI**—Chairman, Howard Lepple; Secretary, J. L. Hollis, 6511 Betts Ave., North College Hill, Cincinnati, Ohio.
- CLEVELAND**—Chairman, F. C. Everett; Secretary, Hugh B. Okeson, 4362 W. 58 St., Cleveland, Ohio.
- CONNECTICUT VALLEY**—Chairman, W. M. Smith; Secretary, R. E. Moe, Radio Dept., General Electric Co., Bridgeport, Conn.
- DALLAS-FORT WORTH**—Chairman, H. E. Applegate; Secretary, P. C. Barnes, WFAA-WBAP, Grapevine, Texas.
- DETROIT**—Chairman, F. M. Hartz; Secretary, E. J. Hughes, 14209 Prevost, Detroit, Mich.
- EMPORIUM**—Chairman, R. K. Gessford; Secretary, H. D. Johnson, Sylvania Electric Products, Inc., Emporium, Pa.
- INDIANAPOLIS**—Chairman, S. E. Benson; Secretary, B. H. Rinehart, 1920 Park Ave., Indianapolis, Ind.
- KANSAS CITY**—Chairman, H. K. Morgan; Secretary G. L. Taylor, Midland Radio School Power and Light Building, Kansas City, Mo.
- LOS ANGELES**—Chairman, Lester Bowman; Secretary, R. C. Moody, 4319 Bellingham Ave., North Hollywood, Calif.
- MONTREAL**—Chairman, L. T. Bird; Secretary, J. C. R. Punchard, Northern Electric Co., 1261 Shearer St. Montreal, Que., Canada.
- NEW YORK**—Chairman, H. M. Lewis; Secretary, H. F. Dart, 33 Burnett St., Glen Ridge, N. J.
- PHILADELPHIA**—Chairman, W. P. West; Secretary, H. J. Schrader, Bldg. 8, Fl. 10, RCA Manufacturing Co., Camden, N. J.
- PITTSBURGH**—Chairman, D. A. Myer; Secretary, A. P. Sunnergren, West Penn Power Co., Rm 1304, West Penn Bldg., Pittsburgh, Pa.
- PORTLAND**—Chairman, K. G. Clark; Secretary, E. D. Scott, Rt. 14, Box 414, Portland, Ore.
- ROCHESTER**—Chairman, O. L. Angevine, Jr.; Secretary, G. R. Town, Stromberg-Carlson Tel. Mfg. Co., Rochester, N. Y.
- ST. LOUIS**—Chairman, P. S. McDaniel; Secretary, H. D. Seielstad, 1017 S. Berry Rd., Oakland, St. Louis, Mo.
- SAN FRANCISCO**—Chairman, Karl Spangenberg; Secretary, David Packard, Hewlett-Packard Co., Palto Alto, Calif.
- SEATTLE**—Chairman, L. B. Cochran; Secretary, H. E. Renfro, 4311 Thackeray Pl., Seattle, Wash.
- TORONTO**—Chairman, T. S. Farley; Secretary, J. T. Pfeiffer, Erie Resistor of Canada, Ltd., Terminal Warehouse Bldg., Toronto, Ont., Canada.
- TWIN CITIES**—Chairman, E. S. Heiser; Secretary, B. R. Hilker, KSTP, St. Paul Hotel, St. Paul, Minn.
- WASHINGTON**—Chairman, C. M. Hunt; Secretary, H. A. Burroughs, Rm. 7207, Federal Communications Commission, Washington, D. C.



# Beyond the Ultra-Short Waves\*

G. C. SOUTHWORTH†, FELLOW, I.R.E.

*Summary*—This article reviews briefly the work done many years ago by the pioneering physicists with the so-called electric waves as well as the more recent efforts by engineers to put these waves to practical use. It also describes some of the expedients and changes of technic used to overcome difficulties as this work progressed to higher and higher frequencies. One, of fairly recent origin, is the wave-guide or hollow-pipe technic. The latter not only provides a simple and efficient way of propagating microwave power from one point to another but there have also grown from it some very interesting counterparts of the tuned circuits, the matching transformers, and the filters that have been in common use for some time at the lower frequencies. The possible bearing of this new technic on the future of electrical communications, as, for example, television, is pointed out.

OF THE many interesting trends that have developed in electrical engineering, perhaps none has been more spectacular than that toward the higher frequencies. No doubt many of the readers of this article remember when the term *high frequency* was used to distinguish 60 cycles from 25 cycles. At other times it was applied in a similar way to 500 cycles, to 1000 cycles and sometimes to the whole band of frequencies then used in ordinary telephony. With the advent of radio and the general appreciation by engineers that radio waves were a kind of offspring of alternating currents, this high-frequency frontier surged forward almost as a flood, quickly passing from kilocycles to megacycles and thence to tens, hundreds, and, more recently, to thousands of megacycles. The latter is well past the region of ultra-short waves and in the region sometimes referred to as microwaves.

Today the engineer pauses momentarily at an indefinite but nevertheless real frontier somewhere above 1000 megacycles. Naturally he is not the first to arrive on the scene. Those hardy pioneers, the physicists, have been here for years. The Cabots, the LaSalle's, and the De Sotos passed by more than a half century ago. Even the Lewis and Clarks, the Daniel Boones, and the Kit Carsons have long since come and gone. Perhaps it would be fair to say that the engineer is here as a kind of a homesteader. His is the very important task of breaking the primeval sod to sow the seeds that he hopes will place the countryside on a productive basis.

In the paragraphs that follow, an effort will be made to collect together some of the information left by the early explorers. It is hoped that this will serve as a rough homesteader's map that will show in a general way the boundaries of the territory and perhaps also some of its more important physical features. Engineering Baedekers for this region have not as yet appeared.

\* Decimal classification: R110. Original manuscript received by the Institute, February 17, 1943. Presented, Joint I.R.E.-A.I.E.E. Winter Conference, New York, N. Y., January 28, 1943.  
† Bell Telephone Laboratories, Inc., Red Bank, New Jersey.

## WHY MICROWAVES

Before proceeding with the task at hand, it may be well to review again the basic reasons for the trend toward the higher frequencies. It is almost axiomatic amongst communications engineers that the rate at which intelligence may be transmitted over a given facility, regardless whether this facility is some form of a wire line or radio, is more or less proportional to the width of the band of frequencies available. For example, ordinary dot-and-dash telegraphy transmitted manually, may call for a band of frequencies a few tens of cycles wide whereas high-speed telegraphy, such as sent by mechanical means, will call for a band several tens or even hundreds of cycles wide.

In a similar way, the bare essentials of telephone speech may be carried by a band a few hundred cycles wide whereas the finer qualities of naturalness may call for several thousands of cycles. In the case of television, we now know that even the bare essentials will call for a band of a million cycles while for good definition we shall probably want ultimately a band of 5 or 10 megacycles or even more.

As is generally known, it is possible to group several independent channels of communication together and transmit the whole over a single facility. For example, it has for some time been common practice to transmit over an ordinary telephone line alternatively either a single telephone conversation or ten or a dozen closely spaced telegraph channels. In a similar way, it is possible to transmit over certain kinds of lines either several telephone channels or a very much larger number of telegraph channels. With the very special kind of telephone line known as the coaxial cable this scheme has been stepped up the scale to include either a single television channel or several hundred telephone channels. In this case the number of possible telegraph channels would of course be very great indeed.

Extrapolating the above trend, it seems reasonable that sometime we shall likewise want to transmit several television channels over a single facility. Bearing in mind that each channel may need to occupy space comparable with the entire band which until recently was generally used for radio, it would appear that, if these lofty ambitions are to be realized, they will call for frequencies far beyond the frontiers now in general use.

It also happens that as we pass to the higher frequencies (shorter waves) it becomes feasible to build radio antennas of increasingly higher directivity, thereby conserving a very substantial amount of the power that is ordinarily wasted. Although these very short waves have definite limitations as regards

transmission to points far beyond the horizon, it is not impossible that for point-to-point work these limitations can be overcome, at least in part, by transmitting cross country from one tower top to another.

As contrasted with this still speculative use of radio there is another equally good prospect that a very special kind of line can be devised that will guide these same waves, rather efficiently, from one point to another, possibly over the horizon, and do this with relative immunity from interference and atmospheric noise. It is still too early to appraise completely the merits of these two schemes but it is probable that here, as in other parts of the frequency spectrum, radio and the transmission line will each have its own peculiar field of usefulness and the two together will be mutually complementary in accomplishing a useful result. In this connection it may be of interest that there are several good reasons to believe that regardless which of these two methods of transmission may be used, the same general range of frequencies and the same general physical principles will be utilized. It is possible also that there will be a remarkable similarity in the terminal apparatus finally evolved. The basic principles of some of these components will be discussed more at length later. It is perhaps sufficient if we note at this point that there is not only a potential need for these very high frequencies but there seems to be in the making a radically new electrical technic that appears to apply particularly well to the problem to be solved. This solution is of course one of the interesting engineering tasks that lie immediately ahead.

#### PIONEER HISTORY

As is generally known, the first pioneer in the experimental part of the microwave field was Heinrich

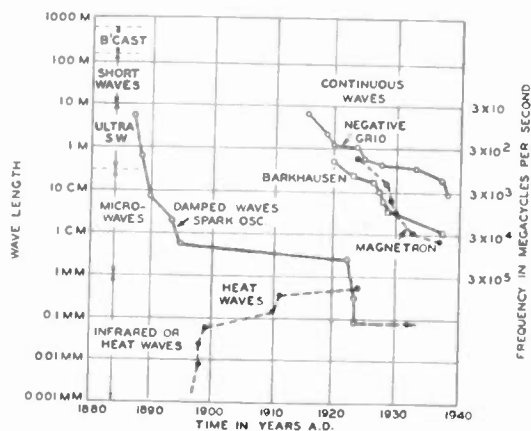

Fig. 1—Pioneer progress toward very short electromagnetic waves.

Hertz. Although his first experiments were conducted at a frequency of roughly 60 megacycles ( $\lambda = 5$  meters), which is somewhat below the range of frequencies under discussion, he later extended them to 500 megacycles ( $\lambda = 60$  centimeters). His work was one of the outstanding accomplishments of the time and as might be expected, many of his young contemporaries turned

to the interesting work which he had started. As he was overtaken early in life by a prolonged illness, much of his work was left for others to complete. He died in 1894 at the untimely age of thirty-seven. It is of interest that during his short life he not only produced and measured the first electric waves, but he also discovered the photoelectric effect. It is said, too, that during some experiments on discharges in gases he barely missed the discovery of X rays.

A detailed history of electric waves is quite outside the scope of the present article. It is, however, of interest that in the first decade following Hertz's discovery the frequency frontier was rather quickly extended from 500 megacycles ( $\lambda = 60$  centimeters) to 75,000 megacycles ( $\lambda = 0.4$  centimeter) whereas the further extension to 0.22 millimeter required almost thirty years. Fig. 1 shows as circles some of the dates and frequency limits reached in this early exploratory work. A complete record of the early work in microwaves would of course show a very large field of points most of which would lie above the limits specified in Fig. 1.

If one examines the history of the so-called optical waves he finds a very similar situation. Beginning at the high-frequency end of the spectrum, progress toward the lower frequencies was at first fairly rapid but later numerous difficulties were encountered. By the year 1900, far infrared frequencies of roughly 3 million megacycles ( $\lambda = 0.1$  millimeter) had been reached. In this case a further progress of only tenfold required a period of twenty more years. This is shown in a rough way by the dots in the lower part of Fig. 1.

The final closing of the gap between the infrared and electric waves remained for E. F. Nichols and J. D. Tear who succeeded in extending both frontiers as noted above until an overlap of approximately an octave was effected. More particularly, electric waves as short as 0.22 millimeter and heat waves as long as 0.42 millimeter were produced. Shortly afterward A. Arkadiewa working in Russia produced electric waves as short as 0.08 millimeter. In both of the latter cases the electric waves appeared as a kind of harmonic or as overtone components of somewhat lower frequencies. The power level was very low indeed.

During the decade following 1910 it appeared that Mother Nature had firmly entrenched herself in the narrow band between 0.4 millimeter and 4 millimeters and persisted in denying admittance to all oncomers. This is perhaps worth noting for it is quite possible that the region that resisted exploration will also resist exploitation.

As is generally known, all of the very early work in microwaves made use of spark discharges. According to this method, two small conductors, often closely spaced spheres, were charged by means of a static machine or an induction coil until breakdown occurred. At the time of breakdown, the path between the two spheres became semiconducting and the



configuration as a whole fell into oscillation. Although a fair portion of the total stored energy was probably dissipated as heat in the spark, there was a small but significant part left as radiation. In general, the wavelength was proportional to the dimensions of the conductors. Since the stored energy was also more or less proportional to this dimension, it is evident that the power radiated fell off rapidly as work proceeded to higher and higher frequencies. Since discharges were relatively infrequent, the sustained power was at best very low. The results were barely sufficient for the fundamental investigations then in progress and they offered little hope for any very interesting practical applications.

The need for simple sinusoidal oscillations in the microwave range was appreciated at a very early date. Soon after the development of the three-element tube, work was started toward extending its range into the higher frequencies but here the difficulties were also great. The conventional three-element tube having followed technics inherited from the manufacture of lamp bulbs was at best ill adapted to the task at hand. Then, too, there came a time when in spite of the close spacing of the various electrodes and the tremendous velocities with which electrons may travel, the latter were unable to cross from one electrode to another within the allotted time. With an appreciation of the nature of the difficulties and with appropriate modifications of structure, these, and other difficulties were temporarily overcome but they reappeared later at a slightly higher frequency again to challenge the ingenuity of the designing engineer. There are plotted as triangles in Fig. 1 some of the more important steps taken in extending the range of conventional negative-grid oscillators.

About 1920, Barkhausen, working with a particular type of vacuum tube then in use, in Germany, discovered that for a certain range of positive voltages on the grid and somewhat smaller negative voltages on the plate, he could produce small but nevertheless measurable oscillations. These were subsequently known as Barkhausen oscillations and they became the subject of considerable study not only in Germany but also in England, France, and America. By a suitable modification of the electrodes, frequencies of about 6000 megacycles ( $\lambda = 5$  centimeters) were produced by Kohl in Germany as early as 1928. There are plotted, as squares on Fig. 1, some of the steps taken in developing the so-called Barkhausen oscillations.

A third source of continuous oscillations is the magnetron. Proposed initially by A. W. Hull in 1921 it subsequently received considerable modification, notably by Habann in Germany and Hidetsugu Yagi and Kinjiro Okabe in Japan who split the anode into two or more parts and thereby obtained improvements in both frequency and power output. Although it offered considerable promise, it too ultimately en-

countered the same kind of difficulties as the positive- and negative-grid oscillators. Amongst other limitations, the physical dimensions of the component parts became so small that it was difficult to dissipate, in the small space available, the heat losses that were inherent in the device. Perhaps the highest frequency reported for a magnetron was the 50,000-megacycle ( $\lambda = 0.6$  centimeter) obtained by C. E. Cleeton and N. H. Williams of the University of Michigan in 1936. Some of the points reached in the development of the magnetron are shown as dots in Fig. 1. It is interesting to note that by 1936, this *continuous-wave* frequency limit had been brought to substantially the same point that had prevailed for damped waves forty years earlier. This again reflects the difficulties encountered in the development of continuous-wave sources, particularly at the higher frequencies.

Fig. 1 above is intended mainly to illustrate the *earlier* history of microwave sources. It omits several very interesting sources suggested within recent years, as for example the Klystron by the Varian brothers and similar devices by W. C. Hahn and G. F. Metcalf and another of a somewhat different kind by A. V. Haeff. These have not been included in Fig. 1 for the ultimate limits which can be reached by these devices are apparently not yet generally known.

The long trek of the early explorers into the microwave region, as evidenced in Fig. 1, has of course given us a useful even though limited preview of the region ahead. There remains however much that is very important to the engineer. In particular he needs to know the relative powers that may be obtained with these various devices, the facility with which intelligence-bearing signals may be impressed upon their output and recovered at the receiving end and perhaps a host of other questions. It is outside of the scope of the present article to discuss these matters except possibly to say that answers to certain of them have already been found and the way to some of the others seems assured.

#### LANGUAGE

As might be expected, the settlement of this new territory has made several new demands on the engineer's vocabulary and perhaps also on his point of view. The flora and fauna in this region are, so to speak, somewhat different than those found in other parts of electrical engineering.

Actually, of course, the differences between 60 cycles and 6000 megacycles are rather superficial, for the same fundamental principles underlie the entire field of electricity. The language difficulties, such as they are, appear only because at high frequencies there are certain features that are of great importance which at low frequencies are mainly of academic interest and are usually forgotten. On the other hand, there are certain other features important at low frequencies that may on occasion be overlooked at high frequencies.

It so happens that the phenomena that one observes at low frequencies can most simply be described as currents flowing in go-and-return conductors of a wire line. There may be an occasion to refer also to lines of magnetic force but in so doing it is common to consider such lines as merely incidental to the flow of current. In certain of these branches of electrical engineering there is little occasion to use the idea of lines of electric force. Indeed there is sometimes a tendency to regard lines of electric force as a mysterious entity that becomes of importance only when high-voltage power tries to leap over insulators.

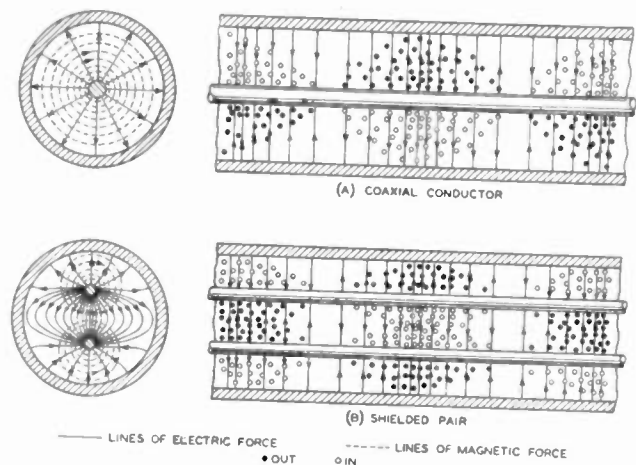

Fig. 2—Approximate configuration of lines of electric and magnetic force in a coaxial conductor and also in a shielded pair of conductors.

As contrasted with low-frequency phenomena where the current concept is so very useful, microwave phenomena often call for a point of view in which the flow of currents is relatively unimportant and both the magnetic and electric fields are extremely important. In fact, it becomes very difficult, if not impossible, to describe microwave phenomena without the concept of lines of force. According to this viewpoint the lines of electric force and lines of magnetic force are so intimately related that they may at times be regarded simply as different aspects of the same thing. As further evidence that the current concept may not always be adequate, it should be noted that there are certain cases in microwave technic where the type of circuit, containing ordinary go-and-return conductors, virtually ceases to exist.

In explaining microwave phenomena, it is convenient to regard the transmission of power along a wire line as taking place through the space between the conductors and not through the conductors themselves. In this respect the conductors are relegated to the less spectacular but nevertheless important role of guiding the wave power residing between the wires from one point to another. This concept seems to hold regardless of whether the frequency is 60 cycles or 6000 megacycles. In fact, it is possible in both cases to specify the power very simply in terms of the intensi-

ties of the electric and magnetic fields prevailing between the conductors and the velocity at which the configuration is propagated along the line. This principle, which was first proposed by J. H. Poynting of the University of Birmingham, is so general that it applies not only to transmission along wire lines but to radio transmission and also to a relatively new form of transmission to be described very shortly.

To illustrate the point in question there are shown as Fig. 2 the electromagnetic-wave configurations corresponding to transmission along both a shielded-pair transmission line and also along a coaxial-pair transmission line. In both cases there are shown the relative directions of the electric force, (solid lines) and the magnetic force (dotted lines). The Poynting vector which represents the flow of power is perpendicular to both the electric and magnetic force. It therefore lies parallel to the conductors themselves.

#### EXPERIMENTAL TECHNICS

As the engineer has pushed his way upward to ever-increasing frequencies, he has found it necessary to modify his methods from time to time. There are various ways by which this may be exemplified but perhaps the best is the matching of one impedance to another. Several of these modifications are shown in Fig. 3 together with a logarithmic scale of frequency extending up to the light frequencies. At low frequency, a matching unit usually takes the form of the conventional iron-core transformer. The iron, amongst other things, permits us to use smaller structures and therefore less copper than might otherwise be possible. (See Fig. 3(A).) As we proceed to higher frequencies there may be occasion to remove the iron core, but still we keep the coils. In this region the phenomenon of resonance is in many cases avoided.

Continuing to still higher frequencies there may be occasion to invoke resonance in order to bring about matching and, accordingly, capacitances are often connected across both the primary and the secondary coils. (See Fig. 3(B).) Continuing still further into the region of high frequencies, both the coils and condensers become progressively smaller until at some point near that at which Hertz first worked, i.e., 100 megacycles, they become inconveniently small. In this case, the complete transformer, including the two coils and condensers, if it were practicable to build them, might be placed inside a large sewing thimble. Obviously, devices of this kind can hardly be expected to dissipate very much power. Also numerous difficulties are encountered when it becomes necessary to connect these small elements to other devices such as vacuum tubes. The necessary connecting wires themselves introduce reactances comparable with those of the coil and condenser and comparable with the circuit element to which it is to be connected.

At this point the outlook might appear very dark indeed if it were not feasible to invoke another slightly

different technic almost as old but not as thoroughly exploited as that of the simple resonant circuit. It was first used by Hertz, Lecher, and other early workers in microwaves more than fifty years ago and more recently by development engineers working in the practical side of this field. Although often referred to as the Lecher-wire circuit, it is in reality an electrically long transmission line on which standing waves are set up. (See Fig. 3(C).) Since the phenomenon of standing waves is a kind of resonance we may obtain with such a Lecher circuit most of the necessary reactance

At this point the engineer, finding himself confronted with the problem of radiation, adopts the simple expedient of reshaping one of the two conductors of his Lecher frame into a hollow metal cylinder that completely encloses the second conductor and also the power residing between the two as shown in Fig. 3(D).

Although the refinements just mentioned eliminate radiation and suffice for a certain range of frequencies, there soon comes a time when other difficulties of one kind or another are encountered. One of the more important of these difficulties is that of power losses

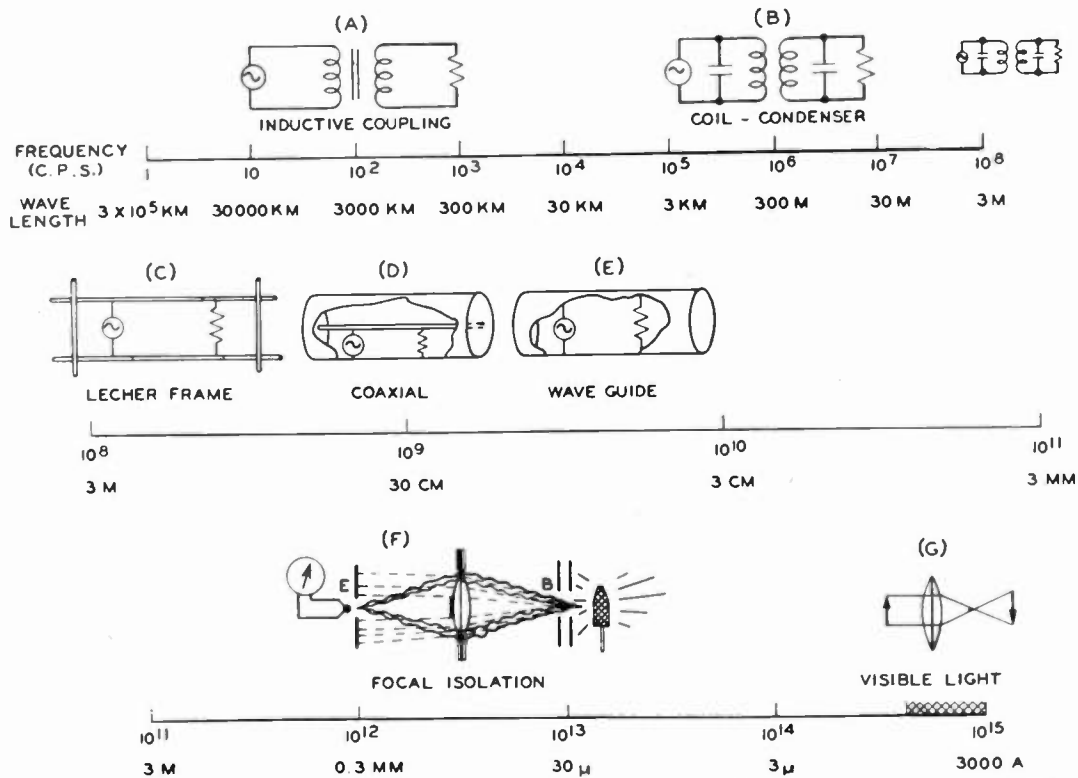

Fig. 3—Methods of impedance matching representative of various regions of the frequency spectrum.

effects necessary for providing a match. An important feature is that this is done with an arrangement of sizable dimensions. Fig. 3(C) is a schematic representation of but one of several possible Lecher-frame coupling units.

Although this arrangement works very well for a certain range of frequencies, there comes a time when even this scheme encounters serious difficulties. One, in particular, is radiation. The latter is the property of a circuit by virtue of which a portion of the resident power detaches itself and is lost to the surrounding space. Under many circumstances this is, of course, a very useful property for without it radio would not have been possible. It turns out, however, that at the higher frequencies radiation arising in rather unexpected places in a circuit may become so prominent as to be a problem. As will be readily appreciated, radiated power is equivalent to power dissipated in a resistance and hence has the effect of reducing the sharpness of the resonance effects. In the parlance of the engineer it reduces the  $Q$  of the circuit.

within the resonant chamber itself. For instance, the metal conductors, no matter how heavy we make them, consume a fair amount of the total power. Another even more important loss is that due to any insulators that may be necessary for supporting the central conductor. Losses in the tuning element shown are particularly deleterious for the standing-wave principle by which we effect a match, implies a repeated excursion of waves back and forth through the resonant chamber.

The load shown as a resistance in Fig. 3(D) is merely schematic. It may for example be a relatively long coaxial line leading to another sink of power some distance away, perhaps matched to the coaxial line by another similar resonant transformer. When a coaxial line is to be connected to a resonant chamber the outer conductors are joined in the usual way. The central conductor may either protrude a short distance into the chamber or it may be given a short loop and be joined to a near-by point on the inner wall of the chamber. The connecting line between the two resonant



chambers suggested above will also involve losses, particularly if its length is considerable. True enough, some further improvement may be had by a proper choice of materials but these are merely the improvements that result from good engineering and should not be considered at this time. It should be pointed out in passing that the difficulties just mentioned become particularly critical as the wavelength and hence the physical dimensions of the various elements become smaller. Anything we may do therefore that will tend to simplify the over-all structure and perhaps enlarge it relative to the wavelength, will be of help.

At this point it will be only natural for the engineer to start an appraisal of the total losses of his system. As already mentioned, the insulator losses are usually very considerable and anything that can be done to reduce their number will represent a very definite improvement. A further appraisal of the various conductor losses shows that in a coaxial system, by far the greater loss lies in the central conductor. They may readily be several times those associated with the surrounding cylinder. Therefore if we are to have further improvements in the  $Q$  of the circuit we should preferably look both to the central conductor and to the insulators. If by chance a way can be found to eliminate the central conductor, we can of course get rid of the insulators also. Such a venture will of course be radical for by it we are seemingly throwing overboard the idea that the go-and-return conductor is a necessary requisite for the transmission of power. Since this takes us into methods rather different from those commonly used in electrical engineering, it will be necessary to digress for a time from our principal theme. However, for the sake of completeness there is in Fig. 3(E) a schematic arrangement that might be expected to result from such a change. Its explanations must be left for later paragraphs.

Also for the purpose of completeness, there are shown on the lower portion of this chart schematic arrangements of two methods used in optics. The one to the right is a simple lens arrangement with object and image. This is assumed to represent methods typical of the visible part of the spectrum. At the left is an extremely interesting method used by R. W. Wood of Johns Hopkins University perhaps thirty years ago to segregate long-wave components from the heterogeneous radiation from the Welsbach mantle. It depends for its action on the fact that the refractive index of quartz for wavelengths of around 0.1 millimeter is about 2.2 whereas that for the shorter waves is very much smaller. A lens made of quartz is so located relative to screens  $B$  and  $E$  that for long-wave radiation the two are at conjugate foci. Owing to the fact that the index of refraction for the shorter-wave components is relatively small, these rays actually diverge after leaving the lens. The relative ray paths of the two components are shown respectively as wavy lines and dots.

In order to prevent the small amount of short wave radiation from passing directly through the lens and reaching the hole in screen  $E$ , a piece of foil  $D$  is fastened to the center of the quartz lens. A sensitive thermocouple and meter placed at the second iris shows the relative long-wave power. To test whether the short waves have been completely eliminated, a plate of rock salt is introduced in front of screen. The latter is transparent to the shorter waves but is opaque to waves a few tenths of a millimeter in length. If the deflection drops to a very low level we can be reasonably sure that no very considerable amount of short-wave radiation is present. Sometimes two stages of focal isolation are necessary in order to obtain the desired high purity of waves.

#### NEW MECHANISMS OF ELECTRICAL TRANSMISSION

After more than a century of wire-line transmission and upwards to fifty years of radio one might reasonably ask if there could be any other mechanisms of electrical transmission besides radio and wire-line transmission now used by the engineer. Indeed the study of electrical transmission, conducted as it has been, by the means of both mathematics and physics, has told so comprehensive a story as almost to preclude such a possibility. Nevertheless there are several such possibilities. They have for convenience been grouped into a single class and called wave-guide transmission. All of these newer mechanisms are peculiar to very high frequencies, much higher in fact than have, until recently, been used in any practical transmission system. They are, therefore, of particular interest to the microwave field for by this technic we are again able to extend very materially the range of frequencies with which the engineer may work.

In this newer form of transmission, the guiding structure may take any one of several different forms. In one case it may be a hollow metal pipe which with the present state of development may be two or three inches in diameter. In other cases it can be a somewhat smaller pipe filled with a low-loss dielectric, while in a third it may conceivably be merely a wire of dielectric with no metal whatever present. This form of transmission is not peculiar to circular guides. In fact there are many circumstances where rectangular guides are preferable.

The several different mechanisms suggested above refer to possible modes of transmission. They differ amongst other ways by the orientations of the lines of force which go to make up the wave front and also by the dimensions of guide necessary to propagate the waves. The smallest diameter of pipe for a given mode varies inversely as the frequency and also inversely as the square root of the dielectric constant of the internal medium. For one particular mode, for which a considerable amount of experimental work has already been done, the diameter must be at least 0.585 wavelength. If a rectangular pipe is chosen the larger

dimension must be at least 0.5 wavelength. A little calculation shows that wavelengths of a few centimeters are needed for guides of practicable dimensions.

MODES OF WAVES

The configurations of four of the more important modes or types of waves that may be transmitted through a guide are shown in Fig. 4. Time does not permit us to discuss these waves in great detail except to say that both the one designated as  $TE_{11}$  and that designated as  $TE_{01}$  appear, at the moment, to be most useful. The latter, which is better known as the *circular electric wave*, has one very interesting characteristic. Theoretically, at least, a wave of this type when propagated through a circular metal pipe of a given diameter suffers progressively less attenuation as the frequency is indefinitely increased. This suggests, vaguely at least, that sometime we may be able to

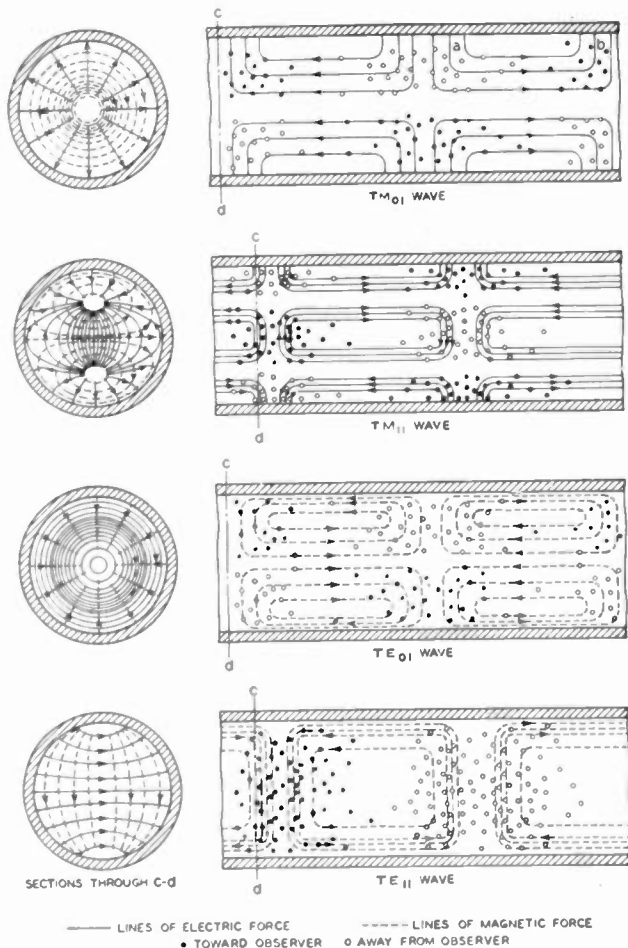

Fig. 4—Approximate configuration of lines of electric and magnetic force for four types of waves that may be propagated in a wave guide.

obtain very low attenuations merely by increasing the frequency. The former mode which is now generally known as the *dominant wave*, is of even greater interest, partly because it can be maintained in a smaller pipe than the others and partly because it can easily be adapted to a great many projects for which we now have practical use. Because of its immediate interest,

all discussions that follow will relate to this type of wave.

FUNDAMENTAL PROPERTIES OF WAVE GUIDES

A wave guide, like an ordinary transmission line, has a definite velocity of propagation, a characteristic impedance, and an attenuation. Although these quan-

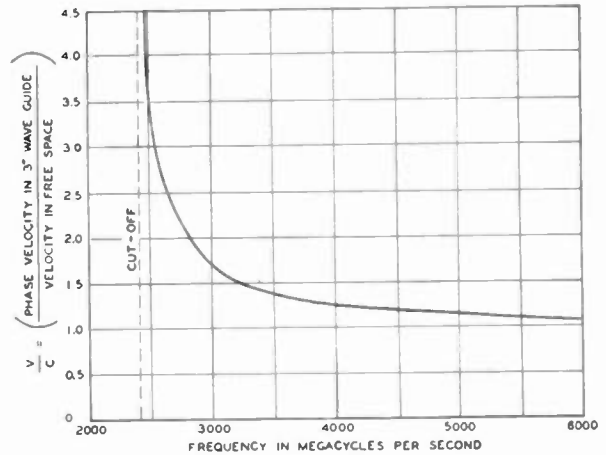

Fig. 5—Relative phase velocity of the transverse electric wave propagated through a three-inch hollow metal pipe.

tities are amenable to calculation, their expressions are somewhat involved. For this reason they can perhaps best be shown in graphical form for some very reasonable set of conditions that might be encountered in practice. This is done below for two of these quantities. For instance, Fig. 5 shows the relative phase velocity of propagation of the dominant or lowest-order wave at various frequencies, for a hollow metal pipe 3 inches in diameter.

It will be observed that at frequencies above a certain very definite critical or cutoff limit, the phase velocity drops from infinity, first very suddenly and then more slowly and approaches the velocity of light as its asymptotic limit. This, it must be remembered, is a phase velocity and not the velocity at which energy is propagated. There is no violation of the accepted views concerning the optimum velocity of propagation of energy. It may be of interest to know that this relationship has been checked experimentally over a considerable range of frequencies and that the two have been found to agree within a small fraction of 1 per cent.

The attenuation offered by a wave guide has been calculated for a considerable range of frequencies and this result has also been checked experimentally. Fig. 6 gives typical results not only for a wave guide but also for two particular types of coaxial conductors that might be used in microwave work. Curve A refers to the dominant or lowest-order wave in a 3-inch diameter copper pipe. It will be observed that the attenuation is infinite at cutoff but falls rapidly to a minimum at a frequency which turns out to be 3.18 times the cutoff frequency, after which the attenuation increases more or less linearly.

Curve *B* of Fig. 6 refers to the corresponding attenuation for a coaxial line having for its outer conductor the same 3-inch pipe assumed in curve *A* and for its inner conductor a diameter that will give a minimum

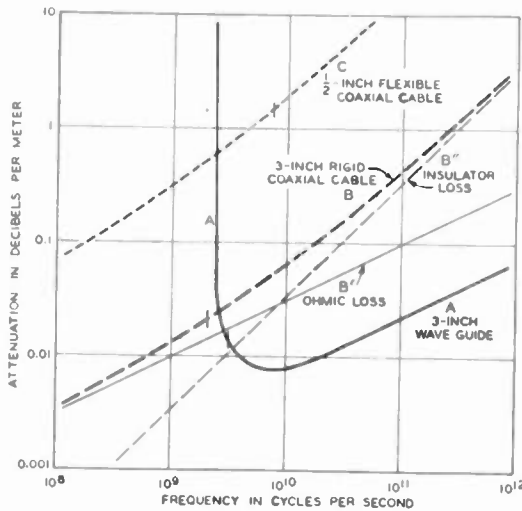

Fig. 6—Relative attenuations suffered by electromagnetic waves propagated through a wave guide as compared with the attenuations through two representative coaxial cables.

of attenuation. An allowance has also been made for insulator attenuation. For this case, the conductor and insulator attenuations are separately shown. This proportioning of diameters would presumably represent one of the better coaxial lines that might be used for microwave work. Such a line would obviously be more complicated than the corresponding wave guide and also more expensive.

A comparison of curves *A* and *B* shows immediately that for the lower frequencies the coaxial line is by far the better. In fact the wave guide is altogether unsuitable for very low-frequency work. At high frequencies, on the other hand, the guide is to be preferred. It happens that this matter is somewhat more involved than might at first sight appear. In particular, when the guide is used at frequencies where the lower attenuations may be realized, certain higher-order waves such as already described may appear. The position of the first is noted by a transverse line on curve *A*. Although these higher-order waves need not necessarily appear, the engineer will in many instances prefer to operate his guide at frequencies where the higher-order waves cannot be sustained.

It so happens that higher-order waves may also appear on coaxial lines. In fact they can accordingly occur at lower frequencies than for wave guides. This is shown by the transverse mark on curve *B*. It is evident, therefore, if we are to use coaxials for microwave work, we should not make them too large. This suggests that in practice we are not likely to realize quite as low attenuations as are indicated by curve *B* of Fig. 6.

One of the limitations of the wave-guide type of line is that, for most circumstances, it must be a rigid in-

flexible pipe. The coaxial just described is also of this kind. However, it is possible with a coaxial line to make the diameter of both the outside and inside conductors small and separate the two by some kind of a continuous low-loss insulator, thereby obtaining a measure of flexibility.

A semiflexible coaxial of this kind would need to be kept to a diameter of perhaps one-half inch and perhaps be made of woven conductor. Curve *C* of Fig. 6 shows the calculated attenuation of a one-half inch coaxial with a 1/16-inch diameter inner conductor assuming the woven outer conductor is as good electrically as solid material. This, of course, is by no means true. One of the better dielectric materials is assumed. It is fairly evident that we have paid dearly in attenuation for the flexibility feature. By the use of a small coaxial we have, of course, raised somewhat the limits at which higher-order waves may appear.

### SOME APPLICATIONS OF WAVE GUIDES

It will be recalled that an ordinary two-conductor transmission line may be used in three rather fundamental ways.

- (1) It may be used to propagate power from one point to another.
- (2) It may radiate power.
- (3) It may support standing waves and thereby provide the resonance phenomena so useful in effecting matches between sources and sinks of power.

It is interesting that wave guides exhibit these same three rather fundamental properties and they can be used in the same corresponding ways all with certain outstanding advantages. The reactive property will be chosen as an example for it is particularly versatile in its application and it relates to the general picture shown in Fig. 3.

In carrying the reactive property into practice, use is made of arrangements that are strikingly like the resonant air columns or organ pipes so familiar in acoustics. In principle they are also similar to the resonant transmission lines or Lecher wires already mentioned.

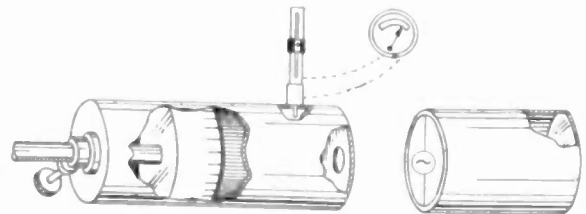

Fig. 7—Chamber suitable for demonstrating electrical resonance.

One very simple approach to this subject is to imagine a short section of circular wave guide such as described in connection with Fig. 7. To be specific, assume that it is 3 inches in diameter and 8 inches long and that it is closed at one end by a tightly fitting metal piston and closed at the other by a circular



metal plate with an iris opening perhaps an inch in diameter.

It is quite apparent that any small increment or pulse of power such as produced by a spark discharge, upon entering the iris, will be propagated along the guide and be reflected first by the piston and then by the iris plate, successively, until the energy is dissipated either in the metal walls or has escaped through the iris back to the outside space. Such a device is therefore a kind of an electrical echo chamber in which there is a very substantial amount of electrical reverberation.

If the iris is too small, very little power can enter but once inside the power will probably reverberate longer before being completely dissipated. If the iris is large it is obvious that the opposite will be true. It is fairly evident that the period of these echoes will depend both on the velocity of propagation within the guide and on the distance from iris to piston. The rate of decay will depend not only on the iris diameter but also on the attenuation imposed by the material of the guide.

Suppose next that we replace the pulse by a source of sinusoidal wave power of a given frequency  $f$ . It is fairly obvious that as we adjust the piston there will be certain lengths of the chamber at which a kind of resonance will be produced. In general resonance will appear at positions of the piston corresponding to one-half wavelength as measured within the guide. To the source which in this case is assumed to be located at the iris, the chamber will appear as a kind of a resonant circuit consisting of a coil and condenser in series with the source and in tune with the applied frequency. Since the velocity within the guide is in general greater than that of light, the dimensions of such a resonant chamber will be greater than for the corresponding Lecher-wire system. This is often an advantage, particularly where the frequency is so high that the Lecher-wire arrangement is inconveniently small.

At another adjustment of the piston, we may picture a condition where the wave power reflected by the piston arrives at the iris in a phase that will oppose the wave power about to enter. Under this circumstance the chamber behaves somewhat like an antiresonant circuit, that is, a resonant coil and condenser connected in parallel with the source. The first case probably looks to the source like a low impedance and the second like a high impedance. At intermediate adjustments we may, of course, get intermediate effects. It would appear, therefore, that we have at our disposal the counterpart of the simple coil and condenser and that we may derive from it many of the effects familiar in electrical communications. Perhaps the most obvious application is that of a wavemeter. Its accuracy will naturally depend on its sharpness of resonance. Wavemeters of this kind have been built and they are very useful.

If we could take appropriate measuring apparatus

inside the resonant chamber, we should find near the reflecting piston a region where the resultant electric intensity is very low. If the conductivity were infinite this intensity would actually be zero. At this point, however, the magnetic intensity is a maximum. This implies that in the adjacent wall, very high currents are flowing and that this is a region of low impedance.

At a point along the guide a quarter wave removed from the piston we should find another plane in which the electric force is a maximum and the magnetic force is very small. It is convenient to regard this as a region of high impedance. Although this simple picture may not be quite correct it is nevertheless true that the first is a region where a mass of low-resistance material would tend to absorb power readily while the second is a region where high-resistance materials would absorb best. At intermediate points along the standing wave we should presumably be able to locate materials of intermediate resistivity and to expect absorption. Under this circumstance it is convenient to regard the resonant chamber as a kind of transformer that matches the absorber to a source of power, the source in this case being the iris through which power is entering the chamber.

If what has been said is true, it should be possible to place the resonant chamber together with its absorbing element at the end of a wave guide and thereby terminate the line in its characteristic impedance. This is true and it can be verified very readily. It is of interest that it is possible to replace this type of termination with a properly proportioned horn and obtain the same result. It would appear that merely by flaring the end of the pipe into a horn it had aided the wave power to escape. In the latter case it is convenient to think of the radiator as a kind of transformer that matches the guide to the outside medium.

#### MEASURING THE MATCH

It will be remembered that one of the criteria of termination in an ordinary transmission line is the absence of reflection. Since a reflected wave together with its corresponding incident wave gives rise to a standing wave, we may say that freedom from standing waves is also a criterion for termination. One of the more useful instruments of the wave-guide technic is based on this principle. This device is known as a standing-wave detector and it enables one to tell whether or not a line is properly terminated merely by measuring the relative magnitudes of the maxima and minima in the standing wave.

The right-hand portion of Fig. 8(A) shows in a rough way a standing-wave detector. It consists of a probe which reaches into the wave guide and extracts a small amount of the passing-wave power and impresses the same on a crystal detector where a continuous electromotive force is produced. The latter actuates a near-by microammeter giving readings that may be made more or less proportional to power. The probe is made free

to move along a longitudinal slot in the wave guide to indicate the existence of any standing waves that may be present.

If the probe of the standing-wave detector, which, let us say, follows the square law, is moved along the

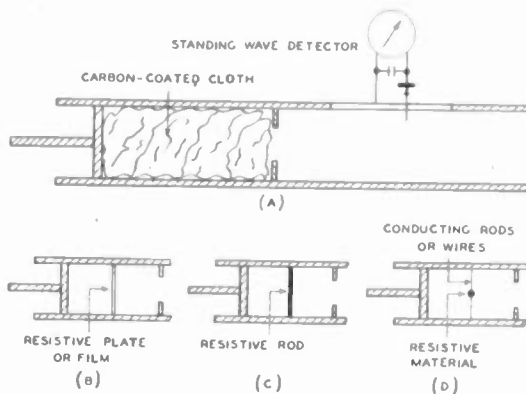

Fig. 8—Possible methods of terminating a wave guide in its characteristic impedance.

slot until the maximum of standing wave is found, we may say that this reading is proportional to the square of the sum of the incident and reflected amplitudes. If it is shifted to a minimum, the new reading represents the square of the difference between the incident and reflected amplitudes. We may calibrate such a detector and thereafter be in a position to measure power. Also we may, if we like, deduce from these readings the reflected power and also the coefficients of transmission and reflection.

It is fairly obvious that the standing-wave detector may be used not only to tell when a line is terminated in its characteristic impedance but also to detect the presence and nature of discontinuities that may unwittingly have been introduced into a line. Fig. 9 shows one of several practicable forms which such a standing-wave detector may take.

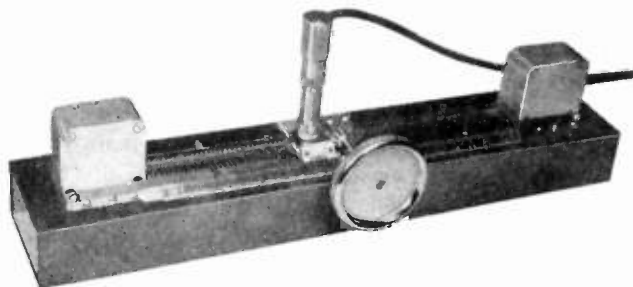

Fig. 9—Standing-wave detector suitable for measuring the nature and magnitude of electric discontinuities in a wave guide.

Referring again to the resonant chamber, let us enclose in the chamber some absorbing medium as shown in Fig. 8(A). It is convenient to regard the whole as an impedance made up of a reactance and a resistance. We may fairly say that the absorber which, let us say, is a mass of carbon-coated cloth represents the resistance component and the chamber the reactance component. Presumably the latter may by proper adjust-

ment be made to present to the line to which it may be attached either a negative reactance or a positive reactance as the nature of the line may dictate. As a laboratory exercise, it is not at all difficult to find adjustments of iris diameter and piston setting to effect a degree of match such that the minimum readings are at least 95 per cent of the maxima.

In considering further the resonant chamber and its absorber, it is not difficult to see how reflected waves passing repeatedly back and forth through the semi-conducting medium will finally be absorbed. It is only slightly less obvious that the mass of cotton could be replaced by a thin disk of semiconducting material placed in a transverse position across the guide as shown in Fig. 8(B). It is not at all obvious however that it can be replaced by a thin rod of resistance material connected across the diameter of the chamber as shown in Fig. 8(C). However, this turns out to be the case. Finally it would seem extremely unlikely that a tiny particle of resistance material connected as shown

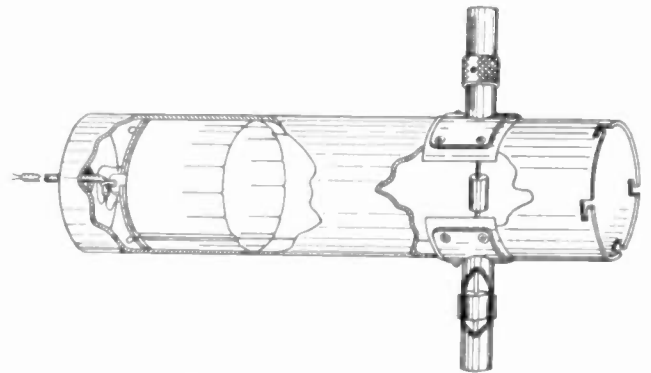

Fig. 10—Receiver suitable for wave-guide use.

in Fig. 8(D) could gather all of the energy entering the chamber but it turns out that this also can be done. This fact is very important from the engineer's point of view for it enables him to impress substantially all of the wave power received from a wave-guide line onto a small object like a crystal detector or other element and thereby derive from the wave all of the signal characteristics that may have been transmitted.

#### THE RECEIVER

The step-by-step reasoning followed in Fig. 8 has led ultimately to the rudiments of a receiver. Although the piston-iris arrangement is very suitable for explanatory purposes, there are other arrangements more convenient for practical use. Fig. 10 shows an arrangement of this kind. In this particular case the iris has been replaced by two coaxial tuners connected to opposite terminals of the crystal. Experiment shows that the coaxial tuners can in this case function as the iris. This is somewhat more convenient, particularly in the laboratory where adjustments are frequently made, than to vary the diameter and possibly the position of an iris.

### THE GENERATOR

It is generally true that a source of wave power such as a short-wave oscillator will work most efficiently when it looks into its own characteristic impedance. If a wave-guide line is not an appropriate load to such a source it would appear that we might use the hollow-cavity type of transformer as a means of matching the source to the line. In addition, there are also possible

and as a result 20-centimeter oscillations of considerable magnitude are built up on the Lecher-frame circuit. Under this circumstance, it is probably true that the tube is driven to the limits of its operating characteristic. At any rate, harmonics of considerable magnitude are set up. The diameter of the pipe is so chosen that these harmonic waves ( $\lambda=10$  centimeters) are carried away. Such a generator, while not overly effi-

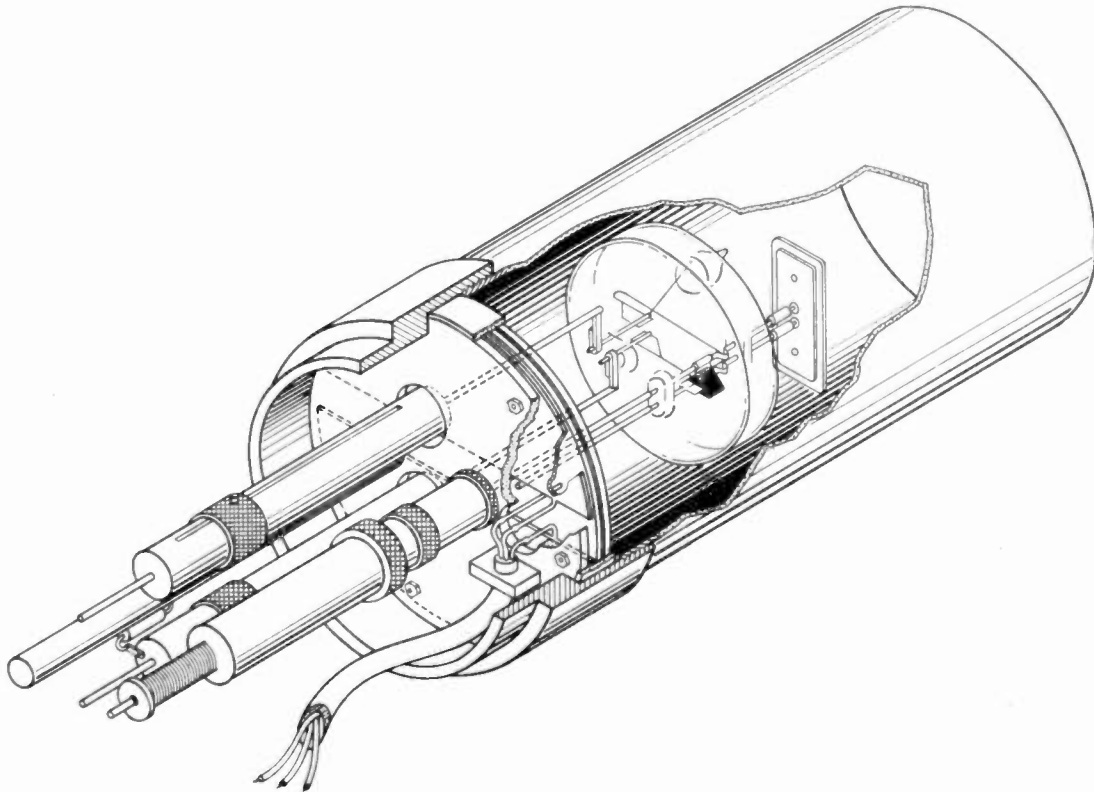

Fig. 11—Harmonic type of oscillator using a conventional negative-grid tube.

cases where the chamber may be used as a frequency-determining unit of high precision to be associated with an oscillator.

There is shown in Fig. 11 an oscillator suitable for continuous waves of a frequency of 3000 megacycles ( $\lambda=10$  centimeters). As will be observed, it combines the older Lecher-wire technic with the newer wave-guide methods. A three-electrode tube of conventional principles but of rather unusual design has its grid and plate terminals brought out at the opposite sides of a glass envelope. These are made a part of a Lecher-wire circuit upon which waves having a length of roughly 20 centimeters are generated. Were it not for the surrounding pipe this would be the principal wavelength generated and a considerable amount of 20-centimeter power would be radiated. However, by surrounding the generator with a 3-inch-diameter pipe, we are able to invoke the cutoff property already mentioned and thereby prevent the transmission of any appreciable amount of 20-centimeter power. It appears that under this circumstance the oscillator looks into a nondissipative load of considerable magnitude

cient, can be modulated to give audible signals and is a very useful element in an experimental transmitting system.

### FILTERS

Following the analogue of the resonant chamber and the various arrangements of coils and condensers further, we may expect that there should be possible a variety of filters. It will be sufficient to mention a few of the simpler forms. Some, at least, resemble the so-called acoustic filter. In Fig. 12(A) there is shown a side tube connected across a wave-guide line. By adjusting the length of this tube, relative to the frequency, we may effectively place across the main wave guide either a high transverse impedance thereby allowing waves to pass freely or a low transverse impedance thereby preventing their free passage. In the latter case it is almost as though the metal piston placed in the side chamber were transferred to a position transverse to the main guide. As will be readily appreciated a multiplicity of these side chambers arranged perhaps as shown in Fig. 12(B) will permit the



passage of certain frequencies while inhibiting others. More particularly it passes all but a relatively narrow band of frequencies. It may conveniently be regarded as a band-reject filter. In this, as in ordinary radio practice, it is assumed that varying the tuning of a circuit at a fixed frequency is roughly equivalent to varying the frequency at a fixed tuning.

Fig. 12(C) shows another kind of filter element that will also perform (in reverse order) the function just mentioned. At frequencies for which the chamber is tuned, wave power passes with little or no loss. At other frequencies, the chamber presents a high impedance to the oncoming wave. It is therefore a kind of band-pass filter. It is convenient to regard this type

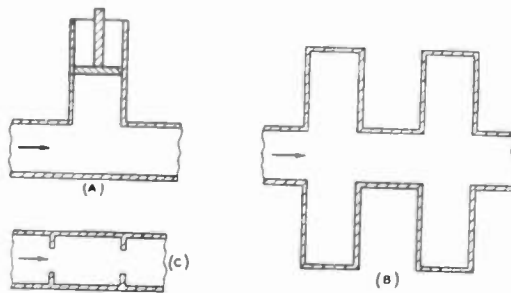

Fig. 12—Two simple forms of wave-guide filters. (A) and (B) pass all but certain selected bands of frequencies. (C) rejects all but certain selected bands of frequencies.

of filter as a resonant chamber, like Fig. 7, in which for practical purposes, a source (power arriving at the input iris) is matched to a sink (power leaving the output iris). At this frequency the filter element and the line that follows offer no discontinuity to the incident wave power. At other frequencies there is a gross mismatch between the source and sink and the unit presents effectively a high series impedance (or low transverse impedance) to the oncoming wave power. As in the case of the simple resonant chamber, one may picture for himself a series of reflections that conspire to aid the wanted waves in passing through the chamber while rejecting these that are unwanted.

## GENERAL CONSIDERATIONS

Returning again to Fig. 3, it should be evident that at some point in the frequency scale above 1000 megacycles ( $\lambda = 30$  centimeters) microwave technic is again destined to undergo a marked change. Methods using the conventional go-and-return conductor type of circuit give way to the somewhat simpler hollow-pipe or wave-guide circuit. These newer methods seem to be at their best in the centimeter-wavelength range. At the longer wavelengths, the component parts become inconveniently large. As we go to the shorter waves, it would appear that ability to manufacture small parts would become an important limitation. It may also turn out that losses in component parts may again return to haunt the engineer. What the technic will be beyond this point, we can only guess.

From what has been said, it is fairly evident that we have, in this newer wave-guide art, the high-frequency counterparts of most of the essential circuit elements used in ordinary communications practice. Not only do we have a fairly efficient transmission line for propagating wave power from one point to another but we have in principle the necessary matching methods for impressing intelligence-bearing components onto the line and also the methods for recovering them at the receiving end. In addition there are also the essentials of a high-frequency filtering technic of the kind that has been so very useful at lower frequencies particularly in carrier-current practice. To this should be added a rather large variety of antennas for use in places where radio seems preferable.

The adaptation of these rather fundamental principles to practical use is one of the interesting problems that lie ahead. What form this may assume and what direction it may take we cannot as yet be quite certain. It would appear, however, that in the region *Beyond the Ultra Short Waves* there will be interesting variety both in the principles and methods of electrical engineering. It is probable that the homesteader will, as usual, look forward with high hopes.

# Tubes for High-Power Short-Wave Broadcast Stations—Their Characteristics and Use\*

G. CHEVIGNY†, NONMEMBER, I.R.E.

**Summary**—This paper outlines the vacuum-tube requirements necessary because of the increasing power of short-wave broadcast transmitters.

Different ways of meeting the requirements are discussed: use of a large number of tubes in parallel; of demountable structures; or of sealed tubes.

The development of a sealed tube capable of 200 kilowatts carrier output for two tubes in parallel is described. The main features of the different parts of the tube are indicated together with its characteristics. A description is also given of some of the tools and machines specially developed for the manufacture of these tubes.

A broadcast center in which the tubes are used is briefly described. The salient points of the transmitting circuit and equipment are shown. A short description of high-power grid-controlled rectifiers is also given.

## INTRODUCTION

FOR YEARS before the present War, there was a very rapid increase in the power of broadcast transmitters in Europe, brought about mainly by the importance attached to propaganda by radio. Despite limitations on power recommended by successive international meetings, the governments of European countries always tried to increase the emission of their broadcast transmitters as much as technically possible. As soon as progress in the manufacture of transmitting tubes and equipment made it possible to obtain a higher output, new stations were ordered or old stations were modernized so that the only limit to the power output of a station was, in fact, that imposed by the technical possibilities of the moment.

This race toward higher powers, which took place at first on medium waves, was followed by a similar race on short waves. For instance, transmitters of 100 kilowatts carrier or more started regular operation on medium waves in 1931 and on short waves in 1939. The high output power of stations was often supplemented by efficient radiating systems, some of which were over 1000 feet high for medium-wave broadcasting, or which used large numbers of highly directive antennas for short-wave broadcasting.

As the demand toward still larger powers was quite apparent, development of a new type of high-power, short-wave vacuum tube was started in 1937 at the Paris Laboratory of the International Telephone and Telegraph Corporation. Two years later, in 1939, design of this tube had been completed and it was available when, in the same year, French authorities decided to build a broadcast center with a large number

of short-wave channels each capable of a carrier of 150 to 200 kilowatts.

## GENERAL CONSIDERATIONS

Before starting the design of the new tube, several different methods of meeting the requirements were considered.

1. Use of a large number of high-power tubes connected in parallel.
2. Development of new demountable structures of suitable power.
3. Development of a sealed tube of sufficient power output so that two tubes would be adequate in the last stage.

A solution using four tubes in parallel had already been adopted for certain high-power transmitters; however, because of the many drawbacks, parallel operation was not considered entirely satisfactory for the following reasons:

1. Operation of the transmitter is made more difficult.
2. Critical adjustment of the circuits is necessary, particularly when two transmitters must be worked in parallel.
3. Causes of stoppage of the station are considerably increased, making the station much less reliable.

Demountable structures were rejected, although, from the standpoint of power output, they would have been adequate. They involve the following inherent objections:

1. Require more careful handling than sealed-off tubes.
2. Require highly trained maintenance personnel.
3. Auxiliary pumping and conditioning equipment is essential.
4. Provision of spares is complicated.
5. Cost per hour per kilowatt is greater.

While far from sturdy, sealed-off transmitting tubes, even in the largest sizes, are now being made sufficiently strong to be shipped, stored, and installed safely with only reasonable care. To date, such is not the case with demountable tubes.

Maintenance of demountable tubes is not simple. The same knowledge, skill, and care are required for the replacement of burned-out electrodes as is necessary in their original manufacture. Personnel with normal experience in maintenance of electrical equipment would require additional training in vacuum-tube technique; for example, scrupulous chemical cleanliness is essential to the successful operation of high-vacuum, high-voltage devices.

Demountable tubes while in operation require a

\* Decimal classification: R331×R355.4. Original manuscript received by the Institute, January 29, 1943; revised manuscript received April 12, 1943. Presented, New York Section, March 3, 1943.

† Federal Telephone and Radio Laboratories, New York, N. Y.

complete associated pumping system that does not differ materially from the equipment used in the manufacture of sealed-off tubes. Such equipment usually comprises two diffusion pumps and a mechanical pump, the latter being arranged to run only when the degree of vacuum on the last stage of the diffusion pumps reaches a predetermined minimum value. Rotating machinery, controls, and considerable space for piping and connections, all requiring continuous supervision, are involved.

The problem of providing spares is also complicated by the use of demountable tubes. A complete spare tube and vacuum system must be kept in operation and ready for instant service. This equipment, because of its size and complexity, usually must be a permanent installation making it necessary to arrange the transmitter circuit to be switched to the spare. Obviously, such an arrangement complicates the transmitter design, especially at higher frequencies. In addition, other equipment must be maintained to pump and condition tubes that have been repaired. When parts, such as a filament or grid, are replaced in a demountable structure, several hours of conditioning are required before the tube is fit for service. Such an amount of spare time would not ordinarily be available from the main high-voltage supply; hence an additional power source would be required.

Opinions differ considerably regarding the relative cost of operation of demountable tubes and sealed-off tubes. In the case of the tubes under consideration, comparative calculations were made, taking into account the cost of the demountable tube, its associated

equipment, and the maintenance cost. These calculations showed that, with a sealed-off tube life of 10,000 hours (about two years' operation), the cost per hour of the sealed-off tube is lower.

The demountable structures seem to be interesting only when the power output required is so high that it is impossible to make reliable sealed tubes at an economical price.

As it appeared quite feasible to proceed with the construction of sealed tubes, two of which would provide a carrier output of 200 kilowatts on short waves, this solution was adopted.

#### DESIGN OF THE TUBE

Different possibilities of design of sealed tubes were examined. As is well known, there are two main types of structures of water-cooled tubes: one with the anode at one end and the grid and filament at the other, called the single-ended tube; the other with the anode in the middle with filament and grid brought out respectively through each end of this anode, called the double-ended tube. Much discussion has taken place concerning the relative advantages and disadvantages of these two types of structure. From the viewpoint of production neither has any real advantage over the other. In the present case, the singled-ended structure was favored since it is easier to connect in the type of circuit planned for the transmitters. At high frequencies, the tube is an integral part of the circuit and it is highly advantageous that tube and circuit be well adapted to each other.

For operation on the highest practical frequency, the tube over-all length was kept to the minimum and the diameter was made as large as possible. Thus the mechanical strength of the electrodes also was increased.

Before proceeding with the assembly of the sealed tubes, the filament and grid structures were both tested in a demountable unit which had been developed with a view to producing a demountable tube of power sufficient to give 500 kilowatts carrier output for two tubes in parallel. Several types of structures were tried and some life tests were started with a dissipation higher than that normally required to ensure stability of the parts. It was only when these electrodes were considered satisfactory that the first sealed tubes were assembled and tested. Only minor modifications of certain parts of the structure were then necessary, since the completed filament and grid units functioned as satisfactorily as in the demountable structure. Fig. 1 shows a view of the demountable structure in which the electrodes of the tubes were tested.

Fig. 2 is a view of the tube without its water jacket. The filament leads are at the top. On the side of the bulb, the grid is fastened through three leads formed by three copper caps. The copper anode is located at the bottom. Over-all length of the tube is about four feet.

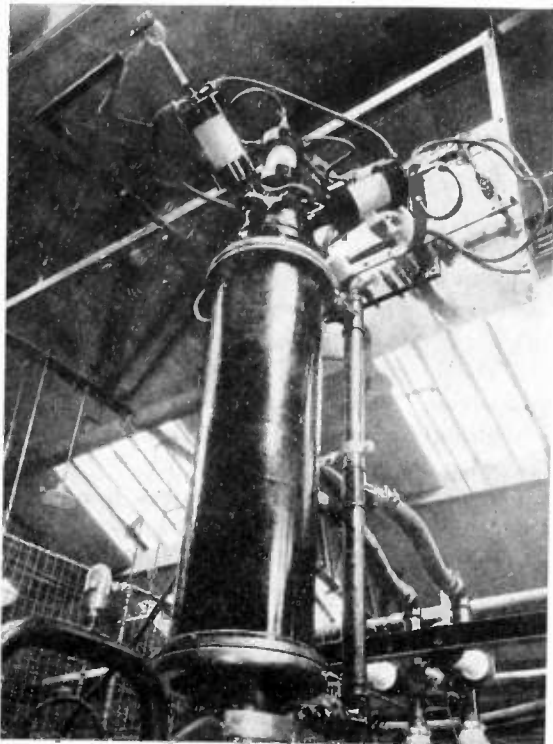

Fig. 1—Demountable structure.



### FILAMENT

Most of the design work was centered on the construction of the filament structure. It would have been possible, for instance, either to use structures comprising several V's, or parallel strands with springs applied at one end, or a self-supporting, parallel-strand structure without springs.

Because of the necessity for supporting and guiding the springs, their use entails a complicated and bulky mechanical structure. Such structures, which must operate adjacent to filaments working at a high temperature, are difficult to design and are very often a source of trouble; they also necessitate the use of numerous insulators which are generally fragile and difficult to outgas.

The extra volume occupied by filament springs causes an appreciable increase in interelectrode capaci-



Fig. 2—3067A vacuum tube.

tance which, in the case of a tube working on short wavelengths, is obviously undesirable. If, in addition, certain parts are subjected to high-frequency fields, operation becomes rather unreliable. It was consequently decided to adopt a self-supporting structure with a minimum number of insulators and no springs to pull on the filament.

The filament structure utilized is shown in Fig. 3. It comprises 18-filament strands connected in parallel. This filament was designed for direct-current or single-phase alternating-current excitation but, with minor modifications, can be adapted to 3-phase alternating current.

The strands are so connected that the current in two adjacent strands always flows in opposite directions.

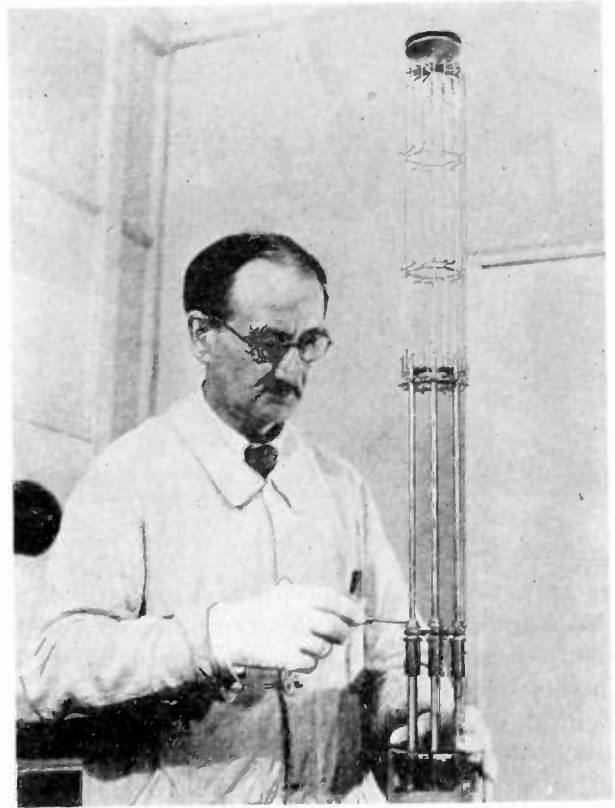

Fig. 3—Filament assembly.

This is very important, since the action of the electromagnetic force is great due to the high current passing through the filament. With this arrangement the electromagnetic forces tend to bow out the filament, all the forces being radial and directed towards the outside. In order to prevent this distortion, strands having the same potential were fastened together at regular intervals. With the length of filament used, a fastening at two points suffices.

In such structures, it is essential that the different strands expand equally when heated. Uniform expansion can be obtained only by exercising the greatest care in selecting filament strands of practically identical diameter. The highly polished tungsten filaments are, therefore, manufactured to the very narrow limits of  $\pm 0.5$  per cent of the diameter. The strands are all weighed when they are received and their diameters are measured on two perpendicular directions at several points. Each strand is then placed in one of six groups. When selecting the 18 strands for a particular tube, all are taken from a single group but, even then, the strands are matched as closely as possible, the grouping being made merely to facilitate this final matching process.

The strands are then shaped and heated in hydrogen in order to set them. One end of each strand is arc-welded on short filament leads. Next, all the strands are placed on the stem, and the other ends of all the strands are arc-welded on the filament leads mounted on the stem. A suitable fixture is used to keep the strands in place and to guide them during the welding.

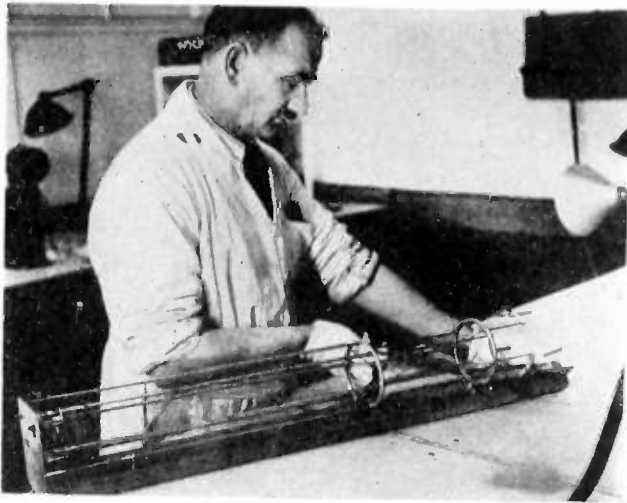

Fig. 4—Grid assembly.

After that, the ends of the leads on all strands are welded together as well as to a central connector, the atomic hydrogen process being employed. With this method of assembly, the filament strands remain quite straight and parallel.

Using leads at the common end of the strands, instead of welding the filaments themselves onto the central connector, allows for an appreciable decrease of filament power and increases the rigidity of the filament structure. After the filament structure has been so completed, it is flashed in hydrogen by passing a suitable current through the filament strands in order to set it permanently.

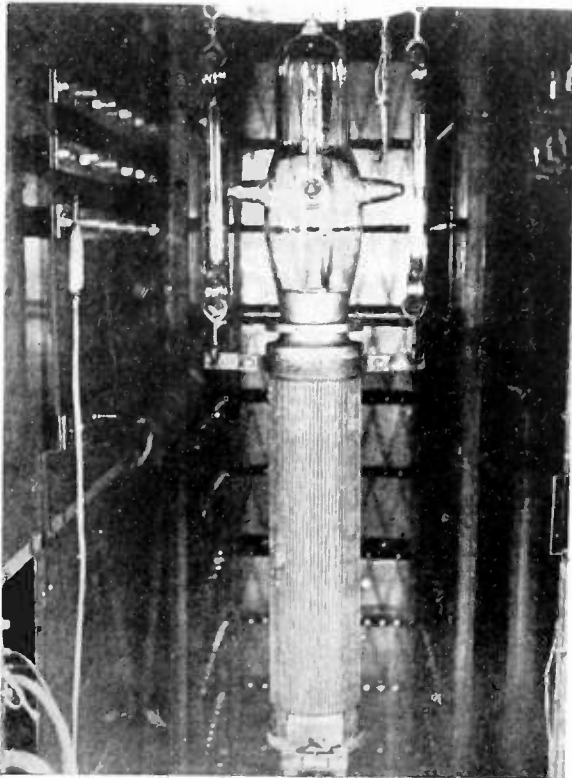

Fig. 5—Baking of anode structure.

The filament supports comprise two molybdenum plates on one side of which the molybdenum leads of the filament strands are welded and on the other side of which large-diameter molybdenum rods are also welded. These are inserted into copper tubes in which they are fastened by means of screws. The ends of these copper tubes are themselves brazed inside of copper caps which are sealed on a moulded flare. The bottom end of the filament structure is provided with two shields and a guide rod which enters an insulator fastened at the end of the grid. It is to be noted that the bearing between this rod and the quartz insulator is not made directly but through another quartz insulator mounted at the end of the rod.

#### GRID AND ANODE

Fig. 4 shows the grid structure. The grid is wound inside a cage consisting of six tungsten rods fastened

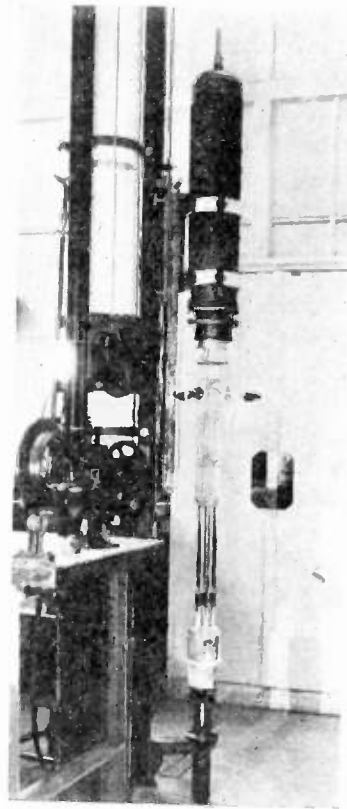

Fig. 6—Filament anode assembly.

on a support which is itself fastened on the three leads passing through the bulb. At the bottom of these rods, a support is provided for the quartz insulator which is used as a guide for the end of the filament structure. The grid winding is fastened on the leads by means of a tungsten spiral.

The anode, which is made of copper and comprises several parts, can be seen in Fig. 5. The central part is provided with grooves in order to increase the anode dissipation. A cup is brazed on the bottom end. It is provided with a hole used during the assembly of the

tube to assure the centering of the filament structure.

On the top of the central part, a collar with a feather edge is brazed, on which, in turn, a glass bulb is sealed. This part is adapted for water cooling to keep the copper seal at a sufficiently low temperature.

Three radial arms for mounting the grid are sealed on the bulb. Then, the bulb is sealed on the anode and the whole structure is evacuated and left in stock for a sufficient number of weeks to make sure that the copper parts and the seals are airtight.

#### ASSEMBLY

To proceed with the assembly of the tube, the grid is mounted inside the anode and, next, the filament structure is sealed in place.

Originally, the tube was sealed on a horizontal lathe; the operation, though feasible, was difficult due to the necessity of accurately centering the filament structure. Fig. 6 shows a tube being aligned in the centering device.

At first, the filament was mounted in the anode in a vertical position and both structures were fastened on a common support. The whole assembly was then transferred to a lathe where the anode was fixed in one head while the filament support was fastened on the other head. Fig. 7 shows this sealing operation.

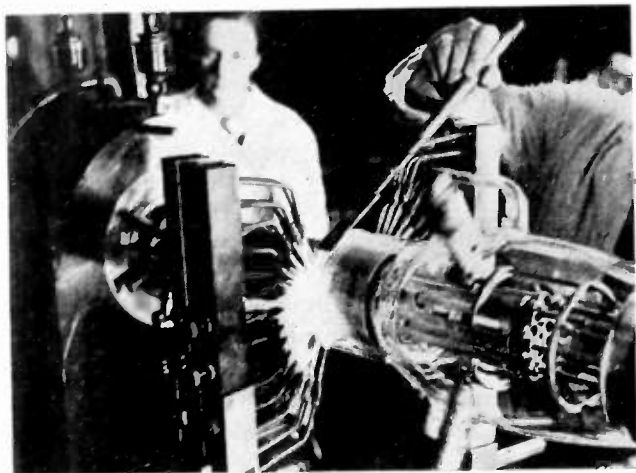

Fig. 7—Sealing of the tube.

In order to make the assembly of such tubes much easier and remove any danger of warping of the filament, a vertical lathe of a special design was developed. At the time, two possibilities were considered: rotating the flames with the tube fixed, or the flames fixed with the tube rotating.

Design of a vertical lathe in which only the flames rotate involves certain delicate problems, but does not require accuracy so great as that of the other type. It is simpler in design and less expensive; however, the sealing operation requires, in addition to the rotating fires, a rotating graphite paddle to shape the glass, operation of this paddle being obtained by vertical

motion of a disk on which a part of the paddle bears. Such an operation on a seal of large diameter is not so easy as the usual hand paddling of the seal when in rotation. In this latter case, the glass can be worked in a better manner. It was this main consideration which

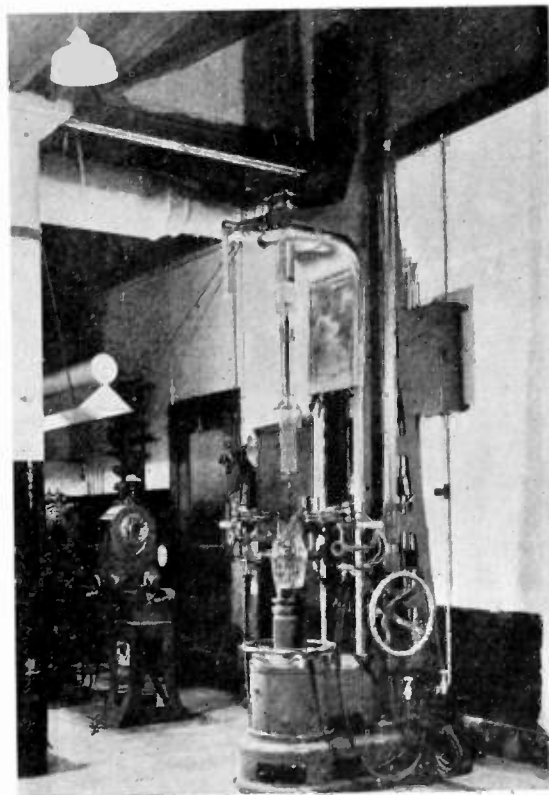

Fig. 8—Vertical sealing lathe.

led to the design of a lathe utilizing fixed fires while the tube rotates.

Fig. 8 shows the vertical lathe. The anode is fixed at the bottom of the lathe, passing through large ball bearings on which a suitable chuck is mounted. Fastening the anode on this chuck is accomplished by means of a large wheel. The filament is mounted on a support which passes through the top head which is vertically movable by means of a large wheel. Both this and the bottom head are machined with very great accuracy so that the parts have an eccentricity less than 0.02 millimeter and the shafts are aligned within 0.02 millimeter. The flames can be moved easily, and their position can be adjusted.

#### EXHAUST

After the tube is sealed, it is immediately put under rough vacuum. The tube is then exhausted. The exhaust station comprises a large movable platform which can be brought around the tube during the baking and moved back afterwards to leave the space around the tube free for the different connections during the other operations of the exhaust.

The exhaust process comprises the usual steps of baking, bombardment of electrodes and high-voltage



conditioning under high voltage with the filament cold. The total length of the exhaust of a tube varies from one tube to another but, on an average, takes approximately 35 hours.

Before testing the tube, an X-ray picture is taken to



Fig. 9—3067A vacuum tube with water jacket and truck.

make sure of the shape of the electrodes and of their relative centering.

Tests include the usual vacuum measurement and the determination of the static characteristics. The tube is formed, at first on direct current with high voltage up to the peak anode dissipation, and tested as a self-oscillator at 25,000 volts with 400 kilowatts output.

#### COOLING

Cooling of the tube is accomplished through a water jacket. With a flow of 60 gallons of water per minute, the anode is tested for a dissipation of 340 kilowatts, which corresponds to about 1.3 kilowatts per square inch of the anode, much more than needed under the normal operating conditions of the tube. Fig. 9 shows the tube mounted in the water jacket. The grid and filament seals need no special cooling.

#### MOUNTING

When used on medium wavelengths, the tube can be mounted on a small truck which makes it possible to replace the tube readily. At higher frequencies, the truck is too large and the tube is fastened on a suitable support. In both cases, corona shields are placed in the

vicinity of the anode and grid seals, and a ring is used for the grid connections.

#### CHARACTERISTICS

Fig. 10 gives the filament characteristics of the tube, Type 3067A. For 100 amperes emission, the filament voltage required is 30 volts, corresponding to a power of above 19 kilowatts. The emission then is less than 5.5 milliamperes per watt which is a relatively low figure resulting in a filament life of more than 10,000 hours. While use of a filament working at such a low temperature increases the filament power, the cost per hour is, however, decreased by the considerable increase in tube life.

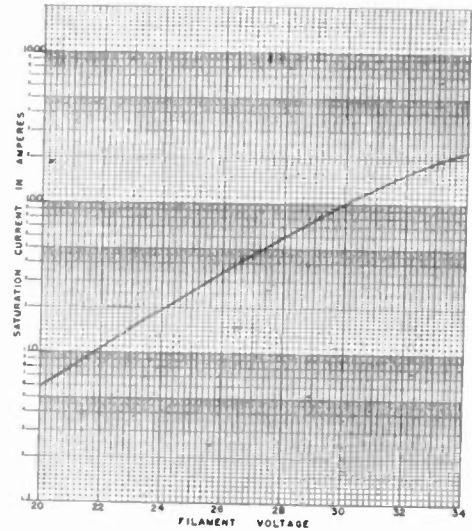

Fig. 10—Tube type 3067A—emission characteristics.

Static characteristics are shown on Figs. 11, 12, and 13. Table I summarizes the main characteristics of the tube.

The station in which these tubes were used comprised a group of two transmitter units, each unit composed of three final amplifiers and two modulators. A single unit was, therefore, capable of radiating

TABLE I  
TECHNICAL DATA

<i>Characteristics</i>			
Filament voltage		30 volts	
Filament current		635 amperes	
Total emission current		100 amperes	
Amplification factor		44	
Impedance		720 watts	
Mutual conductance		50,000 micromhos	
Grid-anode capacitance		110 micromicrofarads	
Grid-filament capacitance		90 micromicrofarads	
<i>Water Circulation</i>			
Normal water flow		60 gallons per minute	
Pressure drop for normal flow		15 pounds per square inch	
Maximum water pressure		50 pounds per square inch	
<i>Dimensions and Weight</i>			
Over-all length		47.5 inches	
Maximum diameter		20 inches	
Net weight		104 pounds	
<i>Limiting Conditions for Safe Operation</i>			
Normal direct plate voltage		17,500 volts	
Maximum plate dissipation		160 kilowatts	
Maximum grid dissipation		3 kilowatts	
<i>Typical Operating Conditions on a Plate-Modulated Amplifier 100 Per cent Modulation</i>			
Working plate voltage	12,000	11,500	11,000 volts
Normal plate current	11	11	11 amperes
Carrier output per tube	100	90	80 kilowatts
Frequency	12	18	22 megacycles

two separate programs simultaneously on different frequencies so that, with both units, four separate programs could go on the air from the station at one time. The extra final amplifier in each transmitter unit permitted wavelengths and antennas to be switched without interrupting programs since these amplifiers could be readjusted with the power off. When power was applied, one of the modulators could be switched instantly to the third final amplifier. Whichever amplifier had been left free could then also be readjusted after its power had been turned off. The process of switching frequencies was, consequently, continuous and uninterrupted. Ten directive antennas were provided at the station; twelve pretuned frequencies permitted operation in the radio-diffusion range of 6, 7, 9, 11, 15, 17, and 21 megacycles. All the commutations, that is, choice of frequency, choice of circuit, and choice of antenna, were automatic and controlled from the sta-

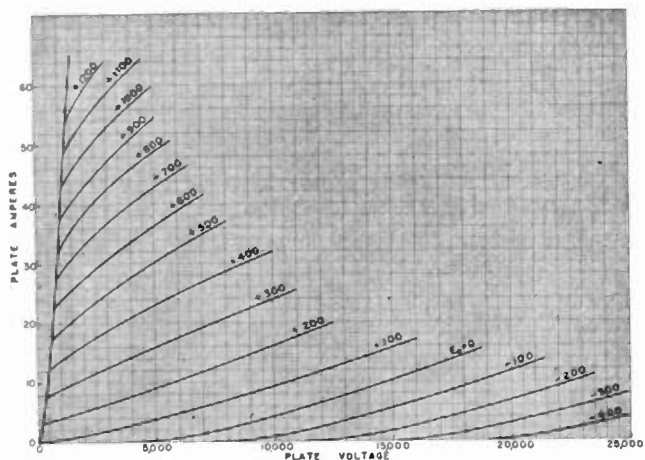

Fig. 11—Tube type 3067A—plate characteristics.

tion control desk. Three similar stations were under construction to provide in all twelve simultaneous programs.

OUTPUT STAGE

The low-power stages of the station were conventional and need not be described. The last stages, however, possessed some unusual features.

Two of the 3067A tubes were used in the final stage and were connected in a so-called inverted amplifier circuit. The high-frequency drive was applied on the filaments of the tubes, the grid being kept to a voltage very close to that of the ground. In each tube, the grid thus acted as a shield between the input circuit, which was the filament-grid circuit, and the output circuit, which was the grid-anode circuit. Among the advantages of this kind of a circuit, the following can be indicated:

1. It is possible to reduce the value of the neutralizing condensers considerably or even, in certain cases, to eliminate them entirely. This is due to the fact that the coupling of the input and output circuits through the tube is caused solely by the capacitance between

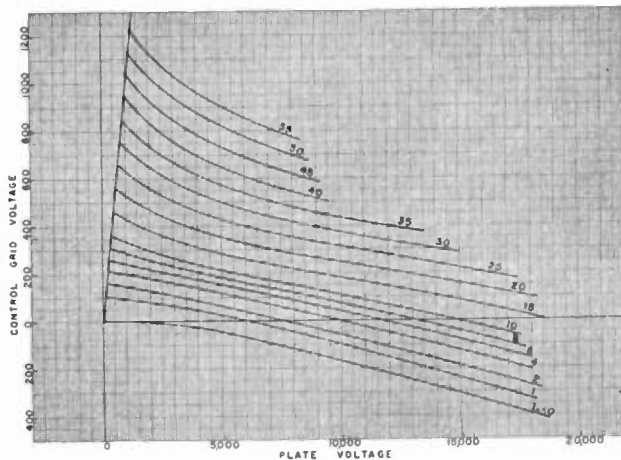

Fig. 12—Tube type 3067A—plate characteristics—constant-current curves.

filament and plate, which is much smaller than that between filament and grid. A decrease in the circulating current consequently results in appreciably lowering the losses in the last stage. Elimination of the neutralizing condensers is particularly advantageous when the transmitter must operate on a relatively wide band of frequencies.

2. The inverted amplifier can operate in a rather wide band of frequencies without having to modify the tuning.

3. A large negative feedback is applied on the input circuit due to the fact that the plate current passes through the filament circuit. The latter circuit, being tuned, the alternating component of the plate current produces on the filament circuit a voltage in phase opposition to the driving voltage. Hence stability of the last stage is increased since parasitic oscillations are suppressed. Harmonic distortion introduced by the last stage also is reduced.

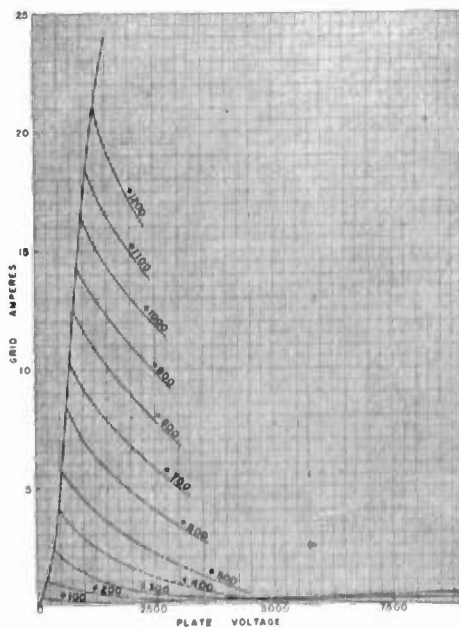

Fig. 13—Tube type 3067A—grid characteristics.

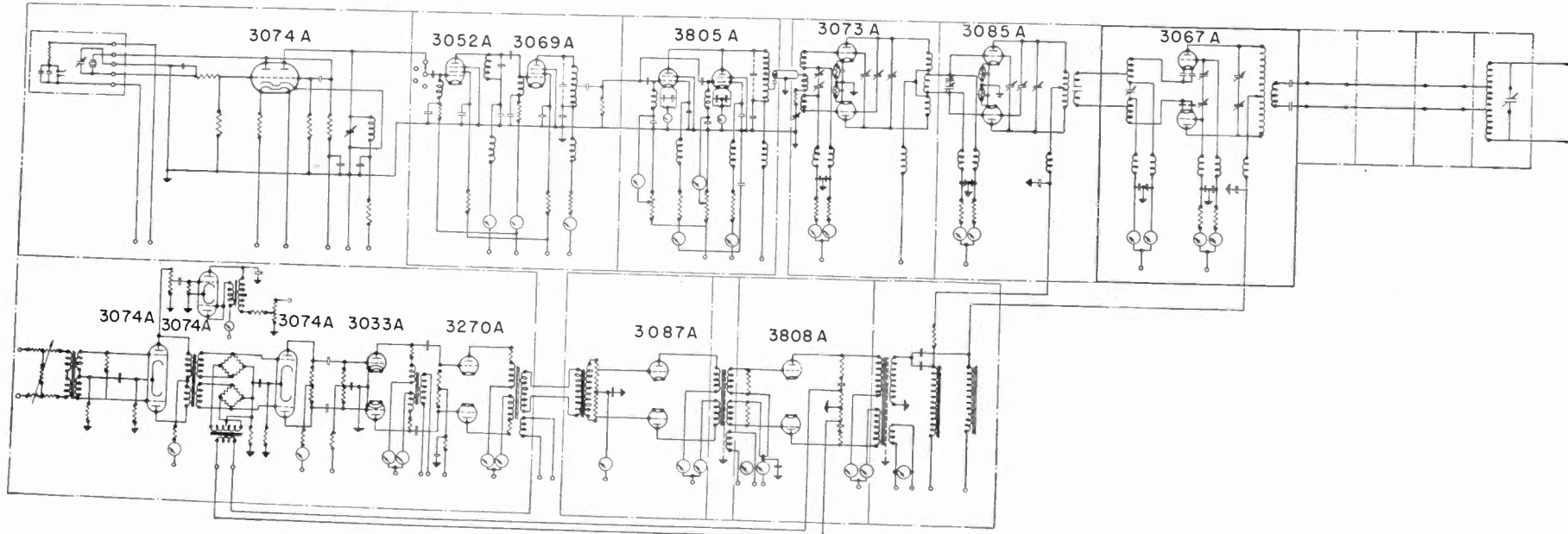

Fig. 14—Schematic diagram of transmitter.

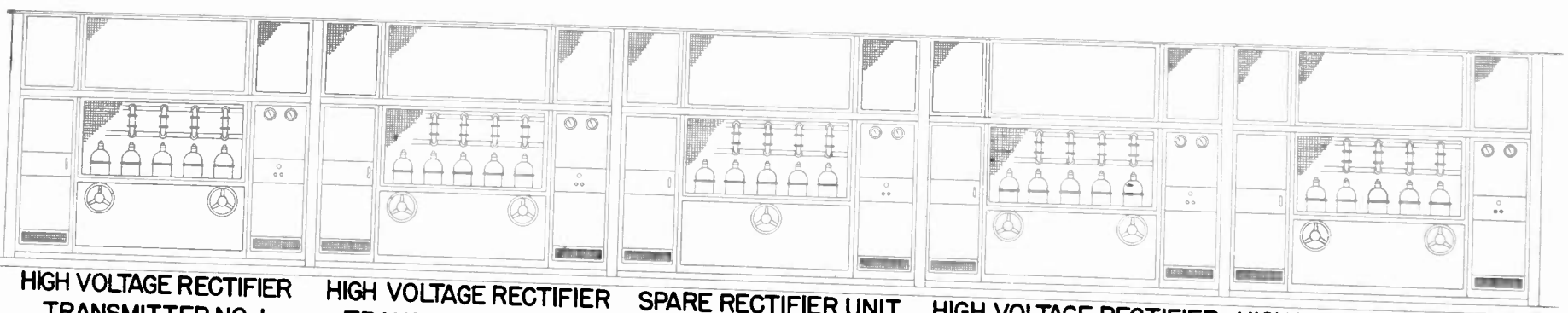

Fig. 18—High-power rectifier units—front view.



4. The inverted amplifier, as compared with the usual type amplifier, makes it possible to obtain a higher output inasmuch as an appreciable part of the high-frequency energy supplied to the antenna comes from the penultimate stage.

Plate modulation was adopted. Its advantages can be summarized as follows:

1. The modification of the high-frequency circuit necessary to change over from one frequency to another does not alter the modulation characteristics as both circuits are entirely independent.

2. With the exception of the last two stages, the high-frequency circuits are not modulated, allowing the use of shielded-grid tubes for these circuits. A very high gain per stage can be thus obtained without requiring accurate adjustment of the operating conditions. It is possible to overdrive the different stages in a manner such that the power which is obtained is practically independent of the driving conditions or of the bias of the tubes. This appreciably decreases noise due to the intermediate stages of the high-frequency circuits.

3. The last stage of the transmitter always works at its maximum efficiency.

4. The power which is absorbed by the last stage of the modulation amplifier is very small for the carrier, and the efficiency of the amplifier is up to 60 per cent for the maximum percentage of modulation of the transmitter.

Another particularly interesting feature of the transmitters was the use of a very large negative feedback which improves the characteristics of the transmitters.

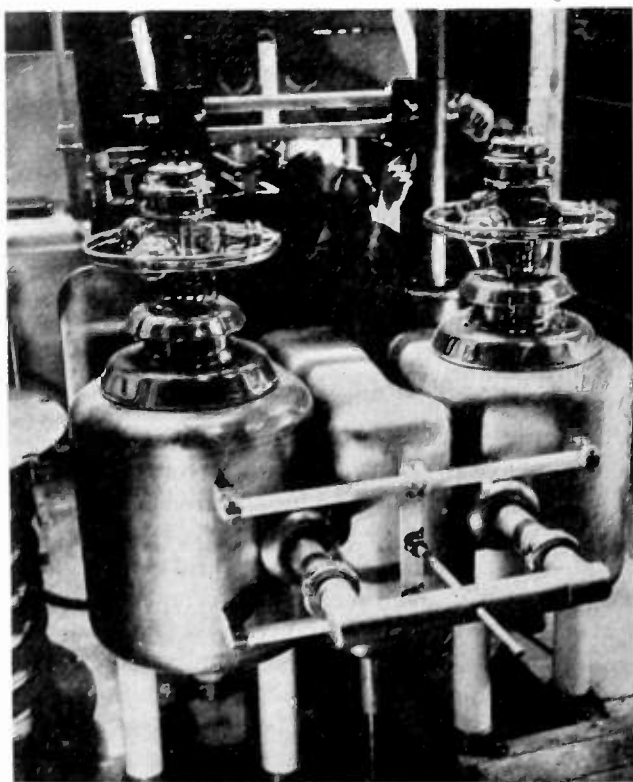

Fig. 15—Final amplifier.

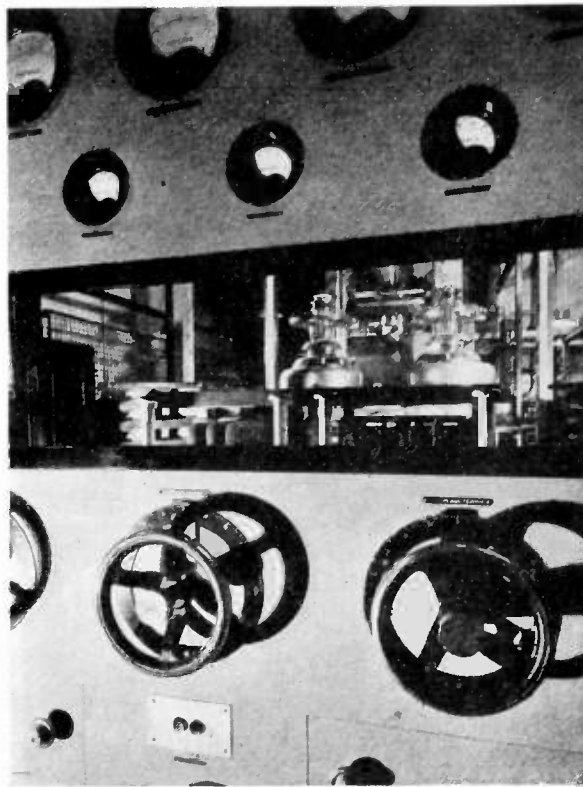

Fig. 16—Front panel—final amplifier.

The advantages resulting from high negative feedback are:

1. Total gain of the audio amplifier is kept practically constant throughout the frequency band.

2. Variation in tube characteristics and some of the changes in the voltage supplies are compensated for.

3. Harmonic distortion and noise introduced by the different amplifiers are considerably reduced.

Fig. 14 shows the schematic of the different stages of the transmitter. Fig. 15 indicates the location of the tubes inside the last stage of the transmitter. Fig. 16 illustrates the front view of the panel.

#### POWER SUPPLY

The power taken from the mains by the high-power rectifiers as a function of the level of modulation for 150 kilowatts carrier and 13,000 volts applied to the anodes of the tubes for four programs simultaneously was as follows for the three last high-frequency stages and the last two modulating stages:

Per Cent Modulation	Kilowatts
0	1360
3.3	1700
80	2260
100	2490

To feed the different low- and high-power stages with high voltage, hot-cathode mercury-vapor rectifiers were used. Fig. 17 shows the type of units used for low power. They were small compact units built up exactly like oil-cooled transformers. They comprised a tank inside of which were mounted the filament

transformers, the high-tension transformers and the choke for the smoothing circuit. The different tubes and insulators through which the connections to the tubes were made were mounted on top of the tank. According to the power and voltage of the rectifier, forced ventila-

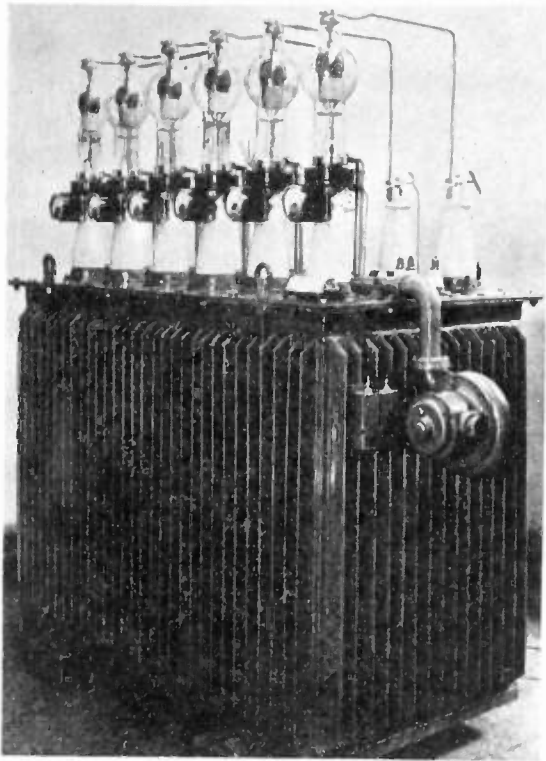

Fig. 17—Low-power rectifier unit.

tion was provided on the base of each tube. The design of these units is such that they may be located inside a vault suitable for high voltage in the same manner as high-tension transformers are placed.

In the case of the high-power stages, five high-power rectifier units were used for an output of 13,000 volts and 37 amperes. Taps were provided for 12,000 volts at 40 amperes and 11,000 volts at 40 amperes. Fig. 18 shows a front view of the units. The rectifier tubes were of the grid-controlled type. Each unit comprised six tubes connected in the three-phase, full-wave, six-tube series circuit. Each tube was mounted on top of its filament transformer through the intermediary of a high-voltage insulator. They were all placed alongside of each other and each tube was surrounded by a shield at the base of which hot air at a constant temperature of 40 degrees centigrade was blown.

The voltage of the rectifier could be varied from zero to peak voltage by applying properly phased pulses on the grids of the rectifier tubes. This excitation of the grid was accomplished by equipment which did not include rotating parts or moving relays; a special transformer was used comprising a magnetic circuit made partly of permalloy. One transformer was associated with each tube; its size was very small so that it could be included in the same tank as the filament transformer itself. It was supplied with alternating

current from the same supply as that to be rectified. A direct current passed through one of the windings and was used as a control. Whenever the alternating current through the winding changed polarity, the flux of the core was reversed, and a peaked wave was produced in a third winding.

If the value of the direct current in this control winding was increased, the peaked waves were displaced with respect to the alternating-current cycles. The effect is illustrated in Fig. 19 which is an oscillogram of the output voltage of the transformer. In this case, the peaked wave was displaced by 60 degrees for a 200-ampere-turn change in the control winding. If the current were reversed, the displacement of the peaked wave would have been in the opposite direction so that the total displacement would be 120 degrees. A further increase in the value of direct current had the effect of completely saturating the core system with the result that peaked waves were no longer produced and the grid-control rectifier tubes were no longer excited. The displacement of the position of the pulse determined the corresponding variation of the time at which each rectifier tube in the circuit started; and, in the case of a three-phase, full-wave, six-tube series circuit, it was sufficient to move this sharp pulse by 90 degrees to adjust the voltage from zero to peak voltage of the rectifier. In practice, variation of voltage by means of the control of the grid was used only during

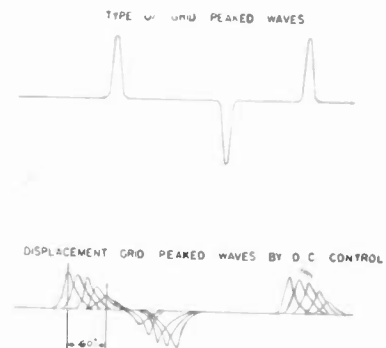

Fig. 19—Wave shape of the peak wave used for firing grids and displacement of the peaked waves by direct-current control.

certain tests of the transmitter, when starting the transmitter, and to compensate for variation of the mains. This compensation could be practically automatic as the amplitude of the direct current applied on the peak-wave transformers could be made a function of the rectified voltage, and an accurate compensation could be obtained. One very important characteristic of grid-control rectifiers is that the grid can be used to stop a rectifier in less than 20 milliseconds in case of a short circuit caused, for instance, by a flash arc inside the high-power vacuum tubes. Voltage can then be restored in a fraction of a second after the short circuit has been stopped; and, in this length of time, the voltage is applied at its minimum value and brought up to the maximum value of the rectifier without noticeable interruption of the program.

# Analysis of Rectifier Operation\*

O. H. SCHADE†, MEMBER, I.R.E.

**Summary**—An analysis of rectifier operation in principal circuits is made. The introduction of linear equivalent diode resistance values permits a simplified and accurate treatment of circuits containing high-vacuum diodes and series resistance. The evaluation of these equivalent resistance values and a discussion of emission characteristics of oxide-coated cathodes precede the circuit analysis.

Generalized curve families for three principal condenser-input circuits are given to permit the rapid solution of rectifier problems in practical circuits without inaccuracies due to idealizing assumptions.

The data presented in this paper have been derived on the basis of a sinusoidal voltage source. It is apparent that the graphic analysis may be applied to circuits with nonsinusoidal voltage sources or intermittent pulse waves.

It is also permissible to consider only the wave section during conduction time and alter the remaining wave form at will. Complicated wave shapes may thus be replaced in many cases by a substantially sinusoidal voltage of higher frequency and intermittent occurrence as indicated by shape and duration of the highest voltage peak.

The applications of these principles have often explained large discrepancies from expected results as being caused by series or diode resistance and excessive peak-current demands.

Practical experience over many years has proved the correctness and accuracy of the generalized characteristics of condenser-input circuits.

## INTRODUCTION

RECTIFIER circuits, especially of the condenser-input type, are extensively used in radio and television circuits to produce unidirectional currents and voltages. The design of power supplies, grid-current bias circuits, peak voltmeters, detectors and many other circuits in practical equipment is often based on the assumption that rectifier- and power-source resistance are zero, this assumption resulting in serious errors. The rectifier element or diode, furthermore has certain peak-current and power ratings which should not be exceeded. These values vary considerably with the series resistance of the circuit.

General operating characteristics of practical rectifier circuits have been evaluated and used by the writer for design purposes and information since early 1934, but circumstances have delayed publication. Several papers<sup>1-4</sup> have appeared in the meantime treating

one or another part of the subject on the assumption of zero series resistance. Practical circuits have resistance and may even require insertion of additional resistance to protect the diode and input condenser against destructive currents. The equivalent diode resistance and the emission from oxide-coated cathodes are, therefore, discussed preceding the general circuit analysis. This analysis is illustrated on graphic constructions establishing a direct link with oscillograph observations on practical circuits. A detailed mathematical discussion requires much space and is dispensed with in favor of graphic solutions, supplemented by generalized operating characteristics.

## I. PRINCIPLES OF RECTIFICATION

### General

Rectification is a process of synchronized switching. The basic rectifier circuit consists of one synchronized switch in series with a single-phase source of single frequency and a resistance load. The switch connection between load terminals and source is closed when source and load terminals have the same polarity, and is open during the time of opposite polarity. The load current consists of half-wave pulses. This simple circuit is unsuitable for most practical purposes, because it does not furnish a smooth load current.

The current may be smoothed by two methods: (a) by increasing the number of phases, and (b) by inserting reactive elements into the circuit. The phase number is limited to two for radio receivers. The circuit analysis which follows later on will treat single- and double-phase rectifier circuits with reactive circuit elements.

Switching in reactive circuits gives rise to "transients." Current and voltage cannot, therefore, be computed according to steady-state methods.

The diode functions as a self-timing electronic switch. It closes the circuit when the plate becomes positive with respect to the cathode and opens the circuit at the instant when the plate current becomes zero.

The diode has an internal resistance which is a function of current. When analyzing rectifier circuits, it is convenient to treat the internal resistance of the diode rectifier as an element, separated from the "switch action" of the diode. Fig. 1 illustrates the three circuit elements so obtained and their respective voltage-current characteristics (see Section II). The diode characteristic is the sum of these characteristics. The resistance  $r_d$  is effective only when the switch is closed, i.e., during the conduction period of the diode. The effective diode resistance must, therefore, be measured or evaluated within conduction-time limits. Consider a

\* Decimal classification: R337×R356.3. Original manuscript received by the Institute, August 4, 1942; revised manuscript received, March 9, 1943.

† RCA Victor Division, Radio Corporation of America, Harrison, New Jersey.

<sup>1</sup> M. B. Stout, "Analysis of rectifier filter circuits," *Elec. Eng. Trans. A.I.E.E. (Elec. Eng., September, 1935)*, vol. 54, pp. 977-984; September, 1935.

<sup>2</sup> N. H. Roberts, "The diode as half-wave, full-wave and voltage-doubling rectifier," *Wireless Eng.*, vol. 13, pp. 351-362; July, 1936; and pp. 423-470; August, 1936.

<sup>3</sup> J. C. Frommer, "The determination of operating data and allowable ratings of vacuum-tube rectifiers," *PROC. I.R.E.*, vol. 29, pp. 481-485; September, 1941.

<sup>4</sup> D. L. Waidelich, "The full-wave voltage-doubling rectifier circuit," *PROC. I.R.E.*, vol. 29, pp. 554-558; October, 1941.



switch in series with a fixed resistance and any number of other circuit elements connected to a battery of fixed voltage. The direct current and root-mean-square current which flow in this circuit will depend on the time intervals during which the switch is closed and open; the resistance value is not obtainable from these current values and the battery voltage. The correct value is obtained only when the current and voltage

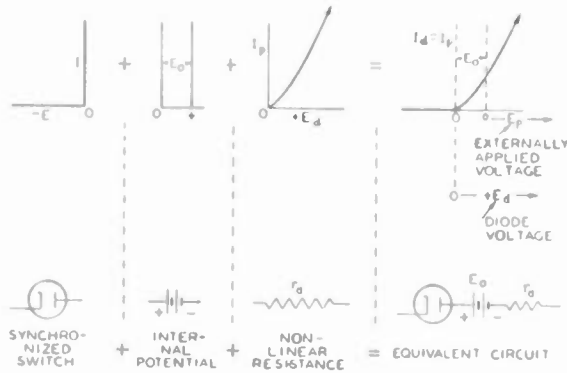

Fig. 1—Characteristics and equivalent circuit for high-vacuum diodes.

drop in the resistance are measured during the time angle  $\phi$  (Fig. 2) when the switch is closed.

The method of analysis of rectifier circuits to be discussed in this paper is based on the principle that the nonlinear effective resistance of the diode may be replaced analytically by an equivalent fixed resistance which will give a diode current equal to that obtained with the actual nonlinear diode resistance. The correct value to be used for the equivalent fixed resistance depends upon whether we are analyzing for peak diode current, average diode current, or root-mean-square diode current.

At the outset of an analysis amplitude and wave shape of the diode current are not known and the diode resistance must, therefore, be determined by successive approximations.

The complexity of repeated calculations, especially on condenser-input circuits, requires that the operating characteristics of the circuit be plotted generally as functions of the circuit constants including series resistance in the diode circuit as a parameter.

Data for these plots (such as Figs. 3 to 7) are to be obtained by general analysis of circuits with linear resistances.

The solution of a practical condenser-input-circuit problem requires the use of three different equivalent linear circuits and diode resistance values.

The resistance values are obtainable from the peak current alone because wave shape can be eliminated as a factor by means of a general relation given by (6). The practical analysis of condenser input circuits thus simplified, is carried out as follows:

The average diode current is estimated roughly and the diode peak current is assumed to be four times the average value. The diode characteristic (Fig. 8) fur-

nishes an initial peak-resistance value and (6) furnishes the other diode resistance values (see  $\hat{R}$ , values in Fig. 9). Direct output voltage and average current are now obtained with the equivalent average value  $\bar{R}$ , from the respective plot (Figs. 3 to 5) as a first approximation. Another chart (Fig. 6) furnishes the peak-to-average-diode-current ratio with the peak value  $\hat{R}$ , and thus the peak current and diode peak resistance in close approximation.

A second approximation gives usually good agreement between initial and obtained resistance values, which are then used to obtain other operating data.

A theoretical treatment of the method just described will be omitted in favor of an analysis of operating characteristics of the rectifier tube itself. The user of tubes may welcome information on the subject of peak emission which is of vital importance in the rating and trouble-free operation of any tube with an oxide-coated cathode.

## II. ANODE AND CATHODE CHARACTERISTICS OF RECTIFIER TUBES

### Anode Characteristics

#### 1. Definitions of Resistance Values

The instantaneous resistance ( $r_d$ ) of a diode is the ratio of the instantaneous plate voltage  $e_d$  to the instantaneous plate current  $i_p$  at any point on the characteristic measured from the operating point (see Fig. 1). It is expressed by

$$r_d = \frac{e_d}{i_p} \tag{1}$$

The operating point (0) of a diode is a fixed point on the characteristic, marked by beginning and end of the

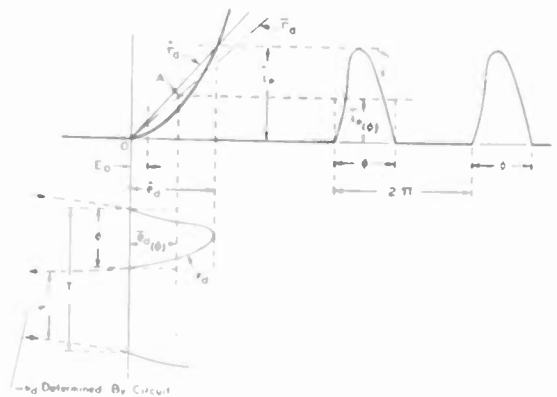

Fig. 2—Graphic evaluation of equivalent diode resistance values.

conduction time. It is, therefore, the cutoff point  $I_d=0$  and  $E_d=0$ , as shown in Fig. 1. The operating point is independent of the wave form and of the conduction time  $\phi$  (see Fig. 2).

The peak resistance ( $\hat{r}_d$ ) is a specific value of the instantaneous resistance and is defined as

\* For system of symbols, see Appendix.

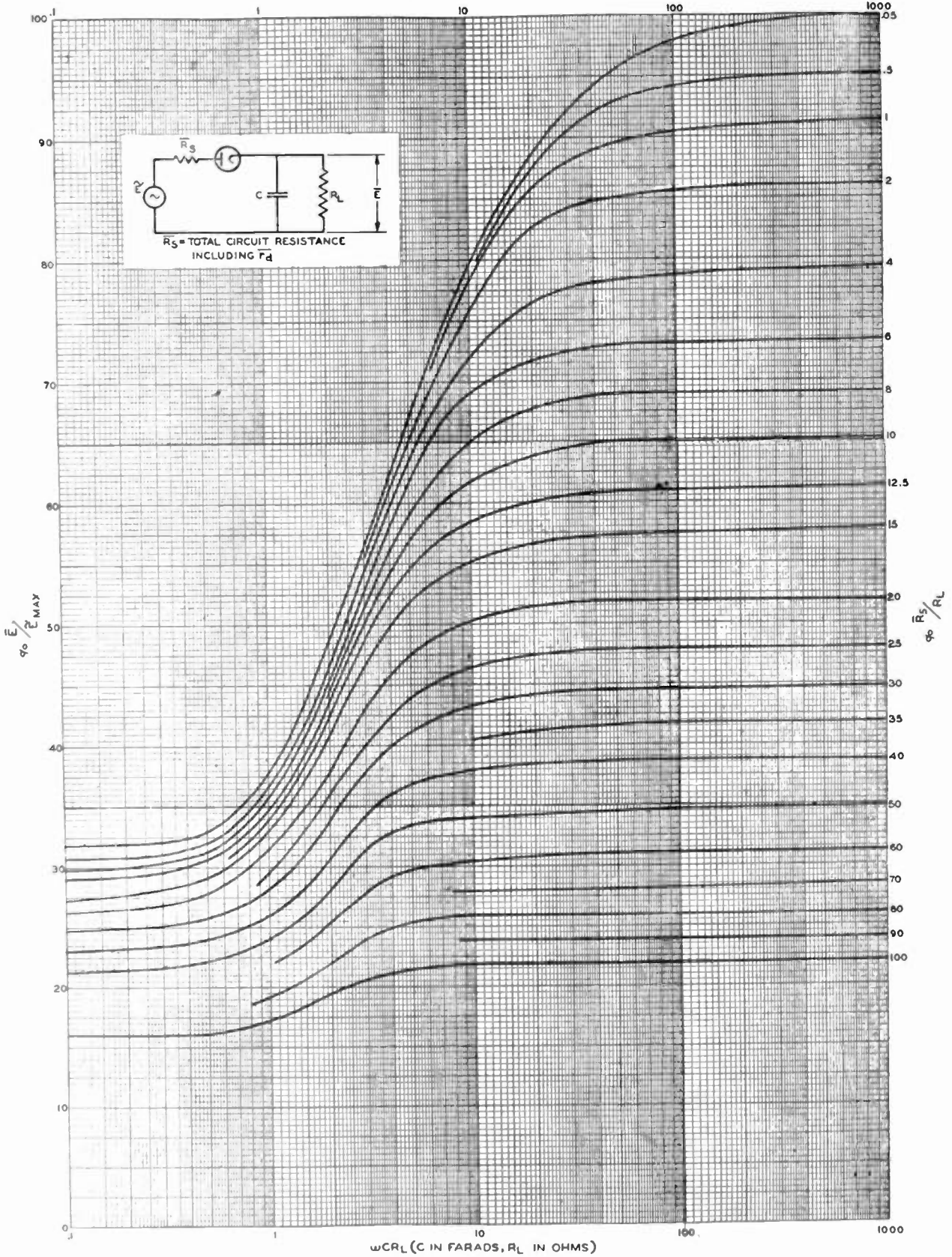

Fig. 3—Relation of applied alternating peak voltage to direct output voltage in half-wave, condenser-input circuits.

$$\bar{r}_d = \frac{\hat{e}_d}{I_p} \quad (\text{see Fig. 2}). \quad (2)$$

Peak voltage  $\hat{e}_d$  and peak current  $I_p$  are measured from the operating point 0.

The equivalent average resistance ( $\bar{r}_d$ ) is defined on the basis of circuit performance as a resistance value determining the magnitude of the average current in the circuit. The value  $\bar{r}_d$  is, therefore, the ratio of the average voltage drop  $\bar{e}_{d(\phi)}$  in the diode during conduction

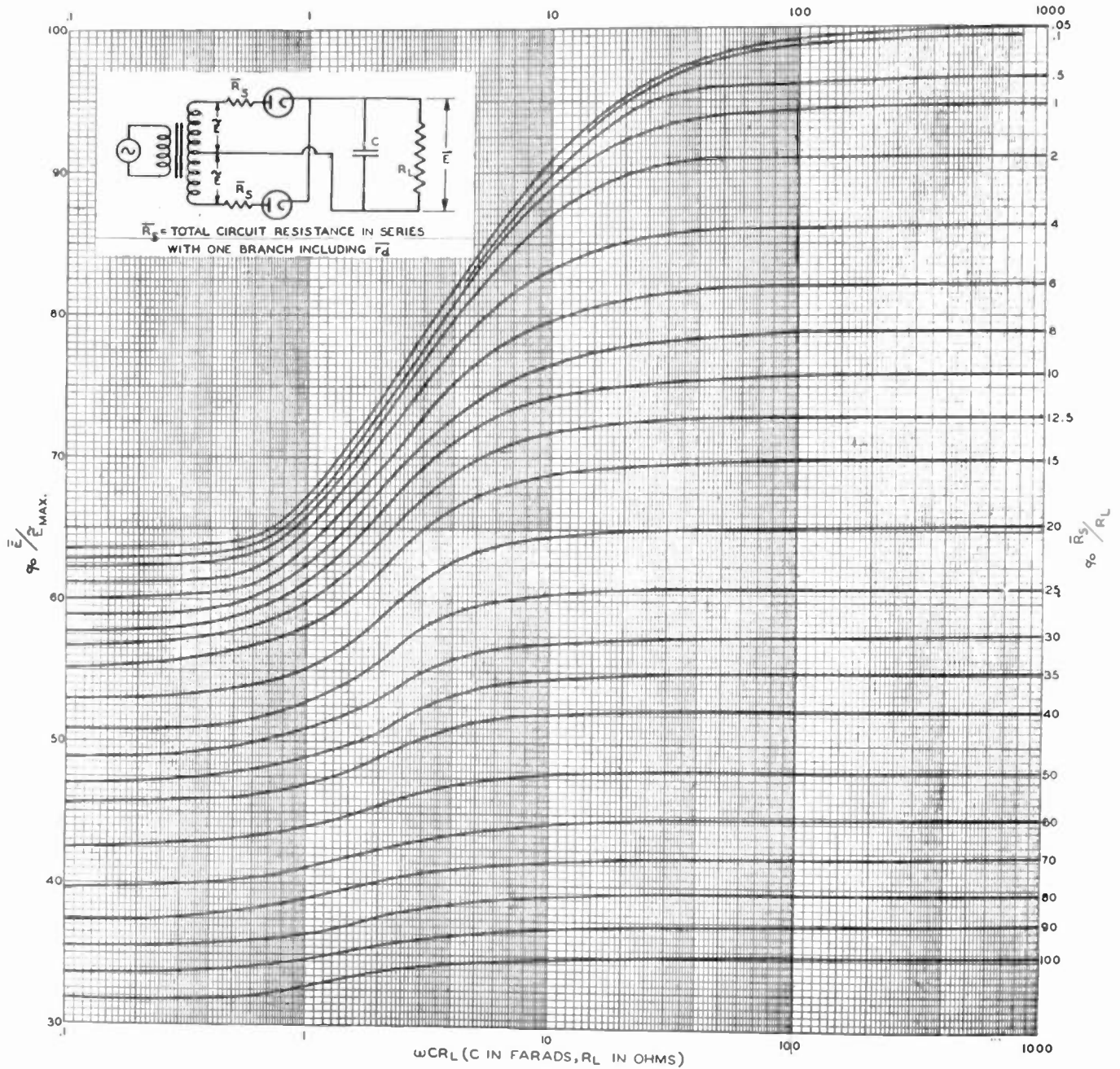

Fig. 4—Relation of applied alternating peak voltage to direct output voltage in full-wave, condenser-input circuits.

time to the average current  $\bar{i}_{p(\phi)}$  during conduction time, or

$$\bar{r}_d = \frac{\bar{e}_{d(\phi)}}{\bar{i}_{p(\phi)}} \tag{3}$$

The curved diode characteristic is thus replaced by an equivalent linear characteristic having the slope  $\bar{r}_d$  and intersecting the average point  $A$ , as shown in Fig. 2. The co-ordinates  $\bar{e}_{d(\phi)}$  and  $\bar{i}_{p(\phi)}$  of the average point depend on the shape of voltage and current within the time angle  $\phi$ . The analysis of rectifier circuits shows that the shape of the current pulse in actual circuits varies considerably between different circuit types.

The equivalent root-mean-square resistance ( $|r_d|$ ) is defined as the resistance in which the power loss  $P_d$  is

equal to the plate dissipation of the diode when the same value of root-mean-square current  $|I_d|$  flows in the resistance as in the diode circuit. It is expressed by

$$|r_d| = \frac{P_d}{|I_d|^2} \tag{4}$$

### 2. Measurement of Equivalent Diode Resistances

The equivalent resistance values of diodes can be measured by direct substitution under actual operating conditions. The circuit arrangement is shown in Fig. 10. Because the diode under test must be replaced as a whole by an adjustable resistance of known value, a second switch (a mercury-vapor diode identified in the figure as the ideal diode) with negligible resistance



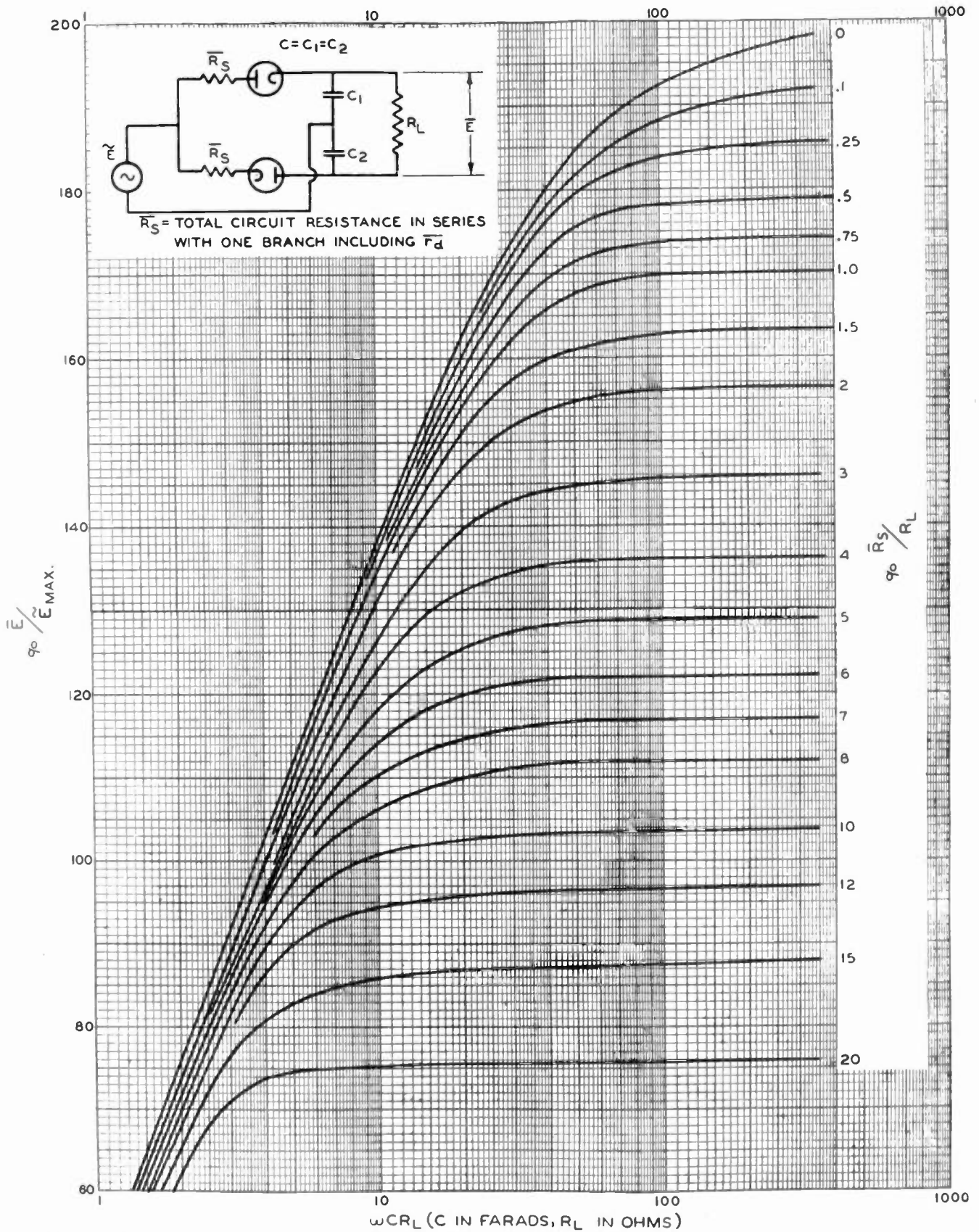

Fig. 5—Relation of applied alternating peak voltage to direct output voltage in condenser-input, voltage-doubling circuits.

must be inserted in order to preserve the switch-action in the circuit.

When a measurement is being made, the resistor  $R_d$  is varied until the particular voltage or current under

observation remains unchanged for both positions of the switch  $S$ . We observe (1) that it is impossible to find one single value of  $R_d$  which will duplicate conditions of the actual tube circuit, i.e., give the same

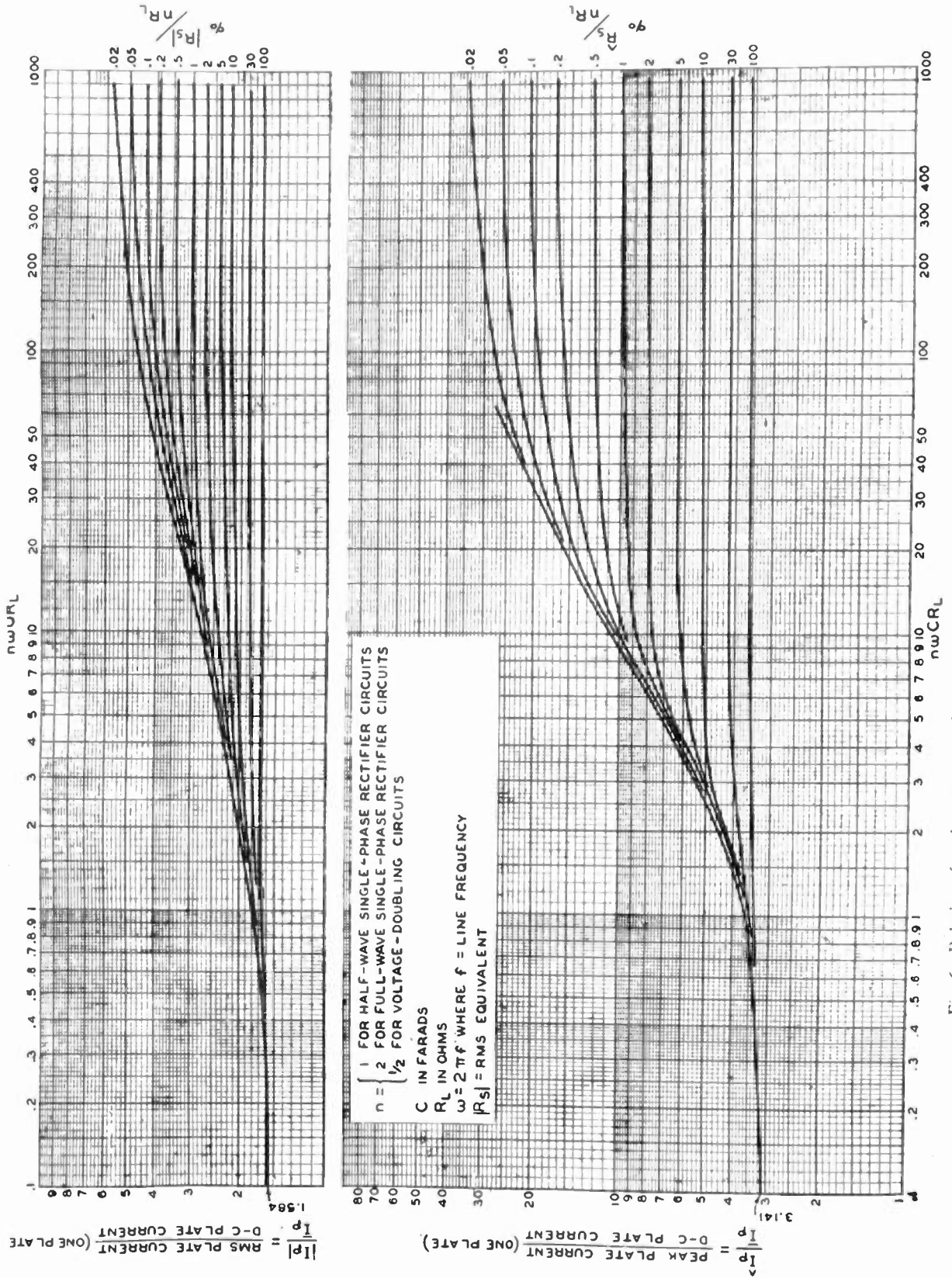

Fig. 6—Relation of peak, average, and root-mean-square diode current in condenser-input circuits.

values of peak, average, and root-mean-square current in the circuit; (2) that the ratio of these three "equivalent" resistance values of the diode varies for different combinations of circuit elements; and (3) that the resistance values are functions of the current amplitude and wave shape.

### 3. Wave Forms and Equivalent Resistance Ratios for Practical Circuit Calculations

The form of the current pulse in practical rectifier circuits is determined by the power factor of the load circuit and the phase number. Practical circuits may be





characteristics: the 3/2-power-law characteristic of high-vacuum diodes, and the idealized rectangular characteristic of hot-cathode, mercury-vapor diodes. In this table, the designation  $|i_p|_{(t)}$  represents the root-mean-square value of the current during the conduction time.

It follows that the relation

$$\bar{r}_d = 0.88\bar{r}_d = 0.93|r_d| \quad (6)$$

is representative for the group of condenser-input circuits containing high-vacuum diodes, and holds within  $\pm 5$  per cent over the entire range of variation in wave

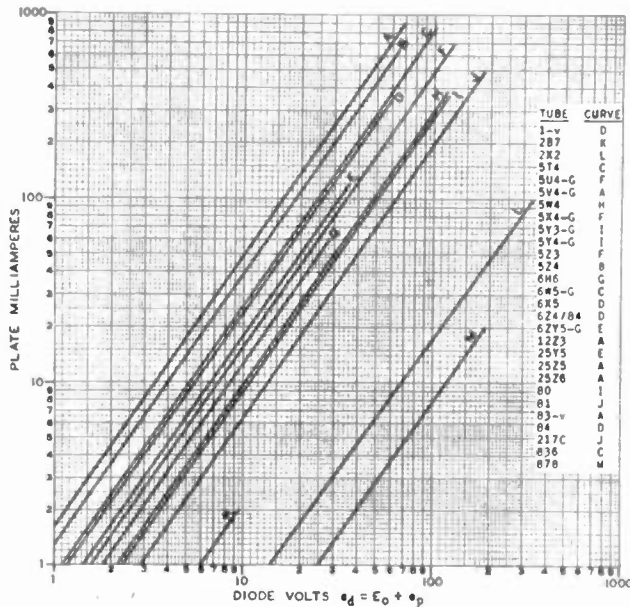

Fig. 8—Average anode characteristics of some RCA rectifier tubes.

shape. The actual error in circuit calculations is smaller as the diode resistance is only part of the total series resistance in the circuit.

CATHODE CHARACTERISTICS

Peak-Emission and Saturation of Oxide-Coated Cathodes

The normal operating range of diodes (including instantaneous peak values) is below the saturation potential because the plate dissipation rises rapidly to dangerous values if this potential is exceeded. Saturation is definitely recognized in diodes with tungsten or thoriated-tungsten cathodes as it does not depend on the time of measurement, provided the plate dissipation is not excessive. The characteristics of such diodes are single-valued even in the saturated range. i.e., the range in which the same value of current is obtained at a given voltage whether the voltage has been increased or decreased to the particular value.

Diodes with oxide-coated cathodes may have double-valued characteristics because of the coating characteristic. The cathode coating has resistance and capacitance, both of which are a function of temperature, current, and the degree of "activation."

A highly emitting monatomic layer of barium on oxygen is formed on the surface of the coating, which,

when heated, supplies the electron cloud forming the space charge above the coating surface (see Fig. 11). The emission from this surface may have values as high as 100 amperes per square centimeter. The flow of such enormous currents is, however, dependent on the internal-coating impedance and is possible only under certain conditions. Special apparatus is required

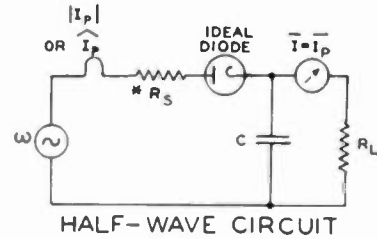

HALF-WAVE CIRCUIT

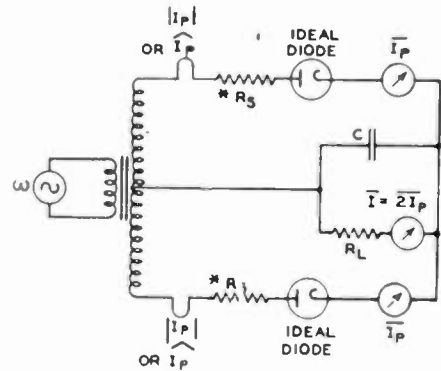

FULL-WAVE CIRCUIT

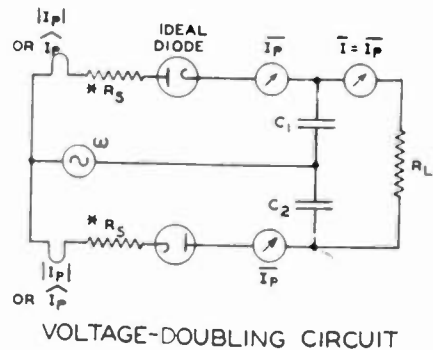

VOLTAGE-DOUBLING CIRCUIT

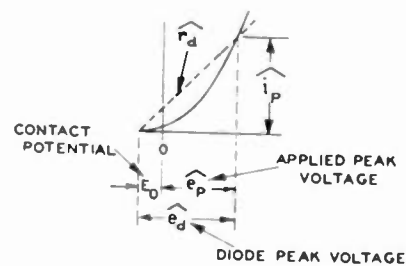

$$\hat{r}_d = 0.88\bar{r}_d = 0.93|r_d| = \frac{e_d}{i_p}$$

$R_S$  = EXTERNAL RESISTANCE  
 $\hat{r}_d$  = PEAK DIODE RESISTANCE  
 $\bar{r}_d$  = EQUIVALENT AVE. DIODE RESISTANCE  
 $|r_d|$  = EQUIVALENT R.M.S. DIODE RESISTANCE  
 $|R_S| = R_S + |r_d|$   
 \* USE  $\hat{R}_S, \bar{R}_S,$  OR  $|R_S|$  AS REQUIRED

Fig. 9—Equivalent circuits and resistance values for condenser-input rectifier circuits.

to permit observation of high current values which, to prevent harm to the tube, can be maintained only over very short time intervals determined by the thermal capacity of the plate and coating. For example, an instantaneous power of 15 kilowatts must be dissipated in the close-spaced diode type 83-v at a current of 25 amperes from its cathode surface of only 1 square centimeter.

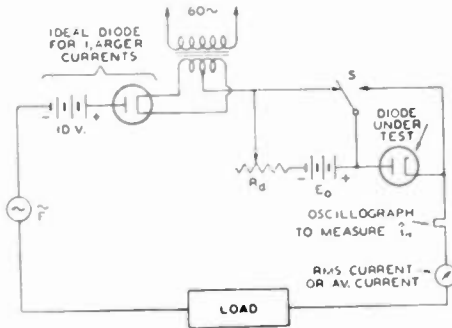

Fig. 10—Circuit for measuring equivalent diode resistance values.

Equipment for such observations was built in June, 1937, by the author after data obtained in 1935 on a low-powered curve tracer<sup>6</sup> indicated the need for equipment having a power source of very low internal impedance for measurements on even relatively small diodes.

1. Measurement of Diode Characteristics and Peak Emission

The circuit principle is shown in Fig. 12. The secondary voltage of a 2-kilovolt-ampere transformer  $T_m$  is

<sup>6</sup> Demonstrated, Rochester Fall Meeting, Rochester, N. Y., November 18, 1935.

adjustable from zero to 2 kilovolts by means of an autotransformer  $T_A$ . Transformer and line reactances are eliminated for short-time surge currents by a large condenser load ( $C=20$  to 80 microfarads). The large reactive current is "tuned out" by a choke  $L$  of con-

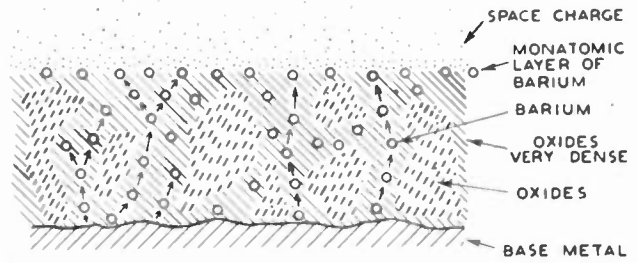

Fig. 11—Representation of cathode coating.

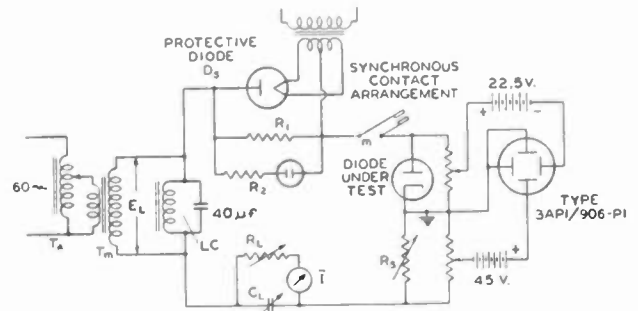

Fig. 12—Peak emission test circuit.

siderable size. The voltage is applied through a large mercury diode and a synchronous contact arrangement  $m$  to the tube under test in series with a resistance box  $R_s$  and a condenser input load  $C_L$  and  $R_L$ . This load

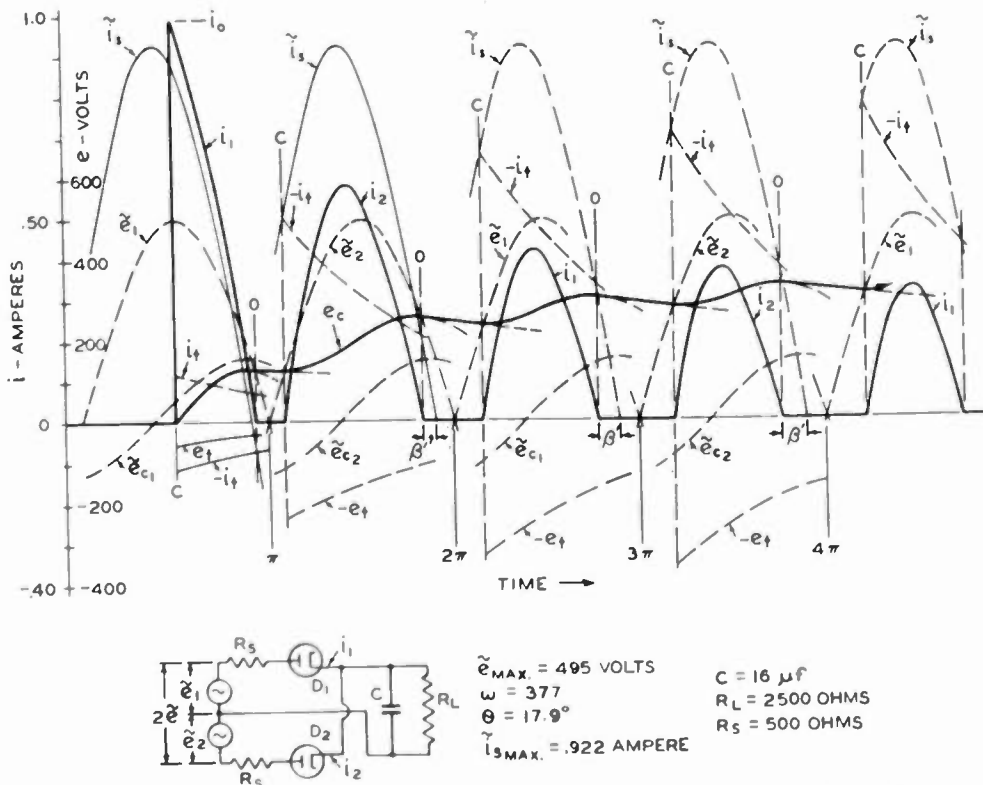

Fig. 13—Starting conditions in a full-wave, condenser-input circuit with large series resistance.





through poorer sections. Forced electron flow results in local power dissipation and temperature increases and may cause ionization and electrolysis accompanied by liberation of gas (oxygen) and formation of barium metal; i.e., it causes an accelerated activation process.

These conditions in the diode coating, therefore, should furnish a voltage-current characteristic of purely ohmic character as long as activation-gas liberation is substantially absent. Characteristics of this type are single valued. Single-valued characteristics indicate, however, unsaturated ohmic coating conductance and limiting surface emission when moderate-current densities are involved as will be apparent from the following discussion. As cathode and coating temperatures are relatively slowly varying parameters, characteristics such as shown in Fig. 15 are observed on the cathode-ray curve tracer. The characteristic

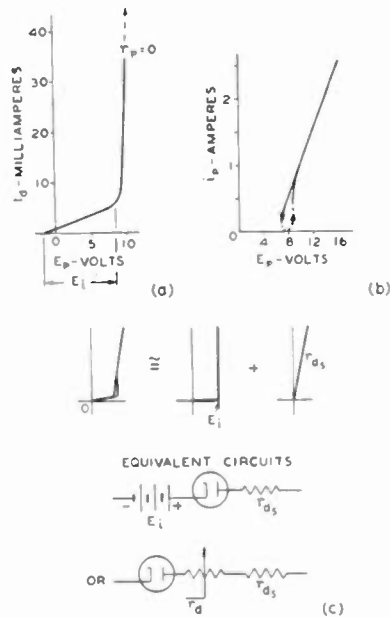

Fig. 16—Characteristics and equivalent circuit for hot-cathode, mercury-vapor diodes.

of diodes containing larger amounts of gas exhibits a discontinuity or "gas loop" (compare Fig. 16 (b)) which is recognized by the fact that corresponding current values after ionization require less diode potential than before "breakdown." The characteristic, hence, is steeper than normal.

### 3. Transient Emission

Let us now consider the action of insulating oxides in the coating. They block many possible electron paths to sections of the surface layer which, therefore, cannot emit steady electron currents. However, electrons can be moved to the oxide surfaces and a displacement current can flow in these coating sections allowing transient-emission currents to be drawn from the corresponding surface sections.

The displacement current in the coating and the corresponding transient surface emission represent a certain fraction of the total diode current, which may

permit a total emission current of short duration much in excess of the possible steady-state conduction current. The "transient-emission" current depends on the effective capacitance value of the blocking oxides, their series and shunt conductance in the coating, the emission and area of corresponding surface elements to the plate as well as on the external plate-circuit impedance, and the wave form of the applied plate voltage.

For the purpose of analysis, therefore, we may draw representative networks such as shown in Figs. 17 or

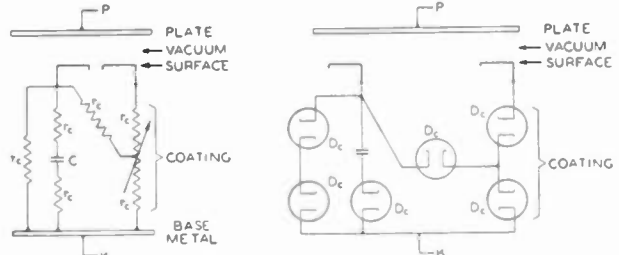

Fig. 17 (left)—Circuit network representing the coating impedance in high-vacuum diodes.

Fig. 18 (right)—Same as Fig. 17 with resistances replaced by special diodes.

18 and show the temperature-controlled coating conductances  $r_c$  as a network of "close-spaced diodes" which may conduct in two directions, each one having a single-valued characteristic which may be unsaturated or saturated depending on the assumed conditions in the coating; the conductance values of these "diodes" depend on the number of parallel or series paths they represent.

The diode contains, therefore, in its coating, a type of condenser-input load circuit, which is analyzed later on in this paper; its action explains double-valued voltage-current characteristics obtainable from the diode alone.

Consider a high plate voltage suddenly applied by means of a switch to a diode as in the circuit of Fig. 19.

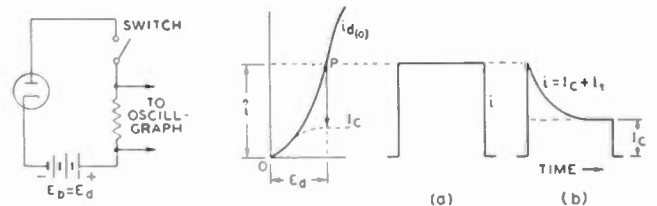

Fig. 19—Circuit for observation of peak emission transients.

If the coating is not limiting, the current obtained is that at a point  $P$  on the corresponding diode characteristic. Hence, the current wave form in the circuit is as shown in Fig. 19(a). If the surface emission is assumed to be unchanged, but the coating conductance is limited, due to an insufficient number of "coating diodes" and too many nonconducting oxide groups, the wave form of Fig. 19 (b) is obtained. At the instant when the switch is closed the current value  $i$  is demanded by  $E_d$  from the surface layer; the conduction current in the coating is limited to the value  $I_c$  by saturation of

the "coating diodes." Because of the oxide capacitance, a displacement current can flow and charge up the oxides, but their charge may be limited by hypothetical series diodes.

The coating resistance is extremely low<sup>7</sup> below saturation, but becomes infinite when the conduction current is saturated; the charging current must then flow in the plate circuit (external) of the diode. The total plate current is, therefore, the sum of the conduction current  $I_c$  and a "transient-emission" current. The "coating transient" decays to zero the same as normal transients at a rate depending on the actual shunt-conductance value and the total series resistance in the circuit (Fig. 19(b)). The decay can be changed by adding external resistance in the plate circuit. When the surface emission is good, i.e., as long as the total vacuum-space plate current is space-charge-limited, the current will rise initially to the value (point  $P$ ) determined by the applied potential, but will then decay to the saturation value determined by the coating conductance.

The condition of oxide-coated cathodes can, therefore, not be judged alone by their capability of furnishing high peak currents, but the time of current flow and the current wave form must also be carefully considered, because the diode characteristic may not be single-valued. Fig. 14 shows characteristics which are not single-valued. It should be noted that the characteristic loops are formed in the opposite sense as gas loops. Their extent depends on the time interval involved and the current value exceeding the unsaturated conductance current. An artificially produced characteristic of this type is also shown in Fig. 14(c). The loop size can be varied by adjusting the cathode temperature of the shunting diode. Both diodes had single-valued characteristics.

#### 4. Current Overload and Sputter

The degree of activation is not stable during the life of the cathode. Coating conductance and surface emission change. Factors affecting the change are the coating substances, the evaporation rate of barium which depends on the base material, and the operating conditions to which the cathode is subjected. This life history of the cathode is the basis on which current ratings are established. Rectifier tubes especially are subject to severe operating conditions. If a diode is operated with too high a current in a rectifier circuit and its surface emission is decreased to the saturation value, then the tube-voltage drop will increase rapidly and cause excessive plate dissipation and destruction of the tube. Should the coating conductance in this diode decrease to a value which limits the demanded current, power is dissipated in the now-saturated coating with the result that the coating-voltage drop and coating temperature are raised. The voltage and tem-

perature rise in the coating may cause reactivation but also may become cumulative and melt the coating material. We may consider that good conducting paths are fused or that a dielectric breakdown of oxide capacitance occurs; in any event vapor or gas discharges result from saturated coatings. In most cases breakdown occurs during one of the following inverse voltage cycles as observed on the curve tracer. A saturation loop is first formed as shown in Fig. 14 and a certain time must be allowed for diffusion of the gas into the vacuum space. Fusion of coating material may also occur during the conduction period. These breakdowns are known as "sputter," and in usual circuits destroy the cathode.

A second type of sputter is caused by the intense electrostatic field to which projecting "high spots" on the plate or cathode are subjected. The resulting current concentration causes these spots to vaporize with the result that an arc may be started. Hundreds of scintillating small spots can be observed at first at very high applied surge potentials, but may be cleared after a relatively short time.

Transient peak currents of 25 amperes per square centimeter have been observed from well-activated oxide-coated cathodes. The stable peak emission over an extended period is usually less than one third of this value.

#### 5. Hot-Cathode Mercury-Vapor Diodes

The breakdown voltage  $E_i$  of mercury vapor for cumulative ionization is a function of the gas pressure and temperature. It is approximately 10 volts in the RCA-83 and similar tubes. A small electron current begins to flow at  $E_p=0$  (see Fig. 16), and causes ionization of the mercury vapor. This action decreases the variational diode resistance  $r_p$  to a very low value. The ionization becomes cumulative at a certain current value ( $r_p=0$  at 40 milliamperes in Fig. 16(a)), and causes a discontinuity in the characteristic. Hence, it is not single-valued within a certain voltage range. Beyond this range (see Fig. 16(b)), the slope ( $r_p$ ) of the characteristic becomes again positive until saturation of the emitter is reached.

For circuit analysis, the mercury-vapor diode may be replaced by a bucking battery having the voltage  $E_i$  and a fixed resistance as shown in Fig. 16(c); or the diode characteristic may be replaced by an ideal rectangular characteristic and its equivalent resistance values and the series resistance  $r_{ds}$  as shown.

The first representation is adequate for most practical calculations. The value  $r_{ds}$  is in the order of 4 ohms for small rectifier tubes. The low series resistance and the small constant-voltage drop  $E_i$  are distinct advantages for choke-input filters, as they cause very good regulation; the low resistance, however, will give rise to enormously high starting transients in condenser-input circuits, in case all other series resistances are also small. The destruction of the coating in

<sup>7</sup> Its magnitude depends on the number of series diodes and, hence on the barium content and thickness of the coating.

mercury-vapor diodes is caused by concentration of current to small sections of the coating surface and not by heat dissipation in the coating. Mercury-vapor diodes as well as high-perveance (close-spaced), high-vacuum diodes having oxide cathodes should, therefore, be protected against transient-current overloads when they are started in low-resistance circuits to prevent destruction of the cathode coating.

### 6. Protective Resistance Values.

Very high instantaneous peak currents may occur in noninductive condenser-input circuits when the circuit is opened long enough to discharge the condenser, but reclosed before the cathode temperature of the diode has decreased substantially. The maximum peak current  $\hat{I}_{\max}$  occurs when closing the circuit at peak line voltage. At the instant of switching,  $C$  is a short circuit and the current  $\hat{I}_{\max}$  is limited only by the series resistance (including diode) of the circuit,

$$\hat{I}_{\max} = \frac{\bar{e}_{\max}}{\hat{R}_s}$$

For a given maximum diode current  $\hat{I}_{d\max}$  and the corresponding diode peak voltage  $\hat{E}_{d\max}$ , the minimum effective series resistance  $R_s$  in the circuit must hence be

$$R_s = \frac{\bar{e}_{\max} - \hat{E}_{d\max}}{\hat{I}_{d\max}}$$

This limiting resistance must be inserted in series with low-impedance sources (power line in transformerless sets). Commercial power transformers for radio receivers have often sufficient resistance besides some leakage reactance to limit starting currents to safe values.

## III. CIRCUIT ANALYSIS

### General

The rectifier diode is a switch operated in synchronism with the applied alternating-current frequency. Switching in reactive circuits causes transients. The total current in the circuit may be regarded as the sum of all steady-state currents and transient currents within the time between two switching operations. Steady-state voltages ( $e_s$ ) and currents ( $i_s$ ) in the particular circuit before and after switching are determined without difficulty. It is very helpful to draw them approximately to scale and with proper phase relation.

The switching time of the diode is then located on the graph. Currents change at switching time  $t_0$  from  $i_1$  to  $i_2 = i_{s(2)} + i_t$  and voltages from  $e_1$  to  $e_2 = e_{s(2)} + e_t$ . The transients  $i_t$  or  $e_t$  are zero, when the current change does not occur in an inductive circuit or when a voltage change is not required on a capacitance at the time of switching. A sudden change  $\Delta i_L$  or  $\Delta e_c$  demanded at  $t_0$  causes transients. They initially cancel the change  $\Delta i_L$  or  $\Delta e_c$  because an inductance offers infinite impedance to an instantaneous change in total

current and a capacitance offers zero impedance to an instantaneous voltage change.

The initial transient values are, therefore,

$$i_{t(0)} \text{ in } L = -\Delta i_L$$

and

$$e_{t(0)} \text{ on } C = -\Delta e_c$$

The transients decay exponentially from their initial value.

According to the decay time of the transients, fundamental rectifier circuits may be classified into two principal groups: (1) circuits with repeating transients in which the energy stored in reactive elements decreases to zero between conduction periods of the diode; and (2) circuits with chain transients in which (a) the magnetic energy stored in the inductance of the circuit remains above zero value, and (b) the electric energy stored in the capacitance of the circuit remains above zero value. The much used "choke-input" and "condenser-input" circuits fall under the second group.

We shall analyze the operation in important circuits, i.e., the full-wave choke-input circuit and condenser-input circuits.

### 1. The Full-Wave Choke-Input Circuit

a) Operation of circuits with  $L$  and  $R_s$  in the common branch circuit

Circuit and operation are shown in Fig. 20. The analysis is made by considering first one of the diodes short-circuited to obtain the phase relation of the alternating voltage  $\bar{e}$ , and the steady-state current  $\bar{i}_s$ , as shown. If we assume that the diode  $D_1$  closes the circuit  $I$  at the time  $\bar{e}=0$ , a transient  $i_t$  with the initial value  $i_{t(0)} = -\bar{i}_{s(0)}$  will flow in the circuit. The total current  $i$  is the sum of the currents  $\bar{i}_{s1} + i_t$ . It starts, therefore, at zero and rises as shown until the second switching operation occurs at the commutation time  $t=\pi$  when the second diode  $D_2$  receives a positive plate voltage. The total current  $i$  in circuit II after  $t=\pi$  is again the sum of currents  $\bar{i}_{s2} + i_t$  ( $\bar{i}_{s2}$  has reversed polarity with respect to  $\bar{i}_{s1}$  and is not shown in Fig. 20) but the initial value  $i_{t(0)}$  of the second transient is increased by the value  $i_{t(\pi)}$  now flowing in the common circuit inductance  $L$ .

The current  $i_{t(0)}$  increases, therefore, at every new switching time until the decay of the transient  $i_{t(n)}$ , during the time  $t=\pi$ , is numerically equal to the steady-state current rise  $2\bar{i}_{s(0)}$ . For the final operating current at the  $n$ th commutation time (see right side of Fig. 20)

$$\begin{aligned} (i_{(n\pi)} - \bar{i}_{s(0)})(1 - e^{-R_s/2FL}) &= -2\bar{i}_{s(0)} \\ i_{(n\pi)} &= \bar{i}_{s(0)} - (2\bar{i}_{s(0)}/1 - e^{-R_s/2FL}). \end{aligned} \quad (7)$$

A broken line is shown connecting all commutation-current values. This line represents closely the average current  $\bar{I}$  in the common circuit branch. The final average current  $\bar{I}$  in the load resistance  $R_s$  is given by

(7), when the transient decay  $i_{t(n)}$  during the time  $\pi$  (Fig. 20) can be regarded as linear (low steady-state power factor of circuit). The average plate current per diode is  $\bar{I}_p = 0.5\bar{I}$ , since each diode conducts

b) The full-wave choke input circuit with capacitance-shunted resistance load

For large capacitance values the by-passed load resistance  $R_L$  of practical circuits is equivalent to a

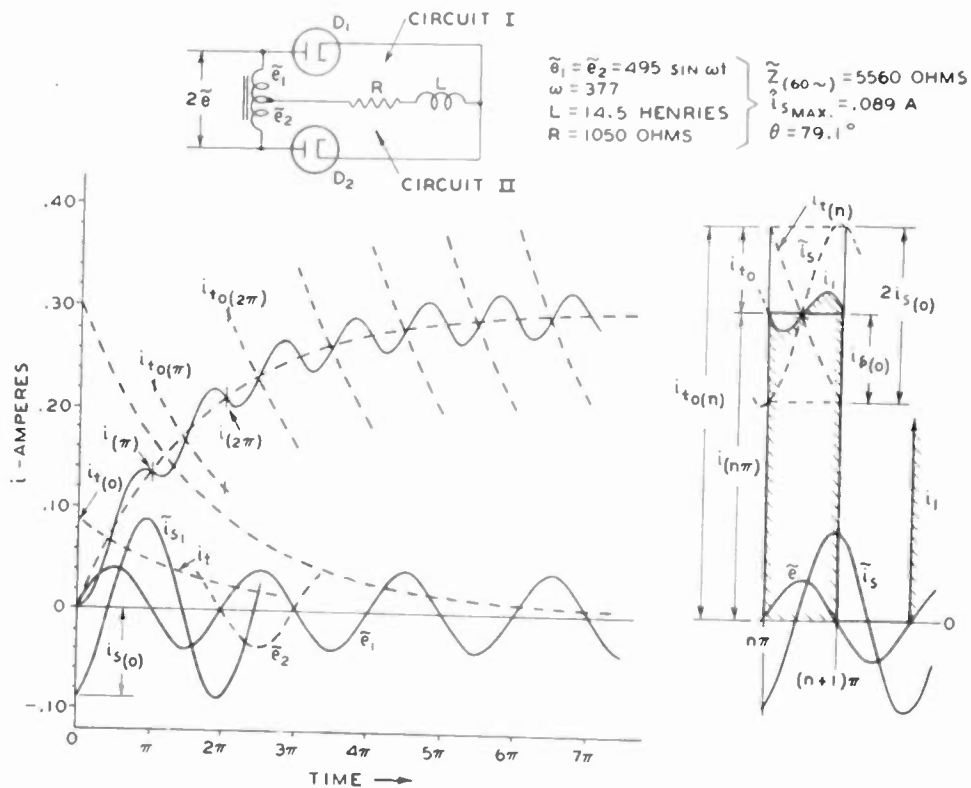

Fig. 20—Starting and operating conditions of an aperiodic full-wave, choke-input rectifier circuit.

alternately, and passes a current pulse shown by the shaded area in Fig. 20. With the numerical values of the circuit Fig. 20 substituted in (7) we obtain

$$i_{(n\pi)} \cong \bar{I} = 0.298 \text{ ampere.}$$

The oscillogram in Fig. 21 was taken on circuit Fig. 20.

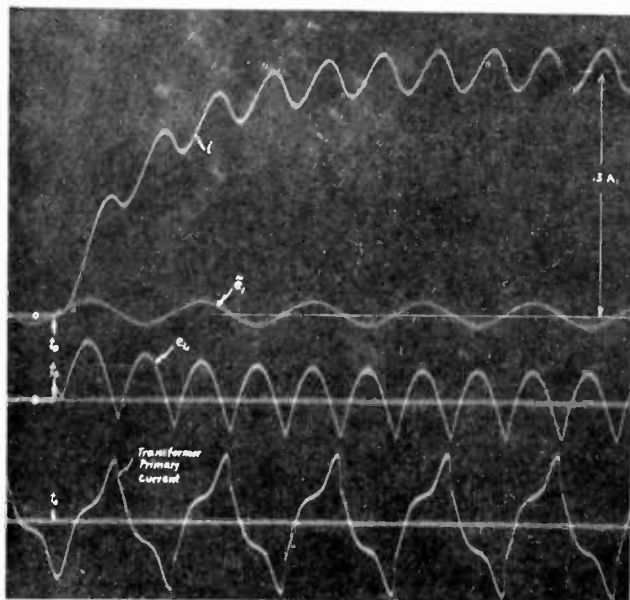

Fig. 21—Oscillograms taken with circuit of Fig. 20.

battery having a voltage  $\bar{E}_B = \bar{I}R_L$ , where  $\bar{I}$  is the average load current or battery-charging current. The circuit operation (see Fig. 22) is described by obtaining  $\bar{I}$  as a function of  $\bar{E}_B$ . The final commutation current  $i_{(n\pi)}$  which is closely the average current  $\bar{I}$  is given by

$$\bar{I} \cong i_{(n\pi)} = (\bar{I}_B + i_{s(0)}) - 2i_{s(0)}/(1 - e^{-R_s/2FL}) \quad (7b)$$

and similar to (7) except for an increase of the transient term due to the battery current  $\bar{I}_B = \bar{E}_B/R_s$ .

Equation (7b) is valid only over a range of load or battery voltage ( $\bar{E}_B$ ) in which switching time and conduction period of the diodes are constant ( $\phi = \pi$ ). This range is shown by the solid part of curve F in Fig. 22 and ends at a particular current and voltage of the circuit characteristic marked the "critical point."

The critical point is the operating condition at which the instantaneous current  $i$  in the common branch circuit has zero value at one instant. An analysis shows that in the range  $\bar{E}_B = \bar{e}_{max}$  to  $\bar{E}_B = E_B'$  each diode circuit operates independently as a half-wave rectifier circuit (battery-charger operation, curve II in Fig. 22). Current commutation begins at  $E_B'$ ; the diode circuits begin to interact, but the conduction angle is still  $\phi < \pi$ .

The conduction angle increases from  $\phi = 0$  at  $\bar{E}_B = \bar{e}_{max}$  to  $\phi = \pi$  at the critical point  $E_B''$  which marks the beginning of chain current operation.



The critical operating condition is obtained by solving for  $i=0$  with  $\phi=\pi$  or by equating the direct current to the negative peak value of the total alternating current in  $L$ . The critical point is hence specified by a certain current or by a certain ratio  $K$  of direct-

If we neglect harmonics higher than  $2F$ , which contribute little to the peak value because of phase shift and increasing attenuation in  $L$ , the peak ripple current (equation (10)) becomes

$$i_{\min} = 4/3\pi(\bar{e}_{\max}/Z_{(2F)})$$

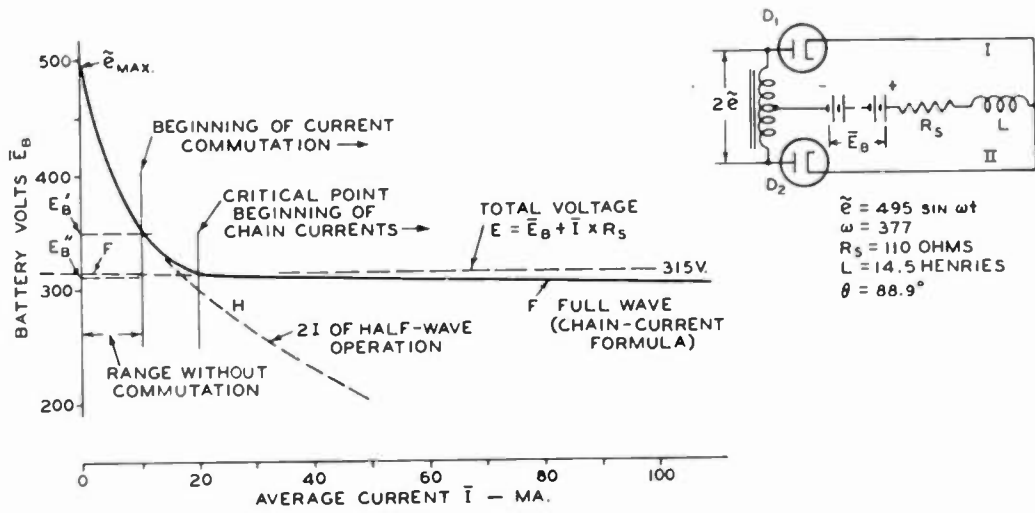

Fig. 22—Operating characteristic of a full-wave, choke-input rectifier circuit with battery load  $\bar{E}_B$  or resistance load  $R_L = \bar{E}_B/\bar{i}$  shunted by a large capacitance.

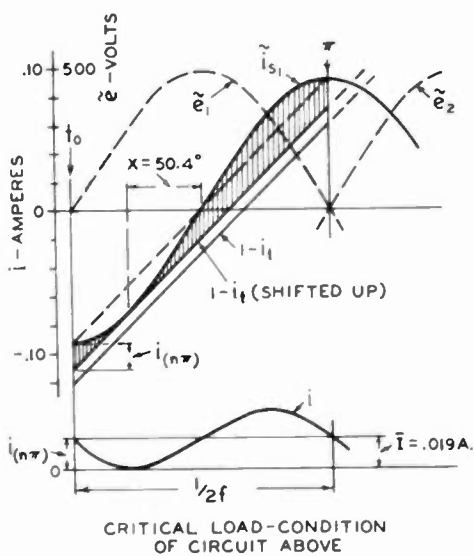

Fig. 23 (left)—Graphic solution for the critical load condition with negligible series resistance.

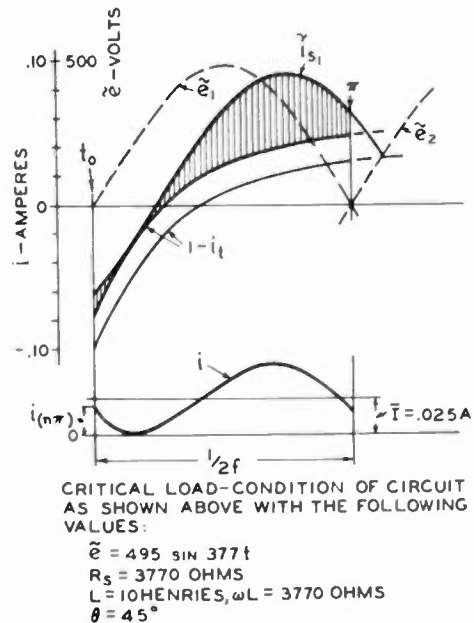

Fig. 24 (right)—Same as Fig. 23 but with large series resistance.

current resistance to alternating-current impedance in the circuit. With reference to the equivalent circuit treated in the following section, a relation to the fundamental alternating-current component of the rectified current (see (10)), i.e., to the impedance  $Z_{(2F)}$ , at double line frequency is more useful. We set, therefore,

$$\frac{(R_s + R_L)}{Z_{(2F)}} = K \tag{8}$$

and determine significant values of  $K$  for particular circuit impedance conditions.

and setting it equal to the average current

$$\bar{I} = 2/\pi(\bar{e}_{\max}/(R_s + R_L))$$

we obtain  $K = 1.5$  for the ratio as shown in (8).

The exact solution for the critical current can be obtained from a graphic analysis by simple reasoning for the case  $R_s = 0$ . The general solution will only be indicated. It is obtained by drawing the complementary curve  $(1 - i_t)$  of the total transient beginning at the time  $\bar{e} = 0$  (see Figs. 23 and 24) and shifting it upward until it touches the current  $i_t$ , thus solving

for  $i=0$  at the point of contact. Note that  $i_{(n\pi)}$  is the same at  $t_0$  and  $\pi$  in both cases shown.

For  $R_s=0$ , the transient section becomes a straight line having the slope  $2/\pi$  and running parallel to the peak-to-peak connecting line of  $\bar{i}_s$ . The sine-wave slope  $2/\pi = -\cos x$  gives the point of contact at  $X=50.4$  degrees (Fig. 23), and the peak ripple current is obtained from

$$i_{min} = \bar{i}_{smax} \left( \sin 50.4^\circ - \frac{50.4}{90} \right) = 0.211 \bar{i}_{smax}$$

$$= 0.211 \frac{\bar{e}_{max}}{\omega L}$$

Equating this value to the average current given by (10), we obtain the value  $K=1/0.211=1.51$  for cir-

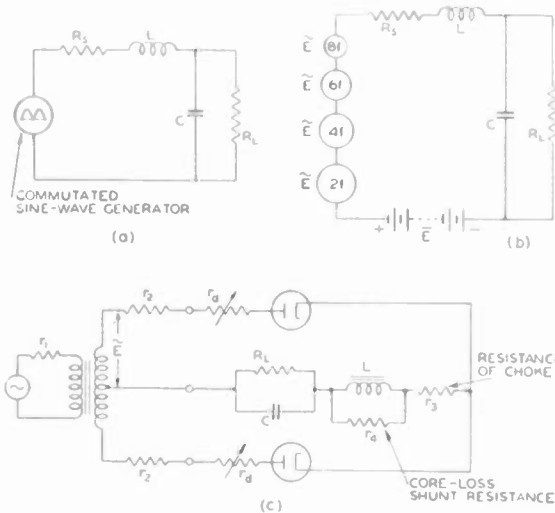

Fig. 25—Components of equivalent and practical full-wave, choke-input circuits.

cuits with  $R_s=0$ . The graphic analysis of circuits with larger resistance (see Fig. 24) furnishes  $K$  values sufficiently close to 1.5 to justify the use of this constant for all practical purposes. For practical circuits with  $2\omega L \gg 1/2\omega C$  we may further write  $Z_{(2F)} \approx 2\omega L$  and obtain the *critical inductance*<sup>8</sup>

$$L_0 \cong (R_s + R_L)/2\omega K = (R_s + R_L)/6\pi F \quad (9)$$

c) Equivalent circuit for the chain current operating range ( $\phi = \pi$  or  $(R_s + R_L) < 1.5Z_{(2F)}$ )

Inspection of (7b) shows that average and commutation current are directly proportional to the sum of battery current  $\bar{I}_B$  and a term having a constant current value " $I_K$ " for a given circuit and constant line voltage. Equation (7b) can be changed into the form

$$\bar{I} = (I_K R_s)/(R_L + R_s),$$

indicating that the secondary circuit may be replaced by an equivalent circuit without switches and energized by a voltage which contains a constant direct-

<sup>8</sup> The relation  $L_0 = R_L/1000$  was given on an empirical basis for  $\omega = 377$  by F. S. Dellenbaugh, Jr., and R. S. Quinby, "The important first choke in high-voltage rectifier circuits," *QST*, vol. 16, pp. 14-19; February, 1932.

current component  $\bar{E} = I_K R_s$ . The equivalent voltage in the circuit is the commutated sine wave resulting from the sequence of positive half cycles  $+\bar{e}_1$  and  $+\bar{e}_2$  in the range  $\phi = \pi$ . The equivalent circuit is shown in Fig. 25(a). The single generator may be replaced by a battery and a series of sine-wave generators (Fig. 25(b)) having amplitudes and frequencies as given by the following equation of the commutated sine wave:

$$e = \frac{2\bar{e}_{max}}{\pi} \left( 1 - \frac{2 \cos 2F}{1.3} - \frac{2 \cos 4F}{3.5} - \frac{2 \cos 6F}{5.7} - \dots \right) \quad (10)$$

All current components in the circuit may now be computed separately by steady-state methods; the direct-current component is the total average voltage  $\bar{E}$  in the circuit.

Some useful relations of voltage components are: Line voltage induced in one half of the secondary winding (root-mean-square)

$$|\tilde{E}| = 1.1\bar{E}$$

Total average voltage

$$\bar{E} = \begin{cases} 0.90 |\tilde{E}| \\ 0.637 \bar{e}_{max} \end{cases}$$

Voltage of frequency  $2F$  (root-mean-square)

$$|\tilde{E}|_{2F} = \begin{cases} 0.424 |\tilde{E}| \\ 0.471 \bar{E} \end{cases} \quad (11)$$

Voltage of frequency  $4F$  (root-mean-square)

$$|\tilde{E}|_{4F} = \begin{cases} 0.085 |\tilde{E}| \\ 0.0945 \bar{E} \end{cases}$$

Total choke voltage (root-mean-square)

$$|E|_L = \begin{cases} \sqrt{|\tilde{E}|^2 - \bar{E}^2} \\ 0.482 \bar{E} \end{cases}$$

The current components in the common circuit branch are calculated from the above voltages divided by the impedance of one branch circuit at the particular frequency. Because the current is commutated every half cycle of the line frequency from one to the other branch circuit, the average current in each diode circuit is one half of the total average current; and root-mean-square values of currents or current components in each branch circuit are obtained by multiplying the root-mean-square current values in the common circuit branch by  $1/\sqrt{2}$ . The peak current in each diode circuit has the same value as in the common circuit branch.

Average load current

$$\bar{I} = \frac{\bar{E}}{R_s + R_L}$$

Average plate current (per diode)

$$\bar{I}_p = 0.5\bar{I} \quad (12a)$$

Double-frequency current (root-mean-square) in common circuit branch

$$|\tilde{I}|_{2F} = \frac{|\tilde{E}|_{2F}}{Z_{(2F)}}$$

Total current (root-mean-square) in common circuit branch

$$|I|_L = \sqrt{I^2 + |\tilde{I}|_{2F}^2}$$

Root-mean-square diode current or root-mean-square current per transformer winding

$$|I|_p = \frac{|I|_L}{\sqrt{2}} \tag{12b}$$

Peak diode current

$$i_d = \bar{I} + (|\tilde{I}|_{2F} \times \sqrt{2})$$

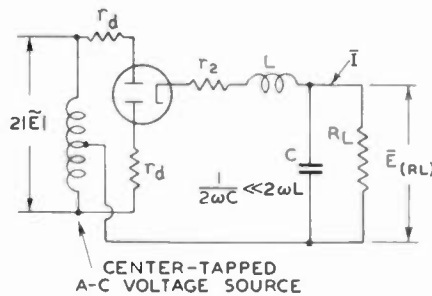
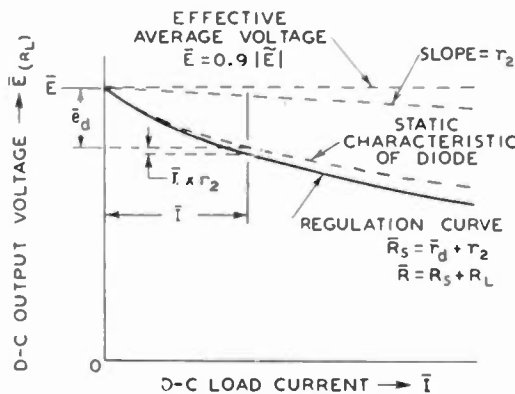

Fig. 26—Regulation characteristic of a full-wave, choke-circuit with high-vacuum diode.

The total power dissipated in diode and load circuits of the practical secondary circuit shown in Fig. 25(c) is the sum of the power losses in the circuit resistances. In equation form, it is

$$\begin{aligned} \text{Total power} = & \text{series-resistance loss} \\ & + \text{choke-core loss} \\ & + \text{direct-current power in load.} \end{aligned}$$

The plate dissipation per diode is given by

$$P_d = 0.5 |I|_L^2 \times |r_d| \tag{13}$$

With reference to (5), we have

$$P_d = 0.5 |I|_L^2 \times \frac{\bar{e}_d}{\bar{I}} \tag{14}$$

where  $\bar{e}_d$  is the diode voltage taken from the static diode characteristic at the output-current value  $\bar{I}$ .

d) Regulation

The regulation of choke-input circuits is determined by the total series resistance  $\bar{R}_s$ , since the voltage  $\bar{E}$  in the circuit is constant in the useful chain current range for an energizing alternating voltage of constant value. Thus, the regulation curve has the slope  $\bar{R}_s$  (see Fig. 26), which includes the diode resistance.

The regulation curve for a circuit with high-vacuum diodes is the sum of the 3/2-power-law diode characteristic and the ohmic series resistance  $r_2$  of one branch circuit as shown in Fig. 26. The curve is correct for constant voltage  $\bar{e}$  and beyond the critical current value. In practical circuits, the voltage source  $\bar{e}$  has a certain equivalent resistance, which must be added to  $r_2$ . The regulation curve Fig. 26 is invalid below the critical current value and must be replaced by a curve following the laws discussed for Fig. 22.

The equivalent internal resistance of the rectifier circuit as a direct-current supply source is the slope of the regulation curve at the current value under consideration. This value should be used for steady-output conditions only, since the reactances in the load circuit cause transients at the instant of sudden load changes.

2. The Condenser-Input Circuit

In rectifier circuits with shunt-condenser-input loads, the condenser is alternately charged and discharged. In the final state of operation, charge and discharge are balanced. The graphic analysis of such circuits is comparatively simple and readily followed. Formulas for the calculation of specific circuit conditions are easily derived from the constructions.

a) Circuits without series resistance

The graphic analysis of a half-wave rectifier circuit without series resistance ( $R_s$ ) is illustrated in Fig. 27. Steady-state voltage  $\bar{e}$  and current  $\bar{i}$ , are constructed on the assumption that the diode is short-circuited. The steady-state condenser voltage  $\bar{e}_c$  coincides with  $\bar{e}$  because  $R_s = 0$ .

The diode timing is as follows:

The diode opens the circuit at point 0 when the diode current becomes zero.

Since the condenser-discharge circuit consists of  $C$  and  $R_L$ , the condenser voltage decays exponentially as shown. At point C it has become equal to the energizing voltage  $\bar{e}$ . The diode becomes conducting and closes the circuit. Because there is no potential difference between the steady-stage voltages  $\bar{e}$  and  $\bar{e}_c$ ,

the condenser does not receive a transient charge. The current, therefore, rises instantly to the steady-state value of the  $i_s$  curve and follows it until zero at point O.

The timing of the full-wave circuit in Fig. 28 is quite similar. The time for the condenser discharge through  $R_L$  is reduced since  $e_c$  meets the positive half cycle  $\bar{e}_2$  and thus closes the circuit through  $D_2$ . Point C in Fig. 28 is located at a higher value of  $\bar{e}$  than in Fig. 27. The conduction angle  $\phi$  is consequently reduced although  $C$ ,  $R_L$ , and  $\Theta$  have the same values in both circuits. The average current in the full-wave circuit is, therefore, smaller than twice that of the half-wave circuit.

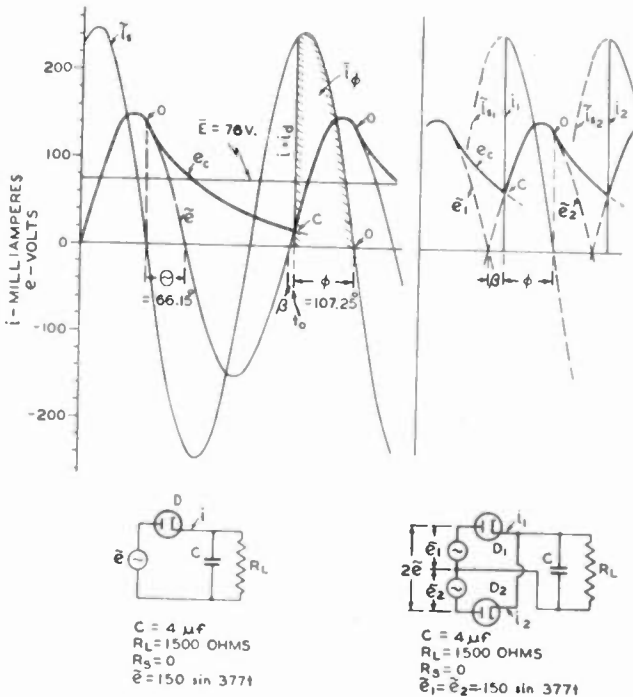

Fig. 27 (left)—Graphic solution of operation for a half-wave, condenser-input circuit without series resistance.

Fig. 28 (right)—Graphic solution of operation for a full-wave, condenser-input circuit without series resistance.

Some of the relations obtainable directly from Figs. 27 and 28 are

i. the conduction angle  $\phi = 180^\circ - \Theta - \beta$ . (15)

The intersection of  $\bar{e}$  with the decaying voltage  $e_t$  furnishes for half-wave operation ( $n=1$ ) and full-wave operation ( $n=2$ )

ii.  $\sin \beta = \sin (\Theta) e^{-(\pi+\Theta+\beta)/\omega CR_L}$  for  $n = 1$  }  
 and  $\sin \beta = \sin (\Theta) e^{-(\Theta+\beta)/\omega CR/L}$  for  $n = 2$  } (16)

where  $\pi$ ,  $\Theta$ , and  $\beta$  in the exponents are in radius. This equation may be solved graphically or by trial and error, varying  $\beta$ .

iii. The average current during conduction time is

$$I_{(\phi)} = I_s(1 - \cos \phi)/\phi.$$

It is the area under a sine-wave section divided by its

base. Hence, the average plate current is as shown in (iv).

iv. 
$$\bar{I}_p = i_{(\phi)} \frac{\phi}{2\pi} = \frac{i_s}{2\pi} (1 - \cos \phi). \quad (17)$$

v. Average current  $\bar{I}$  and voltage  $\bar{E}$  in the load resistor are

$$\left. \begin{aligned} \bar{I} &= \bar{I}_p & \text{for } n &= 1 \\ \bar{I} &= 2\bar{I}_p & \text{for } n &= 2 \end{aligned} \right\} \quad (18)$$

$$\bar{E} = \bar{I}R_L$$

vi. The diode peak current  $i_p$  is, obviously

$$\left. \begin{aligned} i_p &= i_s & \text{for } \phi > 90^\circ \\ i_p &= i_s \sin \phi & \text{for } \phi < 90^\circ \end{aligned} \right\} \quad (19)$$

The performance of these circuits, hence, is determined by their power factor  $\omega CR_L$  and the phase number  $n$ . It will be evident from the following that the series resistance  $R_s$  of practical circuits appears as an additional parameter which cannot be neglected.

b) Circuits with series resistance

In circuits with series resistance, the steady-state condenser voltage  $\bar{e}$  does not coincide with the supply

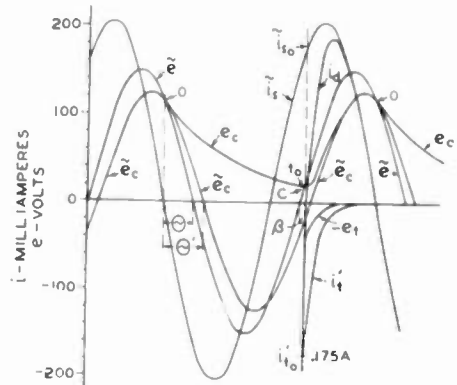

Fig. 29—Graphic solution of operation for a half-wave, condenser-input circuit with series resistance.

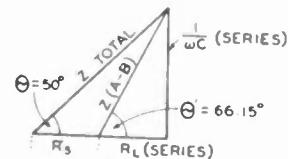
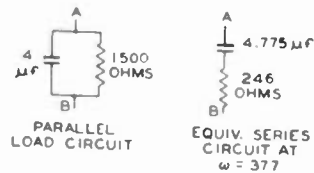
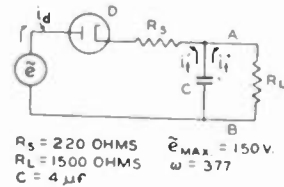

Fig. 30—Equivalent series circuit for the analysis of half-wave, condenser-input circuits with  $R_s > 0$ .



voltage  $\bar{e}$ , as illustrated in Figs. 29 and 30. Phase displacement and magnitudes of current and voltage under steady-state conditions are required for analysis of the circuit and are computed in the conventional manner. The parallel circuit  $C || R_L$  is converted into an equivalent series circuit to determine the angles  $\Theta$  and  $\Theta'$  by which  $\bar{i}_s$  is leading  $\bar{e}_c$  and  $\bar{e}$ , respectively. The steady-state condenser voltage  $\bar{e}_c$  in the parallel circuit equals the voltage across the equivalent circuit as shown by the vector diagram in Fig. 30.

The diode opens the circuit at the instant  $i_d = 0$ . For circuit constants as in Fig. 30, the diode current  $i_d$  substantially equals  $\bar{i}_s$  at the time of circuit interruption because the transient component  $i_t'$  of the current, as shown later, has decayed to a negligible value. Point 0 is thus easily located. In circuits with large series resistance, however,  $i_d = 0$  does not coincide with  $\bar{i}_s = 0$  due to slow decay of the transient  $i_t'$ . In both cases the condenser voltage  $e_{c(0)}$  equals the voltage  $\bar{e}_{c(0)}$  at the time 0, because  $i_d = 0$  and consequently there is no potential difference on  $R_S$  and transients do not occur at 0. The condenser voltage decays exponentially on  $R_L$  from its initial value at 0, as discussed for circuits with  $R_S = 0$ , and meets the supply voltage  $\bar{e}$  again

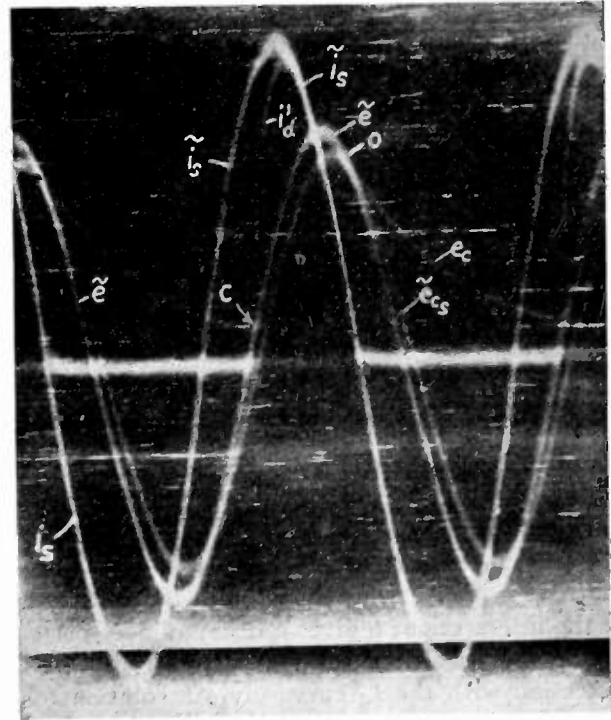

Fig. 31—Oscillograms taken with circuit of Fig. 30.

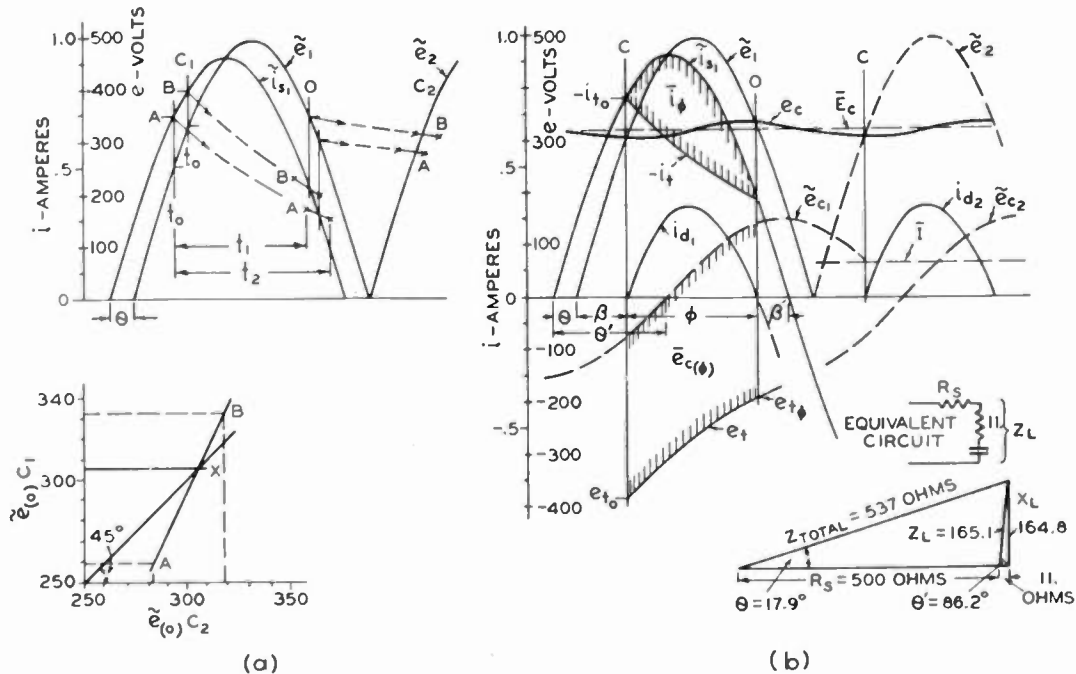

Fig. 32—Graphic solution of final operating conditions for circuit in Fig. 13.

at point C. At this instant ( $t_0$ ), the diode closes the circuit. Current and voltage, however, do not rise to their steady-state values as in circuits with  $R_S = 0$ , because the steady-state voltage  $\bar{e}_{c(0)}$  differs from the line voltage  $\bar{e}_{(0)}$  by the amount  $\Delta e_c = \bar{i}_{s(0)} R_S$ . A transient voltage of initial value  $e_{t(0)} = -(\bar{i}_{s(0)} R_S)$  occurs on C. It drives transient currents  $i_t'$  and  $i_t''$ , determined by Ohm's law through the resistances  $R_S$  and  $R_L$  respectively. (See Fig. 30.)

The transients  $e_t$  and  $i_t'$  prevent voltage and current from following the steady-state wave forms, as

$$i_d = \bar{i}_s + i_t' = \bar{i}_s - \bar{i}_{s(0)} e^{-t/(R_S || R_L)C} \quad (20)$$

and

$$e_c = \bar{e}_c + e_t = \bar{e}_c + R_S \bar{i}_{s(0)} e^{-t/(R_S || R_L)C} \quad (21)$$

between the time  $t_0$  and the opening time at 0.

For small values  $R_S$  and  $C$ , the transient decay is rapid as shown in Fig. 29 and point 0 is readily

determined. The oscillogram Fig. 31 was taken on the circuit Fig. 30 and checks the graphic construction.

The solution of operating conditions in circuits with large time constants requires additional steps, as  $e_c$  and  $i_d$  do not reach steady-state values before  $\bar{i}_s = 0$ . The diode opens the circuit earlier at an angle  $\beta'$ , which increases from cycle to cycle as shown for a full-wave circuit in Fig. 13. The condenser voltage  $e_c$  rises in successive conduction periods until its numerical decay over  $R_L$  equals the numerical rise during  $\phi$ . This final condition is shown in Fig. 32(b). The graphic solution for the final operating condition is illustrated in Fig. 32(a) and is made as follows:

Steady-state current  $\bar{i}_s$  and voltage  $\bar{e}_s$  are drawn with proper phase relation. A closing time  $t_0$  is assumed near the estimated average output voltage, condition  $A$  in Fig. 32(a) assumes  $\bar{i}_s(t_0) = 0.7A$  and  $\bar{e}_s(t_0) = 258$  volts at  $t_0$ . The current transient  $i_t'$  is subtracted graphically from  $\bar{i}_s$ . Only two points  $t_1$  and  $t_2$  are necessary near the intersection;  $t_1$  gives a decay of 57.4 per cent and then  $t_2$  gives a decay of 50 per cent from  $\bar{i}_s(t_0)$ . The intersection with the  $\bar{i}_s$  curve gives a solution for  $i_p$  equal to 0 and determines line 0, which gives  $\bar{e}_1 = 308$  volts which is also the voltage  $e_c$ . This voltage decays now over  $R_L$  until it intersects the following half cycle  $\bar{e}_2$  for closing time  $C_2$  at point  $A = 283$  volts which is the second closing time. As this voltage is higher than the initially assumed voltage ( $\bar{e}_s(t_0) = 258$  volts), the final condition is not yet reached. A second trial marked  $B$  was made with an initial voltage  $\bar{e}_s(t_0) = 333$  volts and furnished  $\bar{e}_s(t_2) = 319$  volts at  $C_2$ . The correct condition  $\bar{e}_s(t_0) = \bar{e}_s(t_2)$  is obtained from the auxiliary graph in Fig. 32(a) in which the voltage pairs  $A$  and  $B$  are connected by a straight line, which intersects the 45-degree line  $\bar{e}_s(t_0)C_1 = \bar{e}_s(t_2)C_2$  at the point  $X$ , and provides the solution for the final condition  $\bar{e}_s(t_0) = 306$  volts. If desired this value can be checked and corrected by exact calculation.

The final construction in Fig. 32(b) was made with this value. The shaded areas include the amplitude values  $i_d$  and  $e_c$  during  $\phi$  which are given by (20) and (21).

The average current during  $\phi$  is the area under the sine-wave section minus the area under the exponential curve  $i_s$ , both divided by the base. This furnishes

$$\bar{i}_{d(\phi)} = \bar{i}_{s\max} [(\cos \beta' - \cos(\phi + \beta')) - (\omega CR'(1 - e^{-\phi/\omega CR'}) \sin(\Theta + \beta))] / \phi \quad (22)$$

with  $R' = R_S || R_L$  and  $\phi$ ,  $\beta$  and  $\beta'$  determined graphically from the construction or by trial of values. The average plate current per diode is again

$$\bar{I}_p = \bar{i}_{d(\phi)} \phi^\circ / 360^\circ$$

and the direct load current in this full-wave circuit is  $\bar{I} = 2\bar{I}_p$ . In case of large time constants, as in the example, the average condenser voltage  $\bar{E}_c$  is quite accurately obtained from

$$\bar{E}_c = 0.5(e_{c(\phi)} + e_{c(0)}) \quad (23)$$

and the load current by Ohms law  $\bar{I} = \bar{E}_c / R_L$ .

The root-mean-square values of ripple voltage and diode current are needed for many calculations. They may be obtained for all cases from

$$|E|_{(\text{ripple})} = 0.321(e_{c\max} - e_{c(\min)}) \quad (24)$$

and

$$|I_p| = 1.1\bar{I}_p \sqrt{\frac{360^\circ}{\phi^\circ}} \quad (25)$$

Equation (24) holds within 10 per cent for wave shapes varying from a sine-wave to a saw-tooth and (25) gives better than 5 per cent accuracy for all wave shapes occurring in condenser-input circuits.

### c) Generalized operation characteristics (steady-state operation)

It has been shown that the conduction angle is a function of the circuit constants in condenser-input circuits. The section of the energizing voltage  $\bar{e}$  utilized during conduction time has, therefore, no fixed value as in choke-input circuits where  $\phi = 180$  degrees and where the voltage  $\bar{e}$  during  $\phi$  is a half sine wave. It is, therefore, not possible to derive a general equivalent circuit for condenser-input circuits which contains a voltage source of fixed wave shape and magnitude.<sup>9</sup>

Steady-state conditions as well as transients are controlled by the circuit constants, which are contained in the product  $\omega CR_L$ . The angle  $\phi$  depends further on the relative magnitudes of  $R_L$  and  $R_S$  and is, therefore, described in general if also the ratio  $R_S/R_L$  is known. General curve families may thus be evaluated which show the dependent variables  $\bar{E}$ ,  $i$ , and  $\bar{I}$  in terms of ratio versus the independent variable  $\omega CR_L$  for various parameter values  $R_S/R_L$ . The series resistance  $R_S$  includes the equivalent diode resistance which is evaluated by means of (6), because the current wave is periodic in the final operating state. The reasoning leading to (6) is not applicable to a single transient, as obtained for starting conditions of rectifier circuits.

Generalized characteristics have been evaluated for the three types of circuits shown in Fig. 9. The characteristics in Figs. 3, 4, and 5 show the average voltage  $\bar{E}$  across the load resistance  $R_L$  as a function of  $\omega CR_L$  and  $\bar{R}_S$  for half-wave, full-wave, and voltage-doubling circuits. They permit the solution of the reversed problem to determine the magnitude of the applied voltage necessary to give a certain average voltage output for a given load. The series-resistance value  $\bar{R}_S$  includes the equivalent average resistances as reflected into one secondary winding. As their complete

<sup>9</sup> The equivalent voltage may be expressed by a Fourier series for each individual case as shown for the simplest case  $R_s = 0$  by M. B. Stout in footnote reference 1; the method, however, is hardly suitable for practical circuit analysis.

calculation required too much time, the characteristics were plotted from accurately measured values. The measurements were made on circuits of negligible inductive reactance. Series-resistance values in these circuits were determined accurately by the method shown in Fig. 10. Table II gives a number of calculated

TABLE II

Type of Condenser-Input Circuit	$n\omega CR_L$	$\frac{\bar{R}_s}{n R_L}$	$\theta$ degrees	$\phi$ degrees	$\bar{E}$ $\bar{e}_{max}$	$\frac{t_d}{T_p}$	$\frac{ I_p }{\bar{I}_p}$
Half-Wave $n = 1$	0.5	0	26.5	153.5	0.335	3.33	1.69
	1.	0	45.0	134.0	0.384	3.68	1.81
	2.	0	63.4	111.6	0.486	4.61	2.00
	2.26	0	66.15	106.4	0.503	4.91	2.02
	4.	0	75.9	87.1	0.623	6.60	2.24
	8.	0	82.9	65.1	0.742	9.86	2.60
	16.	0	86.4	48.6	0.862	13.92	3.00
	32.	0	88.2	35.3	0.930	19.90	3.51
	64.	0	89.1	25.1	0.996	27.57	4.16
	2.	0.10	—	121.	0.434	4.48	1.9
	2.26	0.147	—	50.	0.428	4.42	1.88
	4.	0.05	65.1	99.3	0.632	5.28	2.1
	4.	0.10	56.	108.4	0.537	5.14	2.0
	Full-Wave $n = 2$	1.	0	26.5	142.5	0.644	3.47
2.		0	45.0	121.0	0.678	4.17	1.90
4.		0	63.4	92.6	0.740	6.06	2.17
4.52		0	66.15	86.8	0.744	6.55	2.24
8.		0	75.9	67.0	0.816	9.30	2.55
16.		0	83.0	49.0	0.885	13.74	3.00
32.		0	86.4	35.6	0.945	19.70	3.50
64.		0	88.2	25.4	0.999	27.17	4.15
4.		0.05	—	104.	0.671	5.43	2.05
4.52		0.0735	—	105.	0.636	5.35	2.04
8.		0.05	56.	90.	0.710	6.20	2.20
30.2		0.10	17.9	100.6	0.646	5.39	2.08

values which show the accuracy of the curves to be approximately 5 per cent or better.

In compiling the data for the current-ratio characteristics in Fig. 6, it was found that the three rectifier-circuit types could be shown by a single family after a "charge factor"  $n$  was added to the product of the circuit constants  $\omega CR_L$  and to  $R_s$  as shown in Table II. The factor  $n$  is unity for the half-wave circuit. For the full-wave circuit,  $n$  is 2 because the condenser  $C$  is charged twice during one cycle. For the voltage-doubling circuit,  $n$  is  $\frac{1}{2}$  because the two condensers require together twice the charge to deliver the same average current at double voltage. The values in the table indicate that the factor  $n$  is actually not a constant. The mean value of the current ratios does, however, not depart more than 5 per cent from the true value, the error being a maximum in the steep portion of the curves and decreasing to zero at both ends. The upper section of Fig. 6 shows the ratio of root-mean-square current to average current per diode plate. This family is of special interest in the design of power transformers and for computation of diode plate dissipation.

Fig. 7 shows the root-mean-square value of the ripple voltage across  $R_L$  in per cent of the average voltage.

The voltage-doubling circuit shown with the other two condenser-input circuits in Fig. 9 may be regarded in principle as a series connection of two half-wave rectifier circuits. Each condenser is charged separately during conduction time of one diode, but is discharged in series with the other condenser during the time of nonconduction of its associated diode. The analysis of operation is made according to the method discussed but will not be treated. The average anode characteristics of RCA rectifiers are shown in Fig. 8. The method of carrying out a practical analysis by use of these curve families has been outlined in the first section of this paper.

APPENDIX

System of Symbols

The number of special symbols and multiple indexing have been greatly reduced by introducing four special signs for use with any symbol.

- 1) The symbols in general are of standard notation, lower case letters  $i, r$ , indicate instantaneous, sectional, or variable values and capital letters  $I$  and  $R$  indicate steady values.
- 2) Special values
  - a) *Sinusoidal voltages or currents* are indicated by a sine-wave sign above the symbol  $\bar{e}, \bar{i}, \bar{E}$ . Their maximum values are indicated by index,  $\bar{e}_{max}, \bar{E}_{max}$ .
  - b) *Peak values* are indicated by a circumflex;  $\hat{e}_c, \hat{i}, \hat{r}_d$ , maximum peak values are written  $\hat{i}_{max}$ , etc.
  - c) *Average values* are indicated by a horizontal bar;  $\bar{E}, \bar{I}, \bar{R}$ .
  - d) *Root-mean-square values* are indicated by vertical bars  $|E|, |I|, |R_s|$ .
- 3) An index in parenthesis specifies the time at which the symbol is valid, i.e., its numerical value. Hence,  $\bar{i}_{\theta(\pi)}$  is the steady-state alternating-current value at the time  $\pi$  and  $\bar{i}_{t(0)}$  is the transient current at the time 0. When used with an average or root-mean-square value, the time index specifies the period over which average or root-mean-square-values are taken, such as  $\bar{i}_{(\phi)}, |\bar{i}_p|_{(\phi)}$ . A conduction time index ( $\phi$ ) on resistance values such as  $\bar{r}_d, \bar{R}$ , is unnecessary. (See definition.)

# Radiation from Vee Antennas\*

CHARLES W. HARRISON, JR.†, ASSOCIATE, I.R.E.

**Summary**—Certain aspects of the directional qualities of a non-resonant inclined vee antenna are discussed briefly. Formulas, based on the assumption of a perfectly conducting earth, are derived for the radiation intensity in two planes. These relations show that the antenna is unidirectional when center driven. Its wide-band performance, combined with ease of erection and low cost should make it an attractive antenna, particularly for receiving applications.

RADIATION from rhombic antennas has been treated by Bruce, Beck, and Lowry.<sup>1</sup> A more complete mathematical analysis of the rhombic antenna problem is due to Foster.<sup>2</sup> The writer<sup>3</sup> has given an elementary discussion of the inclined rhombic antenna, restricting the analysis to the vertical plane containing the principal axis. An antenna related to the inclined rhombic consists of two wires spread out from their supporting pole, and run directly into the ground at their outer extremities as shown in Fig. 1. Such an inclined vee antenna is terminated by the earth. For the present purposes, nonresonant operation will be assumed.

In solving the problem of the nonresonant inclined vee antenna, an exponential current distribution, neglecting attenuation, is assumed. Additionally, it is desirable to proceed on the basis of a perfectly conducting earth in that a solution of sufficient simplicity cannot be obtained for the antenna when it is located above an earth of finite constants. In this connection it should be remembered that horizontal rhombic-antenna design is based largely upon equations obtained on a basis of the assumption of a perfectly conducting earth.

The equations needed are

$$N = \int I_0(s') e^{j\beta r' \cos \psi} ds' \quad (1)$$

$$\cos \psi = \cos \theta \cos \theta' + \sin \theta \sin \theta' \cos (\phi - \phi') \quad (2)$$

$$N_\theta = (N_x \cos \phi + N_y \sin \phi) \cos \theta - N_z \sin \theta \quad (3)$$

$$N_\phi = -N_x \sin \phi + N_y \cos \phi \quad (4)$$

$$K^2 \equiv N_\theta N_\theta^* + N_\phi N_\phi^* \quad (5)$$

In these relations

$N$  is the electric radiation vector.

\* Decimal classification: R111.2X R125. Original manuscript received by the Institute, September 30, 1942; revised manuscript received, February 24, 1943.

† Cruft Laboratory, Harvard University, Cambridge, Massachusetts.

<sup>1</sup> E. Bruce, A. C. Beck, and L. R. Lowry, "Horizontal rhombic antennas," Proc. I.R.E., vol. 23, pp. 24-46; January, 1935.

<sup>2</sup> Donald Foster, "Radiation from rhombic antennas," Proc. I.R.E., vol. 25, pp. 1327-1353; October, 1937.

<sup>3</sup> Charles W. Harrison, Jr., "The inclined rhombic antenna," Proc. I.R.E., vol. 30, pp. 241-244; May, 1942. The following corrections should be made to this paper: In (7) the exponent in the first integral should read  $-j2\pi/\lambda(l-x)$ . The curves shown in Figs. 2 to 7 inclusive are drawn for  $\lambda = 25$  meters.

$I_0(s')$  is the complex current in amperes flowing in the antenna element  $ds'$ . This current is a function of the distance  $s$  in meters along the antenna.

$\beta (= 2\pi/\lambda)$  is the propagation constant in radians per meter.

$(r', \theta', \phi')$  are the spherical co-ordinates of a point on any wire.

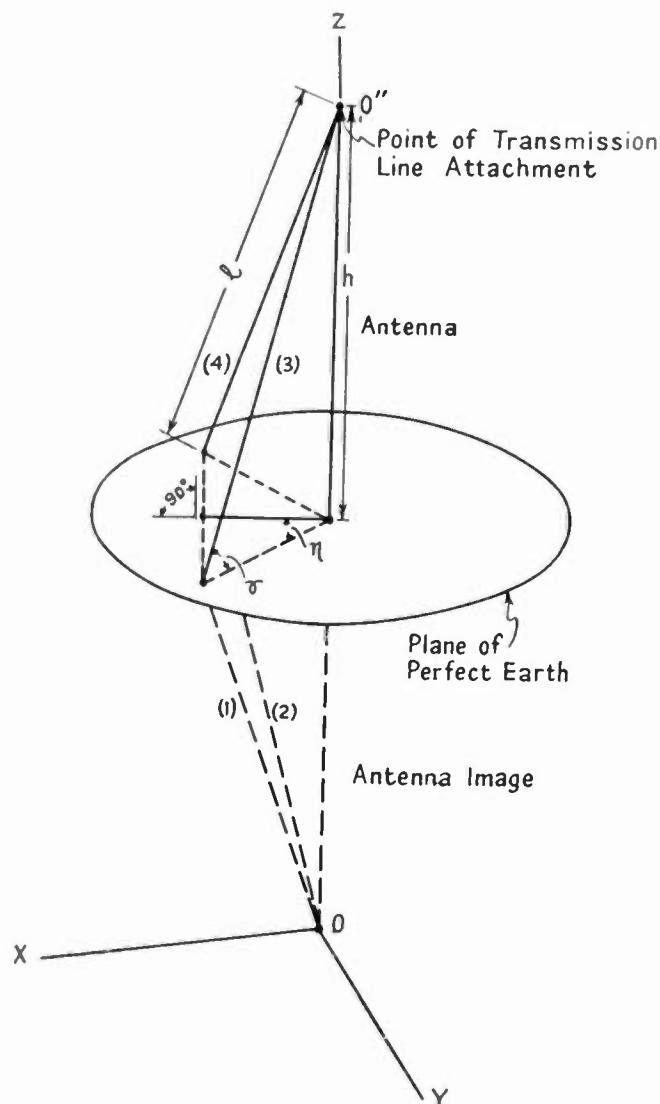

Fig. 1—Nonresonant inclined vee antenna with image.

$\psi$  is the angle formed by the radii  $(\theta', \phi')$  and  $(\theta, \phi)$ , where the latter are the spherical co-ordinates of a typical point anywhere in the far zone of the antenna.  $\theta$  and  $\theta'$  are measured from the positive  $Z$  axis;  $\phi$  and  $\phi'$  from the positive  $X$  axis.

$(N_x, N_y, N_z)$  or  $(N_\theta, N_\phi)$  are the rectangular or spherical components of the electric radiation vector  $N$  at the point  $(\theta, \phi)$ .

$N_\theta^*, N_\phi^*$  means the conjugate of  $N_\theta, N_\phi$ , respectively.



$K^2$  is the radiation function which depends on the orientation of the radiated wave and not upon the distance. The field strength in any direction  $(\theta, \phi)$  is proportional to the square root of this factor.

In Fig. 1 is shown an inclined nonresonant vee antenna with image. In this drawing, and in the following mathematics

$\eta$  is one half the apex angle of the isosceles triangle obtained by projecting the sides of the antenna onto the horizontal plane.

$\gamma$  is the angle made by the antenna wires with the horizontal plane.

$l$  is the length of antenna leg. Equal leg lengths are assumed.

A relation between  $\eta, \gamma,$  and the semiangle between the wires at the supporting pole  $\tau$  is

$$\tau = \sin^{-1}(\cos \gamma \sin \eta). \tag{6}$$

It is desirable to work from the origins  $0$  and  $0''$  shown, for the elemental antenna lengths are along lines of constant  $(\theta', \phi')$  for each integration. Once the radiation vectors have been found for  $0$  and  $0''$ , those at  $0''$  may be referred to  $0$  by finding the phase difference between these origins projected upon the typical radius vector. This transfer is effected by use of the relations

$$\begin{aligned} N_3 &= N_3'' e^{j2\beta l \sin \gamma \cos \theta} \\ N_4 &= N_4'' e^{j2\beta l \sin \gamma \cos \theta}. \end{aligned} \tag{7}$$

If the antenna is driven at the top of the supporting pole, the currents in the antenna and image branches may be written

$$\begin{aligned} I_{z1} &= -I_{z2} = I_0 \cos \gamma \cos \eta e^{-i\beta s} \\ I_{z3} &= -I_{z4} = -I_0 \cos \gamma \cos \eta e^{-i\beta s''} \\ I_{y1} &= I_{y2} = I_0 \cos \gamma \sin \eta e^{-i\beta s} \\ I_{y3} &= I_{y4} = -I_0 \cos \gamma \sin \eta e^{-i\beta s''} \\ I_{x1} &= -I_{x2} = I_0 \sin \gamma e^{-i\beta s} \\ I_{x3} &= -I_{x4} = I_0 \sin \gamma e^{-i\beta s''}. \end{aligned} \tag{8}$$

Here  $s$  refers to  $0; s''$  to  $0''$ . Equation (8) in conjunction with (1) may be used to calculate the electric radiation vectors in rectangular co-ordinates. Then the vectors computed with respect to  $0''$  are transferred to  $0$  by means of (7). After ascertaining the spherical co-ordinates of points on the antenna wires (including the image), (2) may be applied to determine  $\cos \psi$  for each case. It will be discovered that  $\cos \psi_1 \neq \cos \psi_2 \neq \cos \psi_3 \neq \cos \psi_4$ . Thus it is impracticable to attempt a summation of the rectangular components of the electric radiation vector in the general case. Considerable simplification is achieved by restricting the analysis to the plane  $y=0$ , and to the plane  $z=h$ . Happily the field patterns in the vertical and horizontal planes as here defined are usually of most interest, the general directivity equation being of value principally in radiation-resistance determinations.

For the vertical-plane directional characteristic it is readily shown that

$$\begin{aligned} \cos \psi_1 &= \cos \psi_2 = \cos \theta \sin \gamma + \sin \theta \cos \gamma \cos \eta \\ \cos \psi_3 &= \cos \psi_4 = -\cos \theta \sin \gamma + \sin \theta \cos \gamma \cos \eta \end{aligned} \tag{9}$$

also

$$N_\theta = N_x \cos \theta - N_z \sin \theta = 0 \tag{10}$$

and

$$N_\phi = N_y. \tag{11}$$

For this case

$$\begin{aligned} K^2 &= N_\phi N_\phi^* = N_y N_y^* \\ &= \left\{ \frac{4I_0 \cos \gamma \sin \eta}{\beta} \right\}^2 \left\{ \frac{\sin^2 \frac{\beta l}{2} (1 - \cos \psi_1)}{(1 - \cos \psi_1)^2} \right. \\ &\quad - \frac{2 \sin \frac{\beta l}{2} (1 - \cos \psi_1)}{1 - \cos \psi_1} \\ &\quad - \frac{\sin \frac{\beta l}{2} (1 - \cos \psi_3)}{1 - \cos \psi_3} \cos (\beta l \sin \gamma \cos \theta) \\ &\quad \left. + \frac{\sin^2 \frac{\beta l}{2} (1 - \cos \psi_3)}{(1 - \cos \psi_3)^2} \right\}. \end{aligned} \tag{12}$$

This equation was obtained for  $\phi=0$  degrees. The field strength in the vertical plane in the forward direction is proportional to the square root of (12). When  $\phi=180$  degrees, for  $\cos \psi_1$  and  $\cos \psi_3$  write  $-\cos \psi_3$  and  $-\cos \psi_1$ , respectively. The field pattern in the vertical plane, for either the forward or backward direction, is obtained when  $0 \leq \theta \leq +90$  degrees.

For the horizontal directional characteristic in the plane  $z=h$ ,

$$\begin{aligned} \cos \psi_1 &= \cos \psi_3 = \cos \gamma \cos (\phi - \eta) \\ \cos \psi_2 &= \cos \psi_4 = \cos \gamma \cos (\phi + \eta) \end{aligned} \tag{13}$$

also

$$N_\phi = -N_x \sin \phi + N_y \cos \phi = 0 \tag{14}$$

and

$$N_\theta = -N_x. \tag{15}$$

For this case

$$\begin{aligned} K^2 &= N_\theta N_\theta^* = N_x N_x^* \\ &= \left\{ \frac{4I_0 \sin \gamma}{\beta} \right\}^2 \left\{ \frac{\sin^2 \frac{\beta l}{2} (1 - \cos \psi_1)}{(1 - \cos \psi_1)^2} \right. \\ &\quad - \frac{2 \sin \frac{\beta l}{2} (1 - \cos \psi_1)}{1 - \cos \psi_1} \end{aligned}$$

$$\frac{\sin \frac{\beta l}{2} (1 - \cos \psi_2)}{1 - \cos \psi_2} \cos (\beta l \cos \gamma \sin \phi \sin \eta) + \frac{\sin^2 \frac{\beta l}{2} (1 - \cos \psi_2)}{(1 - \cos \psi_2)^2} \quad (16)$$

The field strength in the horizontal plane is proportional to the square root of (16).

It is to be observed that when  $\theta = +90$  degrees, and  $\phi = 0$  degrees, both (12) and (16) reduce to zero. When  $\theta = +90$  degrees, and  $\phi = 180$  degrees the same condition obtains. Accordingly, (16) does not convey any information relative to the azimuthal width of the major lobe. Unfortunately a simple formula has not

directional characteristic when driven at the top of the supporting pole, but shows *entirely different directional properties when driven at the base of one leg*. A discussion of this alternative mode of operation is reserved for another paper.

#### ACKNOWLEDGMENT

The writer is indebted to Mr. Gunther Rudenberg, Instructor in Physics and Communication Engineering at the Cruft Laboratory, for his careful reading of the paper.

#### Note Added in Proof:

The Mackay Radio and Telegraph Company has been kind enough to supply the writer with the following practical details relative to inclined vee antennas actually in use by the company for receiving:

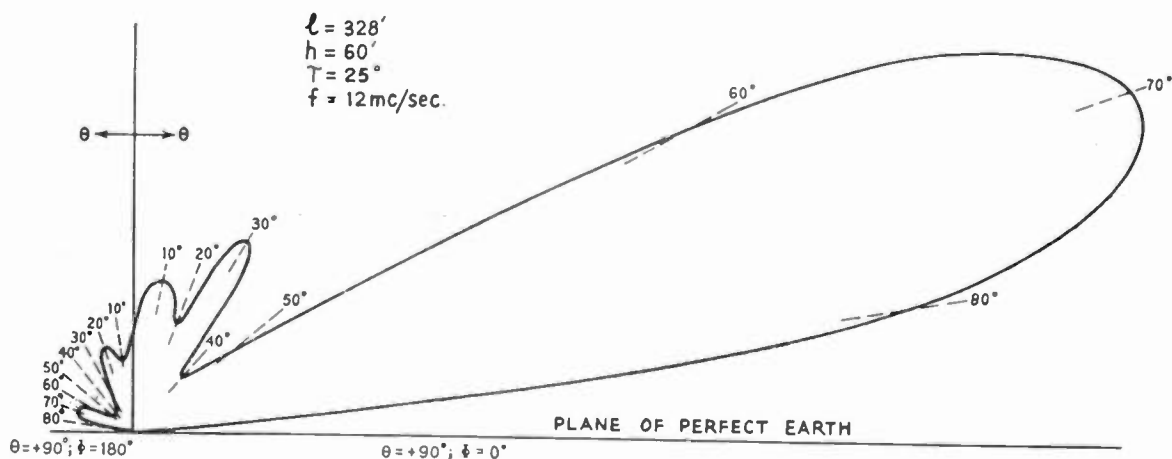

Fig. 2—Relative field intensity in the vertical plane for a nonresonant inclined vee antenna.

been developed for the azimuth pattern for an arbitrary value of  $\theta$ .

In Fig. 2 is shown a typical field pattern in the vertical plane, computed from (12). Points were determined at intervals of 10 degrees, no attempt being made to locate accurately the positions of minimum field. For this calculation,  $l = 328$  feet,  $h = 60$  feet,  $\tau = 25$  degrees, and  $f = 12$  megacycles per second. The dimensions given here are in no way indicative of an optimum design. If the leg length is fixed by space considerations, and the pole height has been decided upon, the optimum angle  $\tau$  for a given frequency may (in many cases) be satisfactorily determined by the calculation of several field patterns using (12). In other instances, the most direct approach is probably to calculate  $N_x$ ,  $N_y$ , and  $N_z$  directly, and then apply (3), (4), and (5) in sequence.

The nonresonant inclined vee antenna shows a uni-

The vee legs are approximately 1000 feet long, with the outer end of each leg grounded. The supporting pole is around 90 feet in height, and the angle at the apex is determined the same way as it is for horizontal vee antennas. The orientation is such that the line of the great-circle path from the station to be received bisects the angle between the wires at the supporting pole. The antenna, if constructed over earth of suitable constants, is essentially aperiodic, and has a satisfactory frequency coverage of 3 to 1. In order to cover this broad band of frequencies, the usual design is to restrict the apex of the vee in an exponential form so that a good match is obtained to the transmission line. The antenna is not ordinarily used for transmitting, as other types are more satisfactory for this purpose. It is covered by U. S. Patent 2,081,162, which is owned by the Mackay Radio and Telegraph Company, New York, N. Y.



It remains yet to be shown that the poles and zeros are alternate, which is the direct consequence of the positiveness of the slope of the driving-point impedance with respect to the frequency. This latter property can be shown in various ways. A simple proof based on energy considerations is as follows.<sup>6</sup> Taking  $e_1$  as reference, i.e., considering it as a real quantity, it is evident that all the mesh currents are pure imaginary. Therefore the total potential energy of the system is given by<sup>6</sup>

$$V = -\frac{1}{2} \sum_{(r,s)} \frac{i_r i_s}{\omega^2 C_{rs}} \quad (6)$$

and the total kinetic energy by<sup>7</sup>

$$T = -\frac{1}{2} \sum_{(r,s)} L_{rs} i_r i_s \quad (7)$$

In terms of  $V$  and  $T$ , (5) can be rewritten as

$$Z_{11} = \frac{e_1^2}{2j\omega(V - T)} \quad (5a)$$

In order to find the variation of the impedance with the frequency, differentiate (1) with respect to  $j\omega$  and solve for the derivative of  $i_1$

$$\frac{\partial i_1}{\partial j\omega} = -\frac{1}{D} (H_1 A_{11} + H_2 A_{21} + \dots + H_n A_{n1}) \quad (8)$$

where

$$H_r = \left( L_{1r} + \frac{1}{\omega^2 C_{1r}} \right) i_1 + \left( L_{2r} + \frac{1}{\omega^2 C_{2r}} \right) i_2 + \dots + \left( L_{nr} + \frac{1}{\omega^2 C_{nr}} \right) i_n \quad (9)$$

Substituting in the values of the  $A$ 's and  $H$ 's, it yields

$$\begin{aligned} \frac{\partial i_1}{\partial j\omega} &= -\frac{1}{e_1} \left( \sum \frac{i_r i_s}{\omega^2 C_{rs}} + \sum L_{rs} i_r i_s \right) \\ &= \frac{2}{e_1} (V + T) \end{aligned} \quad (8a)$$

and

$$\frac{\partial Z_{11}}{\partial j\omega} = -\frac{e_1}{i_1^2} \frac{\partial i_1}{\partial j\omega} = -\frac{2}{i_1^2} (V + T) \quad (10)$$

Now that  $i_1$  is pure imaginary and the potential and kinetic energies are all real and positive, it is evident that  $\partial Z_{11}/\partial j\omega$  is always positive. So the driving-point reactance is an increasing function of the frequency and its poles and zeros are necessarily alternate. It is also obvious that  $Z_{11}$  has no double poles nor double

zeros and hence neither  $D$  nor  $A_{11}$  can have double roots. From the above conclusions, one can write

$$Z_{11} = \frac{H(1 - \omega^2/\omega_1^2)(1 - \omega^2/\omega_3^2) \dots (1 - \omega^2/\omega_{2n-1}^2)}{j\omega(1 - \omega^2/\omega_2^2)(1 - \omega^2/\omega_4^2) \dots (1 - \omega^2/\omega_{2n-2}^2)} \quad (11)$$

where

$$0 < \omega_1 < \omega_2 < \omega_3 < \dots < \omega_{2n-2} < \omega_{2n-1}$$

giving the alternate poles and zeros of the driving-point impedance. To realize  $Z_{11}$  in simple forms, one has at least four different ways, viz.,

(1) by separating  $Z_{11}$  into partial fractions with

terms of the form  $\frac{j\omega L_r}{1 - \omega^2/\omega_r^2}$ , one gets a series combination of antiresonant circuits;

(2) by separating  $1/Z_{11}$  into partial fractions with terms of the form  $\frac{j\omega C_s}{1 - \omega^2/\omega_s^2}$ , one gets a parallel combination of resonant circuits;

(3) by reducing  $Z_{11}$  into a continuous fraction of the form  $j\omega L_1 + \frac{1}{j\omega C_1} + \frac{1}{j\omega L_2} + \frac{1}{j\omega C_2} + \dots$ , one gets a ladder network with inductive series arms and capacitive shunt arms; and

(4) by reducing  $Z_{11}$  into a continuous fraction of the form  $(j\omega C_1)^{-1} + \frac{1}{(j\omega L_1)^{-1}} + \frac{1}{(j\omega C_2)^{-1}} + \frac{1}{(j\omega L_2)^{-1}} + \dots$ , one gets a ladder network with capacitive series arms and inductive shunt arms.

These are exactly the Foster's and Cauer's forms.

## II. MECHANICAL AND ACOUSTICAL SYSTEMS

It is seen that the above treatment is by no means restricted to electrical systems. If a mechanical system, one may take  $e$  as the driving force,  $i$  the vibrating velocity,  $L$  the mass, and  $C$  the mechanical compliance (the reciprocal of the stiffness), and (1) will still hold as the equations of motion. By following exactly the above steps, it can be shown that Foster's reactance theorem is true for a mechanical impedance which is defined as the ratio of the driving force to the vibrating velocity produced at the driving point. And similarly in an acoustical system, one takes  $e$  as the driving sound pressure,  $i$  the volume current of the vibrating air,  $L$  the inertance, and  $C$  the acoustic capacitance, and obtains Foster's reactance theorem for an acoustic impedance which is defined as the ratio of the driving sound pressure to the volume current produced at the driving point.

Thus one sees that Foster's theorem applies to the three kinds of systems equally well and a general impedance can always be reduced to the four simple forms discussed in the last section. These forms are shown in Fig. 1 for the three kinds of systems.

<sup>6</sup> A similar proof has been given by E. A. Guillemin, "Communication Networks," vol. 2, John Wiley and Sons, New York, N. Y., 1935, pp. 226-229.

<sup>7</sup> Cf. Sir James Jeans, "The Mathematical Theory of Electricity and Magnetism," Cambridge University Press, New York, N. Y., 1933, p. 95.

<sup>8</sup> See p. 443 of footnote reference 6.



III. SYSTEMS WITH DISTRIBUTED ELEMENTS<sup>8</sup>

In encountering a distributed element, one may consider it as formed of a large number of infinitesimal constituents, each of which has the nature of a lumped element. Thus a distributed system is nothing but the limiting case of a lumped network when the number of meshes becomes large and the elements in the individual meshes become small. As a result, the positiveness of  $\partial Z_{11}/\partial j\omega$  is still true but the number of poles and zeros will be infinite. In other words, the driving-point reactance is no more a rational function of the frequency, and (11) becomes

$$Z_{11} = \frac{H(1 - \omega^2/\omega_1^2)(1 - \omega^2/\omega_3^2) \dots}{j\omega(1 - \omega^2/\omega_2^2)(1 - \omega^2/\omega_4^2) \dots} \quad (12)$$

where both the numerator and the denominator have

$$\frac{\partial^2 \eta}{\partial x^2} - \frac{1}{c^2} \frac{\partial^2 \eta}{\partial t^2} = 0 \quad (13)$$

where  $c^2 = 2lT/M$ , with the boundary condition that

$$\eta = 0 \text{ at } x = \pm l \text{ and } \frac{\partial \eta}{\partial x} = \mp \frac{F \cos \omega t}{2T} \text{ at } x = \pm 0 \quad (14)$$

where  $x = \pm 0$  indicates that  $x$  is slightly greater or less than zero. The solution of (13) is

$$\eta = \frac{cF \cos \omega t \sin \frac{\omega}{c} (l \pm x)}{2T\omega \cos \frac{\omega}{c} l} \text{ for } x \leq 0 \quad (15)$$

and the mechanical driving-point impedance is

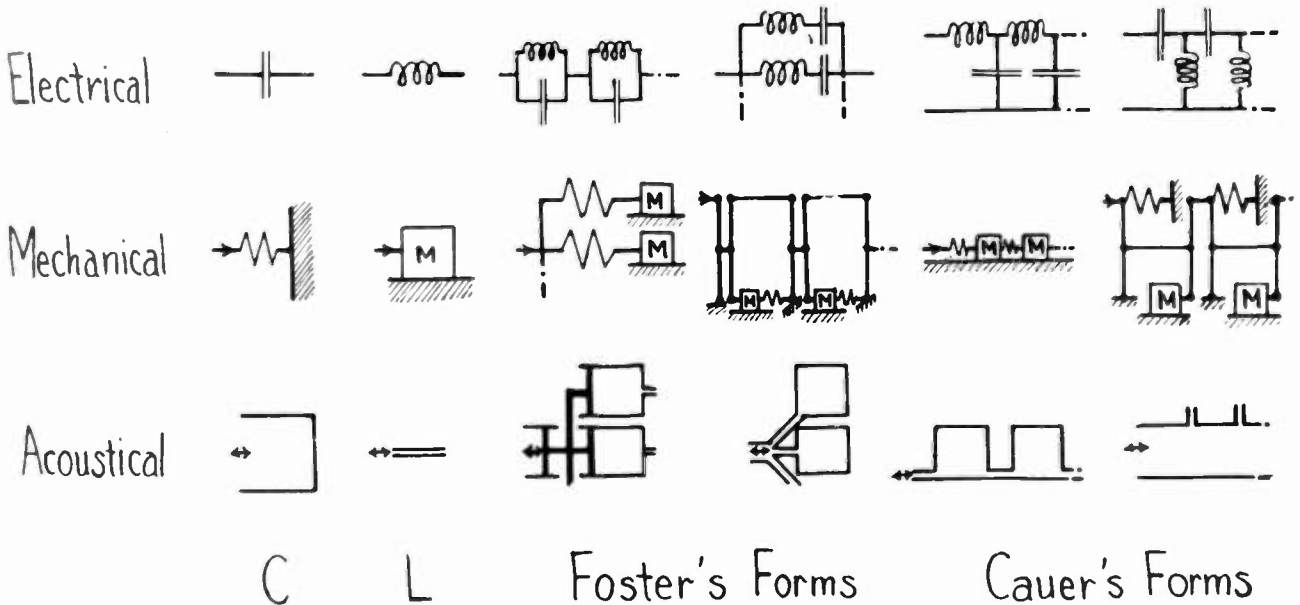

Fig. 1—Basic forms of electrical, mechanical, and acoustical impedances.

an infinite number of factors. The theorem can be formulated as follows:

The driving-point impedance of a dissipationless network (electric, mechanical, or acoustical) containing distributed elements is a pure reactance, which is an odd function of the frequency. This function has an infinite number of poles and zeros occurring alternately as the frequency goes up.

It takes an infinite number of lumped elements if one tries to realize such an impedance in the simple forms given by Foster and Cauer, unless approximations are made (see Section V). To illustrate the properties of the distributed networks, let us take a simple example of a stretched flexible string of length  $2l$ , mass  $M$ , and tension  $T$ . If the displacement of the string at any point is  $\eta$ , for a force  $F \cos \omega t$  applied normally at the mid-point of the string, the equation of motion is

$$Z_{11} = \left. \frac{F \cos \omega t}{j\omega \eta} \right|_{x=0} = \frac{2T}{jc \tan \frac{\omega}{c}} \quad (16)$$

which has poles at

$$\omega = \frac{h\pi c}{l}$$

and zeros at

$$\omega = \frac{(2h + 1)\pi c}{2l} \quad (17)$$

$h$  being zero or an integer. Using the infinite product expansion<sup>9</sup> for the tangent, (16) can be rewritten as

$$Z_{11} = \frac{2T(1 - \omega^2/\omega_1^2)(1 - \omega^2/\omega_3^2) \dots}{i\omega l(1 - \omega^2/\omega_2^2)(1 - \omega^2/\omega_4^2) \dots} \quad (18)$$

where

$$\omega_r = r\pi c/2l, \quad r = 1, 2, 3, \dots \quad (19)$$

<sup>8</sup> See Brune, *Jour. Math. and Phys. (M.I.T.)*, vol. 10, pp. 191-235, 1931.

<sup>9</sup> Cf. E. T. Whittaker and G. N. Watson, "Modern Analysis," Cambridge University Press, 1935, p. 136.

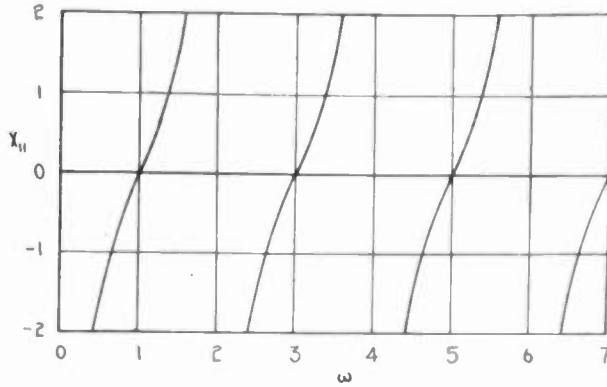

Fig. 2—Driving-point reactance of a flexible string (arbitrary units).

Equation (18) has exactly the form of (12). From the similarities between the three kinds of systems, it is seen that (18) also gives the form of the driving-point impedance of a dipole antenna or an open transmission line in the electrical case and that of a closed pipe in the acoustical case. In all these simple cases, the driving-point impedance has poles and zeros equally spaced along the frequency scale. In less simple systems they will not be so. For example, a uniform bar clamped at one end and driven at the other by a shearing force has an impedance, found with a similar method,

$$Z_{11} = \frac{QS\kappa^2\mu^3(1 + \cosh \mu l \cos \mu l)}{j\omega(\sin \mu l \cosh \mu l - \sinh \mu l \cos \mu l)} \quad (20)$$

where  $Q$  is the Young's modulus,  $l$  the length,  $S$  the cross-sectional area of the bar,  $\kappa$  the radius of gyration of  $S$  about a median line, and  $\mu = \sqrt[4]{\rho\omega^2/Q\kappa^2}$ ,  $\rho$  being the density of the bar. Using again the infinite product expansion, it yields

$$Z_{11} = \frac{3QS\kappa^2}{l^3} \frac{(1 - \omega^2/\omega_1^2)(1 - \omega^2/\omega_3^2) \dots}{j\omega(1 - \omega^2/\omega_2^2)(1 - \omega^2/\omega_4^2) \dots} \quad (21)$$

the critical angular frequencies being given by

$$\omega \sqrt{\frac{Q\kappa^2}{\rho l^2}} = 0, 1.1194\pi, 4.908\pi, 7.104\pi, 15.939\pi, 19.60\pi, \dots \quad (22)$$

Again a form of (12) is obtained, although the spacings of the poles and zeros are no longer uniform, as in the above simple cases.

It is evident, from the above derivation, that the theorem is still true when both lumped and distributed elements exist in the same system. A simple illustration is that of a dissipationless transmission line of length  $l$  terminated at a lumped reactance  $X$ . If  $L$  and  $C$  are the inductance and capacitance per unit length (loop), the equations of motion will be

$$\frac{\partial e}{\partial x} = -j\omega Li, \quad \frac{\partial i}{\partial x} = -j\omega Ce \quad (23)$$

with the boundary conditions that

$$e = e_1 \text{ at } x = 0 \text{ and } e/i = jX \text{ at } x = l. \quad (24)$$

Solving for the current, one gets

$$i = e_1 \frac{Z_0 \cos \frac{\omega}{c}(l-x) - X \sin \frac{\omega}{c}(l-x)}{j\left(Z_0 \sin \frac{\omega}{c}l + X \cos \frac{\omega}{c}l\right)} \quad (25)$$

where

$$Z_0 = \sqrt{L/C} \text{ and } c = 1/\sqrt{LC} \quad (26)$$

and the driving-point impedance is given by

$$Z_{11} = \frac{e}{i} \Big|_{x=0} = jZ_0 \frac{Z_0 \sin \frac{\omega}{c}l + X \cos \frac{\omega}{c}l}{Z_0 \cos \frac{\omega}{c}l - X \sin \frac{\omega}{c}l} \quad (27)$$

The distribution of the poles and zeros of  $Z_{11}$  will depend on the form of  $X$ , but its slope

$$\frac{\partial Z_{11}}{\partial j\omega} = \frac{(Z_0^2 + X^2) \frac{l}{c} + Z_0 \frac{\partial X}{\partial \omega}}{\left(Z_0 \cos \frac{\omega}{c}l - X \sin \frac{\omega}{c}l\right)^2} \quad (28)$$

is evidently positive for all values of the frequency, whatever  $X$  may be.

#### IV. A FURTHER EXTENSION

The theorem can be extended further to cases where the driving force is also distributed. Consider first a lumped network driven by equal forces in all its meshes. The equations become

$$\left. \begin{aligned} z_{11}i_1 + z_{12}i_2 + \dots + z_{1n}i_n &= e \\ z_{21}i_1 + z_{22}i_2 + \dots + z_{2n}i_n &= e \\ \dots &\dots \\ z_{n1}i_1 + z_{n2}i_2 + \dots + z_{nn}i_n &= e \end{aligned} \right\} \quad (29)$$

On solving it yields

$$i_r = \frac{e}{D} \sum_s A_{rs} \quad (30)$$

Summing up

$$\sum_{(r)} i_r = \frac{e}{D} \sum_{(r,s)} A_{rs} \quad (31)$$

Now if one defines the ratio of the total driving force to the average of the currents produced in all the meshes as the *mass driving-point impedance* and denotes it with  $Z_{00}$ , it is seen that

$$Z_{00} = \frac{n^2 e}{\sum i_r} = \frac{n^2 D}{\sum A_{rs}} \quad (32)$$

Or, in terms of the energies,

$$Z_{00} = \frac{n^2 e^2}{2j\omega(V - T)} \quad (33)$$

$V$  and  $T$  being given by (6) and (7), respectively. The zeros of  $Z_{00}$  correspond to the roots of the determinant  $D$ , just as in the case of the simple driving-point impedance discussed in Section I. Therefore the zeros of the driving-point impedance of a network are not changed by changing the mode of driving it. The change occurs only in the redistribution of the poles. It is easily seen that the mass driving-point impedance is also a pure reactance given by an odd rational function of frequency. In order to see how  $Z_{00}$  varies with frequency, one may perform as before and find that

$$\frac{\partial i_r}{\partial j\omega} = -\frac{1}{D} \sum_{(r)} H_r A_{r,r} \tag{34}$$

and

$$\frac{\partial}{\partial j\omega} \sum i_r = -\frac{1}{D} \sum_{(r,e)} H_r A_{r,r} = \frac{2}{e} (V + T) \tag{35}$$

by (6), (7), (9), and (30). The rate of change of  $Z_{00}$  with frequency is

$$\frac{\partial Z_{00}}{\partial j\omega} = -\frac{2n^2(V + T)}{(\sum i_r)^2} \tag{36}$$

Now that the  $i$ 's are all pure imaginary quantities and  $V$  and  $T$  are always real and positive, it is evident that  $\partial Z_{00}/\partial j\omega$  is always positive and  $Z_{00}$  possessed alternate poles and zeros. Thus the mass driving-point impedances have properties similar to the simple ones and the above discussions on the latter are all applicable to the present case.

It goes without saying that the above analysis applies to mechanical and acoustical systems, too. Further, the system may be formed of distributed elements, in which case the driving force will be distributed uniformly over the elements and one will be actually getting a "driving-line" or a "driving-area" impedance. As a matter of fact, this extension of Foster's reactance theorem is more important for the distributed networks which are encountered more frequently than the lumped ones especially in mechanical and acoustical systems and in electrical systems at high frequencies.

Take a simple example of the single string discussed in Section III and subject it to a uniform sinusoidal driving force of  $f \cos \omega t$  per unit length. The equation of motion is now<sup>10</sup>

$$\frac{\partial^2 \eta}{\partial x^2} - \frac{1}{c^2} \frac{\partial^2 \eta}{\partial t^2} = -\frac{f}{T} \cos \omega t \tag{37}$$

and the boundary condition is that

$$\eta = 0 \text{ at } x = \pm l. \tag{38}$$

On solving, it yields

$$\eta = \frac{2lf \cos \omega t}{\omega^2 M} \left( \cos \frac{\omega}{c} x / \cos \frac{\omega}{c} l - 1 \right). \tag{39}$$

The average vibrating velocity is

$$\frac{j\omega}{2l} \int_{-l}^l \eta dx = \frac{2lf \cos \omega t}{j\omega M} \left( 1 - \tan \frac{\omega}{c} l / \frac{\omega}{c} l \right). \tag{40}$$

The mechanical mass driving-point impedance is found as

$$Z_{00} = \frac{j\omega M}{1 - \frac{c}{\omega l} \tan \frac{\omega}{c} l} \tag{41}$$

which has zeros at

$$\frac{\omega l}{c} = 0.5\pi, 1.5\pi, 2.5\pi, 3.5\pi, \dots \tag{42}$$

as in the case of simple driving force in Section III, and poles at

$$\frac{\omega l}{c} = 0, 1.4303\pi, 2.4591\pi, 3.4712\pi, \dots \tag{43}$$

The latter are still alternate with the zeros although all displaced to higher positions on the frequency scale from the values given by (17).

A slightly more complicated case is that of a circular membrane under a uniform sinusoidal pressure  $f \cos \omega t$  per unit area, such as that used in a condenser microphone. Let the membrane have a radius  $R$ , mass  $M$ , surface tension  $T$  and is fixed at the periphery. The equation of motion is

$$\frac{\partial^2 \eta}{\partial r^2} + \frac{1}{r} \frac{\partial \eta}{\partial r} - \frac{1}{c^2} \frac{\partial^2 \eta}{\partial t^2} = -\frac{f}{T} \cos \omega t \tag{44}$$

with the boundary condition that

$$\eta = 0 \text{ at } r = R. \tag{45}$$

The solution can be found

$$\eta = \frac{\pi R^2 f \cos \omega t}{\omega^2 M} \left[ J_0 \left( \frac{\omega r}{c} \right) / J_0 \left( \frac{\omega R}{c} \right) - 1 \right] \tag{46}$$

$J_0$  being the Bessel's function of the first kind and zeroth order. The average velocity of vibration of the membrane is then

$$\frac{j\omega}{\pi R^2} \int_0^R \eta \cdot 2\pi r dr = \frac{\pi R^2 f \cos \omega t}{j\omega M} \left[ 1 - \frac{2J_1 \left( \frac{\omega R}{c} \right)}{\frac{\omega R}{c} J_0 \left( \frac{\omega R}{c} \right)} \right] \tag{47}$$

$J_1$  being the Bessel's function of the first kind and first order. So the mechanical mass driving-point impedance takes the form

<sup>10</sup> Cf. P. M. Morse, "Vibrations and Sound," John Wiley and Sons, New York, N. Y., 1936, p. 96.

$$Z_{00} = j\omega M \frac{\frac{\omega R}{c} J_0\left(\frac{\omega R}{c}\right)}{\frac{\omega R}{c} J_0\left(\frac{\omega R}{c}\right) - 2J_1\left(\frac{\omega R}{c}\right)} \quad (48)$$

or, by using the infinite product expansions,<sup>9</sup>

$$Z_{00} = \frac{8\pi T(1 - \omega^2/\omega_1^2)(1 - \omega^2/\omega_3^2) \dots}{j\omega(1 - \omega^2/\omega_2^2)(1 - \omega^2/\omega_4^2) \dots} \quad (49)$$

whose poles occur at the angular frequencies

$$\omega_0, \omega_2, \omega_4 \dots = 0, 1.6343 \frac{\pi c}{R}, 2.6855 \frac{\pi c}{R}, \dots \quad (50)$$

and zeros at

$$\omega_1, \omega_3, \omega_5 \dots = 0.7655 \frac{\pi c}{R}, 1.7571 \frac{\pi c}{R}, 2.7546 \frac{\pi c}{R}, \dots \quad (51)$$

The poles and zeros are alternate but the spacing between a pole and the next zero becomes small at higher frequencies.

By a similar method it can be founded that for a circular thin plate clamped at the edge the mechanical mass driving-point impedance is given by

$$Z_{00} = \frac{128Qh^3(1 - \omega^2/\omega_1^2)(1 - \omega^2/\omega_3^2) \dots}{(1 - s^2)R^2j\omega(1 - \omega^2/\omega_2^2)(1 - \omega^2/\omega_4^2) \dots} \quad (52)$$

whose critical angular frequencies are given by

$$\omega R^2 \sqrt{\frac{3\rho(1 - s^2)}{Qh^2}} = 0, 3.2365\pi, 11.1012\pi, 12.655\pi, 26.898\pi, 28.274\pi, \dots \quad (53)$$

where  $Q$  is the Young's modulus,  $s$  the Poisson's ratio,  $\rho$  the density,  $R$  the radius, and  $2h$  the thickness of the plate. The form of  $Z_{00}$  is quite similar to that of the membrane except for the unequal spacings of the poles and zeros. The function  $Z_{00}$  for the membrane and the plate is plotted in Fig. 3. It is seen that they are quite similar to the plot for the uniform string driven by a concentrated force so far as the general character is

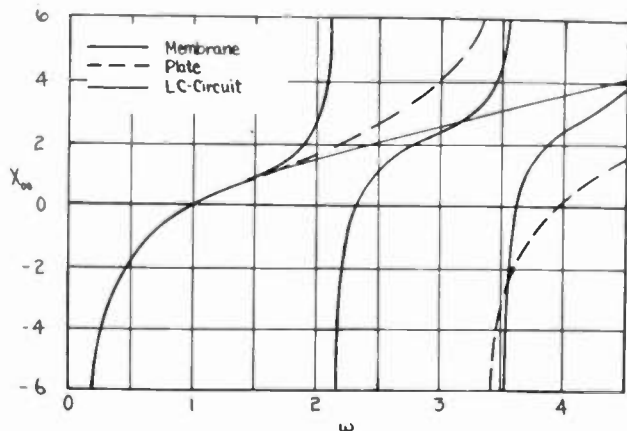

Fig. 3—Mass driving-point reactances of membrane and plate (arbitrary units).

concerned and it seems to be a general property of the mass driving-point impedances that the poles get closer and closer to the subsequent zeros as the frequency goes up. This is because of the integration for the averaging which brings in a factor inversely proportional to the frequency to one of the terms, as seen from (40) and (47). And this factor is the chief reason of this closing up of the poles and zeros.

### V. APPLICATIONS AND CONCLUDING REMARKS

In the above discussions only simple examples have been treated. The theorem is, however, quite a general one and it applies to more complicated systems just as well. It may prove useful in the considerations of electric-circuit problems at ultra-high frequencies, where all circuit elements are distributed. And also in more complicated vibration problems, one example is that of room acoustics, which is nothing but a three-dimensional vibration problem.

A radio engineer usually takes mechanical systems such as microphone diaphragms and acoustical systems such as small air chambers as simple resonant systems.<sup>11</sup> The above discussion serves to show how good these approximations are. Since in most mechanical and acoustical systems only distributed elements are present, there are always an infinite number of resonances and antiresonances. The exact form of the impedance is

$$Z_{00} = \frac{H(1 - \omega^2/\omega_1^2)(1 - \omega^2/\omega_3^2) \dots}{j\omega(1 - \omega^2/\omega_2^2)(1 - \omega^2/\omega_4^2) \dots} \quad (12a)$$

Within a limited range of frequency the factors corresponding to the critical frequencies not in or at the vicinity of the interested range may be taken as constants, and the system is taken approximately as one with a finite number of poles and zeros. For instance, if only low frequencies are of interest, the higher factors may all be omitted (the approximation will be especially good for the mass driving-point impedances on account of the close spacing of the poles and zeros at higher frequencies). A first approximation is to omit all except the first critical frequency besides zero and one gets

$$Z_{00} \doteq \frac{H}{j\omega} + j\omega H/\omega_1^2 \quad (54)$$

which is the impedance of a simple resonant circuit. Applying this to the cases of the membrane and plate in the last section, one obtains, respectively,

$$Z_{00} \doteq \frac{8\pi T}{j\omega} + 1.3832j\omega M \quad (55)$$

and

$$Z_{00} \doteq \frac{128\pi Qh^3}{i\omega(1 - s^2)R^2} + 1.8583j\omega M \quad (56)$$

<sup>11</sup> For numerous examples, see H. F. Olson and F. Massa, "Applied Acoustics," Blakiston Company, Philadelphia, Pa., 1939.



which give the effective stiffnesses and the effective masses for the membrane and plate used in simple calculations. It is obvious that the approximate results are valueless when the driving frequency approaches the first pole  $\omega_2$ . When this happens, it will be necessary to take into account also the first antiresonant frequency, thus obtaining a series-resonant circuit in parallel with a capacitance; or the first pole together with the second zero, thus obtaining two series-resonant circuits in parallel for the approximate representation of the distributed system. In Fig. 3 the reactance of a simple resonant circuit is plotted in order to compare with the actual reactances of the membrane and the plate. It is seen that below the first resonant frequency there is practically no difference between the three curves and the difference becomes more and more pronounced as the frequency goes up. To represent the actual system with a simple resonant circuit, the error is within 5 per cent for frequencies up to one and one half times the first resonant frequency for the membrane and up to two times it for the plate. If the approximation is used primarily in the neighborhood of the first resonant frequency, a result better than (54) is obtained by taking only the first resonant factor and substituting  $\omega_1$  for  $\omega$  in the rest, thus,

$$Z_{00} = \frac{H(1 - \omega^2/\omega_1^2)(1 - \omega_1^2/\omega_3^2) \cdots}{j\omega(1 - \omega_1^2/\omega_2^2)(1 - \omega_1^2/\omega_4^2) \cdots}, \quad (57)$$

and instead of (55) and (56), one has

$$Z_{00} = \frac{26.269T}{j\omega} + 1.4127j\omega M \quad (58)$$

and

$$Z_{00} = \frac{411.3Qh^3}{i\omega(1 - s^2)R^2} + 1.9007j\omega M \quad (59)$$

respectively. Similar methods may be applied in the consideration of other vibrating systems.

In the above, the properties of the driving-point impedances, in a broader sense, have been discussed and it is shown that Foster's reactance theorem applies to all vibrating systems. However, one's attention has been confined to the vibration produced at the point or points where the driving force is applied. In numer-

ous other problems frequently encountered, the vibration produced at points other than the driving point are of importance. For instance, in a carbon microphone, while the force acts on the surface of the diaphragm the vibration produced at the center point alone is responsible for the electrical output. Also in a transmitting radio antenna, while the driving is at one end, the average current accounts for the electromagnetic-wave radiation. All these cases, in which the action and the effect are not at the same place, will be discussed in a later paper concerning transfer impedances.

The reciprocal of the driving-point impedance, the driving-point admittance, possesses exactly the same properties as the impedance and in some cases the use of the admittance is more desirable than the use of the impedance itself. From (12a), the *mass driving-point admittance* has the form

$$Y_{00} = \frac{1}{Z_{00}} = \frac{j\omega(1 - \omega^2/\omega_2^2)(1 - \omega^2/\omega_4^2) \cdots}{H(1 - \omega^2/\omega_1^2)(1 - \omega^2/\omega_3^2) \cdots} \quad (12b)$$

which has alternate poles and zeros just as  $Z_{00}$  does.

It will be of interest to note that the driving-point impedance or admittance retains its general form even after the system is coupled to some other systems not of the same kind. For example, an electrical system may be coupled to a mechanical one or *vice versa* by electrostatic, electromagnetic, piezoelectric, or magnetostrictive means; and the mechanical system may, in turn, be coupled to an acoustical system through a diaphragm or the like, and so on. The driving-point impedance will be changed when the coupling exists, but the separation property of the poles and zeros will remain just the same. Take a simple example of an electrical system coupled to a mechanical one with a coupling constant  $K$ . The resulting driving-point impedance can be found as<sup>12</sup>

$$Z = Z_e + \kappa^2/Z_M \quad (60)$$

where  $Z_e$  is the driving-point impedance of the electrical system when the coupling does not exist and  $Z_M$  that of the mechanical system at the coupling point. It is evident that  $Z$  is still an increasing function of the frequency and hence has alternate poles and zeros.

<sup>12</sup> A. E. Kennelly, "Electrical Vibrating Instruments," The Macmillan Company, New York, N. Y., 1923.

# Charts for Simplifying High-Impedance Measurements with the Radio-Frequency Bridge\*

R. L. NIELSEN†, ASSOCIATE, I.R.E.

**Summary**—The equal-arm capacitance bridge for making radio-frequency impedance measurements gives excellent results with very little labor, provided the magnitude of the unknown impedance is not too high. If the unknown is high, and if its components change rapidly with frequency, it is desirable from the standpoint of ease of balance and accuracy of determination to shunt the unknown at the bridge terminals with a high-quality fixed condenser of known capacitance. The difficulty with this so-called shunt-condenser method has been the tedious calculations necessary to convert bridge readings into resistance and reactance of the unknown. In this paper there are presented charts which allow this conversion to be made quickly and easily. This should make possible more extensive use of the shunt-condenser method, especially in the standard broadcast band where there is considerable need for this type of measurement. In an example on the use of the charts there is pointed out a further advantage of the shunt-condenser method, the possibility for interpolation between bridge readings in the case of impedances which change very rapidly with the frequency.

## INTRODUCTION

THERE ARE several reasons why the common radio-frequency bridge takes the form of an equal-arm,<sup>1</sup> or one-to-one ratio, capacitance bridge in which the unknown impedance is balanced directly against the built-in bridge arm containing

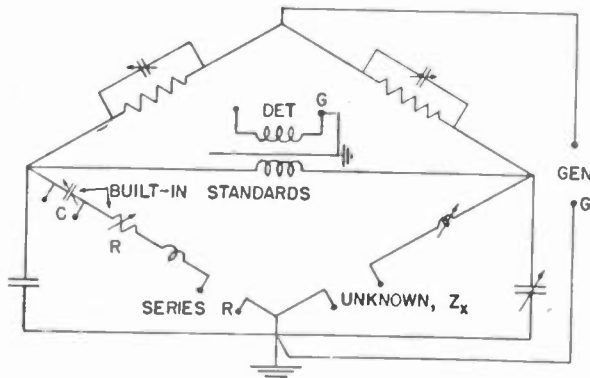

Fig. 1—Schematic of General Radio Type 516-C radio-frequency bridge.

standard variable resistance  $R$  and capacitance  $C$  in series, Fig. 1. One reason is that the fixed bridge arms cannot feasibly have a ratio different from one-to-one due to the difficulty of balancing the shunt admittances in the proper ratio. Another is that high variable resistance added to the standard arm is not desirable due to difficulties of inductive compensation of high-resistance steps.<sup>2</sup> Because of its one-to-one ratio, the bridge

\* Decimal classification: R241.5. Original manuscript received by the Institute, June 26, 1942; revised manuscript received, March 9, 1943.

† University of Minnesota, Minneapolis, Minnesota.

<sup>1</sup> R. F. Field, "An equal-arm capacitance bridge," *Gen. Rad. Exp.*, vol. 4, pp. 1-8; January, 1930.

<sup>2</sup> R. F. Field, "Constant inductance resistors," *Gen. Rad. Exp.*, vol. 8, pp. 6-9; March, 1934.

can conveniently be used for the measurement of low impedances which are of the same order of magnitude as the standards built into the bridge, but it does not lend itself so well to the determination of high impedances. Thus, unless some other bridge connection is possible, the convenience and accuracy of bridge methods must sometimes be sacrificed if the unknown impedance is too high.

There is, however, at least one connection which allows the standard bridge to measure, accurately and conveniently, high impedances which are beyond the range of the built-in standards. This is the so-called shunt-condenser connection, in which the unknown impedance is shunted, at the bridge terminals, by a low-loss, fixed condenser of known capacitance. If the shunt capacitance is properly chosen, the bridge balance is sharp and easy to make using only the internal bridge standards. The disadvantage of this method is the tediousness of the calculations which are necessary in order to convert the bridge settings into ohms impedance of the unknown.

It is thought that if this conversion could be made more simply, the shunt-condenser connection would find more application; accordingly, charts have been prepared which give, with a minimum of effort, both the resistive and reactive components of the unknown impedance in terms of the bridge settings at balance. The charts are particularly applicable to a large and important class of high impedances associated with the effects of parallel-resonance—half-wave antennas, resonant transmission lines, choke coils at their resonant frequencies, and the like. Not only are the impedances in this group high, but their two components change so rapidly and abruptly with frequency that bridge balance using any other method is difficult to attain; expert operators must spend considerable time in the mere mechanics of adjustment, and the inexperienced are inclined to give up.

## METHODS IN BRIDGE MEASUREMENT

There are several ways in which an unknown impedance may be connected to the terminals of a radio-frequency bridge; the connection to use in any particular instance depends upon the nature and magnitude of the unknown impedance. Three common connections, each with its equivalent circuit, are shown in Fig. 2.

Fig. 2(a) shows the simple direct connection which requires that the magnitude of the unknown impedance  $Z_x$  lie within the range of the built-in bridge standards. In particular  $R_x$  cannot exceed about 110 ohms unless

it is desirable to add series resistance to the standard arm, and  $C_x$  must fall within the approximate limits 100 to 1000 micromicrofarads. This method is however the most convenient one to use, if possible, because the unknowns  $R_x$  and  $C_x$  are read directly on the bridge at balance.

Fig. 2(b) is the connection to use in case the equivalent-series reactance of the unknown is a capacitance greater than 1000 micromicrofarads or is inductive in nature, provided of course that  $R_x$  is less than 110 ohms or that it is feasible to add extra resistance to the standard bridge arm. The fixed standard condenser  $C_1$  in series with the unknown allows the combination to be balanced on the bridge. Equations for finding  $R_x$  and  $X_x$  from the balanced-bridge readings  $R$  and  $C$  are easy to apply, and in fact charts for making this conversion have been drawn.<sup>3</sup>

If the magnitude of the unknown is high and particularly if its components also change rapidly with fre-

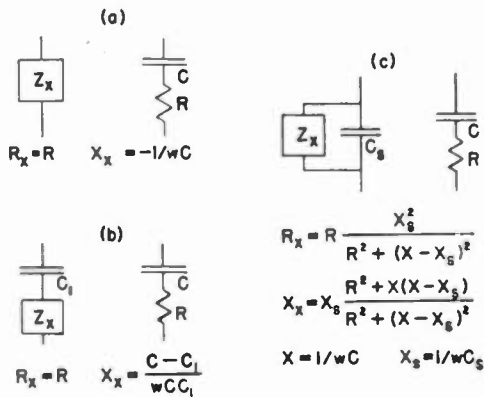

Fig. 2—Equivalent series circuit for various methods of connecting the unknown impedance.

quency, the above methods of connection are often very difficult and sometimes impossible to apply. In this case the shunt-condenser method of connection, Fig. 2(c), is useful. The high-quality fixed condenser  $C_s$  in shunt with the unknown reduces the impedance of the combination to such a value that it can be balanced on the bridge. Several advantages of this method can be enumerated as follows.

1. It is a most reliable method because no series impedance need be added to the balance arm of the bridge. The parallel combination of the unknown impedance and the standard fixed condenser looks, at the bridge terminals, like a low impedance.
2. It keeps the impedance of the four bridge arms more nearly equal in magnitude, thus insuring good balance sensitivity.
3. It allows for easy balance in antenna and parallel-resonance measurements where the resistance and reactance components change very rapidly with frequency. This obviates "hunting" for each new balance and allows for reliable interpolation be-

tween bridge-balance settings, if necessary. This latter point will be further brought out in an example to follow, see Fig. 3.

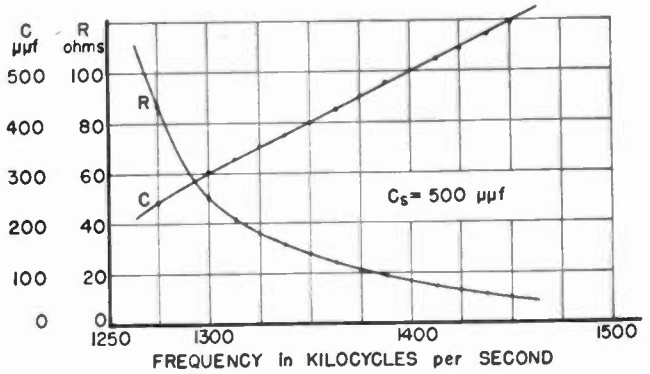

Fig. 3—Bridge readings for illustrative example. Unknown was a 150-foot length of concentric cable short-circuited at the far end so as to form a quarter-wave line.

4. It reduces interference from local broadcast stations, and frequently allows antenna measurements to be made in the daytime.

The only difficulty with this method of connection is that the transformation equations for converting bridge readings  $R$  and  $C$  into ohms impedance  $R_x$  and  $X_x$  are so long and tedious to apply. This is especially true if a large number of readings is necessary in order to plot the curves  $R_x$  and  $X_x$  versus frequency. For this reason the following conversion charts,<sup>4</sup> which make this transformation with a minimum of effort, have been prepared.

CHARTS FOR THE SHUNT-CONDENSER CONNECTION

In the equations of Fig. 2(c) the following notation has been used:

- $Z_x = R_x + jX_x$ , the unknown
- $R$  = bridge-arm resistance
- $X = 1/\omega C$ ,  $C$  the bridge-arm capacitance
- $X_s = Z_s = 1/\omega C_s$ ,  $C_s$  is shunting capacitance, its losses have been neglected
- $\omega = 2\pi f$ ,  $f$  the frequency of the oscillator in cycles per second.

By algebraic manipulation of the equations in Fig. 2(c) a separation of variables is effected and they can be written as follows:

$$\frac{R}{R_x} - \left(1 - \frac{C_s}{C}\right)^2 = \omega^2 C_s^2 R^2 = k^2 \quad (1)$$

$$\frac{C_s \omega X_x}{1 - C_s \omega X_x} \left(1 - \frac{C_s}{C}\right) + \frac{C_s}{C} \left(1 - \frac{C_s}{C}\right) = \omega^2 C_s^2 R^2 = k^2. \quad (2)$$

Here  $k^2$  is any constant and  $R_x/R$  and  $fX_x$  are considered as secondary variables. By defining a transfer constant  $K$  such that

$$K = \log_{10} fR, \quad (3)$$

<sup>4</sup> Charts which provide a partial solution to the equations have been previously published. See "Antenna measurements with the radio-frequency bridge," *Gen. Rad. Exp.*, vol. 17, pp. 1-8; June, 1942.

<sup>3</sup> "A chart for use with the type 516-C radio-frequency bridge," *Gen. Rad. Exp.*, vol. 15, pp. 7-8; February, 1941.

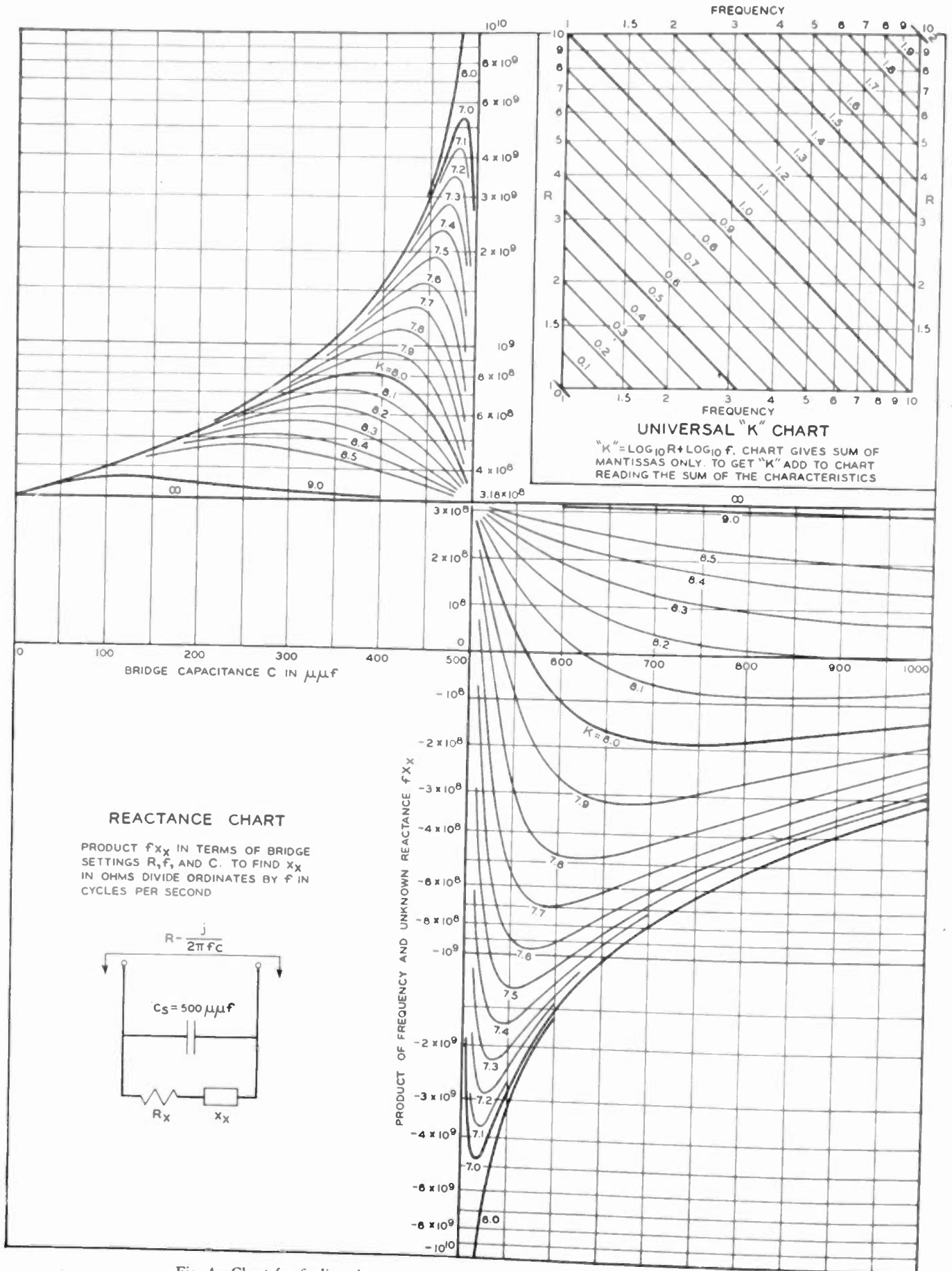

Fig. 4—Chart for finding the reactance component  $X_x$  of the unknown impedance.



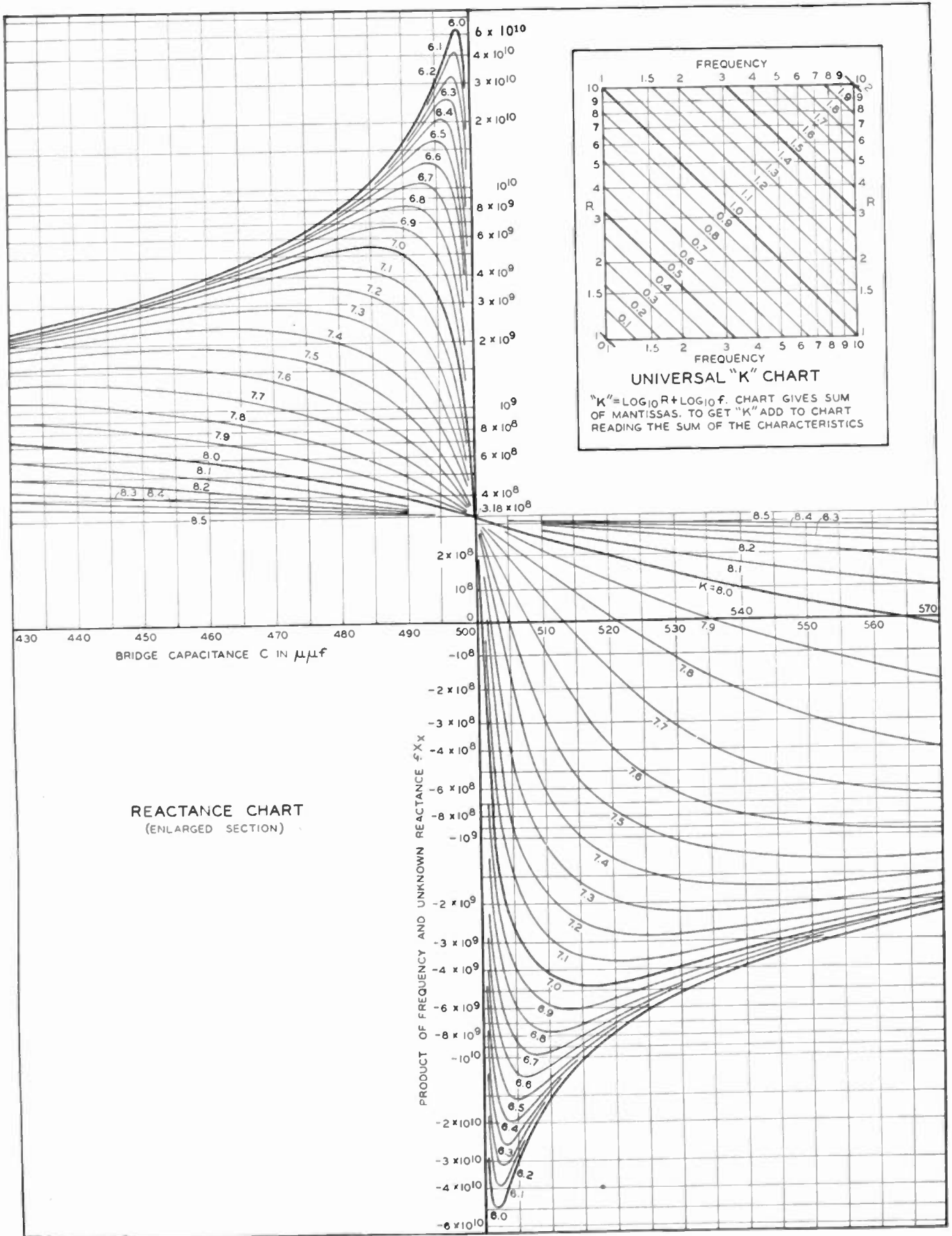

Fig. 5—Enlargement of the central portion of Fig. 4 for reactance, and extension to lower values of K.

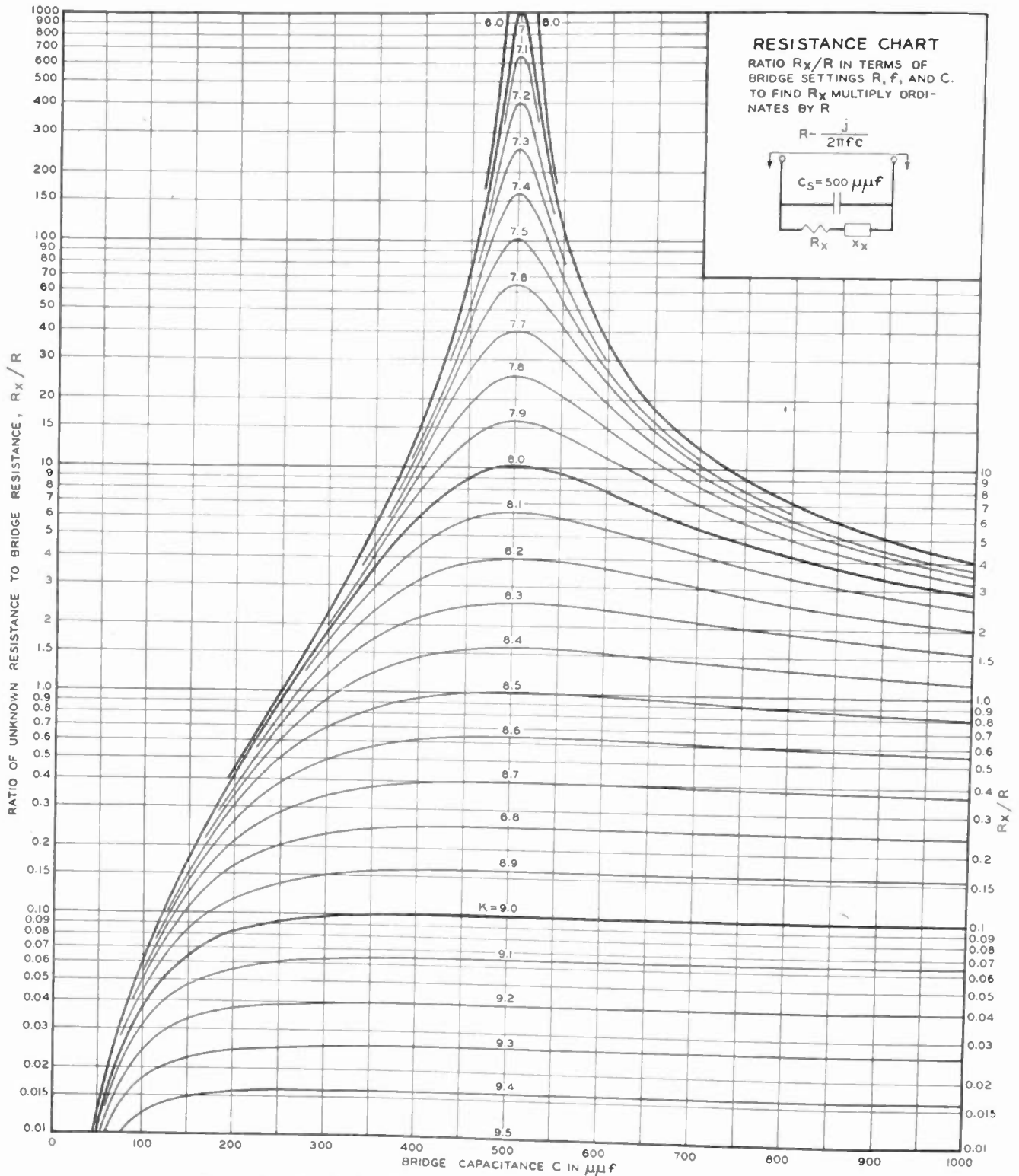

Fig. 6—Chart for finding the resistance component  $R_x$  of the unknown impedance.

$k^2$  becomes

$$k^2 = \omega^2 C_s^2 R^2 = 4\pi^2 C_s^2 \cdot 10^{2K}$$

and the fundamental equations are then

$$\frac{R_x}{R} = \frac{1}{4\pi^2 C_s^2 \cdot 10^{2K} + \left(1 - \frac{C_s}{C}\right)^2}$$

$$fX_x = \frac{1}{2\pi C_s} \frac{4\pi^2 C_s^2 \cdot 10^{2K} - \frac{C_s}{C} \left(1 - \frac{C_s}{C}\right)}{4\pi^2 C_s^2 \cdot 10^{2K} + \left(1 - \frac{C_s}{C}\right)^2} \quad (5)$$

(4) Equations (3), (4), and (5) are plotted, for various values of  $K$ , to form the accompanying charts, Figs. 4 to 7.

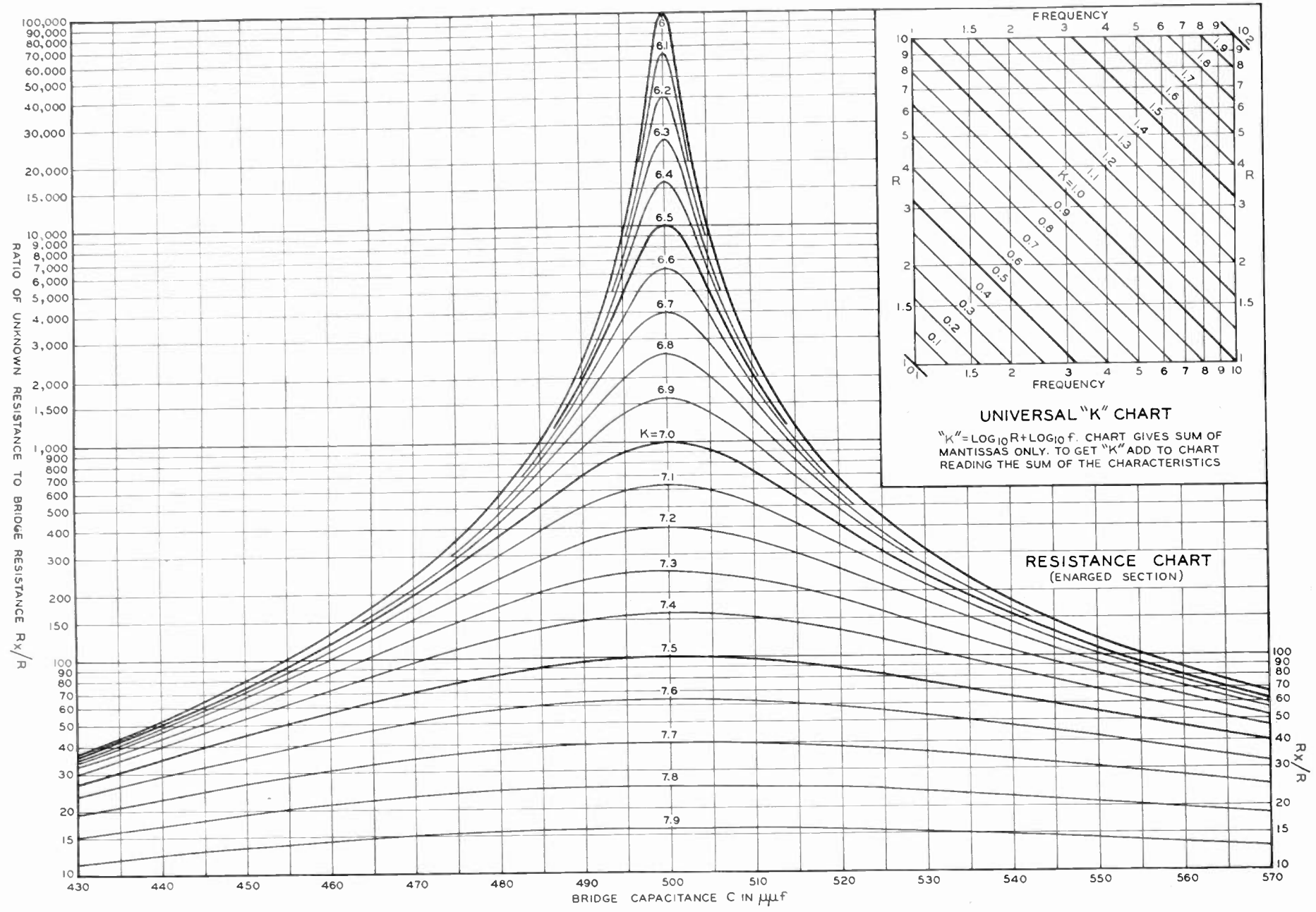

Fig. 7—Enlargement of the central portion of fig. 6 for resistance, and extension to lower values of  $K$ .

The range of bridge capacitance  $C$  covered in the charts is up to 1000 micromicrofarads. The charts are plotted for a constant value of  $C_s$  of 500 micromicrofarads, which is probably the most useful single value as it lies at the mid-point of the scale of  $C$ . Two charts

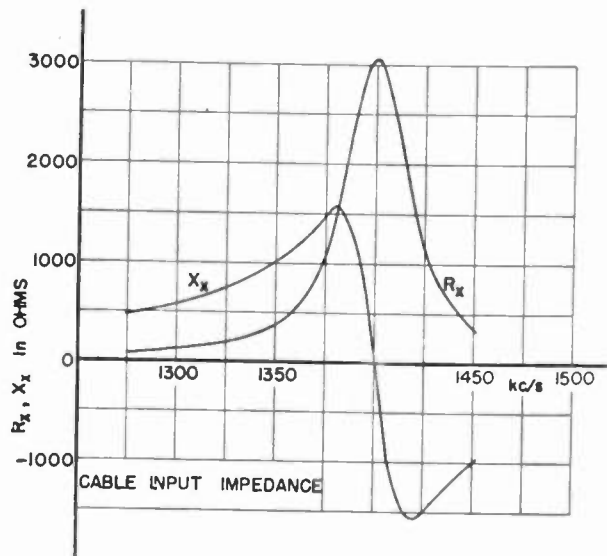

Fig. 8—Impedance of the cable from the data of Fig. 3, obtained by use of the conversion charts.

each of resistance and reactance are plotted, one covering the entire capacitance range, the other being an enlargement of the center section and most useful portion of the first, and moreover extending the range to lower values of  $K$ . The transfer constant  $K$  is given as an insert on the three of the four charts that had room for it (its absence on the fourth is no drawback inasmuch as  $K$  is the same for all charts and need be found only once for each bridge balance).

The resistance charts were conveniently made on semilogarithmic paper in order to handle a range of  $R_z/R$  of some  $10^7$ . The reactance charts also plot nicely on semilog paper with one difficulty, namely, the problem of passing through zero. This was handled by the insertion of linear paper for low values of the magnitude of  $fX_z$ . Linear paper was arbitrarily inserted for  $fX_z$  between  $\pm 3.18 \times 10^8$ , the reason being that  $+3.18 \times 10^8$  is a "natural" break in the graph sheet because it is the limit of the constant  $K$  curves for  $K \rightarrow \infty$ . The vertical scale on the linear paper was chosen so that it matches that on the log paper at the point of junction. Therefore, no break in the curves is apparent, and no cognizance need be taken of the change in scale when reading the charts.

The use of the charts is probably best illustrated by following step by step through a numerical example. Let  $C_s$  be 500 micromicrofarads and  $f$  be 900 kilocycles per second, and suppose bridge balance is obtained for  $R = 35$  ohms and  $C = 488$  micromicrofarads. The capacitance 488 lies within the range covered by the enlarged section charts; so it is useful to turn first to Fig. 5. On the insert of that chart the mantissa of  $K$  is read directly (from 3.5 on the  $R$  scale and 9 on the  $f$  scale)

as 1.5. Mentally adding to this the sum of the characteristics of  $\log_{10} 35$  and  $\log_{10} 900,000$  gives  $K$  as  $1.5 + 1 + 5$  equals 7.5. On Fig. 5 we look to the intersection of the  $K = 7.5$  line with the  $C = 488$  line, and read on the scale of ordinates the product  $fX_z = 1.05 \times 10^9$ . From this  $X_z = (1.05 \times 10^9)/(9 \times 10^6) = 1170$  ohms. On Fig. 7 the intersection of the similarly labeled lines gives for the quotient  $R_z/R = 94$ , from which  $R_z = 94(35) = 3290$  ohms. The total impedance becomes  $3290 + j1170$  ohms.

#### APPLICATION TO A TYPICAL PROBLEM

It is well known<sup>6</sup> that a low-loss transmission line, if its receiving end is short-circuited, will exhibit at its input end wide fluctuations in impedance as the applied signal frequency is varied. Whenever the frequency is such that the line represents any odd multiple of a quarter wavelength, the impedance will be high, the resistance component will pass sharply through a maximum, and the reactance component will rapidly change sign. Impedance measurements of this kind are difficult to make, and frequently they are just not made through the entire high-impedance range.

As an example of the facility which the shunt-condenser method affords when conversion charts are available, data are shown for the input impedance of a 150-foot length of ceramic insulated concentric cable short-circuited at the far end. Fig. 3 shows the data as taken on the bridge with  $C_s = 500$  micromicrofarads. These data were converted by means of the charts into the impedance variations of Fig. 8. Of course plotting of the bridge data as in Fig. 3 is not necessary in general, but it illustrates what can be done if necessary or desirable. Several points of importance should be noted:

1. All readings are obtained on the built-in bridge standards directly, and balance is sharp.
2. Starting below and going right through the critical frequency range, the bridge settings  $R$  and  $C$  change slowly and monotonically despite the violent fluctuations of  $R_z$  and  $X_z$ . Balance need not be hunted with difficulty at each new frequency even though, as is the case here at 1400 kilocycles, the reactance changes at the rapid rate of about 150 ohms per kilocycle.
3. If plotting of the actual resistance  $R_z$  and reactance  $X_z$  shows certain critical points to have been missed, it is evident from Fig. 3 that interpolation between successive bridge readings can confidently be made. This cannot be done for  $R_z$  and  $X_z$  directly, especially in the neighborhood of peak values.

#### ACKNOWLEDGMENT

The author extends his thanks to Dr. J. S. Webb, Professor of Radio at the University of Minnesota, for his criticisms and suggestions in connection with this work.

<sup>6</sup> F. E. Terman, "Resonant lines in radio circuits," *Elec. Eng.*, vol. 53, pp. 1046-1053; July, 1934.



# Wartime Radio Production\*

RAY C. ELLIS†, NONMEMBER, I.R.E.

WHEN I talk to some people about radio production and supplies, they think that I am referring to the sets still to be found in Cortlandt Street. It is pleasant, indeed, to address the members of The Institute of Radio Engineers, for you are men who appreciate radio's part in defeating the Axis, who are keenly aware of the problems of radio, and know how to go about solving them.

When the program for production of military radio started, the manufacturers knew little about production for the Armed Services. It is vastly different to produce radios which fit comfortably in a corner of the living room and those which will take part in the front-line fight. The difference is greater than between a well-groomed and polished civilian and a toughened Commando or Ranger, for the civilian can become a Commando.

Back in 1940 and 1941, the industry was turning out the sets made for our leisure rather than to take part in the world struggle. Although 13,000,000 of them were fabricated in 1941, from the military point of view, radio wasn't much. In July, 1941, military production was \$8,000,000 per month, and by the end of the year was \$15,000,000 per month. The War Production Board had not yet been formed; and within the Office of Production Management, predecessor of the WPB, radio was an obscure unit of the Fire Control and Optics Branch. The events at Pearl Harbor had not yet fractured our peace. It was not apparent that the munitions program would grow to its present height and that, as part of this program, production of military radio would reach an output of over \$200,000,000 per month. It was not known that in but a few months the United States would be at war and that the facilities of a peacetime industry, among them the plants of some fifty-odd home-radio producers, would be placed at the service of our Armed Forces. Because it was not evident in 1941 that virtually all industry soon would go to war, all types of military production was increased by adding new plant and facilities and by hiring new workers.

Early in 1942, production of home and automobile sets was cut 40 per cent by General Limitation Order No. L-44. As of April 23, 1942, production of civilian radio sets virtually stopped. Facilities, materials and manpower were released for war work. Military production, which at first had been undertaken by a handful of companies, now was widely divided. Today, about 1500 concerns participate in production of radio

and detector equipment for the Army, the Navy, and for our Allies.

As the industry pushed its production figures upward, shortages of materials which, at first, were merely occasional and relatively mild, became more severe. Conservation orders solved part of the problem. A few months ago, for example, use of steatite talc for other than a few designated purposes, including the manufacture of electronic insulators, first was restricted and then prohibited altogether. Recently, restrictions were placed upon deliveries of mica in order, among other things, to insure a greater supply for the production of radio condensers. Similar orders were promulgated to cover nickel, zinc, and other materials.

These orders alone do not solve the problem. They do, indeed, stop the use of a host of materials for non-essential purposes. They prevent dissipation of our resources on mere comforts, when there is a war to fight. They eliminate much of the competition of peacetime luxury with the rigors of war production.

What conservation orders cannot do is equitably dole out materials to the different war industries, whose needs often conflict. Every material which is needed by a radio manufacturer is also needed by someone else. Every ounce of material which goes to one war industry in a sense is taken from another. To distribute the materials in accord with the requirements of each branch of the Armed Services requires a new instrument, notably, the Controlled Materials Plan, with which you will become more familiar as the months go by.

In our industry, leading components such as electronic tubes, transformers, etc., are on the B-1 list. Just as we must avoid waste of materials by producing some end products in amounts greater than are immediately required, so production of components must be synchronized with that of completed equipment. Seeing to it that component production and shipment is scheduled to the basic radio program is one of the major problems of 1943. It is a problem which scrupulous care and constant ingenuity will solve.

For the producers of electronic equipment, the major problem for this year lies in finding the engineer, the chemist, and the key-production supervisors in sufficient numbers. It is true that the universities have trimmed their liberal-arts courses and that the students are learning one or another of the physical sciences. However, while many of these young men are studying Maxwell's equations, while they are observing the ways and foibles of the electron, they are also dreaming of themselves in uniform. How many will come to our laboratories and plants? How many will be permitted to stay?

\* Decimal classification: R560. Original manuscript received by the Institute, January 28, 1943. Presented, Winter Conference, New York, N. Y., January 28, 1943.

† Radio-Radar Division, War Production Board, Washington, D. C.

In general, then, the problem of war production, in radio as elsewhere, is to keep output in line with the requirements of war. That involves synchronizing the various kinds of output. It requires that the factors of production, namely, facilities, materials, manpower, be available where needed. The WPB, in co-operation with the Armed Services, is endeavoring to minimize these problems.

Within the Radio Division there are three groups which handle the three major problems of war production. There is a program group which keeps abreast of the requirements for military electronic equipment. Another group, working primarily with the B-1 components, sees to it that critical materials are delivered at the right time and delivered to the right places. A resources group makes certain that equipment and facilities of the industry are adequate to meet the schedules which have been set. There is a separate group in full charge of the maintenance of our civilian radio equipment. Finally, there is a new Radio Field Operations section working within the WPB regional-office structure, which assists the manufacturers at their plants, helping to solve their specific problems outside of Washington.

An Engineering Advisory Section closely watches the developmental work going on in the laboratories in order that, when new devices reach the production stage, there be facilities to undertake the production swiftly; and also that these new designs use the minimum critical materials and components.

The Radio Division, as you know, is concerned primarily with war production which comprises all but a negligible volume of the present output of the industry. Nevertheless, it is vital that the broadcasting stations and the radio sets in our homes be maintained.

A separate group within the Division keeps constant check over the amounts of materials and the quantities of components needed to keep the civilian network of radio communications in repair. It is true that broadcasting stations no longer may expand their facilities and that manufacturers no longer may put new sets on the market. To keep existing broadcasting and receiving apparatus in working order requires some part of the output of the radio industry; it is the Division's responsibility to determine what this part is and to see that its efforts are properly allocated.

I think that we are becoming familiar with the fact that while we may have sufficient food, there is less variety. Civilian radio is in approximately the same position as domestic housekeeping. The radio set is to get its proper allotment of tubes and condensers. How-

ever, the great variety of designs for each component is not feasible in wartime. The group in charge of civilian production has done much work in the direction of standardizing the components which enter civilian manufacture.

Since the manufacture of standard parts economizes use of our resources, one effect is to insure that the radio sets in our homes will be adequately nourished.

In describing the organization of the Radio Division, mention must be made of the Field Section. Until recently, a radio manufacturer with a problem to solve felt that he was virtually forced to come to Washington. While the WPB maintained regional offices, the regional men were not radio specialists, trained in the peculiar problems confronting the radio manufacturers. Although we are always delighted to see you, the Field Section was set up in order to allow you to stay at home. The men in the field are sufficiently informed to handle intelligently a great many of the WPB problems, which in the past seemed impossible to deal with anywhere except in the Nation's capital.

This, gentlemen, is a general and rather rough description of the Division of the WPB which supervises in an over-all manner, the war production of your industry. You will readily appreciate that the job of channeling a military program into production timetables, of finding the resources with which to produce each component, of watching new developments, and of maintaining our civilian radio system is a broad assignment that involves a great amount of subsidiary detail. It does; and the handling of that detail is reflected in the setup of our organization. It is, however, only the broad outline which I have sketched.

When production one year ago was less than \$15,000,000 a month, the organization was much simpler. There were fewer problems and less to watch. As production grew to more than fourteen times that amount within a year's time, a more complex organization was needed.

You are well aware that by the end of 1943 production will be far above present levels. As the figures steadily climb toward our 1943 goals, it is almost certain that new problems will emerge. These problems may require changes in the structure and functions of the Radio Division. You may be sure that the men in the Division are sufficiently open-minded, sufficiently elastic of attitude, to alter their own routines to conform to the developments in this war industry. We welcome any suggestions from The Institute of Radio Engineers which will assist the WPB, the Services, and Industry, to reach our 1943 objectives.

# Radio Standards Go to War\*

HAROLD P. WESTMAN†, MEMBER, I.R.E.

*Summary*—World War I clearly demonstrated the economies which engineering standards provide. To obtain such benefits in the radio field at this time, the War Committee on Radio is developing, under the war procedure of the American Standards Association, standards for radio components. The wartime and peacetime procedures of preparing standards are described.

To be most useful, single designs of components must be chosen which are suitable for all military and naval conditions which may be met all over the world, and each part must carry unchanged its own identification number throughout all of the branches of the Armed Services. These standards must not only give complete instructions to the manufacturer who produces the component but must also provide the equipment design engineer with all the data he needs.

To permit the inspection of components by personnel with sharply limited engineering knowledge, the standards are written in simple language and mathematics and other complexities are avoided.

WORLD WAR I introduced standards into many fields that had not previously been interested in them and extended and intensified their application in numerous other industries. In fact, that conflict undoubtedly did more to establish the value of standards as an effective method of increasing production and reducing waste of both materials and man-hours of labor than any other single event. It is not strange, therefore, that another war should call upon the standards mechanism for assistance in producing the implements of its trade.

The interlude of peace between these two worldwide conflicts has provided a period of consolidation of the type that men seem to need between spurts of high activity. In this peacetime interval, much has been learned of methods of developing standards, of making their availability known to those who should be interested, and of putting them in operation effectively and with least upset to existing systems. We are, accordingly, in an excellent position to do a fine piece of standardizing at this time.

Radio, being a relatively young engineering field, has benefited from standardization for a substantial number of its years. Engineering standards<sup>1</sup> exclusively on radio were first published in this country about thirty years ago. Manufacturing standards<sup>2</sup> were developed later as a result of the problems of supplying broadcast receiving apparatus to the public. Both types of stand-

ards have been continuously developed and effectively applied since their introduction.

These peacetime standards may be divided into four classes: (a) definitions of technical terms; (b) letter and graphical symbols; (c) methods of testing and rating components and equipment; and (d) physical dimensions. Because theory must precede practice—it would be difficult to make something without thinking about it first—the earliest standards leaned heavily towards the defining of terms. This has continued to be an essential study, for if we do not speak the same language we might just as well not speak.

Letter and graphical symbols may well be considered the shorthand of terminology and their standardization follows logically. These first two classes get little if any attention during war and may be considered primarily as peacetime projects.

In contrast to peacetime requirements, wartime places most emphasis on physical equipment. Although no belligerent dares give up research on the assumption that the war will last too short a time to permit its fruits to lead the way to victory, nevertheless, wartime is production time, in earnest, and the wheels of industry must spin fast and purposefully. Each day's battle is fought with the things at hand regardless of their limitations and not with those which are being designed or conceived, however excellent and effective they will be at some future date.

Furthermore, peacetime standards have another limitation which cannot be tolerated during war. They ignore the differences in material and labor costs among the various manufacturers, depending on sales and advertising mechanisms to adjust selling prices and keep the more expensively manufactured product on the market and its fabricator in business. There can be only one economy in wartime. Each item must be produced in the shortest time with the least expenditure of materials and manpower.

Approximately three months after this country was precipitated into the war, S. K. Wolf, of the Radio and Radar Division of the War Production Board, arranged through the American Standards Association for a conference which resulted in the establishment of the War Committee on Radio of which he is chairman.

The War Committee on Radio does not operate under the same procedure as the Sectional Committee on Radio which, since 1923, has been responsible for peacetime radio standards. The Sectional Committee is comprised of representatives of the manufacturers and consumers actively interested in the radio field. Its subcommittees are similarly representative and are responsible for preparing drafts of proposed standards.

\* Decimal classification: R200.XR560. Original manuscript received by the Institute, January 25, 1943. Presented, Winter Conference, New York, N. Y., January 28, 1943.

† Secretary, War Committee on Radio, American Standards Association, New York, N. Y.

<sup>1</sup> Preliminary Report of the Committee on Standardization of the Institute of Radio Engineers, Inc., September 10, 1913.

<sup>2</sup> Issued by The Association of Manufacturers of Electrical Supplies in September, 1924, and continued by the National Electrical Manufacturers Association to August, 1928. Succeeding manufacturers standards were published by the Radio Manufacturers Association starting March 1, 1929.

It is the function of the Sectional Committee to be certain that, in the preparation of standards, all viewpoints are obtained and given adequate consideration. The drafts which are accepted by the Sectional Committee are next examined by the sponsor, The Institute of Radio Engineers, to ascertain that both the procedure of developing the proposed standard and its technical contents are satisfactory. The Electrical Standards Committee of the American Standards Association then reviews the procedure and if it is approved, recommends the adoption of the standard to the Standards Council where final validating action occurs. This is an exceedingly thorough process which guarantees that all minorities are protected. It requires a substantial amount of time and is, therefore, not strictly suitable for a wartime program.

The War Committee on Radio, which is charged with preparing standards for radio components for use in equipment for our Armed Services, consists of a group of individuals who are skilled in the production processes and requirements for such radio equipment. They are not chosen as representatives of any organization in this field. This permits them to vote on proposed standards as individuals and saves much time that would be required in referring proposals back to large organizations which must search their internal structures for comments and criticisms.

The War Committee selects relatively small task groups or drafting committees which are charged with the responsibility of preparing the proposed standards. Usually a series of drafts are made, each based on criticisms of a previous one. As each draft is completed it is sent to all known interested groups and individuals with requests for comments. The last draft is circulated in printed form and is made as nearly like the final copy as knowledge at that stage of the work permits.

A meeting of the task group is then held to make all final changes prompted by the criticisms submitted and the document in its revised form as approved by the task group is sent to the War Committee on Radio for ballot. After approval by the War Committee final action of adoption is taken in behalf of the Standards Council by the Chairman of that body on the recommendation of the Electrical Standards Committee.

A few weeks after the War Committee on Radio was set up and its personnel established, a second meeting was held and a project to draft purchase specifications for fixed mica-dielectric capacitors was initiated. This was to be a "guinea pig" to test the possibilities of doing a successful job and of developing a workable procedure.

Strangely enough, one of the most time-consuming problems did not concern technical design or manufacture. Each branch of the Services identifies its radio equipment and component parts by a code group of letters and numbers. This permits bookkeeping, inventory, and other records to be kept of the apparatus.

For a component to be interchangeable among all branches of the Armed Services, it must be identified in all of them by the same code designation. A change like this may seem simple but when it is applied to thousands of components it is not insignificant. However, our Armed Services were willing to accept the confusion and possibilities for error which a change of this kind inevitably brings and the development of a new identification system was undertaken.

As a result of much consideration, a system was evolved which is applicable to all components. It consists of alternate groups of letters and numbers and follows a definite pattern in which the differences between the components are indicated successively from the coarsest to the finest. Thus, the first two letters indicate the kind of component, such as a fixed mica-dielectric capacitor, a variable composition resistor, or a steatite standoff insulator. The next numbers identify the drawing which establishes the physical size of the unit. The variations within these groups are then indicated in finer and finer steps by means of the succeeding code groups. No two parts having significant engineering differences may carry the same designation. To avoid possible errors in handwriting or telegraphic messages ordering replacement parts, the four letters, I, O, Q, and Z are not used as they may be confused with numbers.

When it was evident that the work on fixed mica-dielectric capacitors showed excellent prospects of a successful conclusion, another meeting of the War Committee on Radio was held and a comprehensive program was inaugurated.

The following subjects are now on the agenda of the War Committee.

- |                      |                           |
|----------------------|---------------------------|
| (a) Components       | (b) Materials             |
| Connectors           | Insulating Materials      |
| Crystals and Holders |                           |
| Dry Batteries        | (c) Processes             |
| Dynamotors           | Metallic Surface Coatings |
| Fixed Capacitors     | Organic Surface Coatings  |
| Fixed Resistors      | Soldering                 |
| Tube Sockets         |                           |
| Variable Resistors   |                           |
| Vibrators            |                           |

The objective of the program is to produce a series of specifications which provide a range of components suitable for practically all normal designs of radio-and-electronic equipment for use by the Armed Services. These specifications must cover all the significant physical and electrical requirements of each component and the necessary tests to insure that they are suitable for the services to which they may be applied. No further technical data should be required by either the manufacturer of the component or the equipment design engineer. The components must be suitable for operation at any place on the surface of the earth, or above it.



Further factors that are desired include (a) interchangeability among all branches of the Armed Services, (b) increased production, (c) reduced wastage of materials, critical or otherwise, (d) conservation of labor time, and (e) clarity of presentation to avoid unnecessary difficulties between manufacturing and inspection personnel.

The tremendous importance of radio in this war has increased the demand for experienced personnel to the point where the supply is hopelessly inadequate. This forces the utilization of nonengineering personnel in all positions where a brief training period will develop reasonably adequate abilities. The inspection of radio components to see that they comply with the purchase specifications is one service in which relatively untrained personnel can be utilized. It is anticipated that in the near future many of our government inspectors will be girls having general high-school educations and a couple of months' intensive training in the inspection of some particular component.

Under these conditions, specifications must be simply and clearly phrased. While this does not outlaw the use of technical terms, they should not be employed unnecessarily nor should they be overly complex. Simple language is vastly to be preferred to that which "makes an impression."

Formulas should be avoided if at all possible. Often they may be replaced by simple graphs or even by tables where the number of factors under consideration is not too large. Where formulas must be used, they should be reduced to the simplest form and care taken to define all terms fully, including the units of measurement. So far as possible, common units such as inches and pounds, should be used instead of centimeters and grams.

Almost all components are tested over various ranges of temperature. Industrial thermometers which are found in the field may be calibrated for either the Fahrenheit or centigrade systems. This requires that all temperatures be designated in both values and it is unwise to depend on a conversion table to which reference will have to be made while reading a test procedure. It is much better to give both readings by putting one in parentheses after the other.

It must always be kept in mind that the inspector will probably not be an engineer and, therefore, cannot be expected to use engineering judgement. When a list of tests is given to determine the goodness of the product, the number of failures permitted without penalty to the manufacturer must be clearly shown. If too many failures occur, the inspector should be instructed as to the next step. It should not be left to the inspector to decide whether (a) to reject the actual components which failed, (b) complain to the foreman of the production line, (c) search through the manufacturing processes for the cause of the failures, or (d) shut down the whole production line.

Fortunately, we may expect the qualification tests,

which are performed to prove the effectiveness of the original design, to be made by engineers or under the immediate direction of an engineer. These tests are extremely thorough and rigorous. They include life testing and therefore require many days for their completion.

In view of the many new manufacturers who have limited or no experience in this field of production, the specifications go beyond qualification and production tests. Definite tests are required at regular intervals of production to provide reasonably thorough checks on the entire manufacturing system. These production-sampling tests are made under the observance and authority of the government inspector. A manufacturer does not have the right to engage in an uneconomical process which wastes materials and manpower simply because he may still be able to meet his production quotas. If his production sampling shows too large a rejection percentage, he must stop his production line until the trouble has been located and remedied.

Tests should be based on the performance of the component and not on its materials or constructional features. This gives the designer the widest possible latitude and avoids modification of the test methods or requirements if some materials become unavailable at a future time. Provisions for substitute materials are always included and acceptance is based on a qualification test to prove that the substitute material is adequate for its purpose.

In peacetime, uneconomical designs often result from fancied or real necessities on the part of the equipment designers. In an attempt to reduce the size and weight of a unit, the designer may demand, let us say, a higher capacitance in a given molded case than has been available previously. This results in a capacitor stack which is so large that there is insufficient molding material around it to hold it firmly and thereby maintain its value constant, or the slight amount of tipping which may occur in the molding process may expose the stack and ruin the capacitor. It is conceivable to manufacture such units with shrinkages of 50 or 60 per cent, provided someone wants the good ones sufficiently to pay as well for the rejects. However, with mica on the critical list, we cannot afford to throw any of it away and if a designer needs such a unit so greatly that he cannot do without it, it should be ordered as a special design and not be included among the standard values. If it were made standard simply because it could be manufactured and was needed for a small part of the total production, it is certain that most designers in choosing a by-pass or blocking capacitor of a given physical size would automatically pick the largest capacitance value on the list on the theory that it cannot be too large but it can be too small. This would tend to concentrate production on the most uneconomical sizes.

Dimensional standards to secure interchangeability

are thought of in peacetime as primarily a benefit to the ultimate consumer. While this is a vital factor under war conditions, the benefit goes much further. A manufacturer who is building equipment for several branches of the Armed Services, may require many thousand components of a given size on one production schedule and a few dozen for another. He could not previously combine the orders to the parts manufacturer because the type numbers were not the same and there might be other subtle differences. Unified procurement specifications will clarify this situation to the benefit of everyone concerned.

Every effort is being made to develop specifications for components which are suitable for operation anywhere on the surface of the earth, below the sea, or in the sky above. This is a global war and our fighting forces will be found in every climate. Any component which is limited to one extreme service, as in the arctic or the tropics, presents a serious problem. It requires that the piece of equipment and spare parts be earmarked for that particular climate. If changes in the course of the war demand unanticipated concentrations in some other climate, the equipment cannot be diverted there without the delay of replacing the components which are unsuited for the new destination. Information on the placement of substantial orders for apparatus for a certain climate would be extremely valuable to the enemy who would be forewarned of things to come.

A next logical step to the adoption by the Armed Services of common purchase specifications for radio components would be a unified system of inspection and qualification testing. It is recognized that there are numerous difficulties in setting up such a system but it is questioned whether any of these offer problems as complex and extensive as the acceptance of the

new numbering system. The advantages of dealing with a single responsible and authoritative laboratory on any given component are manifold and compelling from the viewpoint of both the Armed Services and industry.

All war standards expire when peace arrives. This, and the fact that military requirements are very different from those for the civilian, has permitted the problems of war standards to be viewed without any strong commercial bias on the part of component and apparatus manufacturers. It is almost certain that little or no military radio equipment will be ordered for a substantial time after the cessation of hostilities. Thus, there will be no postwar military market to divide but, rather, a complete shift to civilian radio products.

The existence of several billion dollars worth of equipment throughout the various branches of the Armed Services, bearing common type numbers and built under specifications which are the product of the country's most experienced engineers, will do much to continue these standards in operation. This gives rise to the hope that we shall never again be caught with such a variety of "standards" as to be essentially without any.

The function of the American Standards Association in this program is to provide the rules, guidance, and secretarial assistance. None of these, nor all three, can of themselves produce standards. The outstanding cooperation of the three major groups, the Armed Services, the equipment manufacturers, and the component suppliers has made possible the extensive results which have already been achieved. They give promise of a fulfilled schedule in the near future which should do much for that early and victorious peace which is so desired by us all.

### Corrections

There has been brought to the attention of the editors by the author, on the suggestion of a reader of the corresponding paper, an error in equation (6) of George F. Levy's paper, "Loop Antennas for Aircraft," which appeared on pages 56-67 of the February, 1943, issue of the PROCEEDINGS. This equation should read

$$Z = \frac{-1}{\omega C_T} (R_0 + j\omega L_0) \cdot \frac{1}{\omega L_0 - \frac{1}{\omega C_T}}$$

E. H. Schulz, on the suggestion of a reader of his paper, "Comparison of Voltage- and Current-Feedback Amplifiers," which appeared on pages 25 to 28 of the January, 1943, issue of the PROCEEDINGS, has called the attention of the Editor to the following corrections:

In equation (3)  $Z_i$  should be replaced by  $V_i$ .

In equations (5) and (6) a minus sign should be placed in front of  $\mu$ .

In the sentence following equation (4)  $V_1$  should be replaced by  $V_i$ .

## "Thermal-Frequency-Drift Compensation"\*

T. R. W. BUSHBY

Herbert Sherman<sup>1</sup>: Mr. Bushby's article is of great interest in present military communications design. The design of military communication equipment must consider, among other factors, the effect of varying temperature on the equipment, and Mr. Bushby's article is therefore very opportune.

Unfortunately, he omits the discussion of a very basic point to his whole article. On page 548, Section III, he says, "If we make the simplifying assumption that  $\theta$  varies linearly with frequency, it can be shown that it will have its minimum value, integrated throughout the range, when  $\theta_L^2 + \theta_H^2$  is a minimum, and that  $\theta_L$  and  $\theta_H$  will then have opposite signs." It seems that this basic criterion is established on the premise of finding the smallest average  $\theta$  over the frequency range.

This criterion is not the most desirable condition. Since the frequency drift of a superheterodyne oscillator is primarily limited by the intermediate-frequency bandwidth, consideration of the percentage (or if I may coin a word, "permegage") frequency drift is not of primary importance.

The optimum condition may be one of two choices depending on the application of the equipment.

(1) Making the *absolute* frequency drift as low as possible at the most unfavorable frequency,

or

(2) Making the average *absolute* frequency drift a minimum.

The mathematical conditions for the first are not yet obvious and the mathematical conditions of the second (i.e., making the area under the curve of  $f$  versus  $\theta f$  equal a minimum) leads to a cubic equation which complicates the solution; therefore, results are not yet available for easy comparison with Mr. Bushby's work.

It is quite possible in light of the other approximations made by Mr. Bushby that the difference is not of great importance, but the prospective user of his results should be made aware of the criterion on which these results were obtained; that the lowest average *percentage* frequency drift was found rather than the lowest average, or maximum, *absolute* frequency drift.

T. R. W. Bushby<sup>2</sup>: I thank Mr. Sherman for his comment on my paper and for the opportunity of amplifying a point of evident interest, as I have had another inquiry on the same subject.

As Mr. Sherman has premised in paragraph 2 of his letter, the criterion is established on the basis of determining the minimum average  $\theta$  (*drift factor*) throughout the frequency range and not the minimum average  $f\theta$  (*drift in kilocycles*). It is also necessary to add that the sign of  $\theta$  must be disregarded for two reasons. First, the direction of drift is usually of little concern, the modulus being of importance, and second, if the sign be not disregarded, the solution results in  $\theta_L = -\theta_H$  (average  $\theta$  zero), which is the condition for lowest maximum  $|\theta|$  and not necessarily nor usually the condition for minimum average  $|\theta|$  throughout the range, save in the special case of the variable-inductance-tuned circuit as shown in (12a) and (12b) in the paper.

In paragraph 3, Mr. Sherman states "This criterion is not the most desirable condition," and I agree that under certain circumstances this may be so. For instance, in a system utilizing continuous-wave telegraphy, it might be desirable to aim at minimum average  $|f\theta|$  rather than minimum average  $|\theta|$ . Innumerable considerations may enter into the question, but specifications usually call for the drift to be less than a given figure expressed in *parts per million per degree centigrade*, which is  $|\theta|$ . Mr. Sherman then mentions the superheterodyne oscillator and I would point out that the discussion of section III of the paper is not applicable to padded circuits, which are dealt with in section VII, where it is shown that provided  $\theta$  does in fact vary linearly with frequency, it can be zero throughout the range.

Regarding Mr. Sherman's first "optimum condition," it is possible to have zero drift at any one frequency in the range by simply regarding the circuit as fixed tuned at that frequency (section II), and this probably accounts for his statement that "the mathematical conditions for the first are not yet obvious." The selection of an arbitrary frequency for zero drift may result in excessive drift at one or other of the frequency extremes, and it was just this circumstance that prompted the search for an optimum condition.

The condition for minimum average  $|\theta|$  throughout the range is demonstrated geometrically as follows: Remembering the assumption of linearity, the straight line  $\theta$  versus  $f$  may have one of three positions: (i) It may coincide with the zero axis, a special case dealt with in section IV of the paper. (ii) If it does not coincide with the zero axis, it can touch it at only one point. That is to say, failing (i),  $\theta$  can be zero at one frequency only. (iii) It may be either completely above or below the zero axis, that is, it need not touch it at all. These two positions are combined for the purpose of the demonstration. Neglecting (i) it may be

\* PROC. I.R.E., vol. 30, pp. 546-554; December, 1942.

<sup>1</sup> Philadelphia Signal Corps Procurement District, Philadelphia, Pennsylvania.

<sup>2</sup> Amalgamated Wireless, Australasia, Ltd., Ashfield, N.S.W., Australia.

said that the line either does or does not cross the zero axis.

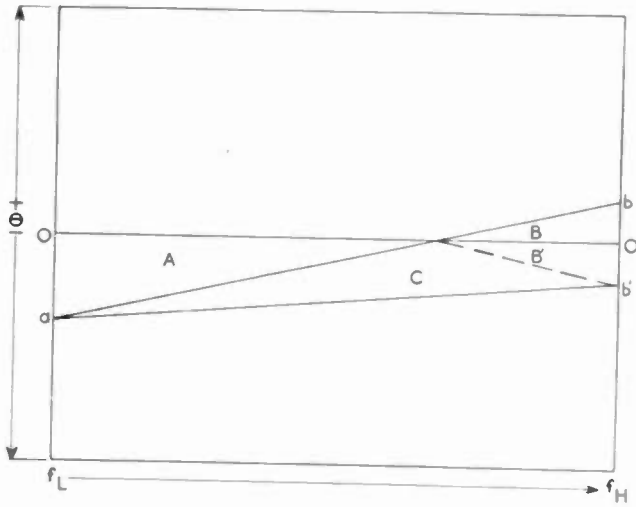

Therefore in the figure, assume that line  $a-b$  or line  $a-b'$  represents the condition for minimum average  $|\theta|$  which is then proportional to area  $A+B$  or area

$A+B'+C$ . The first area is obviously the lesser, so that we establish the condition that minimum average  $|\theta|$  occurs when the line crosses the zero axis and  $\theta_{L'}$  and  $\theta_{H'}$  will then have opposite sign. In the similar right triangles  $A$  and  $B$ , the heights are respectively  $\theta_{L'}$  and  $\theta_{H'}$  and the bases respectively  $g\theta_{L'}$  and  $g\theta_{H'}$  where  $g$  is any factor. Therefore average  $|\theta|$  is proportional to  $A+B$  which equals  $g/2(\theta_{L'}^2 + \theta_{H'}^2)$  which has its minimum value when  $\theta_{L'}^2 + \theta_{H'}^2$  is a minimum, as stated in the paper.

This leads readily to a solution for minimum average  $|f\theta|$  on the assumption that  $f\theta$  instead of  $\theta$  varies linearly with frequency. I cannot state to what extent this assumption is justified in practice. Substituting  $f\theta$  for  $\theta$  in the figure, the line will cross the zero axis as in the previous case and we then have

$$A+B = f_L^2(g/2)(\theta_{L'}^2 + k\theta_{H'}^2)$$

where  $k = f_H^2/f_L^2$  as in the paper. This expression has its minimum value when  $\theta_{L'}^2 + k\theta_{H'}^2$  is a minimum. This is the most satisfactory solution I am able to give to Mr. Sherman's second "optimum condition." The lowest maximum  $|f\theta|$  occurs when  $\theta_{L'} = -\theta_{H'}\sqrt{k}$ .



# Institute News and Radio Notes

## Board of Directors

The regular meeting of the Board of Directors, held on May 5, 1943, was attended by L. P. Wheeler, president; S. L. Bailey, W. L. Barrow, E. F. Carter, I. S. Coggeshall, W. L. Everitt, H. T. Friis, Alfred N. Goldsmith, editor; G. E. Gustafson, O. B. Hanson, R. A. Heising, treasurer; F. B. Llewellyn, B. J. Thompson, H. M. Turner, H. A. Wheeler, W. C. White, and W. B. Cowilich, assistant secretary.

The following applications were approved: for transfer to Member grade from F. S. Howes, Glenn Koehler, J. D. Kraus, and W. G. McConnel; for admission to Member grade from O. S. Schairer; and 106 for Associate, 149 for Student, and 3 for Junior grades.

The resolution, given below and relating to the named Constitutional Amendment included with those reported in the April, 1943, issue of the PROCEEDINGS, was adopted:

Article III, Section 7: "Resolved, that the Constitutional Amendments proposed by the Board of Directors at its February 3, 1943, meeting, be altered to the extent of changing the word 'three' to 'four' in Article III, Section 7."

This amendment, following consideration by legal counsel, will be submitted to a vote by the membership.

With respect to the Institute's participation in studies of postwar problems of the radio industry, unanimous approval was given to a plan describing the organization and activities of a proposed "Radio Technical Planning Association," as embodied in exemplary fashion in a proposed charter for that organization.

The committee, consisting of Secretary Pratt, chairman; Editor Goldsmith, B. J. Thompson, and H. M. Turner, was appointed and given the responsibility of promoting the R.T.P.A. plan among the proposed sponsors named in the charter, of redrafting the charter to meet with the views of the representatives, of estimating the amount of the first year's budget for the information of the sponsors, and of referring the redrafted charter to all sponsors with the recommendation for unanimous adoption.

A discussion took place on the Senate Bill S-702, which proposes the mobilization of the scientific and technical resources of the nation and the establishment of an Office of Scientific and Technical Mobilization. The committee, appointed to investigate the subject Bill, includes S. L. Bailey, chairman; E. W. Engstrom, and F. E. Terman.

The nominations for officers and directors were made as follows:

For President—1944  
H. M. Turner

For Vice President—1944  
E. M. Deloraine

For Directors—1944-1946  
S. L. Bailey                      R. K. Potter  
G. E. Gustafson                F. X. Rettenmeyer  
R. F. Guy                        W. C. White

An increase in the maximum balance of the Office Account was authorized.

Permission was given to the Chicago Section to affiliate with the Illinois Engineering Council.

## Important Notice

The Post Office Department requests the co-operation of patrons in order to simplify distribution and promote delivery of mail in New York City. The delivery district number for The Institute of Radio Engineers is 18. Mail should be addressed to the Institute as follows:

Institute of Radio Engineers  
330 West 42nd Street  
New York 18, N. Y.

President Wheeler announced the resignation of A. F. Van Dyck, now on active service in the United States Navy, as chairman of the Admissions Committee. G. T. Royden, a member of that committee, was appointed to fill the chairmanship vacancy.

The report on the Institute's investments, prepared by Treasurer Heising, was discussed.

President Wheeler called attention to the serious illness of John Stone Stone, President of the Institute in 1915.

## Executive Committee

The Executive Committee met on May 4, 1943, and those present were L. P. Wheeler, chairman; Alfred N. Goldsmith, editor; R. A. Heising, treasurer; Haraden Pratt, secretary; H. A. Wheeler, and W. B. Cowilich, assistant secretary.

Office management matters were handled including certain resignations, sick leaves, promotions, new employments, overtime work, and summer office

hours. It was agreed to recommend to the Board of Directors that a change be made in the maximum balance of the Office Account; that the initial dues' billing date be changed from December 1 to December 27, with due allowance for transit time in case of foreign members; and, that the termination date on unpaid memberships be changed from April 1 to May 1.

Approval was given to the installation of a payroll-check system.

The 1943 audit of the Institute's financial records and other related office matters were discussed.

A report was given by H. A. Wheeler relative to the Institute's membership in the Audit Bureau of Circulations, and the work and records involved in the preparation of reports for that organization.

The insurance policy on back issues of the PROCEEDINGS was renewed at a lower premium.

For confirming action by the Board of Directors, approval was given to the application for transfer to Member grade in the names of F. S. Howes, Glenn Koehler, J. D. Kraus, and W. G. McConnel; for admission to Member grade in the name of O. S. Schairer; and to 106 applications for Associate, 149 for Student, and three for Junior grades.

The assistant secretary submitted the requested analysis of delinquent memberships for each of the last five years, and it was noted that the total number of delinquents for the current year is the lowest of these years.

It was reported by the assistant secretary that the records of recent years are being checked relative to the status of the Institute representation on other bodies, and that letters requesting additional information are being mailed to the present Institute representatives in this category.

The request of the Chicago Section to affiliate with the Illinois Engineering Council was discussed and referred to the Board of Directors with recommendation that permission be granted.

Chairman Wheeler stated that he and Institute's General Counsel Zeamans recently presented the Institute's appeal for exception to the modified Paper Limitation Order to the War Production Board, at Washington. Supplementary data were requested by WPB and the assistant secretary, in collaboration with Editor Goldsmith and General Counsel Zeamans, was instructed to prepare such additional information.

On recommendation of WPB careful consideration was given to the early use of lighter-weight paper on the cover and inside pages of the PROCEEDINGS as a means of conserving paper. Appropriate steps will follow.

Editor Goldsmith announced that the Cumulative Index (1913-1942) would be distributed with, and as a supplement to, the June issue of the PROCEEDINGS.

## Correspondence Concerning Proposed Constitutional Amendments

From: F. E. TERMAN

The writer has read with interest the correspondence appearing in the May, 1943 issue of the PROCEEDINGS relative to proposed constitutional amendments affecting the membership structure of the Institute. He feels that one of the important aspects of this proposal is being overlooked, and would accordingly like to add a few words to the discussion.

The proposed constitutional amendments provide that the privilege of voting for Institute officers shall be extended to the new Member grade which, with the Senior Members and Fellows, is intended to represent the professional radio engineers; i.e., those who have been in the profession a reasonable length of time and are making radio engineering their life work.

The present constitution withholds the voting privilege from all Associated who joined the Institute since this constitution became effective, even though many of these new Associated are professional radio engineers of maturity. The only Associates who now are privileged to vote are those whose membership dates back, without a break, to before the adoption of the present constitution. The number of such voting Associates is decreasing year by year and within a very short time the majority of the Institute members who are professional radio engineers will have no say in the affairs of the Institute.

It is not believed that the present situation is a healthy one for the Institute. Approval of the proposed new constitutional amendments will remedy this situation by enabling all who have definitely established themselves as professional radio engineers to participate in Institute affairs. Furthermore, the proposed constitution extends the voting privilege to these engineers without requiring that they pay the high dues that go with the present Member (the new Senior Member) grade, thus removing the dollar sign from the voting privilege.

F. R. LACK

At the regular meeting of the Board of Directors of the Western Electric Company held May 11, 1943, Frederick R. Lack was elected a vice president of the Company. Mr. Lack, who resigned as an officer of Western Electric on November 1 last year to become director of the Army and Navy Electronics Procurement Agency with offices in Washington, will now resume the direction of Western Electric's Radio Division in New York.

His Washington assignment marked

the second occasion during Mr. Lack's 31 years with the company when he has entered the wartime services of the United States. During World War I, he enlisted in the Signal Corps and saw action in France.

Mr. Lack entered the manufacturing department of Western Electric August 1, 1911, as an assembler. Following his return from France in 1919, he was assigned to development work on radiotelephony. As an outgrowth of this, he supervised the installation of a radiotelephone link between Peking and Tientsin.

Entering Harvard as a special student in 1923, he earned his B.S. degree with high honors in two and a half years.

Re-entering the Bell System as a member of Bell Telephone Laboratories, he engaged at first in studies preliminary to the



F. R. LACK

short-wave transatlantic radio. As a part of these studies, Mr. Lack carried on a research program on the use of piezoelectric crystals in radio-frequency generators. This work led to the use of quartz-crystal oscillators in the transatlantic radio, broadcasting, aviation, police, and marine radio fields.

During this phase of Mr. Lack's career he also had charge of designing and building the ship equipment for the Bell System's first commercial installation of ship-to-shore radiotelephone on the *Leviathan*.

In charge of vacuum-tube development from 1935 to 1939, when he became manager of Western Electric's Specialty Products Division, Mr. Lack directed the engineering of tubes for use on ultra-high-frequency radio and for high-power operations, which are fundamental to the present manifold applications of radio in war operations. He is a Fellow of The Institute of Radio Engineers.

WILLIAM J. KNOCHEL

William J. Knochel has been appointed assistant superintendent of electronics manufacturing of the Westinghouse Electric and Manufacturing Company. He will be responsible for co-ordinating the manu-

facture of electronic tubes. Mr. Knochel joined the Westinghouse Company as a draftsman in 1929. He has been associated with radio-tube engineering and manufacturing activities since 1933, and was appointed engineer and production supervisor of electronic tubes in 1942.

He is an Associate member of the Institute of Radio Engineers, and a member of the American Institute of Electrical Engineers, and the American Welding Society. He received his technical training at Newark Technical School, Columbia University, and Stevens Institute of Technology.

### DIRECTIONAL U-H-F ANTENNA

A new radio-relay antenna for studio-to-transmitter service has been developed by engineers of the General Electric Electronics Department at Schenectady, N. Y. It is designed for relaying frequency-modulation programs from the studio to the main transmitter via any one of the 23 assigned channels centering on 337 megacycles. One of the new antennas is in operation at Schenectady where it is installed atop a building to relay programs of frequency-modulation station W85A, with studios in the building, to the station's main transmitter in the Helderberg Mountains, 12 miles away.

According to M. W. Scheldorf, Associate member of the Institute and General Electric electronics engineer, "The antenna concentrates its radiation in a narrow beam in the desired direction only, in accordance with well-defined and narrow limitations of the Federal Communications Commission. The antenna consists essentially of five sets of simple dipole antennas, properly mounted and

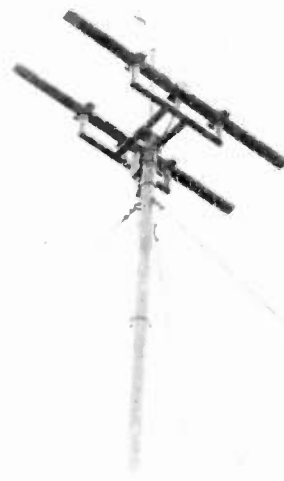

connected electrically in a manner to achieve the necessary radiation pattern. The entire electrical system is mounted within a nonmetallic housing which protects it from rain, snow, and ice. It is made to mount easily on a single metal pole."

## NEW ACOUSTIC STETHOSCOPE

A new acoustic stethoscope has been developed in RCA Laboratories so sensitive in its range of hearing that it introduces many sounds doctors have never heard. This stethoscope, developed by Dr. Harry F. Olson, promises to widen the study of sound within the human body. The beat of the heart, normal or abnormal, respiratory rattles, peristaltic squeaks, murmurs and groans, all are amplified to facilitate diagnosis, based upon the structure of sound.

It has been found that the sounds of the body range from 40 to 4000 cycles, the full range of which are covered for the first time by the new stethoscope. Above 4000 cycles most of the sounds in the body are so weak that they are masked by the ambient random noises generated within the body. It is explained that respiratory sounds such as wheezes and the rushing of air are of a complex nature. Therefore, in designing the new stethoscope to gain maximum intelligence, the instrument transmits all frequencies over the range from 40 to 4000 cycles without attenuation or discrimination. The ordinary stethoscope has an effective range between 200 and 1500 cycles.

The advantages of the new stethoscope, according to Dr. Olson, come from the fact that it couples the ears of the diagnostician much more closely to the human body through the employment of a reversed taper tube which results in greatly improved matching of the acoustic elements. Thus, sounds produced by the organs of the body are heard more clearly and their range is greatly widened. In fact, so many new sounds are heard with the instrument, that a filter is built into it to enable the user, by simply turning a knob, to limit the range at will. This was done at the suggestion of one of the testing physicians in order to prevent confusion until the meaning of the new sounds can be determined through further study. It also makes the stethoscope a more flexible tool of the doctor.

In discussing the practical application of the acoustic stethoscope, he pointed out that the conventional type of instrument is not effective with the lower sound frequencies of the heart or with the higher frequencies produced in the chest. The new stethoscope is expected to be invaluable by making these frequencies available to the physician.

"By the application of modern acoustic principles, the new stethoscope has been developed in which the disadvantages of existing stethoscopes have been eliminated," said Dr. Olson. "As a result, the performance of the new stethoscope is far superior to existing instruments."

Detection of weak sounds by means of an ordinary stethoscope is limited, according to him, by the presence of noise which blankets the desired sound. "For the most part," he said, "such extraneous sounds are caused by the movement of clothing, and room noises, most of which are air-borne. The new stethoscope is insensitive to air-borne noise because of the

high mismatch between the air and the stethoscope. The ordinary acoustic stethoscope is one of the most useful instruments which the physician uses in mediate auscultation (study of body sounds by the stethoscope). By means of the stethoscope the physician is able to study sounds produced within the heart, lungs, stomach, intestines, or other portions of the body, and to determine whether normal or abnormal conditions exist as indicated by sounds. Obviously, it is the structure of the sound, which involves the intensity, the fundamental frequency, and the harmonic components, that makes it possible to diagnose normal or abnormal conditions by auscultation." The stethoscope was invented in the early years of the nineteenth century by a French physician, R.T.H. Laennec. Until now, there has been very little advance in its basic design.

Dr. Olson has been in charge of RCA's acoustics research as related to radio, sound motion pictures, and phonograph sound pickup and reproduction for many years. He is an Associate of the Institute of Radio Engineers.

## CALIBRATING WAVEMETERS

In this global war, Army and Navy radio transmitters have to work equally as well in the frozen Arctic as in the steaming tropics. But to do this, they have to be adjusted accurately for the effect of changes in temperature and humidity. For this purpose, a wavemeter is used—a device against which the wave length of the transmitting set can be checked and corrected.

Unfortunately, the same atmospheric conditions that knocked radio transmitters off their wavelength did the same thing to wavemeters. In fact, these meters could be exactly calibrated the day they were manufactured, and then be grossly inaccurate 24 hours later, if there was a marked change in the weather.

Philco engineers and production experts wrestled with this problem for an extended period, finally concluding that some change in the construction of the wavemeter would be necessary to make it "weatherproof." By introducing a thermostatic control into the radio circuit of the wavemeter, they worked out a self-compensating device in which the effective length of the wire in the control coil was increased or reduced, as temperature varied, to maintain the same exact wavelength at all times. The principle adapted to this essential war service is similar to that used in thermostats for automatic heating in thousands of American homes.

Chief credit for this engineering contribution goes to E. O. Thompson, Philco Engineering Department, and David Sunstein of the Philco Factory Organization, who were officially cited for their work by the Board for Individual Awards of the War Production Board. Mr. Thompson is an Associate member of the Institute.

## Books

### Electrical Counting, by W. B. Lewis

Published by the Cambridge University Press, 60 Fifth Avenue, New York, N. Y., 1942. 144 pages. 73 figures. 5½×8½ inches. Price, \$2.50.

This is a book in which a physicist analyzes the application on electronic-engineering techniques to the special need for particle-counting devices in the field of experimental nuclear physics. On the side of the specific application, there are included chapters descriptive of ion trails, counting ionization chambers, Geiger-Muller tube counters, statistics of random distribution as applied to interpretation of data obtained from counters, and the various problems involved in interpreting counter data in terms of particle energies. On the engineering side, there are chapters dealing with resistance-coupled amplifier design, noise limits, oscillographic recording, feedback, triggering, electronic and electromechanical-count recorders, and discrimination between impulses, both as to magnitude and time of occurrence.

It is presumed that the reader knows the terminology of experimental physics and is familiar with the general basic principles of use of electronic tubes. Where amplifier circuits discussed extend beyond the simpler ones commonly used, quantitative as well as qualitative discussion of their behavior is included.

Although written primarily for specialists in a particular field, this book can be very useful to an engineer concerned with amplifier-circuit techniques, even though he has no interest whatever in the specific laboratory applications. There are useful discussions of causes of certain kinds of trouble and of ways to eliminate them. The treatment is concise but clear, and the illustrations are very helpful.

W. G. Dow  
University of Michigan  
Ann Arbor, Michigan

### Alternating-Current Circuits, by E. M. Morecock

Published by Harper and Brothers, 49 W. 33 Street, New York, N. Y. 172 pages+3-page index+xii pages. 116 figures. 6×9 inches. Price, \$2.75.

This is an elementary textbook intended for students who have not had calculus. The subject is presented clearly with the aid of many simple diagrams. Not the least important are the systematic instructions and suggestions for study and laboratory procedure, preparation of reports, etc. There are many examples with answers.

The subjects are alternating-current waves, vectors and complex quantities, and single and polyphase systems. There is some attention to radio problems, such as resonance. Tables of trigonometric functions are appended.

H. A. WHEELER  
Hazelintone Electronics Corporation  
Little Neck, L. I., N. Y.

# Contributors



GEORGES CHEVIGNY

Georges Chevigny was born at Paris, France, on August 15, 1901. After receiving his B.S. degree from Paris University, he was graduated as a physicist from the "Ecole de Physique et Chimie de Paris" in 1922.

He started his career in the communications industry with an associate company of the International Telephone and Telegraph Company, Le Matériel Téléphonique, Paris, in 1923. Mr. Chevigny specialized in vacuum-tube development from 1933 onward and was later placed in charge of vacuum-tube research and development, both for radio and wire transmission.

Since 1941, he has continued his activities along the same lines in the laboratories of the Federal Telephone and Radio Corporation in New York. His principal efforts have been directed towards the development of very high-power tubes, both sealed and demountable. He also has devoted much attention to ultra-high-frequency tubes.



Ray C. Ellis was born at Warren, Massachusetts and was educated at the Massa-



RAY C. ELLIS

chusetts Institute of Technology and Tri State College.

He was the manager of the Delco Division of General Motors before his present association with the War Production Board. In June, 1941, the present Radio and Radar Division started as a one-man organization as a unit of the Optics and Fire Control Section, Ordnance Branch, Production Division, WPB, with Mr. Ellis as head of the unit. Today Radio and Radar is a Division with Mr. Ellis as Director.



R. L. Nielsen (S'40-A'41) was born at St. Paul, Minnesota, on October 8, 1913. He received the B.E.E. degree from the University of Minnesota in 1936, and the M.S. in 1942. From 1937 to the present



R. L. NIELSEN

Mr. Nielsen has been an assistant and instructor in the electrical engineering department at the University of Minnesota. He is a member of Eta Kappa Nu, Tau Beta Pi, and Sigma Xi.



George C. Southworth (M'26-F'42) was born at Little Cooley, Pennsylvania, on August 24, 1890. He received the bachelor's and master's degrees from Grove City College and doctorate from Yale University. Prior to 1923 he was a teacher of physics and radio. Most of the period since has been spent on communications research in the Bell System. Dr. Southworth is the author of papers relating to radio transmission, earth currents, antenna arrays, and the principles of wave-guide transmission. He has lectured before the Institute of Radio Engineers and other technical societies on subjects of popular scientific interest. He is a Fellow of the American Physical Society and the American Association for the Advancement of Science.



G. C. SOUTHWORTH

Harold P. Westman (J'24-A'25-M'30) was born in Springfield, Massachusetts, on May 29, 1904.

After attending grammar school in New York City, he worked for a number of electrical and radio organizations. He became active in amateur radio in 1919.

In 1926, Mr. Westman joined the staff of the American Radio Relay League becoming Technical Editor of *QST* two years later. In 1929, he was appointed Assistant Secretary of the Institute of Radio Engineers and was named Secretary early in 1930. He was actively associated with the standardization work of the Institute and served as its representative on several committees of the American Standards Association. In March, 1942, he became Secretary of the War Committee on Radio. His services were loaned on a full-time basis to this project in the early fall of that year and at its close he resigned as Secretary of the Institute becoming a member of the staff of the American Standards Association.



For a biographical sketch of Charles W. Harrison, Jr., see the PROCEEDINGS for February, 1943; for Otto H. Schade, see the PROCEEDINGS for April, 1943.



HAROLD P. WESTMAN





## Better control for America's might

Victory is based upon the simple proposition that a fighting man must be equipped with the fighting best. And "fighting best" applies to component parts as well as to the material which does the actual shooting. DAVEN Attenuators have met the most critical standards for accurate and consistent service . . . abroad and at home. In a tank or a plane or a ship . . . in manufacturing plants where weapons are produced, DAVEN Attenuators are actively engaged in increasing efficiency and speeding production.

*More than 80 models of Output Power Meters, Transmission Measuring Sets, Decade Resistance Boxes, Attenuation Networks, Volume Level Indicators and many other types of DAVEN Laboratory Test Equipment are used extensively in electrical, broadcast, sound picture and television fields. The DAVEN catalog lists the most complete line of precision Attenuators in the world. We'll be glad to send you a copy.*

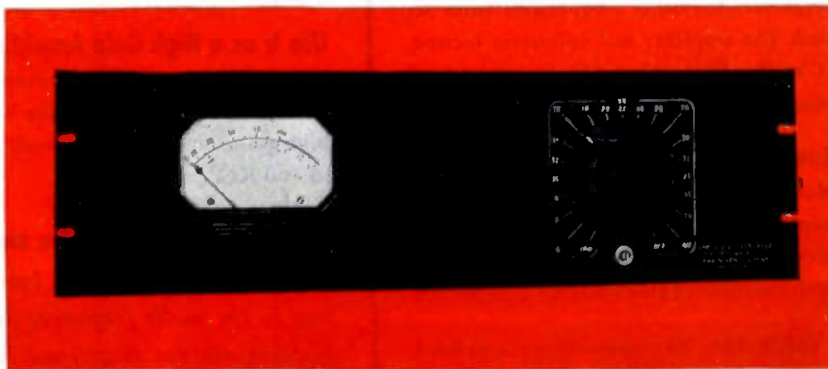

*Ordering standard components and equipment may facilitate deliveries.*

# THE DAVEN COMPANY

158 SUMMIT STREET

NEWARK, NEW JERSEY



## LOOK WHAT THIS INSTRUMENT can do for you

**Meet the Requirements of the Most Exacting A. F. Production Test Problem.** Combined with an *-hp-* resistance tuned Oscillator all of the measurements usually required on audio equipment can be made quickly and accurately with a minimum of additional equipment.

**Measure Total Harmonic Distortion at Nine Specific Frequencies.** The Model 325B is designed to measure total harmonic distortion at the nine specific frequencies recommended by the FCC for measurements on frequency modulation as well as amplitude modulation equipment. On special order, filters for other frequencies from 30 cps to 20 KC can be supplied. The amplifier and voltmeter section is flat from 10 cps to 100 KC so that harmonics as high as the 5th of 20 KC will be correctly indicated.

**Measure Noise and Hum Level in A. F. Equipment.** Sufficient sensitivity is available in the Model 325B to measure noise and hum level in audio frequency equipment such as amplifiers and broadcast equipment. With the addition of a detector, distortion and noise level can be measured in carrier output of transmitting equipment.

**Use It as a Vacuum Tube Voltmeter.** The instrument can be used as a voltmeter for measuring voltage level, power output, amplifier gain, and in making all of the other measurements for which a high impedance voltmeter with a wide frequency range is necessary.

The vacuum tube voltmeter section is a two stage amplifier with feedback to insure stable operation. It is identical with the Model

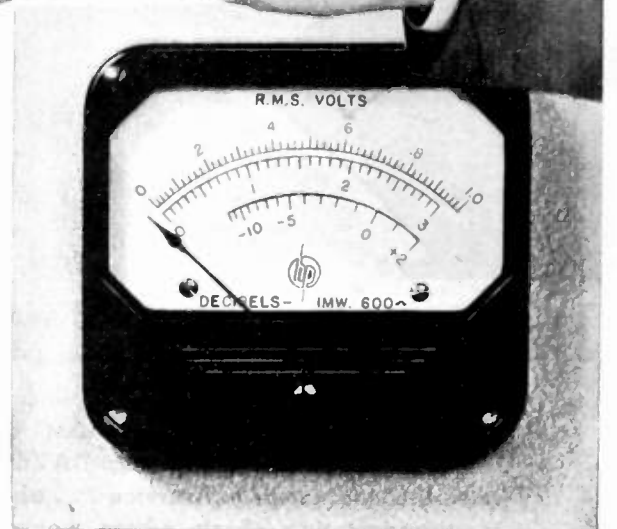

*Voltmeter face. Note that voltage and D.B. are calibrated separately.*

400A voltmeter except the frequency range is limited to 100 KC. The input amplifier of 325B can be used directly with the voltmeter section to give full scale indication on 3 MV

**Use It as a High Gain Amplifier.** Terminals at the meter output are provided for waveform observations with an oscilloscope and to allow the instrument to be used as a high gain amplifier. The overall gain is 75 DB from 10 cps to 100 KC.

 **Model 325B Noise and Distortion Analyser** is almost indispensable for laboratories or production tests in the audio frequency field. Many outstanding features are not mentioned here. Write for complete details today.

**HEWLETT-PACKARD CO.**  
STATION A, BOX 235A, PALO ALTO, CALIFORNIA



# ELECTRONEER IT

## WITH ALSIMAG STEATITE

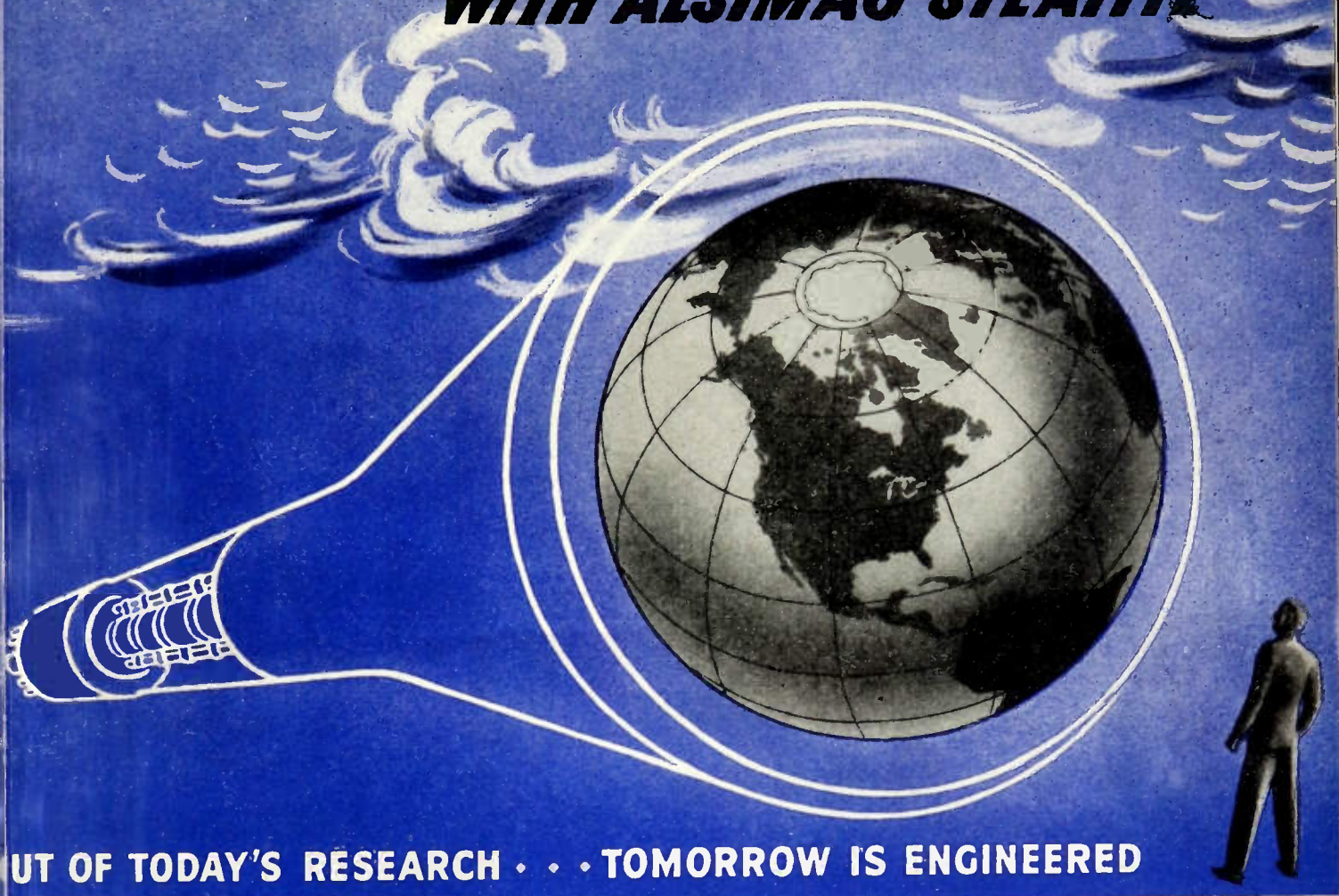

OUT OF TODAY'S RESEARCH . . . TOMORROW IS ENGINEERED

**I**N that *Better World* which you are Electroneering, substitute materials of lesser performance have no place.

It is a well known fact that the properties of steatite for high frequency insulation are not duplicated.

ALSiMAG lifts the properties of steatite to highest levels of dielectric and mechani-

cal strength. ALSiMAG Steatite Ceramic insulators are custom made to your design.

Do your Electroneering . . . your planning, thinking and designing with ALSiMAG steatite in mind. Our research people will gladly cooperate in today's blueprint or tomorrow's production.

41st YEAR OF CERAMIC LEADERSHIP



# ALSiMAG

TRADE MARK REGISTERED U. S. PATENT OFFICE

## AMERICAN LAVA CORPORATION

CHATTANOOGA, TENNESSEE



## TESTED ON AN ATOLL

**O**N a tiny strip of coral . . . an observation post pierces the dawn with cryptic messages that may spell the difference between victory and defeat. Duty on this speck on your map calls for iron men and dependable equipment.

Under the toughest of conditions . . . under the roughest of handling . . . far from sources of replacement . . . parts must work—for men's lives hang in the balance. Utah Parts are passing this final test on tiny atolls, in steaming jungles, on burning sands in all parts of the world—from pole to pole.

A shooting war is also a talking war. The weapons of communications must have the same dependability and non-failing action as weapons of destruction. These qualities are built into Utah Parts at the factory where

soldiers of production are working 100% for Victory. In Utah laboratories, engineers and technicians are working far into the night developing new answers to communication problems—making improvements on devices now in action.

But "tomorrow" all this activity, all this research, all this experience learned in the hard school of war, will be devoted to the pursuits of peace. Thanks to the things now going on at Utah—there will be greater convenience and enjoyment in American homes . . . greater efficiency in the nation's factories. **UTAH RADIO PRODUCTS COMPANY**, 842 Orleans Street, Chicago, Ill. Canadian Office: 560 King Street West, Toronto. In Argentine: UCOA Radio Products Co., SRL., Buenos Aires. Cable Address: **UTARADIO**, Chicago.

**PARTS FOR RADIO, ELECTRICAL AND ELECTRONIC DEVICES, INCLUDING SPEAKERS, TRANSFORMERS, VIBRATORS, VITREOUS ENAMELED RESISTORS, WIREWOUND CONTROLS, PLUGS, JACKS, SWITCHES, ELECTRIC MOTORS**





# ONE *Expert* TO SEND THE MESSAGE



Miss Gertrude Theberge records results of 955 ultra-high-frequency performance tests.

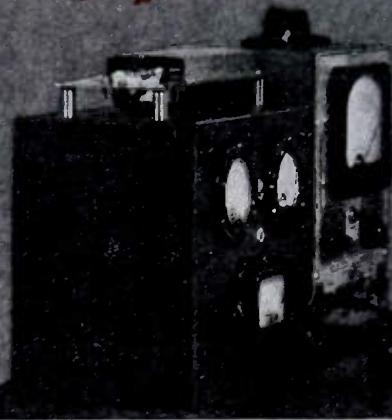

# ONE *Expert*. TO PROVIDE THE EQUIPMENT

Specialists on the Factory Front must back up those on the Fighting Front. As an American, you would be proud to see at Hytron carefully trained girls holding down important supervisory and technical jobs, and displaying manual dexterity on fine work which a watchmaker would admire.

Here at Hytron we realize fully our responsibility for fashioning well the radar, radio, and electronic tubes upon whose performance the lives of our fighting men depend. To fulfill this trust, we have gone all out to train hundreds of new specialists capable of building to exacting standards countless dependable War tubes. That their skills may help bring closer the day when our boys come marching home, is the sole purpose of all Hytron employees.



VR105-30 and VR150-30  
Gaseous voltage-regulator tubes

*Oldest Exclusive Manufacturer of Radio Receiving Tubes*

# Hytron

ELECTRONIC AND  
RADIO TUBES

# Corporation

SALEM AND NEWBURYPORT, MASS.



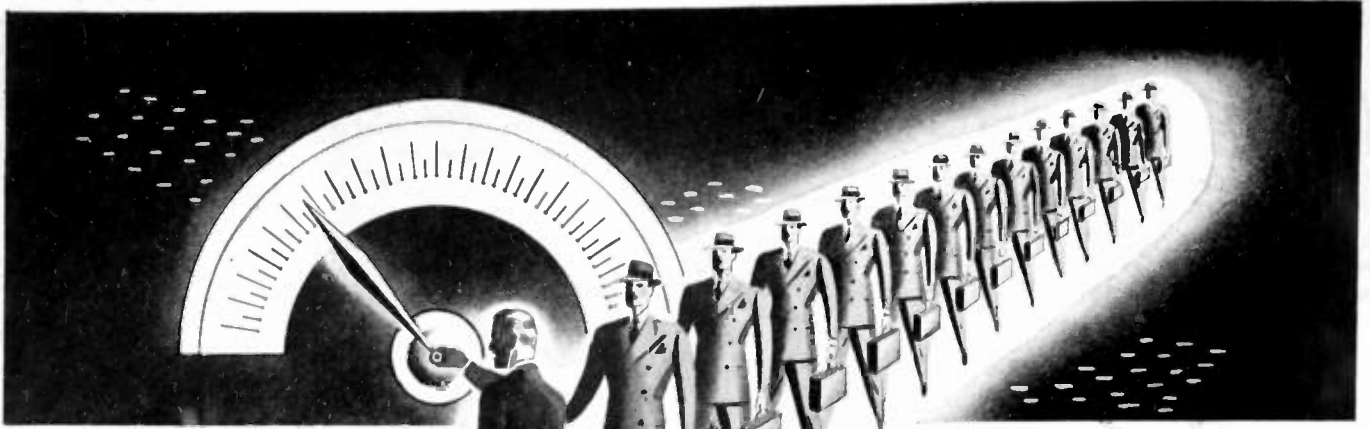

**IN GOOD WORKING ORDER...**

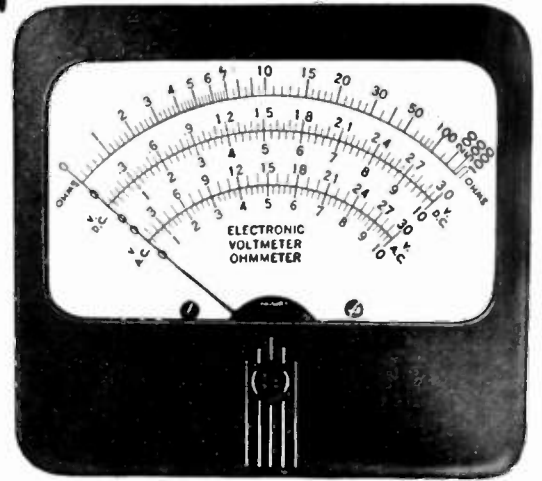

America is watched over by people... "little people"... the policeman, the druggist, the shopkeeper, the repairman and so on. Bulking large in the life of the community these days is the radio serviceman... he's got to keep present sets operating for the duration.

Because his must be dependable equipment, you'll find that a DeJur Meter is the heart of his sensitive testing and checking apparatus. He has learned from long and constant use that this meter is consistently accurate, that it can take a lot of punishment, and that it can save precious time by enabling him to get to the bottom of the trouble immediately. For the fine job that the Radio Servicemen are doing in wartime America, the needle of the DeJur Meter points with pride.

*KEEP BUYING WAR BONDS AND STAMPS*

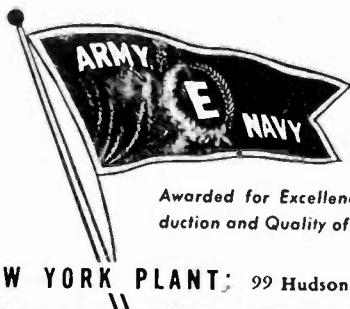

*Awarded for Excellence in Production and Quality of Material*

**DeJUR-AMSCO CORPORATION**

**SHELTON, CONNECTICUT**

**NEW YORK PLANT:** 99 Hudson Street, New York City • **CANADIAN SALES OFFICE:** 560 King Street West, Toronto





**YOU CAN HELP US** *Do Our Part!*

**American workers on the production front are contributing to Victory as surely as if they were helping to fire the guns on the fighting fronts; and there must be no let-up until Victory is made complete. Electronic Corporation of America is now 100% engaged in secret war work . . . but we can do more! The highly skilled personnel of ECA is pledged to do all in its power . . . and then a little more . . . as its part in winning the war sooner.**

**To Manufacturers and Government Agencies**

The Electronic Corporation of America factory is perfectly set up for the manufacture and assembly of electronic devices and equipment. ECA invites inquiries from manufacturers and government agencies who can make use of our facilities and experience to help win the war sooner.

*"Let's Win the War Now! . . . with the Utmost in Production"*

Buy More — **AND MORE** — War Bonds!



**ELECTRONIC CORPORATION OF AMERICA**  
 45 WEST 18th STREET, NEW YORK CITY • • • PHONE WAikins 9-1870

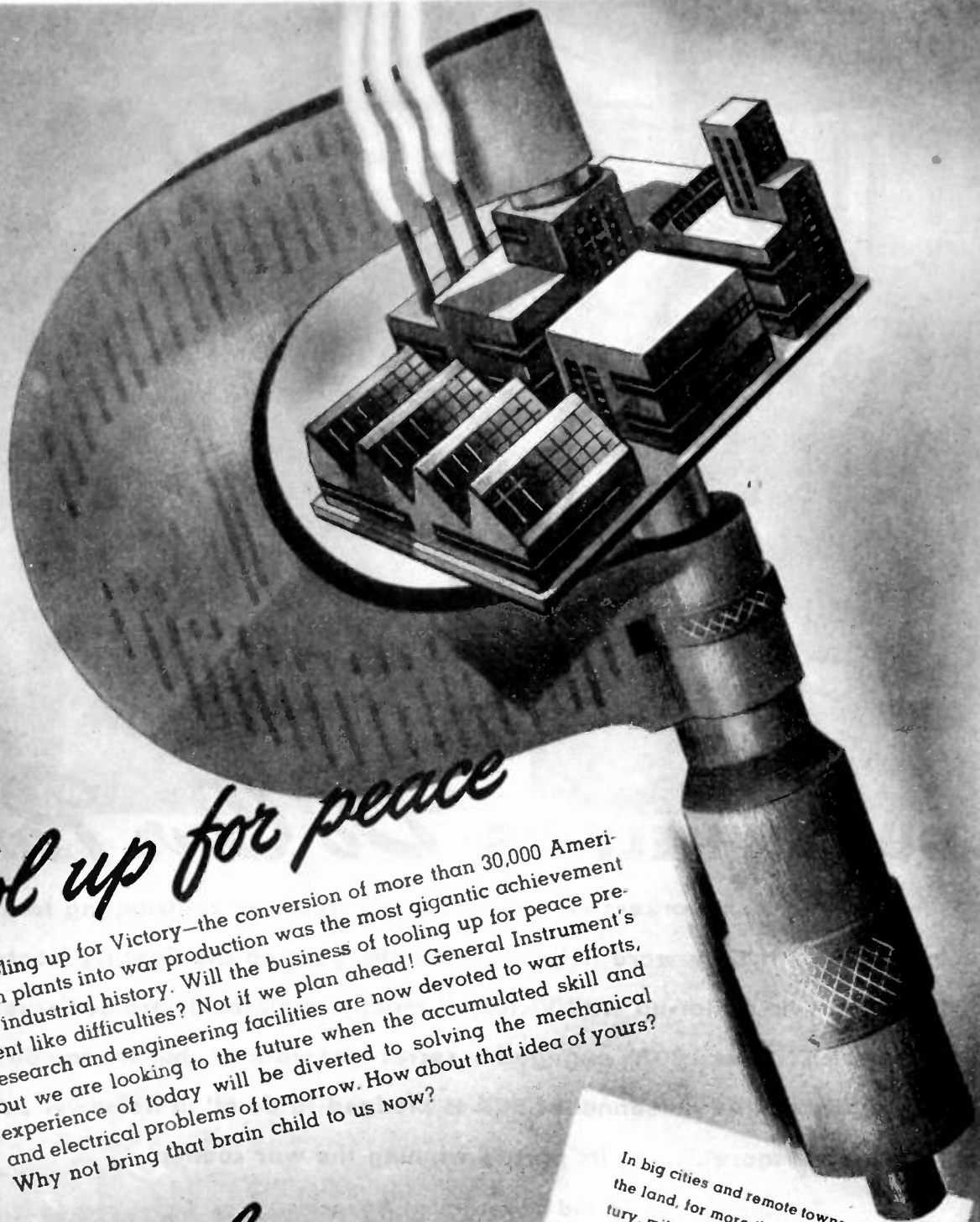

# *Tool up for peace*

Tooling up for Victory—the conversion of more than 30,000 American plants into war production was the most gigantic achievement in industrial history. Will the business of tooling up for peace present like difficulties? Not if we plan ahead! General Instrument's research and engineering facilities are now devoted to war efforts, but we are looking to the future when the accumulated skill and experience of today will be diverted to solving the mechanical and electrical problems of tomorrow. How about that idea of yours? Why not bring that brain child to us now?



## *General Instrument*

CORPORATION

Executive Offices: 829 Newark Avenue, Elizabeth, New Jersey

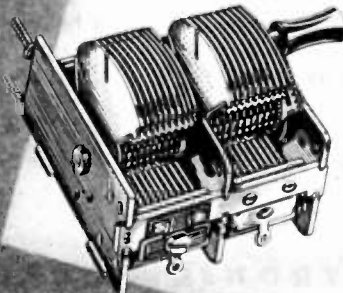

In big cities and remote towns all over the land, for more than a quarter century, millions of owners of home radio sets have enjoyed better reception because of General Instrument precision equipment.



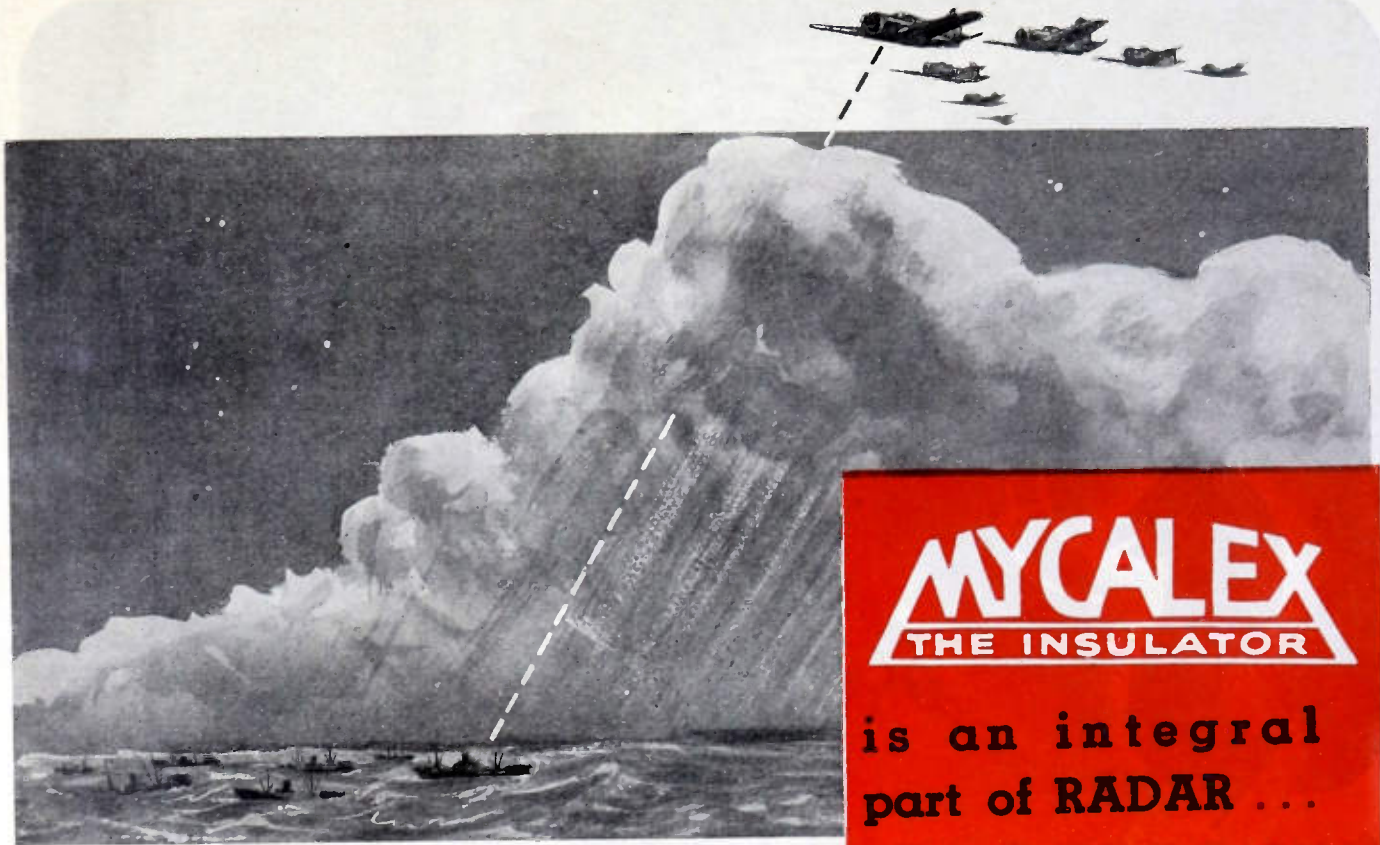

**MYCALEX**  
THE INSULATOR

is an integral  
part of RADAR ...

## THERE IS ONLY ONE MYCALEX

A secret weapon stands guard. It keeps constant vigil along our shores, rides on the bridges of our battleships, watches faithfully over the skies and the seas. Darkness, rain, clouds, and storms cannot blind its sure stab for hostile aircraft and ships. RADAR locates enemy targets, measures the distances, points the swift annihilation of vandal raiders. Ultra-high frequency waves make possible this new miracle. The electronic age shrivels the forces of barbarism.

MYCALEX plays its part in making this secret weapon available to aid us—plays its part in this as faithfully, as dependably, as in all other applications. There is scarcely a phase of the entire war program in which MYCALEX is not performing, as reliably as it has for more than a quarter century of peace-time services. Navy and Army approval is the reward for years of dependability, and the Mycalex Corporation of America has been labouring night and day since before Pearl Harbor to meet the needs of our armed forces.

The return of peace will reveal new realities born of the blood and smoke of war, and MYCALEX will serve as always in these visions turned real.

MYCALEX is not the name of a class of materials. MYCALEX is the registered trade-name for low-loss insulation manufactured only by the Mycalex Corporation of America in the Western Hemisphere. MYCALEX is specified by engineers because MYCALEX is required. There is only one MYCALEX.

**MYCALEX**  
THE INSULATOR

Trade Mark Reg. U. S. Pat Off.

## MYCALEX CORPORATION OF AMERICA

Exclusive Licensee under all patents of MYCALEX (PARENT) CO. Ltd.

60 CLIFTON BOULEVARD

CLIFTON, NEW JERSEY

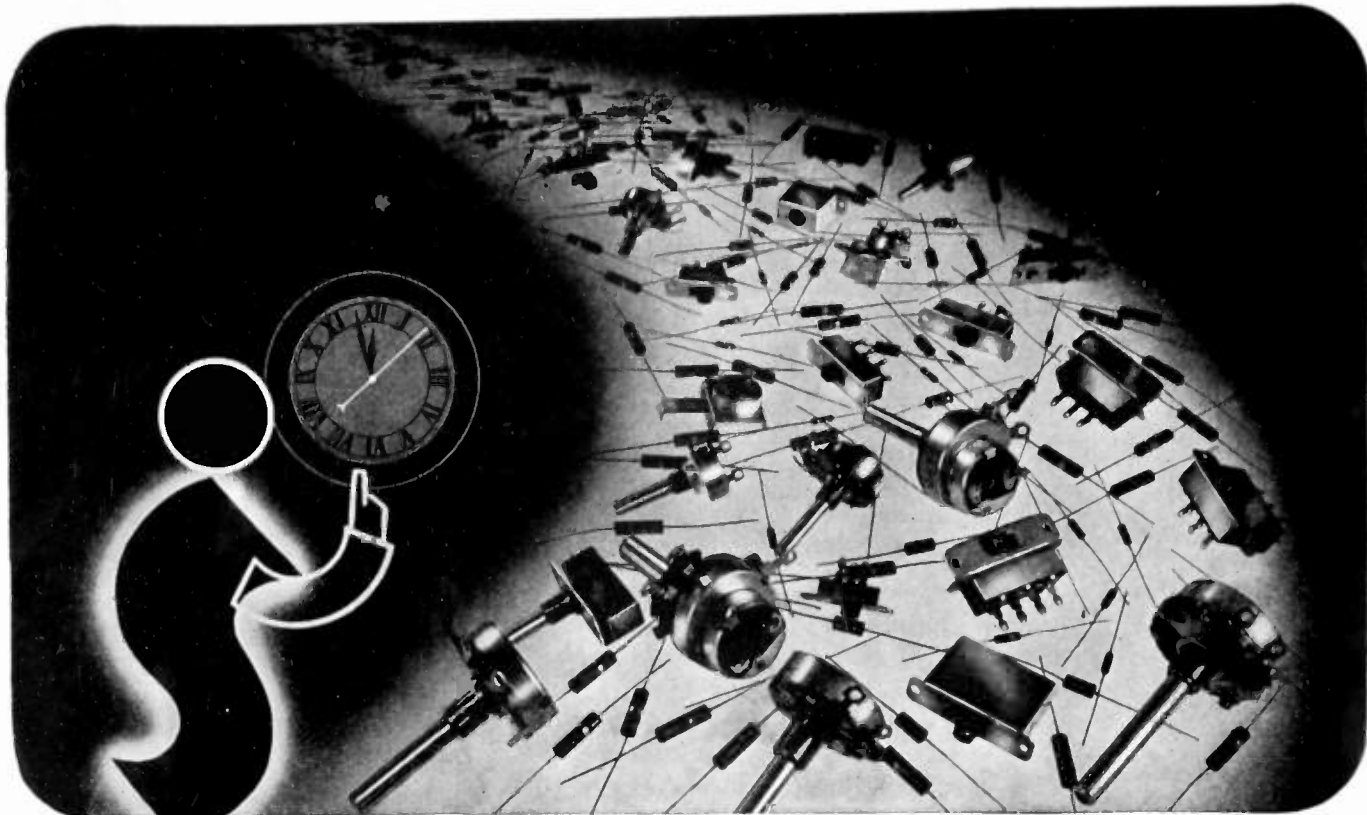

# HUNDREDS OF COMPONENTS A MINUTE

... EVERY MINUTE—EVERY DAY!

Every minute, every day, Stackpole electronic components to the tune of hundreds of units are being completed—each one ear-marked for an inconspicuous but highly important part in the war effort.

These Stackpole items include iron cores, line switches, slide-action switches, fixed resistors, and standard variable resistors as well as those designed for dusty, extremely humid, or salt spray conditions.

Stackpole facilities—long among the very largest—have been greatly expanded. Stackpole engineers have the all-essential “know how” to help solve your resistance problems. Stackpole service assures personalized attention to your requirements.

## STACKPOLE CARBON COMPANY

Electronic Components Division • St. Marys, Penna.

### STACKPOLE MAKES THESE PRODUCTS

Brushes for all rotating equipment • Carbon, Graphite, Malted Metal, and Composition Contacts • Powder Metallurgy Components • Bearings • Anodes • Electrodes • Power Tube Anodes • Brazing Blacks • Welding Rods, Electrodes and Plates • Packing, Piston, and Seal Rings • Flashlight Battery Carbons • and numerous others.

**IRON CORE PROBLEMS ANSWERED**

Stackpole *knows* iron cores—*knows* their applications—and *knows* how to make units of the proper characteristics and shapes to match today's requirements. High among more recent developments in this line are Stackpole Iron Cores for modern high frequency equipment. When you need cores, it pays to try Stackpole first!

# STACKPOLE

MOLDED METAL POWDER AND CARBON PRODUCTS





## Meet your RCA TUBE and EQUIPMENT DISTRIBUTOR!

*... 'Round the Corner Supplier of Electronic Items to War Industry*

Need RCA Tubes and other electronic equipment in a hurry?

Need "trade-wise" expediting on important material orders that require intelligent follow-through?

Then get in touch with your nearest RCA Tube and Equipment Distributor today! Filling hurry-up priority orders—often from stock—is his business. If he hasn't got what you need, he'll know where to obtain it as fast as priorities permit. He knows the trade. He knows delivery conditions. Equally im-

portant, he knows the technical angles of the equipment that he sells. You'll find his technical help and suggestions invaluable—and these, like his delivery facilities, pertain not only to RCA Tubes and Equip-

ment, but to countless other related electronic items produced by many other manufacturers as well.

There are over 300 of these RCA Distributors throughout the United States to serve you. If you do not already know the one nearest you, a list will gladly be sent on request.

✓ TECHNICALLY-INFORMED SERVICE

✓ NORMALLY LARGE STOCKS

✓ FAST DELIVERIES

✓ INTELLIGENT EXPEDITING



# RCA ELECTRON TUBES

RCA Victor Division, RADIO CORPORATION OF AMERICA, Camden, N. J.

# 5 Mile Dives

## are Tough on Headphones

Buy BONDS For  
VICTORY!

Permoflux Dynamic Headphones  
Meet the Challenge — They  
Breathe and Outperform at  
any Level . . . . .

Efficiency in action is their keynote! Designed for instantaneous pressure difference compensation at all altitudes, Permoflux Dynamic Headphones provide extra efficiency and greater safety under every battle condition. Today's Permoflux developments will set the pace for peace time tomorrow. Inquiry is invited on essential sound reproduction problems.

TRADE MARK  
**PERM-O-FLUX**

**CORPORATION**

4916-22 W. Grand Ave., Chicago, Ill.

PIONEER MANUFACTURERS OF PERMANENT MAGNET DYNAMIC TRANSDUCERS

## POSITIONS OPEN

The following positions of interest to I.R.E. members have been reported as open. Apply in writing, addressing reply to company mentioned or to Box No. . . . .



### PROCEEDINGS of the I.R.E.

330 West 42nd Street, New York, N. Y.

#### RADIO ENGINEERS

Qualifications should consist of a Class A "ham" license, good electrical background, and knowledge of building your own transmitter, receiver and test equipment.

Positions available in laboratory, testing and design work with a mid-west manufacturer engaged 100 per cent in production of war equipment. "Ham's Paradise" with annual salary ranging from \$3000 to \$5000.

Applicants, not now employed at highest skill and able to obtain release, are requested to send full data including draft status, salary required, and a small photo (which will not be returned). Address Box 295.

#### ENGINEER

Electrical or electrochemical engineer, thoroughly versed in the theory of liquid and solid dielectrics, to direct a research and development program in the development and application of dielectrics to capacitors. This is an unusual opportunity for a capable engineer interested in his present and post-war future. Write to Industrial Condenser Corporation, 1725 W. North Avenue, Chicago, Ill.

#### ENGINEERING RESEARCH DIRECTOR

A leading manufacturer of small compact electrical parts, widely used in communication equipment and industry in general, seeks engineer to direct its research activities leading to development of new products.

Qualifications must include thorough knowledge of fundamental physical sciences, ability to do and direct research work, resourcefulness, originality, and a sufficiently practical slant to conserve time and energy.

Interesting work. Remuneration depending on the individual. Location in eastern Pennsylvania.

In reply, state complete qualifications which will be kept confidential. Those engaged in war work cannot be considered. Address Box 296.

#### ELECTRO-ACOUSTIC ENGINEER

One experienced in laboratory development and research activities. New position open in the development of war-production items. Situation includes excellent opportunities for post-war employment. Salary open. Write Personnel Manager, Universal Microphone Co., Box 299, Inglewood, California.

#### ELECTRICAL ENGINEERS— PHYSICISTS

Radio or ultra-high frequency experience desirable but not essential. Interesting radio tube development work. Good location, Lancaster, Pennsylvania. Address replies to Personnel Dept., RCA, Victor Division, Harrison, N.J. If you are using your full skill, full time on war work, please do not apply.

#### RADIO AND COMMUNICATIONS

Commonwealth of Australia War Supplies Procurement requires high type man to take charge of Radio and Communications Department in Washington, D.C. Qualifications: general knowledge of radio and communications gained in either purchase or sales field. Draft exempt. Excellent opportunity for right man with salary commensurable. For interview, write Box 293.

(Continued on page lvi)



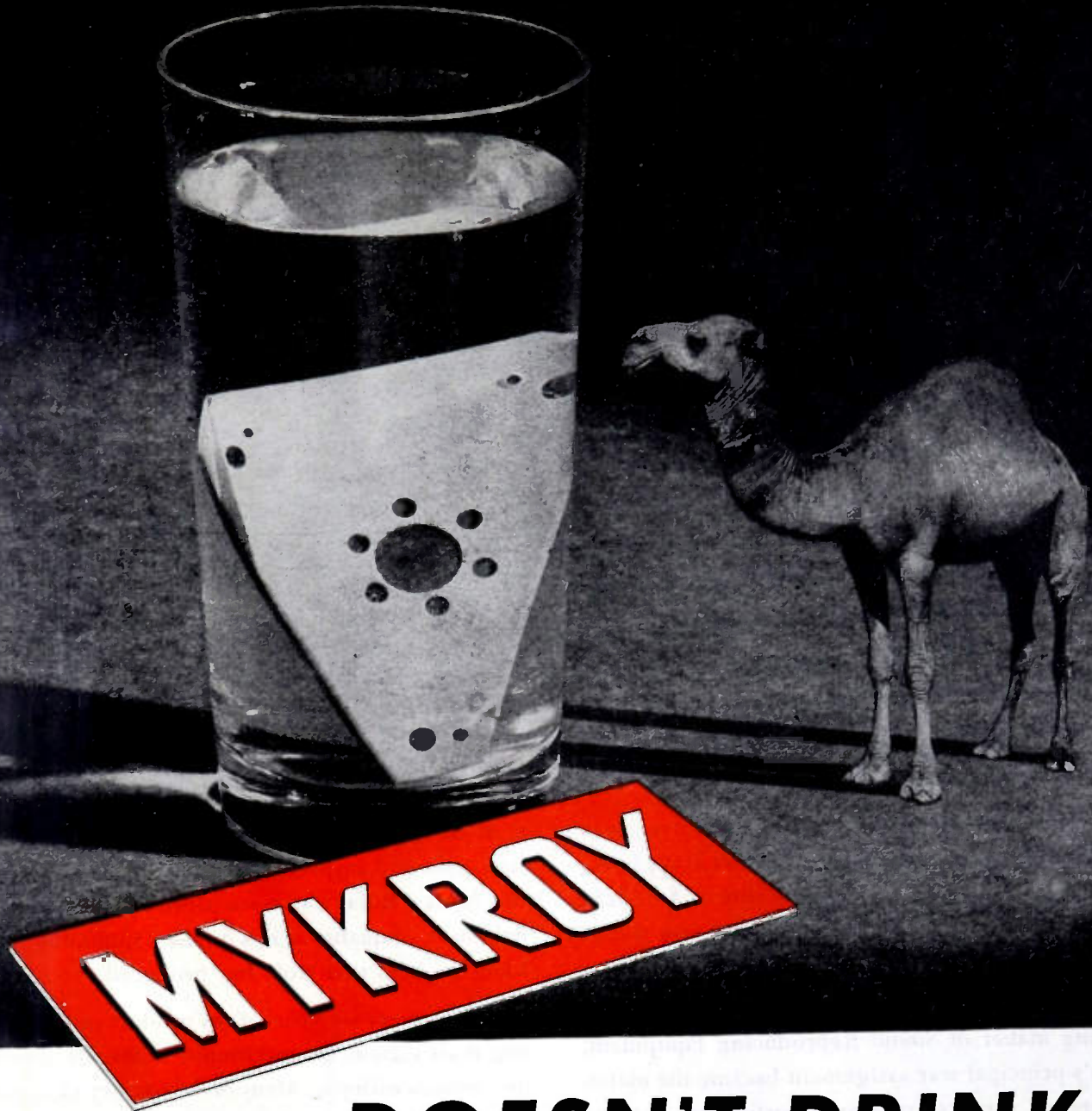

**TYPICAL EXAMPLES OF  
MYKROY APPLICATIONS**

- Stand-off Insulators
- Variable condensers
- Tube and Crystal Sockets
- Mounting strips
- Structural supports  
for radio circuits
- Plug-in bases
- Insulated couplings
- Lead-in insulators
- Antenna reel insulators
- Motor generator  
brush holders
- Padding condenser supports
- High voltage arc shields
- Oscillator circuits
- Fixed condensers
- Impregnated resistors
- Radio frequency coil forms
- Radio frequency  
panel assemblies
- Radio frequency switches
- Relay bases and arms

## DOESN'T DRINK!\*

One of the many reasons why MYKROY is a more efficient insulating material is that MYKROY is non-porous. Its superior mica and specially prepared glass are fused in intimate molecular contact. Hence, hygroscopic absorption and adsorption of oils, vapors or moisture are virtually nil. Surface treatment and impregnation are not needed.

This advance over old-style ceramics makes MYKROY a more dependable insulator under conditions of heat and humidity . . . whether in steaming jungle, dense ocean fog or the acid-laden vapors of a submarine.

MYKROY dissipates negligible electrical energy throughout the entire range of frequencies. It bonds inherently with metals, and will not warp. MYKROY combines extreme lightness in weight with mechanical strength comparable to cast iron. It can be machined or molded with great precision.

Ask our engineers for detailed specifications concerning MYKROY—the perfect insulation for today's more exacting needs.

\* ABSORPTION FACTOR .02% IN 48 HOURS

MYKROY IS SUPPLIED IN SHEETS AND RODS . . . MACHINED OR MOLDED TO SPECIFICATIONS

MADE EXCLUSIVELY BY

**ELECTRONIC  
MECHANICS  
INC.**

70 CLIFTON BOULEVARD • CLIFTON, NEW JERSEY  
Chicago: 1917 NO. SPRINGFIELD AVENUE . . . TEL. Albany 4310

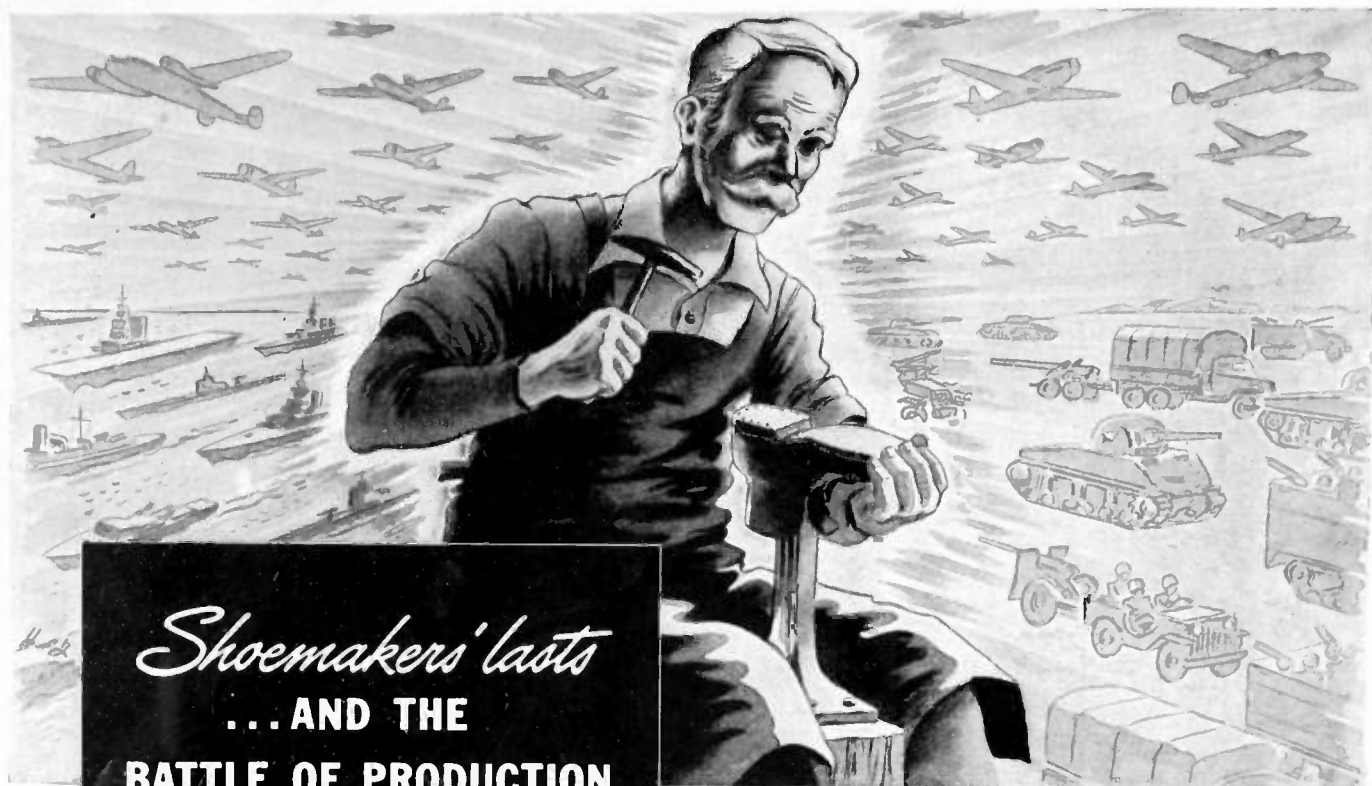

*Shoemakers' lasts*  
 ... AND THE  
**BATTLE OF PRODUCTION**

"SHOEMAKER stick to thy last" may have been good advice once . . . but it doesn't apply in the Battle of Production, where the ability of American industry to enter new fields and make new things has amazed the world.

Take Rola, for example. Recognized for years as a leading maker of Sound Reproducing Equipment, Rola's principal war assignment became the manufacture of various types of transformers for the intricate communications systems of our Army and Navy Air Forces.

The specifications were unusually "tough" but Rola was equipped to do the unusual. Calling upon the skill and ingenuity of its people and upon an experience that dates from the very beginning of Radio Communications, Rola "tooled up". New machines

were designed, new methods and processes devised, new tests and inspections employed, so that today the name "Rola" on a transformer is as much a hall-mark of quality as it is on the 25,000,000 radio loud-speakers that Rola has produced.

If transformers are a part of any product you are making, Rola solicits an opportunity to discuss your requirements with you. Many of the country's foremost prime producers of communications equipment have found our product and our performance eminently satisfactory. We are sure you would, too. The Rola Company, Inc., 2530 Superior Ave., Cleveland, Ohio.

RECEIVER OUTPUT • MODULATION • MICROPHONE  
 FILAMENT • AUDIO INPUT • RADIO STAGE • POWER • CHOKE COILS  
 HEAD SETS • RELATED ELECTRONIC ITEMS

★ **ROLA** ★

MAKERS OF THE FINEST IN SOUND REPRODUCING AND ELECTRONIC EQUIPMENT

# Reliability ★ BUILT IN ★ for The Nerve Centers of Air Lines

The dependability of Wilcox equipment has been proved in use by leading air lines. Today, the entire output of Wilcox factories goes to military needs. Wilcox was chosen to help win the war by "building in" reliability for vital communications. When the war is over, Wilcox facilities will be ready to keep pace with a greater air-borne world.

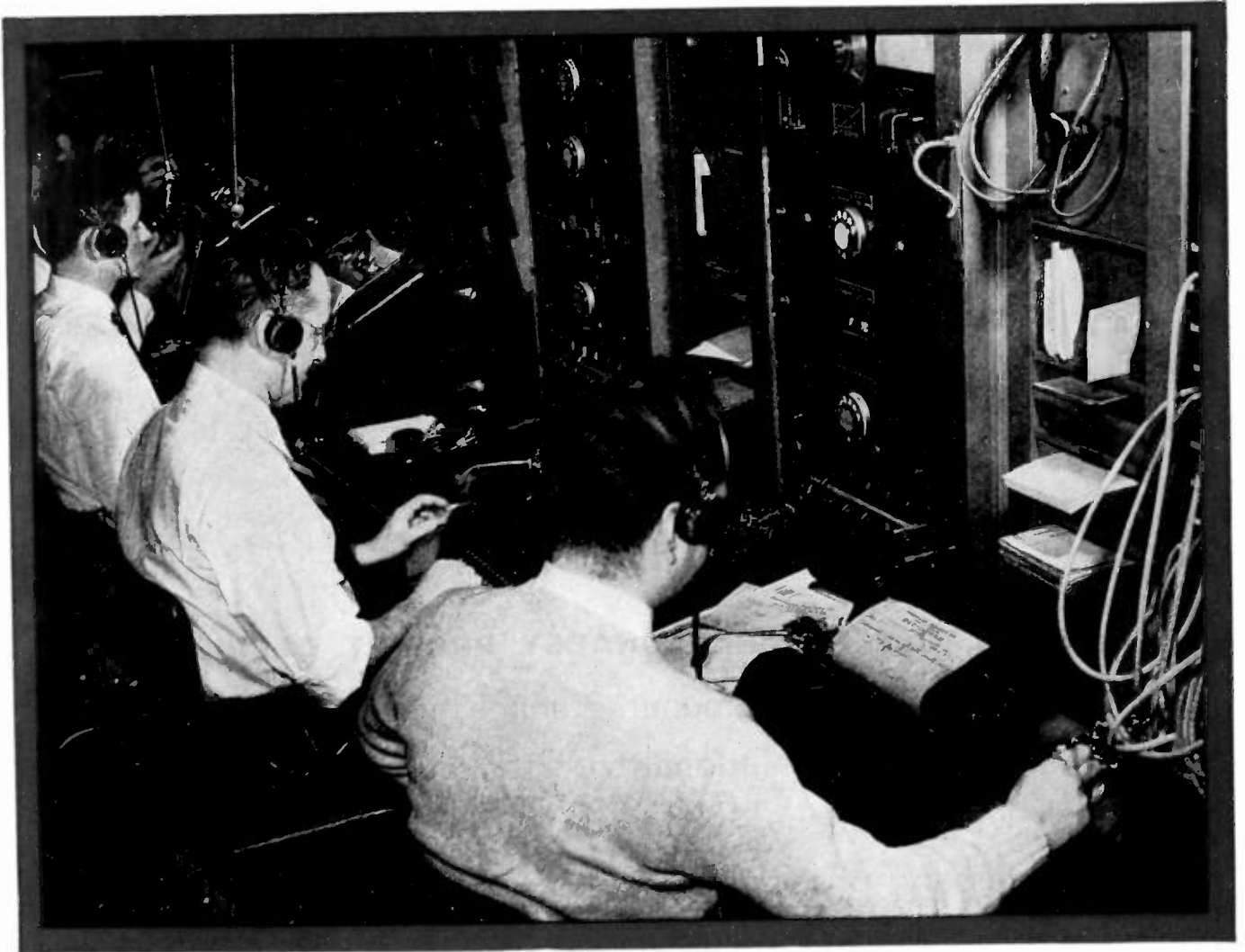

Wilcox Installations. Photo, courtesy American Airlines

There **MUST** Be Dependable Communications

Communication Receivers  
Aircraft Radio  
Airline Radio Equipment  
Transmitting Equipment

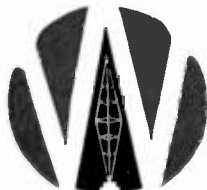

**WILCOX ELECTRIC  
COMPANY**

*Quality Manufacturing of Radio Equipment*

14th & Chestnut

Kansas City, Missouri



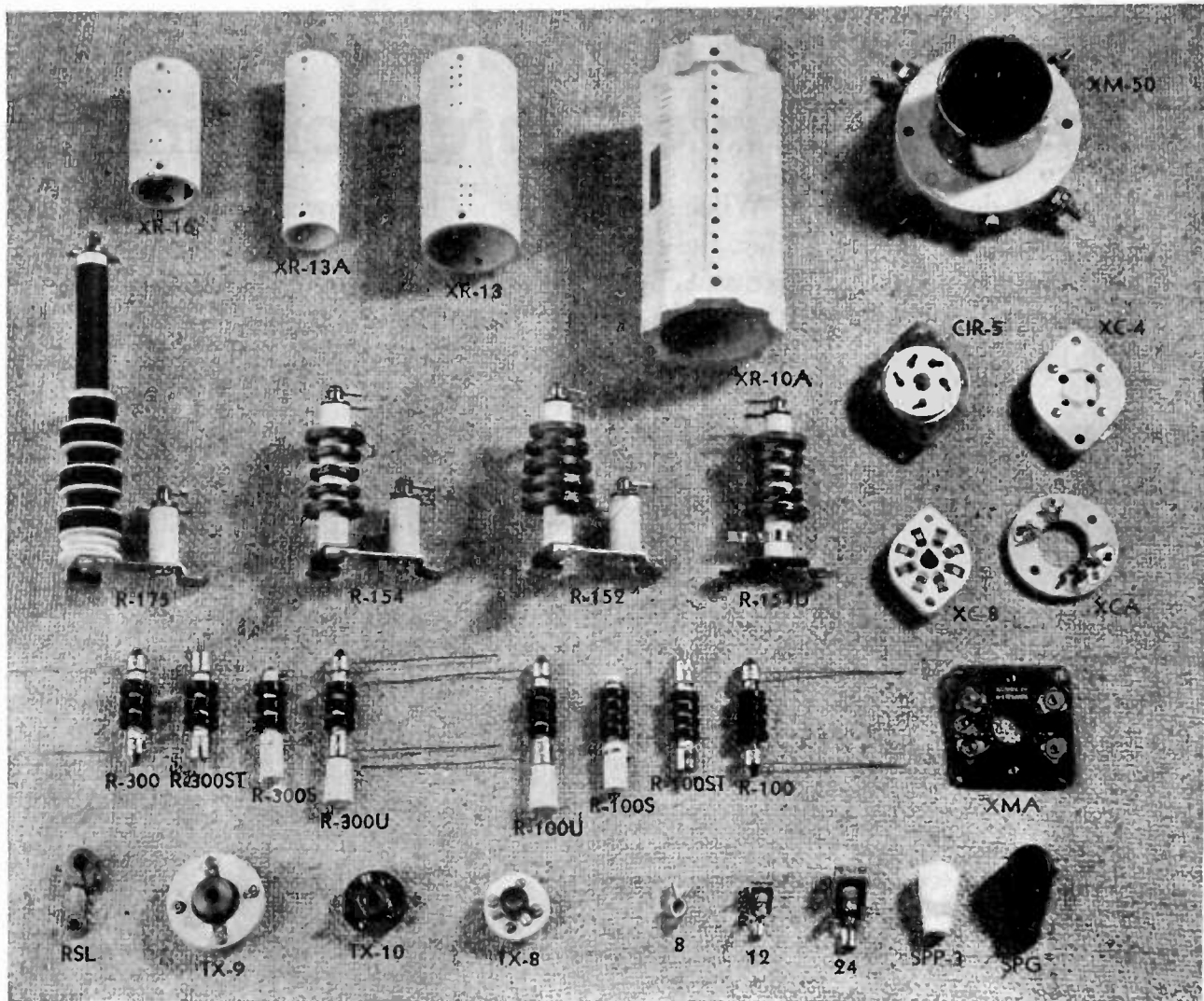

**AVAILABLE FOR REASONABLY PROMPT DELIVERY**



Enlarged manufacturing facilities have enabled National to offer reasonably prompt delivery on many small parts to those who have the necessary priorities. The sockets, coil forms, RF chokes, Grid Grips, couplings and rotor shaft locks shown in the photograph above are available on especially good delivery schedules, and in the case of a few items, limited quantities may even be shipped from stock.

**NATIONAL COMPANY, INC.      MALDEN, MASS.**



# Where was RCA on the night of January 2, 1940?

- January 2, 1940 — 23 months and 5 days before Pearl Harbor — where was RCA on that night?
  - It was at the point of launching a peace-time program that was to be recognized eventually as an important military measure. For that program was one of simplification.
  - It was called the *RCA Preferred Type Tube Program* and was inaugurated because the several hundred different tube types then in existence resulted in short, uneconomical manufacturing runs, complex problems of warehousing and replacements, and other inefficiencies which made it impossible to give the ultimate customer the maximum of dependable service and the greatest value for his money.
  - With the advent of war, the government recognized the advantages of such a program and issued an "Army-Navy Preferred List of Tube Types." The latest revision of this list is dated March 1, 1943. We will be glad to send you a copy on request.
  - The urgent requirements of war are proving the worth of this program in releasing for other purposes the large quantities of materials ordinarily tied up in many types and styles of tubes. Also, the principle of Preferred Type Tubes is proving a blessing on the fighting fronts— where vital replacements can be expedited for equipment designed to use standard types of tubes.
- ★ Buy United States War Bonds and Stamps ★



## RCA ELECTRON TUBES

RCA VICTOR DIVISION • RADIO CORPORATION OF AMERICA  
CAMDEN, N. J.

### TUBE RECOMMENDATIONS FOR POST-WAR DEVELOPMENTS

The advantages of the Preferred Type Tube Program are so far-reaching that it is only logical to assume that we will continue the program after the war. Our applications engineers will be glad to consult with equipment manufacturers concerning the tube types most likely to be on our list of post-war preferred types.

★ *In a Hurry . . .*

# REMLER

## Plugs and Connectors

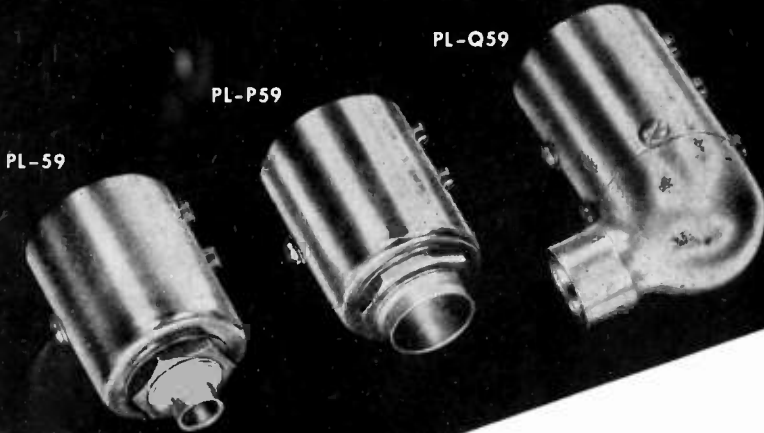

**Made to  
ARMY SIGNAL  
CORPS SPECIFICATIONS**

Remler made plugs and connectors of the following types are used by more than fifty concerns engaged in manufacturing communications equipment for the U. S. Army Signal Corps:

Types:	PL	PLP	PLQ	PLS
50-A 61	74 114 150	56 65	56 65	56 64
54 62	76 119 159	59 67	59 67	59 65
55 63	77 120 160	60 74	60 74	60 74
56 64	104 124 354	61 76	61 76	61 76
58 65	108 125	62 77	62 77	62 77
59 67	109 127	63 104	63 104	63 104
60 68	112 149	64	64	

### Special Designs to Order

Remler is equipped to manufacture other plugs and connectors of special design—in large quantities. Submit specifications.

### Prompt Delivery • Inspection

Signal Corps inspectors in attendance. Uniformity assured—no rejects. Write, wire or telephone if we can be of assistance.

**Remler facilities and production techniques frequently permit quotations at lower prices**

*Manufacturers of Communication Equipment  
SINCE 1918*

**REMLER COMPANY, Ltd. • 2101 Bryant St., • San Francisco, Calif.**

## Section Meetings

### BOSTON

"Evaluation of Plastics," by W. A. Zinzow, Bakelite Corporation; May 7, 1943.  
An Address by Dr. L. P. Wheeler, President of The Institute of Radio Engineers; May 7, 1943.

### CHICAGO

"Transmission Lines and Wave Guides," by Dr. C. S. Roys, Illinois Institute of Technology; May 21, 1943.  
"Directional and Nondirectional Systems," by Dr. R. J. Moon, University of Chicago; May 21, 1943.  
"Coupling and Phasing Devices," by Dr. V. J. Andrew, Victor J. Andrew Company; May 21, 1943.

### CINCINNATI

"The Electron Microscope," by Professor A. F. Prebus, Ohio State University; April 20, 1943.

### KANSAS CITY

"A Low-Frequency Exponential Horn of Small Dimensions," by R. N. White, Transcontinental and Western Air, Inc.; January 28, 1943.  
"Piezoelectric Applications," by Ashly Elbl, Crystal Products Company; May 13, 1943.  
"The De Rosa System of Artificially Produced Wide-Range Audio," by H. K. Morgan, Transcontinental and Western Air, Inc.; May 13, 1943.

### LOS ANGELES

"A Wide-Band Cathode-Ray Oscilloscope," by Dr. E. D. Cook (Presented by P. G. Caldwell), General Electric Company; April 20, 1943.  
"Practical Applications of the Wide-Band Cathode-Ray Oscilloscope," by Harold Jury, Don Lee Television Station W6XAO; April 20, 1943.

### MONTREAL

Trip to Factory of Canadian Vickers, Ltd., Montreal; April 24, 1943.

### NEW YORK

"Recording from the Air as a Hobby," by T. R. Kennedy, Jr., *The New York Times*; May 5, 1943.  
"Need for Signal Corps Officers: Education and Other Requirements, and Procedure for Applying for Commissions," by Lt. Col. K. D. Johnson and Major Theodore Simon, both U. S. Army; May 12, 1943.

### PHILADELPHIA

"New York-Philadelphia Television Radio Relay," by F. J. Bingley, Philco Radio and Television Corporation; May 6, 1943.

### PITTSBURGH

"Introspective Inventory of an Engineering Education," by R. N. Harmon, Westinghouse Electric and Manufacturing Company; February 8, 1943.  
"Broadcast Studio Acoustics," by G. M. Nixon, National Broadcasting Company; March 8, 1943.  
"The Electron Microscope," by Dr. C. S. Barrett, Carnegie Institute of Technology; April 20, 1943.

*(Continued on page xlv)*

*Proceedings of the I.R.E. July, 1943*



# BLUEPRINTS OF SAFETY



## BRINGING 'EM BACK... ALIVE!

Smash the objectives—then high-tail for home—that's the job of our Bomber Command . . . And because the use of quartz crystals, in radio transmitting equipment is the only way to insure the stability of prearranged frequencies, so vital in guiding pilots there and back, the A. A. C. method of manufacturing them is of particular importance. . . Among other rigid specifications, our "Blueprints of Safety" demand, that A. A. C. Crystals be ground to  $-.0001$  of an inch tolerance. . . . P. S.: Check our interesting story on deliveries!



### AIRCRAFT ACCESSORIES CORPORATION

MANUFACTURERS OF  
PRECISION AIRCRAFT EQUIPMENT  
HYDRAULICS . . . . . ELECTRONICS

FURBANK, CALIF. • KANSAS CITY, KANS. • NEW YORK, N. Y. • CABLE ADDRESS: AACPRO

*Ralph E. Walker*

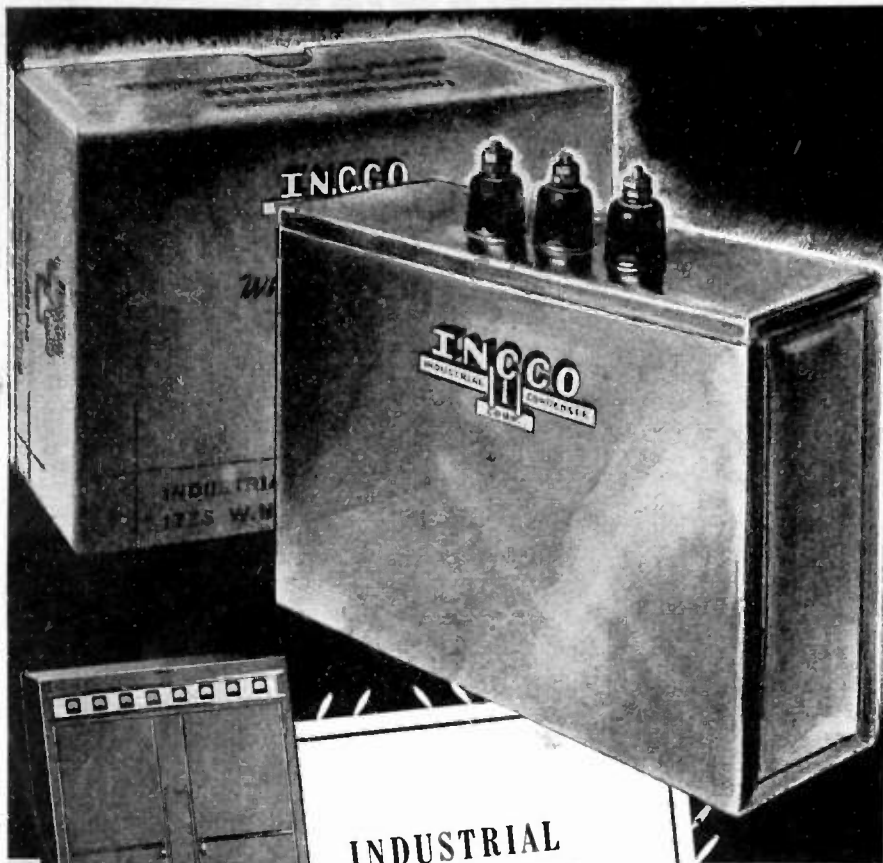

INDUSTRIAL  
CONDENSERS  
ARE IN  
SERVICE THE  
WORLD OVER  
WITH —



WILCOX ELECTRIC  
COMPANY  
COMMUNICATIONS  
EQUIPMENT

PAPER, OIL AND ELECTROLYTIC CAPACITORS

**INDUSTRIAL  
CONDENSER  
CORPORATION**

1725 W. NORTH AVE., CHICAGO, U. S. A.

DISTRICT OFFICES IN PRINCIPAL CITIES  
QUICK DELIVERY FROM DISTRIBUTOR'S STOCKS

## Section Meetings

(Continued from page xlii)

### ROCHESTER

"Noise Measurement with the Sound-Level Meter," by Benjamin Olney, Stromberg-Carlson Telephone Manufacturing Company; April 15, 1943.

"The Conservation of Critical Materials," by Dr. H. S. Osborne, American Telephone and Telegraph Company; May 6, 1943.

"The Conservation of Critical Materials," by E. M. MacDougal, War Production Board; May 6, 1943.

### ST. LOUIS

"Rectifier Circuits for Voltage Doubling," by Professor D. L. Waidelich, University of Missouri; April 24, 1943.

### WASHINGTON

"Recent Developments in the Design, Testing, and Application of Solid Dielectric Transmission Lines," by Dr. Harner Selvidge, U. S. Office of Scientific Research and Development; May 10, 1943.

## Membership

The following indicated admissions and transfers of membership have been approved by the Admissions Committee. Objections to any of these should reach the Institute office by not later than July 31, 1943.

### Transfer to Member

Goldman, S., 37 Fairmount Ter., Bridgeport, Conn.

Seaton, S. S., 5241 Broad Branch Rd., N.W., Washington, D. C.

Sziklai, G. C., Maxwell's La., Box 3, Princeton, N. J.

### Admission to Member

Cole, D. D., 2 Lindon St., Haddonfield, N. J.

Forsyth, P. G., British Ministry of Supply Mission, 1139 Connecticut Ave., Washington, D. C.

Gunzbourg, P. M., 61 Broadway, New York, N. Y.

Hancock, G. N., 1785 Massachusetts Ave., Washington, D. C.

Toeppen, M. K., 3217 Old Dominion Blvd, Alexandria, Va.

Ziegler, M., Herrera 527, Buenos Aires, Argentina

The following admissions and transfers of membership were approved by the Board of Directors on June 2, 1943.

### Transfer to Member

Bennett, R., Radio Division, Bureau of Ships, Navy Dept., Washington, D. C.

Eilenberger, S. D., 6309-13-27 Ave., Kenosha, Wis.

Harvey, H. C., 406 E. Big Bend Blvd., Webster Groves, Mo.

Jutson, R. P., Bell Telephone Laboratories, 463 West St., New York, N. Y.

(Continued on page xlvii)



**AMERICAN MEN and AMERICAN SHIPS  
are equal to any occasion...**

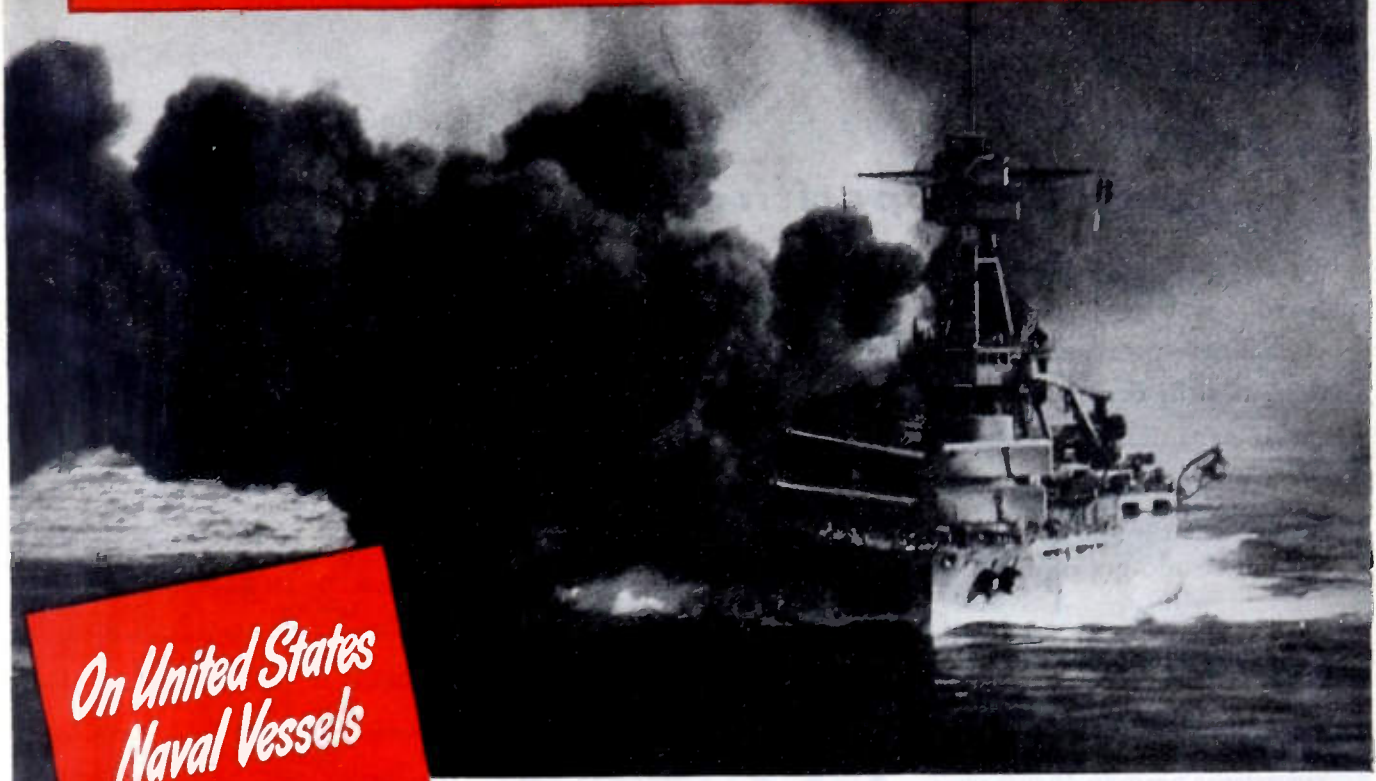

OFFICIAL U. S. NAVY PHOTO

*On United States  
Naval Vessels*

AmerTran Transform-  
ers, Reactors and  
Rectifiers are used  
in Radar, fire control,  
searchlight control,  
communications and  
other applications.

**I**N THE beginning the enemy had a field day. But it's the end of a war that determines the victor.

Already, the United States Navy has proven that it is master of the best the Axis can produce. That goes for personnel, for ships and for equipment.

Take Radar, for example. Only a nation of the greatest inventiveness and highest technical development could

have produced the quality of Radar equipment that helped to smash the Jap at Midway, Coral Sea and elsewhere.

We contemplate the future of the war and of our Country with complete confidence. Our Armed Forces, assisted by American technical knowledge and industry, will win in the end.

AMERICAN  
TRANSFORMER COMPANY  
178 EMMET STREET, NEWARK, N. J.



**PIONEER MANUFACTURER OF  
TRANSFORMERS, REACTORS AND RECTIFIERS  
FOR ELECTRONICS AND POWER TRANSMISSION**



# SKILL

## To Meet Your Specifications

**PERFORMANCE** is the real measure of success in winning the war, just as it will be in the post-war world. New and better ideas—production economies—speed—all depend upon inherent **skill and high precision** . . . For many years our flexible organization has taken pride in doing a good job for purchasers of small motors. And we can help in creating and designing, when such service is needed. Please make a note of Alliance and get in touch with us.

### ALLIANCE DYNAMOTORS

Built with greatest precision and "know how" for **low ripple—high efficiency—low drain and a minimum of commutation transients**. High production here retains to the highest degree all the "criticals" which are so important in airborne power sources.

### ALLIANCE D. C. MOTORS

Incorporate precision tolerances throughout. Light weight—high efficiency—compactness. An achievement in small size and in power-to-weight ratio. Careful attention has been given to distribution of losses as well as their reduction to a minimum.

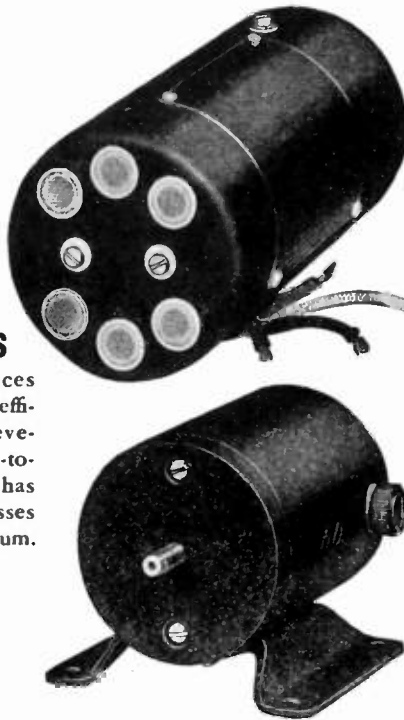

*Remember Alliance!*  
—YOUR ALLY IN WAR AS IN PEACE

**ALLIANCE**  
**MANUFACTURING CO.**  
**ALLIANCE . OHIO**

## Membership

(Continued from page xlv)

- Long, F. V., Box 1725, Delray Beach, Fla.  
Richey, J. L., Oaklynne, Princeton Junction, N. J.  
Singelton, H. C., 2005 N. E. 28 Ave., Portland, Ore.  
Smith, A. H. R., College of Engineering, Rutgers University, New Brunswick, N. J.

### Admission to Member

- Davis, S. L., Miller Rd. and Hoyt St., Darien, Conn.  
Milne, G. O., c/o Blue Network Co., Inc., 30 Rockefeller Pl., New York, N. Y.  
Patrick, K. R., No. 1 Wireless School, Montreal, Que., Canada  
Pumphrey, F. H., 4621 23 St., North, Arlington, Va.  
Tynan, A. G., 1525 Haynes Ave., Kokomo, Ind.

### Admission to Associate

- Aderhold, H. J., 111 E. Arlington Hts., North Augusta, S. C.  
Allender, F. L., 418—11 St., Dunbar, W. Va.  
Bailey, K. D., 331 Beechwood Ave., Norfolk, Va.  
Bartholomew, L. E., 57 Dentonia Pk. Ave., Toronto, Ont., Canada  
Bassett, F. E., Jr., 1328 Grinnell St., Key West, Fla.  
Bennett, A. E., 3304 Forest Lawn Ave., Omaha, Neb.  
Bennon, M., 1320 S. 5th St., Philadelphia, Pa.  
Berger, M., 221 S. W. Third Ave., Ft. Lauderdale, Fla.  
Bierkamp, C. S., Jr., 1413 Wilson Ave., Youngstown, Ohio  
Booker, C. C., No. 1 Wireless School, Montreal, Que., Canada  
Botticher, G. H. L., 712 N. Penn. Ave., Webb City, Mo.  
Brinkman, H. A., 901 S. Washington St., Alexandria, Va.  
Brown, W. R., 305 Main St., Toledo, Ohio  
Browning, J. H., c/o Fleet P. O., San Francisco, Calif.  
Bryant, H. G., Jr., Box 262, Athens, Ga.  
Bucher, T. T. N., 1604 Powder Mill La., Wynnewood, Pa.  
Bus, B. R., General Electric Co., Nela Pk., Cleveland, Ohio  
Callaway, D. E., 433 Ellis St., San Francisco, Calif.  
Chan, G., 600 Great North Rd., Auckland, W. 2, New Zealand  
Chapman, C. N., 228 Ashworth Ave., Toronto, Ont., Canada  
Collins, E. N., Jr., 314 McDowell Rd., Lexington, Ky.  
Collins, W. G., 4648 Saratoga Ave., Ocean Beach, Calif.  
Colman, A., 21 W. Mosholu Pkwy., N., Bronx, N. Y.  
Corcoran, G. F., Elec. Engr. Dept., Univ. of Maryland, College Pk., Md.  
Cornwell, R. C., 605 Mt. Prospect Ave., Newark, N. J.  
Clutterbuck, E. L., Westinghouse Electric and Manufacturing Co., Third and Elm Sts., Cincinnati, Ohio

(Continued on page xlviii)



Mr. B. B. Bauer, Chief Engineer of Shure Brothers, inventor of the Shure Reactance Slide Rule

*Our Engineering Staff is pleased to serve 51,158\* Engineers, Technicians and Students with the*  
**Shure Reactance Slide Rule**

\* The Shure Reactance Slide Rule has been offered since February, 1943. Engineers, technicians and students have been requesting it at the rate of approximately 10,000 per month.



During these days, while our efforts are devoted to the job of supplying the Army, Navy, and Air Force with microphones, we are pleased that our engineering department has also been of additional service to industry.

51,158 engineers, technicians and students have found the Shure Reactance Slide Rule a big help in radio computations. Makes the calculation of complicated problems in resonant frequencies extremely simple. Also helps in the solution of circuit problems involving inductances and condensers. Covers a frequency range of 5 cycles per second to 10,000 megacycles. Indispensable for radio and electrical engineers, technicians and circuit designers.

If you haven't your Slide Rule—we will be pleased to send it to you with complete instructions. Kindly send 10c in coin to cover handling.

**SHURE BROTHERS, Dept. 174P, 225 West Huron St., Chicago, U. S. A.**  
*Designers and Manufacturers of Microphones and Acoustic Devices*



# KELVIN- WHEATSTONE BRIDGE NO. 637

## A SHALLCROSS Development

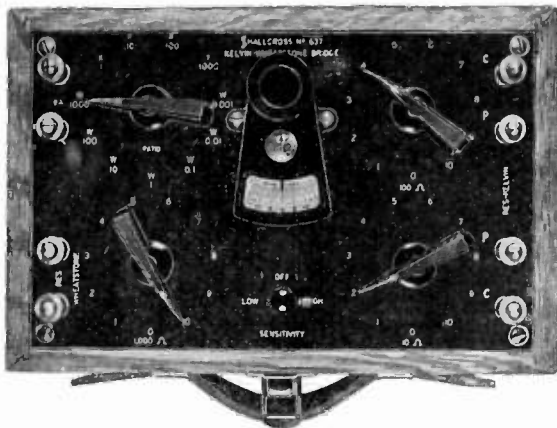

A wide range resistance-measuring instrument — combining the features of the Kelvin and the Wheatstone Bridge.

### IT MEASURES . . .

Low resistances between 0.001 and 1 ohm on the Kelvin range.

Normal resistances between 10 ohms and 11,000,000 ohms on the Wheatstone range.

A portable instrument of moderate accuracy for practical resistance measurements for factory, service shop and field use.

Address Dept. 23

### Creators and Makers of

Accurate Resistors—Switches—Special Equipment and Special Measuring Apparatus for Production and Routine Testing of Electrical Equipment on Military Aircraft . . . Ships . . . Vehicles . . . Armament . . . and Weapons



# SHALLCROSS MFG. CO.

COLLINGDALE, PENNA.

## Membership

(Continued from page xlvi)

- Cook, F. D., 1206 Elmwood Ave., Evanston, Ill.  
 Covington, O. C., c/o Fleet P. O., New York, N. Y.  
 Craig, J. H., 2718 Minnesota Ave., S. E., Washington, D. C.  
 Crossley, R. C., 2346 Ashland Ave., Evanston, Ill.  
 Daniels, V. L., 1918 Thurston Ave., Racine, Wis.  
 Davison, M. C., 60 Broughton St., Tonawanda, N. Y.  
 Devol, G. C., Jr., 342 W. Putnam Ave., Greenwich, Conn.  
 Dike, E. E., 452 Victoria Pk. Ave., Toronto, Ont., Canada  
 Ehrensacht, H., 4345 N. Sawyer Ave., Chicago, Ill.  
 Elliott, T. A., 5406 Belmont Ave., Dallas, Texas  
 Ellis, R. E., 4710 Nichols Ave., S. W., Washington, 20, D. C.  
 Else, S. C., 92 Farnham Ave., Toronto, Ont., Canada  
 Emmett, R. A., 2811 Pennsylvania Ave., D. E. Washington, D. C.  
 Feilen, A. E., c/o Fleet P. O., New York, N. Y.  
 Fleming, J. Y., No. 1 Wireless School, Montreal, Que., Canada.  
 Fisher, J. T., 34 Keystone Ave., Upper Darby, Pa.  
 Fraser, W. T., No. 1 Wireless School, Montreal, Que., Canada  
 Frieberg, M., 642 Oak St., Cincinnati, Ohio  
 Gable, M. L., 309 W. Harris Ave., La-Grange, Ill.  
 Galbreath, J. R., Box 105 Lansdale, Pa.  
 Ghosh, S. P., 726 Cooper St. Camden, N. J.  
 Glasgow, W. S., 5011 West 30 St., Little Rock, Ark.  
 Godley, P. F., Jr., 29 Lake Ave., Riverhead, L. I., N. Y.  
 Greig, J. H., North Beach, Md.  
 Grubb, D. L., 236 Paiko Dr., Honolulu, T. H.  
 Hanson, A. W., Tumbarumba, The Grove, Bridgforth, England  
 Hanscome, T. D., 3516 B St., S. E., Washington, D. C.  
 Harcher, A. J., Box 262, Eighth and Washington Sts., Lansdale, Pa.  
 Harper, E. E., Traymore Apts., Virginia Beach, Va.  
 Hargreaves, R. F., 3120 N. E. 31 Ave., Portland, Ore.  
 Harris, H. W., 129 Eng. Bldg., Univ. of Md., Columbia, Mo.  
 Hayford, N., 3236 Mayflower St., Jacksonville, Fla.  
 Heil, S. H., 725 Folk St., Easton, Pa.  
 Hilburn, E. D., 4111 E. Washington St., Indianapolis, Ind.  
 Holtmann, E. H., 198 Lexington St., Belmont, Mass.  
 Hundstad, C. E., 1630 Carrie St., Schenectady, N. Y.  
 Hurlburt, R. R., No. 1 Wireless School, Montreal, Que., Canada  
 Johannesen, J. D., 1921 K St., N. W. Washington, D. C.  
 Jones, M. W., 5241 Broad Branch Rd., N. W., Washington, D. C.  
 Keith, R. M., Jr., 3161 North Elston Ave., Chicago, Ill.

(Continued on page 1)



$$V = V_0 [H(t) - H(t - \tau)]$$



## ...AND $V_0$ IS ANYTHING UPWARDS OF 1 Kv.!

If you're dealing with voltages of a type indicated by the above formula—well, we don't have to tell you that the job of finding suitable components is a tough one, especially if these  $V$ 's are working into low  $Z$ 's.

Obviously then, we don't pretend that transient voltages of this order haven't been a contributing factor to premature gray hairs for Sprague engineers charged with developing condensers and Koolohm Resistors to meet these difficult specifications. They have—and some problems re-

main to be solved. We're working on them now!

On the other hand, more often than not, eminently suitable components have been forthcoming. A typical illustration is the Sprague Type PX-25 "VITAMIN Q" Paper Capacitor that reads "off scale" on megohm bridges at more than 200,000 megohms.

Let us know just what your problems are, and how the capacitors are to be used. We'll make our recommendations accordingly—telling you frankly and honestly just what you can expect.

# SPRAGUE

## SPECIALTIES COMPANY

NORTH ADAMS, MASS.

### SUB-CONTRACTORS, ATTENTION!

Sprague Specialties Company will be glad to hear from reliable firms having screw machine and metal stamping facilities available for sub-contract work on high-priority orders; also from concerns equipped to make up jigs and fixtures, and having female help available.

F. W. McNAMARA, Purchasing Agent  
Telephone: NORTH ADAMS (MASS.) 804

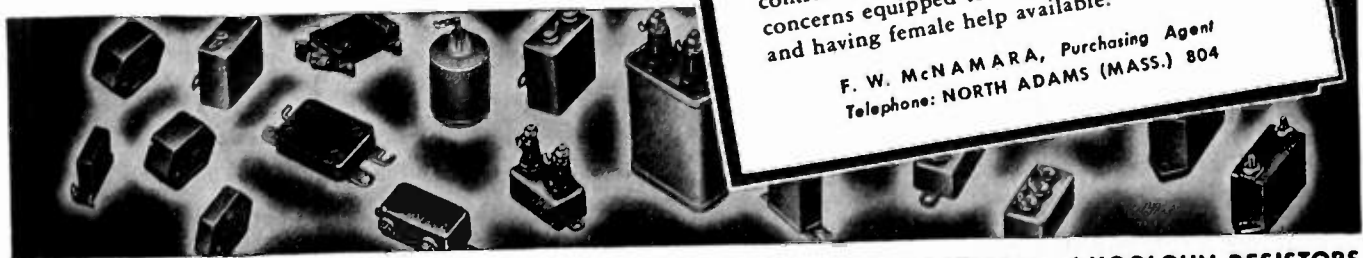

MANUFACTURERS OF A COMPLETE LINE OF RADIO and INDUSTRIAL CAPACITORS and KOOLOHM RESISTORS

# DELAYS *Are Not* NECESSARY!



**...get vital radio and electronic parts and equipment - Quickly!**

Research in electronics is now devoted almost exclusively to wartime applications—and every minute counts in war!

Electronic engineers and research technicians need not delay completion of vital projects for lack of parts or equipment. Lafayette Radio Corp. is headquarters for every nationally known manufacturer in the field.

The reputation of Lafayette Radio Corp. for complete stocks and prompt deliveries is well known to thousands of electronic engineers. We can fill your needs—quickly!



Write today for FREE 130 page Radio and Electronic Parts and Equipment Catalog...  
Address Dept. 7H3

**LAFAYETTE  
RADIO CORP.  
CHICAGO**

## LAFAYETTE RADIO CORP.

★ 901 W. JACKSON BLVD.

★ 265 PEACHTREE STREET

CHICAGO, ILLINOIS

ATLANTA, GEORGIA

## Membership

(Continued from page xlvi)

- Kelly, H. P., 50 Park Ter., West, New York, 34, N. Y.
- Keller, D. F., 1225 Jefferson Ave., Winston-Salem, N. C.
- Kenney, T. C., KDKA, Grant Bldg., Pittsburgh, Pa.
- Kirkpatrick, E. L., 3964 Nichols Ave., S. W., Washington, D. C.
- Kirschner, M., 859 Jennings St., Bronx, N. Y.
- Kleeberg, S. L., 2 Catherine St., Schenectady, N. Y.
- Klug, J. D., 2142 Scheffer Ave., St. Paul, Minn.
- Koivu, J. C., 403 W. 6th St., Emporium, Pa.
- Konersman, E. J., 8 Bellefonte Ave., Lakeside Pk., Covington, Ky.
- Lee, J. W. H., No. 1 Wireless School, Montreal, Que., Canada
- Lekberg, D. G., 10 Marsh Ave., Worcester, Mass.
- Leonard, J., Midland Radio and Television School, Athens, Ga.
- Lichtenstein, R. M., Reed College, Portland, Ore.
- MacLean, W. C., No. 1 Wireless School, Montreal, Que., Canada
- Majors, V. R., General Delivery, Heber, Calif.
- Margolis, D., Sylvania Electric Products Inc., Montoursville, Pa.
- Manley, J. M., Bell Telephone Laboratories, Murray Hill, N. J.
- Markman, E. L., Georgian La., Darien, Conn.
- Markham, T. R., No. 1 Wireless School, Montreal, Que., Canada
- McCormick, E. M., 424 N. E. 10 Ave., Ft. Lauderdale, Fla.
- McLaughlin, R. B., Naval Auxiliary Air Facility, Otter Pt., Alaska
- McVay, M. S., Naval Research Laboratories, Anacostia Station, D. C.
- Miller, A., 179 Kent St., Brookline, Mass.
- Miller, R. F., 2248-14 St., Cuyahoga Falls, Ohio
- Mortlock, A., 28 Cornwallis Gdns., Hastings, England
- Moyer, G. E., McConnellstown, Hunt County, Pa.
- Munsell, A. F., 4615 Oakland St., Philadelphia, Pa.
- Nicholson, G. D., 5913 Roosevelt Blvd., Philadelphia, Pa.
- Norgorden, O., 166 Chesapeake St., S. W., Washington, D. C.
- Nurmela, G. E., 736 Wilcox Ave., Bronx, New York, 61, N. Y.
- O'Neil, J. A., 3101 Lawton St., San Francisco, Calif.
- Osborn, R. L., 822 Wesley Ave., Evanston, Ill.
- Pace, M. W., Box 662, Athens, Ga.
- Paine, H. G., 3317 B St., S. E., Washington, D. C.
- Parker, R. O., 4216 Nicholas Ave., S. W., Washington, D. C.
- Parsegian, V. L., C. J. Tagliabue Manufacturing Co., Park and Nostrand Aves., Brooklyn, N. Y.
- Pelonio, A. J., 2428 Chestnut St., Oakland, Calif.
- Prishchepenko, B. G., 3355-16 St., N. W., Washington, D. C.

(Continued on page lii)

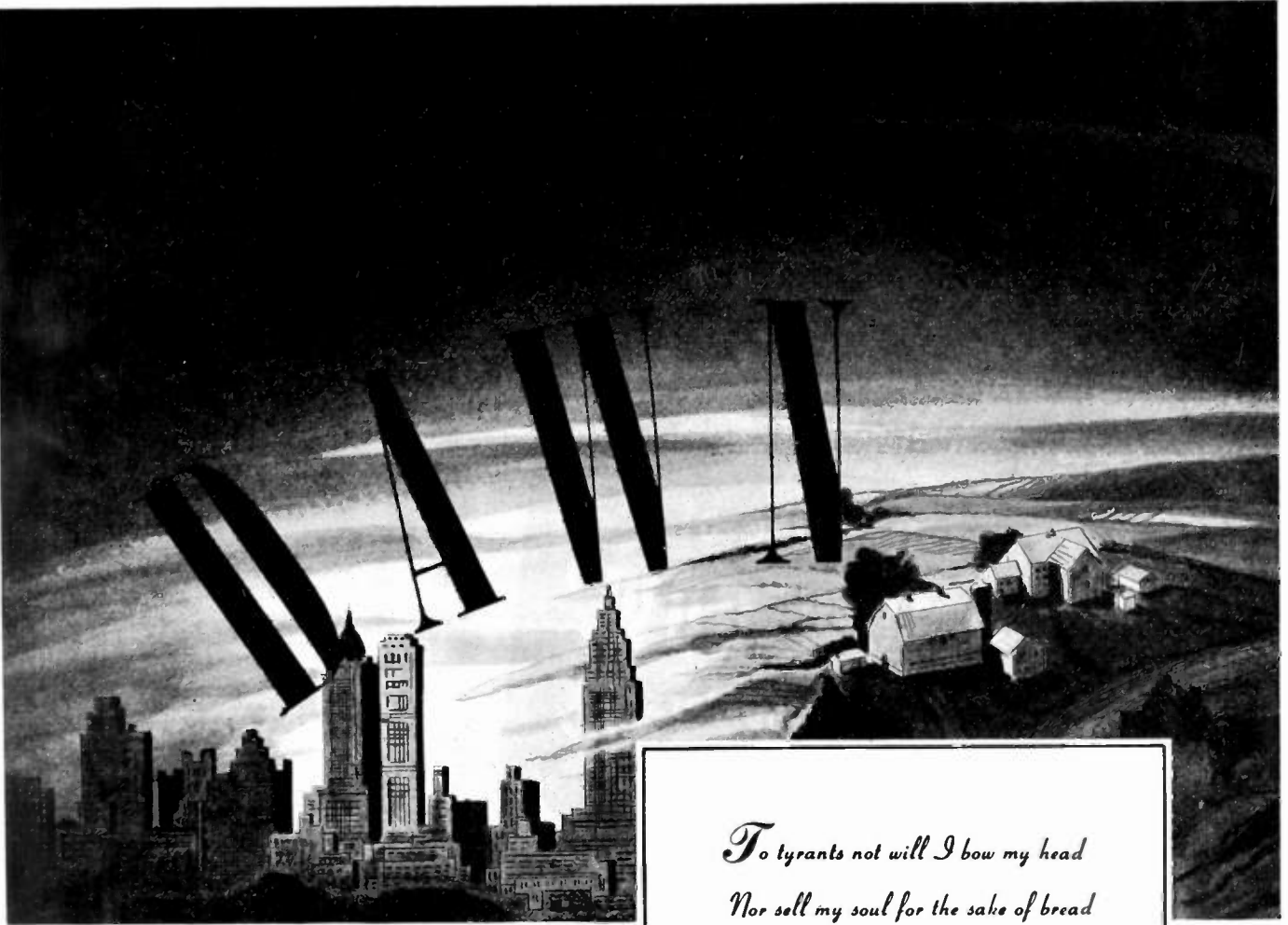

*To tyrants not will I bow my head  
Nor sell my soul for the sake of bread  
Willingly I bear sacrifice and pain  
Willingly I serve in democracy's name  
Until my debt to humanity has been paid  
Will I face the dawn unafraid*

From the Atlantic to the Pacific;  
from the great cities to the tiny  
hamlets; from the mighty and the  
humble—come tangible evidences of  
America's payment to humanity.

Giving of our sons and our resources and our dollars  
. . . to free the world from dictators and tyrants. We  
of Kenyon know that building a better transformer is  
but a small accomplishment when you consider the  
whole of the war effort. However, that is our part,

and we're giving it our best . . . and when the dawn of  
peace-day breaks, we'll be tremendously thankful that  
we did. Come on—everybody—faster, better—better, faster!



THE MARK OF

EXCELLENCE

**KENYON TRANSFORMER CO., Inc.** 840 BARRY STREET  
NEW YORK, U. S. A.

**YOUR PINT OF BLOOD CAN SAVE A SOLDIER'S LIFE... VISIT YOUR LOCAL RED CROSS BLOOD BANK TODAY!**

## Membership

(Continued from page 1)

- Reynolds, G. A., 301 Seventh Ave., N., Nashville, Tenn.
- Richard, V. W., 36 Salem La., Red Bank, N. J.
- Riley, R. R., 134 Irvington St., S. W., Anacostia Station, D. C.
- Roberts, H. C., 108 Talbot Laboratories, Urbana, Ill.
- Rueppel, G. E., St. Louis University, St. Louis, Mo.
- Ruff, H. M., 565 Golden Ave., Topeka, Kan.
- Ryan, J. U. C., 22 Hillcrest Ave., Yonkers, N. Y.
- Schenk, P. J., Hq. 1, Fighter Command, Mitchel Field, L. I., N. Y.
- Schoenuetter, H. K., 153 W. Hancock Ave., Athens, Ga.
- Scott, J. E., Jr., San Bernardino Valley Junior College, San Bernardino, Calif.
- Sees, J. E., 423 Mellon St., S. E., Washington, D. C.
- Simberkoff, S. W., 160 E. Fourth St., Mt. Vernon, N. Y.
- Shaw, G. L., Y.M.C.A., Rahway, N. J.
- Sidhu, H. S., Indian Institute of Science, Bangalore, India
- Sinclair, G. W., No. 1 Wireless School, Montreal, Que., Canada
- Skinner, E. E., Officer's Club, Boca Raton Field, Fla.
- Smith, G. G., No. 1 Wireless School, Montreal, Que., Canada
- Smith, P. A., 1608 Ashland Ave., Des Plaines, Ill.
- Smith, W. T., 1414 Harrison St., Topeka, Kan.
- Staahl, G. E., Northwestern technological Institute, Evanston, Ill.
- Stang, R. A., 1404 8th Ave., Neptune, N.J.
- Stevens, J. E., 9944 National Blvd., Los Angeles, Calif.
- Stewart, J. W., 436 Case Ave., St. Paul, 1, Minn.
- Surrige, N. H., 2044 Melrose Ave., N.D.G., Montreal, Que., Canada
- Sweet, J. L., No. 1 Wireless School, Montreal, Que., Canada
- Thumm, R. N., Northeast Airlines, Inc., Presque Isle, Maine
- Tipton, W. F., Burnside Laboratories, E. I. DuPont De Nemours and Co., Pennsgrove, N. J.
- Thielking, D. H., Sylvania Electric Products Inc., Ipswich, Mass.
- Voorhies, H. G., Jr., Radiation Laboratories, M.I.T., Cambridge, Mass.
- Walden, G. R., 300 Berkeley St., Boston, Mass.
- Webb, L. R., No. 1 Wireless School, Montreal, Que., Canada
- Westbrook, R. D. Naval Research Laboratories, Anadostia Station, D. C.
- White, W. A., Forest Heights, R. 2, Anacostia, D. C.
- White, W., Radiation Laboratories M.I.T., 77 Massachusetts Ave., Boston, Mass.
- Wirtanen, C. W., 185 W. Prospect St., Jackson, Mich.
- Wright, O. N., 132 Reilly St., Coral Hills, Md.-Via Benning, D. C. Zone 19



A lifetime of  
**"KNOW-HOW"**  
has made Thordarson  
*the LEADER!*

It takes more than mere "book learning" . . . more even, than an "all out" determination to succeed, in order to build a leader . . . Nothing else can take the place of long experience, painstakingly accumulated through years of conscientious research and the burning of the midnight oil. Thordarson engineers have always followed this tradition. The result is a type of leadership, accepted and unquestioned, among all who appreciate real transformer quality.



**THORDARSON**

ELECTRIC MFG. COMPANY  
500 WEST HURON STREET, CHICAGO, ILL.

*Transformer Specialists Since 1895*  
**ORIGINATORS OF TRU-FIDELITY AMPLIFIERS**



# The Institute of Radio Engineers

... serves those engaged in radio and allied fields through the presentation and publication of technical information on the subjects.

**THE PROCEEDINGS**, the official magazine of I.R.E., has been published without interruption since 1913 when the first issue appeared. The contents of each paper published in the **PROCEEDINGS** are the responsibility of the author and are not binding on the Institute or its members. Material appearing in it may be reprinted or abstracted in other publications on the express condition that specific reference shall be made to its original appearance in the **PROCEEDINGS**. Illustrations of any variety, however, may not be reproduced without specific permission from the Institute.

**STANDARDS** reports are published from time to time and are sent to each member without charge. Current reports include two each on Radio Receivers, Transmitters and Antennas, and Radio Wave Propagation, and one each on Electroacoustics, and Facsimile; a detailed description of these reports will be sent on request.

**MEMBERSHIP** has grown from a few dozen in 1912 to approximately eight thousand. Practically every country in the world in which radio engineers may be found is represented in our roster. Dues for the five grades of membership range from \$3.00 to \$10.00 per year. The **PROCEEDINGS** is sent to each member without further payment.

**SECTIONS** in twenty-seven cities in the United States, Canada, and Argentina hold regular meetings. The chairmen and secretaries of these sections are listed on the page opposite the first article in this issue.

**SUBSCRIPTIONS** are accepted for the **PROCEEDINGS** at \$10.00 per year in the United States of America, its possessions, and Canada; when college and public libraries order direct from the Institute, the subscription price is \$5.00. For other countries there is an additional charge of \$1.00 for postage.

**APPLICATION** for **ASSOCIATE** membership may be made by using the convenient blank on this page, or preferably on written request to the Institute headquarters.

The Institute of Radio Engineers, Inc.  
330 West 42nd Street  
New York, N.Y.

*Convenient Associate Membership Blank*

## The Institute of Radio Engineers

Incorporated  
330 West 42nd Street, New York, N.Y.

To the Board of Directors

Gentlemen:

I hereby make application for **ASSOCIATE** membership in the Institute of Radio Engineers on the basis of my training and professional experience given herewith, and refer to the sponsors named below who are personally familiar with my work.

I certify that the statements made in the record of my training and professional experience are correct, and agree if elected, that I shall be governed by the Constitution of the Institute so long as I continue a member. Furthermore I agree to promote the objects of the Institute so far as it shall be in my power.

.....  
(Sign with pen)

.....  
(Address for mail)

.....  
(City and State)

.....  
(Date)

### SPONSORS

(Signatures not required here)

Mr. ....

Address .....

City and State .....

Mr. ....

Address .....

City and State .....

Mr. ....

Address .....

City and State .....

*Fill Out Reverse Side Also*



# Drilling Diamonds for Victory

**D**RAWING of fine wire for delicate precision instruments depends on the accuracy with which the diamond dies are made. Philips manufacture these dies down to .0008 of an inch with diamond drilling machines developed by Philips engineers.

This operation—as well as the actual drawing of the wire—calls for extreme precision and exemplifies the wide technical knowledge and skill behind all Philips products.

Today, the research and experience of the North American Philips Company in electronics are devoted to the single aim of aiding the United Nations war effort. Tomorrow, this knowledge will aid industry in creating a new world for free men.

Products For Victory include Cathode Ray Tubes; Amplifier Tubes; Rectifier Tubes; Transmitting Tubes; Electronic Test Equipment; Oscillator Plates; Tungsten and Molybdenum in powder, rod, wire and sheet form; Tungsten Alloys; Fine Wire of all drawable metals: bare, plated and enameled; Diamond Dies; X-Ray Apparatus for industrial, research and medical applications.

## NORTH AMERICAN PHILIPS COMPANY, INC.

*Electronic Research and Development*

Factories in Dobbs Ferry, N. Y.; Mount Vernon, N. Y. (Philips Metals Corp.); Lewiston, Maine (Elmet Division)

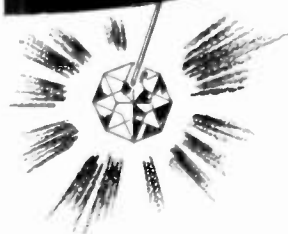



# Keep 'Em Running FOR THE DURATION!

It is difficult to secure new Generating Sets or new Rotary Converters . . . Pioneer is devoting all of its resources toward winning the war . . . but we can, and will, help you keep your present equipment running for the duration. Send your service problems, by letter, to Pioneer's Customer Service Department.

DYNAMOTORS · CONVERTERS · GENERATORS · DC MOTORS · POWER PLANTS  
GEN-E-MOTORS

## PINCOR Products

PIONEER GEN-E-MOTOR  
CHICAGO, ILLINOIS · EXPORT ADDRESS: 25 WARREN STREET, NEW YORK CITY  
CABLE ADDRESS: SIMONTRICE, NEW YORK CITY

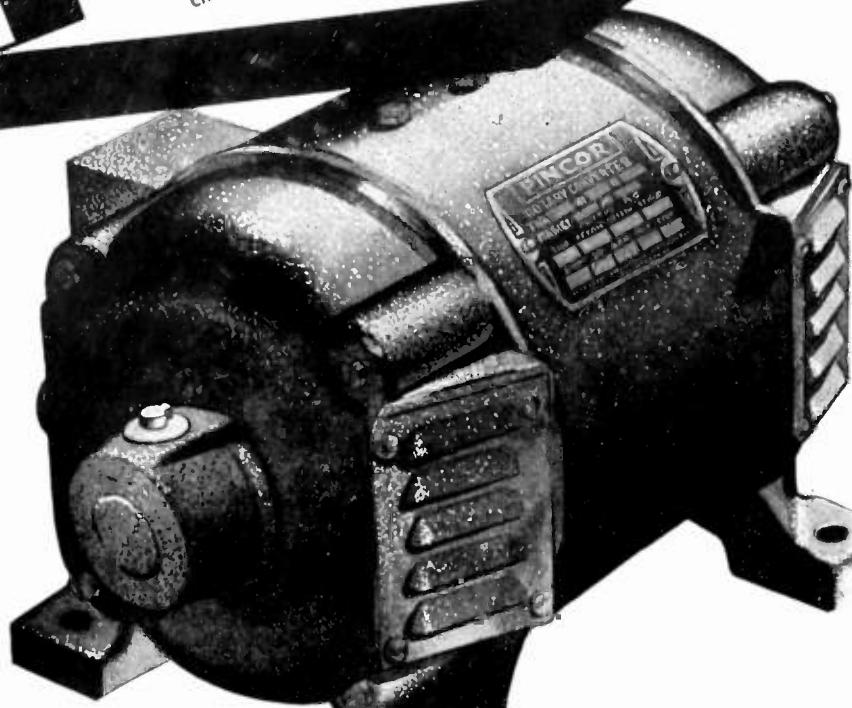

(Continued from page xxxvi)

### ENGINEERS—PHYSICISTS

Radio engineers, electronic engineers, electrical engineers, physicists. A non-profit research laboratory engaged in urgent war research must increase its scientific staff. Men or women (college graduates) with experience in vacuum tube circuit design, construction of aircraft radio equipment and design of small electromechanical devices are needed. Salaries range from \$3,000 to \$8,000 depending upon experience, ability, education and past earnings.

Apply by mail to Airborne Instruments Laboratory, Columbia University Division of War Research, Box 231, Mineola, N.Y.

### RADIO ENGINEERS AND TECHNICIANS

A progressive company with a sound background in radio and electronics needs, at once, several men with training and experience in any phase of the radio industry. The work open is vital to the war effort but offers a promising post-war future for the right men. College degree or equivalent experience necessary. Men now engaged at highest skill on war production should not apply. Write Box 294.

### RADIO ENGINEER

Wanted for general work covering design and installation with major communication company chiefly in New York area. Technical graduate preferred. Must have car. Position not limited to duration. Address Box 298.

### RADIO ENGINEERS AND TECHNICIANS

In critical war industry. Opportunity for several competent men in research and production engineering on Government contracts. Work is with a company well known in the radio industry, located in a Michigan city. Send full particulars of your experience and photo. Address Box 284.

### NAVAL ORDNANCE LABORATORY

The Naval Ordnance Laboratory, located in Washington, D.C., is a research development agency of the Bureau of Ordnance, concerned with the design of new types of naval mines, depth charges, aerial bombs and other ordnance equipment, including measures for the protection of ships against mines.

This laboratory needs physicists and electrical engineers with electronics experience, mechanical engineers familiar with the design of small mechanical movements or mechanisms, and personnel for technical report writing and editing. Write to Naval Ordnance Laboratory, Navy Yard, Washington, D.C.

### RADIO ENGINEERS AND TECHNICIANS

Technicians with specialized engineering knowledge. Perform efficient maintenance and adjustment of radiotelegraph operating office equipment. Technical knowledge of special radio and related equipment needed in the service. Must be capable of sending and receiving the International Morse Code at a minimum speed of 20 words per minute and must hold a Federal License as required by law.

Radio Instructor on operation and maintenance of radio transmitting equipment.

Maintenance Engineers to keep machinery, mechanical equipment, radio-communication operating machines, and radio instruments in good repair. Construct and install new apparatus. A combination of maintenance mechanic and machinist duties.

Maintenance Electricians to take charge of all plant maintenance pertaining to all the electrical facilities, wiring and machinery. Must be capable of doing mechanical construction of communication equipment and electrical wiring, and work from blueprints. Address Box 283.

### ENGINEERS

The salary is open and depends only upon the ability and experience of the engineer.

1. Electronic and radio engineers to design electronic navigation and communication equipment for aircraft.

(Continued on page lviii)



# *Facts about* **STEATITE** **LOW LOSS** **INSULATORS**

## **NO SHORTAGE EXISTS**

in STEATITE parts so necessary in Radio and Radar Equipment for the war effort—the demand is being met.

## **AMPLE FACILITIES**

—are available for producing precision made extruded, pressed and machined STEATITE parts  
—NO SHORTAGE exists of production facilities.

## **EXPERIENCED ENGINEERING STAFF**

—with years of training in research and the development of methods and processes—so necessary to produce precision made STEATITE parts of rigid and exacting specifications.

## **SUBSTITUTES**

—for STEATITE are no longer necessary—STEATITE parts *are available* for prompt delivery in all sizes, shapes and quantities.

*For the duration 100 per cent of our attention—  
all personnel and equipment—is being  
used to hasten Victory.*

BUY WAR  
BONDS



"for great  
achievement"

**STUPAKOFF CERAMIC AND MANUFACTURING CO., LATROBE, PA.**

*Ceramics for the World of Electronics*



## JACKSON INSTRUMENTS *are found* NOT FAR BEHIND THE FRONT!

"Handie talkies"—miniature transmitter-receivers, each not much larger than a carton of cigarettes—are in constant use by our fighting men over-seas.

These important little instruments are aiding the airplane spotters, the reconnaissance squads, and even the commanders who are directing attacks.

But occasionally, of course, severe usage may put these little "talkies"

out of order . . . and then the Signal Corps experts—quite possibly aided by Jackson testing equipment—will soon have the "talkie" back in operation.

Jackson production is now entirely war work. We are happy in doing our best toward helping to keep vital war communication lines open.

1 1 1

*All Jackson employees—a full 100%—are buying War Bonds on a payroll deduction plan. Let's ALL go all-out for Victory.*

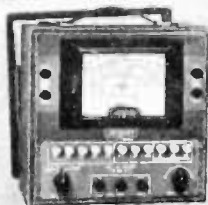

Model 642 Multimeter



Model 652 Audio Oscillator

# JACKSON

*Fine Electrical Testing Instruments*

JACKSON ELECTRICAL INSTRUMENT COMPANY, DAYTON, OHIO

lviii

(Continued from page lvi)

2. Mechanical engineers familiar with and interested in the design of small precision equipment and familiar with shop practice and tools.
3. Engineers familiar with the design of components for electronic equipment.
4. Technical men able to write technical material for instruction books.

These positions can be permanent for the right men. Excellent opportunities for advancement.

Engineers with experience are preferred, but the right persons do not need experience if they have the ability to learn and the required aptitude. Applications may be male or female. Persons already engaged in war work cannot be considered.

Write directly to Chief Engineer, Bendix Radio Division, Bendix Aviation Corp., Baltimore, Maryland giving complete details of education and experience.

### ELECTRONIC ENGINEERS

Engineers with backgrounds for acoustics, supersonics, broadcasting, frequency modulation, or ultra-high frequencies. Applicants should not be subject to immediate draft call and should not be engaged at their highest skilled war work. An engineering degree is desirable but not required.

Women with similar technical knowledge and experience will be considered.

Company is a large electrical manufacturer and is within twenty minutes commuting distance of New York City. Salaries are commensurate with education and experience. Address Box 287.

### RADIO ENGINEER

Experienced in the manufacture and testing of ultra-high-frequency apparatus; must be capable of taking complete charge of war projects. Splendid opportunity. War workers at highest skill need not apply.

Inquiries will be kept confidential. Please state age, experience, and salary expected. Write Box 288.

### RADIO INSTRUCTION-BOOK WRITERS

Thorough knowledge of radio principles and ability to describe in simple terms the operation of UHF circuits required. Work relates to instruction books for electrical apparatus. Excellent opportunity to do essential work in very essential war industry. Salary depends upon qualifications and experience.

Replies solicited from Engineers, Patent Attorneys, Teachers and others qualified.

Write complete qualifications and salary desired to Hazeltine Electronics Corporation, 1775 Broadway, New York, N.Y.

### RADIO ENGINEER

Mathematical knowledge to include trigonometry and elementary calculus. Must be familiar with all types of circuits for reception and transmission on frequencies up to 200 mc/s. Knowledge of transmission lines, aerial arrays, television and cathode-ray-tube technique desirable. Must also have knowledge of radio test equipment and must understand any circuit diagram.

Prefer man conversant with manufacture, repair and fault location on all types of transmitters and receivers. Address Box 289.

### RADIO ENGINEER

**EDUCATION:** Minimum of two years college in Electrical Engineering.

**EXPERIENCE:** Minimum of two years in radio test or engineering, or five years in electrical control work (power station or telephone central-office wiring, etc.).

Must be of a type qualified to interpret and clarify with inspectors and responsible executives electrical specifications, problems of manufacture, test and inspection. Address Box 290.

### ELECTRO-MAGNETIC ENGINEER

Unusual opportunity for engineer with vision for new ideas in design work with nationally known, long established firm in Eastern Pennsylvania, now 100% on war work. Firm large enough to make remuneration attractive, small enough to insure

(Continued on page lx)

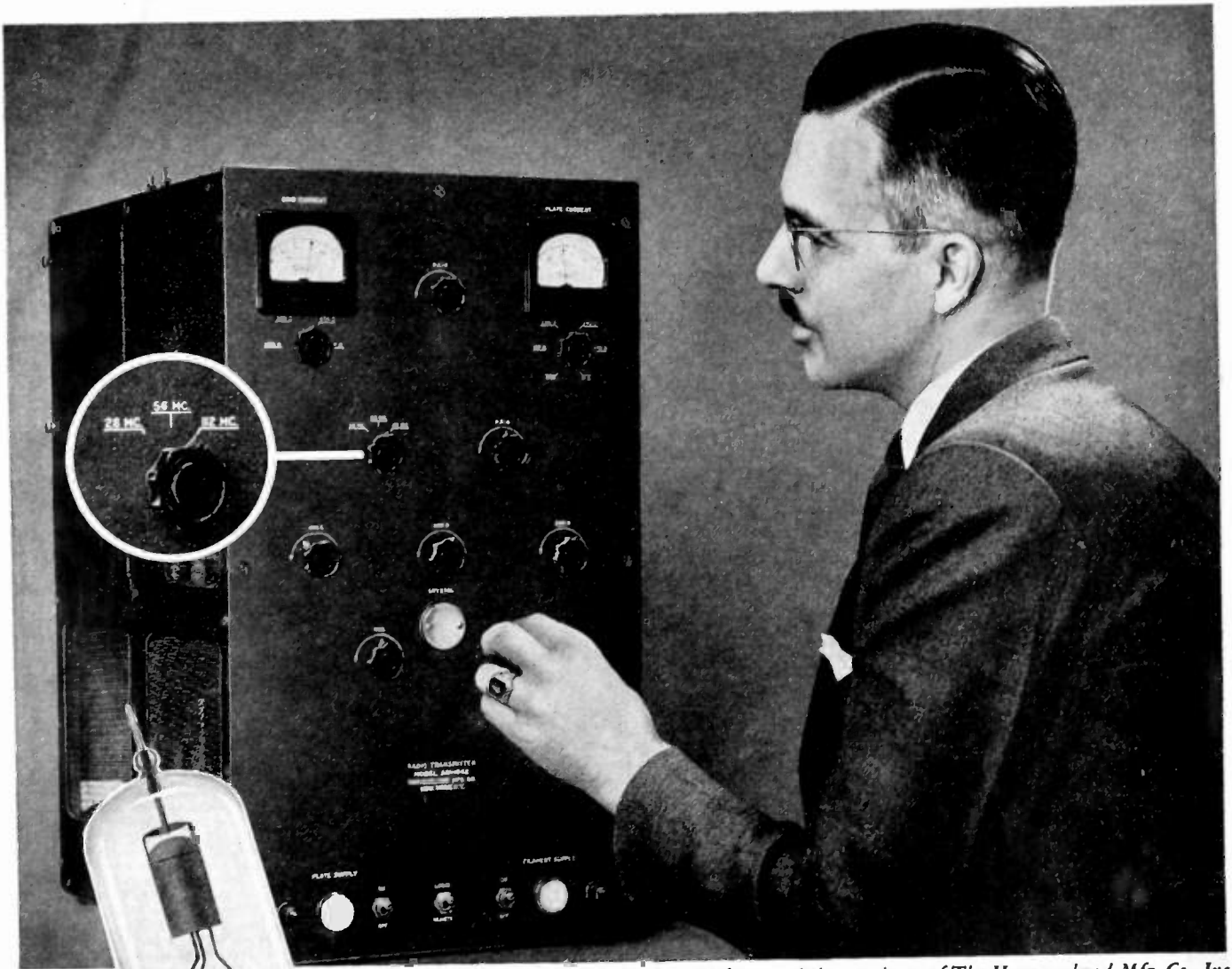

*James N. Whitaker, chief transmitting engineer of The Hammarlund Mfg. Co., Inc. is shown with the remarkable very high frequency transmitter he recently designed.*

## FROM 25 TO 125 MEGACYCLES ...without reneutralization

### EFFICIENT VHF OPERATION WITH GAMMATRON HK-24's

The high efficiency of HK-24 Gammatrons at very high frequencies is the result of two things: the long, capped tantalum plate which confines the entire electron stream for useful output, and the fact that the grid is closely spaced to the filament for short electron time-flight.

The HK-24 triode is easy to neutralize, and parasitic oscillation is avoided, because the inter-electrode capacities are low and the grid and plate leads are short. The grid to plate capacity is only 1.7 micro-microfarads.

For maximum and typical ratings of the HK-24 as an r. f. power amplifier, audio amplifier, crystal oscillator, doubler, or tripler, write for data.

**P**ICTURED above is the new Hammarlund AW-1042, undoubtedly the first neutralized power amplifier to operate on 28, 56, and 112 megacycles without reneutralization.

High stability is not the only news-worthy feature of this new transmitter. It has been engineered with such skill that it replaces an accepted transmitter of similar performance requiring twice the power input and weighing seven times as much!

The AW-1042 produces 50 watts of useful carrier power with either audio or narrow-band frequency modulation, both of which are crystal-controlled. It offers CW, tone telegraph, and phone performance.

Hammarlund's AW-1042 eloquently demonstrates the ability of their engineers to evaluate design; and Heintz and Kaufman, Ltd. is proud that HK-24's are used in the final, as well as in the three preceding doubler stages.

States Mr. Whitaker: "I chose HK-24 Gammatrons because their mechanical and electrical characteristics render them particularly suitable for high frequency operation with unusually high efficiency and stability."

**HEINTZ AND KAUFMAN, LTD.**

SOUTH SAN FRANCISCO, CALIFORNIA, U. S. A.

*Gammatron Tubes*

# An Opportunity

## We Need a —

Radio Engineer (Senior Grade) to Design Communications Receivers.

The man qualified for this position is now employed in an essential industry, but not to full capabilities at his greatest skill. He can obtain a Certificate of Availability. He is 35 to 40 years of age with an E.E. degree from a leading technical college. In addition to a broad design experience, he has a wide knowledge of modern manufacturing methods.

The qualified engineer will become responsible for receiver design and head a development group of 8 or 10 engineers.

To the qualified man the salary will be in excess of \$5,000 per year for a work week of 48 hours.

This is permanent employment with a long-established communications manufacturer now devoted 100% to making military radio and telephone equipment. Please write to:

**BOX NUMBER 297**

**The Institute of Radio Engineers**

**330 West 42nd St.**

**New York, N.Y.**

## ● FORWARD-LOOKING COMPANY NEEDS ENGINEERS . . . .

● A progressive company with an expanding engineering department is seeking several good men—but of course cannot take men now employed at their highest skills in war industry.

One should have a good theoretical knowledge of acoustics and experience with magnetic circuits and acoustical measurements.

Another is needed for laboratory measurements on a-f communications apparatus. He will design and supervise equipment for production testing, maintaining laboratory standards, and he should be familiar with government specifications and inspection procedure.

A third man must be familiar with the application and molding techniques of plastics. He should have several years of design experience on small electrical apparatus and an understanding of magnetic and electrical circuits.

These men will be concerned now with war contracts and planning post-war developments in a technically expert organization that's going places. Write, phone or wire the Chief Engineer, giving background and salary requirements.

**GREAT AMERICAN INDUSTRIES, INC.**

**70 Britannia St., Meriden, Conn.**

(Continued from page lviii)

recognition. Training in design of relays, timers and solenoids would be helpful. Write Box 285.

### PATENT ATTORNEY

Patent Attorney to join small Patent Department. Write Personnel Director, Brush Development Company, 3311 Perkins Avenue, Cleveland, Ohio.

### RADIO ENGINEER

Opening in engineering department of concern making communication apparatus. Prefer college graduate with ultra-high-frequency experience, but lack of experience in this field will not bar an adaptable man.

Duties involve developing, designing and carrying the product through the shop with a minimum of supervision. If inexperienced, the duties would be the same under supervision. The company is engaged in war activity exclusively and expects to continue this work after the war.

Salary \$2,500 to \$5,000 depending upon qualifications. Pleasant surroundings and working conditions. If now employed in war work, a release from the employer must be obtainable. Address: Chief Engineer, Templeone Radio Company, Mystic, Conn.

### TECHNICAL AND SCIENTIFIC AIDS

Federal government needs aids for research and testing in the following fields: chemistry, geology, geophysics, mathematics, metallurgy, meteorology, physics, and radio. The positions pay \$1,620 to \$2,600, plus overtime.

For the assistant grade, applications will be accepted from persons who have completed 1 year of paid experience or a war training course approved by the U. S. Office of Education. One year of college study, including 1 course in the option applied for, is also qualifying. Persons now enrolled in war training or college courses may apply, subject to completion of the course. For the higher grades successively greater amounts of education or experience are required.

The majority of positions are in Washington, D.C., but some will be filled in other parts of the United States. There are no age limits, and no written test is required. Persons using their highest skills in war work are not encouraged to apply.

Applications will be accepted at the U. S. Civil Service Commission, Washington, D.C., until the needs of the service have been met.

### INSTRUCTORS IN ADVANCED ARMY-NAVY PROGRAM

Prominent Eastern technical institute needs additional instructors in officer training program in modern electronics and radio applications. An excellent opportunity to acquire advanced knowledge and to render important service in war effort. Men having various degrees of qualifications are needed, from recent graduates in Electrical Engineering or Physics to those with long experience in radio engineering or teaching. Salary according to qualifications and experience. Applicants must be U. S. citizens of unimpeachable reputation. Any inquiries will be treated as highly confidential. Please send personnel data and photograph to Box 292.



### Attention Employers . . .

Announcements for "Positions Open" are accepted without charge from employers offering salaried employment of engineering grade to I.R.E. members. Please supply complete information and indicate which details should be treated as confidential. Address: "POSITIONS OPEN," Institute of Radio Engineers, 330 West 42nd Street, New York, N.Y.

The Institute reserves the right to refuse any announcement without giving a reason for the refusal.



**JAMES**

*Crystals*

**KNIGHTS**



*You...*

will use James Knights Precision Crystals in your broadcast receivers of tomorrow! Today, new James Knights developments make it possible to supply large numbers of Crystals of many types for the Nation's needs. If you have a vital Crystal problem—we can help you.

Phone  
65

PRECISION CUTTERS OF QUARTZ  
FOR RADIO AND OPTICAL USES

**The JAMES KNIGHTS Co.**  
SANDWICH, ILLINOIS



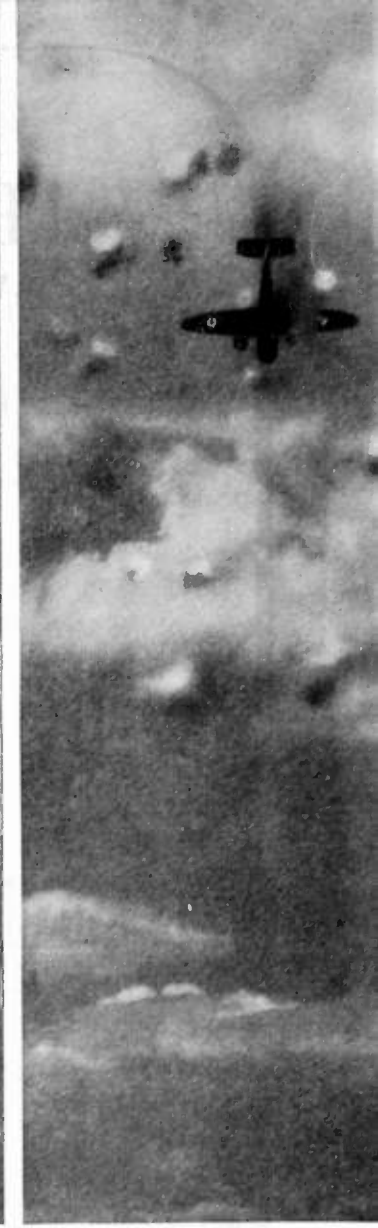
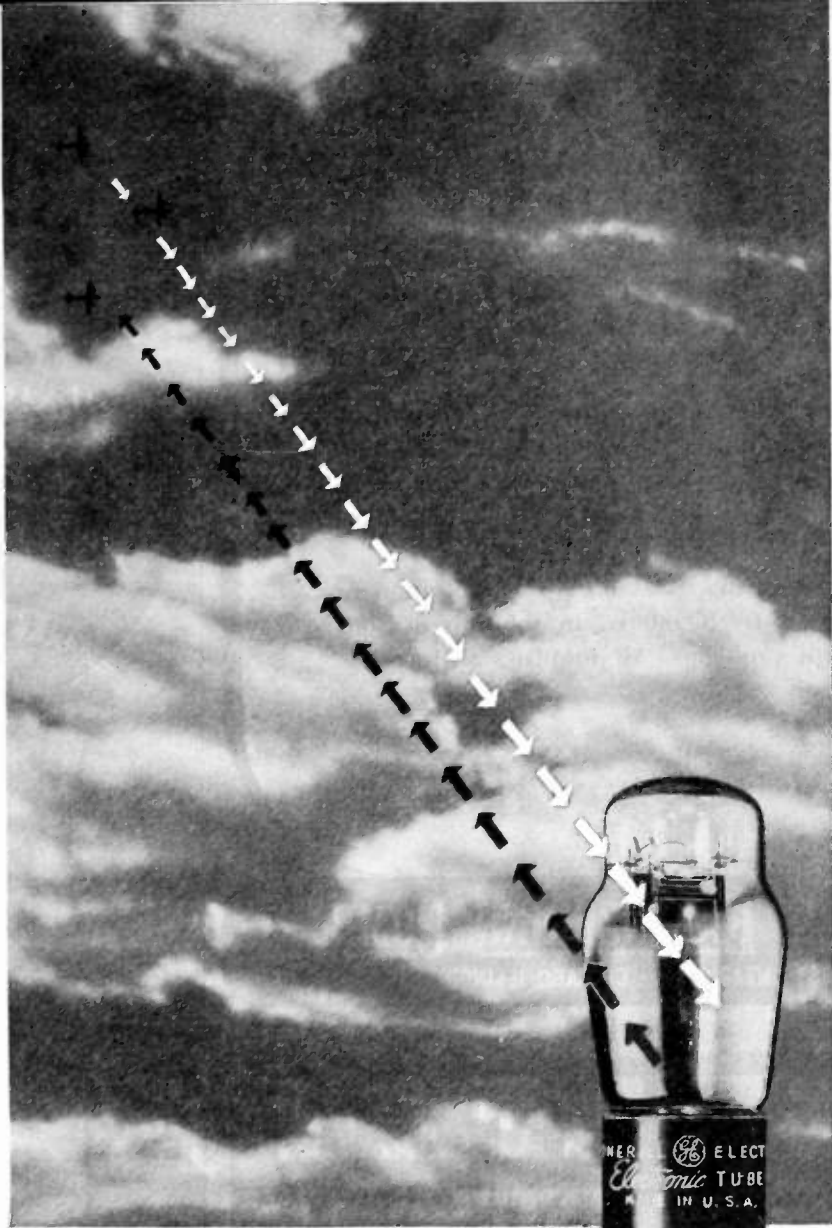
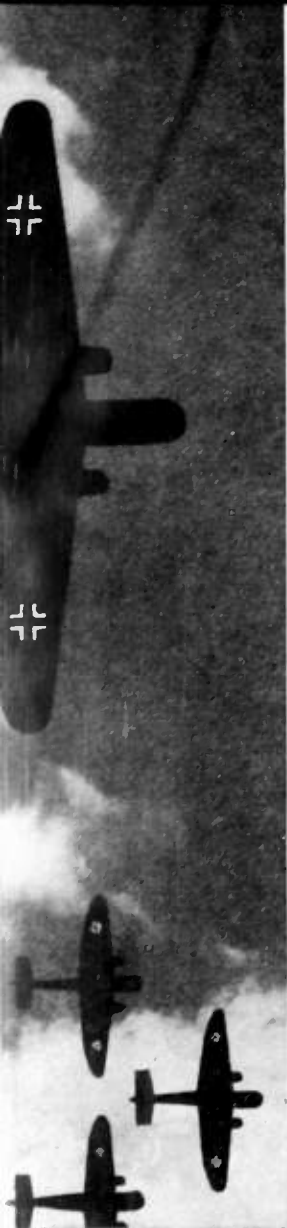

1. Enemy planes rise from distant airfields.

2. Radar sends out beam of ultra-high-frequency waves, reflected back to instruments which determine planes' location, speed, and direction.

3. Interceptor planes then surprise and destroy the advancing enemy.

# The facts about RADAR

"The whole history of Radar has been an example of successful collaboration between Allies on an international scale."

THE NEW YORK TIMES, MAY 16

This amazing electronic invention that locates distant planes and ships despite darkness and fog is a great co-operative achievement of Science and Industry.

In this country and in the British Isles, over 2000 scientists and engineers, some

working alone, some in the Army and the Navy, many in research laboratories of colleges and industrial firms, joined eagerly in the search for Radar knowledge.

**Team-work that succeeded.** Once this electronic device had been perfected, industry after industry rallied to the nation's call to manufacture Radar. General Electric is proud to have played a large part, with other manufacturers, in supplying to the Army and Navy this key weapon whose peacetime applications hold so high a promise.

As early as the Twenties, G-E engineers and scientists were developing the kind of high-frequency tubes, circuits and apparatus that make Radar possible. Thus long before Pearl Harbor, G-E was able to build Radar equipment.

Post-war applications will be many. Radar will guard and guide the flight of great commercial transports. Planes will land blind. Transoceanic liners will slip safely into fog-bound harbors — all with Radar detection equipment.

In addition to Radar, General Electric is supplying to the Army, Navy, and Marines radio transmitters, antennae and receivers, carrier-current equipment, all kinds of electronic measurement equipment, and monitors. *Electronics Department, General Electric, Schenectady, N.Y.*

Tune in General Electric's **WORLD TODAY** and hear the news from the men who see it happen, every evening except Sunday at 6:45 E.W.T. over C.B.S. . . . On Sunday evening listen to the G-E Mazda Lamp program over N.B.C. network.

**GENERAL ELECTRIC**

G-E employees are now purchasing over \$1,000,000 in War Bonds weekly

180-85

# PERMANENT MAGNETS



The Arnold Engineering Company produces all ALNICO types including ALNICO V. All magnets are completely manufactured in our own plant under close metallurgical, mechanical and magnetic control.

Engineering assistance by consultation or correspondence is freely offered in solution of your magnetic design problems. All inquiries will receive prompt attention.



## THE ARNOLD ENGINEERING COMPANY

147 EAST ONTARIO ST. • CHICAGO, ILLINOIS

# TRIPLLETT *Combat Line* INSTRUMENTS

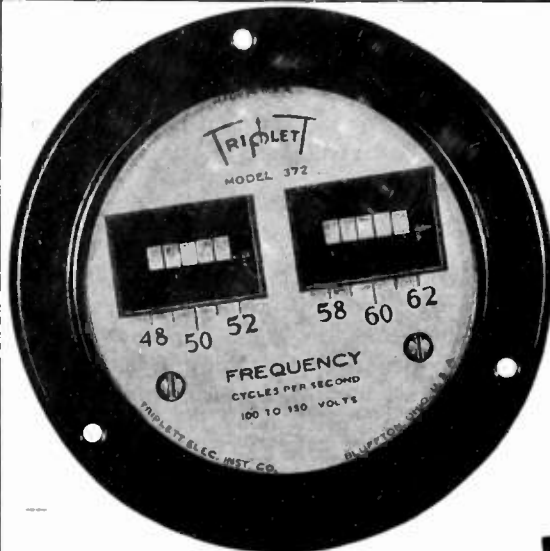

### TRIPLLETT MODEL 372

★  
"All American" make. Vibrating reed frequency meter. Maximum readability by grouping of reeds. Range—Frequency—Voltage to specific requirements. Illustration approximately full size.

Deliveries under government requirements are facilitated by two large sub-contracting organizations combining to greatly increase Triplett output.

TRIPLLETT ELECTRICAL INSTRUMENT CO. • BLUFFTON, OHIO

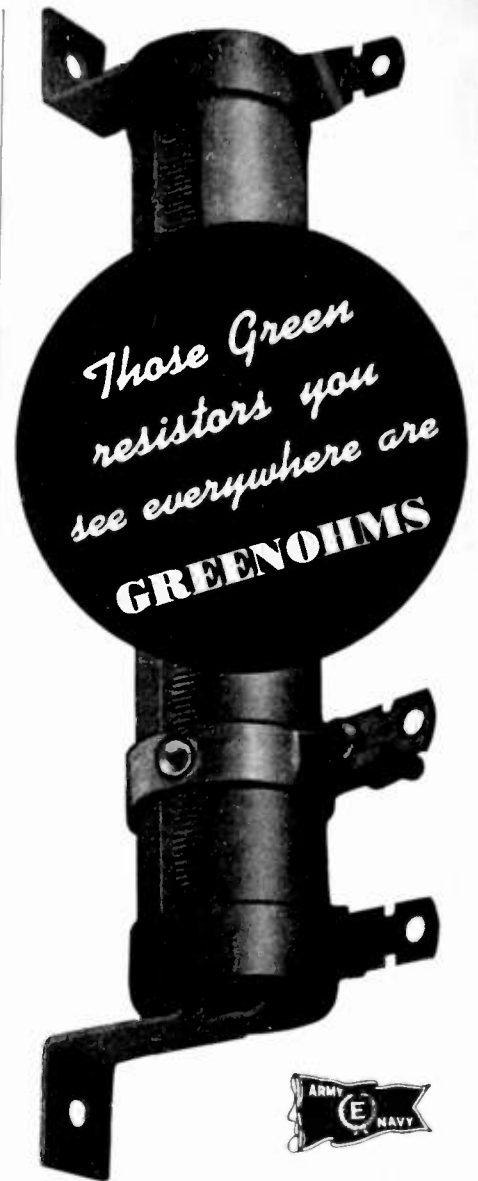

★ Yes sir, you see them everywhere—those green-colored special-inorganic-cement-coated power resistors. But more particularly in aircraft electrical, electronic and radio assemblies that must stand up, regardless.

Greenohms can take an awful beating. Even when seriously overloaded—red hot—they won't burn out, flake, peel, crack. Standard units: 10 and 20 watts fixed; adjustable, up to 200 watts. Also special types with choice of windings, taps, terminals, mountings. Remember, only Clarostat makes Greenohms.

★ Consult us . . .



CLAROSTAT MFG. CO., Inc. • 285-7 N. 6th St., Brooklyn, N. Y.





Said the Patrol Plane to the Carrier:  
**"Enemy raider sighted  
 -- due North!"**

They work together better . . .  
 because they can talk together

The streaking  
 Reconnaissance plane  
 Can't wait  
 Until its wheels touch  
 The lifting flat top  
 To tell its news . . .

While still  
 Only a growing shape  
 Over the horizon  
 This homing eagle  
 Calls to the mother ship . . .  
 Summons its brother warbirds  
 To the kill . . .  
*By radio.*

In a matter of minutes  
 The whole angry brood  
 Will swarm down  
 And polish off  
 The fleeing cruiser that

Just a few seconds before  
 Was a threat  
 To our bridge of ships . . .

Seconds count  
 In this thundering war  
 Of time and teamwork . . .  
 And seconds are saved  
 By the radiotelephone.

Today, modern radio equipment  
 Designed and manufactured  
 By I.T.&T. associate companies  
 Is helping Uncle Sam's fighting forces  
 Work together  
 On land, sea, and in the air . . .

Tomorrow, the broad experience  
 Of I.T.&T.  
 In the field of communications  
 Will help men build  
 A better world.

INTERNATIONAL TELEPHONE AND TELEGRAPH CORPORATION 67 Broad St., New York, N. Y.

**I T & T**

Manufacturing Associate:

FEDERAL TELEPHONE AND RADIO CORPORATION

# ACCURATE



Accuracy and dependability are built into every Bliley Crystal Unit. Specify BLILEY for assured performance.  
BLILEY ELECTRIC COMPANY  
EBU, PENNSYLVANIA

## Bliley Crystals

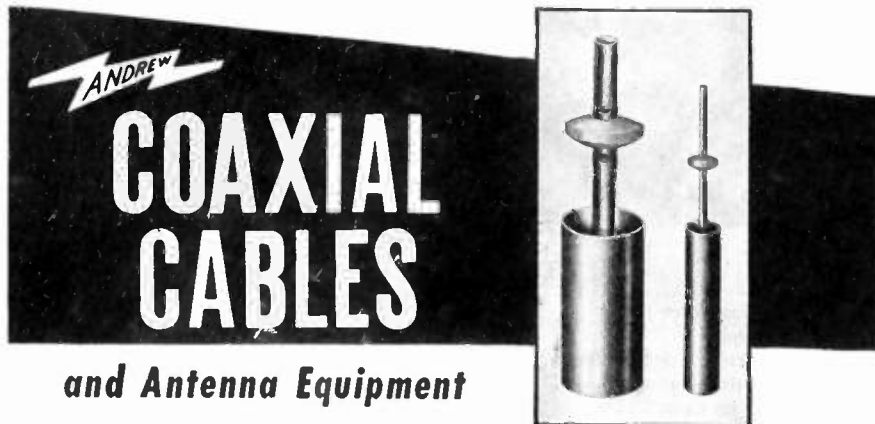

## ANDREW COAXIAL CABLES

and Antenna Equipment

If you need ceramic insulated coaxial cables, you are invited to consult the engineering staff of the Victor J. Andrew Company for recommendations to meet *your* requirements. The Andrew Company, pioneer specialists in the manufacture of antenna equipment, is now in a position to take additional orders, in quantity, for all sizes of ceramic insulated coaxial cables and equipment for all applications.

*If coaxial cables are your problem . . . write for new catalog showing complete line of coaxial cables and accessories.*

**VICTOR J. ANDREW CO.**

363 East 75th Street, CHICAGO, ILLINOIS  
ANTENNA EQUIPMENT

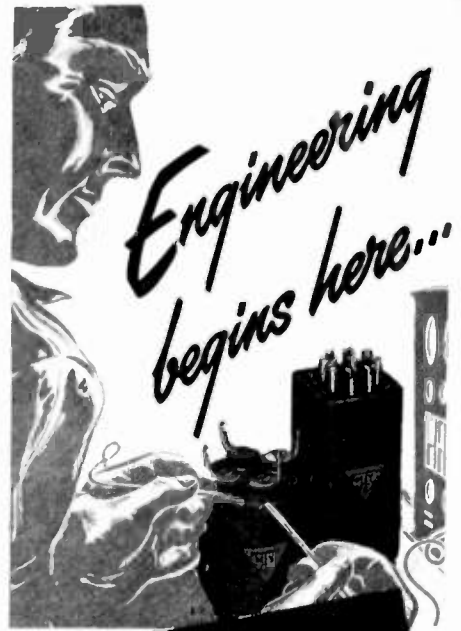

**FOR THE SOLUTION  
OF TRANSFORMER  
PROBLEMS**

Grey matter—as measured in terms of Victory in war, or progress in peacetime—is a decisive, tangible factor. Strategies, techniques and analyses—whether for military or commerce—are its by-products. Success is directly proportionate to the quality involved.

The calibre of N-Y-T engineering is proved by the thousands of new transformer designs evolved to individual requirements over the past few years. These audio and power components are now assuming a vitally important role in World War II, in Army, Navy and Air Corps applications.

When the world crisis is over, and our present 100% Victory effort terminates, N-Y-T engineers and technicians will be available for collaboration in the solution of your transformer problems. The vast experience gained now, should be of tremendous value then.

**NEW YORK  
TRANSFORMER  
COMPANY**



24-26 WAVERLY PLACE NEW YORK, N. Y.

Proceedings of the I.R.E. July, 1943

# SALUTE TO THE WORLD OF TOMORROW!

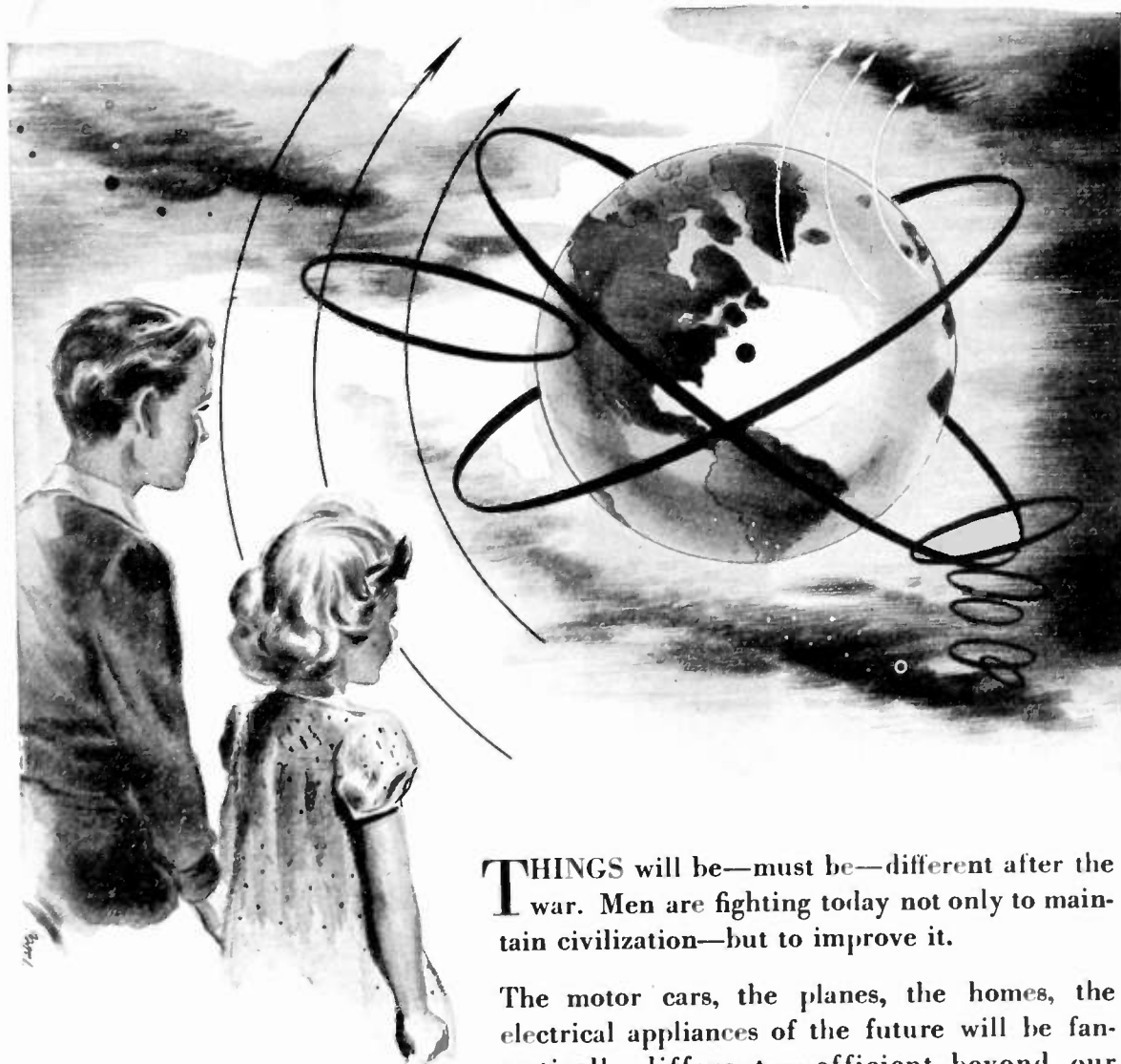

**T**HINGS will be—must be—different after the war. Men are fighting today not only to maintain civilization—but to improve it.

The motor cars, the planes, the homes, the electrical appliances of the future will be fantastically different — efficient beyond our present dreams,

Industrial leadership in this world of tomorrow will be won by today's most forward-minded organizations. This new spirit of progressive enterprise is typified by Small Electric Motors (Canada) Limited.

Here, where all activities are geared to war production, the groundwork is already set, through research and invention, for revolutionary peace-time products for ships and planes—for homes and factories!

## DESIGNERS

AND MANUFACTURERS  
of all types of precision  
electrical apparatus  
including

*D.C. & A.C. Motors for  
specialized purposes  
Aircraft Generators  
Aircraft Engine Starters  
Alternators  
Motor Generators  
Electric Pumps  
Motors with Governors  
Gyros, etc.*

*Small Electric Motors (Canada) Limited*

LEASIDE • TORONTO 12 • CANADA

3-43



## A Flag with 46,200 Stars

**T**HE service flag of the Bell System had 46,200 stars on May 1. It has a lot more now. Telephone men and women are serving with the armed forces everywhere.

Those who are right in the middle of the fighting realize especially the importance of the telephone job back home.

"Tell the gang," their letters say, "to keep on plugging."

"We wouldn't have the stuff for fighting if the rest of the Bell System wasn't sticking to the job and pushing through the calls that get things done.

"Takes team-work to win a war — especially a big one like this."

BELL TELEPHONE SYSTEM



*★ Your continued help in making only vital calls to war-busy centers is more and more essential every day.*



# for Permanent resistance today and tomorrow...

**OHMITE**  
Resistance Units



Many factors contribute to the permanent performance of Ohmite Units—factors of design and construction that enable them to meet every condition of service . . . to withstand shock, vibration, heat and humidity . . . and keep going. These characteristics make Ohmite Rheostats, Resistors, Chokes and Tap Switches especially well fit for today's critical wartime needs.

What's more . . . Ohmite leadership in developing an extensive range of types and sizes has made it possible to serve innumerable applications. All this, of course, makes them readily applicable for the new peacetime products of tomorrow. Ohmite Engineers are glad to assist on any problem for today . . . or tomorrow. Write on company letterhead for helpful Industrial Catalog and Engineering Manual No. 40.

**Send for Handy Ohmite Ohm's Law Calculator.** Thousands of these Ohmite Calculators are in practical use today. Figures ohms, watts, volts, amperes—quickly, easily. Solves any Ohm's Law problem with one setting of the slide. All values are direct reading. Send only 10c in coin to cover handling and mailing. (Also available in quantities.)

**OHMITE MANUFACTURING COMPANY**  
4860 FLOURNOY STREET, CHICAGO, U. S. A.



# REMOTE CONTROL

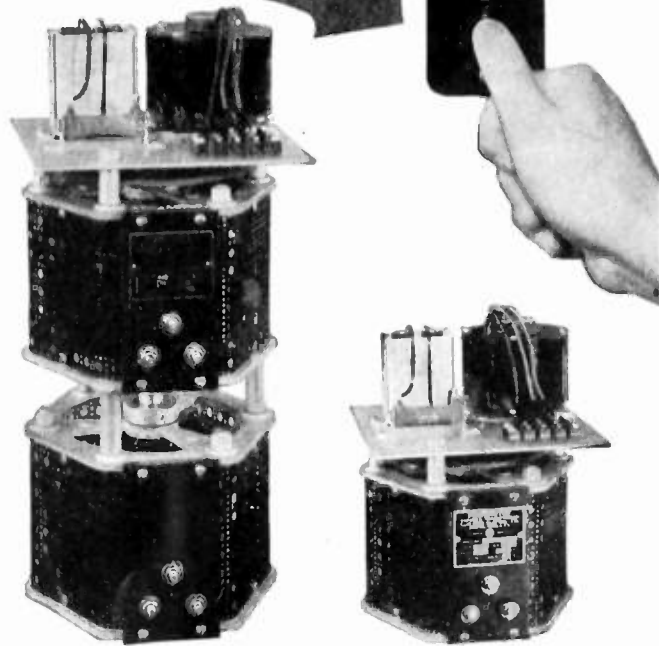

Available in sizes up to 75 KVA

Large amounts of POWER can now be controlled by a push button or automatic device

Choose POWERSTAT MOTOR DRIVEN VARIABLE TRANSFORMERS for control. When regulation of voltage, current or power is necessary in your design, POWERSTATS are the answer to your most rigid specifications. This equipment is an engineered combination of a POWERSTAT VARIABLE TRANSFORMER and a highly damped low speed motor of advanced design.

for

SMOOTH STEPLESS CONTROL

EXACTING CORRECTION

FREEDOM FROM OVERSHOOTING

ZERO WAVE FORM DISTORTION

CONNECTION TO AUTOMATIC OR PUSH BUTTON CONTROL STATIONS

GOOD REGULATION WHERE OUTPUT IS TO BE INDEPENDENT OF LOAD AND POWER FACTOR

SELECT

POWERSTAT MOTOR DRIVEN VARIABLE TRANSFORMERS

Send for POWERSTAT Bulletin No. 149 ER and Automatic Voltage Regulator Bulletin No. 163 ER.

## SUPERIOR ELECTRIC CO.

174 LAUREL ST. BRISTOL, CONN.

# INDEX

Positions Open .....	xxvii
Section Meetings .....	xliii
Membership .....	xliv

## DISPLAY ADVERTISERS

Aerovox Corporation .....	lii
Aircraft Accessories Corp. ....	xliii
Alliance Manufacturing Co. ....	xlix
American Lava Corporation .....	xxvii
American Telephone & Telegraph Co. ....	lxviii
American Transformer Co. ....	xlv
Amperex Electronic Products, Inc. ....	Cover II
Victor J. Andrew Company .....	lxvi
Arnold Engineering Co. ....	lxiv
Bendix Aviation Corp. ....	viii
Biiley Electric Co. ....	lxvi
Browning Laboratories, Inc. ....	ix
Centralab .....	lxvii
Clarostat Manufacturing Co. ....	lxiv
Connecticut Telephone & Electric .....	xxiii
Cornell-Dubilier Electric Corp. ....	Cover III
Daven Company .....	xxv
DeJur-Amsco Corporation .....	xxx
Tobe Deutschmann Corp. ....	lxxi
Wilbur B. Driver Company .....	xv
DX Crystal Company .....	lxvii
Eitel-McCullough, Inc. ....	xvi
Electronic Corp. of America .....	xxxi
Electronic Laboratories, Inc. ....	vi
Electronic Mechanics, Inc. ....	xxviii
Electro-Voice Mfg. Co., Inc. ....	ii
Federal Telephone & Radio Corp. ....	lxv
Galvin Mfg. Co. ....	xxi
General Electric Co. ....	lxviii
General Instrument Corp. ....	xxviii
General Radio Company .....	Cover IV
Great American Industries, Inc. ....	ix
Hallicrafters Co. ....	xx
Harvey Radio Laboratories, Inc. ....	lxvii
Heintz & Kaufman, Ltd. ....	lix
Hewlett-Packard Co. ....	xxvi
Hytron Corporation .....	xxix
Industrial Condenser Corp. ....	xliv
International Resistance Co. ....	Facing ix
International Tel. & Tel. Corp. ....	lxv
Isolantite Inc. ....	Facing viii
Jackson Electrical Instrument Co. ....	lviii
Kenyon Transformer Co., Inc. ....	li
James Knights Company .....	lxii
Lafayette Radio Corp. ....	l
John Meck Industries .....	xxviii
Mycalex Corp. of America .....	xxviii
National Company, Inc. ....	xl
National Union Radio Corp. ....	v
New York Transformer Co. ....	lxvi
North American Philips Co., Inc. ....	lv
Ohmite Mfg. Co. ....	lxix
Permotlux Corp. ....	xxvii
Pioneer Gen-E-Motor Corp. ....	lvi
Premax Products .....	lxiii
Radio Corp. of America, Victor Div. ....	xii, xiii, xxiv, xxv, xli
Rauland Corp. ....	ii
Remler Company, Ltd. ....	xliii
Rola Company, Inc. ....	xxviii
Shalleross Mfg. Co. ....	xlviii
Shure Brothers .....	xlvii
Small Electric Motors (Canada) Ltd. ....	lxvii
Sola Electric Co. ....	xix
Solar Mfg. Corp. ....	xvii
Sprague Specialties Co. ....	xlix
Stackpole Carbon Co. ....	xxvix
Standard Transformer Corp. ....	xviii
Stupakoff Ceramic & Mfg. Co. ....	lvii
Superior Electric Co. ....	lxv
Taylor Tubes, Inc. ....	xiv
Thordarson Elec. Mfg. Co. ....	lii
Triplett Electrical Instrument Co. ....	lxiv
United Electronics Co. ....	iv
United Transformer Co. ....	xi
Utah Radio Products Co. ....	xxviii
Westinghouse Elec. & Mfg. Co. ....	vii
Wilcox Electric Co. ....	xxix

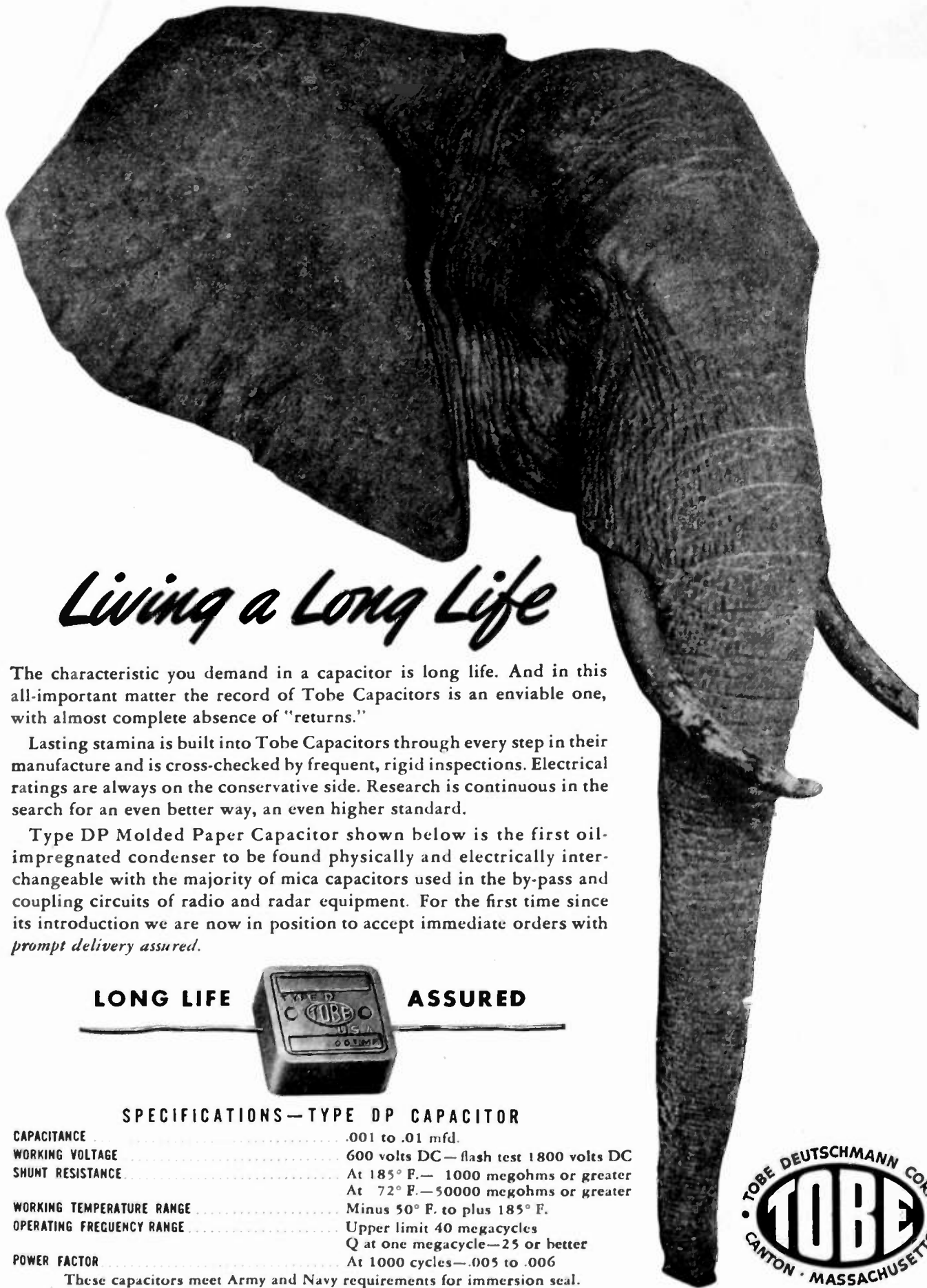

# Living a Long Life

The characteristic you demand in a capacitor is long life. And in this all-important matter the record of Tobe Capacitors is an enviable one, with almost complete absence of "returns."

Lasting stamina is built into Tobe Capacitors through every step in their manufacture and is cross-checked by frequent, rigid inspections. Electrical ratings are always on the conservative side. Research is continuous in the search for an even better way, an even higher standard.

Type DP Molded Paper Capacitor shown below is the first oil-impregnated condenser to be found physically and electrically interchangeable with the majority of mica capacitors used in the by-pass and coupling circuits of radio and radar equipment. For the first time since its introduction we are now in position to accept immediate orders with *prompt delivery assured.*

**LONG LIFE**



**ASSURED**

## SPECIFICATIONS—TYPE DP CAPACITOR

CAPACITANCE .....	.001 to .01 mfd.
WORKING VOLTAGE .....	600 volts DC—flash test 1800 volts DC
SHUNT RESISTANCE .....	At 185° F.— 1000 megohms or greater At 72° F.—50000 megohms or greater
WORKING TEMPERATURE RANGE .....	Minus 50° F. to plus 185° F.
OPERATING FREQUENCY RANGE .....	Upper limit 40 megacycles Q at one megacycle—25 or better
POWER FACTOR .....	At 1000 cycles—.005 to .006

These capacitors meet Army and Navy requirements for immersion seal.



**A SMALL PART IN VICTORY TODAY — A BIG PART IN INDUSTRY TOMORROW**



# Ceramics by Centralab

## NO NEED TO RATION STEATITE

Fortunately you do not need to worry about a substitute for Steatite, since it is now more available than formerly proposed substitutes. We are equipped to furnish Steatite coil forms up to 5 inches diameter and pressed pieces to approximately 6 inches square. Our production, engineering and laboratory facilities are at your disposal.

# Centralab

Division of Globe-Union Inc., Milwaukee, Wisconsin





the order  
must get  
through  
**QUICKLY!**

Today, time isn't the methodical ticking away of the minutes and hours. Today, time is LIFE — life which is often absolutely dependent on the split-second accuracy and unfailing reliability of communications in action. We have made it our responsibility to provide capacitors that you can depend on, no matter how tough the operating conditions might be. We can do this because 33 years of invaluable experience goes into the making of every C-D capacitor. Cornell-Dubilier Electric Corporation, South Plainfield, New Jersey.

MORE IN USE TODAY THAN ANY OTHER MAKE

*Cornell-Dubilier*  
*capacitors*

Mica • Dykanol • Paper • Wet & Dry Electrolytics



**CYLINDRICAL FILTER CAPACITORS  
TYPE TQ**

The type TQ Dykanol Filter Capacitors are supplied with two insulated terminals and universal mounting bracket for mounting either above or below subpanel assembly. These units are ideally suited for high power amplifying systems, where utmost dependability is essential and space limitations are severe. Check these unusual features.

Impregnated and filled with Dykanol, the non-inflammable chlorinated diphenyl impregnant, of outstanding dielectric characteristics.

Dried, impregnated and filled under continuous vacuum and then hermetically sealed.

Glazed porcelain or bakelite terminal insulators—according voltage rating of unit.

Rigidly tested and conservatively rated. Will safely operate at 10% overloading.

The type TQ Dykanol capacitors and others in the complete C-D line are described in Catalog No. 160T now available.



SERVICE AND MAINTENANCE NOTES  
for the  
TYPE 650-A IMPEDANCE BRIDGE

1.0 GENERAL MAINTENANCE ★

1.1 From time to time all switch blades and contacts and the contact surfaces of the four potentiometers should be cleaned and lubricated. For cleaning, it is recommended that a solution of half ether and half alcohol be used, followed by a few light strokes with crocus cloth. A very light smear of petrolatum should then be applied, except on the GENERATOR and DETECTOR switches and the cam switch on the CRU. HILL switch shaft. In

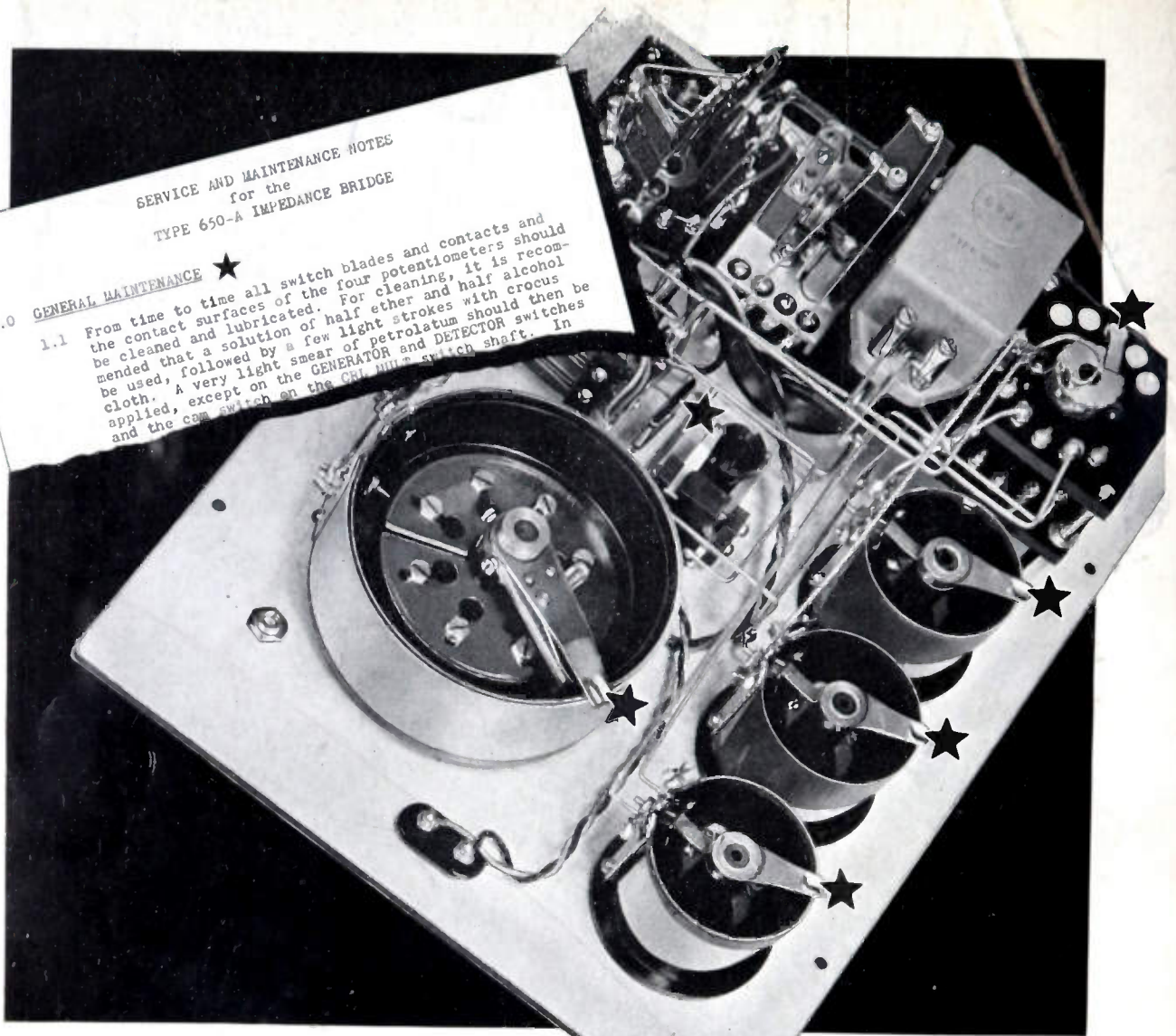

# MAINTENANCE

## helps to keep them in service



★ Thousands of users of General Radio instruments find our SERVICE AND MAINTENANCE NOTES useful in keeping their instruments in service. If you do not already have these notes for your GR instruments, send us the type numbers and serial numbers of the equipment you have. Your service notes will be forwarded promptly.

Your impedance bridge, like your automobile, needs occasional cleaning and lubrication.

Moving contacts wear out faster when dry and when dust gets into them. Neglect may result in failure when equipment is needed most.

Periodic maintenance will go a long way toward keeping your electrical test equipment in trouble-free operation. Increased life and reliability will more than repay you for the effort. Set up a definite maintenance program for your test equipment.



**GENERAL RADIO COMPANY · Cambridge, Massachusetts**

NEW YORK

LOS ANGELES