

Proceedings



of the

I·R·E

MARCH 1943

VOLUME 31 NUMBER 3



Official U. S. Navy Photograph

BRIDGING SNOWY WASTES

Wartime Service

F-M Tuning Indicators

Wartime Broadcast Operations

Television View Finders

Television Studio Lighting

Distortion Meter

Institute of Radio Engineers



*To Build the Machines
to Build the Tools
to Beat the Axis*



U.S. Navy Official Photo

Tubes for INDUSTRIAL electronic devices that help to increase production are regarded as no less important than the use of such tubes in some military communications needs. Consequently, they are available to manufacturers of essential INDUSTRIAL electronic equipment.

AMPEREX power and rectifier tubes are incorporated in many of these new machines that make the tools . . . and forge the weapons . . . to defeat the Axis.

If you have a problem in which electronic tubes are required for machines that will help to speed war production, consult our engineering department.

AMPEREX ELECTRONIC PRODUCTS
79 WASHINGTON STREET ● BROOKLYN, NEW YORK

BOARD OF DIRECTORS

1943

- Lynde P. Wheeler, *President*
 F. Sherbrooke Barton,
Vice President
 Raymond A. Heising, *Treasurer*
 Haraden Pratt, *Secretary*
 Alfred N. Goldsmith, *Editor*
 Stuart L. Bailey
 Wilmer L. Barrow
 E. Finley Carter
 Adolph B. Chamberlain
 Ivan S. Coggeshall
 William L. Everitt
 Harold T. Friis
 Gilbert E. Gustafson
 O. B. Hanson
 Frederick B. Llewellyn
 Frederick E. Terman
 Browder J. Thompson
 Hubert M. Turner
 Arthur F. Van Dyck
 Harold A. Wheeler
 William C. White

•
 Harold R. Zeamans,
General Counsel

BOARD OF EDITORS

- Alfred N. Goldsmith, *Editor*
 Ralph R. Batcher
 Philip S. Carter
 Lewis M. Clement
 Elmer W. Engstrom
 William L. Everitt
 Peter C. Goldmark
 Frederick W. Grover
 C. M. Jansky, Jr.
 John D. Kraus
 Frederick B. Llewellyn
 Samuel S. Mackeown
 Edward I. Nelson
 Harry F. Olson
 Greenleaf W. Pickard
 Haraden Pratt
 Conan A. Priest
 Lynne C. Smeby
 Browder J. Thompson
 Harold A. Wheeler
 Laurens E. Whittemore
 Gerald W. Willard
 William Wilson
 Charles J. Young

•
 Helen M. Stote,
Associate Editor
 William C. Copp,
Advertising Manager
 William B. Cowilich,
Assistant Secretary

Proceedings

of the I·R·E

Published Monthly by

The Institute of Radio Engineers, Inc.

VOLUME 31

March, 1943

NUMBER 3

Wartime Service	Board of Directors	87
Charles McKinley Saltzman, 1871-1942		88
Tuning Indicators and Circuits for Frequency-Modulation Receivers	John A. Rodgers	89
Maintenance of Broadcast Operations in Wartime	J. A. Ouimet	93
The Focusing View-Finder Problem in Television Cameras	G. L. Beers	100
Mercury Lighting for Television Studios	H. A. Breeding	106
A New Type of Practical Distortion Meter	J. E. Hayes	112
Institute News and Radio Notes		118
Wartime Engineering Accomplishments		118
Winter Conference—1943		118
Board of Directors		119
Executive Committee		119
Leslie J. Woods		119
Books: "The Electrical Fundamentals of Communications," by Arthur L. Albert	Ralph R. Batcher	119
"Fundamentals of Radio," Edited by William L. Everitt	Ralph R. Batcher	120
"Principles of Electron Tubes," by Herbert J. Reich	H. M. Turner	120
"A Graphic Table Combining Logarithms and Anti-Logarithms," by Adrian Lacroix and Charles L. Ragot	Frederick W. Grover	120
"Microwave Transmission," by J. C. Slater	S. D. Robertson	120
"Fundamentals of Electric Waves," by Hugh Hildreth Skilling	S. A. Schelkunoff	121
"Aligning Philco Receivers, Volume II, 1941," by John F. Rider	W. O. Swinyard	121
"Principles of Radio, Fourth Edition," by Keith Henney	Knox McIlwain	121
"An Introduction to the Operational Calculus, First Edition, 1941," by Walter J. Seeley	L. P. Wheeler	121
Contributors		122
Section Meetings		xviii
Membership		xviii
Booklets		xxx
New Equipment Notes		xxxviii
Current Literature		xliv
Positions Open		xlvi
Fire Prevention Requirements for Electric Radios Revised	H. B. Smith	liv
Advertising Index		lxii

Responsibility for the contents of papers published in the PROCEEDINGS rests upon the authors. Statements made in papers are not binding on the Institute or its members.



Entered as second-class matter October 26, 1927, at the post office at Menasha, Wisconsin, under the Act of February 28, 1925, embodied in Paragraph 4, Section 538 of the Postal Laws and Regulations. Publication office, 450 Ahnaip Street, Menasha, Wisconsin. Editorial and advertising offices, 330 West 42nd St., New York, N. Y. Subscription \$10.00 per year; foreign, \$11.00.

THE INSTITUTE OF RADIO ENGINEERS

INCORPORATED



SECTION MEETINGS

ATLANTA March 19	CHICAGO March 19	CLEVELAND March 25	DETROIT March 19	
LOS ANGELES March 16	NEW YORK April 7	PHILADELPHIA April 8	PITTSBURGH April 12	WASHINGTON April 12

SECTIONS

- ATLANTA**—Chairman, J. M. Comer; Secretary, Ivan Miles, 554—14 St., N. W., Atlanta, Ga.
- BALTIMORE**—Chairman, G. J. Gross; Secretary, A. D. Williams, Bendix Radio Corp., E. Joppa Rd., Towson, Md.
- BOSTON**—Chairman, R. F. Field; Secretary, R. O. Oberg, Northeastern Univ., Boston, Mass.
- BUENOS AIRES**—Chairman, J. P. Arnaud; Secretary, Alexander Nadosy, Florida St. 1065, Dept. C-6, Buenos Aires, Argentina.
- BUFFALO-NIAGARA**—Chairman, F. H. Scheer; Secretary, A. J. Dybowski, Dymac Radio, Inc., 1531 Main St., Buffalo, N. Y.
- CHICAGO**—Chairman, A. B. Bronwell; Secretary, W. O. Swinyard, Hazeltine Electronics Corp., 325 W. Huron St., Chicago, Ill.
- CINCINNATI**—Chairman, Howard Leppele; Secretary, J. L. Hollis, 6511 Betts Ave., Cincinnati, Ohio.
- CLEVELAND**—Chairman, P. L. Hoover; Secretary, A. S. Nace, 3209 Archwood Ave., Cleveland, Ohio.
- CONNECTICUT VALLEY**—Chairman, W. M. Smith; Secretary, R. E. Moe, Radio Dept., General Electric Co., Bridgeport, Conn.
- DALLAS-FORT WORTH**—Chairman, H. E. Applegate; Secretary, P. C. Barnes, Radio Station WFAA-WBAP, Grapevine, Texas.
- DETROIT**—Chairman, F. M. Hartz; Secretary, E. J. Hughes, 14209 Prevost, Detroit, Mich.
- EMPORIUM**—Chairman, R. K. Gessford; Secretary, H. D. Johnson, Sylvania Electric Products, Inc., Emporium, Pa.
- INDIANAPOLIS**—Chairman, S. E. Benson; Secretary, B. H. Rinehart, 1920 Park Ave., Indianapolis, Ind.
- KANSAS CITY**—Chairman, H. K. Morgan; Secretary G. L. Taylor, Midland Radio School Power and Light Building, Kansas City, Mo.
- LOS ANGELES**—Chairman, Lester Bowman; Secretary, R. C. Moody, Don Lee Broadcasting System, 5515 Melrose, Hollywood, Calif.
- MONTREAL**—Chairman, J. A. Ouimet; Secretary, J. R. Bain, Dept. 912, Northern Electric Co., 1231 Shearer St., Montreal, Que., Canada.
- NEW YORK**—Chairman, H. M. Lewis; Secretary, H. F. Dart, 33 Burnett St., Glen Ridge, N. J.
- PHILADELPHIA**—Chairman, J. B. Coleman; Secretary, H. J. Schrader, Bldg. 8, Fl. 10, RCA Manufacturing Co., Camden, N. J.
- PITTSBURGH**—Chairman, D. A. Myer; Secretary, A. P. Sunnergren, West Penn Power Co., 14 Wood St., Pittsburgh, Pa.
- PORTLAND**—Chairman, K. G. Clark; Secretary, E. D. Scott, Rt. 14, Box 414, Portland, Ore.
- ROCHESTER**—Chairman, O. L. Angevine, Jr.; Secretary, G. R. Town, Stromberg-Carlson Tel. Mfg. Co., Rochester, N. Y.
- ST. LOUIS**—Chairman, P. S. McDaniel; Secretary, H. D. Seielstad, 1017 S. Berry Rd., St. Louis, Mo.
- SAN FRANCISCO**—Chairman, Karl Spangenberg; Secretary, David Packard, Hewlett-Packard Co., Palto Alto, Calif.
- SEATTLE**—Chairman, K. H. Ellerbeck; Secretary, H. E. Renfro, 4311 Thackeray Pl., Seattle, Wash.
- TORONTO**—Chairman, T. S. Farley; Secretary, J. T. Pfeiffer, Erie Resistor of Canada, Ltd., Terminal Warehouse Bldg., Toronto, Ont., Canada.
- TWIN CITIES**—Chairman, R. E. Allison; Secretary, A. G. Peck, Twin-Cities Studios, Columbia Broadcasting System, 625 Second Ave., S., Minneapolis, Minn.
- WASHINGTON**—Chairman, C. M. Hunt; Secretary, H. A. Burroughs, Rm. 7207, Federal Communications Commission, Washington, D. C.

Quality Capacitors Backed by

AEROVOX Application Engineering

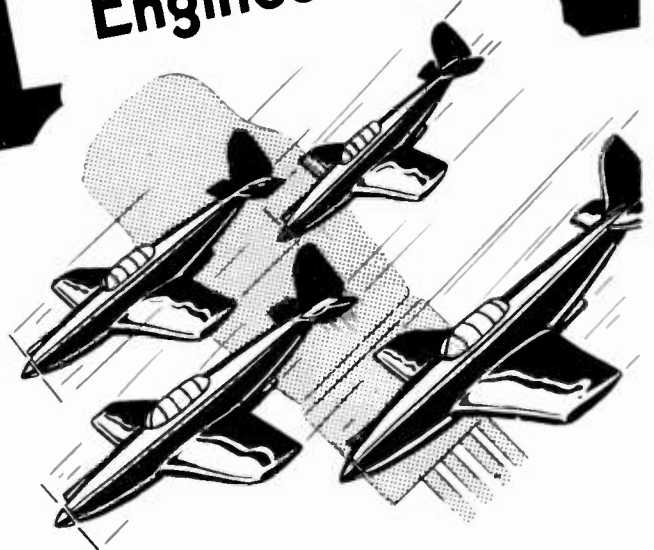

Aerovox Series 1870 medium-duty cast-aluminum-case transmitting capacitor. Particularly suitable for all frequencies except the ultra-high-frequencies. Completely shielded from stray fields of adjacent components, in maintaining stable circuit characteristics. Individual mica sections rigidly and non-magnetically clamped. Thoroughly vacuum-impregnated and sealed in metal case with low-loss filler. Corona losses avoided by stack construction design, grounded case, and single corrugated high-tension steatite and brass-stud terminal assembly. A quality capacitor—backed by A.A.E. (Aerovox Application Engineering)

● Supplying quality capacitors—standard and special types alike, in any quantities, is just half of the Aerovox job. Of equal if not greater significance is the *proper application* of such capacitors; for, unless quality capacitors are properly applied, they may fail to render satisfactory service.

Which explains why Aerovox places such importance on *application engineering*. Over the past two decades Aerovox not only has produced millions upon millions of quality capacitors, but, more important still, has collaborated with designers,

engineers and manufacturers in the correct application of such components. This background of application experience, probably second to none in the industry, is just as responsible for outstanding performance of Aerovox capacitors as their inherent goodness.

So be sure to bear A.A.E. (Aerovox Application Engineering) in mind when you are considering capacitors. It is an indispensable factor in capacitor performance, life, economy. It is available to you when you specify "Aerovox" capacitors.

NEW BEDFORD, MASS.,
U. S. A.
Sales Offices in All
Principal Cities

AEROVOX

CORPORATION



In Canada
AEROVOX CANADA LTD.
Hamilton, Ont.
EXPORT: 100 Varick St., N. Y.
Cable 'ARLAB'

Ready Room



A laugh. A smoke. A last lingering look at the chart. It won't be long now.

You're rarin' to go, Tom. It isn't easy to sit back and tell funny stories . . . waiting for the call.

Maybe you're a little scared. Who wouldn't be? But you're ready.

You're ready because you're a fighter pilot with the best training, the best equipment and the best cause on earth.

There she goes, Tom! Good luck . . . and God bless you!

Overnight we changed at ALCO to the sort of setup that would get things ready for Tom. That meant going on a 24-hour basis, developing the speed, facilities, personnel for insuring maximum wartime production to the extent of ten times 1939 production. Unhappily, too, it meant deserting the AlSiMag needs of long-time ALCO friends of 40 years standing. We're geared to the war job now . . . and it's full speed ahead and all of it financed without government participation!

The ALCO plant was on the first list of 43 awards for excellence in quality and quantity of war production.



ALSiMAG

TRADE MARK REGISTERED U. S. PATENT OFFICE

AMERICAN LAVA CORPORATION
CHATTANOOGA, TENNESSEE

Waste is as damnable as sabotage

Electrical and mechanical design are the foundation of our military production. Small individual savings, when multiplied in mass production, add up to large savings in critical materials and labor time. Here are some examples from our organization:

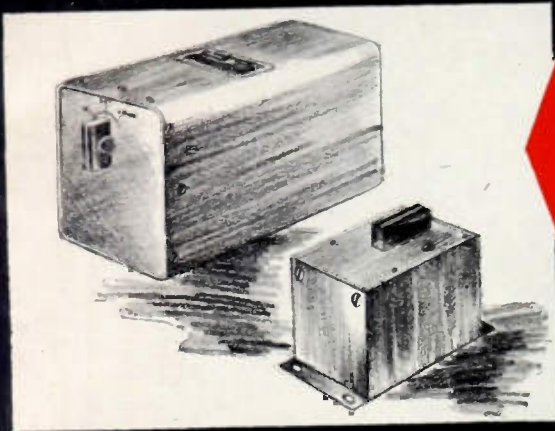

Cumulative electrical and mechanical redesign reduced the quantity of critical materials in this unit 60%, reduced total size and weight in direct proportion.

Through proper mechanical redesign, the weight and volume of this unit were halved, yet the same mounting centers were maintained for field replacements.

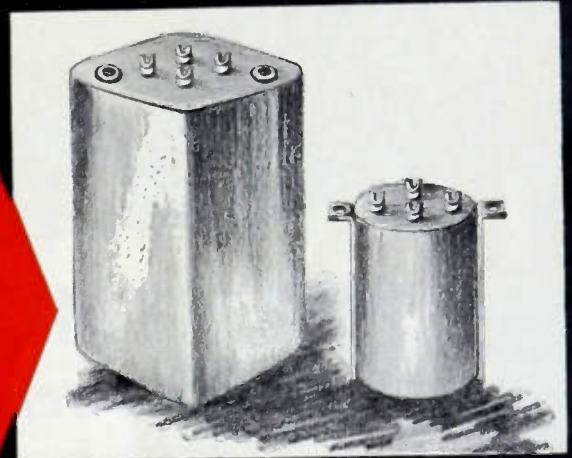

This application employed three of our Ouncer units. By combining the three in one case, we eliminated two aluminum housings, four terminals, two terminal strips, etc.

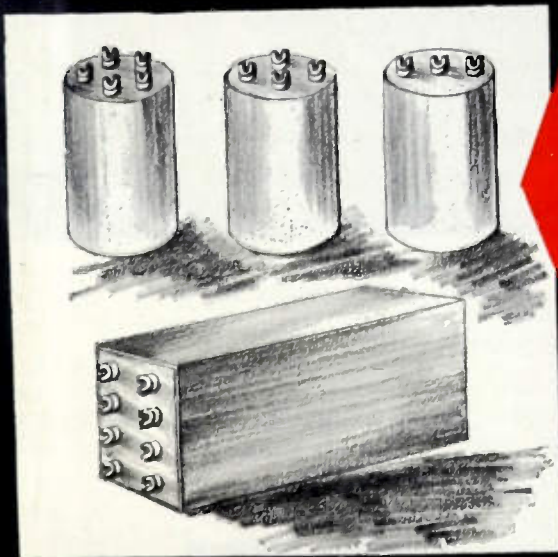

Electrical redesign reduced the amount of nickel iron alloy used in this filter by 50% . . . the mechanical redesign eliminated a dozen brass brackets and screws and cut installation time one-half hour.



UNITED TRANSFORMER CO.

150 VARICK STREET



NEW YORK, N. Y.

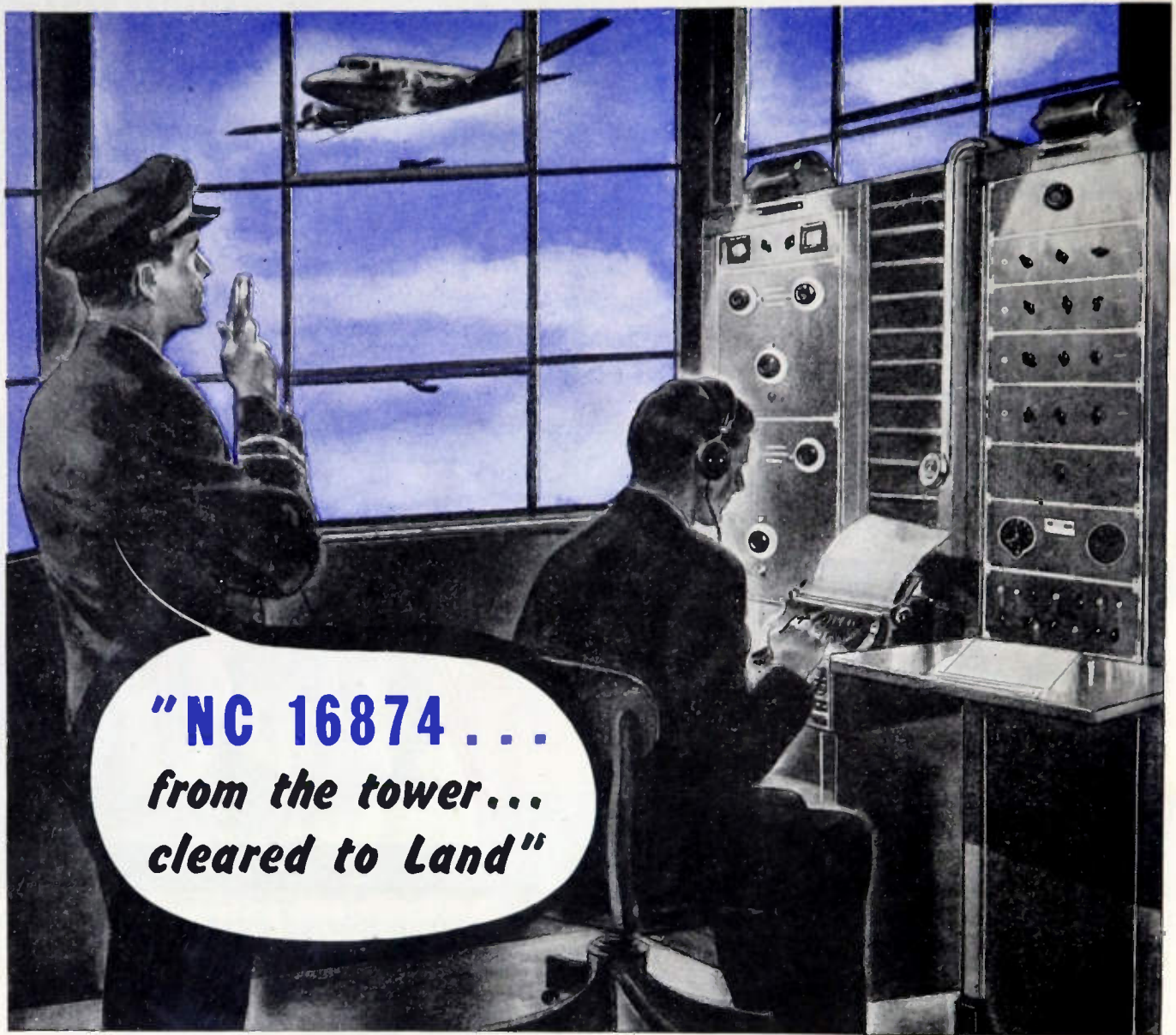

**"NC 16874 . . .
from the tower . . .
cleared to Land"**

Communications and other radio equipment made by Wilcox are at work to help carry on flight control safely under the increased strain of wartime activity. Present Wilcox manufacturing is devoted exclusively to the Government's needs to coordinate fighting forces on land, sea and in the air with vital communications. Until peace is won, the sign on our door reads, "Uncle Sam comes first."

Communication Receivers
Aircraft Radio
Broadcast Equipment
Control Apparatus
Transmitting Equipment



**WILCOX ELECTRIC
COMPANY**

Quality Manufacturing of Radio Equipment

14th & Chestnut

Kansas City, Missouri

Proceedings of the I.R.E.

March, 1943

Keeping fugitive carbon on the job



GIUSTI

TO WIN A WAR, we *must* have hardened steel gears, pinions, and other essential parts that can take a terrific beating—and keep on going.

All steel is basically a mixture of iron and carbon. To bring out its stamina and strength, steel must be heat-treated at high temperature.

But the carbon in steel is a *fugitive* thing. When exposed to highly heated air, carbon literally “boils off” the metal. The steel surface gets softer through loss of carbon.

The problem in heat-treatment is to keep fugitive carbon on the job—in the steel surface where maximum wear and strain occur.

Fortunately, Westinghouse Engineers tackled this problem years ago. They developed an “artificial atmosphere” in heat-treating furnaces that would not rob steel of its fugitive carbon—that left hardened steel parts *clean and free of scale.*

It is known as the Westinghouse “Endogas” Balanced Atmosphere. It is

made from inexpensive natural or manufactured city gas—in a self-contained mixing chamber which is simple and easy to operate. It is exclusively a Westinghouse development.

And the balanced atmosphere in the “Endogas” Furnace may be varied, at will, for heat-treating practically *any kind of steel*—by merely changing the proportion of fuel gas and air in the mixing chamber. A typical result of Westinghouse “know how” in solving a problem that has perplexed metal workers since primitive man hammered out his first battle-ax!

Today, Westinghouse “Endogas” Furnaces are heat-treating vast quantities of gears, cams, dies, and other steel parts. They are setting the pace as

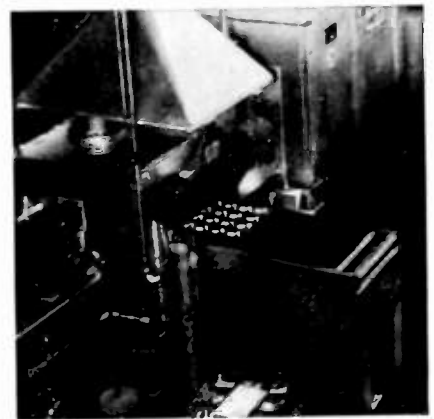

America’s astonishing war-production shifts into high.

Westinghouse Electric & Manufacturing Company, Pittsburgh, Penna.

Westinghouse



PLANTS IN 25 CITIES... OFFICES EVERYWHERE



G-E TELEVISION APPARATUS + G-E PROGRAMMING EXPERIENCE =

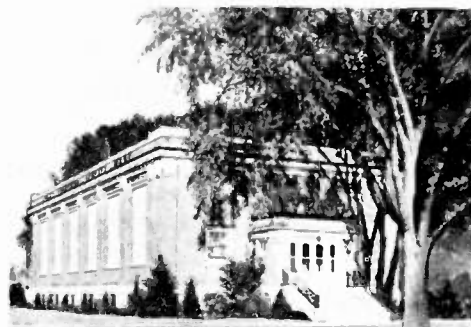

WITHIN the limits of all-out war production, General Electric television broadcast equipment is undergoing rigid testing at G.E.'s own proving-ground television station, WRGB, at Schenectady.

Flexibility of equipment is constantly being analyzed. New television programming arts and skill are being developed. Three times weekly live talent shows — such as boxing matches, menu planning, style shows, and operettas with full orchestral accompaniment — are being televised.

YOUR FUTURE TELEVISION SYSTEM



Techniques in staging, lighting, and make-up are being tried. Carefully checked results provide a vast fund of practical experience for you to draw upon when television is again available. Development of television at WRGB is greatly helped by a co-operative home television audience organized to criticize the programs.

And the G-E post-war television receiver for the home will come out of the same vast fund of television experience. It will be a receiver that will get the most out of the

most recent discoveries and developments in television broadcasting.

G-E television broadcast equipment, program experience and receivers are working together for your future television success. We are experimenting so you won't have to.

General Electric cordially invites you when in Schenectady to visit Station WRGB for a preview of your future television system. . . . Radio, Television, and Electronics Department, General Electric Company, Schenectady, New York.

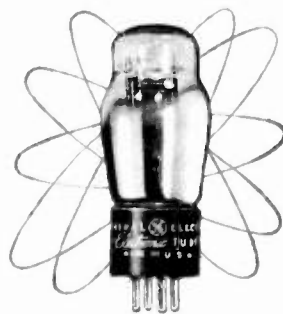

LEADER IN RADIO, TELEVISION, AND ELECTRONICS

GENERAL  ELECTRIC

160-B2-5912

TELEVISION

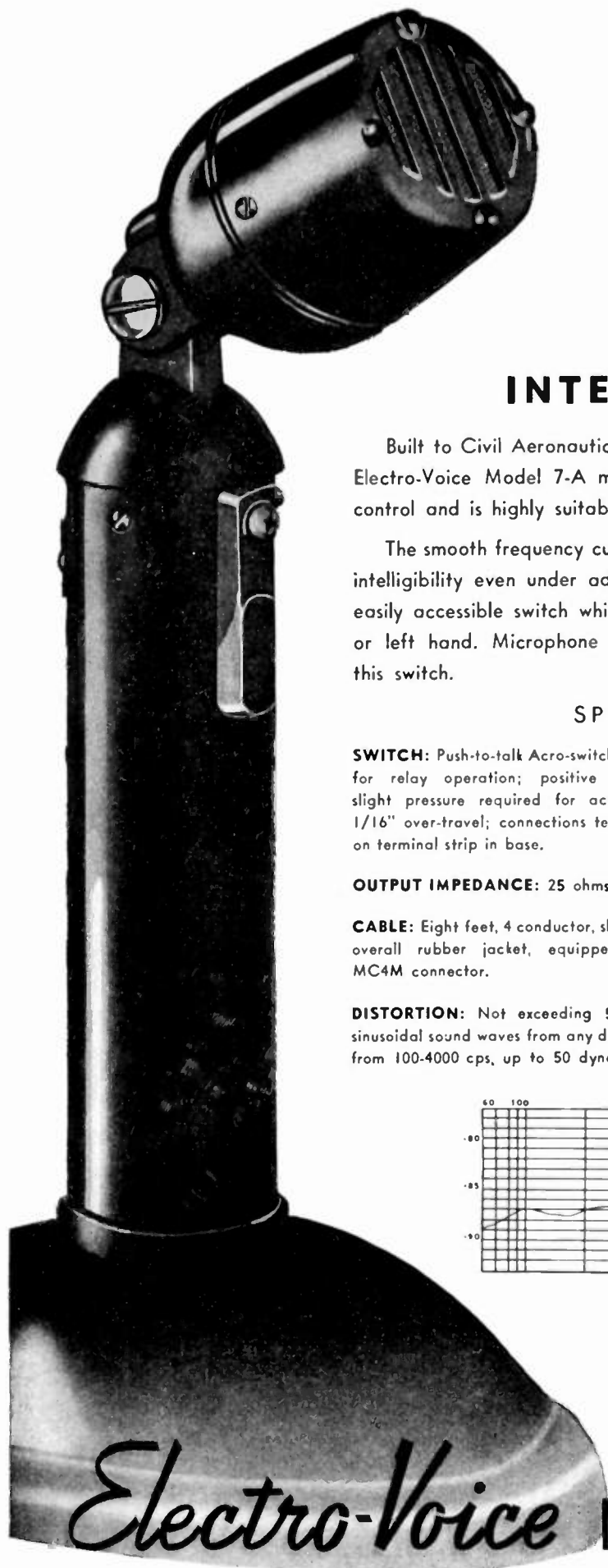

INTELLIGIBILITY

Built to Civil Aeronautics Administration specifications, CAA-515, the Electro-Voice Model 7-A microphone is widely used for airport landing control and is highly suitable for many other sound pick-up applications.

The smooth frequency curve, rising with frequency, gives extremely high intelligibility even under adverse conditions. Desk mounting incorporates easily accessible switch which can be operated by thumb of either right or left hand. Microphone may be moved without danger of pressing this switch.

SPECIFICATIONS

SWITCH: Push-to-talk Acro-switch, SPDT, for relay operation; positive action; slight pressure required for actuation; 1/16" over-travel; connections terminate on terminal strip in base.

OUTPUT IMPEDANCE: 25 ohms.

CABLE: Eight feet, 4 conductor, shielded, overall rubber jacket, equipped with MC4M connector.

DISTORTION: Not exceeding 5% for sinusoidal sound waves from any direction from 100-4000 cps, up to 50 dynes/cm².

INSULATION: Leads from the moving coil are insulated from the microphone housing and stand, and are capable of withstanding 500 volts RMS, 60 cps.

STAND TUBE: Wear resistant, 1/8" XXM bakelite.

CORROSION RESISTANCE: The entire microphone is completely inhibited against corrosion and will successfully withstand a 20% salt spray atmosphere for 100 hours at 95° F.

NET WEIGHT: 3 1/2 lbs.; Shipping wt.: 5 lbs.

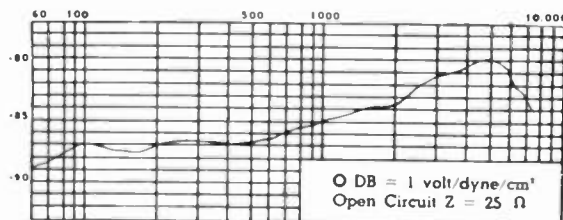

This Model 7-A Desk Mounting Communication Microphone supersedes our previous Model S-7. Our Engineering Department may be able to assist you with your microphone problem. Electro-Voice Manufacturing Co., Inc., 1239 South Bend Avenue, South Bend, Indiana. Export Division: 100 Varick Street, New York, N. Y., U. S. A. — Cable Address: "Arlab"

Electro-Voice MICROPHONES

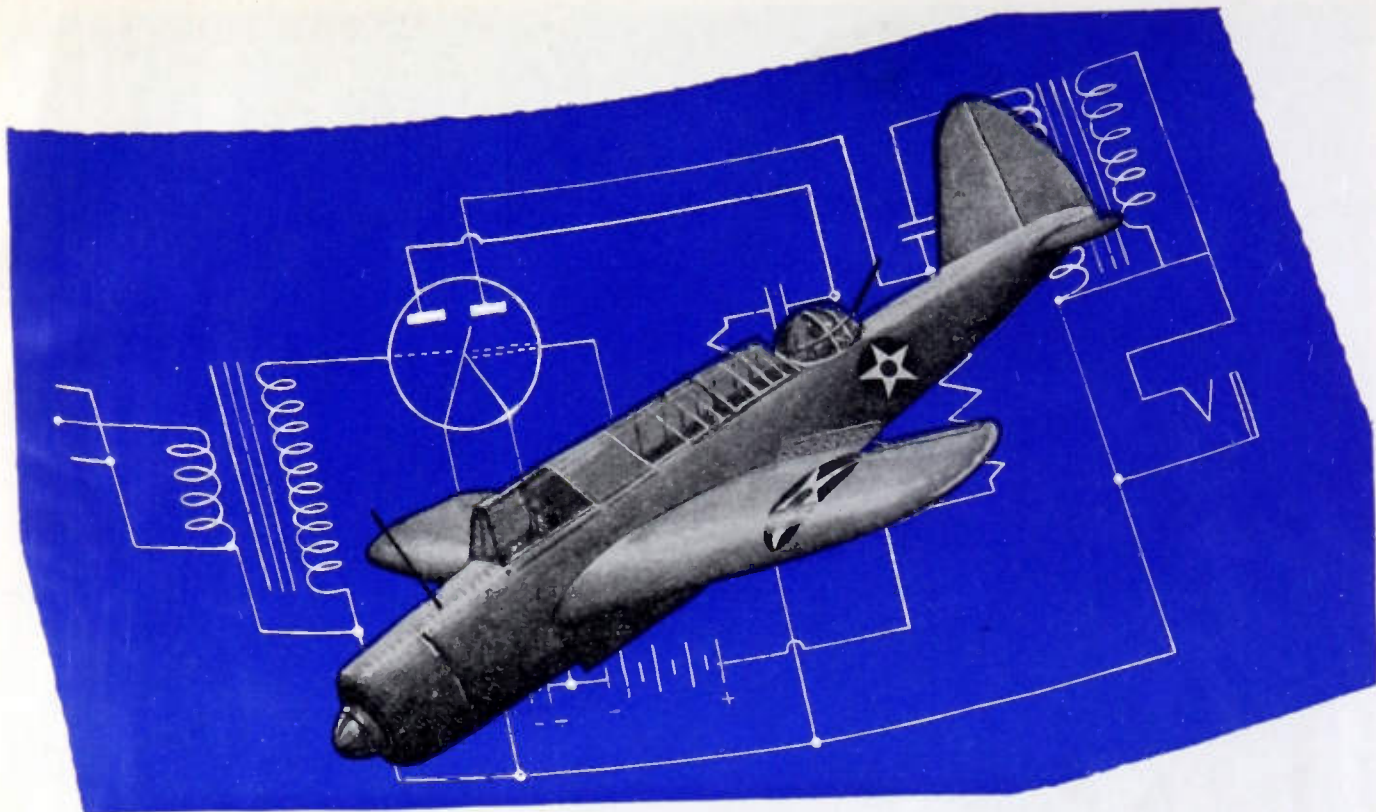

Our responsibility

To safeguard the lives of our men, each component part or assembled mechanism that is incorporated in our war machine must perform at maximum efficiency under favorable or adverse circumstances. There can be no compromise on that score.

MYCALEX

THE INSULATOR

"... is the most nearly perfect electrical insulator known today."

—an opinion subscribed to by leading engineers in radio, television and industry.

★ MYCALEX is the only mica base ceramic insulating material that is leadless.
 ★ Leadless MYCALEX is the low loss ceramic insulating material that is rated highest. ★ MYCALEX can be machined more easily, more rapidly and more accurately. ★ Full sheets of MYCALEX, large or small quantities, can be furnished immediately. ★ Authorized MYCALEX fabricators now can supply your machined part needs to accommodate almost any production and delivery schedules.

Comparable in cost . . . Incomparable in quality

MYCALEX
THE INSULATOR

Trade Mark Reg. U.S. Pat. Off.

MYCALEX CORPORATION OF AMERICA

Exclusive Licensee under all patents of MYCALEX (parent) Co., Ltd.

60 CLIFTON BOULEVARD

CLIFTON, NEW JERSEY

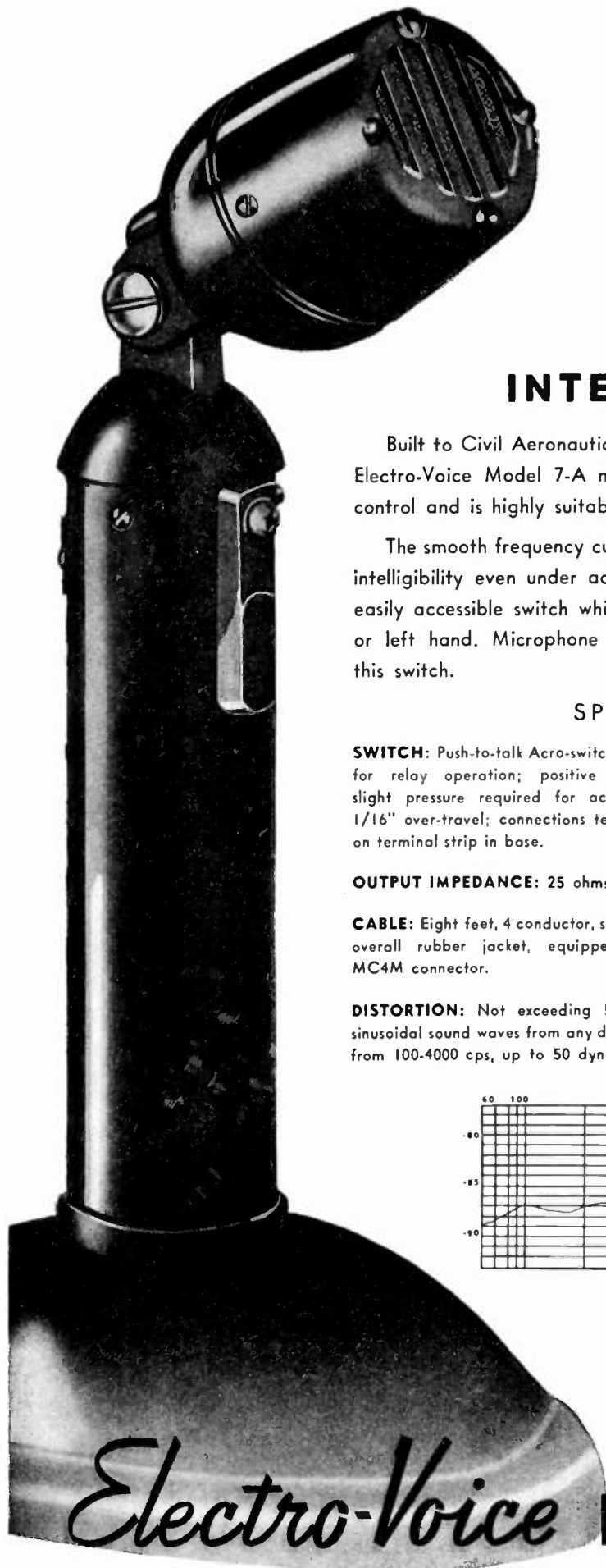

INTELLIGIBILITY

Built to Civil Aeronautics Administration specifications, CAA-515, the Electro-Voice Model 7-A microphone is widely used for airport landing control and is highly suitable for many other sound pick-up applications.

The smooth frequency curve, rising with frequency, gives extremely high intelligibility even under adverse conditions. Desk mounting incorporates easily accessible switch which can be operated by thumb of either right or left hand. Microphone may be moved without danger of pressing this switch.

SPECIFICATIONS

SWITCH: Push-to-talk Acro-switch, SPDT, for relay operation; positive action; slight pressure required for actuation; 1/16" over-travel; connections terminate on terminal strip in base.

OUTPUT IMPEDANCE: 25 ohms.

CABLE: Eight feet, 4 conductor, shielded, overall rubber jacket, equipped with MC4M connector.

DISTORTION: Not exceeding 5% for sinusoidal sound waves from any direction from 100-4000 cps, up to 50 dynes/cm².

INSULATION: Leads from the moving coil are insulated from the microphone housing and stand, and are capable of withstanding 500 volts RMS, 60 cps.

STAND TUBE: Wear resistant, 1/8" XXM bakelite.

CORROSION RESISTANCE: The entire microphone is completely inhibited against corrosion and will successfully withstand a 20% salt spray atmosphere for 100 hours at 95° F.

NET WEIGHT: 3 1/2 lbs.; Shipping wt.: 5 lbs.

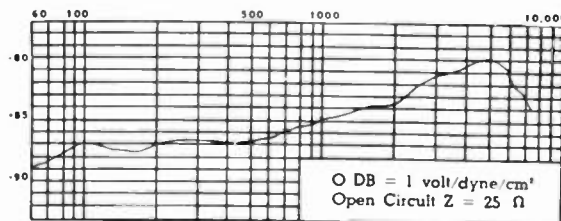

This Model 7-A Desk Mounting Communication Microphone supersedes our previous Model 5-7. Our Engineering Department may be able to assist you with your microphone problem. *Electro-Voice Manufacturing Co., Inc.*, 1239 South Bend Avenue, South Bend, Indiana. Export Division: 100 Varick Street, New York, N. Y., U. S. A. — Cable Address: "Arlab"

Electro-Voice MICROPHONES

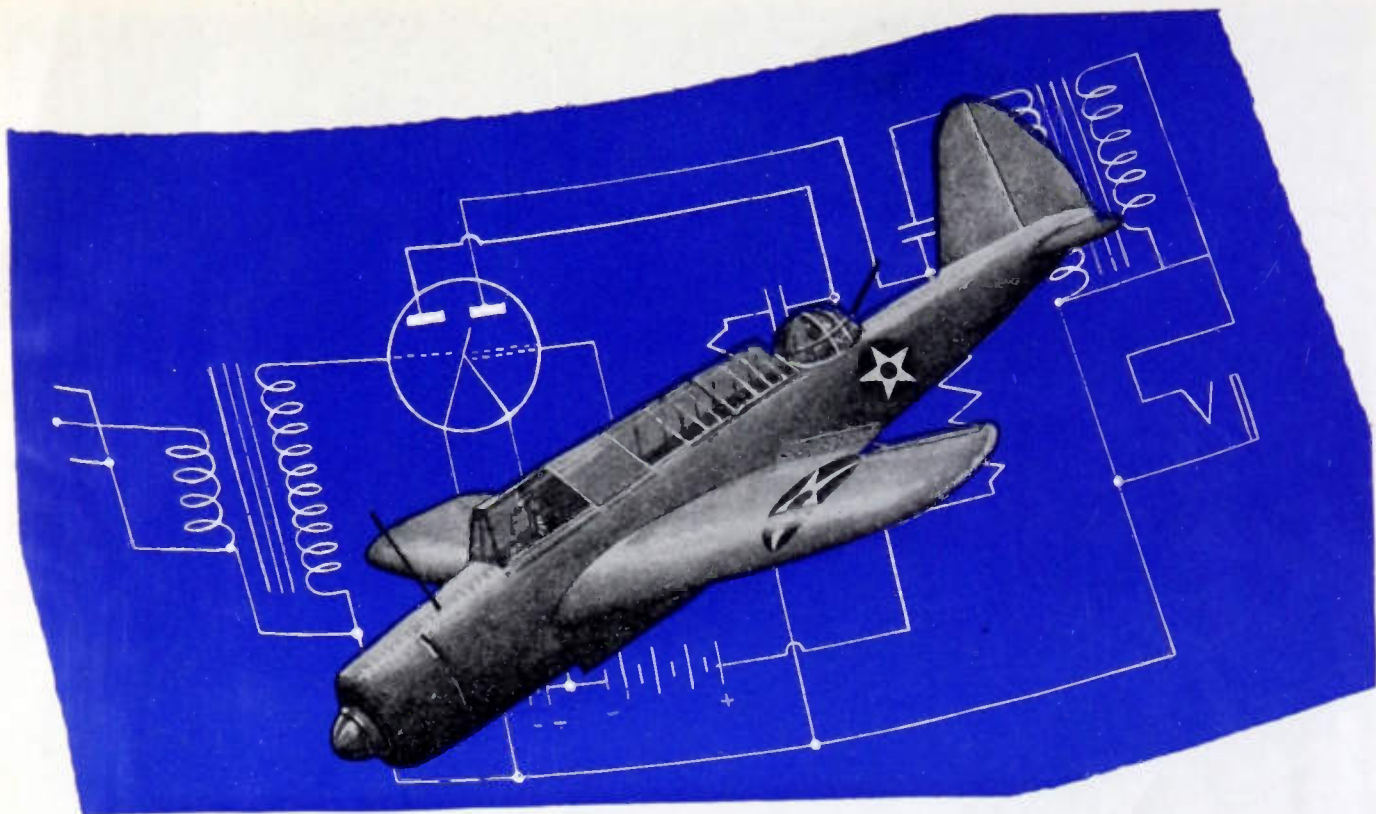

Our responsibility

To safeguard the lives of our men, each component part or assembled mechanism that is incorporated in our war machine must perform at maximum efficiency under favorable or adverse circumstances. There can be no compromise on that score.

MYCALEX

THE INSULATOR

"... is the most nearly perfect electrical insulator known today."

—an opinion subscribed to by leading engineers in radio, television and industry.

★ MYCALEX is the only mica base ceramic insulating material that is leadless.
 ★ Leadless MYCALEX is the low loss ceramic insulating material that is rated highest. ★ MYCALEX can be machined more easily, more rapidly and more accurately. ★ Full sheets of MYCALEX, large or small quantities, can be furnished immediately. ★ Authorized MYCALEX fabricators now can supply your machined part needs to accommodate almost any production and delivery schedules.

Comparable in cost . . . Incomparable in quality

MYCALEX
THE INSULATOR

Trade Mark Reg. U.S. Pat. Off.

MYCALEX CORPORATION OF AMERICA

Exclusive Licensee under all patents of MYCALEX (parent) Co., Ltd.

60 CLIFTON BOULEVARD

CLIFTON, NEW JERSEY

STUPAKOFF

FOUNDED IN 1897

Ceramics for the World of Electronics

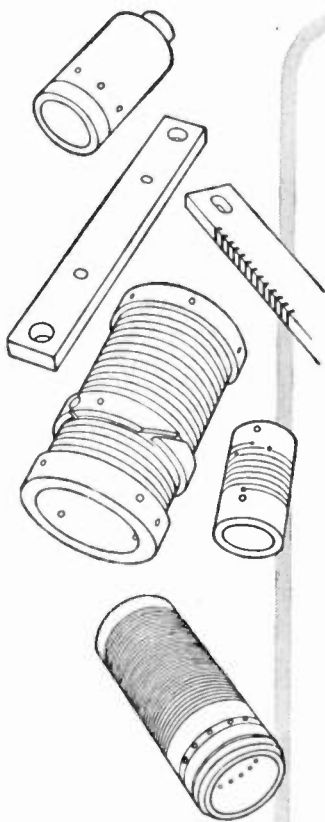

Pioneer Manufacturers of Dependable Ceramic Insulators

- 1900** The late S. H. Stupakoff, Sr., a former associate of George Westinghouse, establishes his own business in Pittsburgh, Pa., manufacturing pyrometers in which ceramics play an important part. Through research and ingenuity, he revolutionizes the industry by producing pyrometers of far greater accuracy and reliability.
- 1914** World War I cuts off the supply of ceramic protection tubes from Germany. Mr. Stupakoff, aided by the U. S. Bureau of Standards, takes immediate steps to develop tubes that will be equal in quality to those imported. From the beginning, this American-made product proves far superior.
- 1923** Continued research and development leads to widespread application. Stupakoff ceramics used in first A. C. radio tube.
- 1930** Stupakoff manufactures daily over a million ceramic parts for the radio tube industry.
- 1936** Kovar,* alloy for sealing to hard glass, fabricated and distributed by Stupakoff in many forms and shapes for various applications.
*Trade Mark 337962. Registered in U. S. Patent Office
- 1940** Increased manufacturing facilities needed for expanding line. Stupakoff moves to larger, modern plant at Latrobe, Pa.
- 1943** Stupakoff is equipped to produce *every type of ceramic used by the electronic industry*. Today our ceramic manufacturing facilities are devoted 100% to the production of "radio grade" ceramics for the war program. An experienced engineering staff is ready at all times to assist you in the development of ceramic parts for war products.

**STUPAKOFF CERAMIC AND MANUFACTURING CO.
LATROBE, PA.**

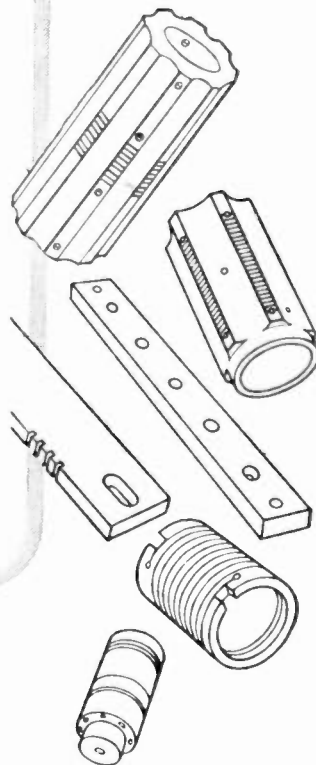

STUPAKOFF

Steatite

INSULATORS



the resistors that said "GOODBYE" ... to all of that!

Goodbye to the many shortcomings common to conventional resistors space wound with bare wire and protected by brittle outer coatings! And good riddance!

For years now, and on almost all types of jobs, Koolohm Resistors have proved the superiority of their ceramic insulated wire construction beyond all question. For Koolohms are much smaller than other resistors of equal rating. They weigh less. They deliver full wattage ratings, regardless of resistance values. They utilize larger, safer wire

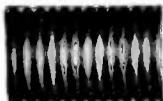

KOOLOHM layer winding Turns cannot "swim" or short. Insulation has a dielectric strength of 350 volts per mil. at 400° C.

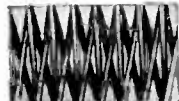

KOOLOHM interleaved winding—the perfect Ayrton-Perry type. Resistors are available having negligible inductance, even at 50 to 100 Mc.



Section of KOOLOHM wire with ceramic insulation removed to show contrast between bare and insulated wire. This flexible, heat-proof insulation is actually applied to the wire at a temperature of 1000° C.

sizes. They have ceramic insulated windings which avoid danger of shorts and changed values, at the same time permitting layer-windings, or high-density, progressively-wound interleaved patterns. They may easily be mounted anywhere, even direct to a chassis—because, with their wire already ceramic insulated before it is wound, Koolohms are doubly protected by a chip-proof outer ceramic tube.

Write today for the Koolohm Catalog and sample resistors. Please mention company connection.

SPRAGUE SPECIALTIES COMPANY
(Resistor Division) North Adams, Mass.



SPRAGUE

KOOLOHM

WIRE-WOUND RESISTORS





G-E TELEVISION APPARATUS + G-E PROGRAMMING EXPERIENCE =

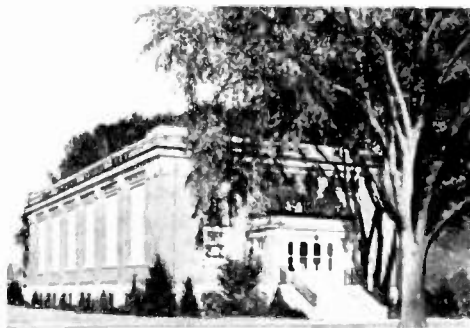
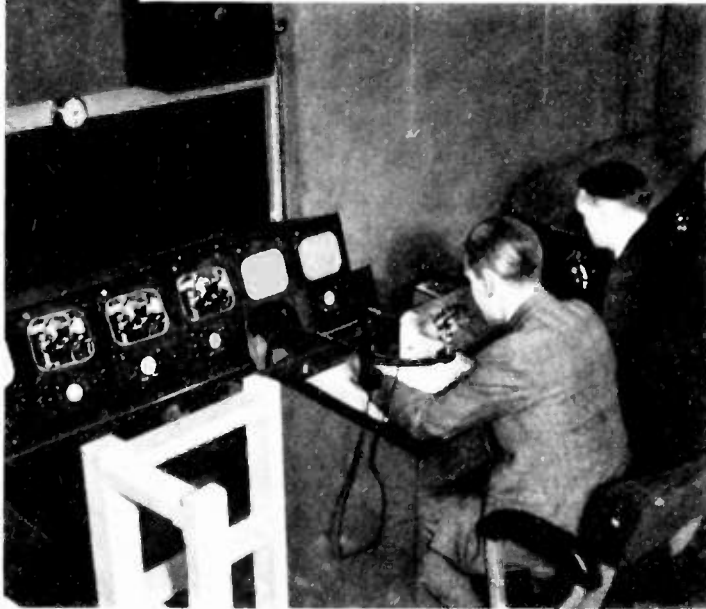

WITHIN the limits of all-out war production, General Electric television broadcast equipment is undergoing rigid testing at G.E.'s own proving-ground television station, WRGB, at Schenectady.

Flexibility of equipment is constantly being analyzed. New television programming arts and skill are being developed. Three times weekly live talent shows — such as boxing matches, menu planning, style shows, and operettas with full orchestral accompaniment — are being televised.

YOUR FUTURE TELEVISION SYSTEM



Techniques in staging, lighting, and make-up are being tried. Carefully checked results provide a vast fund of practical experience for you to draw upon when television is again available. Development of television at WRGB is greatly helped by a co-operative home television audience organized to criticize the programs.

And the G-E post-war television receiver for the home will come out of the same vast fund of television experience. It will be a receiver that will get the most out of the

most recent discoveries and developments in television broadcasting.

G-E television broadcast equipment, program experience and receivers are working together for your future television success. We are experimenting so you won't have to.

General Electric cordially invites you when in Schenectady to visit Station WRGB for a preview of your future television system. . . . Radio, Television, and Electronics Department, General Electric Company, Schenectady, New York.

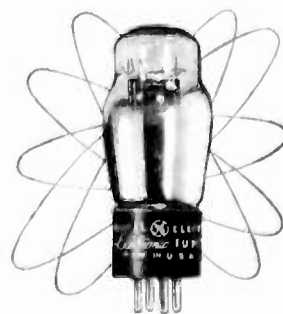

LEADER IN RADIO, TELEVISION, AND ELECTRONICS

GENERAL  ELECTRIC

100-82-917

TELEVISION

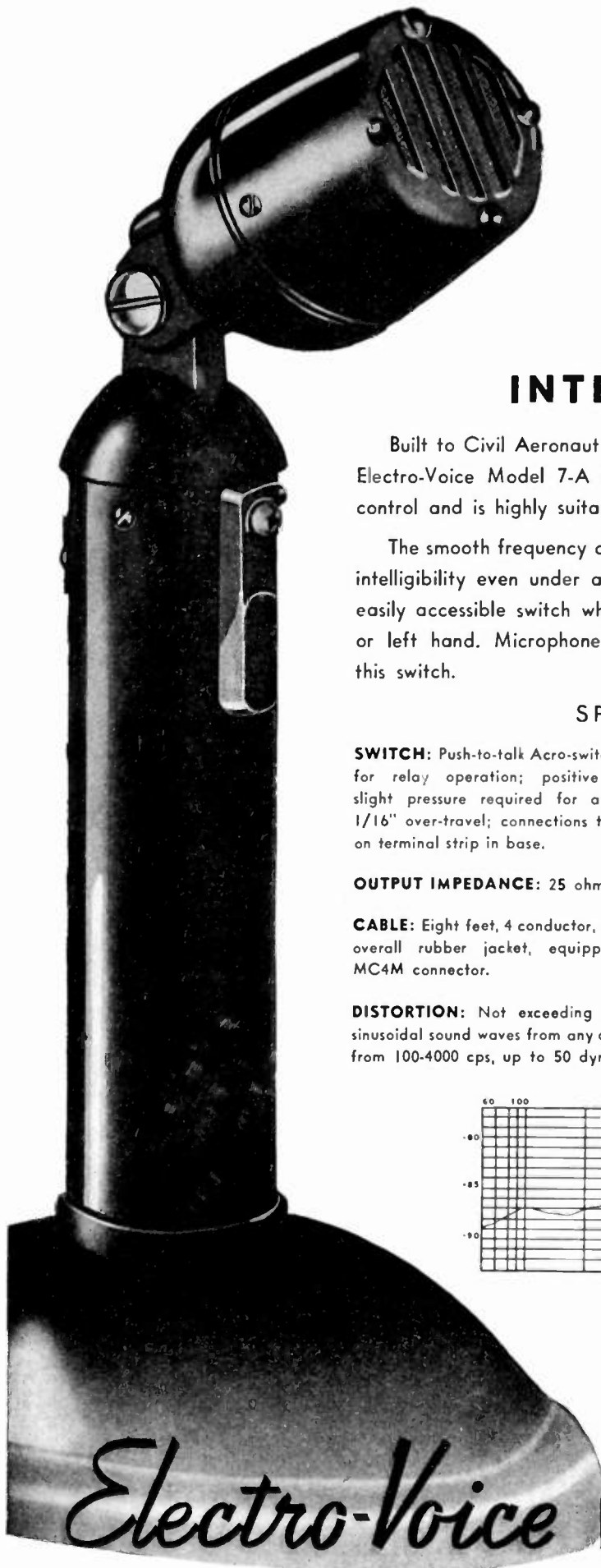

INTELLIGIBILITY

Built to Civil Aeronautics Administration specifications, CAA-515, the Electro-Voice Model 7-A microphone is widely used for airport landing control and is highly suitable for many other sound pick-up applications.

The smooth frequency curve, rising with frequency, gives extremely high intelligibility even under adverse conditions. Desk mounting incorporates easily accessible switch which can be operated by thumb of either right or left hand. Microphone may be moved without danger of pressing this switch.

SPECIFICATIONS

SWITCH: Push-to-talk Acro-switch, SPDT, for relay operation; positive action; slight pressure required for actuation; 1/16" over-travel; connections terminate on terminal strip in base.

OUTPUT IMPEDANCE: 25 ohms.

CABLE: Eight feet, 4 conductor, shielded, overall rubber jacket, equipped with MC4M connector.

DISTORTION: Not exceeding 5% for sinusoidal sound waves from any direction from 100-4000 cps, up to 50 dynes/cm².

INSULATION: Leads from the moving coil are insulated from the microphone housing and stand, and are capable of withstanding 500 volts RMS, 60 cps.

STAND TUBE: Wear resistant, 1/8" XXM bakelite.

CORROSION RESISTANCE: The entire microphone is completely inhibited against corrosion and will successfully withstand a 20% salt spray atmosphere for 100 hours at 95° F.

NET WEIGHT: 3 1/2 lbs.; Shipping wt.: 5 lbs.

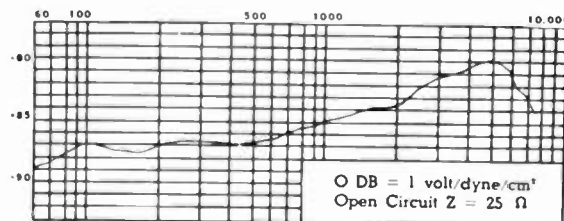

This Model 7-A Desk Mounting Communication Microphone supersedes our previous Model S-7. Our Engineering Department may be able to assist you with your microphone problem. Electro-Voice Manufacturing Co., Inc., 1239 South Bend Avenue, South Bend, Indiana. Export Division: 100 Varick Street, New York, N. Y., U. S. A. — Cable Address: "Arlab"

Electro-Voice MICROPHONES

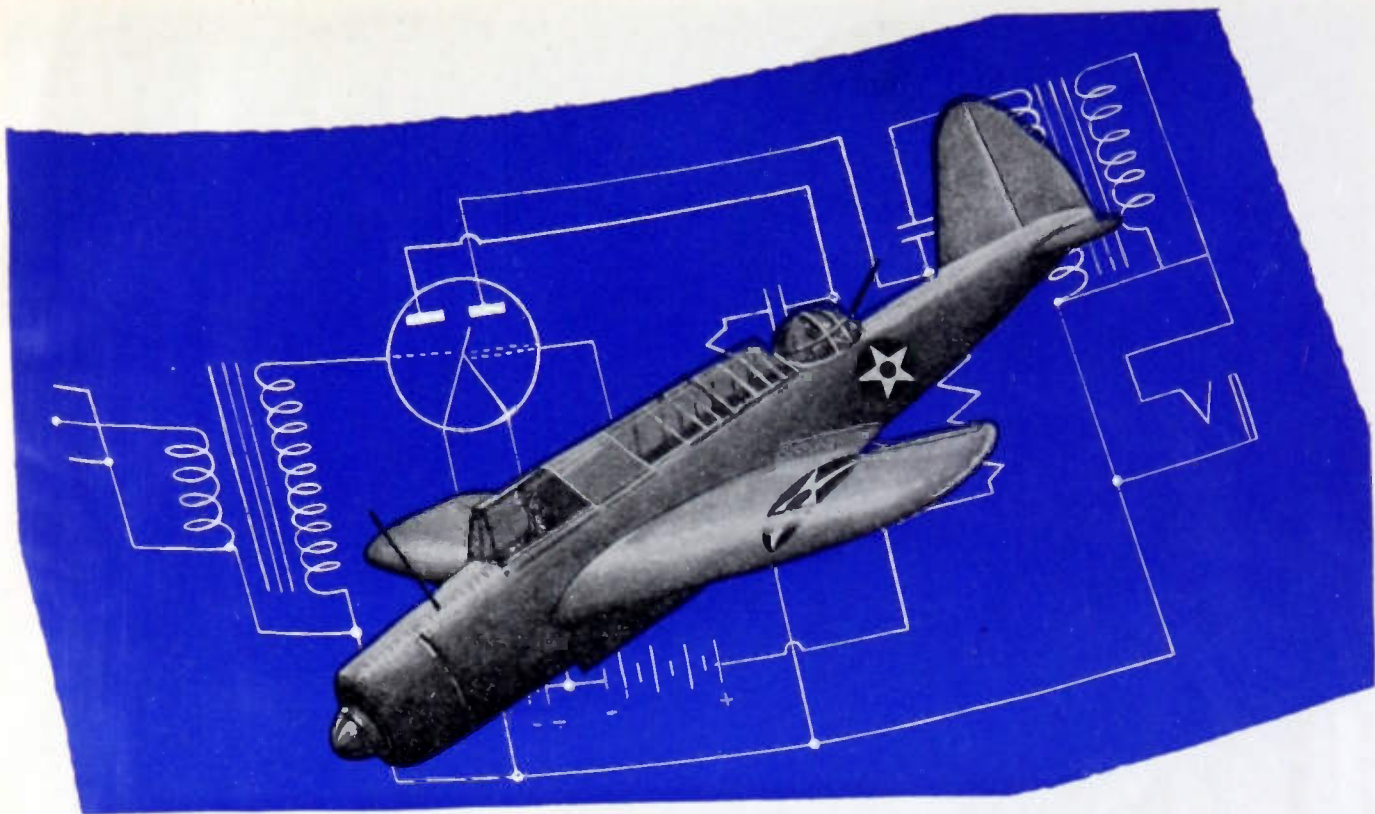

Our responsibility

To safeguard the lives of our men, each component part or assembled mechanism that is incorporated in our war machine must perform at maximum efficiency under favorable or adverse circumstances. There can be no compromise on that score.

MYCALEX

THE INSULATOR

"... is the most nearly perfect electrical insulator known today."

—an opinion subscribed to by leading engineers in radio, television and industry.

★ MYCALEX is the only mica base ceramic insulating material that is leadless.
 ★ Leadless MYCALEX is the low loss ceramic insulating material that is rated highest. ★ MYCALEX can be machined more easily, more rapidly and more accurately. ★ Full sheets of MYCALEX, large or small quantities, can be furnished immediately. ★ Authorized MYCALEX fabricators now can supply your machined part needs to accommodate almost any production and delivery schedules.

Comparable in cost . . . Incomparable in quality

MYCALEX
THE INSULATOR

Trade Mark Reg. U.S. Pat. Off.

MYCALEX CORPORATION OF AMERICA

Exclusive Licensee under all patents of MYCALEX (parent) Co., Ltd.

60 CLIFTON BOULEVARD

CLIFTON, NEW JERSEY

STUPAKOFF

FOUNDED IN 1897

Ceramics for the World of Electronics

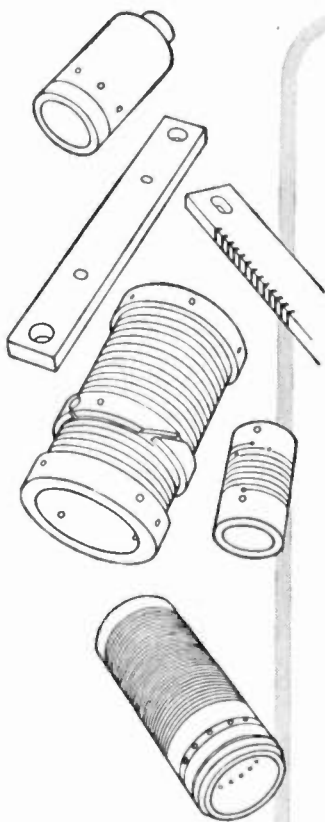

Pioneer Manufacturers of Dependable Ceramic Insulators

- 1900** The late S. H. Stupakoff, Sr., a former associate of George Westinghouse, establishes his own business in Pittsburgh, Pa., manufacturing pyrometers in which ceramics play an important part. Through research and ingenuity, he revolutionizes the industry by producing pyrometers of far greater accuracy and reliability.
- 1914** World War I cuts off the supply of ceramic protection tubes from Germany. Mr. Stupakoff, aided by the U. S. Bureau of Standards, takes immediate steps to develop tubes that will be equal in quality to those imported. From the beginning, this American-made product proves far superior.
- 1923** Continued research and development leads to widespread application. Stupakoff ceramics used in first A. C. radio tube.
- 1930** Stupakoff manufactures daily over a million ceramic parts for the radio tube industry.
- 1936** Kovar,* alloy for sealing to hard glass, fabricated and distributed by Stupakoff in many forms and shapes for various applications.
*Trade Mark 337962. Registered in U. S. Patent Office
- 1940** Increased manufacturing facilities needed for expanding line. Stupakoff moves to larger, modern plant at Latrobe, Pa.
- 1943** Stupakoff is equipped to produce *every type of ceramic used by the electronic industry*. Today our ceramic manufacturing facilities are devoted 100% to the production of "radio grade" ceramics for the war program. An experienced engineering staff is ready at all times to assist you in the development of ceramic parts for war products.

**STUPAKOFF CERAMIC AND MANUFACTURING CO.
LATROBE, PA.**

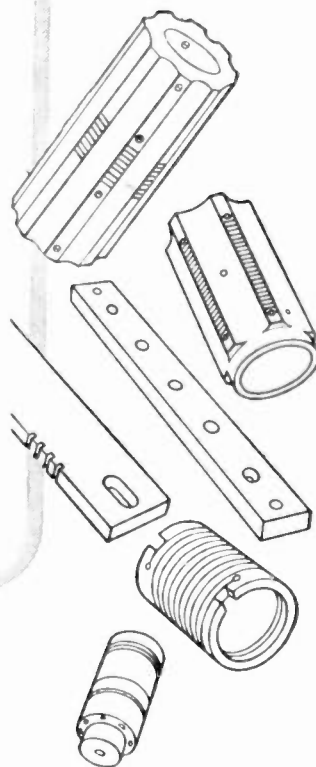

STUPAKOFF

Steatite

INSULATORS



the resistors that said "GOODBYE" ... to all of that!

Goodbye to the many shortcomings common to conventional resistors space wound with bare wire and protected by brittle outer coatings! And good riddance!

For years now, and on almost all types of jobs, Koolohm Resistors have proved the superiority of their ceramic insulated wire construction beyond all question. For Koolohms are much smaller than other resistors of equal rating. They weigh less. They deliver full wattage ratings, regardless of resistance values. They utilize larger, safer wire

sizes. They have ceramic insulated windings which avoid danger of shorts and changed values, at the same time permitting layer-windings, or high-density, progressively-wound interleaved patterns. They may easily be mounted anywhere, even direct to a chassis—because, with their wire already ceramic insulated before it is wound, Koolohms are doubly protected by a chip-proof outer ceramic tube.

Write today for the Koolohm Catalog and sample resistors. Please mention company connection.

SPRAGUE SPECIALTIES COMPANY
(Resistor Division) North Adams, Mass.

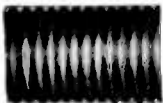

KOOLOHM layer winding Turns cannot "swim" or short. Insulation has a dielectric strength of 350 volts per mil. at 400° C.!

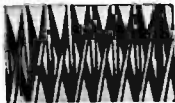

KOOLOHM interleaved winding—the perfect Ayrton-Perry type. Resistors are available having negligible inductance, even at 50 to 100 Mc.!



Section of **KOOLOHM** wire with ceramic insulation removed to show contrast between bare and insulated wire. This flexible, heat-proof insulation is actually applied to the wire at a temperature of 1000° C.



SPRAGUE

KOOLOHM

WIRE-WOUND RESISTORS



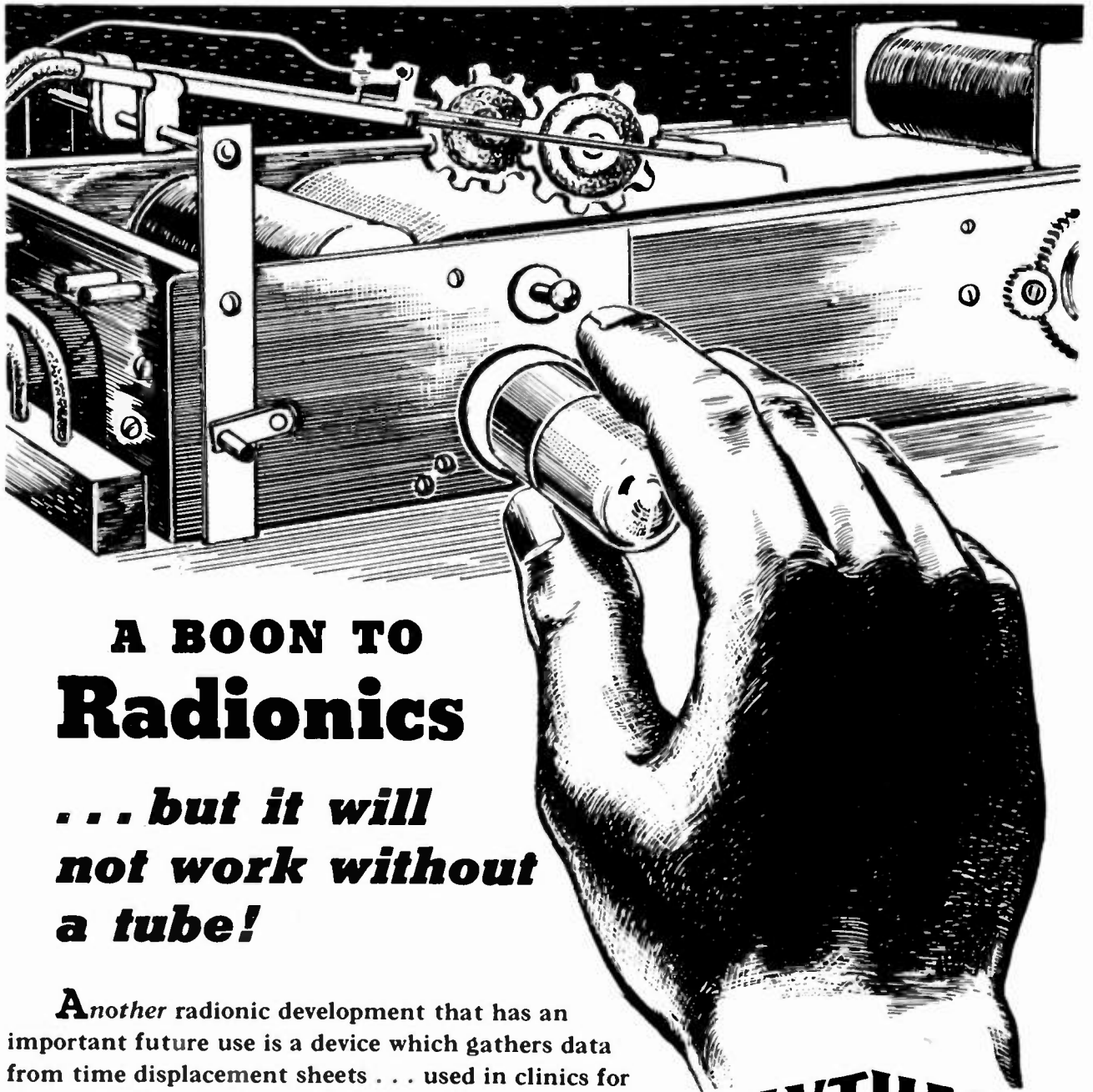

A BOON TO Radionics

***... but it will
not work without
a tube!***

Another radionic development that has an important future use is a device which gathers data from time displacement sheets . . . used in clinics for the study of respiratory and diadochokinetic movements. A boon to radionics, but it will not work without tubes.

Just how well RAYTHEON has succeeded in developing and producing special tubes that have large potential wartime vital needs, as well as postwar industrial applications, is evidenced by RAYTHEON'S outstanding record of production.

This has enabled RAYTHEON to become a greatly increased factor in secret tubes and equipment for global warfare.

When these developments can be released for general domestic use they will be an important factor in the new industrial art of radionics, maintaining RAYTHEON'S leadership and ability in keeping ahead with the most advanced tube designs.

RAYTHEON

Raytheon Manufacturing Company

WALTHAM AND NEWTON, MASSACHUSETTS

DEVOTED TO RESEARCH AND THE MANUFACTURE OF TUBES
AND EQUIPMENT FOR THE NEW ERA OF ELECTRONICS

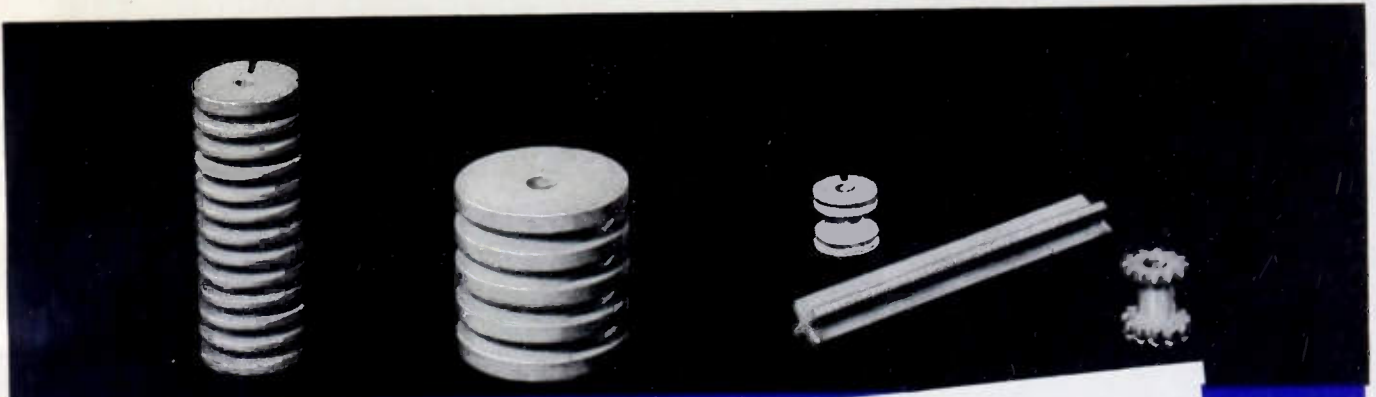

**CAPACITY AVAILABLE FOR
QUANTITY PRODUCTION OF
STEATITE PARTS LIKE THESE!**

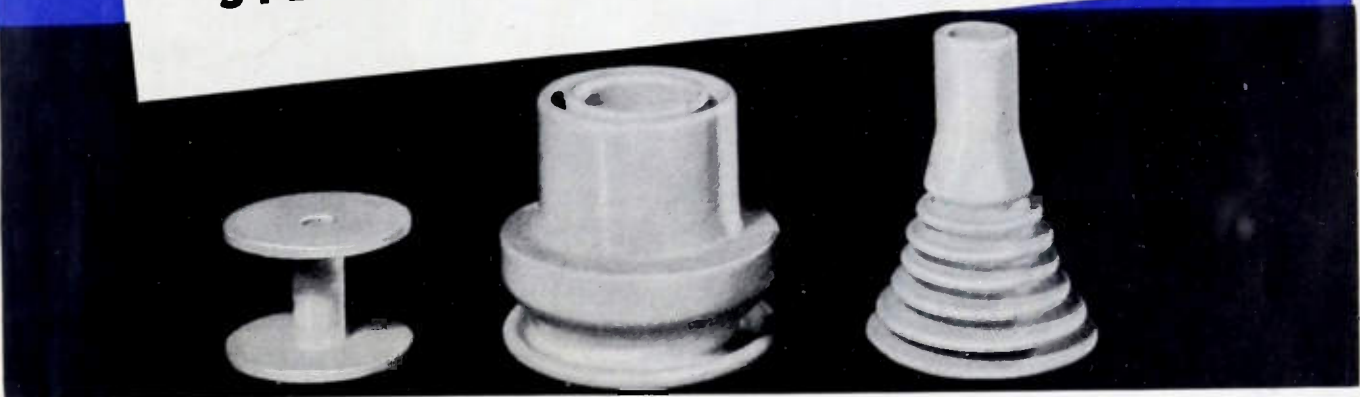

If you need reasonably prompt delivery on high production orders for steatite parts formed by turning operations, bring your requirements to Isolantite Inc.

As a result of comprehensive expansion of its manufacturing facilities, Isolantite is in an excellent position to accept additional orders for *large* quantities of parts of the type illustrated—and of many other shapes fabricated by machining operations. Unusually quick deliveries for these unusual times can be made, particularly where special tools are not required.

When close tolerances are required on parts like these, you can benefit by Isolantite's manufacturing processes, which permit certain critical dimensions to be fabricated after firing... resulting in exceptional dimensional accuracy, compared with general ceramic requirements. And in *all* types of ceramic parts, you

benefit by the outstanding advantages offered by Isolantite*—uniformity of product, nonabsorption of moisture, electrical efficiency, high mechanical strength.

If you need machined steatite parts that meet exacting specifications—and need them promptly—write, wire, or phone your requirements.

ISOLANTITE

CERAMIC INSULATORS

ISOLANTITE INC., BELLEVILLE, NEW JERSEY

*Registered trade-name for the products of Isolantite Inc.

**Technically-informed supplier
of electronic materials . . .**

★ ★ ★ ★
★ BUY
★ U.S. WAR
★ BONDS
★ ★ ★ ★



Your local

RCA TUBE and EQUIPMENT DISTRIBUTOR

'ROUND-THE-CORNER SERVICE!

Following are but a few of the electronic items regularly handled by your local RCA Tube and Equipment Distributor:

**RCA, CUNNINGHAM, and RCA VICTOR
RADIO TUBES**

RCA SPECIAL PURPOSE TUBES

**RCA POWER TUBES, PHOTOTUBES,
CATHODE RAY TUBES, etc.**

RCA ELECTRONIC TEST EQUIPMENT

. . . also condensers, resistors, rheostats, controls, potentiometers, coils, transformers, wire, and numerous other radio and electronic components produced by many manufacturers.



Making war equipment that necessitates frequent calls for tubes and other electronic components?

Then get acquainted with your *local* RCA Tube and Equipment Distributor today!

He may have just what you need in stock for immediate delivery upon receipt of a suitable priority. If he doesn't, he is well equipped to get it for you as fast as circumstances permit—and to render an intelligent, personalized expediting service all along the line.

Equally important is his technical knowledge. He has been dealing with things electronic since the "knee pants" days of radio. He knows what to use and how to use it. You'll find his technical advice and recommendations a big help.

There are over 300 RCA Tube and Equipment Distributors throughout the country. Write or wire for a list of those nearest you.

RADIO CORPORATION OF AMERICA
RCA Victor Division, Camden, N. J.

AN ADVERTISEMENT OF THE RCA TUBE AND EQUIPMENT DIVISION IN THE INTEREST OF
GREATER SERVICE AND EFFICIENCY IN PRIORITY-COVERED WAR MATERIALS BUYING

Wartime Service

To the Membership of the Institute From the Board of Directors

For the second time in the life of the Institute, we have laid aside the tasks of peace and turned to the grimmer needs of war. Inevitably this radical change imposes on us strict obligations and offers us inspiring opportunities.

On its part, the Board pledges itself to conduct the affairs of the Institute with the wholehearted purpose of making the maximum contribution to the war effort. In so doing, the Board fully recognizes that it is living up to the wishes and determination of the membership.

Manifestly we cannot have—and until victory comes, we do not wish—“engineering as usual.” The myriad of new and interesting radio-and-electronic devices for peacetime purposes of which we can conceive are largely banished from our thoughts as they are from our daily work. The needs of our Armed Forces occupy our closest attention to the exclusion of all else. And this is as it should and must be.

There are many ways in which we can serve. To some of us is given the privilege of active service as officers or men in the Military Services. All can understand the meaning and standing of such service and justly appraise its worth.

To others is granted the opportunity to act as civilian experts or employees of the Army or Navy. And here again only the dullest would fail to appreciate the national value of such services and their wartime appropriateness.

And to many of us is accorded a different task which, to some at least, is not so clearly meritorious and praiseworthy. Far behind the lines—some in secluded and quiet laboratories, offices, and drafting rooms, some close to the busy production line—many of our numbers are carrying on their wartime services. For them there is neither the excitement of danger nor the glamour of applause and fame. Ready understanding, sympathy, and community approval are seldom for them. Yet they too serve, and serve truly and well. But for their toil, the incredibly huge aggregation of equipment needed for modern warfare would be missing at the front—and with tragic consequences.

To those in the Armed Forces, as military or civilian personnel, the Board extends its respects and its most hearty wishes for success. And to those others often working in obscurity and tempted, it may be, to forsake their tasks for brighter ones, the Board offers its full understanding and sincere commendation.

May both these groups of engineers continue to stand shoulder to shoulder, in a brotherhood which is none the less real for being intangible, until that day of triumph when they shall again be united in homes and working places.

For the Board of Directors
Lynde P. Wheeler, President

February 3, 1943





Photo by U. S. Army Signal Corps

CHARLES MCKINLEY SALTZMAN

1871-1942

Major-General Charles McKinley Saltzman, chairman of the Federal Radio Commission from 1930 to 1932, and Chief Signal Officer, U.S.A., from 1924 to 1928, died on November 25 in Washington, D. C.

General Saltzman was born at Panora, Iowa, on October 18, 1871. After his graduation from West Point in 1896, he saw service in the Spanish-American War and the Philippine Insurrection. He was given two citations for "gallantry in action" in the Spanish-American War and awarded the Distinguished Service Medal for "exceptionally meritorious and conspicuous services" during World War I. He was also awarded the Silver Star with oak-leaf cluster for gallantry in action.

In 1901 he transferred to the Signal Corps and in 1912 he was a member of the Interdepartmental Board that formulated the first

regulations for the control of radio in the United States.

General Saltzman was a delegate to numerous international radio conferences from 1912 on. In 1929 he was appointed to the Federal Radio Commission and instituted its reorganization. From 1930 to 1932 he served as its chairman.

Shortly after his resignation from the Commission, he was recalled in 1933 to prepare a report on the regrouping and consolidation of government agencies with particular reference to those concerned with transportation and communication. As chairman of a special interdepartmental committee, he submitted a report on the communication facilities of the country which, transmitted to Congress by the President, resulted in the Federal Communications Commission, an agency which he had persistently recommended.

Tuning Indicators and Circuits for Frequency-Modulation Receivers*

JOHN A. RODGERS†, ASSOCIATE, I.R.E.

Summary—Frequency modulation provides good reception, but requires operation at resonance. The circuits described in these pages are applicable to standard receivers and provide effective means for accurate tuning. Some of these circuits include additional diodes, triodes, and combinations of diodes and triodes to produce sharp determination of the discriminator crossover point. A novel tuning eye employing two grids is suggested for a simplified tuning indicator.

TUNING A FREQUENCY-MODULATION RECEIVER

THOSE who have had occasion to use a frequency-modulation receiver are aware of the necessity for a good visual tuning indicator. Here it is a case of "must," since reception exists for such an extended range around the correct tuning point. The results of mistuning are quite different in the case of frequency modulation. Here there is little change in audio-frequency characteristic and the volume level remains essentially constant as the receiver is tuned in and out of resonance.

At resonance, the noise is at a minimum and so also is the distortion. Slight mistuning may cause only a small increase in the ordinary type of background noise, but the high audio frequencies and all frequencies fully modulated will be noticeably distorted. The reason for this is that the frequency-modulation detector is a balanced circuit and depends upon exact resonance to deliver undistorted signals to the audio amplifier. This balance likewise results in the canceling out of amplitude changes, which are the unwanted responses, such as noise. Just how effectively the

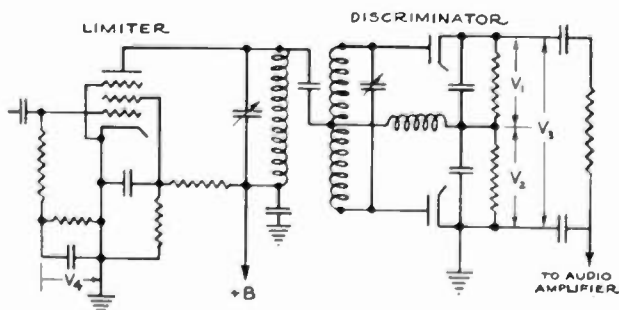

Fig. 1—Conventional frequency-modulation circuits.

frequency-modulation radio eliminates interference, then, depends to a very large extent upon this balance of the discriminator. With even slight mistuning, the ignition of a passing car will produce an annoying staccato that would not be audible with the receiver tuned to resonance.

* Decimal classification: R361XR414. Original manuscript received by the Institute, July 5, 1942.

† Stromberg-Carlson Telephone Manufacturing Company, Rochester, N. Y.

It is logical to assume, then, that if we are going to take advantage of all the benefits which frequency modulation affords—extended frequency range, increased dynamic range, decreased distortion, and freedom from noise—we must tune the receiver to exact resonance and there must be some means provided for indicating this condition.

SIMPLIFIED TYPE OF INDICATOR

The first and simplest method is similar to that used with the amplitude-modulation receiver. The grid of

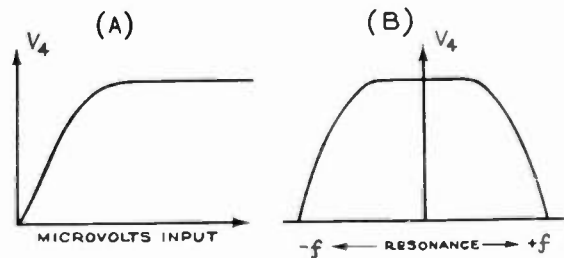

Fig. 2—Limiter rectified grid voltage.

the eye tube receives voltage V_4 from the limiter grid circuit (Fig. 1) and will, therefore, indicate the peak of the over-all selectivity curve. This is an indirect method of approach because the correct tuning point is the balance of the detector and this method assumes that the receiver is and remains perfectly aligned throughout, so that the selectivity curve is perfectly symmetrical and the discriminator curve is centered upon it.

In actual practice it has not only been found impossible to keep the over-all selectivity characteristic sufficiently symmetrical, but the curve shape will alter as the strength of the incoming signal changes. Moreover the selectivity curve is so broad that the eye is insensitive and on very strong signals a glance at the curve in Fig. 2 (B) will show how little aperture change can be expected for quite a departure from resonance.

However inadequate this method may seem, it is still better than no indicator at all and has been used with some degree of success on many receivers.

CIRCUITS FOR ACCURATE TUNING

The direct method utilizes the voltages from the discriminator and of necessity involves greater complication. Exact resonance occurs when the incoming wave is centered on the detector curve so that, according to Fig. 3, V_3 , the sum of voltages V_1 and V_2 , is zero. These are direct voltages.

By actually placing a voltmeter, preferably of the center-zero type, directly across the discriminator load, the receiver may be tuned accurately. However, the meter has been considered unsuitable and the next

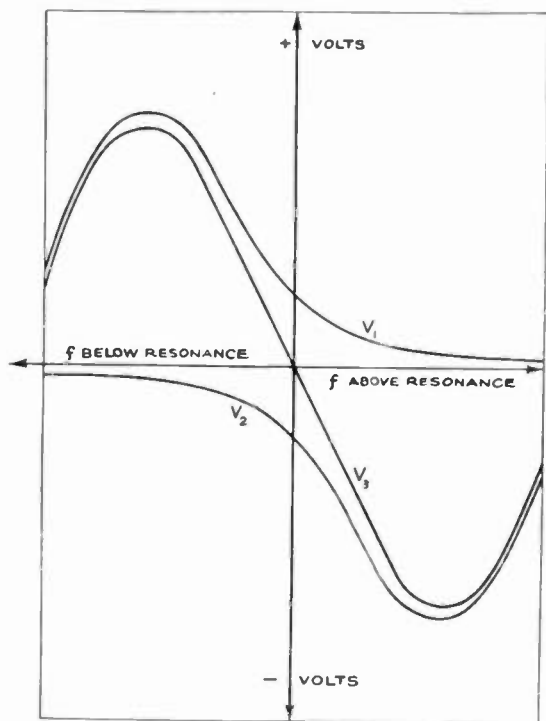

Fig. 3—Discriminator voltages.

step is to find out how the tuning eye can be utilized. If its grid is connected to the high side of the discriminator load, voltage V_3 will cause the aperture to increase and decrease but there will be no way of determining where the zero-voltage point occurs. It is therefore necessary to establish some zero-voltage reference point. This may be done in several ways.

The tuning indicator can be operated with an initial fixed bias sufficient to close the aperture when the voltage V_3 from the discriminator is zero. When V_3 becomes positive then, the eye will open and when V_3 swings negative, the eye will overlap. Thus the point of zero voltage or correct tuning is established. Some form of potentiometer must be provided with this method, since changes in line voltage, tube characteristics, etc., will require a readjustment of this reference point.

An alternative means of accomplishing this same function but avoiding the necessity of regularly checking the zero points consists in providing enough bias voltage to close the eye part way. A switch is then placed across the discriminator load so that when closed, the voltage on the eye grid is zero. By tuning the receiver until the tuning indicator aperture is the same for both positions of the switch, the correct point for true resonance is assured.

Since a manually operated switch is undesirable, it

may be replaced by a contactor of special design such as shown in Fig. 4. This is a vibrating contact operating on alternating current to produce rapid intermittent short-circuiting of the tuning indicator grid to ground. The result is two eye apertures, one remaining fixed and representing the interval when the grid is grounded and the other opening and closing according to the voltage V_3 . Correct tuning will occur at the point where these two apertures coincide.

A desirable variation here is shown by the dotted line, where the negative voltage for the initial bias is supplied by the limiter grid circuit. Because the bias from the limiter is zero when no station is being received, the tuning indicator is wide open, but narrows as a station is approached on the dial. This circuit change makes operation less confusing, since there is a difference then between the condition where no station

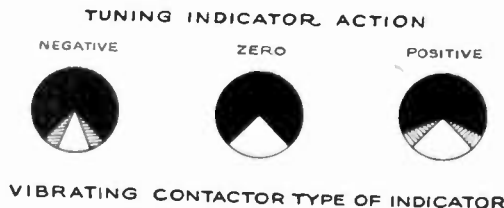
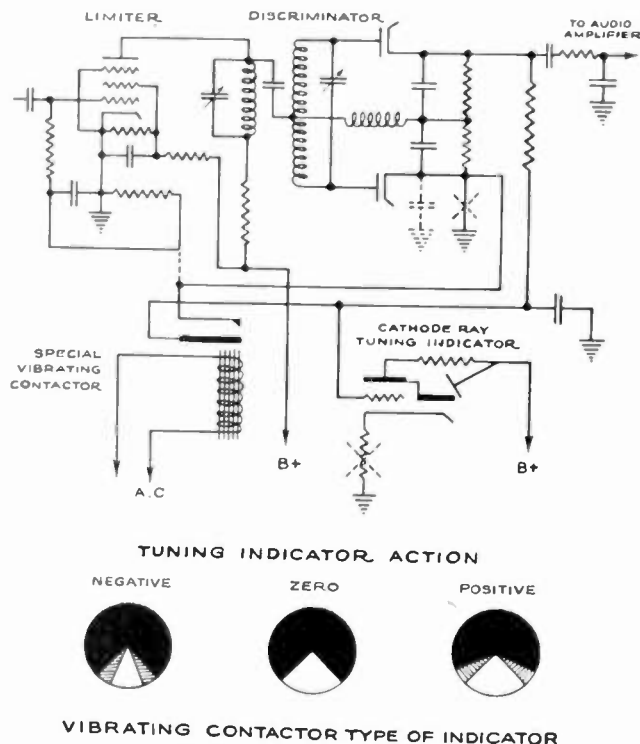

Fig. 4

is being received and the case of reception with the radio tuned exactly to resonance, both occurring when V_3 is zero.

Another method is to put the positive and negative discriminator voltages through special circuits so that they will each produce a voltage in the same direction. This is shown in Fig. 5 where a double diode and double triode are used in addition to the indicator tube.

Here the detector voltage is impressed upon the cathode of one diode and the plate of the other, the two other corresponding electrodes being grounded through resistors across which voltages are developed and impressed upon the triode grids. It is apparent

that through the unidirectional action of each diode, one triode will receive only negative voltage and the other only positive. The latter, therefore, will have its plate current increased with a consequent lowering of the plate voltage through an increased drop in the load resistor. This will decrease the voltage on the focusing

on either side of resonance the eye will open and good reception can be assured in the regular manner by tuning for the greatest closing of the eye.

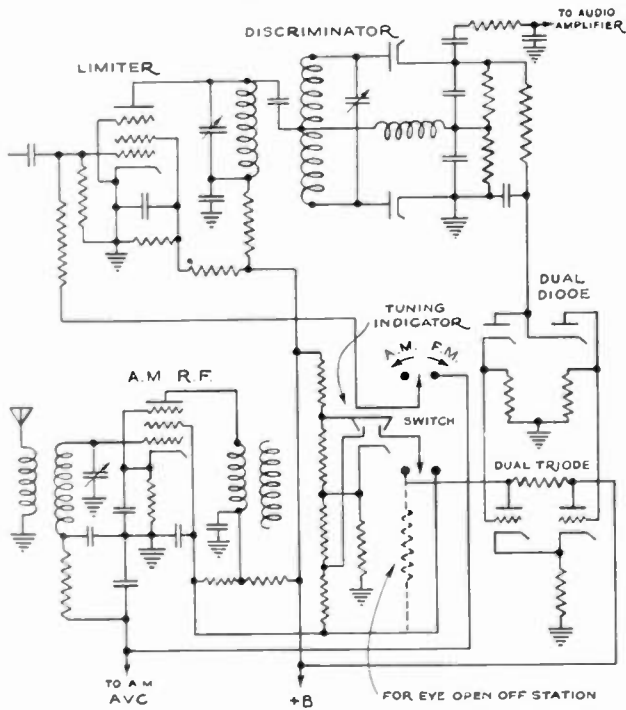

Fig. 5—Dual-diode and dual-triode indicator circuit.

electrode of the tuning indicator, since it is attached to this triode plate, and the eye aperture will increase. In a like manner, a negative voltage at the discriminator will tend to decrease the plate current of the second triode and thereby reduce the voltage drop in the cathode resistor, effectively decreasing the bias on the first triode to produce the same effect again. Therefore,

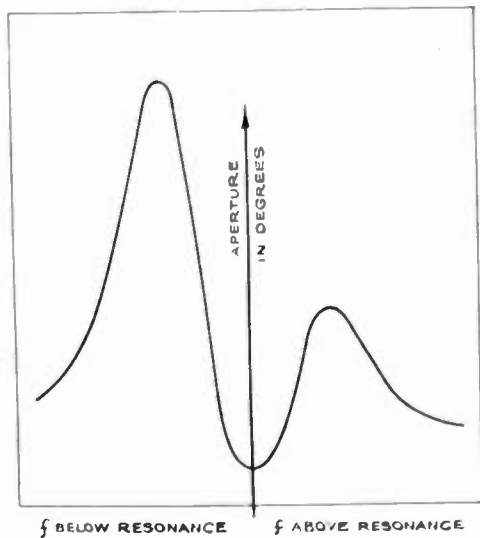

Fig. 6—Indicator aperture angle using circuit of Fig. 5.

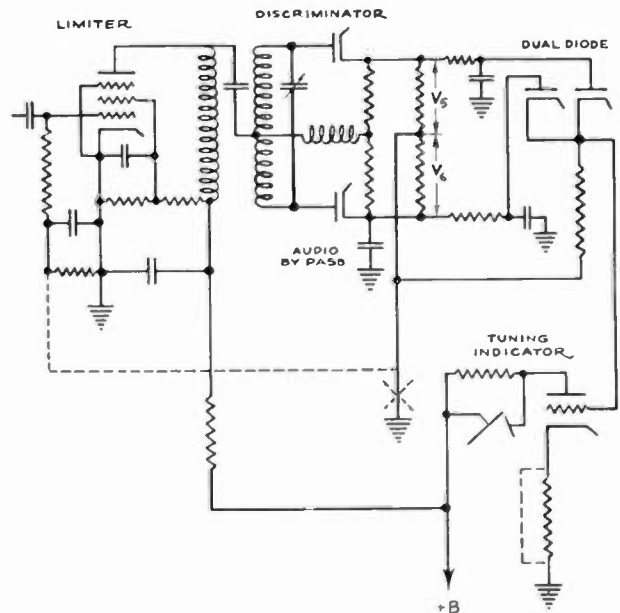

Fig. 7—Dual-diode indicator circuit.

By proper choice of resistors, the eye can be just closed for the condition of zero voltage across the detector. This is an extremely sensitive tuning device, more so than the voltmeter, and requires no preliminary setting up.

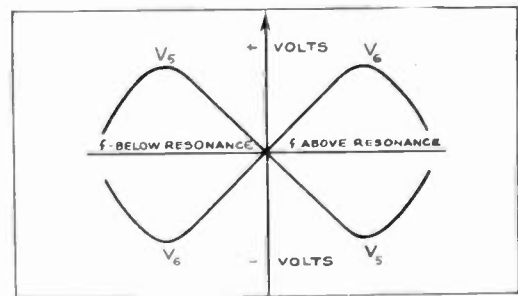

Fig. 8—Discriminator voltages.

The second portion of the eye is actuated by the biasing of an auxiliary tube with the negative voltage derived from the limiter grid circuit and may be omitted, of course.

Since the first section of the tuning indicator is closed when no signal is received as well as for the condition of exact resonance to a received signal, the operation may be confusing. However, this can be overcome by the addition of the resistor shown dotted in Fig. 5. This reduces the voltage of the electrode controlled by the discriminator when no station is being received. As a signal is approached the voltage on the electrode connected to the single triode rises because of the increase in bias voltage supplied from rectification in the limiter grid circuit. The voltage on the discriminator-controlled electrode will also rise because of

the connecting resistor, so that when the station has been correctly tuned, the combination of effects will result in both apertures of the tuning indicator being closed.

A curve of the change in aperture angle with tuning

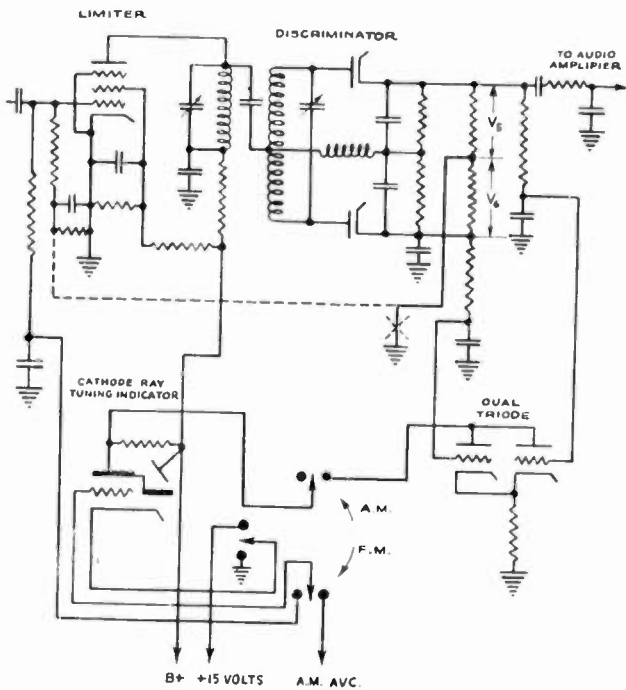

Fig. 9—Dual-triode indicator circuit.

is shown in Fig. 6 and it will be observed that the effect is more pronounced on the side for which the discriminator voltage is positive. This would be expected, since a direct effect is produced, while the negative voltage operates indirectly through the second triode. However, the lack of symmetry does not interfere

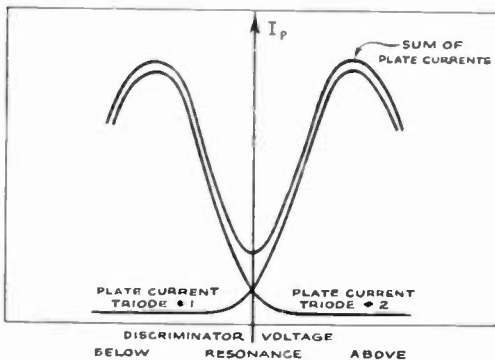

Fig. 10—Plate-current characteristics of dual-triode in Fig. 9.

with the effectiveness of the indicator, since it lies outside of the close-tuning area.

In Fig. 7 is shown a relatively simple yet useful circuit whereby the positive and negative detector voltages are both converted to positive voltages and then impressed on the eye-tube grid. It will be noticed that the direct-current ground has been removed from the cathode of the discriminator diode and has effectively been placed at the electrical center of the load so that

the voltages with respect to ground are of the form shown in Fig. 8. A by-pass condenser is used to ground the low side of the discriminator load for audio frequencies, as it is still necessary to deliver the full amount of detected audio frequencies to the audio amplifier.

With this type of indicator it is necessary to use a sharp-cutoff eye tube so that sufficient sensitivity can

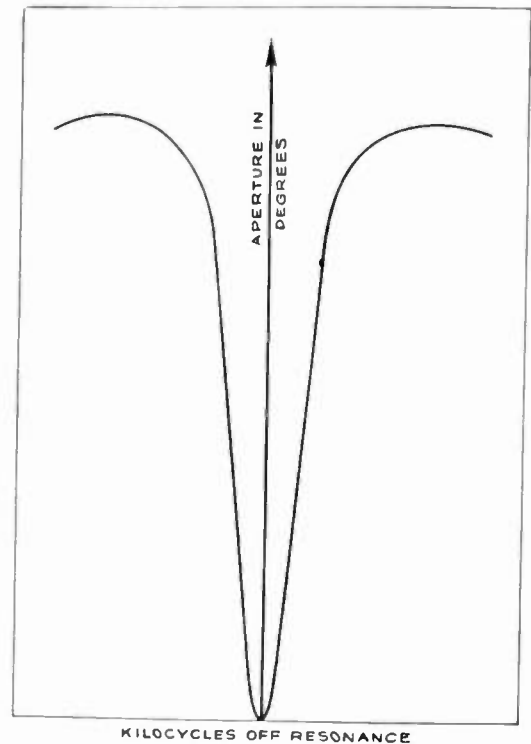

Fig. 11—Tuning indicator aperture angle with circuit of Fig. 9.

be obtained for accurate tuning. In combination amplitude-modulation and frequency-modulation receivers

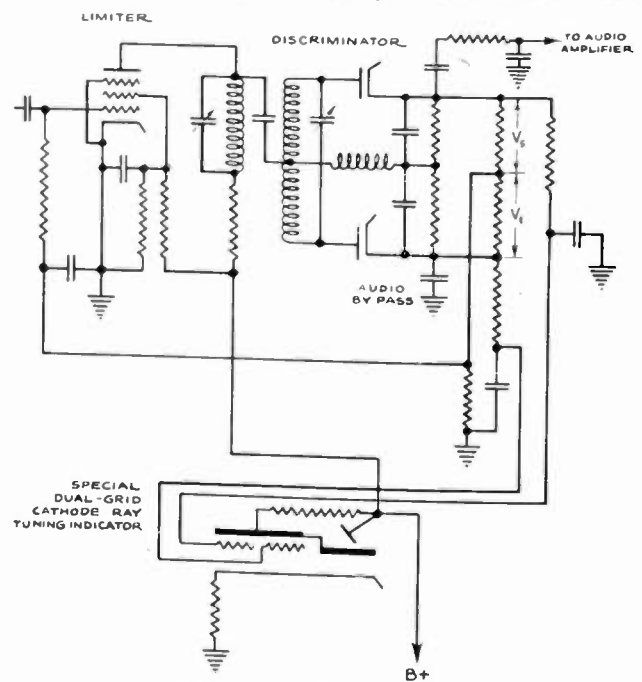

Fig. 12—Indicator circuit using special eye tube.

where the same indicator tube would logically be used, this imposes an undesirable restriction, since amplitude modulation requires an indicator tube of the remote-cutoff type.

Better results may be obtained with the use of the circuit shown in Fig. 9 where a dual sharp cut-off triode receives the voltages of Fig. 8. It can be seen from the curves that when one grid is positive, the other is negative by an equal amount and at first thought it would seem that any effect produced on the tuning indicator by one triode would immediately be canceled by the other. However, since these triodes are operated in the region of plate-current cutoff, the negative grid voltage from the discriminator produces a negligible plate-current change but the corresponding positive voltage on the other grid causes an abrupt plate-current rise. The two plate-current curves are shown in Fig. 10 and added to give the total current flowing in the load resistor. The plate voltage, which the focusing electrode receives, is of the same form and the over-all tuning characteristic appears in Fig. 11.

Not only is this type of indicator symmetrical, but also extremely sensitive. Here again by using a portion of the limiter grid voltage, the eye can be open when no station is being received and closed only when a signal is correctly tuned. This variation is shown dotted in Fig. 9.

If it is found desirable to use the more frequently found tuning indicator with the remote-cutoff triode in the same envelope, provision must be made for biasing this unwanted triode beyond plate-current cutoff, since it is connected internally to the focusing electrode and the slightest conduction will render the indicator circuit insensitive.

If an indicator tube of the sharp-cutoff type is used, however, the included triode will form one branch of the circuit and only a single additional triode will be required.

SPECIAL INDICATOR TUBE

Proceeding a step farther by designing a special indicator tube for this service, the function can be performed with a minimum of equipment as shown in Fig. 12. Here a sharp-cutoff indicator tube with two identical grids is used in the same manner as the separate dual triode and eye tube in the circuit previously described. This functions very well for frequency modulation but is unsuited to the remote-cutoff requirements of amplitude modulation.

The possibility exists of making one of these indicator tubes with two sharp-cutoff grids and a third remote-cutoff grid to be used especially for combination amplitude-modulation—frequency-modulation receivers with a consequent saving in tubes but such an eye has yet to be designed.

Maintenance of Broadcast Operations in Wartime*

J. A. OUIMET†, ASSOCIATE, I.R.E.

Summary.—This paper deals with the technical measures which have been taken in Canada by the Canadian Broadcasting Corporation to meet the daily increasing difficulties of maintenance of broadcast operations in war time. After a brief description of the facilities involved in these plans the paper outlines the steps that have been taken in the physical protection and guarding of broadcast plants. The problem of conservation of equipment in the face of acute shortages is then discussed with the measures that have been applied to prolong the life of tubes, microphones, and other equipment. In treating the final aspect of the problem, that is, the maintenance or resumption of essential operations after destruction of regular facilities, the paper describes the setting up of emergency and stand-by facilities such as secondary control centers, stand-by transmitters, frequency-modulation links, and other equipment designed to insure continuity of service.

FOR THE Canadian Broadcasting Corporation, the problem of maintaining its operations in war-time is essentially the same as that which faces American broadcasters. It is confronted with the same serious economic difficulties, with the same dangers of

sabotage, and finally with the same possibilities of enemy action which may bring about the destruction of its facilities.

Compared to the individual broadcasting station, however, there is one important difference, and that is, its much greater obligations as a publicly owned national service. The Canadian Broadcasting Corporation has been created as an independent, nonprofit-making institution responsible to the Canadian Government to provide a national broadcast service to all Canadians; this service, which is now even more vital than ever before, must be maintained whatever may be the difficulties which rise in its path. For this reason it may have gone more deeply into the problem than has the average station and has concerned itself, not only with measures of plant protection and equipment conservation, but also with measures designed to insure continuity of service in the event of destruction of some of its facilities.

With 10,000 miles of transmission lines operating through five time zones, the CBC network extends from Sydney, Nova Scotia, to Vancouver in British

* Decimal classification: R550XR560. Original manuscript received by the Institute, June 29, 1942. Presented, Summer Convention, Cleveland, Ohio, June 30, 1942.

† Assistant Chief Engineer, Canadian Broadcasting Corporation, Montreal, Que., Canada.

Columbia and links together a total of 57 stations. (See Fig. 1.) Of these, 36 are basic outlets and 21 are supplementary; 47 are privately owned, and 10 are owned and operated by the CBC. Four are 50-kilowatt

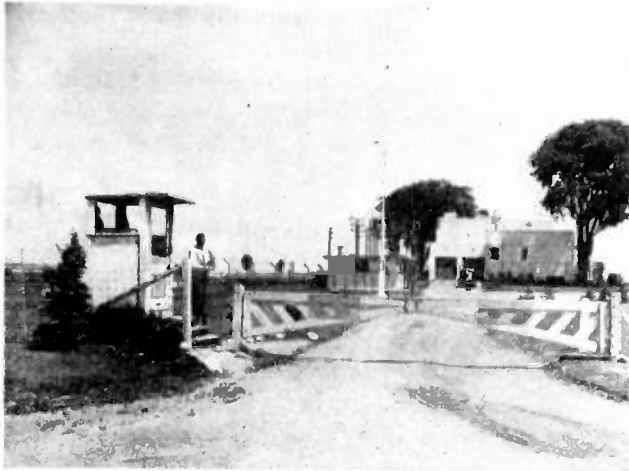

Fig. 2—Gate at CBF transmitter, showing protecting fence, armed guard, and guardhouse.

transmitters: CBA, located at Sackville, is the Regional outlet for the Maritime provinces; CBF, near Montreal, is the French outlet for the province of Quebec; CBL, near Toronto, is the Ontario Regional station, and finally CBK, at Watrous, serves the three Canadian Prairie provinces. In addition, there are stations of either 5 kilowatts or 1 kilowatt at Van-

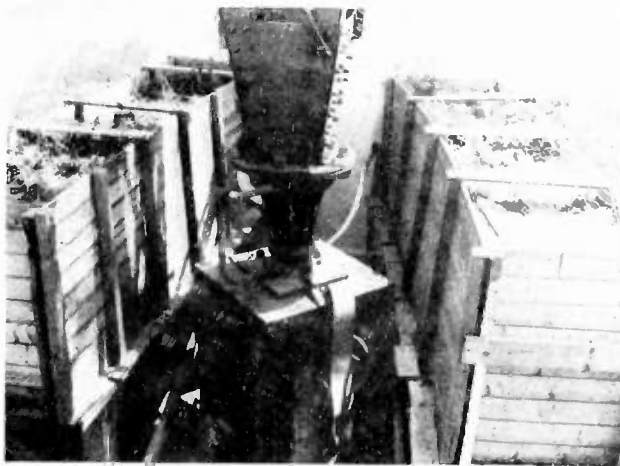

Fig. 3—Sand barricade protecting base insulator of CBF vertical radiator.

couver, Toronto, Ottawa, Montreal, Quebec, and Chicoutimi, as well as three short-wave stations. These CBC stations represent 71 per cent of the total power of all Canadian stations and cover 85.5 per cent of all Canadian radio homes. To produce the programs which feed this network, the CBC has studio installations in Vancouver, Winnipeg, Toronto, Ottawa, Montreal, Quebec, Chicoutimi, and Halifax. This is further supplemented by international exchanges with the American networks and the British Broadcasting

Corporation. Programs from England and particularly from the CBC Overseas Mobile Unit are received at a four-channel short-wave diversity receiving station located near Ottawa. To man these facilities, a technical staff of more than 150 people is maintained, exclusive of the engineering personnel of its headquarters in Montreal.

The first wartime measures were introduced right at the start of the war, in the fall of 1939, and were directed against possible sabotage. These included the construction of barbed-wire fences, the installation of floodlights, the erection of sandbag barricades, and



Fig. 4—Sand barricade in front of glass-brick section of CBF transmitter building.

finally the establishment of armed guards at all main outside plants.

For reasons of economy these fences do not enclose all of the transmitter grounds but only that portion which contains vital components such as the transmitter building, transmission line, antenna, guy anchors, and power substation. However, the fences are kept sufficiently far away from any of these points to guarantee the desired protection. The fence itself is of simple and cheap construction, about seven feet high, using steel posts and barbed wire. (See Fig. 2.)

Armed guards are on duty at all times and access to the plants is restricted to the identified personnel of the corporation. Others can be admitted only for special serious reasons and must show passes which are issued only after thorough investigation. Because of our rigorous climate it has been necessary to provide small heated guardhouses where the men on duty can recuperate between their rounds. (See Fig. 2.)

The floodlighting used is simple and has been designed only for protection purposes and not for decoration or publicity. Its function is to provide sufficient

illumination to those parts of the property which are considered vulnerable to enable the guards on duty to detect any moving person from any location covered in their rounds.

Finally, to protect vital parts against destruction by explosive projectiles that may be directed from outside of the fenced enclosure, sand barricades have been erected around the guy anchors and at the base insulators of all vertical radiators. (See Fig. 3.)

The same precaution is also taken for the outside power substations and in front of certain sections of the transmitter buildings such as the large glass-brick section of the transmitter at Vercheres. (See Fig. 4.)

It may be interesting to note that sandbags are not used here but loose sand between wooden supports. This construction is in sections so that damage to one part of the structure will not cause all the sand to pour out, rendering the whole barricade useless. It was learned by experience early in the game that sandbags are not suited to long exposure to Canadian climatic conditions; all the sandbag barricades that were originally installed collapsed within twelve months, due to rotting of the bags.

Protection against sabotage is, of course, only a small part of the measures we have had to take. The situation in Canada with regard to shortage of equipment and difficulties of procurement is just as serious as in the United States, and perhaps even more so, since practically all of the major radio parts and transmitter tubes used in Canada have to be purchased from American manufacturers.

As a contribution towards the solution of the general problem of equipment shortage and as the surest way of insuring the continuity of service, the engineers of the CBC are now concentrating their energies in an extensive conservation program. Realizing that the success of such a program depends primarily on the extent to which every one of its staff is convinced of the fact that no conservation measure is too unimportant to receive his fullest attention, the CBC is taking every possible means to keep its operators, as well as members of other departments, constantly "conservation conscious." This is a most difficult task because, as is generally recognized, there is no other young industry that has been so spoiled as broadcasting in getting everything it wanted with so little consideration to the problem of equipment procurement. Everyone will readily agree as to the necessity of conservation, but from this abstract admission to effective acts of conservation lies a gap which only organized, persistent, and thorough efforts can bridge.

The backbone of this conservation drive is a sort of war-emergency manual which is distributed to all who handle equipment. This manual outlines the facts of the problem and indicates practical ways of meeting it. This has been prepared in loose-leaf form so that sections can be modified or added with ease. This is supplemented by releases from the engineering head-

quarters designed to keep the interest of the staff in conservation matters constantly alive. The material for these releases is generally taken from news items or from articles in newspapers and magazines which provide some striking examples of shortage difficulties or of particularly interesting ways of meeting them.

As to the contents of this manual, there is nothing that is not already known or cannot be written down by any engineer analyzing all the possible methods of protecting and conserving equipment by careful handling, efficient circuit protection, prevention of abnormal conditions, elimination of unnecessary operation, efficient and economical utilization, and by good maintenance and operating practices.

In the same manual are given full instructions regarding fire protection. Necessary precautions have been established at all plants to protect them against the ordinary peacetime risks of fire, which probably are still, at this time, the gravest risks of destruction which have to be faced.

Since many good papers have already been written on this subject of protection and conservation, it would seem unnecessary to go further into the matter now. A few specific measures, however, have been taken to reduce equipment requirements which may be interesting to note.

An accurate inventory has been made of all CBC facilities, spare parts, expendables, and even of so-called "junk piles" as a preliminary step towards redistribution if necessary. With the number of plants operated by the CBC this is an equivalent, within one organization, of the idea of "pooling of equipment" which is being considered by American broadcasters and under this plan the spares of any one of the CBC stations can be shipped at a moment's notice to any other CBC plant which may be in difficulty.

This idea has been extended even to complete installations. At the Toronto studios, the program and network traffic has so increased as a result of special war productions that its master-control facilities can no longer handle the load. To meet this situation without new equipment arrangements, the CBC engineers are now moving to Toronto a complete modern master-control installation of 8 input, 10 output, and 8 transfer busses of the preset type from their Ottawa studios where it was installed two years ago. At Ottawa it will be necessary to operate with a simplified switching system assembled from units already on hand until radio manufacturers are again in a position to supply new equipment.

To conserve high-quality microphones, restrictions have been made to limit the number of microphones to be used on any one program. This last measure should actually improve the quality of programs since good engineering indicates the use of as few microphones as possible. Similarly, for turntables and reproducers, all high-quality units are used only where the higher performance can actually be appreciated and

they have been replaced with the cheaper types for such work as sound effects, auditions, etc. In addition, a survey has been made of all so-called obsolete equipment, and antiquated amplifiers, which have been discarded on account of high noise level, etc.; when needed, these units will be rejuvenated by minor changes in tube types and circuits.

The possibility of reducing the operating time of transmitters has also been studied but to date the desire for such a reduction has been counteracted by the need of extended hours of operation to provide service to many workers of the war industry who cannot listen at regular hours.

Perhaps the most important contribution that broadcasting could make towards conservation of tubes and equipment would be actually to reduce the power output of broadcast stations. A 20 per cent power reduction might double the life of tubes and yet hardly affect the service to the listener. The CBC engineers are convinced of the advisability of this measure and have already taken active steps towards its application by recommending its adoption to the Canadian Radio Administration. Pending an official decision, the necessary simple modifications to the control and protective circuits have been made at all CBC stations to switch over to reduced-power operation without delay as soon as permission is granted. Tests have shown that many tubes that had to be taken out of service as unable to deliver full power can give many more hours of useful life in operation with reduced-power output.

While still on the subject of maintenance of operations under conditions of war economy, some notes on the personnel problem might be of interest. Out of a total of 180 engineers or technicians, the CBC has already given around 50 to the military services or to the war research, and many more are expected to go. Generally speaking, these have been replaced by men with less experience who were not eligible because of age or physical unfitness. At two studio points, women operators are now employed and so far have been entirely satisfactory for manual broadcast operations where actual knowledge of radio theory is not essential. To counteract the inevitable degradation of operating standards as an inexperienced staff gradually replaces a fully qualified personnel, an extensive educational program has been established to give the necessary theoretical background to the newcomers as well as to refresh the knowledge of the regular men who have been able to remain. These same educational advantages are made available to the office staff in the hope that they may be not only of personal benefit to them but may also result in the formation of a trained reserve which can be drawn on at a later date.

For obvious reasons, the second aspect of the problem, that is, the carrying on of operations during an actual enemy attack, cannot be covered in detail here. At all points the usual routine arrangements have been

made with military and civilian defense authorities regarding the shutting down of transmitters and blackouts. In the more exposed locations, in co-operation with civilian and national defense, special facilities have been established to broadcast independently of the main studios the official instructions to the local population and other transmissions that would be necessary during such an attack.

Finally, there is the third aspect of the problem and that is the maintenance or the resumption of essential operations after the partial or complete destruction of regular facilities. This covers measures designed to protect operations in the sense of providing for alternate methods of operation and for stand-by equipment to be used in the case of loss of vital facilities. Because of economic considerations and more particularly because of the impossibility of getting any new equipment, these measures, which have to be taken solely with materials already on hand, had to be restricted to the more essential and important parts of the system in the light of their relative vulnerability. The word "vulnerability" is used here in its broad sense to include not only the possibility of destruction by enemy action and sabotage but also by the normal peacetime risks such as fire. Whatever the cause of destruction, the results would be the same at this time when replacement is virtually impossible.

In addition to the direct measures which have already been mentioned regarding the protection of plants against destruction by fire and sabotage, there are three distinct methods by which the effect of such losses can be minimized should they occur in spite of these precautions. These are the dispersion of facilities, the provision of stand-by or emergency facilities, and finally the prearrangement of facilities and operations in such a way as to allow readily the shifting of operations from one point to another if necessary.

To meet the possibility of destruction of the regular antennas, emergency aerials will be installed at all transmitters. Having already lost one of our aerials in a gale, the 525-foot radiator of CBM near Montreal, the CBC engineers have practical experience in the subject of antenna losses. They have come to the conclusion that a simple structure of the L or T type with 80-foot masts is adequate. On a frequency of 1070 kilocycles, calculations give a field strength of 158 millivolts per kilowatt at a mile and this is enough for emergency operation. Such an antenna costs only \$1000 complete. A similar structure with masts of 150 feet would cost twice as much while giving only 15 per cent more radiation. By placing the emergency antenna close to the transmitter building, the question of the emergency transmission line offers no problem.

To protect against the loss of power service some of the CBC plants are already equipped either with two independent electric-power feeds or with a stand-by gas engine. Unfortunately other points have no such power protection but efforts are being made to locate,

on the used-equipment market, odd gasoline engines and generators which might be assembled together to provide at least enough power for operation of these plants out of their driver stages.

This brings us to the important point of low-power operation. Only one of the CBC transmitters uses high-level modulation where low-power operation is not feasible and all other plants either have or will have facilities permitting rapid switching from full power to reduced power out of the driver stages. This provision, which can usually be made with only minor circuit changes and is already a most useful one under normal conditions, may now become a necessity with the present shortage of power tubes becoming more acute each day.

Obviously, emergency antennas, alternate power supplies, and low-power operation are no guarantee against the total loss of the plant, or against serious interruptions of service in a multitude of different ways. The only way to circumvent this eventuality is to have another transmitter which can be put into service in an emergency. Fortunately, such protection is possible at most of the CBC main outlets. In Montreal, there are two CBC stations: CBF on 50 kilowatts and CBM on 5 kilowatts. Similarly, in Toronto there is CBL on 50 kilowatts and CBY on 1 kilowatt, with a directional antenna concentrating the signal on the city. Normally, these stations carry different programs but in an emergency, when program diversity becomes of secondary importance, all essential broadcast services could be shifted to either one of the two stations. As a matter of fact, the service in these cities and also in Vancouver has been further protected by low-power stand-by transmitters of 100 watts installed directly at the studio plants. These transmitters are arranged for operation on either one of the frequencies of the two main transmitters as well as on medium short-wave to be used also as a studio transmitter link in case of failure of the studio transmitter lines. Although these 100-watt stand-bys are not capable of serving the outlying districts covered by the main transmitters, they can provide adequate service at least within the cities concerned which represent more than half of the population served by the regular stations.

These stand-by transmitters have been assembled from old units which were taken out of service from other CBC stations whose power was increased some years ago. The case of the Vancouver stand-by may be interesting. Normally, this is the short-wave station CBRX which is used to provide short-wave broadcast service to sparsely populated areas inside British Columbia which cannot be covered by CBR's broadcast-band transmissions. This short-wave transmitter was originally located with the main transmitter at Lulu Island outside Vancouver. The masts for the short-wave doublet are used at present to support the emergency antenna for the main transmitter and the

short-wave transmitter itself has been moved directly to the studios while a new short-wave doublet was installed on the roof of the hotel in which the studio is located. This same antenna is also used as a T aerial for broadcast stand-by service with the short-wave transmitter modified for operations on the frequency of the main transmitter. This transmitter can serve also as a studio transmitter link. The only drawback is, of course, that the regular short-wave service would have to be discontinued in case of an emergency. This, however, is not serious.

At transmitters such as CBA and CBK which are 50-kilowatt stations situated in areas of widely scattered population, 100-watt stand-by transmitters would be useless and the establishment of duplicate high-power stations is out of the question. Fortunately, however, there are on the CBC network a number of privately owned stations of lower power which are dispersed throughout the same area. In case of an emergency, essential official broadcast services could, therefore, be taken over by these stations which are already receiving regular CBC service.

Finally, a few words about the protection of program-production centers. At the Toronto studios, protection measures are only in their initial stage but they are proceeding according to a general plan. In addition to the main studios which are located in a fireproof building, there are two remote permanent auditorium studios as well as a number of other rented halls which are used more or less regularly. With this original dispersion the loss of the main studios would not cause complete loss of service inasmuch as it would be possible to continue on a much reduced scale from the auditorium studios and halls. But this is not sufficient as it is desired to guarantee the restoration of service to practically full normal standards. To accomplish this, it has been decided to install at one of the concert studios small talk studios and control equipment to be used as transmitter booths in case of an emergency. Similarly, at the same point there will be a stand-by master control to handle the program distribution to and from the networks which is normally carried at the main studios. Since the transfer of operations to this emergency point must be done with the minimum loss of time, it will also be necessary to install independent loops to the telephone and telegraph companies for feeds to the transmitters and networks.

While this problem of line and network protection is too involved to be discussed here, the fact should be emphasized that it is very important as well as very complex. It has been found from experience that the various wire circuits to and from a studio plant may actually be all routed through the same telephone exchange, in which case the destruction of this particular exchange may be just as serious as the loss of the studios. To avoid this difficulty, the emergency-studio point should be so located in another part of the city that its loops will follow a route different from that

taken by the regular facilities. Of course, the ideal protection for loops is frequency-modulation links. Unfortunately, these can no longer be procured and the few units which are already on hand have to be saved for locations where loops are not available.

Of course, two small booths and two auditorium

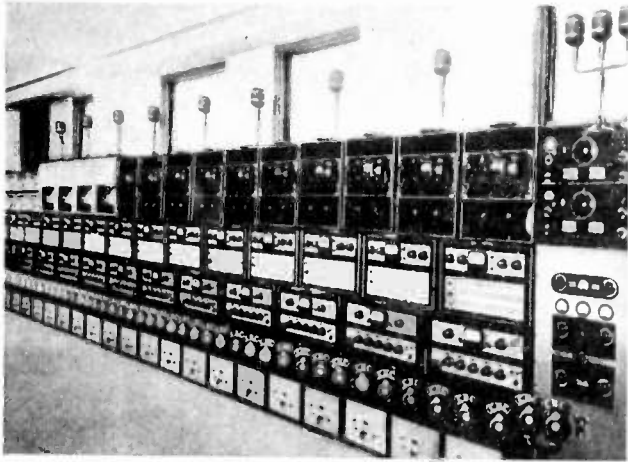

Fig. 5—Some of the special portable equipment to be used by the CBC in the protection of studio operations.

studios would not be sufficient to carry the load of normal production. To take care of this it is planned to originate some programs at outside halls equipped with portable speech-input equipment. This equipment is probably the most important single element of protection for studio operations. At all CBC studio points, all remote gear, amplifiers, microphones, stands, cables, order-wire telephones, sound-effects turntables, portable recorders, and mobile units are to be kept away at all times from main studios and are to



Fig. 6—One of the mobile units of the CBC.

be stored in the safest possible location. This measure will be very inconvenient from an operating standpoint, but on the other hand, no matter what disaster has to be faced, it is hardly likely that both main-studio facilities and the remote gear would be destroyed at the same time.

Fortunately, the CBC already had on hand enough portable equipment to insure this protection at all

studios as well as to equip the emergency master control and booths mentioned previously.

This equipment was designed before the visit of the King and Queen of England to take care of the very extensive hookups that were made at that time. Some of these broadcasts, which required as many as 30 operators for a single event, could not be handled with the ordinary portable sets. To meet the situation the CBC engineers designed new equipment: special, 2-channel, 10-microphone, alternating-current—direct-



Fig. 7—The van which is used by the CBC correspondents in England for remote and recording work.

current portable amplifiers; portable master-control units, capable of handling any combination of inputs or outputs; portable order-wire communication sets, etc. (See Fig. 5.) With these units it is possible to set up practically any kind of emergency-control point anywhere that lines are available.

Finally, a word about the CBC mobile units which should play a most important role in any emergency situation.

The corporation has three permanently equipped mobile stations but mobile unit No. 2, which is attached to the Quebec region, is the most complete installation of that type which it operates. (See Fig. 6.)



Fig. 8—Inside view of CBC's mobile unit in England showing recorders and amplifiers.

It is a trailer and car combination with the electric-power plant in the rear compartment of the automobile. The trailer is equipped with two recording channels, two 40-watt transmitters which can operate on either medium short-wave or ultra-high frequencies, also with a push-button master-control position and the necessary audio equipment for the simultaneous broadcasting of two separate feeds. It is also supplied with the usual accessories, microphones, cables, test equipment, packsets, receivers, etc. This unit has actually been used in motion to transmit separate French and English commentaries at the same time. Under normal conditions, transmissions from this unit are excellent, and unless the fact is stated on the air, it is generally quite difficult to distinguish them from an ordinary broadcast.

The most recently built unit, which is now in operation in England, uses a special military van designed to meet the conditions under which it has to operate. (See Figs. 7 and 8.) It has been overseas now for more than two years and has seen actual war service during the height of the blitz over the British Isles, making more than 6000 recordings, in connection with the activities of the Canadian Corps overseas.

As mentioned in the foregoing, all these measures which have been described are pretty obvious and none represents any innovation:

Protection against sabotage, by the erection of fences and barricades, by the provision of floodlighting and armed guards.

Protection of plant by fire instructions and precautions.

Conservation of equipment by efficient utilization, by good maintenance and operations practices, by the rehabilitation of obsolete units, by the elimination of unnecessary operations, and by the reduction of the power of transmitters.

Protection of transmitter operations by emergency antennas, by operations out of the driver stages, by stand-by generators, and by stand-by transmitters of low power.

Protection of studio operations by dispersion of facilities, by the setting up of emergency control points, and by the use of portable equipment and mobile units.

In all these measures and in the many others which have been taken, the engineering difficulties which had to be solved are minor ones, and yet, as every one knows who has been faced with the problem, progress

is most difficult. The real problem of the broadcast engineer is, first, to bring about a full and general realization of the seriousness of the situation, and second, to take immediate and effective measures to meet that situation irrespective of the efforts, inconvenience, and constant self-discipline which these may entail. In the face of an emergency which may strike at any time and in any location, preparedness is our first and most important duty.

APPENDIX

Since this paper was prepared, some months ago, much progress has been made in the execution of the plans already described and a few notes may now be useful to bring the subject matter up to date. Our plans for the conservation of tubes by the readjustment of the operating conditions at transmitters have been given effect and all high-power stations of the CBC have now been operating under reduced voltages following the experimental period which began in May, 1942.

An investigation of the vulnerability of local loops and other wire facilities has shown that extensive protection by the use of radio-frequency links was necessary. After considerable procurement difficulties enough parts have been obtained from used equipment and other sources to undertake the setting up of a number of frequency-modulation and amplitude-modulation links at various strategic points. With these units it is expected that adequate programming service can be maintained in large operating centers independently of normal physical circuits.

But perhaps the most important development in the CBC's war-emergency plans has been in the field of co-operation with military and civilian-defense authorities. With the continually growing realization of the potentialities of broadcasting and its associated networks, these authorities have requested, in certain regions, the use of portions of the CBC network for instructions to broadcast stations and the public generally concerning the silencing of stations, black-outs, and other civilian-defense matters necessary in an emergency.

These important developments and others, particularly in the field of conservation, have in great part been made effective by the work of a special War Emergency Operations Committee which has been set up to study and co-ordinate all phases of the problem.

The Focusing View-Finder Problem in Television Cameras*

G. L. BEERS†, MEMBER, I.R.E.

Summary.—The technical excellence of a television program may frequently depend on the characteristics of the view finder used in the television camera. Conditions peculiar to television make it desirable that television-camera view finders be of the focusing type. The requirements of an ideal view finder of this type are discussed. During the past ten years a number of view-finder arrangements have been investigated in connection with the development of television cameras. Several of these are described and their relative merits indicated.

INTRODUCTION

ONE OF the most essential elements in a television camera is the view finder. On its characteristics may depend the technical excellence of the television program. The desirability of minimizing operating personnel and the necessity for keeping a camera in practically continuous operation during television programs of one or two hours make it necessary that the view finder be of the focusing type. Such a view finder not only provides a view of the scene which is included in the field of the camera but also indicates when the lens is properly focused on the desired scene.

During the past ten years a number of focusing view finders were investigated to determine their suitability for use in television cameras. Brief mention of some of these arrangements has already been made in the technical literature on television equipment. Practical operating experience with several view finders both in the studio and outdoors has established certain requirements which an ideal view finder should meet. It is the purpose of this paper to discuss these requirements; to describe briefly several of the view-finder arrangements which have been investigated, and to indicate their relative merits.

REQUIREMENTS OF AN IDEAL FOCUSING VIEW FINDER FOR TELEVISION CAMERAS

The requirements of an ideal view finder may be stated as follows:

1. It should at all times accurately indicate when the camera is in focus on the desired scene or object.
2. It should not only define that portion of the scene which is being converted into the television image but also should reproduce a sufficient portion of the scene outside the camera field so that the cameraman will know in advance what the television picture will include if he pans the camera in any direction.
3. It should provide an erect image which is correct left to right and of sufficient size and brightness to minimize eyestrain.

* Decimal classification: R583. Original manuscript received by the Institute, September 30, 1942. Presented, Summer Convention, Cleveland, Ohio, June 30, 1942.

† RCA Manufacturing Company, Camden, New Jersey.

4. It should not unduly complicate the procedure of interchanging camera lenses or pickup tubes.

5. For portable pickup work the view finder should not contribute substantially to the size and weight of the camera.

It will be noted that the first three of these requirements deal with performance whereas the last two are concerned primarily with operating convenience.

In order to appreciate the significance of these requirements it is of interest to discuss them in connection with the two general groups of view finders into which the several individual view finders are subsequently classified. For the purpose of this discussion the first group will consist of those view finders which derive the view-finder image either directly or indirectly from the camera lens. The second group includes those which make use of a separate optical system for producing the view-finder image.

REQUIREMENT NUMBER 1

Requirement 1 specifies that the view finder should at all times accurately indicate when the camera is "in focus" on the desired scene or object. Practical operating experience has shown that in respect to this requirement it is desirable that the cameraman be aware of a degradation in picture detail due to improper focus before the loss in resolution is apparent to the television audience. The view finders in group 1 have several limitations with respect to this requirement. When the scene which is being televised is sufficiently illuminated so that the camera lens can be stopped down to provide greater depth of focus the view finders in this group do not provide an accurate focus indication since the view-finder image has the same depth of focus as the camera image. In other words, no apparent change in detail is observed by the cameraman as the lens is moved back and forth through an appreciable range. This limitation may not be particularly apparent to the television audience from the standpoint of picture detail but is likely to be disturbing for another reason. Under this condition the cameraman has a tendency to move the camera lens back and forth to determine by approximation the center of the range over which no effect on picture detail is observed and thus establish the "in-focus" position of the lens. As the lens is moved back and forth, the area included in the television image changes in such a manner that the sides of the picture appear to move in and out; an effect which is disturbing to most observers.

Another result of this inaccurate focus indication is encountered when the camera is used under conditions

where the illumination may vary suddenly through a fairly wide range. Such conditions are frequently encountered in outdoor pickup of sporting events or spot news, etc. If the lens is stopped down and the camera is inaccurately focused on a scene in bright sunlight and the sun subsequently goes behind a cloud, making it necessary to increase the lens aperture, the camera will be out of focus. The focusing readjustment which is then required would have been avoided if the view finder had met requirement 1.

The view finders in group number 2 can all be made to meet requirement 1 provided they are constructed with sufficient mechanical rigidity to maintain, at all times, the proper alignment between the optical systems for the view finder and pickup tube.

REQUIREMENT NUMBER 2

Requirement 2 states that the view finder should always provide an image of and accurately define that portion of the scene which is being converted into the television picture and should also provide a view of at least a small part of the scene on each side of the television-picture area. Unless the first part of this requirement is fulfilled the cameraman may not know, for example, whether or not an individual's head is in the picture. The second half of this requirement gives the cameraman an indication of what will be included in the picture if he pans the camera in any direction. The need for this information may depend to some extent on whether the camera is being used in the studio or outdoors. From one standpoint, there is less need for this additional view-finder-image area in the studio because studio programs are usually rehearsed several times. On the other hand, in studios several sets are frequently used in a limited space so that a camera can be changed quickly from one scene to another. This makes it necessary for the cameraman to know what is included in a small area outside the field of his camera so that he does not inadvertently include an edge of an undesired set in the picture. If the view finder does not provide an image of this additional area it is frequently necessary for the cameraman to move his head sufficiently so that he can look along one side of the camera to determine the effect of panning the camera in a desired direction. Not only is this inconvenient but when the cameraman looks around the camera at the brighter scene and then again looks at the image in the view finder it is necessary for his eyes to readjust themselves to the difference in the light intensity. In outdoor pickup work such as sporting events, where the action is unpredictable, if the cameraman looks around one side of the camera he may lose the action altogether before he has time to again look into the view finder.

In general, the view finders in group 1 do not meet requirement 2 since the view-finder image which they provide is obtained from the camera lens and covers the same picture area as the television image.

The view finders in group 2 make use of a separate optical system and, therefore, can be made to provide a view of some of the scene around the area which is converted into the television image. Such view finders are, of course, provided with hairlines on the viewing screen or some other expedient which indicates the actual area of the scene which is included in the television picture. It is essential that the view finders in this group be provided with some means which will correct for parallax between the two optical systems.

REQUIREMENT NUMBER 3

The ideal view-finder requirement 3 is met if the view finder provides an erect image which is correct left to right and of sufficient size and brightness to minimize eyestrain. A difference of opinion may exist as to the necessity of having the view-finder image erect and correct left to right. If the cameraman has received considerable training with cameras providing images which are inverted and reversed left to right, such a view finder is undoubtedly satisfactory. He will then have developed the proper co-ordination between the image he sees in the view finder and the direction in which he must move the camera to produce a desired effect. On the other hand, in a new field, such as television, where it will be necessary to start with relatively untrained personnel, it is felt that the corrected view-finder image will be more satisfactory.

With respect to the other stipulations in requirement 3, a view-finder image at least 3 by 4 inches at a viewing distance of 12 inches has been considered to be satisfactory. The image should be as bright as possible. No difficulty has yet been encountered from having the view-finder image too bright. The ability of a specific view-finder arrangement to meet requirement 3 is basically determined by the amount of light which it supplies to produce the optical image since, if sufficient light is available, an optical system can be used to increase the image size and reverse it in either or both directions.

The problem of providing sufficient light to produce a satisfactory view-finder image is becoming more difficult as the sensitivity of camera pickup tubes is increased. This limitation may ultimately make it necessary to resort to a highly complicated view-finder arrangement which will be described later.

REQUIREMENT NUMBER 4

This requirement is concerned with the effect of the view finder on the ease of interchanging either pickup tubes or lenses. Since emergencies may arise which make it necessary to change pickup tubes and since it is frequently desirable to change to a different focal-length camera lens, it is essential that these changes be made in the shortest time and with the least inconvenience.

This requirement is met to the greatest extent by

the view finders in group 1 since they derive the view-finder image from the camera lens. The view finders in group 2, which use a separate optical system for producing the view-finder image, all contain some element which must be adjusted to provide satisfactory optical alignment between the two optical systems when pickup tubes are changed. Up to the present time it has been impracticable to manufacture pickup tubes with sufficiently close tolerance on the position of the mosaics and other elements of the tubes to make them optically interchangeable. Some adjustment, therefore, is necessary so that the view-finder image and the image on the pickup tube are "in focus" simultaneously. It is possible to shift the position of the pickup tube in a camera to obtain satisfactory optical alignment between the two optical systems. The size and weight of the pickup tube with its deflecting yoke, however, make it much more practical to move a ground-glass screen or some other element in the view finder to provide the necessary alignment between the two optical systems.

No serious complications are encountered in interchanging lenses of different focal lengths in cameras employing the view finders in group 1 since only the camera lens is changed.

The additional lens required with the dual-lens view-finder arrangements in group 2 make the problem of interchanging lenses somewhat more difficult. This is particularly true where the lenses are large and heavy such as those having focal lengths of 20 inches or more and apertures of the order of $f/4.5$.

REQUIREMENT NUMBER 5

Requirement 5 is based on the desirability of keeping the size and weight of television cameras for portable pickup work at a minimum. Studio cameras are usually semipermanently mounted on large dollies similar to those used in motion-picture work and the size and weight of the television camera for studio work is, therefore, not a primary consideration. Portable television cameras, however, are used on conventional tripods and are set up and subsequently taken down at each pickup location. It is, therefore, desirable to keep the size and weight of cameras for portable pickup work at a minimum. In some cases a sacrifice in view-finder performance has been made to permit a reduction in the size and weight of the camera. Some portable cameras which employ one of the more complicated view finders are constructed so that the camera can be separated into two units. This construction not only makes the camera more portable but also makes it possible to mount the two parts separately on the tripod.

Since the view finders in group 1 require less parts, occupy less space, and contribute less weight, they are more acceptable from the standpoint of requirement 5 than those in group 2.

DESCRIPTION OF INDIVIDUAL VIEW FINDERS

The following is a list of the view finders which will be described.

1. Mirror arrangement for observing the optical image on the mosaic of the pickup tube.
2. Semisilvered mirror arrangement for utilizing the camera lens to produce an optical image on a ground-glass viewing screen.
3. Kinescope or electronic view finder.
4. Kinescope or electronic view finder with remote focusing control.
5. Split-image view finder as used in the Contax and similar cameras.
6. Duplicate-lens view finder as used in the Rolliflex camera.
7. Combination duplicate lens and kinescope view-finder.

The first four view finders in this list derive the view-finder image either directly or indirectly from the camera lens and are those which were previously classified as the group 1 view finders. View finders 5, 6, and 7 are the group 2 view finders and obtain the view-finder image from a separate optical system. For the sake of simplicity, the diagrams which will be used to illustrate the several view finders will not show any means either for magnifying the optical image or for correcting it in the vertical and horizontal directions. It is apparent, that if sufficient light is available, lens and mirror arrangements can be used to accomplish any of these results. The means for correcting for parallax is likewise omitted from the diagrams of the group 2 view finders. Although the iconoscope is shown as the pickup tube in each of the diagrams it is obvious that the orthicon or any other type of pickup tube may be used.

MIRROR ARRANGEMENT FOR VIEWING THE OPTICAL IMAGE ON THE MOSAIC OF THE PICKUP TUBE

The original iconoscope camera view-finder arrangement is illustrated by the diagram in Fig. 1. With this view finder the cameraman, through the use of mirror *A*, observes on the mosaic *B* the optical image which is produced by the camera lens *C*. The shape of the glass envelope of the pickup tube is usually such that only a portion of the image on the mosaic can be observed through the use of this system. The mosaics of the more recent pickup tubes have very poor light-reflecting properties and the optical image produced on the mosaic is, therefore, unsatisfactory from the brightness standpoint. The chief advantage of this arrangement is its simplicity. It requires a minimum of equipment since it makes use of only the camera lens and does not employ a separate viewing screen. No special adjustments are necessary when changing either the camera lens or the pickup tube. It has, however, all the limitations previously mentioned in connection with the group 1 view finders.

SEMISILVERED MIRROR ARRANGEMENT UTILIZING THE CAMERA LENS TO PRODUCE AN OPTICAL IMAGE ON A GROUND-GLASS VIEWING SCREEN

The diagram in Fig. 2 illustrates the view finder system, which makes use of a semisilvered mirror *A* to reflect some of the light transmitted by the lens *B*. This light is again reflected by the mirror *C* to produce an optical image on the ground-glass viewing screen *D*. In the experimental work on this arrangement, mirrors were used in which the reflected light varied from 15 to 40 per cent. Since the total light reflected from the front-surfaced mirror *A* is a comparatively small percentage of the light passing through the mirror, the light reflected from the back surface of the mirror may be a fairly large percentage of the total reflected light. It is, therefore, necessary to use either a very thin

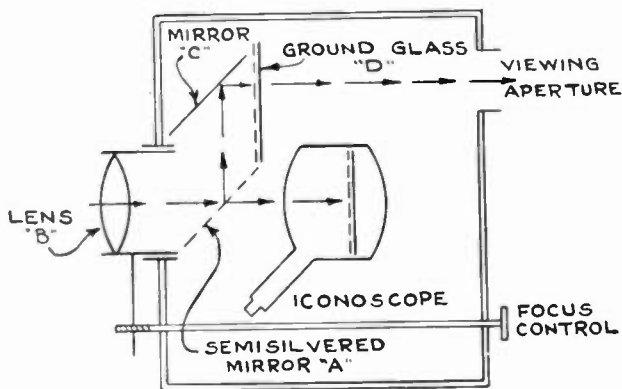

Fig. 1—Mirror arrangement for viewing the optical image on the mosaic of the pickup tube.

mirror or else have the back surface of the mirror coated with a nonreflecting film; otherwise the light reflected from the back surface produces an image which is sufficiently displaced from the front-surface image to reduce the effective resolution of the view finder to a point where it is definitely unsatisfactory.

The chief advantage to be found in this view finder likewise lies in its relative simplicity. With respect to the arrangement shown in Fig. 1, it has the advantages of giving a somewhat brighter image and also will provide a view of the scene whose area is greater than that included in the field of the camera.

The most serious disadvantage of this view-finder arrangement is that it robs light from the mosaic of the pickup tube and therefore decreases the effective light sensitivity of the system. Although it meets requirement 2 it has the other limitations of the group 1 view finders. Since a separate ground-glass viewing screen is used with this arrangement it is necessary to adjust the position of the viewing screen when changing pickup tubes so that the viewing screen is the same distance from the optical center of the lens as the mosaic of the pickup tube. This view-finder arrangement also imposes a limitation on the shortness

of the focal length of the camera lens which can be used.

KINESCOPE OR ELECTRONIC VIEW FINDER

This view-finder arrangement is obtained by incorporating in the camera a kinescope on which is reproduced the television image. It is illustrated by the diagram in Fig. 3.

The chief advantage of this view-finder system is

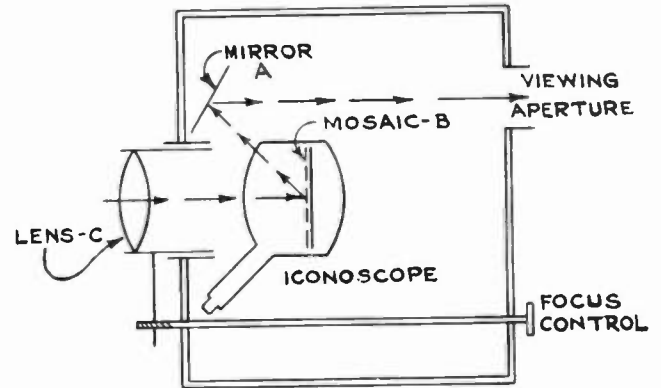

Fig. 2—Semisilvered-mirror view-finder arrangement.

that the relative brightness of the view-finder image does not diminish as the sensitivity of the pickup tube is increased. The brightness of the Kinescope view-finder image is determined primarily by the characteristics of the kinescope which is used and the operating voltages which are employed. It, like the view-finder arrangements illustrated in Figs. 1 and 2, does not necessitate any view-finder adjustments when either pickup tubes or camera lenses are interchanged and no correction for parallax is required.

In addition to the several limitations discussed in connection with the group 1 view finders the kinescope

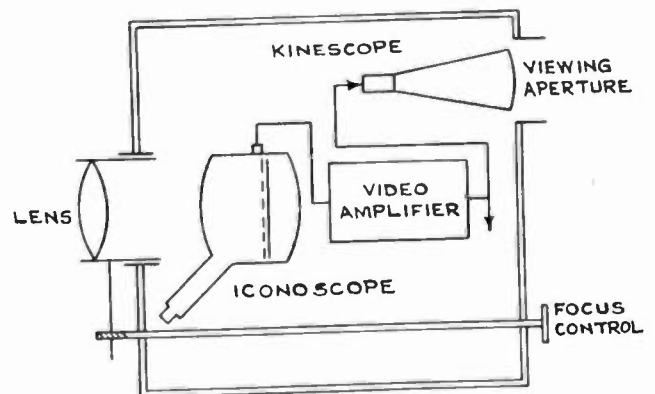

Fig. 3—Kinescope or electronic view finder.

type of view finder has the further restriction that the sharpness of the view-finder image is dependent on the resolution of that portion of the television system which it includes. It is, therefore, necessary that satisfactory electrical focus of the kinescope be maintained for this view finder to function satisfactorily. The

space required in a camera to house this type of view finder is relatively large. The several thousand volts which are used as anode supply for the kinescope present a problem in providing a satisfactory camera cable. If this camera-cable problem is avoided by incorporating a voltage-supply unit in the camera a corresponding increase in the size and weight of the camera results.

KINESCOPE OR ELECTRONIC VIEW FINDER WITH REMOTE-FOCUSING CONTROL

In the kinescope view-finder arrangement just described, a television monitoring unit with its kinescope

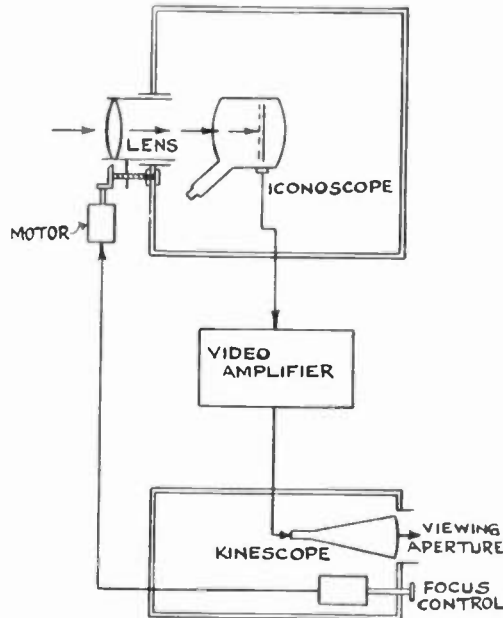

Fig. 4—Kinescope or electronic view finder with remote focusing control.

is in effect moved from its normal location so that it can be associated directly with the focusing control in the camera. In the remote-control form of the kinescope view finder the physical location of the parts is reversed and a remote camera-focusing control is provided that can be used at the normal location of the television monitoring unit. The diagram in Fig. 4 illustrates this arrangement. As indicated in the diagram, the remote control of focus is accomplished through the use of Selsyn motors.

The chief advantage of this view-finder system lies in the fact that it permits a camera which is small in size and light in weight. This is especially desirable in portable pickup work. It makes possible a camera which is particularly suitable for locations which are inaccessible to a cameraman. It also provides the advantages which have been discussed in connection with the previous kinescope view finder. With the remote-focusing arrangement the only view-finder equipment which must be housed in the camera is the small Selsyn motor. A wire-frame view finder mounted on the side of the camera is used by the cameraman to

keep the camera trained on the desired scene. The focusing is done by a control operator at the monitoring unit.

In addition to the deficiencies of the kinescope view finder illustrated by Fig. 3, this arrangement has the further limitation that a fairly high degree of coordination is required between the man who is panning the camera and the man at the remote point who is operating the focusing control. When the focusing and panning are done by the same individual he subconsciously starts to adjust the focusing control in the proper direction to correct for any change in distance between the camera and the desired scene.

SPLIT-IMAGE VIEW FINDER AS USED IN THE CONTAX AND SIMILAR CAMERAS

The diagram in Fig. 5 illustrates this type of view finder. It utilizes an optical system which is actuated by the focusing control simultaneously with the camera lens and produces two optical images which are accurately superimposed when the camera lens is in focus on a desired object or scene. The two images are displaced with respect to each other when the focusing control has not been properly adjusted. In a view finder of this type which was investigated the condition of focus could be accurately determined only in a small area in the center of the picture. Another limitation of this particular view finder was that when using long focal-length lenses the actual size of an object in

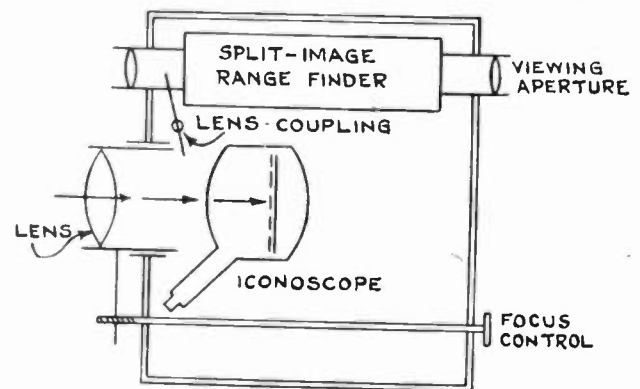

Fig. 5—Split-image view finder.

the view finder remained the same as when a short focal-length lens was used. A hairline indicator was provided to indicate the smaller field covered by the longer focal-length lens. An adjustment is required with this type of view finder when interchanging pickup tubes so that the optical system of the view finder is adjusted to compensate for variations in the position of the mosaic in different pickup tubes.

DUPLICATE-LENS VIEW FINDER AS USED IN THE ROLLIFLEX CAMERA

As shown in Fig. 6, an auxiliary lens *A*, which has the same focal length as the camera lens *B*, is used to produce on the ground glass *C* an optical image which

corresponds to the optical image on the mosaic *D* of the pickup tube. The position of the ground glass *C*, with respect to the optical center of the lens *A*, must always correspond to the position of the mosaic *D* with respect to the lens *B*. The two lenses must be matched accurately for focal length. To facilitate interchanging lenses of different focal lengths each pair of lenses are usually assembled on a single mounting plate. This view-finder system provides an image of a portion of the area outside that covered by the field of the camera. A view finder of this type provides a very accurate indication of focus under all conditions since the view-finder lens can be kept wide open when the camera lens is stopped down. Since a fast lens is nor-

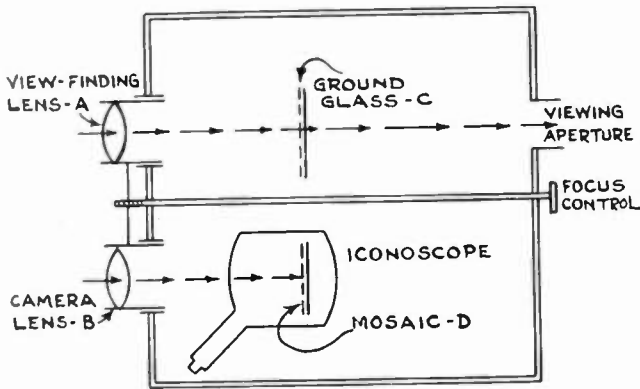

Fig. 6—Duplicate-lens view finder.

mally used to provide the view-finder image the brightness of this image has been relatively satisfactory. The increased sensitivity of pickup tubes, however, is causing the image brightness obtained from this view-finder system to decrease to the point where it no longer will be satisfactory. Some system for parallax correction is required with this type of view finder. The amount of correction which is necessary is generally determined by the maximum diameter of the lenses supplied with the camera.

The inability of this view finder to meet the ideal view-finder requirements is found in connection with requirements 4 and 5. Since a separate lens is used to

produce an optical image on a ground-glass screen, the position of this screen must be adjusted to correspond to that of the pickup-tube mosaic whenever pickup tubes are interchanged. Since the longer focal-length lenses (20-inch, *f*/4.5 lenses are frequently used) are large and heavy, the additional lens required for this view finder not only makes the problem of interchang-

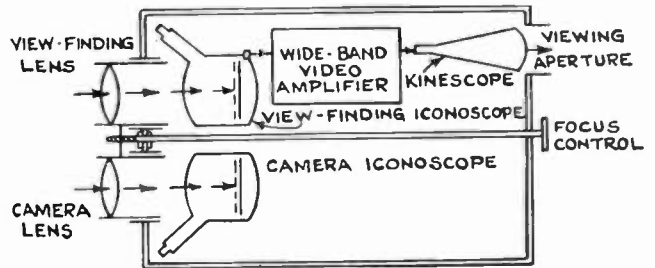

Fig. 7—Combination duplicate-lens and kinescope view finder.

ing lenses more difficult but materially increases the over-all size and weight of the camera.

COMBINATION DUPLICATE-LENS AND KINESCOPE VIEW FINDER

It has previously been pointed out that as the sensitivity of the television pickup tube is increased a corresponding decrease occurs in the relative brightness of the image in an optical view finder. At present, when the maximum sensitivity of the orthicon pickup tube is utilized, the image brightness obtained from an optical view finder, such as the duplicate-lens arrangement previously described, is on the verge of being unsatisfactory. With the kinescope type of view finder any increase in the sensitivity of the pickup tube is automatically compensated insofar as the brightness of the view-finder image is concerned. The types of kinescope view finders which have been described, however, do not meet performance requirements 1 and 2. If a further improvement is made in the sensitivity of television pickup tubes, it may be necessary to use a view finder of the type illustrated in Fig. 7.

In this diagram it will be noted that two pickup

TABLE I

View Finders	No. 1 Mirror Arrangement for Observing the Optical Image on the Mosaic of the Pickup Tube	No. 2 Semisilvered Mirror Arrangement Utilizing Camera Lens to Produce Image on Viewing Screen	No. 3 Kinescope or Electronic View Finder	No. 4 Kinescope View Finder with Remote-Focus Control	No. 5 Split-Image View Finder	No. 6 Duplicate-Lens View Finder	No. 7 Combination Duplicate-Lens and Kinescope View Finder
Ideal View-Finder Requirements							
No. 1 Provides accurate indication of focus under all conditions.	No	No	No	No	Questionable	Yes	Yes
No. 2 Accurately defines scene in television picture and gives view of some additional area.	No	Yes	No	No	Yes	Yes	Yes
No. 3 Provides image of satisfactory size and brightness.	No	No	Yes	Yes	Questionable	Yes at Present	Yes
No. 4 No special adjustments required when pickup tubes or lenses are interchanged.	Yes	No	Yes	Yes	No	No	No
No. 5 Does not require a serious increase in the size and weight of the camera.	Yes	Yes	No	Yes	Yes	No	No

tubes are used with a pair of duplicate lenses. Associated with the camera pickup tube are the normal television amplifier and deflection circuits. The amplifier used with the view-finder pickup tube is designed to pass a wider frequency band than is normally required by the television system. The increase in resolution, which the wider frequency band permits, enables this view finder to provide a more accurate indication of focus than could be obtained from the previous kinescope view finders. Since a separate view-finder lens is employed it can always be used at its maximum aperture even though the camera lens is stopped down, and thus provide at all times an accurate indication of the proper focus adjustment. The deflection circuits for the view-finder pickup tube are so arranged that a slightly greater area of the scene is scanned than is the case with the camera pickup tube.

The deficiencies of this view finder from the standpoint of the ideal view finder are in respect to the requirements 4 and 5 which deal primarily with operating convenience. With reference to requirement 4, when pickup tubes are interchanged, the position of one of the pickup tubes must be adjusted so that the mosaics of the two tubes are the same distance from their respective lenses. The electrical focus of both the view-finder pickup tube and kinescope must be kept in proper adjustment for this view finder to function satisfactorily. The extra equipment required for this type of view finder materially increases the size and weight of a television camera.

COMPARISON OF THE INDIVIDUAL VIEW FINDERS

Table I shows the ideal view-finder requirements

that are met by the several view finders which have been described. The wording used in the table for each of the requirements is such that a "yes" in the column beneath a given view finder indicates that it meets the specified requirements.

CONCLUSIONS

It is apparent that none of the view finders which have been described meet all the requirements of an ideal view finder. The relative importance of some of the requirements is determined to a considerable extent by whether the camera is intended for studio or outdoor pickup work. In general, the duplicate-lens type of view finder has given the most satisfactory results. If it is desired to keep the size and weight of the camera as near the minimum as possible, the kinescope view finder with remote-focusing control is a practical arrangement. A substantial increase in the sensitivity of television pickup tubes will result in more consideration being given to the several types of kinescope view finders.

In this discussion no reference has been made to the relative cost of the various view-finder arrangements. For the time being, at least, the cost of television pickup equipment has been considered to be of secondary importance to performance and operating convenience.

ACKNOWLEDGMENT

The writer wishes to acknowledge the individual and co-operative efforts of numerous Radio Corporation of America and National Broadcasting Company engineers who have contributed to the solution of the view-finder problem.

Mercury Lighting for Television Studios*

H. A. BREEDING†, NONMEMBER, I.R.E.

Summary.—This paper includes a brief history of the use of water-cooled Mazda H lamps, a light that is cooler than noon sunlight, for television studio lighting, with a detailed description of an installation of remote-controlled floodlights in the General Electric Television Broadcasting Studio WRGB at Schenectady, New York.

Results are shown by photographs of the line-monitor tube picture when the illumination of the set is provided by mercury lamps. Lamp performance is discussed and data on light maintenance presented.

THE NEW YORK WORLD'S FAIR INSTALLATION

GENERAL Electric's experiment with water-cooled mercury lamps for television studio lighting began at the New York World's Fair in 1939 and finally culminated in a complete installa-

tion in the new modern studios of WRGB at Schenectady in the fall of 1941.

The "House of Magic" television installation made use of two banks of three A-H6 1000-watt water-cooled H type Mazda lamps.¹ These were operated from a 3-phase source of power stepped up from 120 volts through high-reactance transformers connected in wye on both primary and secondary.

The three lamps in each luminaire were spaced along the focal axis of the reflectors and connected in series to the city water system and throttled to take about 4 quarts of water per minute. The water circuit was electrically interlocked with the power supply so that without water the lamps could not be started.

The trough-type floodlights were mounted in a

* Decimal classification: 621.327.4×R583. Original manuscript received by the Institute, August 12, 1942. Presented, Summer Convention, Cleveland, Ohio, July 1, 1942.

† Lighting Division, General Electric Company, Schenectady, New York.

¹ E. B. Noel and R. E. Farnham, "A water-cooled quartz mercury arc." *Jour. Soc. Mot. Pic. Eng.*, vol. 31, pp. 221-239; September, 1938.

fixed position forward of and to right and left above a stage about 6 by 8 feet approximately 8 feet high.

OTHER EXPERIMENTAL INSTALLATIONS OF THESE LAMPS

In experimental station W2XB four portable floor-lamp units were devised from 18-inch Miller-etched Alzak-finished concentrating reflectors. Each of these floods likewise used three lamps, but the grouping was about a horizontal line through the focal point of the reflectors with the various lamps about $1\frac{1}{2}$ inches apart on the sides of an equilateral triangle. These floods were supplemented by groups of eight 500-watt reflector flood lamps mounted on portable wooden frames.

A single water-cooled unit of this same type was used in the General Engineering Laboratory at Schenectady for the lighting of experimental subjects in connection with general television developments. All of these devices were mounted on standard motion-picture-studio tripods with an extra telescopic rod for vertical adjustment so that a maximum height of approximately 9 feet could be obtained. In actual practice the height of the devices was seldom changed during any show because of the mechanical difficulty involved.

This type of lighting was recognized as a temporary expedient, but due to the limited headroom no overhead lighting could be provided in the experimental studio. The desirability of a lighting system which would provide a general exposure level at any point in the studio with a minimum of physical effort and equipment was soon apparent, and, coupled with the simplification of studio operation to be expected by removing equipment from the floor, provided the necessary impetus for developing the present ceiling-mounted design.

The first experimental models of the ceiling-mounted units were manufactured for the Columbia Broadcasting System in the fall of 1940. Columbia purchased three of these units, and a fourth was made as a sample for experimental work and testing. The general idea of the first ceiling devices was the same as the design used at present in WRGB, except for the minor changes and refinements that come with building of the second lot of any new device. The reflector was an etched Alzak-finished aluminum trough generally parabolic in shape. The front-door glass was Peblex diffusing glass and the opening was approximately 21 by 33 inches. A motor for rotating the device in the horizontal plane was installed in a canopy mounted against the ceiling and a second motor was mounted inside the reflector housing to rotate the device vertically. Three lamps were spaced along the axis of the paraboloidal trough reflector. The lamps remain in a horizontal plane while the reflector is elevated or depressed. This is a necessary precaution with this type of lamp. The power supply and water feed are brought in through flexible hoses from the canopy at the top

into the reflector housing and no slip rings are used. The "elevating" and "rotating" motors are operated from a remote push-button station. The first devices could be rotated through one complete turn horizontally and could be elevated through 90 degrees. In the WRGB installation, the arrangement for horizontal rotation remained as before, but the vertical rotation angle was extended to 180 degrees.

A solenoid valve and a flow switch for interlocking the electrical and water circuits are also mounted in the canopy. The flow switch also acts as a check valve to prevent backflow of water from the discharge line in case of water-jacket rupture. Power cannot be supplied to the lamps unless water is flowing, and if a jacket rupture takes place, water is cut off on both the supply and discharge sides of the unit. A door switch in the same interlock circuit prevents servicing the lamps with power on.

THE WRGB INSTALLATION

General Proposals

Late in December, 1940, it was decided to proceed with lighting WRGB's new station with ceiling-

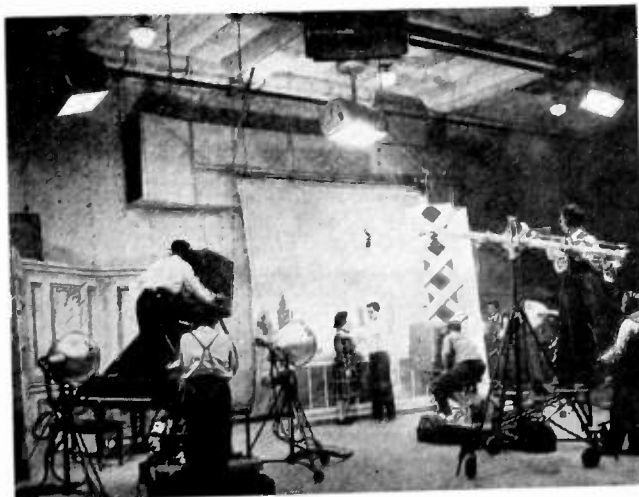

FIG. 1—General studio view.

mounted units supplemented by the four tripod-mounted floor lamps which were to be moved from the old studio to the new. The new studio is 42 by 70 feet, with approximately 18 feet ceiling height between beams. The clear headspace for scenery and microphone booms is approximately 14 feet.

The piping and conduit run to each luminaire was made to a special ceiling plate fastened on a 30-inch square plank base bolted to the ceiling before the floodlights were mounted. It was originally estimated that the lamps should be spaced on centers to allow about 100 square feet per luminaire, but the final layout in WRGB studio is staggered on rows $9\frac{1}{2}$ feet apart across the building and $6\frac{1}{2}$ feet apart along the building. The average space per unit, therefore, is approximately 120 square feet. In the studio there will

finally be, according to present plans, 19 luminaires, of which 12 are at present installed and in operation. Figs 1, 2, 3, and 4 show the general form and construction of these devices.

Transformer-Room Installation

To conserve space, remove heat from the studio, and maintain the noise level at low values, it was decided to locate the transformer room in the basement

lamp. The transformers are connected delta on the primary and wye on the secondary. Primary taps at 208/220/230/240 volts are provided, and the 220-volt tap is used in this case. The transformers have a capacitor for high-power-factor maintenance built directly into them, and in order to keep the noise at a low level,

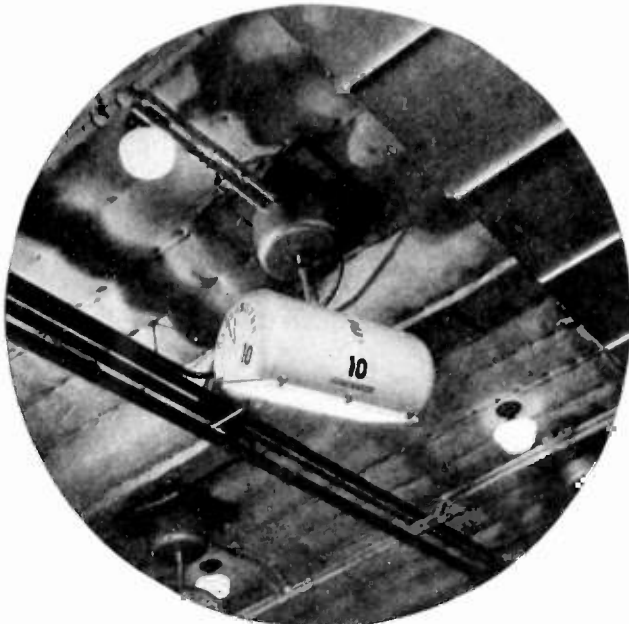

Fig. 2—Close-up of portion of ceiling in television studio in WRGB.

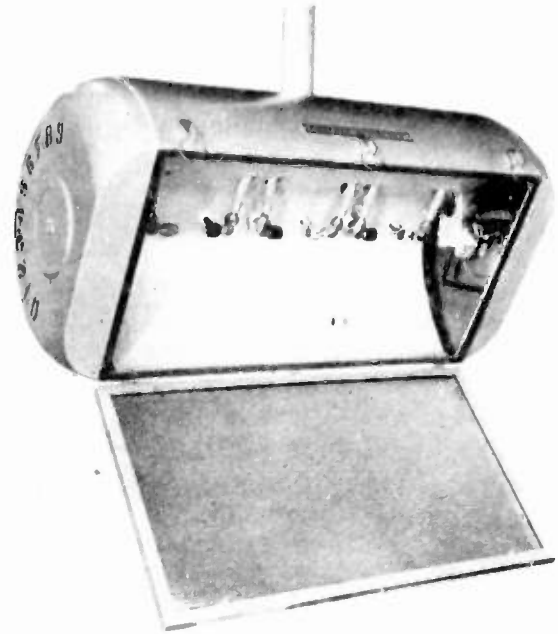

FIG. 4—L-71 showing detail of assembly in canopy.

of the studio. A 3½-inch incoming-power conduit was fed into the transformer room from the front of the building. A corner of the transformer room is shown in Fig. 5. Power from the service switch is distributed

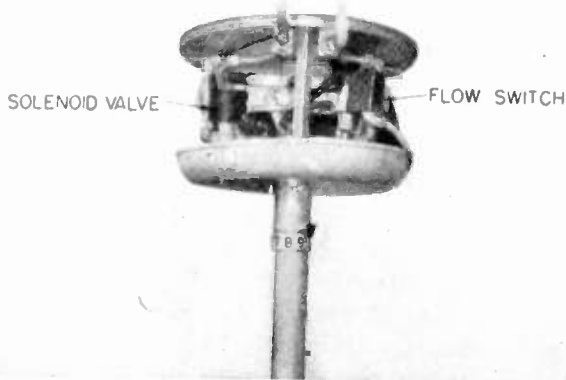

FIG. 3—L-71 with door open showing elevating motor.

through a Flex-a-power distribution system with a 30-ampere disconnect switch to the primary of each control relay. These switches are mounted at about head height and can easily be reached by an operator from the floor. A 4-pole, 13.5-ampere relay operated from a control desk in the studio is mounted on the same pipe framework which supports individual single-phase high-power-factor transformers feeding each

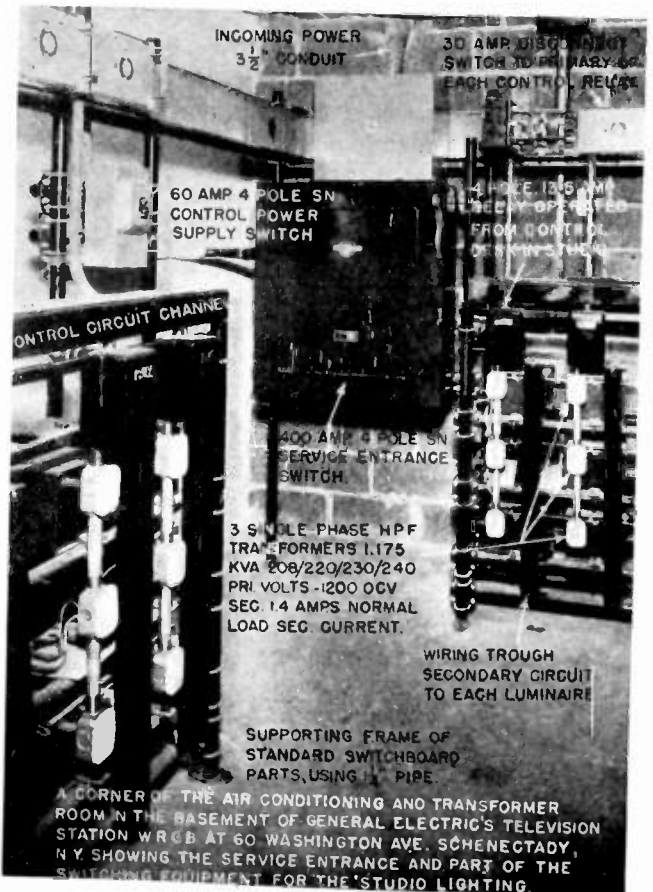

FIG. 5—Transformer room.

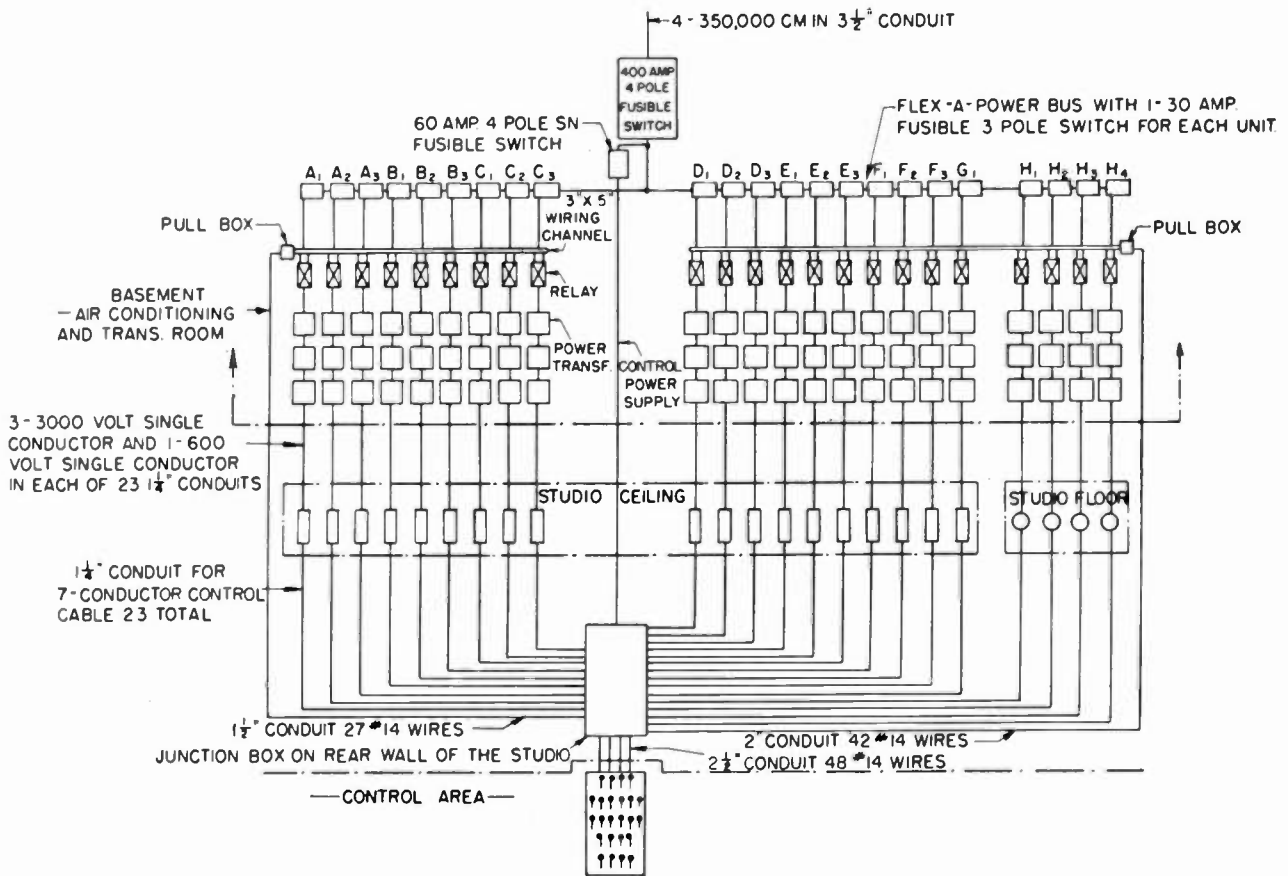

FIG. 6—Master system wiring diagram.

the capacitor and core are imbedded in a silica-loaded compound and the whole device enclosed in a sheet-steel housing. The noise level of the installation is very low, noticeable noises being those of contactor operation and some contactor hum.

the ceiling beams and is shown in Fig. 2. The high-voltage runs were made before the rock-wool insulating blanket was applied to the studio walls and so are

System Wiring

A master diagram of the system is shown in Fig. 6. High-voltage conduit runs go directly from the transformer room in the basement to each individual luminaire on the ceiling. Three No. 10 solid, 3000-volt, 3/8-inch varnished-cambrix single conductors with single-braid insulation and one single-conductor No. 14 rubber-insulated, 600-volt, National Electric Code wire with white finish are run in each conduit. These conduits terminate in a high-voltage junction box in the canopy of the luminaire. A low-voltage junction box is also provided in each canopy for control wiring from the terminal board below the light bridge which is mounted on the rear wall of the studio as shown in Fig. 7.

A 24-connection terminal board for the control circuits to each floodlight is provided in the large junction box just below the light bridge. Each terminal board is fed from a separate fused circuit supplied through the lighting console on the light bridge. Mains protection for the control-circuit power is provided by the two air circuit breakers mounted on top of the lighting console.

The control-conduit installation is suspended from

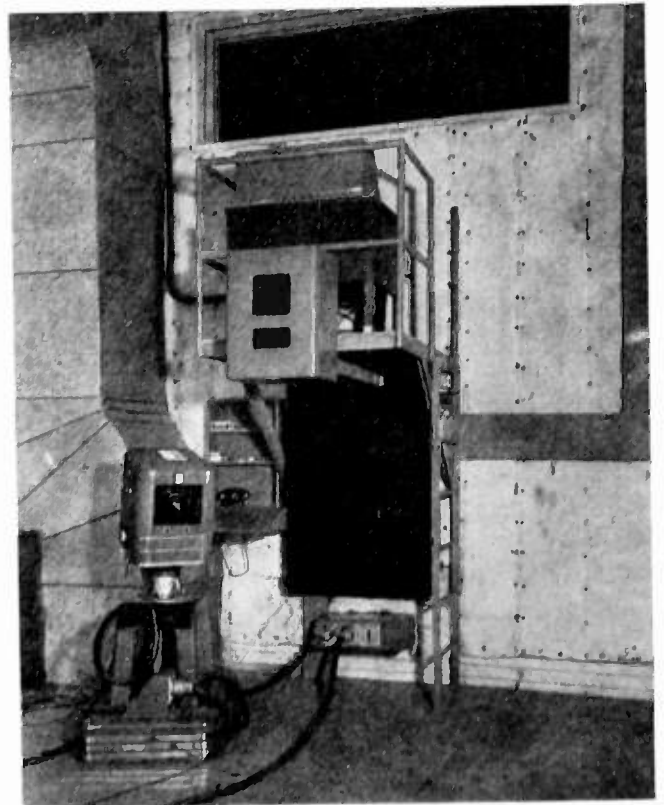

FIG. 7—Rear wall of studio showing light bridge.

hidden except near the connections to each floodlight.

The wiring for each individual floodlight circuit is the same as shown in Fig. 8.

On the lighting console (Fig. 9) the circuits can be individually operated and an individual telephone-

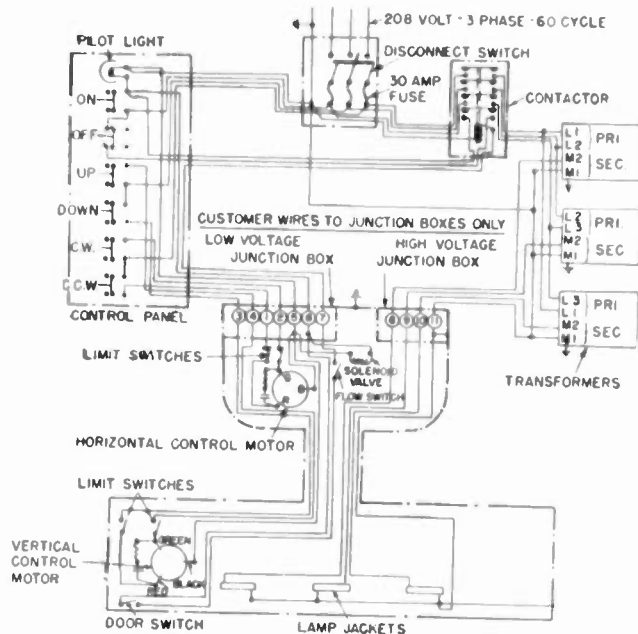

FIG. 8—Unit connection diagram.

type key is provided for the turn-on and turn-off function, another for the elevation motor, and a third for the horizontal-rotation motor. Each control circuit is individually fused by a cartridge-type fuse near the bottom of the console. A pilot light is provided which indicates when the control relay in the transformer room is closed.

Water Circuits

Copper tubing is used throughout for permanence and quiet operation. All pipes are antisweat lagged which also reduces the noise level greatly. A globe valve is supplied for shutoff at each floodlight. A gate valve at waist height above the studio floor in the main riser is used for cutoff and for throttling to the proper head for the system.

The main riser is 1½-inch tubing which branches into two 1¼-inch headers. These headers branch into ¾-inch runs feeding 4 ceiling plates in parallel in

TABLE I
LAMP DATA
1000-Watt A-H6 Water-Cooled Mazda H Lamp

Watts (lamp only)	1,000
Operating current (amperes)	1.4
Operating voltage (volts)	840
Approximate initial lumens	65,000
Bulb	
Material	Quartz
Finish	Clear
Approximate diameter (inside)	2 millimeters
Approximate diameter (outside)	6 millimeters
Approximate length of light source ¹	25 millimeters
Life ²	75 hours
Burning position	Horizontal
Number of electrodes	2

¹ Distance between electrode tips

² Average lamp laboratory life when operated 25 minutes on and 5 minutes off.

each of 4 bays and 3 in the fifth bay. Of these only the first 12 are now used. One-half inch connections to the floodlights are through unions inside the canopy which encloses the ceiling plate and other equipment mentioned above.

The discharge lines are pitched downward from the unit connection to the 4-inch building vent pipe at 1/8-inch per foot continuous drop. Vent valves were originally supplied at the highest point in each discharge line to vent air bubbles from the system. Difficulty with leaking vents has led to discontinuation of most of them now.

The system uses approximately 1½ gallons of water per unit per minute or about 16,000 gallons of water per week for 15 hours of operation.

TABLE II
APPROXIMATE ENERGY ACCOUNT FOR 3-KILOWATT GENERAL ELECTRIC WATER-COOLED STUDIO FLOODLIGHT

Distribution of Input Power ²	Per Cent of Total	Approximate Watts
Ultraviolet	5.7	200
Divided as follows		
Less than 2,800 Å	0.00	
2,800-3,165	0.42	
3,165-3,800	5.30	
Visible	23.60	823
Divided as follows		
3,800-5,000	12.10	
5,000-6,000	8.50	
6,000-7,600	3.00	
Infrared	6.1	214
Divided as follows		
7,600-14,000	6.10	
14,000-26,000	0.00	
Carried off by cooling water	55.6	1,953
Transformer and control losses	9.0	315
Total energy input	100.00	3,510

From Table II it can be seen that of the total wattage input to each luminaire only slightly more than one third is actually radiated into the studio, either as ultraviolet, light, or heat. Luckiesh and Taylor³ rate the energy per foot-candle from H-6 lamps at 4 micro-watts per square centimeter compared to 7½



FIG. 9—Lighting console.

² B. T. Barnes, W. E. Forsythe, and W. J. Karash, "Spectral distribution of radiation from lamps of various types," *Gen. Elec. Rev.*, vol. 42, pp. 540-543; December, 1939.

³ Matthew Luckiesh and A. Hadley Taylor, "Cool light," *Gen. Elec. Rev.*, vol. 43, pp. 410-411; October, 1940.

micro-watts per square centimeter for noon sunlight through $\frac{1}{8}$ -inch window glass, making this lamp *much cooler per foot-candle than noon sunlight*.

RECENT EXPERIENCE WITH WRGB INSTALLATION

Lamps

On March 30, time meters were placed on two floodlights in different parts of the installation. On the basis of studies of the resulting data, the average operating time for the lights has been 15 hours per week for the past eleven weeks to June 17. The average lamp life during that period has been 72 hours, exclusive of floor-lamp units which were not included. The rated life is 75 hours of operation in periods of 25 minutes per start. Longer periods of operation per start tend to increase the lamp life. Performance at the World's Fair, where the lamps operated continuously during each day for approximately 10 hours, ran approximately 300 hours, average. Those lamps were produced

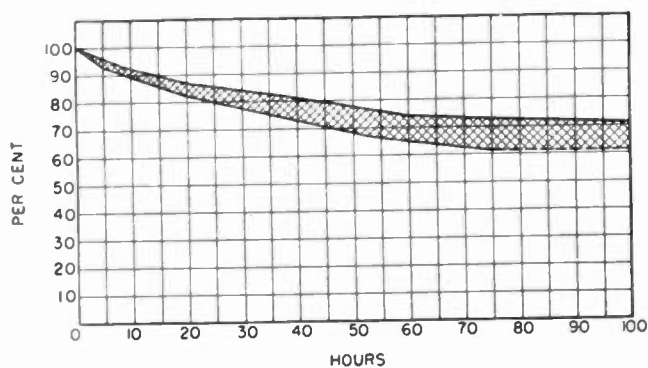

FIG. 10—Lumen maintenance of lamps.

in the laboratory. Factory production is just getting into full swing and as production increases and practices improve the life should increase toward the 300-hour average of the World's Fair depending somewhat on the operating cycle just how far it goes.

The average spread of lumen maintenance during the life for three groups of lamps is shown in Fig. 10. Initially the drop is quite rapid as with all electrical-discharge lamps. The stability through life is not quite so good as with some lower temperature lamps, but a very large output is generated from a small space making the lamp extremely valuable where high-intensity illumination is required.

Monitor-Tube Photos

Three pictures of the line monitor on one channel are shown. (Fig. 11.) The exposure was 2 seconds at $f/8.0$ on Eastman Panatomic X film. The detail is good, exceeding 350 lines.

Back lighting of the iconoscope is used and no difficulty is experienced with ripple except from the floor lamps in which one lamp is closer to the reflector opening and therefore more effective than the other two at very close ranges. A more nearly planar positioning of the lamps should improve this item.

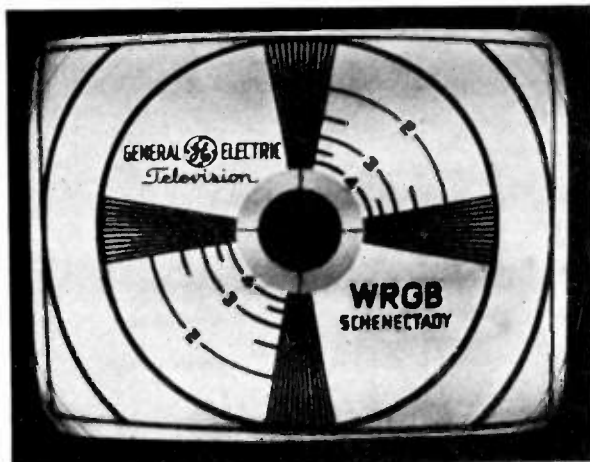

(a)



(b)



(c)

Fig. 11 (a, b, and c)—Line monitor photos.
Peak tube brightness—4
Exposure—2 seconds at $f/8.0$
Film—Panatomic X
Image—normal on 12-inch tubes

Light ripple introduced by lamp burnout during a performance depends mainly on the number of floods covering the scene at the time. It is probably safe to say that with four 3-phase lights per set one burnout would not be detected.

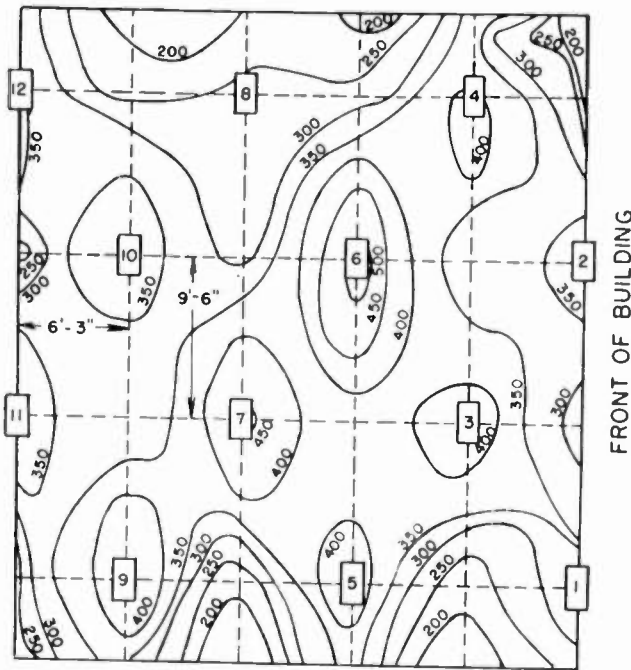

Fig. 12—Isolux chart of studio illumination. □ Type L-71 Novalux water-cooled floodlight with 3 A-H6 Mazda lamps. Nominal input 3500 watts.

Mounting height to light center 14 feet, 8 inches
 Total lighting load 40 kilowatts
 Average illumination at floor level 315 foot-candles
 Illuminated area approximately 1500 square feet
 Lumens per watt per square foot of illuminated area 11.8
 Average age of lamps at time of test 20.8 hours

Light-Output Performances

The etched Alzak-finished aluminum reflectors shown in Fig. 3 were later changed to polished chrome-plated copper which was the wartime substitute for polished Alzak aluminum. The polished reflector was found desirable to aid in piling more light on the set from distant floodlights and, while the polished chromium has an 18 per cent lower reflection factor than polished Alzak aluminum, still the directional beam is considered more useful than the softer beam from the original reflector. The maximum candle power at the rated average lamp life is approximately 70,000.

As to actual light performance from the installation, Fig. 12 shows an isolux chart prepared from data taken on June 17 when the average life of the lamps then in service was approximately 21 hours. The average foot-candles with all the floods pointed downward and oriented with the long axis of the reflector across the room was 315 foot-candles. It is possible to build up the intensity over a 10- × 15- × 10- foot high scene to 650 or more foot-candles of general lighting, with the upper portions of the scene reaching 1000 foot-candles. By supplementing this lighting with floor lamps, good pictures are produced with little or no discomfort to the performers. This "no-discomfort" feature is the crowning achievement of this high-intensity lighting system.

A New Type of Practical Distortion Meter*

J. E. HAYES†, ASSOCIATE, I.R.E.

Summary.—This paper gives a description of a distortion meter embodying circuits which differ somewhat from the types previously employed for this type of instrument. It consists essentially of a bridged-T audio-frequency bridge circuit, in which the inductance element is replaced by a reactance-tube circuit. Because of the flexibility obtainable in vacuum-tube circuits, it is a relatively simple matter to vary the effective inductance continuously over a fairly wide range, and thus allow the distortion meter to be used at any frequency in the audio range.

Certain precautions must be taken in a circuit of this type in order to avoid difficulties due to nonlinear action of the reactance-tube circuit. Application of negative feedback to the reactance-tube circuit effectively reduces the nonlinearity, increases stability, and at the same time keeps tube noise and hum at a minimum level. An analysis of the reactance part of this circuit, together with formulas for calculating the effective Q and the optimum operating conditions are included.

Although the study of the properties of the reactance-tube circuit with negative feedback was limited to features applicable to the problem at hand, some of the information obtained may be of use in other fields.

THE development of the distortion-measuring instrument described here was prompted by two conditions. First, commercially available instru-

ments were usually either rather critical in adjustment or else could be used only on certain predetermined frequencies and second, the instruments which were on the market could not be obtained without a high priority rating.

Desirable characteristics for a distortion meter include ease of operation, a minimum number of controls, good stability, continuous frequency coverage, and operation independent of any direct connection with the source of the test frequency. The last feature simplifies distortion measurements on lines and over-all checks from transmitter input to receiver output.

FUNDAMENTAL CIRCUIT

A simple method of distortion measurement is based on the bridge circuit¹ of Fig. 1. At a frequency such that,

$$\omega = \frac{1}{\sqrt{L_p C}}$$

the bridge may be balanced by making

$$R_B = \frac{2}{\omega Q C}$$

* Decimal classification: R148.1. Original manuscript received by the Institute, June 29, 1942. Presented, Summer Convention, Cleveland, Ohio, June 29, 1942.

† Transmission and Development Department, Canadian Broadcasting Corporation, Montreal, Que., Canada.

¹ W. N. Tuttle, "Bridged-T and parallel-T null circuits for measurements at radio frequencies," *Proc. I.R.E.* vol. 28, pp. 23-29; January, 1940.

so that $e_2=0$ at terminals 3 and 4 when a voltage e_1 of the above frequency is applied to terminals 1 and 2. At all other frequencies of e_1 the voltage e_2 will have a value dependent on the characteristics of the bridge elements.

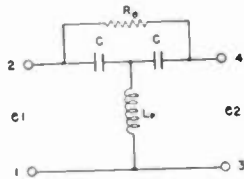

FIG. 1—Bridged-T bridge circuit.
Circuit relations

$$\omega = \frac{1}{\sqrt{2L_p C}}$$

$$R_B = \frac{2}{\omega Q C}$$

for $e_2 = 0$

Fig. 2 shows the absolute value of e_2 as the frequency of e_1 is varied and its amplitude held constant. The curves show the effect of variation in Q of the inductance arm of the bridge and indicate that if a Q of 7 or better is maintained in the inductance, the effect of the bridge on harmonics of the null frequency will be negligible. This provides an effective method of eliminating the fundamental so that any harmonics present may be measured across terminals 3 and 4.

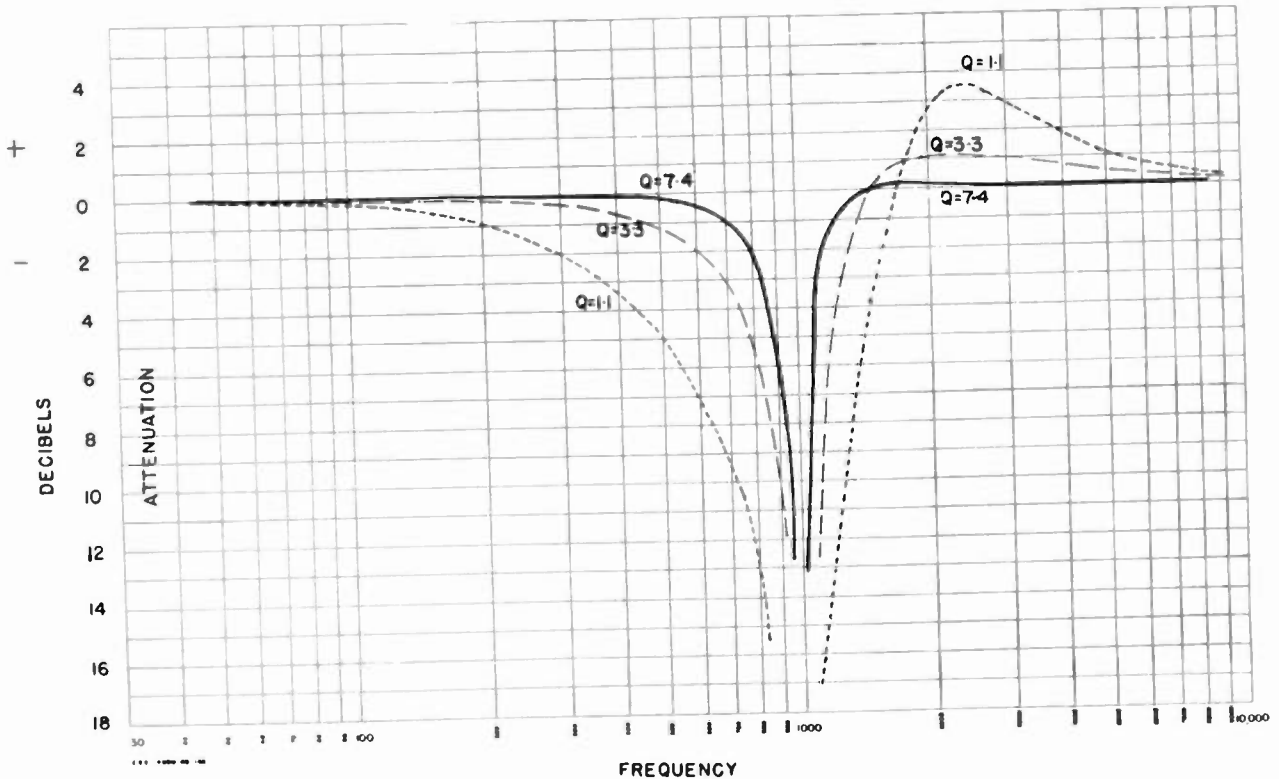

FIG. 2—Attenuation of bridged-T bridge circuit using air-core inductance.

To be useful at any frequency, means must be provided for adjusting the L and C arms of the bridge. Practical considerations, such as the impedance of the bridge arms and physical size of the condensers require that the inductance have a range of from 0.04 to 40 henries. Besides covering this range, the inductance

should have a sufficiently high Q at the frequency at which it is used to provide the desired frequency characteristics in the bridge circuit. A vacuum-tube reactance circuit was developed which had the characteristics necessary for the purpose.

ELECTRONIC INDUCTANCE

Fig. 3 shows a simplified reactance-tube circuit in which the voltage applied to the grid of the vacuum

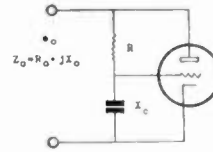

FIG. 3—Simplified reactance-tube circuit. Z_0 is the effective impedance at the input terminals.

tube is retarded almost 90 degrees with respect to e_0 by making R large with respect to X_c . The plate current, therefore, also lags e_0 by almost 90 degrees producing an effective inductance at the input terminals.

Fig. 4 is a vector diagram of the voltage and current values of such a circuit. The grid-voltage vector e_g and plate-current vector i_p are not to scale but are exaggerated for the sake of clarity.

Fig. 3 represents either a single tube or an amplifier

of more than one tube, having an effective output impedance R_p , the output voltage e_p 180 degrees out of phase with the input voltage e_g , and a voltage gain

$$G = \frac{e_p}{e_g}$$

Then

$$e_v = e_0 \left[\frac{-jX_c}{R - jX_c} \right]$$

and

$$e_p = -G \cdot e_v = G \cdot e_0 \left[\frac{jX_c}{R - jX_c} \right]$$

$$i_p = \frac{e_0 - e_p}{R_p} = \frac{e_0}{R_p} \left[1 - \frac{jX_c G}{R - jX_c} \right]$$

If the phase-shifting network impedance $R - jX_c$ is made much greater than the desired terminal im-

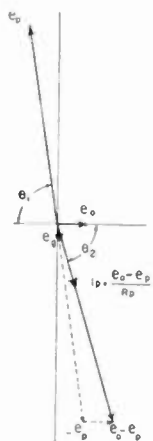

FIG 4—Vector diagram of reactance-tube circuit.

$$\theta_1 = \tan^{-1} \frac{R}{X_c}$$

$$\theta_2 = \text{phase angle of } Z_0$$

$$G = 44$$

$$\frac{R}{X_c} = 6.7$$

$$Q = \tan \theta_2$$

pedance Z_0 , the admittance of the phase-shifting network may be neglected in the calculations of Z_0 ,

$$Z_0 = \frac{e_0}{i_p} = \frac{R_p}{1 - \frac{jX_c G}{R - jX_c}}$$

Rearranging gives

$$Z_0 = R_p \left[\frac{R^2 + X_c^2(1+G)}{R^2 + X_c^2(1+G)^2} + j \frac{X_c R G}{R^2 + X_c^2(1+G)^2} \right] \quad (1)$$

from which the Q of the impedance is

$$Q = \frac{X_0}{R_0} = \frac{X_c R G}{R^2 + X_c^2(1+G)} \quad (2)$$

By differentiation we find the condition for maximum Q ,

$$\frac{R}{X_c} = \sqrt{1+G} \quad (3)$$

Substituting (3) in (2) gives

$$\text{maximum } Q = \frac{G}{2\sqrt{1+G}} \quad (4)$$

In a more convenient form,

$$X_0 = +jR_p \frac{\frac{R}{X_c} G}{\left(\frac{R}{X_c}\right)^2 + (1+G)^2} \quad (5)$$

$$Q = \frac{\frac{R}{X_c} G}{\left(\frac{R}{X_c}\right)^2 + 1 + G} \quad (6)$$

Equation (5) may be rearranged in the form,

$$L_0 = \frac{R_p R C G}{(R\omega C)^2 + (1+G)^2}$$

in which $(R\omega C)^2$ is negligible.

$$L_0 = \frac{R_p R C G}{(1+G)^2} \quad (7)$$

In designing an electronic reactance, (4) is used to determine the gain required in the amplifier section to provide the desired Q . The constants of the other parts of the circuit may then be calculated from (3) and (5). Equation (6) is then used to find the Q at any frequency other than that for which the maximum Q is obtained.

PRACTICAL CIRCUIT OF ELECTRONIC INDUCTANCE

In the reactance circuit used in the distortion bridge (Fig. 5), two tubes are required to obtain the desired results. A pentode tube provides the necessary gain while a triode used as a cathode follower maintains the proper phase relationship and gives the low output impedance necessary for low values of reactance. Smooth control of the reactance is obtained by a

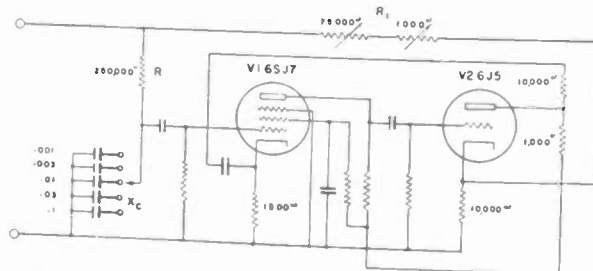

FIG. 5—Electronic inductance used in distortion meter.

variable resistor R_1 (consisting of a "coarse" and a "fine" adjustment) which changes the effective output impedance R_p of V_2 . As can be seen from (5) and (6) the reactance is directly proportional to R_p but the Q is not affected by it. Furthermore, any instability due to variation in output impedance r_p or V_2 is reduced in the ratio

$$\frac{r_p}{R_1 + r_p}$$

The effective inductance of the circuit is changed in 3-to-1 steps by one section of a gang switch selecting any one of five phase-shifting condensers. Two other sections of the gang switch change the condensers in the bridge arms in similar steps, so that by providing a 10-to-1 range of R_p , and, therefore, of the effective inductance of the circuit, it is possible to balance the bridge at any frequency within its range of 30 to 10,000 cycles. Since any one phase-shifting condenser is used only over a 3-to-1 frequency range, if the circuit constants are adjusted to provide the optimum value of R/X_c at the middle of each range the Q will still be reasonably good at either end of the range.

The addition of negative feedback stabilizes the gain of the tubes and at the same time reduces noise and distortion. Without the use of negative feedback, line-voltage fluctuations cause sufficient changes of gain and, therefore, of reactance, that the null settings of the bridge circuit are unstable. Since distortion or noise introduced by the tubes in the reactance circuit

of 6.7. While this Q is somewhat lower than might seem desirable, it is difficult to obtain a higher value without sacrificing some stability or increasing the complexity of the circuit. It was felt that for practical purposes the accuracy obtainable with this circuit was sufficient.

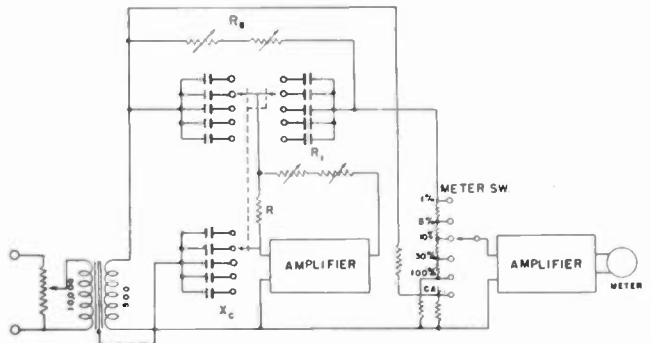

FIG. 6—Simplified circuit of distortion meter.

The attenuation characteristics are shown in Fig. (7). The curves shown for "LOW," "MID," and "HIGH FREQUENCY" were actually taken for 300-, 600- and 1000-cycle balance points on the 300- to 1000-cycle

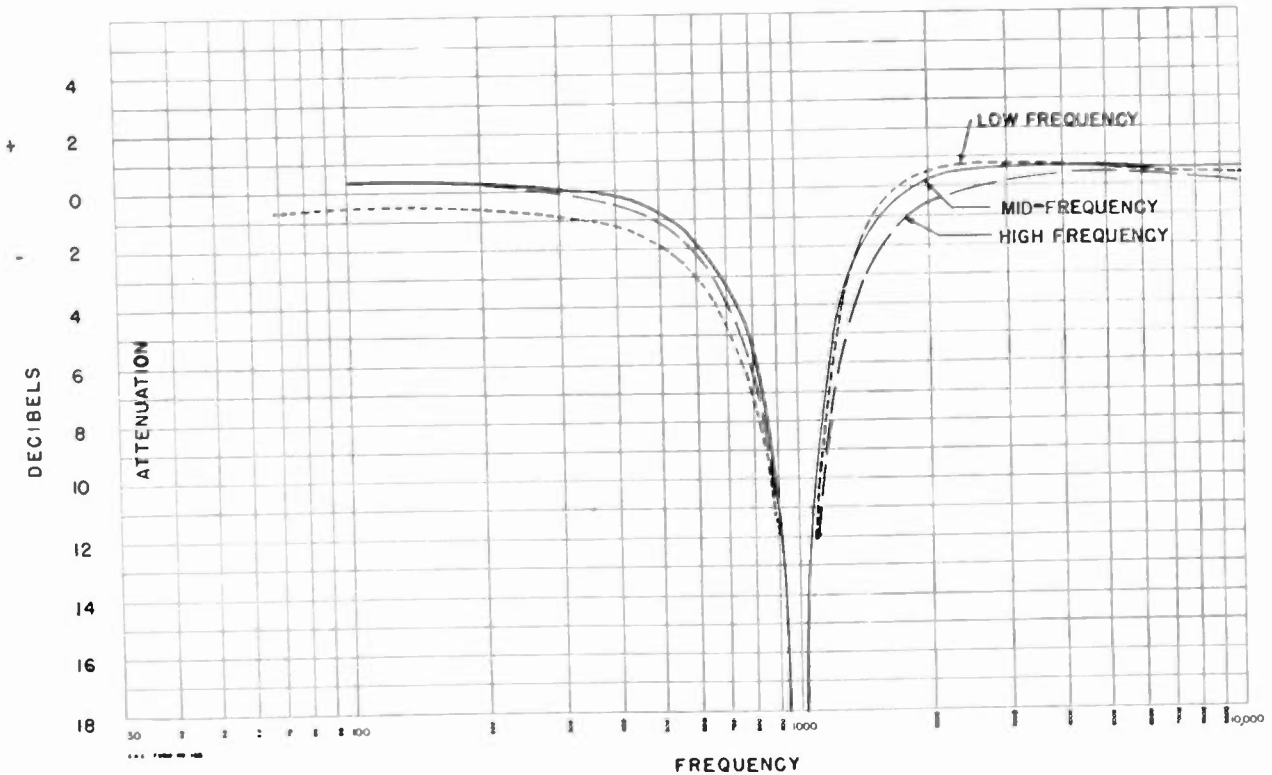

FIG. 7—Over-all characteristics of distortion meter using electronic inductance.

can cause a false reading on the indicating meter, it is essential that both be kept to a very low level.

APPLICATION TO DISTORTION METER

Fig. (6) shows the circuit of the electronic inductance as applied in the distortion meter. The amplifier section has a gain of 44 and an output impedance of 5350 ohms. The maximum Q obtained is 3.3 for a ratio R/X

range of the bridge but are shown plotted on the 1000-cycle point in order to facilitate comparisons. The variation in shape of the curves is caused by the variation in the ratio of R/X_c as the bridge is balanced for different frequencies. These curves are somewhat flatter than those of Fig. (2), probably because, while the Q of an air-core inductance increases with frequency in the audio range, the Q of an

electronic inductance decreases slowly after the frequency-producing optimum R/X_c ratio is exceeded.

COMBINED BALANCING CONTROLS

From (7) it may be seen that if R_p and R are varied simultaneously in proportion to the rotation (θ degrees) of a dial, $L_0 = K\theta^2$, where K includes all the individual constants. Therefore, the null frequency of the bridge will be inversely proportional to the dial rotation. Since the reactance X_c of the condenser in the phase-shifting circuit also varies inversely with frequency, conditions are obtained which makes the ratio R/X_c constant. This results in L_0 having a con-

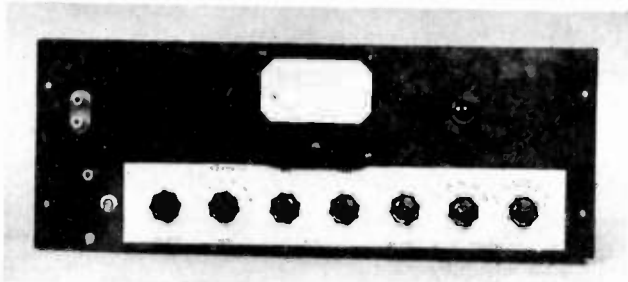

FIG. 8—Experimental model of the distortion meter.

stant Q no matter what null frequency is used in the bridge circuit. Greater accuracy is obtainable in the distortion meter since the variations shown in Fig. (7) are considerably reduced.

The balancing resistor in the bridge circuit has a value $R_B = 2/\omega QC$ and consequently varies inversely with frequency if Q and C are held constant. Therefore, R_B may be operated simultaneously with R_1 and R by the same control knob. This combined control of both resistive and reactive balance of the bridge circuit makes operation of the instrument very simple. The accuracy with which the bridge may be balanced with the single control knob is dependent on the proper ratio being maintained at all times for the three variable resistors. Two "fine controls" which consist of low-value variable resistors, one as part of R_B and the other as part of R_1 , can compensate for a reasonable amount of mistracking in the ganged controls, making an exact balance easily obtainable. A 3-to-1 frequency range is obtained on the ganged control by placing fixed resistors of suitable value in series with R , R_1 , and R_B .

In an experimental model of the distortion meter, satisfactory operation was obtained by ganging ordinary receiver-type volume controls having a linear taper. Not all controls tried, however, were sufficiently close to their rated resistance or taper to track properly. One advantage of the circuit using separate controls for R_1 and R_B is that none of the parts, with the exception of the meter multiplier resistors, need be held to close tolerance. Fig. 8 is a photograph of the experimental model of the instrument.

The controls appearing on the front panel have the following functions:

1. A "calibrate" knob to set the incoming test tone to the proper level.
2. A "frequency" control (R_1) and its associated range switch. The accuracy of the frequency calibration is dependent on the tolerances of the fixed condensers of the bridge arms and the elements determining the value of L_0 .
3. A "balance" control (R_B) which may be omitted from the front panel and ganged with the "frequency" control if desired.
4. "Fine" adjustments for the "frequency" and "balance" controls.
5. A "meter" switch to provide the desired meter sensitivity.

The amplifier preceding the meter consists of two 6SJ7 pentodes and a 6J5 triode. Negative feedback is used across the two pentodes to stabilize the gain. The 6J5 is run at very low plate voltage so that its output cannot exceed a safe value for the meter. The meter is a standard copper-oxide-type vu meter with the addition of a special meter scale. It is coupled through a suitable series resistor and condenser to the plate of the 6J5 tube. Full-scale deflection of the meter is obtained with about 0.5 millivolt at the input of the amplifier.

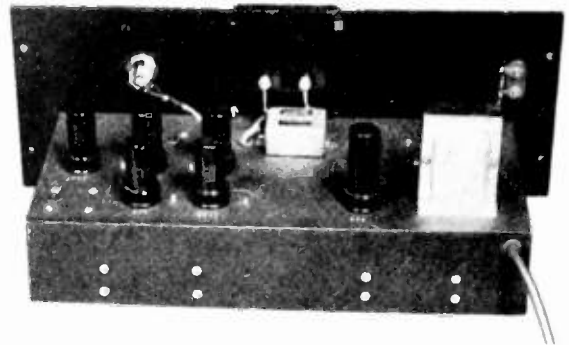

FIG. 9—Rear view of the instrument. Two tubes are in the electronic reactance circuit, three in the amplifier preceding the meter, and one in the power supply.

CONCLUSION

The above application of an electronic reactance provides a good example of its flexibility. Certain limitations are, however, inherent in a reactance circuit of this type.

1. It can be used only in relatively low-voltage circuits.
2. The Q of the circuit drops off on either side of some optimum frequency.
3. Care must be taken in the design of the amplifier portion that phase shifts introduced by it do not cause the circuit to break into oscillation.

ACKNOWLEDGMENT

The writer wishes to express his appreciation to Mr. J. A. Ouimet, Assistant Chief Engineer of the Canadian Broadcasting Corporation, for his interest and helpful discussions during the progress of the work on this subject.

APPENDIX

1. Accuracy of Formulas

The accuracy of the formula giving the value of the effective inductance of the circuit was checked by independent measurements. Excellent agreement between the calculated and the measured value was obtained.

(a) The distortion meter was first adjusted for operation on 1000 cycles and then the values of R_p , R , C , and G were carefully measured.

Equation (5) was used to obtain the value of X_0 .

(b) A General Radio 650A impedance bridge was then used to measure the electronic-inductance part of the circuit and a correction, in this case about 1 per cent, applied to allow for the admittance of the phase-shifting network.

(c) A third result was obtained from the formula for the null condition of the bridged-T bridge circuit, $L_p = 1/2C\omega^2$. Since, in this case L_p is the effective parallel inductance it was converted to the effective series inductance and the proper correction allowed for the admittance of the phase-shifting network.

The three methods gave respectively, 0.362, 0.361, and 0.363 henries. The variation is well within the accuracy of the General Radio bridge.

In a similar manner the Q of the electronic inductance was checked. The calculated values were 3.12 and 3.13 and the value measured on the General Radio bridge 3.0. The discrepancy between calculated and measured Q is again within the accuracy of the method of measurement.

2. Effect of Line-Voltage Variations

The stability of the electronic-reactance circuit is sufficiently good that no voltage regulation is necessary. The controls on the distortion meter were adjusted for a null balance of its bridge circuit at 1000 cycles. The line voltage was then varied above and below its normal value of 110 volts and the change in the null frequency of the bridge circuit determined.

Line Voltage

Volts

90
100
110
120
130

Frequency

Cycles

995.0
997.8
1000.0
1002.7
1004.5

The average change in bridge null frequency is, therefore, about 0.025 per cent per volt change in line voltage. Since the null frequency of the bridge circuit is determined by

$$\omega = \frac{1}{2\sqrt{L_p C}}$$

the variation in the inductance would, therefore, be close to 0.05 per cent per volt change in line voltage.

3. Circuit Stability

Since the gain of two tubes in the electronic-inductance circuit is stabilized by the application of 14 decibels of negative feedback, the effect of variation in tube characteristics is relatively small.

The circuit of Fig. 5 shows no tendency to oscillation and is perfectly stable in that respect. However, some circuits using conventional triode amplifiers with an interstage transformer were found to be quite impracticable as they oscillated continuously.

4. Instrument Accuracy

As indicated by the curves of Fig. 7, a slight variation in the attenuation of harmonics existed in the experimental model. The variation is about plus or minus $\frac{1}{2}$ decibel from the average or about 5 per cent of the meter indication. Thus, if the meter indicated 1 per cent distortion the actual value would be between the limits of 0.95 and 1.05 per cent. This accuracy is improved by ganging the controls R , R_1 , and R_2 , as discussed previously. The variations are then reduced to approximately plus or minus 2 per cent.

5. Sensitivity

At maximum sensitivity the instrument will give a full-scale reading on its meter for 1 per cent distortion present in the wave being tested. Residual hum and circuit noise give an initial meter reading of 0.05 per cent or less, which is quite negligible for practical purposes.

Institute News and Radio Notes

Wartime Engineering Accomplishments

Reviewing the accomplishments of radio engineers and their industry in 1942, James T. Buckley, President of the Philco Corporation, speaks in terms encouraging to our engineering members. In part he states:

"To meet the needs of the war emergency, the radio manufacturing industry has achieved new engineering and production miracles in 1942, and further technical progress and manufacturing accomplishments are confidently expected in 1943.

"Instantaneous communication between land, sea, and air forces was never more important than it is in this global war we are fighting. Every military action has a direct bearing on the whole world-wide struggle, and there must be dependable, uninterrupted communications facilities available at all times. Modern radio equipment is meeting this test under the most difficult combat conditions in remote corners of the earth. . . .

"In many ways besides the furnishing of instantaneous communications service, radio is helping to win the war. It is common knowledge that only the use of electronic equipment made it possible for England to win the Battle of Britain. Many of the "secret weapons" now in use by the United Nations are the result of new practical applications given to radio and television principles. Very recently Prime Minister Churchill said that the development and production of aircraft and the extension of radio research would be, in his opinion, two of the most important factors in winning the war.

"The knowledge and skill that are contributing to the winning of the war will later be turned again to the arts of peace. When the time comes, the work being done now should result in major improvements in radio transmitting and receiving techniques. Of even more importance, the art of television should be so far advanced that it will be ready to become the basis of an entirely new and great industry."

Winter Conference—1943

The one-day Winter Conference, held on January 28, 1943, in New York City, took place concurrently with the National Technical Meeting of the American Institute of Electrical Engineers in session during the week at the Engineering Societies Building there.

Despite a snowstorm of blizzard proportions, approximately 450 members and guests attended the morning technical session, 350 the afternoon session, and 600 the evening meeting and broadcast.

MORNING TECHNICAL SESSION

The program of the morning session, extending from 10:00 A.M. to 12:30 P.M., consisted of the following technical papers:

- "Radio-Frequency-Operated High-Voltage Supplies for Cathode-Ray Tubes," by O. H. Schade, RCA Manufacturing Company, Inc., Radiotron Division, Harrison, N. J.
- "Transmission-Line Charts," by R. S. Julian, Bell Telephone Laboratories, Inc., Whippany, N. J.
- "Polydirectional Microphones," by H. F. Olson, RCA Manufacturing Company, Inc., Victor Division, Camden, N. J.
- "Phosphors and the Periodic System of the Elements," by H. W. Leverenz, R.C.A. Communications Laboratories, Princeton, N. J.
- "Direct-Reading Wattmeters for Use at Radio Frequencies," by G. H. Brown, J. Epstein, and D. W. Peterson, RCA Laboratories, Princeton, N. J.

AFTERNOON SESSION AND ANNUAL MEETING

The afternoon program, continuing from 2:30 P.M. to 5:00 P.M., is summarized below:

- "Address of Retiring President," by A. F. Van Dyck, President for 1942.
- Formal Induction of Dr. L. P. Wheeler, President for 1943, and Transfer-of-Gavel Ceremony.
- Introduction of F. S. Barton of England, Institute Vice President for 1943.
- Presentation of the Medal of Honor of the Institute to Dr. William Wilson.
- Presentation of Fellowship Awards and Diplomas to Andrew Alford; I. S. Coggeshall, Captain J. B. Dow, Dr. P. C. Goldmark, D. E. Harnett, D. D. Israel, A. G. Jensen, Lt. Col. G. F. Metcalf, Dr. Irving Wolff (*in absentia*), and at Boston Section Conference to Dr. L. A. Du Bridge.
- "Electric Communications—The Past and Present Illuminate the Future: A Suggestive Interpretation," by Lloyd Espenschied, Consultant, Bell Telephone Laboratories, Inc., New York, N. Y.
- "Production of Radio Facilities for the Armed Services," by Rear Admiral S. C. Hooper, United States Navy, General Consultant for Radio, Radar, and Underwater Sound Equipment (read by Commander J. L. Allen, Eastern Sea Frontier Communications Officer, New York, N. Y.).
- "The Army-Navy Electronics Production Agency," by F. R. Lack, Director, Army-Navy Electronics Production Agency.
- "The Function of the War Production Board in Radio," by Ray Ellis, Director, Radio and Radar Division, War Production Board.
- "Radio Standards Go to War," by H. P. Westman, War Committee on Radio,

American Standards Association, New York, N. Y.

"The Engineer's Position in the Manpower Program," by Kirk Miles, National Roster of Scientific and Specialized Personnel, War Manpower Commission.

Question-and-Answer Period.

JOINT EVENING MEETING WITH A.I.E.E.

The following joint-meeting program began at 8:30 P.M. and with the special broadcast concluded the conference at 10:45 P.M.:

Haraden Pratt, Past Institute President and Chairman of A.I.E.E. National Committee on Communications, Presided.

Address of the Evening: "Beyond the Ultra Shorts," by Dr. G. C. Southworth, Bell Telephone Laboratories, Inc., New York, N. Y.

Personal Greetings and Reminiscences, by Sir Noel Ashbridge, Fellow of the Institute, Chief Engineer, British Broadcasting Corporation, London, England (transmitted by beam telephone and heard at meeting from transcription).

Nation-wide Radio Broadcast (via CBS): Brief Addresses by Dr. L. P. Wheeler, Institute President for 1943 and A. F. Van Dyck, Retiring President, from New York, N. Y.

"Radio Engineering in Wartime," by the Honorable James Lawrence Fly, Chairman, Board of War Communications and Federal Communications Commission, from Washington, D. C.

Preprint copies of the papers were not made. However, it is the intention to publish as many of these conference papers as possible in forthcoming issues of the PROCEEDINGS.

The committee responsible for the Institute's conference arrangements consisted of I. S. Coggeshall, chairman; Austin Bailey, E. K. Cohan, D. D. Israel, H. M. Lewis, and H. A. Wheeler.

Ten Sections Hold Winter Conferences

Ten Sections throughout the United States and Canada held separate technical conferences simultaneously with the one at New York City on January 28, 1943.

The participating Sections were Boston, Cincinnati, Detroit, Kansas City, Montreal, Portland, St. Louis, San Francisco, Toronto, and Washington.

Members of the Connecticut Valley, New York, and Philadelphia Sections attended the conference in New York City, which was sponsored by the Institute.

As the conference reports from Sections are received, they will be published in the PROCEEDINGS.

Board of Directors

The Annual Meeting of the Board of Directors took place on January 6, 1943, and was attended by L. P. Wheeler, president; F. S. Barton, vice president; W. L. Barrow, W. L. Everitt, H. T. Friis, Alfred N. Goldsmith, editor; O. B. Hanson, F. B. Llewellyn, F. E. Terman, B. J. Thompson, H. A. Wheeler, and W. B. Cowlich, assistant secretary.

To serve during 1943, R. A. Heising was appointed treasurer, Haraden Pratt was named secretary, and Alfred N. Goldsmith was reappointed editor.

These five directors were appointed for 1943: S. L. Bailey, E. F. Carter, I. S. Coggeshall, G. E. Gustafson, and W. C. White.

H. M. Turner was designated to fill the vacancy of elected director for 1943.

Appointment was made of the personnel to serve on the 1943 Awards, Constitution and Laws, Executive, Nominations, and Tellers Committees.

Approval was given to the change in rate of compensation paid to Mr. W. C. Copp for soliciting advertising in the PROCEEDINGS.

It was voted to transfer A. B. Bailey, H. V. Griffiths, and J. A. Stobbe to the Member grade. J. C. Bayles, S. T. Fisher, and D. L. Hathaway were elected to the grade of Member.

Also, 168 Associates, 296 Students, and 8 Juniors were elected to the named grades of membership.

The employment of Klauser and Todt, C.P.A., to make the financial audit of Institute's 1942 records, was confirmed.

A budget for 1943 was adopted.

Editor Goldsmith reported on the prospects for obtaining additional papers for the PROCEEDINGS.

The personnel of the 1943 Admissions, Public Relations, Sections, Membership, Papers, Papers Procurement, and Registration of Engineers Committees, as well as Board of Editors, was named.

The following resolution on deferment of engineering students was passed:

"WHEREAS: The greater and greater requirements for engineers needed both by the armed services and by the industries supplying them have brought about an acute shortage of both experienced and student engineers, and

"WHEREAS: A particularly acute shortage of radio engineers has developed due to the complex and manifold radio communication and other allied radio requirements of present-day warfare, and

"WHEREAS: It appears that the demand for trained engineers is increasing, and if a continuous flow thereof is not assured for the future, serious dislocation of the entire war effort may result, and

"WHEREAS: A factual survey does not appear to be available upon which a rational plan for the training and distribution of professional manpower may be formulated, and

"WHEREAS: Occupational Bulletin No. 10, amended December 14, 1942, recommends deferment of a draft registrant who is in training only if he has completed his first academic year of study, and

"WHEREAS: If Freshman students in engineering schools are not deferred, there will be, in addition to a future curtailment in the flow of young engineers, the danger that the teaching staffs may become dispersed and the machinery of technical education become seriously affected at a time when it may be most needed.

"THEREFORE, BE IT RESOLVED: That the Board of Directors of The Institute of Radio Engineers, at its Annual Meeting held in New York City, January 6, 1943, urges that an adequate supply of engineers be maintained by preserving the status of engineering students and particularly students specializing in radio and allied branches of engineering.

"That this be accomplished by granting a deferred classification under the Selective-Service procedures to individual students maintaining a satisfactory scholarship record in schools of recognized standing.

"That such deferment be temporary until a comprehensive study of shortages and surpluses (if any) is available, together with a satisfactory program covering the training, supply, and distribution of technical personnel for the future."

President Wheeler was appointed chairman of the committee on draft deferment of radio personnel.

A. F. Van Dyck was added to the committee on War Service Awards.

Executive Committee

A special meeting of the Executive Committee was held on January 6, 1943, and those in attendance were Alfred N. Goldsmith, editor and acting chairman; F. B. Llewellyn, B. J. Thompson, L. P. Wheeler (president-elect; guest); and W. B. Cowlich, assistant secretary.

Leslie J. Woods

With a long record of pioneering in the radio industry behind him, Leslie J. Woods has been named vice president and general manager of the National Union Radio Corporation, manufacturers of radio tubes and electronic devices, it was announced today by S. W. Muldowny, president.

Born in England, Mr. Woods studied at the London Telegraph Training College, and later had commercial experience in Denmark and Russia. From 1915 to 1918 he served in the British Army in France, becoming a Second Lieutenant in the Royal Engineers. Later he joined the North Persian Expeditionary Force as Officer in Charge of Wireless Communications. From 1919 to 1923, Mr. Woods served first in military and then in civilian capacities in the Middle East, helping to develop a world-wide communications system with the construction of wireless stations in Hamadan, Teheran, and Baghdad.

In 1923, he decided to make his home in the United States and began a long connection with Philco. Following several years service as district representative in California, he joined the Engineering Department of the Company in Philadelphia

as First Television Engineer in 1928. From 1930 to 1938 he contributed in substantial measure to the growth of the Company as engineer in charge of export radio receivers and vacuum-tube development. For the following three years, Mr. Woods was in Detroit with the Auto Radio Division of Philco, becoming General Manager of the Division in 1941. Upon the outbreak of war, because of his engineering knowledge and experience, Mr. Woods was transferred to Washington to assist in carrying through the large commitments for communications equipment that the Government has asked Philco to undertake.

Mr. Woods became a Member of the Institute in 1935.

Books

The Electrical Fundamentals of Communications, by Arthur L. Albert.

Published, 1942, by the McGraw-Hill Book Company, 330 W. 42 St., New York, N. Y. 546 pages+8-page index+vi pages. 359 figures. 6x9 inches. Price \$3.50.

This book seems well adapted for use by the individual who has derived a working knowledge of radio technique and kindred subjects the easy way, working around with the apparatus. Such experience often brings about complete familiarity with electrical processes with but little knowledge of the principles involved. The book deals almost entirely with the analysis of electrical terms, laws, and measurements as applied to communications, particularly radio. The presentation is such that the book can be used for home study as well as for a classroom text. Any technician who is finding difficulty either in understanding others or expressing his own ideas in the language of the engineer, will find help here.

While the book omits all references to actual electronic applications and complete circuits, all of the common electrical equipment items are discussed as circuit elements and described as to their functions in the usual applications.

After a simple explanation of each subject, the general plan is to describe measuring instruments and technique in that field and the fundamental mathematical principles involved, requiring only a working knowledge of algebra. Each chapter stands on its own feet, and can be studied in any order by anyone who has a general knowledge of the subject. At the end of each chapter three valuable features are included: the student (the term referring to the broad field of knowledge-seekers) having discovered that he is acquainted with the high lights as listed in the "Summary" then takes up a short list of "Review Questions." He then is given a well-chosen list of practical "Problems." These problems and examples parallel those distributed throughout the text. The text is particularly free from discrepancies and errors such as frequently appear in a first edition.

RALPH R. BATCHER
Hollis, L. I., N. Y.

Fundamentals of Radio, Edited by William L. Everitt.

From the work of Edward C. Jordan, Paul H. Nelson, William C. Osterbrock, Fred H. Pumphrey, Lynne C. Smeby. Published by Prentice-Hall, Inc., 70 Fifth Ave., New York, N. Y. 392 pages + 8-page index + xiii pages. 273 figures. $6\frac{1}{2} \times 9\frac{1}{4}$ inches. Price \$5.00.

The present ever-increasing scarcity of trained radio personnel is requiring the employment of vast numbers of persons who are unacquainted with even the basic principles of radio communication. The difficulty of giving adequate training to these operators has usually resulted in each one becoming adept at one particular operation or test only. This book is well adapted to the providing of additional information about the whole subject and the basic plan of the art in which they have become active.

The book is all-inclusive for a beginner, starting with the study of the few arithmetical and algebraic principles needed to work out problems in the succeeding chapters. Following that, the book progressively builds up the reader's knowledge of electrical circuits (a-c and d-c), electronic principles, and the fundamentals of the modern radio communication art. The book is a timely and practical treatment of the art and while it will not in itself make a person a radio "engineer," a good serviceman, or a technical operator, it will provide the background for a subsequent study in any of the numerous fields of activity now open to beginners, whether they are training for industrial or military activity or for one operation of communication equipment in one of its various applications. It is quite possible that many radio salesmen and executives will also find the book an authentic and easily read source of information about the technical details of the problems with which they are concerned.

As listed above, the book has been developed by a group of educators and engineers who are well acquainted with the problems of training students in radio fundamentals. The various contributions (which are not identified as to their particular author) have been edited by Professor W. L. Everitt, whose activity in the field of radio broadcasting technique has long been recognized. The book is recommended for either a classroom text or for home study. Its 400 pages are crowded with practical examples and problems and contain 309 illustrations.

RALPH R. BATCHER
Hollis, L. I., N. Y.

Principles of Electron Tubes, by Herbert J. Reich

Published by the McGraw-Hill Book Company, 330 West 42 St., New York, N. Y. 383 pages + 13-page index + xv pages. 314 figures, $6\frac{1}{2} \times 9\frac{1}{4}$ inches. Price, \$3.50.

This is an abridgment of the author's "Theory and Application of Electron Tubes" published in 1939. Despite the fact that there has been a reduction of nearly 300 pages it still contains most of the essential material and is sufficiently comprehensive for a first course in electronics even for students specializing in the subject. As in the previous book the presentation is clear and orderly. The author, with his usual regard for precision of statement, has provided a substantial foundation in physical concepts, emission, space charge, grid control, glow- and arc-discharge tubes, and light-sensitive cells which in some respects is more effective than in the earlier volume. The space devoted to special applications such as amplifiers, oscillators, and electrical conduction in gases has been considerably reduced but will be found adequate for most purposes and has the added merit of being somewhat more readily available.

H. M. TURNER
Yale University
New Haven, Conn.

A Graphic Table Combining Logarithms and Anti-Logarithms, by Adrian Lacroix and Charles L. Ragot

Published by the Macmillan Company, New York, N. Y. 56 pages. 7×10 inches. Price, \$1.60.

This is the fifth reprint of a work first published in 1925. In it logarithms and anti-logarithms are presented by parallel scales of the numbers and their logarithms. These enable the five-place logarithm of a number, or the number corresponding to a five-place logarithm, to be obtained by the simple reading of a scale, without any necessary interpolation.

For this purpose there are provided forty pages of the juxtaposed scales. The usual table of five-place logarithms with proportional parts fills twenty pages only. However, in the present work, no interpolation whatever is necessary for five-place work, and by simple estimation of tenths of a division, six-place logarithms and six-place anti-logarithms are obtained. Thus these scales occupy much less space than the usual six-place logarithm table. In addition, a second table of only six pages is included in the book. From this may be taken, without interpolation, four-place logarithms and anti-logarithms, and simple estimation of tenths of a division gives all the accuracy of the usual five-place table.

The scales are beautifully and clearly executed and are sufficiently open to allow tenths of a division to be estimated with certainty. This method of obtaining logarithms and for making calculations using logarithms, should especially appeal to computers accustomed to use the slide rule.

A five-page introduction, with portions

of the scales reproduced in the text for purposes of illustration, clearly and fully explains the use of the tables.

FREDERICK W. GROVER
Union College
Schenectady, N. Y.

Microwave Transmission, by J. C. Slater

Published by the McGraw-Hill Book Company, Inc., 330 West 42 St., New York, N. Y. 304 pages + 5-page index + x pages. 76 figures. $6\frac{1}{2} \times 9\frac{1}{4}$ inches. Price, \$3.50.

The scope of this book is clearly defined by its title. The first chapter occupies 78 pages and gives a lucid development of classical transmission-line theory. Material is included concerning lines with continuously varying parameters. The second chapter is a 5-page treatment of Maxwell's equations, plane waves, and reflection. As the author points out, this is not a treatise on electromagnetic theory. It does however, supply a clear physical interpretation of the meaning of Maxwell's equations. Especially good is the explanation of Maxwell's displacement current. In this chapter the author introduces the m-k-s units which should be gratifying to the worker in the field. The third chapter, comprising 26 pages, takes up the analysis of rectangular wave guides. The subject is introduced by a study of wave propagation between parallel planes. The material on rectangular wave guides is reasonably complete, including a derivation of the attenuation formulas. This is followed by a 43-page chapter dealing with the general transmission line from the viewpoint of Maxwell's equations. Parallel-wire lines, coaxial lines, and circular wave guides are treated. It is to be regretted that the material on the circular wave guide is so brief. This chapter also includes a good general discussion of reflection effects in lines due to changes in dielectrics, and changes in cross-section and iris diaphragms. The fifth chapter is a study of the radiation of electromagnetic energy from dipoles and antennas with a discussion of the recent calculations of Schelkunoff and of Stratton and Chu on the impedances of antennas. The remaining 69 pages of the book are devoted to directive devices for antennas and the coupling of coaxial lines to wave guides. There is a rather serious lack of material on electromagnetic horus. Parabolic reflectors are discussed in a qualitative way. The material on the coupling of coaxial lines to wave guides is of considerable interest.

As a whole, the reviewer is of the opinion that this book, while incomplete in some respects, is very well written and represents a good introduction to the study of microwaves. It should be a useful addition to the book shelf of either the beginner or the advanced worker in microwaves.

The teacher will need to supply his own problems as none is included in the text.

S. D. ROBERTSON
Bell Telephone Laboratories, Inc.
New York, N. Y.

Fundamentals of Electric Waves, by Hugh Hildreth Skilling

Published by John Wiley and Sons, Inc., 440 Fourth Ave., New York, N. Y. 182 pages+4-page index+vii pages. 65 figures. 5½×9 inches. Price \$2.75.

"Fundamentals of Electric Waves" is devoted exclusively to a thorough explanation of electromagnetic concepts and equations and of those vector concepts which have become part and parcel of electromagnetics. The book includes 40 pages of graphic discussion of vector fields, gradient, divergence, and curl. These chapters are followed by brief chapters on electrostatic field, electric-current flow, and magnetic fields. Thus, a proper foundation is laid for understanding Maxwell's equations. The final third of the book is devoted to uniform plane waves, power flow and Poynting vector, radiation, rudiments of antenna theory, and glimpses of guided-wave propagation. The exposition is very good.

The book is intended for undergraduate students and caters to those who wish to understand fundamentals; there is little specific information.

Gaussian units are used almost exclusively, but some final results are expressed also in practical units. Inasmuch as the primary purpose of the book is to help students and engineers to read modern literature on microwave transmission, in which m-k-s units are used almost exclusively, the author's choice of the units is perhaps unfortunate. However, the book is concerned primarily with ideas and units are not particularly important.

S. A. SCHELKUNOFF
Bell Telephone Laboratories, Inc.
New York, N. Y.

Aligning Philco Receivers, Volume II, 1941, by John F. Rider

Published by John F. Rider, Publisher, Inc., 404 Fourth Ave., New York, N. Y. 176 pages+ xv pages. 167 figures. 5½×7½ inches. Price \$1.60.

This volume supplements Volume I which appeared in 1937. It contains specific alignment instructions for all Philco receivers marketed between 1937 and the present time, since the manufacture of receivers was stopped in April, 1941. The tabular form of alignment instructions employed so successfully in the earlier

volume has been retained. The Appendix treats problems of general interest to those concerned with receiver alignment. Such topics as signal strength, output meter, intermediate-frequency alignment, wave-trap alignment, oscillator adjustment, image check, etc., are covered.

This volume was compiled with the cooperation of the Philco Service and Engineering Divisions. It presents in compact form and with unusual clarity information regarding chassis layout, locations of the various trimmers and alignment procedures. Servicemen should find in this and in volume one, all the information necessary in their work on the alignment of "Philco Receivers."

W. O. SWINYARD
Hazeltine Electronics Corporation
Chicago, Ill.

Principles of Radio, Fourth Edition, by Keith Henney

Published by John Wiley and Sons, Inc., 440 Fourth Avenue, New York, N. Y. 1942. 536 pages+13-page index+xii pages. 310 illustrations. Price \$3.50.

It is always difficult for a reviewer to know how to cope with a fourth edition of a book. If he should decide the book was no good, what could he do? Obviously many cash customers have disagreed with him, or there would be no fourth edition. Fortunately, Keith Henney saved this reviewer from such a conflict by writing a book which he can heartily recommend and endorse.

The book was written "for the student who had little background in radio upon which to build and yet who wanted to know the basis upon which radio communication existed." And it is consistently held at that level, suitable for the trade school, not for the college. In fact the author specifically states that the book is not designed for college use. The liberal sprinkling of well-graded problems leads one on from the simplest case to those of the maximum complexity consistent with the amount of mathematics available. It is a joy to this reviewer to find a book which admittedly does not fill all requirements in its field, but which does fulfill one requirement so well.

The book starts with a description of the electron and a statement of Ohm's law. It then discusses practical sources of current, circuit elements, resonance phenomena, the vacuum tube and its uses (including chapters on practical design), and ends up with complete radio, facsimile, and television systems. This is a truly mammoth undertaking, but by hewing to the line the author manages to succeed in it.

The book is, of course, not perfect. It has all the inevitable faults of a non-mathematical presentation of a very involved mathematical theory. Equations are pulled out of hats right under the nose

of the reader. The presentation is at times repetitious in the author's hope that of several explanations of a phenomenon, at least one will seem plausible to the reader.

Furthermore, the presentation is at times uneven and the organization at times jerky. The author uses (and occasionally misuses) capacitance, capacity, and capacitor with complete disregard for the standards. There is no bibliography to help the ambitious student to take the next step in his education. The indexing is only fair.

Erroneous trivia include:

A mild inconsistency in developing some equations in great detail while simply stating other less obvious ones.

An incorrect derivation of a sine wave.

Several dubious statements as to current practice and what is and is not possible.

However, these are minor imperfections. The main fact is that the book cannot help but have been of great assistance to many an aspiring novice. It is easy to understand why it is in its fourth edition.

KNOX McILWAIN
Hazeltine Electronics Corporation
Little Neck, L. I., N. Y.

An Introduction to the Operational Calculus, First Edition, 1941, by Walter J. Seeley

Published by the International Textbook Company, Scranton, Pa. 162 pages +3-page index+xi pages. 25 figures. 5½×8½ inches. Price, \$2.00.

This book is intended for advanced undergraduates and others having a similar mathematical background. It starts with a three-chapter review of the classical method of solution for linear differential equations and passes by natural steps to the operational methods of solution. A considerable number of problems serving to fix the principles already expounded are included at frequent intervals throughout the text and adequate references to the literature to enable the reader who is interested to follow the more advanced portions of the subject are given.

The author is to be congratulated on having produced the most teachable book on this subject which has come to the reviewer's attention. The style is interesting and lucid and although the nature of the subject matter does not make it as easy reading as a detective yarn, the reviewer is of the opinion that most engineers will find it interesting. The book is closed with an appendix consisting of a table of formulas and is provided with an adequate index.

L. P. WHEELER
Federal Communications Commission
Washington, D. C.

Contributors



G. L. BEERS

G. L. Beers (A'27-M'29) was born at Indiana, Pennsylvania, in 1899. He received the B.S. degree in electrical engineering from Gettysburg College in 1921. Mr. Beers was in the graduate student course and engineering school of Westinghouse from 1921 to 1922; in the radio engineering department of the Westinghouse Electric and Manufacturing Company, in charge of superheterodyne receiver development, from 1922 to 1930; section engineer in the research department of the RCA Manufacturing Company from 1930 to 1940; in charge of the advanced development division from 1940 to 1942; manager of the engineering and manufacturing service division 1942 to 1943; and since 1943 on the engineering administration staff.



H. A. Breeding was born near Malvern, Iowa. He joined General Electric shortly after his graduation from Iowa State College in 1926 and was elevated to his present position upon graduation from the General Electric Test Course. Since 1928 he has been intimately associated with the entire



H. A. BREEDING

development and application of gaseous-discharge and vapor lamps, including hot-cathode, neon, sodium and mercury, as well as fluorescent lamps. He designed the thyatron control equipment for the Texas Centennial's plaza lighting and assisted in the lighting of the Chicago Century of Progress and the Golden Gate International Exposition. He laid out and constructed the first sodium street lighting in this country and conceived and designed the first "cooler-than-daylight" television lighting installation. Mr. Breeding has just completed a series of studies on sky glow in conjunction with the United States Army and Navy.



J. E. Hayes (A'39) was born in Arcola, Saskatchewan, on February 14, 1910. He received the degree of B.Sc. in electrical engineering from Queen's University at



J. E. HAYES

Kingston, Ontario, in 1935. The following year he joined the engineering department of the Canadian Radio Broadcasting Commission; when the Commission was supplanted by the Canadian Broadcasting Corporation, he became a member of the transmission and development department of the new organization. His work has included rather extensive field intensity, antenna efficiency, and ground-conductivity measurements across Canada. Recently Mr. Hayes has been occupied chiefly with development work supplemented by occasional problems in antenna design.



J. A. Ouimet (A'39) was born in Montreal, Canada, in 1908. He received his B.A. degree in 1928 from the University of Montreal and B.Eng. degree in 1932 from McGill University. Mr. Ouimet was research engineer at the Canadian Tele-



J. A. OUIMET

vision and Canadian Electronic Company between 1932 and 1934. He joined the engineering division of the Canadian Radio Broadcasting Commission in 1934 as research engineer and became operations engineer of the Canadian Broadcasting Corporation in 1937 and assistant chief engineer in 1940. He is a member of the Engineering Institute of Canada and Chairman of the Montreal Section of the Institute of Radio Engineers.



John A. Rodgers (A'38) was born on September 5, 1910, at Niagara Falls, New York. In 1933 he received the A.B. degree from Williams College, and two years later the S.B. degree from the Massachusetts Institute of Technology. During the succeeding six years Mr. Rodgers has done development engineering in radio at the Stromberg-Carlson Telephone Manufacturing Company, where he is now in charge of this company's physical testing laboratory. He is a member of the American Society for Testing Metals.



JOHN A. RODGERS

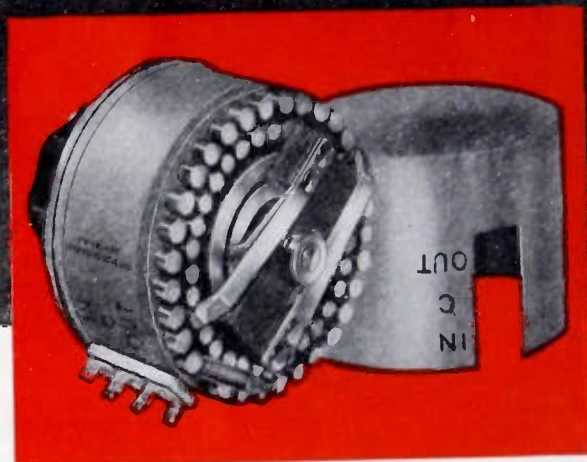
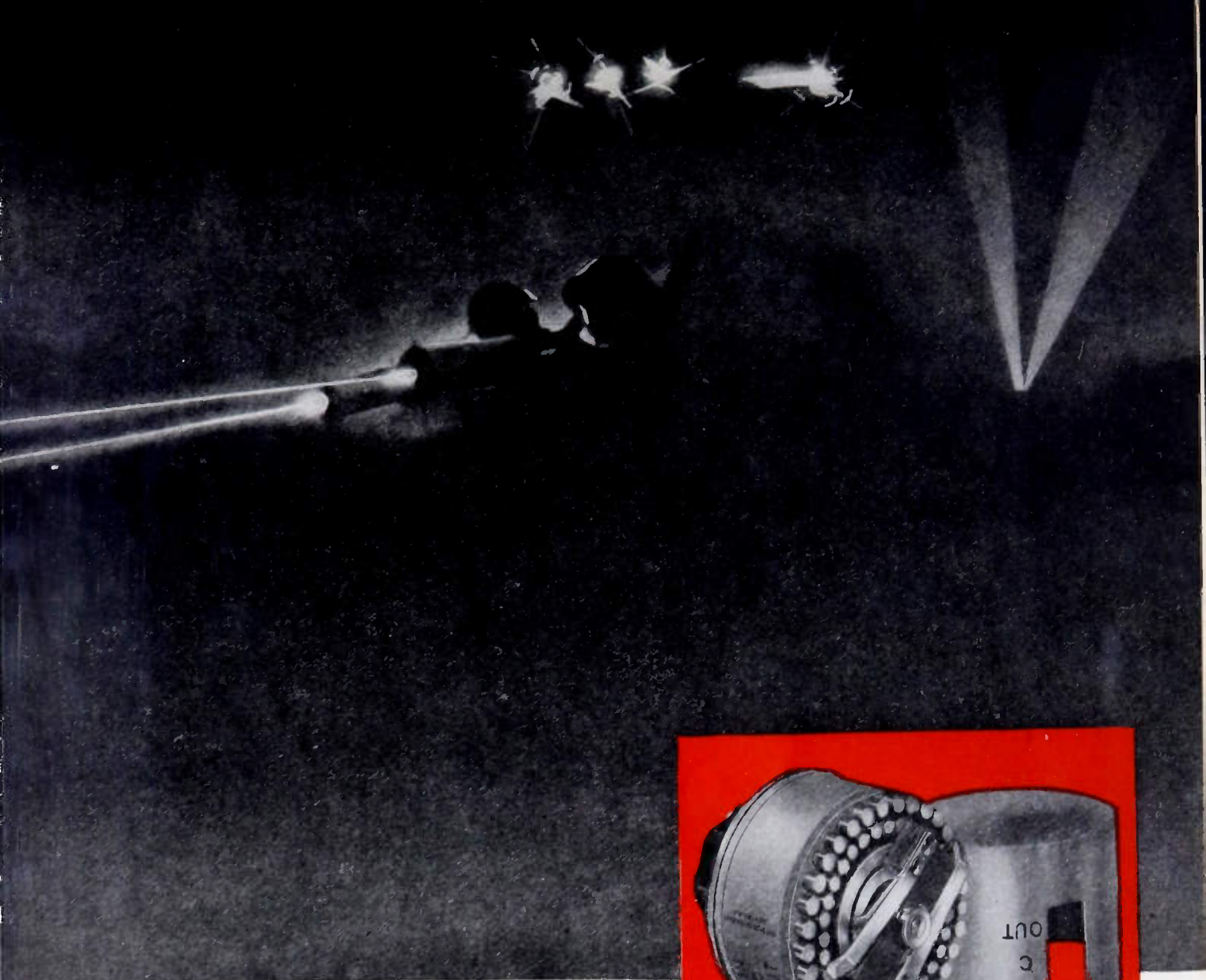

The Handwriting on the wall

Victory is being won by our men and materiel . . . by an ever-increasing stream of weapons which will write doom for the Axis. Rapidly expanding American production has already turned the tide.

Daven plays a relatively small but necessary role in this great battle of supply. Daven components provide electrical control and measurement equipment for many fields. We furnish American industry with more than eighty models of laboratory test equipment and the most complete line of precision attenuators in the world.

THE DAVEN COMPANY

158 SUMMIT STREET

NEWARK, NEW JERSEY

Section Meetings

BALTIMORE

"Absolute Measurements of Aircraft Speed and Course," by Lieutenant Colonel D. K. Lippincott, Signal Corps, U. S. A., January 21, 1943.

CHICAGO

Colored Motion Picture of Battle of Midway, Shown and with Remarks by Ensign Werrenrath, Navy Procurement Office, November 20, 1942.

"Industrial Broadcasting," by D. D. Halpin, RCA Manufacturing Company, November 20, 1942.

Election of Officers, Dinner and Entertainment, December 18, 1942.

"The New Signal Corps Inspection Agency," by Major E. A. Koerner, Signal Corps, January 15, 1943.

"Recent Developments in Industrial Electronics," by L. L. Worner, Worner Products Corporation, January 15, 1943.

CINCINNATI

"Antenna-Matching-Network Design as Applied to Mobile Transmitters," by H. M. Sarasohn and J. S. Cohen, Crosley Corporation, December 22, 1942.

Election of Officers, December 22, 1942.

LOS ANGELES

"Television, Present and Future," by H. R. Lubcke, Don Lee Broadcasting System, January 19, 1943.

NEW YORK

"Analysis of Rectifier Operation," by O. H. Schade, RCA Manufacturing Company, January 6, 1943.

PORTLAND

"Problems in Design and Application of Carrier Systems," by C. W. Lund, Pacific Telephone and Telegraph Company, December 30, 1942.

Election of Officers, December 30, 1942.

TORONTO

"Radio Interference," by H. O. Merriman, Department of Transport, Ottawa, December 7, 1942.

"Frequency Modulation," by I. W. Elliott, Canadian Marconi Company, Ltd., January 11, 1943.

Membership

The following admissions and transfers of membership were approved on February 3, 1943.

Transfer to Member

Dinger, H. E., 1301—46 St., S.E., Washington, D. C.

Dudley, B., 235 W. 71 St., New York, N. Y.

Ferrill, T. M., Jr., 6 Clare Rd., East Hempstead, L. I., N. Y.

Knight, J. B., U. S. Navy Underwater Sound Laboratory, Ft. Trumbull, New London, Conn.

Radius, C., 126 W. Hudson Ave., Englewood, N. J.

Proceedings of the I.R.E. March, 1943

Creators and Makers of

ACCURATE RESISTORS—SWITCHES—SPECIAL EQUIPMENT AND
SPECIAL MEASURING APPARATUS FOR PRODUCTION AND
ROUTINE TESTING OF ELECTRICAL EQUIPMENT ON MILITARY AIR-
CRAFT... SHIPS... VEHICLES... ARMAMENT... AND WEAPONS

DEPENDABLE

Whether your requirements are for Accurate Resistors, Silver Contact Rotary Selector Switches or Electrical Measuring Instruments you can depend on Shallcross Quality.

It has been our privilege to contribute to the Victory Effort through the creation and development of many Special designs.

Perhaps we can be of service in connection with your problems.

Write Dept. A 23



HALLCROSS MFG. CO.
COLLINGDALE, PENNA.

Membership

Sparling, A. G., 622 W. 20, Spokane, Wash.
 Terry, C. J., 1175 Bushwick Ave., Brooklyn, N. Y.
 Zender, R. G., 1751 N. Western Ave., Chicago, Ill.

Admission to Member

Cose, J. A., 1165 Loraine Ave., Plainfield, N. J.
 Davis, D. M., Zenith Radio Corp., 6001 Dickens Ave., Chicago, Ill.
 Innes-Crump, J. E., No. 3 Training Command, R.C.A.F., Montreal, Que., Canada
 Maedel, G. F., 593 E. 38 St., Brooklyn, N. Y.
 Meixell, O. S., 19 Pease Ave., Verona, N. J.
 Omberg, A. C., 4112 Fourth St., Arlington, Va.
 Sheer, C., 189-12—43 Rd., Flushing, L. I., N. Y.
 Wenger, W. D., 1480 Glenwood, Sylvania Village, Pontiac, Mich.

Admission to Associate

Abrahams, W., 390 Ocean Pkwy., Brooklyn, N. Y.
 Allen, A. E., 4007 — 75 St., Jackson Heights, L. I., N. Y.
 Bairos, C. A., 125 W. Division St., Pleasanton, Calif.
 Baptist, W. G., 114 Irvine Rd., Lexington, Ky.
 Barrett, C. C., R.C.A.F., No. 1 Wireless School, Montreal, Que., Canada
 Blasdel, F. G., Jr., U.S.S. Marblehead, Postmaster, New York, N. Y.
 Blashfield, W. H., 252 Orange St., Galion, Ohio
 Boario, W. R., 103 Market St., Leechburg, Pa.
 Bow, A., 236 Brock Ave., Toronto 3, Ont., Canada
 Bouie, W., 613 W. 146 St., New York, N. Y.
 Boyd, L. K., R.M.O. Office N.O.B., Trinidad, B.W.I.
 Boyter, R. W., 1327 McCutcheon Rd., Manhasset Village, Richmond Heights, Mo.
 Briggs, V. R., 25 Lexington Ave., Bloomfield, N. J.
 Brockner, C. E., Electrical Engineering Department, Union College, Schenectady, N. Y.
 Brouse, H. L., 1755 Lanfair St., College Hill, Cincinnati, Ohio
 Browning, R. G., 552—11 Ave., Prospect Pk., Delaware Co., Pa.
 Buckley, W. C., 69 Parra Grande La., Santa Barbara, Calif.
 Bull, C. A., R.C.A.F., No. 1 Wireless School, Montreal, Que., Canada
 Buller, T. C., R.C.A.F., No. 1 Wireless School, Montreal, Que., Canada
 Buonincontri, J., 920 Sandford Ave., Irvington, N. J.
 Butt, H. G. T., R.C.A.F., No. 1 Wireless School, Montreal, Que., Canada
 Calladine, B. T. O., R.C.A.F., No. 1 Wireless School, Montreal, Que., Canada
 Caron, J. S. R., R.C.A.F., No. 1 Wireless School, Montreal, Que., Canada
 Charton, S., USNTS (Ind.), Hollywood Beach Hotel, Hollywood, Fla.
 (Continued on page xxii)

Proceedings of the I.R.E. March, 1943

This trade mark
 is your guarantee of
ACCURACY · SPEED · ECONOMY
 in laboratory and production
 measurements



Model 205 AG
 Audio Signal Generator



INSTRUMENTS are as revolutionary as the one dial radio. They are designed to operate with the minimum of adjustments. Thus greater speed without sacrifice of accuracy is obtained.

SIMPLICITY IS THE KEYNOTE

Variable frequency, audio frequency oscillators require no zero setting. Vacuum tube voltmeter as simple to operate as a multi-range d-c instrument. Many types of instruments available separately or combinations in a single unit to fit your requirements such as the Model 205 AG which combines a resistance tuned audio oscillator, input meter, attenuator and impedance matching system. Illustrated are four -hp- instruments.

GET COMPLETE INFORMATION NOW!

Write today for technical data sheets. Give details of your problem so that our engineers can be of help. There is no cost or obligation.

HEWLETT-PACKARD COMPANY

Box 135 F. Station A Palo Alto, California



Model 200 B
 Resistance Tuned Audio Oscillator

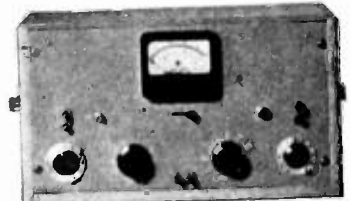

Model 325 B
 Noise and Distortion Analyzer

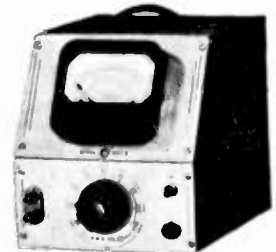

Model 400 A
 Vacuum Tube Voltmeter

MYKROY

CERAMIC INSULATING MATERIAL

A special bonded mica product
now serving widely in Army and Navy equipment

COMPARE!

These are some of the outstanding features and characteristics of MYKROY

INSULATING PROPERTIES—A low loss material that will not pass high frequencies nor dissipate h.f. energy. Will not carbonize under heat or arc, and therefore cannot create a path for leakage or short circuits.

MOISTURE RESISTANT—Absorption is negligible because it is non-porous, impervious to moisture, water, vapor, etc., thereby preventing failures otherwise due to improper insulation.

MECHANICAL STRENGTH—Nearly as strong in rupture as cast iron. Because it is not fragile it will withstand severe shock and vibration.

BONDING—Binds or seals perfectly to certain metals, thereby permitting its use in applications where bond or seal is critical.

MACHINABILITY—Machinable to high precision, either in simple surfaces or intricate parts.

NON-WARPING—No strain . . . no impairment of electrical contacts . . . no change in relation to associated parts . . . no change in form factor.

	No. 4		No. 8
FROM REPORTS OF INDEPENDENT TESTING LABORATORIES	6.68.....	Dielectric Constant	(Dry).....6.75
	6.73.....	Dielectric Constant	(Wet).....6.70
	.00240.....	Power Factor	(Dry)......00164
	.00241.....	Power Factor	(Wet)......00231
	1.60.....	Loss Factor	(Dry).....1.11
	1.62.....	Loss Factor	(Wet).....1.54
	630 Volts per Mil.....	Dielectric Strength660 Volts Per Mil.
	22,000 lbs. per sq. in. rupture.....	Mechanical Strength16,000 lbs. per sq. in. rupture

If you are confronted with an insulating problem, our engineers will welcome the opportunity to acquaint you with the performance of MYKROY. It is available in ample quantities and can be supplied for war and essential production requirements. For further information, please write to us or telephone today . . . Passaic 3-4108.

MYKROY IS SUPPLIED IN SHEETS . . . MACHINED
WITH PRECISION . . . MOULDED TO
SPECIFICATION . . . MADE EXCLUSIVELY BY

ELECTRONIC MECHANICS
INC.

70 CLIFTON BOULEVARD • CLIFTON, N. J.



Hytron

DEDICATES *the* **PRESENT**

to **PRESERVATION** *of the* **FUTURE**



HYTRON'S SOLE PURPOSE for the duration is to maintain an always-increasing flow of tubes into the radio and electronic equipment which is playing a vital part in winning this Radio War. It is our firm conviction that the torch of Liberty which Hytron is helping to keep burning will light the way to the unconditional surrender of our enemies and to an electronic age which will amaze a freed world.

HYTRON CORP., Salem and Newburyport, Mass.

... *Manufacturers of Radio Tubes Since 1921* ...



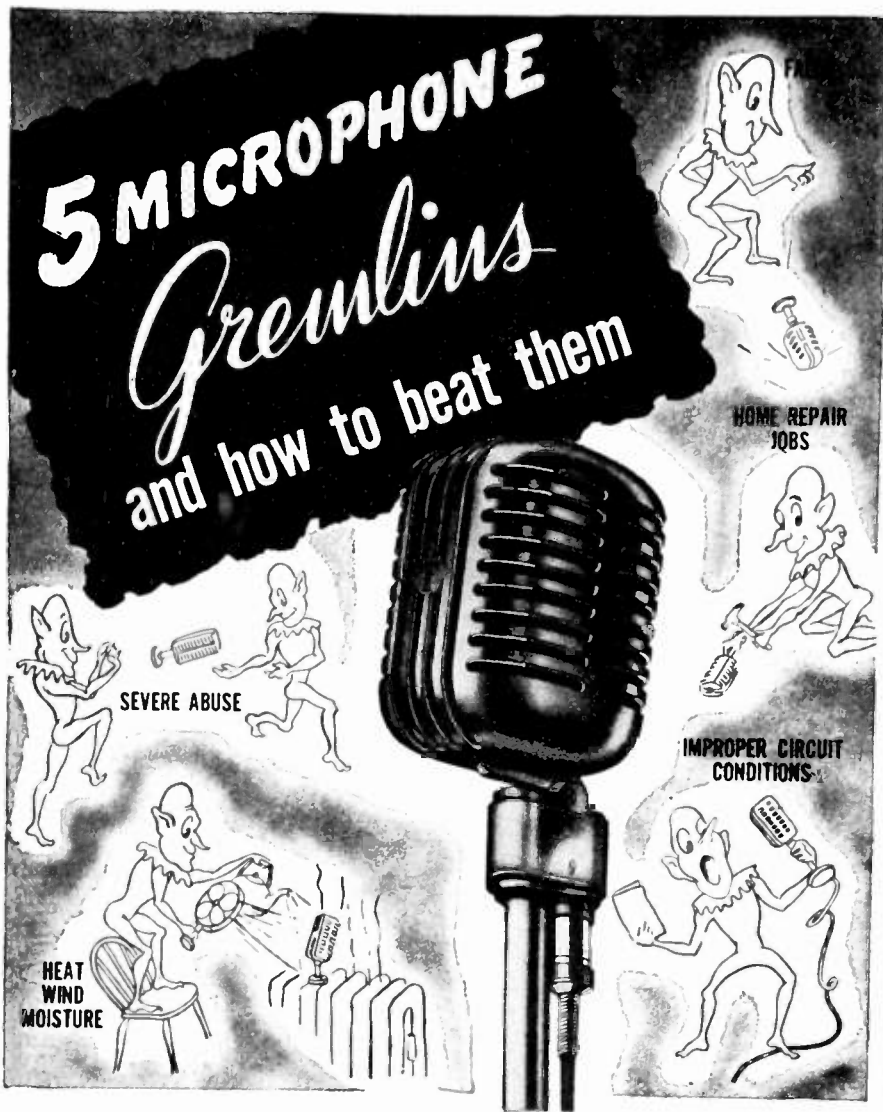

These imaginary pixies that haunt our pilots can also gum up your microphone. Protect your unit from falls, heat, wind, moisture and improper circuit conditions. Above all, use common sense in handling your mike. Don't bang it around as though it were a football. You'll get longer, better service if you treat it right. When your mike fails or gives trouble, send it to the factory or its dealer — don't try home repair jobs!

The back page of the new Turner Microphone Catalog lists the DOs and DON'Ts for longer mike life. It's Free. Send for yours.



Send NOW for your Free Copy of Turner's new 8-page, fully illustrated, colorful Microphone Catalog. Each unit is engineered for specific jobs and trouble-free performance. Select the one best suited to your needs at the price you want to pay.

Free

THIS NEW TURNER
MICROPHONE CATALOG

**The
Turner
Company**

Cedar Rapids, Iowa

Membership

(Continued from page xix)

- Chernosky, E. J., 5241 Broad Branch Rd., N.W., Washington, D. C.
- Childerhose, R. H., R.C.A.F., No. 1 Wireless School, Montreal, Que., Canada
- Christilaw, J. S., 2516 Mayfield Ave., Montrose, Calif.
- Cline, J. F., R.F.D. 5, Ann Arbor, Mich.
- Cowan, S. D., R.C.A.F., No. 1 Wireless School, Montreal, Que., Canada
- Crawford, W. G. R., R.C.A.F., No. 1 Wireless School, Montreal, Que., Canada
- Cunningham, L. W., Edgewater Hotel, Winter Garden, Fla.
- Declercq, R. H., 5360 Decelles Ave., Montreal, Que., Canada
- Diamond, M., R.C.A.F., No. 1 Wireless School, Montreal, Que., Canada
- Dingle, W. H., 169 Strathcona Ave., Ottawa, Ont., Canada
- Disney, V. H., Madison and Damen Ave., Chicago, Ill.
- Dorfman, J., 16 Martin Pl., Irvington, N. J.
- Douglas, W. L., R.C.A.F., No. 1 Wireless School, Montreal, Que., Canada
- Doyle, W. P., R.C.A.F., No. 1 Wireless School, Montreal, Que., Canada
- Easterwood, D. F., Box 313, Lexington, Ky.
- Fernane, J., 10 Cottage St., Medfield, Mass.
- Fouchaux, J. D., Pilot Marine Corporation, 25 Beaver St., New York, N. Y.
- Franta, A. L., Naval Research Laboratory, Anacostia Station, D. C.
- Frenette, A., R.C.A.F., No. 1 Wireless School, Montreal, Que., Canada
- Gash, R. W., U.S.S. *Helena*, c/o Fleet P. O., San Francisco, Calif.
- Grier, R. W., R.C.A.F., No. 1 Wireless School, Montreal, Que., Canada
- Grigg, R. W., 248 Broad St., Matawan, N. J.
- Grunwald, R., Naval Ordnance Laboratory, Navy Yard, Washington, D. C.
- Gurevics, D., 136 W. 70 St., New York, N. Y.
- Hamilton, J. R., R.C.A.F., No. 1 Wireless School, Montreal, Que., Canada
- Hardy, A. O., 9311 Sudbury Rd., Silver Spring, Md.
- Harper, F. N., 327 N. Pine St., Chicago, Ill.
- Haywary, F. T., R.C.A.F., No. 1 Wireless School, Montreal, Que., Canada
- Herron, W. A., R.C.A.F., No. 1 Wireless School, Montreal, Que., Canada
- Hertzler, E. A., Pratt Institute, Ryerson St., Brooklyn, N. Y.
- Hill, M. O., R.C.A.F., No. 1 Wireless School, Montreal, Que., Canada
- Hobbs, N. M., R.C.A.F., No. 1 Wireless School, Montreal, Que., Canada
- Hudson, G. G., R.C.A.F., No. 1 Wireless School, Montreal, Que., Canada
- Huge, H. M., Lorain Products Corporation, Lorain, Ohio
- Hulstede, G. E., 16 Ware St., Cambridge, Mass.
- Ingerville, C. S., R.C.A.F., No. 1 Wireless School, Montreal, Que., Canada

(Continued on page xxvi)

FROM TIMER CONTROL
TO STARTING MOTORS

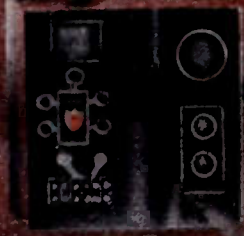

RELAYS by **GUARDIAN**



Giving split-second accuracy to timing devices, "Relays by Guardian" are widely used in Thermatrols . . . Pyrometers . . . and dozens of other electrically operated instruments. But the war has brought thousands of new uses, calling for greater precision than ever . . . for firing and timing guns . . . for controlling battle radios . . . for swiveling "Fortress" turrets . . . for doing hundreds of war control jobs. One of the newest Guardian developments is . . .

B-8 . . . NEW LIGHTWEIGHT SOLENOID CONTACTOR

Built to U. S. Army Air Force specifications for aircraft engine starting motors. With variations in mounting brackets and terminals the B-8 will meet intermittent duty specifications of the B-4, B-6A and B-7A Contactors. Contacts are rated at 200 amperes and will not chatter on voltage drops caused by starting current surges. "Pull-in" voltage is 6 volts as compared to 18 volts on contactors with which the B-8 is interchangeable.

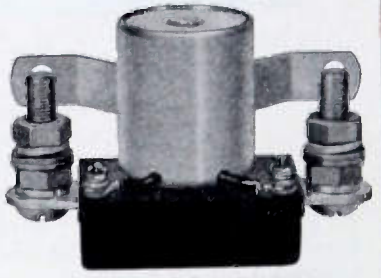

B-8 SOLENOID CONTACTOR
On ten thousand units this new design saves over three tons of critical materials.

Write for B-8 Bulletin for further information. Or for SC-25 Bulletin for technical data on continuous duty contactors.

GUARDIAN  **ELECTRIC**
1628-C WEST WALNUT STREET CHICAGO, ILLINOIS

A COMPLETE LINE OF RELAYS SERVING AMERICAN WAR INDUSTRY

A PROBLEM IN *Communications*

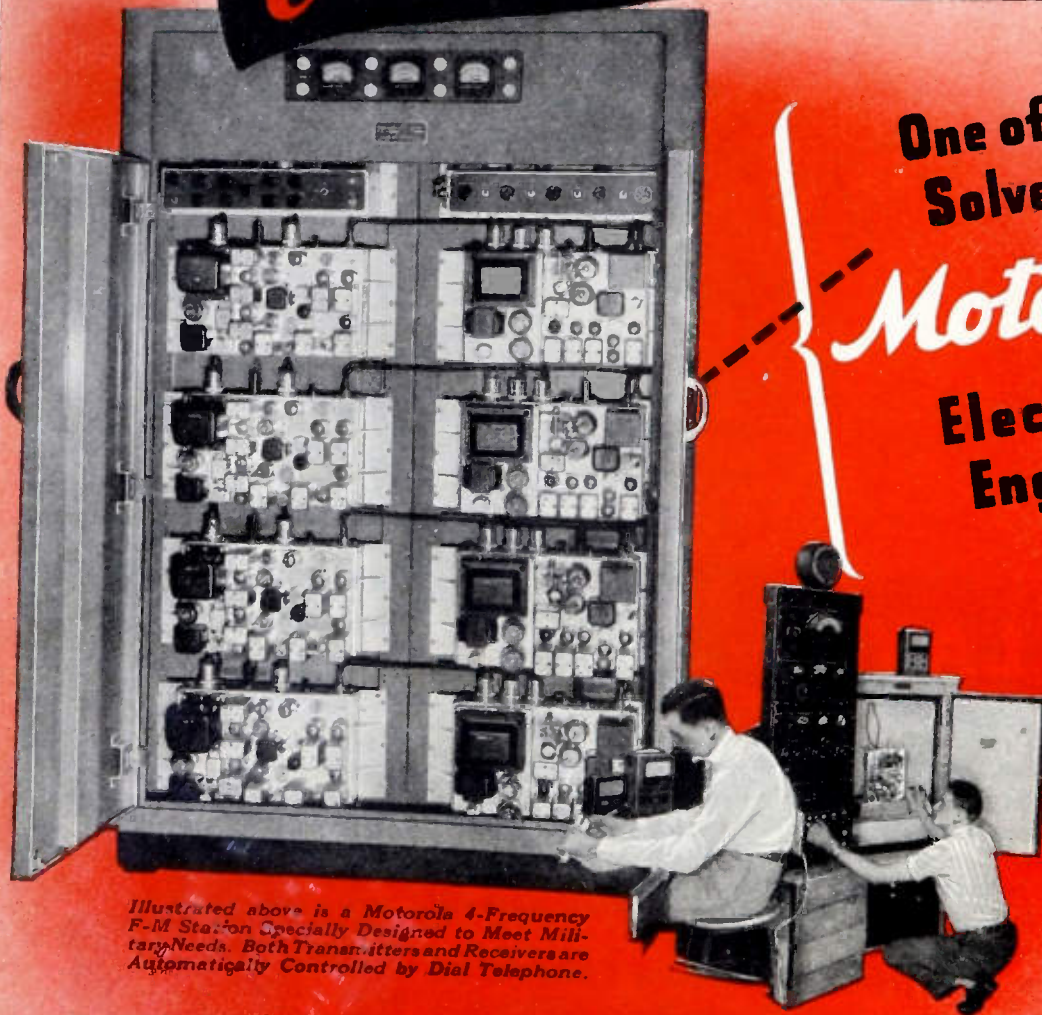

One of Many
Solved by

Motorola

Electronics
Engineers

Illustrated above is a Motorola 4-Frequency F-M Station Specially Designed to Meet Military Needs. Both Transmitters and Receivers are Automatically Controlled by Dial Telephone.

Pioneers in the development of Portable and Mobile F-M and A-M Radiotelephone Equipment, Motorola engineers are today applying their accumulated skills and scientific knowledge to solving problems which confront our country, its states, counties, cities and towns. Housed in a new Engi-

neering Building, with expanded facilities for research and engineering, the Motorola capacity for vital service is greater than ever. Electronic knowledge thus gained will one day soon be applied to the normal peacetime demands of a nation eager for better things in all phases of its living.



THE ARMY-NAVY "E"—Awarded for excellence in the production of Communications Equipment for America's Armed Forces

Motorola Radio Communication Systems
Designed and Engineered to Fit Special Needs
GALVIN MFG. CORPORATION • CHICAGO



Now...

MANY ADDITIONAL HOURS OF LIFE

BECAUSE OF EXCLUSIVE RCA DESIGN IMPROVEMENTS

RCA engineering scores again—this time with manufacturing improvements which make it possible for the famous RCA-828 Beam Power Amplifier to deliver its 150 watts* with only 2.1 watts of driving power many hours longer than heretofore.

Chief among the improvements has been the incorporation of the RCA zirconium-coated molybdenum anode in this popular tube. Actual service tests over a long period have proved that this construction change increases the life of the tube several fold!

Ordinarily, such a change might well warrant a substantial boost in the performance ratings of a tube—but not under war conditions. Longer and still longer tube life now looms far more essential than high "peak" performance. Thus, always conservatively rated in line with RCA practice, the RCA-828 now comes to you with a safety factor several times greater than ever before—just as similar improvements in other RCA Transmitting Tube types have been reflected, not in spectacular rating increases, but in terms of making the tubes perform better and lasting longer at the ratings at which you are already accustomed to using them.

RADIO CORPORATION OF AMERICA
RCA Victor Division, Camden, N. J.

RATINGS

FILAMENT VOLTAGE, 10 VOLTS	SCREEN VOLTAGE, 400 VOLTS, MAX.*
FILAMENT CURRENT, 3.25 AMPERES	PLATE DISSIPATION, 70 WATTS, MAX.*
PLATE VOLTAGE, 1250 VOLTS, MAX.*	MAX.*

*CCS rating for class C telegraph service.

HOW TO MAKE YOUR TUBES LAST LONGER

This valuable booklet, based on RCA Transmitting Tube advertising of the past year, contains dozens of helpful tips on getting maximum life from your old tubes. Get your copy today... free. Address: Radio Corporation of America, Commercial Engineering Section, Harrison, N. J.



828

BEAM POWER
AMPLIFIER

\$17⁵⁰

RCA TRANSMITTING TUBES
PROVED IN COMMUNICATION'S MOST EXACTING APPLICATIONS

1901



1943

Platinum and Platinum Alloys in Sheet, Wire, Tubing and Special Shapes

Every step in the production of Platinum and alloys—from ingot to finished product—under one roof and specialized supervision. . . . Your inquiry is invited. We shall be glad to advise regarding the adaptability of Platinum or an alloy for any specific purpose. . . .

- FUSE WIRE—In Iridium Platinum and other alloys; drawn to exact resistance specifications
- FINE WIRE, RIBBON, FOIL—drawn to close tolerances . . . Wire as fine as .0005" diameter; Ribbon to .0001" thickness
- RHODIUM PLATING SOLUTION—for reflecting surfaces
- SPECIAL FORMS—to meet individual requirements . . .

SIGMUND COHN

44 GOLD ST.

NEW YORK

SINCE  1901

REMLER

Plugs and Connectors

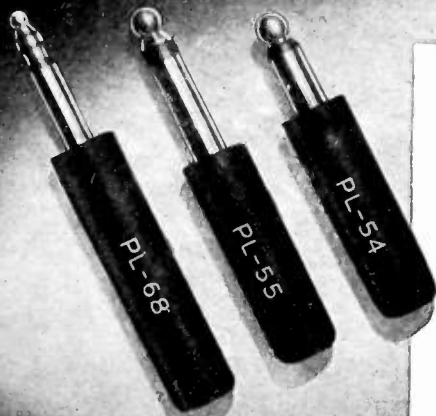

ARMY SIGNAL CORPS SPECIFICATIONS

- Also PL—PLP—PLQ and PLS Plugs
- M Type Connectors
- M Type Caps
- FT Type Fittings

Quantity Prices Quoted
on receipt of Delivery
Schedules

Manufacturers of Communication Equipment
SINCE 1918

REMLER COMPANY, Ltd. • 2101 Bryant St. • San Francisco, Calif.

Membership

(Continued from page xxii)

- Johnson, H. C., R.C.A.F., No. 1 Wireless School, Montreal, Que., Canada
- Jones, E. L., R.F.D. 1, Oncida, N. Y.
- Koski, J. I., 2228 Yucca St., Fort Worth, Tex.
- Kurz, T. M., Calzadz Tacubaya 10-C, Mexico, D. F.
- LaBossiere, E. R., 230 W. 76 St., New York N. Y.
- Lisman, H., 214—14 St., Belmar, N. J.
- Logan, R. W., R.C.A.F., No. 1 Wireless School, Montreal, Que., Canada
- Lynch, J. A., Naval Research Laboratory, Anacostia Station, D. C.
- Margolin, S. I., 2713 Montezuma Ave., Alhambra, Calif.
- Mawson, N. M., R.C.A.F., No. 1 Wireless School, Montreal, Que., Canada
- McArthur, B. M., 2708 S. Arlington Ridge Rd., Arlington, Va.
- McCaffrey, F. K., D.S.O., 3 Base P.O., San Juan, P. R.
- McLean, J. W., R.C.A.F., No. 1 Wireless School, Montreal, Que., Canada
- Neesley, T. R., 635 Roscoe St., Chicago, Ill.
- Norman, R. O., R.C.A.F., No. 1 Wireless School, Montreal, Que., Canada
- Nuss, S. L., Jr., 224 Washington St., Boonton, N. J.
- O'Donnell, C. F., R.C.A.F., No. 1 Wireless School, Montreal, Que., Canada
- Olsen, E. P., 1605—Sixth Ave., N., Great Falls, Mont.
- Onyskin, M., 91-40 Lamont Ave., Elmhurst, L. I., N. Y.
- Paquin, C. E., R.C.A.F., No. 1 Wireless School, Montreal, Que., Canada
- Parker, A. B., 432 B Lewers St., Honolulu, T. H.
- Pilling, T., P.O. Research Station, London, N.W. 2, England
- Pugh, J. E., 547 Mellon St., S.E., Washington, D. C.
- Ramirez, G. C., Calle C 711 altos., Vedado, Havana, Cuba
- Ramsay, A. R., R.C.A.F., No. 1 Wireless School, Montreal, Que., Canada
- Reid, G. K., R.C.A.F., No. 1 Wireless School, Montreal, Que., Canada
- Rhodes, C. E., 209 Beach 138 St., Belle Harbor, L. I., N. Y.
- Roberts, A. E., 515 Hillsdale Ave., E., Toronto, Ont., Canada
- Robinson, G. D., 975 Midwood Dr., Rahway, N. J.
- Schumacher, C. M., 695 Morrill Ave., Columbus, Ohio
- Scroggins, C. M., 1232½—14 St., Corpus Christi, Tex.
- Seale, G. A., 67 Bournedale Rd., No., Manhasset, L. I., N. Y.
- Seltzer, L. N., 2234 Wisconsin Ave., N.W., Washington, D. C.
- Sherburne, C. J., 3139 Wynwood La., Los Angeles, Calif.
- Silbert, D. T., 53 W. Pomona St., Germantown, Pa.
- Silk, N. R., 2408 Malabar St., Los Angeles, Calif.
- Smith, A. A., 48 Broad St., Newark, N. J.
- Swistum, W., R.C.A.F., No. 1 Wireless School, Montreal, Que., Canada
- Szekely, G., 127 W. 96 St., New York, N. Y.

(Continued on page xxx)

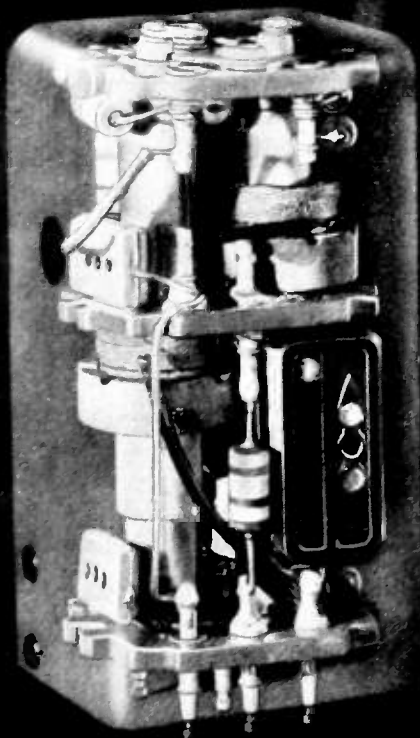

"BENDIX" Intermediate Frequency Transformer Assembly

Electrical characteristics are held to close tolerances thus assuring proper gain in the intermediate frequency amplifier with uniform band pass characteristics. Tuning is accomplished by means of adjustable iron cores. Rugged shield holds assembly firmly in place, prevents undesirable coupling.



Maintains Communication *under Fire*

THE SHOCK of bursting shell can violently disturb, perhaps destroy, the communication systems so vital to our bomber crews. An ever alert guard against such disaster is the rugged construction built into "BENDIX" Precision Radio Equipment.

An excellent example is the Intermediate Frequency Transformer Assembly illustrated. Its ability to function perfectly through extremes of temperature, humidity, vibration and shock . . . to provide proper band pass characteristics and uniform amplification . . . results from the unification of minute details which in turn are built to standards of ruggedness and precision.

Applying Bendix precision technique to the volume production demanded today is an exacting task. But here at Bendix Radio, and in the plants of some 30 sub-contractors, these high standards are successfully maintained . . . assuring the finest equipment for our gallant air crews.

Products of the Bendix Radio Division are vital members of "The Invisible Crew" . . . precision instruments and controls, which 25 Bendix plants from coast to coast are speeding to our fighting crews on world battle fronts.

THE INVISIBLE CREW

Precision

Equipment by

Bendix
AVIATION CORPORATION

BENDIX RADIO

B E N D I X R A D I O D I V I S I O N

TOUGH NUTS TO CRACK

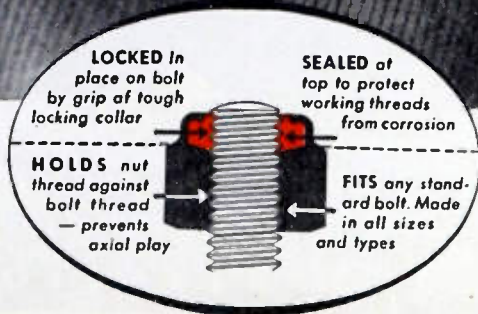
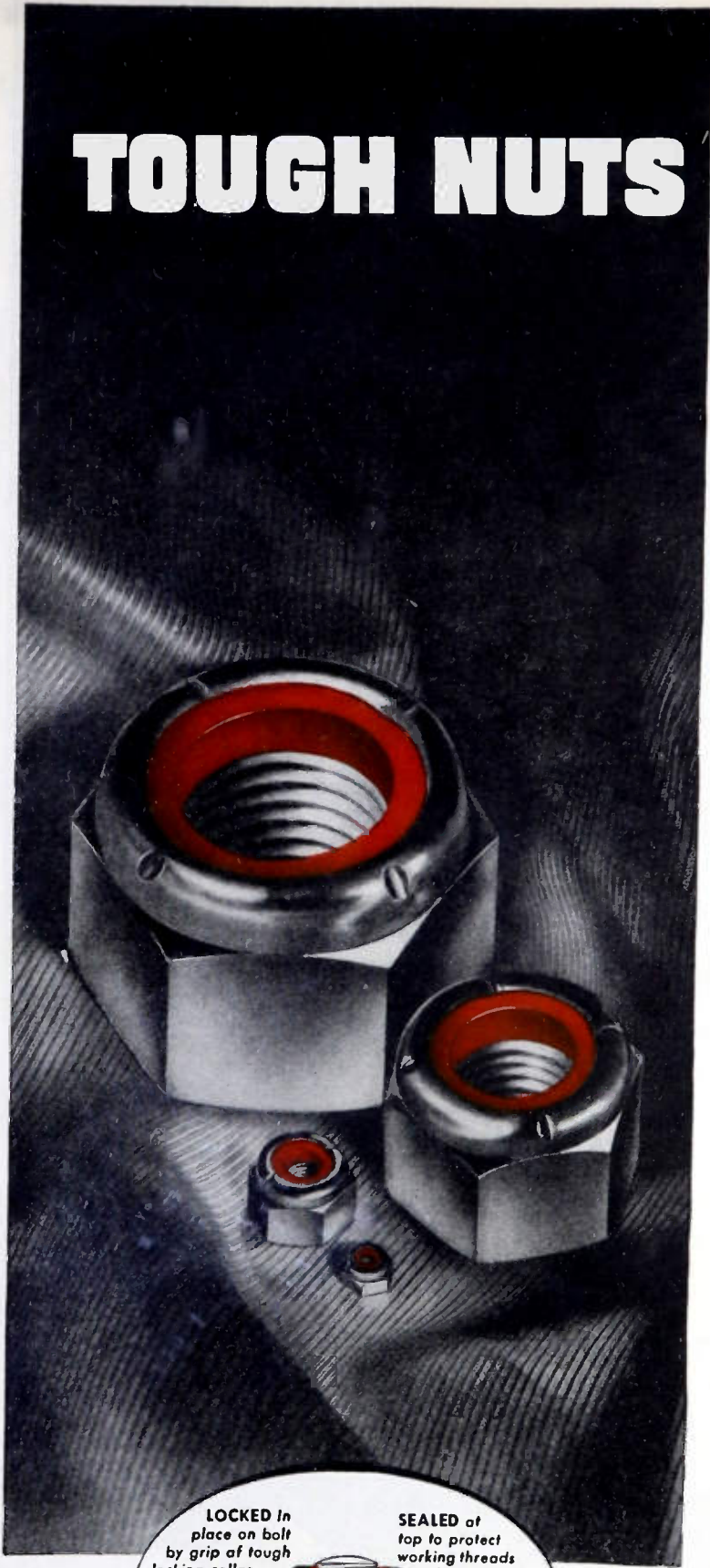

● We've made billions of Elastic Stop Nuts.

And to our knowledge not one has failed to do its job.

But the tough nuts we refer to now are the fastening problems which looked hopeless until Elastic Stop Nuts were used.

We've met lots of these in our day - and licked them.

There have been plenty of them in war production.

And how well these fastenings have filled the bill can best be told this way:

Every nut we can possibly produce is going into war goods. Yet even doubling our round-the-clock plant capacity hasn't let us gain on the demand.

In the days to come there will be many peacetime needs for these nuts.

Some will be simple. Others will look like "tough nuts to crack."

Our engineers like to meet both kinds. They stand ready to share their experience with you, work on your fastening problem and recommend the proper Elastic Stop Nut application for the job.

ELASTIC STOP NUTS

Lock fast to make things last



ELASTIC STOP NUT CORPORATION OF AMERICA
UNION, NEW JERSEY

Proceedings of the I.R.E. March, 1943



Radio Noise SABOTAGES COMMUNICATIONS unless...

So many demons, the crashes and crackles of unwanted radio noise can play havoc with communications. They blot out words—words broadcast from plane to plane, from ship to ship, from land car to jeep or tank. They endanger the lives of fighting men—they sabotage communications—unless the proper suppressor-filter system is installed.

Solar Elim-O-Stats suppress interference *right where it starts*. They absorb interference from generators, motors, contacts and other electrical sources. Thousands of these compact filters protect the lives of men on land, sea and air fighters. They prevent the blotting out of vital communications in radio-directed combat.

Solar engineers in capacitor manufacture and electronic research, Solar engineers probe the rapidly-expanding future of radio development. In post-victory cars, ships and planes, Solar war-proven capacitors and Elim-O-Stats will safeguard civilian communications, just as they are safeguarding military operations today. Solar Manufacturing Corporation, Bayonne, New Jersey.

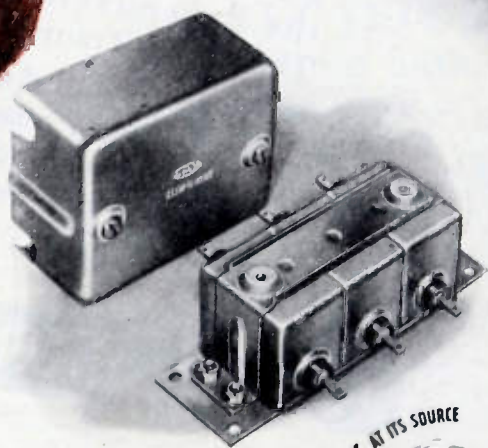

Solar **SOLAR** **ELIM-O-STAT**



3717

MAKERS OF RADIO NOISE SUPPRESSION FILTERS AND CAPACITORS



Whether it's

GLOBAL OR NATIONAL

**THORDARSON TRANSFORMERS
PERFORM VITAL SERVICES**

- There is no limit to the important part that Thordarson Transformers are playing on the stages of the world to-day.
- In the war plants and communications centers of America . . . in far-away places with unpronounceable names . . . and on isolated battlefronts all over the globe, vital tasks are being performed with greater speed and efficiency, due to the dependable character of Thordarson Transformers.
- We are proud of the recognition given to the 47 years of effort we have put into the development of the finest transformers that engineering skill can possible produce.



THORDARSON

ELECTRIC MFG. COMPANY
500 WEST HURON STREET, CHICAGO, ILL.

Transformer Specialists Since 1895

Membership

(Continued from page xxvi)

- Therhault, J. A. L., R.C.A.F., No. 1 Wireless School, Montreal, Que., Canada
- Thompson, P. A., R.C.A.F., No. 1 Wireless School, Montreal Que., Canada
- Thunen, G. W., 950—30 St., Oakland, Calif.
- Tucker, F. M., R.C.A.F., No. 1 Wireless School, Montreal, Que., Canada
- Tyson, O. A., 52 Garden St., Cambridge, Mass.
- Volz, P. E., 188 Main St., Orange, N. J.
- Webb, H. E., Jr., 153 Moss Ave., Highland Pk., Mich.
- Wheeler, M. S., 37 Watsessing Ave., Bloomfield, N. J.
- Wilkerson, J. R., 204-08—42 Ave., Bay-side, L.I., N. Y.
- Wollman, E., 466 Rockaway Pkway., Brooklyn, N. Y.
- Zaander, C. J., Naval Research Laboratory, Anacostia Station D. C.

Booklets

The following commercial literature has been received by the Institute.

COAXIAL CABLES

The extensive use of coaxial cable and its related adjuncts in modern radio technique render timely a booklet (Bulletin 23) issued by the Victor J. Andrew Co. of 363 East 75th Street, Chicago, Illinois. Soft-temper cable in crated coils from $\frac{1}{4}$ inch up to and including $\frac{3}{8}$ inch diameter is available. Hard-temper cable from $\frac{1}{4}$ inch diameter upward is provided in straight 20-foot lengths with a pair of connectors for each such length. Information is given on the transmission loss in such cables, the use of dry nitrogen gas in such cables, their high frequency performance and installation, and the factors which determine the choice of suitable cable diameter. There is a tabular list of mechanical and electrical properties of such cables in unusually convenient form.

Sealed terminals, attachments, pressure gauges, soldered fittings, straight connectors, junction boxes, right angle bends, expansion fittings, anchor sections, collar clamps, gas inlet tees, and other fittings are described together with their mode of use. The nitrogen gas fittings with pressure gauge panels and equipment for air dehydration are also shown. Gas-tight cable terminals involving a glass-to-metal seal are interestingly explained.

Passing into devices for use with directional antenna arrays, a phase monitor of the direct-reading type is described and its normal use indicated. The booklet concludes with descriptions of remote-indicating antenna ammeters.

Proceedings of the I.R.E. March, 1943

PIONEERS...in war and peace

U. S. NAVY PERFECTED THE FIRST SUBMARINE

The first practical submarine, combining an internal combustion engine, electric motors, torpedo tubes, and ballast tanks was designed by John P. Holland for the U. S. Navy.

GAMMATRONS INTRODUCED THE FIRST INHERENTLY GAS-FREE VACUUM TUBE

The presence of gas, released slowly at operating temperatures, or suddenly by overloads, shortened the life of all vacuum tubes until Heintz and Kaufman engineers introduced Gammatrons in 1928.

The name Gammatron stands for tubes that are inherently gas-free. Plates and grids are made of tantalum, a remarkable element which absorbs gas readily, and replaces the unstable chemical "getters" previously necessary.

Gammatron design has also eliminated the need for internal insulators, which are a source of gas.

The long life of Gammatrons, and their ability to endure terrific punishment, is especially valuable in time of war. These same qualities, plus new Gammatron developments in the ultra-high frequency band, will make a major contribution to the peacetime era of electronics.

GAMMATRONS...OF COURSE!

Proceedings of the I.R.E. March, 1943



HK-854 TRIODE OPERATING DATA

(As an R. F. Power Amplifier,
Class C, Unmodulated)

	Typical	Maximum
Power Output.....	1800 Watts	—
Driving Power.....	40 Watts	—
DC Plate Voltage....	5000 Volts	6000
DC Plate Current....	450 M.A.	600
DC Grid Voltage....	-575 Volts	-1500
DC Grid Current....	45 M.A.	80
Peak RF Grid Volts..	915 Volts	—
Plate Input.....	2250 Volts	2250
Plate Dissipation....	450 Watts	450

HEINTZ  KAUFMAN
SOUTH SAN FRANCISCO, CALIFORNIA U.S.A.

"Thanks for helping"

We are grateful for your help in difficult times.

Here in the Bell System we have seen some 43,000 of our people go into the armed services.

Shortages of copper and other materials have made it impossible to add much-needed lines and equipment.

We have been unable to install telephones for all who want them and many of our lines are overcrowded.

Yet in spite of all this, telephone users have been tolerant and we have fewer complaints right now than at any time in the history of the business. Thanks a lot for understanding.

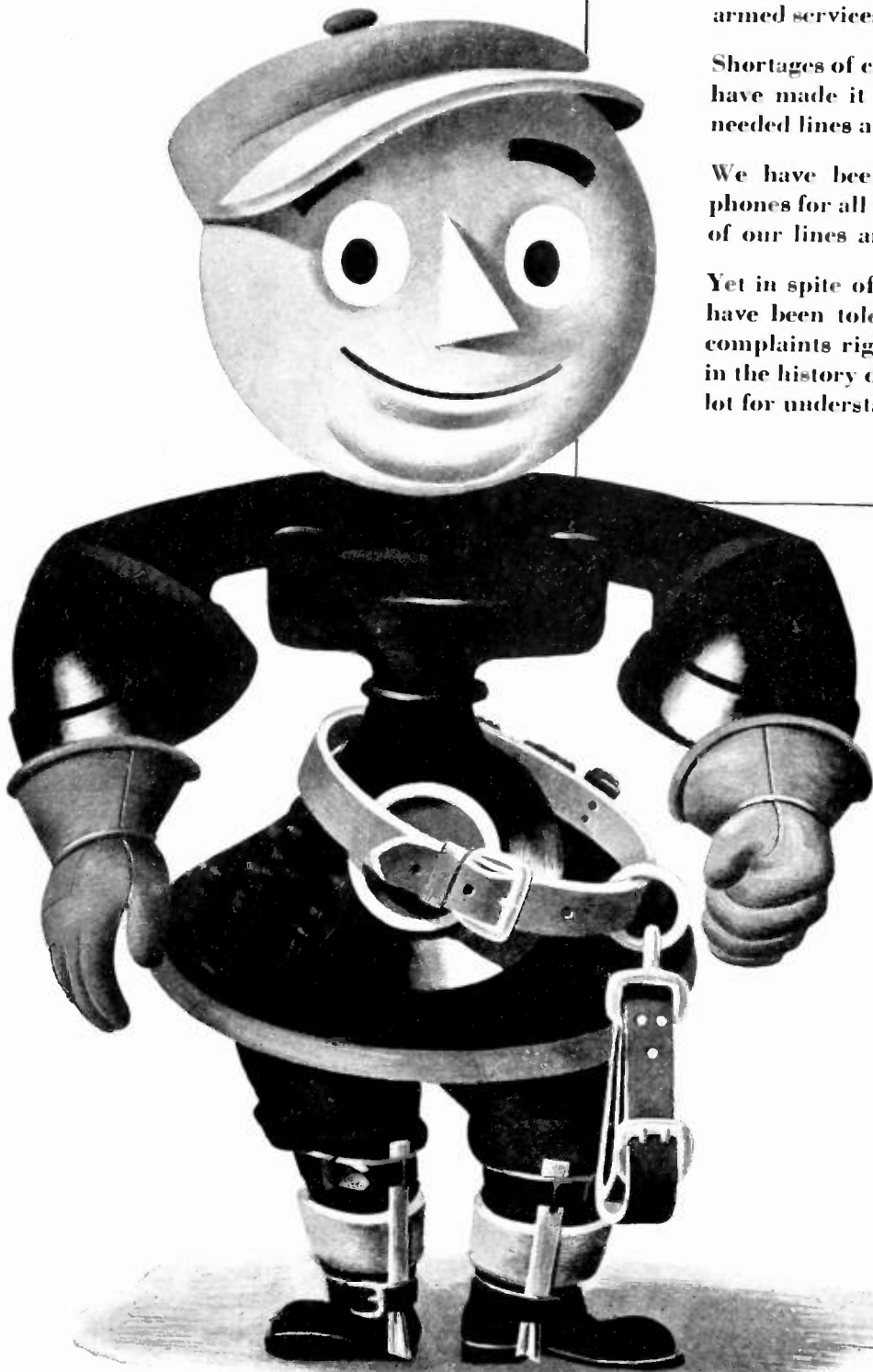

BELL TELEPHONE SYSTEM

**WAR CALLS
COME FIRST**



YESTERDAY



For more than twenty years recognized as builders of the finest sound reproducers. 15,000,000 users of fine radio sets testify to ROLA Quality.

TODAY



Expanded facilities completely dedicated to serving war needs. Producing a variety of high precision, tough-to-make electronic parts, fine radio communications equipment for the U. S. Army and Navy Air Forces.



TOMORROW!

will bring to you all the benefits of improved equipment and processes, all the gains of concentrated experience *plus* the tremendous advantages of intense unhampered research during war years. In the world of tomorrow, Rola will maintain its peacetime leadership. THE ROLA COMPANY, INC., 2530 Superior Avenue, Cleveland, Ohio.

ROLA

MAKERS OF THE FINEST IN SOUND REPRODUCING AND ELECTRONIC EQUIPMENT

PRECISION
POWER TUBES
FOR EVERY PURPOSE
MADE BY

UNITED

Skills in Electronics

When the war ends, there will be a phenomenal expansion in the peace-time use of electronics. Today—while the war absorbs the tube output—try to fix in your mind this unique source for tubes which you will seek tomorrow:

Its name: UNITED. Its organization: a group of eminent engineers and technicians, uniting their highly specialized skills. Its product: power tubes, unsurpassed in precision, for every electronic requirement including radio communication, physiotherapy and industrial control. Its standard: power tubes that consistently attain the highest record in every test of performance. Remember the name "United."



UNITED ELECTRONICS COMPANY

NEWARK, NEW JERSEY





Paved with Good INVENTIONS

Application of fundamental discoveries in science, the *development of inventions* into practical devices, presents challenging problems to the Electronic Industries.

Inspired theoretical analyses of men like Henry, Faraday and Maxwell; inventions of others like Marconi, de Forest and Armstrong—these are the fundamental ideas of modern communications and electronics.

Working with these ideas, electronic engineers have progressed brilliantly over a part of the long, winding road from scientific discovery to a fast-growing industry serving millions of people.

In this great task IRC is proud to have played a notable part in its special province: investigation in the field of Electronics directed toward the design and construction of fixed and variable Resistors and the use of Resistors as com-

ponents in the circuits of electronic devices.

Though we may not be able right now to supply you with the Resistors you need for other than war uses, our engineers and executives are at your service for counsel, without obligation, to help you in the solution of Resistor problems. Please feel free to consult them in your search for the best obtainable resistance devices under existing conditions.



INTERNATIONAL RESISTANCE COMPANY

401 N. BROAD ST., PHILADELPHIA

**I KNOW WHERE
YOU CAN GET
CRYSTALS
IN A HURRY**

If you need crystals—promptly—not TOO many—we can supply them. We have set up a special Crystal Service to handle rush orders to small-lot users—in a hurry. When you write—or better yet—phone, a competent crystal engineer will immediately be assigned to your project to insure accuracy, as well as speed. Our service today makes friends for the future for our Family of Activities in the field of Sound and its projection.



Phone **CRYSTAL SERVICE DIVISION**
PLYMOUTH THREE THREE

JOHN MECK INDUSTRIES
PLYMOUTH, INDIANA



OHMITE RESISTORS

*function under all
variations of
climatic conditions...*



Extremes of climate are an old story to Ohmite Resistors. These rugged wire-wound vitreous enameled units have proved their worth in both the freezing cold of the arctic and the heat and humidity of the tropics. Often the same resistors face both extremes as they go from one climate to the other, yet they keep doing their job accurately, dependably, *because* they are built right. Ohmite Resistors are used today in endless variety and number in war and industry, and are ready to aid in the development of new devices for tomorrow.

There are many types and sizes in regular and special units to meet practically every requirement. Units produced to Government specifications. Ohmite Engineers are glad to help you.



Write on company letterhead for 96-page Catalog and Engineering Manual No. 40—a helpful guide in the selection and application of Rheostats, Resistors, Tap Switches, Chokes and Attenuators.

OHMITE MANUFACTURING CO.

Foremost Manufacturers of Power Rheostats, Resistors, Tap Switches

4862 FLOURNOY STREET, CHICAGO, U. S. A.

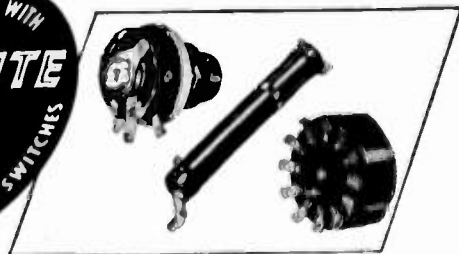

New Equipment Notes

Durashield, A New Laminated Plastic

There has recently been developed and marketed a material known as Durashield, a laminated plastic planned to meet defense demands for a satisfactory substitute for brass, copper, or bronze nameplates, tool checks, dial faces and similar marking plates on ships, machinery, and metal equipment of every kind.

Durashield is the product of Plastic Fabricators, Inc., 500 Sansome Street, San Francisco, California, and is built to meet minimum Navy requirements in the standard grade. Both the Navy and the U. S. Maritime Commission have accepted the product for ships being built at West Coast shipyards, and for use on machinery or other equipment connected with defense contracts.

Durashield is produced by a lamination process. In order to meet minimum Navy specifications, the center sheet upon which the wording is printed is an opaque cellulose acetate plastic, .010 thick. On each side of this is laminated a transparent acetate plastic, .020" thick; making a finished product measuring .050" thick. The transparent outside allows clear vision of the directions, name, or whatever may be printed on the center, and being laminated in a solid plate is stated to resist wear and remains a solid unit to replace the familiar brass, bronze, or copper plates heretofore used. An advantage of the new product is the fact that it can be die-cut, stamped, drilled, or otherwise made to conform to any specification as to size and shape. It is fire resistant, successfully withstanding temperatures of 200 degrees F. Durashield can be obtained in colors, thus conforming in many cases to well-established and familiar trade marks heretofore reproduced in metal.

New High Speed Relay

Allied Control Company's Model AK Relay is a high speed Keying and Break-In Relay for Aircraft Radio Equipment. It is compactly designed for high voltage, high speed and resistance to vibration. Its push-pull magnetic arrangement provides magnetic holding pressure on both transmit and receive contacts. One pole is equipped with two windings one of which is a holding winding connected directly across the battery supply. The other winding is connected in series with the single winding on the other pole and polarized so that when the circuit is completed through the key, the flux is neutralized on the holding or receive position pole and the armature pulls up to the transmit position. Opening the key cuts off the bucking flux and the holding flux pulls the armature back to receive position.

Allied's AK Relay is completely balanced; its arms are equipped with anti-bounce features; it is magnetically held in both positions and does not rely on back spring pressure; it keys at 20 cycles; its contact rating is 1,000 volts at 30,000 feet, 20 megacycles; 4 pole double throw; it is insulated to sustain 10,000 volts at sea

level; its standard models are in 12 and 24 volts D.C.; its wattage consumption is 5.5 in first position and 17.0 in second position; it withstands vibratory motion to better than 20 G.; all of its terminals are easily accessible; its insulation plate is of high pressure steatite; it is mounted with elastic stop nuts and its dimensions are 2 7/16 X 3 1/2 X 2 1/4 inches; its weight is 17 ounces

Type TD4 Time Delay Relay

Designed specifically to furnish maximum protection to vacuum tube equipment under unusual and difficult operating conditions, a new time delay relay has been developed by The R. W. Cramer Company, Inc. of Centerbrook, Connecticut.

Basically, the Type TD4 Time Delay Relay consists of a synchronous motor-driven timer which delivers an accurately measured but adjustable time delay prior to activation of a switch mechanism. As such, it is suitable for the controlling application of plate voltage to mercury vapor rectifiers and other tube equipment.

The heavy steel base plate provided for mounting is zinc plated. The cover is zinc plated and has a black crackle finish enamel over the zinc. The joint between cover and base plate is sealed by a compressible gasket. The entrance for control cables is sealed by a special grommet and by a sealing compound. The entire mechanism is, therefore, protected against dust, moisture and air with intent to eliminate any possibility of condensation inside the case. The wiring is protected against moisture by protective coating.

The Cramer Type TD4 Time Delay Relay provides the customary resetting action of its predecessors so that the full delay period is delivered in cases where circuits are re-energized after power interruptions of considerable duration.

In cases of momentary power failures some ordinary timers reset completely. The Type TD4, however, holds the time actuated switch in operating position for about 3/10 seconds after all power is cut off. Interruptions of less than 3/10 seconds, however, do not cause resetting of the timer and equipment functions normally with power restoration. In addition to protection against atmospheric conditions, the mechanism is designed to prevent opening or closing of the switch by heavy jarring or rapid vibration. This is a requirement for many industrial applications as well as for Marine and Military service.

New Shure Reactance Slide Rule

A handy new Reactance Slide Rule that speeds up the solution of reactance and resonant frequency problems has been devised by Shure Brothers, designers and manufacturers of microphones and acoustic devices.

Electronic and electrical engineers, physicists, radio service men, radio amateurs, teachers and students find this ac-

(Contained on page xl)

Proceedings of the I.R.E. March, 1943

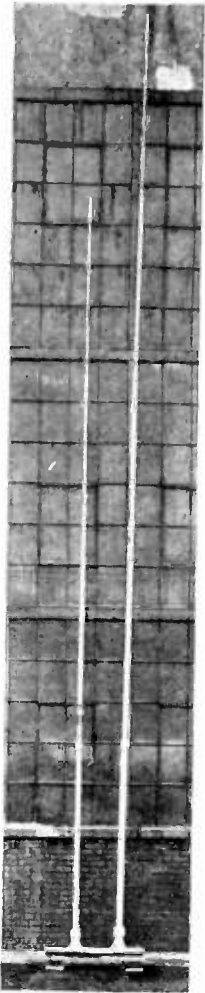

PREMAX

TUBULAR METAL ANTENNAS

**IN THE ARMED SERVICES
OF THE UNITED NATIONS**

- ... ON LAND
- ... ON SEA
- ... IN THE AIR

Premax Metal Antennas are meeting the rigid requirements of the fighting forces of the Allied Nations. Send for Bulletin of Standard Designs, or submit your specifications for special types of Antennas and Mountings.

Premax Products

DIVISION OF

CHISHOLM-RYDER CO. INC.

4301 Highland Ave., Niagara Falls, N.Y.



JOE, MARY, TONY, MAC *You've* **WON IT!**

Dear Employees:

You've earned the Army-Navy . . . "E" . . . And yet, we knew you would . . .

Not many months ago, you, of the DeJur Amsco Corporation served a peacetime market in a peacetime world . . . Today you work with fervor . . . hurdling all obstacles to produce for the Armed Forces . . . Your time, your labor have been diverted to **PRODUCTION FOR WAR . . . PRODUCTION OF MATERIALS TO WIN THIS WAR . . .**

Today DeJur Instruments, Potentiometers, and Meters have joined the fighting fronts . . . to serve America . . . and the World.

RALPH A. DeJUR President

DeJUR-AMSCO CORPORATION

Shelton, Connecticut

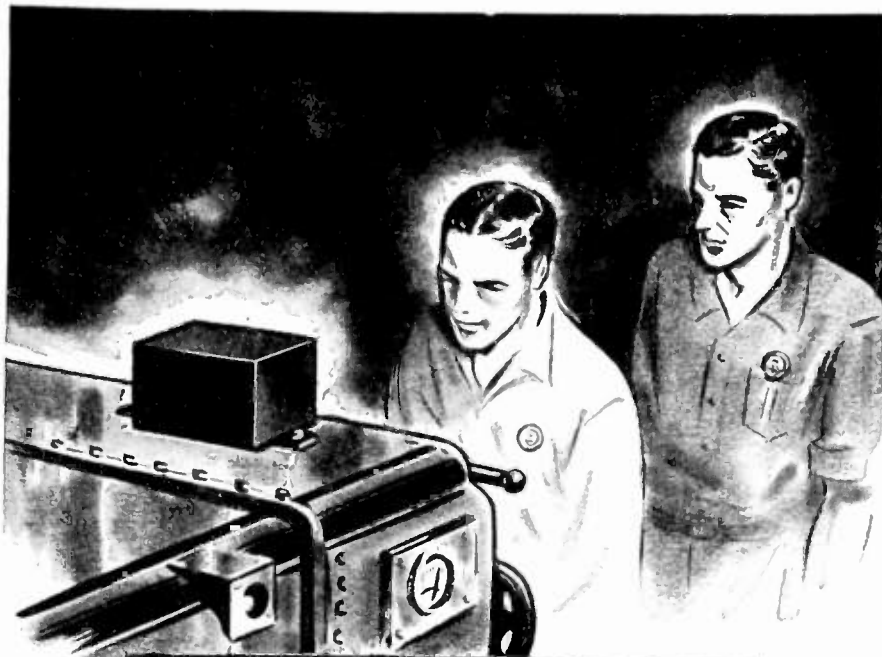

**LOOK .. FOR THE
LITTLE BLACK BOX!**

● We believe every good American wants above all to get this war won. Certainly that is the spirit here in the "Connecticut" plant. But postwar planning is as necessary to the business world as to government.

We do not believe tomorrow's world and yesterday's world have much in common.

We think that many of tomorrow's better things will come from "a little black box" containing automatic electric and electronic equipment. It will do much more than turn things on and off automatically at certain times—it will "look inside" materials being fabricated into finished products, "inspect" transportation equipment to be sure it is safe. It will improve communications amazingly.

This "little black box" is not the invention of "Connecticut" or any other one company. It merely represents the practical application of advanced electrical and electronic principles, many of which are being learned from wartime development. "Connecticut" development engineers will have much to offer the manufacturer who would like to see the magic of "a little black box" applied to his product, or to machines in his plant.

CONNECTICUT TELEPHONE & ELECTRIC DIVISION



MERIDEN, CONNECTICUT

**New Equipment
Notes**

(Continued from page xxxviii)

curate Slide Rule useful in their every-day work. It saves time solving resonant frequency problems, capacitive reactance problems, inductive reactance problems, coil "Q" problems, and dissipation factor problems.

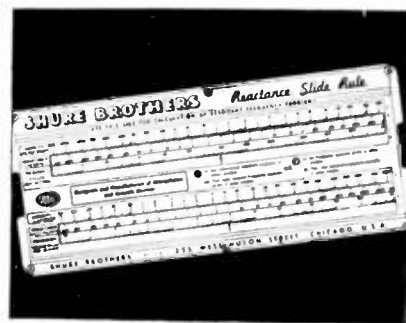

On one side of this new Shure Slide Rule, resonant frequency problems are solved with one setting of the slide, using

$$\omega^2 LC = 1$$

with ranges of 5 cycles to 500 megacycles, .001 mmf. to 1,000 mf., and .00001 mh. to 10,000 henries.

On the other side of the Slide Rule, reactance, dissipation factor and coil "Q" problems are solved with one setting of the slide, using the following formulae:

$$X_C = \frac{1}{2\pi f C}$$

$$X_L = 2\pi f L$$

$$Q = \frac{2\pi f L}{R}$$

$$D = 2\pi f C R$$

The ranges on this side are 0.1 cycle to 10,000 megacycles, 1 mmf. to 100 mf., and .001 mh. to 100 henries.

This new Reactance Slide Rule is available at a nominal charge of 10¢ in coin or stamps to cover the cost of handling and mailing. Shure Brothers, 225 West Huron St., Chicago, Ill.

New Multitester

The new R.C.P. model 419 Multitester combines in one instrument, A.C.-D.C. voltmeter, milliammeter, ammeter, capacitometer, ohmmeter and inductance meter, thus making this unit suited for a wide range of shop, laboratory and field applications.

The model 419 incorporates in its design the new R.C.P. system of A.C. measurements, eliminating the copper oxide rectifier. A.C. scales are linear with D.C. scales. Sensitivity of meter is 2,000 ohms per volt—accurate to within 2%. Capacity-meter is direct reading with widespread scales. Ohmmeter has self-contained power supply. Sensitivity of low ohm range permits checking shorts, measuring of contact resistance, resistance of voice coils, etc. Meter is fused and supply line double fused.

Special position provided for determining

(Continued on page xlii)

Engineers • Technicians • Teachers • Students Send for this NEW SHURE REACTANCE SLIDE RULE

Note: Use yellow scales together for cycles per second

CAPACITIVE REACTANCE
Set arrow opposite frequency. Read ohms (capacitive reactance X_c) opposite capacity.

DISSIPATION FACTOR
Set resistance opposite capacity. Read D opposite frequency.

USE YELLOW SCALES FOR CYCLES PER SECOND.

USE BLUE SCALES FOR MEGACYCLES PER SECOND.

SHURE BROTHERS Reactance Slide Rule

USE THIS SIDE FOR CALCULATION OF RESONANT FREQUENCY PROBLEMS

SHURE Designers and Manufacturers of Microphones and Acoustic Devices

1 (a) Set inductance opposite capacity in either window.
(b) Then read resonant frequency opposite arrow in same window.

OR

2 (a) Set frequency opposite arrow in either window.
(b) Then read inductance opposite capacity in same window.

SHURE BROTHERS • 225 WEST HURON STREET, CHICAGO, U.S.A.

Saves Time in Solving Resonant Frequency, Capacitive Reactance, Inductive Reactance, Coil "Q" and Dissipation Factor Problems

Here's how it works

FRONT	EQUATION	SOLVES	RANGE
Resonant Frequency problems	$\omega^2 LC = 1$	1. Resonant Frequency if L and C are known 2. Various L and C values for desired resonant frequency	Frequency 5 cycles to 500 megacycles Capacitance .001 mmf. to 1,000 mf. Inductance .00001 mh. to 10,000 henrys
BACK	$X_L = 2 \pi fL$	Any single unknown variable, providing remaining variables are known in equations for Inductive Reactance, Capacitive Reactance, Coil "Q", Dissipation Factor	Frequency 0.1 cycle to 10,000 megacycles Capacitance 1 mmf. to 100 mf. Inductance .001 mh. to 100 henrys
Reactance problems	$X_c = \frac{1}{2 \pi fC}$ $Q = \frac{2 \pi fL}{R}$ $D = 2 \pi fCR$		

Write Shure Brothers, Dept. 174P, 225 W. Huron, Chicago, U.S.A.
Sending 10c in Coin or Stamps to cover cost of handling and mailing

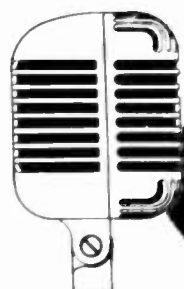

Shure Brothers, designers and manufacturers of Microphones and Acoustic Devices, are supplying our Armed Forces and our Allies with rugged military microphones for duty on land, on the sea, and in the air. However, you can still obtain our standard line of microphones for vital civilian needs. See your local radio parts distributor—or write for catalog 154P.

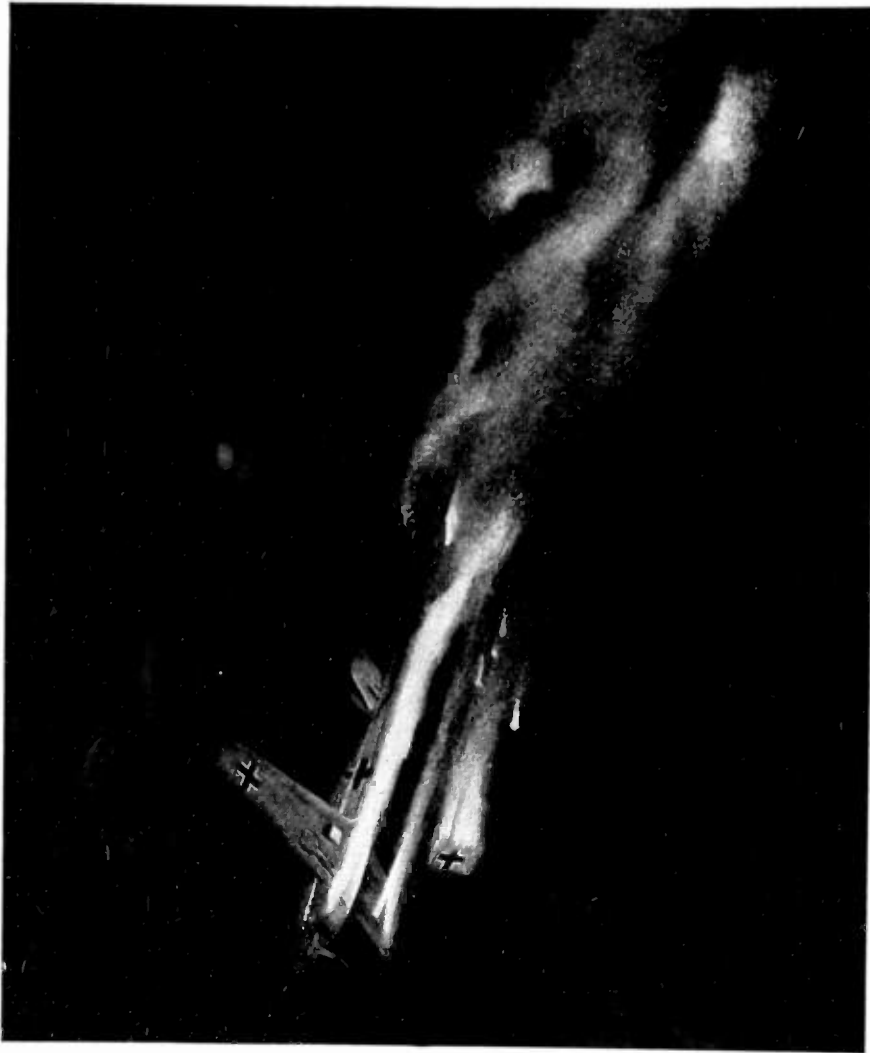

BULL'S-EYE IN THE DARK

Stabbing out into the black of night . . . locating winged raiders . . . downing an unseen enemy . . . electrical and electronic devices are helping United Nations win mastery of the air.

Today, the Allies are benefiting by the years of peacetime research. Companies long active in the radio industry, like Utah Radio Products Company, are turning the skill of their laboratories to the manufacture of weapons for war.

Utah dependability, long a byword in the radio industry, is being built into all kinds of electrical and electronic devices, for the Navy, Army and Air Corps.

We would like to tell you this whole story of Utah developments, but that would be interesting to the enemy, too; so the full details will have to wait until after the war.

Then, when America is back in the swing of peacetime activity—American homes and factories will benefit from the wartime research and improvements that are now going on at Utah. Re-united family circles will have greater convenience and enjoyment. Industrial production will be assured of greater economy and efficiency. UTAH RADIO PRODUCTS COMPANY, 842 Orleans St., Chicago, Ill.



PARTS FOR RADIO, ELECTRICAL AND ELECTRONIC DEVICES, INCLUDING SPEAKERS, TRANSFORMERS, VIBRATORS, UTAH-CARTER PARTS, ELECTRIC MOTORS

New Equipment Notes

(Continued from page xl)

ing output voltage. New improved terminals replace the conventional jacks.

Range: D.C. voltmeter: 0-5-50-250-2,500-5,000 volts. A.C. voltmeter: 0-10-100-500-1,000-5,000 volts. D.C. milliam-



meter: 0-1-10-50-250-1,000 ma. D.C. ammeter: 0-1-5-25 amps. Capacitometer: 0-.03-.30-3.0-30-300 mfd. Low ohmmeter: 0-100-15,000-150,000 ohms. Megohmmeter: 0-1.5-15 megohms. Inductance measurements—chart reference: .25-1,000 millihenries, .25-100-1,000-10,000 henries.

Model 419 is available in three types, prices ranging from \$34.50 to \$44.50. Further information can be obtained upon application to the manufacturer: Radio City Products Co., Inc. 127 West 26th Street, New York City.

Worker Moral High at Microphone Plant

This is a brief account of worker morale in a radio manufacturing plant. At Cedar Rapids, Iowa is the factory of the Turner Company, makers of crystal and dynamic microphones. Their output goes to the Galvin Manufacturing Corporation, which has expressed its gratitude for the high-speed production of its supplies.

But this accomplishment did not satisfy the Turner Company's employees. At Christmas, they earnestly petitioned their employer not to give them their well-earned Christmas bonus but instead to devote the funds to the purchase of a jeep for the Army. This was done—and followed two days later by an enthusiastic citation from the Secretary of the Treasury expressing the Governmental appreciation of the employees' "patriotic and generous donation."

Proud of the spirit in its plant, the Company nevertheless presented the regular Christmas bonus in addition to its employees. In democratic union, there is strength!

Burned Out

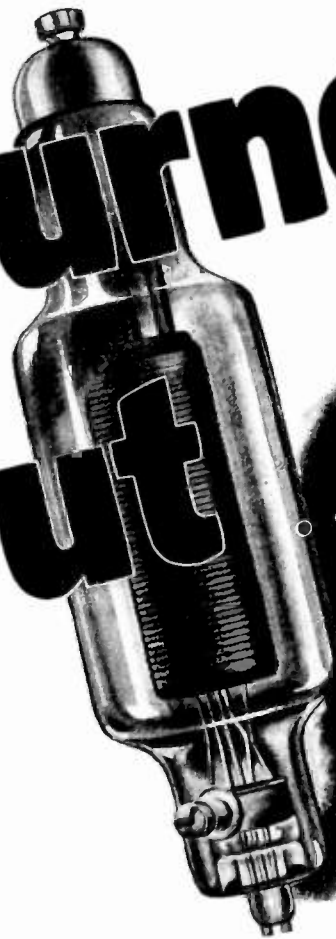

... at the moment
it was needed most

WITH CONSTANT VOLTAGE THIS MIGHT HAVE BEEN AVOIDED

This tube might have been transmitting orders to a battle fleet . . . or controlling some delicate operation in a war plant . . . or guiding an airliner through a storm "upstairs".

Then, a sudden surge of line voltage, a tiny filament gives way—and thousands of tons of fighting ships are out of contact with land . . . a whole production line has broken down . . . or a slender silver airliner lies wrecked against a peak.

Human lives and enterprises depend daily upon hundreds of functions controlled by electronic tubes. These tubes are delicate, precious, nowadays all but irreplaceable. Their priceless life must be kept safe.

In operation, rotate your tubes and spares. And guard them against destructive voltage

fluctuation with SOLA CONSTANT VOLTAGE TRANSFORMERS. Sola "CV's" eliminate distortion, faulty emission, grid activation and filament failure due to voltage variation. They absorb line sags and surges up to 30% and still put out a constant filament voltage at rated level. Day and night, without supervision, they're on the job—instantaneous in action, without moving parts, self-protecting against short circuit.

Sola "CV's" are available in standard units with capacities from 10 VA to 15 KVA. Special units can be built to specification.

Note to Industrial Executives: *If you have a problem involving voltage control, no matter what its nature, Sola "CV" transformers can help you solve it. Ask for bulletin KCV-74.*

SOLA

Constant Voltage Transformers

Transformers for: Constant Voltage • Cold Cathode Lighting • Mercury Lamps • Series Lighting • Fluorescent Lighting • X-ray Equipment • Luminous Tube Signs
Oil Burner Ignition • Radio • Power • Controls • Signal Systems • Door Bells and Chimes • etc. SOLA ELECTRIC CO., 2525 Clybourn Ave., Chicago, Ill.

PUT IT IN

Electronic

WRITING...



39° = 1.80 Milliseconds



Oscillogram of the operation of a two-way snap-switch, accurately timed in milliseconds. The segment represented by the curved trace or arc, measures 39°, or the equivalent of 1.8 millisecond.

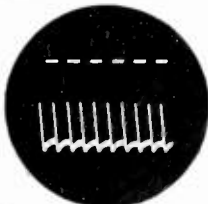

Oscillogram showing the precise wave form of the DuMont Variable-Frequency Stimulator for brain surgery and research. The remarkable uniformity of wave form and amplitude of the stimuli, is clearly disclosed here. Time interval: 1 millisecond.

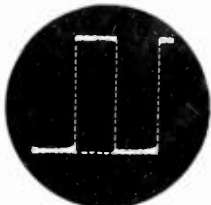

Oscillogram of the response of a given amplifier to a 100 kilocycle square-wave signal. Such electronic writing provides the best evidence of actual performance.

★ Your report on electronic, radio, electrical and most technological functions should be put in *electronic writing* to save time, to be really explicit, to facilitate proper consideration and decision.

As an oscillogram vividly traced on the DuMont oscillograph screen, your presentation permits of either a quick grasp of the situation, or a highly detailed study if the finer intricacies of the wave form receive due consideration. A photograph of the oscillogram provides a permanent record.

Yes, it pays to put such matters in *electronic writing* these days. More and more presentations, explanations, discussions, are being handled that way.

And DuMont equipment, because of its versatility of application as well as sharp, detailed, brilliant, high-fidelity oscillograms, is now the recognized standard the world over.

★ Write for Literature . . .

Current Literature

New books of interest to engineers in radio and allied fields—from the publishers' announcements.

A copy of each book marked with an asterisk (*) has been submitted to the Editors for possible review in a future issue of the Proceedings of the I.R.E.

*A GUIDE TO CATHODE RAY PATTERNS. By Merwyn Bly, Associate Engineer (Radio) Navy Department * * * John Wiley & Sons, Inc., 440 Fourth Ave., New York, N. Y. (40 pages + covers, 8½ × 11 inches, spiral bound, 175 figures and 4 graphs.) This book presents under one cover a "sketch-and-caption" summary of cathode ray pattern types encountered in the usual course of laboratory and test bench work. It is dedicated to the oscilloscope operator who would prefer to check the chart than plot the points. Published in October, 1942. Paper bound. Price \$1.50.

THE INDUCTANCE AUTHORITY. By Edward M. Shiepe, B.S., M.E.E. * * * Gold Shield Products, 350 Greenwich St., New York, New York. (9 × 12 inches, flexible fiber cover, price \$2.50.) This book dispenses with computation for the construction of solenoid coils for tuning with variable or fixed condensers of any capacity, covering from ultra frequencies to the borderline of audio frequencies. Accuracy to 1 per cent may be attained from the charts. There are thirty-eight of these charts, of which thirty-six cover the numbers of turns and inductive results for the various wire sizes used in commercial practice. (Nos. 14 to 32), as well as the different types of covering. Each turns-chart for a given wire has a separate curve for each of the thirteen form diameters.

An interesting 32-page booklet entitled: "Electronics—A New Science for a New World" has been issued by the General Electric Company and is obtainable by writing to that organization at Schenectady, New York and requesting their booklet GED-1024.

The booklet is written in popular style, and contains numerous descriptions of historical episodes in the development of electron theory. The story is brought up to date in a broad review of modern electronic applications.

Specifically treated are numerous highlight fundamental discoveries in electricity, the production of high vacua and the study of the nature and behavior of electrons. Diverse applications of electronics are mentioned including the recording spectrophotometer, textile-inspection equipment, lighting-control registration in multiprinting, the electron microscope, radio-frequency heating for plywood production, as well as agricultural and biological applications of electronic devices. Television is presented as a radio-and-electronic art and the close resemblance between that field and electron microscopy is evident.

The booklet is a striking presentation of the radio-and-electronic field in which the members of the Institute of Radio Engineers are so intensely active and to which their PROCEEDINGS is dedicated.

Proceedings of the I.R.E. March, 1943

DUMONT

ALLEN B. DU MONT LABORATORIES, Inc.
 Passaic • New Jersey
 Cable Address: Wespexlin, New York



PARTS BY
Centralab

*Serving the Electronic Industry
Since 1922!*

FOR more than two decades CENTRALAB has been indelibly connected with the radio industry. Since the first "battery" and "loud speaker" sets, practically every radio of importance to this day contains CENTRALAB parts.

NOW . . . more than ever before . . . CENTRALAB is a definite part of the radio and electronic picture. While to a very limited extent we are still taking care of the civilian needs, we are putting our main effort into supplying the armed forces with vitally needed equipment. We are proud to be able to contribute our pioneer experience as well as our extensive facilities at this crucial time.

CENTRALAB PARTS INCLUDE:

- | | |
|------------------------|---------------------------|
| Steatite Insulators | Volume Controls |
| Ceramic Trimmers | Ceramic Capacitors |
| High Frequency Circuit | Wire Wound Controls |
| Switches | Sound Projection Controls |

Centralab

DIV. OF GLOBE-UNION INC., MILWAUKEE, WIS.

A WARTIME MESSAGE

... to users of Jackson Electrical Instruments



ANY product bearing the Jackson trade-mark, sent back to us for calibration, checking, parts replacement, or whatever may be necessary, will be properly serviced and returned to you as promptly as possible.

That's a difficult pledge to make in these times. For like hundreds of hard-working war plants, we're rushed continually to get out equipment the Signal Corps must have on schedule. Nevertheless, we consider proper maintenance of Jackson equipment a wartime obligation to you and to Uncle Sam. We are meeting this obligation with all the means at our command.

... and to all engineers planning for post-war radio



A simple yet compelling fact: Electronic and communications equipment will help profoundly in shaping the post-war world. Already the electron has become a powerful, responsive servant in a thousand tasks. Already our voices and images span oceans with the speed of thought. Let us not forget the strength of the tools so close at hand and the obligations they impose on us to use them well. And may we ask you to remember this, too: That in the peace to come Jackson will be making electronic and communications test equipment. It will be good equipment, made with care, accuracy, and fine components.

JACKSON

Fine Electrical Testing Instruments

JACKSON ELECTRICAL INSTRUMENT COMPANY, DAYTON, OHIO

POSITIONS OPEN

The following positions of interest to I.R.E. members have been reported as open. Apply in writing, addressing reply to company mentioned or to Box No.



PROCEEDINGS of the I.R.E.
330 West 42nd Street, New York, N.Y.

INSTRUCTORS IN RADIO AND ELECTRICITY

50 civilian instructors needed immediately for Army Air Forces Radio Instructor School. Subjects of instruction: Direct current and alternating current electricity, vacuum tubes, standard radio receivers and transmitters; international Morse code, telegraph and radiotelephone procedure. Salaries follow Civil Service starting from \$2,000 per year. State experience, education, code speed, personal data. Positions open immediately. Saint Louis University, Army Air Forces Radio Instructor School, 221 N. Grand Boulevard, Saint Louis, Mo. A. H. Weber, Technical Director.

COMMUNICATIONS ENGINEER OR PHYSICIST

The National Geophysical Company has an opening on its Engineering staff for a communications engineer, or physicist with electronic training, who is interested in research and development work. Projects cover all phases of geophysical work, and in addition, developmental work on Government projects. This position is permanent. Salary open. For additional details address National Geophysical Company, Research Laboratory, 8806 Lemmon Avenue, Dallas, Texas.

RADIO ENGINEERS

Large New York City plant has excellent opportunities and immediate employment for those who can qualify as foremen, leaders, or designers in the production of aircraft radio equipment. Electrical engineer's degree or equivalent, with experience in manufacture of electronic equipment required. Lesser positions in many other classifications available for those lacking above qualifications. Send full details to Box 277.

RADIO ENGINEER OR TECHNICIAN

Knowledge of circuits for supervisory position in transmitting tube circuit laboratory. Circuit knowledge and executive ability more important than college degree. Married man with children preferred. Salary open. Minimum \$250. Box 279.

RADIO, MECHANICAL AND ELECTRICAL ENGINEERS

Several men needed immediately for work on government radio equipment. Men with at least three years experience in design and development of quality equipment desired. College degree or equivalent experience necessary. Any person now employed at highest skill on war production work should not apply. Address Box 280.

COMMUNICATIONS ENGINEERS

Transcontinental & Western Air, Inc. has openings for three Radio Engineers in the Communications Department. Applicants should have completed an electrical or radio engineering course, or should have had one to two years practical experience. These openings are permanent. For additional details and application forms, write to Personnel Department, Transcontinental & Western Air, Inc., Kansas City, Missouri.

(Continued on page xlvi)

Now Available . . .

STANCOR PROFESSIONAL SERIES TRANSFORMERS

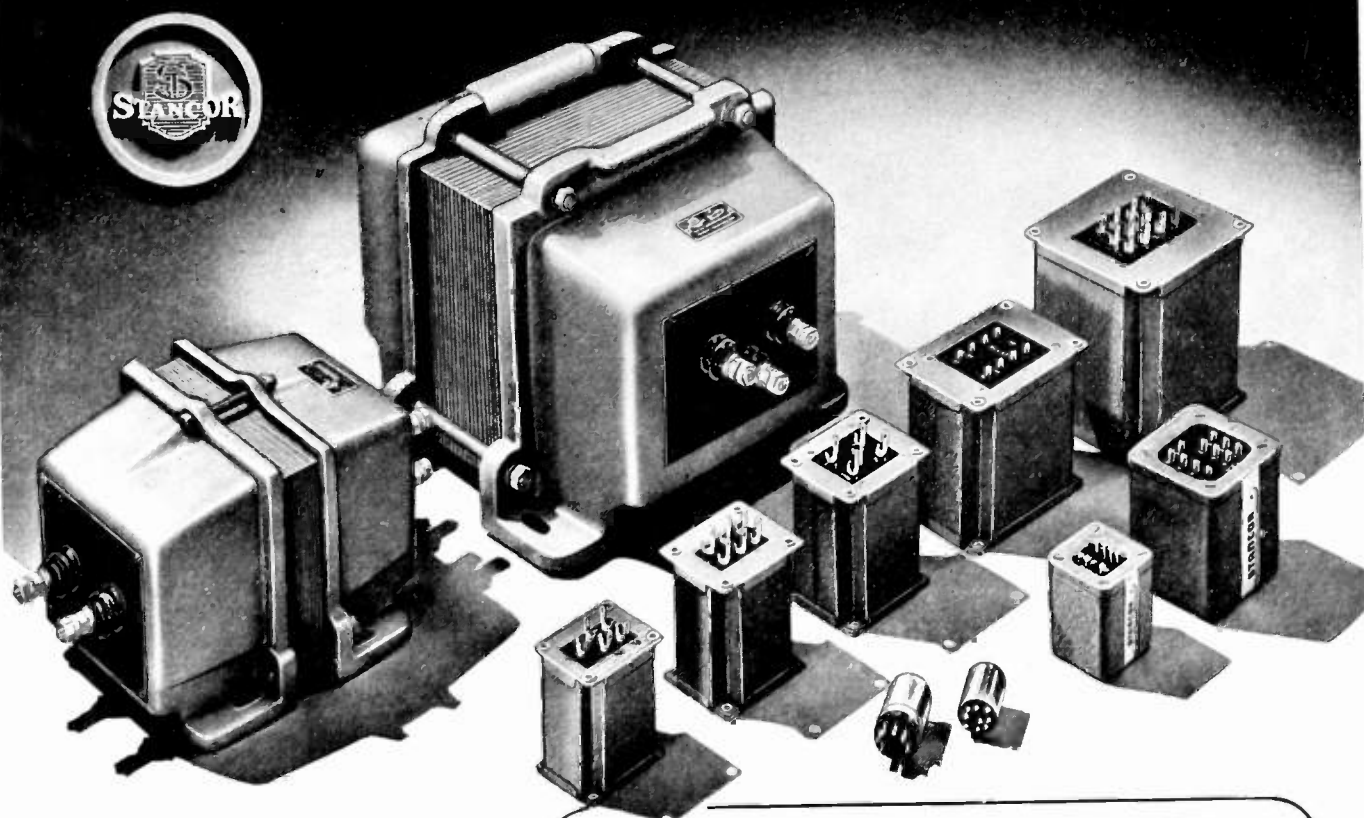

THE Stancor Professional Series Transformers are now available to manufacturers who are doing essential war work. Built to fit many needs, the multiple features of these transformers combine to make them the finest and most versatile group of units Stancor ever has designed.

Sound engineering, highest quality materials and precision manufacturing have won these transformers highest acclaim.

For information write for catalog No. 240 or contact our representative nearest you. See list at right.

SALES OFFICES IN PRINCIPAL CITIES

WIRE OR CALL THE NEAREST STANCOR SALES OFFICE

ATLANTA
Main 5878

BOSTON
Hancock 0200

BUFFALO
Washington 2517

CLEVELAND
Academy 4932

COLUMBUS
Adams 8928

DALLAS
Tennessee 37093

DENVER
Emerson 2437

DETROIT
Vermont 7-5310

KANSAS CITY
Victor 7057

LOS ANGELES
Richmond 6363

MEMPHIS
2-0612

MILWAUKEE
Concord 7799

NEW YORK CITY
Rector 2-1423—2-5334

PHILADELPHIA
Walnut 3575

ST. LOUIS
Franklin 0482

ST. PAUL
Emerson 8619

SAN FRANCISCO
Hemlock 2625

SEATTLE
Main 8811

Main Office and Warehouse • CHICAGO • Mohawk 5300

STANDARD TRANSFORMER CORPORATION • 1500 NORTH HALSTED STREET • CHICAGO

STANCOR

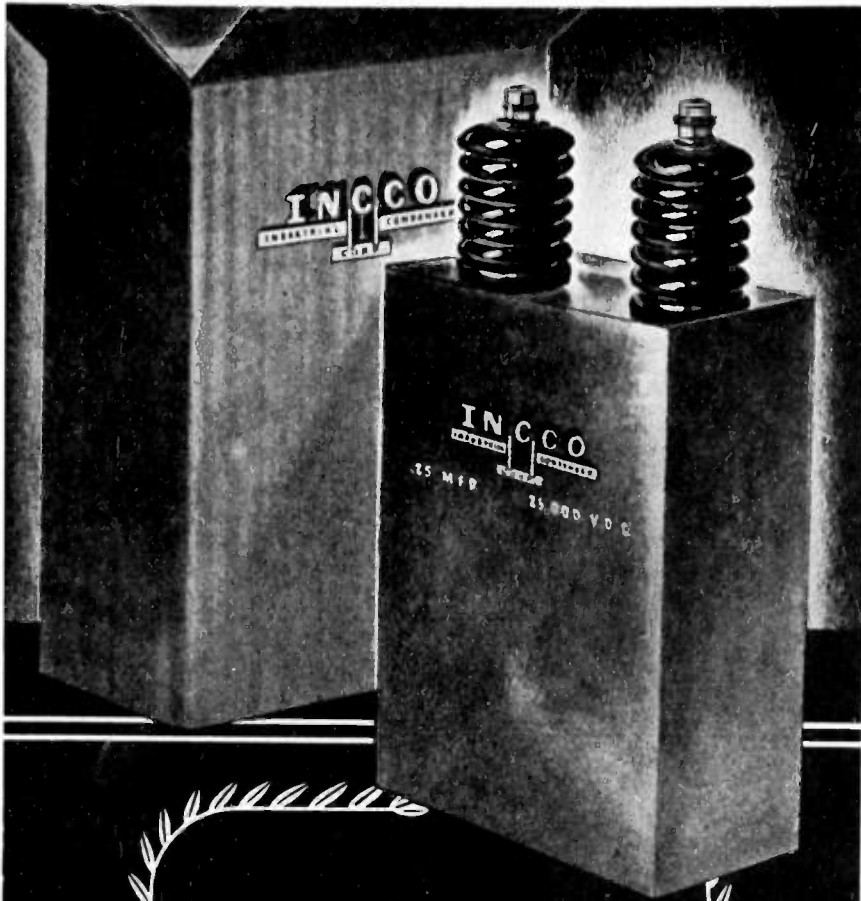

**THE
CONDENSER
LINE OF
UNSURPASSED
QUALITY**

PAPER, OIL AND ELECTROLYTIC CONDENSERS

INDUSTRIAL

CONDENSER CORPORATION
1725 W. NORTH AVE., CHICAGO, U. S. A.

DISTRICT OFFICES IN PRINCIPAL CITIES
QUICK DELIVERY FROM DISTRIBUTOR'S STOCKS

(Continued from page xlvi)

NAVAL ORDNANCE LABORATORY

The Naval Ordnance Laboratory, located in Washington, D.C., is a research development agency of the Bureau of Ordnance, concerned with the design of new types of naval mines, depth charges, aerial bombs and other ordnance equipment, including measures for the protection of ships against mines.

This laboratory needs physicists and electrical engineers with electronics experience, mechanical engineers familiar with the design of small mechanical movements or mechanisms, and personnel for technical report writing and editing. Write to Naval Ordnance Laboratory, Navy Yard, Washington, D.C.

RADIO AND ELECTRONIC ENGINEER

For developmental work. Must combine practical ability with a little of the "dreamer." Excellent opportunity with alert organization. Write Radio Receptor Company, Inc., 251 W. 19th Street, New York, N.Y.

ELECTRONIC ENGINEER, PHYSICIST AND DRAFTSMAN

Capable radio engineer for work on x-ray and allied applications, and physicist with specialized experience in electronics. Mechanical draftsman, with practical production experience, for work involving usual drafting for production of electronic devices, primarily in x-ray field. Write Philips Metalix Corporation, 419 Fourth Avenue, New York, N.Y.

RADIO INSTRUCTORS

Urgent need for men and women to serve as civilian instructors in radio at the Army Air Forces Technical School, Sioux Falls, South Dakota. Starting salaries range from \$1,620 to \$2,600 per annum, depending upon the education and experience of the applicant. Minimum requirements include a high school education (which may be waived in some cases), plus one of the following:

1. Holds, or has recently held an amateur or commercial radio operators license.
2. One year's experience as a radio operator, radio engineer, or radio repairman.
3. Successful completion of a six month's resident course in radio or an E.S.M.D.T. radio course.
4. One year of college work in a recognized institution.

Applicants who have had at least six months experience in advanced and difficult radio work, who have taught radio or allied subjects for at least six months or who have a degree in electrical or radio engineering or the equivalent, will qualify for a starting salary of \$2,000. Those with certain additional experience may qualify for a starting salary of \$2,600.

For full particulars write to: A. A. F. Employment Officer, Army Air Forces Technical School, Sioux Falls, South Dakota.

RADIO ENGINEERS AND MONITORING OFFICERS

Applications for positions with the Federal Government of radio engineer at \$2,600 to \$8,000 a year, radio monitoring officer at \$2,600 and \$3,200 a year, and radio mechanic technician at \$1,440 to \$2,600 a year, will be accepted at the Washington, D.C., office of the United States Civil Service Commission. Qualified persons urged to apply immediately. No written tests. Applicants will be rated on the basis of their statements in the application, subject to verification by Commission. For full information, and application forms, write to United States Civil Service Commission, Washington, D.C.

(Continued on page 1)

Attention! COMMUNICATIONS EQUIPMENT MANUFACTURERS

We have capacity available to produce the following products for communications equipment manufacturers. Orders can be accepted for prompt delivery on these items. Can they help you speed war production?

HIPERSIL TYPE "C" CORES

Three grades of two-piece, laminated steel cores for power, audio, intermediate radio and higher frequencies. Space factors 95%, 92% and 89%. Windows down to $\frac{1}{2}$ " x $\frac{1}{4}$ ". These cores do not require dies or nickel.

PRESTITE—CERAMICS

"Solder-Seal" hermetically tight bushings and terminal boards; standoff insulators, coil forms, bushings. Grade "F" characteristics.

MICARTA—PLASTICS

Phenol-formaldehyde, thermosetting. 11-NEMA Grades including XXX; X; P; and LE. Sheets, shapes, punchings, moldings.

TUFFERNELL INSULATING MATERIALS

Varnished cambric and cotton tapes; synthetic, air drying and baking varnishes; thinners; compounds and enamels.

RECTOX—RECTIFIERS

Copper oxide rectifiers for power packs, instruments, etc.

BI-METAL THERMOSTATS

Strip and disc type. For temperature control in crystal ovens, humidity control, etc.

INERTEEN CAPACITORS

Noninflammable, hermetically-sealed, very compact. Ratings from 10,000 to 100,000 volts.

DYNAMOTORS

Types PE-59, 60, 86; DM-25, 32, 33, 34, 35, 36, 45, 53.

BLOWER MOTORS

400-800 cycle models, 6700 rpm, for cooling radio transmitters.

For further information on products or deliveries, wire or write to Communications Division, Dept. 10-L, Westinghouse Elec. & Mfg. Co., East Pittsburgh, Pa.

J-94545



Westinghouse

PLANTS IN 25 CITIES . . . OFFICES EVERYWHERE

skilled hands and willing hearts . . .

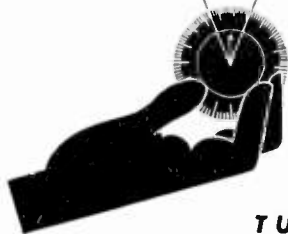

TUNED FOR BATTLE

Advanced developments by *Doolittle* for critical WAR EQUIPMENT today means better communications for your peacetime needs tomorrow.

To Assure Victory
Buy More U. S. War
Bonds and Stamps

Doolittle
RADIO, INC.

Builders of Precision Radio Communications Equipment
7421 S. Loomis Blvd., Chicago, U. S. A.

TECHNICAL WRITER WANTED

We offer you adequate salary, interesting work, and a permanent position . . .

. . . if you know technical radio, and can write *so clearly, so informatively* that you can edit manuscripts prepared by engineers—and convert them into “popular” booklets which will *interest and instruct* students of a long-established home study organization.

You will also have opportunity to do *original* writing. By your use of words, pictures and diagrams, you will help teach radio and electronics to many thousands of seriously enthusiastic students. You will have the rare opportunity of watching both individual and mass reaction to instruction material you prepare.

We want an UNUSUAL man. Therefore, we lay down no hard and fast specifications as to who and what he should be. If you believe you may qualify, write us *so fully* about your education, experience, salary requirements, etc., that an *immediate* interview will be justified.

Post Office Box 2701, Washington, D.C.

(Continued from page xlviii)

COMMUNICATIONS ENGINEERS AND PHYSICISTS

Several openings in the Research Laboratory, Development and Engineering Divisions for communications engineers and physicists. Men holding Ph.D. and B.S. (E.E.) Degrees, and men with proven ability in physics or electrical engineering desired.

Other positions open for engineers and physicists with experience in development of microphones and telephone receivers to predetermined standards. Another position calls for experience in the design and measurement of microphones and telephone receivers. Another calls for acoustical engineering experience in communications. Opportunity is given for permanent post-war connections in the communications-equipment manufacturing industry.

Only American Citizens can be considered. Apply by letter stating full qualifications. Bert Holland, Personnel Manager, Kellogg Switchboard & Supply Co., 6650 South Cicero Avenue, Chicago, Illinois.

RADIO INSPECTORS

Radio Inspectors sought by Federal Communications Commission. The positions pay \$2,000 and \$2,600 a year, and are located throughout the United States. Duties include inspection of radio equipment on ships and aircraft, or at land stations, the making of frequency runs and harmonic analyses, and the examination of radio operators.

No written test will be given to applicants. To qualify for Radio Inspectors, \$2,600 a year, applicants must have had education and experience as described in one of the following: (1) a full 4-year course in electrical or communications engineering at a recognized college or university, (2) a full 4-year college course with major study consisting of at least 24 semester hours in physics, (3) 4 years of technical experience in radio work, or (4) any time-equivalent combination of (1), (2), or (3). Amateur radio experience under a class A license may be substituted for 2 years or less of experience. For Assistant Radio Inspector, \$2,000 a year, only 3 years of this education and experience are required.

In addition, applicants must hold a valid second-class radiotelegraph operator's license, or must demonstrate during the first 6 months of service their ability to transmit and receive 16 code groups per minute in International Morse Code. They must also be able to drive an automobile.

Full information, and application forms, may be obtained at first- and second-class post offices, except in regional headquarters cities where they are available only at the civil service regional offices, or from the U. S. Civil Service Commission at Washington, D.C.

ENGINEERS

Electrical, Electronic, and Mechanical Engineers (men or women) with at least some development laboratory experience. Recent graduates also considered.

Old established plant located in Central Indiana, normally manufacturing precision parts for wide range of industries, including aviation, automobile and electrical. At present devoted to developing and producing war equipment.

Excellent post-war opportunities for those who qualify. If not employed in war production to highest skill, write giving full details of experience, education, age, draft status and salary expected. Address Box 282.

(Continued on page lii)

Important Openings for **ENGINEERS & TECHNICAL MEN**



The following engineering positions with Bendix Radio, Division of Bendix Aviation Corporation in Baltimore, Maryland, are open. The salary is open and depends only upon the ability and experience of the engineer.

- 1 Electronic and radio engineers to design electronic navigation and communication equipment for aircraft.
- 2 Mechanical engineers familiar with and interested in the design of small precision equipment and familiar with shop practice and tools.
- 3 Engineers familiar with the design of components for electronic equipment.
- 4 Technical men able to write technical material for instruction books.

These positions are not for the duration only, and can be permanent for the right men. There are excellent opportunities for advancement.

Engineers with experience as outlined are preferred, but the right persons do not need experience if they have the ability to learn and the required aptitude. Applicants may be male or female. Persons already engaged in war work cannot be considered.

*Write directly to Chief Engineer, Bendix
Radio Division, Baltimore, Maryland, giving
complete details of education and experience*

BENDIX RADIO DIVISION

THE INVISIBLE CREW



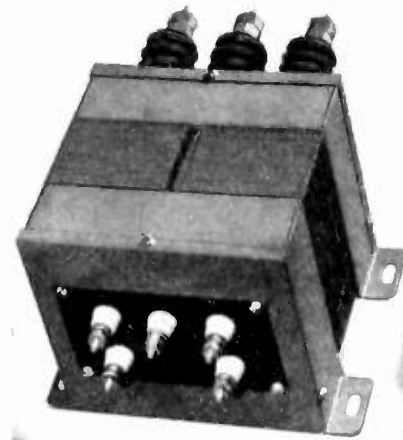

TRANSFORMERS

that fly for Navy

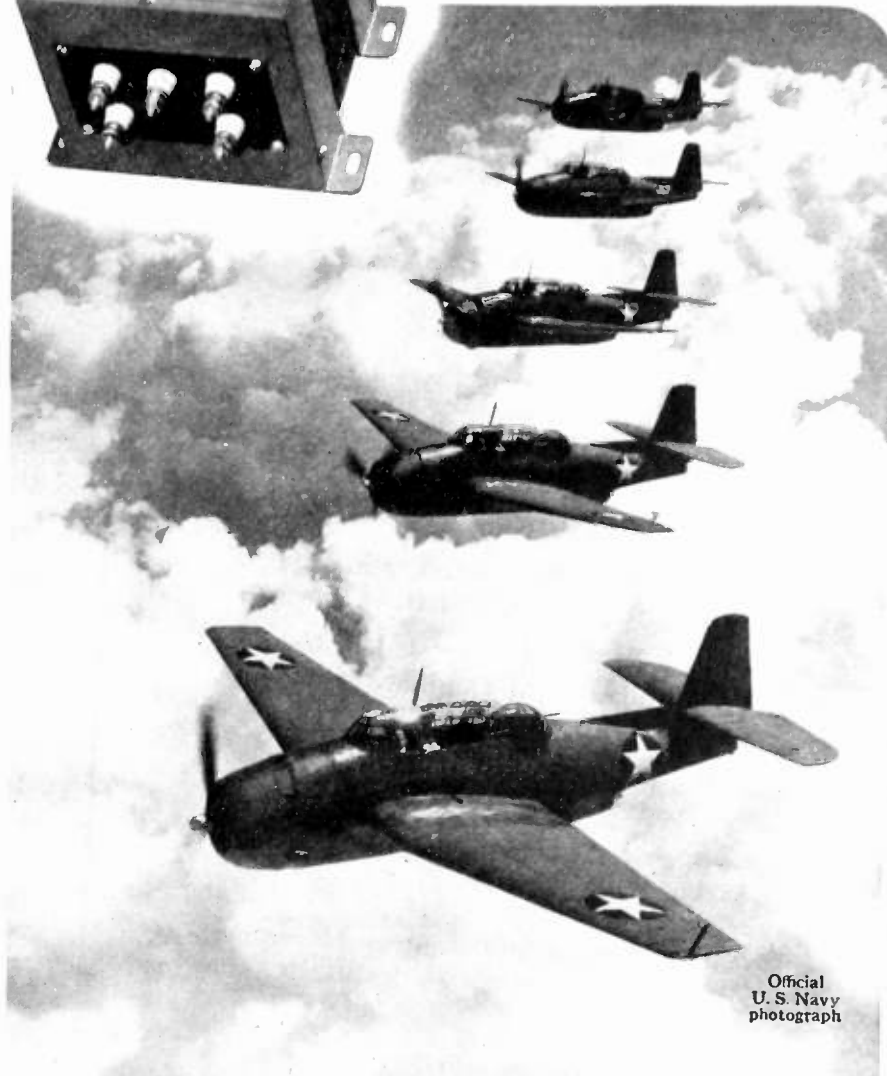

Official
U. S. Navy
photograph

THE Transformers that Fly For Navy are subjected to many unusual conditions not found in ordinary operations. Sudden changes in temperature and atmospheric pressure not only have to be dealt with but must be met by lighter and smaller Transformers that carry heavier loads.

Waterproof-Hermetically Sealed Transformers, built by the Chicago Transformer Corporation not only pass the Navy Five-Cycle Salt Water Immersion Test but also other severe operating, pressure and temperature tests set up in our own laboratories.

Manufacturers of all types of Transformers up to 10KVA



CHICAGO TRANSFORMER
CORPORATION
3501 WEST ADDISON STREET • CHICAGO

(Continued from page 1)

ENGINEERS

The salary is open and depends only upon the ability and experience of the engineer.

1. Electronic and radio engineers to design electronic navigation and communication equipment for aircraft.
2. Mechanical engineers familiar with and interested in the design of small precision equipment and familiar with shop practice and tools.
3. Engineers familiar with the design of components for electronic equipment.
4. Technical men able to write technical material for instruction books.

These positions can be permanent for the right men. Excellent opportunities for advancement.

Engineers with experience are preferred, but the right persons do not need experience if they have the ability to learn and the required aptitude. Applicants may be male or female. Persons already engaged in war work cannot be considered.

Write directly to Chief Engineer, Bendix Radio Division, Bendix Aviation Corp., Baltimore, Maryland giving complete details of education and experience.

RADIO INTERCEPT OFFICERS

Persons qualified to intercept radio messages are needed by the Federal Communications Commission. The positions pay \$2,000 and \$2,600 a year, plus overtime, which increases the salaries about 21% for 8 hours of overtime a week.

Radio intercept officers will participate with Army Air Forces in effecting radio silence and insuring compliance with silence orders, test the efficiency of methods of control, maintain a continuous watch on distress channels, and otherwise participate in monitoring assignments relating directly to the war effort.

For assistant radio intercept officer, \$2,600 a year, persons must have had either a full 4-year course in electrical engineering or physics at a college or university of recognized standing, 4 years of technical experience in the field of radio, or a time-equivalent combination of such education and experience. For the \$2,000 grade, less education and experience is required. Applicants for both grades must be able to transmit and receive in International Morse Code, and in some cases may substitute experience as a radiotelegraph operator, or as an amateur holding a Class A license, or radio and engineering study at a recognized college or radio institute for part of the prescribed education or experience.

No written test is required, and the only age limitation is that applicants must have reached their eighteenth birthday. Positions are to be filled throughout the United States.

Persons using their highest skills in war work are not encouraged to apply. Complete information and application forms may be obtained at post offices, from the United States Civil Service, Washington, D.C., as well as from civil service regional offices.



Attention Employers . . .

Announcements for "Positions Open" are accepted without charge from employers offering salaried employment of engineering grade to I. R. E. members. Please supply complete information and indicate which details should be treated as confidential. Address: "POSITIONS OPEN," Institute of Radio Engineers, 330 West 42nd Street, New York, N. Y.

The Institute reserves the right to refuse any announcement without giving a reason for the refusal.

Announcing a change of name

HAZELTINE SERVICE CORPORATION

becomes...

HAZELTINE *Electronics* **CORPORATION**

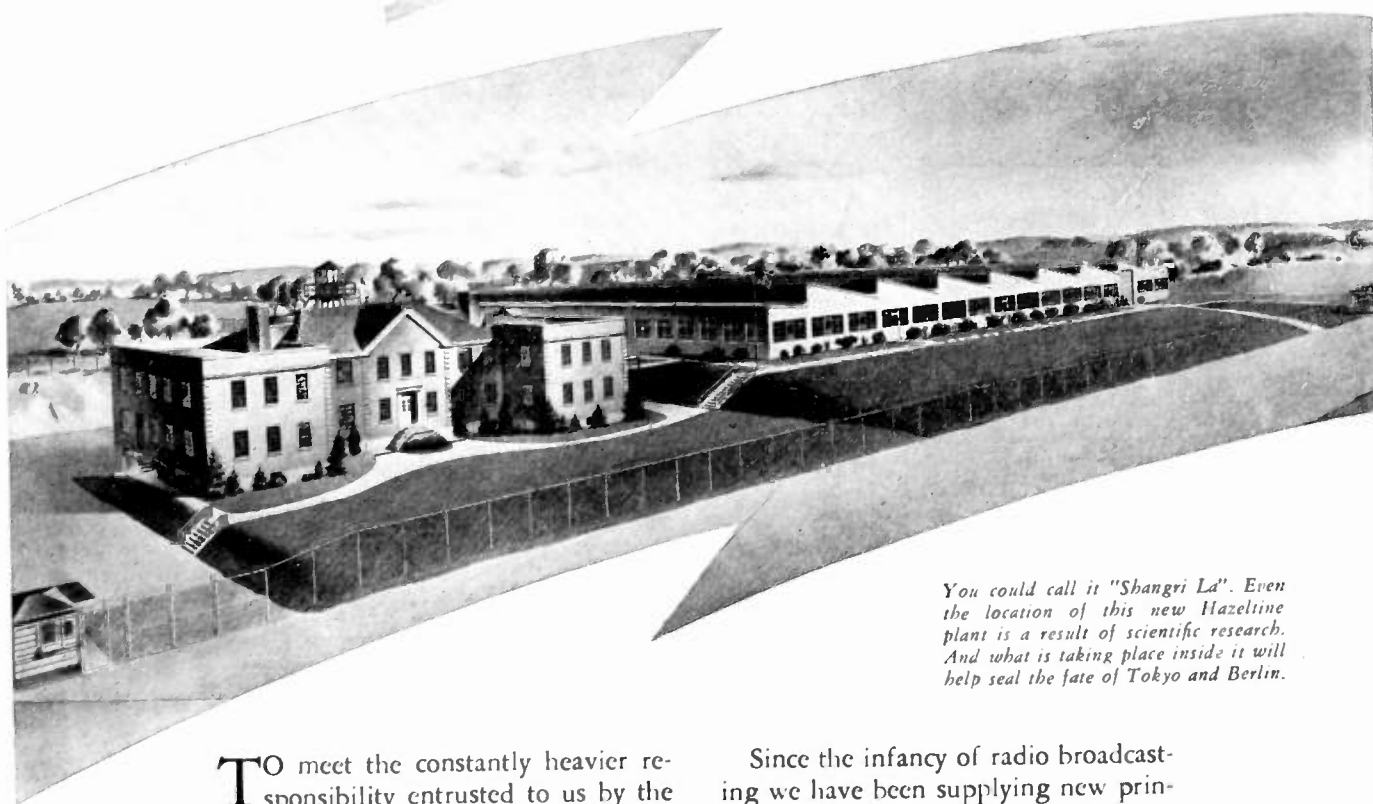

You could call it "Shangri La". Even the location of this new Hazeltine plant is a result of scientific research. And what is taking place inside it will help seal the fate of Tokyo and Berlin.

TO meet the constantly heavier responsibility entrusted to us by the Army and Navy — and ultimately to serve industry better—we at Hazeltine have enlarged all facilities for research and development in the field of electronics.

With the completion of this project it is fitting that we take the new name —HAZELTINE ELECTRONICS CORPORATION. For we are equipped in plant and personnel to undertake solution of the most complex problems in electronics.

Since the infancy of radio broadcasting we have been supplying new principles, circuits, techniques and equipment. Today, Hazeltine developments are playing a vital part in keeping the United Nations superior to the enemy.

Under the stress of war we are concentrating years of research into the space of months. When our facilities once again can be turned to peace-time use, there will be at Hazeltine a deep reservoir of knowledge and experience that can be invaluable in tomorrow's world of electronics.

HAZELTINE ELECTRONICS CORPORATION

A WHOLLY OWNED SUBSIDIARY OF THE HAZELTINE CORPORATION • 1775 BROADWAY, NEW YORK

Proceedings of the I.R.E. March, 1943

TRIPLITT

Combat Line

TESTING EQUIPMENT

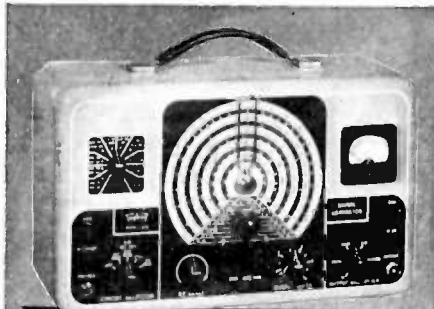

TRIPLITT

The Toughest Test in History

Miracles must be done in minutes in mechanized warfare. And Triplitt Testers, built to the needs of war, are valued tools with America's armed forces.

Here are a very few of Triplitt Combat Line Testers. There are many! Each different in adaptation to each specific purpose; unflinchingly alike in precision performance under the toughest test ever devised.

After Victory the values of Triplitt wartime experience will be evidenced by advanced technical superiority and by precision performance that might well seem miraculous today.



A WORD ABOUT DELIVERIES

Naturally deliveries are subject to necessary priority regulations. We urge prompt filing of orders for delivery as expeditiously as may be consistent with America's War effort.

TRIPLITT ELECTRICAL INSTRUMENT CO.
BLUFFTON, OHIO

Fire Prevention Requirements for Electric Radios Revised

by H. B. Smith

Associate Electrical Engineer, Underwriters' Laboratories, Inc.

Note: The following paper which is reprinted by permission from "Industrial Standardization," a publication of the American Standards Association, is of interest to radio engineers. It presents recent data on a design and production question normally requiring the engineer's consideration. THE EDITOR.



Courtesy Underwriters' Laboratories

Here, the various circuits of the internal wiring of a small portable receiver are being checked.

A FEW weeks ago, the November, 1942 edition of the Standard for Power-Operated Radio Receiving Appliances¹ of Underwriters' Laboratories, Inc., was given approval by the American Standards Association and is now a recognized American Standard. This is the sixth edition of the Standard, superseding the edition of April, 1938, and it is the third edition of the Standard which has had ASA approval.

The Standard contains the Laboratories' requirements for power-operated radio receiving appliances for non-commercial use, designed to be employed on interior wiring systems in accordance with the National Electrical Code. The requirements, in so far as they apply, cover also television receivers, non-commercial or domestic phonographs, record players, recorders, and similar equipment. Battery chargers, however, either portable or for permanent installation and not intended for use with radio appliances, are classed as rectifiers and are not covered by the requirements.

This current edition of the Radio Standard is the outgrowth of the Laboratories' experience with power-operated radio receiving appliances for about seventeen years, beginning with the examination and testing of separate A- and B-battery eliminators about 1926. Prior to that time, the radio sets in use by the general public had been crystal sets and battery-operated vacuum-tube sets which involved no hazardous connections to electricity lighting and appliance circuits. Eliminators were superseded within a year or two by power packs built into the receivers themselves, and from that time to the present practically all radio receivers have been complete and self-contained with only an external supply cord to be plugged into a convenient outlet.

The general purpose of the Standard is to serve as a guide for the manufacturers whose products have been or will be sub-

¹ American Standard for Power-Operated Radio Receiving Appliances (C65.1-1942) 25 cents.

mitted to Underwriters' Laboratories, Inc., for investigation, and for the Laboratories' engineers at the testing stations at New York, Chicago, and San Francisco where the examination and test work is done. Radio manufacturers knowing the requirements which their receivers must meet in order to be listed by the Laboratories are able to proceed with the details of design and construction, including what is frequently rather expensive equipment in the way of dies, tools, molds, etc.; and they are assured that listed receivers in competing lines will also have to meet the same requirements. With Standard requirements for reference, the Laboratories' engineers, although located at three widely separated points, are able to conduct their examination and test work with a high degree of uniformity—something which is particularly essential in work of this nature.

Reduce Fire and Accident Hazards

The Laboratories' work on radio appliances is to determine that the fire and accident hazards involved have been reduced to an acceptable degree. Accordingly, such features as the size, shape, and general appearance of a receiver or its selectivity, sensitivity, fidelity, and the various refinements of control and station selection are not investigated; and there is, therefore, practically nothing in the requirements covering these items.

The requirements call for a substantial enclosure which will house all live or current-carrying parts involving fire or accident hazard, except cords or cables. Capacitors and inductors operating at a potential obtained directly from a metallic conductive connection to the power-supply circuit and involving fire hazards are required to be housed within a complete enclosure of noncombustible material. The area of openings for ventilation or other purposes is limited. The type of flexible cord for connection to the supply circuit

(Continued on page lvi)

Sealed
AGAINST
MOISTURE



Sealed
AGAINST
DIRT, SAND
AND GRIT

MAKING EQUIPMENT THAT CALLS FOR *Sealed* VARIABLE RESISTORS?

Need Variable Resistors that will stand the gaff of operation under wet, humid, sandy, or dusty conditions?

Then it should pay to check your requirements against the Stackpole Types MG and LP units that were specifically developed for just such jobs.

Type MG Variable Resistor is designed for extremely humid or salt spray conditions, and for use where internal and external leakage must be held to a minimum. *Actually, leakage is on the order of 300 meg. after 48 hours in 95% humidity at 40° C.*

Type LP Variable Resistor, long known for its dependability, is now furnished with a dust-proof cover and effectively sealed with a special compound to the point where resistivity from current carrying parts after 48 hours of 95% relative humidity at 40° C. *is five times that of the previous open-construction units!*

Complete details gladly sent upon request.

STACKPOLE CARBON COMPANY, ST. MARYS, PENNA.

STACKPOLE MOLDED PRODUCTS

Carbon, Graphite, Metal and Composition Contacts • Brushes for all rotating equipment • Carbon Anodes • Bearings • Brazing Blocks • Electrodes • Pipe • Rheostat Plates and Discs • Welding Rods, Electrodes and Plates, etc., etc.

STACKPOLE ELECTRONIC COMPONENTS

Fixed and Variable Resistors • Iron Cores • Switches

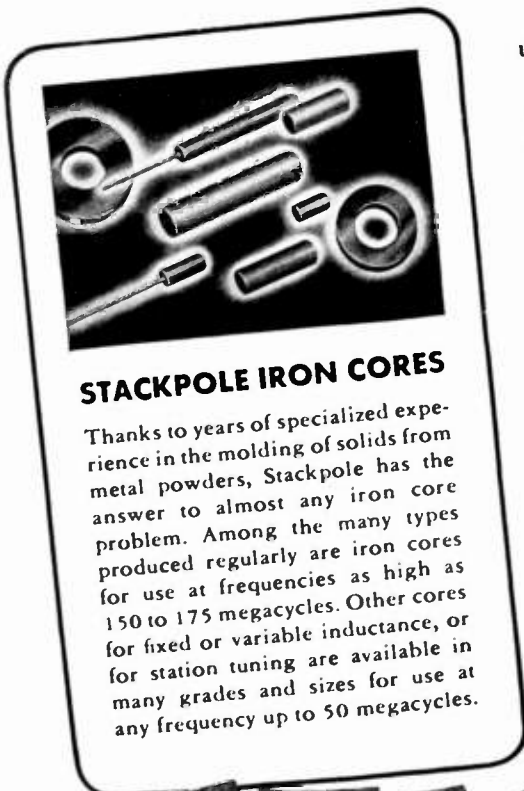

STACKPOLE IRON CORES

Thanks to years of specialized experience in the molding of solids from metal powders, Stackpole has the answer to almost any iron core problem. Among the many types produced regularly are iron cores for use at frequencies as high as 150 to 175 megacycles. Other cores for fixed or variable inductance, or for station tuning are available in many grades and sizes for use at any frequency up to 50 megacycles.

STACKPOLE

EVERYTHING IN CARBON BUT DIAMONDS

*Melting
'em
down.*

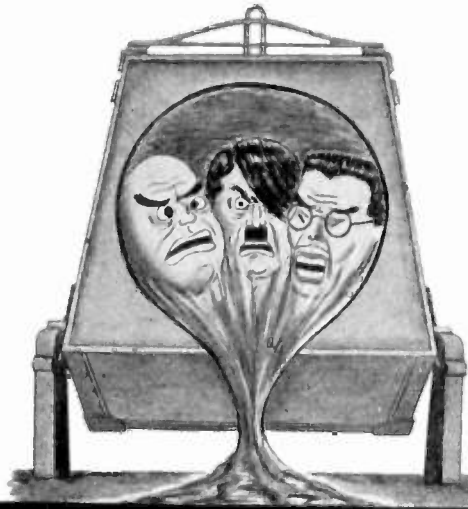

All Wilbur B. Driver Company special alloys including "BERALOY A" (beryllium-copper), "TOPHET" (nickel-chrome), and "CUPRON" (copper-nickel) are melted in our Ajax Northrup Induction Furnaces under the supervision of our Metallurgical Staff. The countless vital war applications for these alloys in rod, wire, ribbon, and strip are definitely helping to dissolve the Axis. We are literally "melting 'em down"!

WILBUR B. DRIVER CO.
NEWARK, NEW JERSEY



**RADIO AND ELECTRONIC
PARTS DELIVERED**

... Now!

FOR ALMOST a quarter of a century Lafayette has maintained quick, accurate delivery service from complete stocks—one or a thousand units, there is no order too small or too large.

ENGINEERS: Get acquainted with Lafayette's immediate delivery service—send in your order now to this ONE CENTRAL SUPPLY DEPOT for those hard to find parts—radio, electronic, or sound. Draw on the thousands of varied items now in Lafayette's stockrooms. You can depend on Lafayette quality.

FREE! 130 page illustrated CATALOG containing thousands of items indexed for quick reference—order your copy now! Address 901 W. Jackson Blvd., Chicago—Dept. 3H3.

Camera Fans: Photographic Equipment at lowest prices. Write for FREE PHOTOGRAPHIC CATALOG.

LAFAYETTE RADIO CORP.

901 W. JACKSON BLVD., CHICAGO, ILL. 265 PEACHTREE STREET, ATLANTA, GA.

Fire Prevention

(Continued from page liv)

is specified and provision is made for suitable bushings and strain relief in connection with the cord.

Materials and Devices Must Comply with Requirements

The various materials used are required to be products which are recognized as suitable for the particular application; and accessories such as receptacles, lamp-holders, switches, etc., are required to be devices which comply with the Laboratories' requirements for those classes. Capacitors are required to present no undue fire or accident hazard. Substantial transformers with impregnated coils are specified, and definite limitations are placed upon the ventilating openings in transformer enclosures. Appropriate insulated conductors are required for all interior wiring, and spacings throughout a receiver are specified. Special attention is given to the accessibility and hazards of live parts. Fire and accident hazards are defined and provisions are made for the reduction of these hazards to an acceptable degree.

The complete investigation of a radio receiver consists of a careful examination of construction details to determine that the appliance complies with the above-mentioned requirements, and a comprehensive test program designed to insure the safe operation of the receiver under the conditions of actual service—including some of the abnormal conditions which are likely to obtain.

To Be Checked by Tests

The features which are checked by means of tests include:

Power Consumption—A determination of wattage input, to insure that the power required to operate a receiver is not more than 5 per cent in excess of the marked rating on the appliance.

Leakage Currents—A determination of the currents which may flow from exposed or partially protected live parts. Such leakage currents are required to be held within safe limits.

Temperature—Operation of a receiver under normal conditions to determine that specified temperature limits on various materials and parts are not exceeded. Temperatures high enough to present any fire hazard and temperatures which would result in the deterioration of insulation or other essential nonmetallic material are not considered to be acceptable.

Dielectric Strength—A comprehensive check on the adequacy of the insulation and spacings throughout a receiver, with particular reference to the factor of safety over the potentials normally existing at various points.

Strain Relief—A 35-pound test on supply cords.

Abnormal Operation—Special tests on parts which are normally operated for limited periods of time, but which may be operated continuously under abnormal conditions. Pull-out tests on separable connectors. Short circuit tests on capacitors and cables.

(Continued on page lviii)

PROVEN UNDER FIRE

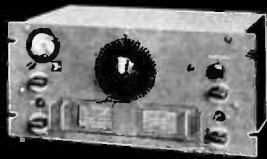

National Radio Equipment, designed for peacetime use, is proving out in the hardest tests of war. Receivers and parts that look familiar to any Ham are coming off our lines in steadily increasing quantities to serve in combat communications. National takes especial pride that war brought no sudden redesign of our products.

Just as in peacetime, our equipment was tailored to serve the amateur, so now the same basic designs have been modified to meet the specialized needs of United Nations fighting men. As in peacetime, National designs are being steadily improved, but under the pressure of war, years of research and development are being telescoped into months.

There are many technical developments that we wish we could tell you about now. When the war is won, you will be able to see them in the finest equipment National has ever built.



NATIONAL COMPANY, INC., MALDEN, MASS.



OFFICIAL U. S. NAVY PHOTOGRAPH

LONGER LIVES...

FOR MEN AND EQUIPMENT

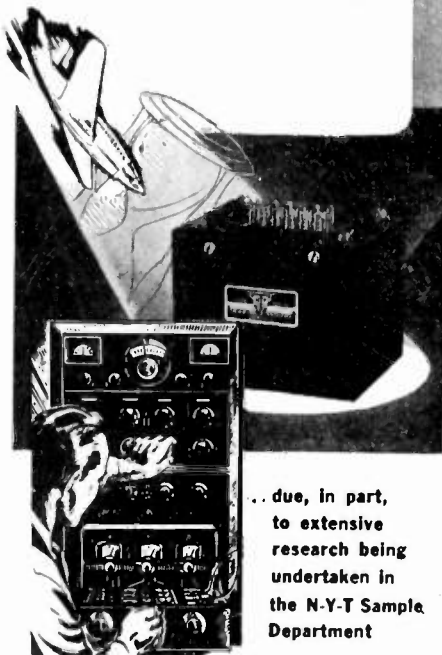

... due, in part, to extensive research being undertaken in the N-Y-T Sample Department

THE development of new-type transformers to diversified and extremely critical specifications . . . their perfection for accurate and dependable functioning under varying operating conditions . . . mechanical and dimensional designing to meet physical limitations of the applications—all these make up the work of the N-Y-T Sample Department. And all are tremendously important in safeguarding our Armed Forces, and increasing the life-span of their machines and equipment.

The N-Y-T Sample Department is prepared to give immediate consideration to your special problems and make deliveries within a matter of days. Send us your inquiries.

NEW YORK TRANSFORMER COMPANY



24-26 WAVERLY PLACE NEW YORK, N. Y.

lviii

Fire Prevention

(Continued from page lvi)

New Features in Revised Edition

Among the new features of the revised edition of the Standard are the following paragraphs relating to shock hazard, and a description and wiring diagram of a device with provision for input, line, and meter connections which has been found to be suitable for determining compliance of a radio receiver with the new requirements for voltages and corresponding leakage currents at exposed or partially protected live parts.

A current-carrying part which involves shock or fire hazard shall be spaced or otherwise suitably insulated for the voltage involved and suitably protected for the expected service.

Shock hazard shall be considered to exist at a live part in a circuit involving a potential of 125 volts or less in the following cases:

(A) At an exposed live part, if the open-circuit potential is more than 25 volts and the current with a 1500-ohm load is more than 5 milliamperes.

(B) At a partially protected live part, except as noted in paragraph 75, if the open-circuit potential is more than 35 volts and if the current with a 1500-ohm load is more than 15 milliamperes, with a maximum allowable A-C component of 10 milliamperes in any case.

A—Terminals for the connection of a 120-volt A-C supply circuit.

C—0.5 mf paper capacitor.

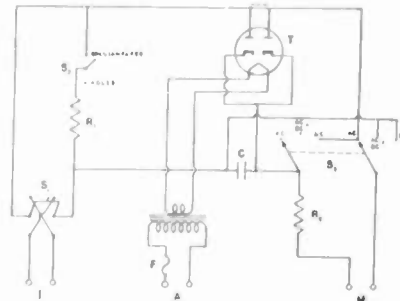

F—Fuse in the transformer primary circuit.

I—Terminals for input connection from the appliance under test.

M—Terminals for the connection of a meter having a full-scale deflection of 100 microamperes.

R₁—1500-ohm resistor.

R₂—2,121,000-ohm resistor.

S₁—Reversing switch (two-pole, double throw).

S₂—Single-pole switch (may be double-throw) with settings for reading volts or milliamperes on the meter.

S₃—Two-pole, three-point selector switch with settings for reading AC, DC, or AC+DC on the meter.

T—Twin-diode tube, No. 6H6.

For AC plus DC—Throw the reversing

(Continued on page lx)

HT-4B

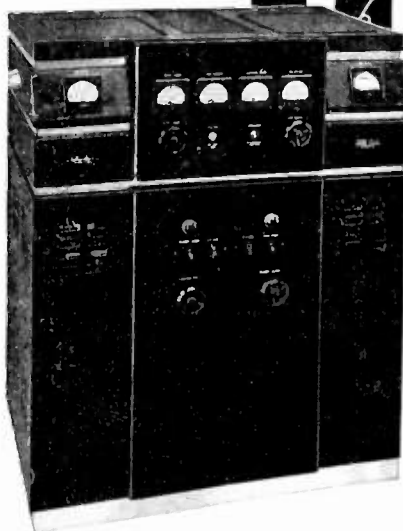

HERE is that high-powered rig you have always wanted to own . . . one that you can depend upon for peak operating efficiency. Hallicrafters have built into the HT-4B the resultant experience from years of engineering research.

Model HT-4B delivers a carrier output of 325 watts on phone and 450 watts on CW. The preamplifier supplied with the transmitter can be mounted conveniently at the operating position, controlling volume, keying and standby . . . once adjusted to any band the rig may be operated remotely.

When, once again, we are permitted to sell communications equipment for civilian use—your HT-4B will be waiting for you.

hallicrafters

CHICAGO, U. S. A.

World's largest exclusive manufacturer of short wave radio communications equipment.



Proceedings of the I.R.E.

March, 1943

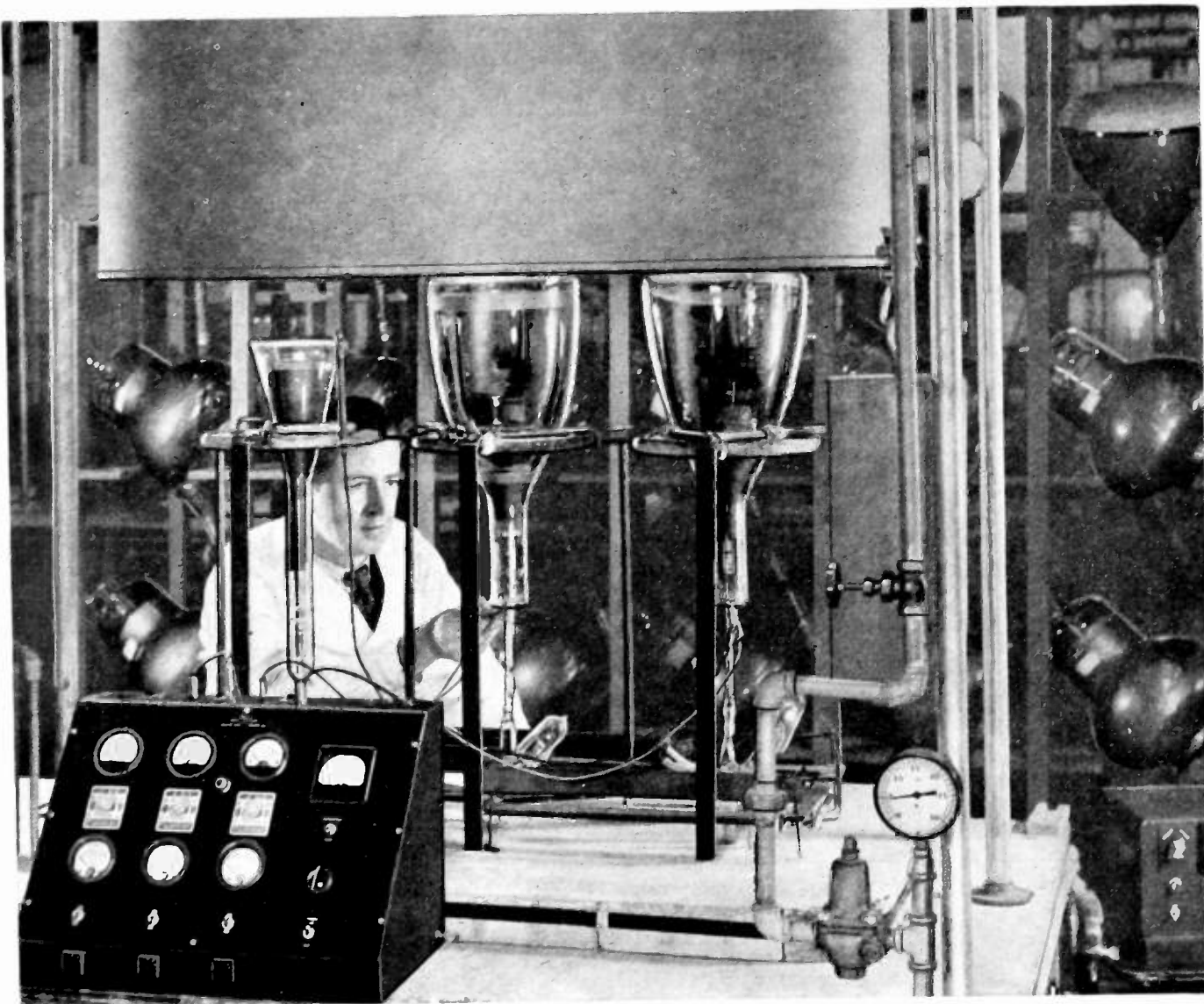

Electronic "brains" made to order

Electronic energy . . . that powerful, mystifying force, is being directed into highly useful channels at RAULAND laboratories. RAULAND engineers, with a background of years devoted to the development of specialized electronic devices, culminating, for example, in the high power cathode ray tube for large screen television, are performing modern miracles. Unlike the familiar radio tube, cathode ray tubes which harness this class of electronic power, cannot be made in mass production. Each is

designed for a special application . . . sizes and shapes varying greatly, depending upon the particular job for which each is "tailor-made."

Research-physicists, engineers and craftsmen at RAULAND are proud that their cathode ray tubes and

similar special electronic tube types are contributing so much to the advancement of *Communications* for our armed forces . . . that their present efforts promise also great benefits to human welfare when war is done.

• *Electroneering* is our business •

Rauland

RADIO — SOUND — COMMUNICATIONS
The Rauland Corporation . . Chicago, Illinois

Buy War Bonds and Stamps! Rauland employees are all investing 10% of their incomes in War Bonds.



ACCURATE • PRECISION BUILT • RELIABLE
BLILEY ELECTRIC COMPANY
 ERIE, PENNSYLVANIA

Fire Prevention

(Continued from page lviii)

switch, S_1 to the position which gives the maximum reading.

- (a) For current, the reading is in milliamperes (rms of the sine wave or 0.707 times the peak of the complex wave),
- (b) For potential in volts, multiply the reading by 1.5 (rms of the sine wave or 0.707 times the peak of the complex wave).

For AC Only—The meter readings are the same as (a) and (b). If different readings are obtained using both positions of the reversing switch, the average of the two readings is to be taken.

For DC Only

- (c) For current in milliamperes, multiply by the reading 1.414.
- (d) For potential in volts, multiply the reading by 2.12.

At the present time, in accordance with the orders of the War Production Board, there is no production of radio receiving appliances for civilian domestic use. The Standard does not cover commercial or military radio equipment, and there is, therefore, practically nothing being made at this particular time which is judged under the requirements. The Standard has, however, been carefully studied by all the manufacturers of listed power-operated radio receiving appliances and reviewed by others known to have an interest in the subject; and in its up-to-date form will be available for use by the Laboratories, the manufacturers, and others concerned as soon as the present war emergency is over.

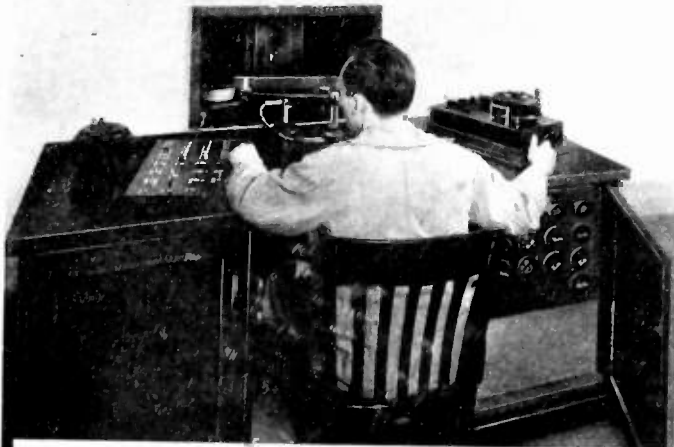

To maintain a high degree of uniform magnetic quality and precision, Arnold engineers use The High H Permeameter (illustrated)... a duplicate of the Permeameter in use at the National Bureau of Standards... just one example of the close magnetic control under which the Arnold magnets are manufactured.

All ALNICO types of Permanent Magnets... including ALNICO V... are completely fabricated in the Arnold plant under exacting metallurgical, mechanical and magnetic control.

Arnold engineers are available to solve your magnetic design problems... all inquiries will receive prompt attention.

PRODUCERS OF MAGNETS FOR AIRCRAFT, MARINE, RADIO, ELECTRICAL AND OTHER TYPES OF MEASURING INSTRUMENTS

... the Highest Standard in Magnetic Measurements



★
 FOR VICTORY
 ... invest at
 least 10% in
 War Bonds.
 ★

THE ARNOLD ENGINEERING COMPANY

147 EAST ONTARIO STREET • CHICAGO, ILLINOIS

Helping Speed the Liberty Fleet Off the Ways and On the Way...



... Awarded the Maritime M "for Outstanding
Development and Production of Radio Equipment"

The new Liberty Ship radio
Developed for The Maritime Commission
By I. T. & T.'s manufacturing associate
Federal Telephone and Radio Corporation
Is helping save the manpower hours
That build our bridge of ships.

Not eight or ten separate parts
But *one*

Compact, all-in-one
Radiotelegraph Unit—
Takes care of
Both sending and receiving.

Installed in one-fifth the time
Normally required—
Ready to plug in and tune in—
It is freeing skilled craftsmen
For other vital jobs.

In recognition of
"Outstanding performance
In the development and production
Of radio equipment"

The Maritime Commission has awarded
Federal Telephone and Radio Corporation
The Maritime "M" Pennant
The Victory Fleet Flag
And Maritime Merit Badges.

Federal Telephone and Radio Corporation

General Offices: 200 Mt. Pleasant Avenue, Newark, N. J.

AN **I T & T** ASSOCIATE



Proving ground for the future of electronics

On the battlefields, electronics is meeting its extreme test. Failure here means death to men, defeat to armies. Conversely, experience here means vastly broadened knowledge, improved techniques, and progress so rapid as

to be impossible of description.

The collective brains of Eimac engineers are concentrated full tilt on the new knowledge which is coming out of this holocaust. And are consequently still setting the pace in vacuum tube de-

velopments. The fruits of their efforts are going directly to Uncle Sam and our Allies to play a vital role in the war.

When the fighting stops you'll find Eimac still the pre-eminent choice of engineers throughout the world.

Army-Navy "E" awarded for high achievement in production for war.

Follow the leaders to



Eimac
TUBES

EITEL-McCULLOUGH, INC.
SAN BRUNO · CALIFORNIA · U.S.A.

Export Agents: FRAZAR & CO., LTD.
201 Front Street, San Francisco, California, U.S.A.



the order
must get
through
QUICKLY!

Today, time isn't the methodical ticking away of the minutes and hours. Today, time is LIFE — life which is often absolutely dependent on the split-second accuracy and unfailing reliability of communications in action. We have made it our responsibility to provide capacitors that you can depend on, no matter how tough the operating conditions might be. We can do this because 33 years of invaluable experience goes into the making of every C-D capacitor. Cornell-Dubilier Electric Corporation, South Plainfield, New Jersey.

MORE IN USE TODAY THAN ANY OTHER MAKE

Cornell-Dubilier
capacitors

Mica • Dykanol • Paper • Wet & Dry Electrolytics



**CYLINDRICAL FILTER CAPACITORS
TYPE TQ**

The type TQ Dykanol Filter Capacitors are supplied with two insulated terminals and universal mounting bracket for mounting either above or below subpanel assembly. These units are ideally suited for high power amplifying systems, where utmost dependability is essential and space limitations are severe. Check these unusual features. Impregnated and filled with Dykanol, the non-inflammable chlorinated diphenyl impregnant, of outstanding dielectric characteristics.

Dried, impregnated and filled under continuous vacuum and then hermetically sealed.

Glazed porcelain or bakelite terminal insulators—according voltage rating of unit.

Rigidly tested and conservatively rated. Will safely operate at 10% overloading.

The type TQ Dykanol capacitors and others in the complete C-D line are described in Catalog No. 160T now available.



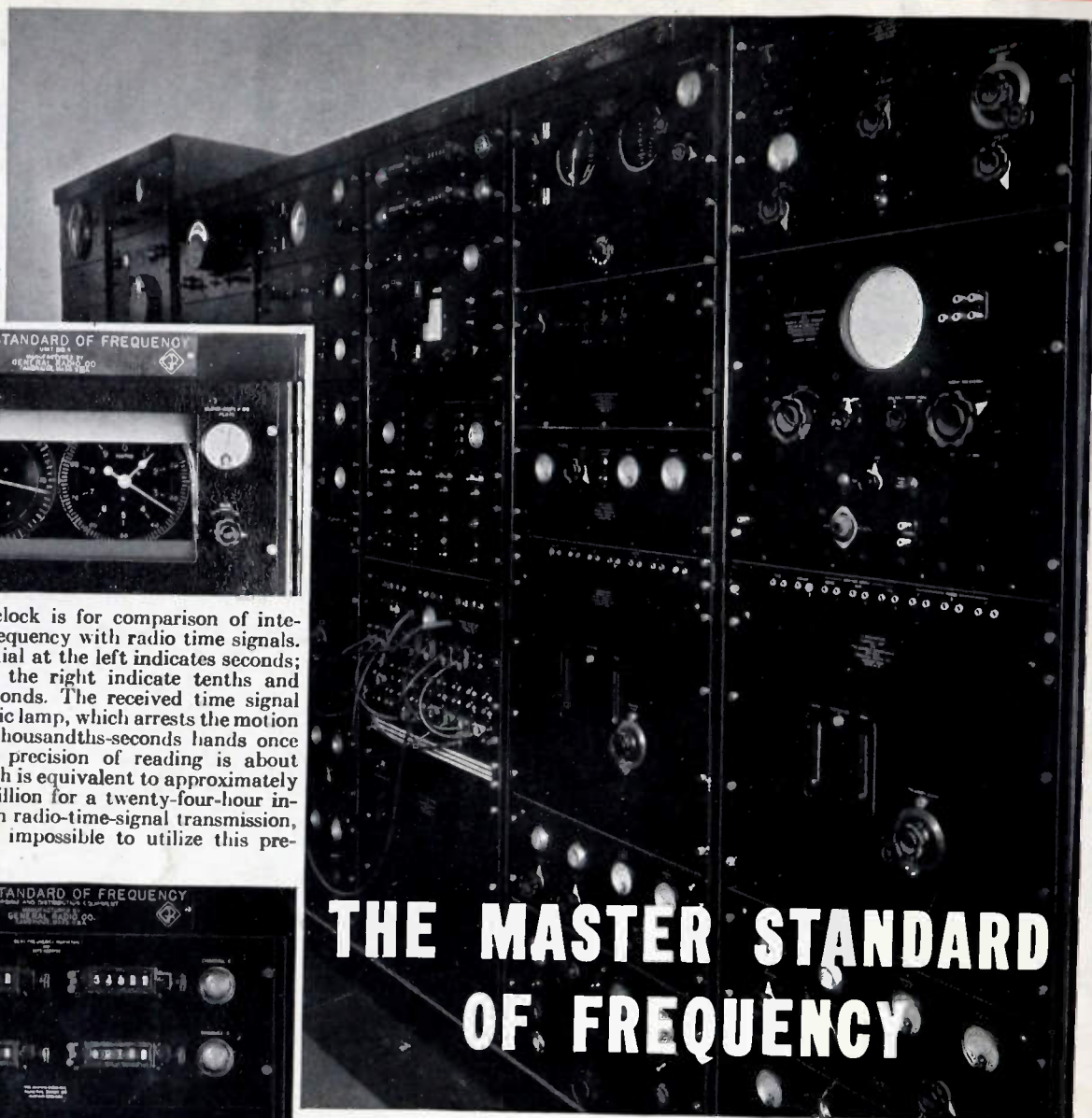

THE MASTER STANDARD OF FREQUENCY

Nearly twenty years ago, the General Radio Company started a program of research and development in the field of frequency standardization, which has produced many general-purpose and specialized frequency measuring instruments for the world's civil and military communication systems.

The center of this research program is the master primary standard of frequency shown here, which supplies standard frequencies for the calibration of General Radio instruments and for measurements in the General Radio laboratories. Consisting of five quartz-crystal-controlled oscillators, with means for timing and inter-comparing their frequencies, this standard is far more accurate than present-day commercial requirements. In addition to the frequency standard itself, the racks shown in the photograph include experimental equipment in which new circuits and methods are proved before their incorporation into commercial instruments.

To implement the production of military radio equipment, General Radio frequency measuring instruments are now more important than ever before. Their continued reliability and accuracy are assured by this master standard and the unceasing research program associated with it.



The stroboscopic clock is for comparison of integrated oscillator frequency with radio time signals. The hand on the dial at the left indicates seconds; the two hands at the right indicate tenths and thousandths of seconds. The received time signal flashes a stroboscopic lamp, which arrests the motion of the tenth- and thousandths-seconds hands once each second. The precision of reading is about 0.0002 second, which is equivalent to approximately two parts in one billion for a twenty-four-hour interval. Variations in radio-time-signal transmission, of course, make it impossible to utilize this precision completely.

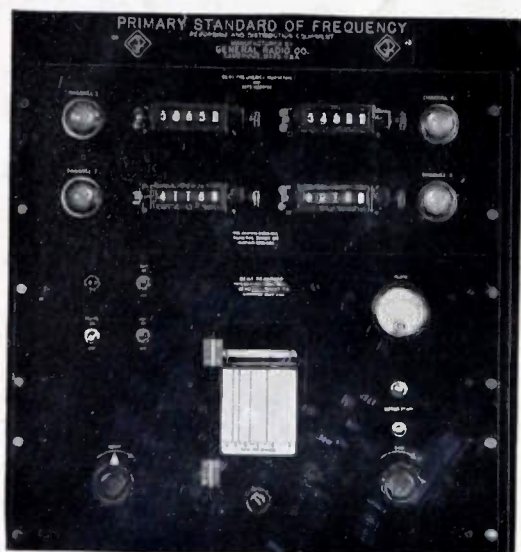

Note the recording panels which show the beats between pairs of oscillators. The deviation from a vertical line is a measure of the variation in frequency of one oscillator with respect to the other, as indicated by the scale at the bottom of the chart. The precision of reading can be increased or decreased if desired. Beats are recorded between each of four oscillators and a common reference oscillator. If all beat records show identical deviations, the reference oscillator is drifting, while if only one line deviates, the drift is in the oscillator being measured.

Above the recorder are counters which indicate the time in seconds for a predetermined number of beats.



GENERAL RADIO COMPANY · Cambridge, Massachusetts