

# Proceedings

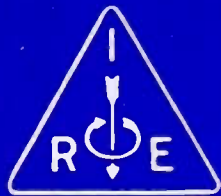

*of the*

# I·R·E



ARTHUR VAN DYCK  
President, 1942



LYNDE P. WHEELER  
President, 1943

## JANUARY 1943

VOLUME 31 NUMBER 1

Problems in Television Sound  
Synchronization in Television  
Receivers

Emergency Power Plants

Architectural Acoustics

Frequency-Modulated Oscillator

Voltage- and Current-Feedback  
Amplifiers

Coupled Resonant Circuits

Postwar-Radio Planning

I.R.E. and the War

# Institute of Radio Engineers

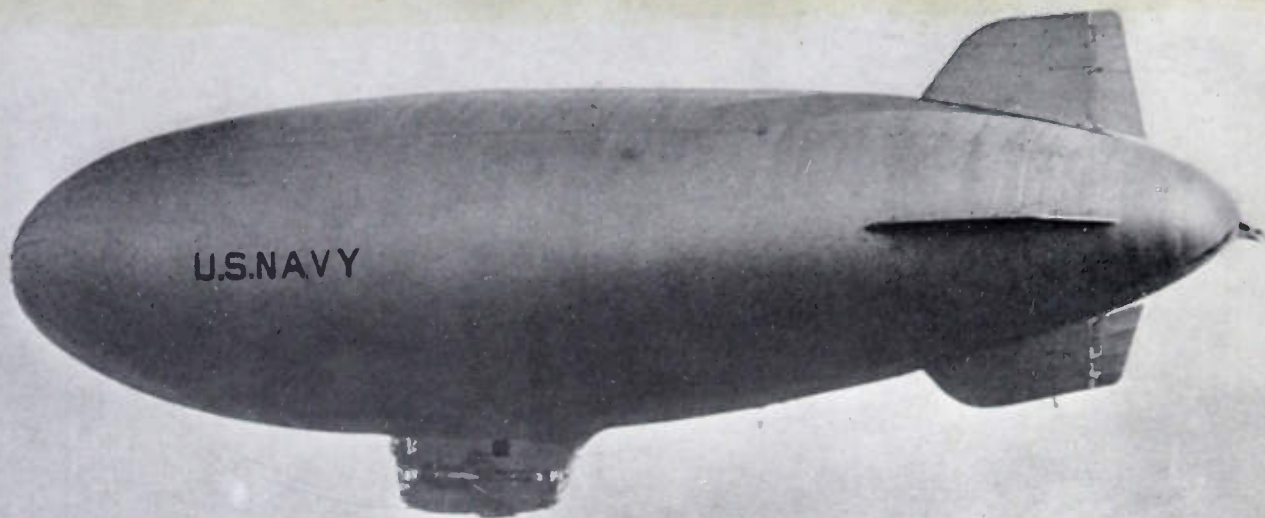

U. S. NAVY OFFICIAL PHOTO

**MILITARY today — INDUSTRIAL tomorrow**



AMPEREX Electronic Tubes are incorporated in vital protective equipment serving an alert convoy system speeding vital materials over vast and dangerous distances.

And AMPEREX, now building for battle, is working steadfastly to produce electronic tube designs with highly important military significance. Coincidentally, we are contributing, in these same wartime engineering advancements, to the myriad of practical industrial applications which are already evident . . . for tomorrow.

**AMPEREX ELECTRONIC PRODUCTS**  
79 WASHINGTON STREET  
BROOKLYN, NEW YORK

BOARD OF DIRECTORS  
1942

Arthur F. Van Dyck, *President*  
Walter A. Rush, *Vice President*  
Haraden Pratt, *Treasurer*  
Harold P. Westman, *Secretary*  
Alfred N. Goldsmith, *Editor*  
Austin Bailey  
Adolph B. Chamberlain  
Carl C. Chambers  
Ivan S. Coggeshall  
William L. Everitt  
Harold T. Friis  
O. B. Hanson  
Lawrence C. F. Horle  
C. M. Jansky, Jr.  
J. Kelly Johnson  
Frederick B. Llewellyn  
Frederick E. Terman  
Browder J. Thompson  
Hubert M. Turner  
Harold A. Wheeler  
Lynde P. Wheeler

Harold R. Zeamans,  
*General Counsel*

BOARD OF EDITORS

Alfred N. Goldsmith, *Editor*  
Ralph R. Batcher  
Lloyd V. Berkner  
Philip S. Carter  
Lewis M. Clement  
Elmer W. Engstrom  
William L. Everitt  
Peter C. Goldmark  
Frederick W. Grover  
C. M. Jansky, Jr.  
John D. Kraus  
Frederick B. Llewellyn  
Samuel S. Mackeown  
Edward L. Nelson  
Harry F. Olson  
Greenleaf W. Pickard  
Haraden Pratt  
Conan A. Priest  
Leon J. Sivian  
Lynne C. Smeby  
Browder J. Thompson  
Harold A. Wheeler  
Lynde P. Wheeler  
Laurens E. Whittemore  
Gerald W. Willard  
William Wilson  
Charles J. Young

Helen M. Stote, *Assistant Editor*  
William C. Copp,  
*Advertising Manager*  
William B. Cowlich,  
*Assistant Secretary*

# Proceedings

## of the I·R·E

*Published Monthly by*  
The Institute of Radio Engineers, Inc.

VOLUME 31

*January, 1943*

NUMBER 1

Radio-and-Electronic Engineers.....	Alfred N. Goldsmith	1
Section Meetings.....		2
Contemporary Problems in Television Sound.....	C. L. Townsend	3
Automatic Frequency and Phase Control of Synchron- ization in Television Receivers.....	K. R. Wendt and G. L. Fredendall	7
Engine-Driven Emergency Power Plants.....	Karl Troeglen	15
Selected Problems in Architectural Acoustics.....	M. Rettinger	18
A Frequency-Modulated Resistance-Capacitance Oscil- lator.....	C.-K. Chang	22
Comparison of Voltage- and Current-Feedback Ampli- fiers.....	E. H. Schulz	25
Coupled Resonant Circuits for Transmitters.....	N. I. Korman	28
Postwar-Radio Planning.....	James Lawrence Fly	33
I.R.E. and the War.....	Arthur Van Dyck	36
Correction to "Theory of Antennas of Arbitrary Size and Shape," by S. A. Schelkunoff.....		38
Institute News and Radio Notes.....		39
Winter Conferences—1943.....		39
Board of Directors.....		41
Executive Committee.....		41
Books:		
"Mathematics for Electricians and Radiomen," by Nelson M. Cooke.....	H. M. Turner	41
"Rhombic Antenna Design," by A. E. Harper.....	H. O. Peterson	42
"The Radio Amateur's Handbook, Special De- fense Edition," published by the American Radio Relay League.....	H. O. Peterson	42
"Acoustics of Music," by Wilmer T. Bartholo- mew.....	Benjamin Olney	42
Contributors.....		43

Responsibility for the contents of papers published in the PROCEEDINGS rests upon the authors. Statements made in papers are not binding on the Institute or its members.



Entered as second-class matter October 26, 1927, at the post office at Menasha, Wisconsin, under the Act of February 28, 1925, embodied in Paragraph 4, Section 538 of the Postal Laws and Regulations. Publication office, 450 Alnaip Street, Menasha, Wisconsin. Editorial and advertising offices, 310 West 42nd St., New York, N. Y. Subscription \$10.00 per year; foreign, \$11.00.

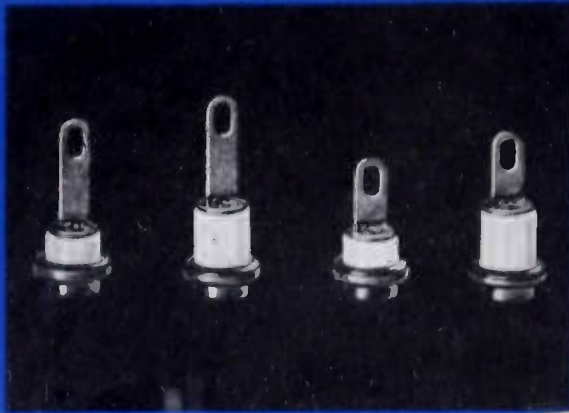

## METAL-AND-STEATITE ASSEMBLIES FURNISHED BY ISOLANTITE

*release production facilities  
and personnel for major  
assembly jobs*

It is the countless minor assembly operations that add to the cost and delay the production of war equipment. By turning over to Isolantite Inc., for assembly, the parts in which steatite is combined with metal in various forms, you release needed production facilities and skilled hands for major assembly tasks. The ability of Isolantite to furnish assemblies that meet the most exacting demands is a matter of record.

In addition to speeding war production, such assemblies give you all the advantages of Isolantite\*. Among these

are the extremely close dimensional tolerances Isolantite's manufacturing processes permit... its adaptability to the production of intricate shapes... and a uniformity of product, high mechanical strength, electrical efficiency and non-absorption of moisture which contribute greatly to dependable insulation performance.

If you have a problem in production that is vital to Victory, Isolantite-furnished assemblies might help solve it. War equipment manufacturers taking advantage of this unique service enjoy the benefits of Isolantite high-grade insulation at the same time that they ease the burden of war production.

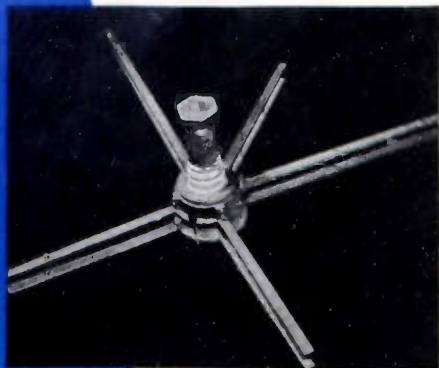

# ISOLANTITE

**CERAMIC INSULATORS**  
ISOLANTITE INC., BELLEVILLE, NEW JERSEY

\*Registered trade-name for the products of Isolantite Inc.

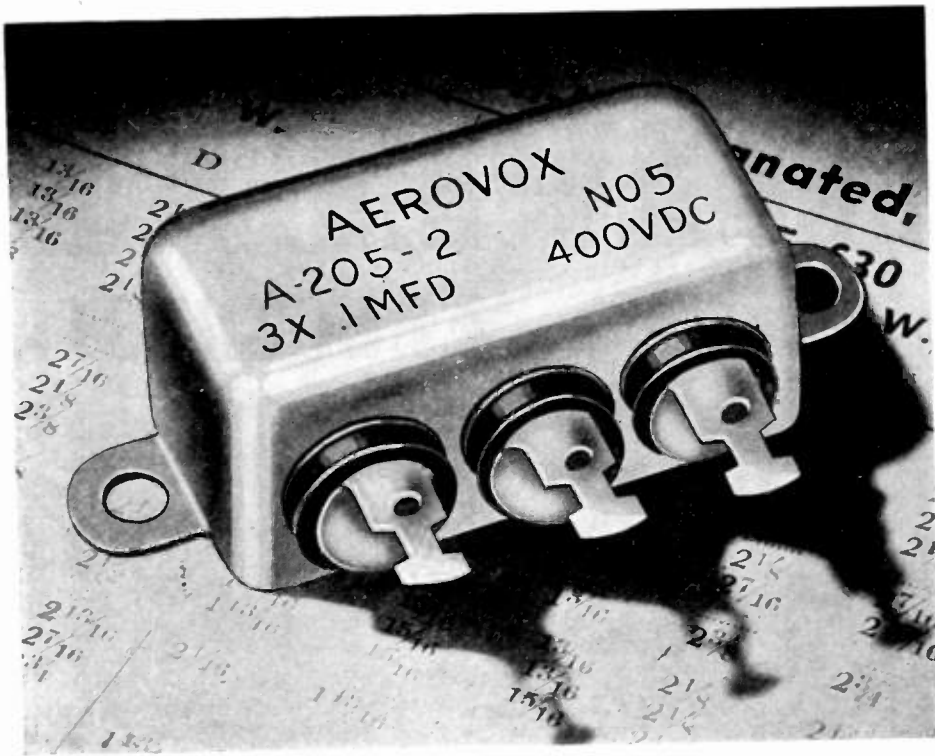

"Bathtubs" available in 400, 600 and 1000 v. D.C.W. .05 to 2 mfd.; .05-.05 to 1.0-1.0 mfd.; .05-.05-.05 to .25-.25-.25 mfd.

For upright or inverted mounting, there are Types 16 and 18 oil-filled capacitors in rectangular metal cases. Hermetically-sealed. Immersion-proof terminals. 400 to 1000 v. Single, dual and triple sections.

There are the round-can adjustable-mounting-ring Type 40 oil-filled units. 400 and 600 v. D.C.W. Single, dual and triple section.

Several high-voltage transmitting capacitors, including the giant Series 20 for operating voltages up to 50,000.

## OIL-FILLED METAL-CASE "Bathtubs"

Compact superior-grade capacitors. Designed for applications in severe-service apparatus such as aircraft, police and broadcast radio, p.-a., and similar equipment. Non-inductive type, oil-filled and oil impregnated. Container is one-piece drawn-metal case with soldered bottom plate. Aerovox-designed "double rubber bakelite" terminal insulators are permanently riveted to case, making a sturdy, absolutely immersion-proof terminal assembly.

*Ask for Catalog . . .*

These "bathtubs," along with other heavy-duty capacitors, are listed in the Aerovox Transmitting Capacitor Catalog, to be released soon. Write on your business letterhead to reserve your registered copy.

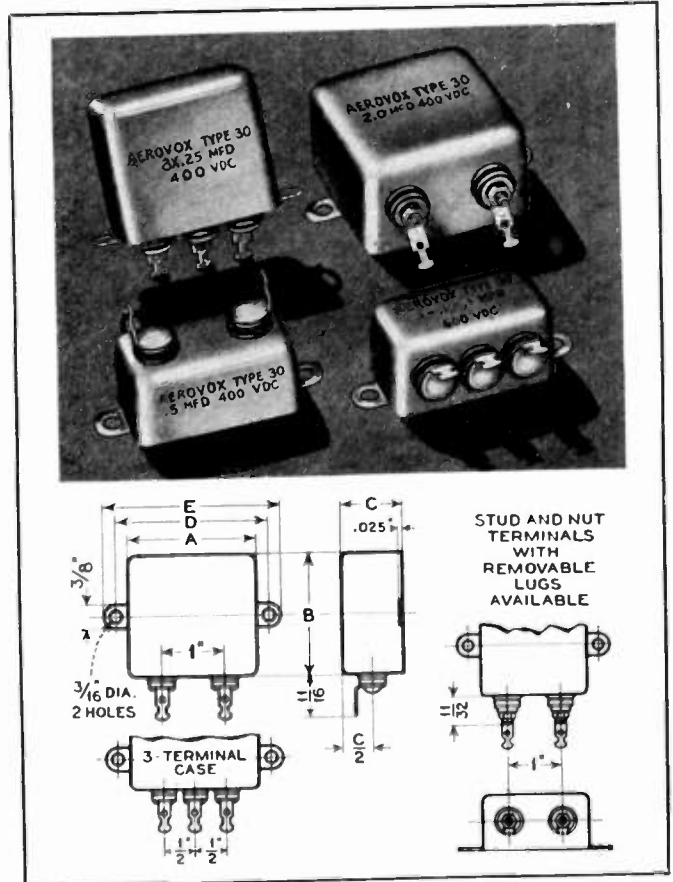

STUD AND NUT  
TERMINALS  
WITH  
REMOVABLE  
LUGS  
AVAILABLE

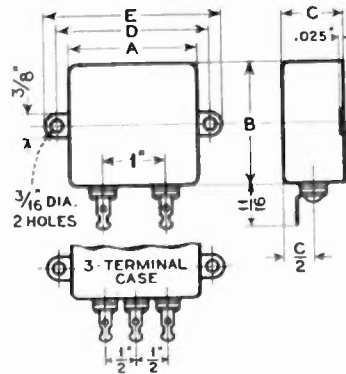

NEW BEDFORD, MASS.,  
U. S. A.  
Sales Offices in All  
Principal Cities

# AEROVOX

CORPORATION



In Canada  
AEROVOX CANADA LTD.  
Hamilton, Ont.  
EXPORT: 100 Varick St., N. Y.  
Cable 'ARLAB'

# The **TRIPL**ETT ELECTRICAL



*Passing*

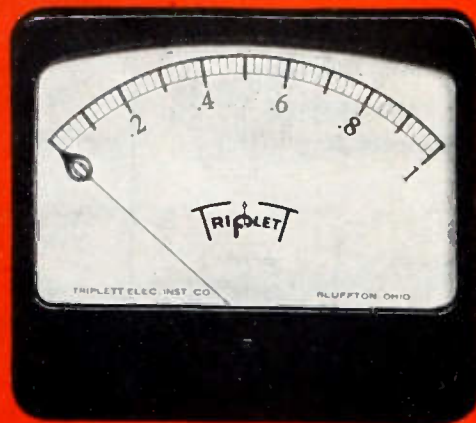
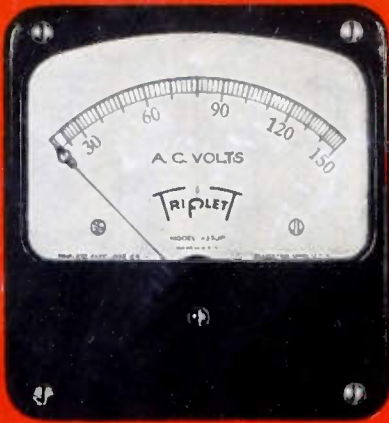

## THE TRIPL

ETT ELECTRICAL INSTRUMENT CO.

### A WORD ABOUT DELIVERIES

Naturally deliveries are subject to necessary priority regulations. We urge prompt filing of orders for delivery as may be consistent with America's War effort.

# Combat Line

## MEASURING INSTRUMENTS



### *in Review*

**A Glimpse into the Future**

Out of the needs of war; out of tripled production lines and twenty-four hour days; out of the drive for "better performance under spectacular stress and vibration," comes Triplet precision instruments in volumes impossible by now outmoded peacetime methods. Today our country's needs come first—Tomorrow when America again takes up peacetime pursuits, the values of these experiences will be apparent, in savings, in performance, in technical superiority beyond the concepts of yesterday.

**BLUFFTON, OHIO** ★ ★ ★ ★

**TRIPLET**

## "AN URGENT CALL FOR YOU"

*"Please do not make Long Distance telephone calls to war-busy centers unless it is really necessary."*

That helps keep the lines open for war messages and war's on the wires these days. When we can get telephone materials again we'll give you all the wires you desire. Many thanks.

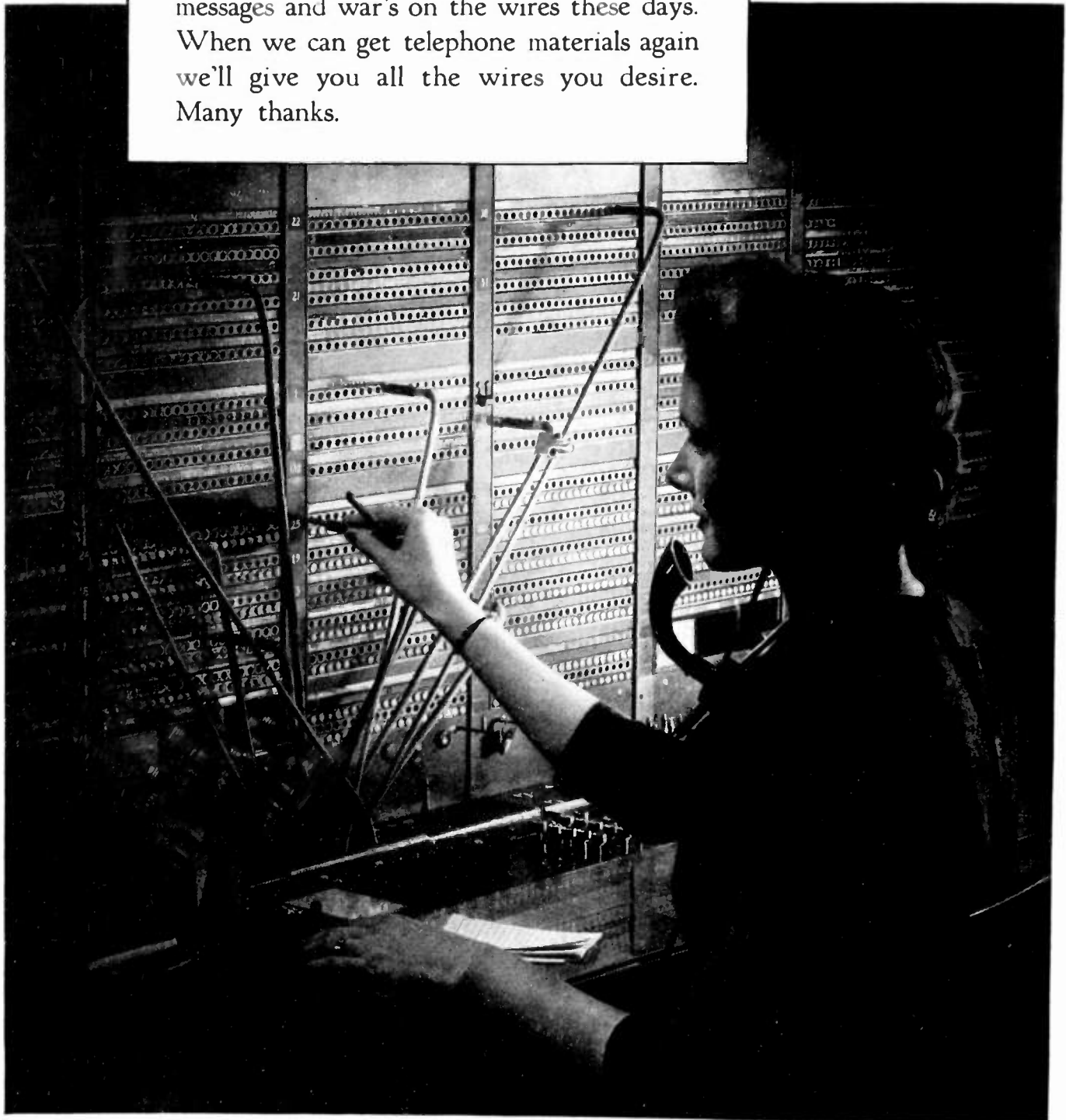

BELL TELEPHONE SYSTEM







**SWITCHES**

to fit your  
circuit and space requirements



## **NOTHING TO A GREMLIN—** *with dependable Utah Switches*

**T**HOSE mischief-making, invisible little creatures, known among the RAF as Gremlins, can't stir up trouble where Utah Switches are concerned. Like other Utah-Carter parts, Utah Switches are built to give dependable performance—and have proved themselves in hundreds of electrical operations.

Compact size, highest quality and economical price are combined in Utah "Imp" push-button switches. They have the finest nickel silver or phosphorous

bronze springs with integral contacts. Springs are fully insulated in the mounting, bushing and shaft—have high grade phenolic insulation. They are available in three circuit arrangements: "Single-Make"—"Single-Break"—one "Break-Make."

Also available are Utah-Carter Rotary and Push-Button Jack switches, in long and short types. Small and compact in size, they are made to take minimum panel size. Full insulation is provided for all electrical parts. Write today for full details.

**UTAH VITREOUS ENAMEL RESISTORS**—from 5 to 200 watts, they are available either as fixed—tapped or adjustable. Also non-inductive types.

**UTAH JACKS**—long and short frame and "Imp" type jacks to meet your requirements. Special Utah jacks to meet Navy and Signal Corps specifications.

**UTAH PHONE PLUGS**—two or three conductor types—for practically every type of application.

**UTAH TRANSFORMERS** are fully guaranteed. Able to meet the requirements in choke, input, output and smaller capacity power transformers.

# **UTAH RADIO PRODUCTS COMPANY**

*General Offices and Factory*

**842 ORLEANS STREET**

**CHICAGO, ILLINOIS**

# Preview

## OF TRIPLE CHECKED ACCURACY

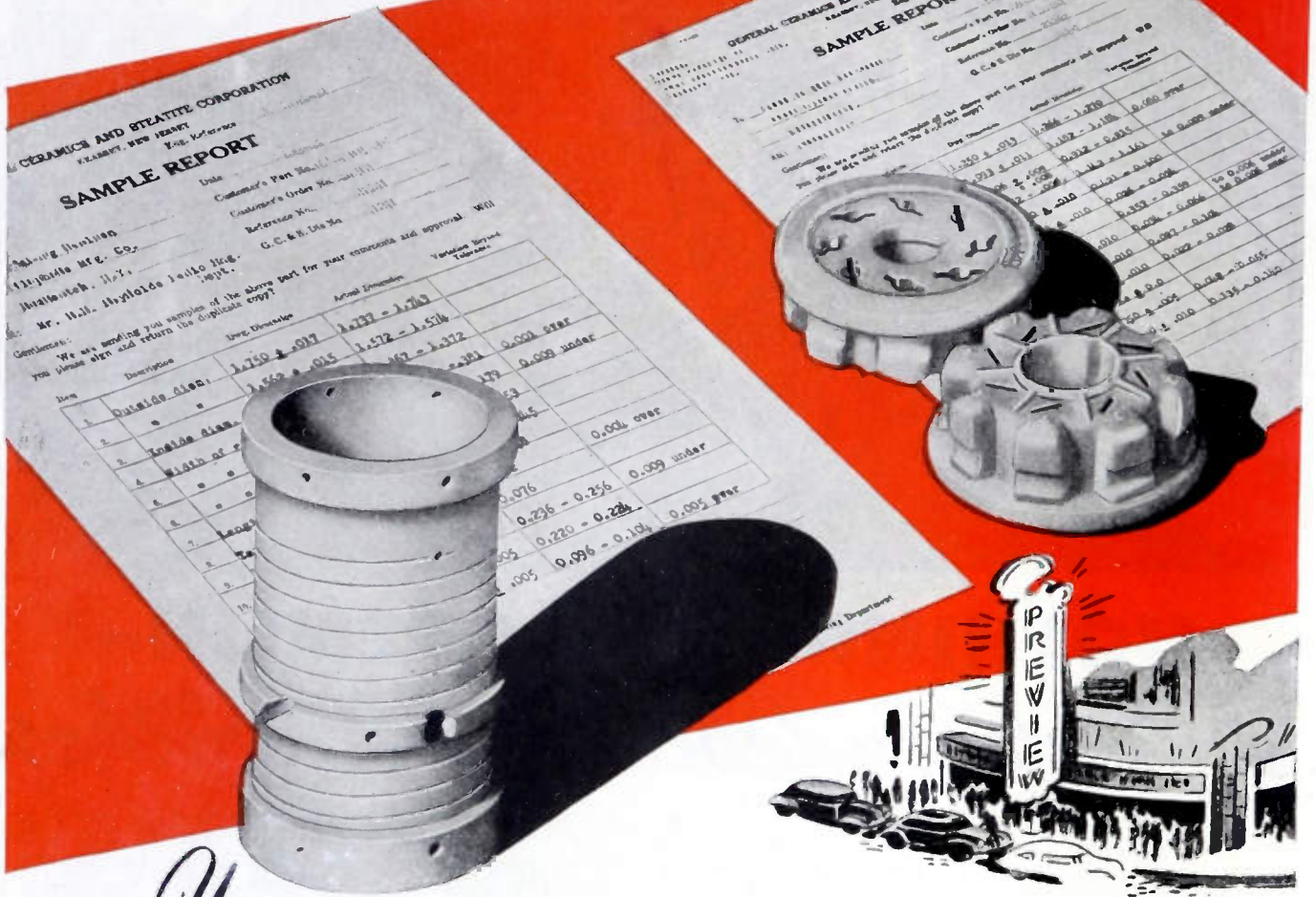

**Y**OU get a preview of your special steatite insulators when we make them — and a *triple check* on the accurate compliance with your blueprints and specifications.

We make and check the tools for fabricating your order. *Check number one.*

Samples produced for you with these tools get a complete inspection of every detail. *Check number two.*

Inspectors make a "Sample Report" which you

receive with the samples. The report states drawing dimensions, actual dimensions and variations beyond tolerance, if any. Your *check number three* — after a preview of the product.

After your O.K., you can be sure that the rest of the order will conform to your specifications.

To the best of our knowledge, this service is unique in our field. It is one of the factors of our controlled manufacturing technique which assures quality and uniformity of product.

# General Ceramics

**AND STEATITE CORP.**  
KEASBEY NEW JERSEY



# A NEW *Motorola* BUILDING

DEVOTED EXCLUSIVELY TO ELECTRONIC

*Research and Engineering*



When war came, Motorola research and engineering was already at work around the clock on special assignments for our Armed Forces. Now in its new home, the Motorola staff of engineers and technicians is by specific government assignments at work on problems which embrace many important phases of electronic knowledge. This new Motorola engineering building increases many times our capacity for service of the highest order.

#### THE ARMY-NAVY "E"

Awarded for excellence in the production of Communications Equipment for America's Armed Forces



*Photo Courtesy U. S. Army Signal Corps*

**Motorola Radio Communication Systems  
Designed and Engineered to Fit Special Needs  
GALVIN MFG. CORPORATION • CHICAGO**

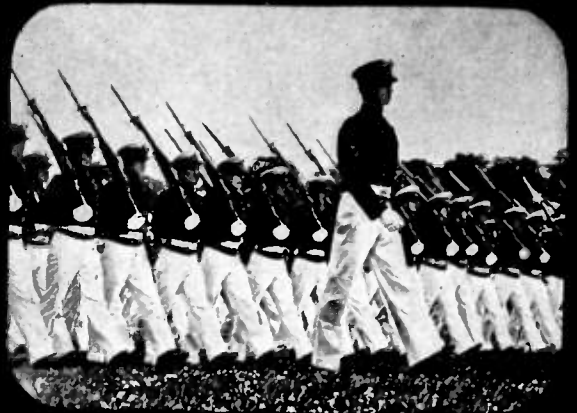

**We're experimenting  
so you won't have to**

General Electric is operating today one of the world's most complete television stations, WRGB, at Schenectady. There, within the limitations of full-scale war production, G. E. is gaining practical knowledge on which to build a new industry.

For a clear television picture on a fluorescent screen is only the beginning of television. From there on out, problems still loom. What will television offer that movies, theater, concert hall,

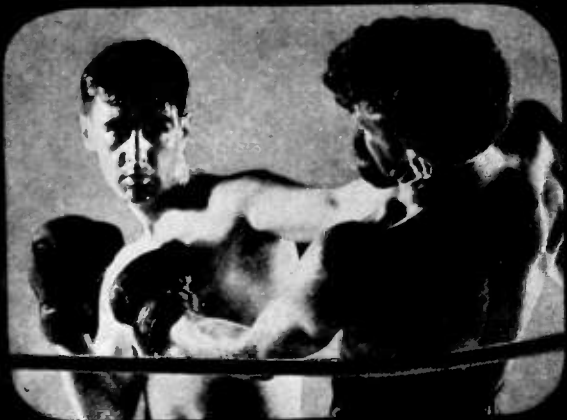

To help you plan for television, visit General Electric's proving-ground station WRGB, shown above

school, and radio cannot offer? Will the television screen make a good teaching platform? Will it further the fine arts, science, industry? What can it offer uniquely to the church?

How, in short, will television best serve the public welfare? How best improve our lives?

General Electric electronic engineers are studying and improving transmission and reception. And studio manager and program staff are urged to give fullest expression to creative

talents and ideas. For the General Electric vision is to make television stand on its own feet as a new cultural and entertainment medium.

In the future, when you are planning your television station, General Electric will be ready with a wealth of experience in television programming and techniques. General Electric today is scanning tomorrow. . . . Radio, Television, and Electronics Department, General Electric Company, Schenectady, New York.

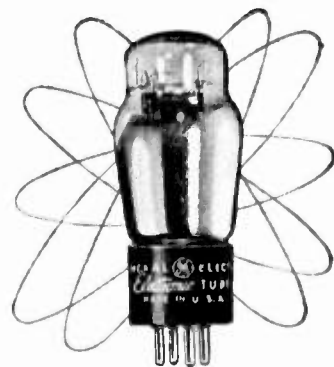

LEADER IN RADIO, TELEVISION, AND ELECTRONIC RESEARCH  
**GENERAL  ELECTRIC**  
190. A1-0218

# TELEVISION



## THE RADIO-PHONE THAT DIALS ITS OWN NUMBERS

COMMUNICATING with ground stations for commercial transport pilots has now become as easy as "dialing" a neighbor. Using the "BENDIX" RTA-1 Communication Unit, he turns a small frequency selecting switch... and the desired communication channel is instantly available.

In addition to the remotely-controlled motor-driven channel selector and accurate crystal controlled frequencies that make this possible, the RTA-1 provides other big advantages. Light, rugged, and built in one compact unit, it weighs less than 75 pounds. The whole unit may be easily and quickly removed for repairs or replacement.

Developed with the cooperation of every major airline in America, the RTA-1 typifies Bendix Radio design superiority and ability to meet out-of-the-ordinary specifications.

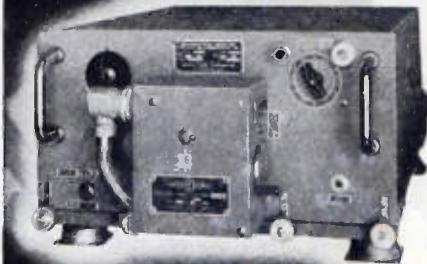

The "BENDIX" RTA-1 Communication Unit, which combines 10 crystal-controlled receiver and transmitter channels with integral power supply into one compact, light-weight unit.

The various types of equipment made by Bendix Radio are important members of "The Invisible Crew"... the precision instruments and equipment which 25 Bendix plants from coast to coast are speeding to our fighting crews on World battle fronts.

THE INVISIBLE CREW

Precision

Equipment by

**Bendix**  
AVIATION CORPORATION

BENDIX RADIO DIVISION

BENDIX RADIO



1776 1898

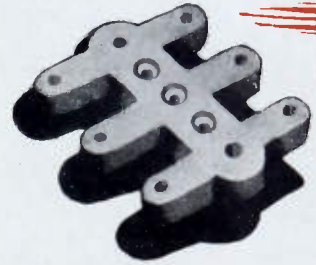
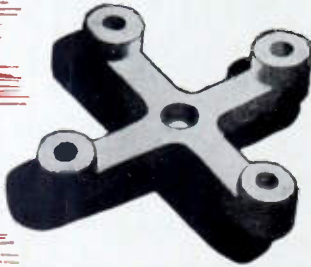

ALSiMAG 1943

# Wartime ceramics

Mugs, jugs and goblets were about the only ceramics actively participating in past wars. Spirits were enlivened and convictions reaffirmed by mugs and plates bearing appropriate sentiments. Gay commemorative jugs, fashioned by earlier American ceramists, helped perpetuate the memory of men famed in war and peace.

But today ceramics play an active and vital role in war. Complex electrical mechanisms depend upon ALSiMAG steatite ceramic insulation for unflinching performance.

It was a proud day for American Lava Corporation when it was the first in the land to produce electrical insulators meeting Navy "G" specifications. Since that

time ALSiMAG insulators complying with the toughest specifications of Army and Navy have gone out of this plant in an ever-increasing flood.

The men who make ALSiMAG have only one regret. The all-out efforts of the past two years have forced them to lose touch, for the time being, with many peacetime friends and customers. Every consideration beyond the war effort was proudly and gladly thrust aside. But when peace comes, you will find that the stresses and strains of war have resulted in new and better ALSiMAG products, backed by the same alert organization ready to serve you in the same old spirit of friendly helpfulness.



AWARDED JULY 27, 1942

# ALSiMAG

TRADE MARK REGISTERED U. S. PATENT OFFICE

## AMERICAN LAVA CORPORATION

CHATTANOOGA, TENNESSEE



**We're experimenting  
so you won't have to**

General Electric is operating today one of the world's most complete television stations, WRGB, at Schenectady. There, within the limitations of full-scale war production, G. E. is gaining practical knowledge on which to build a new industry.

For a clear television picture on a fluorescent screen is only the beginning of television. From there on out, problems still loom. What will television offer that movies, theater, concert hall.





To help you plan for television, visit General Electric's proving-ground station WRGB, shown above

school, and radio cannot offer? Will the television screen make a good teaching platform? Will it further the fine arts, science, industry? What can it offer uniquely to the church?

How, in short, will television best serve the public welfare? How best improve our lives?

General Electric electronic engineers are studying and improving transmission and reception. And studio manager and program staff are urged to give fullest expression to creative

talents and ideas. For the General Electric vision is to make television stand on its own feet as a new cultural and entertainment medium.

In the future, when you are planning your television station, General Electric will be ready with a wealth of experience in television programming and techniques. General Electric today is scanning tomorrow. . . . Radio, Television, and Electronics Department, General Electric Company, Schenectady, New York.

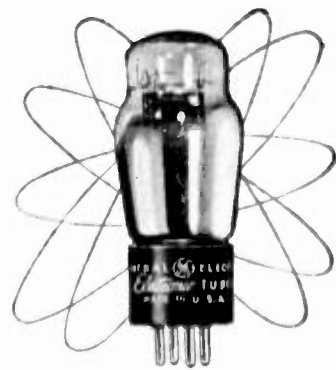

LEADER IN RADIO, TELEVISION, AND ELECTRONIC RESEARCH  
**GENERAL  ELECTRIC**  
160-A1-0910

# TELEVISION



## THE RADIO-PHONE THAT DIALS ITS OWN NUMBERS

COMMUNICATING with ground stations for commercial transport pilots has now become as easy as "dialing" a neighbor. Using the "BENDIX" RTA-1 Communication Unit, he turns a small frequency selecting switch . . . and the desired communication channel is instantly available.

In addition to the remotely-controlled motor-driven channel selector and accurate crystal controlled frequencies that make this possible, the RTA-1 provides other big advantages. Light, rugged, and built in one compact unit, it weighs less than 75 pounds. The whole unit may be easily and quickly removed for repairs or replacement.

Developed with the cooperation of every major airline in America, the RTA-1 typifies Bendix Radio design superiority and ability to meet out-of-the-ordinary specifications.

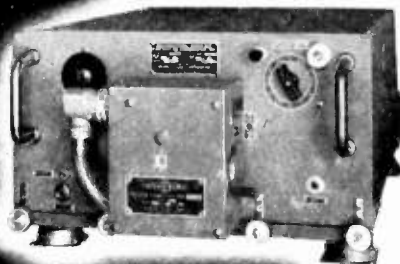

The "BENDIX" RTA-1 Communication Unit, which combines 10 crystal-controlled receiver and transmitter channels with integral power supply into one compact, light-weight unit.

The various types of equipment made by Bendix Radio are important members of "The Invisible Crew" . . . the precision instruments and equipment which 25 Bendix plants from coast to coast are speeding to our fighting crews on World battle fronts.

THE INVISIBLE CREW

Precision

Equipment by

**Bendix**  
AVIATION CORPORATION

BENDIX RADIO DIVISION

BENDIX RADIO



1776

1898

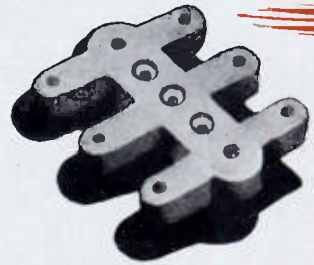
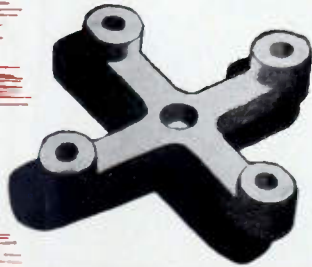

**ALSIMAG 1943**

# Wartime ceramics

Mugs, jugs and goblets were about the only ceramics actively participating in past wars. Spirits were enlivened and convictions reaffirmed by mugs and plates bearing appropriate sentiments. Gay commemorative jugs, fashioned by earlier American ceramists, helped perpetuate the memory of men famed in war and peace.

But today ceramics play an active and vital role in war. Complex electrical mechanisms depend upon ALSIMAG steatite ceramic insulation for unfailing performance.

It was a proud day for American Lava Corporation when it was the first in the land to produce electrical insulators meeting Navy "G" specifications. Since that

time ALSIMAG insulators complying with the toughest specifications of Army and Navy have gone out of this plant in an ever-increasing flood.

The men who make ALSIMAG have only one regret. The all-out efforts of the past two years have forced them to lose touch, for the time being, with many peacetime friends and customers. Every consideration beyond the war effort was proudly and gladly thrust aside. But when peace comes, you will find that the stresses and strains of war have resulted in new and better ALSIMAG products, backed by the same alert organization ready to serve you in the same old spirit of friendly helpfulness.



AWARDED JULY 27, 1942

**ALSIMAG**  
TRADE MARK REGISTERED U. S. PATENT OFFICE

**AMERICAN LAVA CORPORATION**

**CHATTANOOGA, TENNESSEE**

# SPRAGUE

HERMETICALLY SEALED METAL  
ENCASED PAPER TUBULARS  
TYPES PX-24, -24A, and -24B

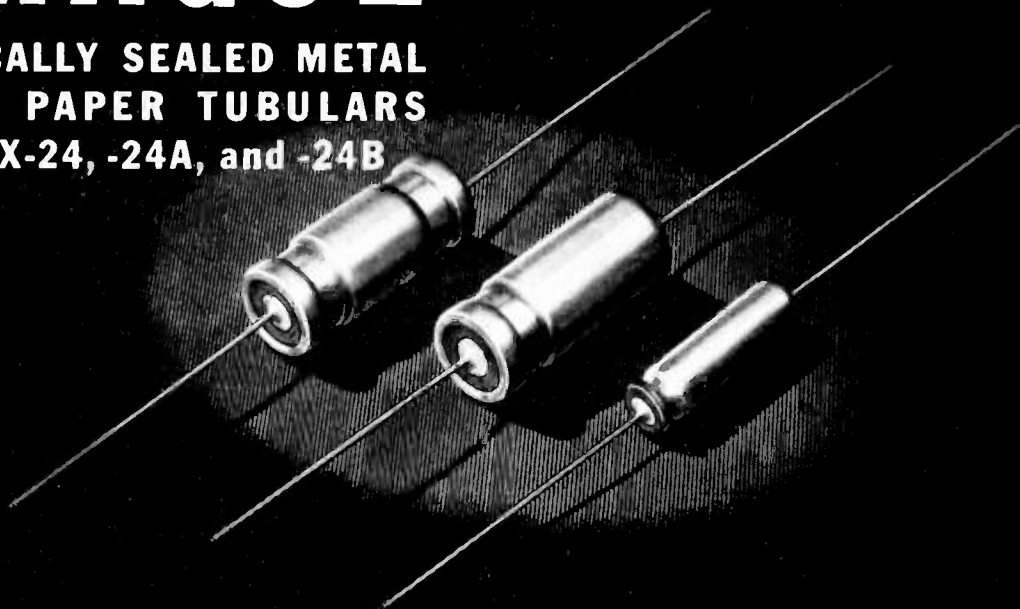

## BUILT TO DO MICA CAPACITOR JOBS *... and do them well!*

**SMALL**—light in weight—hermetically sealed, and outstandingly sturdy, these Sprague Metal-Encased Paper Tubular Capacitors have proved eminently satisfactory for numerous blocking and by-pass applications previously assigned exclusively to molded mica units. Not only is this true as regards less critical "mica jobs," but also on more exacting applications where characteristics such as temperature-insulation resistance, voltage-capacitance, or temperature-capacitance are important considerations.

There remain, of course, certain applications where mica capacitors should still be used, and Sprague regularly produces large quantities of transmitting mica capacitors in a complete range of types and sizes.

Deliveries of both types are obviously dependent on prevailing priorities. Production facilities—especially on the Metal-Encased Paper units—are being steadily expanded, and Sprague engineers will gladly cooperate in determining the adaptability of these Capacitors to your requirements.

**SPRAGUE SPECIALTIES COMPANY**  
North Adams, Mass.

### MATERIALS WANTED!

Sprague offers a constant market for large quantities of critical materials. Present requirements include: 7/16" and 1/4" hex brass rod, free turning; 5/16" and 1/4" diameter brass rod, free turning; #22 gauge long ternes, 8# to 15# coating; 8/32" standard hex brass nuts; also ferrous and non-ferrous metals. Offers of these items in small lots or large will be reported upon promptly and AA1 Priorities supplied to cover purchases.

F. W. McNAMARA, Purchasing Agent  
Telephone: North Adams (Mass.) 804



MANUFACTURERS OF A COMPLETE LINE OF RADIO INDUSTRIAL CAPACITORS AND KOOLOHM RESISTORS

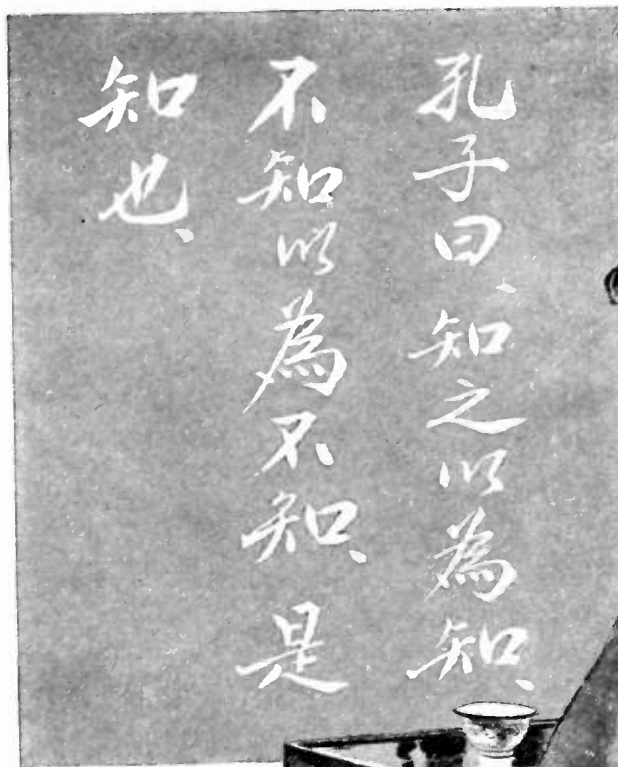

Translation: — "When you know a thing, to hold that you know it; and when you do not know a thing, to allow that you do not know it; this is knowledge." — Confucius



## "This is Knowledge" said the Sage . . .

Through the ages, the most learned have always been the most aware of their limitations.

Why is milk white? . . . Scientists admit that they do not know. They say, as did the late great Thomas Edison, that the total of man's knowledge is pitifully small.

In the vast field of Electronics, IRC certainly does not profess total knowledge. But in one small part of that field—the construction and application of Fixed and Variable Resistors—we do know many of the answers.

Because of our specialized research, we have succeeded in developing a line of resistance devices "Preferred for Performance" throughout the Electronic industries. Today IRC Resistors are so vitally essential for war equipment that we must concentrate our production efforts on caring for the needs of the Armed Services.

Though we may not be able right now to supply you with the Resistors you need for other than war uses, our Engineers and Executives are at your service for counsel, without obligation, to

help you in the solution of Resistor problems. Please feel free to consult them in your search for the best obtainable resistance devices under existing conditions.

You will find a source of complete Resistor information here.



FIXED & VARIABLE RESISTORS

*Preferred for Performance*

**INTERNATIONAL  
RESISTANCE COMPANY**

401 NORTH BROAD ST., PHILADELPHIA, PA.

## HEADQUARTERS FOR ACCURATE, INFORMED Local Order Service

Your local RCA Tube and Equipment Distributor is headquarters for the following items, and, equally important, for the all-essential "know how" of their application and uses:

RCA, CUNNINGHAM, and RCA VICTOR RADIO TUBES  
RCA SPECIAL PURPOSE TUBES, POWER TUBES,  
PHOTOTUBES, CATHODE RAY TUBES, etc.  
RCA ELECTRONIC TEST EQUIPMENT

... also condensers, resistors, rheostats, controls, potentiometers, coils, wire, and numerous other radio and electronic components produced by many manufacturers.



# OVER 300 RCA TUBE AND EQUIPMENT DISTRIBUTORS

...TO SERVE YOU LOCALLY!

**W**HETHER your need is for one electronic item or a dozen, your RCA Tube and Equipment Distributor is geared to help you select it and get it as rapidly as possible! The fact that there are over 300 of these distributors throughout the nation means that there is one close by—ready to deliver personalized, 'round-the-corner service.

RCA Tube and Equipment Distributors not only afford a convenient, 'round-the-corner source of supply, but back their merchandise



with a technical knowledge that has proved invaluable.

If you do not already know the name of your nearest RCA Distributor, write or wire us today.

Put his services to work in solving your electronic equipment buying problems. Take advantage of the large stocks he normally maintains. Let him serve as your specialized "expediter" on orders that must be deferred. Ask him for the technical suggestions he is so well qualified to give! RCA MANUFACTURING CO., INC., Camden, N. J.

AN ADVERTISEMENT OF THE RCA TUBE AND EQUIPMENT DIVISION IN THE INTEREST OF GREATER SERVICE AND EFFICIENCY IN PRIORITY-COVERED WAR MATERIALS BUYING

## Radio-and-Electronic Engineers

This is *your* Institute—

It thrives only if *you* support it.

These are *your* PROCEEDINGS—

Their value comes only from the papers *you* write.

Of course we fully understand:

—much of what you do is confidential or secret

—you are really overworked on war duties

—you are tired at the end of the day and rarely feel like writing a paper for the PROCEEDINGS.

But we also are convinced that:

—one of your important war duties is to keep abreast of radio progress *and* to help others do the same

—many parts of your work are *not* confidential (some of the circuits, measurement or test methods, details of construction, and general technical information would not be of military value to the enemy)

—and to maintain or enhance your own standing, that of your company, of the Insti-

tute, and of radio-and-electronic engineering, you must present your work to your colleagues through the major existing outlet—the PROCEEDINGS of the I.R.E.

It is easy to put off the present matter after reading this far; but remember that “procrastination is the thief of time.” Instead of delaying, we urge that you *immediately* take the following steps:

Write to any of the officers of the Papers Procurement Committee of the Institute at the following addresses:

Mr. Dorman Israel, Chairman  
Emerson Radio and Phonograph Corporation  
111 Eighth Avenue  
New York, N. Y.

Professor W. L. Everitt, Vice Chairman  
1616 North Abingdon Street  
Arlington, Virginia

Dr. J. R. Pierce, Vice Chairman  
6 Cape Court  
Milburn, New Jersey  
In your letter give the title of

the paper you have decided to prepare, the date on which you expect it to be available, and its approximate length and number of figures,

—and then start work on the paper and keep “slogging away” until the job is done.

You will feel all the better for having presented your work to the readers of the PROCEEDINGS of the I.R.E.

And remember that if you fail to carry out these suggestions,

—your own standing will fall below the level it might have reached

—the radio-and-electronic field —your own field—will drift backward to some extent—  
—and America and its Allies will be the weaker.

The engineering-publication situation is nearing a crisis! It is your and our duty to act so that the radio-and-electronic field does not retrogress. Need we say more to you? *Your immediate action can be the only satisfactory answer.*

Alfred N. Goldsmith  
Editor

# THE INSTITUTE OF RADIO ENGINEERS

INCORPORATED



Winter Conferences, January 28, 1943, New York, N. Y.



## SECTION MEETINGS

<b>ATLANTA</b> February 19	<b>CHICAGO</b> February 19	<b>CLEVELAND</b> January 28	<b>DETROIT</b> February 19	
<b>LOS ANGELES</b> February 16	<b>NEW YORK</b> February 3	<b>PHILADELPHIA</b> February 4	<b>PITTSBURGH</b> February 8	<b>WASHINGTON</b> February 8

## SECTIONS

- ATLANTA**—Chairman, J. M. Comer; Secretary, Ivan Miles. 554—14 St., N. W., Atlanta, Ga.
- BALTIMORE**—Chairman, G. J. Gross; Secretary, A. D. Williams, Bendix Radio Corp., E. Joppa Rd., Towson, Md.
- BOSTON**—Chairman, R. F. Field; Secretary, R. O. Oberg, Northeastern Univ., Boston, Mass.
- BUENOS AIRES**—Chairman, J. P. Arnaud; Secretary, Alexander Nadosy, Florida St. 1065, Dept. C-6, Buenos Aires, Argentina.
- BUFFALO-NIAGARA**—Chairman, F. H. Scheer; Secretary, A. J. Dybowski, Dymac Radio, Inc., 1531 Main St., Buffalo, N. Y.
- CHICAGO**—Chairman, R. A. Kay; Secretary, Walter Kenworth, 5505 Potomac Ave., Chicago, Ill.
- CINCINNATI**—Chairman, W. L. Schwesinger; Secretary, Howard Leppele, 4432 Raceview Ave., Cincinnati, Ohio.
- CLEVELAND**—Chairman, P. L. Hoover; Secretary, A. S. Nace, 3209 Archwood Ave., Cleveland, Ohio.
- CONNECTICUT VALLEY**—Chairman, W. M. Smith; Secretary, R. E. Moe, Radio Dept., General Electric Co., Bridgeport, Conn.
- DALLAS-FORT WORTH**—Chairman, Truett Kimzey; Secretary, P. C. Barnes, Radio Station WFAA-WBAP, Grapevine, Texas.
- DETROIT**—Chairman, H. F. Tank; Secretary, E. J. Hughes, 14209 Prevost, Detroit, Mich.
- EMPORIUM**—Chairman, R. K. Gessford; Secretary, H. D. Johnson, Hygrade Sylvania Corp., Emporium, Pa.
- INDIANAPOLIS**—Chairman, S. E. Benson; Secretary, B. H. Rinehart, 1920 Park Ave., Indianapolis, Ind.
- KANSAS CITY**—Chairman, H. K. Morgan; Secretary G. L. Taylor, Midland Radio School Power and Light Building, Kansas City, Mo.
- LOS ANGELES**—Chairman, Lester Bowman; Secretary, R. C. Moody, Don Lee Broadcasting System, 5515 Melrose, Hollywood, Calif.
- MONTREAL**—Chairman, J. A. Ouimet; Secretary, J. R. Bain, Dept. 912, Northern Electric Co., 1231 Shearer St., Montreal, Que., Canada.
- NEW YORK**—Chairman, H. M. Lewis; Secretary, H. F. Dart, 33 Burnett St., Glen Ridge, N. J.
- PHILADELPHIA**—Chairman, J. B. Coleman; Secretary, H. J. Schrader, Bldg. 8, Fl. 10, RCA Manufacturing Co., Camden, N. J.
- PITTSBURGH**—Chairman, D. A. Myer; Secretary, A. P. Sunnergren, West Penn Power Co., 14 Wood St., Pittsburgh, Pa.
- PORTLAND**—Chairman, R. W. Deardorff; Secretary, B. R. Paul, 5960 S. W. 41st. Ave., Portland, Ore.
- ROCHESTER**—Chairman, O. L. Angevine, Jr.; Secretary, G. R. Town, Stromberg-Carlson Tel. Mfg. Co., Rochester, N. Y.
- ST. LOUIS**—Chairman, P. S. McDaniel; Secretary, H. D. Seielstad, 1017 S. Berry Rd., St. Louis, Mo.
- SAN FRANCISCO**—Chairman, H. E. Held; Secretary, W. G. Wagener, Heintz and Kaufman, South San Francisco, Calif.
- SEATTLE**—Chairman, K. H. Ellerbeck; Secretary, H. E. Renfro, 4311 Thackeray Pl., Seattle, Wash.
- TORONTO**—Chairman, T. S. Farley; Secretary, J. T. Pfeiffer, Erie Resistor of Canada, Ltd., Terminal Warehouse Bldg., Toronto, Ont., Canada.
- TWIN CITIES**—Chairman, R. E. Allison; Secretary, A. G. Peck, Twin-Cities Studios, Columbia Broadcasting System, 625 Second Ave., S., Minneapolis, Minn.
- WASHINGTON**—Chairman, C. M. Hunt; Secretary, H. A. Burroughs, Rm. 7207, Federal Communications Commission, Washington, D. C.



# Contemporary Problems in Television Sound\*

C. L. TOWNSEND†, ASSOCIATE, I.R.E.

*Summary*—The present rapid development of television is introducing new problems in sound pickup and operation. As the art progresses, engineering tools and methods must not only keep pace with, but generally anticipate, the needs of the program-producing staff in the production of more and more intricate material. The nature of the acoustic problems so raised, and their solutions, are treated in this paper. New tools necessary to proper operation and the methods of their employment are discussed. For a better understanding of television requirements, the methods normally employed in motion pictures and standard radio broadcasting are compared with those in use in the present television studio. Some indications as to what may be required in the near future are discussed and possible developments suitable for such use are described.

IN THE history of every new activity, problems and concepts peculiar to itself arise. Certainly television is no exception to this rule nor is that part of television which we are to consider. There may have been many who felt in the earlier days of the art that television's sound accompaniment could well be expected to care for itself, for much had been done to perfect a technique of sound pickup with action in progress in the motion-picture studios of Hollywood. But very shortly, marked departures from the accepted methods were found desirable, and gradually it became clear that good television sound required not only different treatment but also different tools than were used at first. As the show-producing workers in television become familiar with their picture-making

and considers what may be done to overcome them.

A consideration of the mechanics of television studio operation will disclose some of the problems arising in sound pickup associated with visual programs. The National Broadcasting Company's studio is equipped at present with three television cameras and normal set lighting requires the use of four floor broads of about 3 kilowatts each. All of this equipment must be positioned for best advantage as to camera angles and lighting effects. If no sound equipment were used at all, the portion of the studio in use would be crowded



Fig. 1—For good pictures, television cameras require most of the space. Sound equipment must operate in what remains.

equipment, more and more is being demanded of it, and the sound accompaniment must keep pace. No consideration of the sound portion of a problem arising in a television studio is permitted to interfere with the picture technique, since the production staff has come to rely upon the sound engineer to find a way around his difficulties. This paper discusses these difficulties,

\* Decimal classification: R583. Original manuscript received by the Institute, September 10, 1942.

† National Broadcasting Company, New York, N. Y.



Fig. 2—Efficient utilization of floor space is a necessity in television.

enough, but it is necessary for the microphone boom to find a place also. The boom operator chooses his position with regard not only to his own best sound requirements but also considers the possible camera movements. If it is likely that a camera-dolly movement will find him in its way, he must be able to move the base of the boom sufficiently in advance of the dolly to clear the necessary space. Thus, the boom operator must not only follow closely the action on the set but must also bear in mind the exact pattern of off-stage activities. The present operators have become adept at maintaining the position of the microphone correctly above the heads of the persons on picture, while stepping from the boom platform and moving it bodily a sufficient distance to permit passage of a camera. Often, too, only a few seconds can be allowed for a complete change from one set to another, necessitating accurate planning of movements and precise co-operation between sound- and sight-equipment personnel. To aid in this the boom used is as small as is presently practicable, having a maximum extension of 14 feet and being about 4 feet wide across the base. A unidirectional microphone is used to aid in reducing off-set noise, but this adds to the

precision necessary in operation, for if close-ups are being used, the microphone must be aimed at the person being televised. This means that the boom operator must watch the camera-switching lights and position the microphone to suit the camera as well as the actor, being careful to discriminate against off-camera sounds only.

To facilitate scene transitions, or to provide a second pickup in a set where two widely spaced sound sources act concurrently, a method of hanging micro-



Fig. 3—A transition from one scene to another may require the use of a fixed-position microphone for opening the new scene. Action will be restricted until the arrival of the boom microphone.

phones has been devised. The studio ceiling carries a network of pipes of approximately  $2\frac{1}{2}$  inches in diameter. A special clamp has been made to fit these pipes. Connected to each clamp is an adjustable length of light conduit, designed to accept a standard microphone coupling. The clamp can be operated by twisting the conduit making it unnecessary to climb ladders to hang microphones; this greatly increases the all-important factor of speed.

Three types of microphones are normally used in the National Broadcasting Company's television studio. The unidirectional type with a cardioid pickup pattern is used for dialogue, mainly because of its ability to reduce the effect of off-stage noise. Television, unavoidably, has rather more of this than is used on a motion-picture sound stage, since following scenes must be prepared, equipment moved continuously to new locations, and the show kept running generally. This contrasts markedly with the complete stopping of all other activity when a scene is made in motion pictures. Regular velocity microphones are used in cases requiring more reverberation, or when convenient to use both sides for pickup. Usually this occurs when music is used on the set, and an acoustically bright effect is desired. A pressure microphone is used when its nondirectional characteristic is advantageous. The production staff at NBC recognizes that in

recent years a microphone has become an integral part of some scenes. A supper-club set may call for several microphones, and if a grouping dictated by picture requirements is too wide for other types, a pressure microphone will solve the problem. As these microphones are relatively small, they are also most suitable for use in positions where they might tend to obscure the picture, or when a microphone must be held in the hand.

Even with the above variety of tools, situations arise that defy ordinary "on-the-spot" pickups. These cases generally can be classified into those in which high scenes limit the possibility of bringing a microphone close to the action, and those in which the action is too fast or too complicated to permit its being followed by the microphone boom. Both occur usually in the musical production type of scene. It may be that a large and decorative background has been erected for a solo song, center stage and low. Obviously, no reasonable balance can be obtained between voice and accompaniment if the microphone must be far enough away to be out of the picture when it includes so large a backdrop. In the second case, trouble usually is encountered when performers not only sing but also move through a routine of action not suited to sound pickup. This may include singing while facing away from the camera, or while moving through a doorway, or per-



Fig. 4—Musicians must be close to the set for good musical coordination, introducing problems in balance and overlapping pickups. Unidirectional microphones aid greatly in such situations.

haps next to percussion instruments of an orchestra where maintenance of balance would be impossible. All of these situations call for prerecording, a technique developed in Hollywood and happily adaptable to television. Two methods of procedure are available. In the first type mentioned above, the microphone is located in a suitable position for the making of the record, usually several hours before show time. The action is carried out as usual and the timing of the record automatically fits the scene as it will be

broadcast. When the actual show takes place, a cue from the production director will start the record and kill all sound pickup in the studio. The record is then not only put on the air, but also fed back into the studio, where the performers can hear it, and synchronize their actions to it. When the recorded portion ends, the studio microphones are opened and the show continues normally. In the second type mentioned, the action is too detrimental to sound pickup to permit recording with it in progress even though no picture is required. Hence the action is carefully timed and cues noted. The recording will then be made without action, the setup being entirely to suit the sound situation. Such a record is then checked for synchronism on another rehearsal, and used "on the air" as described. A lacquer disk recording with the NBC Orthacoustic characteristic is used, resulting in transitions from direct pickup to record and back again with practically no noticeable change in sound quality. With such satisfactory matching of sound quality available, prerecording is a very useful tool in television.

Another angle of the studio-mechanics problem is in peculiar contradiction to the case in motion pictures. In some instances, the motion-picture-making equipment causes some trouble through making noise which may interfere with the desired sounds. In television the reverse is true. Sound in the studio may be of such intensity and frequency that it will cause spurious signals due to microphonics to appear in the picture. These generally consist of horizontal bars across the picture, and result from vibration of elements of vacuum tubes used in the video preamplifier in the camera. It is necessary to treat the television camera to keep sound out, rather than in. A heavy material, similar to roofing felt may be cemented to the inside surfaces of the camera housing to reduce sound transmission, and particularly to damp vibration occurring in the large plane sections of the present camera's sides and top. Without such damping, these parts will vibrate very heavily at their natural periods, making sound crossover almost a certainty. With sufficient loading the tendency to vibrate disappears almost completely, permitting operation with any normal studio sound level.

The very nature of television is that its appeal must be in the intimate manner. As long as the present methods of picture reproduction are being used extensively, this will continue to be the case, for picture size and detail make best use of close-ups and penalize the extreme long shots. The sound that accompanies these pictures should partake of the same quality, heightening the tone and mood of a scene. The methods adopted and the tools used must, then, be suitable for such work.

The National Broadcasting Company's live-talent studio is a room 30×50×17 feet. Its acoustic treatment differs radically from what a motion-picture engineer might expect to find on a sound stage, in that

the reverberation constant is not as short as it could be made, but rather a variable quantity, being in some cases as long as  $1\frac{1}{4}$  seconds, and in others as short as  $\frac{1}{2}$  second (over the essential range of frequencies). The reasons for this are close to the heart of the television problem. In the usual sound-stage case, the studio is a large acoustically dead room, in which relatively permanent sets are erected. It is normally the intention to permit those sets to exhibit their own characteristic reverberation without much, if any, artificial reinforcement. The case in television is somewhat different. Our sets are designed for rapid scene changes, and efficient use of personnel. They are made of linen stretched on wood frames in the manner of legitimate stage scenery. Instead of adding a lifelike reverberation to the sound originating in them, such sets produce undesirable low-frequency resonance effects, and add large amounts of high-frequency absorption in their unpainted surfaces. If the studio itself were very "dead" these effects would add detrimentally. Dialogue equalizers are used, which help to avoid this trouble, but the less equalization that can be employed, the better will be the average sound quality.

Studio acoustics also play an important part in television sound for other reasons. The volume of the sets in use is always a very large portion of the total studio volume, since many scenes must be set up at once to provide a continuous performance. Under usual conditions almost the whole studio is used in a show to run an hour and a half. With so much absorption added in the sets, much of the original treatment of the studio must be removed to produce anything like normal reverberation. Most television shows will also present music as well as speech in the same studio, without a pause between the two portions of the program. Such a case in motion-picture production would call for the use of a scoring stage, or a set especially treated for music. In television, the problem is attacked by making large sections of the acoustic treatment on the studio walls movable. These panels can be opened to expose a hard, reflective surface, increasing the reverberation to an acceptable level. Should an outdoor scene be required, however, all the absorbing panels would be closed, and equalization added to produce an essentially reverberation-free pick-up.

It has often been remarked that television even now should use large studios of the motion-picture sound-stage variety. There are however certain mechanical and acoustical considerations that make this doubtful. Present television practice, which demands many close-ups and rather restricted action during most of the show, means that even with a relatively large set, for the major portion of a "take," the cameras, lights, and sound equipment must be crowded together to serve best the particular portion of it used at the moment. It is a provoking fact that although most of the studio may be empty, the television equipment must be worked in close quarters. Consequently, additional

room would not materially increase the freedom of action of the cameras as far as any one set is concerned. Mechanical considerations, then, indicate that the size of the studio is determined by the number of sets which reasonably can be used on one show, or can be served by one group of equipment. Under present production conditions, this would result in a studio considerably smaller than the larger motion-picture sound stages. Acoustically, the smaller studio is desirable, because of the requirement mentioned above that



Fig. 5—Making close-ups and long shots simultaneously introduce problems of acoustic realism.

studio acoustics be adjustable to compensate for set absorption. If the studio becomes too large, it cannot contribute usefully to the over-all sound quality, for reverberation as a desirable enhancement is replaced by what is commonly called room-slap, or echo. Hence, if a very large studio is to be used, it *must* be very "dead," which inflexibility seriously limits its usefulness as an acoustic tool. The answer to this problem seems to be that television studios should be of a size between those used in radio broadcasting and the large stages of Hollywood if all the mechanical and acoustical advantages are to be realized.

The excellent work currently done in the broadcast-studio has raised to a high stage of refinement the art of producing mood and atmosphere with sound. Television must offer at least as much facility for creation of these effects and at the same time must not limit in any way the freedom of action necessary to good pictorial effect. Some of the problems encountered in this blending of sound technique and sight productions are worthy of consideration.

In the television studio, both close-up and long shots must be taken at the same time. The accompanying sound must not only suit the apparent distances shown in the picture, but may also be required to produce an effect complementary to it. At times, perspective in television sound is so important that what would normally be only a medium long shot can be made to *seem* very long, if the sound which accompanies it

carries sufficient reverberation to suggest great distance to the mind of the listener. Since actual long shots are not usually permitted for long periods of time, such an aid in producing the effect of distance is a valuable tool. Close-ups, of course, require intimate sound, and often the change from a distant view to a close-up occurs too quickly to permit any actual change in microphone placement or acoustic treatment, so the *effect* of a change must be produced electrically. Reverberation once added cannot be deleted; consequently, the pickup conditions must be set to produce close-up sound. It is then possible to add reverberation through the use of the standard echo-chamber method. In the studio, close-up cameras are provided with long-focal-length lenses, and long-shot cameras have either normal- or short-focus lenses. Switching between the cameras actuates a set of relays so connected that amounts of reverberation and volume level can be adjusted to suit the lens of the camera in use. This is accomplished by providing for each camera a separate volume control, and a separate reverberation control. If a camera is to be used to take a long shot, the volume control associated with it is turned down an amount calculated to produce the proper psychological effect, and the reverberation control is opened to accept a large portion of the output of the echo chamber. Another camera having an intermediate focal length would use more direct sound and less reverberation, while the close-up camera would use full volume and no feed from the echo chamber at all. When the technical director switches from one camera to another, the sound is also switched from one set of controls to another, producing instantaneous changes in sound quality to suit the picture requirements. Of course such artificial correction is confined in its application to interior shots which would normally exhibit acoustical characteristics similar to those available from the echo chamber. Corrections can be applied to outdoor scenes by changing the volume level and low-frequency response of the system to match the camera switching. Thus an exterior long shot would be accompanied by a reduction in volume-control setting and an increase of equalization designed to remove low and high frequencies, thus simulating the conditions obtaining in nature. Without such processing, the sound accompanying a television picture would not only lose valuable contributing effects, but at times might give an almost ludicrous effect, for the human eye and ear have been trained to expect a certain correlation between sight and sound perspective, and violations of their normal relationships are not acceptable.

Another problem peculiar to television sound is the result of a demand for realism in its dynamic range. In motion pictures, the acceptable range of loudness is a strictly measurable and controllable quantity. The lowest modulation permitted is a function of track hiss, frequency response, audience noise, etc., and the

highest sound output is determined by the 100 per cent modulation point and reproducer power. No one in the audience is able to change the volume reaching him, nor does he expect to hear sound which is not dimensioned to fit the picture on view. In radio broadcasting, almost the exact opposite is true. With no visual program, the listener demands the maintenance of a relatively constant level, and often writes to his station complaining that he has to adjust his receiver volume control during the progress of a show. Television encounters portions of both of these troubles, and has had to evolve its own operating procedures to combat them. Since television is broadcast, a reasonably high average modulation should be maintained, in order that receiver noise levels may be low. Maximum deviation is determined, of course, by channel width. Within these two extremes must be confined sound to suit anything from the scraping of a pen across paper, to the crashing thunder of a modern blitzkrieg. Such matching of sound and sight is necessary, for if the eye sees what would in nature produce a loud sound, but the ear hears only a small, muted version of what is expected, the mind rejects both sight and sound as being counterfeit. Thus a dynamic range is required of television sound which is greater than absolutely necessary in sound broadcasting. Here the home receiver enters the problem. If dialogue, and other relatively quiet sounds, are broadcast at their proper level over a period of time, it is likely that the volume of the home receiver will be increased by the listener to match what has come to be expected of broadcast sound. Then, if full dynamic range is employed, the louder passages will exceed reasonable

living-room power, or perhaps overload the receiver. Hence, some compression must be employed, yet without producing the above-mentioned unconvincing mismatch. Treatment of this problem has evolved into a skillful handling of audio levels in such a way as to produce changes in apparent loudness which are greater than those actually broadcast. If it is known in advance that some particular point in a performance will require a large increase in volume, the loudness of the passages preceding the expected increase in level is gradually lowered, the process sometimes extending over several minutes. This decrease in loudness is accomplished so slowly that it does not come to the attention of the listener and is in some degree compensated by what appears to be an increase in the listener's aural sensitivity. Then, when the large amplitude is required, an increase to maximum deviation is sufficient to produce an admirable effect. Of course, such a loud period causes the listener's hearing again to be reduced, and care must be exercised in returning to a medium or low level of modulation.

The television sound problems which have been discussed are a few of those that have already been encountered in television broadcast operation. They have increased in complexity as television program production has advanced its techniques. In an art developing as rapidly as television, no one can be certain that indicated trends will be followed or that present methods and materials will be adequate, or even useful, in the future. It is only by continuing the present close cooperation between the studio and the development laboratory that television's sound problems can be solved.

## Automatic Frequency and Phase Control of Synchronization in Television Receivers\*

K. R. WENDT†, ASSOCIATE, I.R.E., AND G. L. FREDENDALL†, ASSOCIATE, I.R.E.

*Summary*—One of the problems in the reception of television images is to provide satisfactory synchronization in the presence of noise. During the past several years considerable experience has been gained with respect to this problem under various receiving conditions. The system of synchronization which has given satisfactory results up to the present time has depended for its operation on the reception and separation of individual pulses. In general, it can be said that with this system satisfactory synchronization can be obtained from those signals which will in all other respects provide an entirely acceptable picture. However, for limiting conditions of service, particularly during early operation where field strength may be low, an improvement in synchronization will be effective and desirable provided that it does not involve other complications or disadvantages.

This paper describes a synchronizing means at the receiver that employs a new principle in the field of synchronization. The principle is automatic frequency and phase control of the saw-tooth scanning

voltages. In such a system, synchronization depends on the average of many regularly recurring synchronizing pulses. Noise has insufficient energy at the scanning frequencies to effect control through the direct-current link from which all but relatively long-time variations are filtered out.

Experimental receivers, in which automatic phase and frequency control of the scanning oscillators has been incorporated, have operated with high immunity to noise. The degree of immunity is of a different order of magnitude from that found in conventional synchronizing systems.

Noise cannot affect horizontal resolution or interlacing. An intrinsic property of the new system is perfect interlacing. The return line in an automatic-frequency-controlled system may start before synchronization.

Consideration of this new development indicates that its use would result in several improvements in television service: (1) when severe noise conditions occur, an improved picture is obtainable at points within the present service area; (2) under such noise conditions, the useful service area is extended; (3) the maximum resolution permitted by a television channel is realizable at locations having low field strengths. It is expected that these improved results will be attained without increase in the cost of the television receiver.

\* Decimal classification R583XR361. Original manuscript received by the Institute, June 30, 1942. Presented, Summer Convention, Cleveland, Ohio, July 1, 1942.

† RCA Laboratories, Princeton, N. J.

CONVENTIONAL SYNCHRONIZING SYSTEMS

IN THE operation of present commercial television receivers, the natural frequencies of the horizontal and vertical scanning oscillators, in the absence of a synchronizing signal, are lower than the line or field frequencies, respectively, at the transmitter. The application of a transmitted pulse initiates or "triggers" a new cycle of the oscillator before one would other-

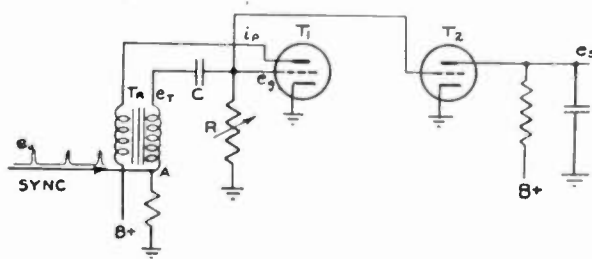

Fig. 1—Conventional triggered scanning oscillator.

wise occur. The period of the horizontal-scanning oscillator is shortened to conform to line frequency and the period of the vertical oscillator to field frequency. Thus, triggering is required for each successive horizontal and vertical scan. This is the basic principle of operation of conventional synchronizing systems.

Fig. 1 shows a scanning oscillator of a typical commercial television receiver. A cycle of operation in the absence of a synchronizing signal is shown in Fig. 2. As the grid potential  $e_g$  of the tube  $T_1$  reaches the cutoff point as a consequence of leakage of charge through resistance  $R$  from the previously charged capacitance  $C$ , plate current  $i_p$  begins to flow. A short time later, the induced voltage  $e_i$  causes the capacitance  $C$  to take a large charge which, in turn, lowers  $e_g$  to a high negative value. Plate current does not flow again until sufficient current has leaked through  $R$ . The excursions of  $e_g$  above the cutoff point of the tube  $T_2$  are responsible for the generation of a saw-tooth wave  $e_s$  in the plate circuit of that tube.

Assume now that a synchronizing pulse  $e_0$  is applied

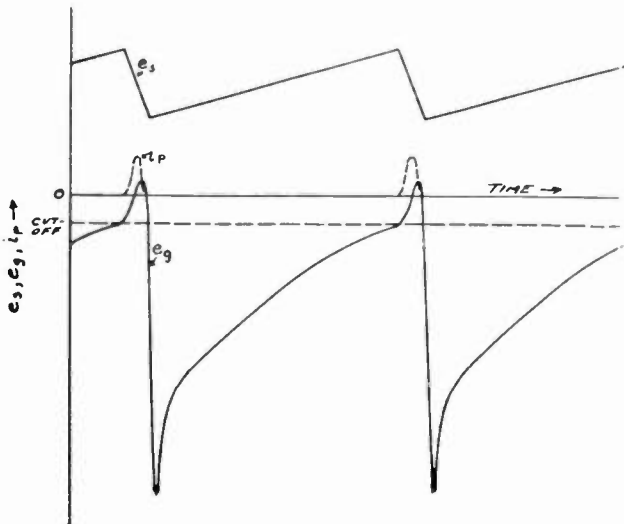
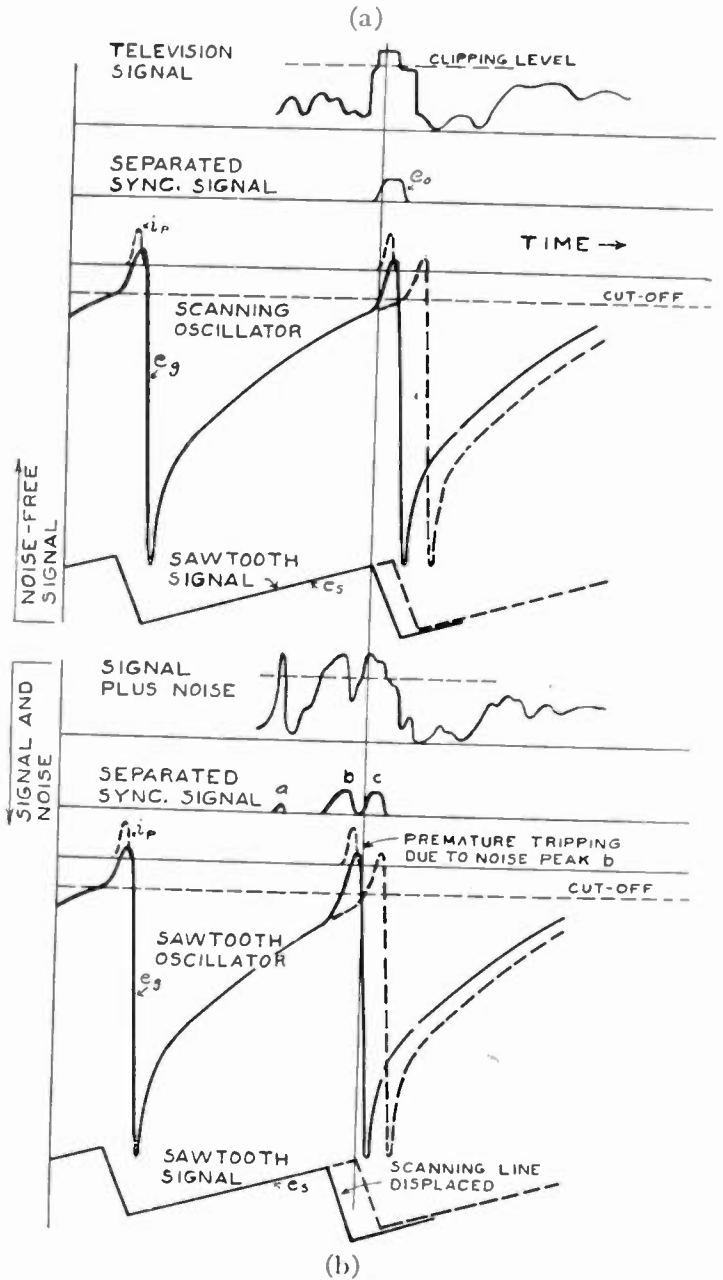

Fig. 2—Operation of the scanning oscillator.

between point  $A$  and ground in Fig. 1. The effect is a premature rise of the potential  $e_g$  to the cutoff voltage of  $T_1$  as shown in full lines in Fig. 3a. A pulse of plate current  $i_p$  occurs earlier than in the absence of a synchronizing signal. The dotted wave in Fig. 3a shows



(a)—Operation of scanning oscillator.  
(b)—Operation of scanning oscillator when noise is present.

the variations of currents and voltages in the absence of a pulse as in Fig. 2. Wave  $e_s$  may represent current variations in the coils of an electromagnetically deflected tube or voltage variations across the plates of an electrostatically deflected tube.

The behavior of the triggered oscillator when noise is present in the signal is the primary interest here. Hence, we shall wish to determine how the frequency or phase of the scanning voltages are affected when the picture signal is accompanied by noise peaks which

exceed black level and therefore appear in the synchronizing signal as shown in Fig. 3b. Noise peak "a" superimposed on the normal grid potential  $e_o$  curve is insufficient to raise the potential above the cutoff of tube  $T_1$ ; hence, the peak is ignored by the oscillator. Noise peak "b," however, does have sufficient amplitude to cause  $e_o$  to rise above the cutoff potential, and therefore initiates a new cycle of oscillation prematurely. The legitimate synchronizing pulse at "c" would have caused the normal cycle shown in dashed lines. The deflection signal  $e_s$  shown in full lines corresponds to the premature synchronization. The dashed lines represent the desired signal.

If  $e_s$  represents the horizontal-deflection signal, the observer interprets the misplacement of  $e_s$  as a line out of the normal position on the viewing screen. If  $e_v$  represents the vertical deflection signal, he observes a vertical movement of the picture.

It will be realized that the immunity of the system to noise is least when  $e_o$  is near cutoff because lower noise peaks are sufficient to initiate a new cycle of the oscillator. In the event that a synchronizing pulse is obliterated by noise, the oscillator may remain inactive until  $e_o$  reaches the cutoff potential of the tube and thus initiates a new cycle which is late relative to the normal position. It is clear, therefore, that triggered synchronization as described above is subject to noise limitations that are inherent in the principle of operation.

### AUTOMATIC FREQUENCY- AND PHASE-CONTROLLED SYNCHRONIZING SYSTEMS

Fig. 4 is a block diagram of the essential components of an automatic frequency- and phase-controlled synchronizing system. Since the same principle is involved in the operation of the horizontal and vertical circuits, it is unnecessary to specify a particular circuit. The phase detector receives the synchronizing signal at  $A$  and a saw-tooth wave at  $B$  taken from the output of the scanning oscillator. A control voltage produced at  $D$  by the phase detector contains information regarding the phase of the saw-tooth wave relative to the synchronizing pulses. The phase detectors described below respond to changes in relative phase that may exist at the time of arrival of each pulse. However, only the slowly varying components of the control voltage are passed by the filter following the phase detector. Rapid variations corresponding to rapid or erratic changes in relative phase are eliminated. Thus, the con-

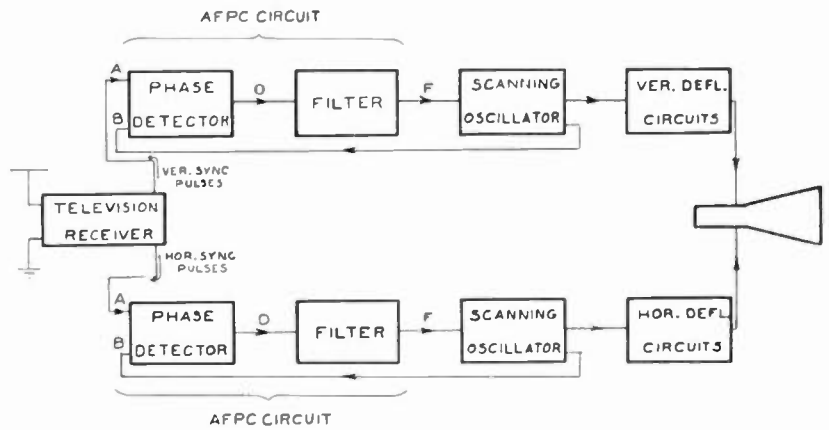

Fig. 4—Block diagram of an automatic frequency- and phase-controlled system.

trol voltage at  $F$  may be regarded as a direct voltage which is applied to the scanning oscillator in order to restore the phase of the oscillator relative to the synchronizing pulses when there is a long-time trend in phase away from the equilibrium state established by the speed control of the scanning oscillator. Such changes in phase and frequency of the saw-tooth as occur as a result of the action of the control voltage are conducted back to the phase detector through the feedback path in order to provide further correction.

In the presence of noise of sufficient magnitude, the phase detector may register the relative phase of a noise peak and the corresponding saw-tooth cycle. Such spurious components in the control voltages at  $D$  usually lie in the range of frequencies beyond cutoff of the filter and are therefore effectively removed from the voltage at  $F$ . The noise immunity of automatic frequency- and phase-controlled circuits is a consequence largely of the action of the filter. Further insight into the theory of automatic frequency- and phase-controlled synchronization may be obtained from a more detailed account of the operation of specific circuits.

Fig. 5 shows a circuit which may be used for automatic frequency and phase control of a horizontal or a vertical oscillator. Here, synchronizing pulses are supplied to the terminals  $A_1$ - $A_2$  of the phase detector by means of a balanced circuit. A fraction of the output of the scanning oscillator is introduced at point  $B$  of the phase detector in order to form the composite

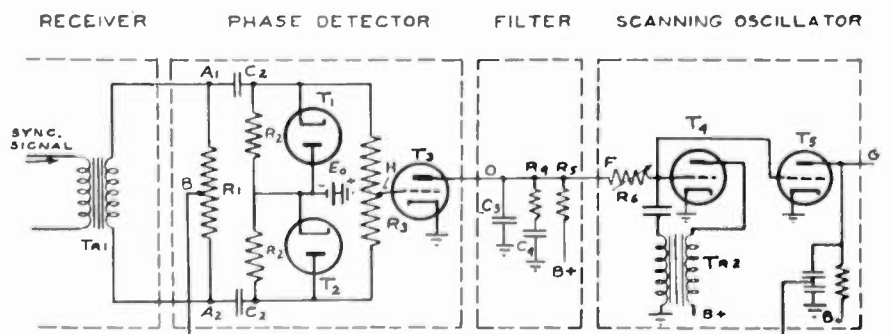

Fig. 5—Automatic frequency- and phase-controlled circuit.

signals shown in Fig. 6(a) and (b). In practice, when the automatic frequency- and phase-controlled system is in equilibrium, the synchronizing pulse must occur sometime during the return line, that is, during the steep portion of the saw-tooth wave. This restriction

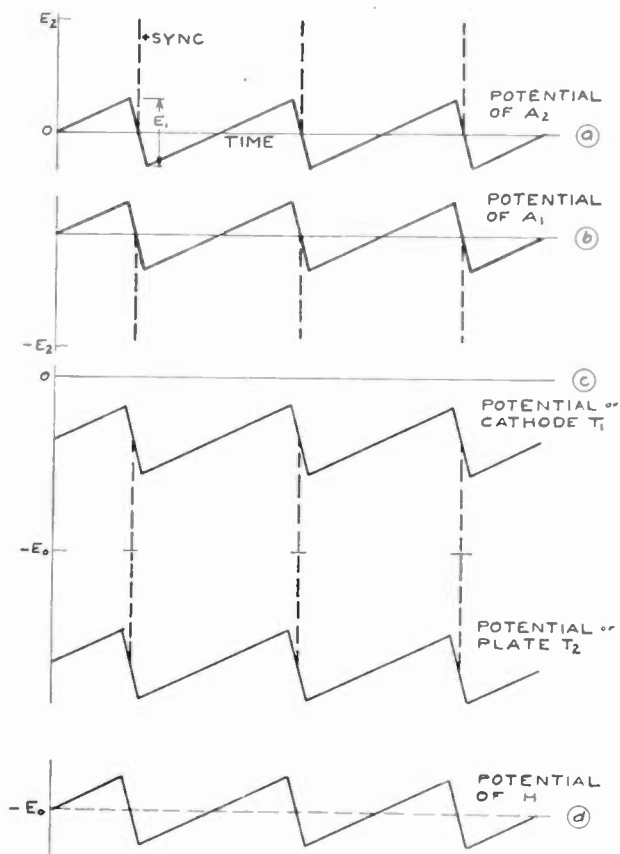

Fig. 6—Composite signals for possible equilibrium position.

is necessary for the viewing of a television picture in the correctly framed position on the screen of the cathode-ray tube.

If it is assumed that a state of equilibrium is attained, the condition is maintained in the following manner. Tubes  $T_1$  and  $T_2$  are diode rectifiers which may be idealized for simplicity of explanation. We shall assume that the circuit composed of the resistance  $R_2$  and the capacitance  $C_2$ , associated with the diode  $T_1$ , maintains a potential variation (Fig. 6(c)) at the cathode of the diode that resembles the wave in Fig. 6(b) in every respect except that the peak amplitudes of the pulses are definitely located at  $-E_0$  volts. In popular terms, the diode is said to "set direct current." The values of  $R_2$  and  $C_2$  must be chosen with the view of causing  $T_1$  to act as a direct-current setter or peak rectifier.

In a similar manner, the diode  $T_2$  in combination with its associated elements  $R_2$  and  $C_2$  maintains the potential variation at the plate of  $T_2$  as shown in Fig. 6(c) in which the peak amplitude of the synchronizing pulse is maintained at a potential of  $-E$  volts with respect to ground. The potential with respect to

ground of the mid-point of the resistance  $R_3$  shown in Fig. 6(d) is the average of the potentials at the end points of  $R_3$ . An important observation to be made in Fig. 6(d) is that the synchronizing signal is balanced out. This leads to the conclusion that the waveform and the direct-current component of the signal at point  $D$  are independent of the amplitude assumed for the synchronizing signal, but that the direct-current component is dependent upon the phase relation of the synchronizing signal and saw-tooth wave.

The low-pass filter in the plate circuit of the amplifier tube  $T_3$  transmits the direct-current component of the signal at point  $D$  and greatly attenuates the alternating-current components. The amplified direct-current component or control signal at point  $F$  is applied as a positive bias to the grid of the scanning oscillator tube  $T_4$ . The frequency of the oscillator is a function of the grid bias. Consequently, the saw-tooth wave generated by tube  $T_5$  has a frequency controlled by the resistance  $R_6$  and the control voltage at point  $F$ . This signal is applied to the phase detector at point  $B$  by way of the feedback path.

The capability of the circuit for controlling the fre-

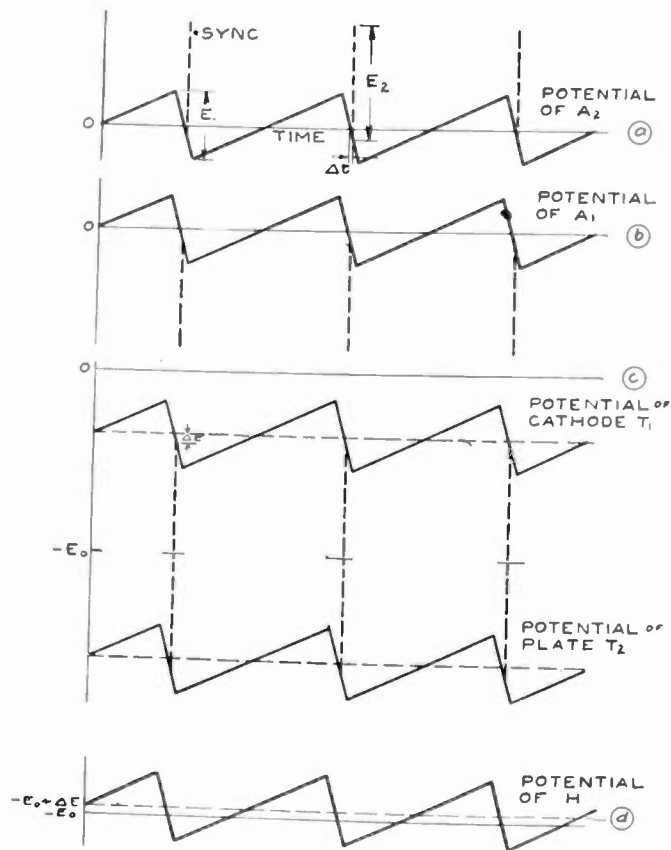

Fig. 7—Phase of saw-tooth delayed from equilibrium position of Fig. 6.

quency and phase of the saw-tooth wave may be understood with the aid of Fig. 7. Assume, as was done above, that Fig. 6 expresses a state of equilibrium in the circuit and that the frequency and phase of the saw-tooth will remain indefinitely as shown if the



circuit is not disturbed. Let Fig. 7(a) represent a departure from the equilibrium condition as a result of some disturbance such as a drifting in the values of circuit constants or voltages. The relative phase of the synchronizing signal and the saw-tooth wave differs from the equilibrium phase relation (Fig. 6(a)) by an amount  $\Delta T$ . As before, the peak rectifiers hold the peaks of the synchronizing signal at a potential  $-E_0$ . Hence, the alternating-current axis of the control signal at point *II* (Fig. 7(d)) is lowered by an amount  $\Delta E$ . The direct-current component at point *II* therefore amounts to  $-(E_0 + \Delta E)$  volts or an increment of  $-\Delta E$  volts over the equilibrium value in Fig. 6(d). This increment tends to increase the frequency of the oscillator and thus to shift the saw-tooth wave toward the position of equilibrium. Similarly, a departure from equilibrium shown in Fig. 8(a) and (b) gives rise to an increment of  $+\Delta E$  volts in the control voltage which acts to decrease the frequency of the oscillator and thus again restore the equilibrium of the circuit.

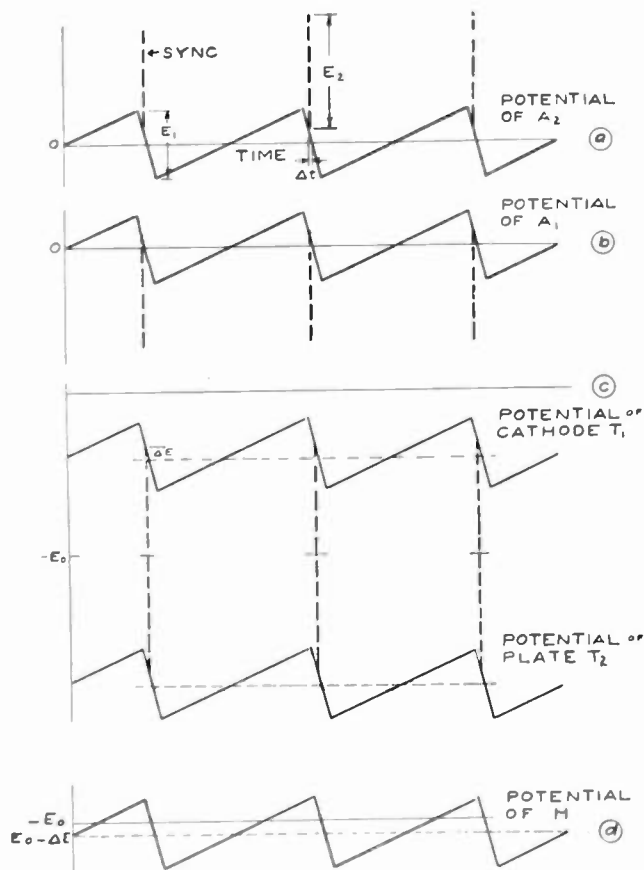

Fig. 8—Phase of saw-tooth advanced from equilibrium position of Fig. 6.

The amount of control or hold-in power available for overcoming phase and frequency deviations of the saw-tooth wave is proportional to the gain of the direct-current amplifier and to the difference between the direct-current components of the control signals at *II* corresponding to the two extreme phase conditions. Extreme conditions occur when a synchronizing pulse

occurs either at the maximum or minimum points of the saw-tooth wave. This difference is equal to the amplitude of the saw-tooth signal introduced at point *B* except for negligible voltage drops in the phase-detecting circuit.

When noise is present in the synchronizing signal, the voltage across the terminals  $A_1$ - $A_2$  contains noise

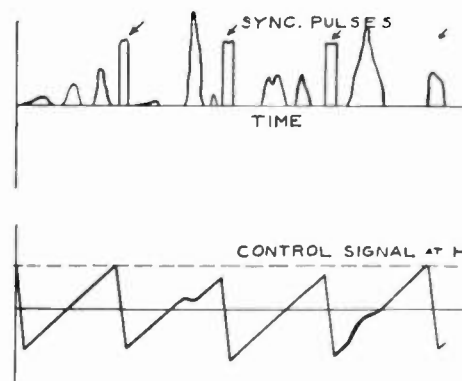

Fig. 9—Synchronizing signal and control signal when noise is present.

pulses which have been passed by the synchronizing separators as sketched in Fig. 9(a). The peak amplitude of some noise pulses exceed the bias voltage of the diodes and cause diode current to flow. Hence, the signal at point *II* resembles the erratic saw-tooth wave shown in Fig. 9(b) in which the noise pulses themselves are balanced out. The filter in the plate circuit of  $T_3$  transmits only the direct-current component and the slowly varying components of the grid voltage. All components above a few cycles per second in frequency are effectively suppressed. The slowly varying components represent a persistent trend in the alternating-current axis away from the equilibrium position and give rise to a change in the control voltage applied to the oscillator. The resulting deviation in the phase and frequency of the oscillator is automatically minimized by the restoring effect of the automatic frequency- and phase-controlled circuit.

Almost identical constants have been used in the filters for the horizontal and vertical circuits. The response of the filter is reduced to about one third for a sine wave of 1 cycle per second and the response to 60 cycles is practically zero. Therefore, individual scanning lines cannot be perceptibly displaced with respect to neighboring lines. That is, the horizontal oscillator cannot respond to noise fast enough to impair horizontal resolution. In general, a triggered oscillator is sensitive to noise to an extent that horizontal resolution is decreased. Likewise the response to 30 cycles is so low that interlace is essentially perfect, even in the presence of severe noise or an imperfect vertical-synchronizing signal.

Another form of phase detector is shown in Fig. 10. This circuit uses four diodes and is inherently balanced, except for second-order effects. The circuit is more

complicated than the two-diode circuit of Fig. 5 but is somewhat easier to set up and adjust. The principle of operation is the same as the two-diode circuit, although the details are different, and a description can be given more easily in another manner. The four

order that the phase relation for a properly framed picture shall exist, the saw-tooth applied at point *D* must have the polarity for which the return-line portion has a positive slope. The reason for this requirement may be seen by tracing the operation of the

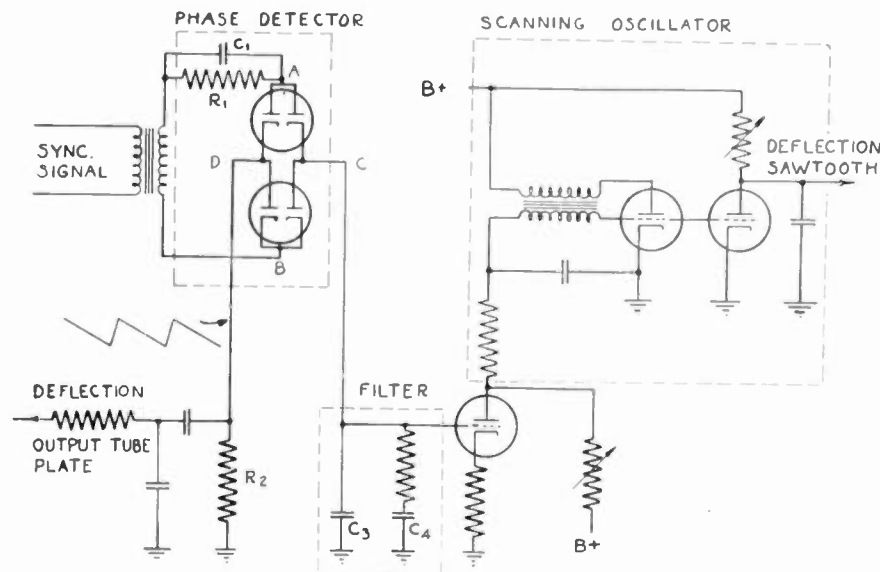

Fig. 10—Four-diode automatic frequency- and phase-controlled circuit.

circuit. Assume that the local oscillator is out of equilibrium in such a direction that its frequency is low. The return line (positive slope) of the saw-tooth will occur late, as shown dotted in Fig. 11 and the synchronizing pulse will occur at a more negative point as shown at *B*, rather than at *A*. The potential of capacitance  $C_3$  then becomes more negative and the plate of the amplifier tube becomes more positive with the result that the frequency is increased and the equilibrium restored.

The circuits shown in Figs. 5 and 10 require the application of saw-tooth signals of opposite polarity to the phase detector. Furthermore, the signal applied to the direct-current amplifier in Fig. 5 contains a saw-tooth component whereas the circuit

diodes may be considered as a single-pole single-throw switch which connects the output capacitance  $C_3$  to the input circuit resistance  $R_2$  during the synchronizing pulse interval. This is accomplished as follows: the four diodes may be considered as a bridge in which synchronizing pulses are applied in push-pull across the diagonal *AB* with polarities such as to cause current conduction in each diode. A direct-current biasing voltage, that maintains all diodes in the nonconducting stage during the intervals between pulses, is built up across the combination  $R_1C_1$ . This circuit is complete in itself; no battery is needed. The two corners *C*, *D* of the bridge are connected to the input and output circuits, respectively. It will be noted that each of these corners connect within the bridge to both a cathode and an anode. Thus, when the diodes are in a conducting state, current may flow in either direction between the input and output circuits. Capacitance  $C_3$  in the output circuit receives a charge which brings the potential at point *C* nearly to the value existing at the input point *D* during the synchronizing pulse interval. This voltage will, of course, depend upon the phase of the synchronizing pulse and the saw-tooth signals.

In the circuit of Fig. 10, the signal at *C* contains neither of the input signals but only a direct-current component which is corrected once during each pulse in accordance with the phase relation between the input signals. This voltage controls the output of the direct-current amplifier which acts through the feedback loop and causes the phase of the saw-tooth wave to vary until an equilibrium is reached. This equilibrium occurs on the positive slope of the saw-tooth. In

order that the phase relation for a properly framed picture shall exist, the saw-tooth applied at point *D* must have the polarity for which the return-line portion has a positive slope. The reason for this requirement may be seen by tracing the operation of the circuit. Assume that the local oscillator is out of equilibrium in such a direction that its frequency is low. The return line (positive slope) of the saw-tooth will occur late, as shown dotted in Fig. 11 and the synchronizing pulse will occur at a more negative point as shown at *B*, rather than at *A*. The potential of capacitance  $C_3$  then becomes more negative and the plate of the amplifier tube becomes more positive with the result that the frequency is increased and the equilibrium restored.

The circuits shown in Figs. 5 and 10 require the application of saw-tooth signals of opposite polarity to the phase detector. Furthermore, the signal applied to the direct-current amplifier in Fig. 5 contains a saw-tooth component whereas the circuit of Fig. 10 does not. Either circuit could be changed to operate the same as the other in these two respects by reversing the input and output connections of the phase detector. There are many possible variations in phase detectors. However, the two described have been used satisfactorily and serve to illustrate the important characteristics of this portion of an automatic frequency- and phase-controlled system.

In an automatic frequency- and phase-controlled system there is an approximate equivalent to the degree of lock-in of a tripped oscillator. The tripped oscil-

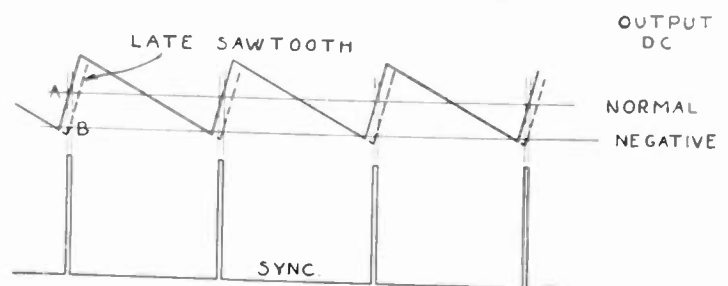

Fig. 11—Equilibrium and off-equilibrium conditions for four-diode circuit.

lator is locked in tighter when the amplitude of the synchronizing signal is increased. Greater susceptibility to noise is noticed in the tightly locked-in oscillator. In the automatic frequency- and phase-controlled system the amplitude of the synchronizing signal is relatively unimportant but the alternating-current gain from the phase detector to the oscillator influences the speed with which the oscillator may be changed in

frequency, that is, the tightness of lock-in. If the automatic-frequency and phase-controlled oscillator can be shifted rapidly, relatively few pulses are required to obtain control and noise is averaged out over a short period. Conversely, if the gain is low, many consecutive pulses are necessary to obtain control and noise is averaged out over a long period, a condition which is obviously desirable. A low alternating-current gain, unfortunately, has another effect; i.e., when the receiver has just been turned on, or for some other reason is completely out of synchronism, the time for pulling into synchronism may be excessively long.

The mechanism of pull-in in an automatic frequency- and phase-controlled system may be outlined as follows: Assume that when no signal is received, the speed-control setting is such that the frequency of the oscillator deviates from synchronous frequency by a small amount. When a synchronizing signal is received, the phase detector generates an alternating-current wave, the frequency of which is the difference frequency of the synchronizing signal and the locally generated saw-tooth wave. If the difference frequency is attenuated strongly by the filter, there is little or no tendency for the oscillator to pull in since no direct-current control signal is generated. If the filter is such that some components of control voltage are passed without excessive phase shift and attenuation, the frequency of the oscillator tends to follow the instantaneous value of the control signal.

When the oscillator is pulled toward synchronism, the momentary difference frequency is decreased and the oscillator tends to remain longer in this phase than in the opposite phase during which the difference frequency is increased. This amounts to a distortion of the control signal which produces a new axis of the control voltage in the direction to pull the oscillator toward synchronism. The oscillator may be said to take three steps toward synchronism and two away, the sequence continuing until the deviations become sufficiently small and the oscillator falls into synchronism. Low phase shift through the filter and appreciable alternating-current gain are favorable for rapid pull-in. However, since the system employs a feedback loop, care must be taken to avoid self-oscillation. These requirements have led to the unusual filter, shown in Figs. 5 and 10.

An automatic frequency- and phase-controlled system, unlike a triggered system, is not limited to a single phase relationship between synchronizing and deflection. That is, the blanking bar may be caused to occur, tightly locked in, anywhere on the screen. This means that the deflection-return line may start at the beginning of the "front porch,"<sup>1</sup> ahead of the synchronizing pulse, thus greatly easing the return-line time requirements in the deflection system. Shifting of the blanking

bar is accomplished as follows: Equilibrium, as previously stated, occurs with the synchronizing pulse located on the return line of the saw-tooth signal applied to the phase detector. This saw-tooth, however, need not be taken directly from the oscillator. The steep edge of the original saw-tooth wave may easily be delayed and, since the synchronizing pulse occurs in equilibrium on this delayed edge, the blanking bar must necessarily occur after the oscillator has tripped. An appropriate delay for horizontal deflection occurs automatically if the saw-tooth is made by integrating the pulse on the plate of the deflection tube, the delay being caused by the deflecting coil itself.

#### EXPERIMENTAL RECEIVERS

Several experimental receivers incorporating automatic frequency- and phase-controlled circuits have been constructed. These have been tested both in the

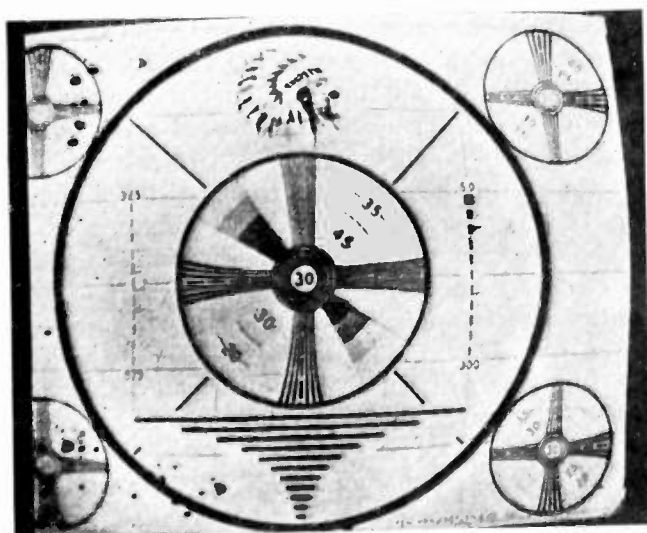

Fig. 12—Automatic frequency- and phase-controlled receiver—interference from high-frequency buzzer.

laboratory and the field and have given remarkably superior performance over conventional receivers for limiting conditions of service. Some pictures were taken in an attempt to show this difference but obviously it is impossible to convey accurately information regarding accuracy of synchronization by means of a still photograph. Fig. 12 shows a test pattern received by an automatic-frequency and phase-controlled receiver when operating with a signal above the hiss level but with interference from a high-frequency buzzer. The interference can be seen only as short black lines, and the figure serves mainly to show the resolution and interlace obtained essentially in the absence of noise. Exposure for this and the other test-pattern pictures was approximately 1/15 second, or 2 frames.

Figs. 13 and 14 are test patterns showing the relative synchronizing capabilities of a conventional receiver and an automatic frequency- and phase-controlled receiver in the presence of about equal amounts of hiss

<sup>1</sup> The term "front porch" refers to the part of the synchronizing signal between the beginning of the blanking signal and the front edge of the synchronizing pulse.

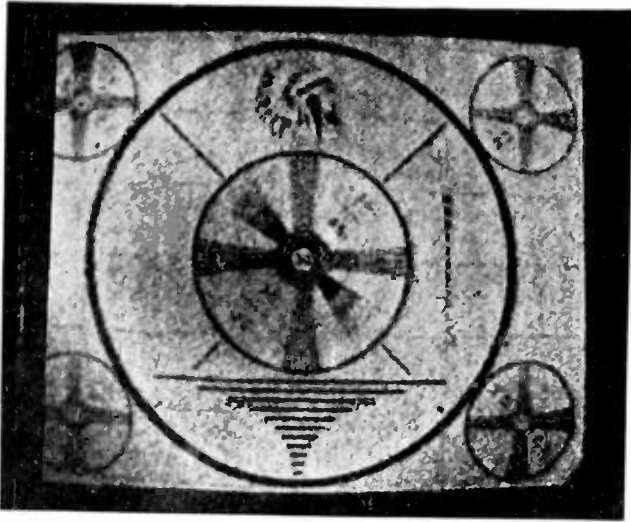

Fig. 13—Conventional receiver—hiss noise.

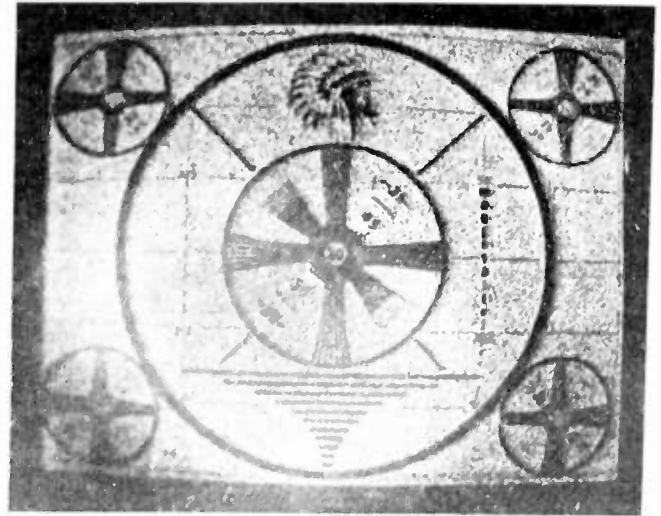

Fig. 14—Automatic frequency- and phase-controlled receiver—hiss noise.

noise. The loss of horizontal resolution and lack of interlace are plainly evident in Fig. 13. Resolution in Fig. 14 is limited only by the modulation of the kinescope by noise. This observation was made when a noise-free driven synchronizing signal was substituted but the picture signal left unchanged. Interlacing in Fig. 14 is not perceptibly affected by noise.

The interference in Figs. 15 and 16 was caused by an electric razor. Synchronization in Fig. 15 (conventional receiver) is lost entirely during severe noise peaks. Horizontal resolution is also seriously affected. Fig. 16, received on an automatic frequency- and phase-controlled receiver, does not exhibit the loss of resolution seen in Fig. 15.

The operating characteristics of an automatic frequency- and phase-controlled receiver and of a conventional receiver are quite different. During severe noise conditions a picture synchronized by automatic frequency and phase control remains together as a whole but may appear to move slightly about the

equilibrium position in a random manner. Single lines or groups of lines cannot tear out horizontally because the filter in the horizontal circuit does not pass components of the control signal which would cause abrupt changes in oscillator speed. When synchronizing signals are obliterated for an appreciable length of time, the vertical and horizontal oscillators run at the free-running speed until synchronization is re-established. When the receiver is properly adjusted, the free-running speeds are equal to or very close to the synchronous speeds, a condition which favors pull-in.

Automatic frequency- and phase-controlled synchronization is not entirely without disadvantages. For instance, reasonably good stability must exist in the synchronizing generator at the transmitter. However, the tentative standard recommended by the Federal Communications Commission is deemed entirely adequate and present synchronizing generators are well within the recommended standard. Also, since the system is slow to fall out of synchronism, it is likewise

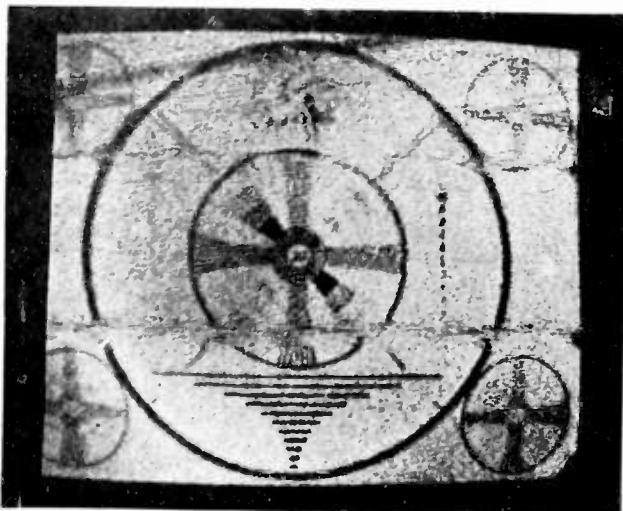

Fig. 15—Conventional receiver—interference from electric razor.

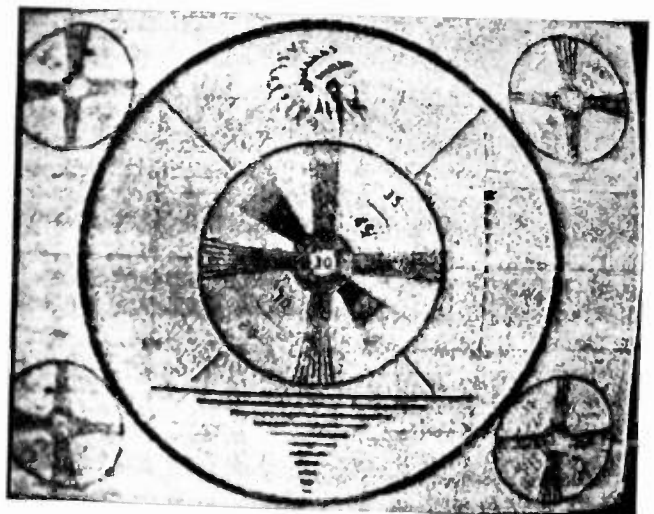

Fig. 16—Automatic frequency- and phase-controlled receiver—interference from electric razor.

slow to pull into synchronism. For instance, during a local thunderstorm, when a multiple lightning stroke obliterates the signal for a considerable portion of a second, the oscillators may fall out of synchronism and require as much as a second to resynchronize.

The system is sensitive to line-voltage variations unless glow-tube regulation is used. The regulated power required is small, however, and the chief objection is that occasioned by the extra tubes and sockets.

#### CONCLUSIONS

Superior reception resulting from the use of auto-

matic frequency- and phase-controlled synchronizing has been experienced in field tests under conditions of severe noise such as may exist occasionally even within the normally useful service area of a television station. Horizontal resolution is found to be limited only by modulation of the kinescope by noise. Noise does not destroy interlacing of scanning lines. Tearing of the picture in horizontal strips and rapid vertical movement which may occur in a conventional receiver during severe noise bursts are essentially eliminated by the long time constants of an automatic frequency- and phase-controlled system.

## Engine-Driven Emergency Power Plants\*

KARL TROEGLEN†, MEMBER, I.R.E.

*Summary*—This paper covers various factors involved in the selection, installation, and maintenance of a power plant used by radio station WIBW to furnish emergency power for its transmitting station.

AS THE importance of radio broadcasting increases in the everyday life of the American people, the need of increased reliability of this service also grows, if the listener and commercial interests are to be served properly. Failure of technical facilities affecting this reliability of service can generally be divided into two classes.

1. Those under the control of the station engineer.
  - (a) Studio and transmitter equipment failure.
2. Those beyond the control of the station engineer.
  - (a) Telephone-facilities failure.
  - (b) Power-supply failure.

It is the power-supply problem with which we shall concern ourselves at this time. Until recently engine-driven power units were commercially available in wide variety. Since such machines are increasingly difficult to obtain now, it is of special interest to see what can be accomplished with a power-supply assembly made up of separately purchased components not necessarily designed for use together. The finished machine should have the following characteristics:

1. It should be able to furnish its full output continuously. The voltage and frequency stability should be sufficient, under moderate load variations, to avoid causing serious carrier shift.
2. It should be easy to start and capable of delivering full load in as short a time as possible so as to reduce carrier interruptions to a minimum.
3. It should be built from component parts that are in common use so that repairs to both motor and generator can be made more easily.
4. It should be as simply constructed as is possible.

\* Decimal classification: R356.2. Original manuscript received by the Institute, March 10, 1942; revised manuscript received, October 2, 1942. Presented, Broadcast Engineering Conference, Columbus, Ohio, February 24, 1942.

† WIBW, Topeka, Kansas.

5. It should offer a minimum of installation problems.

6. It should operate economically.

7. The price of the machine should be reasonable. Power interruptions in some areas are so infrequent it is difficult to justify a large expenditure.

While various types of machines are available, consideration of the above-named features indicates that only two types of engine-driven supplies have most of these characteristics.

1. Diesel-driven units
2. Gasoline or natural-gas-driven units.

The Diesel-driven machine has the advantage of slower speed and lower fuel consumption (in cost per kilowatt hour). However, it weighs considerably more than an ordinary gasoline engine for the same power delivered and offers some starting problems not encountered with a gasoline engine. The problem of maintenance and repair is also more complex in the case of the Diesel. The original cost of a gasoline-engine-driven machine is quite a bit lower than that of a Diesel. While the Diesel is more economical for continuous use, it is not so economical as the gasoline engine for use over short periods of time.

Thus the machine decided upon for our station consists of a general-purpose gasoline engine of reliable manufacture and a standard, well-known alternator with externally mounted exciter.

The six-cylinder engine, designed to deliver 82-brake horsepower at 1200 revolutions per minute, is equipped with a standard centrifugal governor for speed regulation. This governor has two movable weights which are attached to a gear connecting with the crankshaft. As the speed of the machine increases, these weights press against a bar which in turn moves the lever controlling the carburetor flipper valve. Thus by controlling the amount of gasoline entering the engine, the speed is held essentially constant. Experience indicates that this type of governor is not so

rapid in action as the flyball type but is still satisfactory, as will be shown later. Starting is accomplished by a standard starter motor operated automatically by a Bendix Startix. A 12-volt starting and ignition system is used to facilitate easy starting; a Sisson electric choke is used in conjunction with the starting system. The engine is equipped with oil and air filters and a standard generator. A thermal cutout is provided which opens the starting circuit if repeated cranking does not start the machine and a backfire

and short-circuiting the exciter field rheostat. Since this is 60-cycle current, the regulator actually functions 120 times per second. Any change in alternator voltage is thus compensated for by the regulator. The total range over which this regulator will control the output voltage depends on the adjustment of the contacts. The automatic transfer switch is conventional in that it has full three-phase protection. The emergency supply is started when any one of the phases of the regular supply drops to 70 per cent of

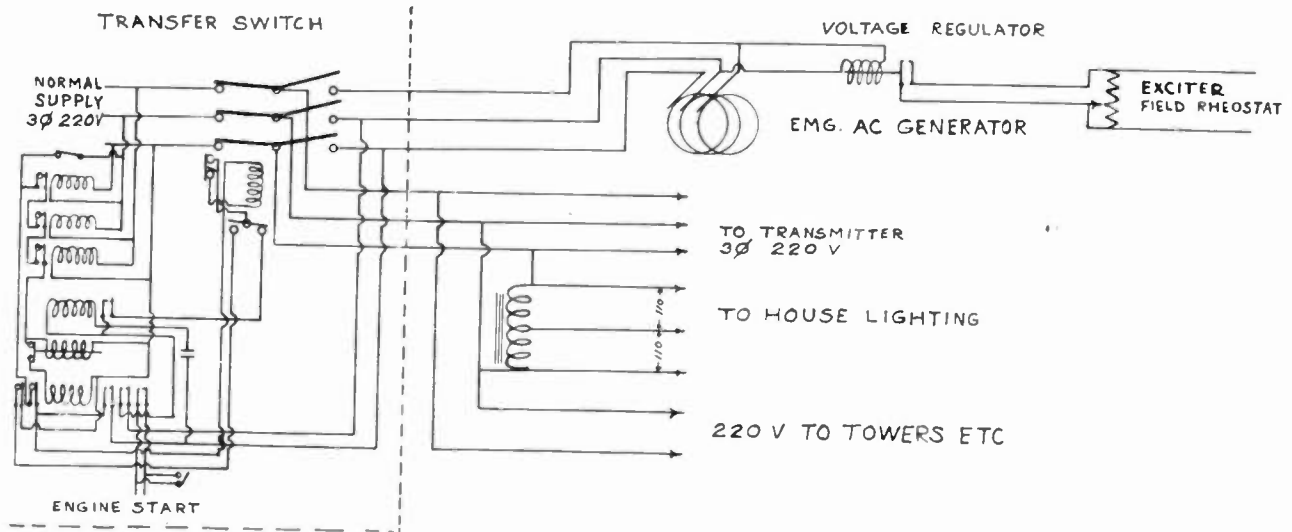

Fig. 1—Transfer switch and connections to generator and building wiring.

cutout is provided which opens the ignition circuit in case of engine backfire. The generator is rated at 37.5 kilovolt-amperes and will deliver 30 kilowatts at 0.80 power factor. This output is at 220 volts, 60 cycles, three phase in a three-wire circuit. A three-wire system is used in this installation for several reasons. First, the power to the building is brought in on three wires. Inside of the building, a 5-kilovolt-ampere auto-transformer across one phase is used to supply the 120-volt circuits. By using a three-wire system the automatic switch can be used to transfer from normal to auxiliary supply at the point where the power enters the building. A three-wire system is more economical to install. In some cases it might be better to install a four-wire system, in this way dispensing with the house transformer. The engine and generator are mounted on a welded-steel frame made of 10-inch channels. The over-all size of the machine is 103 inches long, 30 inches wide, and 67 inches high. The weight is about 4000 pounds. The engine and generator are coupled through a large double-flange type of coupling. A vibrator-type regulator is used to regulate the output voltage under varying load conditions. This type of regulator is inexpensive and seems to function very well in this service. A solenoid is energized from one of the three phases of the alternator. Inside of this solenoid is a floating core which serves to open and close a set of contacts, thereby alternately inserting

its normal value. Transfer is effected as soon as the voltage and frequency of the emergency supply reach predetermined values and is controlled by a tuned relay circuit. After the regular supply voltage has been restored to at least 90 per cent of normal on all three phases, return to the regular supply is delayed for a predetermined period by a time-delay relay. This is done to avoid outages due to the regular supply coming on for a few seconds and dropping out again. Switches are also provided to start the machine for test purposes and to permit connecting the load to the emergency supply even if the regular supply has not failed. The machine will start and connect itself to the load in from four to six seconds. The transfer back to the regular supply is so rapid that no carrier interruptions are apparent. A circuit diagram of the power supply and auxiliary alternating-current wiring is shown in Fig. 1.

In planning the installation of such a machine it is best to consult with the local Fire Inspection Bureau. While the National Fire Underwriters do have some regulations regarding the installation of such machines, the local rules take precedence. Generally speaking, the machine should be located in a well-lighted and well-ventilated room, preferably on the first floor. If the machine is to be mounted on a wood floor, the floor within 24 inches of the machine should be covered with some fireproof material. An overflow pipe from

the carburetor back to the fuel-supply tank should be provided. Exhaust pipes should be run so as not to present a fire hazard. Buried fuel tanks must be so buried that the top of the tank is at least 30 inches under ground and they must be properly ventilated. Fuel pipes should be at least of one-quarter inch inside diameter and of either wrought iron or copper. Where copper is used precautions must be taken to protect this pipe from mechanical damage.

In our case the machine was set up in a room especially intended for this purpose. It is 10 by 20 feet with a 10-foot ceiling height. The room is well lighted and can be ventilated when the machine is in operation. The machine, being equipped with a standard truck radiator, depends entirely on the surrounding air for its cooling. A gauge on this radiator shows that even after several hours of operation at ambient temperatures about the 100-degree mark, the water temperature did not go above 180 degrees Fahrenheit. The room is heated in winter to facilitate easy starting. The machine is set on a single layer of Keldur which serves as an efficient vibration deadener. Mounting bolts are insulated from the machine by Keldur bushings and washers. A 250-gallon tank buried just outside of this room serves as the fuel-supply container. The top of this tank is actually five feet below the gasoline pump on the engine but this has presented no problem as

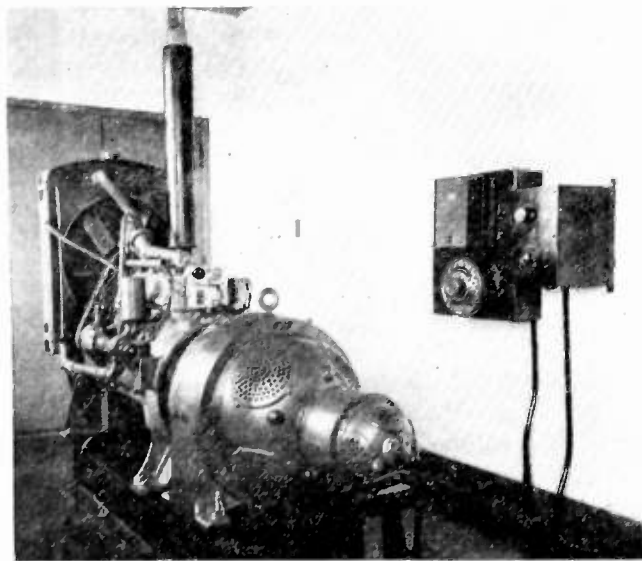

Fig. 2—Plant as installed with exciter field rheostat and voltage regulator mounted on wall next to battery charger.

the pump is well able to lift the gasoline this distance. As shown in Fig. 2, the muffler is mounted directly on the exhaust manifold. From this muffler a three-inch pipe about ten feet long leads to the outside to serve as an exhaust for the engine. To prevent this pipe from being a fire hazard it was led through the wall in the center of a foot-square hole. The space between the pipe and the wall was filled with the clay used to pack between bricks in a furnace firebox.

After installation it is necessary to adjust the engine speed and generator voltage to the desired operating conditions. While it is desirable to have a voltmeter and frequency meter as an integral part of this machine, experience showed that they were not necessary once the system was adjusted. The voltmeter, which

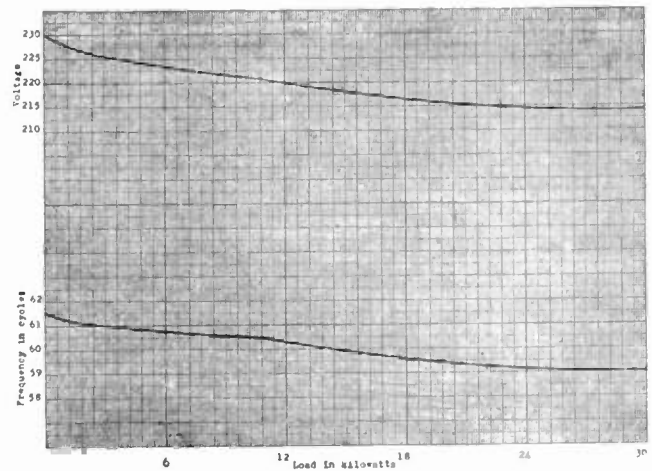

Fig. 3—Voltage and frequency change as plant load is increased from no load to full load.

is part of the transmitter proper, serves as a constant-voltage check. While the operating frequency can be checked in various ways, an oscilloscope was used in this case, the commercial supply being considered as normal 60-cycle current. Other methods which would also serve the purpose are:

1. Synchronous phonograph motor with stroboscope disk and a neon light operated from the commercial supply.
2. Two synchronous clocks, one connected to normal supply the other to the emergency supply.
3. Motor-speed indicator of the type used by motor-repair shops to check reconditioned motors.

The performance of this machine is indicated in Fig. 3. The voltage and frequency graphs were made under actual operating conditions by turning on the lighting, heating, and transmitter load in stages. The gradual decreasing of the output frequency is due to the slowing down of the gasoline engine. It can be seen that the voltage regulator becomes very effective after the machine is carrying approximately one half of its full load. Under operating conditions the output frequency was observed to hunt slightly, varying a quarter of a cycle above and below the operating value. This frequency shift is slow and irregular and hence is not shown on the graph. The frequency variation, however, was not noticeable when electrical transcriptions were played and when the turntable was run from this power source. Fig. 3 shows that from no load to full load the output frequency varied from 61.5 to 59 cycles. This is equal to an engine-speed variation of from 1230 to 1180 revolutions per minute. This regulation is sufficient for ordinary uses and

would present no problem to stations equipped with automatic voltage regulators on the transmitter input. Fuel consumption under full load is six gallons per hour.

#### MAINTENANCE

The maintenance routine consists of regular inspection and cleaning. The starting battery is kept fully charged at all times. The machine is given an actual load running test weekly so as to operate the transfer switch and machine under service conditions.

#### CONCLUSIONS

That machines of this type will give satisfactory results in radio stations even for continuous service is evident from the fact that this machine has been in service for nearly three years. The transmitter is a Western Electric 355-E-1, 5-kilowatt unit, low-level-modulated, and it has only a water pump and fan as

rotating components. No extreme voltage surges have ever occurred when part of the load was removed or rapidly applied. Under these conditions there is a voltage swing, but due to the inertia of the machine it is not very rapid. When operating under full load, the output voltage actually is more constant than that of our normal supply. There seems to be no need for either a frequency meter or speed indicator on the output of this machine. The speed adjustment was set when the machine was installed and has not had to be changed since that time. Care in selection should be exercised to insure that the machine is capable of handling the load with a generous reserve margin. Generally speaking the gasoline engine should be able to furnish from 2.5- to 3-brake horsepower per kilowatt of delivered output power. This is especially necessary where the load on the machine varies due to modulation of the broadcast transmitter.

## Selected Problems in Architectural Acoustics\*

M. RETTINGER†, NONMEMBER, I.R.E.

*Summary*—The paper discusses a number of undesirable acoustic effects together with measures which have to be taken to avoid or ameliorate these conditions. The first problem discussed deals with the absorption of high-frequency sound in air, the change of high-frequency reverberation with relative humidity of the air in a specific enclosure, and the average surface absorptivity required in this room to provide constant reverberation time for frequencies above 1000 cycles. Noted also is the energy reduction of high-frequency sound with change in reverberation and the air attenuation of high-frequency sound as a function of distance. In another problem the effects of sound interference are pictured as a function of the distance between source of sound and the point of observation and attention is drawn to the interference-reducing effect of surfaces not too highly reflective. After a comparison between "optic" and "acoustic diffusers," there is cited and pictured graphically the (Rayleigh) solution to the problem of the interference effect produced by a wall of sinusoidal cross section.

IT IS the purpose of this paper to consider in some detail a number of problems in acoustics pertaining to recording studios and the conditions of microphone pickup. A case deserving attention, particularly in the recording of music, is the absorption of high-frequency sound in air and the change of reverberation time of these higher registers with a change in the relative humidity of the air. Fig. 1 (after Knudsen<sup>1,2</sup>) shows the absorption of sound in air for various frequencies as a function of relative humidity, while Fig. 2 shows the (extrapolated) absorption characteristic for various degrees of relative humidity. In order to obtain an illustrative picture of the degree in which

high-frequency sound is absorbed in a room, let us consider a scoring stage of 100,000 cubic feet volume having a reverberation time of 1 second at 1000 cycles. This means, working with the "Sabine reverberation-time formula," that the total absorption of sound in the room at 1000 cycles comes to

$$\begin{aligned} A &= \frac{0.05V}{T} \\ &= \frac{0.05 \times 100,000}{1} \\ &= 5000 \text{ sabines} \end{aligned}$$

where  $A$  = total absorption units (sabines)

$T$  = reverberation time (seconds)

$V$  = volume (cubic feet).

Let us further assume that by some means it became possible to keep this total (surface) absorption constant for all frequencies above 1000 cycles. Fig. 3 depicts the reverberation characteristic of this room when the absorptivity of the air is taken into consideration according to

$$T \frac{0.05V}{[A + 4mV]}$$

where  $m$  represents the absorptivity of air as shown on Figs. 1 and 2. It is seen that the reverberation time for the higher registers is rather short, even at the relative humidities of 40 and 50 per cent.

The question naturally arises now what the average absorptivity characteristic of the wall surfaces would have to be if a constant reverberation time of 1

\* Decimal classification: 534. Original manuscript received by the Institute, July 21, 1941; revised manuscript received, November 4, 1942.

† RCA Manufacturing Co., Hollywood, California.

<sup>1</sup> V. O. Knudsen, "The effect of humidity upon the absorption of sound in a room, and a determination of the coefficient of absorption of sound in air," *Jour. Acous. Soc. Amer.*, vol. 3, p. 120; July, 1931.

<sup>2</sup> V. O. Knudsen, "Absorption of sound in air, in oxygen, and in nitrogen effects of humidity and temperature," *Jour. Acous. Soc. Amer.*, vol. 5, p. 112; October, 1933.



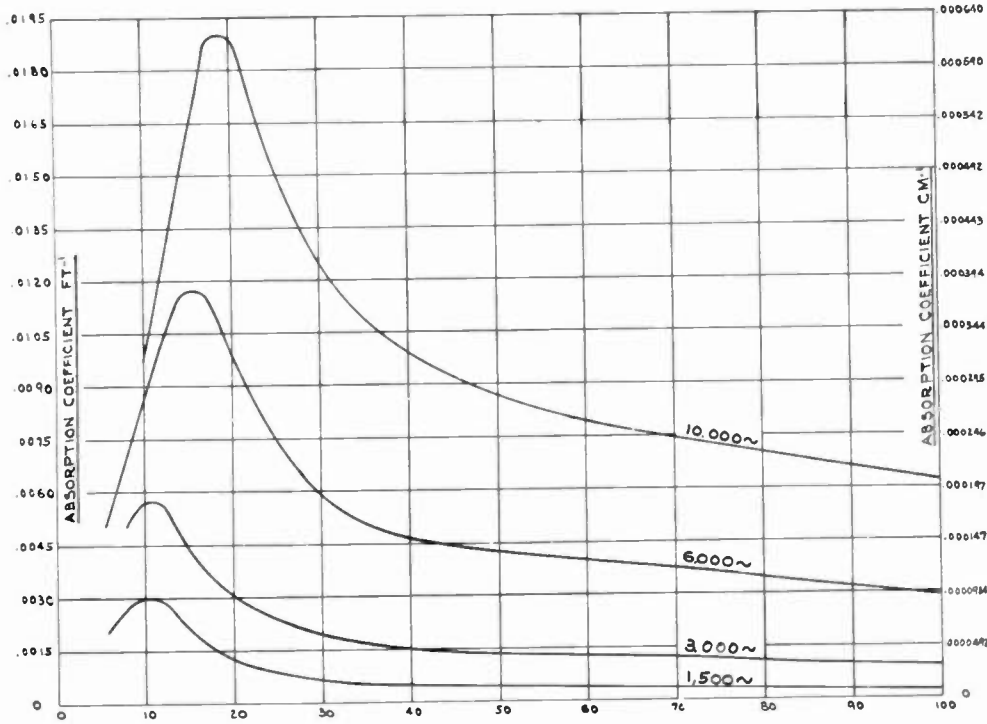

Fig. 1—Absorption of sound in air at 20 degrees centigrade (68 degrees Fahrenheit) and relative humidities shown on the X axis.

second were desired in the room. For this purpose let us assume that the ratio of dimension for the height, width, and length of the enclosure of 100,000 cubic feet corresponds to the oft-quoted ratio of 2:3:5, so that the total interior surface will come closely to 14,000 square feet. Fig. 4 represents, for various per cent relative humidities, the absorptivity characteristic of the wall material required to secure a constant

reverberation time of 1 second for all frequencies above 1000 cycles. This figure shows that at low relative humidities it is impossible to secure this condition of constant reverberation time, while for higher relative humidities some effort may have to be exerted to devise an acoustic treatment exhibiting the decreased absorptivity called for on Fig. 4. The question as to the most desirable reverberation characteristic in

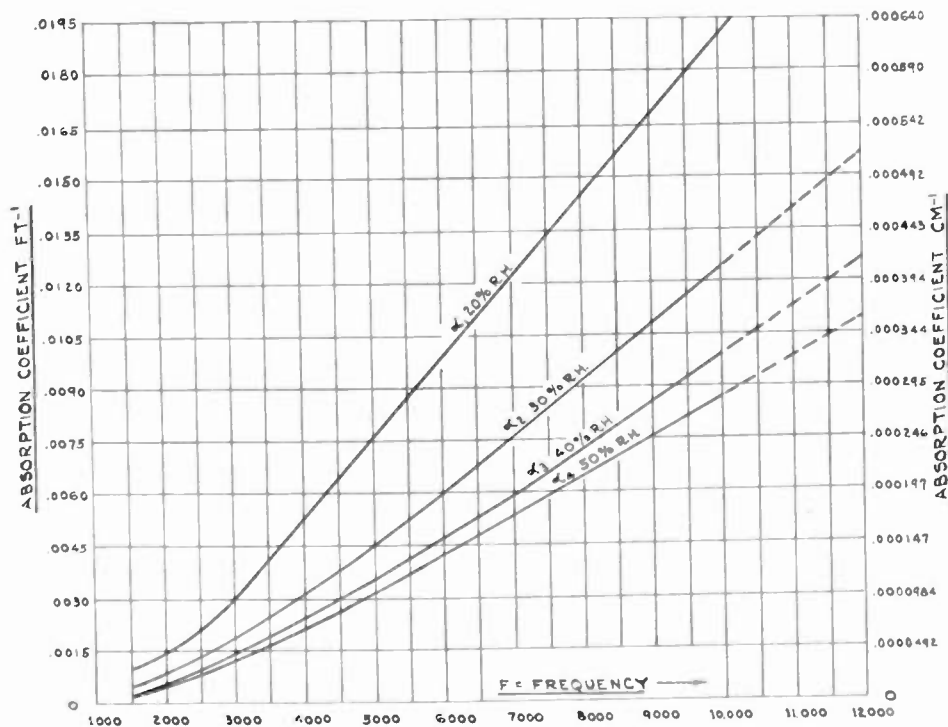

Fig. 2—Absorption characteristic of sound in air for various degrees of relative humidity.

recording studios has been widely discussed in the literature, with the result that a number of criteria for this characteristic are available. In this connection the

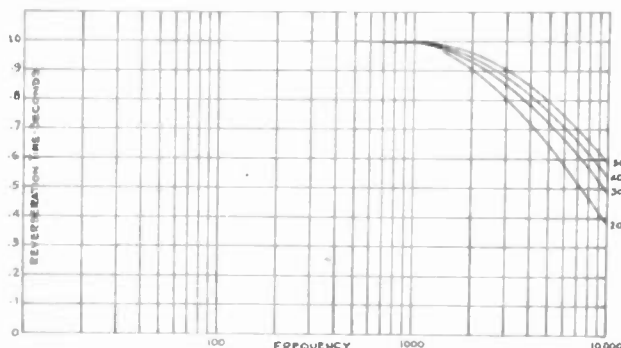

Fig. 3—Variation of reverberation time with frequency in a room of 100,000 cubic feet volume at 20 degrees centigrade and various per cent relative humidities, assuming constant boundary absorption (5000 sabines) above 1000 cycles.

reader is also referred to a recent article by the author dealing at some length with this subject.<sup>3</sup>

Fig. 5 shows the reverberation characteristic of a scoring stage recently completed in Hollywood as measured with a high-speed level recorder while the relative humidity in the stage was 40 per cent. The high absorption required in the stage for the frequencies below 1000 cycles was achieved not so much by means of one particular acoustic material as by means of an acoustic treatment for which conversion of sound energy into heat through the frictional resistance of the pores of the wall surfaces was small. Porous materials are notoriously high absorbers of high-frequency

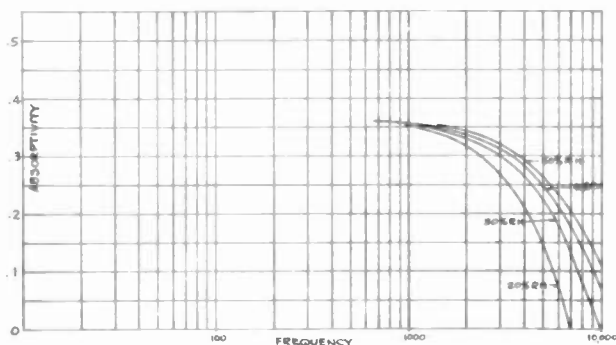

Fig. 4—Average absorptivity required of boundary material in a room of 100,000 cubic feet volume and 14,000 square feet interior surface at 20 degrees centigrade and various per cent relative humidities to secure constant reverberation of 1 second.

sound while frequently their low-frequency absorption is comparatively small. The acoustic treatment employed in this particular stage consisted of variously sized panels of oil-painted high-density fiberboard nailed to studs and backed by rockwool which exerted a damping action. Such a treatment provides decreasing absorption with increasing frequency, which is the condition previously specified for constant reverberation time above 1000 cycles.

<sup>3</sup> M. Rettinger, "A modern music recording studio," *Jour. Soc. Mol. Pic. Eng.*, vol. 39, p. 186; September, 1942.

The lowering of the reverberation time brought about by a change in the relative humidity is accompanied by a sound-energy reduction within the enclosure. The sound-energy reduction is given by

$$db = 10 \log \frac{T_1}{T_2}$$

where  $T_1$  is the reverberation time at a relative humidity  $R/H_1$  and  $T_2$  the reverberation time at a relative humidity  $R/H_2$ .

In this connection it may be of interest to note the reduction in sound energy due to air absorption for the higher registers as a function of distance. Fig. 6 shows this relationship graphically, and it is seen that this sound-energy reduction is rather large even at moderate distances from the sources. This condition points clearly to the desirability of employing, particularly in the recording of music where the microphone distance may be large, a recording characteristic in which the high frequencies are considerably amplified.

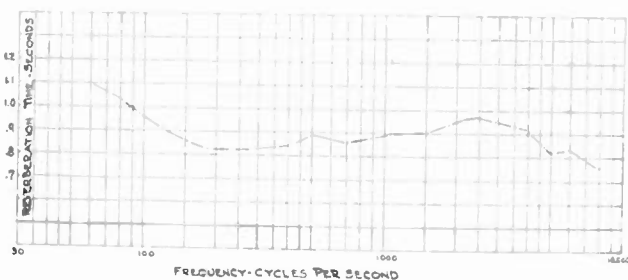

Fig. 5—Reverberation of Hollywood scoring stage as measured with a high-speed level recorder.

It should be noted that the amounts of attenuation shown on Fig. 6 are those due entirely to the absorption of sound in air. These amounts were calculated as follows (assuming an inverse square field, as in the open):

$$\begin{aligned} \text{Let } I_2 &= I_1 \exp[-m(d_2 - d_1)] \\ \text{where } I_1 &= \text{intensity of sound at distance } d_1 \\ I_2 &= \text{intensity of sound at distance } d_2 \\ m &= \text{absorption of sound in air (values of Fig. 1).} \end{aligned}$$

The attenuation, therefore, comes to

$$\begin{aligned} db &= 10 \log I_2/I_1 = 10 \log \exp[-m(d_2 - d_1)] \\ &= -4.3m(d_2 - d_1). \end{aligned}$$

The total decrease in sound level as the point of observation is moved from  $d_1$  to  $d_2$  is given by

$$-db = 20 \log d_2/d_1 + 4.3m(d_2 - d_1).$$

Another undesirable acoustic effect which deserves some scrutiny in connection with the recording of sound is that produced by interference. It is well

known that when the path difference between a reflection and the direct sound "ray" amounts to a wavelength or a multiple thereof, sound reinforcement takes place, while when this path difference comes to a half wavelength or an odd multiple thereof cancellation or destructive interference occurs. As the frequency spectrum is traversed, there occurs at a point of observation a series of sound pressure (or particle velocity) maxima and minima as shown on Fig. 7. If we move the microphone to a greater distance, similar maxima

which are flat in a recording studio where the microphone distances employed are large. It may also prove advisable to use some covering on the floor, as this surface is usually the most likely to offend in this respect.

While the sound-pressure interference effects can

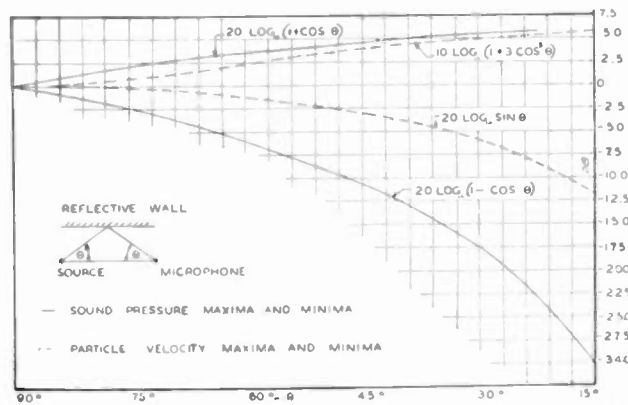

Fig. 8—Magnitude of sound pressure and particle velocity interference maxima and minima as a function of the angle  $\theta$ .

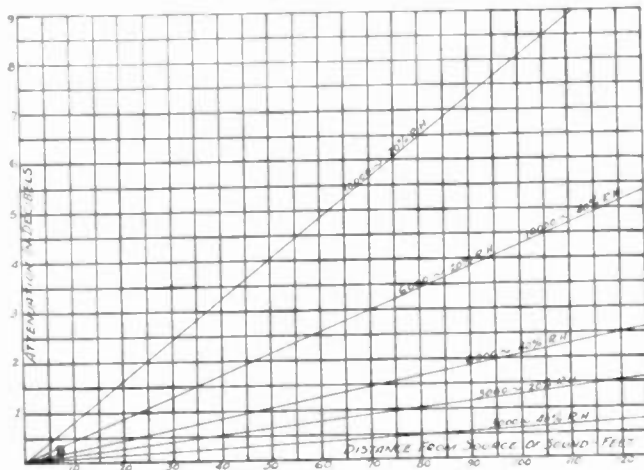

Fig. 6—Attenuation of sound due to absorption in air at 70 degrees Fahrenheit and relative humidities indicated on curves.

and minima occur which may be shifted along the frequency axis. The point to notice, however, is not the displacement of these partial nodes and antinodes along the frequency scale, but their change in value. The greater the microphone distance the more violent do these "peaks" and "dips" become. It may be of interest to note the change in magnitude of these interference maxima and minima as the point of observation moves farther away from the source. Fig. 8 depicts this relationship graphically. It is seen that a wall material with even relatively small absorptivity can markedly reduce this interference effect. This points to the inadvisability of employing large hard surfaces

readily be measured with a pressure microphone, care must be exercised when a velocity microphone is used. To obtain the absolute value of the particle velocity in an interference field it is necessary to take three independent readings with the velocity microphone being oriented along mutually perpendicular axes and then to take the vectorial sum of these readings.<sup>4</sup>

Rooms in which the acoustics of the enclosure is given marked consideration are often designed to have the wall surfaces well broken up, either in the form of pilasters, pillars, niches, etc., or by making the con-

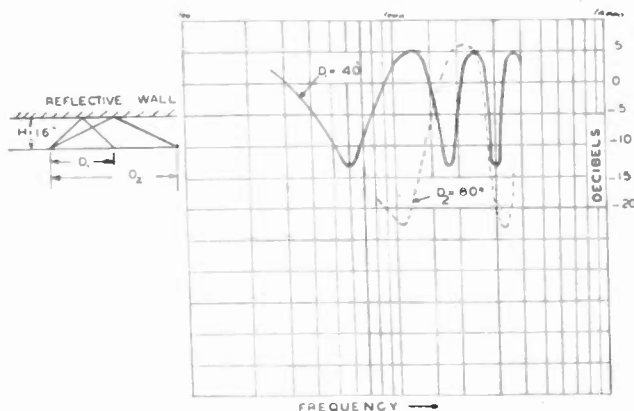

Fig. 7—Pressure interference maxima and minima produced by reflections from a reflective wall.

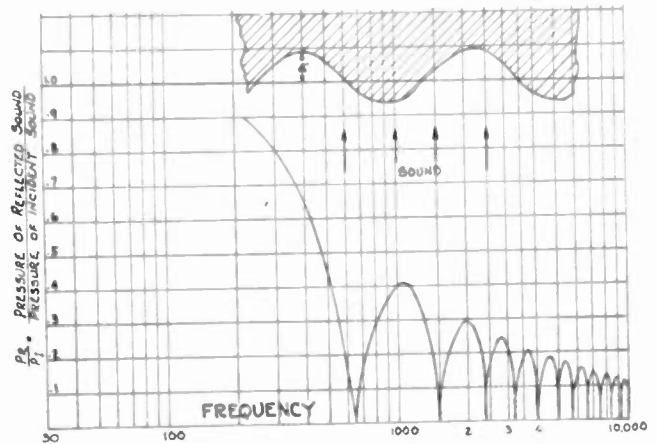

Fig. 9—Sound-reflection characteristic from a rigid non-porous wall of sinusoidal contour.

tour of the entire wall itself more or less irregular. The chief benefit of such irregularities of wall surface lies in the reduction and even complete elimination of the echo effect (at least as far as the ear is concerned). No examination shall be made here as to the ineffectual use of such irregularities in altering the number of

<sup>4</sup> H. F. Olson and F. Massa, "Applied Acoustics," second edition, P. Blakiston's Sons and Co., Philadelphia, Pennsylvania, p. 311.

room resonances or eigentones in an enclosure of given volume.<sup>5</sup>

In evaluating the dispersing or diffusing effect of irregularly shaped wall surfaces it may be advisable to consider more closely the term diffuser or diffuse reflector. In optics a diffuse reflector is one which obeys Lambert's cosine law; that is  $I = I_0 \cos \theta$ , where  $\theta$  is the angle between the normal to the surface and the given direction, and  $I_0$  the intensity along the normal. It should be appreciated here that in the case of good light diffusers, such as freshly fallen snow for instance, a great deal of the light which penetrates the material to a considerable extent and suffers numerous reflections in its transit is eventually reflected back into the original medium. This is hardly possible in the case of sound, however, where a large portion of the incident energy is absorbed (changed into heat) if it enters the material. Nongeometric reflection of sound is therefore primarily dependent on surface irregularities and only secondarily on internal scattering.<sup>6</sup> For this reason the linear dimensions of wall irregularities must represent several wavelengths before it can be hoped to secure diffuse reflections of sound from such a wall. If this is not the case, if the irregularities are of the order of half a wavelength or even smaller, the wall will act in the first instance more like an acoustical mirror permitting mainly of specular reflections.

Rayleigh<sup>7</sup> investigated the case of sound reflection

<sup>5</sup> The reader is referred to recent issues of the *Journal of the Acoustical Society of America*.

<sup>6</sup> E. Skudrzyk, "Über die Eigentöne von Räumen mit nichtebenen Wänden und die diffuse Schallreflexion," *Akust. Zeit.*, vol. 4, p. 172; May, 1939.

<sup>7</sup> Lord Rayleigh, "Theory of Sound," Macmillan and Co., Ltd., London, England, vol. 11, p. 272a.

from a wall whose cross-sectional profile is that of a sine wave (see Fig. 9). The assumptions made are that the point of observation is considerably removed from the wall and that the sound is not permitted to penetrate the material to any great depth. Penetration of sound into the material will bring about not only a change in the amplitude of the peaks shown on the figure, but will also effect a shift of the peaks along the frequency axis. The equation<sup>8</sup> for the curve shown is

$$\frac{P_R}{P_X} = J_0(2kA)$$

where  $J_0$  = Bessel function of zeroth order

$$k = \frac{2\pi F}{c}$$

$c$  = velocity of sound

$F$  = frequency

$A$  = amplitude of the sine wave of profile.

A wall of this contour acts in the same manner as a Rowland grating in optics and produces acoustic spectral lines of the  $n^{\text{th}}$  order corresponding to path differences of  $rX$ .

From the foregoing we should appreciate the fact that wall irregularities, no matter how complex, can not eliminate interference of sound in a room. They are able, however, to eliminate echoes, and to effect some dispersion of sound, especially when they are convex.

<sup>8</sup>  $J_0(x)$ , for large values of  $x$ , is given approximately by  $\sqrt{2/\pi x} \cos(x - \pi/2)$ .

## A Frequency-Modulated Resistance-Capitance Oscillator\*

C.-K. CHANG†, NONMEMBER, I.R.E.

**Summary**—A method of producing frequency-modulated waves is described in which a resistance element in a resistance-capacitance-tuned oscillator is replaced by the output resistance of a variable- $\mu$  tube. As the grid potential of the latter tube is varied, its output resistance varies, and a wide-band frequency modulation of the oscillator is obtained. Mathematical relations between the frequency variation and the grid-potential change are derived. Experimental results are discussed.

### INTRODUCTION

AMONG the present methods of obtaining frequency modulation, the most successful have been the Armstrong method and the reactance-tube method. This paper describes a simple, alternative method which gives wide frequency deviation directly.

\* Decimal classification: R355.9×R414. Original manuscript received by the Institute, April 20, 1942; revised manuscript received, September 29, 1942.

† Stanford University, California.

A resistance-capacitance-tuned oscillator, as shown in Fig. 1, is employed. The frequency of oscillation is given by the expression<sup>1</sup>

$$f = \frac{1}{2\pi\sqrt{C_1 C_2 R_1 R_2}} \quad (1)$$

This shows that the frequency may be varied by varying  $R_1$  or  $R_2$ . Let  $R_1$  or  $R_2$  consist of the plate resistance of a vacuum tube. If the grid voltage of this tube (which we shall call the resistance tube) is varied, its plate resistance will vary, and the frequency of the oscillator will change accordingly. If the grid voltage

<sup>1</sup> F. E. Terman, R. R. Buss, W. R. Hewlett, and F. C. Cahill, "Some applications of negative feedback with particular reference to laboratory equipment," *Proc. I. R. E.*, vol. 27, pp. 649-655; October, 1939.

is varied at an audio rate, frequency modulation will result.

Ordinary triodes or pentodes are not suitable as resistance tubes when the oscillator frequency is of the order of several megacycles, because of their high plate resistance. However, by means of the cathode-follower circuit, there may be obtained a resistance of a low value which is equal<sup>2</sup> to

$$R = \frac{1}{G_m + \frac{1}{R_c}} \quad (2)$$

where  $G_m$  is the transconductance of the tube and  $R_c$  is the cathode resistor.

The complete frequency-modulated oscillator circuit is shown in Fig. 2. Here, the resistance tube ( $T$ ) is preferably a variable- $\mu$  tube. This type of tube allows greater variation of  $G_m$  with grid voltage than other types of tubes.  $L_1$  and  $L_2$  are high-frequency compensating coils which will be explained later.

MATHEMATICAL ANALYSIS

Let us now proceed to find a quantitative relation between the frequency of the oscillator and the change of grid potential of the resistance tube. The frequency of oscillation is repeated below:

$$f = \frac{1}{2\pi\sqrt{C_1 C_2 R_1 R_2}}$$

If  $R_2$  is replaced by the output resistance of the resistance tube, then, by substituting  $R$  of (2) for  $R_2$  and writing

$$\frac{1}{2\pi\sqrt{C_1 C_2 R_1}} = a,$$

we have

$$f = a \sqrt{G_m + \frac{1}{R_c}} \quad (3)$$

For simplicity, assume that  $R_c$  is large enough so that

<sup>2</sup> A. A. Barco, "An iconoscope pre-amplifier," *RCA Rev.*, vol. 4, pp. 89-107; July, 1939.

$(G_m + 1/R_c)$  is approximately equal to  $G_m$ ; then (3) can be written

$$f = a\sqrt{G_m} \quad (4)$$

For further simplification, suppose that the plate voltage of the resistance tube is high enough to cause the

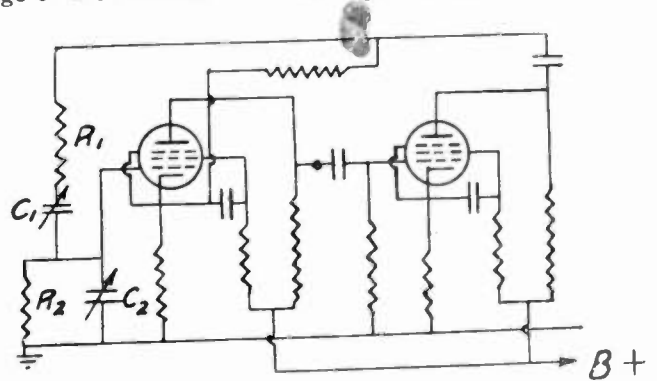

Fig. 1.—Typical circuit of a resistance-capacitance-tuned oscillator.

plate to receive most of the space current. Then for the plate current we can write

$$I_p = k(E_o + E_{s0}/\mu_{s0})^{3/2}.$$

Now suppose that the value of  $\mu_{s0}$  remains essentially constant where  $E_o$  varies (this will be true if  $E_o$  does not go highly negative). Then

$$G_m = \frac{\partial I_p}{\partial E_o} = \frac{\partial}{\partial E_o} [k(E_o + E_{s0}/\mu_{s0})^{3/2}] = \frac{3}{2}k(E_o + E_{s0}/\mu_{s0})^{1/2}.$$

Substituting this into (4) we have

$$f = a(\frac{3}{2}k)^{1/2}(E_o + E_{s0}/\mu_{s0})^{1/4} \quad (5)$$

The frequency deviation with respect to the grid potential is then

$$\frac{\partial f}{\partial E_o} = \frac{a}{4} \left(\frac{3k}{2}\right)^{1/2} (E_o + E_{s0}/\mu_{s0})^{-3/4} \quad (6)$$

If both  $R_1$  and  $R_2$  of the tank circuit of the oscillator consist of resistance tubes, better frequency deviation is obtained. For this case, equation (3) has the form

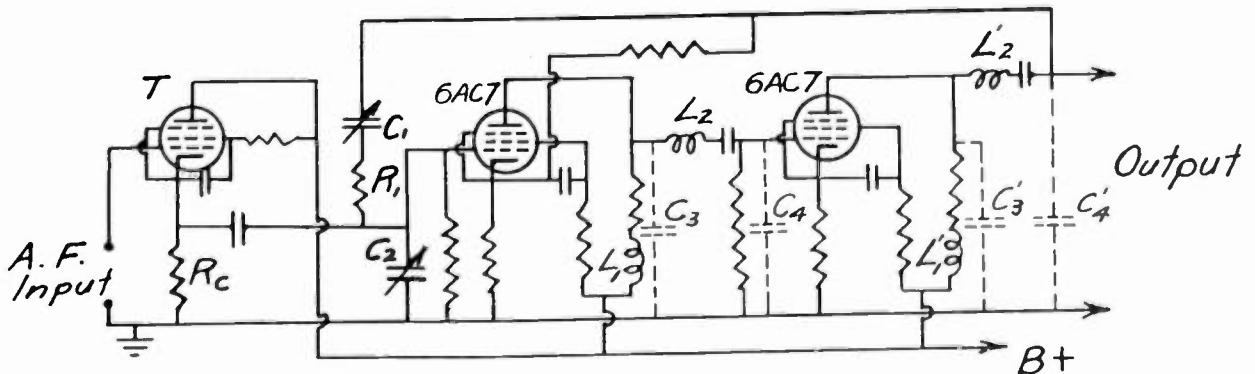

Fig. 2.—Circuit diagram of a frequency-modulated resistance-capacitance oscillator.

$$f = \frac{b}{\frac{1}{G_m + \frac{1}{R_c}}} = b \left( G_m + \frac{1}{R_c} \right) \quad (7)$$

where

$$b = \frac{1}{2\pi\sqrt{C_1 C_2}}$$

Equation (4) becomes

$$f = bG_m, \quad (8)$$

and (5) becomes

$$f = \frac{3}{2}bk(E_g + E_{g0}/\mu_{g0})^{1/2}. \quad (9)$$

The rate of change of frequency with respect to grid voltage is then

$$\frac{\partial f}{\partial E_g} = \frac{3}{4}bk(E_g + E_{g0}/\mu_{g0})^{-1/2}. \quad (10)$$

These formulas apply to triodes if  $E_p$  and  $\mu$  are used in place of  $E_{g0}$  and  $\mu_{g0}$ , respectively.

The above results may be summarized as follows: When two resistance tubes are used in the oscillating circuit, the frequency of oscillation is directly proportional to the transconductance of the tubes, or to the square root of the quantity  $(E_g + E_{g0}/\mu_{g0})$ ; the frequency deviation with respect to the grid voltage is inversely proportional to the square root of the same quantity. If one resistance tube is used the frequency of oscillation will be directly proportional to the square root of the transconductance of the tube, or to the fourth root of the quantity  $(E_g + E_{g0}/\mu_{g0})$ ; the frequency deviation with respect to the grid voltage is inversely proportional to the three-fourths root of the same quantity.

It is seen that when two resistance tubes are used we can obtain greater frequency deviation than when only one tube is used, but the circuit arrangement involved is rather complicated. It requires two sets of power supplies and is inconvenient. As it has been found experimentally that the frequency deviation obtained with one tube is more than actually used in practice, the circuit arrangement of Fig. 2 is preferred.

#### HIGH-FREQUENCY COMPENSATION

The oscillator works well up to four megacycles if television tubes are used. To work at higher frequencies, a compensating device must be provided. In order to obtain best results both shunt and series peaking compensation must be used.<sup>3</sup> The shunt peaking coil  $L_1$  (see Fig. 2) should have an inductance equal to  $0.12(C_3 + C_4)R_L^2$ , and the series peaking coil  $L_2$  should have an inductance equal to  $0.52(C_3 + C_4)R_L^2$  where  $C_3$  and  $C_4$  are the stray capacitances indicated

in Fig. 2, and  $R_L$  is determined from  $C_3$  and  $C_4$ , as will be shown later. The design procedure is as follows: first, decide upon the frequency of oscillation  $f_0$ ; second, measure  $C_3$  and  $C_4$  for each tube of the oscillator circuit by finding the frequency  $f$  at which the amplification falls to 70.7 per cent of its mid-range value and then calculating  $C_3 + C_4$  from the relation  $f = 1/2\pi R_L'(C_3 + C_4)$ ; next, determine the value of  $R_L$  which is given by the expression  $R_L = f_0/2\pi R_L'(C_3 + C_4)$ ; and then evaluate  $L_1$  and  $L_2$  from the foregoing equations.

When the combined shunt-series peaking is employed the oscillator can be made to operate at 9 megacycles. It has been found that there is no difficulty in obtaining oscillation at even higher frequencies.

#### AMPLITUDE-LIMITING DEVICE

Finally, let us consider the amplitude variation of the output voltage of the oscillator during modulation. It is by no means constant, for the audio-frequency voltage due to the audio-frequency current flowing in the output of the resistance tube is applied directly to the input of the oscillator. This voltage will be amplified and cause the output voltage of the oscillator to vary at an audio rate, which is undesirable. In order to remedy the defect, a limiter may be connected to the output of the oscillator. It can be either a diode or a pentode type. If the former is used we should first estimate the value of  $E_{min}$  to which the oscillator voltage swings when it is modulated and then set the bias on the diode exactly equal to or a little less than this value. If a pentode is used, it may conveniently be of the plate-saturation type. By means of this arrangement the output power can be maintained practically constant over a grid-excitation voltage range of more than one hundred to one.

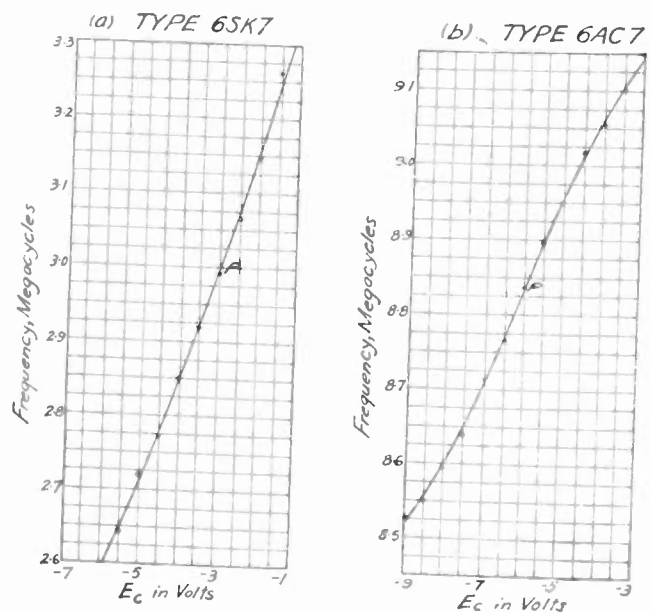

Fig. 3.—Oscillator frequency as a function of grid voltage of the resistance tube. Note that  $E_c$  is the battery bias only.

<sup>3</sup> D. G. Fink, "Principles of Television Engineering," McGraw-Hill Book Co., New York, N. Y., 1940, ch. 6.

## EXPERIMENTAL RESULTS

The frequency-modulated oscillator just described has been tested experimentally and satisfactory results were obtained.

In order to measure the frequency variation of the oscillator against the grid-voltage change of the resistance tube, an adjustable bias was connected to the input terminals of the latter (see Fig. 2), the audio-frequency source being disconnected at the time. Several types of tubes have been tested in this way and sample results for two tubes are plotted in Fig. 3.

From these curves it is seen that the oscillator frequency varies considerably with the grid voltage of the resistance tube. At the point *P*, a frequency change of more than 0.1 megacycle is obtained per volt change of grid voltage. This may seem astonishing at first sight, but if we look at the average characteristics of the tubes we note that the transconductance of the 6SK7 tube will increase from 1150 to 2250 micromhos as its grid voltage varies from  $-6$  to  $-2$  volts, and the transconductance of the 6AC7 tube increases from

1500 to 6000 micromhos<sup>4</sup> as its grid voltage varies from  $-8$  to  $-4$  volts. Since the frequency of oscillation is a function of the transconductance of the tube (as is shown roughly by the relation  $f = a\sqrt{G_m}$ ), the results obtained above are reasonable.

The linearity of these frequency variation curves is comparable to that of the average characteristics of the tubes. If the operating point is suitably chosen (say, at *P*, Fig. 3), the 6SK7 tube gives a frequency deviation of the order of 16 kilocycles in 3 megacycles with less than 0.5 per cent distortion, while the 6AC7 tube gives a deviation of the order of 25 kilocycles in 8.8 megacycles with the same distortion.

### ACKNOWLEDGMENT

The writer is greatly indebted to Professors F. E. Terman and K. Spangenberg and Messrs. S. W. Athey and H. J. Shaw for their valuable suggestions and helpful discussions during the course of this work.

<sup>4</sup> It should be remarked that these values are for  $E_p = 300$  volts and  $E_{g0} = 150$  volts; in our case the values of  $E_p$  and  $E_{g0}$  used were 240 and 120 volts, respectively, and hence a smaller variation of the transconductance of the tube is to be expected.

# Comparison of Voltage- and Current-Feedback Amplifiers\*

E. H. SCHULZ,† ASSOCIATE, I.R.E.

*Summary*—This paper points out the differences between an amplifier with voltage feedback and one with current feedback. The effect of variations of amplifier constants on output voltage and current is decreased by either type of negative feedback. Voltage feedback decreases the effect of load impedance on output voltage, and current feedback decreases the effect of load impedance on load current. Voltage feedback increases the damping of a loudspeaker and improves its response. A table also is given to assist in the choice of type and amount of feedback to be used in a given application.

## INTRODUCTION

THE operating characteristics of an amplifier may be improved considerably by the use of negative feedback. When a large part of the output voltage is fed back to the input so as to oppose the impressed voltage, the gain of the amplifier becomes essentially independent of operating voltages, tube constants, etc., and distortion, noise, and hum are materially reduced.

The method of obtaining the feedback voltage may have an appreciable effect on the characteristics of the amplifier. The various methods of obtaining feedback may be separated into two groups; namely, voltage and current feedback. In voltage feedback the feedback voltage is proportional to the output voltage, while in current feedback the feedback voltage is proportional to the output current. The term "feed-

back" will imply negative feedback throughout this paper.

## SYMBOLS

- $\alpha$  = vector gain of amplifier without feedback
- $\beta$  = vector feedback factor
- $\mu$  = vector amplification factor =  $\mu$  of output stage  
× vector gain of previous stages
- $E$  = equivalent vector internal generated voltage
- $Z$  = vector impedance of amplifier looking into output terminals when feedback is used
- $Z_i$  = vector impedance of amplifier looking into output terminals when no feedback is used
- $Z_0$  = vector load impedance
- $\theta_a$  = angle of phase shift through amplifier without feedback
- $\theta_\beta$  = phase angle of  $\beta$
- $\theta_\mu$  = phase angle of  $\mu$
- $\theta_0$  = phase angle of  $Z_0$
- $\theta_i$  = phase angle of  $Z_i$
- $\phi$  = factor by which  $\alpha$  must be increased to obtain same output as with no feedback.

## EQUIVALENT CIRCUITS OF AMPLIFIERS WITH FEEDBACK

Figs. 1 and 2 show the circuits of an amplifier with voltage feedback and one with current feedback. The

\* Decimal classification: R363.2. Original manuscript received by the Institute, May 26, 1942.

† Illinois Institute of Technology, Chicago, Illinois.

equivalent circuits shown in Figs. 1 (c) and 2 (c) are obtained by Thevenin's theorem. The magnitude of the generator voltage  $E$  is equal to the value of  $V_0$  obtained when the amplifier is operating with no load (i.e.,  $Z_0 = \infty$ ). The value of  $Z$  is equal to the impedance looking back into the output terminals with all inter-

But  $E_i = 0 + \mu\beta V_0$  (since  $V_i = 0$ ) and hence

$$I_0 = \frac{\mu\beta V_0 + V_0}{Z_i} \quad (6)$$

The impedance of the amplifier looking into the output terminals will be  $V_0/I_0$ . Hence

$$Z = \frac{Z_i}{1 - \mu\beta} \quad (7)$$

A similar process may be followed in the case of current feedback to arrive at the results of Fig. 2 (a).

### CHARACTERISTICS OF FEEDBACK AMPLIFIERS

An inspection of Figs. 1 (c) and 2 (c) shows that voltage feedback increases the value of  $E$  above its value without feedback, while current feedback has no effect on the magnitude<sup>1</sup> of  $E$ . Also it may be seen that voltage feedback decreases the impedance looking back into the amplifier, while current feedback increases this impedance.

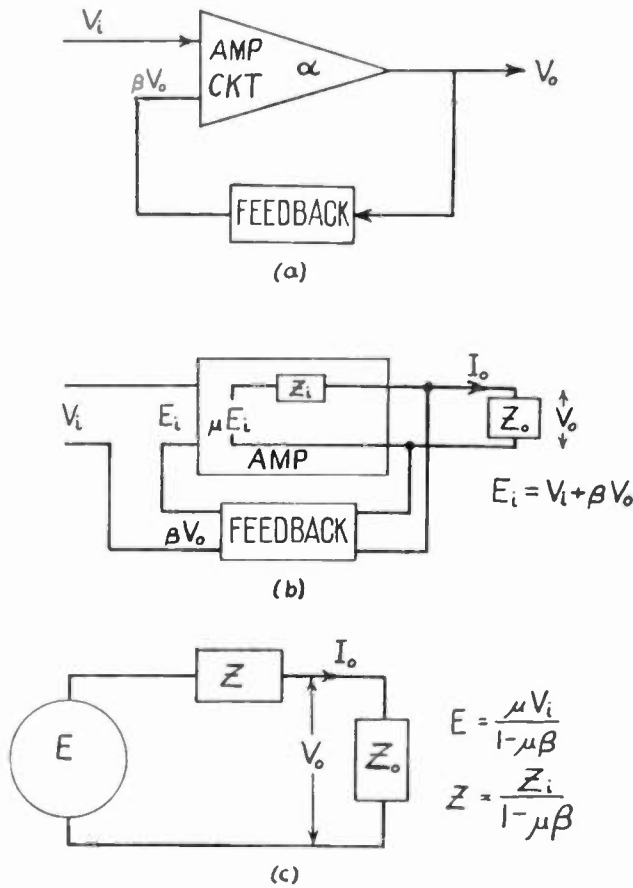

Fig. 1

nal voltages equal to zero (i.e.,  $V_i = 0$ ). For example, to obtain  $E$  in Fig. 1 (c), the circuit of Fig. 1 (b) may be solved to obtain

$$V_0 = \frac{\mu Z_0 E_i}{Z_0 + Z_i} \quad (1)$$

where

$$E_i = V_i + \beta V_0 \quad (2)$$

Solving (1) and (2) for  $V_0$ ,

$$V_0 = \frac{\mu Z_0 Z_i}{Z_0(1 - \mu\beta) + Z_i} \quad (3)$$

If  $Z_0 = \infty$ ,

$$E = V_0 = \frac{\mu V_i}{1 - \mu\beta} \quad (4)$$

To find the value of  $Z$ , let  $V_i = 0$ , replace  $Z_0$  by a source of voltage  $V_0$ , and calculate  $I_0$  as follows:

$$I_0 = \frac{\mu E_i + V_0}{Z_i} \quad (5)$$

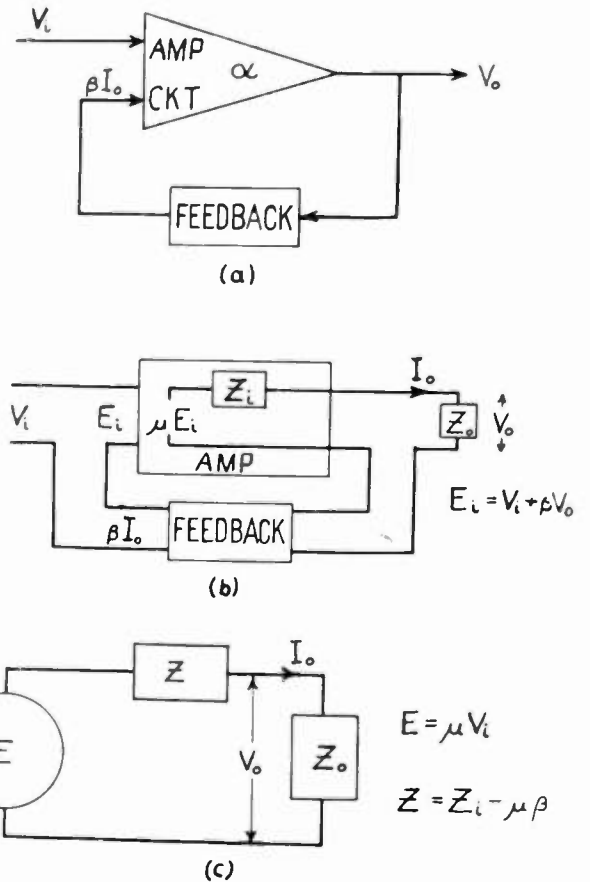

Fig. 2

From the above it follows that in an amplifier feeding a loudspeaker, voltage feedback results in a lower effective impedance shunting the loudspeaker, whereas current feedback would increase this impedance.

<sup>1</sup> In order to obtain negative feedback  $\theta_\mu + \theta_\beta$  must be less than 270 degrees but greater than 90 degrees and hence  $|1 - \mu\beta| > 1$ .



TABLE I  
CHARACTERISTICS OF AMPLIFIERS WITH FEEDBACK

	No Feedback	Voltage Feedback	Current Feedback
1. Voltage gain = $\frac{V_o}{V_i}$	$\frac{\mu Z_o}{Z_o + Z_i}$ $\alpha$	$\frac{\mu Z_o}{Z_o(1 - \mu\beta) + Z_i}$ $\frac{\alpha}{1 - \alpha\beta}$	$\frac{\mu Z_o}{Z_o + Z_i - \mu\beta}$ $\frac{\alpha}{1 - \frac{\alpha\beta}{Z_o}}$
2. Phase angle between $V_o$ and $V_i$	$\theta_{\alpha} = \theta_{\mu} + \theta_o - \tan^{-1} \left[ \frac{Z_o \sin \theta_o + Z_i \sin \theta_i}{Z_o \cos \theta_o + Z_i \cos \theta_i} \right]$	$\theta_{\alpha} - \tan^{-1} \left[ \frac{- \alpha\beta  \sin(\theta_{\beta} + \theta_{\alpha})}{1 -  \alpha\beta  \cos(\theta_{\beta} + \theta_{\alpha})} \right]$	$\theta_{\alpha} - \tan^{-1} \left[ \frac{-\left  \frac{\alpha\beta}{Z_o} \right  \sin(\theta_{\beta} + \theta_{\alpha} - \theta_o)}{1 - \left  \frac{\alpha\beta}{Z_o} \right  \cos(\theta_{\beta} + \theta_{\alpha} - \theta_o)} \right]$
3. Output current = $\frac{I_o}{V_i}$	$\frac{\mu}{Z_o + Z_i}$	$\frac{\mu}{Z_o(1 - \mu\beta) + Z_i}$ $1 - \alpha\beta$	$\frac{\mu}{Z_o + Z_i - \mu\beta}$ $1 - \frac{\alpha\beta}{Z_o}$
4. $\phi$	—	$1 - \alpha\beta$	$1 - \frac{\alpha\beta}{Z_o}$
5. $\frac{d}{dZ_o} \left( \frac{V_o}{V_i} \right)$	$\frac{\mu Z_i}{(Z_o + Z_i)^2}$	$\frac{\mu Z_i}{[(1 - \mu\beta)Z_o + Z_i]^2}$	$\frac{\mu(Z_i - \mu\beta)}{[Z_o + Z_i - \mu\beta]^2}$
6. $\frac{d}{dZ_i} \left( \frac{V_o}{V_i} \right)$	$\frac{-\mu Z_o}{(Z_o + Z_i)^2}$	$\frac{-\mu Z_o}{[(1 - \mu\beta)Z_o + Z_i]^2}$	$\frac{-\mu Z_o}{[Z_o + Z_i - \mu\beta]^2}$
7. $\frac{d}{d\mu} \left( \frac{V_o}{V_i} \right)$	$\frac{Z_o}{Z_o + Z_i}$	$\frac{Z_o^2 + Z_o Z_i}{[(1 - \mu\beta)Z_o + Z_i]^2}$	$\frac{Z_o^2 + Z_o Z_i}{[Z_o + Z_i - \mu\beta]^2}$
8. $\frac{d}{dZ_o} \left( \frac{I_o}{V_i} \right)$	$\frac{-\mu}{(Z_o + Z_i)^2}$	$\frac{-\mu(1 - \mu\beta)}{[(1 - \mu\beta)Z_o + Z_i]^2}$	$\frac{-\mu}{[Z_o + Z_i - \mu\beta]^2}$
9. $\frac{d}{dZ_i} \left( \frac{I_o}{V_i} \right)$	$\frac{-\mu}{(Z_o + Z_i)^2}$	$\frac{-\mu}{[(1 - \mu\beta)Z_o + Z_i]^2}$	$\frac{-\mu}{[Z_o + Z_i - \mu\beta]^2}$
10. $\frac{d}{d\mu} \left( \frac{I_o}{V_i} \right)$	$\frac{1}{Z_o + Z_i}$	$\frac{Z_o + Z_i}{[(1 - \mu\beta)Z_o + Z_i]^2}$	$\frac{Z_o + Z_i}{[Z_o + Z_i - \mu\beta]^2}$
11. Noise voltage	$N$	$\frac{N}{1 - \alpha\beta}$	$\frac{N}{1 - \frac{\alpha\beta}{Z_o}}$

Hence, voltage feedback increases the speaker damping and improves the response, while current feedback decreases the damping and results in poorer response.

Item 1 of Table I shows that the gain of an amplifier is decreased by either type of feedback. Item 3 shows the factor by which  $\alpha$  must be increased to obtain the same gain as without feedback. Item 11 shows that noise and hum are decreased by the same amount that the gain is decreased.

The signal-to-noise (or hum) ratio may be improved by applying feedback and by increasing the gain to compensate for loss of gain, provided the noise is not introduced in the input stage. If the noise is introduced at the input, the added gain will also amplify the noise, and hence the signal-to-noise ratio cannot be improved appreciably by feedback.

Items 6, 7, 9, and 10 show that the effect of changes of  $Z_i$  and  $\mu$  on both voltage gain and output current is decreased in either type of feedback. Item 5 shows that the effect of changes of  $Z_o$  on the voltage gain is decreased by voltage feedback, and increased by current feedback. Item 8 shows that the effect of changes of  $Z_o$  on the output current is increased by voltage feedback, and decreased by current feedback. These points are illustrated by Figs. 3, 4, and 5.

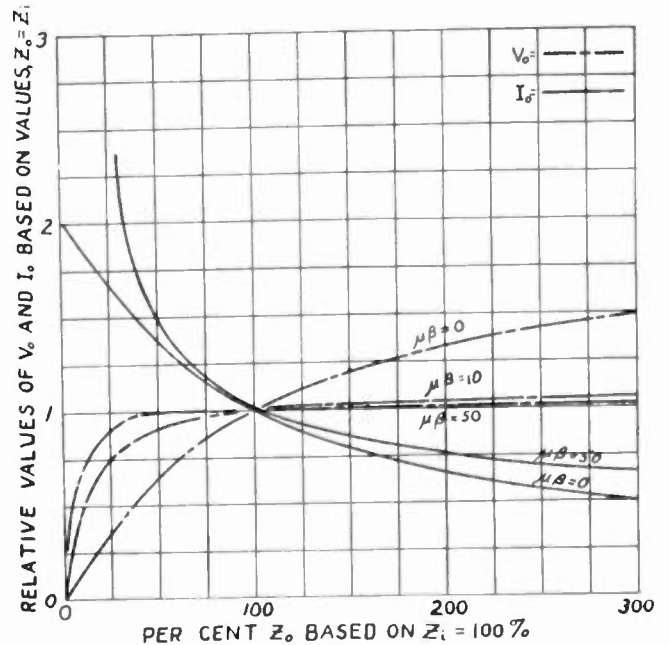

Fig. 3

CONCLUSIONS

Either type of feedback will decrease the effect of the constants of the amplifier on the voltage gain and

output current. That is, either type of feedback will have the following effects:

1. Reduce hum and tube noise.
2. Reduce variation of voltage or current gain with input voltage, operating voltages, tube age, etc.

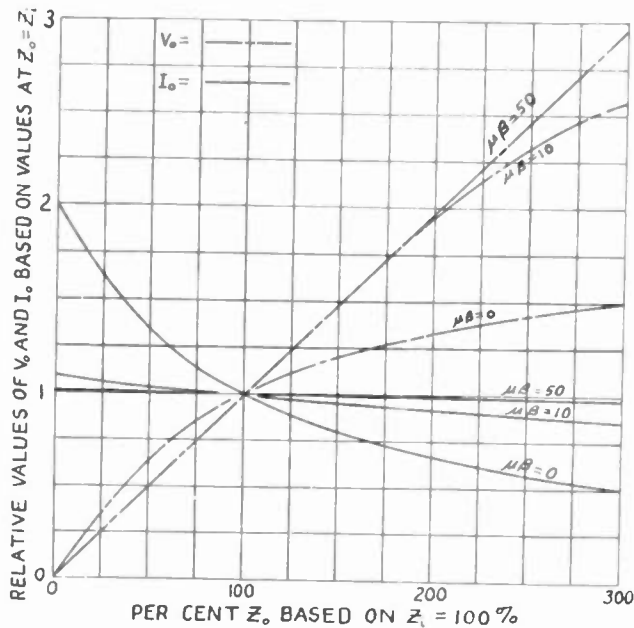

Fig. 4

Either type of feedback requires an increase in amplifier gain to obtain the same over-all gain as without feedback.

The difference in the behavior of amplifiers with voltage and current feedback is primarily in the effect of variations in the load on the output voltage and current. Voltage feedback will have the following effects:

1. Reduce the variation of voltage gain and phase angle of output voltage with load constants, but increase variations of output current and output-cur-

rent phase angle with load constants.

2. Increase damping of loudspeaker transients and resonance, and hence improve speaker response.

Current feedback will have the following effects:

1. Reduce variations of load current and load-current phase angle with load constants, but increase variations of voltage gain and output-voltage phase angle with load constants.

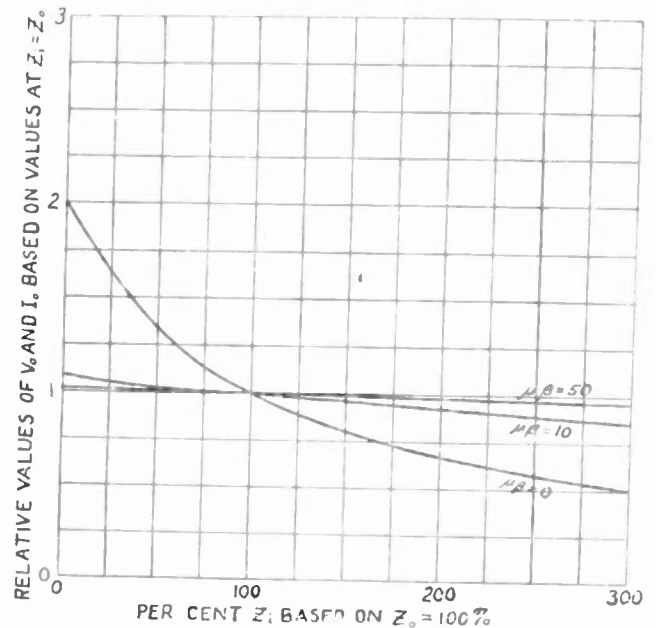

Fig. 5

2. Decrease damping of loudspeaker, and hence cause poorer speaker response.

#### REFERENCES

1. H. S. Black, Stabilized feed-back amplifiers, *Elec. Eng.*, vol. 53, pp. 114-116; January, 1934.
2. H. J. Reich, "Theory and Application of Electron Tubes," McGraw-Hill Book Co., New York, N. Y., 1939, pp. 230-231.

## Coupled Resonant Circuits for Transmitters\*

N. I. KORMAN†, ASSOCIATE, I.R.E.

**Summary**—This paper discusses the design of coupled resonant circuits for use as interstage coupling units in transmitters. Simplifying assumptions are made which, although they reduce somewhat the accuracy and scope of the treatment, result in extremely simple and useful relationships.

### INTRODUCTION

THE subject of coupled resonant circuits has been treated many times in the various technical publications pertaining to radio. However, discussion with transmitter engineers has disclosed a certain amount of confusion on this subject. For instance,

\* Decimal classification: R142.3. Original manuscript received by the Institute, October 15, 1941; revised manuscript received, September 17, 1942.

† RCA Manufacturing Company, Inc., Camden, N. J.

Terman<sup>1</sup> states that the condition for the flattest band-pass characteristic is the same as that for critical coupling, which is that the coupling  $K = 1/\sqrt{Q_1 Q_2}$ . A perfectly efficient interstage coupling unit for a transmitter will be one in which the inductances and capacitances will have no losses, and all of the damping is concentrated on the secondary side in the load. In this case,  $Q_1$ , the primary  $Q$ , is infinite (assuming also a constant current source of infinite internal impedance). Terman's formula for the coupling, which is strictly true only in the case where  $Q_1 = Q_2$ , evidently is not

<sup>1</sup> F. E. Terman, "Radio Engineering," Second Edition, McGraw-Hill Book Co., New York, N. Y., 1937, pp. 78-84.

applicable. Furthermore, for a transmitter engineer the coupling is an inconvenient quantity to design and to measure. It is preferable to design in terms of such things as voltage ratios, capacitances, and reactive powers.

**BAND-PASS—LOW-PASS ANALOGY**

In the discussion of the transmission characteristics of coupled resonant circuits, a considerable simplification may be obtained by the use of the band-pass—low-pass analogy. This analogy is a concept which has been recognized in certain quarters for many years. It has been stated by Landon<sup>2</sup> as follows (with modifications added by the writer in italics to include the phase characteristic):

“If in a given low-pass filter, a capacitor is added in series with each inductor, of the proper value to tune it to a frequency  $f_0$ ; and if an inductor is added in parallel with every (originally present) capacitor of the proper value to tune it to parallel resonance at the frequency  $f_0$ ; then the bandwidth of the new band-pass filter is exactly the same as the bandwidth of the previous low-pass filter at every attenuation ratio *and at every phase shift*. In the band-pass filter the frequency  $f_0$  is the geometric mean of any two frequencies of equal attenuation *or equal phase shift*.”

When the band of frequencies considered is small compared with the mean frequency  $f_0$ ,  $f_0$  can be taken as the arithmetic mean of any two frequencies of equal attenuation (or phase shift) with but small error.

**CLASS C AMPLIFIER-TUBE EQUIVALENT CIRCUIT**

Radio-frequency amplifier tubes in transmitters are usually operated class C. As a first approximation, these amplifier tubes may be considered to be current generators independent of the load impedance. As a better approximation they may be considered to be current generators shunted by a high resistance. This resistance is the internal plate resistance of the tube multiplied by a factor which depends on the angle of plate-current flow. This effective internal plate resistance of a class C tube is given by<sup>3</sup>

$$R = r_p \frac{2\pi}{2\theta - \sin 2\theta}$$

where

- R = effective internal plate resistance
- $\theta$  = half the angle of plate-current flow in radians
- $r_p$  = internal plate resistance

**RESPONSE OF THE ANALOGOUS LOW-PASS NETWORK**

Consider the low-pass network shown in Fig. 1a. The response of this network is

$$\frac{E_2}{E_1} = \frac{1}{j\omega C + \frac{1}{r_c} r_L + j\omega L + \frac{1}{j\omega C + \frac{1}{r_c}}}$$

$$\left. \frac{E_2}{E_1} \right|_{\omega=0} = \frac{1}{1 - \left(\frac{\omega}{\omega_r}\right)^2 + j \frac{\omega}{\omega_r} D_r} \tag{1a}$$

$$\left. \frac{E_2}{E_1} \right|_{\omega=0} = \frac{1}{\sqrt{\left[1 - \left(\frac{\omega}{\omega_r}\right)^2\right]^2 + \left(\frac{\omega}{\omega_r}\right)^2 D_r^2}}$$

$$\tan^{-1} \frac{\frac{\omega}{\omega_r} D_r}{\left(\frac{\omega}{\omega_r}\right)^2 - 1} \tag{1b}$$

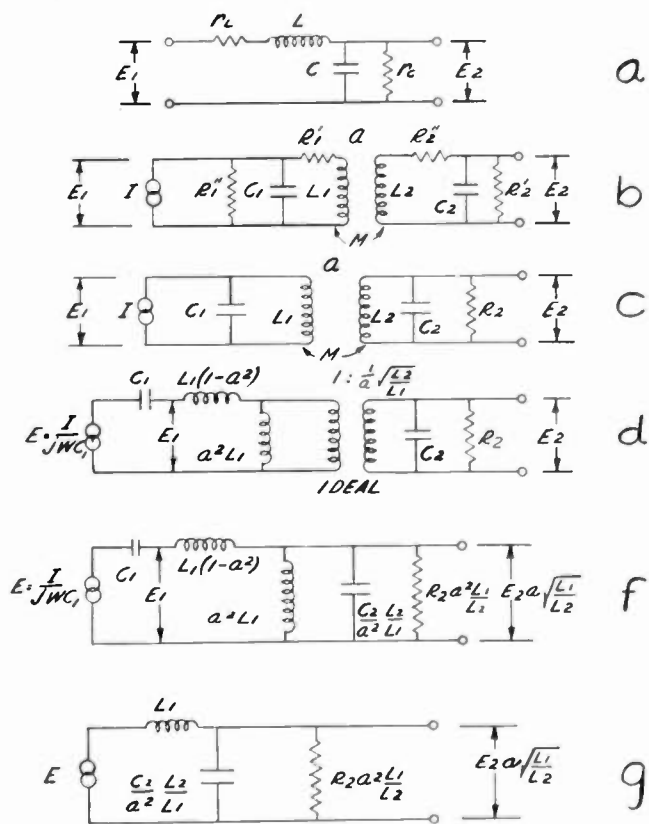

Fig. 1—Equivalent circuits for coupled resonant circuits.

where

$$\omega_r^2 = \frac{1 + r_L/r_c}{LC} \quad \text{the frequency at which phase shift} = 90 \text{ degrees} \tag{1c}$$

$$\left. \frac{E_2}{E_1} \right|_{\omega=0} = \frac{r_c}{r_L + r_c} \tag{1d}$$

$$D_r = \frac{r_L}{\omega_r L} + \frac{1}{r_c \omega_r C} \quad \text{the dissipation or damping factor.} \tag{1e}$$

The response of this network is plotted as a function of frequency for various values of  $D_r$  in Figs. 2 and 3.

<sup>2</sup> V. D. Landon, "Band-pass—low-pass analogy," PROC. I.R.E., vol. 24, pp. 1582-1584; December, 1936.

<sup>3</sup> W. L. Everitt, "Communication Engineering," Second Edition, McGraw-Hill Book Co., New York, N. Y., 1937, p. 568.

It should be noted that all the curves of Fig. 2 for various values of  $D_r$  approach asymptotically an attenuation of 12 decibels per octave removed from  $\omega_r$ ; i.e., at  $\omega=2\omega_r$ , the attenuation is approximately 12 decibels, at  $\omega=4\omega_r$  it is approximately 24 decibels, at  $\omega=8\omega_r$  it is approximately 36 decibels, etc.

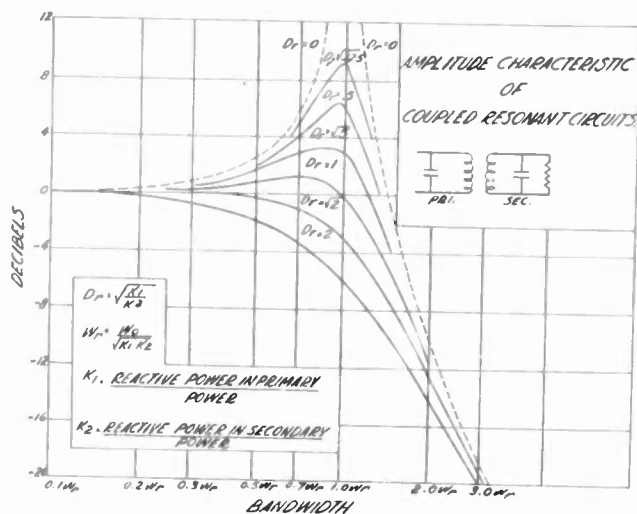

Fig. 2—Coupled resonant circuits for transmitters.

For certain purposes it is desirable to express the amplitude and phase parts of (1b) as infinite power series. These series expansions are

$$\frac{E_2}{E_1} = \frac{E_2}{E_1} \Big|_{\omega=0} \left[ 1 - \frac{1}{2} (D_r^2 - 2) \frac{\omega^2}{\omega_r^2} + \frac{1}{8} \{ 3(D_r^2 - 2)^2 - 4 \} \frac{\omega^4}{\omega_r^4} - \frac{1}{16} \{ 5(D_r^2 - 2)^3 - 12(D_r^2 - 2) \} \frac{\omega^6}{\omega_r^6} + \dots \right] \quad (1f)$$

$$\theta = -D_r \frac{\omega}{\omega_r} + D_r(D_r^2 - 3) \frac{1}{3} \frac{\omega^3}{\omega_r^3} - D_r(D_r^4 - 5D_r^2 + 5) \frac{1}{5} \frac{\omega^5}{\omega_r^5} + D_r(D_r^6 - 7D_r^4 + 14D_r^2 - 7) \frac{1}{7} \frac{\omega^7}{\omega_r^7} + \dots \quad (1g)$$

For the derivation of these expressions see the Appendix.

We are often interested in making the amplitude characteristic "flat." At other times we may be interested in making the phase function "linear." If the coefficient of  $(\omega/\omega_r)^2$  in (1f) is made zero, the amplitude characteristic will be "maximally flat."<sup>4</sup>

$$D_r^2 = 2$$

$$\frac{E_2}{E_1} \Big|_{\text{max flat}} = \frac{E_2}{E_1} \Big|_{\omega=0} \left[ 1 - \frac{1}{2} \frac{\omega^4}{\omega_r^4} + \frac{3}{8} \frac{\omega^8}{\omega_r^8} - \dots \right] \quad (1h)$$

<sup>4</sup> Maximally flat is a phrase coined by Landon.<sup>5</sup> A maximally flat curve may be defined as one which approaches a horizontal straight line at a point in such a manner that one or more of the first, second, third, etc., of its derivatives (in order) has been made zero at the point.

A maximally linear curve may be defined as one which approaches a straight line at a point in such a manner that one or more of the second, third, fourth, etc. of its derivatives (in order) has been made zero at the point.

If the coefficient of  $(\omega/\omega_r)^3$  in (1g) is made zero, the phase characteristic will be "maximally linear."<sup>4</sup>

$$D_r^2 = 3$$

$$\theta \Big|_{\text{max linear}} = -\sqrt{3} \frac{\omega}{\omega_r} \left[ 1 - \frac{1}{5} \frac{\omega^4}{\omega_r^4} + \frac{1}{7} \frac{\omega^6}{\omega_r^6} + \dots \right] \quad (1i)$$

### ELEMENT VALUES IN ANALOGOUS COUPLED RESONANT CIRCUITS

A common type of interstage coupling unit used in transmitters is shown in Fig. 1b

where  $I$  = current generator equivalent to the driver tube

$R_1''$  = internal impedance of the driver tube

$R_1'$  = equivalent resistance of the losses in the coil  $L_1$

$R_2''$  = equivalent resistance of the losses in the coil  $L_2$

$R_2'$  = impedance of the load

$a = M/\sqrt{L_1 L_2}$ , the coefficient of coupling

In practical transmitters, the effects of  $R_1''$ ,  $R_1'$ , and  $R_2''$  are small if not negligible. Hence, Fig. 1b becomes Fig. 1c. The coupled coils may be replaced by an ideal transformer and two inductances<sup>6</sup> as shown in Fig. 1d. By an application<sup>7</sup> of Thevenin's theorem, the current generator  $I$  may be replaced by a voltage generator  $E$ , in series with the capacitor  $C_1$  as shown in Fig. 1d.

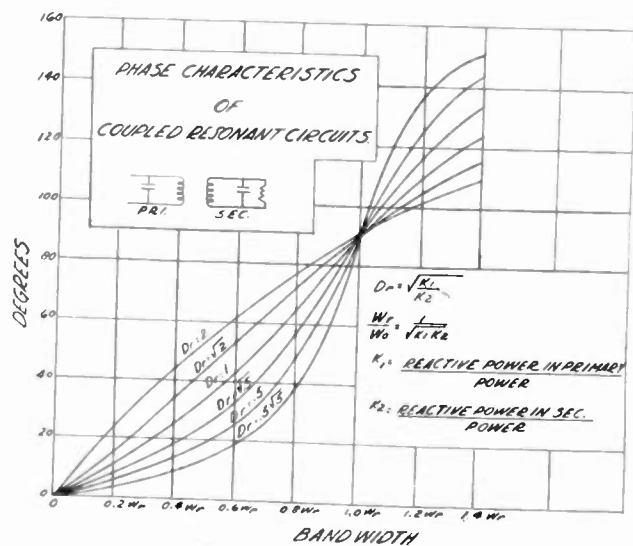

Fig. 3—Phase characteristics of coupled resonant circuits.

The ideal transformer can be removed by an impedance transformation as in Fig. 1f.

If it is assumed that the primary and secondary are tuned to resonance at the same frequency, that is,

<sup>5</sup> V. D. Landon, "Cascade amplifiers with maximal flatness." Part I, *RCA Rev.*, vol. 5, pp. 347-362, January 1941; Part II, vol. 5, pp. 481-497, April, 1941.

<sup>6</sup> E. A. Guillemin, "Communication Networks," John Wiley and Sons, New York, N. Y., 1935, vol. II, pp. 153-154, Figs. 40 and 42b.

<sup>7</sup> See page 47 of footnote reference 3.

$$C_1 L_1 (1 - a^2) \cong C_1 L_1 = \frac{1}{\omega_0^2} = C_2 L_2 \quad (2)$$

where  $a^2 \ll 1$

then, the low-pass network analogous to Figs. 1b, 1c, 1d, and 1f is Fig. 1g. The bandwidth<sup>8</sup> at which 90-degree phase shift occurs is, from (1c),

$$\omega_r^2 = \frac{1}{L_1 C_2 \frac{1}{a^2} \frac{L_2}{L_1}} = \frac{a^2}{L_2 C_2} = \omega_0^2 a^2. \quad (3)$$

The damping factor is, from (1e) and Fig. 1g

$$D_r = \frac{1}{R_2 a^2 \frac{L_1}{L_2} \omega_r \frac{C_2}{a^2} \frac{L_2}{L_1}} = \frac{1}{a \omega_0 R_2 C_2}$$

Defining

$$K_2 = \omega_0 R_2 C_2 = \frac{R_2}{\omega_0 L_2} \quad (4)$$

as the kilovolt-ampere ratio of the secondary, we obtain

$$D_r = \frac{1}{a K_2} \quad (5)$$

In Fig. 1c we can find  $E_{01}$ , the value of  $E_1$  at resonance, as follows:

The currents flowing in the secondary at resonance must be

$$I_{R_2} = \frac{E_{02}}{R_2}, \quad I_{C_2} = E_{02} j \omega_0 C_2, \quad I_{L_2} = \frac{E_{02} - e_0}{j \omega_0 L_2}$$

where  $e_0$  = voltage induced in  $L_2$  due to the current in  $L_1$ .

$E_{02}$  = value of  $E_2$  at resonance.

Since the sum of these currents must be zero

$$I_{R_2} + I_{C_2} + I_{L_2} = 0$$

$$\frac{e_0 - E_{02}}{j \omega_0 L_2} = E_{02} \left( \frac{1}{R_2} + j \omega_0 C_2 \right)$$

$$e_0 - E_{02} = E_{02} \left( \frac{j \omega_0 L_2}{R_2} - \omega_0^2 L_2 C_2 \right)$$

$$e_0 = E_{02} \left( 1 - \omega_0^2 L_2 C_2 + \frac{j \omega_0 L_2}{R_2} \right)$$

$$e_0 = E_{02} \frac{j \omega_0 L_2}{R_2} \quad (\text{since } 1 - \omega_0^2 L_2 C_2 = 0).$$

The current in  $L_1$  must be

$$I_{L_1} = \frac{e_0}{j \omega_0 M} = E_{02} \frac{L_2}{M R_2}$$

and  $E_{01}$  must be

$$E_{01} = j \omega_0 L_1 I_{L_1} + \frac{E_{02}}{j \omega_0 L_2} j \omega_0 M$$

<sup>8</sup>As stated in the paragraph titled "Band-Pass-Low-Pass Analogy," the term bandwidth means the difference between frequencies of equal attenuation, or phase shift, for band-pass configurations and the actual frequency for low-pass configurations.

$$= E_{02} \left[ \frac{j \omega_0 L_1 L_2}{M R_2} + \frac{M}{L_2} \right]$$

$$= E_{02} \left[ \frac{\sqrt{L_1 L_2}}{M} \sqrt{\frac{L_1}{L_2}} \frac{j \omega_0 L_2}{R_2} + \frac{M}{\sqrt{L_1 L_2}} \sqrt{\frac{L_1}{L_2}} \right]$$

From (4)

$$\frac{R_2}{\omega_0 L_2} = K_2$$

and from (2)

$$\frac{L_1}{L_2} = \frac{C_2}{C_1}$$

and since  $M/\sqrt{L_1 L_2} = a$ , which is the coefficient of coupling, we find

$$\begin{aligned} \frac{E_{01}}{E_{02}} &= j \frac{1}{a K_2} \sqrt{\frac{C_2}{C_1}} + a \sqrt{\frac{C_2}{C_1}} \\ &= j D_r \sqrt{\frac{C_2}{C_1}} (1 + j a^2 K_2) \end{aligned}$$

and

$$\left| \frac{E_{01}}{E_{02}} \right| = D_r \sqrt{\frac{C_2}{C_1}} \sqrt{1 + \frac{1}{D_r^4 K_2^2}}$$

Squaring, we obtain the equation

$$\left| \frac{E_{01}}{E_{02}} \right|^2 \frac{C_1}{C_2} = D_r^2 + \frac{1}{D_r^2 K_2^2}$$

If we take  $P$  as the power through the network, we recognize that

$$\left| \frac{E_{01}}{E_{02}} \right|^2 \frac{C_1}{C_2} = \frac{|E_{01}|^2 \omega_0 C_1}{P} \frac{P}{|E_{02}|^2 \omega_0 C_2} = \frac{K_1}{K_2} \quad (6)$$

where  $K_1$  and  $K_2$  are kilovolt-ampere ratios of primary and secondary, respectively, and therefore,

$$D_r^4 - \frac{K_1}{K_2} D_r^2 + \frac{1}{K_2^2} = 0.$$

Finally, solving the quadratic and taking the correct root

$$D_r^2 = \frac{1}{2} \frac{K_1}{K_2} + \frac{1}{2} \frac{K_1}{K_2} \sqrt{1 - \frac{4}{K_1^2}}$$

If  $K_1 > 2$

$$D_r^2 = \frac{K_1}{K_2} \left( 1 - \frac{1}{K_1^2} - \frac{1}{K_1^4} - \frac{4}{K_1^6} - \dots \right).$$

Furthermore, if  $K_1 \gg 1$ , as is almost always the case,

$$D_r^2 \cong \frac{K_1}{K_2} \quad (7)$$

## CONCLUSIONS

Figs. 2 and 3 give the amplitude and phase characteristics of coupled resonant circuits as a function of bandwidth for various values of the damping factor. The bandwidth is the difference between two frequencies of equal attenuation (or phase shift). The

product of any two frequencies of equal attenuation is equal to the square of the mid-band frequency  $\omega_0$ .

The assumptions made are that:

1. The driver tube may be assumed to be an ideal current generator (one whose internal impedance is infinitely high).
2. The dissipation in the coils and capacitors is negligibly small.
3. The degree of coupling between primary and secondary is small enough; i.e.,  $a^2 \ll 1$ .
4. The primary kilovolt-ampere ratio is large enough; i.e.,  $K_1 \gg 1$ .

We can summarize our results as follows:

From (2)

$$C_1 L_1 = \frac{1}{\omega_0^2} = C_2 L_2. \quad (8)$$

From (3), (5), and (7)

$$\frac{\omega_r}{\omega_0} = \frac{1}{\sqrt{K_1 K_2}}. \quad (9)$$

From (7)

$$D_r = \sqrt{\frac{K_1}{K_2}}. \quad (10)$$

From (6) and (7)

$$\frac{C_1}{C_2} = \frac{K_1}{K_2} \left| \frac{E_{02}}{E_{01}} \right|^2 \quad (11)$$

where

$$K_1 = \left| \frac{E_{01}^2 \omega_0 C_1}{P} \right| \quad (12)$$

and

$$K_2 = \left| \frac{E_{02}^2 \omega_0 C_2}{P} \right| = K_2 \omega_0 C_2 \quad (13)$$

are defined as the kilovolt-ampere ratios of primary and secondary, respectively.

The symbols used above are summarized as follows:

$C_1$  = primary capacitance

$C_2$  = secondary capacitance

$L_1$  = primary inductance

$L_2$  = secondary inductance

$\omega_0$  = mid-band frequency in radians per second

$\omega_r$  = bandwidth at which 90-degree phase shift occurs in radians per second

$D_r$  = shape, or damping, factor of the response curves

$E_{01}$  = voltage across the primary at resonance

$E_{02}$  = voltage across the secondary at resonance

$P$  = power transferred through the network

$K_1$  = kilovolt-ampere ratio of the primary

$K_2$  = kilovolt-ampere ratio of the secondary

#### ACKNOWLEDGMENT

The writer is grateful for the inspiration of Mr. V. D. Landon, to whom he is indebted for many of the concepts and methods of attack used in this paper.

#### APPENDIX I

Power Series Expansions of Amplitude and Phase Characteristics of the Low-Pass Analogy to Resonant Coupled Circuits

$$[(1 - \delta^2) + \delta^2 D_r^2]^{-1/2} = [1 + \delta^2(D_r^2 - 2) + \delta^4]^{-1/2}$$

$$[1 + \delta^2(\alpha^2 + \delta^2)]^{-1/2} = 1 - \frac{1}{2} \delta^2(\alpha^2 + \delta^2) + \frac{3}{8} \delta^4(\alpha^2 + \delta^2)^2 - \frac{5}{16} \delta^6(\alpha^2 + \delta^2)^3 + \dots$$

$$= 1 - \frac{1}{2} \alpha^2 \delta^2 - \frac{1}{2} \delta^4 + \frac{3}{8} \alpha^4 \delta^4 + \frac{3}{4} \alpha^2 \delta^6 + \dots - \frac{5}{16} \alpha^6 \delta^6 + \dots$$

$$= 1 - \frac{1}{2} \alpha^2 \delta^2 + \frac{1}{8} (3\alpha^4 - 4) \delta^4 - \frac{1}{16} (5\alpha^6 - 12\alpha^2) \delta^6 + \dots$$

$$= 1 - \frac{1}{2} (D_r^2 - 2) \delta^2 + \frac{1}{8} [3(D_r^2 - 2)^2 - 4] \delta^4 - \frac{1}{16} [5(D_r^2 - 2)^3 - 12(D_r^2 - 2)] \delta^6 - \dots$$

$$\theta = \tan^{-1} \frac{\delta D_r}{\delta^2 - 1} = -\tan^{-1} \frac{(a+b)\delta}{1 - ab\delta^2} = -\tan^{-1} a\delta - \tan^{-1} b\delta$$

where

$$ab = 1$$

$$a + b = D_r$$

$$\theta = \left[ -a\delta + \frac{1}{3} a^3 \delta^3 - \frac{1}{5} a^5 \delta^5 + \dots \right] + \left[ -b\delta + \frac{1}{3} b^3 \delta^3 - \frac{1}{5} b^5 \delta^5 + \dots \right]$$

$$\theta = - \left[ (a+b)\delta - \frac{1}{3} (a^3 + b^3) \delta^3 + \frac{1}{5} (a^5 + b^5) \delta^5 - \dots \right]$$

$$\theta = - (a+b)\delta + [(a+b)^3 - 3ab(a+b)] \frac{\delta^3}{3} - [(a+b)^5 - 5ab(a+b)^3 + 5ab(a+b)] \frac{\delta^5}{5} + [(a+b)^7 - 7ab(a+b)^5 + 14ab(a+b)^3 - 7a^2b^2(a+b)] \frac{\delta^7}{7} - \dots$$

$$\theta = -D_r \delta + D_r(D_r^2 - 3) \frac{\delta^3}{3} - D_r(D_r^4 - 5D_r^2 + 5) \frac{\delta^5}{5} + D_r(D_r^6 - 7D_r^4 + 14D_r^2 - 7) \frac{\delta^7}{7} - \dots$$

# Postwar-Radio Planning\*

JAMES LAWRENCE FLY†, NONMEMBER, I.R.E.

THIS IS an opportunity to which I have looked forward. It's always a bit awe inspiring to undertake to get the experts told. It does permit me to congratulate the Institute of Radio Engineers upon its selection of Doctor L. P. Wheeler for its president during 1943. It has been my good fortune to have had the benefit of Dr. Wheeler's counsel and assistance ever since I have been with the Commission. As Chief of the Technical Information Division of our Engineering Department, Dr. Wheeler has brought to the Federal Communications Commission all of his experience as a teacher at Yale and as a research physicist at the Navy's laboratories at Bellevue. The background of electronics at his command has served us well in coping with radio problems. The Commission appreciates having a member of its staff so recognized by this outstanding group of radio engineers.

It has been remarked that the war in which we are engaged is the greatest technical and engineering war of all time. It is being fought by machines—flying through the air, rolling over the ground, sweeping over the oceans, or gliding underneath the surface of the seas. All these are machines which must be supplied with most complex and delicate instruments. History may record radio supremacy as comparable in importance to the control of the seas. There are none more fully aware of the part that radio is playing in this war than you who are here this evening. An irritating squawk and fascinating toy twenty-five years ago, today it quickly co-ordinates our military and naval operations; locally in the case of individual ships, airplanes, and tanks; and across the seas in the case of whole armies and task forces. The date lines on daily news stories show how far afield our various machines of war operate. None operate more remotely than our submarines. Incidentally, it may surprise many of you to learn that the man who will be the IRE president in 1943 contributed a great deal to make these submarine operations possible. Over long periods he conducted research inside a "pig boat" as it lay on the bottom of Hawaiian waters. His work on electronics has done much to make our submarines the most feared in the world.

Radio, along with other communications, is playing another role. It helps to tie more closely the fighting forces with those at home. Modern conscription of the masses for war service, beginning with Napoleon, has called for a greater and greater part to be played by the citizen with each succeeding war. War today is no

longer impersonal even to noncombatants. The war today is called a "People's War" largely because of the ideology that surrounds the conflict. I think too that radio has helped to make it a "People's War." Bridged by radio, the soldier on the battlefield and the citizen on the home front are nearly one in thought and attitude during the trials and fortunes of battle.

Our industrial radio machine and our national communications system have been making adjustments for conversion from peace to war work. The progress we have made so far in converting radio to its war role was ably discussed by the Presidents of the Institute of Radio Engineers and the Radio Manufacturers Association at the IRE convention in Cleveland last June. We now have our manufacturing plants and our communications systems going with ever-increasing momentum and we plan to keep it so until we have won.

It has been as gratifying to you, I am sure, as it has been to me to receive reports from time to time from our fighting men that indicate that their radio equipment is matching our highest hopes. However, we must not relapse into overconfidence. We will have to await the outcome of the final battle before relaxing for a moment. The demands upon radio are heavy, and there are still many problems to be licked. This Association can help. From this meeting with fellow workers in allied lines, seeing them, talking with them, exchanging ideas,—we can go back to our jobs with new perspective and new inspiration. Often from our discussion of some troublesome problem, there emerges a solution that has been just around the corner.

I want to look around the corner briefly and to discuss postwar radio with you. Radio moves so fast that we have to keep peering into the future. In doing so, we are unable to see sharply and clearly, with strong contrasts and good definition. But we can see rough shapes and enough outlines to guess at what's coming.

We know that after this war our radio machine will be plunging ahead with a far greater speed. The machine cannot be stopped nor even permitted to slow down. At that time we will have to readjust its direction and continue to move ahead. The energy required to make this change will be great. I want, therefore, to suggest that you consider the formation of a committee or committees to work on postwar problems. Such committees might well be organized on the model of the National Television Standards Committee, which, under the effective leadership of W. R. G. Baker and James Knowlson rendered great assistance in the preparation of standards for television.

In passing, I should be derelict should I let another occasion pass without recognizing the work of Ewell

\* Decimal classification: R560. Original manuscript received by the Institute, December 10, 1942. Presented, Rochester Fall Meeting, Rochester, N. Y., November 9, 1942.

† Chairman, Federal Communications Commission, Washington, D. C.

K. Jett. He is a man of effective personality and an untiring devotion to duty and he has been of great assistance in the Commission's problems of administration. He is the spark plug of the Board of War Communications. Search though you may through Government, the Army, and the Navy, and the industry, you cannot find another man of such broad competence in the field of world communications. Mr. Jett will stand ready to work with your industry organization.

I know of no organization better qualified to initiate this suggested work than those that are represented here tonight. In the Radio Manufacturers Association and the Institute of Radio Engineers, there exist two great organizations in which are co-ordinated practically all activities of the radio industry. There are pure scientists, mathematicians and teachers, laboratory workers, experimenters and inventors, designers and developers, organizers and standardizers, managers, manufacturers, administrators, and all the rest. To this project, however, we must add regulators too, for it surely is advisable to include representatives of the Commission in the discussion of these important problems. In fact, the list of committee members should be representatives of all parts of the field, for radio has become a very broad term indeed. We no longer think of it as associated solely with communications such as broadcasting, radiotelegraphy, and the like. It is rapidly infiltrating into almost every phase of our lives. In the postwar period it unquestionably will be as important and vital a factor in industrial conversion and economic reconstruction as it is now on the battlefronts.

As I said before, we shall not be able to see in the future any pictures of sharp outline, but the nearer we approach, the clearer shall we see the things that are there. A committee already set up and functioning will be able to make use of its experience and make provisions in plans and policies in the light of newer conditions. It will be better able to appraise and aid in the exploitation of discoveries which wartime research will surely bring forth. We know that work must be started and plans prepared if we are to win the peace that follows without undue hardship and distress. In addition to the problems of readjustment, reorganization, reconversion of plant equipment, and the many others with which we have had experience in passing from peace to war, there are others which we can see most clearly at this time.

*First:* We can confidently predict a great expansion of the television and frequency-modulation broadcast and general communications services, and planning for their proper development is definitely in order. As you know, the present plant and status of the broadcasting industry is practically frozen, both by license and priority regulations. Therefore a committee working on this problem can do so with relative confidence because depreciation and obsolescence of exist-

ing plants are running on just as usual. With time, and the possibility of fully developed plans for television and frequency modulation and improvements in the other fields, the economic obstacles normally facing new technological advances will be of less concern. This will be particularly true where our business executives see that sound depreciation policies continue to be employed.

*Second:* Somewhat related to the first problem is the fact that there will be a great surplus of radio war equipment. In addition, there will be new types which are the result of new developments and inventions which may not be revealed at this time. The disposal of this equipment certainly constitutes a major objective.

*Third:* There will be many thousands of men with new skills gained in the armed forces—skills in radio which will have to find a place. Then there are the many women who have absorbed skills in radio repair and installation while working in the aircraft factories and other plants now devoted to war production. It is certain that an appreciable proportion will want to continue in this line of work. Employment for all of these people, who most certainly will want to work with us in radio, is something to think about at this time.

*Fourth:* Radio has been on the move into fields other than communications. This trend started even before the war. In the case of medicine and surgery as many as 80,000 diathermy machines have been registered with the Commission; and this hardly indicates the extent to which radio is being used for the relief of human ills. Radio is moving rapidly into industrial applications too, for precision measurements and testing and for the synthesis, manufacture, and processing of new materials. Its progress needs to be carefully watched in this direction as it is likely to become an essential and invaluable tool of almost every modern industry. Better health, comfort, convenience, and safety are only a few of the boons which postwar radio will give mankind.

In this connection I would like to quote from a recent institutional ad of the *New York Times*, which expresses the thought very well. In this ad there is a striding American soldier with a walkie-talkie on his back. The reader is startled by the statement that the tube upon his back will save a million lives. To go on, it states:

"Under the flaring northern lights at the fringe of the great ice, on craggy Pacific islands, in the desert sands of Africa, Americans are holding a world-wide front. Against Odds!

"But they have a new protection. A voice that can penetrate the noise of a tank, that can search out a shadowy group lost in a jungle, that can direct a plane in flight. A voice that can warn of lurking killers or threatening flankers. A voice that can comfort or command as needed.



"That voice comes from a pack upon the speaker's back. In that pack there is a tube. That tube is the secret of an immense new power that we are learning to control.

"It is the electronic tube.

"Today it will save thousands of lives that must otherwise have been sacrificed to war. Tomorrow it will save millions by preventing accidents, by improving medical and surgical practice. Electronics can see into germ structure or through the utter blackness of night and fog with equal ease. It can smell out poisons, anticipate fires, guarantee food values, assure the perfection of manufactured goods.

"In many ways it is a symbol of this war.

"For actually we are fighting to determine whether the fruits of science shall be used for our enslavement or our enjoyment.

"If we lose, this latest great achievement of man will supply the victor with the jailer's unfailing eye, the pitiless supervisor of slave labor, the impassable wall of the concentration camp.

"But if we win, electronics will provide new work and happiness for millions of Americans.

"Throughout the world it will make possible a better life."

So, gentlemen, your public awaits you. The people already have an idea of what is in your power.

It is quite probable that in the postwar period we shall become the world's principal suppliers of radio equipment. We shall have to make provision for this export trade. And in this connection we must not overlook the potential importance of international broadcasting as a method of assuring an enduring peace. New methods and techniques may be found in the broadcasting of sound and pictures to peoples of foreign lands to give visual and living emphasis to aspirations common to people of good will everywhere. Color television must be developed. The distance limitations hitherto imposed upon television must be broken down. You engineers already have a pincers movement underway against this one obstacle. We are bound to have a feasible method for the long-distance relay of television by high-frequency emissions.

We can never forget the allocation and interference problems. They are always with us. We may expect the present congestion in the lower regions of the spectrum to increase rather than diminish. We are going up. In the upper regions of the spectrum we must prepare for expansion. Fortunately, it is virtually certain that we will be ready to make some immediate use of that portion between the present upper top of approximately 150 megacycles to at least 3000 megacycles. While we advance into wider spaces the uses of radio multiply, and the problem of allocation continues to haunt us. This may appear at first sight to be purely the Commission's pigeon, but that is not so. For allocation engineering is also one of these specialties peculiar to radio which is not so simple as to permit the Commission to proceed alone. You are always concerned, and assistance from you experts of the industry has always been freely given. We shall continue to rely upon that assistance.

Radio has been called a science and it has been called an art. It is something of both. When I think of radio, I always think of the grand engineers who have developed this important science through the decades. But we cannot ignore the sound and telephone experts or the optical and photographic specialists, on the one hand, nor can we forget all the artists, announcers, production managers, and program people, on the other. The postwar problems are so interconnected that, should you act upon my suggestion the committees which go to work upon them will require the collaboration and assistance of a number of organizations. But this should not be difficult. That assistance will not have to be sought—it will be volunteered. Everyone in radio is seeking to contribute his share. And why not? There is a great vista ahead which we shall fully exploit at the end of the war.

Engineers and scientists commonly say: "What is your problem? We can't do anything if we don't know what we have to look for." I hope that I, as a layman, have been of some little assistance in reminding you of some of our "problems" and that you will start "looking for" the answers.

# I.R.E. and the War\*

ARTHUR VAN DYCK†, FELLOW, I.R.E.

**WE** ARE nearing the end of our first year of war. It has been a year of preparation, necessarily. The national effort, not having been geared for war, has had to be redirected toward new aims and to use new methods and tools. Similarly with the Institute of Radio Engineers; it has had to be a year of preparation, of clearing for action, of getting ready for the decisive efforts ahead.

The Officers and the Board of Directors have given much time during the year to this preparation and planning. You will see the evidence shortly in proposals to the membership of measures designed to enable the Institute better to meet the new conditions, and better to assist toward winning the war and winning the peace.

Among those proposals is one for revision of the membership-grade structure of the Institute, in such manner as to provide an additional grade between the present Member and Associate grades, of intermediate requirements, and limited to those actually in radio and allied fields.

The new grade will meet a long-felt need for a professional classification less stringent than the present Member grade. It will be especially appropriate in the enormous war expansion in the number of people engaged in various technical branches of radio, with varying degrees of professional competence.

Insofar as immediate efforts are concerned, I think the job can be outlined in a five-point program.

One task is to aid in the allocation of radio manpower to maximum service in the war effort. A little has been done on this in connection with the National Roster, but much more remains to be done. The conflicting requirements of Selective Service and various other radio personnel demands need to be compromised, with the exercise of maximum information, wisdom, and judgment. Steps to accomplish this end are under way. Personnel-readjustment conditions after the war will be serious, and perhaps we can make preparations soon, which will lessen the later problem.

Another task is to aid in the standardization and simplification of radio parts and equipment used by the armed forces. This is one of drudgery, a maximum of work, and a minimum of reward, but is one which is the obligation of engineering societies to conduct as a part of their professional, impartial, technically sound contribution to industry and the nation. Its benefits are incalculable. They are not only contributions to more efficient production of apparatus, but have

highly desirable effects upon the operation of apparatus in the field.

Next it is necessary to broaden the scope of operations of the Institute, in order to accord with the increasing sphere of radio's influence. Once upon a time radio was merely a point-to-point telegraph communication means, then telephony was added, then mass communication, or sound broadcasting. And then came vision by radio. Now we have in view still more applications of radio-frequency wonders, which I can conveniently and fortunately avoid having to name by adopting the necessary and very popular cloak of military secrecy.

The whole field of electronics is in process of broadening, although not quite so prismatically as advertising copy writers occasionally describe the picture, but *we* are concerned only with those fields which involve radio frequency. Recently, I heard a new term for these new radio fields which seems apt. It is "radionics." That seems to be a good term, if we want to find one which will win friends and influence people. However, in this matter of terminology, I hope that engineers will remain sound and sensible, and I want to utter a word of warning.

In the past we have seen commercial and advertising interests place more importance on names and slogans than on technical soundness, and come to grief after a flurry of excitement which looked like success for a while. Now that engineers are just entering into the period of more influence in planning and administration, I hope that they will not make the mistake of forsaking the path of technical rectitude for the glitter of side-show-barker methods. It doesn't work in the long run anyway, because you can't change Nature's laws by giving them fancy names, and it backfires on the industry which tries it. In the past few years there have been some attempts in the radio industry to substitute promissory words for real service delivered. Let us not have any more of this but instead, as we broaden our field of activity, let us as ethical, professional men, stick to facts, and practical, useful facts, too, in all our dealings with the profession, the industry, the government, and the public.

A necessary item in our program is to maximize the efficiency of our own organization. Progress has been made toward this, but more remains to be achieved. It will interest many of you who have previously recommended the step, to learn that a Section has been instituted in New York. This will not only free the National office of local matters, but will undoubtedly increase the extent and interest of activities in the New York area. Other plans for improving operations are under consideration.

\* Decimal classification: R560. Original manuscript received by the Institute, December 7, 1942. Presented, Rochester Fall Meeting, Rochester, N. Y., November 9, 1942.

† RCA License Laboratories, New York, N. Y.

A fifth step, advisable to take soon, is that of post-war planning for radio and radionics, particularly television. There was a time when the Institute was very active in co-operation with commercial and governmental agencies in new radio matters. But, about 1930, there came such a large and sudden expansion in radio technique, that Institute activities unconsciously became concentrated on the purely technical aspects of the new developments. Thus it came about that even such important developments as international broadcasting, television, and ultra-high-frequency broadcasting, received little attention from the Institute except as subjects of technical interest, involving papers to be published for the information of the membership. The situation was not realized at the time, but we can see now that the Institute missed an opportunity to render those services which may properly be expected from the professional engineering society of the industry. Now that it is realized, we should perform accordingly in the future, and it should be possible for the Institute to aid materially in post-war industrial activities. Such aid will include furnishing authoritative information and recommendations in many industry matters, and assistance in the adjustment of dislocations in technical personnel. Of course, there will be a tremendous job of publication to do, in papers which will have been withheld throughout the war. In general, radio has now grown up, and its engineering association should take the place therein, which other engineering associations have taken in their older industries.

If substantial efforts are to be applied immediately at the end of the war, when they will be needed most, planning should be undertaken now. There are some things which ought to be done in the near future, if they can be done without loss to the war effort, which of course must come first. And I would like to suggest that, while it is necessary to think about the conversion of war discoveries to peacetime utilizations, we should be realistic enough to appreciate that radically new things can have only small benefit in the early postwar period. Time is required for introduction and growth of new things to a magnitude which means much to basic matters such as employment of large numbers of workers. In other words, there will be a "switchback" period, which, if it is to see large-scale activity must depend upon things not wholly new, and which have some war or prewar experience and facilities already available. If we take care of the "switchback" period, the later period will be much easier to take care of, and probably will take care of itself.

Radio is probably unique among American industries in that it has available such a new service and one of vast possibilities. That one is television, which passed through its incubation period before the war, and can be made ready quickly for full service, with only minor time and effort to incorporate the moderate

degree of improvement which war developments will have made possible.

So I think that our five-point program should include postwar planning, and that the radio industry is a fortunate one in that it has not only a later postwar period of enormous promise, but can have as well an early postwar possibility of quick usefulness.

In the meantime, radio engineers are devoting time and overtime in helping to win the war. They will be entitled to good vacations when it is over, but even then they are not likely to get them. The Armistice of this war, in distinction to World War I, will be heralded by radio loudspeakers all over the world. Those welcome sounds will mark not only the end of the conflict, but the beginning of a new period in which radio engineers will have many new problems in the vital duty to translate radio possibilities to peacetime benefit as rapidly as possible.

At various times during the past year, in talking about the future, I have emphasized the need for broader vision on the part of scientists and engineers, a larger participation by them in affairs of the everyday world, and a larger voice in the utilization of their output. It is not necessary or desirable to dwell upon that idea again in this statement. But it is perhaps appropriate to conclude with these words of L. A. Hawkins<sup>1</sup> of the General Electric research laboratory which should inspire any engineer who has appreciation of the high responsibility of his profession.

"We have seen the far greater number and complexity of the problems now confronting us. We have seen the number of scientists engaged in war research increased from hundreds to thousands, and their expenditures from millions to tens of millions of dollars. Are we now to look forward to the organization, in another twenty-five years, of tens of thousands of scientists, spending hundreds of millions of dollars, to attack the still more numerous problems of still more mechanized and still more terrible war? Or this time shall we finish the job?"

"When victory is won, and the consequent emotional let-down brings war-weariness sweeping over us in waves, shall we again permit our isolationists to lead us back into the primrose paths of so-called 'normalcy,' leaving the world in an international chaos to breed still more sanguinary conflicts? Shall we again pour out our blood and treasure to 'make the world safe for democracy,' and then desert the task just when we have won the power to complete it? Or shall we finish the job, joining with the other free nations in intensive, sustained, and unselfish cooperation, to erect upon the field of victory, around the corner-stone of the Atlantic Charter, a new world structure, to which all nations of good will may resort to find liberty, security, and opportunity, and which will be so strong that no gangster nation will dare attack it?"

<sup>1</sup> L. A. Hawkins, *Gen. Elec. Rev.*, June, 1942.

"Are we to go down in history as the generation which twice had offered to it the greatest opportunity in the history of mankind, and twice refused it in selfish stupidity, or are we to be recorded as the generation which fought and won the world's last and greatest war, and established the world's first enduring peace?"

The answers to those questions will be largely de-

termined during the next ten years. We men of science, accustomed to planning on a basis of facts and control of Nature's laws, have an opportunity to assist others toward a realization that there is a scientific way to design all affairs of men, not merely their buildings, bridges and radios. The scientific way is constructive, not destructive, and leads to more joy and even more profit. Let us show the way.

## CORRECTION

### "Theory of Antennas of Arbitrary Size and Shape"

S. A. SCHELKUNOFF

#### Correction

S. A. Schelkunoff, whose paper, "Theory of Antennas of Arbitrary Size and Shape," which appeared on pages 493 to 521 in the September, 1941, issue of the PROCEEDINGS, has brought to the attention of the editors an error in Fig. 9 of his paper. This is an isolated error and does not affect either the reactance formula or other formulas and curves depending on it. The corrected figure is shown to the right.

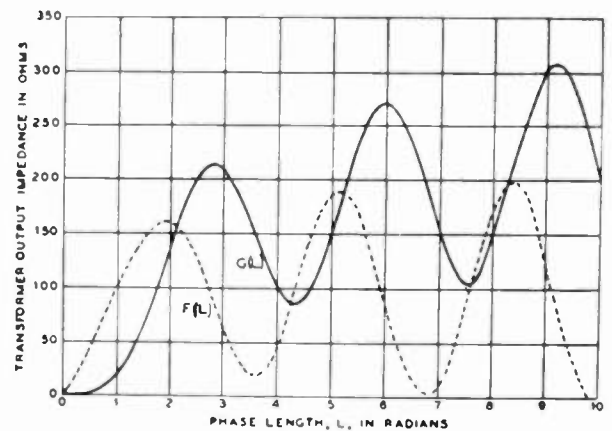

FIG. 9—The real and the imaginary parts of the "transformed" output impedance  $k^2/Z_t = G(L) + iF(L)$ , where  $L = 2\pi l/\lambda$ .

# Institute News and Radio Notes

---

## Winter Conferences—1943 January 28, 1943

As this notice is being written, in early December, 1942, it appears that Boston, Buffalo-Niagara, Cincinnati, Montreal, Portland, St. Louis, San Francisco, Toronto, Washington, and other Institute Sections will hold meetings on or near Winter Conference Day, designated by the Board of Directors to coincide with the date of the Annual Meeting in New York, January 28, 1943. Connecticut Valley, New York, and Philadelphia Sections will throw their support to the all-day Annual Meeting, which, as announced in the December PROCEEDINGS, will be held jointly on that date with the National Technical Meeting of the American Institute of Electrical Engineers in the Engineering Societies Building, 33 West 39 Street, New York, N. Y.

Each Section will circularize its membership as to time, place, date, and all particulars of its meeting, wherever one is being held. The Cincinnati, New York, San Francisco, and Washington Sections have already contributed papers and made them available for other Sections' use; Montreal, Philadelphia, Pittsburgh, and Toronto Sections are among those active in obtaining other papers for similar disposition.

### Nationwide Hookup

Through the initiative of the Washington Section, Captain E. M. Webster, United States Coast Guard, chairman; a coast-to-coast radio hookup has been obtained over the facilities of the Columbia Broadcasting System, from 10:30 to 10:45 P. M., Eastern War Time, January 28, for the broadcasting of ceremonies linking the Washington banquet and the New York meeting. Sections which can make suitable dispositions of their meeting schedules will tie in with this feature through locally arranged public-address systems. The event will be of widespread interest to Institute members in their homes throughout the United States and Canada. The newly inducted President of the Institute for 1943, Dr. L. P. Wheeler, will broadcast a brief word of greeting from New York, following an introduction by the Junior Past President, Arthur F. Van Dyck.

### Washington

The radio program will then be shifted to Washington, where that Section, holding a banquet at the Willard Hotel, will be in front of the microphone

while the Honorable James Lawrence Fly, chairman of the Board of War Communications speaks during the remainder of the 15-minute broadcasting period.

This radio event is but the finale of a full evening's program planned by the Washington Section, carrying out the theme "Radio Goes to War!" A technical papers' session of an hour or more at the Willard, under the chairmanship of Fred W. Albertson, will get under way at 5:00 P. M., followed by a social get-together preceding the banquet at 8 o'clock. Gerald C. Gross heads the banquet committee, and he has scheduled a grand evening of entertainment. Captain Webster, who is in general charge of the evening's events, will pass the Section gavel to the new chairman, Clyde M. Hunt, during the ceremonies.

All members of the Institute temporarily or permanently in Washington, their wives, and their friends are cordially invited to attend. Tickets are obtainable from Mr. Gross whose telephone number is Executive 3620.

### New York

The day's activities at New York, on January 28, will open with a technical session, beginning at 10:00 A. M. A folder giving the names of papers and authors and describing the entire day's events will be mailed to the Connecticut Valley, New York, and Philadelphia membership a reasonable time prior to the Annual Meeting.

The following papers will be presented Thursday morning, January 28 from 10:00 A. M. to 12:30 P. M.

"Radio-Frequency-Operated High-Voltage Supplies for Cathode-Ray Tubes," by O. H. Schade, RCA Manufacturing Company, Harrison, N. J.

"Transmission-Line Charts," by R. S. Julian, Bell Telephone Laboratories, Whippany, N. J.

"Polydirectional Microphones," by H. F. Olson, RCA Manufacturing Company, Camden, N. J.

"Phosphors and the Periodic System of the Elements," by H. W. Leverenz, R.C.A. Communications Laboratories, Princeton, N. J.

### Annual Meeting

In accordance with provisions of the Constitution, the Annual Meeting of the Institute will be held in the Engineering Societies Building, 33 West 39 Street, New York, N. Y., at 2:30 P. M., January 28, 1943. This

announcement constitutes legal notice thereof.

The annual report of the Secretary will be received.

Past-President Van Dyck will give an account of his term of office and the trend of Institute accomplishment. He and President Wheeler will then engage in the traditional ceremony of transferring the gavel as the symbol of office, with appropriate remarks by Dr. Wheeler.

The Institute Medal of Honor will be presented to William Wilson for his achievements in the development of modern electronics, including its application to radiotelephony, and for his contributions to the welfare and work of the Institute.

Fellowships of the Institute will be conferred on the following:

Andrew Alford for his contributions to the theory of radiation and the design of short-wave antennas.

Ivan S. Coggeshall for his services to the welfare of the Institute and the engineering profession.

Captain Jennings B. Dow for engineering accomplishments in the development and procurement of radio equipment for the United States Navy.

Lee A. DuBridge for engineering and administrative leadership in the development and application of new radio techniques.

Peter C. Goldmark for his contributions to the development of practical color television.

Daniel E. Harnett in recognition of his outstanding direction of radio engineering activities.

Dorman D. Israel in recognition of his contributions to the engineering of broadcast receivers.

Axel G. Jensen for his constructive participation in the development of the short-wave transatlantic telephone, the development of broad-band, multichannel telephony, and the art of television.

Lieutenant Colonel George F. Metcalf for his development work on vacuum tubes and vacuum-tube circuits and the successful co-ordination of many technical projects requiring broad scientific knowledge.

Irving Wolff for basic research in centimeter-wave radio and application of it to the development of navigation instruments.

The special-papers symposium, with which the Annual Meeting will be concluded, takes its color from current world events, to which the radio engineer is contributing more than a full share of influence. In a technological war, distinguished members of the Institute are to be found engaged in tasks quite foreign in purpose to those which occupied them in times of peace, some of them in their accustomed locale while others are in the armed forces and in Government agencies prosecuting the war. The work of many of them imposes strict secrecy. With respect to others, certain phases of their work may be explained for the benefit and education of other members of the Institute. Several of these men have consented to address the Institute at its Annual Meeting. Lloyd Espenschied will set the stage with a brief summary paper on

radio in two World Wars. Rear-Admiral S. C. Hooper of the United States Navy will speak on "The Production of Radio Facilities for the Armed Services," Ray Ellis, Director of the Radio-Radar Division of the War Production Board will address the group on "The Function of the War Production Board in Radio." "The Army-Navy Electronics Production Agency," will be discussed by F. R. Lack, Director of that agency. H. P. Westman of the War Committee on Radio, American Standards Association, will speak on "Radio Standards Go to War." Kirk Miles of the National Roster, War Manpower Commission, will describe the engineer's function in selective service and manpower plans.

### Evening Meeting

The day's events will culminate in a joint A.I.E.E.-I.R.E. technical meeting at 8:30 p. m., on the subject of Ultra-High-Frequencies, the address being given by Dr. George C. Southworth of Bell Telephone Laboratories, Inc. Doctor Southworth, a Fellow of the I.R.E., has previously given two notable addresses on this general subject before the I.R.E. and various Sections of the A.I.E.E. The Institute values greatly this privilege of joining with its sister society in hearing Doctor Southworth.

### A.I.E.E. Joint Activities

Members of the Institute of Radio Engineers have been extended a cordial invitation by the American Institute of Electrical Engineers to attend any of the sessions of A.I.E.E. held during the period of their five-day meeting, January 25 to 29. Maximum aid to the war effort will be the principal theme for most of their sessions and conferences. Arrangements are being made for a program on the subject of technical manpower requirements to aid the war effort, with prominent speakers presenting both the military and industrial phases of the subject. Many of the sessions will deal with utilizing existing electrical equipment to the utmost in order to conserve copper and other critical materials.

Of especial interest to I.R.E. registrants are:

A symposium on Varistors and Thermistors, to be held under the auspices of the A.I.E.E. Communication Committee.

A conference on Industrial Electronics.

Award of the Edison, John Fritz, and Hoover Medals, on Wednesday evening, January 27.

The I.R.E.-A.I.E.E. co-operating committees consist of Messrs. F. A. Cowan and Louis Pacent, for the A.I.E.E., and Messrs. H. A. Wheeler, D. D. Israel, and I. S. Coggeshall, for the I.R.E. In addition, the Institute Committee consists of Mr. H. M. Lewis, chairman of the New York Section, acting as chairman of a subcommittee on registration, and Dr. Austin Bailey, chairman of the subcommittee on program.

## Registration

There will be an I.R.E. registration desk open in the lobby for the issuance of badges to I.R.E. members and their guests at the morning and afternoon sessions

of Thursday, January 28, only. I.R.E. members only, desiring to attend A.I.E.E. sessions on any day except Thursday, should register as a guest of the A.I.E.E. at their lobby registration desk, by courtesy of that society.

## Board of Directors

A regular meeting of the Board of Directors was held on December 2, 1942, and was attended by Haraden Pratt, acting chairman; Austin Bailey, C. C. Chambers, I. S. Coggeshall, W. L. Everitt, H. T. Friis, O. B. Hanson, C. M. Jansky, Jr., F. B. Llewellyn, B. J. Thompson, H. M. Turner, H. A. Wheeler, L. P. Wheeler, H. P. Westman, secretary; and W. B. Cowilich, assistant secretary.

The resignation of Secretary Westman to be effective December 15, 1942, was accepted.

In view of modifications which are being made in the editorial procedure and staff, Helen M. Stote was advanced from assistant editor to associate editor.

The 1942 Budget was revised to show receipts and disbursements of approximately \$104,000 and \$92,000, respectively.

President-elect Wheeler is serving on the Board of Directors as an elected Director whose term expires at the end of 1943. In order to avoid a vacancy on the Board of Directors, his resignation as an elected Director for 1943 was accepted.

The service of President Van Dyck as a representative of the Institute on the Consultative Committee on Engineering of the Division of War Manpower Commission of the Office for Emergency Management and of Mr. Pratt as an alternate, was approved.

Mr. Thompson was appointed to investigate the problem of the status of radio engineers under Selective Service. The Executive Committee was empowered to appoint a committee on this subject.

On recommendation of the Awards Committee, the Medal of Honor for 1943 was voted to William Wilson for his achievements in the development of modern electronics, including its application to radiotelephony, and for his contributions to the welfare and work of the Institute.

The following addition to the Constitution for Sections, adopted by the Sections Committee as a result of its annual meeting on June 29, 1942, was approved.

### ARTICLE VI

Sec. 6—The Chairman shall, when notified of the Annual Meeting of the Committee on Sections, arrange for representation of his Section at such Annual Meeting by himself or by some member of his Section or he shall forward a letter to the Committee Chairman explaining inability to provide representation and

giving the views of his Section on the agenda or proposals before the meeting.

Failure to comply with the above shall be punished by a fine of \$10.00 to be deducted from the rebates to the Section. Sections so remotely located as to make the requirements unusually difficult, may be excused by the Sections Committee from these penalties.

The above penalty shall not be exacted if the Chairman of the Sections Committee shall fail to forward to each Section Chairman and Secretary, at least forty-five days in advance of the date of the Annual Meeting of the Sections Committee, notice of that meeting and the agenda to be considered thereat.

## Executive Committee

A meeting of the Executive Committee which was attended by A. F. Van Dyck, chairman; I. S. Coggeshall, Alfred N. Goldsmith, R. A. Heising (guest); F. B. Llewellyn, Haraden Pratt, B. J. Thompson, and H. P. Westman, secretary; was held on November 12, 1942.

The meeting was devoted to a discussion of the office organization, the operation of the Institute, and the appointments to Institute Committees.

On November 20, 1942, the Executive Committee met. Those present were: A. F. Van Dyck, chairman; I. S. Coggeshall, Alfred N. Goldsmith, R. A. Heising (guest); F. B. Llewellyn, Haraden Pratt, B. J. Thompson, L. P. Wheeler, (president-elect); and W. B. Cowilich, assistant secretary.

Several matters pertaining to the operation of the office and of the personnel were considered.

The financial operations of the Institute for the first ten months of 1942 were discussed.

The Executive Committee met on December 2, 1942 and those present were Haraden Pratt, acting chairman; I. S. Coggeshall, R. A. Heising (guest); F. B. Llewellyn, B. J. Thompson, L. P. Wheeler, (president-elect); H. P. Westman, secretary; and W. B. Cowilich, assistant secretary.

Certain revisions in the budget for 1942 were discussed and were recommended to the Board of Directors for adoption.

A proposed amendment to the Constitution for Sections was considered and

recommended favorably to the Board of Directors.

Applications for transfer to Member in the names of A. B. Bailey, H. V. Griffiths and J. A. Stobbe, and for admission to Member in the names of J. C. Bayles, S. T. Fisher, and D. L. Hathaway, were approved.

Approval was granted to 82 applications for Associate, 179 for Student, and 6 for Junior.

## Books

### Mathematics for Electricians and Radiomen, by Nelson M. Cooke

Published by the McGraw-Hill Book Company, 330 West 42 Street, New York, N. Y. 595 pages+7-page index+viii pages. 301 figures. 6½×9¼ inches. Price, \$4.00.

As indicated by the title, this book was written for electricians and radiomen having little if any mathematical foundation. The author has succeeded in presenting the various phases of the subject necessary for these groups in a simple and understandable manner. The numerous illustrative problems that are worked out in detail with each step clearly indicated and the results checked will be a great help to the beginner who is without any other guidance. For the most part the mathematics is applied to electrical problems of practical value to the reader. The book contains an unusually large number of problems by means of which one can test his ability to solve them. Answers for many of them can be found in the back. The tables which are included in the Appendix will prove convenient. The author has departed from standard conventions in a number of cases among which are: using a small rectangle instead of a short line for the negative battery element; "I" is shown flowing in the opposite direction to that universally used and in conflict with that indicated by an ammeter placed in the line; using a rectangle for instruments with binding posts at the top, instead of circles with leads brought out at any convenient place. The latter frequently results in unnecessarily complicated diagrams. It would have been wiser to use the generally accepted symbols.

H. M. TURNER  
Yale University  
New Haven, Conn.

## The Radio Amateur's Handbook, Special Defense Edition

Published by The American Radio Relay League, West Hartford, Conn. 280 pages+8-page index. 301 figures.  $6\frac{1}{2} \times 9\frac{1}{2}$  inches. Price, \$1.00.

The Special Defense Edition of the Handbook is a revised edition designed primarily to serve as a textbook for defense training courses such as are given in numerous high schools, community centers, etc., throughout the country. It retains all of the basic theory included in previous editions of the Handbook but omits most of the apparatus construction details primarily of interest to the radio amateur.

A very good chapter has been added dealing with the elementary operations of simple mathematics.

There is also a section dealing with the learning of the telegraph code, and some suggestions for a classroom code table.

The material is well chosen to be of special value to those seeking to qualify as radio operators and it is conveniently arranged and clearly presented.

H. O. PETERSON  
R.C.A. Communications, Inc.  
Riverhead, L. I., N. Y.

## Acoustics of Music, by Wilmer T. Bartholomew

Published by Prentice Hall, Inc., 70 Fifth Avenue, New York, N. Y., 1942. 242+xvi pages. 42 illustrations.  $6\frac{1}{2} \times 9\frac{1}{2}$  inches. Price \$3.00.

Although both the musician and the acoustical engineer deal intimately with the same basic phenomena, their points of view have differed greatly and their contacts with each other have too often resulted in friction, with its inevitable product, heat. The present book, which is written from the musician's point of view, aims to acquaint musicians with the basic physical facts of acoustics as well as with the more subtle psychophysiological factors with which the musician is familiar through experience, but concerning which his opinions may have outstripped his knowledge. The author, who is a member of the faculty of the Peabody Conservatory of Music, is to be congratulated upon having produced such a well-written, readable, and informative exposition of the subject. The treatment is simple, clear, and nonmathematical and while leaning, as it should, toward the language of the musi-

cian rather than that of the engineer, the book still makes interesting reading for the latter, although it may occasionally send him to a dictionary of musical terms.

The author, in his preface, at once does much to place himself in the good graces of his scientific readers by statements such as the following: "... although written from the musician's standpoint, and with, I hope, a constant awareness of aesthetic factors too subtle and too tenuous to be caught in the scientist's sieve, it does eschew the typical pseudo-mystical misinformation that weakens so many texts written by musicians lacking either scientific training or a true mysticism. It does not go far into the scientific realm, but it attempts to be correct, up-to-date, and truly scientific in spirit as far as it goes."

In the body of the book, the author surveys, in his first chapter, the nature of vibration and its relationship to music, and then passes on to sound waves and their characteristics. Next comes a chapter on vibratory sources of sounds used in music, wherein are treated stretched strings, air columns, percussion, voice, and noise. The section on voice, the specialty of the author, has the ring of authority and, we suspect, is intended to exert a considerable debunking influence upon the voice-teaching profession. The manner in which one may obtain the relaxed, open throat which, the author emphasizes, is a primary requisite for good voice quality, is painstakingly explained, and even a bathtub-singing engineer should be able to improve his vocal performance from the study and application of this section.

Chapter 4 on harmony and scales is probably the only portion which will be found difficult reading for the engineer without musical training, and may require frequent reference to the musical dictionary for terms which are the everyday language of the musician. There follows a chapter on hearing; and the book concludes with a chapter on electrical recording and reproduction of sound, and electronic musical instruments. Here the radio engineer will find some interesting comments on the frequency and volume ranges of radio receivers, as well as some conclusions with regard to high-fidelity reception, although these comments lose some of their point with the advent of frequency modulation. A bibliography with some 138 entries appears in the back of the volume.

There are a number of errors which will be noticed by the engineer, but which may not greatly harm any musician who may accept them as fact. For example, on

page 38 it is stated that the lowering of the natural frequency of a Helmholtz resonator by decreasing the size of the aperture is due to the slowing down by air friction of the piston motion in the opening. Resonance in rooms at low frequencies is, on page 39, mistakenly likened to that in Helmholtz resonators. The newer concepts of architectural acoustics are disregarded on page 72, where it is stated that it does not make a great difference in what part of a room acoustic-absorbing material is placed. On page 204, in a table attributed to Jeans, energy is expressed in watts. On page 209 the bar is defined in a footnote as equal to one megadyne per square centimeter. This is a good example of why the use of the term bar in acoustics is deprecated by the American Standards Association. The acoustic bar is equal to one dyne per square centimeter, but in all other fields it is defined as above. On page 212 the reference level of sound intensity ( $10^{-16}$  watt per square centimeter) is stated to be "that fraction of a watt per square centimeter which is indicated by the numeral 1 with sixteen ciphers after it."

In spite of these criticisms, this book will be found to be a valuable contribution in bridging, in an effective and interesting manner, two fields which have suffered much from isolationism. It may be read with profit not only by the musician but by the acoustic scientist as well.

BENJAMIN OLNEY  
Stromberg-Carlson Telephone  
Manufacturing Co.  
Rochester, N. Y.

## Rhombic Antenna Design, by A. E. Harper

Published, 1941, by D. Van Nostrand Company, Inc., 250 Fourth Avenue, New York, N. Y. 108 pages+3-page index+xv pages. 55 figures.  $8\frac{1}{2} \times 11\frac{1}{2}$  inches. Price \$4.00.

This book deals with current design and construction practices relative to the rhombic antenna, which has found widespread application during recent years in the field of short-wave communications. Tabulated and graphical functions have been included to expedite design computations. Plans of typical transmitting and receiving antennas have been appended to indicate essential components and construction details. Typical directive diagrams and other performance characteristics are also given.

H. O. PETERSON  
RCA Communications, Inc.  
Riverhead, L. I., N. Y.



# Contributors



CHUNG-KUEI CHANG

Chung-Kuei Chang was born on March 15, 1900, in Hopei province, China. He received the B.S. degree in physics from the National Peking University in 1924, and the engineer degree in electrical engineering from Stanford University in 1940. From 1929 to 1937, he was an instructor in physics at the Peking University. Mr. Chang is now doing research in radio communication at Stanford University.



James Lawrence Fly was born at Seagoville, Dallas County, Texas, on February 22, 1898. He received his commission as ensign from the United States Naval Academy in 1920 and remained in the Navy until 1923 when he resigned. In 1926, he received the LL.B. degree from the Harvard Law School.

Mr. Fly was admitted to the Massachusetts and New York State bars in 1926, and practiced law in New York City until 1929. From 1929 to 1934, he served as a Special Assistant United States Attorney General acting as government counsel in actions involving restraint of trade under federal antitrust laws and regulatory measures under commerce power.



J. L. FLY

In 1934, Mr. Fly became general solicitor and head of the legal department of the Tennessee Valley Authority, and served in this capacity until 1937 when he became general counsel of the Tennessee Valley Authority.

President Roosevelt nominated him to be a member of the Federal Communications Commission on July 27, 1939, filling the unexpired term of the late Anning S. Prall. On September 1 of that year, he took his oath of office, at which time the President designated him as Chairman of the Federal Communications Commission. Reappointment for a full seven-year term occurred last July.

When the Defense Communications Board was created by Executive Order on September 24, 1940, Mr. Fly was made the Chairman. He has continued in that capacity since the Board of War Communications succeeded the Defense Communications Board.



G. L. FREDENDALL

G. L. Fredendall (A'41) received the Ph.D. degree from the University of Wisconsin. From 1931 to 1936 he was at the University teaching electrical engineering, mathematics, and doing research work in mercury-arc phenomena. Since 1936 he has been with the RCA Manufacturing Company engaged in television research.



Nathaniel I. Korman (S'38-A'39) was born in Providence, Rhode Island, on February 23, 1916. He received a B.S. degree from Worcester Polytechnic Institute in 1937. Working at Massachusetts Institute of Technology under a Charles A. Coffin Fellowship, he received an M.S. degree in electrical engineering in 1938. That same year he became a student engineer with the RCA Manufacturing Company. Since 1940, Mr. Korman has been employed as an engineer in the transmitter advanced development section of the special apparatus division of this company and has been concerned with frequency modulation and ultra-high-frequency problems. He is a member of Sigma Xi.



NATHANIEL I. KORMAN



Vepa V. Lakshmana Rao\* (A'35) was born on May 12, 1911, at Vizagapatam, India. He obtained the B.E. degree from Madras University in 1932 and from 1932 to 1933, he was an apprentice engineer at the Pykara Hydro-electric Scheme. He was a research and postgraduate scholar in the Electrical Technical Department, Indian Institute of Science, Bangalore, 1933 to 1934, and in the Madras Government Electrical Department from 1935 to 1936. Mr. Rao received the D.I.C. degree from the Imperial College of Science and Technology, London, in 1938 for postgraduate research work in telecommunications. He served his apprenticeship with Messrs Philips', Holland, in 1937 and with the British Broadcasting Corporation in 1938 and received a diploma from the Marconi School of Wireless Communication, Chelmsford, in 1938. He was a senior shift engineer, H.E.H. The Nizam's State Broadcasting Service in 1939 and a lecturer in radio engineering, Indian Institute of Science, Bangalore, in 1939. Since 1939, Mr. Rao has been a radio engineer with

\* Paper appeared in November, 1942, issue of the PROCEEDINGS.



VEPA V. LAKSHMANA RAO



M. RETTINGER

the Provincial Broadcasting Government of Madras in charge of a laboratory and workshop; engaged in the purchase, testing, modifying, installation, and maintenance of radio sets and public-address systems in the rural and urban parts as a part of the Madras Government's Rural Broadcasting Scheme.

❖

M. Rettinger received from the University of California at Los Angeles the B.A. degree in physics in 1932 and the M.A. degree in 1934. Since 1936, he has served as an acoustic engineer for the RCA Manufacturing Company at Hollywood, California.

❖

Elmer H. Schulz (A'38) was born at Lockhart, Texas, on October 30, 1913. He received the B.S. degree in electrical engineering in 1935 and the M.S. degree in



ELMER H. SCHULZ

electrical engineering in 1936 from the University of Texas. He was on the teaching staff of the electrical engineering department of The University of Texas from 1936 to 1942 when he joined the staff of the electrical engineering department of Illinois Institute of Technology. Mr. Schulz is a member of Tau Beta Pi and the American Institute of Electrical Engineers.

❖

Karl Troeglen (A'30-M'42) was born on August 17, 1908, in Kiel, Germany, and came to the United States in 1913. He has been active in amateur and commercial radio work since 1923. He was a marine operator on the Great Lakes during 1927



KARL TROEGLN

and 1929 and a field engineer with the Universal Wireless Communications Company during 1929 and 1930. Since July, 1930, Mr. Troeglen has been with the Topeka Broadcasting Association, becoming chief engineer of that company in 1933. He was a member of the National Association of Broadcasters Engineering Committee during 1941-1942.

❖

Arthur Van Dyck (A'13-M'18-F'25) was born on May 20, 1891, at Stuyvesant Falls, New York. He received the Ph.B. degree from Sheffield Scientific School, Yale University in 1911. From 1907 to 1910 Mr. Van Dyck was an amateur experimenter and commercial operator at sea. He was associated with the National Electric Signalling Company, Brant Rock, Massachusetts, 1911-1912; research department, Westinghouse Electric and Manufacturing Company, 1912-1914; instructor in electrical engineering, Carnegie Institute of Technology, 1914-1917; expert radio aide, U. S. Navy, 1917-1919;



ARTHUR VAN DYCK

Marconi Company, Aldene, New Jersey, 1919-1920; in charge, radio receiver design, General Electric Company, 1920-1922. Since 1922 he has been with the Radio Corporation of America.

❖

Karl R. Wendt (A'36) was born on January 3, 1906, at Coshocton, Ohio. He attended the Municipal University of Akron, Marquette University, and the University of Wisconsin. During 1928 and 1929, he was a research assistant in the chemistry department of the University of Wisconsin, and in 1929 and 1930 he was in the research laboratory of the Sun Oil Company. In 1930, Mr. Wendt joined the RCA Manufacturing Company and has been a member of the research department of that company since 1934 and is now located in the RCA Laboratories at Princeton, New Jersey. He is a member of Alpha Chi Sigma.



K. R. WENDT

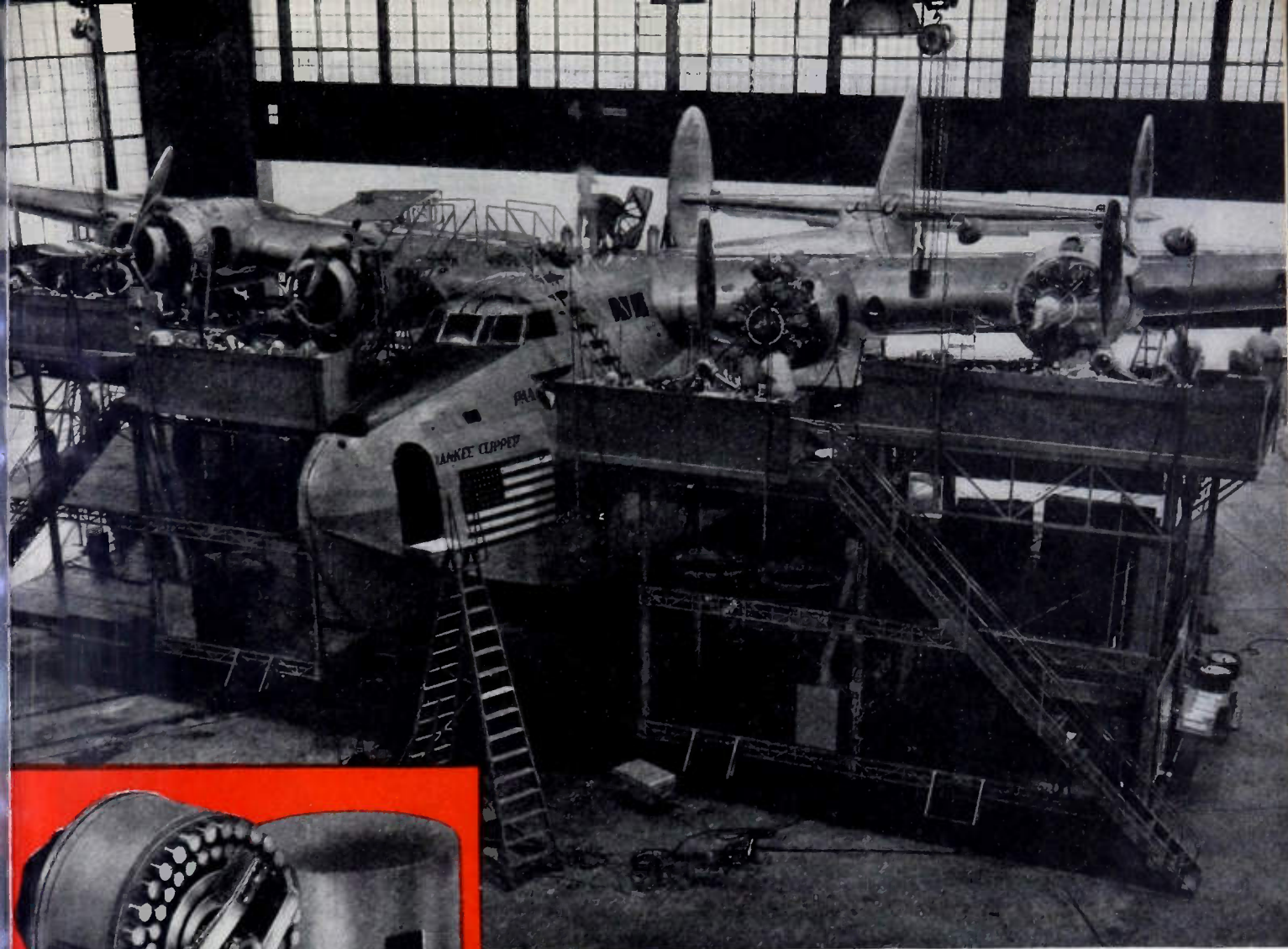
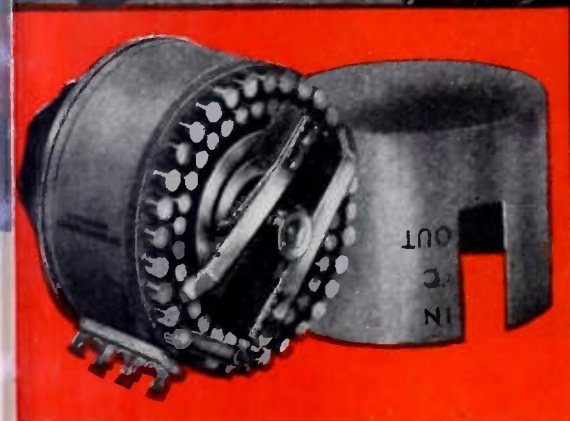

PHOTO COURTESY PAN AMERICAN AIRWAYS



## **Vital Battlefield**

Modern battlefronts are not limited to theaters of war since successful production lies behind military victories. Not only tanks, planes and guns are needed, but machines to make ever-increasing amounts of fighting equipment.

DAVEN builds component parts for many of these machines . . . parts for electronic devices which increase efficiency and speed production.

*More than 80 models of Output Power Meters, Transmission Measuring Sets, Decade Resistance Boxes, Attenuation Networks, Volume Level Indicators and many other types of DAVEN Laboratory Test Equipment are used extensively in electrical, broadcast, sound picture and television fields. The DAVEN catalog lists the most complete line of precision attenuators in the world; "Ladder," "T" type, "Balanced H" and potentiometer networks—both variable and fixed—as well as Super DAVOHM precision type wire-wound resistors, with accuracies from  $\pm 1\%$  to  $\pm 0.1\%$ . A copy should be in your reference files.*

# **THE DAVEN COMPANY**

158 SUMMIT STREET

NEWARK, NEW JERSEY



## "Q. E. D."

Television . . . "which was to be proved" . . . *has been proved, decisively.* For British-Gaumont, Ltd., Baird Television and Cinema Television, Ltd., long recognized as leaders in this field, have already thrilled London theatre audiences with televised events projected on regulation 15' x 20' screens, showing such attractions as prize fights, boat races and cricket matches. In view of these world-leading achievements it is of marked significance that RAULAND has been assigned all American rights to patents and processes of these pioneer companies, thus combining proved British technique with the advanced electronic applications of RAULAND research-physicists and engineers; in final perfection of commercial television when conditions permit. RAULAND's full productive facilities are devoted to *one* objective . . . *total allied victory* . . . but developments unfolding at RAULAND laboratories foreshadow complete fulfillment of the promise of television entertainment.

Buy War Bonds and Stamps! . . . Rauland employees are all doing their part as members of the 10% Bond club.

Dr. C. S. SZCZEPKO, Rauland Chief Research-Physicist, has devoted a major part of his scientific career to the development of specialized electron optical devices culminating in the high power cathode ray tube for large screen television. A native of Czechoslovakia, he received his Electrical Engineering degree at Munich Institute of Technology and his Doctorate at Aix La Chapelle, where he became lecturer in Electro-Physics. Eight years ago he was made head of Research for Baird Television of London and New York from which post he joined the Rauland organization.



• *Electroneering* is our business •

# Rauland

RADIO  SOUND  COMMUNICATIONS  
The Rauland Corporation • Chicago, Illinois

# The Institute of Radio Engineers

... serves those engaged in radio and allied fields through the presentation and publication of technical information on the subjects.

**THE PROCEEDINGS**, the official magazine of I.R.E., has been published without interruption since 1913 when the first issue appeared. The contents of each paper published in the **PROCEEDINGS** are the responsibility of the author and are not binding on the Institute or its members. Material appearing in it may be reprinted or abstracted in other publications on the express condition that specific reference shall be made to its original appearance in the **PROCEEDINGS**. Illustrations of any variety, however, may not be reproduced without specific permission from the Institute.

**STANDARDS** reports are published from time to time and are sent to each member without charge. Current reports include two each on Radio Receivers, Transmitters and Antennas, and Radio Wave Propagation, and one each on Electroacoustics, and Facsimile; a detailed description of these reports will be sent on request.

**MEMBERSHIP** has grown from a few dozen in 1912 to approximately eight thousand. Practically every country in the world in which radio engineers may be found is represented in our roster. Dues for the five grades of membership range from \$3.00 to \$10.00 per year. The **PROCEEDINGS** is sent to each member without further payment.

**SECTIONS** in twenty-seven cities in the United States, Canada, and Argentina hold regular meetings. The chairmen and secretaries of these sections are listed on the page opposite the first article in this issue.

**SUBSCRIPTIONS** are accepted for the **PROCEEDINGS** at \$10.00 per year in the United States of America, its possessions, and Canada; when college and public libraries order direct from the Institute, the subscription price is \$5.00. For other countries there is an additional charge of \$1.00 for postage.

**APPLICATION** for **ASSOCIATE** membership may be made by using the convenient blank on this page, or preferably on written request to the Institute headquarters.

The Institute of Radio Engineers, Inc.  
330 West 42nd Street  
New York, N.Y.

*Convenient Associate Membership Blank*

## The Institute of Radio Engineers

Incorporated

330 West 42nd Street, New York, N.Y.

To the Board of Directors

Gentlemen:

I hereby make application for **ASSOCIATE** membership in the Institute of Radio Engineers on the basis of my training and professional experience given herewith, and refer to the sponsors named below who are personally familiar with my work.

I certify that the statements made in the record of my training and professional experience are correct, and agree if elected, that I shall be governed by the Constitution of the Institute so long as I continue a member. Furthermore I agree to promote the objects of the Institute so far as it shall be in my power.

.....  
(Sign with pen)

.....  
(Address for mail)

.....  
(City and State)

.....  
(Date)

### SPONSORS

(Signatures not required here)

Mr. ....

Address .....

City and State .....

Mr. ....

Address .....

City and State .....

Mr. ....

Address .....

City and State .....

*Fill Out Reverse Side Also*





# 872-A/872

## HALF-WAVE MERCURY-VAPOR RECTIFIER

Price \$7.50



*Designed for*

**LONGER LIFE - HIGHER  
PEAK EMISSION**  
WITH CORRESPONDINGLY LOWER TUBE DROP

### RATINGS

Filament Voltage, 5 volts

Filament Current, 7.5 amperes

Peak Inverse Voltage, 10,000 volts, max.\*

Peak Plate Current, 5 amperes, max.

Average Plate Current, 1.25 amperes, max.

\* For condensed-mercury temperature of 20-60° C.

While you've been busy making hard-to-replace transmitting tubes last longer on the job, RCA engineers have been losing no time in building longer potential life into the tubes that are produced. The RCA 872-A/872 Half-Wave Mercury-Vapor Rectifier offers a good example of achievements scored in this direction:

Adoption of a special alloy for the cathode base has yielded materially increased emission with correspondingly low tube drop which, in turn, has resulted in greatly improved shelf and operating life. Thermal efficiency has been greatly increased, and, therefore, the tube will withstand higher surge currents without sputtering of the cathode coating—an important factor in increasing life.

In brief, the RCA 872-A/872 of today is a stronger, sturdier tube than ever before—just as numerous other RCA Transmitting Tube types are delivering longer life and better performance as the result of progressive RCA engineering developments.

### TIPS ON MAKING YOUR TRANSMITTING TUBES LAST LONGER

Many valuable operation hints on making Transmitting Tubes last longer that were incorporated in previous RCA advertising have now been compiled into a handy booklet. A copy will gladly be sent upon request to RCA Mfg. Co., Commercial Engineering Section, Harrison, N. J.



# RCA TRANSMITTING TUBES

PROVED IN COMMUNICATION'S MOST EXACTING APPLICATIONS

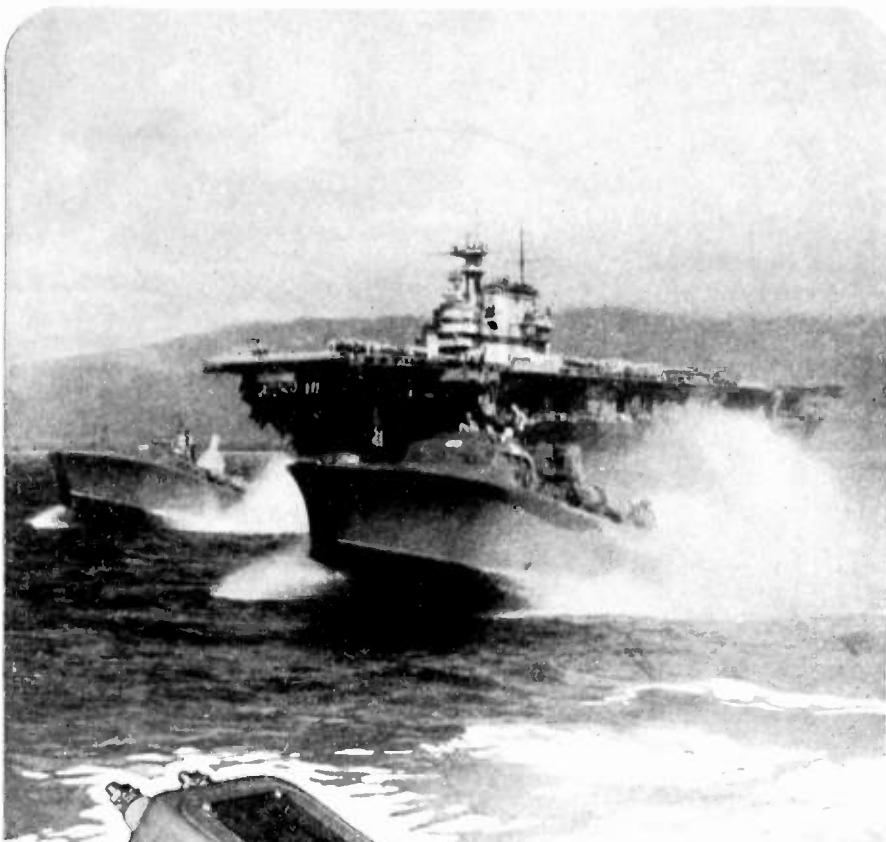

Official  
U. S. Navy  
photograph



## Custom Designed TRANSFORMERS

*Built as well as the ships  
on which they serve*

Custom Built Transformers that meet the rigid requirements of the United States Navy have reached a new high in efficient design, sturdy construction and operating accuracy.

Waterproof-Hermetically Sealed Transformers, built to these specifications by the Chicago Transformer Corporation, not only pass the Navy Five-Cycle Salt Water Immersion Test but also other severe operating, temperature and pressure tests set up in our own laboratories.

*Manufacturers of all types of Transformers up to 10 KVA.*



**CHICAGO TRANSFORMER  
CORPORATION**  
3501 WEST ADDISON STREET • CHICAGO

## Section Meetings

### ATLANTA

"The WAGA Transmitter Installation," by Russ Shettler, WAGA, October 23.

### BALTIMORE

"Crystals," by R. S. Bailey, Bendix Radio Division, Bendix Aviation Corporation, October 15.

"Industrial Broadcasting," by D. D. Halpin, Industrial Music Committee of RCA, November 19.

### BOSTON

"German War Radio Apparatus Design," by F. S. Barton, British Air Commission, October 30.

"Conservation of Critical Materials," by H. F. Osborn, American Telephone and Telegraph Co., November 24.

### BUFFALO-NIAGARA

"The Behavior of Dielectrics Over Wide Ranges of Frequency and Temperature," by R. F. Field, October 21.

"The Application of Electronics in the Power Industry," by L. K. Yerger, November 18.

### CHICAGO

"The Use of Counter Circuits as Frequency Dividers," by Earle Kent, C. G. Conn, Ltd., October 16.

"Plastics in the Radio Industry," by James Boyajian, General Television, October 16.

"What Lies Ahead in Short Waves," by W. A. Edson, Illinois Institute of Technology; J. E. Brown and R. Di Cola, Zenith Radio Corporation, November 13.

### CINCINNATI

"The General Electric Wide-Band Oscilloscope," by E. D. Cook, General Electric Company, October 20.

"Communications Facilities of United Air Lines," by C. A. Petry, United Air Lines, November 10.

"Africa, the Prize of Europe," by C. B. Hoffman, University of Cincinnati, November 10.

### CLEVELAND

"Recent Developments in Powdered Iron Cores," by Mr. Andrews, Stackpole Carbon Company, September 22.

"The Design of a Wide-Band Oscilloscope," by E. D. Cook, General Electric Company, October 22.

### DALLAS-FORT WORTH

Open Discussion led by Chairman Kimsey, October 23.

### DETROIT

"Wide-Band Oscilloscope," by E. D. Cook, General Electric Company, October 21.

"Measurement of Soil Moisture," by G. J. Bouyoucos, Michigan State College, October 21.

"Broadcast and Commercial Recording Technique," by Andrew Friedenthal, WJR, November 20.

*(Continued on page xxiv)*



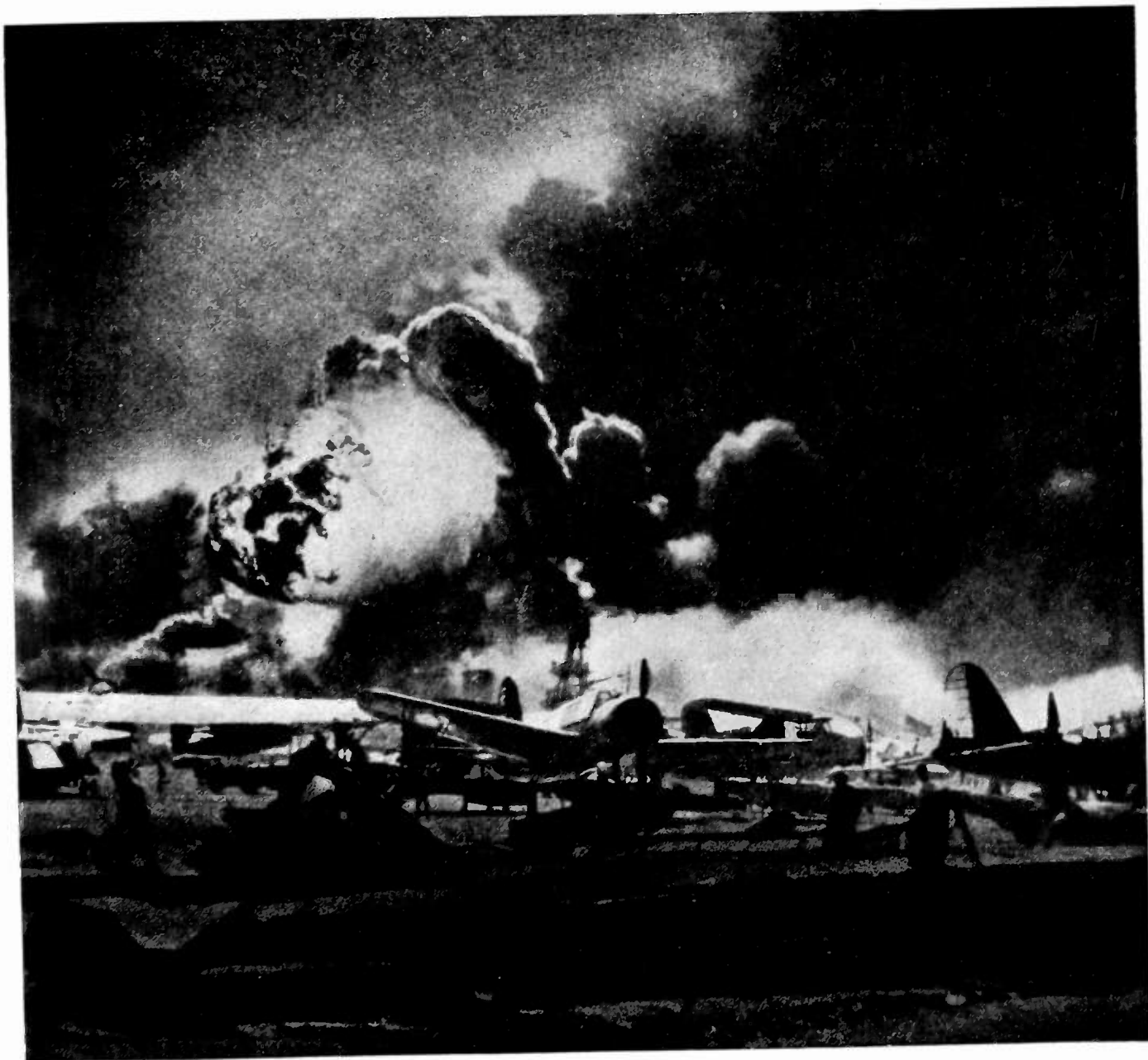

U. S. Navy Official Photo

## Minus Sound Effects

If you were receiving radio broadcasts from men in the midst of ear-splitting battle noises, you'd hear crisp speech undistorted by background sound effects.

Electro-Voice Microphones, in military service, are helping to make it possible. Similar microphones, designed to achieve such results, will be available for specific commercial applications . . . after our wartime job is done.

*Electro-Voice* MICROPHONES

ELECTRO-VOICE MANUFACTURING CO., INC.

1239 SOUTH BEND AVENUE, SOUTH BEND, INDIANA

## Section Meetings

(Continued from page xxvii)

### EMPORIUM

"Wide-Band Oscilloscope," by E. D. Cook, General Electric Company, October 19. Business Meeting and motion pictures, November 19.

### LOS ANGELES

"Development and Application of Radio Devices as Applied to Flood Control in Southern California," M. E. Kennedy, Los Angeles County Flood Control, October 20.

"The Installation of a 10,000-Watt Transmitter Plant and a Three-Element Directional Array," by L. C. Sigmon, KMPC, November 24.

"The Need for Radio Engineers in the United States Army," by A. H. Harwood, Los Angeles Officer Procurement District, War Department, November 24.

### MONTREAL

"A New Type of Practical Distortion Meter," by J. E. Hayes, Canadian Broadcasting Corporation, October 14.

"New Audio Equipment for CJRC—Winnipeg," by F. R. Quance, RCA Victor Company, Ltd., October 14.

"Methods of Technical Instruction in the Royal Canadian Air Force," R. K. Patrick, Royal Canadian Air Force, November 14.

"German War Radio Apparatus Design," by F. S. Barton, British Air Commission, November 25.

### PHILADELPHIA

"Technical Problems of Wartime Broadcast Station Operation," by H. Frazier, National Association of Broadcasters, November 5.

"Power-Tube Operation and Conservation at Station WOR," by H. E. Mendenhall, Bell Telephone Laboratories, and G. Robinson, WOR, November 5.

### PITTSBURGH

"Engineering Features of Carrier-Current Applications," by J. G. McKinley, West Penn Power Company, September 14.

"Discussion of National Association of Broadcasters Recording and Reproducing Standards," by Roland Lynn, National Broadcasting Company, October 12.

"Future Sources of Power," by C. C. Furnas, Curtis Wright Corporation, November 10.

### PORTLAND

"Video Coupling Units," by A. V. Eastman, University of Washington, October 23.

### ST. LOUIS

"Radio-Interference Prevention and Location on Power Systems," by S. R. Luben, Rural Electrification Administration, September 30.

"Priorities in the Communications Industry," by R. McCarty, War Production Board, October 28.

(Continued on page xxvii)

Proceedings of the I.R.E. January, 1943



Need  
Intelligible  
Communications?

Use a

# TURNER Microphone

TURNER Microphones are specifically designed and engineered to faithfully reproduce gradations of volume, amplifying only the vibrations received by the diaphragm, without adding any of the harmonics.

## A. Turner Cardioid 101

Here's the unit that stymies all background noises. The 2-element generator produces true cardioid characteristics and offers the best features of both the dynamic and velocity. Where the going is tough and acoustic conditions practically impossible, a Turner Cardioid can handle the job. Available in Standard, De Luxe and Broadcast Models.

## B. Turner U9-S Multiflex

This ONE Turner unit offers your choice of 4 impedances—50, 200 or 500 ohms or hi-impedance, simply by twisting the switch. A dynamic microphone that's free from peaks and holes from 40 to 9000 cycles. Be sure you can handle ANY job with Turner U9-S.

## C. Turner 211 Dynamic

Utilization of a new type magnet structure and acoustic network permits outstanding performance characteristics with the 211. High frequency range has been extended and extreme lows raised, to compensate for over-all deficiencies in loud speaker systems.

## D. Turner Han-D

Hold it, hang it, or mount it on standard desk or floor stand, this Turner is HAN-D. Positive contact slide switch permits off-on operation. Will not blast from close speaking. Crystal or Dynamic.

## If You Have a Priority Rating

WRITE, explaining your communications problems and we can help you select the Turner Microphone best suited to your needs. Also, information on how to make your present Turner Microphones and Equipment give longer, better service.

**FREE** Turner Microphone Catalog, with complete information and prices on Turner Microphones and Equipment. Write:

Crystals Licensed Under Patents of The Brush Development Co.

# THE TURNER CO.

CEDAR RAPIDS, IOWA



# RELAYS



FROM GUN BLAST HEAT

TO ARCTIC COLD

★ Smothered in dust... seared by gun blast heat... shrouded in fog... gripped by stratosphere cold... shaken by blasts of bomb and shell... these are daily incidents in the life of a relay. Under these conditions Relays by Guardian have already "proved their metal."

THE SERIES 195 RELAY weighs less than an ounce! But don't let its tiny size fool you. It shrugs off the most severe vibrations likely to be encountered in aircraft. And it's especially adaptable to jobs where space as well as weight is at a premium. It's about wrist watch size in length and width—and not a great deal thicker.

SERIES 345 RELAY. A radio relay for use in aircraft. Maximum contact combination of three pole, double throw, combined with large coil winding area makes this a highly efficient relay in compact space.

While thinking, building and engineering the tools of war today, Guardian is also looking ahead to peacetime applications of Relays, Solenoids, Electrical Controls of all kinds. If you are planning for the future too, write us—our war-time experience can help you build better peacetime products.



Series 195 Relay. One of the smallest relays made. Write for new Bulletin.



Series 345 Relay. For radio aircraft use. Write for new Bulletin.

## GUARDIAN ELECTRIC

1628 WEST WALNUT STREET CHICAGO, ILLINOIS

A COMPLETE LINE OF RELAYS SERVING AMERICAN WAR INDUSTRY

## Section Meetings

(Continued from page xxiv)

"Use of High-Frequency Currents in Treatment of Human Body," by W. H. V. Hoefler, Lutheran Hospital, November 24.

### SAN FRANCISCO

"The Electron Microscope," by L. Marton, Stanford University, November 11.

### TORONTO

"Oil-Filled Condensers," by W. S. Franklin, John E. Fast and Company, November 23.

### TWIN CITIES

"Requirements of Radio Men for Navy Personnel," W. W. Hall, Office of Naval Officer Procurement, October 28.

"Recording Theory and Practice," by K. L. Sueker, WCCO, and Midwest Transcriptions, Inc., October 28.

"Some Distinctive Characteristics of Micro Radio Waves," by M. Phillips, Graduate School, University of Minnesota, November 23.

### WASHINGTON

"Wire and Radio Circuits for Network Broadcasting and Communications," by A. H. Petersen, Columbia Broadcasting System, October 12.

## Membership

The following indicated admissions and transfer of memberships have been approved by the Admissions Committee. Objections to any of these should reach the Institute office by not later than January 31, 1943.

### Transfer to Member

- Dinger, H. E., 1301—46 St., S.E., Washington, D. C.  
Dudley, B., 235 W. 71 St., New York, N. Y.  
Ferrill, T. M., Jr., 6 Clare Rd., East Hempstead, L. I., N. Y.  
Knight, J. B., U. S. Navy Underwater Sound Laboratory, Ft. Trumbull, New London, Conn.  
Radius, C., 126 W. Hudson Ave., Englewood, N. J.  
Sparling, A. G., 622 W. 20 St., Spokane, Wash.  
Terrey, C. J., 1175 Bushwick Ave., Brooklyn, N. Y.  
Zender, R. G., 1751 N. Western Ave., Chicago, Ill.

### Admission to Member

- Cose, J. A., 1165 Loraine Ave., Plainfield, N. J.  
Davis, D. M., Zenith Radio Corporation, 6001 Dickens Ave., Chicago, Ill.  
Innes-Crump, J. E., No. 3 Training Command, R.C.A.F., Montreal, Que., Canada

(Continued on page xxviii)

Proceedings of the I.R.E. January, 1943

**ARMY** **E** **NAVY**

**"FROM** that high resolve was born the Army-Navy Production Award which stands today as our fighting forces' joint recognition of exceptional performance on the production front . . . of the determined persevering, unbeatable spirit which can be satisfied only by achieving today what yesterday seemed impossible!"

We're sincerely proud of our award — its significance will always be our goal.

**BLILEY**  
FREQUENCY CONTROL  
R19659  
7412  
MADE IN U.S.A.  
ERIE, PA.

**BLILEY ELECTRIC COMPANY · ERIE, PA.**

*Bliley Crystals*

# STANDARD

## PROFESSIONAL SERIES

## PLATE TRANSFORMERS

The best of insulating and conducting materials scientifically applied thruout the coil afford generous margins of safety against electrical failure.

Phenolic side panels with heavy duty insulators insure excellent dielectric characteristics and easy accessibility.

Cast semi-steel end bells provide a rugged mounting and a symmetrically finished appearance.

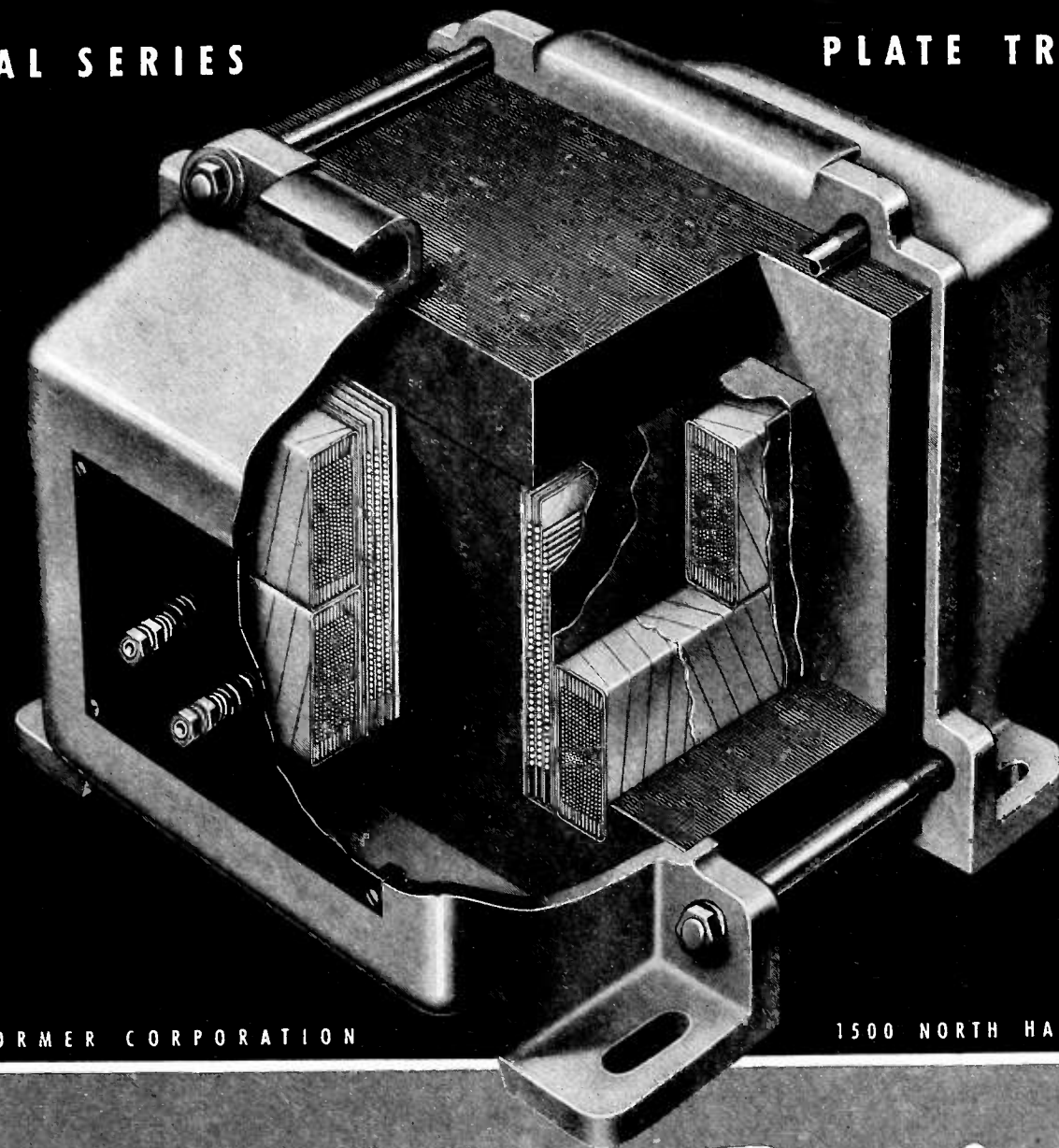

Accurately processed high grade silicon steel stampings, carefully laminated, result in an efficient and low loss core structure.

Vacuum impregnation of coils and thorough penetration of potting compounds furnish complete protection against the effects of humidity and time.

Rigid inspection of materials and progressive testing thruout fabrication result in a quality product.

STANDARD TRANSFORMER CORPORATION

1500 NORTH HALSTED STREET • CHICAGO



# *Built like a Battleship!*

## Membership

(Continued from page xxvii)

- Macdel, G. F., 593 E. 38 St., Brooklyn, N. Y.  
Meixell, O. S., 19 Pease Ave., Verona, N. J.  
Omberg, A. C., 4112 Fourth St., Arlington, Va.  
Sheer, C., 189-12-43 Rd., Flushing, L. I., N. Y.  
Wenger, W. D., 1480 Glenwood, Sylvan Village, Pontiac, Mich.

The following indicated admissions and transfers of memberships were approved on December 2, 1942.

### Transfer to Member

- Bailey, A. B., Bell Telephone Laboratories, 180 Varick St., New York, N. Y.  
Griffiths, H. V., British Broadcasting Corporation, Nr. Westerham, Kent., England  
Stobbe, J. A., 63 Wall St., New York, N. Y.

### Admission to Member

- Bayles, J. C., 406 Lenox Place, South Orange, N. J.  
Fisher, S. T., Box 64, Station H, Montreal, Que., Canada  
Hathaway, D. L., Box 930, Casper, Wyo.

### Admission to Associate

- Adams, R. J., 3110 Massachusetts Ave., S.E., Benning Station, Washington, D. C.  
Anderson, E. P., 730 S.W. Oak, Portland, Ore.  
Auerbach, M., 5201A Montour St., Philadelphia, Pa.  
Baum, R. F., Windsor Hotel, 305 Academy St., Jersey City, N. J.  
Benjamin, R., 59 W. Cromwell Rd., London, S.W. 5, England  
Benowitz, H. S., 1301 Seneca Ave., Bronx, N. Y.  
Bernes, B., Box 32C7, Route 1, Chula Vista, Calif.  
Bloomer, A., A.I.D. Office, Ericsson Telephones, Ltd., Beeston, Notts., England  
Bondy, J. O., 10 Bush Ave., Newburgh, N. Y.  
Boothe, A. M., 384 Probasco St., Clifton, Cincinnati, Ohio  
Brandt, R., Sylvania Electric Products, Inc., Emporium, Pa.  
Brogdon, L. C., 619 Forrest Ave., Chattanooga, Tenn.  
Brownell, H. R., 426 Hudson St., New York, N. Y.  
Buchtenkirch, A. J., Powers Electronic and Communications Company, New St., Glen Cove, L. I., N. Y.  
Burwell, A. C., Jr., Sylvania Electric Products, Inc., Emporium, Pa.  
Carroll, C. F., 7009 Fordham Court, College Park, Md.  
Carsner, F. J., 664 Spazier Ave., Pacific Grove, Calif.  
Clapper, A. B., 115 Ellison St., Paterson, N. J.  
Contreras, M. J. A., YMCA, 215 W. 23 St., New York, N. Y.

(Continued on page xxvii)

Proceedings of the I.R.E. January, 1943

*Creators and Makers of*

ACCURATE RESISTORS—SWITCHES—SPECIAL EQUIPMENT AND  
SPECIAL MEASURING APPARATUS FOR PRODUCTION AND  
ROUTINE TESTING OF ELECTRICAL EQUIPMENT ON MILITARY AIR-  
CRAFT... SHIPS... VEHICLES... ARMAMENT... AND WEAPONS

## SHALLCROSS SWITCHES

Are constructed of the finest materials available. Many designs may be obtained having solid, fine silver contacts, and ceramic or phenolic insulation. Where essential War Production dictates the use of switches that are rugged and dependable, send your specifications to Shallcross, Dept. C23.

MEMBER



**HALLCROSS MFG. CO.**  
**COLLINGDALE, PENNA.**



**EVEN** war can bring out much that is good.

The gauging of thin mica sheets threatened to be a production bottleneck. Fingers, highly trained by the Braille system, were called upon to replace mechanical gauges and slower vision. The fingers responded.

Today a group of blind employees at SOLAR are gauging mica quicker and more accurately than ever achieved before. They and their "seeing-eye" dogs bring unusual talents to the production front.

## "HANDS THAT SEE"

SOLAR is proud to be a pioneer in drawing upon the untapped reservoir of such able employees. SOLAR "Quality Above All" is well protected by these "hands that see."



*Solar*



SOLAR MANUFACTURING CORP., BAYONNE, N. J.  
Makers of Capacitors (Mica, Paper and Electrolytic)

— **CAPACITORS** —

A basic "course" in electronics  
... in ONE outstanding  
volume!



# PRINCIPLES OF ELECTRONICS

by ROYCE G. KLOEFFLER  
Head of the Department of  
Electrical Engineering, Kan-  
sas State College

Here's a book that has been developed, enlarged, and worked over for almost a decade by Professor Kloeffler, who used the information contained as the basis for an actual course in electronics and then arranged it in book form. It is therefore an up-to-date story of electron theory and the electron tube which begins with the discovery of the electron and carries the subject along to the most modern research in the field.

Clearly and simply this book presents the important facts about electronics, and forms a basis for the study of the more complex problems of electrical engineering. Well illustrated, and comprehensively arranged, it is an ideal text for the student or the practitioner who would have a firmer grasp of the subject.

### REVIEWERS SAY:

"... perfectly adapted for use in undergraduate radio defense courses in colleges, and in the Army and Navy communication courses."

"The author has done an excellent job of compiling and arranging the information now scattered in many places, and his explanations are clear and concise."

175 Pages 177 Illustrations 6x9  
\$2.50

### ON APPROVAL COUPON

John Wiley & Sons, Inc.  
440 Fourth Avenue, New York, N.Y.

Please send me a copy of Kloeffler's PRINCIPLES OF ELECTRONICS on ten days' approval. At the end of that time, if I decide to keep the book, I will remit \$2.50 plus postage; otherwise I will return the book postpaid.

Name .....  
Address .....  
City and State .....  
Employed by .....

WILEY 1-43

## Rochester Fall Meeting

The Rochester Fall Meeting for 1942 was reduced from three days to one day, November 9. The meeting was held at the Sagamore Hotel in Rochester, New York.

The morning session was devoted to a "Symposium on Radio Production and the War Effort" which was participated in by W. R. G. Baker, Director of the Engineering Department of the Radio Manufacturers Association; A. B. Chamberlain, Lieutenant Commander, U.S.N.R., Radio Branch, Bureau of Ships; Billings MacArthur, Captain, U.S.A., Army-Navy Communications Production Expediting Agency; and F. S. Barton, British Air Commission and Vice President-Elect of the Institute.

At the afternoon session, three technical papers were presented as follows:

"Flexibility in Communications-Equipment Production," by J. J. Farrell, General Electric Company.

"Radio Production Test Methods," H. E. Rice, Sperry Gyroscope Company, Inc.

"Photographic Templates," by E. C. Jewett and C. D. Tate, Eastman Kodak Company.

The evening was devoted to the annual Rochester Fall Meeting dinner.

The registered attendance totaled 278. There was no exhibition of radio equipment at this meeting.

## CURRENT LITERATURE

New books of interest to engineers in radio and allied fields—from the publishers' announcements. A copy of each book marked with an asterisk (\*) has been submitted to the Editors for possible review in a future issue of the Proceedings of the I.R.E.

\*ELECTRICAL COUNTING. By W. B. Lewis, M.A., Ph.D., Cambridge University Lecturer in the Cavendish Laboratory \* \* \* Cambridge University Press, 60 Fifth Ave., New York, N. Y. (144 pages, many circuit diagrams, 5½x8½ inches, bound in red cloth.) This book deals with the technique of Electrical counting, with special reference to counting Alpha and Beta Particles. Price \$2.50.

\*FREQUENCY MODULATION. By August Hund, Member of the Navy Radio and Sound Laboratory, San Diego, California \* \* \* McGraw-Hill Book Company, Inc., 330 W. 42nd St., New York, N. Y. (x+375 pages, 114 illustrations, 6x9½ inches, bound in blue cloth.) This is the first book in the new Radio Communication Series being Edited by Beverly Dudley. It is a critical engineering treatment of all phases of frequency modulation from basic principles. The text is designed to

(Continued on page xxvii)

# A NEW AND VITAL SERVICE



OUR sample department is now delivering highly specialized transformers in a matter of days only. This is a direct result of the increased demands by our customers for greater speed in the development of new designs for military equipment. The establishment of this entirely independent organization was effected for the sole purpose of delivering engineering service and sample components in the shortest possible time.

The significance of this N-Y-T Service can be stressed when case histories in our files (confidential for the present) show that performance was not merely fulfilled—but surpassed.

That's what we mean by a 'new and vital service'... a service which has been personalized to meet your requirements.



One of the thousands of designs made in the N-Y-T Service Department is illustrated here; a custom-designed unit suited perfectly to the circuit and the application. Inquiries invited.

## NEW YORK TRANSFORMER COMPANY



24-26 WAVERLY PLACE NEW YORK, N. Y.  
Proceedings of the I.R.E. January, 1943



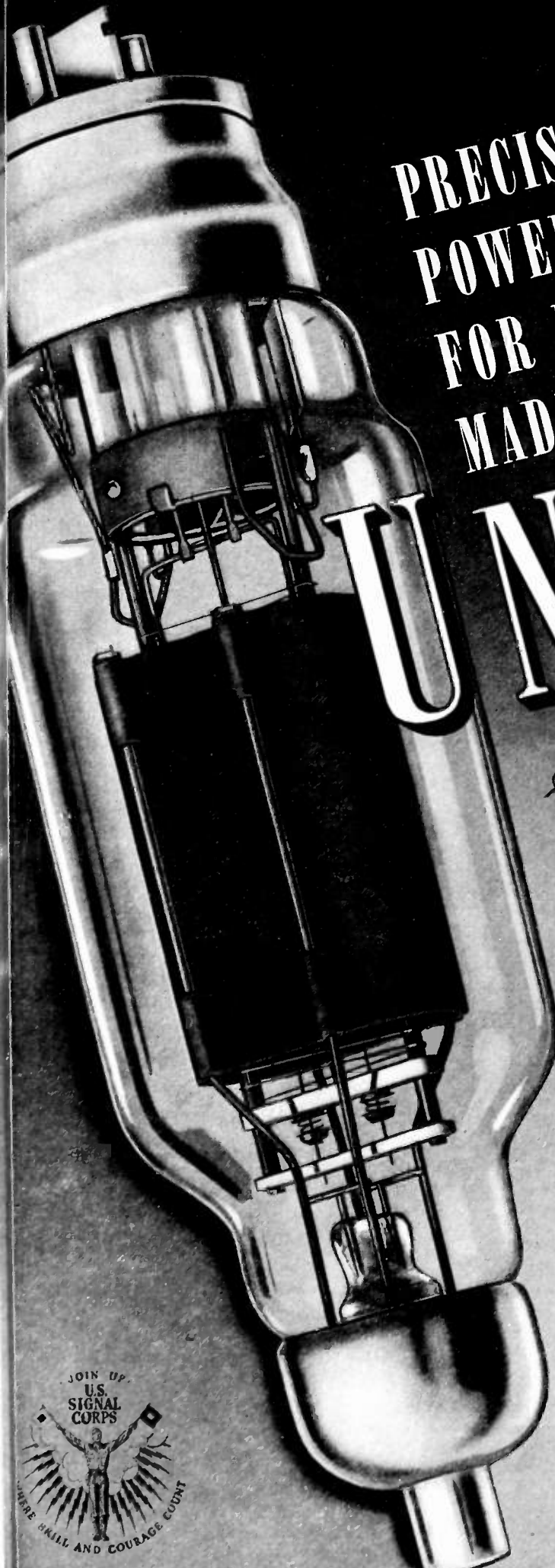

PRECISION  
POWER TUBES  
FOR EVERY PURPOSE  
MADE BY

**UNITED**

*Skills in Electronics*

**W**hen the war ends, there will be a phenomenal expansion in the peace-time use of electronics. Today—while the war absorbs the tube output—try to fix in your mind this unique source for tubes which you will seek tomorrow:

Its name: UNITED. Its organization: a group of eminent engineers and technicians, uniting their highly specialized skills. Its product: power tubes, unsurpassed in precision, for every electronic requirement including radio communication, physiotherapy and industrial control. Its standard: power tubes that consistently attain the highest record in every test of performance. Remember the name "United."



**UNITED ELECTRONICS COMPANY**

NEWARK, NEW JERSEY





**MORE THAN  
11 Hash Marks**

... and we have earned them the hard way too, majoring in electrical research thruout our 47 years... Thordarson Engineers have always been ahead of new developments... that is why you will find, both in military and civilian use, engineers specifying Thordarson transformers for that vital job where unfailling performance is paramount.

Submit your transformer problems to Thordarson Engineers... they know how to solve them.

**THORDARSON**

ELECTRIC MFG. CO.  
500 WEST HURON STREET CHICAGO, ILL., U. S. A.

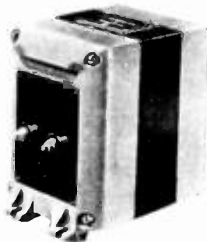

*Transformer Specialists Since 1895*

## Membership

(Continued from page xxviii)

- Crawley, J. B., 2165 Winchester Ave., Ashland, Ky.
- Currier, M. G., Box 412, Morristown, N. J.
- Darden, R. R., Jr., 197 Acadia Terr., Fairfield, Ala.
- Day, F. H., R.F.D. 2, Superior, Neb.
- DeCoursey, R. V., 2119 H St., Washington, D. C.
- Deniz, R., Viamonte 1332, Buenos Aires, Argentina
- Everett, J. E., 40-26 Main Ave., Douglaston, L. I., N. Y.
- Femenias, L. H., Calle Cuevas No. 960, Santiago, Chile
- Fletcher, B. W., 5010-56 Ave., Rogers, Hyattsville, Md.
- Fournier, R., 1008 Allard Ave., Verdun, Que., Canada
- Gable, N. P., 208 South Broad St., Emporium, Pa.
- Gaenzle, J. B., 310 W. Fifth St., Emporium, Pa.
- Gibson, G. B., 2108-31 St., S.E., Washington, D. C.
- Haggerty, M. B., Police Department, Gainesville, Fla.
- Headley, C. B., 184 William St., East Orange, N. J.
- Heitner, A. J., 208 S. Broad St., Emporium, Pa.
- Hogue, W. T., 1904 W. Third St., Grand Island, Neb.
- Hunt, W. V., Park Manor Hotel, 5560 Pershing Ave., St. Louis, Mo.
- Imerson, H. E., 657 Oakdale, Chicago, Ill.
- Johnson, L., 533 Kinnaird Ave., Fort Wayne, Ind.
- Kaplan, M., 1115 Sterling Pl., Booklyn, N. Y.
- Karel, G. M., 21 W. 101 St., New York, N. Y.
- Keen, C. D., 529 Robinson Pl., Shreveport, La.
- Kimmel, L. D., 348 S. Harvard Ave., Villa Park, Ill.
- Kinsburg, B. J., Rm. 1304, 180 Varick St., New York, N. Y.
- Knieriem, R. A., 360 Riverside Ave., Buffalo, N. Y.
- Lambert, R. L., Sylvania Electric Products, Inc., Emporium, Pa.
- Landeck, J. H., 151 Norwood Ave., Long Branch, N. J.
- Loughlin, J. H., Sylvania Electric Products, Inc., Emporium, Pa.
- Lewis, L. L., WOI, Ames, Iowa
- Lombardi, E. H., 45 Parkway Dr., Port Chester, N. Y.
- Lurye, J. R., 28 W. 69 St., N. Y.
- Maass, C. E., Hotel Statler, Boston, Mass.
- Marzetti, E. J., General Paz 137, Temperley, F. C. S., Argentina
- McConnell, T. E., A.P.O. 868, c/o Postmaster, New York, N. Y.
- Melton, A., 8638-55 Rd., Elmhurst, L. I., N. Y.
- Miles, I. M., 554-14 St., N.W., Atlanta, Ga.
- Padgett, G. E., 118 Hawkins Ave., Somerset, Ky.
- Peoples, J. E., 1954 Wellesley Rd., San Marino, Calif.
- Postal, R. H., 366A Mosholu Pkway., Bronx, N. Y.
- Raskind, E., 103 Gordon St., Brighton, Mass.

(Continued on page xxix)

**I**t is typically American to accomplish yesterday's impossibility today!—The Raytheon research laboratory today and every day is delving into seemingly impossible Radio Electronic Tube problems . . . . and solving them in an incredible space of time.

This unending scientific research carried on at Raytheon to aid our Armed Forces during this conflict will, when we are once more on a peacetime basis, give Raytheon tubes the advantage of these newly developed electronic principles... Your new Raytheons will be the product of the latest scientific research.

★  
**Raytheon  
Manufacturing Company**

Waltham and Newton, Massachusetts

★  
DEVOTED TO RESEARCH AND THE MANUFACTURE  
OF TUBES AND EQUIPMENT FOR THE NEW  
ERA OF ELECTRONICS

*For military reasons  
the tube shown is not  
a new development.*

# QUICK DELIVERY ON CONDENSERS!

## INDUSTRIAL CONDENSER CORP.

through a new distribution plan enables you to secure *small lots* of condensers locally. Contact the Industrial Condenser district office nearest you:

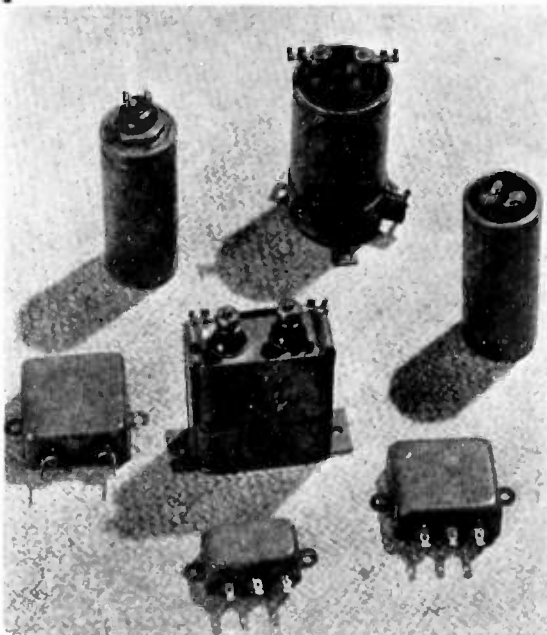

### ADDRESS TELEPHONE NO.

Box 1052  
Dallas, Texas Logan 6-1685

117 Water St.  
Boston, Mass. Hancock 0200

1404 S. Grand Ave.  
Los Angeles, Calif. Richmond 6161

Box 1202  
Asheville, N.C. 7149-J

27 Park Place  
New York, N.Y. Barclay 7-4977

Rm. 220—Medical  
Arts Bldg.  
34th & Broadway  
Kansas City, Mo. Westport 5323

1456 Waterbury Road  
Lakewood (Cleveland),  
Ohio Academy 4932

2434 W. 22nd St.  
Minneapolis, Minn. Kenwood 2833

1135 Lincoln Tower  
Ft. Wayne, Ind. Anthony 5278

2016 Third Ave.  
Seattle, Wash. Seneca 1088

Lutz (Tampa), Fla. 99-144

6432 Cass Ave.  
Detroit, Mich. Madison 6300

401 N. Broad St.  
Philadelphia, Pa. Walnut 4163

235 9th St.  
San Francisco Calif. Market 4166

**Engineers Attention!** Condensers immediately available from distributors stocks meet Army and Navy requirements . . . Industrial Condensers are specified where precision is vital . . . Capacitors to 150,000 volts—WRITE FOR COMPLETE NEW CATALOG.

## INDUSTRIAL CONDENSER CORP.

1725 W. NORTH AVE.

CHICAGO, U.S.A.



**Manufacturers of Quality Oil, Wax and  
Electrolytic Capacitors**

## Membership

(Continued from page xxxii)

- Rasley, D. R., 3702 E. Pontiac St., Fort Wayne, Ind.
- Rhoads, J. A., 2908 W. Santa Barbara Ave., Los Angeles, Calif.
- Ringwalt, D. L., 3003 Seventh S.E., Washington, D. C.
- Russell, G. D., 3517 N.W. 26 St., Oklahoma City, Okla.
- Rustemeyer, G. L., 3846 Alexander St., St. Louis, Mo.
- Scheibe, E. H., 144 W. Gilman St., Madison, Wis.
- Seelen, H. R., 637 School La., Lancaster, Pa.
- Sieve, R., 3 Lawrence Rd., Westcliffe Ext., Johannesburg, South Africa
- Stabler, H. P., Thompson Physical Laboratory, Williamstown, Mass.
- Stern, R. K., 114-06 Queens Blvd., Forest Hills, L. I., N. Y.
- Stott, H. B., RCA Manufacturing Company, Bldg. 5, Camden, N. J.
- Thomson, E. C., c/o Photoswitch, Inc., S. Canal St., Lawrence, Mass.
- Trompeter, R. J., 9400 Kathlyn, Overland Station, St. Louis, Mo.
- Vislisl, R. L., Box 1243, Colorado Springs, Colo.
- Walker, A. P., Box 3886, Honolulu, T. H.
- Ward, D. M., 78 Woodside Rd., Winchester, Mass.
- White, G. R., 7340 Ethel Ave., Richmond Heights, Mo.
- Williams, L. E., St. Clair Acres, Bridgeville, R.D. 2, Pa.
- Wolfson, W., 876 Elsmere Pl., Bronx, N. Y.
- Young, H. H., 131 Hudson Ave., Red Bank, N. J.
- Young, R. A., 314 W. Fifth St., Emporium, Pa.
- Young, W. R., Jr., 180 Varick St., New York, N. Y.
- Zavala, J. R., Box 6, Reinos, Tamps, Mexico

## Current Literature

(Continued from page xxx)

provide up-to-date information on circuit design, in the discussion of design formulas employed in connection with band width and the speed of electrical actions. Phenomena and features in frequency modulation are described in comparison with customary amplitude modulation and in comparison with phase modulation. Price \$4.00.

\*ELECTRIC and MAGNETIC FIELDS. By Stephen S. Attwood, Professor of Electrical Engineering, University of Michigan . . . John Wiley & Sons, Inc., 440 Fourth Ave., New York, N. Y. (xiii+430 pages, 218 illustrations, 6x9½ inches, bound in blue cloth.) This is the second revised edition to a text originally published in 1932. It gives a thorough coverage of electric and magnetic fields, with emphasis on the field point of view rather than on circuits. Field-mapping methods are clearly set forth. The revisions to the original text are extensive and bring the text up-to-date with recent developments. Price \$4.65.

Proceedings of the I.R.E. January, 1943



# Wire Wound Radiohms by Centralab

Available in single or tandem type . . . with or without switch . . . for use as a potentiometer or rheostat . . . in resistance values up to 10,000 ohms.

Linear taper only . . . rated conservatively at 3 watts . . . temperature rise of 100 ohm unit is 28° C. at 3 watts, 40° C. at 4 watts with load carried over total resistor.

Total rotation 300°. Switch type requires 40° for switch throw.

*Available to Your Specifications*

**CENTRALAB:** DIV. OF GLOBE-UNION, INC., MILWAUKEE, WIS.

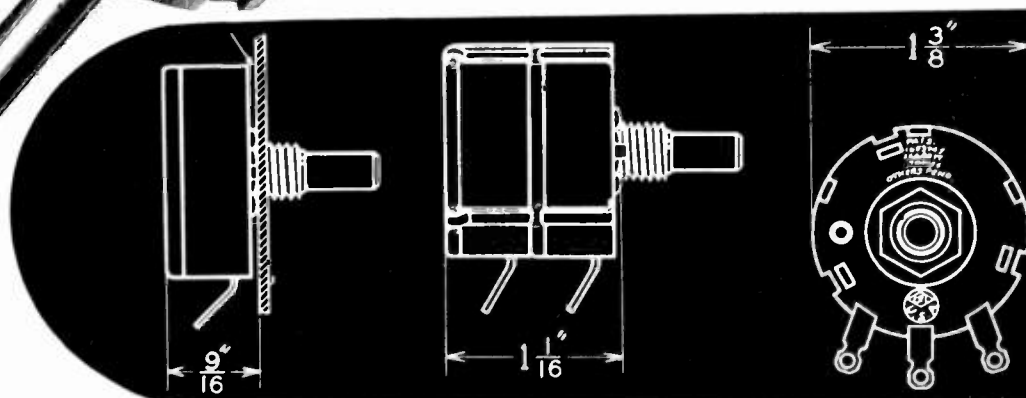
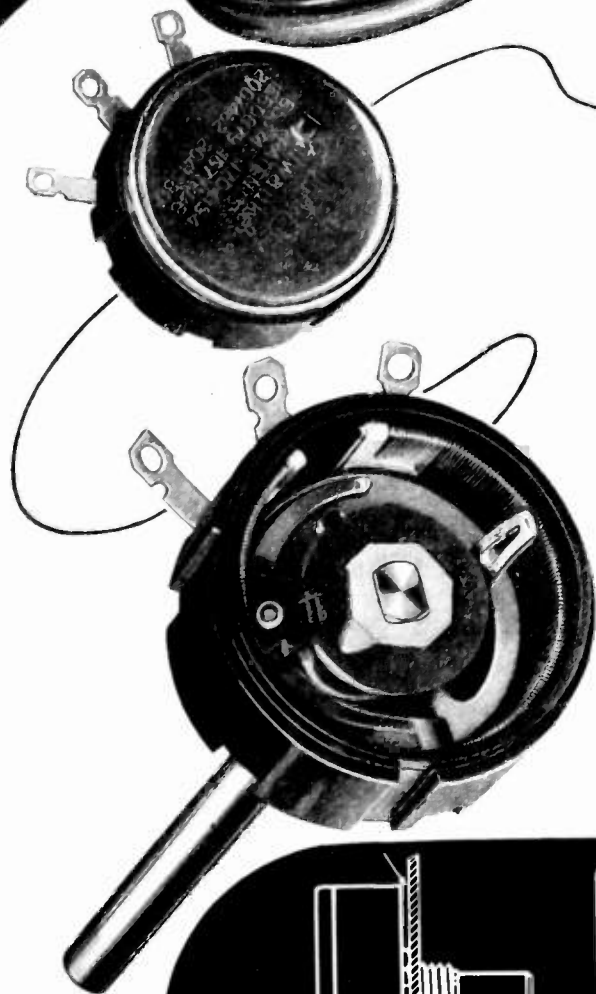



## Harvey UHX-25

25-watt General Purpose Radio Telephone Transmitter available for operation between 1.5 M. C. and 30 M. C.

# HARVEY Radio Laboratories, Inc.

★ 447 CONCORD AVENUE · CAMBRIDGE · MASSACHUSETTS ★

**RADIO, ELECTRONIC AND SOUND SUPPLIES AVAILABLE!**

Lafayette is your COMPLETE source of supply, especially on those hard to find Electronic, Radio and Sound Equipment parts . . . no order too small or too large for our prompt attention. LAFAYETTE GIVES YOU IMMEDIATE ACTION on deliveries! Lafayette personnel is trained to work with your expeditors.

If quick delivery of engineering samples, or production quantities is your problem, write, wire or phone Lafayette.

**FREE Buyers Guide!**—130 pages indexed for quick reference . . . Get your copy now! Address Dept. 1H3, 901 W. Jackson Boulevard, Chicago, Ill.

[ Camera Fans—Photographic equipment at lowest prices! Write for complete catalog. ]

## LAFAYETTE RADIO CORP.

901 W. JACKSON BLVD., CHICAGO, ILL. • 265 PEACHTREE ST., ATLANTA, GA.



## POSITIONS OPEN

The following positions of interest to I.R.E. members have been reported as open. Apply in writing, addressing reply to company mentioned or to Box No. . . . .



### PROCEEDINGS of the I.R.E.

330 West 42nd Street, New York, N.Y.

#### RADAR LABORATORY

The Signal Corps Radar Laboratory has urgent need for Physicists and Engineers with Mechanical, Electrical, and Radio training. Inexperienced engineering graduates can also qualify.

Salaries range from \$2000 to \$3200 and up.

Draftsmen, Engineering Aides, Electricians, and Radio Mechanics also are wanted.

Apply in writing stating full qualifications to: Civil Service Representative, Signal Corps Radar Laboratory, Camp Evans, Belmar, New Jersey.

#### COMMUNICATIONS ENGINEERS

Transcontinental & Western Air, Inc. has openings for three Radio Engineers in the Communications Department. Applicants should have completed an electrical or radio engineering course, or should have had one to two years practical experience. These openings are permanent. For additional details and application forms, write to Personnel Department, Transcontinental & Western Air, Inc., Kansas City, Missouri.

#### INSTRUCTORS IN RADIO AND ELECTRICITY

50 civilian instructors needed immediately for Army Air Forces Radio Instructor School. Subjects of instruction: Direct current and alternating current electricity, vacuum tubes, standard radio receivers and transmitters; international Morse code, telegraph and radiotelephone procedure. Salaries follow Civil Service starting from \$2,000 per year. State experience, education, code speed, personal data. Positions open immediately. Saint Louis University, Army Air Forces Radio Instructor School, 221 N. Grand Boulevard, Saint Louis, Mo. A. H. Weber, Technical Director.

#### RADIO EDITOR

Radio engineering editor for radio-electronic journal reaching manufacturing and operating fields. Older man acceptable if thoroughly up-to-date on radio and electronic principles. Interesting, pleasant work, with headquarters at New York. Write fully, outlining experience, salary expected, etc., to Box 278.

#### RADIO ENGINEER OR TECHNICIAN

Knowledge of circuits for supervisory position in transmitting tube circuit laboratory. Circuit knowledge and executive ability more important than college degree. Married man with children preferred. Salary open. Minimum \$250. Box 279.

#### Attention Employers . . .

Announcements for "Positions Open" are accepted without charge from employers offering salaried employment of engineering grade to I.R.E. members. Please supply complete information and indicate which details should be treated as confidential. Address: "POSITIONS OPEN," Institute of Radio Engineers, 330 West 42nd Street, New York, N.Y.

The Institute reserves the right to refuse any announcement without giving a reason for the refusal.



# MICROPHONES

## Yesterday . . . Today . . . Tomorrow

**Prewar Microphones.** In prewar microphone design, the chief development was in directional pickup. This was a stride forward in the discrimination against unwanted sounds, feedback and background noise. The most efficient directional pickup pattern was the "Super-Cardioid". It effects a 73% reduction in pickup of random noise energy. This was developed by the Shure engineering staff and is being utilized today to good advantage in many wartime applications.

**War Microphones.** Naturally most improvements are a military secret. It is obvious that service in battle requires—RUGGED construction never before thought possible—CONTROL of frequency response to solve

new and unique acoustic problems. Special applications are being solved for Microphones in masks and on the throat, in tanks, planes, ships and on the battlefield.

**Postwar Microphones.** New experience in war engineering and war production will provide tomorrow's Microphones with incredible ruggedness—special frequency responses for specific applications—controlled pickup that will permit wider use of sound amplification. When the war for world-wide freedom has been won, Shure Brothers will be ready to make its contribution to *better sound in a better world.*

Shure Brothers • 225 West Huron Street • Chicago, U. S. A.



**Designers and Manufacturers of Microphones and Acoustic Devices**

# One Year

*We have come a long way since Christmas 1941, all of us. American Amateurs have flocked to the colors—made themselves the backbone of the great Army Signal Corps and Navy Communications. Makers of Amateur equipment have put their entire effort into design and construction of Military communications units. For example, the Hallicrafters have, since Pearl Harbor, turned out production that would normally have taken seven years! ☆ We can all be proud that we have in one short year turned the tide of battle from almost unopposed conquest by the enemy to the first stages of the Victory drive on every front. And, let us all fervently hope that another wartime Christmas will be unnecessary.*

*W. J. Halligan*

**the hallicrafters co.**  
CHICAGO, U. S. A.



## Binders

for the Proceedings  
Protect your file  
of copies against  
damage and loss



Binders are available for those who desire to protect their copies of the PROCEEDINGS with stiff covers. Each binder will accommodate the twelve monthly issues published during the year. These binders are of blue Spanish grain fabricoid with gold lettering and will serve either as temporary transfers or as permanent binders. They are so constructed that each individual copy of the PROCEEDINGS will lie flat when the pages are turned. Copies can be removed from the binder in a few seconds and are not damaged by their insertion.

Available for both the old, small size, PROCEEDINGS or the new, large size (1939 to date).



Price: \$1.50

either size (specify which)  
Postpaid to all countries

You may have a volume number or your name stamped in gold for 50 cents additional.

Remittance should accompany  
your order

THE INSTITUTE OF  
RADIO ENGINEERS, INC.  
330 West 42nd Street,  
New York, N.Y.

*Putting  
'em  
Thru the Mill!*

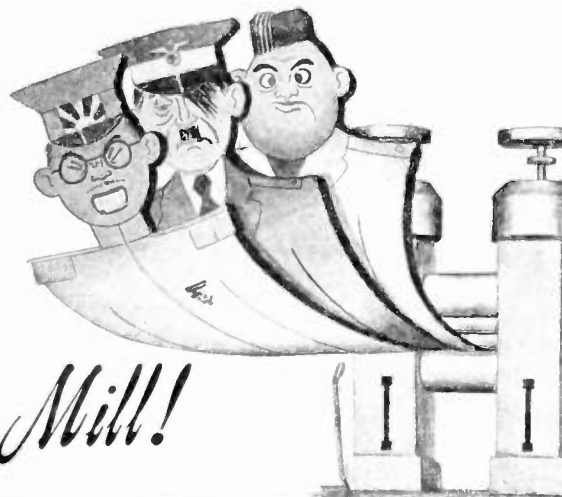

Strip for Action! Strip made from Wilbur B. Driver Co. special alloys! Strip that has so many essential war uses! As it is rolled through our mills, day and night, we know it will do its part in flattening the Axis!

Consult us for your special alloy requirements in rod, wire, ribbon and strip—both hot and cold rolled.



**WILBUR B. DRIVER CO.**  
NEWARK, NEW JERSEY





# Industry steadies its "nerves"

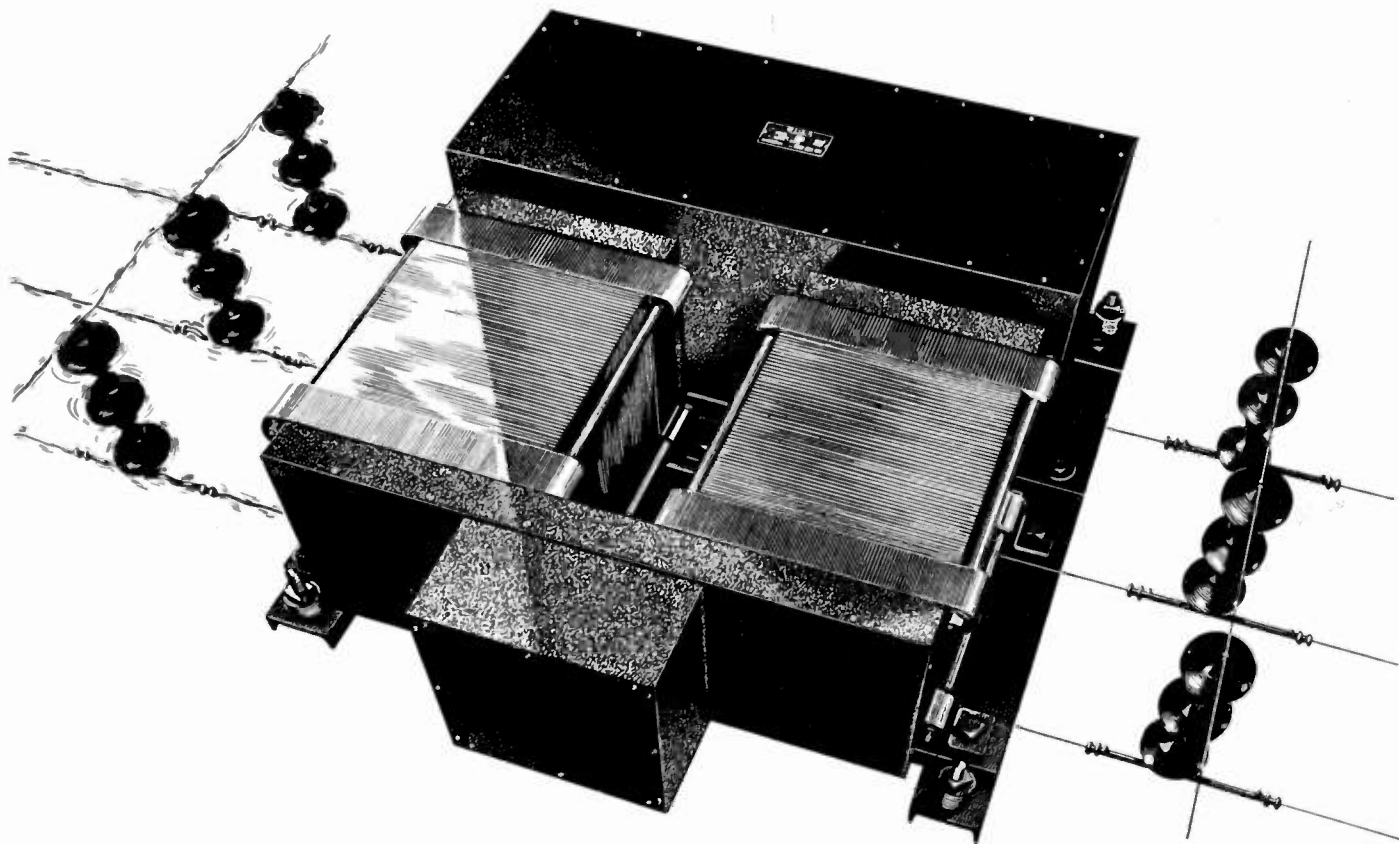

**F**ACED with production schedules that have no precedent in history, American industry finds the fluctuating voltages of its over-loaded power lines wholly inadequate to meet the "deadly" precision demanded for total war.

Vital "nerve centers" of production lines are geared for precise performance when operated at specific line voltages. Any variation from these rated values, and there are many these days, may well mean lagging production schedules and a noticeable lack of uniformity in products.

Fluctuating line voltages are no problem in plants where Sola "CV's" have taken over. Even though the peaks and valleys of power consumption may cause a voltage variation of as much as  $\pm 30\%$ —the vital "nerve centers" of their pro-

duction lines continue to operate smoothly and with unerring precision.

Day and night, without care or supervision, Sola Constant Voltage transformers maintain positive control over electrically operated instruments and machines that are indispensable to the nation's war effort. These transformers are available in standard units with capacities ranging from 15 KVA, which might be used for an entire communications system for instance, to the small 10 VA units for vacuum tubes. Special units can be built to specifications.

---

**Note to Industrial Executives:** *The problems solved by Sola "CV" transformers in other plants may have an exact counterpart in yours. Find out. Ask for bulletin KCV-74*

## Constant Voltage Transformers

# SOLA

**Transformers for:** Constant Voltage • Cold Cathode Lighting • Mercury Lamps • Series Lighting • Fluorescent Lighting • X-ray Equipment • Luminous Tube Signs  
Oil Burner Ignition • Radio • Power • Controls • Signal Systems • Door Bells and Chimes • etc. **SOLA ELECTRIC CO., 2525 Clybourn Ave., Chicago, Ill.**

# REMLER

## Plugs and Connectors

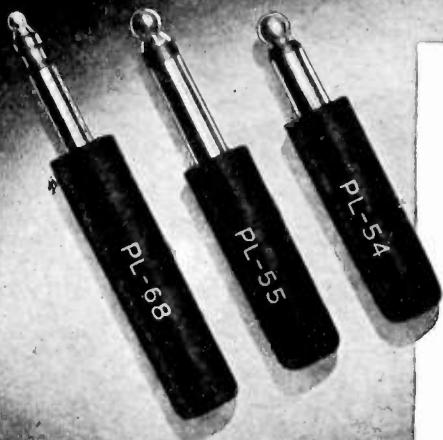

### ARMY SIGNAL CORPS SPECIFICATIONS

- Also PL—PLP—PLQ and PLS Plugs
- M Type Connectors
- M Type Caps
- FT Type Fittings

Quantity Prices Quoted  
on receipt of Delivery  
Schedules

Manufacturers of Communication Equipment  
SINCE 1918

REMLER COMPANY, Ltd. • 2101 Bryant St. • San Francisco, Calif.

## ENGINEERS WANTED TRANSFORMER DESIGN ENGINEERS

Unusual opportunity with national manufacturer for several thoroughly experienced Transformer Design Engineers capable of Audio & Power up to 15 K.V.A.

### **A War Job Now! . . . A Future Later!**

We are at present manufacturing vital war equipment for our fighting forces and our peace time activities and expansion program should provide steady employment and promotional opportunities to capable men.

*Those now employed in war industry  
at full skill need not apply*

Write to Personnel Manager

## FEDERAL TELEPHONE & RADIO CORP.

Manufacturing unit of the  
International Telephone & Radio Mfg. Co.  
1000 Passaic Ave., E. Newark, N.J.



## MEMBERSHIP EMBLEMS

The I.R.E. emblem is available to members in 3 useful forms: the lapel button, the pin, and the watch charm. Each is of 14-karat gold, enameled in color to designate the grade of membership.

Grade	Background Color
Fellow	Gold
Member	Blue
Associate	Maroon
Junior	White
Student	Green

### LAPEL BUTTON—\$2.75



Supplied with a screw back having jaws which grip the cloth of the coat.

### PIN—\$3.00



Provided with a safety catch.

### WATCH CHARM—\$5.00



Enameled on both sides and equipped with a suspension ring for attaching to a watch charm or fob.

Prices on emblems are the same for all grades of membership and include tax, postage and insurance registered-mail fee. Federal Tax included.

Remittance should accompany your order

## THE INSTITUTE OF RADIO ENGINEERS, INC.

330 West 42nd Street, New York, N.Y.

Proceedings of the I.R.E. January, 1943

# PIONEERS...in war and peace

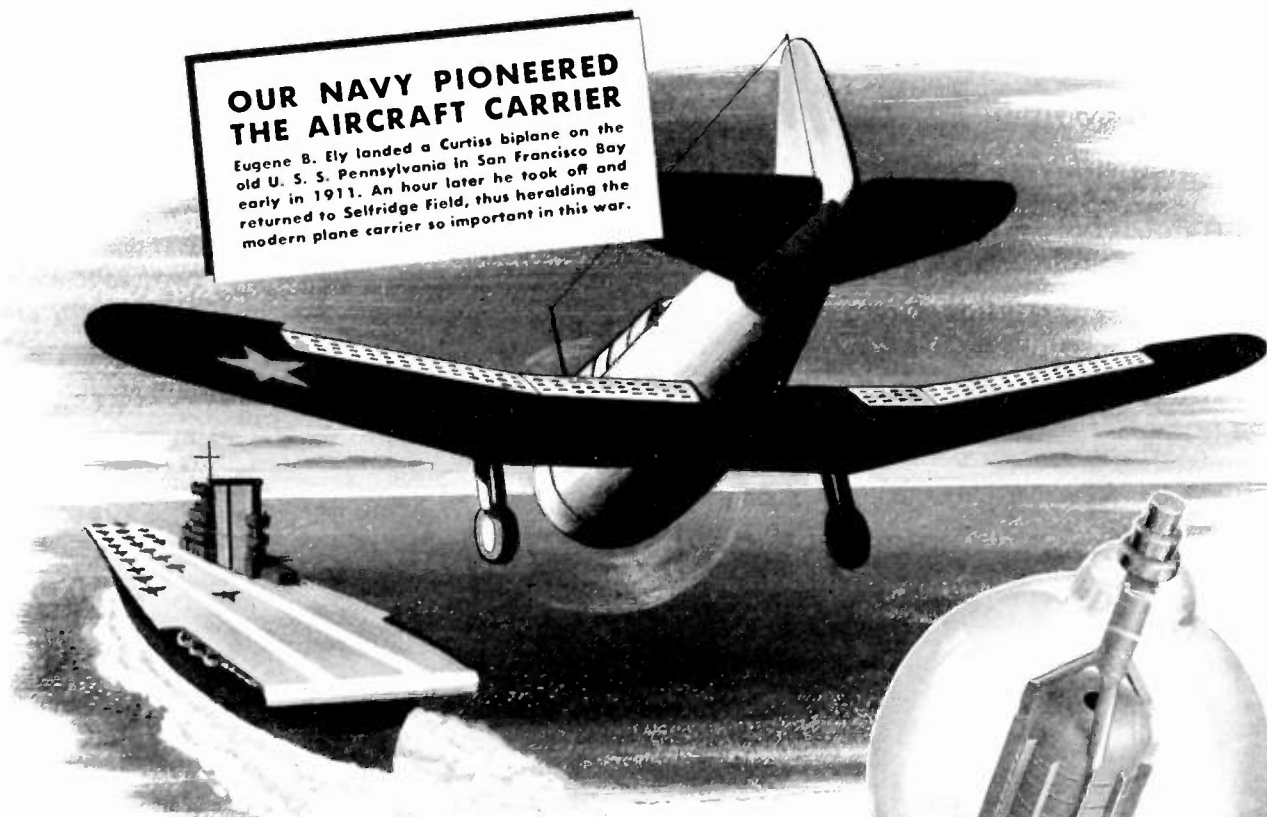

## GAMMATRON BUILT THE FIRST TANTALUM TUBE

Heintz and Kaufman engineers designed the first tantalum tube in 1928 to provide the ruggedness and reliability needed in marine transmitters. Today nearly 30 Gammatron types, with power ratings from 50 to 5000 watts, are engaged in handling America's war-time communications.

By now tantalum is recognized as the ideal element for plates and grids. It has the lowest gas content of all metals, gives up this gas readily during the pumping process, and then acts as a powerful absorbent for any gas released during operation.

Tantalum construction explains the remarkable ability of Gammatron transmitting tubes to withstand tremendous overloads without producing free gas which would cause filament emission failure.

Our electronic engineers are now pioneering remarkable new types of tantalum tubes for the service of America at war . . . and some day for the world at peace.



**HK-1054**  
MAXIMUM POWER OUTPUT  
3000 WATTS

### GAMMATRON SALES REPRESENTATIVES

**MARSH AGENCIES**  
104 Battery Street  
Seattle, Washington

**W. F. SEEMAN**  
505 Franklin St.  
Buffalo, New York

**KENNEDY SALES CO.**  
2362 University Ave.  
St. Paul, Minnesota

**E. P. DEMAREST**  
1630 South Flower St.  
Los Angeles, California

**H. A. ROES**  
2017 Grand Avenue  
Kansas City, Missouri

**RALPH M. HILL**  
**GORDEN GREY**  
1 North Crawford Ave.  
Chicago, Illinois

**M. B. PATTERSON & CO.**  
434 Allen Building  
Dallas, Texas

**W. E. McFADDEN**  
915 Montrose Ave.,  
Bexley  
Columbus, Ohio

**W. B. SWANK**  
610 Blaine Avenue  
Detroit, Michigan

**PAUL R. STURGEON**  
25 Huntington Avenue  
Boston, Massachusetts

**HOLLINGSWORTH & STILL**  
Norris Bldg., Atlanta, Ga.

**S. K. MACDONALD**  
1343 Arch Street  
Philadelphia, Pa.

**D. R. BITTAN SALES CO.**  
53 Park Place  
New York City, N. Y.



# GAMMATRONS...OF COURSE!

**TROUBLE SHOOTER**

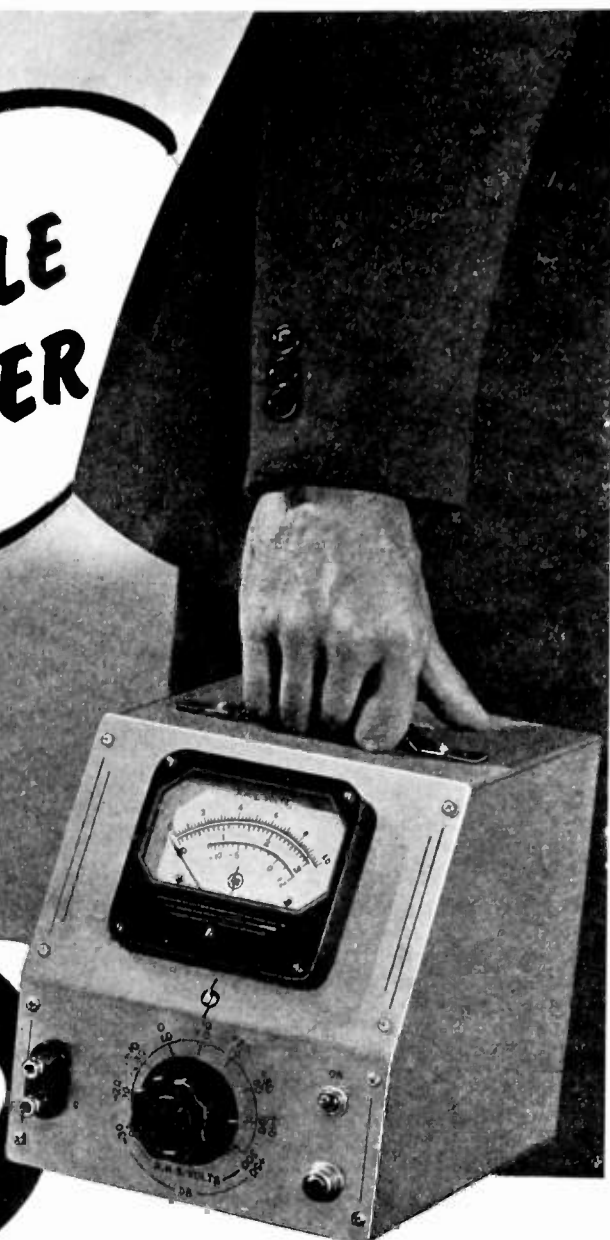

**VACUUM TUBE VOLTMETER**

Top ranking engineers give this handy portable instrument high priority for its ease of operation, extreme sensitivity over wide frequency range and its ability to make accurate measurements below 1 megacycle. Best of all, the -hp- Model 400 Vacuum Tube Voltmeter gives voltage indication that is proportional to the average value of the full wave. This is a feature not found in the average voltmeter on the market today. Get information now on this and other superior -hp- instruments. Give details of your problem so our engineers can be of greatest help. No obligation, of course.

CHICAGO OFFICE: ALFRED GROSSLEY 549 W. RANDOLPH ST. CHICAGO, ILLINOIS	HOLLYWOOD OFFICE: N. B. NEELY 5334 HOLLYWOOD BLVD. HOLLYWOOD, CALIF.	NEW YORK OFFICE: BRUCE D. BURLINGAME ASSOC. 69 MURRAY ST. NEW YORK, NEW YORK
--	---	---

**HEWLETT  PACKARD**

**COMPANY**  
Box 135X, Station A, Palo Alto, California

*Available  
I. R. E. Standards*



- |   | Price  |
|---|--------|
| 1) Standards on Electroacoustics, 1938 .....  | \$0.50 |
| Definitions of Terms, Letter and Graphical Symbols, Methods of Testing Loud Speakers. (vi+37 pages, 6x9 inches.)  |        |
| 3a) Standards on Transmitters and Antennas: Definitions of Terms, 1938 .....  | \$0.20 |
| A Reprint (1942) of the like-named section of "Standards on Transmitters and Antennas, 1938." (vi+8 pages, 8½x11 inches.)   |        |
| 3b) Standards on Transmitters and Antennas: Methods of Testing, 1938 .....  | \$0.50 |
| A Reprint (1942) of the like-named section of "Standards on Transmitters and Antennas, 1938." (vi+10 pages, 8½x11 inches.)  |        |
| 4a) Standards on Radio Receivers: Definitions of Terms, 1938 .....  | \$0.20 |
| A reprint (1942) of the like-named section of "Standards on Radio Receivers, 1938." (vi+6 pages, 8½x11 inches.)   |        |
| 4b) Standards on Radio Receivers: Methods of Testing Broadcast Radio Receivers, 1938 .....  | \$0.50 |
| A reprint (1942) of the like-named section of "Standards on Radio Receivers, 1938." (vi+20 pages, 8½x11 inches.)  |        |
| 5) Standards on Radio Wave Propagation: Definitions of Terms, 1942 .....  | \$0.20 |
| (vi+8 pages, 8½x11 inches.)   |        |
| 6) Standards on Radio Wave Propagation: Measuring Methods, 1942 .....   | \$0.50 |
| Methods of Measuring Radio Field Intensity, Methods of Measuring Power Radiated from an Antenna, Methods of Measuring Noise Field Intensity. (vi+16 pages, 8½x11 inches.) |        |
| 7) Standards on Facsimile: Definitions of Terms, 1942 .....   | \$0.20 |
| (vi+6 pages, 8½x11 inches.)   |        |
| ASA STANDARDS<br>(Sponsored by the I. R. E.)  |        |
| 9) American Standard: Standard Vacuum-Tube Base and Socket Dimensions .....   | \$0.20 |
| (ASA C16.2-1939). (8 pages, 7¾x10¾ inches.)   |        |
| 10) American Standard: Manufacturing Standards Applying to Broadcast Receivers .....  | \$0.20 |
| (ASA C16.3-1939). (16 pages, 7¾x10¾ inches.)  |        |

Prices are net and include postage to any country. Include remittance with order and address.

**THE INSTITUTE OF  
RADIO ENGINEERS, Inc.**  
330 West 42nd Street, New York, N.Y.

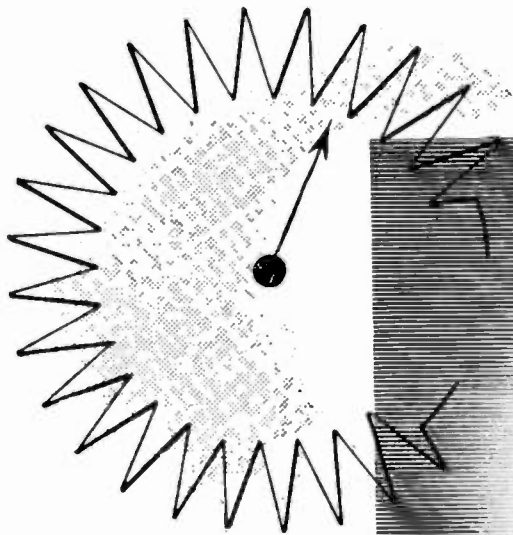

# OHMITE

All-Ceramic Vitreous-Enameled

## RHEOSTATS

for **PERMANENT** Smooth Control . . .

There is a basic difference in Ohmite rheostat design that becomes more and more apparent in actual service . . . a difference in smoothness of action, in long life, in trouble-free performance that means *permanently* smooth, close, electrical control. Every design feature has been time-proved under the most critical conditions, in every climate, on land, at sea and in the air. This soundness of design, plus the wide range of types and sizes, has made Ohmite Rheostats readily applicable to today's vital needs in war and industry. It also makes them ready to serve in the design of new devices to defeat the enemy and build for tomorrow's peace. Many stock types. Special units engineered for you. Approved types for Army and Navy specifications.

**Send for Catalog and Engineering Manual No. 40**

Write on company letterhead for this helpful 96 page guide in the selection and application of Rheostats, Resistors, Tap Switches.

**OHMITE MANUFACTURING CO., 4860 FLOURNOY ST., CHICAGO, U. S. A.**

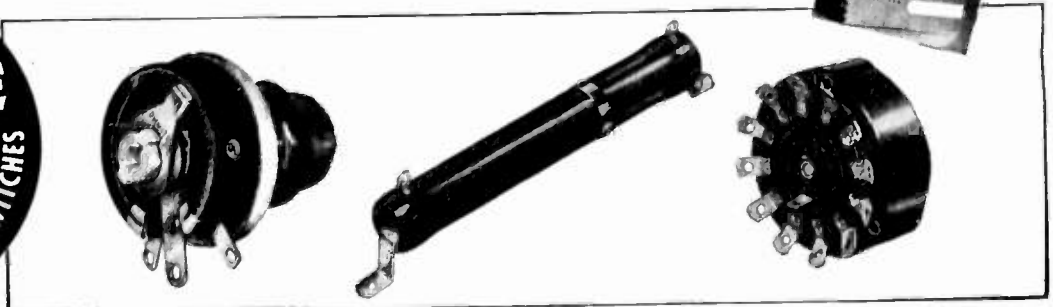

# COMPLETE YOUR FILES OF Proceedings



of the I·R·E

## WITH THESE AVAILABLE BACK ISSUES

Now is the time to fill in the gaps on your *Proceedings* shelf and replace lost or borrowed copies. Already, more than 25% of all back numbers are no longer available. The following issues are in stock as of October 1, 1942 and, subject of course to prior sale, are available at this time:

<b>1913-1915</b>	<b>Volumes 1-3</b>	<b>QUARTERLY</b>	<b>\$1.00 per copy</b>
	1913 Vol. 1 Jan. (a reprint);	1915 Vol. 3, Dec.	
<b>1916-1926</b>	<b>Volumes 4-14</b>	<b>BI-MONTHLY</b>	<b>\$1.00 per copy</b>
1917 Vol. 5	Apr., June, Aug., Oct., Dec.	1922 Vol. 10	All 6 issues
1918 Vol. 6	Feb., Apr., June, Aug., Dec.	1923 Vol. 11	All 6 issues
1919 Vol. 7	Apr., Dec.	1924 Vol. 12	Aug., Oct., Dec.
1920 Vol. 8	Apr., June, Aug., Oct., Dec.	1925 Vol. 13	Apr., June, Aug., Oct., Dec.
1921 Vol. 9	All 6 issues	1926 Vol. 14	All 6 issues
<b>1927-1942</b>	<b>Volumes 15-30</b>	<b>MONTHLY</b>	<b>\$1.00 per copy</b>
1927 Vol. 15	Apr. to Aug., inc., Oct. Nov., Dec.	1936 Vol. 24	Jan. to April, inc., June
1928 Vol. 16	Feb. to Dec., inc.	1937 Vol. 25	Feb. to Dec., inc.
1929 Vol. 17	Feb. to Sept., inc., Nov., Dec.	1938 Vol. 26	All 12 issues
1930 Vol. 18	All 12 issues.	<i>New Format—Large Size</i>	
1931 Vol. 19	All 12 issues	1939 Vol. 27	Jan. to July, inc., Sept., Nov., Dec.
1932 Vol. 20	All 12 issues.	1940 Vol. 28	All 12 issues
1933 Vol. 21	All 12 issues.	1941 Vol. 29	All 12 issues
1934 Vol. 22	All 12 issues	1942 Vol. 30	Jan. to May, inc., Oct. to Dec.
1935 Vol. 23	All 12 issues		

### I.R.E. MEMBERS . . . PUBLIC AND COLLEGE LIBRARIES

### POSTAGE

I.R.E. members in good standing are entitled to a discount of 25% from the above prices. Information on discounts to accredited public and college libraries will be supplied on request.

Prices include postage in the United States and Canada. Postage to other countries: 10 cents per copy.

**Remittance should accompany your order.**

**THE INSTITUTE OF RADIO ENGINEERS, Inc.**

**330 WEST 42nd STREET, NEW YORK, N. Y.**



**I**N the manufacture of precision instruments for the Armed Forces we strive for short cuts in production—but not in *quality*. There can be no expediency, no compromise, no half-way measures. The success of the bomber's mission depends as much upon the efficiency of the instruments as it does upon the skill of the officers and men.

Meeting the specifications of the United States Armed Forces

is in itself an eloquent testimonial to the *quality* of DeJur meters, potentiometers and rheostats. However, we do not rest upon these laurels alone. Behind DeJur workers is the stern tradition of New England . . . honesty of craftsmanship, pride of skill, the deep, personal delight in doing a job and doing it better than anyone else—anywhere.

**in war as in peace . . . nothing takes the place of quality.** *Your inquiries are invited.*



**DeJUR-AMSCO CORPORATION**

SHELTON, CONNECTICUT

*Manufacturers of DeJur Meters, Potentiometers, Rheostats and other Precision, Quality Electrical Instruments*

**Theory and Practice  
"Connect"... in ...**



## COMMUNICATION CIRCUITS

by LAWRENCE A. WARE,  
*Associate Professor of Elec-  
trical Engineering, and*

HENRY R. REED, *Professor  
of Electrical Engineering;  
both at The State University  
of Iowa.*

Here is ONE book that clearly and comprehensively presents the relation between the theory of communication and its practice. It offers a concise, authoritative introduction to the principles of communication transmission lines and their associated networks and attention is concentrated on the essentials of transmission. Logical steps than lead gradually up to a discussion of filters, impedance matching, wave guides, etc.

An introduction to the use of Maxwell's equations and Bessel functions is offered, and numerous illustrative examples are given throughout and at the end of the book. A knowledge of calculus and the elements of alternating current theory are prerequisites to a thorough understanding of the subjects discussed.

287 Pages 116 Illustrations 6x9  
\$3.50

JOHN WILEY & SONS, INC.

### ON APPROVAL COUPON

John Wiley & Sons, Inc.  
440 Fourth Avenue, New York, N.Y.

Please send me a copy of Ware and Reed's COMMUNICATION CIRCUITS on ten days' approval. At the end of that time, if I decide to keep the book, I will remit \$3.50 plus postage; otherwise I will return the book postpaid.

Name .....  
Address .....  
City and State .....  
Employed by .....

IRE 1-43

## PERMANENT MAGNETS

The Arnold Engineering Company produces all **ALNICO** types including **ALNICO V**.

All Magnets are completely manufactured in our own plant under close metallurgical, mechanical and magnetic control.

The Arnold Engineering Company freely offers engineering assistance in the solution of your magnetic design problems.

All inquiries will receive prompt attention.

### THE ARNOLD ENGINEERING COMPANY

147 EAST ONTARIO STREET  
CHICAGO, ILLINOIS

INVEST 10% IN WAR BONDS AND STAMPS

## INDEX

Section Meetings .....	xxii
Membership .....	xxvi
Rochester Fall Meeting .....	xxx
Current Literature .....	xxx
Positions Open .....	xxxvi

### DISPLAY ADVERTISERS

Aerovox Corporation .....	liii	Guardian Electric Mfg. Co. ....	xxv
American Lava Corporation .....	xiii	Hallicrafters Company .....	xxxviii
American Telephone & Telegraph Co. ....	vi	Harvey Radio Laboratories, Inc. ....	xxxvi
Amperex Electronic Products, Inc. ....	Cover II	Heintz & Kaufman, Ltd. ....	xli
Arnold Engineering Company .....	xlvi	Hewlett-Packard Company .....	xlii
Bendix Aviation Corporation .....	xii	Industrial Condenser Corp. ....	xxxiv
Bliley Electric Company .....	xxvi	International Resistance Co. ....	xv
Centralab .....	xxxv	Isolantite, Inc. ....	ii
Chicago Transformer Corporation .....	xxii	Lafayette Radio Corp. ....	xxxvi
Cornell-Dubilier Electric Corp. ....	Cover III	New York Transformer Company .....	xxx
Daven Company .....	xxvii	Ohmite Manufacturing Co. ....	xliiii
DeJur-Amsco Corp. ....	xl	Rauland Corporation .....	xviii
Tobe Deutschmann Corp. ....	xlvii	Raytheon Manufacturing Co. ....	xxxviii
Wilbur B. Driver Company .....	xxxviii	RCA Manufacturing Co. ....	xvi, xx
Eitel-McCullough, Inc. ....	xlviii	Remler Company, Ltd. ....	xl
Electro-Voice Mfg. Company, Inc. ....	xxiii	Shallcross Manufacturing Co. ....	xxviii
Federal Telephone & Radio Corp. ....	xl	Shure Brothers .....	xxxvii
Galvin Manufacturing Corp. ....	ix	Sola Electric Company .....	xxxix
General Ceramics Company .....	viii	Solar Manufacturing Corp. ....	xxix
General Electric Company .....	x, xi	Sprague Specialties Company .....	xiv
General Radio Company .....	Cover IV	Standard Transformer Corp. ....	xxvii
		Thordarson Electric Mfg. Company .....	xxxii
		Triplett Electrical Instrument Co. ....	iv, v
		Turner Company .....	xxiv
		United Electronics Company .....	xxxi
		Utah Radio Products Co. ....	vii
		John Wiley & Sons, Inc. ....	xxx, xlvi



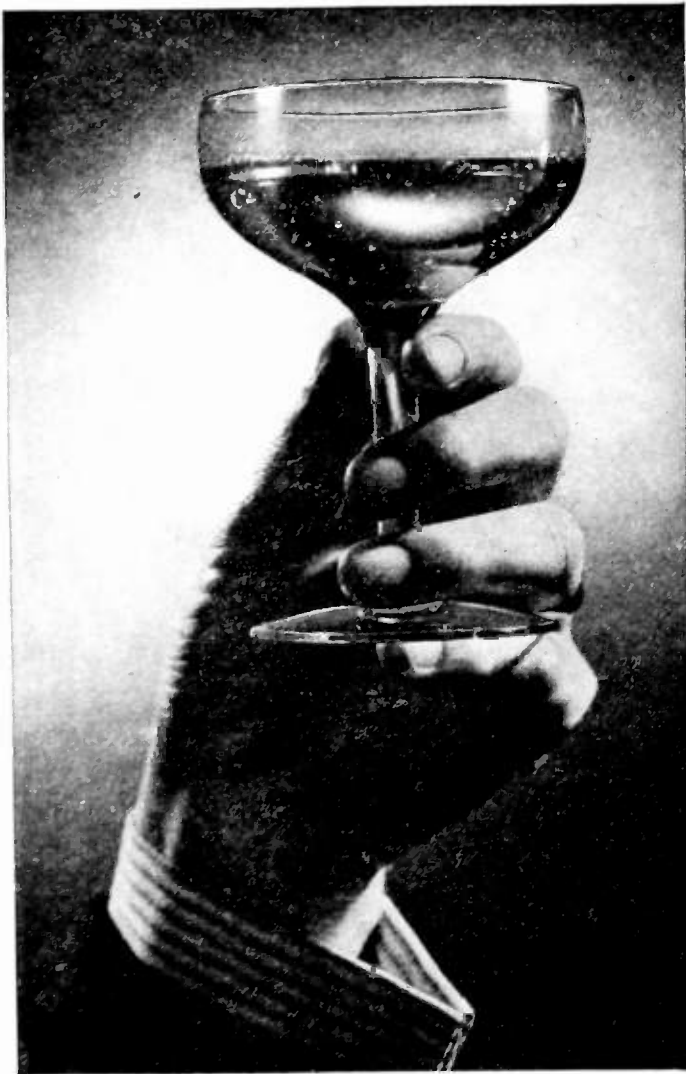

## HERE'S TO LONG LIFE!

This TOBE PLUG-IN CAPACITOR — Type PTSC-2—is a refinement of the plug-ins originated over seven years ago by Tobe engineers. It has quite a history—and quite a future, too. In engineering and design, we have one primary objective—to assure *long and satisfactory life* for this and *all* Tobe capacitors under *all* operating conditions. And the testimony of

users of Tobe Capacitors proves that this objective is being reached.

Fortunately, too, to help war production requirements, we now have *additional complete* capacitor manufacturing facilities in operation, meeting urgent production needs. We invite discussion of *your* capacitor problems.

### TOBE FILTERMITE (TYPE PTSC-2)

A refinement of early "plug-ins"—wax impregnated, hermetically sealed (also available in oil). Passes all required Army and Navy immersion tests. Low power factor.

**CAPACITY:** 2 x 8 microfarads

**RESISTANCE:** 2000 megohms per mfd.

**VOLTAGE:** 600 volts D.C. continuous working.

Individually tested at 1800 volts D. C.

(Available in 4 and 6-prong base)



### THE HOUSE OF "3-PLUS" MANUFACTURE

The quality of Tobe Capacitors is unquestioned; a direct result of . . .

1. PERSISTENCE in Research
  2. SOUNDNESS in Engineering
  3. EXCELLENCE in Production
- PLUS . . . 15 years of Condenser Experience.

**ARMY**

**NAVY**

**Medal of Honor  
won in the battle  
of production**



***Eimac***  
**TUBES**

**EITEL-McCULLOUGH, INC.**

San Bruno, California, U. S. A.

Expert Agents:

FRAZAR & CO., LTD., 301 Clay St., San Francisco, Calif., U. S. A.

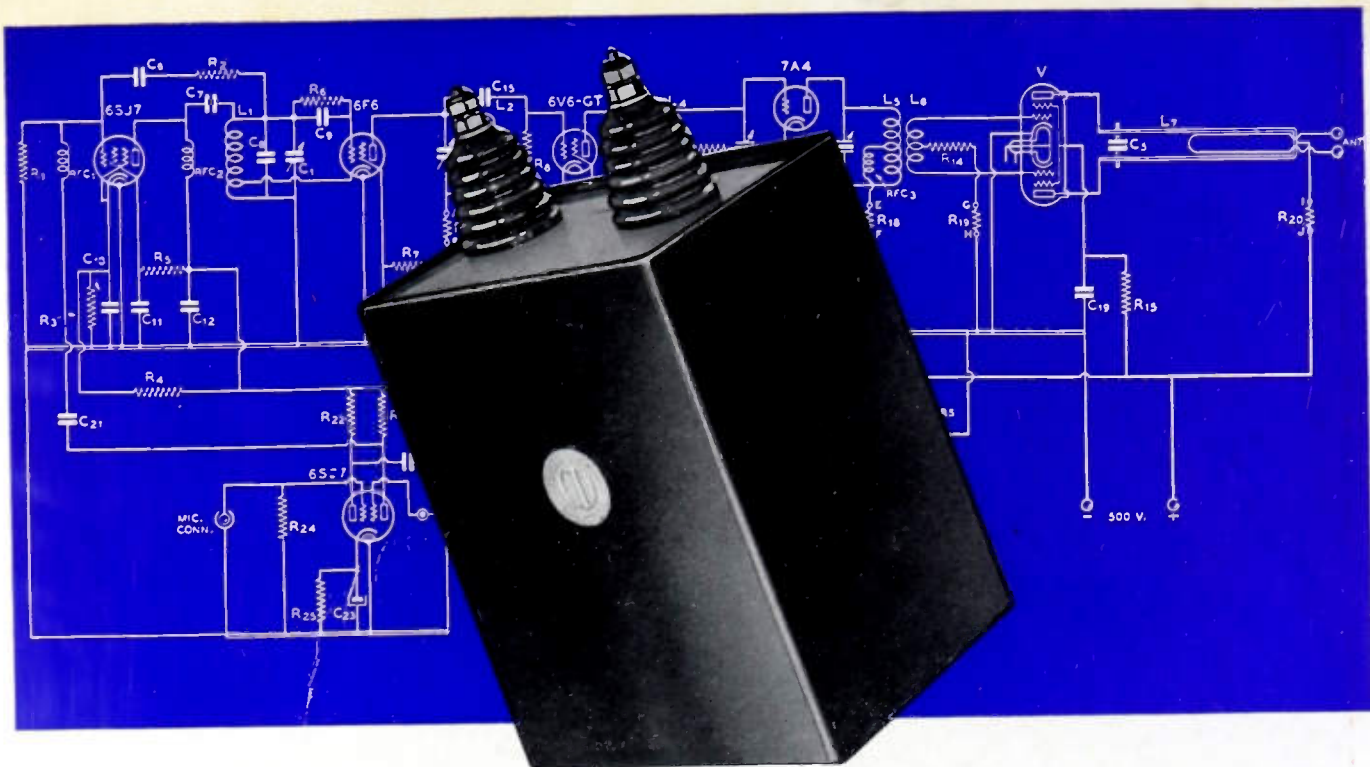

## WHEN THE BLUEPRINT CALLS FOR CAPACITORS give your equipment *maximum reliability* by using C-D Capacitors

Capacitors may look alike but C-Ds are engineered and manufactured by specialists who have made them their lifework. The combined, accumulated experience of 32 years' concentration on capacitors exclusively — is translated into the significant *extra* component that gives C-Ds their *extra* measure of stamina and longer life. C-D means "capacitors dependability"—a very good reason why there are more Cornell-Dubilier Capacitors in use today than any other make. Isn't that worth remembering . . . when the blueprint calls for capacitors?



*As the materials used in the manufacture of capacitors are under control, we are permitted to produce only against those orders carrying the necessary Preference Rating Extensions. Should you be unable to enjoy the finer performance of C-Ds now, we do look forward to serving you once again when Victory has been won.*

more in use today than any other make

# Cornell Dubilier capacitors



Mica • Paper • Dykanol • Wet & Dry Electrolytic Capacitors

### C-D HIGH VOLTAGE DYKANOL CAPACITORS

#### *Type TK*

These capacitors are universally accepted as the finest ever offered in larger capacity and higher voltage for filter service. Because of their compact construction the design engineer will find them suitable where space limitations are a problem.

*Typical features of these outstanding capacitors are:*

- Impregnated and filled with non-inflammable, non-explosive Dykanol, the impregnant noted for its high dielectric constant and stability under all operating conditions.
- Hermetically sealed and therefore not affected by moisture, time or temperature up to 93°C.
- Dried, impregnated and filled under continuous vacuum resulting in lower equivalent series resistance, longer life.
- Conservatively rated—will safely operate continuously at 10% above rated voltage.
- Encased in sturdy, arc-welded steel case, painted with a special blue-gray weather-proof, non-corrosive lacquer.
- Supplied with heavy-duty wet-process glazed porcelain insulator. These insulators are pressure-sealed resulting in leakproof joints and high dielectric strength.

*For further details write for Catalogue No. 160T  
Cornell-Dubilier Electric Corporation  
South Plainfield, N. J.*

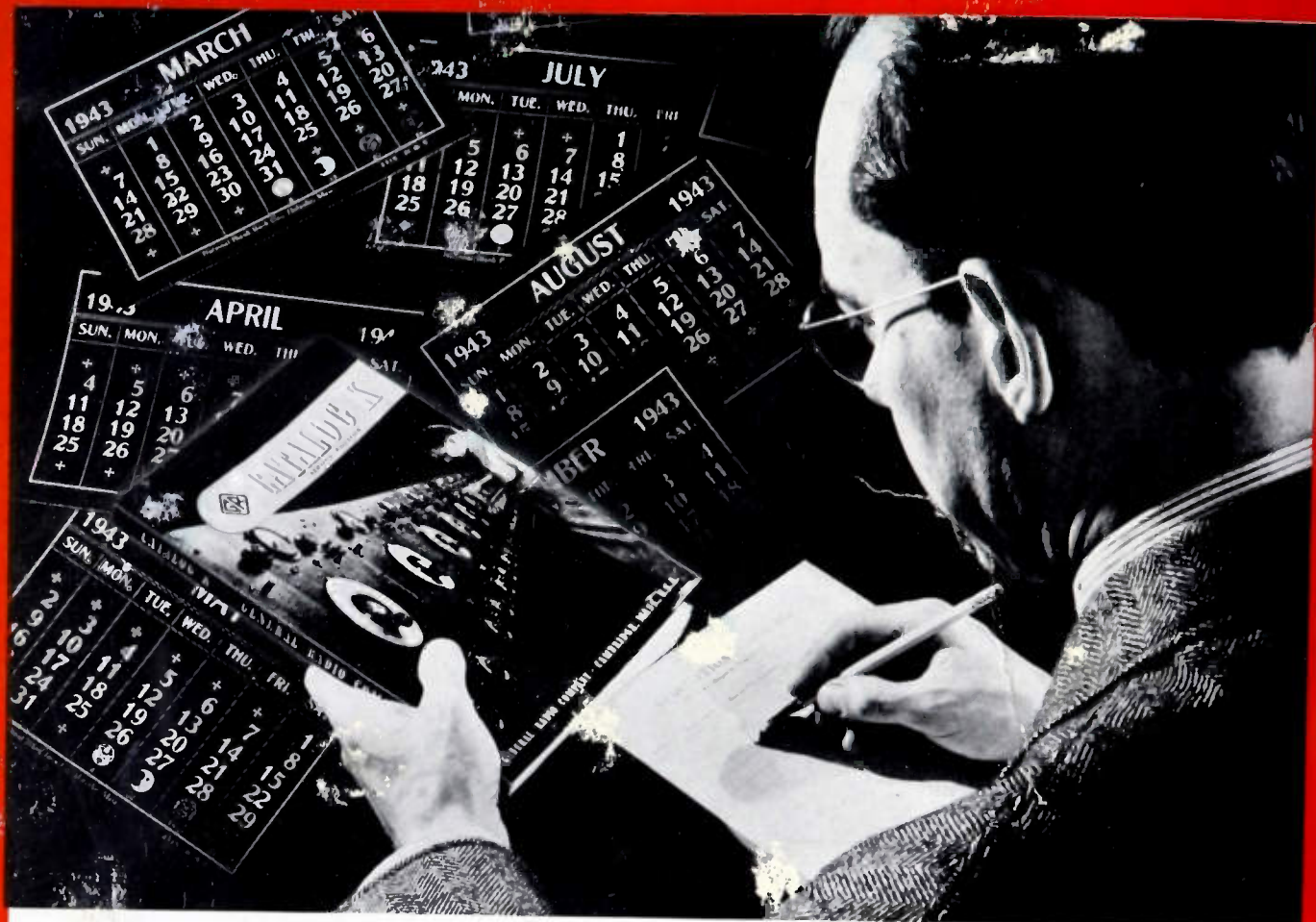

# Forecasting Deliveries

## of TEST EQUIPMENT for 1943

You can help us to schedule production for 1943 more efficiently so that you will be better assured of getting General Radio instruments when you need them. Estimate your test equipment requirements when you plan your own production and place your orders with us well in advance of the desired delivery date.

Our present plant output is completely allocated, and current orders will be de-

livered early in 1943. If you will need instruments for use in late spring and summer, order them now, specifying the desired delivery dates. Ordering well in advance will help to assure on-time deliveries. On the other hand, please do not call for delivery ahead of actual needs, and thus prevent someone else from getting urgently needed equipment on time. Your co-operation will help us to deliver what you want, when you need it.



**GENERAL RADIO COMPANY · Cambridge, Massachusetts**