

Proceedings

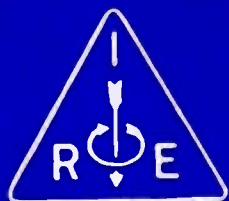

of the

I·R·E

NOVEMBER 1942

VOLUME 30 NUMBER 11

Proposed Standards for Right and Left
Quartz

Thyratron as a Rectifier

The Q Meter and Its Theory

Coupled and Resonant Circuits

Radiation from Antennas

Balanced Four-Wire Lines

Operating Conditions of Triodes

Institute of Radio Engineers

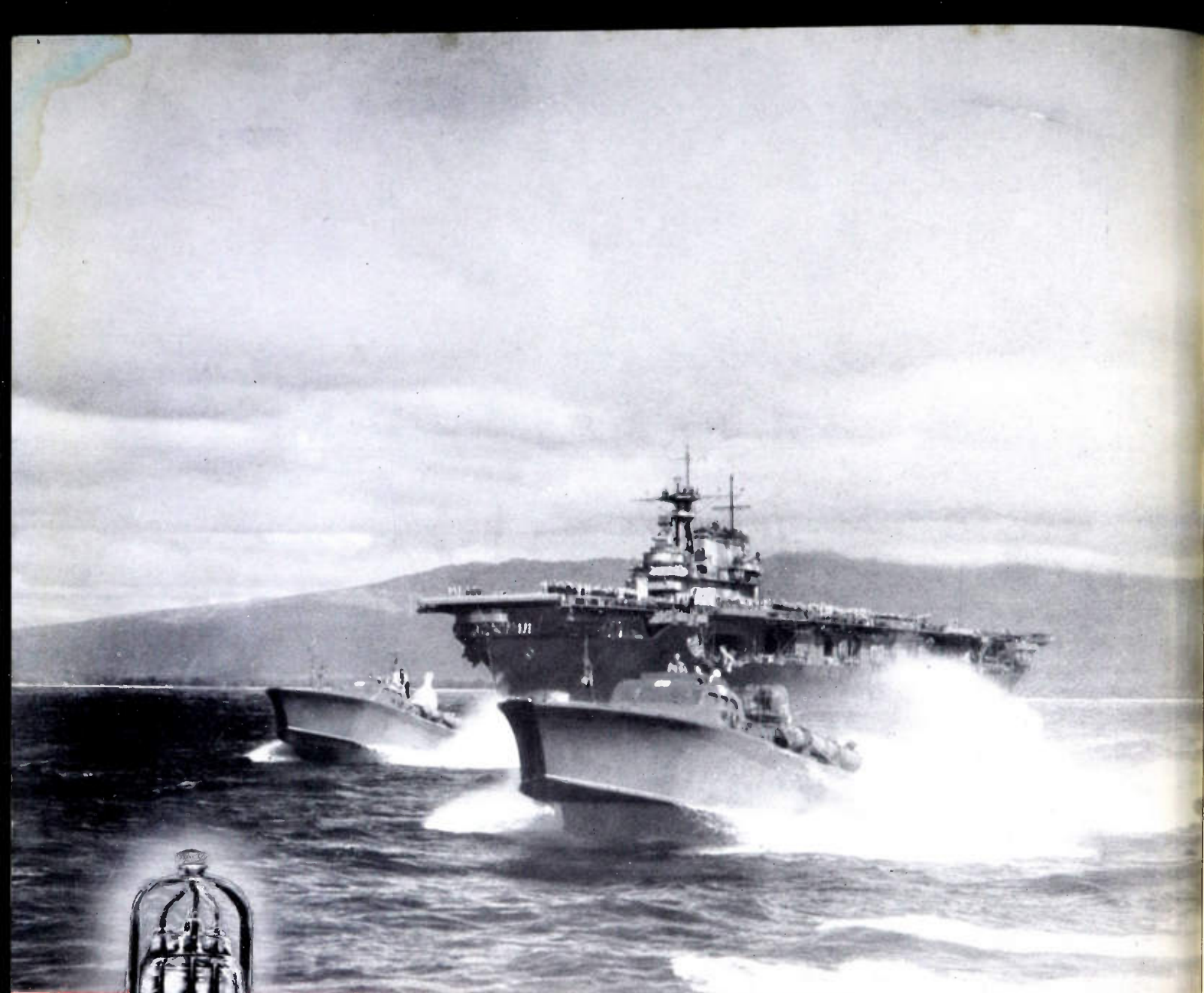

TRANSMITTING POWER



STRIKING POWER of United Nations forces is dependent upon radio communication equipment for smooth, efficient and coordinated action. And though hampered by shortages of critical materials, we are utilizing every facility and substance in order to supply our Armies and Navies with transmitting tubes . . . better transmitting tubes and more of them.

Such design and production achievements call for experienced organizations . . . made up of engineers and technicians who have had long and intimate contact with complex electronic operations and processes. It is fitting that a company such as ours should use its experience as a contribution to victory.

AMPEREX ELECTRONIC PRODUCTS

79 WASHINGTON STREET

BROOKLYN, NEW YORK

BOARD OF DIRECTORS

- Arthur F. Van Dyck, *President*
- Walter A. Rush, *Vice President*
- Haraden Pratt, *Treasurer*
- Harold P. Westman, *Secretary*
- Alfred N. Goldsmith, *Editor*
- Austin Bailey
- Adolph B. Chamberlain
- Carl C. Chambers
- Ivan S. Coggeshall
- William L. Everitt
- Harold T. Friis
- O. B. Hanson
- Lawrence C. F. Horle
- C. M. Jansky, Jr.
- J. Kelly Johnson
- Frederick B. Llewellyn
- Frederick E. Terman
- Browder J. Thompson
- Hubert M. Turner
- Harold A. Wheeler
- Lynde P. Wheeler

Harold R. Zeamans,
General Counsel

BOARD OF EDITORS

- Alfred N. Goldsmith, *Editor*
- Ralph R. Batcher
- Lloyd V. Berkner
- Philip S. Carter
- Lewis M. Clement
- Elmer W. Engstrom
- William L. Everitt
- Peter C. Goldmark
- Frederick W. Grover
- C. M. Jansky, Jr.
- John D. Kraus
- Frederick B. Llewellyn
- Samuel S. Mackeown
- Edward L. Nelson
- Harry F. Olson
- Greenleaf W. Pickard
- Haraden Pratt
- Conan A. Priest
- Leon J. Sivan
- Lynne C. Smeby
- Browder J. Thompson
- Harold A. Wheeler
- Lynde P. Wheeler
- Laurens E. Whittemore
- Gerald W. Willard
- William Wilson
- Charles J. Young

Helen M. Stote, *Assistant Editor*
William C. Copp,
Advertising Manager
William B. Cowilich,
Assistant Secretary

Proceedings

of the I·R·E

Published Monthly by

The Institute of Radio Engineers, Inc.

VOLUME 30

November, 1942

NUMBER 11

Proposed Standard Conventions for Expressing the Elastic and Piezoelectric Properties of Right- and Left-Hand Quartz..... W. G. Cady and K. S. Van Dyke 495

Operation of a Thyatron as a Rectifier..... L. A. Ware 500

The Q Meter and Its Theory..... V. V. L. Rao 502

Some Aspects of Coupled and Resonant Circuits..... Jesse B. Sherman 505

On Radiation from Antennas..... S. A. Schelkunoff and C. B. Feldman 511

On the Pickup of Balanced Four-Wire Lines... Charles W. Harrison, Jr. 517

A Graphical Method to Find the Optimal Operating Conditions of Triodes as Class C Telegraph Transmitters..... J. C. Frommer 519

Corrections to "Discussion on 'The Distribution of Amplitude with Time in Fluctuation Noise,'" by K. A. Norton and Vernon D. Landon... 526

Books:

 "Radiotron Designer's Handbook," edited by F. Langford Smith..... Harold A. Wheeler 526

 "Standard Handbook for Electrical Engineers," edited by Archer E. Knowlton..... R. A. Heising 526

Contributors..... 527

Section Meetings..... xiv

"E" Honor Roll..... xvi

Membership..... xviii

Positions Open..... xxvi

Advertising Index..... xxxiv

The contents of papers published in the PROCEEDINGS are the responsibilities of the authors and are not binding on the Institute or its members.



Entered as second-class matter October 26, 1927, at the post office at Menasha, Wisconsin, under the Act of February 28, 1925, embodied in Paragraph 4, Section 538 of the Postal Laws and Regulations. Publication office, 450 Ahnaip Street, Menasha, Wisconsin. Editorial and advertising offices, 330 West 42nd St., New York, N. Y. Subscription \$10.00 per year; foreign, \$11.00.

THE INSTITUTE OF RADIO ENGINEERS

INCORPORATED



New York Meeting—December 2, 1942

SECTION MEETINGS

ATLANTA
November 20
LOS ANGELES
November 17

CHICAGO
December 18
PHILADELPHIA
December 3

CLEVELAND
November 26
PITTSBURGH
December 14

DETROIT
November 20
WASHINGTON
December 14

SECTIONS

- ATLANTA**—Chairman, J. M. Comer; Secretary, M. H. Honnell, Elec. Eng. Dept., Georgia School of Technology, Atlanta, Ga.
- BALTIMORE**—Chairman, G. J. Gross; Secretary, A. D. Williams, Bendix Radio Corp., E. Joppa Rd., Towson, Md.
- BOSTON**—Chairman, R. F. Field; Secretary, R. O. Oberg, Northeastern Univ., Boston, Mass.
- BUENOS AIRES**—Chairman, J. P. Arnaud; Secretary, Alexander Nadosy, Florida St. 1065, Dept. C-6, Buenos Aires, Argentina.
- BUFFALO-NIAGARA**—Chairman, F. H. Scheer; Secretary, A. J. Dybowski, Dymac Radio, Inc., 1531 Main St., Buffalo, N. Y.
- CHICAGO**—Chairman, R. A. Kay; Secretary, Walter Kenworth, 5505 Potomac Ave., Chicago, Ill.
- CINCINNATI**—Chairman, W. L. Schwesinger; Secretary, Howard Leppele, 4432 Raceview Ave., Cincinnati, Ohio.
- CLEVELAND**—Chairman, P. L. Hoover; Secretary, A. S. Nace, 3209 Archwood Ave., Cleveland, Ohio.
- CONNECTICUT VALLEY**—Chairman, W. M. Smith; Secretary, R. E. Moe, Radio Dept., General Electric Co., Bridgeport, Conn.
- DALLAS-FORT WORTH**—Chairman, Truett Kimzey; Secretary, P. C. Barnes, Radio Station WFAA-WBAP, Grapevine, Texas.
- DETROIT**—Chairman, H. F. Tank; Secretary, E. J. Hughes, 14209 Prevost, Detroit, Mich.
- EMPORIUM**—Chairman, R. K. Gessford; Secretary, H. D. Johnson, Hygrade Sylvania Corp., Emporium, Pa.
- INDIANAPOLIS**—Chairman, S. E. Benson; Secretary, B. H. Rinehart, 1920 Park Ave., Indianapolis, Ind.
- KANSAS CITY**—Chairman, H. K. Morgan; Secretary G. L. Taylor, Midland Radio School Power and Light Building, Kansas City, Mo.
- LOS ANGELES**—Chairman, C. F. Wolcott; Secretary, E. S. Sievers, Room 567, 417 S. Hill St., Los Angeles, Calif.
- MONTREAL**—Chairman, J. A. Ouimet; Secretary, J. R. Bain, Dept. 912, Northern Electric Co., 1231 Shearer St., Montreal, Que., Canada.
- PHILADELPHIA**—Chairman, J. B. Coleman; Secretary, H. J. Schrader, Bldg. 8, Fl. 10, RCA Manufacturing Co., Camden, N. J.
- PITTSBURGH**—Chairman, D. A. Myer; Secretary, A. P. Sunnergren, West Penn Power Co., 14 Wood St., Pittsburgh, Pa.
- PORTLAND**—Chairman, R. W. Deardorff; Secretary, B. R. Paul, 5960 S. W. 41st. Ave., Portland, Ore.
- ROCHESTER**—Chairman, O. L. Angevine, Jr.; Secretary, G. R. Town, Stromberg-Carlson Tel. Mfg. Co., Rochester, N. Y.
- ST. LOUIS**—Chairman, O. S. McDaniel; Secretary, H. D. Seielstad, 1017 S. Berry Rd., St. Louis, Mo.
- SAN FRANCISCO**—Chairman, H. E. Held; Secretary, W. G. Wagener, Heintz and Kaufman, South San Francisco, Calif.
- SEATTLE**—Chairman, K. H. Ellerbeck; Secretary, H. E. Renfro, 4311 Thackeray Pl., Seattle, Wash.
- TORONTO**—Chairman, T. S. Farley; Secretary, L. C. Simmonds, A. C. Simmonds and Sons, 301 King St., E., Toronto, Ont., Canada.
- TWIN CITIES**—Chairman, R. E. Allison; Secretary, A. G. Peck, Twin-Cities Studios, Columbia Broadcasting System, 625 Second Ave., S., Minneapolis, Minn.
- WASHINGTON**—Chairman, E. M. Webster; Secretary, J. D. Wallace, Radio Division U. S. Naval Research Laboratory, Anacostia Station, D. C.

Proposed Standard Conventions for Expressing the Elastic and Piezoelectric Properties of Right and Left Quartz*

W. G. CADY†, FELLOW, I.R.E., AND K. S. VAN DYKE†, MEMBER, I.R.E.

Summary—Three sources of confusion in the literature on quartz crystals have recently been pointed out:¹ the distinction between right and left quartz, the conventions respecting the positive directions of the crystal axes, and conventions respecting the signs of angles when the axial system is rotated. After further consideration of this subject in the present paper, it is recommended that writers employ only that definition of right and left quartz which is now generally accepted, and that uniform conventions be agreed upon for axial directions and rotations. Voigt's usage in the main is advocated with this important exception: it is proposed that a right-handed system of axes be used for right quartz, left-handed for left quartz. This arrangement may appropriately be called the Right-Left axial system. The advantages are that all elastic and piezoelectric constants then retain the same sign for both types of crystal, and that all equations having to do with rotated axes apply equally to both types. No heed need be given to the distinction between right and left quartz except when angles are to be laid off on an actual specimen, and then the difference lies only in the reversal of the x axis for left quartz. A table showing the conventions used by various authors is included.

INTRODUCTION

THE literature on quartz crystals is in a state of great confusion, in the use of the terms "right," "left," "positive," and "negative." This confusion is of three sorts, of which the first arises from the fact that quartz crystals are *enantiomorphic*; that is, they occur in both *right* and *left* forms. Not only in the arrangement of external faces but also with respect to all physical properties one is the mirror image of the other. Not all writers are agreed as to which form should be called "right."

The second source of confusion is the lack of agreement among different authors as to the positive sense of the x and y axes, for both right and left quartz.

The third troublebreeder is found in the equations for transformation of elastic and piezoelectric constants to rotated axes: a clockwise rotation is called by some writers positive, by others negative.

Even if all writers had clearly stated all their conventions, the task of comparing and interpreting their results would be troublesome enough. The too-frequent lack of such statements has brought the situa-

tion to an intolerable state. For this confusion Voigt² himself is partly responsible. If he could have foreseen the development of the electron tube and the important uses to which, in conjunction with electron tubes, piezoelectric crystals, and especially quartz, were destined to be put, he would doubtless have assembled at one point his system of conventions, instead of leaving them scattered casually throughout the pages of the *Lehrbuch*, where they have escaped the attention of most investigators. Indeed, even he uses in the *Lehrbuch* a definition of signs of angles of rotation differing from that in some of his earlier publications.

The two forms of quartz can be distinguished by the disposition of certain faces, when those faces happen to be present (see below). Another method in common use, which can be applied to any specimen, whether natural faces are present or not, takes advantage of the fact that quartz crystals are also *optically active*. When a beam of plane-polarized light passes through the crystal parallel to the optic (z) axis, the plane of polarization becomes progressively rotated, and the direction of rotation is opposite in right quartz from that in left. Confusion has arisen from the fact that a beam of polarized light is rotated to the right or left (clockwise or counterclockwise) according to whether or not the gaze of the observer is in the direction of propagation of the beam. This subject is well discussed by Sosman³ and more recently by Van Dyke,¹ who points out that while most leading authorities today call the rotation "right" or "positive" when it appears clockwise to an observer looking back at the light source (that is, in a direction contrary to that of the beam), the opposite convention has been employed by some.

Fortunately the crystallographers are in agreement in calling α quartz *right* when the " sx " combination of faces, on a crystal held with its optic axis vertical and with a face of the primary positive first-order rhombohedron (an r face) at the *upper front*, appears at both ends of that prismatic edge which is at the *right* of this r face (Fig. 1). This definition is purely a matter of convention. What is not a convention but a fact is that in a crystal satisfying this definition of "right" a beam of plane-polarized light parallel to the optic axis becomes rotated to the *left* from the point of view of the *source of light*. Nevertheless, if we adopt the convention that the direction of rotation is that

* Decimal classification 537.65. Original manuscript received by the Institute, August 19, 1940; revised manuscript received, September 8, 1942. The question of terminology has been raised independently by W. P. Mason and G. W. Willard, "Piezoelectric Crystals," *Proc. I.R.E.*, vol. 28, p. 428; September, 1940, with the suggestion that a committee of the Institute be appointed to recommend a standardization of quartz terminology. The Board of Directors appointed such a committee consisting of K. S. Van Dyke (chairman); J. D. Crawford (secretary); C. F. Baldwin, S. A. Bokovoy, W. L. Bond, W. G. Cady, J. K. Clapp, and W. P. Mason. The definitions and conventions as set forth in the present paper have received the approval of this committee and will be included in its final report.

† Wesleyan University, Middletown, Connecticut.

¹ Karl S. Van Dyke, "On the right- and left-handedness of quartz and its relation to elastic and other properties," *Proc. I.R.E.*, vol. 28, pp. 399-406; September, 1940.

² W. Voigt, "Lehrbuch der Kristallphysik," Teubner, Leipzig, Germany, 1910, also second edition, 1928.

³ R. B. Sosman, "The Properties of Silica," Chemical Catalog Company, New York, 1927, p. 856.

THE INSTITUTE OF RADIO ENGINEERS

INCORPORATED



New York Meeting—December 2, 1942

SECTION MEETINGS

ATLANTA November 20	CHICAGO December 18	CLEVELAND November 26	DETROIT November 20
LOS ANGELES November 17	PHILADELPHIA December 3	PITTSBURGH December 14	WASHINGTON December 14

SECTIONS

- ATLANTA**—Chairman, J. M. Comer; Secretary, M. H. Honnell, Elec. Eng. Dept., Georgia School of Technology, Atlanta, Ga.
- BALTIMORE**—Chairman, G. J. Gross; Secretary, A. D. Williams, Bendix Radio Corp., E. Joppa Rd., Towson, Md.
- BOSTON**—Chairman, R. F. Field; Secretary, R. O. Oberg, Northeastern Univ., Boston, Mass.
- BUENOS AIRES**—Chairman, J. P. Arnaud; Secretary, Alexander Nadosy, Florida St. 1065, Dept. C-6, Buenos Aires, Argentina.
- BUFFALO-NIAGARA**—Chairman, F. H. Scheer; Secretary, A. J. Dybowski, Dymac Radio, Inc., 1531 Main St., Buffalo, N. Y.
- CHICAGO**—Chairman, R. A. Kay; Secretary, Walter Kenworth, 5505 Potomac Ave., Chicago, Ill.
- CINCINNATI**—Chairman, W. L. Schwesinger; Secretary, Howard Leppele, 4432 Raceview Ave., Cincinnati, Ohio.
- CLEVELAND**—Chairman, P. L. Hoover; Secretary, A. S. Nace, 3209 Archwood Ave., Cleveland, Ohio.
- CONNECTICUT VALLEY**—Chairman, W. M. Smith; Secretary, R. E. Moe, Radio Dept., General Electric Co., Bridgeport, Conn.
- DALLAS-FORT WORTH**—Chairman, Truett Kimzey; Secretary, P. C. Barnes, Radio Station WFAA-WBAP, Grapevine, Texas.
- DETROIT**—Chairman, H. F. Tank; Secretary, E. J. Hughes, 14209 Prevost, Detroit, Mich.
- EMPORIUM**—Chairman, R. K. Gessford; Secretary, H. D. Johnson, Hygrade Sylvania Corp., Emporium, Pa.
- INDIANAPOLIS**—Chairman, S. E. Benson; Secretary, B. H. Rinehart, 1920 Park Ave., Indianapolis, Ind.
- KANSAS CITY**—Chairman, H. K. Morgan; Secretary G. L. Taylor, Midland Radio School Power and Light Building, Kansas City, Mo.
- LOS ANGELES**—Chairman, C. F. Wolcott; Secretary, E. S. Sievers, Room 567, 417 S. Hill St., Los Angeles, Calif.
- MONTREAL**—Chairman, J. A. Ouimet; Secretary, J. R. Bain, Dept. 912, Northern Electric Co., 1231 Shearer St., Montreal, Que., Canada.
- PHILADELPHIA**—Chairman, J. B. Coleman; Secretary, H. J. Schrader, Bldg. 8, Fl. 10, RCA Manufacturing Co., Camden, N. J.
- PITTSBURGH**—Chairman, D. A. Myer; Secretary, A. P. Sunnergren, West Penn Power Co., 14 Wood St., Pittsburgh, Pa.
- PORTLAND**—Chairman, R. W. Deardorff; Secretary, B. R. Paul, 5960 S. W. 41st. Ave., Portland, Ore.
- ROCHESTER**—Chairman, O. L. Angevine, Jr.; Secretary, G. R. Town, Stromberg-Carlson Tel. Mfg. Co., Rochester, N. Y.
- ST. LOUIS**—Chairman, O. S. McDaniel; Secretary, H. D. Seielstad, 1017 S. Berry Rd., St. Louis, Mo.
- SAN FRANCISCO**—Chairman, H. E. Held; Secretary, W. G. Wagener, Heintz and Kaufman, South San Francisco, Calif.
- SEATTLE**—Chairman, K. H. Ellerbeck; Secretary, H. E. Renfro, 4311 Thackeray Pl., Seattle, Wash.
- TORONTO**—Chairman, T. S. Farley; Secretary, L. C. Simmonds, A. C. Simmonds and Sons, 301 King St., E., Toronto, Ont., Canada.
- TWIN CITIES**—Chairman, R. E. Allison; Secretary, A. G. Peck, Twin-Cities Studios, Columbia Broadcasting System, 625 Second Ave., S., Minneapolis, Minn.
- WASHINGTON**—Chairman, E. M. Webster; Secretary, J. D. Wallace, Radio Division U. S. Naval Research Laboratory, Anacostia Station, D. C.

Proposed Standard Conventions for Expressing the Elastic and Piezoelectric Properties of Right and Left Quartz*

W. G. CADY†, FELLOW, I.R.E., AND K. S. VAN DYKE†, MEMBER, I.R.E.

Summary—Three sources of confusion in the literature on quartz crystals have recently been pointed out:¹ the distinction between right and left quartz, the conventions respecting the positive directions of the crystal axes, and conventions respecting the signs of angles when the axial system is rotated. After further consideration of this subject in the present paper, it is recommended that writers employ only that definition of right and left quartz which is now generally accepted, and that uniform conventions be agreed upon for axial directions and rotations. Voigt's usage in the main is advocated with this important exception: it is proposed that a right-handed system of axes be used for right quartz, left-handed for left quartz. This arrangement may appropriately be called the Right-Left axial system. The advantages are that all elastic and piezoelectric constants then retain the same sign for both types of crystal, and that all equations having to do with rotated axes apply equally to both types. No heed need be given to the distinction between right and left quartz except when angles are to be laid off on an actual specimen, and then the difference lies only in the reversal of the x axis for left quartz. A table showing the conventions used by various authors is included.

INTRODUCTION

THE literature on quartz crystals is in a state of great confusion, in the use of the terms "right," "left," "positive," and "negative." This confusion is of three sorts, of which the first arises from the fact that quartz crystals are *enantiomorphic*; that is, they occur in both *right* and *left* forms. Not only in the arrangement of external faces but also with respect to all physical properties one is the mirror image of the other. Not all writers are agreed as to which form should be called "right."

The second source of confusion is the lack of agreement among different authors as to the positive sense of the x and y axes, for both right and left quartz.

The third troublebreeder is found in the equations for transformation of elastic and piezoelectric constants to rotated axes: a clockwise rotation is called by some writers positive, by others negative.

Even if all writers had clearly stated all their conventions, the task of comparing and interpreting their results would be troublesome enough. The too-frequent lack of such statements has brought the situa-

tion to an intolerable state. For this confusion Voigt² himself is partly responsible. If he could have foreseen the development of the electron tube and the important uses to which, in conjunction with electron tubes, piezoelectric crystals, and especially quartz, were destined to be put, he would doubtless have assembled at one point his system of conventions, instead of leaving them scattered casually throughout the pages of the *Lehrbuch*, where they have escaped the attention of most investigators. Indeed, even he uses in the *Lehrbuch* a definition of signs of angles of rotation differing from that in some of his earlier publications.

The two forms of quartz can be distinguished by the disposition of certain faces, when those faces happen to be present (see below). Another method in common use, which can be applied to any specimen, whether natural faces are present or not, takes advantage of the fact that quartz crystals are also *optically active*. When a beam of plane-polarized light passes through the crystal parallel to the optic (z) axis, the plane of polarization becomes progressively rotated, and the direction of rotation is opposite in right quartz from that in left. Confusion has arisen from the fact that a beam of polarized light is rotated to the right or left (clockwise or counterclockwise) according to whether or not the gaze of the observer is in the direction of propagation of the beam. This subject is well discussed by Sosman³ and more recently by Van Dyke,¹ who points out that while most leading authorities today call the rotation "right" or "positive" when it appears clockwise to an observer looking back at the light source (that is, in a direction contrary to that of the beam), the opposite convention has been employed by some.

Fortunately the crystallographers are in agreement in calling α quartz *right* when the " sx " combination of faces, on a crystal held with its optic axis vertical and with a face of the primary positive first-order rhombohedron (an r face) at the *upper front*, appears at both ends of that prismatic edge which is at the *right* of this r face (Fig. 1). This definition is purely a matter of convention. What is not a convention but a fact is that in a crystal satisfying this definition of "right" a beam of plane-polarized light parallel to the optic axis becomes rotated to the *left* from the point of view of the *source of light*. Nevertheless, if we adopt the convention that the direction of rotation is that

* Decimal classification 537.65. Original manuscript received by the Institute, August 19, 1940; revised manuscript received, September 8, 1942. The question of terminology has been raised independently by W. P. Mason and G. W. Willard, "Piezoelectric Crystals," Proc. I.R.E., vol. 28, p. 428; September, 1940, with the suggestion that a committee of the Institute be appointed to recommend a standardization of quartz terminology. The Board of Directors appointed such a committee consisting of K. S. Van Dyke (chairman); J. D. Crawford (secretary); C. F. Baldwin, S. A. Bokovoy, W. L. Bond, W. G. Cady, J. K. Clapp, and W. P. Mason. The definitions and conventions as set forth in the present paper have received the approval of this committee and will be included in its final report.

† Wesleyan University, Middletown, Connecticut.

¹ Karl S. Van Dyke, "On the right- and left-handedness of quartz and its relation to elastic and other properties," Proc. I.R.E., vol. 28, pp. 399-406; September, 1940.

² W. Voigt, "Lehrbuch der Kristallphysik," Teubner, Leipzig, Germany, 1910, also second edition, 1928.

³ R. B. Sosman, "The Properties of Silica," Chemical Catalog Company, New York, 1927, p. 856.

seen by an observer looking back toward the source, a given crystal is either "right" or "left" from both the crystallographic and the optical standpoints. Although this convention, used also by Voigt, has become generally recognized as standard, examples of the opposite

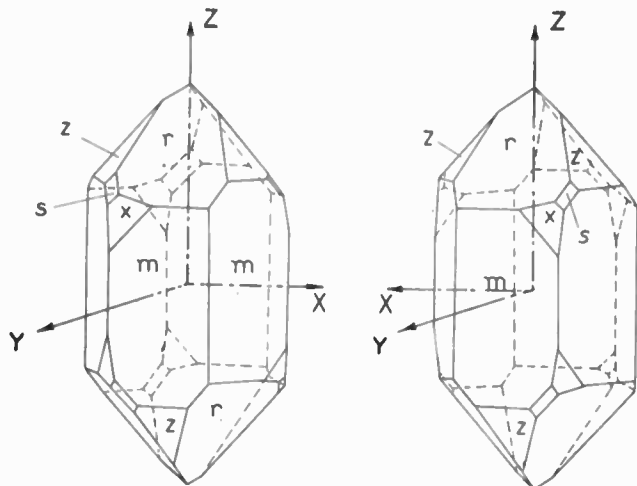

Fig. 1—Left and right quartz crystals, showing the positive directions of axes as recommended in this paper.

and obsolescent terminology can be found, without accompanying explanations, in recent papers.

This paper is a plea for consistency, and it advocates a system of conventions containing only one important departure from the usage of Voigt's *Lehrbuch*, which, if generally adopted, should remove all confusion and ambiguity. While these recommendations have to do explicitly only with quartz, they are applicable in principle to all enantiomorphic crystals, that is, all crystals that occur in both right and left types.

FACES AND AXES OF RIGHT AND LEFT QUARTZ

At the risk of repeating much that is already familiar to the reader, it seems desirable to summarize briefly those characteristics of quartz crystals that concern us here. The most prominent faces of a quartz crystal are the prismatic m faces and the inclined faces r (the primary positive first-order rhombohedron), and z (primary first-order negative rhombohedron) at the ends of the optic or z axis as shown⁴ in Fig. 1. Usually the z faces are less developed and also less smooth than the r faces. It is in terms of the r faces that the y axes are defined. If a given specimen fails to possess natural faces sufficient for sure identification of the axes, recourse must be had to tests by such means as etch figures or X rays for all axes, and polarized light for the z axis. By static piezoelectric tests nothing better than a rough approximation to the direction of the x axis can be obtained, unless very elaborate means are employed. The use of etch figures and polarized light has recently been discussed by Van Dyke.¹

The faces that betray the right and left handedness of quartz are the s and x faces shown in Fig. 1. On

⁴ In conformity with current practice we designate by z the faces called by Groth and others the r' faces. The symbols z and x for faces must not be confused with the z and x axes.

many crystals no trace of these faces can be found. Although such specimens do not exhibit the enantiomorphic property externally, still their structure is as truly enantiomorphic as if the s and x faces were present.

Following is Voigt's convention⁶ for the definitions of the z and y axes in both right and left quartz:

The z axis is the optic axis, parallel to the edges of the prism. Either end may be called positive; diagrams usually show the $+z$ direction pointing vertically upward in the plane of the paper.

There are three possible y axes, normal to the prismatic faces, the positive direction of each pointing outward from a prismatic face that intersects an r face at the $+z$ end of the crystal.⁶

Most writers, including Voigt, have employed a right-handed system of orthogonal axes for both right and left quartz. The serious disadvantage is that in passing from one type to the other the signs of all piezoelectric constants have to be changed, as well as certain signs in the equations for the transformation of axes. Fig. 1 agrees with the Voigt convention for right quartz, but for left quartz our x axis is opposed to his, as will be seen presently.

These annoyances and potential sources of error are completely avoided by the adoption of a *right-handed axial system for right quartz, left-handed for left quartz*. We shall refer to this proposed arrangement as the *Right-Left axial system*.

The advantages of such an arrangement were pointed out by Koga^{7,8} as early as 1929. His recommendation, however, involves the use of x and y axes both of which are opposed to those of Voigt for right quartz. Not only does this run counter to almost everything else in the literature, but it adds to the confusion by demanding changes in sign of some, but not all, of the elastic and piezoelectric constants.

Very recently a similar proposal has been made by Mason and Willard.⁹

Therefore, we propose as the definition of the positive end of an x axis that end at which a *positive charge* appears when the x_x strain is positive (see definitions of strains below); this is equivalent to stating that a *negative charge* appears at the positive

⁶ See page 750 of footnote reference 2.

⁷ It is of course understood that the axes of a crystal are *directions* in the crystal, and not particular lines. The existence of three y axes (and three corresponding x axes) is a consequence of the trigonal symmetry of quartz crystals; in equations and diagrams it is immaterial which of the three possible directions is selected for the y axis (and for the x axis perpendicular thereto), as long as the same axes are retained throughout the discussion. When it comes to cutting a plate from a given crystal, the selection of a particular axial system out of the three possible ones will depend on such considerations as economy of material and avoidance of flaws and twinned regions.

⁸ I. Koga, "Piezoelectricity and its applications," *Jour. I. E. E. (Japan)*, pp. 49-92; July, 1929.

⁹ I. Koga, "Comments on the National Physical Laboratory's notation for piezoelectric quartz," *Electroteck. Jour. (Japan)*, vol. 2, pp. 287-289; December, 1938.

⁹ W. P. Mason, and G. W. Willard, "Piezoelectric crystals," *Proc. I.R.E.*, vol. 28, p. 428, September, 1940.

end of an x axis upon *compression* along this axis. If the original crystal has identifiable x or s faces, the positive end of an x axis as thus defined can be determined at once, since it always emerges at a prismatic edge where the x and s faces are found. According to the present proposal these statements become valid for both right and left quartz.

The x axis defined in this manner is shown in Fig. 1.

system, in left quartz both the geometrical form and the system of reference axes are the mirror images of those for right quartz. Moreover, as has been stated, the same is true of all physical properties of the crystal.

MIRROR IMAGES

It may be helpful at this point to consider the nature of mirror images.

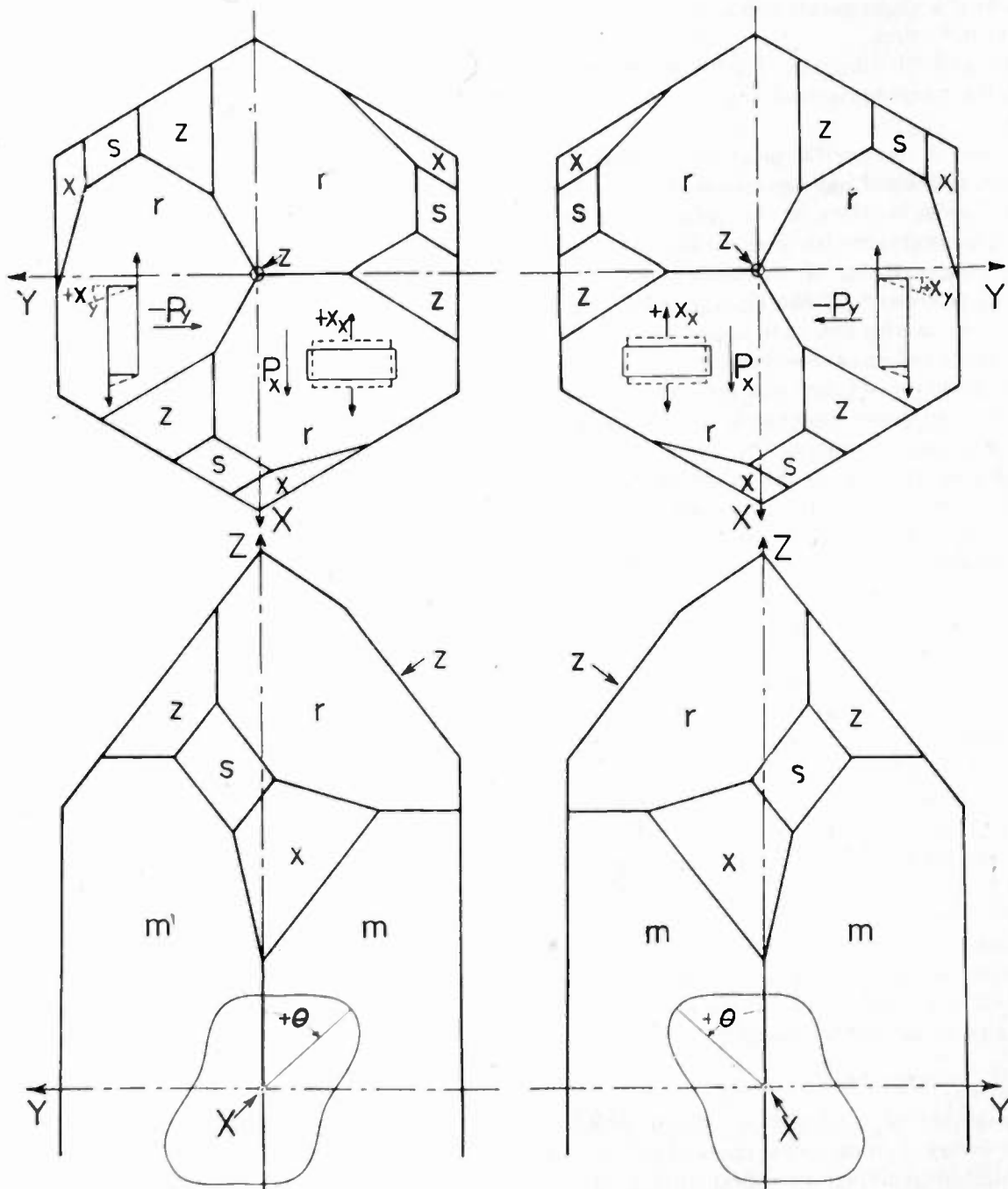

Fig. 2—Left and right quartz, showing strains $+x_x$ and $+x_y$, with accompanying polarizations P_x and P_y , also showing the positive sense of the angle of rotation θ .

Unless otherwise stated this definition of the x axis is employed throughout the remainder of the present paper. It is evident that the right- or left-handedness of the axial system is the same as that of the crystal itself. In other words, according to the Right-Left

When an image is formed of an object by reflection in a mirror, the orientation of the image with respect to the object, but not the form of the image, depends upon the position of the mirror. In representing right and left forms of crystals it is customary to place the

two diagrams side by side with the z axis vertical. For example, in Fig. 2 the right-hand portion is the reflection of the left with respect to a mirror whose normal is horizontal and in the plane of the paper. The advantage of this mode of reflection is that it leaves the z axis unchanged in the transition from right to left. It should be added that in Fig. 1, as in most textbooks, the line drawing of the left form, while entirely correct, does not strictly represent a mirror image of that of the right; it is as if a slight rotation has been given to the crystal after reflection.

The right and left diagrams might equally well be made with the z axis horizontal or indeed in any other orientation.

In any case, if the crystal diagram of which a reflected image is desired has incorporated in it a right-handed axial system, then in the *reflected figure* this axial system is necessarily *left handed*. The change from right to left handedness of the axes is therefore a logical accompaniment to the change from right to left handedness in the external appearance and the physical characteristics of the crystal.

If a photograph were taken of a right quartz crystal showing the right-handed xyz axial system together with all curves, polar diagrams, and models illustrating its physical properties, then the mirror image of this picture, obtained, for example, by making a photographic print with the negative turned over, would be an exact reproduction of a left quartz crystal together with its physical properties.

These considerations are made clear in Fig. 2, which shows an end view and also a cross section in the yz plane, for both right and left quartz. In the upper diagram the positive direction of the z axis, in the lower diagram the positive direction of the x axis, points toward the observer.

This figure shows also an x -cut plate being stretched so that there is an extensional strain x_x in the x direction with an accompanying contraction in the y direction. The arrow P_x indicates the positive direction of the ensuing electric polarization, in conformity with the statement above that a positive strain is associated with a positive charge at the positive end of the x axis. *Compressional and extensional strains and stresses do not change sign in the mirror image.*

STRESSES AND STRAINS

There is danger of confusion in elastic problems between the external stresses that cause elastic strains, and the internal reacting stresses called into play thereby, which, for a system in equilibrium, are equal and opposite to the former. Voigt calls *an extensile strain positive, and the internal reacting stress also positive*. This convention is analogous to the customary association of $+p$ with $+v$ in the laws of gases. It is thus that Voigt is led to regard a positive strain as due to a *negative externally applied stress*. Some well-known texts define a positive stress as that which, applied

from without, causes a positive strain. In conformity with most writers on piezoelectric subjects we shall follow Voigt, whose definitions may be stated thus:

A *longitudinal strain* (that is, a contraction or extension in the direction of the compressional or extensional stress producing it), of type x_x , y_y , or z_z , is positive when it is an extension, negative when a contraction.

A *longitudinal stress* (X_x , Y_y , Z_z) is positive when it tends to cause a negative strain, and vice versa.

The foregoing definitions are exemplified in such equations as $x_x = -s_{11}X_x$, where the compliance coefficient s_{11} is essentially positive.

A *shearing strain* (y_x , z_x , x_y) is positive when the acute angle formed by the deformation of a rectangle, whose sides are originally parallel to the two axes corresponding to the shear, lies in the quadrant between the *positive* directions of these axes. The usual definition of shearing strain, of form $x_y = \partial v / \partial x + \partial u / \partial y$ agrees with this geometrical interpretation of the sense of the strain.

A *shearing stress* (Y_x , Z_x , X_y) is positive when it tends to cause a negative shearing strain, and vice versa. The compliance coefficients for shears, occurring in equations of the type $x_y = -s_{66}X_y$, are essentially positive.

In the upper portion of Fig. 2 is indicated a section of a y -cut plate undergoing a positive shearing strain x_y , together with the associated electric polarization P_y . Tangential forces are indicated by arrows. From the equation $P_y = e_{26}x_y = -e_{11}x_y$ and the sign of e_{11} as given below, it is seen that P_y is negative. In accordance with our proposal, the piezoelectric shear x_y produced by a field E_y in the positive direction of the y axis has the same sign for left as for right quartz. A similar statement applies also to all other piezoelectric shears.

ELASTIC AND PIEZOELECTRIC CONSTANTS

According to Voigt's notation, all elastic coefficients have the same signs for left as for right quartz, but the signs of all piezoelectric constants change in passing from right to left. Attention has already been directed to the changes in sign that this demands in elastic and piezoelectric equations. When a left-handed axial system is adopted for left quartz, not only the elastic but also the piezoelectric coefficients retain the same sign for both forms, and all equations, together with all direction cosines, remain absolutely unaltered. Not until the time comes for laying off angles on an actual specimen is it necessary to pay any attention to the question of right or left handedness, and then all that must be remembered is to use left-handed axes for left quartz, in accordance with Figs. 1 and 2.

Voigt assigns negative numerical values to the constants d_{11} , e_{11} , and e_{14} for left quartz, and a positive

value to d_{14} . These signs are with respect to a right-handed axial system for left quartz. While other observers have obtained values differing in magnitude from Voigt's, there has been no disagreement as to sign. For right quartz the signs, according to Voigt, are reversed, namely, $\delta_{11}+$, $e_{11}+$, $e_{14}+$, $d_{14}-$. We advocate the adoption for the signs of the piezoelectric constants those that Voigt assigns to *right* quartz, although they are opposite to those commonly found in the literature, where in most cases the distinction between right and left quartz has not been properly taken into account. Voigt's statement that his observations were made on left quartz is so inconspicuous¹⁰ as to be easily overlooked, and those who later made determinations seem to have been more interested in numerical magnitudes than in signs. If our suggestion is adopted, along with the Right-Left axial system, these signs will hold for *left as well as for right quartz*.

ROTATED AXES

The last of our recommendations has to do with the signs of angles for rotated axes. Here it is desirable to adhere to Voigt's notation, modified for left quartz in such a way that the equations in the *Lehrbuch* for axial transformations can be used as they stand, for either right- or left-handed crystals. The proposed convention is as follows:

The angle of rotation is to be called positive when the sense of rotation is from $+x$ to $+y$, from $+y$ to $+z$, or from $+z$ to $+x$. The same rule applies to transformed axes, and on the Right-Left system it is valid for both right and left quartz. According to this rule, for *right* quartz the rotation of any pair of axes (including axes, usually designated by x' etc., that have resulted from a previous rotation), is positive when *counterclockwise* as seen from the positive end of the third axis. For *left* quartz the rotation is clockwise.

As an illustration of the rule for rotated axes there are shown in Fig. 2 polar diagrams of the distribution of Young's modulus in the yz plane. This quantity is the reciprocal of the compliance coefficient s'_{33} obtained by rotating the y and z axes through various angles θ about the x axis.¹¹ The maximum value is in the direction approximately perpendicular to a z face, and the corresponding angle θ , according to the Right-Left system, is approximately $+48$ degrees for both right and left quartz.

COMPARISON OF CONVENTIONS

In conclusion, we present a tabular summary of the

¹⁰ See page 861 of footnote reference 2.

¹¹ Polar diagrams of the compliance coefficient s'_{33} itself are shown in Fig. 2 of footnote reference 1, where, although it is not so stated, the axes shown are those of the Right-Left system.

conventions adopted by various writers on the properties of quartz crystals.^{2,12-18} Our own recommendations are included. Each author seems to have been self-consistent in the use of his own conventions.

TABLE I

Author	Convention for type of quartz		Direction of y axis		Axial system		Sign of θ for counterclockwise rotation		Location of + charge on stretch	
	l	r	l	r	l	r	l	r	l	r
Bechmann	l	r	+	+	R	R	(-)	-	-	+
Koga	l	r	-	-	R	R	-	-	+	-
Mason	l	l	(+)	(+)	(R)	(L)	-	+	-	-
Scheibe	l	r	+	+	R	R	-	-	-	+
Straubel	l	r	+	+	R	R	-	-	-	+
Voigt	l	r	+	+	R	R	+	+	-	+
Wright and Stuart	l	r	(-)	(+)	R	R	-	+	-	+
Present Recommendation	l	r	+	+	L	R	-	+	+	+

The letters l and r at the top of each column refer to the type of quartz, as defined in this paper. The first column indicates whether or not this definition was used by each writer. The second column shows the convention adopted for the positive direction of the y axis: a positive sign means agreement with Voigt's definition given above. In column 3 the letters r and l indicate whether a right- or left-handed axial system was used. The fourth column indicates the sign of the angle θ of rotation of the transformed z' axis from the z axis, for a counter-clockwise rotation in the yz plane about the x axis, as seen from the point of view of the positive side of the x axis as defined by the author quoted. The last column shows whether, with respect to the axial system adopted by the author quoted, the positive charge caused by a positive strain (stretch) parallel to an x axis would be found at the positive or negative end of this axis. Symbols are placed in parentheses when the only evidence for their correctness is inferred from equations or curves. It will be noted that the idea of a Right-Left system of axes appears implicitly in Mason's paper.

¹² R. Bechmann, "Temperature coefficients of vibrations of quartz plates and bars," *Hochfrequenz. und Elektroakustik*, vol. 44, pp. 145-160; November, 1934.

¹³ I. Koga, "Notes on piezoelectric quartz crystals," *PROC. I.R.E.*, vol. 24, pp. 510-531; March, 1936. (In this paper, Koga does not employ the convention that he advocates in his footnote reference 7.)

¹⁴ W. P. Mason, "Electrical wave filters employing quartz crystals as elements," *Bell. Sys. Tech. Jour.*, vol. 13, pp. 405-453; July, 1934.

¹⁵ W. P. Mason, "Low temperature coefficient quartz crystals," *Bell Sys. Tech. Jour.*, vol. 19, pp. 74-93; January, 1940. (The same conventions were used by F. R. Lack, G. W. Willard, and I. E. Fair, "Some improvements in quartz crystal circuit elements," *Bell Sys. Tech. Jour.*, vol. 13, pp. 453-463; July, 1934.)

¹⁶ A. Scheibe, "Piezoelektricität des Quarzes," Theodor Steinkopff, Dresden, Germany, 1938.

¹⁷ H. Straubel, "Vibration mode and temperature coefficient of quartz oscillators," *Hochfrequenz. und Elektroakustik*, vol. 38, pp. 14-27; July, 1931.

¹⁸ R. B. Wright and D. M. Stuart, "Some experimental studies of the vibrations of quartz plates," *Bur. Stand. Jour. Res.*, vol. 7, pp. 519-553; September, 1931. (The symbols in the table apply to these authors' data on Young's modulus. For their data on rigidity, the signs of θ in column 4 must be reversed.)

Operation of a Thyatron as a Rectifier*

L. A. WARE†, ASSOCIATE, I.R.E.

Summary—The half-wave thyatron rectifier circuit is treated theoretically taking into account the difference between the firing potential and the tube drop during conduction. Four loads are considered ranging from a pure resistance to a pure inductance, the impedance angles being 0, 59.15, 85.6, and 90 degrees. The first three of these are checked oscillographically and good correspondences are obtained between (1) calculated average current and measured current and (2) oscillographic waveshape of current and calculated waveshape. It is also noted that errors in the current calculation due to erroneous values of E_f (firing potential) are higher for loads of higher impedance angles.

AN INTERESTING digression on the general problem of rectifier analysis is the treatment of the thyatron where the firing potential differs from the tube drop during conduction. It is desirable first, to compare the calculated curve for instantaneous current with the oscillographic record; second, to find how well the calculated average current flow agrees with the measured value; and third, to calculate the effect of a change in firing potential on the average current flow. An FG-81 thyatron is considered here for four different loads, a pure resistance, two R - L circuits of different impedance angles, and a case for $R=0$. The last was calculated only.

In Fig. 1 is shown the elementary half-wave rectifier to which the following analysis may be applied.^{1,2} The circuit is made up of an R - L load and a thyatron

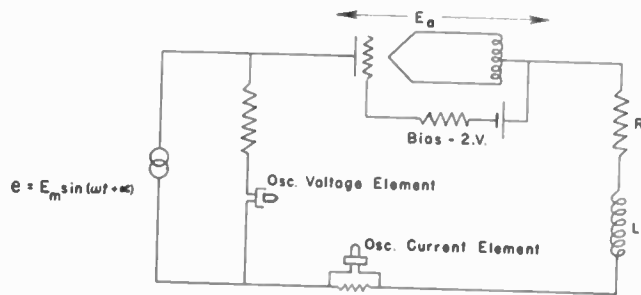

Fig. 1—Arrangement of circuit elements for obtaining oscillographic records.

which has a firing potential E_f and an assumed constant drop during conduction, E_a . Let $\alpha = \sin^{-1} E_f/E_m$ so that time may be counted from the instant of firing. The differential equation may be written

$$E_m \sin(\omega t + \alpha) - E_a = Ri + Ldi/dt. \quad (1)$$

The solution of this equation can be written as the sum of three components

- (1) the transient term $i_t = I_0 e^{-Rt/L}$
- (2) the constant term $i_c = -E_a/R$

* Decimal classification: R134X R337. Original manuscript received by the Institute, December 22, 1941.

† Department of Electrical Engineering, State University of Iowa, Iowa City, Iowa.

¹ C. M. Wallis, "Half-wave gas rectifier circuits," *Electronics*, vol. 11, pp. 12-14; October, 1938.

² C. M. Wallis, "Full-wave rectifier analysis," *Electronics*, vol. 13, pp. 19-22; March, 1940.

and (3) the alternating-current term

$$i_a = (E_m/Z) \sin(\omega t + \alpha - \theta)$$

where $Z = \sqrt{R^2 + X^2}$, and $\theta = \tan^{-1} X/R$.

$$i = i_t + i_c + i_a = (E_m/Z) \sin(\omega t + \alpha - \theta) - E_a/R + I_0 e^{-Rt/L}. \quad (2)$$

For the determination of I_0 the boundary condition, $i = 0$ when $t = 0$, may be used. Thus

$$0 = (E_m/Z) \sin(\alpha - \theta) - E_a/R + I_0$$

and $I_0 = E_a/R - (E_m/Z) \sin(\alpha - \theta)$ and (2) becomes

$$i = (E_m/Z) \sin(\omega t + \alpha - \theta) - E_a/R - [(E_m/Z) \sin(\alpha - \theta) - E_a/R] e^{-Rt/L}. \quad (3)$$

If this expression be integrated from $\omega t = 0$ to $\omega t = \phi$, the cutoff angle, and then divided by 2π , the average current is obtained. This equation is

$$I_{av} = (E_m/2\pi Z) \{ \cos(\alpha - \theta) - \cos(\phi + \alpha - \theta) - E_a \phi Z / E_m R + (X/R) [E_a Z / E_m R - \sin(\alpha - \theta)] (1 - e^{-R\phi/X}) \}. \quad (4)$$

The angle of cutoff ϕ is not always easily calculated. In Section I below it is the result of direct calculation. In Sections II, III, and IV it was determined by trial from (3).

The cases which we wish to consider follow.

1. PURE RESISTANCE LOAD

In this case L is set equal to zero and there immediately results

$$i = (E_m/R) [\sin(\omega t + \alpha) - E_a/E_m]. \quad (5)$$

At the time $t = 0$ this reduces to

$$i_0 = (E_m/R) (\sin \alpha - E_a/E_m).$$

However, $\alpha = \sin^{-1} E_f/E_m$ and i_0 reduces to $(E_f - E_a)/R$ which is of course to be expected at the firing point. Further, when E_f and E_a are equal we have $i_0 = 0$ at the beginning of the positive voltage loop and the case is of the usual high-vacuum tube or the large rectifier which has a relatively small firing potential.

The angle of cutoff may be found by setting the right-hand side of (5), or of (3), equal to zero. This gives

$$\sin(\phi + \alpha) = E_a/E_m$$

or ϕ , the angle of cutoff,

$$= \sin^{-1} E_a/E_m - \sin^{-1} E_f/E_m. \quad (6)$$

The equation for the average current flow becomes, in this case,

$$I_{av} = (E_m/2\pi R) [\cos \alpha - \cos(\phi + \alpha) - E_a \phi / E_m]. \quad (7)$$

In Fig. 2 is shown an oscillogram for a pure resistance load where the constants were as follows:

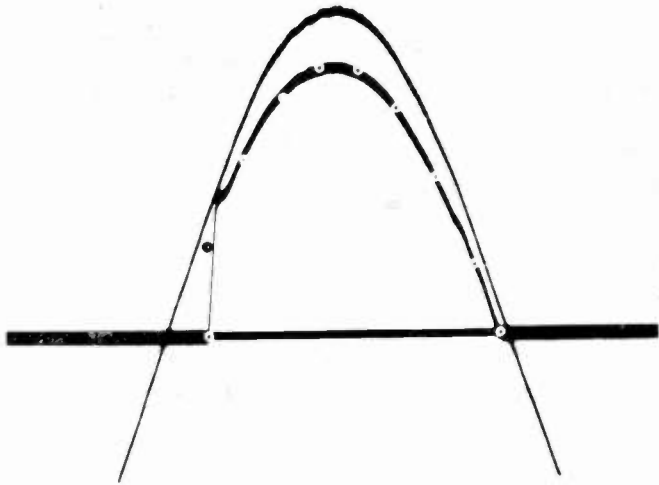

Fig. 2—Oscillogram for a pure resistance load. The small circles indicate the calculated points for the current wave. The upper curve is applied voltage.

$E_m = 164.9$ volts, $R = 137$ ohms, $E_a = 10.5$ volts, $E_f = 62.7$ volts, $\phi = 153.9$ degrees, $\alpha = 22.7$ degrees, $I_{av}(\text{measured}) = 0.321$ ampere.

E_a was determined by averaging the tube drop for several different values of current. E_f is the measured ordinate to the voltage curve at the firing point. The oscillogram shows the voltage and current waves over the conduction period and except for the portion of the current curve near to the firing point, may be considered as representing these variables sufficiently well. The calculated curve for current is represented by the points as shown. The calculated average current obtained by using the constants above was found to be 0.336 ampere, which represents a discrepancy of 4.7 per cent. It is of interest to determine the effect of a change in E_f , and for the various cases calculations will be made also for the arbitrarily chosen value of $E_f = E_a$. The calculated value of I_{av} from (7) using $E_f = E_a = 10.5$ volts gives 0.346 ampere which is within 3 per cent of the value obtained for the larger value of E_f . Table I gives I_{av} for the pure resistance case in terms of the firing potential and the firing angle.

TABLE I

α degrees	E_f volts	I_{av} ampere
3.65	10.5	0.346
10	28.6	0.345
20	56.4	0.338
30	82.5	0.327
40	106.0	0.310
50	126.3	0.288

II. R-L LOAD. $\theta = 59.15$ DEGREES

In the second case a load was used as represented by the following circuit constants. E_f was found in the same manner as above. $E_m = 164.9$ volts, $E_a = 10.5$ volts, $R = 79.5$ ohms, $X = 133.1$ ohms, $\theta = 59.15$ degrees, $\alpha = 22.4$ degrees, $E_f = 62.9$ volts, $\phi = 213.2$ degrees, $I_{av}(\text{measured}) = 0.426$ ampere.

The oscillogram of Fig. 3 shows the variation of cur-

rent and voltage over the interesting range and it is noted that the cutoff angle as calculated checks reason-

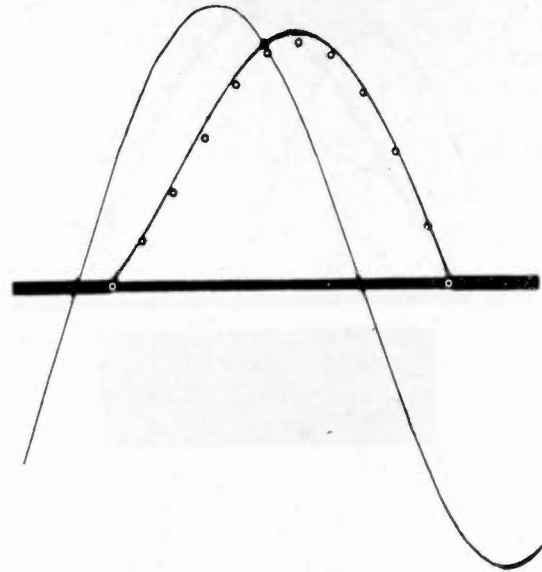

Fig. 3—Oscillogram for impedance angle of 59.15 degrees. The small circles indicate calculated points for the current wave.

ably well with the oscillographic record. However there is more discrepancy between the two curves at the peak than was the case in Section I.

The average current calculated for this case was 0.408 ampere which, compared with the measured value of 0.426, represents a discrepancy of 4.2 per cent. If E_f were equal to the tube drop of 10.5 volts, the calculated average current would be 0.423 ampere. This represents an increase of 3.7 per cent over the value for $E_f = 62.9$ volts.

It should be noted here that the conduction period is well over 180 degrees.

III. R-L LOAD. $\theta = 85.6$ DEGREES

In the case of a very small resistance component the period of conduction is still further increased as shown in Fig. 4. Here the circuit constants are: $E_m = 165$ volts, $R = 14$ ohms, $X = 182.4$ ohms, $E_a = 10.5$ volts, $E_f = 63$ volts, $\alpha = 22.7$ degrees, $\theta = 85.6$ degrees, $\phi = 264$ degrees, $I_{av} = 0.591$ ampere.

The lower set of points on this oscillogram represents the calculated current on the basis of the above constants. The agreement is seen to be somewhat good as far as the area is concerned. However the calculated angle of cutoff does not check especially well with the oscillogram. At this point it is well to mention that no account has been made of the periods of ionization and deionization of the tube. The ionization time is so short that it would not show up on the oscillogram in any case. The part of the curve belonging to the period of deionization is very small and can be neglected. The average value of current calculated for this low resistance case is 0.606 ampere, a value 2.5 per cent higher than the measured value.

Another set of points as marked represents current plotted with the above constants except that E_f is

made equal to E_a . Firing takes place earlier and cutoff later. In this case the cutoff angle is approximately

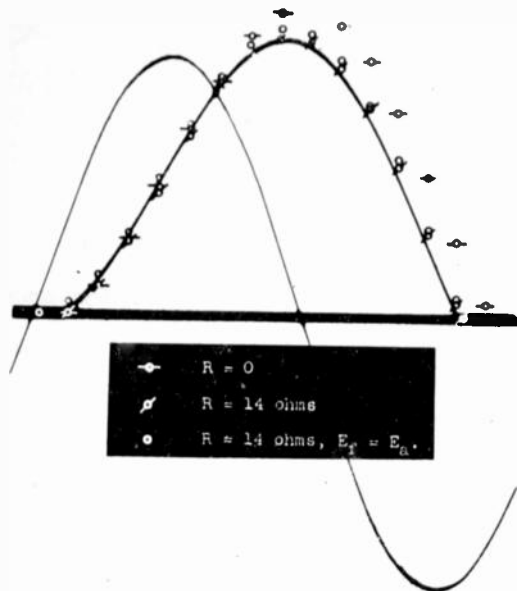

Fig. 4—Oscilloscope for impedance angle of 85.6 degrees. The curves for $R=0$, $R=14$ ohms, and $R=14$ ohms with $E_f = E_a$ are plotted. The effect of the change of 14 ohms is clearly shown.

286 degrees and the calculated average current is 0.635 ampere representing an increase of 4.8 per cent over the value for the case where $E_f = 63$ volts.

IV. $R=0$. $\theta = 90$ DEGREES

It is interesting to consider the case for $R=0$. Here we have

$$i = (E_m/X) [\cos \alpha - \cos (\omega t + \alpha) - E_a \omega t / E_m]. \quad (8)$$

The equation for average current corresponding to this case is

$$I_{av} = (E_m/2\pi X) [\phi \cos \alpha - \sin (\phi + \alpha) + \sin \alpha - E_a \phi^2 / 2E_m]. \quad (9)$$

This was calculated for the data of Section III above, assuming that $R=0$, $X=Z$, and an average value of

current of 0.71 ampere was obtained, a value 20 per cent higher than for $R=14$ ohms. Due to the fact that this represented a rather unexpected increase due to a relatively small change in R the curve for $R=0$ was plotted on the oscillogram in Fig. 4 in order to see where the greatest difference occurred. It is seen that the part after the peak is moved to the right and of course the cutoff angle is greatly increased. It is impossible to check this curve oscillographically as some resistance must be present in the coil and circuit. In this case when E_f is set equal to E_a the average current is calculated to be 0.754 ampere.

In the above it is to be noted that the firing potential has been obtained from the oscillogram itself. The sources of error in the above calculations are as follows: (1) The assumption that E_a is a constant. (2) The neglect of the deionization time. (3) The assumption that the voltage wave is a sine wave. Number (1) is perhaps the most important.

Table II, in which the above calculations are summarized, presents the results of this brief investigation.

TABLE II

θ	E_f	I_{av} (meter)	I_{av} (calculated)	Per cent increase over measured value	Per cent increase over actual E_f
degrees	volts	ampere	ampere		
0	62.7	0.321	0.336	4.7	3.0
0	10.5		0.346		
59.15	62.9	0.426	0.408	-4.2	
59.15	10.5		0.423		3.7
85.6	63.0	0.591	0.606	2.5	
85.6	10.5		0.635		4.8
90	63.0		0.710		
90	10.5		0.754		6.2

It is seen that, in the three cases checked oscillographically, the calculated value of current was within 5 per cent of the measured value, and the variations are about the amounts to be expected upon a comparison of the oscillographic record with the calculated curves for current. It is also interesting to note that the effect of using the lower value of E_f is progressively greater for greater ratios of X to R .

The Q Meter and Its Theory*

V. V. L. RAO†, ASSOCIATE, I.R.E.

Summary—The ratio of the reactance to resistance of a coil or condenser may be expressed as its Q . Direct-reading instruments for this measurement are commercially available. The theory of their operation is given and includes corrections to increase the accuracy of the results of the measurements.

I. INTRODUCTION

IN communication engineering, Q the ratio of effective reactance to resistance at any frequency has great significance as a figure of merit of a coil or a condenser.

* Decimal classification: R202. Original manuscript received by the Institute March 6, 1942.

† Government of Madras Kilpauk Post Office, Madras, South India.

$$Q \text{ for a coil, denoted by } Q_L, = \frac{\omega L_{eff}}{R_{eff}}$$

$$\text{and } Q \text{ for a condenser, denoted by } Q_C, = \frac{1}{\omega C_{eff} R_{eff}}, \text{ where}$$

L_{eff} , C_{eff} , R_{eff} are the effective values at the specified frequency f ($\omega = 2\pi f$).

In order to evaluate the Q of a coil at different high frequencies, one has to measure carefully both L_{eff} and R_{eff} at each frequency and calculate the corresponding values of Q . To obviate this laborious process, a few British and American firms have recently marketed

a very ingenious and versatile meter called the circuit-magnification or *Q* meter, on which values of *Q* between 10 and 500 can be read directly for frequencies between 50 kilocycles and 50 or even 75 megacycles. The accuracy of measurement of the *Q* value in the Marconi-Ekco *Q* meter, Type TF 329D, is ± 5 per cent ± 5 up to 10 megacycles. Its frequency range is from 50 kilocycles to 50 megacycles. The versatility of the meter will be seen from the following list of measurements that can be made with such a meter;

- 1) *Q* of coils and condensers
- 2) Self-capacitance of coils
- 3) Inductance of coils
- 4) Capacitance of condensers
- 5) Power factor of condensers
- 6) Dielectrics and high resistances
- 7) Low impedances
- 8) Transmission-line constants
 - a) Characteristic impedance
 - b) Attenuation constant
 - c) Wave velocity

II. THEORY

A simple theory of this meter is worked out below. Fig. 1 shows the simplified circuit of a *Q* meter and Fig. 2, its equivalent circuit. *S* is an oscillator covering

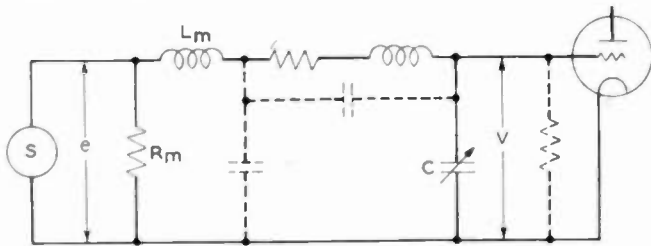

Fig. 1—Simplified circuit of a *Q* meter.

the desired frequency range and injecting a constant voltage *e* into the tuned circuit by means of the resistance *R_m* (0.04 ohm in the Marconi-Ekco meter). *V* is a valve voltmeter, measuring the voltage across the condenser for convenience. Actually, at resonance, the voltage across the coil and that across the condenser are equal in magnitude. *R_a* and *L_a* represent

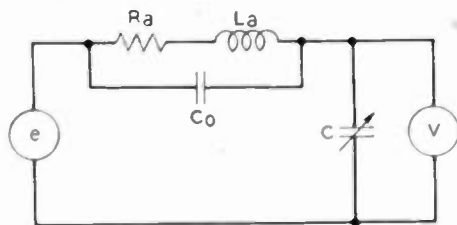

Fig. 2—Equivalent circuit of a *Q* meter.

the apparent values of resistance and inductance, and *C₀*, the self-capacitance of the coil, at the frequency in question. *R_a* and *L_a* are lumped so as to include *R_m*, the internal resistance, and *L_m*, the internal inductance of the source—the meter.

The apparent *Q* of the coil is given approximately by the ratio *V/e*, when the coil is tuned to resonance by

the variable condenser *C*. When *e* is a known and fixed value (say, 20 millivolts), the valve voltmeter *V*, can be calibrated to read *Q* directly as shown below.

Let *i* be the current in the series circuit. Then

$$i = \frac{e}{R_a + j\omega L_a + \frac{1}{j\omega C}}$$

If

$$Z_a = R_a + j\omega L_a, \quad i = \frac{e}{Z_a + \frac{1}{j\omega C_0}} \text{ or } \frac{j\omega C_0 e}{1 + jZ_a \omega C_0} \quad (1)$$

and

$$V = i \times \frac{1}{j\omega C_0} \quad (2)$$

On substituting in (2) the value of *i* obtained in (1) we get

$$V = \frac{e}{1 + jZ_a \omega C_0} \quad (3)$$

But, by definition, magnification = *V/e*

Therefore,

$$\begin{aligned} \frac{V}{e} &= \frac{1}{1 + jZ_a \omega C_0} = \frac{1}{1 + j\omega C_0(R_a + j\omega L_a)} \\ &= \frac{1}{(1 - \omega^2 L_a C_0) + j\omega R_a C_0} \quad (4) \end{aligned}$$

At resonance, *V* is a maximum and, *e* being constant, *V/e* too is a maximum then.

But

$$\left(\frac{V}{e}\right)^2 = \frac{1}{(1 - \omega^2 L_a C_0)^2 + (\omega R_a C_0)^2} \quad (5)$$

Let

$$D \equiv (1 - \omega^2 L_a C_0)^2 + (\omega R_a C_0)^2 \quad (6)$$

Then (*V/e*)² is a maximum when *D* should be a minimum. The condition for *D* to be a minimum is, *d(D)/dC₀* = 0. On differentiating (6), and equating to zero, we get

$$2(1 - \omega^2 L_a C_0)(-\omega^2 L_a) + 2\omega^2 C_0 R_a^2 = 0 \quad (7)$$

This expression, on simplification gives

$$C_0 = \frac{L_a}{R_a^2} \quad (8)$$

Substituting this value of *C₀* in (5) and simplifying the results,

$$\left(\frac{V}{e}\right)^2 = \left(\frac{Z_a}{R_a}\right)^2 \text{ or } \frac{V}{e} = \frac{Z_a}{R_a}, \text{ i.e., } \frac{V}{e} = \frac{R_a + j\omega L_a}{R_a} \quad (9)$$

i.e.,

$$\frac{V}{e} = 1 + j \frac{\omega L_a}{R_a} \quad (10)$$

Thus the valve-voltmeter deflection is proportional to $\sqrt{1+Q^2}=Q$. Hence the meter dial can be calibrated to give $\omega L_a/R_a$, which is the apparent Q of the coil.

III. CORRECTIONS

As stated already, the indication of the meter is not the true Q , but the apparent Q .

Foster and Newlon¹ state that, for the meter they used, corrections for the following conditions were required for measurements above 9 megacycles:

- 1) Loading by the valve voltmeter
- 2) Internal impedance of the meter
- 3) Self-capacitance of the coil.

These corrections will be discussed.

1. Loading does not arise at all in the Marconi-Ekco meter, since the makers state that a special triode valve (*Ac/HIL/DD*) having a very high input resistance was used.

2. The internal impedance of the meter consists of two factors, R_m the internal resistance, and L_m the internal inductance of the meter.

Q_t , the true Q of the coil, is given by

$$\frac{\omega L_t}{R_t} \quad (11)$$

and Q_a , the apparent Q of the coil, by

$$\frac{\omega L_a}{R_a} \quad (12)$$

But,

$$L = L_a - L_m, \quad (13)$$

and

$$R_t = R_a - R_m. \quad (14)$$

Therefore,

$$\frac{Q_t}{Q_a} = \frac{\omega L_t}{R_t} \times \frac{R_a}{\omega L_a} = \frac{L_t}{L_a} \times \frac{R_a}{R_t}$$

or

$$Q_t = Q_a \frac{(L_a - L_m)}{L_a} \times \frac{R_a}{(R_a - R_m)} \quad (15)$$

Evaluation of L_a and L_t is reached as follows: L_a is obtained from the meter readings. Since

$$f = \frac{1}{2\pi\sqrt{L_a(C + C_0)}}, \quad (16)$$

at resonance,

$$L_a = \frac{1}{4\pi^2 f^2 (C + C_0)}, \quad (17)$$

where f is the frequency of the oscillator as read on the frequency calibration scale, C is the condenser reading on the meter, and C_0 , the self-capacitance,

¹ Dudley E. Foster and Arthur E. Newlon, "Measurement of iron cores at radio frequencies," *PROC. I.R.E.*, vol. 29, pp. 269, 274-275; May, 1941.

which can be evaluated either by the negative-intercept method (from the graph of $(1/f^2)$ versus C or otherwise.

If f is in megacycles and C and C_0 are in micro-microfarads, L_a in microhenrys is obtained by

$$\frac{25,330}{f^2(C + C_0)} \quad (18)$$

and the true inductance

$$L \text{ (in microhenrys)} = \frac{25,330}{f^2(C + C_0)} - L_m. \quad (19)$$

$L_m = 0.05$ microhenry in the Marconi-Ekco meter which the author used, and may even be neglected when L_a is comparatively large as that Q meter can measure the inductance of coils in the range 5 microhenrys to 25 millihenrys, approximately, with an accuracy of ± 3 per cent.

Thus, if L_m is neglected, then (15) reduces to

$$Q_t = Q_a \frac{R_a}{R_a - R_m}. \quad (20)$$

The need for the correction factor $R_a/(R_a - R_m)$ will depend solely on the relative values of R_a and R_m . If $R_m = 0.04$ ohm and R_a is of the order of even a few ohms, then $R_a/(R_a - R_m) \doteq 1$, and this correction also can be ignored without appreciable error.

3. The correction for the self-capacitance of the coil is by far the most important correction, which should be applied below 15 megacycles.

An expression for this correction is derived as follows. If f_0 is the natural frequency of the coil and f is the frequency at which Q is measured, then

$$f_0 \doteq \frac{1}{2\pi\sqrt{LC_0}} \quad \text{and} \quad f \doteq \frac{1}{2\pi\sqrt{LC}} \quad (21)$$

Let k^2 denote the ratio

$$\frac{\omega^2}{\omega_0^2} = \left(\frac{f}{f_0}\right)^2 = \frac{C_0}{C}$$

Further,

$$\frac{1}{\omega_0^2} \doteq LC_0, \quad (22)$$

Therefore,

$$\frac{\omega^2}{\omega_0^2} \doteq \omega^2 LC_0 \doteq k^2$$

It is well known that the effective inductance L_n and resistance R_a of a coil at a frequency $\omega = 2\pi f$, are approximately given by the following expressions,² where L and R are the physical or absolute values of inductance and resistance of the coil, respectively. These apparent values at a frequency f are a consequence of

² "Radio Instruments and Measurements" Bureau of Standards Circular C74, 1937, p. 133.

the self-capacitance C_0 of the coil. Fig. 3 shows the equivalent circuit at high frequencies of a coil having

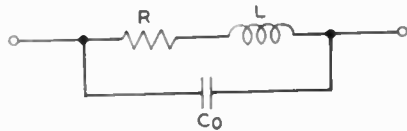

Fig. 3—Equivalent circuit of a coil at high frequencies. resistance and distributed or self-capacitance.

$$L_a = \frac{L}{1 - \omega^2 LC_0} \quad (23)$$

and

$$R_a = \frac{R}{(1 - \omega^2 LC_0)^2} \quad (24)$$

Substituting these values of L_a and R_a in (12) we get

$$Q_a = \frac{\omega L(1 - k^2)^2}{R(1 - k^2)} = \left(\frac{\omega L}{R}\right)(1 - k^2),$$

i.e.,

$$Q_a = Q(1 - k^2) \quad \left(\text{since } Q = \frac{\omega L}{R}\right).$$

Therefore,

$$\text{actual } Q = \frac{Q_a}{1 - k^2} \quad (25)$$

But $k^2 = C_0/C$ as is proved in (22). Therefore,

$$Q = \frac{Q_a}{1 - \frac{C_0}{C}} = Q_a \left(\frac{C}{C - C_0}\right) \text{ or } Q_a \left(1 - \frac{C_0}{C}\right)^{-1} \quad (26)$$

Expanding $(1 - C_0/C)^{-1}$ and neglecting the terms beyond the second we get

$$Q = Q_a \left(1 + \frac{C_0}{C}\right), \quad (27)$$

which is the only important correction below 15 megacycles.

IV. ORDER OF APPLYING CORRECTIONS

After having ruled out the necessity for correction as a result of the valve-voltmeter loading, if more than one correction is required, they should be made in the following order.

- 1) Internal impedance of the meter
- 2) Self-capacitance of the coil.

At each stage the partially corrected values of Q and L should be used for the apparent value of $Q(Q_a)$ and $L(L_a)$ in the succeeding correction.

Some Aspects of Coupled and Resonant Circuits*

JESSE B. SHERMAN†, ASSOCIATE, I.R.E.

Summary—An analysis is presented of the coupled impedance and its components in the two-mesh, inductively coupled circuit with a tuned secondary. A similar analysis is made of the impedance and its components in the parallel-resonant circuit having dissipation in the inductive branch.

I. INTRODUCTION

IT IS well known that in the neighborhood of resonance the effect of the secondary circuit of Fig. 1 is similar to that of a parallel-resonant circuit in series with the primary. It is the purpose of this paper to examine the nature both of the coupled impedance in such a circuit and of the parallel-circuit impedance (Fig. 2). By expressing all of the quantities involved as general functions of a frequency ratio, the results can be presented graphically with relatively little labor of computation.

It is assumed that the circuits have constant resistance rather than constant Q .

II. COUPLED IMPEDANCE

The mesh equations for the circuit of Fig. 1 (a) are

$$I_1 Z_1 + j\omega M I_2 = E_1 \quad (1)$$

$$I_2 Z_2 + j\omega M I_1 = 0. \quad (2)$$

* Decimal classification: R142. Original manuscript received by the Institute, April 13, 1942.

† Electrical Engineering Department, The Cooper Union, New York, N. Y.

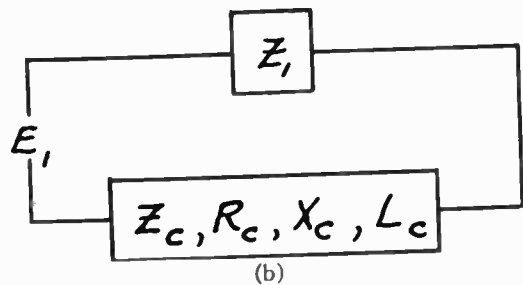
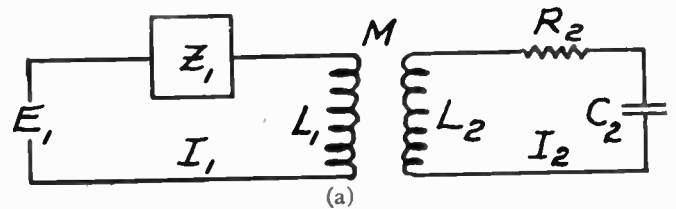

Fig. 1—Inductively coupled circuit with tuned secondary.

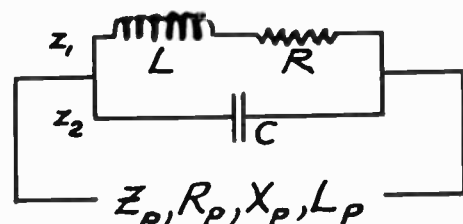

Fig. 2—Parallel circuit.

Solution for I_1 yields

$$I_1 = \frac{E_1}{Z_1 + (\omega M)^2/Z_2} \quad (3)$$

The second term of the denominator represents the coupled impedance. This is

$$Z_c = \frac{\omega^2 M^2}{R_2 + j(\omega L_2 - 1/\omega C_2)} \quad (4)$$

or

$$|Z_c|^2 = \frac{\omega^6 C_2^2 M^4}{\omega^2 C_2^2 R_2^2 + (\omega^2 L_2 C_2 - 1)^2} \quad (5)$$

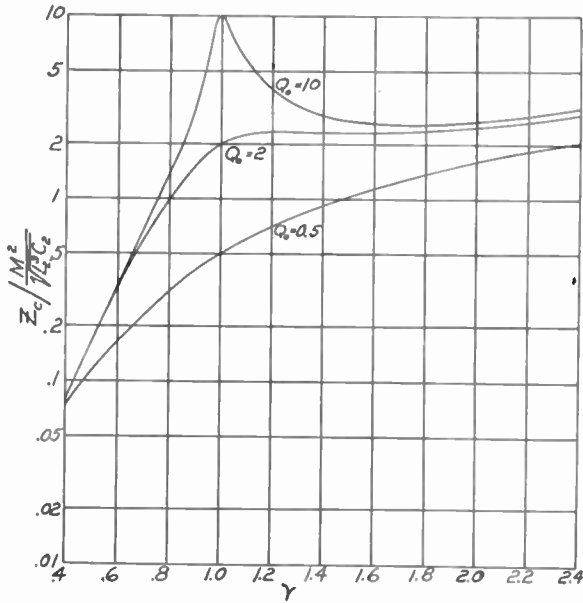

Fig. 3—Coupled impedance.

Making the substitution $\gamma = \omega/\omega_0$, and noting that $\omega_0^2 L_2 C_2$ and its powers are equal to unity, (5) can be written

$$|Z_c|^2 = \frac{M^4}{L_2^2 C_2} \frac{\gamma^6}{\gamma^4 + \alpha \gamma^2 + 1} \quad (6)$$

where $\alpha = 1/Q_0^2 - 2$. Maximizing (6) with respect to γ yields

$$\gamma^4 + 2\alpha\gamma^2 + 3 = 0 \quad (7)$$

whence

$$\gamma = \pm \sqrt{2 - \frac{1}{Q_0^2} \pm \sqrt{1 - \frac{4}{Q_0^2} + \frac{1}{Q_0^4}}} \quad (8)$$

Inspection of (8) indicates that when Q_0 is large there will be two real positive values of γ :

$$\gamma_1 = 1 \quad (9a)$$

and

$$\gamma_2 = \sqrt{3}. \quad (9b)$$

Whether these are maxima or minima remains to be seen. It also appears that there will be a single positive value of γ when

$$1 - \frac{4}{Q_0^2} + \frac{1}{Q_0^4} = 0. \quad (10)$$

Solution for this boundary value of Q yields as the only usable root

$$Q_0 = \sqrt{2 + \sqrt{3}} \quad (11)$$

and substitution of (11) in (8) gives

$$\gamma_3 = \sqrt[3]{3} \quad (12)$$

If we now plot $Z_c \sqrt{L_2^3 C_2}/M^2$ from (6) as a function of γ for several values of Q_0 we obtain the curves of Fig. 3. Examination of Fig. 3 and the above relations shows that the coupled impedance for large Q_0 has a

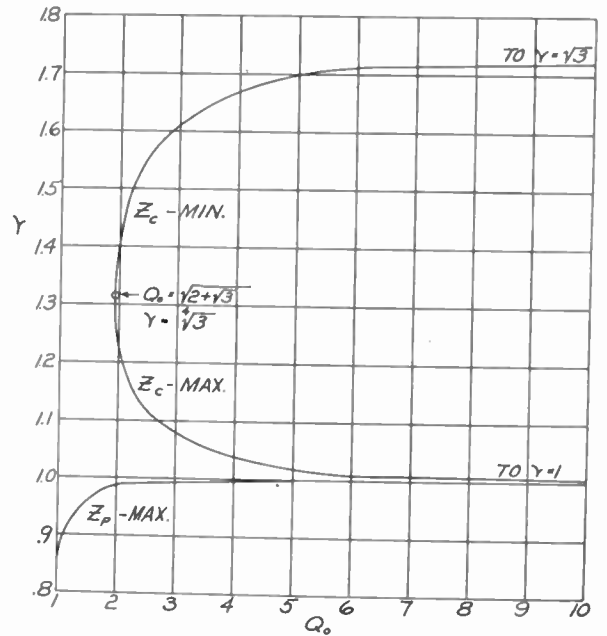

Fig. 4—Loci of impedance maxima.

maximum at $\gamma_1 = 1$ and a minimum at $\gamma_2 = \sqrt{3}$. As Q_0 is reduced these points converge to an inflection at γ_3 , the geometric mean of γ_1 and γ_2 , for which $Q_0 = \sqrt{2 + \sqrt{3}}$. For smaller values of Q_0 the function rises continuously. The loci of the maximum and minimum are plotted from (8), in Fig. 4.

III. COUPLED RESISTANCE

Expansion of (4) yields

$$Z_c = \frac{(\omega M)^2}{Z_2^2} R_2 - j \frac{(\omega M)^2}{Z_2^2} X_2. \quad (13)$$

The resistance component of (13) is

$$R_c = \frac{\omega^2 M^2 R_2}{R_2^2 + (\omega L_2 - 1/\omega C_2)^2} \quad (14)$$

which can be written as

$$R_c = \frac{M^2 R_2}{L_2^2} \frac{\gamma^4}{\gamma^4 + \alpha \gamma^2 + 1} \quad (15)$$

Maximizing (15) with respect to γ gives

$$\gamma^2 + 2/\alpha = 0 \tag{16}$$

whence

$$\gamma = \frac{1}{\sqrt{1 - 1/2Q_0^2}} \tag{17}$$

That is, the coupled resistance displays a maximum if $Q_0 > 1/\sqrt{2}$.

which can be recast as

$$X_c = \frac{\omega_0 M^2}{L_2} \frac{\gamma^3 - \gamma^5}{\gamma^4 + \alpha\gamma^2 + 1} \tag{19}$$

The coupled reactance is plotted in Fig. 7 for several values of Q_0 . As evident from (19), the coupled reactance is always zero at $\gamma=1$, regardless of Q_0 .

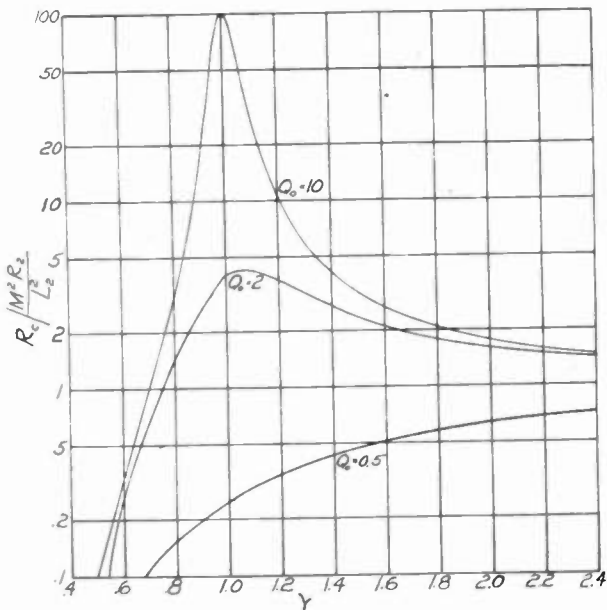

Fig. 5—Coupled resistance.

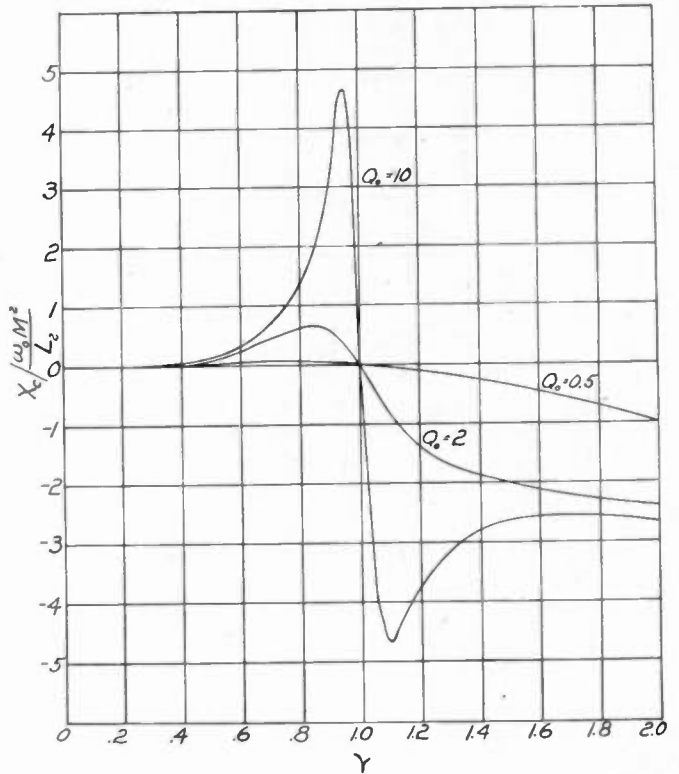

Fig. 7—Coupled reactance.

$R_c \times L_2 / M^2 R_2$ from (15) is plotted for several values of Q_0 in Fig. 5. The locus of the maximum is plotted as a function of Q_0 from (17), as the upper curve of Fig. 6.

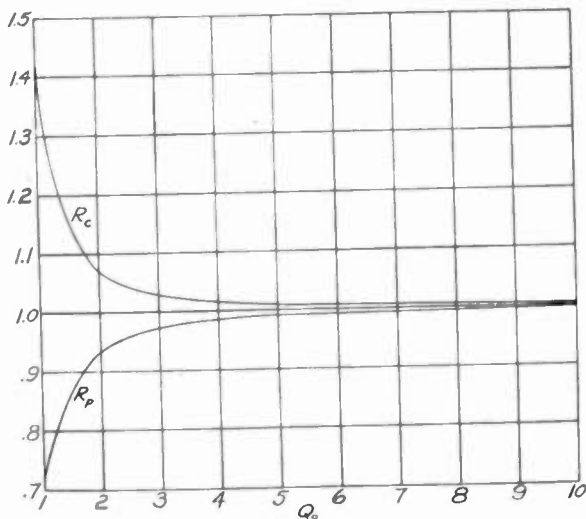

Fig. 6—Loci of resistance maxima.

IV. COUPLED REACTANCE

The reactance component of (13) is

$$X_c = \frac{\omega^3 M^2 C_2 - \omega^5 M^2 C_2^2 L_2}{\omega^2 C_2^2 R_2^2 + (\omega^2 L_2 C_2 - 1)^2} \tag{18}$$

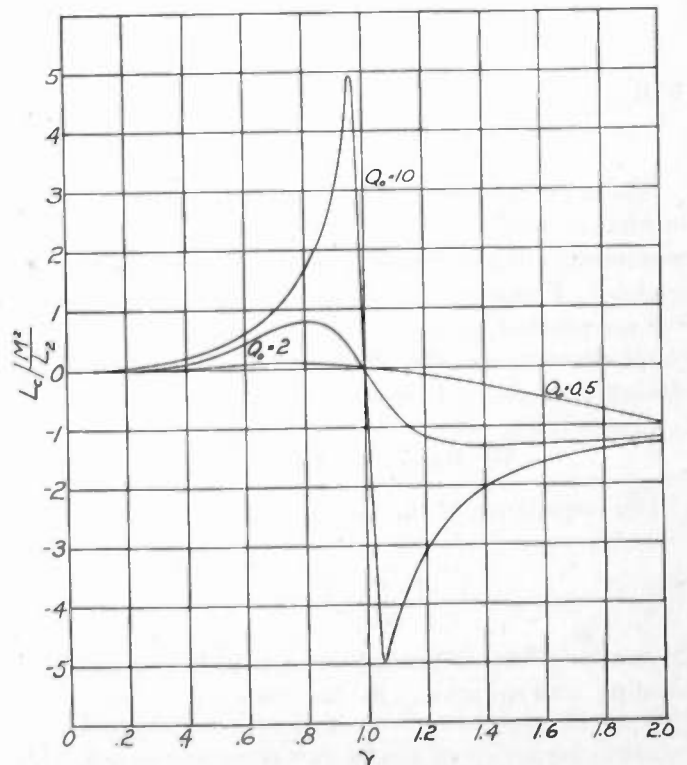

Fig. 8—Effective coupled inductance.

V. EFFECTIVE COUPLED INDUCTANCE

Equation (19) represents an effective inductance X_c/ω . Hence the effective coupled inductance is

$$L_c = \frac{M^2}{L_2} \frac{\gamma^2 - \gamma^4}{\gamma^4 + \alpha\gamma^2 + 1} \tag{20}$$

Maximizing with respect to γ gives

$$(\alpha + 1)\gamma^4 + 2\gamma^2 - 1 = 0 \tag{21}$$

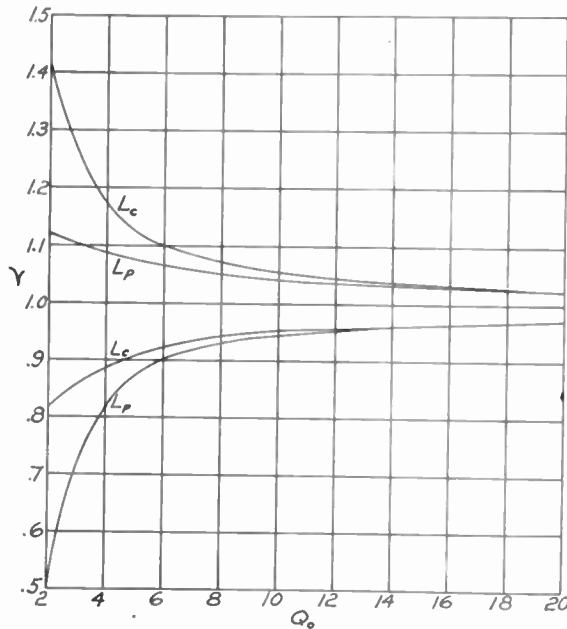

Fig. 9—Loci of effective inductance maxima.

whence

$$\gamma_1 = \sqrt{\frac{Q_0}{Q_0 + 1}} \tag{22a}$$

and

$$\gamma_2 = \sqrt{\frac{Q_0}{Q_0 - 1}} \tag{22b}$$

These expressions are the loci of the maximum and minimum respectively of (20), and indicate that a maximum will always occur, and a minimum will occur if $Q_0 > 1$. Equation (20) is plotted in Fig. 8, and the loci are plotted as the L_c curves of Fig. 9. As with the coupled reactance, the effective coupled inductance is always zero at $\gamma = 1$, regardless of Q_0 .

VI. PARALLEL IMPEDANCE

The impedance of the circuit of Fig. 2 is

$$Z_p = \frac{z_1 z_2}{z_1 + z_2} \tag{23}$$

On making the indicated branch substitutions, expanding, and squaring, (23) becomes

$$|Z_p|^2 = \frac{R^2 + \omega^2 L^2}{\omega^2 C^2 R^2 + (\omega^2 LC - 1)^2} \tag{24}$$

This can be written

$$|Z_p|^2 = R^2 \frac{1 + Q_0^2 \gamma^2}{\gamma^4 + \alpha\gamma^2 + 1} \tag{25}$$

Maximizing with respect to γ and solving yields

$$\gamma = \sqrt{\sqrt{1 + 2/Q_0^2} - 1/Q_0^2} \tag{26}$$

The boundary condition for (26) is

$$\sqrt{1 + 2/Q_0^2} = 1/Q_0^2 \tag{27}$$

whence

$$Q_0 = \sqrt{\sqrt{2} - 1} \tag{28}$$

That is, Z_p^2 (and hence Z_p) will display a maximum if $Q_0 > \sqrt{\sqrt{2} - 1}$. Z_p/R is plotted from (25) in Fig. 10 for several values of Q_0 . When Q_0 is less than the value given by (28), the impedance characteristic degenerates to that of a capacitance and resistance in parallel. Fig. 10 should be compared with Fig. 3. When Q_0 is large the coupled impedance and parallel impedance show similarity in the vicinity of $\gamma = 1$.

The locus of the maximum parallel impedance is plotted from (26) as a function of Q_0 , in Fig. 4.

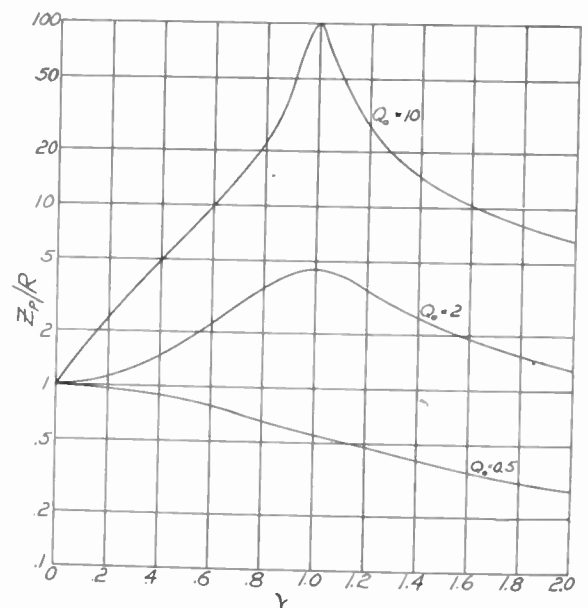

Fig. 10—Parallel-circuit impedance.

VII. PARALLEL-CIRCUIT RESISTANCE

The impedance expression (23) yields on expansion

$$Z_p = \frac{R/\omega^2 C^2}{R^2 + (\omega L - 1/\omega C)^2} + j \frac{L/\omega C^2 - \omega L^2/C - R^2/\omega C}{R^2 + (\omega L - 1/\omega C)^2} \tag{29}$$

The resistance component of (29) can be written as

$$R_p = R \frac{1}{\gamma^4 + \alpha\gamma^2 + 1} \tag{30}$$

Maximizing with respect to γ gives

$$\gamma^2 + \alpha/2 = 0 \tag{31}$$

whence

$$\gamma = \sqrt{1 - 1/2Q_0^2} \tag{32}$$

which is the reciprocal of the expression for the locus of the maximum coupled resistance, and also displays a maximum for $Q_0 > 1/\sqrt{2}$. R_p/R from (30) is plotted in Fig. 11, and the locus is plotted from (32) as the lower curve of Fig. 6.

VIII. PARALLEL-CIRCUIT REACTANCE

The reactance component of (29) is

$$X_p = \frac{\omega L - \omega^3 L^2 C - R^2 \omega C}{\omega^2 C^2 R^2 + (\omega^2 LC - 1)^2} \tag{33}$$

This can be recast as

$$X_p = \omega_0 L \frac{\delta\gamma - \gamma^3}{\gamma^4 + \alpha\gamma^2 + 1} \tag{34}$$

where $\delta = 1 - 1/Q_0^2$. Equation (34) is plotted in Fig. 12. The reactance has a fixed value of $-\omega_0 L$ at $\gamma = 1$, regardless of Q_0 (provided Q_0 is finite); and is equal to

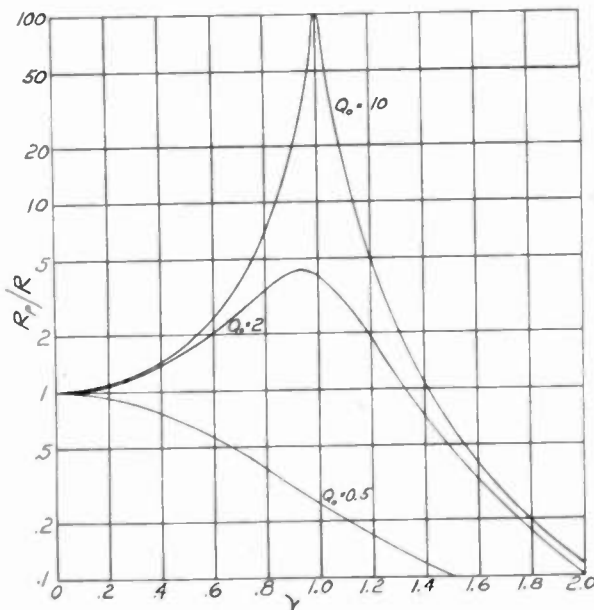

Fig. 11—Parallel-circuit resistance.

zero at some point below $\gamma = 1$, dependent on Q_0 . This resonant point (i.e., unity power factor), is found by setting the numerator of (34) equal to zero:

$$\delta\gamma - \gamma^3 = 0 \tag{35}$$

whence

$$\gamma = \sqrt{1 - 1/Q_0^2} \tag{36}$$

(It can be shown that when the resistance occurs only in the capacitive branch of the parallel circuit, the reactance has a fixed value of $+\omega_0 L$ at $\gamma = 1$; and when equal resistance is present in both branches, the reactance is zero at $\gamma = 1$.)

IX. EFFECTIVE INDUCTANCE OF THE PARALLEL CIRCUIT

Equation (34) represents an effective inductance X_p/ω . Thus the effective inductance is

$$L_p = L \frac{\delta - \gamma^2}{\gamma^4 + \alpha\gamma^2 + 1} \tag{37}$$

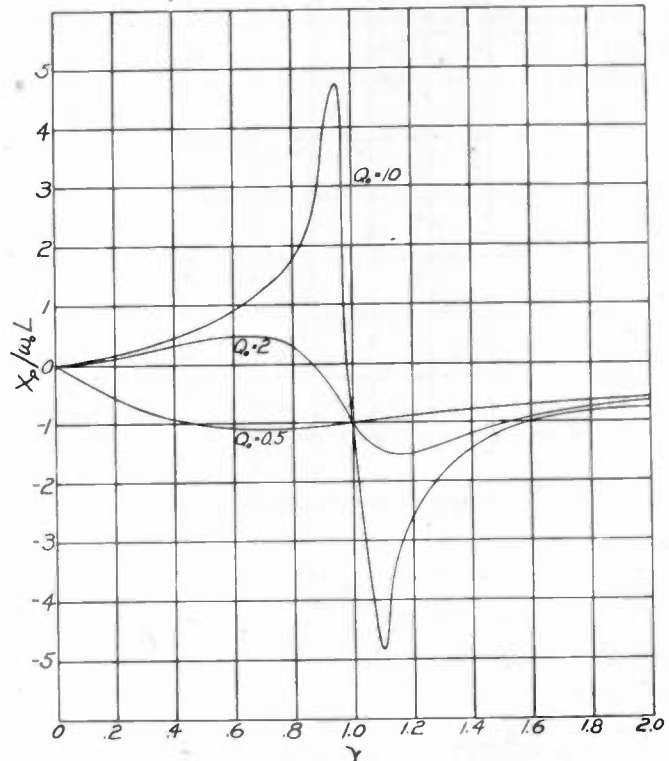

Fig. 12—Parallel-circuit reactance.

Maximizing (37) with respect to γ gives

$$\gamma_1 = \sqrt{1 - 1/Q_0^2 - 1/Q_0} \tag{38a}$$

and

$$\gamma_2 = \sqrt{1 - 1/Q_0^2 + 1/Q_0} \tag{38b}$$

The first is the maximum, which occurs for $Q_0 > 1.62$. The second is the minimum, which occurs for $Q_0 > 0.62$. The loci of maximum and minimum are plotted in Fig. 9. Equation (37) is plotted in Fig. 13. The effective inductance is zero (for sufficient Q_0) at a frequency found by setting the numerator of (37) equal to zero:

$$\delta - \gamma^2 = 0 \tag{39}$$

whence

$$\gamma = \sqrt{1 - 1/Q_0^2} \tag{40}$$

which has already been found to be the point of unity power factor.

It should be observed that (37) and Fig. 13 do not hold for zero frequency, at which the effective inductance in this circuit cannot differ from L .

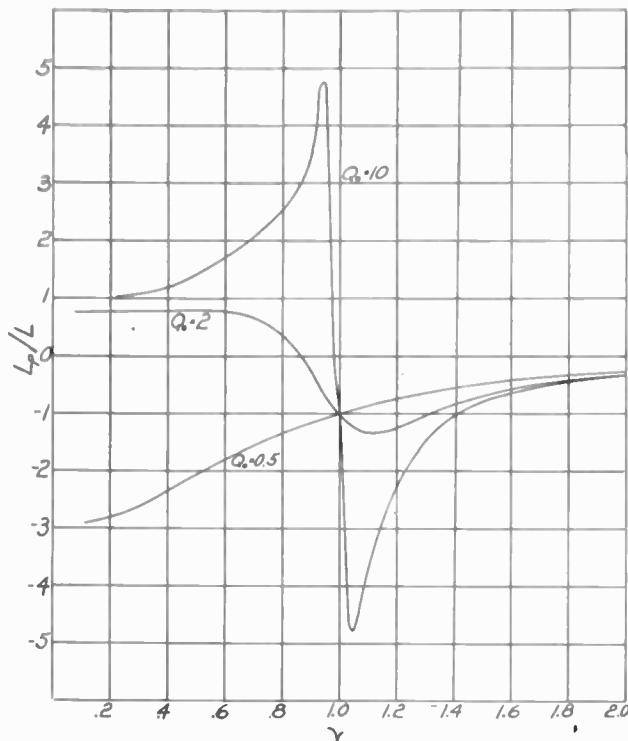

Fig. 13—Effective inductance of parallel circuit.

X. SERIES-CIRCUIT NOTE

It is of interest to note that equations (17) and (32) also give respectively the locus of the maximum inductance and capacitance voltage in a series-resonant

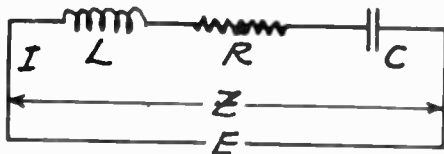

Fig. 14—Series circuit.

circuit. Thus, referring to Fig. 14, the voltage across the inductance is

$$E_L = \omega LI = \frac{E}{Z} \omega L = E \frac{\omega L}{\left[R^2 + \left(\frac{\omega^2 LC - 1}{\omega C} \right)^2 \right]^{1/2}} \quad (41)$$

which can be cast into the form

$$E_L = E \frac{\gamma^2}{(\gamma^4 + \alpha\gamma^2 + 1)^{1/2}} \quad (42)$$

This frequency function is the square root of that of (15). Hence, maximizing (42) with respect to γ also yields (17).

Similarly, the voltage across the capacitance is

$$E_c = \frac{I}{\omega C} = \frac{E}{\omega CZ} = \frac{1/\omega C}{\left[R^2 + \left(\frac{\omega^2 LC - 1}{\omega C} \right)^2 \right]^{1/2}} \quad (43)$$

which can be recast as

$$E_c = E \frac{1}{(\gamma^4 + \alpha\gamma^2 + 1)^{1/2}} \quad (44)$$

This frequency function is the square root of that of (30). Hence, maximizing (44) with respect to γ also gives (32).

ACKNOWLEDGMENT

The author is indebted to Mr. Hugo J. Di Giovanni of this staff for his assistance in obtaining experimental data in connection with this paper.

APPENDIX
NOMENCLATURE

- I_1 = primary current
- I_2 = secondary current
- Z_1 = impedance of the isolated primary
- Z_2 = impedance of the isolated secondary.
- M = mutual inductance
- E_1 = applied primary voltage
- L_2 = secondary inductance
- C_2 = secondary capacitance
- R_2 = secondary resistance (assumed constant)
- L = inductance of the parallel or series circuit
- C = capacitance of the parallel or series circuit
- R = resistance of the parallel or series circuit (assumed constant)
- Z_c = coupled impedance
- R_c = coupled resistance
- X_c = coupled reactance
- L_c = effective coupled inductance
- Z_p = impedance of the parallel circuit
- R_p = resistance component of parallel circuit impedance
- X_p = reactance component of parallel circuit impedance
- L_p = effective inductance of the parallel circuit
- I = current in the series circuit
- E = applied voltage in the series circuit
- E_c = capacitance voltage in the series circuit
- E_L = inductance voltage in the series circuit
- $\omega = 2\pi \times$ frequency
- $\omega_0 = 2\pi \times$ frequency at which $\omega L_2 = 1/\omega C_2$ or $\omega L = 1/\omega C$
- $\gamma = \omega/\omega_0$
- $Q_0 = \omega_0 L_2/R_2$ or $\omega_0 L/R$
- $\alpha = 1/Q_0^2 - 2$
- $\delta = 1 - 1/Q_0^2$

On Radiation from Antennas*

S. A. SCHELKUNOFF†, ASSOCIATE, I.R.E., AND C. B. FELDMAN†, ASSOCIATE, I.R.E.

Summary—This paper presents some theoretical remarks and experimental data relating to applications of the transmission-line theory to antennas. It is emphasized that the voltage, the current, and the charge are affected by radiation in different ways, a fact which should be considered in any adaptation of line equations to antennas.

It is shown experimentally and theoretically that in an antenna of length equal to an integral number of half wavelengths, which is energized at a current antinode, the effect of radiation on the current and the charge (but not on the voltage) can roughly be represented by adding to the resistance of the wires another fairly simple term.

I. GENERAL DISCUSSION

FOR MANY years it has been known that the current distribution in an antenna approximates that obtained by regarding the antenna as an open-circuited transmission line with certain series inductance and shunt capacitance per unit length. In other words, it has been known that effects of radiation on the current distribution are relatively small. During the last decade much thought has been given to improving upon this approximate picture by an inclusion of radiation effects, while remaining within the framework of the transmission-line theory. A theoretical question is whether or not such an improvement is possible within the limits of the line theory. While experimentally minded engineers, not being particularly worried by such questions, have achieved a measure of success, theoreticians have been beset with doubts. These doubts are only natural, since the only safe mathematical approach to the problem is through Maxwell's field equations, and these apparently make the antenna problem quite different from line problems.

In the line theory we write

$$\frac{dV}{dx} = -(R + i\omega L)I, \quad \frac{dI}{dx} = -(G + i\omega C)V, \quad (1)$$

where V and I are the voltage across the line and the current in it; the line parameters R , L , G , and C are, respectively, the series resistance, the series inductance, the shunt conductance, and the shunt capacitance, all per unit length. In applying these equations to a pair of parallel wires (Fig. 1), we say that R is the

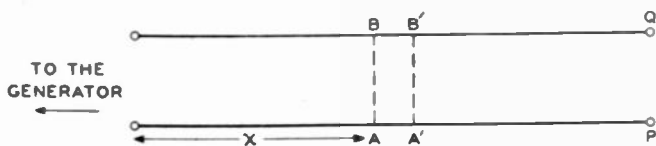

Fig. 1

resistance of the wires per unit length and that it represents the power dissipated in heat. If the medium surrounding the wires is nondissipative, we say that G is equal to 0. We define C as the ratio of the electric

* Decimal classification: R120. Original manuscript received by the Institute, December 31, 1941.

† Bell Telephone Laboratories, Inc., New York, N. Y.

charge per unit length to the voltage across the line. The quantity " $i\omega LI$ " is the counterelectromotive force of induction in "series" with the wires; it represents the reaction of the changing magnetic flux between the wires on the line voltage. This is the picture if radiation is ignored; and if we ignore radiation, there is nothing to prevent us from applying the picture to diverging wires (Figs. 2 and 3). If there is any difference between the three structures in Figures 1, 2, and 3, it is in the magnitude of radiation effects.

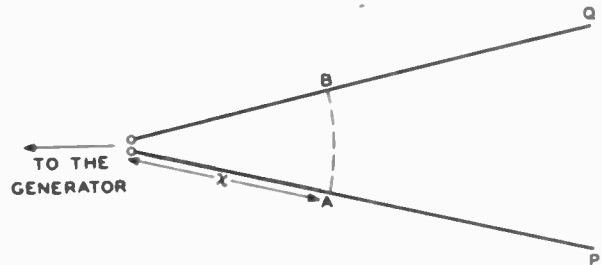

Fig. 2

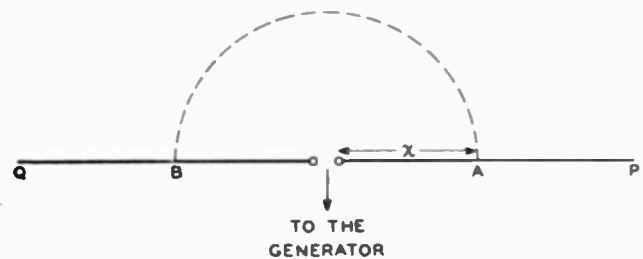

Fig. 3

One of the effects of dissipation is to cause attenuation of the voltage and current waves. Since radiation represents additional loss of power, it has been thought that it should cause further attenuation. In order not to confuse the issue, let us assume, for the time being, that the wires are perfectly conducting and that the surrounding medium is nondissipative; then, if R and G are different from 0, they must represent the effect of radiation.

One line of thought runs somewhat as follows. Ignoring radiation and solving (1) we find the first approximation to the current distribution $I(x)$ and charge distribution $q(x)$. Using this current distribution, we compute the retarded electric potential U and the retarded magnetic vector potential Π

$$U(x) = \frac{1}{4\pi\epsilon} \int \frac{q(x')e^{-i\omega r}}{r} dx',$$

$$\Pi(x) = \frac{1}{4\pi} \int \frac{I(x')e^{-i\omega r}}{r} dx', \quad (2)$$

where the integration is extended over the wires;

$\beta = 2\pi/\lambda = \omega/c$; and r is the distance between the current element $I(x')dx'$ and a typical point in space

$$r = \sqrt{(x' - x)^2 + \rho^2}, \quad \rho^2 = y^2 + z^2. \quad (3)$$

Strictly speaking, the integrals should be taken over the surface of the wires; but if the wires are thin, good approximations are given by (2).

From U and II we compute the field with the aid of the following equations

$$\nabla \cdot E = i\omega\mu II - \text{grad } U, \quad II = \text{curl } II. \quad (4)$$

Next, we obtain the total radiated power by forming the Poynting vector $E \times II$ and integrating it over a surface enclosing the antenna.

At this point we usually leave the solid ground and make the following *a priori* physical assumptions: (1) Equations (1) can take care of radiation, (2) the effect of radiation is expressed solely by a series resistance R_{rad} , and (3) R_{rad} is uniform. Granting tentatively these assumptions, we can compute R_{rad} so that the integral of $R_{rad} I^2$ along the antenna is equal to the radiated power. We can now use (1) for recomputing the current distribution. P. O. Pedersen¹ used this procedure and obtained a current distribution which checked rather well the measured current distribution.

Nevertheless, not all is well with this procedure. Let us examine the three *a priori* assumptions. There are no logical objections to the first assumption, if we permit R , L , G , and C to vary in any manner with x ; since V and I are definite functions of x , we can always use (1) as *definitions* of the line parameters. Naturally, these equations are useless for computing V and I unless we can find R , L , G , and C by independent means; but utility, or lack of it, does not affect the assumption. However, the second assumption, G_{rad} equals 0, is incorrect. It can be shown that V is not affected by radiation and that the ratio of dI/dx to V is a complex number.

This difficulty can be obviated if we write our transmission equations in terms of electric charge $q(x)$ and electric current $I(x)$ rather than the voltage-current form (1). In the first place, we have the equation of conservation of electric charge

$$\frac{dI}{dx} = -i\omega q, \quad (5)$$

which takes place at the second equation in (1). Next, we define V arbitrarily so that $C = q/V$ is independent of x and, finally, we write the first equation of (1) as follows

$$\frac{dq}{dx} = -(R_{rad}C + i\omega LC)I. \quad (6)$$

Of course, V as defined above is fictitious; but then it

¹ P. O. Pedersen, "Radiation from a vertical antenna over flat perfectly conducting earth," *Ingeniørvidenskabelige Skrifter*, ser. A, no. 38, 1935.

does not appear in our ultimate equations (5) and (6) and we need not be concerned with it. Besides, the measurements are carried out on q and I .

In an earlier paper by one of the present authors,² equation (6) was obtained directly from Maxwell's equations. There it was made clear that RC and LC were complicated functions of x .

Comparing the voltage-current transmission equations (1) to the current-charge equations (5) and (6), we observe that the latter are simpler in the sense that the "line" parameters enter into only one equation. Once we are certain that the form of equations (5) and (6) is permissible, we step on a more certain ground with regard to Pedersen's method of obtaining a second approximation to the current distribution in antennas. It appears that while radiation does not affect the voltage distribution in antennas, it affects the current and the charge in more or less the same manner that dissipation does.

Pedersen has assumed *ab initio* that R_{rad} is constant. In the third part of this paper we derive from Maxwell's equations the following approximate expression

$$R_{rad} = \frac{60l}{l^2 - x^2} \quad (7)$$

for the case when the length $2l$ of the antenna (of the type shown in Fig. 3) is an integral number of half wavelengths and the generator is at a current antinode. This function is represented by the solid curve in Fig. 4, where the experimental points, obtained under various conditions, are also marked.

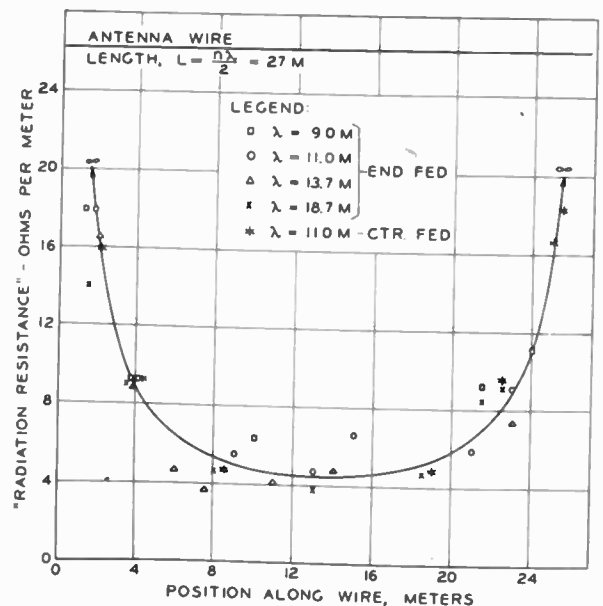

Fig. 4

For other antenna lengths, the formula becomes more complicated and indicates greatly increased radiation resistance near the current nodes.

² S. A. Schelkunoff, "Theory of antennas of arbitrary size and shape," *PROC. I.R.E.*, vol. 29, pp. 493-521; September, 1941.

Before proceeding with an account of our experiments and the mathematical derivation of (7), we shall, following another line of thought, give a descriptive resumé of a recent antenna theory² which is particularly useful for computing input impedances of antennas. Let us go back to (1) and write them in a form suitable to the nondissipative case

$$\frac{dV}{dx} = -i\omega LI, \quad \frac{dI}{dx} = -i\omega CV. \quad (8)$$

These equations apply exactly to an infinitely long pair of conical conductors diverging from a common apex as shown in Figs. 2 and 3. In the limit, they apply to an infinitely long pair of parallel cylindrical wires. In any of the above cases L and C are constant. These equations will also apply with a high degree of accuracy to diverging cylindrical wires if the latter are thin; in this case, however, L and C will vary with the distance x .

The transverse voltage V is defined as the line integral of the electric intensity between the wires, taken along a path lying completely in an equiphase surface, that is, in a plane perpendicular to the parallel wires and in a sphere concentric with the apex of diverging wires.

Now let the wires terminate at P and Q . It turns out that if we subtract a certain "complementary" or "local" current $I_c(x)$ from the actual total current $I_t(x)$, the remainder $I(x) = I_t(x) - I_c(x)$ and the transverse voltage $V(x)$ will satisfy (8). The complementary current is 0 at the apex of the diverging wires; in the case of parallel wires, it diminishes as the distance from the terminals PQ increases. For the case of parallel wires this fact was noted by Carson.³ Thus, the input impedance of diverging wires and long parallel pairs will be given as the ratio of the applied voltage to the "principal current" $I(0)$, the latter being equal to the total current $I_t(0)$.

The total current vanishes at P ; hence, the principal current there becomes equal to $-I_c(P)$. The relation between the total voltage and the principal current at PQ is that which would be obtained if the complementary current were disregarded and in its stead a terminal impedance equal to $V(P)/-I_c(P)$ were assumed. This terminal impedance, which may be called the "radiation impedance," is a complex quantity, the real part of which represents the radiated power. For large values of the characteristic impedance, the radiation impedance is substantially proportional to the square of the characteristic impedance.

In the elementary theory, the complementary current and the complementary charge are ignored. In effect, this makes the terminal radiation impedance infinite and the transmission line becomes electrically "open." In the complete theory, the voltage remains sinusoidal, although the end of the line is no longer a

voltage antinode; of the electric current and electric charge only the major parts are sinusoidal. The effect of the discontinuity of the line at PQ on these major parts is represented completely by the radiation impedance. The complete theory approaches the elementary theory as either the characteristic impedance or the wavelength becomes infinite.

In accordance with what has just been said, we are permitted to think that a wave emerging from a generator is guided by the wires until it reaches the ends where the transmission system suddenly changes;⁴ there, reflection takes place. The amount of reflection is not the same at all points of the wavefront so that besides the reflected wave which is guided back to the generator, there appears a "complementary" field which compensates for the uneven reflection.

The uneven reflection may be pictured as follows. Consider the wavefront passing through the ends of the wires and apply Huygens' principle or, rather, its more explicit form known as the equivalence principle.⁵⁻⁸ The secondary sources, near the wire but on its opposite sides, are 180 degrees out of phase. Being so near each other, their effect on the field beyond the antenna region is very small and they emit very little energy. But the energy arriving from the generator is denser near the wires than elsewhere; hence, the greatest reflection will occur over the area of the wavefront in the neighborhood of the wires.

The quantitative counterpart of the above qualitative antenna theory will be found in the paper² already referred to. The theory is sufficient for obtaining engineering information about performance of many different types of antennas.

We have just discussed several ways in which the line equations can be used in conjunction with the field equations in dealing with radiation problems. At present, the method which has been discussed last appears to be the most promising from the practical point of view and it possesses the theoretical advantage of being a child of the field theory. The earlier method is of interest largely because it shows that the old controversy as to whether radiation takes place continuously or "snaps off" the ends of the antenna is rather meaningless. One can look at it either way.

II. EXPERIMENTAL PART

The experiment concerns verification of (7). The method consists of exciting an elevated antenna wire with a transmitting oscillator, and measuring the shape of the nodes (minima) of current and charge. The total

⁴ The space with wires embedded in it is replaced by space without wires.

⁵ S. A. Schelkunoff, "Some equivalence theorems of electromagnetics and their application to radiation problems," *Bell Sys. Tech. Jour.*, pp. 92-112; January, 1936.

⁶ S. A. Schelkunoff, "On different fraction and radiation of electromagnetic waves," *Phys. Rev.*, pp. 308-316; August 15, 1939.

⁷ S. A. Schelkunoff, "A general radiation formula," *Proc. I.R.E.*, vol. 27, pp. 660-666; October, 1939.

⁸ J. A. Stratton, "Electromagnetic Theory," McGraw-Hill Book Company, New York, N. Y. 1941, pp. 464-470.

³ John R. Carson, "The guided and radiated energy in wire transmission," *Jour. A.I.E.E.*, pp. 906-913; October, 1924.

attenuation suffered by a wave traveling to the open end and back to the node in question can be deduced from the nodal shape, assuming a constant characteristic impedance. Measurements made upon several nodes between the generator and the open end yield a curve of total attenuation versus position on the wire whose slope can be interpreted as the attenuation exponent for that position. In order to obtain the resistance from the attenuation exponent it is necessary to know the characteristic impedance. One method of measuring the characteristic impedance is to measure attenuation for two antennas whose ohmic resistances are different. Such a resistance variation permits the radiation effect to be subtracted out and the characteristic impedance to be calculated from the remaining attenuation. The theory underlying this method of measurement is as follows.

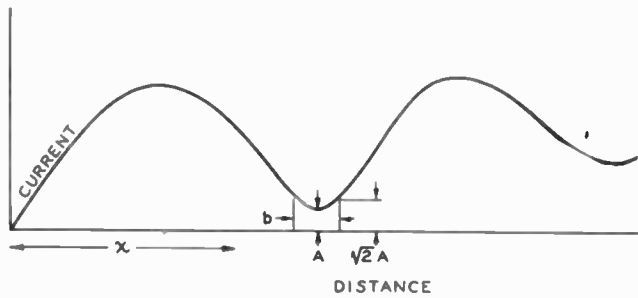

Fig. 5

Assuming that the resistance $R(x)$ of a transmission line is small compared with its characteristic impedance K , we can write an approximate expression for the current at distance x from one end of the wire (Fig. 5) in the form

$$I(x) = \sinh(A + i\beta x) \doteq A \cos \beta x + i \sin \beta x, \quad (9)$$

where $A(x)$ is the total attenuation to point x

$$A(x) = \frac{\int_0^x R(x) dx}{2K} \quad (10)$$

From (10) we have

$$R(x) = 2K \frac{dA}{dx} \quad (11)$$

The values of A corresponding to the current minima and charge minima can be related to the shape of the latter. Thus the minima of $I(x)$ are near points for which $\sin \beta x = 0$, so that minimum amplitudes are given by $A(x)$. The points for which the amplitudes are equal to $\sqrt{2} A$ occur where the real and the imaginary parts of (9) are equal; that is, (Fig. 5),

$$\sin \frac{\beta b}{2} = A \cos \frac{\beta b}{2}, \text{ or } \frac{\beta b}{2} = A, \text{ or } A = \frac{\pi b}{\lambda} \quad (12)$$

Setting

$$A_1(x) = \frac{\int_0^x R_{rad}(x) dx}{2K} \text{ for zero wire resistance} \quad (13)$$

$$A_2(x) = \frac{\int_0^x R_{rad}(x) dx + rx}{2K} \text{ for resistance wire,}$$

where r is the resistance per unit length, we obtain,

$$2K = \frac{rx}{A_2(x) - A_1(x)}, \quad (14)$$

$$R_{rad}(x) = \frac{rx}{A_2(x) - A_1(x)} \frac{dA_1}{dx}$$

The test antenna was a No. 14 B & S gauge wire 27 meters long stretched horizontally under the roof of a large barn. Copper and Nichrome wires were used. A wooden platform erected 7 feet beneath the wire enabled an operator to carry apparatus with which to measure current and charge distribution. The current-measuring equipment employed a small loop highly balanced against response to potential gradient, while charge-measuring equipment employed a receiver with weak capacitive coupling to the antenna. Measurements were made at several wavelengths from 9 to 18 meters and with the oscillator coupled to the wire in various ways near one end and at the middle. A plot of

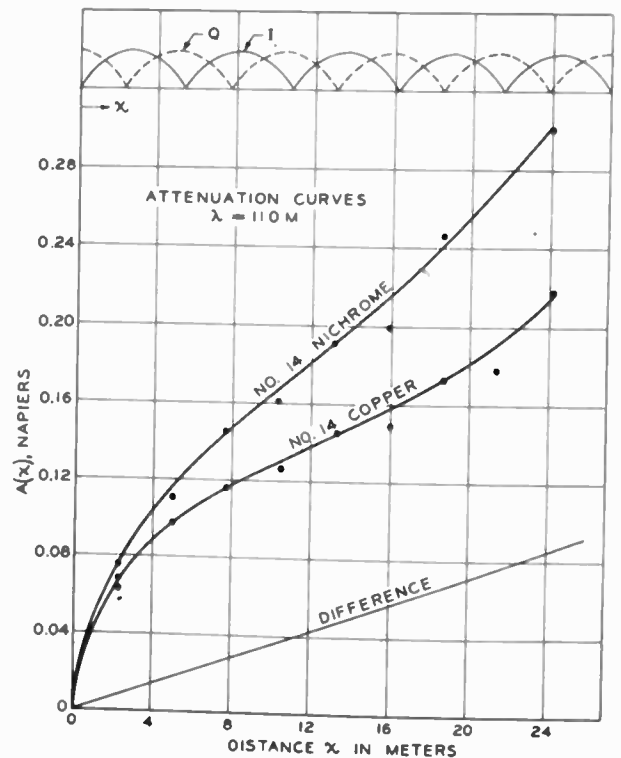

Fig. 6

the total attenuation measured at 11 meters wavelength appears in Fig. 6. The smooth curves, whose slopes are to be determined graphically, were drawn in among the scattered experimental points to conform

with the knowledge that the difference should increase linearly. The slope of this linear curve determines the characteristic impedance, knowing the difference in high-frequency resistance. The slope of the copper-wire curve (the high-frequency resistance is negligible) determines the radiation resistance at any point, knowing the characteristic impedance. The Nichrome-wire resistance was 3.56 ohms per meter at 11 meters wavelength, while the copper-wire resistance was 0.27 ohm per meter. Using these data the characteristic impedance is found to be 470 ohms which agrees well with calculation and other measurements. Radiation-resistance values so determined are plotted in Fig. 4 together with a curve calculated from (7).

III. MATHEMATICAL ANALYSIS

Consider a cylindrical wire of radius a (Fig. 3) so energized that the electric current is parallel to the axis; then, the electric intensity E_x at the surface of the wire and parallel to it is

$$E_x = -i\omega\mu I - \frac{dU}{dx}, \quad (15)$$

where the retarded electric scalar potential U and the retarded magnetic vector potential A are given⁹ by (2).

Everywhere along the wire, except at the generator, the electric intensity E_x is also given by

$$E_x = ZI, \quad Z = \frac{1}{2\pi a} \sqrt{\frac{i\omega\mu}{g}}, \quad (16)$$

where Z is the surface impedance of the wire and g is the conductivity. Substituting from (16) in (15), we have

$$\frac{dU}{dx} = -ZI - i\omega\mu I. \quad (17)$$

We shall now carry out two successive approximations: First, we shall see what happens when the radius of the wire is approaching zero; then, starting from this approximation we shall compute certain correction terms. Consider the following factor in the integrand of (2)

$$\frac{e^{-i\beta r}}{r} = \frac{\cos \beta r}{r} - i \frac{\sin \beta r}{r}. \quad (18)$$

If a approaches zero, the first term approaches infinity in the immediate vicinity of $x' = x$ while the second term remains everywhere finite. Hence, from (2) we obtain the following asymptotic relations

$$\epsilon V(x) = A(x)q(x), \quad \Pi(x) = A(x)I(x); \quad (19)$$

where

$$A(x) = \frac{1}{4\pi} \int_{-l}^l \frac{dx'}{r}. \quad (20)$$

Substituting from (19) in (17), we have

$$\frac{dq}{dx} = - \left[i\omega\mu\epsilon + \frac{\epsilon Z}{A(x)} \right] I - \frac{A'(x)}{A(x)} q. \quad (21)$$

Assuming that Z remains finite as $A(x)$ approaches infinity, we have

$$\frac{dq}{dx} = -i\omega\mu\epsilon I. \quad (22)$$

Next we calculate the effect of the second term in (18) on the values of the integrals in (2), assuming that I and q satisfy (22) and that the wire is energized at $x=0$. Thus we have¹⁰

$$\begin{aligned} & -i \int_{-l}^l \frac{\sin \beta r}{4\pi r} I(x') dx' \\ &= \frac{1}{4\pi\omega\mu\epsilon} \int_{-l}^l \frac{\sin \beta r}{r} \frac{dq(x')}{dx'} dx' \\ &= \frac{1}{4\pi\omega\mu\epsilon} \left[q(l) \frac{\sin \beta r_1}{r_1} - q(+0) \frac{\sin \beta r_0}{r_0} \right. \\ &\quad \left. + q(-0) \frac{\sin \beta r_0}{r_0} - q(-l) \frac{\sin \beta r_2}{r_2} \right. \\ &\quad \left. - \int_{-l}^l q(x') \frac{d}{dx'} \left(\frac{\sin \beta r}{r} \right) dx' \right], \end{aligned} \quad (23)$$

where

$$\begin{aligned} r_0 &= \sqrt{a^2 + x^2}, & r_1 &= \sqrt{a^2 + (l-x)^2}, \\ r_2 &= \sqrt{a^2 + (l+x)^2}. \end{aligned} \quad (24)$$

Similarly, we have

$$\begin{aligned} & \int_{-l}^l \frac{\sin \beta r}{4\pi r} q(x') dx' \\ &= \frac{i}{\omega} \int_{-l}^l \frac{\sin \beta r}{4\pi r} \frac{dI(x')}{dx'} dx' \\ &= \frac{i}{\omega} I(x') \frac{\sin \beta r}{4\pi r} \Big|_{-l}^l \\ &\quad - \frac{i}{\omega} \int_{-l}^l I(x') \frac{d}{dx'} \left(\frac{\sin \beta r}{4\pi r} \right) dx'. \end{aligned} \quad (25)$$

In this expression the first term vanishes if the current is equal to zero at the ends of the antenna.

Neglecting the last terms (the integrals) in (23) and (25), and substituting in (17), we obtain (neglecting also $A'(x)/A(x)$)

$$\begin{aligned} \frac{dq}{dx} &= -i\omega\mu\epsilon I - \frac{\epsilon Z I}{A(x)} - \frac{i}{4\pi A(x)} \left[q(l) \frac{\sin \beta r_1}{r_1} \right. \\ &\quad \left. - q(+0) \frac{\sin \beta r_0}{r_0} + q(-0) \frac{\sin \beta r_0}{r_0} \right. \\ &\quad \left. - q(-l) \frac{\sin \beta r_2}{r_2} \right]. \end{aligned} \quad (26)$$

⁹ In the present case the vector potential is parallel to the wire.

¹⁰ If the wire is energized at $x=0$, $q(+0)$ is not equal to $q(-0)$.

Integrating (20), we have

$$A(x) = \frac{1}{4\pi} \log \frac{\sqrt{a^2 + (l-x)^2} + (l-x)}{\sqrt{a^2 + (l+x)^2} - (l+x)} \quad (27)$$

$$\doteq \frac{1}{4\pi} \log \frac{4(l^2 - x^2)}{a^2}$$

At the center of the wire and at the ends we have

$$A(0) = \frac{1}{2\pi} \log \frac{2l}{a}, \quad A(l) = A(-l) = \frac{1}{4\pi} \log \frac{4l}{a} \quad (28)$$

The average value of $A(x)$ along the wire is

$$A(x) \Big|_{av} = \frac{1}{2\pi} \left(\log \frac{2l}{a} - 2 + 2 \log 2 \right) \quad (29)$$

This average value of $A(x)$ is related to the average capacitance C between two halves of the wire; thus we have very nearly

$$A(x) \Big|_{av} = \frac{\epsilon}{2C} \quad (30)$$

Replacing $A(x)$ in (26) by its average value from (30), we have

$$\frac{dq}{dx} = -i\omega\mu\epsilon l - 2ZCI - \frac{iC}{2\pi\epsilon} \left[q(l) \frac{\sin \beta r_1}{r_1} - q(+0) \frac{\sin \beta r_0}{r_0} + q(-0) \frac{\sin \beta r_0}{r_0} - q(-l) \frac{\sin \beta r_2}{r_2} \right] \quad (31)$$

This approximate equation has been obtained on the assumption that the wire is energized at the center; however, the same expression holds for any position of the generator, in which case x is measured from the generator.

For a centrally disposed generator we have in the first approximation

$$I(x) = I_0 \sin \beta(l-x), \quad x > 0, \\ = I_0 \sin \beta(l+x), \quad x < 0, \quad (32)$$

where I_0 is the maximum amplitude of the current. Hence,

$$q(l) = -\frac{i\beta I_0}{\omega} = -i\sqrt{\mu\epsilon} I_0, \quad q(-l) = i\sqrt{\mu\epsilon} I_0, \\ q(+0) = -q(-0) = -i\sqrt{\mu\epsilon} I_0 \cos \beta l. \quad (33)$$

Substituting these values in (31), we obtain

$$\frac{dq}{dx} = -i\omega\mu\epsilon l - 2ZCI - 60C'I_0 \left(\frac{\sin \beta r_1}{r_1} - 2 \frac{\sin \beta r_0}{r_0} \cos \beta l + \frac{\sin \beta r_2}{r_2} \right) \quad (34)$$

Since a is assumed to be small, we can write (34) as follows

$$\frac{dq}{dx} = -i\omega\mu\epsilon l - 2ZCI - 60C'I_0 \left[\frac{\sin \beta(l-x)}{l-x} - 2 \frac{\sin \beta x}{x} \cos \beta l + \frac{\sin \beta(l+x)}{l+x} \right] \quad (35)$$

It is quite obvious that the last term, representing approximately the effect of radiation on the electric charge and the electric current distribution in the antenna, differs in form from the second term ($-2ZCI$), representing the effect of dissipation in the wire and the effect of the internal inductance of the wire. The latter term is always proportional to the current in the particular section of the antenna while the radiation term is not, as a rule. If, however, the length of the wire is equal to an odd number of half wavelengths,¹¹ then (35) becomes

$$\frac{dq}{dx} = -[i\omega\mu\epsilon + (2Z + 2R_{rad})C']I, \\ R_{rad} = \frac{60l}{l^2 - x^2} \quad (36)$$

In this case, to the extent of our approximation, radiation is represented by a term similar to the dissipation term.

The approximate formula (7) for R_{rad} was also obtained by a different method in an earlier paper.² There a point was made of a curious paradox which seems to us important enough to bear a repetition. Assuming a sinusoidal current distribution ($I_0 \sin \beta \bar{x}$) in an antenna whose length is equal to an integral number of half wavelengths, A. A. Pistolokors¹² obtains the following expression for the electric intensity parallel to the wire at its surface

$$-E_x = 30 \left(\frac{1}{\bar{x}} + \frac{1}{2l - \bar{x}} \right) I_0 \sin \beta \bar{x} \\ + 30j \left[\frac{1}{\bar{x}} - \frac{1}{2l - \bar{x}} \right] I_0 \cos \beta \bar{x}, \quad (37)$$

where $\bar{x} = l+x$ is the distance from an end of the wire. It is evident that the real part $-E_x/I(x)$ gives (7) for the radiation resistance. This cannot be regarded as anything more than a coincidence. If we were fortunate enough (or, perhaps, unfortunate) to know the exact current distribution in the antenna, then we should have found that E_x and, hence, $-E_x/I(x)$ are equal to 0 everywhere on the surface of the wire for the simple reason that $E_x=0$ is the boundary condition from which the correct current distribution must be determined. In an antenna energized at a point there is really no relation between R_{rad} and E_x .

¹¹ In fact, to any number of half wavelengths if the generator is located at a current antinode.

¹² A. A. Pistolokors, "The radiation resistance of beam antennas," Proc. I.R.E., vol. 17, pp. 562-579; March, 1929.

On the Pickup of Balanced Four-Wire Lines*

CHARLES W. HARRISON, JR.†, ASSOCIATE, I.R.E.

Summary—It is demonstrated that for practical purposes the pickup of undesired energy by a balanced four-wire line when compared to the pickup of a balanced two-wire line of the same spacing is so small as to be considered negligible.

SEVERAL methods are in general use for evaluating the power radiated from an antenna or transmission line. One of these methods consists in the integration of the normal component of the Poynting vector over the surface of a great sphere;¹⁻³ in the other method, the integration is carried out over the surface of the wires making up the radiating system.⁴⁻⁶

In the first method, a knowledge of the far-zone field is required. In the latter, one must have expressions for the electromagnetic field which are valid right up to the surface of the radiating wires. Naturally, this field is intrinsically more complicated than the field in the far zone.

There are certain inherent weaknesses in either approach. For a complicated array, the setting up of the radiation function and the carrying out of the integration in an application of the great sphere method is frequently very difficult. In such a case, the solution of a given problem often may be simplified by the use of the second method which implies a knowledge of the self and mutual impedances.

In setting up the radiation function, or the calculation of the self and mutual impedances, one is required to make some assumption regarding the current distribution. Otherwise, one must solve for the distribution using, for example, the methods of Hallén⁷ or King.⁸ The usual approach is to assume a current distribution of the form

$$I_z = I_0 \sin(L - \beta_0 |z|) / \sin L \quad (1)$$

* Decimal classification: R116. Original manuscript received by the Institute, May 26, 1942.

† Cruft Laboratory, Harvard University, Cambridge, Massachusetts.

¹ Stuart Ballantine, "On the radiation resistance of a simple vertical antenna at wave lengths below the fundamental," *Proc. I.R.E.*, vol. 12, pp. 823-832; December, 1924.

² S. A. Schelkunoff, "A general radiation formula," *Proc. I.R.E.*, vol. 27, pp. 660-666; October, 1939.

³ Ronald King, "The approximate representation of the distant field of linear radiators," *Proc. I.R.E.*, vol. 29, pp. 458-464; August, 1941.

⁴ A. A. Pistolokors, "The radiation resistance of beam antennas," *Proc. I.R.E.*, vol. 17, pp. 562-579; March, 1929.

⁵ Rudolf Bechmann, "On the calculation of radiation resistance of antennas and antenna combinations," *Proc. I.R.E.*, vol. 19, pp. 1471-1480; August, 1931.

⁶ P. S. Carter, "Circuit relations in radiating systems," *Proc. I.R.E.*, vol. 20, pp. 1004-1041; June, 1932.

⁷ E. Hallén, "Theoretical investigations into the transmitting and receiving qualities of antennas," *Nova Acta Upsaliensis*, ser. IV, vol. 11, pp. 1-44; November 11, 1938.

⁸ L. V. King, "On the radiation field of a perfectly conducting base insulated cylindrical antenna over a perfectly conducting plane earth, and the calculation of radiation resistance and reactance," *Phil. Trans. Royal Soc. (London)*, vol. 236, pp. 381-422; November 2, 1937.

for the sinusoidal case, and of the form

$$I_z = I_0 e^{-i\beta_0(l-z)} \quad (2)$$

for the traveling-wave case.

Here $L = \beta_0 l$

$$\beta_0 = \frac{2\pi}{\lambda}$$

It may be well to say at this point that in the usual case, the assumption of the distribution given by (2) neglecting attenuation is as accurate as that assumed in (1).

It is known, however, that the condition imposed by (1) is fairly precise only in the physically impossible case of an infinitely thin conducting thread. Now in the reactive term of the general equation for the self-impedance, evaluated on the basis of a sine current distribution, the radius of the conductor appears. It follows, therefore, that under such conditions it is impossible to determine the reactance by the integration of the Poynting vector over the surface of a conductor of finite radius. In addition, one ordinarily assumes a perfect conductor in carrying out this method. The tangential electric field at the surface of the wires assuming a sinusoidal current distribution is not zero, which contradicts the boundary condition for a perfect conductor.

Happily, either of the methods gives the same results in so far as the evaluation of the power radiated from a line or antenna is concerned.

It has been the practice when calculating the power radiated from, or conversely, the pickup of, a transmission line, to neglect the effect of the terminations. Such a procedure involves not only neglecting the power radiated by the terminations, but also the mutual power. Some work is now being done on the radiation from lines, taking into account the terminations. For the present purposes, if one assumes an open-circuited transmission line a multiple of a half wave in length, with vanishing currents at the ends, a satisfactory equation for the radiation resistance can be obtained. Just how the radiation from the line as operated in practice compares with that so determined for the open-circuited case is not known. The nonresonant operation of a line is of great interest, but a determination of the power radiated from such a line should take into account the terminations. However, it remains to be demonstrated that the expressions for the radiation resistance of terminated two-wire transmission lines published to date are invalid. Accordingly, the case of a nonresonant balanced four-wire line, neglecting terminations, and the case of an open-circuited multiple half-wave balanced four-wire line are discussed here.

An expression for the radiation resistance of a balanced line, the wires of which are fixed at the corners of a square, may be determined as follows: Refer to Fig. 1. Wires *A* and *C* and wires *B* and *D* are electrically paralleled. It can be readily shown, using standard

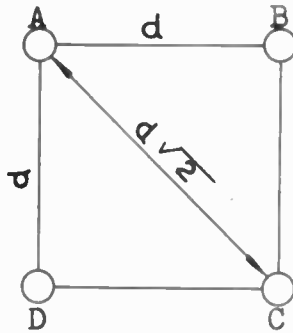

Fig. 1—Four-wire line.

electric circuit theory, that the radiation resistance expressed in ohms is

$$R = R_{11} - 2R_{AB} + R_{AC}. \quad (3)$$

Here R_{11} is the self-resistance of a conductor in ohms (similar conductors not displaced in length are assumed).

R_{AB} and R_{AC} are the mutual resistance in ohms between the conductors denoted by the subscripts.

For a line a multiple half wave in length, open-circuited at both ends,

$$R_{11} = 30 \overline{\text{Ci}} 2L \quad (4)$$

and

$$R_{(\text{mutual})} = 30 [2 \text{Ci} \beta_0 x - \text{Ci} \beta_0(y+l) - \text{Ci} \beta_0(y-l)] \quad (5)$$

where $y = \sqrt{l^2 + x^2}$

x = separation distance of the parallel wires.

$$\text{Ci}(z) = - \int_z^\infty \frac{\cos u}{u} du$$

$$\overline{\text{Ci}}(z) = \int_0^z \frac{1 - \cos u}{u} du$$

Both (4) and (5) are based on the current distribution given by (1).

Using (4) and (5) in (3), and retaining the leading term after making the approximation $l \gg d$, one obtains

$$R_s \doteq 20\pi^4 \left(\frac{d}{\lambda}\right)^4. \quad (6)$$

Here R_s is the radiation resistance of a four-wire balanced line a multiple half wave in length, open-circuited at each end. d is the separation between constants, as shown in Fig. 1.

The self-resistance of an isolated nonresonant wire, as given in numerous places in the literature, is

$$R_{11} = 60 \left(\overline{\text{Ci}} 2L - 1 + \frac{\sin 2L}{2L} \right) \text{ ohms} \quad (7)$$

and the corresponding equation for the mutual resistance worked out by the writer is

$$R_{(\text{mutual})} = 30 \left[4 \text{Ci} \beta_0 x - 2 \text{Ci} \beta_0(y+l) - 2 \text{Ci} \beta_0(y-l) - \frac{2 \sin \beta_0 x}{\beta_0 x} + \frac{\sin \beta_0(y-l)}{\beta_0 y} + \frac{\sin \beta_0(y+l)}{\beta_0 y} \right] \text{ ohms.} \quad (8)$$

Both (7) and (8) are based on the current distribution given by (2).

Using (7) and (8) in (3), and retaining the leading term after making the approximation $l \gg d$, one obtains

$$R_t \doteq 40\pi^4 \left(\frac{d}{\lambda}\right)^4. \quad (9)$$

Here R_t is the radiation resistance of a four-wire balanced transmission line on which a traveling wave system exists. The effect of the termination has not been taken into account.

The corresponding expressions published by Sterba and Feldman⁹ for the two-wire line have been checked using the analysis given here. These expressions are

$$R_s \doteq 120\pi^2 \left(\frac{d}{\lambda}\right)^2 \quad (10)$$

and

$$R_t \doteq 160\pi^2 \left(\frac{d}{\lambda}\right)^2 \quad (11)$$

for the standing and traveling-wave cases, respectively.

It is apparent, upon a consideration of these equations, that the power radiated by a four-wire line for a given value of line current is extremely small compared to that radiated by a two-wire line of the same spacing.

Consequently, by reciprocity, the pickup of a four-wire line is very small compared to a similar two-wire line, and may be considered negligible for all practical purposes.

The writer believes that when the current is non-vanishing at the ends of a line, the actual power radiated will prove to be very much less than that indicated by the use of either (9) or (11). A very limited amount of experimental evidence substantiates this view.

⁹ E. J. Sterba and C. B. Feldman, "Transmission lines," *PROC. I.R.E.*, vol. 20, pp. 1163-1202; July, 1932.

A Graphical Method to Find the Optimal Operating Conditions of Triodes as Class C Telegraph Transmitters*

J. C. FROMMER†, NONMEMBER, I.R.E.

Summary—The oscillation of a triode can be characterized by plate-supply voltage, swing of plate voltage, peak plate current, and angle of current flow. For medium-size transmitters it is economical to draw as much output power as consistent with the ratings of the tube. A graph has been plotted with the swing of plate voltage and peak plate current as co-ordinates showing the output and necessary bias if the plate-supply voltage is held at the rated value and the angle of plate-current flow is chosen to produce just the rated dissipation. Grid resistor, grid current, and grid dissipation can be established from another graph. All data are given in ratios applicable to any type of tube.

I. SYMBOLS

- e_b = momentary value of plate voltage
- i_b = momentary value of plate current
- e_c = momentary value of grid voltage
- i_c = momentary value of grid current
- E_b = plate-supply voltage
- I_b = average value of plate current
- E_c = grid bias
- I_c = average value of grid current
- $e_{b \text{ min}}$ = plate voltage at its downward peak
- $i_{b \text{ max}}$ = plate current at the moment of downward peak of plate voltage
- $e_{c \text{ max}}$ = grid voltage at the moment of downward peak of plate voltage
- $i_{c \text{ max}}$ = grid current at the moment of downward peak of plate voltage.
- Θ = plate-current cutoff angle (half of the angle of plate current flow)
- Θ_g = grid-current cutoff angle (half of the angle of grid-current flow)
- P_1 = plate input power = $E_b I_b$
- P_2 = plate output power
- P_p = plate dissipation = $P_1 - P_2$
- P_l = rated plate dissipation
- P_g = grid dissipation
- $P_{r(D.C.)}$ = power lost in the grid resistor due to direct current
- $P_{r(A.C.)}$ = power lost in the grid resistor due to alternating current
- I_l = unity of current = P_l/E_b
- E_l = plate voltage at which, with the grid connected to the cathode, plate current is I_l
- p = ratio of the output power and the rated plate dissipation = P_2/P_l
- s = ratio of the plate swing and the plate-supply voltage = $1 - (e_{b \text{ min}}/E_b)$
- μ = amplification factor

- u = a parameter = $(\mu E_c - E_b)/E_l$
- R_p = resistance reflected on the plate
- R_g = resistance of the grid resistor
- ω = angular frequency of the oscillation
- t = time reckoned from the downward peak of the plate voltage
- $F(\Theta)_k$ = symbol for the integral

$$\frac{1}{2} \int_{\omega t = -\Theta}^{+\Theta} (\cos \omega t - \cos \Theta)^k d\omega t$$

$G(\Theta)_k$ = symbol for the integral

$$\frac{1}{2} \int_{\omega t = -\Theta}^{+\Theta} \cos \omega t \left(\frac{\cos \omega t - \cos \Theta}{1 - \cos \Theta} \right)^k d\omega t$$

II. INTRODUCTION

WHEN setting the operating conditions of oscillators we have control of the plate-supply voltage, the drive voltage (degree of regeneration), the resistance reflected into the plate circuit, and the grid bias (grid resistor). According to these settings the swing of the plate voltage, the peak plate current, and the angle of current flow will assume different values. For each set of conditions the plate dissipation can be determined. With medium-size transmitting tubes, where the cost of power consumption is negligible compared with the first cost of the installation, it is generally desired to obtain the maximum possible output. This is reached with both the plate-supply voltage and the plate dissipation at their upper permissible (rated) value. Therefore, in the present paper the plate-supply voltage is taken to be the maximum permissible and all settings are eliminated in which the plate dissipation is above the permissible (because such conditions would damage the tube) or in which the plate dissipation is below the permissible maximum (because such conditions would not give the maximum possible output; for exceptions see the end of Section IV). The number of free variables can thus be reduced to two: the swing of the plate voltage and the peak plate current. For each set of these two variables we consider only that particular angle of plate-current flow at which the rated plate dissipation is just reached. For this particular angle parameters giving output and necessary bias are plotted on Fig. 1. This figure shows that the output increases with increased plate swing and with higher peak plate current, which stands to reason. Neither of these values, however, can be augmented

* Decimal classification: R133X R333. Original manuscript received by the Institute, March 27, 1942.

† Ajax Engineering Company, Chicago, Illinois.

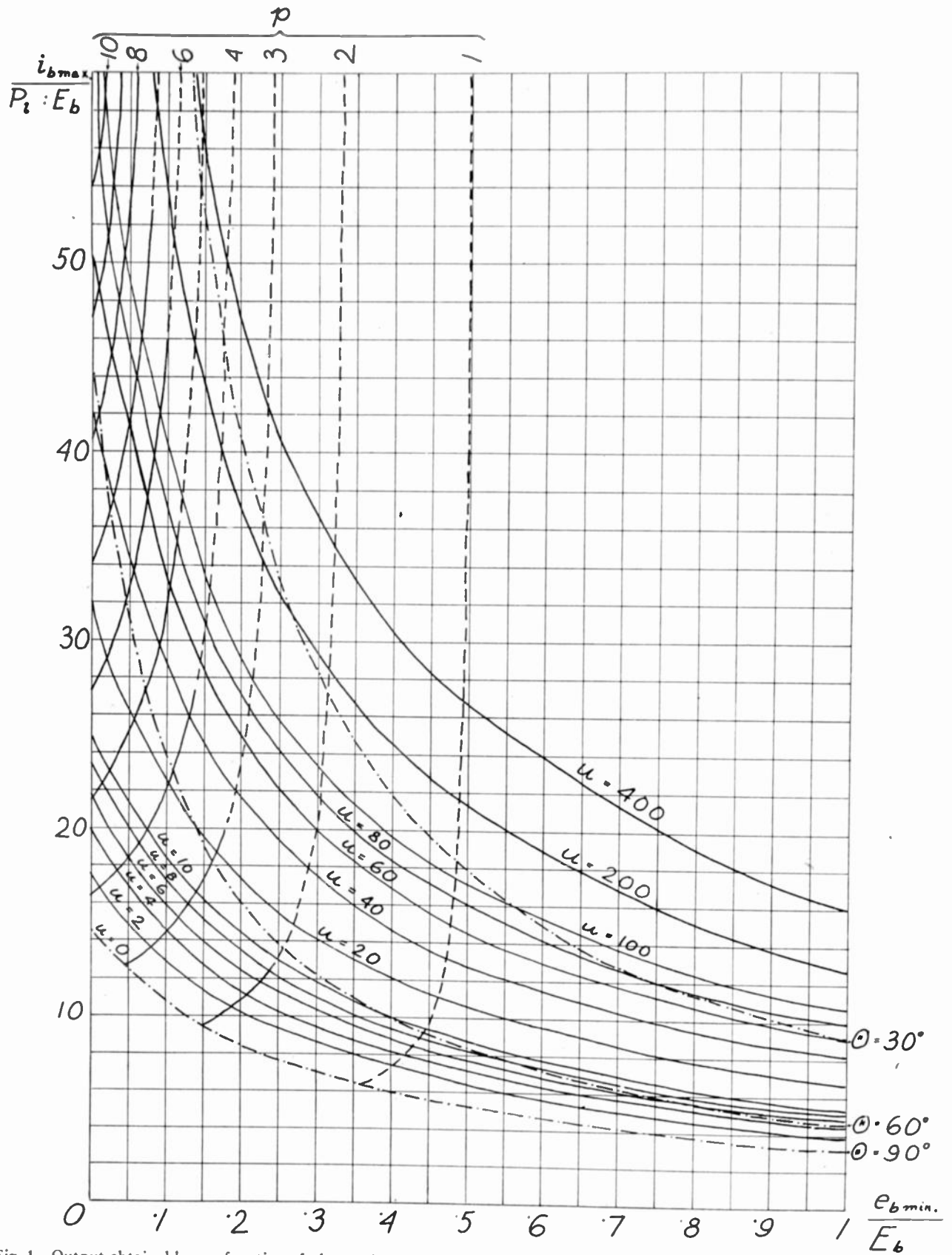

Fig. 1—Output obtainable as a function of plate-voltage swing and the peak value of plate current. To get some rated dissipation P_i , the plate-current cutoff angle has to be θ , and with this angle the power output is ρP_i . The parameter μ serves to locate the necessary bias and with this the data of the grid circuit. Unity of the abscissa scale is the plate-supply voltage, and unity of the ordinate scale is the current obtained by dividing the rated plate dissipation by the plate-supply voltage.

without limit: the peak cathode current must never exceed the emission capacity of the cathode, the plate voltage swing must never assume a value at which the grid dissipation is excessive. We can easily trace these limits on the static characteristics of the tube. They are represented by two lines: one connecting points of equal cathode drain, another connecting the points at which the grid current starts to grow rapidly, say the points at which grid voltage equals plate voltage. The point of maximal output can be found at the upper left corner of the area so limited. The operating conditions pertaining to this point with an angle of current flow chosen to give the rated dissipation can be found from Figs. 1 and 2.

Another section of the same tuned circuit is connected via a blocking condenser to the grid. The grid bias is generated by the grid current across the resistor R_g which is connected either directly or through a choke L_g to the grid. The load is generally inductively coupled, its effect can be represented by the resistance which it reflects into the plate circuit, R_p on the figure.

As a result of regeneration, there will arise an alternating voltage on the plate and on the grid. The time curves of these voltages and of the currents flowing to the plate and to the grid are represented on Figs. 3b and 3c. Because of the properties of tuned circuits these are in phase with each other and the voltages have a very low proportion of harmonics. These harmonics, as well as the phase shifting caused by electron transit time, are neglected in this paper.

Referring to Fig. 3, the instantaneous values of plate voltage and grid voltage are, respectively,

$$e_b = E_b(1 - s \cos \omega t) \tag{1}$$

$$e_c = -E_c + (E_c + e_{c \max}) \cos \omega t. \tag{2}$$

As unity of current the value

$$I_l = \frac{P_l}{E_b} \tag{3}$$

is used, i.e., the continuous direct current which, at a plate voltage $e_b \equiv E_b$ would just cause the rated plate dissipation. The voltage E_l is defined as the plate voltage at which, with the grid connected to the cathode, a plate current I_l would be drawn from the tube.

If the amplification factor of the tube is μ , the plate current is, according to the space-charge law,

$$i_b = I_l \left(\frac{e_b + \mu e_c}{E_l} \right)^\alpha. \tag{4}$$

Because of grid current, actual conditions are best represented with an exponent α being lower than the theoretical $3/2$.

Substituting (1) and (2) into (4),

$$\frac{i_b}{I_l} = \left(\frac{E_b - \mu E_c}{E_l} + \frac{\mu E_c + \mu e_{c \max} - s E_b}{E_l} \cos \omega t \right)^\alpha. \tag{5}$$

Denote

$$\frac{\mu E_c - E_b}{E_l} = u. \tag{6}$$

Substituting (6) into (5) and remembering that i_b is 0 when $\omega t = \Theta$ (cutoff angle of plate-current flow), write

$$\frac{i_b}{I_l} = \left(-u + \frac{u}{\cos \Theta} \cos \omega t \right)^\alpha. \tag{7}$$

The peak plate current $i_{b \max}$ is reached at $\omega t = 0$.

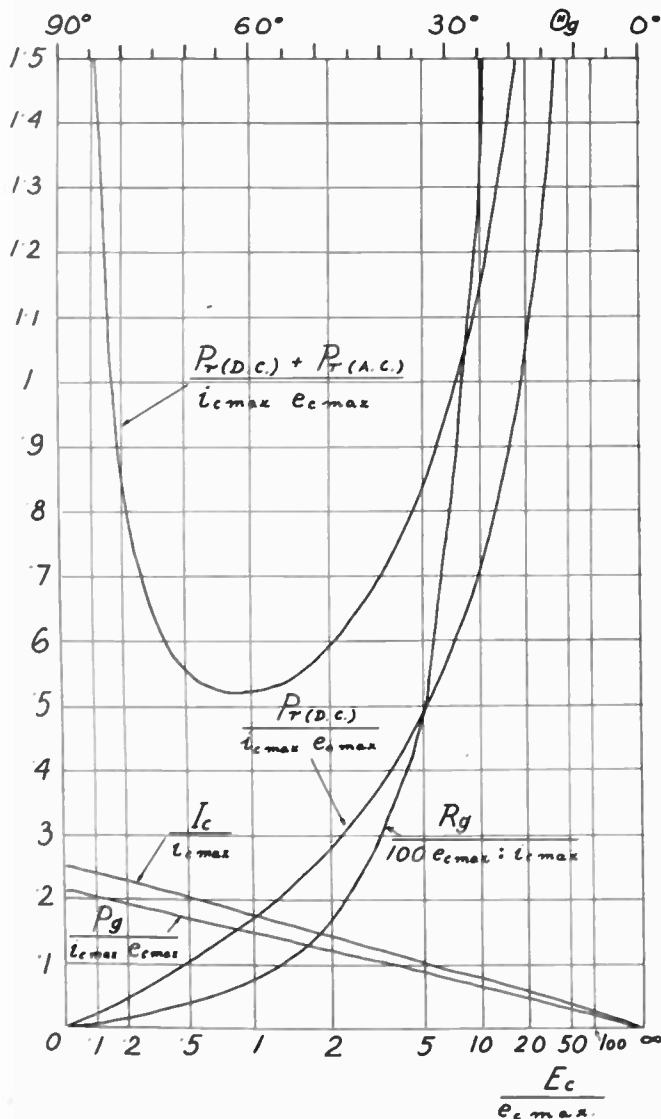

Fig. 2—Grid current, grid dissipation, necessary resistance of the grid resistor, and power consumed in this resistor. The abscissas are the ratio between bias and peak grid voltage. The ordinates are pure numbers, the functions being expressed with the peak grid voltage and peak grid current. These, in turn, can be found from the static characteristics of the tube if the plate-voltage swing and peak value of plate current are known.

III. CALCULATION OF THE GRAPHS

Fig. 3a represents an oscillator circuit. The plate of the tube is connected via one part of a tuned circuit to the positive terminal of the plate-voltage supply.

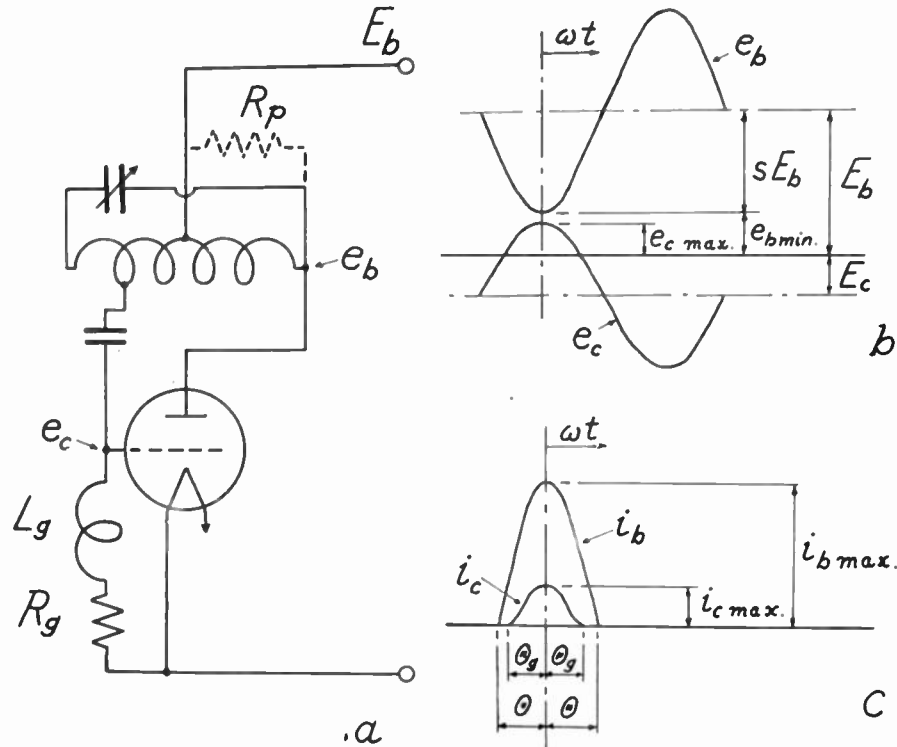

Fig. 3—Fundamentals. a. Schematic of a self-excited oscillator circuit. b. Time curves of plate voltage and grid voltage. c. Time curve of plate current and grid current.

Hence,

$$\frac{i_{b \max}}{I_l} = \left(-u + \frac{u}{\cos \Theta} \right)^\alpha \tag{8}$$

Dividing (7) by (8),

$$\frac{i_b}{i_{b \max}} = \left(\frac{\cos \omega t - \cos \Theta}{1 - \cos \Theta} \right)^\alpha \tag{9}$$

The mean value of plate current is

$$I_b = \frac{1}{2\pi} \int_{-\Theta}^{+\Theta} i_b d\omega t. \tag{10}$$

With (9),

$$I_b = \frac{1}{2\pi} \int_{-\Theta}^{+\Theta} i_{b \max} \left(\frac{\cos \omega t - \cos \Theta}{1 - \cos \Theta} \right)^\alpha d\omega t. \tag{11}$$

With the symbol,

$$F(\Theta)_\alpha = \frac{1}{2} \int_{-\Theta}^{+\Theta} \left(\frac{\cos \omega t - \cos \Theta}{1 - \cos \Theta} \right)^\alpha d\omega t. \tag{12}$$

$$I_b = \frac{1}{\pi} i_{b \max} F(\Theta)_\alpha. \tag{13}$$

The input power is

$$P_1 = E_b I_b = E_b \frac{1}{\pi} i_{b \max} F(\Theta)_\alpha. \tag{14}$$

The output power is

$$P_2 = \frac{1}{2\pi} \int_{-\Theta}^{+\Theta} (E_b - e_b) i_b d\omega t. \tag{15}$$

Substituting (1) and (9),

$$P_2 = \frac{1}{2\pi} \int_{-\Theta}^{+\Theta} E_b s \cos \omega t i_{b \max} \left(\frac{\cos \omega t - \cos \Theta}{1 - \cos \Theta} \right)^\alpha d\omega t. \tag{16}$$

By denoting

$$\frac{1}{2} \int_{-\Theta}^{+\Theta} \cos \omega t \left(\frac{\cos \omega t - \cos \Theta}{1 - \cos \Theta} \right)^\alpha d\omega t = G(\Theta)_\alpha, \tag{17}$$

(16) can be written

$$P_2 = \frac{1}{\pi} s E_b i_{b \max} G(\Theta)_\alpha. \tag{18}$$

With (13), (18) can be written

$$P_2 = s E_b I_b \frac{G(\Theta)_\alpha}{F(\Theta)_\alpha}. \tag{19}$$

With (14) and (19) the plate dissipation is

$$P_p = P_1 - P_2 = E_b I_b \left(1 - s \frac{G(\Theta)_\alpha}{F(\Theta)_\alpha} \right). \tag{20}$$

Now, the graph has to be drawn for the condition that the plate dissipation equals its rated value:

$$P_p = P_l. \tag{21}$$

From (19), (20), (21) the proportion between the output and the plate dissipation is

$$p = \frac{P_2}{P_l} = \frac{s \frac{G(\Theta)_\alpha}{F(\Theta)_\alpha}}{1 - s \frac{G(\Theta)_\alpha}{F(\Theta)_\alpha}} \tag{22}$$

from whence

$$s = \frac{p}{1+p} \frac{F(\Theta)_\alpha}{G(\Theta)_\alpha} \quad (23)$$

From (3) and (13)

$$\frac{i_{b \max}}{I_l} = \frac{\pi}{F(\Theta)_\alpha} \frac{E_b I_b}{P_l} \quad (24)$$

This can be written with (20), (21), and (22)

$$\frac{i_{b \max}}{I_l} = \frac{\pi}{F(\Theta)_\alpha} (1+p) \quad (25)$$

From (6)

$$E_c = \frac{uE_l + E_b}{\mu} \quad (26)$$

To draw Fig. 1, calculate the numerical values of $F(\Theta)_\alpha$ and $G(\Theta)_\alpha$ for different values of Θ between 0 and 90 degrees. Now, with Θ as a parameter, draw the p lines for the different values of p , using (23) for the abscissas and (25) for the ordinates. Connect the points pertaining to the same value of Θ . Draw the lines for the different values of u with Θ as a parameter using (8) for the ordinates and finding the abscissas by intersection with the corresponding Θ curve. The Θ curves serve only for the construction of the u curves. To simplify the figure, only a few of these lines have been left in the graph. The abscissas are marked with $e_{b \min}/E_b = 1-s$.

To reckon the curves of Fig. 2, denote the cutoff angle of grid current flow by Θ_g and remember that grid current starts and stops when $e_c = 0$. Hence

$$(E_c + e_{c \max}) \cos \Theta_g = E_c \quad (27)$$

or

$$\frac{E_c}{e_{c \max}} = \frac{\cos \Theta_g}{1 - \cos \Theta_g} \quad (28)$$

Now, from (2) and (27):

$$e_c = E_c \frac{\cos \omega t - \cos \Theta_g}{\cos \Theta_g} \quad (29)$$

from whence

$$\frac{e_c}{e_{c \max}} = \frac{\cos \omega t - \cos \Theta_g}{1 - \cos \Theta_g} \quad (30)$$

Assume that the grid current is proportional to the β th power of the grid voltage:

$$\frac{i_c}{i_{c \max}} = \left(\frac{\cos \omega t - \cos \Theta_g}{1 - \cos \Theta_g} \right)^\beta \quad (31)$$

from whence

$$I_c = \frac{1}{2\pi} \int_{-\Theta_g}^{+\Theta_g} i_c d\omega t$$

$$= \frac{1}{2\pi} \int_{-\Theta_g}^{+\Theta_g} i_{c \max} \left(\frac{\cos \omega t - \cos \Theta_g}{1 - \cos \Theta_g} \right)^\beta d\omega t \quad (32)$$

With the symbol given in (12),

$$I_c = \frac{1}{\pi} F(\Theta_g)_\beta i_{c \max} \quad (33)$$

The power consumption on the grid is

$$P_g = \frac{1}{2\pi} \int_{-\Theta_g}^{+\Theta_g} e_c i_c d\omega t \quad (34)$$

with (30), (31), and the symbol given in (12),

$$P_g = \frac{1}{\pi} F(\Theta_g)_{\beta+1} e_{c \max} i_{c \max} \quad (35)$$

The grid resistor must have the value

$$R_g = \frac{E_c}{I_c} = \frac{e_{c \max}}{i_{c \max}} \frac{\cos \Theta_g}{1 - \cos \Theta_g} \frac{\pi}{F(\Theta_g)_\beta} \quad (36)$$

E_c and I_c being substituted from (28) and (33).

If alternating current is withheld from the grid by the choke coil L_g , the power lost in this resistor is

$$P_{r(D.C.)} = E_c I_c = e_{c \max} i_{c \max} \frac{\cos \Theta_g}{1 - \cos \Theta_g} \frac{F(\Theta_g)_\beta}{\pi} \quad (37)$$

If no choke is used, the grid resistor will carry an alternating current corresponding to the alternating voltage on the grid. The peak value of this alternating voltage is $E_c + e_{c \max}$. The additional power consumption is, therefore,

$$P_{r(A.C.)} = \frac{(E_c + e_{c \max})^2}{2R_g} \quad (38)$$

which with (27) and (36) is

$$P_{r(A.C.)} = \left(\frac{E_c}{\cos \Theta_g} \right)^2 \frac{I_c}{2E_c} = \frac{E_c I_c}{2(\cos \Theta_g)^2} \quad (39)$$

From the addition of (37) and (39), the full power lost on the grid resistor in this case is

$$P_{r(D.C.)} + P_{r(A.C.)} = e_{c \max} i_{c \max} \frac{\cos \Theta_g F(\Theta_g)_\beta}{(1 - \cos \Theta_g)\pi} \left(1 + \frac{1}{2(\cos \Theta_g)^2} \right) \quad (40)$$

From (33), (35), (36), (37), and (40)

$$\frac{I_c}{i_{c \max}}, \frac{P_g}{i_{c \max} e_{c \max}}, \frac{R_g}{100e_{c \max} i_{c \max}}, \frac{P_{r(D.C.)}}{i_{c \max} e_{c \max}}, \frac{P_{r(D.C.)} + P_{r(A.C.)}}{i_{c \max} e_{c \max}}$$

are reckoned for various values of Θ_g and plotted on Fig. 2. The ordinates are marked with the ratio $E_c/e_{c \max}$ as reckoned from (28).

¹ If secondary emission takes place on the grid, the dissipation is higher.

We set the exponent $\alpha=1$, the exponent² $\beta=2$. With these values the integrals can be obtained in an elementary way.

IV. SETTING OF THE OPERATING CONDITIONS FOR A GIVEN TYPE OF TUBE

To use the graphs for any individual type of tubes follow this procedure.

1. Divide the rated plate dissipation with the rated plate-supply voltage to obtain

$$I_l = \frac{P_l}{E_b} \quad (3)$$

2. Find on the static characteristics of the tube the plate voltage E_l at which, with the grid voltage $e_c=0$, the plate current is I_l .

3. Set the amount of permissible peak cathode current. If not specified by the manufacturer take for each watt of heating power 8 milliamperes for pure-tungsten cathodes, 30 milliamperes for thoriated cathodes, and 100 milliamperes for oxide-coated cathodes.

4. Find along the $e_c=e_b$ line of the static characteristics the point at which the plate current plus twice the grid current³ equals the permissible peak cathode current.

5. Divide the plate voltage pertaining to this point by E_b to obtain

$$\frac{e_{b \min}}{E_b}$$

and divide the plate current pertaining to this point by $I_l=P_l/E_b$ to obtain

$$\frac{i_{b \max}}{P_l:E_b}$$

These are the co-ordinates in Fig. 1 of this point of operation.

6. Find on Fig. 1 the values of p and u pertaining to this point of operation and calculate the necessary bias

$$E_c = \frac{uE_l + E_b}{\mu} \quad (26)$$

and the output to be obtained

$$P_2 = pP_l \quad (22)$$

7. Find on the static characteristics of the tube the grid voltage and the grid current pertaining to the point of operation. Form the quotient $E_c/e_{c \max}$. Find the necessary grid resistor, the grid dissipation, the mean grid current and the power consumed in the resistor with the coefficients on Fig. 2.

If the grid dissipation is found to be too high, choose a new point of operation slightly to the right of the earlier one.

8. The resistance which has to be reflected to the plate is

$$R_p = \frac{(sE_b)^2}{2P_2} = \frac{s^2}{2p} \frac{E_b^2}{P_l}$$

9. The peak value of necessary driving voltage is $e_{c \max} + E_c$. If the tube is self-excited, as on Fig. 3, the necessary factor of regeneration is the ratio between the peak of the grid voltage and the peak of the plate-voltage swings:

$$\frac{E_c + e_{c \max}}{sE_b}$$

A self-excited tube draws the driving power from the plate circuit; accordingly, for self-excited tubes, grid dissipation and power lost on the grid resistor have to be deducted from the output found on Fig. 1.

Numerical Example.

A triode (Taylor *T* 40) has a thoriated cathode for 7.5 volts, 2.5 amperes. Its amplification factor is $\mu = 25$. Its continuous commercial service ratings are $E_b = 1250$ volts, $P_l = 40$ watts.

$$1. I_l = \frac{P_l}{E_b} = \frac{40}{1250} = 32 \text{ milliamperes.}$$

2. On the static characteristics the $e_c=0$ line assumes $i_b=32$ milliamperes at $e_b=600$ volts. Thus, $E_l=600$ volts.

3. Allow a peak cathode current of 7.5 volts \times 2.5 amperes \times 30 milliamperes per watt = 563 milliamperes.

4. On the static characteristics of the tube we find that with $e_b=e_c=130$ volts, $i_b=400$ milliamperes, and $i_c=85$ milliamperes. $400 + 2 \times 85 = 570$; thus we choose this point as peak of plate swing (point of operation) and write $e_{b \min} = 130$ volts, $e_{c \max} = 130$ volts, $i_{b \max} = 400$ milliamperes, and $i_{c \max} = 85$ milliamperes.

$$5. \frac{e_{b \min}}{E_b} = \frac{130}{1250} = 0.104$$

$$\frac{i_{b \max}}{P_l:E_b} = \frac{400}{32} = 12.5$$

6. On Fig. 1 we find that at the point with these co-ordinates $p=2.7$, $u=1.7$. Thus the grid bias has to be

$$E_c = \frac{uE_l + E_b}{\mu} = \frac{1.7 \times 600 + 1250}{25} = 91 \text{ volts.}$$

The power output is $P_2 = pP_l = 2.7 \times 40 = 108$ watts.

7. Write $i_{c \max} e_{c \max} = 85$ milliamperes \times 130 volts = 11 watts; $e_{c \max} : i_{c \max} = 130$ volts : 85 milliamperes = 1530 ohms.

² W. G. Wagener, "Performance of transmitting tubes," Proc. I.R.E., vol. 25, pp. 47-77, January, 1937. See pages 51 and 60.

³ The current density is higher near the grid wires. If the grid wires are close wound the factor 2 can be reduced.

$$\frac{E_c}{e_{c \max}} = \frac{91}{130} = 0.7$$

On Fig. 2 we find at this ordinate the grid dissipation $P_g = 0.16 \times i_{c \max} e_{c \max} = 0.16 \times 11 = 1.76$ watts the main grid current: $I_c = 0.2 i_{c \max} = 0.2 \times 85 = 17$ milliamperes the necessary grid resistor $R_g = 0.04 \times 100 \times e_{c \max} : i_{c \max} = 0.04 \times 100 \times 1530 = 6100$ ohms. As the curve cannot be read properly at this low value take the more exact value

$$\frac{E_c}{I_c} = \frac{91 \text{ volts}}{17 \text{ milliamperes}} = 5350 \text{ ohms.}$$

The power lost on this resistor if direct current only is allowed to pass it $P_{r(D.C.)} = 0.13 i_{c \max} e_{c \max} = 0.13 \times 11 = 1.43$ watts. The power lost on this resistor if it is connected to grid

$$P_{r(D.C.)} + P_{r(A.C.)} = 0.52 i_{c \max} e_{c \max} = 0.52 \times 11 = 5.7 \text{ watts}$$

8. The resistance reflected on the plate should be

$$R_p = \frac{s^2 E_b^2}{2p P_t} = \frac{(1 - 0.104)^2}{2 \times 2.7} \frac{1250^2}{40} = 5800 \text{ ohms.}$$

9. The necessary proportion of feedback is

$$\frac{E_c + e_{c \max}}{sE_b} = \frac{130 + 91}{(1 - 0.104) \times 1250} = 0.197.$$

If a tube is poorly designed or designed mainly for other services, and the capacity of emission of the cathode does not match the capacity of dissipation of the plate, the following irregularities will be noticed:

If the cathode is too weak the point of operation will fall below the line $u=0$. This means that the rated dissipation would not be reached even⁴ with $\Theta=90$ degrees. In such a case we still take $u=0$, but we note that the dissipation is below the rated in the proportion of the height of the actual point of operation to the height of the point of the $u=0$ line vertically above it. The power output will be the output pertaining to this latter point reduced in the same proportion.

With an overdimensioned cathode the point of operation will fall into the region where the p curves are drawn with dotted lines. In this case we will generally find on the $e_c=e_b$ line of the static characteristics a point lower than that found with the limit of cathode current, giving more output than that first. To find this point, draw the $e_c=e_b$ curve of the tube (with its co-ordinates expressed in terms of E_b and I_t) on Fig. 1 and find the point at which this line touches the (interpolated) line of greatest output. This new point of operation will give more output with a smaller peak cathode current.

The method described here has been used to set the operating conditions of a full line of transmitting tubes. The experimental results always corresponded perfectly to the predicted values except that the adjustment for regeneration had sometimes to be slightly different from that calculated. We attributed this to stray coupling between other parts of the plate circuit and the grid circuit. Life tests with our settings gave very satisfactory results.

⁴ Theoretically, with Θ up to about 120 degrees, a slightly higher output could be gained, but practically this is not recommended.

CORRECTIONS

Discussion on

"The Distribution of Amplitude with Time in Fluctuation Noise"*

VERNON D. LANDON

In the equations of the above discussion by K. A. Norton and Vernon D. Landon, errors occurred in the publication of certain exponents, which were originally submitted in correct form by the authors. The right-hand sides of the following equations should have appeared as given below.

$$\frac{2}{n} \exp(-V^2/n) V dV \quad (1a)$$

$$100 \exp(-V^2/n) \quad (2a)$$

$$\frac{2}{E_1^2 + E_2^2 + \dots + E_n^2}$$

$$\exp(-V^2/(E_1^2 + E_2^2 + \dots + E_n^2)) V dV \quad (1b)$$

* Proc. I.R.E., vol. 30, pp. 425-429; September, 1942.

$$100 \exp(-V^2/(E_1^2 + E_2^2 + \dots + E_n^2)) \quad (2b)$$

$$\frac{2}{E^2} \exp(-V^2/E^2) V dV \quad (1c)$$

$$100 \exp(-V^2/E^2) \quad (2c)$$

$$\frac{2V}{E^2} \exp(-V^2/E^2) \quad (17)$$

$$\frac{2}{\pi E^2} \int_{-\infty}^{+\infty} \frac{V}{\sqrt{V^2 - v^2}} \exp(-V^2/E^2) dV \quad (19)$$

$$\frac{1}{E\sqrt{\pi}} \exp(-v^2/E^2) \quad (20)$$

$$\frac{1}{E\sqrt{\pi}} \int_{-\infty}^{+\infty} v^2 \exp(-v^2/E^2) dv = \frac{E^2}{2} \quad (21)$$

Books

Radiotron Designer's Handbook (third edition), edited by F. Langford Smith.

Published by the Wireless Press for the Amalgamated Wireless Valve Company, Sydney, Australia. Wholly reproduced in the United States by lithograph process by the RCA under the direction of the RCA Manufacturing company, Harrison, N. J. 352+iv pages+8-page index. 268 illustrations. 5½×8½ inches. Price, \$1.00

"This handbook has been prepared expressly for the radio set designer, but will be found invaluable to all radio engineers, experimenters, and service mechanics. The information is arranged so that all those interested may derive some knowledge with the minimum of effort in searching"—Foreword. It is recommended to all radio workers as a compact collection of information on radio apparatus; the principles governing its design, the performance of many practical arrangements, and the formulas and tables which are most helpful to the designer.

The range of subjects is limited to the scope of radio broadcast receivers, and is unusually complete within this scope. The emphasis is on labor-saving, so the explanations are brief and there is a generous

supply of useful charts and formulas for all purposes. On every subject, there is a bibliography of further information, and these references are well chosen.

HAROLD A. WHEELER
Hazeltine Service Corporation
Little Neck, L. I., N. Y.

Standard Handbook for Electrical Engineers (seventh edition), edited by Archer E. Knowlton.

Published by McGraw-Hill Book Company, Inc., 330 W. 42 St., New York, N. Y. Revised and enlarged, August, 1941. 2278+xi pages+25-page index. 1757 figures. 6½×9×2½ inches. Price, \$8.00.

This edition follows the sixth edition after a lapse of eight years. The first noticeable change is the size. The page size of previous editions, based upon the original intention of a pocket or "hand" book, has been abandoned. The printed area of the page has been increased over sixty per cent. The number of pages has been reduced and the size type has been increased but the sum total remains an effective increase in content. This volume is much easier to read and to handle than the previous edition.

The material in the book follows the general plan of that in previous editions. Some reorganizing has been done so as to reduce the number of sections from twenty-eight to twenty-six. More emphasis has been put upon those parts in which there has been an increase in technology since the last edition. The three sections covering Wire Communication, Radio and Carrier Communication, and Electronics encompass the same number of pages in this volume as in the previous edition giving a proportionate increase.

Some sections have been merely revised and brought up to date, while others have been entirely rewritten. In the revised sections, new methods of presentation are to be found. Throughout, antiquated material has been dropped, and new material substituted.

The index has been enlarged to include mention of a subject when treated incidentally as part of other subject matter.

This book is valuable to the radio, electronic, or wire communication engineer, not for the treatment of his particular subject but for the basic information on closely allied engineering art of which he occasionally finds himself in need.

R. A. HEISING
Bell Telephone Laboratories, Inc.
New York, N. Y.

Contributors



W. G. CADY

W. G. Cady (A'24-F'27) was born on December 10, 1874, at Providence, Rhode Island. He received the Ph.B. degree in 1895 and the M.A. degree in 1896 from Brown University, the Ph.D. degree from the University of Berlin in 1900, and the D.Sc. degree in 1938 from Brown University. From 1895 to 1897, he was an instructor in mathematics at Brown University, and from 1900 to 1902 he was a magnetic observer with the United States Coast and Geodetic Survey. He became an instructor in physics at Wesleyan University in 1902; associate professor in 1904; and since 1907 has been a professor. He was a member of the Board of Direction of the Institute of Radio Engineers in 1928 and President in 1932. Dr. Cady received the Morris Liebmann Memorial Prize from the Institute of Radio Engineers in 1928 and the Duddell Medal from the Physical Society of London in 1937. He was a member of the Division of National Sciences of the National Research Council from 1935 to 1938.



Carl B. Feldman (A'26) was born at St. Peter, Minnesota, on March 26, 1902.



CARL B. FELDMAN

He received the B.S. degree in 1926 and the M.S. degree in 1928 from the University of Minnesota. Since 1928 Mr. Feldman has been with the Bell Telephone Laboratories.



J. C. FROMMER

Joseph Charles Frommer was born at Budapest in 1904. He received the degree of mechanical engineering from the Hungarian Technical University in 1925 and did research work there the following year. From 1926 to 1927 Mr. Frommer worked in the Liancourt (France) plant of agricultural tractors of the Austin automobile works, and from 1928 to 1929 in a textile mill in Budapest. From 1929 to 1939 he was a member of the research laboratory of the United Incandescent Lamp and Electric Co. (TUNGSRAM works), Uj-



S. A. SCHELKUNOFF

pest, Hungary, doing research work in connection with the production of photocells, vacuum tubes, incandescent lamps, design of valve circuits, and the setting of operating ratings. During 1940-1941 he was employed at the McKay-Massey-Harris Harvester works, Sunshine, Australia,

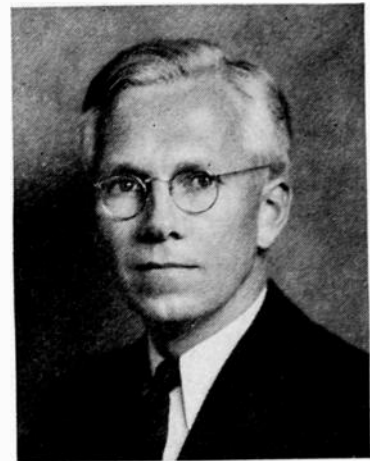

KARL S. VAN DYKE

and during 1941-1942 he did development work at the Beck-Lee Corporation in Chicago. He is now in charge of the research department of the Ajax Engineering Company in Chicago.



For a biographical sketch of C. W. Harrison, Jr., see the PROCEEDINGS for May, 1942; for Jesse B. Sherman, see the PROCEEDINGS for January, 1942.



S. A. Schelkunoff (A'40) received the B.A. and M.A. degrees in mathematics from the State College of Washington in 1923, and the Ph.D. degree in mathematics from Columbia University in 1928. He was in the engineering department of the Western Electric Company from 1923 to 1925; the Bell Telephone Laboratories from 1925 to 1926; the department of mathematics of the State College of Washington, 1926 to 1929; and Bell Telephone Laboratories, 1929 to date. Dr. Schelkunoff has been engaged in mathematical research, especially in the field of electromagnetic theory.



LAWRENCE A. WARE

Karl S. Van Dyke (A'15-M'26) was born at Brooklyn, New York, on December 8, 1892. He received the B.S. degree in 1916 and the M.S. degree in 1917 from Wesleyan University, and the Ph.D. degree in 1921 from the University of Chicago. From 1916 to 1917 Dr. Van Dyke was an assistant in physics at Wesleyan University; 1917 to 1919 in the general engineering department of the American Telephone and Telegraph Company; 1919 to 1921, assistant in physics at the University of Chicago; 1921 to 1925, an assistant

professor of physics at Wesleyan University; 1925 to 1928, associate professor; and 1928 to date, professor. He is a Fellow of the American Association for the Advancement of Science, and a Member of the American Physical Society, the Acoustical Society of America, and Sigma Xi.



Lawrence A. Ware (A'41) was born at Bonaparte, Iowa, on May 21, 1901. He received the B.E. degree in electrical engineering in 1926, the M.S. degree in physics

in 1927, the Ph.D. degree in physics in 1930, and the E.E. degree in 1935, all from the University of Iowa. From 1929 to 1933 Dr. Ware was a transmission engineer with the Bell Telephone Laboratories; from 1935 to 1937 he was assistant professor of physics at Montana State College; and since 1937 he has been assistant professor of electrical engineering at the University of Iowa. He is a member of the American Institute of Electrical Engineers, the American Physical Society, Eta Kappa Nu, Sigma Xi, and Tau Beta Pi.

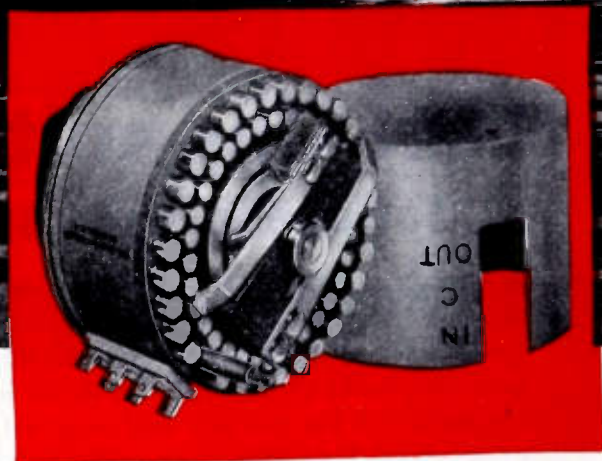

to **DISTANT HORIZONS**

DAVEN engineers, like Pan American clippers poised for flight to distant lands, are charting future applications for our products.

Tomorrow, DAVEN equipment will reach beyond the confines of the Broadcast, Sound Picture, Television and Electrical fields . . . into the expanding industrial applications that are appearing on the electronic horizon.

A DAVEN catalog should be in your reference files. We list the most complete line of precision attenuators in the world; "Ladder," "T" type, "Balanced H" and potentiometer networks—both variable and fixed. Also, more than 80 models of Laboratory Test Equipment as well as Super DAVOHM precision type wire-wound resistors, with accuracies from $\pm 1\%$ to $\pm 0.1\%$. A request will bring this catalog to you.

THE DAVEN COMPANY

158 SUMMIT STREET

NEWARK, NEW JERSEY



Oil Capacitors for use in tight spots

● Something *new* has been added to this long-popular Aerovox "10" series Hyvol capacitor. Note the *double terminals*—spaced on the stepped bakelite threaded terminal post. This means the can is now insulated or "floating," as compared with the previous single-terminal grounded-can construction. No longer is an insulator washer required when a non-grounded mounting on metal chassis is desired.

The "10" series Hyvol is as convenient to install as the usual metal-can electrolytic. Compact. Inverted-screw mounted. And now the insulated-can feature to top it all.

Write for DATA . . .

- This is but one of several types of oil-filled high-voltage capacitors offered by Aerovox, to meet all standard requirements. Special types are developed and produced to meet extraordinary requirements. If you do not have the Aerovox catalog in your working library, write for it.

AEROVOX "10" SERIES with new insulated-can double-terminal feature

- Double terminals spaced on the stepped bakelite threaded terminal post, providing maximum insulation and spacing for convenient wiring.
- Insulated or "floating" can. No insulator mounting washer required for non-grounded mounting on metal chassis.
- Standard units in 600 v., 2, 3 and 4 mfd.; 1000 v., 1 and 2 mfd.; and 1500 v., .5 and 1 mfd. Can sizes: 1½" dia. by 2⅞" to 5¼" high.
- Metal can. Inverted screw mounting. Hyvol dielectric oil maintains effective capacity even at freezing temperatures.

NEW BEDFORD, MASS.,
U. S. A.
Sales Offices in All
Principal Cities

AEROVOX

CORPORATION

In Canada
AEROVOX CANADA LTD.
Hamilton, Ont.
EXPORT: 100 Varick St., N. Y.
Cable 'ARLAB'

What Isolantite is Doing To Supply the Materials that Help Keep Communications Open

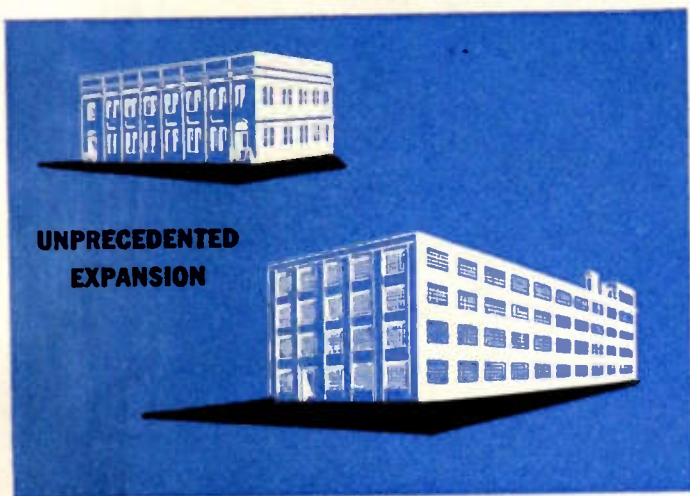

(Above) No one who hasn't been here to see it happen would recognize the great, humming plant that is Isolantite, Inc. today. Here at Isolantite the change has been extraordinary—even for these times. For the products of Isolantite help to keep vital war communication lines operating efficiently.

(Right) Isolantite has not only met the most rigid Government specifications, but found ways to improve the quality of its products and service. Still newer bodies in process of development will increase the efficiency and reliability of communications equipment for wartime service, and promise finer performance in radio once the war is over.

(Below) In some fields of Isolantite activity, notably small pressed parts, there is output capacity to spare. When parts of this type are needed for war applications, Isolantite can make delivery with unusual promptness.

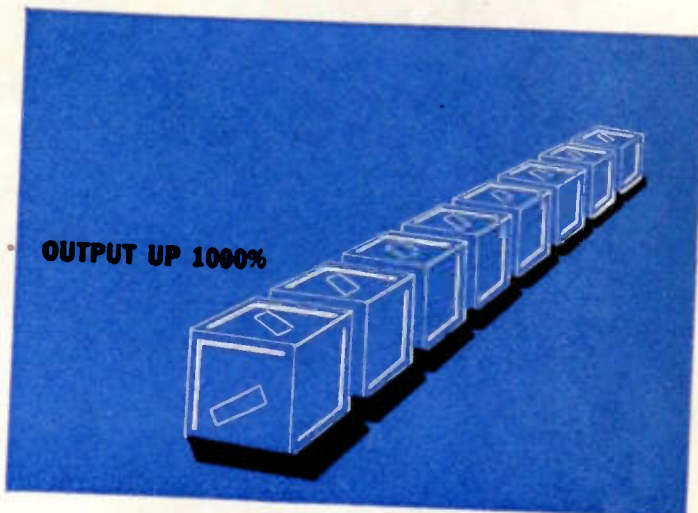

(Above) Isolantite has increased production of precision ceramic parts to ten times the level of two years ago. There is no pause in Isolantite's research for new and improved manufacturing methods, numerous and revolutionary as these have been.



ISOLANTITE

CERAMIC INSULATORS

ISOLANTITE INC., BELLEVILLE, NEW JERSEY



Thanks, Radio Designers, FOR GIVING US SETS THAT ARE SIMPLE!

There's one test our fighting men everywhere apply to that piece of radio equipment you design:

"Does it work when we need it? Can we fix it if anything goes wrong?"

And there's one way you can make sure your radio equipment will meet that test:

Keep it simple. Don't over-design. Don't complicate it with "special" tubes and parts.

For in the far corners of the world, in the distant and isolated outposts where your radio equipment must serve and serve well—there may be no means for repairing or replacing those "special" parts. And a piece of vital radio equipment upon which thousands of lives and the issue of a battle perhaps depend—may be idle and useless at the very moment it's needed most.

The Army and Navy have just issued a joint preference list of radio tubes. You are not only helping yourself, but the entire war effort by sticking to the tubes on this

list. Use standard equipment, standard crystals, standard transformers and condensers and tubes wherever you can.

Our fighting men the world over, who depend on the equipment you design, will send you a fervent "Thanks!"

RADIO TUBE FACTS YOU'LL WANT TO HAVE HANDY!

Here are two useful folders you'll want to keep at your elbow for constant reference.

"RCA Receiving Tubes" lists characteristics of receiving and allied special-purpose tubes and illustrates socket connections. It's yours FREE! Write to Commercial Engineering Section, RCA Manufacturing Company, Inc., Harrison, N. J.

"RCA Guide for Transmitting Tubes" includes special chart for transmitting tubes (air- and water-cooled), cathode-ray tubes, special-purpose tubes, and phototubes. It's packed with information to help you choose the right tube for the job and get the most out of it on the job. Price 35c. Get it from any RCA Jobber or send remittance to above address.



★ BUY U. S. WAR BONDS EVERY PAYDAY ★

RCA RADIO TUBES

RECEIVING TUBES • POWER TUBES • CATHODE RAY TUBES • SPECIAL PURPOSE TUBES

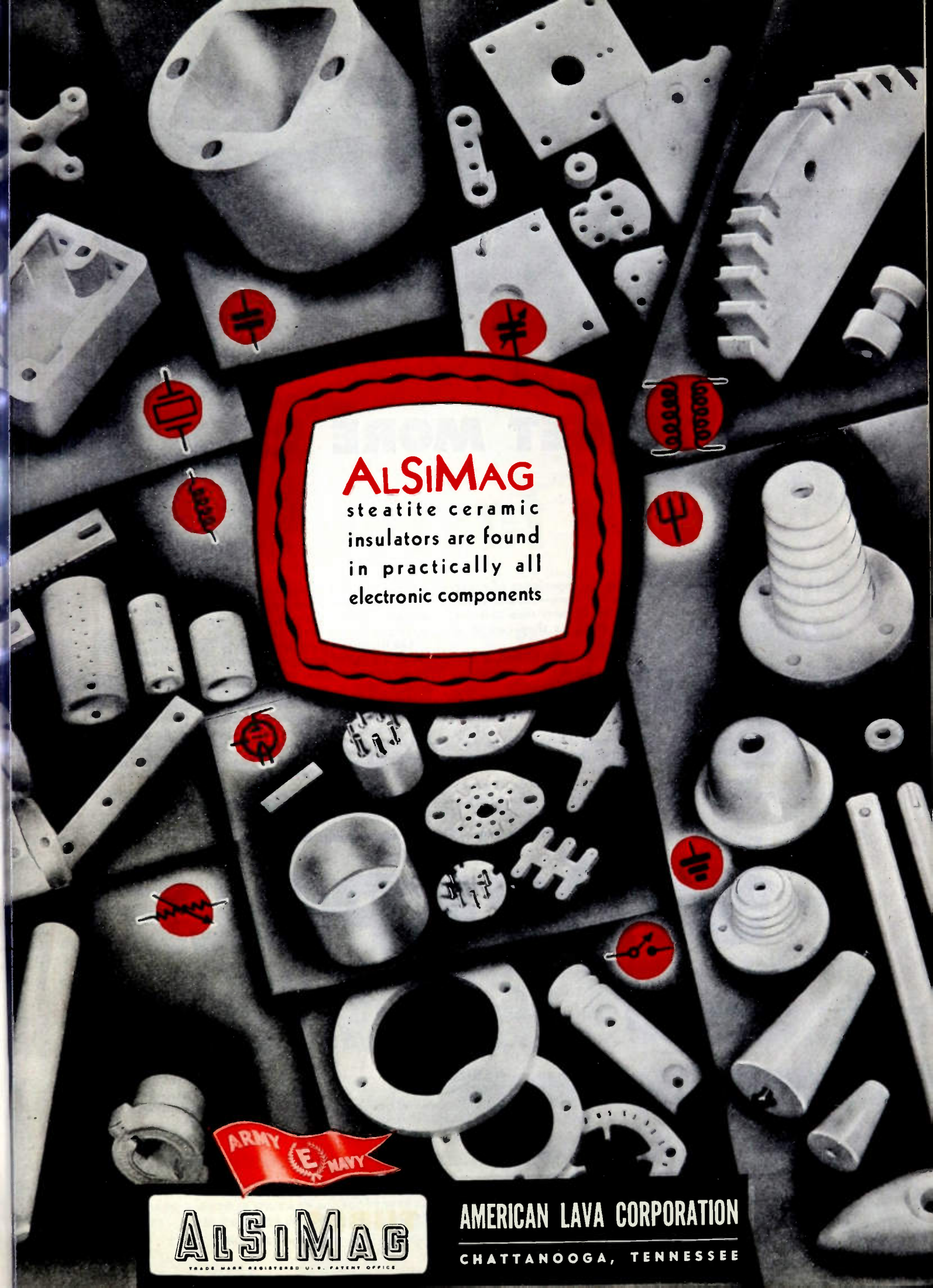

ALSiMAG
steatite ceramic
insulators are found
in practically all
electronic components



ALSiMAG
TRADE MARK REGISTERED U. S. PATENT OFFICE

AMERICAN LAVA CORPORATION
CHATTANOOGA, TENNESSEE



HOW TO GET MORE RESISTORS

faster

In general—and based on the experience of other manufacturers as well as our own—carbon composition resistors can be made *more than twice as fast* to a tolerance of $\pm 20\%$, as they can to a tolerance of $\pm 10\%$.

They can be produced four times as fast, if the tolerance is $\pm 20\%$ instead of $\pm 5\%$ —and the resulting scrap or wastage is reduced by a similar figure!

Obviously, close tolerances are essential on many applications and Stackpole is producing such resistors in tremendous quantities. In other cases, however, $\pm 20\%$ resistors will prove entirely satisfactory, just as they did in approximately 95% of all civilian radio manufacture.

This is especially true in applications calling for resistors of .25 megohms and over. In these higher

ranges, resistor tolerances often lose their relative importance—whereas resistor manufacturing difficulties actually increase, even beyond the percentages previously mentioned.

On higher value resistors, it is also well to consider the use of lower wattage units which are just as satisfactory and, at present, are more readily obtainable.

As the largest manufacturer of carbon resistors, Stackpole will cooperate to the hilt in meeting any war demands. It will help us to help you, however, if care is taken when ordering resistors to avoid specifying any closer tolerance or higher wattage rating than is actually required.

STACKPOLE CARBON COMPANY, ST. MARYS, PA.

Sold to manufacturers only—Catalog and samples on request.

STACKPOLE

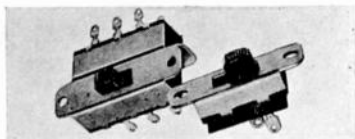

SWITCHES

Slide operated (either indexed or momentary contact type) — Rotary Index and Toggle types.

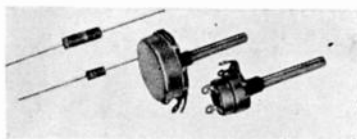

RESISTORS

(Fixed or Variable)

Carbon composition resistors, fixed types up to 4 watts—Variables in 4 different types.

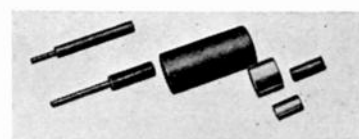

IRON CORES

Molded from metallic powders in a wide variety of grades and sizes for use at frequencies as high as 150-175 meg.

STACKPOLE FOR CARBON — BRUSHES (all types for all rotating machines) — CONTACTS (all carbon, graphite, metal and composition types — also molded rare metal contacts) — ANODES — ELECTRODES — BRAZING BLOCKS — BEARINGS — WELDING RODS, ELECTRODES AND PLATES — PIPE — PACKING, PISTON AND SEAL RINGS — RHEOSTAT PLATES AND DISCS — BRAKE LINING, etc.



**Attention to
Details!**

Near technical perfection is achieved through use of scientific instruments but the trained eyes of skilled workmen inspect completed units before they are passed along to the pumps

An important reason why Eimac tubes set the modern pace in communications

In the fabrication of plates, sealing of stems and leads, winding of grids...every tiny part must pass the rigid inspection of trained individuals, precision testing devices. At the end of each production line sits a group of hardboiled inspectors. All this checking and testing takes place before Eimac tubes reach the vacuum pumps. That's one of many reasons why Eimac tubes possess such uniformity of characteristics . . . why their performance records have made them first choice among world's leading engineers.

Follow the leaders to

Eimac
TUBES

Manufactured by EITEL-McCULLOUGH, INC., SAN BRUNO, CALIFORNIA, U. S. A.
Export Agents: Frazar & Co., 301 Clay St., San Francisco, California, U. S. A.

utilizes polarized light in search for stress
in glass beads which seal leads to bulbs



Polariscope is here used to inspect glass bulbs for flaws
or strain which may occur during the shaping operations



General inspection bench where completed filament
stems and assemblies are thoroughly checked for faulty
construction



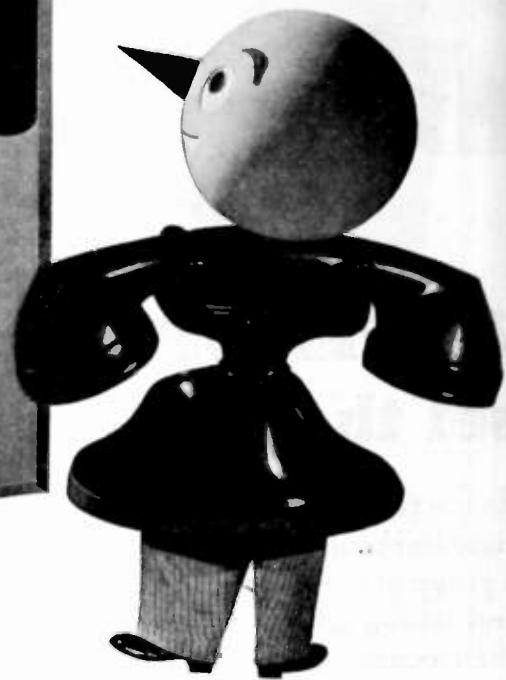

"If I were twice as big"

"Then I could give the public all the service it wants and take care of the war on top of that.

"But I can't get bigger now because materials are needed for shooting. So I'm asking your help to make the most of what we have.

"Please don't make Long Distance calls to centers of war activity unless they are vital. Leave the wires clear for war traffic."

BELL TELEPHONE SYSTEM





**THE RADIO "LAB"
THAT GOES ALOFT**

On a special mission, radio communication between plane and base may be limited to specified frequencies . . . during specified minutes. That, for the radio officer, means fast, accurate checking of frequencies.

With the "BENDIX" Frequency Indicator he accomplishes this with *laboratory precision* . . . adjusts his set, begins transmitting . . . in a matter of seconds.

Men and women of Bendix Radio take pride in knowing that receiving and transmitting equipment bearing the "BENDIX RADIO" nameplate is flying with our fighting pilots on all our vital battle fronts.

Products of the Bendix Radio Division are important members of "The Invisible Crew" . . . precision built instruments and controls which 25 Bendix plants from coast to coast are speeding to our fighting crews on world battle fronts.

THE INVISIBLE CREW

Precision

Equipment by

Bendix
AVIATION CORPORATION

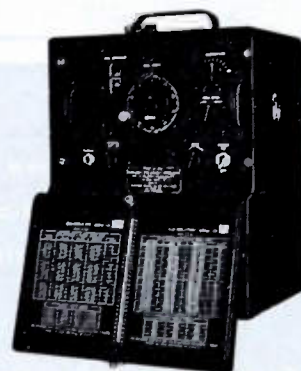

"BENDIX RADIO" Portable Frequency Indicator Equipment provides laboratory precision in the air in a compact, portable form, over a wide range of frequencies.

BENDIX RADIO DIVISION **BENDIX RADIO**

Centralab *now Serves Itself and the Industry with* **STEATITE**

CENTRALAB has added a new plant of large capacity for the production of glazed and unglazed STEATITE.

This highly critical, strategic material is an important factor in the operation of ultra high frequency equipment.

Centralab's STEATITE plant is in a position to furnish coil forms up to 5 inches diameter and pressed pieces to approximately 6 inches square. The same high standards of excellence will be maintained in this department that have characterized every other Centralab product during the past decades. The Centralab Ceramic department that has been in existence since 1930 has built up an extensive engineering, production and laboratory background to ensure a product of the highest quality that fully meets military specifications.

STEATITE is an extremely dense non-porous ceramic of high mechanical strength with low loss factor and low dielectric constant. It can be fabricated in various cylindrical and flat shapes by extrusion or pressing. Centralab is also equipped to engineer and manufacture other grades of ceramics.

CENTRALAB — Division of Globe-Union Inc., Milwaukee, Wis.

1930 Centralab pioneered a fixed resistor of "hard-as-stone" ceramic material.



1936 Centralab added a temperature compensating fixed condenser of ceramic material.



1940 Centralab added a trimmer condenser with temperature compensating characteristics



*Ceramics
by Centralab*

1942 Centralab added a STEATITE plant to take care of its own needs and those of the industry.



THE INSTITUTE serves those interested in radio and allied electrical communication fields through the presentation and publication of technical material.

THE PROCEEDINGS has been published without interruption since 1913 when the first issue appeared. The contents of each paper published in the **PROCEEDINGS** are the responsibility of the author and are not binding on the Institute or its members. Material appearing in it may be reprinted or abstracted in other publications on the express condition that specific reference shall be made to its original appearance in the **PROCEEDINGS**. Illustrations of any variety, however, may not be reproduced without specific permission from the Institute.

STANDARDS reports are published from time to time and are sent to each member without charge. The four current reports are on Electroacoustics, Electronics Radio Receivers, and Radio Transmitters and were published in 1938.

MEMBERSHIP has grown from a few dozen in 1912 to about seven thousand. Practically every country in the world in which radio engineers may be found is represented in our roster. Dues for the five grades of membership range from \$3.00 to \$10.00 per year. The **PROCEEDINGS** is sent to each member without further payment.

SECTIONS in twenty-six cities in the United States, Canada, and Argentina hold regular meetings. The chairmen and secretaries of these sections are listed on the page opposite the first article in this issue.

SUBSCRIPTIONS are accepted for the **PROCEEDINGS** at \$10.00 per year in the United States of America, its possessions, and Canada; when college and public libraries order direct from the Institute, the subscription price is \$5.00. For other countries there is an additional charge of \$1.00.

The Institute of Radio Engineers, Inc.
Harold P. Westman, Secretary
330 West 42nd Street
New York, N.Y.

The Institute of Radio Engineers

Incorporated

330 West 42nd Street, New York, N.Y.

To the Board of Directors

Gentlemen:

I hereby make application for ASSOCIATE membership in the Institute of Radio Engineers on the basis of my training and professional experience given herewith, and refer to the sponsors named below who are personally familiar with my work.

I certify that the statements made in the record of my training and professional experience are correct, and agree if elected, that I shall be governed by the Constitution of the Institute as long as I continue a member. Furthermore I agree to promote the objects of the Institute so far as shall be in my power.

.....
(Sign with pen)

.....
(Address for mail)

.....
(City and State)

.....
(Date)

SPONSORS

(Signatures not required here)

Mr.

Address

City and State

Mr.

Address

City and State

Mr.

Address

City and State

When Space is at a Premium

TRIPLETT
Thin Line
INSTRUMENTS



Full size of Instrument. Note deep shroud for glass protection—and "Quick-Look" Scale.

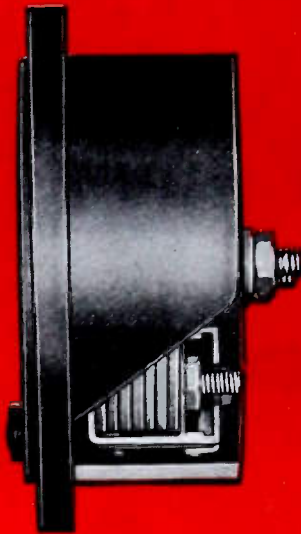

This molded case contains full size Triplet Mechanism. Rugged Construction—Compact Convenience.

THIS IS THE INSIDE STORY

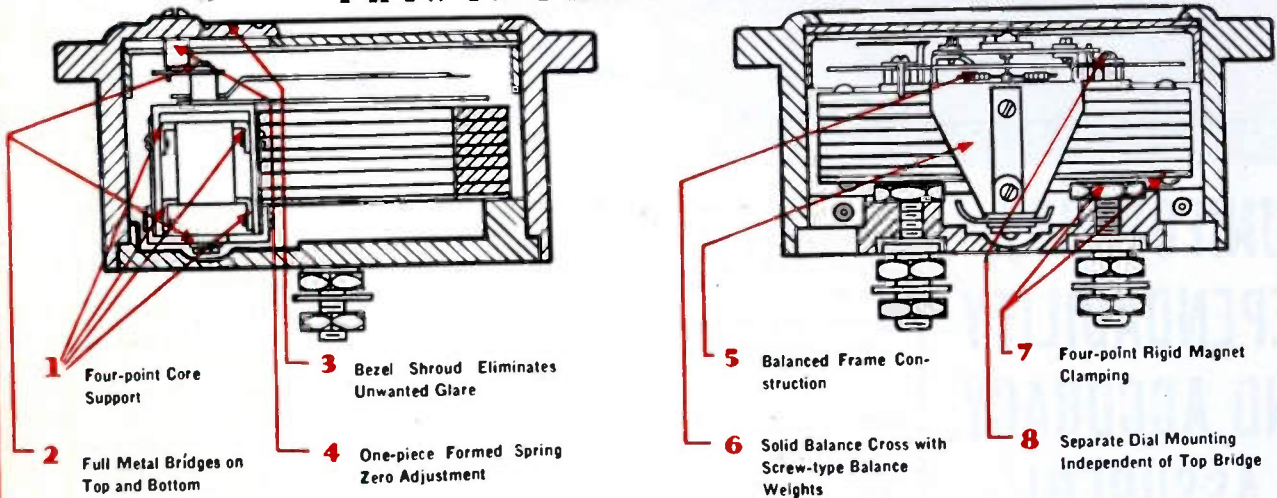

Thin-Line Instruments also have Standard Large Coil Triplet Movements. Furnished with Osmium pivots for special requirements. All these features make for greater rigidity under vibration; greater permanence of calibration; greater user satisfaction.

TRIPLET
Thin-Line

memo

FOR CIRCULATION TO...

Triplet Thin-Line Instruments meet rigid requirements for dependable performance. Though occupying minimum space they are *not* miniatures. Mechanisms are standard size with emphasis on excellent performance over long periods. Standardized installation. Made in three styles of cases — Molded, Metal Wide Rim and Metal Narrow Rim.

Triplet Thin-Line Instruments, available for many industrial applications, can be depended upon for precision performance in limited space. For full details write for "Triplet Thin-Line Bulletin".

THE TRIPLET ELECTRICAL INSTRUMENT CO., BLUFFTON, OHIO, U. S. A.

PLEASE INSERT INITIALS OF YOUR EXECUTIVES

✓



**UNIFORMITY,
DEPENDABILITY
AND ACCURACY
ASSURED!**

-hp- instruments are as revolutionary as the one dial radio.

Dependability of **-hp-** measuring devices is assured by the rigid standards maintained in production. Prior to shipment, each instru-

Here a Model 200B is being checked for distortion with a 325A Distortion Analyzer. Model 325A is a new instrument designed for measuring harmonic distortion, frequency response, hum and noise level on audio equipment.

ment is carefully adjusted and its performance checked against accurate standards. Even before the instrument is assembled, component parts are measured and tested to insure precise performance in the finished instrument.

Needless to say that **-hp-** instruments themselves are used in the production line to check the accuracy of other **-hp-** instruments being manufactured.



HEWLETT PACKARD COMPANY

BOX 135—P. STATION A, PALO ALTO, CALIFORNIA

Section Meetings

ATLANTA

- "Radiations from Directional Antennas," by J. H. DeWitt, Jr., Chief Engineer, WSM, April 17.
- "The Western Union Telefax System," by L. H. Williams, Western Union Telegraph Company, June 19.
- "Wartime Maintenance and Operation of Broadcast Stations," Roundtable Discussions, September 25.

CHICAGO

- "Elements of Ultra-High-Frequency Design," by Robert E. Beam and A. B. Bronwell, Northwestern University, October 2.

CINCINNATI

- "Improving WSAI in Downtown Cincinnati" by J. L. Hollis, Crosley Corporation, September 22.

CONNECTICUT VALLEY

- "Modern Cathode-Ray Tubes" by L. B. Headrick, RCA Manufacturing Company, June 4.

DETROIT

- "Wave Guides" by Stephen S. Atwood, University of Michigan, September 18.
- "Klystron—Generator of Microwaves" by Lewis N. Holland, University of Michigan, September 18.

EMPORIUM

- Sound Movies from General Electric Company and Lytton Engineering Company on Frequency Modulation, Oil-Filled Cables, and Glass Working, September 29.

INDIANAPOLIS

- "Application of Cathode Followers," by Charles E. Rainwater, April 24.

LOS ANGELES

- "Theory and Practical Operation of Wired Music as Provided by Muzak," by Richard Simonton, September 15.
- Seminar of Current Radio Problems, directed by C. F. Wolcott, Gilfillan Brothers, Inc., September 15.

PHILADELPHIA

- "A New Approach to the Problem of Phonograph Reproduction," by C. M. Sinnett, speaker, and G. L. Beers, co-author, RCA Manufacturing Company, October 1.

PORTLAND

- "Electrical Indicating Instruments," by John Wright, Wright Meter Repairing Service, September 23.
- Review: "A Secondary Frequency Standard Using Regenerative Frequency Dividing Circuits" by F. R. Stansel, April, 1942, PROCEEDINGS, Francis McCann, Federal Communications, Commission, September 23.

SAN FRANCISCO

- "Video Coupling Units," by Austin V. Eastman, University of Washington, September 16.

WASHINGTON

- "Effect of Solar Activity on Radio Communication," by H. W. Wells, Carnegie Institution, September 14.

"Get the Message Through!"

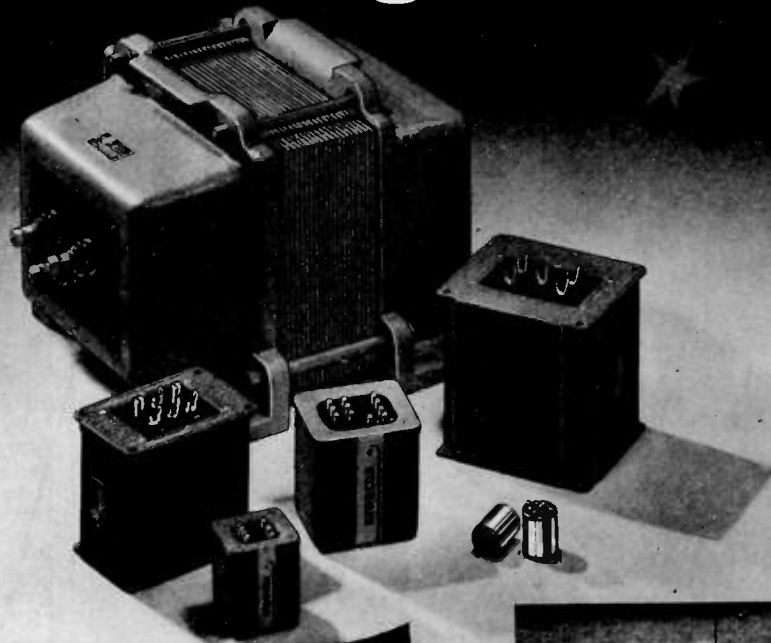

STANCOR
"MADE-TO-ORDER"
TRANSFORMERS

"GET THE MESSAGE THROUGH!"—the slogan of the U. S. Signal Corps—typifies the importance of communications in our armed forces.

★★★STANCOR is geared to the vital necessities of the Signal Corps. Lives depend upon it! Successful operations depend upon it! "Unfailing accuracy" therefore is the STANCOR watchword.

Laboratory research and skillful engineering always have been highly important in the production of STANCOR Transformers. Now, more than ever before, these factors are emphasized in many new fields and in many new uses.

Illustrated above are a few of the many "MADE-TO-ORDER" STANCOR Transformers that are "precision performers." We can assist you in solving your transformer problems and meet your needs in compliance with exacting government specifications. Submit your requirements today.

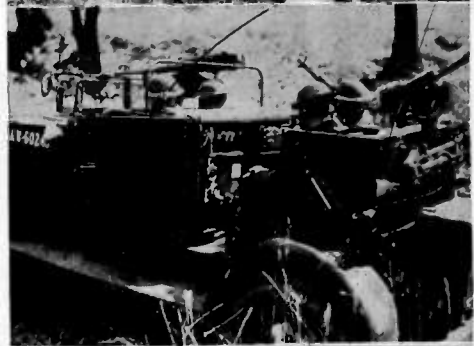
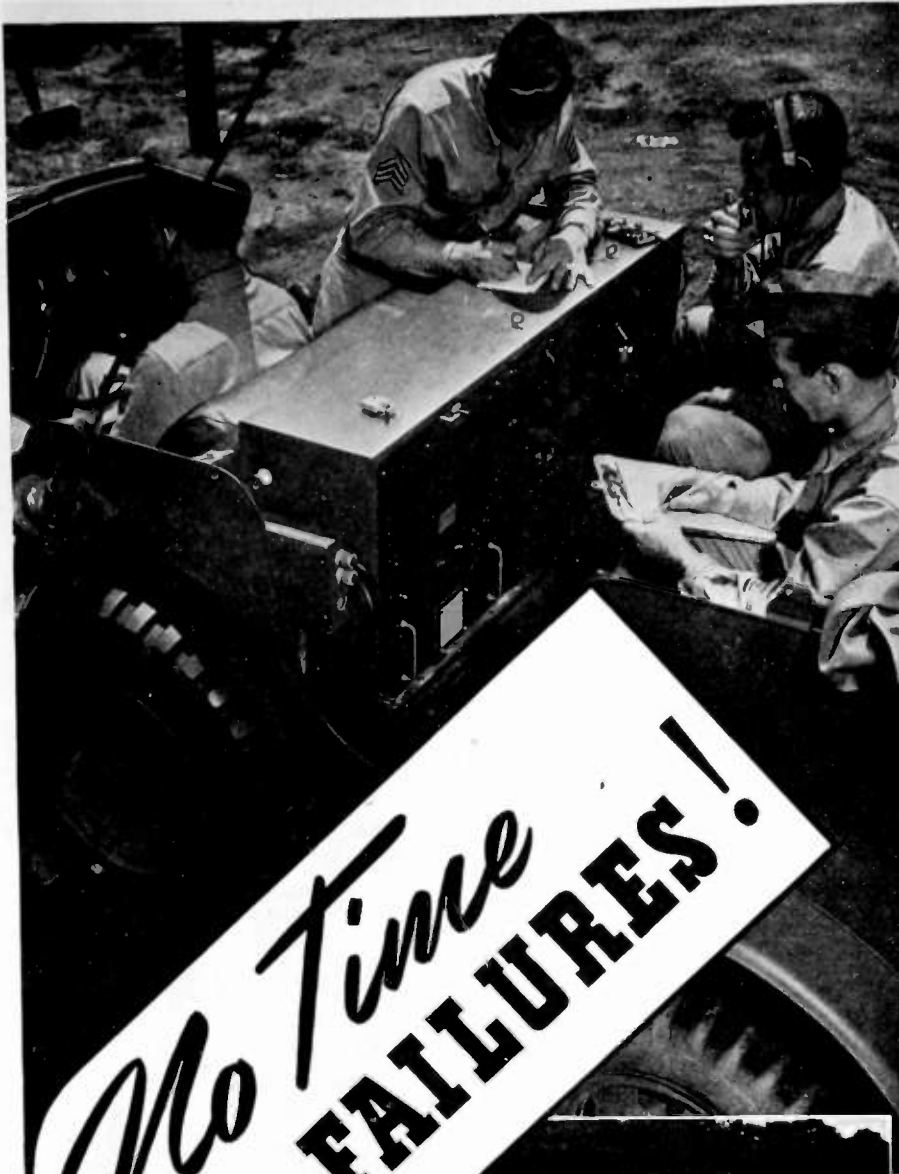

PHOTO BY U. S. SIGNAL CORPS



STANDARD TRANSFORMER
• CORPORATION •
1500 NORTH HALSTED STREET • • • CHICAGO



No Time
FOR FAILURES!

Dependable Men

Dependable Equipment

Dependable Transformers



Official Photographs U. S. Army Signal Corps

When seconds are the determining factor in success or failure of an attack . . . When lives depend upon the perfect operation of communications equipment . . . then engineers insist upon dependable transformers. Thordarson transformers are engineered to give high quality performance under every operating condition.

THORDARSON

ELECTRIC MFG. CO.

500 WEST HURON STREET, CHICAGO, ILLINOIS

Transformer Specialists Since 1895



Army-Navy "E" Honor Roll

History of the Army-Navy "E" Award. In 1906 the Navy instituted the "E" pennant as an award for excellence in gunnery, and later extended this to engineering and communications. Prior to Pearl Harbor the Navy gave the award to a few firms and organizations which showed excellence in producing ships, weapons and equipment for the Navy.

Since Pearl Harbor, the Army and Navy have joined together in making a combined Army-Navy "E" award to both plants and their employees, who working as a team have given "excellent" performance in the battle for production.

In October the *PROCEEDINGS* reported briefly on 14 firms serving the radio industry who have won the honored Army-Navy "E" award. From time to time we hope to give additional reports as further firms win this honor.

RCA Manufacturing Company, Inc., Radiotron Division, celebrated the winning of the Army-Navy "E" award on September 8, 1942 at Roosevelt Park, Harrison, New Jersey. The presentation of the award was made by Lt. Col. Oscar C. Maier, Director of Signal Corps General Development Laboratories, Fort Monmouth, New Jersey. The award was accepted for the company by Mr. J. A. King, Manager of the plant. Lt. J. Douglas Gessford, U.S.N.R. made the presentation of the "E" pins and Joseph Mayer, President, Employees' Council, accepted these pins for the employees. A particularly interesting feature of the ceremony was the singing and broadcasting by radio of a song entitled "It's All Done with Radio." This song was written by Mr. Jack Mason and dedicated to the U. S. Signal Corps by the employees of the Radiotron Division.

The winning of the Army-Navy "E" is a logical outcome of RCA's "Beat the Promise" program which has been in operation in all RCA divisions. This great campaign won for RCA Victor, Camden, N. J., the Navy "E" pennant which was awarded to the company on January 27th and celebrated April 27, 1942 when Admiral Watts awarded the Navy "E" pins to employees.

Ward Leonard Electric Company and its employees celebrated the winning of the Army-Navy "E" award at the Wood Auditorium, Mount Vernon, New York on October 1, 1942. 2500 employees marched from their various factories to the auditorium accompanied by three bands, including that of the Eighth Regiment. Rear Admiral W. C. Watts U.S.N.R. made the award which was accepted for the company by Leonard Kebler, President. The presentation of the "E" pins to employees was made by Capt. J. T. Rhudy, U.S.A. Signal Corps and accepted by John Seixas, President of the Employees Organization. Mr. Kebler also took this ceremony as an opportunity to present three plaques to men serving 50 years with the company. These employees were George Warren Camp, Thomas Layden and Joseph Lynch.



“WELL DONE”

**.. SAY OUR ARMED FORCES TO
EMPLOYEES AND MANAGEMENT AT *Motorola***



IN WARTIME

**Motorola Mobile and
Portable 2-Way F. M.
Communication Systems
for Our Armed Forces
A.M. and F.M. Emergency
Communication Systems**

IN PEACETIME

***Motorola Radio*
for Car and Home**

**Radio Communication Systems
Designed and Engineered to Fit Special Needs**

GALVIN MFG. CORPORATION · CHICAGO

QUICK DELIVERY ON CONDENSERS!

INDUSTRIAL CONDENSER CORP.

through a new distribution plan enables you to secure *small lots* of condensers locally. Contact the Industrial Condenser district office nearest you:

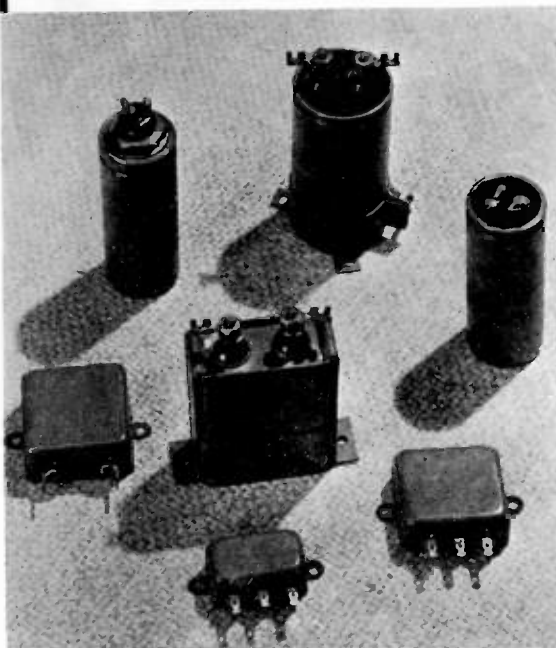

ADDRESS	TELEPHONE NO.
Box 1052 Dallas, Texas	Logan 6-1685
117 Water St. Bdston, Mass.	Hancock 0200
2024 W. Eleventh St. Los Angeles, Calif.	Drexel 7163
Box 1202 Asheville, N.C.	7149-J
27 Park Place New York, N.Y.	Barclay 7-4977
Rm. 220—Medical Arts Bldg. 34th & Broadway Kansas City, Mo.	Westport 5323
1456 Waterbury Road Lakewood (Cleveland), Ohio	Academy 4932
2434 W. 22nd St. Minneapolis, Minn.	Kenwood 2833
1135 Lincoln Tower Ft. Wayne, Ind.	Anthony 5278
2016 Third Ave. Seattle, Wash.	Seneca 1088
Lutz (Tampa), Fla.	99-144
6432 Cass Ave. Detroit, Mich.	Madison 6300
401 N. Broad St. Philadelphia, Pa.	Walnut 4163

Engineers Attention! Condensers immediately available from distributors stocks meet Army and Navy requirements . . . Industrial Condensers are specified where precision is vital . . . Capacitors to 150,000 volts—WRITE FOR COMPLETE NEW CATALOG.

INDUSTRIAL CONDENSER CORP.

1725 W. NORTH AVE.

CHICAGO, U.S.A.



**Manufacturers of Quality Oil, Wax and
Electrolytic Capacitors**

Membership

The following indicated admissions and transfers of memberships have been approved by the Admissions Committee. Objections to any of these should reach the Institute office by not later than November 30, 1942.

Transfer to Member

- Bailey, Arnold B., Bell Telephone Labs., Inc., 180 Varick St., New York, N. Y.
Griffiths, H. V., British Broadcasting Corp., Nr. Westerham, England
Stobbe, John A., 63 Wall St., New York, N. Y.

Admission to Member

- Bayles, John C., 406 Lenox Pl., South Orange, N. J.
Fisher, S. T., Box 64, Station H, Montreal, P. Q., Canada
Hathaway, Donald L., Box 930, Casper, Wyoming

The following admissions to Associate membership were approved on October 2, 1942.

Admission to Associate

- Ameen, Alfred, 2612 St. Paul St., Baltimore, Md.
Antunes, Manuel, 77 Ave. Luis Bivar, 4/D, Lisbon, Portugal
Austin, John F., 19 Court St., Dedham, Mass.
Bedwell, Thomas H., University of South Dakota, Vermillion, S. D.
Bell, William L., Bell Telephone Labs., Inc., 180 Varick St., New York, N.Y.
Berman, Harry, 309 E. Mosholu Pkwy., Bronx, N. Y.
Bernard, Joseph T., 9th Signal Service Co., A.P.O. #958, c/o Postmaster, San Francisco, Calif.
Bradley, John H., British Broadcasting Corp., Tatsfield, Nr. Westerham, Kent, England
Carter, Robert E., 214 D Cypress St., Alameda, Calif.
Caudle, L. L., Jr., 1925 N. Tryon St., Charlotte, N. C.
Cheadle, Herbert A., 50 Sunley Gdns., Perivale, Greenford, Middx., England
Cooke, Kenneth R., WGBI, Scranton, Pa.
Cooper, Donald H., NBC, Trans Lux Bldg., Washington, D. C.
Crooks, Wilbur S., Kings Highway, Route, Fredericksburg, Va.
Devereux, William E., Box 248, 51 Radnor Ave., Harmon, N. Y.
Donaldson, Charles A., Box 212, Dayton, Ohio
Dragoo, K. L., 106 Baden St., San Francisco, Calif.
Duerden, Francis, 112 Springfield Park Ave., Chelmsford, Essex, England
Ecklund, E. Eugene, 3311—22 St., N. E., Washington, D. C.
Edelstein, Sam E., Jr., Commander Task Force 24, c/o Postmaster, New York, N. Y.

(Continued on page xx)

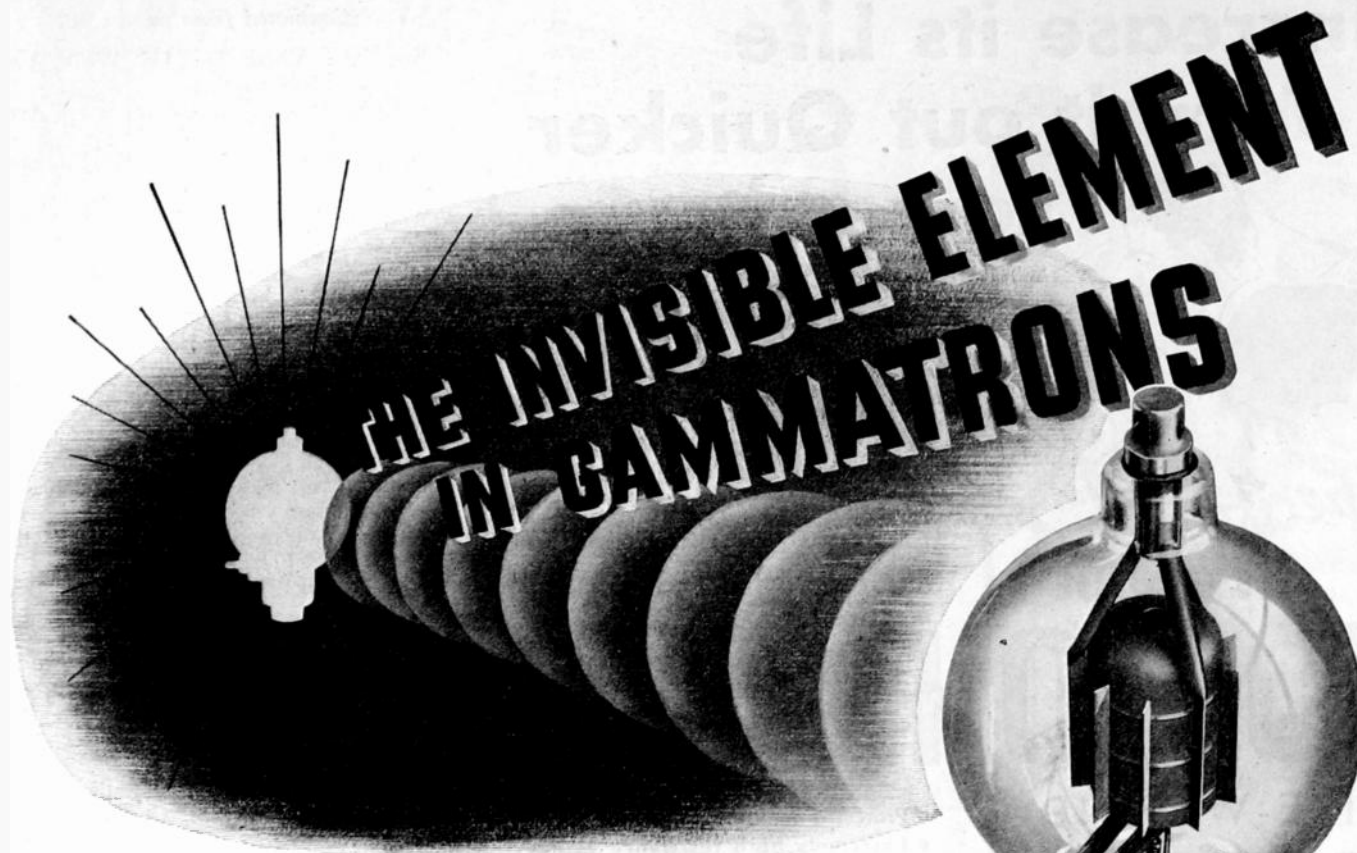

THE INVISIBLE ELEMENT IN GAMMATRONS

SUSTAINED VACUUM FOR LONGER TUBE LIFE

The ability of GAMMATRONS to radiate tremendous amounts of power without release of gas adds hundreds of hours to their efficient life.

Sustained vacuum—the “fourth element” in GAMMATRON triodes—results from the use of tantalum plates and grids, a unique pumping technique, and absence of internal insulators and getter. All gas-releasing impurities are removed from the tantalum by the Heintz and Kaufman process. The tube is exhausted while the plate dissipation is running as high as ten times the rated amount—far hotter than the greatest overload.

Virtually all of the gas is thus squeezed out of the tantalum; and after the vacuum is sealed, this remarkable metal acts as a powerful sponge which actually absorbs any gas later released.

The final vacuum is so hard that if sufficient voltage were applied to the grid and plate, the flash-over would prefer a route outside the tube rather than internally.

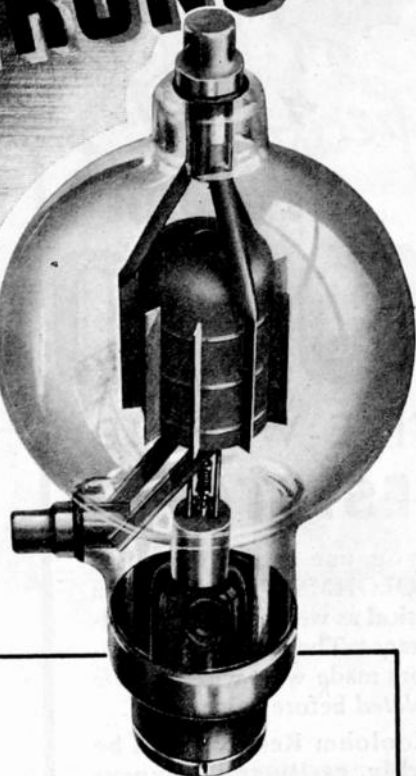

HK-854 TRIODE OPERATING DATA

*As an RF Power Amplifier,
Class C, Unmodulated.
Low mu (14) type*

	Typical	Max.
Power Output . . .	1800 Watts	—
Driving Power . . .	40 Watts	—
DC Plate Voltage . . .	5000 Volts	6000
DC Plate Current . . .	450 M.A.	600
DC Grid Current . . .	45 M.A.	80
DC Grid Voltage . . .	-575 Volts	-1500
Peak RF Grid Volts . . .	915 Volts	—
Plate Input . . .	2250 Volts	2250
Plate Dissipation . . .	450 Watts	450

*For additional data or for a
free copy of "13 Ways to Prolong
Tube Life," write to*



GAMMATRONS OF COURSE!

Increase its Life Turn it out Quicker Lower its Cost

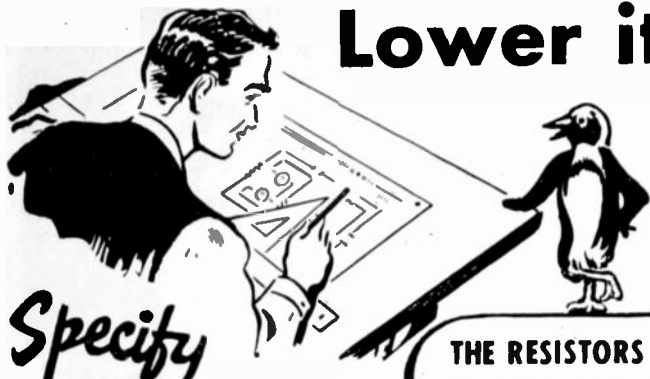

Specify
SPRAGUE

KOOLOHM

WIRE-WOUND RESISTORS

If you use resistors—use KOOLOHMS—they bring you physical as well as electrical advantages. They are the *only* resistors made with wire *ceramic insulated* before it is wound.

Koolohm Resistors can be quickly, easily and inexpensively mounted in a minimum of space—attached directly to, and against metal and grounded parts with complete resistor circuit insulation. If you use resistors, and want to turn out your product easier, faster, and more economically, while you improve its quality—write us for *complete* information, catalog and samples of Sprague Koolohms. Put them to *any* test.

SPRAGUE SPECIALTIES COMPANY
(Resistor Division)
North Adams, Mass.

THE RESISTORS THAT KNOCKED TRADITION INTO A COCKED HAT

*by Doing Things
No Other Wire-
Wound Resistor
Could Do.*

- Protected against changed values.
- Extremely high resistance values in . . .
- . . . Amazingly small size.
- Full-rated wattage dissipation regardless of resistance value.
- Moisture-proof and shock-protected.
- Inductance reduced to negligible values.
- Doubly protected by an extra outer case of tough ceramic or shock-proof glass.



Turns can't "swim" or short, when wound with KOOLOHM ceramic-insulated wire. Insulation has a dielectric strength of 350 volts per mil at 400° C.!

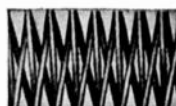

KOOLOHM construction permits perfect Ayrton-Perry windings. Result: resistors are available having negligible inductance, even at 50 to 100 Mc.!



Section of KOOLOHM wire with ceramic insulation removed to show contrast between bare and insulated wire. This flexible, heat-proof insulation is actually applied to wire at a temperature of 1000° C.!

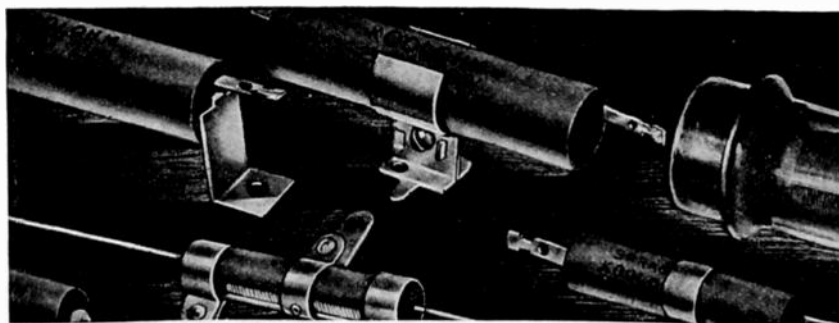

(Continued from page xviii)

- Emurian, Albert D., 337 Wells Ave., Elberon, N. J.
- Falbee, Harold W., 166-15 Jewel Ave., Flushing, N. Y.
- Farr, William, Route 1, Box 660, Edmonds Wash.
- Fernandez, Manuel, 4100 N.W. 11 Court, Miami, Fla.
- Fister, Theo. J., 1000 N. 10 St., Reading, Pa.
- Foil, William P., 1426—21 St., N. W., Washington, D. C.
- Foley, Gerard M., Battelle Memorial Institute, 505 King Ave., Columbus Ohio
- Gates, Stuart H., Southern Bell Tel. and Tel. Co., Louisville, Ky.
- Giddis, Albert N., 362 Adams St., Lowell, Mass.
- Goodyear, W. Frederic, 2693 St. Benedict St., Baltimore, Md.
- Graffam, Perry S., 5921 West Dickens Ave., Chicago, Ill.
- Grelck, Harry L., 528—81 St., Brooklyn, N. Y.
- Gruber, Benj. A., c/o R.A.F. Ferry Command, Gander, Newfoundland
- Hanes, Mortimer, 11366 Meyers Rd., Detroit, Mich.
- Hanson, August R., Aviation Radio School, (Ward Island), Corpus Christi, Texas
- Harriman, D. W., 5029—23 St., Detroit, Mich.
- Humphrey, Gordon S., 301 Windsor St., Silver Spring, Md.
- Isaac, Victor E., 2084 Claremont Ave., Apt. 16, Montreal, P.Q., Canada
- Justman, Simon 220 North Roberts Blvd., Dayton, Ohio
- Kirischjian, Harry H., 6738 Sixth Ave., Brooklyn, N. Y.
- Kline, Harold J., Route 1, Atwater, Ohio
- Kramer, Ambrose W., 3807 Castilla Ct., Corpus Christi, Texas
- Kubilius, Alphonse A., 3952 S. Rockwell St., Chicago, Ill.
- Lazowski, J. M., R.C.A.F. #1 Wireless School, Montreal, P.Q., Canada
- Lenihan, J. M. A., 37 Cochrane Park Ave., Newcastle on Tyne 7, England
- Locker, Melville, 300 W. 72 St., New York, N. Y.
- Lockyer, John S. 272 South Lane, New Malden, Surrey, England
- Lunan, W. Alan, 2312 Wilson Ave., Montreal, P.Q., Canada
- Maguo, Hector T., Mirasol 451, Buenos Aires, Argentina
- Mason, Samuel J., c/o Graham, 66 Huntington Ave., Boston, Mass.
- McCarty, Ignatius H., 1005 De Young Bldg., San Francisco, Calif.
- McCready, Sylvester W., 3101 G St., Vancouver, Wash.
- Mead, H. Bill, E. 1812 First Ave., Spokane, Wash.
- Miller, B. B., 2356a Laurence St., St. Louis, Mo.
- Miner, Leslie C., 380 La Salle Ave., Buffalo, N. Y.
- Murphree, Francis J., Jr., 808 Graymont Ave. West, Birmingham, Ala.
- Olmsted, Donald T., 3327 N. 49 Ave., Portland, Ore.
- Orrien, William, 14 Montieith St., Brooklyn, N. Y.

(Continued on page xxii)

How to Get Longer Life from Your MERCURY-VAPOR TUBES



Here's a four-word formula to make your mercury-vapor tubes last longer—"Handle carefully; operate conservatively." Below are a few suggestions to help you put this formula into effect. They will help prevent many of the causes of tube failure, such as: loss of emission, high arc-drop, cathode bombardment, arc-backs, the liberation of gas, and cathode failure. These safeguards are applicable to such tubes as the following General Electric mercury-vapor rectifiers: GL-266B, GL-857B, GL-866A/866, GL-869B, GL-872, GL-872A. For more complete instructions on operation and handling, write for Bulletin GEH-977B. Also list the types of G-E mercury-vapor rectifiers you are now using. We shall be glad to send you complete service information designed to help you get the most out of your mercury-vapor tubes. *General Electric Company, Schenectady, N. Y.*

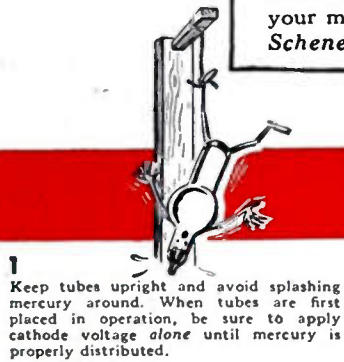

1 Keep tubes upright and avoid splashing mercury around. When tubes are first placed in operation, be sure to apply cathode voltage *alone* until mercury is properly distributed.



2 Keep condensed mercury temperature within limits recommended by tube manufacturer.



3 Be sure cathode base, not the anode end, is coolest part of tube. Don't let drafts blow on tubes. Never allow the mercury to condense at the anode end.

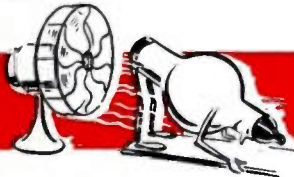

4 If you use forced air against the bottom of the tube, keep the blower on for a few minutes after shutting filaments down.

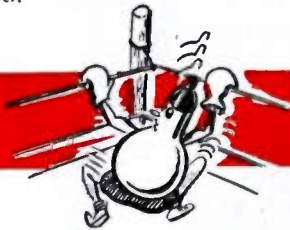

5 Allow plenty of filament warm-up time before applying anode voltage.



6 Keep peak inverse anode voltage and peak current as low as possible for satisfactory operation. Use adequate protective devices for overload and arc-back protection.



7 Do not allow the cathode voltage (measured at the pins) to deviate more than five per cent from the rated value.



8 Don't overload tubes, even for short periods. Maintain full cathode voltage during standby operation when tube is operated without load.



9 Protect the tubes adequately against the effects of r-f.

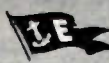

The Navy "E" for Excellence, has been awarded to 92,780 General Electric employees in five plants manufacturing naval equipment.

GENERAL ELECTRIC

161-30B1-8850

This is NO TIME for
DOUBLE TALK

TURNER Microphones Assure Intelligibility

Whatever or wherever your job — in Army Camp, War Plant, Ordnance Plant, Airdrome, Dock, Police Transmitter, Broadcasting Station or on the home front, there is a Turner Microphone that offers you more intelligible communications. The precision engineering in Turner Microphones continues to make these outstanding units first choice of critical users. All Turner Microphones are ruggedly constructed to offer maximum heavy duty operation under any climatic or acoustic conditions. Each and every Turner Microphone is given an individual sound pressure test over the entire audio band before leaving the factory — your assurance of complete satisfaction.

TURNER CARDIOID 101 STOPS BACKGROUND NOISE

Where the going is tough and acoustic conditions practically impossible, the Turner Cardioid will come through. The two-element generator produces true cardioid characteristics, offering the best features of both the dynamic and velocity. No. 101 is highly sensitive to sounds originating in front of the microphone and has extremely low sensitivity to sounds originating in the rear. By combining these two elements no sacrifice of frequency response is necessary. Equipped with tilting head, balanced line output connection and heavy duty cable. Chrome type finish. Available in Standard, De Luxe and Broadcast Models.

TURNER U9-S GIVES YOU FOUR IMPEDANCES

50 — 200 — 500 ohms or Hi-Impedance — at a twist of the switch! That's what you get in Turner U9-S, a ruggedly built dynamic that does the job of four mikes. Adjustable to semi- or non-directional operation, with a level of —52DB at high impedance. Response is free from peaks and holes from 40 to 9000 cycles. Be sure of your ability to handle ANY job with the U9-S.

TURNER HAN-D NO. 9D HAS LOW FEEDBACK

For those jobs where you need a mike that nestles into your hand, gives crisp, clear voice reproduction without blasting from close speaking, use the Han-D. Its positive contact off-on switch permits push-to-talk operation. Feedback is surprisingly low, and this unit withstands rough usage. Can also be mounted on standard floor or desk stands, hung from hook or held in hand. Chrome type finish.

If You Have a Priority Rating

WRITE, explaining your communications problems, and we can help you select the Turner Microphone best suited to your needs. We'll gladly send you, too, any information on how to make your present Turner Microphone and equipment give you longer, better service.

FREE Turner Microphone Catalog, and complete information on Microphones illustrated here. Write:

THE TURNER CO.

Crystals Licensed Under Patents of The Brush Development Co.



101
CARDIOID



U9-S



9D
HAN-D

900 17th ST. N. E.
CEDAR RAPIDS, IOWA

(Continued from page xx)

- Pearson, Carl A., Forest Heights, Box 22M, Route 2, Anacostia, D. C.
Pitigliani, Luis A., 25 de Mayo 489, Buenos Aires, Argentina
Proskauer, Richard, 325 E. 57 St., New York, N. Y.
Quodomine, Richard A., 83 Floyd Ave., Bloomfield, N. J.
Rojo, Alejandro, Transradio Internacional S.A., San Martin 379, Buenos Aires, Argentina
Saunders, Clarence J., 3207 Morrison St., N.W., Washington, D. C.
Scarlett, Alan Edward, 52 Camberwell Rd., Toronto, Ont., Canada
Scheirer, Harry B., 1311 W. Loudon St., Philadelphia, Pa.
Sheppard, Glenn E., 130 Floyd Ave., Bloomfield, N. J.
Sherwood, William W., Sangamo Electric Co., Springfield, Ill.
Shows, W. W., Route 2, Atlanta, Ga.
Silver, Martin, 2806 Webb Ave., New York, N. Y.
Skoller, Marvin, 565 W. Second St., Dayton, Ohio
Smith, Douglas A., 21 Grosvenor Rd., Short Hills, N. J.
Smith, Edward J., 33 Dwight St., Jersey City, N. J.
Smithmeyer, Louis P., 17 Front St., Schenectady, N. Y.
Sprinkle, Melvin C., 3742 Appleton St., N.W., Washington, D. C.
Stello, Karl H., Beltsville, Md.
Stevenson, Hugh, 176 Benton St., Rochester, N. Y.
Stoker, Frank E., Jr., 111 Lincoln Ave., Lexington, Ky.
Swain, James R., 971 Cowper St., Palo Alto, Calif.
Thomson, J. J., o/c Eastern Pool, A/S Installation Div., c/o Naval Officer in Charge, 224 Youville Square, Montreal, P.Q., Canada
Tomalesky, Joseph, 724 Newark Ave., Jersey City, N. J.
Townsend, Charles L., 26 Pondfield Road West, Bronxville, N. Y.
Tremblay, C. E., F/o CAPO #4, R.C.A.F. Gander, R.C.A.F. Overseas
Unsworth, R. G., 649 North State St., Tacoma, Wash.
Wahlquist, Lyle O., 167 N. Sixth West St., Salt Lake City, Utah
Ward, John W., 9906 Fort Hamilton Pkwy., Brooklyn, N. Y.
Wentink, Tunis, Jr., R. D. 4, Box 540, New Brunswick, N. J.
Yust, Harry J., 1909 N. Lawrence St., Philadelphia, Pa.

CURRENT LITERATURE

New books of interest to engineers in radio and allied fields—from the publishers' announcements. A copy of each book marked with an asterisk (*) has been submitted to the Editors for possible review in a future issue of the Proceedings of the I.R.E.

*THE FUTURE OF TELEVISION. By Orrin E. Dunlap, Jr., Manager of the Department of Information of RCA...
(Continued on page xxiv)

**THE POOLING OF SKILLS
EXPRESSED IN A TUBE**



LONG BEFORE "UNITED" symbolized the might of Nations at War, the term possessed a vital significance in electronics.

"United" expressed the vision of a company that undertook to pool, under one roof, the skills of distinguished technicians, engineers and craftsmen, specializing solely in transmitting tubes.

Under the scrutiny of these electronic specialists have

come scores of transmitting tubes, built to a degree of precision, hitherto unknown.

Today, the products of "United" are performing flawlessly in key sockets in countless transmitting instruments of our armed forces. Tomorrow—tempered under the fire of war—"United" products of advanced technical design will meet the exacting post-war requirements of Radio Communications, Physiotherapy and Industrial Electronics. Look for the name "United" on each tube.

UNITED ELECTRONICS COMPANY

NEWARK



NEW JERSEY

(Continued from page xxii)

Harper & Brothers, 49 E. 33rd St., New York, N. Y. (194 pages, 18 illustrations, 6×8½ inches, bound in red cloth.) This book charts the progress of television to date and answers with authority many questions about it from the layman's viewpoint. Price \$2.50.

*ELECTRICAL FUNDAMENTALS OF COMMUNICATION. By Arthur L. Albert, Professor of Communication Engineering, Oregon State College, Member of I.R.E. ••• McGraw-Gill Book Company, 330 W. 42nd St., New York, N. Y. (vi+554 pages, 359 illustrations, 6×9 inches, cloth bound.) A study of electrical fundamentals from the viewpoint of communications—telegraph, telephone, and radio. Written for beginners. Illustrations exceptionally complete and clear. Price \$3.50.

*MICROWAVE TRANSMISSION. By J. C. Slater, Professor of Physics, Massachusetts Institute of Technology ••• McGraw-Hill Book Company, 330 W. 42nd St., New York, N. Y. (x+309 pages, 76 illustrations, 6×9 inches) In this book on high frequency systems the author steers a middle course between elementary and advanced standards; between the highly theoretical and the completely practical. Microwaves are treated both from the standpoint of conventional transmission lines and of Maxwell's equations. Cloth. \$3.50.

*FUNDAMENTALS OF ELECTRIC WAVES. By Hugh Hildreth Skilling, Ph.D.; Professor of Electrical Engineering, Stanford University ••• John Wiley & Sons, Inc., 440 Fourth Ave., New York, N. Y. (vii+186 pages, 63 illustrations, 6×9 inches.) The principles of wave action and the basic idea of Maxwell's equations are presented in an effort to help supply information on electric waves needed by the radio engineer and student of war radio. Cloth. \$2.75.

*ULTRA-HIGH-FREQUENCY TECHNIQUES. By J. G. Brainerd (Editor), Glenn Koehler, Herbert J. Reich, Members of I.R.E., and L. F. Woodruff ••• D. Van Nostrand Company, Inc., 250 Fourth Ave., New York, N. Y. (534 pages, 300 diagrams, 6½×9½ inches.) The authors have devoted 16 chapters to carefully treat U.H.F. in every step from linear circuit theory to transmission lines, radiation, propagation, and wave guides. A series of experiments are described to show the essential phenomena and relationships. Cloth. \$4.50.

BIBLIOGRAPHY ON ELECTRICAL SAFETY 1930-1941. By AIEE Committee on Safety ••• American Institute of Electrical Engineers, 33 W. 39th St., New York, N. Y. (16 pages, 8½×11 inches.) A reference source of information for research workers and safety engineers covering electrical accidents, their causes, prevention methods, safety codes, effects of electric shock and resuscitation. Paper, \$0.50.

Creators and Makers of

ACCURATE RESISTORS—SWITCHES—SPECIAL EQUIPMENT AND
SPECIAL MEASURING APPARATUS FOR PRODUCTION AND
ROUTINE TESTING OF ELECTRICAL EQUIPMENT ON MILITARY AIR-
CRAFT... SHIPS... VEHICLES... ARMAMENT... AND WEAPONS

SHALLCROSS SWITCHES

Are constructed of the finest materials available. Many designs may be obtained having solid, fine silver contacts, and ceramic or phenolic insulation. Where essential War Production dictates the use of switches that are rugged and dependable, send your specifications to Shallcross, Dept. C23.

MEMBER



HALLCROSS MFG. CO.
COLLINGDALE, PENNA.



PREFERRED
for
PERFORMANCE



RESISTORS

WHY? . . . Results of a nation-wide survey conducted by a wholly independent research organization disclosed that Executives and Engineers in the electronic industries *overwhelmingly prefer* IRC resistors. In voting them "superior" by a plurality of more than two to one, these specific reasons were cited—

BECAUSE . . . IRC offers "best product" and "most complete line."



*IRC flies the flag of the
Army-Navy Production Award
for "High Achievement"*

INTERNATIONAL RESISTANCE COMPANY

401 N. BROAD STREET • PHILADELPHIA

CAPACITOR GUIDES FOR BUSY ENGINEERS

These new catalogs will help every engineer! They have been specially designed so that "he who runs may read" — and will simplify your capacitor-preference problems. Your letterhead request will immediately obtain any or all of the three catalog sections shown.



ELECTROLYTIC CAPACITORS:

Thirty-two page Catalog 12 — Section A. Complete illustrations and descriptions of both wet and dry electrolytics for every purpose. Includes special constructions, such as low-temperature types for Government and industrial requirements.

32 pages



PAPER CAPACITORS:

Forty-eight page Catalog 12 — Section C. Complete illustrations and descriptions of all types of paper capacitors, including oil types, for broadcast and transmitting circuits. Also incorporates special types for unusual electronic applications.

48 pages



MICA CAPACITORS:

Thirty-two page Catalog 12 — Section E. Complete illustrations and descriptions of a wide variety of mica capacitors for both broadcast and transmitting applications. Includes many special constructions.

32 pages

MICA CAPACITOR COLOR-CODES:

Industry color-coding standards are clearly defined in separate Solar Form MCC-1, available to all capacitor users.

SOLAR MFG. CORP., Bayonne, N. J.

NAVY NEEDS RADIO MEN

FROM BUREAU OF NAVAL PERSONNEL
NAVY DEPARTMENT
OFFICE OF NAVAL OFFICER PROCUREMENT
CHICAGO, ILLINOIS

Among the most urgent needs of new officer personnel in the United States Navy is for professional technicians in engineering fields, the Director of Naval Officer Procurement, Chicago, has announced.

Perhaps first in the list are graduate electrical engineers, those mainly between 21 and 50 years who have followed electrical engineering since their graduation, and who have a knowledge of ultra-high frequencies, electronics and television. Those more familiar with power engineering likewise may find a place in the Navy which is interested in these men in ages up to 50 years. Electrical engineers are needed especially in the Navy's fields of radio and detection devices. Men with radio or communication engineering degrees may qualify for officers commissions as well. Waivers for minor physical defects often are obtainable

A Petty Officer rating is offered to men with sufficient experience in radio to instruct classes in Radio Theory, Practical Operation, Code, or Maintenance.

The Navy has schools in several parts of the country to instruct enlisted men in radio, and it is for these schools that instructors are needed. The men that are selected will go through a refresher course at the Naval Aviation Service School at East 87th and Anthony Avenue, where they will be instructed in use of the radio equipment used by the Navy.

In some cases men with B.S. degrees in mechanical or other engineering subjects and who have had experience in radio and electrical work may qualify for officer assignments in radio or electrical lines. Usually, however, degrees in engineering other than electrical tend to fit the applicant for other duty. For instance Navy activities in ordnance, construction, and ship operation use mechanical, civil, and chemical engineers. Here again physical waivers often are possible and the age range is usually between 30 and 45 years or beyond those two limits in some cases.

Another special officer procurement program under way is for college teachers of physics, or chemical, diesel, electrical, mechanical, and radio engineering at Naval Reserve Midshipman Schools. Private school and junior college teachers and others qualified to teach those subjects in colleges also are being sought.

Either Ensign W. W. Hall, Room 300, or M. G. Miller, Room 1184, both in the Board of Trade Building, Chicago, will answer all requests for information.

POSITIONS OPEN

The following positions of interest to I.R.E. members have been reported as open. Apply in writing, addressing reply to company mentioned or to Box No.



PROCEEDINGS of the I.R.E.

330 West 42nd Street, New York, N.Y.

RADAR LABORATORY

The Signal Corps Radar Laboratory has urgent need for Physicists and Engineers with Mechanical, Electrical, and Radio training. Inexperienced engineering graduates can also qualify.

Salaries range from \$2000 to \$3200 and up.

Draftsmen, Engineering Aides, Electricians, and Radio Mechanics also are wanted.

Apply in writing stating full qualifications to: Civil Service Representative, Signal Corps Radar Laboratory, Camp Evans, Belmar, New Jersey.

COMMUNICATIONS ENGINEERS

Transcontinental & Western Air, Inc. has openings for three Radio Engineers in the Communications Department. Applicants should have completed an electrical or radio engineering course, or should have had one to two years practical experience. These openings are permanent. For additional details and application forms, write to Personnel Department, Transcontinental & Western Air, Inc., Kansas City, Missouri.

INSTRUCTORS IN RADIO AND ELECTRICITY

50 civilian instructors needed immediately for Army Air Forces Radio Instructor School. Subjects of instruction: Direct current and alternating current electricity, vacuum tubes, standard radio receivers and transmitters; international Morse code, telegraph and radiotelephone procedure. Salaries follow Civil Service starting from \$2,000 per year. State experience, education, code speed, personal data. Positions open immediately. Saint Louis University, Army Air Forces Radio Instructor School, 221 N. Grand Boulevard, Saint Louis, Mo. A. H. Weber, Technical Director.

RADIO EDITOR

Radio engineering editor for radio-electronic journal reaching manufacturing and operating fields. Older man acceptable if thoroughly up-to-date on radio and electronic principles. Interesting, pleasant work, with headquarters at New York. Write fully, outlining experience, salary expected, etc., to Box 278.



Attention Employers . . .

Announcements for "Positions Open" are accepted without charge from employers offering salaried employment of engineering grade to I.R.E. members. Please supply complete information and indicate which details should be treated as confidential. Address: "POSITIONS OPEN," Institute of Radio Engineers, 330 West 42nd Street, New York, N.Y.

The Institute reserves the right to refuse any announcement without giving a reason for the refusal.

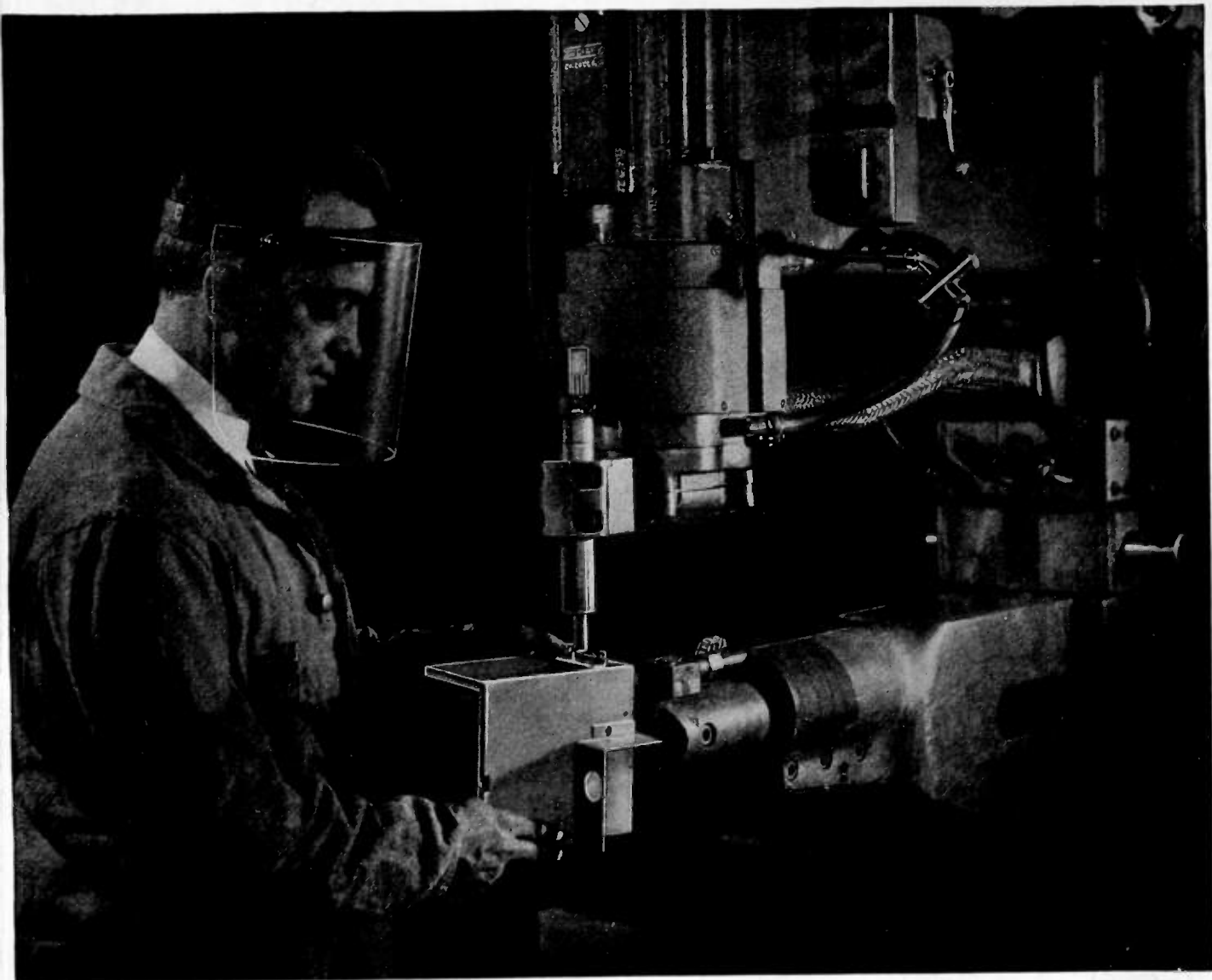

Portrait of a man welding "for keeps"

A meticulous step in "*Electroneering*"*

Spot welding aluminum alloys by the noted Sciaky method of applying welding energy to an extremely accurate and dependable degree is a typical example of precision manufacturing at Rauland.

From engineering conception to finished product there is no compromise with "second best." Our armed forces rely on the mechanical perfection of our electronic equipment whether in searing des-

ert heat or stratospheric cold. Rauland "*Electroneering*"* justifies that confidence.



This wide and successful use of Rauland electronic instruments in

combat foreshadows its great value to Industry when our final victory brings a new era of peacetime activity.

* *The Rauland word for all phases of Electronics from research through engineering to finished product.*

"*Electroneering*"* is our business

Rauland

RADIO  SOUND  COMMUNICATIONS

The Rauland Corporation • • Chicago, Illinois

REMLER

Plugs and Connectors

ARMY SIGNAL CORPS SPECIFICATIONS

Quantity Prices Quoted
on receipt of Delivery
Schedules

Manufacturers of Communication Equipment
SINCE 1918

REMLER COMPANY, Ltd. • 2101 Bryant St. • San Francisco, Calif.

To Those Concerned with the Design and Manufacture of Army or Navy Equipment Utilizing Vacuum Tubes:

1. The accompanying Army-Navy Preferred List of Vacuum Tubes sets up a group of unclassified general purpose tubes selected jointly by the Signal Corps and the Bureau of Ships. The purpose of this list is to effect an eventual reduction in the variety of tubes used in Service equipment.

2. IT IS MANDATORY THAT ALL UNCLASSIFIED TUBES TO BE USED IN ALL FUTURE DESIGNS OF NEW EQUIPMENTS UNDER THE JURISDICTION OF THE SIGNAL CORPS LABORATORIES OR THE RADIO AND SOUND BRANCH OF THE BUREAU OF SHIPS BE CHOSEN FROM THIS LIST. EXCEPTIONS TO THIS RULE ARE HEREINAFTER NOTED.

3. The term "new equipments," as mentioned in Paragraph 2 above, is taken to include:

- a. Equipments basically new in electrical design, with no similar prototypes.
- b. Equipments having a similar prototype but completely redesigned as to electrical characteristics.

(Continued on page xxx)

ARMY-NAVY PREFERRED LIST OF VACUUM TUBES

RECEIVING

Filament Volts	Diodes	Diode Triodes	Triodes	Twin Triodes	Pentodes		Rectifiers	Converters	Power	Indicators
					Remote	Sharp				
1.4	1A3	1LH4	1G4GT 957 958A	1291 3A5	1T4	1S5 959 1LN5 1L4		1LC6 1R5	3A4 1299 3Q4 3Q5GT	991
5.0							5U4G 5Y3-GT			
6.3	6H6* 9004	6SQ7* 6SR7*	6J5* 1201 955 7193 9002	6SL7GT 6SN7GT	6SG7* 6SK7* 956 9003	6AC7* 6AG7* 6SH7* 6SJ7* 717-A 954 9001	6X5-GT 1005	6SA7*	6L6-G 6V6-GT 6N7-GT 6B4-G 6C6-G 6Y6-G	6E5
12.6	12H6*	12SQ7* 12SR7*	12J5-GT	12SL7-GT 12SN7-GT	12SG7* 12SK7*	12SH7* 12SJ7*		12SA7*	12A6	1629

TRANSMITTING

MISCELLANEOUS

Triodes	Tetrodes	Twin Tetrodes	Pentodes	Rectifiers		Grid Cont. Gas Rectifiers	Voltage Regulators	Phototubes
				Vacuum	Gas			
801-A 811 826 833-A 838 1626 8005 8025 304TH	807 813 814 1625	815 829 832	803 837 2E22	2X2 836 1616 8020 (451) 705A 371A	83 866A 872A 4B25	2050 884 394-A C1B C5B	VR-90-30 VR-105-30 (38205) VR-150-30 (38250)	918 927

* Where interchangeability is assured GT counterparts of the preferred metal tubes may be used.
September 28, 1942

PL 423

ENGINEERS



Do you have a development problem that could best be solved by a new electronic tube with characteristics not now available?

The Raytheon Laboratories are prepared to undertake such development assignments provided only that (a) The new tube would make possible new or greatly improved equipment for the successful prosecution of the war either on the field of battle or on production lines. (b) The tube would have wide enough uses to warrant the development expense.

Address correspondence to:

EXECUTIVE SECRETARY
RAYTHEON MANUFACTURING COMPANY
55 CHAPEL STREET, NEWTON, MASS.

ENGINEERS WANTED! Raytheon's vital wartime assignments are in the field of electronic development. Have unusual opportunity for engineers who want to be connected with important war assignments. At Raytheon you would work with some of the best known research specialists on tubes and equipment. Write **SPECIAL ENGINEERING PERSONNEL.**

Raytheon Manufacturing Company

Waltham, Massachusetts

DEVOTED TO RESEARCH AND THE MANUFACTURE OF TUBES FOR THE NEW ERA OF ELECTRONICS

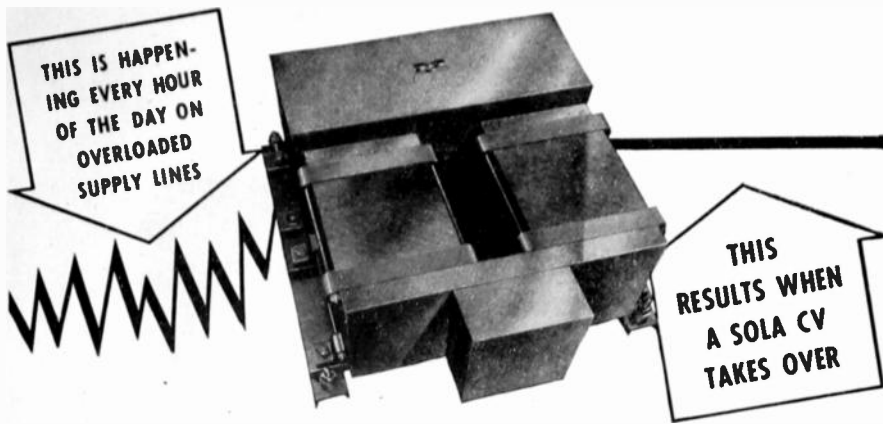

Stabilize your power supply at peak efficiency 24 hours per day

Your equipment, whether it is a vacuum tube, a laboratory instrument or a complex, electrically operated machine is designed for a rated line voltage. Any deviation from this value may mean damaged equipment, misleading results in laboratory research or a noticeable lack of uniformity in products and production schedules.

Sola Constant Voltage Transformers automatically provide perfectly regulated voltage that remains constant regardless of supply line fluctuations.

They have no moving parts, are self-protected against short circuit, and require no supervision. They're on the job 24 hours per day.

Standard designs are available in capacities ranging from 15VA to 10 KVA or special units can be built to your specifications.

SOLA ELECTRIC CO.
2525 Clybourn Ave., Chicago, Ill.

Ask for Bulletin KCV-74



SOLA CONSTANT VOLTAGE TRANSFORMERS

Concentration of Skill!

PAR-METAL
Specializes

IN THE MANUFACTURE OF

- CABINETS
- CHASSIS
- PANELS
- RACKS

for ELECTRONIC APPARATUS

Specialized skill — that is something you cannot specify. It's "in the blood". Par-Metal has it by virtue of years of concentration on making metal housings for sound equipment. — Send specifications; or write for our Catalog No. 41.

PAR-METAL PRODUCTS CORP.
32-62 — 49th STREET . . . LONG ISLAND CITY, N. Y.
EXPORT DEPT: 100 VARICK ST., N. Y. C.

(Continued from page xxviii)

c. New test equipment for operational field use.

4. The term "new equipments," as mentioned in Paragraph 2 above, does not include:

- Equipments either basically new or redesigned, that are likely to be manufactured in very small quantity, such as laboratory measuring instruments.
- Equipments that are solely mechanical redesigns of existing prototypes.
- Equipments that are reorders without change of existing models.
- Equipments in the design stage before the effective date of adoption of this Preferred List.

Note: The foregoing statements in Paragraphs 3 and 4 above are explanatory in nature and are not intended to be all-inclusive.

5. In the event that it is believed that an unclassified tube other than these included in the Preferred List should be used in the design of new equipments for either the Signal Corps or Navy, specific approval of the Service concerned must be obtained. Such approval, when Signal Corps equipment is concerned, is to be requested from the Signal Corps Laboratory concerned with such equipment; the said Laboratory will then make known its recommendations in the matter to the Office of the Chief Signal Officer where the final decision will be made and returned to the laboratory for transmittal to the party requesting the exception. When Navy equipment is concerned, the request for exception shall be addressed to the Bureau of Ships, Navy Department.

6. The publication of the attached Army-Navy Preferred List of Vacuum Tubes has no application to the use of vacuum tubes classified as to security status, or to tubes which have no functional counterparts in the preferred list. The choice of vacuum tubes not covered by the preferred list is to be made with the approval of the Signal Corps or the Bureau of Ships, for Signal Corps or Navy equipment respectively as outlined in Paragraph 5 above.

7. The publication of this list is in no way intended to hamper or restrict development work in the field of vacuum tubes or vacuum tube applications.

8. This list is to take effect immediately. September 28, 1942.

Office of the Chief Signal Officer,
Headquarters, Services of Supply,
War Department.

Chief of the Bureau of Ships,
Navy Department.



AS TOUGH AS THE MEN WHO USE THEM!

Our fighters are tough! They must be when, midst the rhythmic whine of bullets . . . the strident din of roaring cannon, they are face-to-face with a treacherous, ruthless enemy. Their rigorous training must provide them with superior fighting qualities. As in men so in Microphones. They, too, must be tough to match the rugged fighter. Microphones made by Shure Brothers are Tough because they have survived tests in engineering and production more destructive than conditions they meet in service. Truly a fighting pair serving the cause of Freedom . . . the fighter and his "Fighting Mike."

SHURE BROTHERS
*Designers and Manufacturers of Microphones
and Acoustic Devices*
225 West Huron Street, Chicago



SHURE

JUST OUT!

MICROWAVE TRANSMISSION

Deals with such problems as:

- attenuation in rectangular wave guides
- composite wave guides and the avoidance of reflection
- radiation and absorption of energy by a simple antenna
- effect of reflectors and other devices for producing directed beams, with problems of diffraction
- coupling of coaxial lines and wave guides

By J. C. SLATER

Professor of Physics, Massachusetts Institute of Technology
310 pages, illustrated, \$3.50

• For all who are interested in the problems of transmission through hollow pipes and coaxial lines—this book brings together the developments in the field and presents them in a sound, understandable explanation of the distinctive characteristics of microwaves and a discussion of the use of Maxwell's equations as a means of handling the problems of transmission line design. Problems are treated both from the standpoint of conventional transmission lines and of Maxwell's equations.



10 DAY'S FREE EXAMINATION

McGraw-Hill Book Co., 330 W. 42nd St., N.Y.C.

Send me books checked below for 10 days' examination on approval. In 10 days I will pay for the books, plus few cents postage, or return them postpaid. (Postage paid on cash orders. Same return privilege.)

- Slater—Microwave Transmission, \$3.50
 Henney—Radio Engineering Handbook, \$5.00

Solve radio problems faster with
RADIO ENGINEERING HANDBOOK

3rd ed. By 28 specialists. Editor-in-Chief: K. Henney, Editor, *Electronics*. The radio engineering profession's own handbook. Covers everything from electric and magnetic circuits to such radio applications as television and facsimile. 945 pages, 836 illustrations, \$5.00

Name

Address Position

City & State Company IRE. 11-42

Booklets, Catalogs and Pamphlets

ELECTRICAL RESISTANCE MEASUREMENTS ••• *Shallcross Mfg. Co., Colingdale, Penna.* (Bulletin "D-1," 4 pages, 8½×11 inches.) Describes and illustrates two bridges, a Wheatstone and a Kelvin Wheatstone, and also a new "Percent Limit Bridge." Specifications and prices given.

SAVE COPPER AND GET MORE CAPACITY QUICKLY ••• *Cornell-Dubilier Electric Corp., South Plainfield, N. J.* (Bulletin, 6 pages, 8½×11 inches.) The manufacturer recommends C-D Dykanol Capacitors to relieve overloaded lines, and describes three types in this booklet.

HOW TO MAKE TRANSMITTER TUBES LAST LONGER ••• *General Electric, Radio, Television and Electronics Dept., Schenectady, N. Y.* (Booklet, 8 pages, 8×10½ inches.) Gives 28 ways to extend life of tubes and discusses Pure Tungsten Filament Tubes, Mercury Vapor Tubes, and Thoriated Tungsten Tubes. Well worth sending for and giving some study.

MOTOR FITNESS MANUAL ••• *General Electric Co., Schenectady, N. Y.* (Booklet, 40 pages, 8½×11 inches.) A well tabbed and sectioned guide to the selection and maintenance of electric motors.

LOW RADIATION RADIO RECEIVER ••• *E. H. Scott Radio Laboratories, Inc., 4450 Ravenswood Ave., Chicago, Ill.* (Data Sheet, 1 page, 8½×11 inches.) Describes the new Scott Marine Model SLR-12-A designed to cut oscillator radiation to a point of safety against detection by enemy direction finders. Has F.C.C. approval for use at sea on both broadcast and short-wave bands.

THIRTEEN WAYS TO PROLONG TUBE LIFE ••• *Heintz and Kaufman, Ltd., South San Francisco, Calif.* (Booklet, 12 pages, 5×7 inches.) Tips on extending tube life, written in serious vein but with memory catching humorous illustrations. This should be in your literature file.

ELECTROLYTIC CAPACITORS ••• *Solar Mfg. Corp., Bayonne, N. J.* (Catalog 12, Section A, 32 pages, 8½×11 inches.) A very complete listing and description of D.C. Type Solar electrolytic capacitors. Well illustrated, gives full specifications.

FLEXIBLE SHAFTING—FOR REMOTE CONTROL ••• *F. W. Stewart Mfg. Corp., 4311 Ravenswood Ave., Chicago, Ill.* (Catalog, 20 pages, 8½×11 inches.) Describes and gives specifications for flexible shafting and casing end fittings for remote control shafts for antenna controls, automotive, and aircraft antenna reel controls, and for radio receiver controls.

Suppliers to Manufacturers
 Demanding Highest *Quality*

**TRANSFORMERS
 FILTERS
 REACTORS**

★
 Designed to meet the individual manufacturer's specifications.
 Write for folder.
 ★

NEW YORK TRANSFORMER CO.
 26 WAVERLY PLACE, NEW YORK, N. Y.

OHMITE Rheostats!

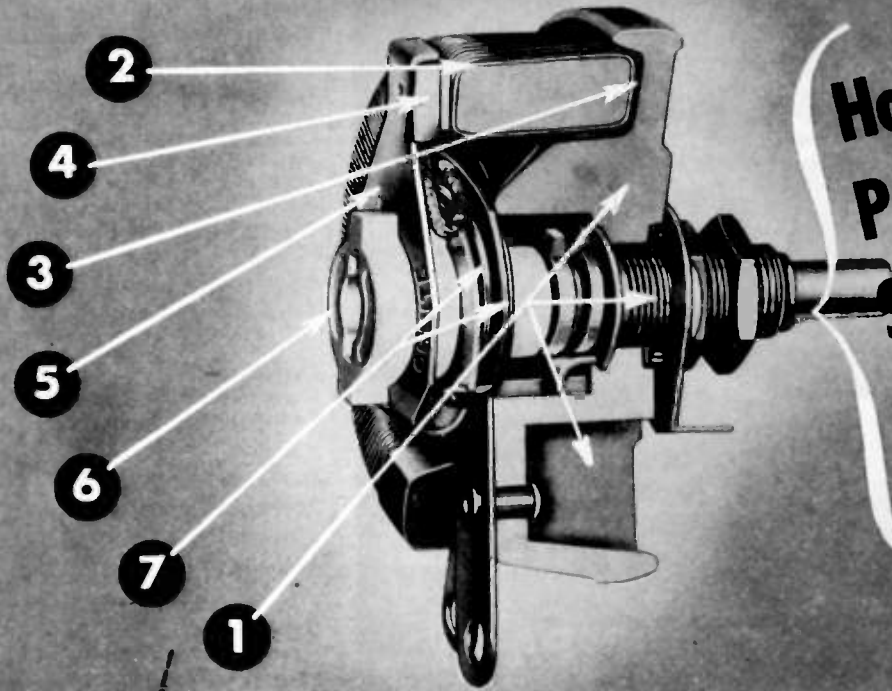

**How
Permanently
Smooth,
Close-Control
Is Built-in**

The cut-away view shows a number of the important features which make Ohmite Rheostats especially suitable for today's exacting requirements in industry, and in planes, tanks, ships.

1. Compact all ceramic and metal construction. Nothing to shrink, shift or deteriorate.
2. Wire is wound on a solid porcelain core. Each turn is a separate resistance step, locked in place and insulated by Ohmite vitreous enamel.

3. Core and base are bonded together into one integral unit by vitreous enamel.

4. Self-lubricating metal-graphite contact brush with universal mounting, rides on a large, flat surface. Insures perfect contact, prevents wear on the wire.

5. Tempered steel contact arm assures uniform contact pressure at all times. Pressure at the contact and at the center lead are independent.

6. High strength ceramic hub insulates shaft and bushing.

7. Compression spring maintains uniform pressure and electrical contact between slipping ring and center lead. Large slipping ring minimizes mechanical wear.

There are many other features which add to the dependability of Ohmite Rheostats—all proved on the Ohmite Life Tester illustrated below, and in actual service as well. They are built to withstand shock, vibration, heat and humidity.

Ten wattage sizes, from 25 to 1000 watts, from 1 9/16" to 12" diameter, in stock or special units to meet each control need. Approved types for all Army and Navy specifications.

Send for Catalog and Engineering Manual No. 40 Write on company letterhead for complete, helpful 96-page guide in the selection and application of Rheostats, Resistors, Tap Switches, Chokes and Attenuators.

OHMITE MANUFACTURING CO., 4861 Flourney St., Chicago, U.S.A.
Foremost Manufacturer of Power Rheostats, Resistors, Tap Switches

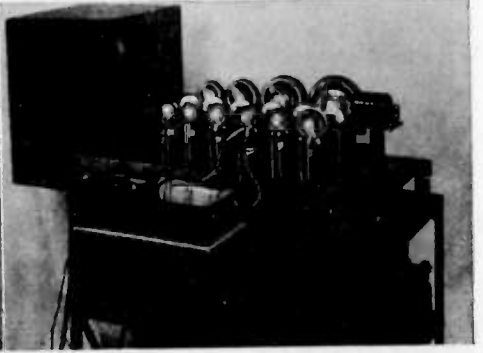
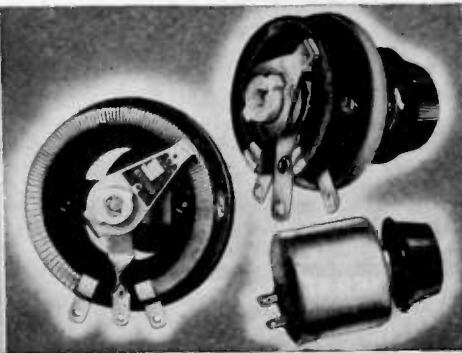

INDEX

Section Meetings	xiv
Army-Navy "E" Honor Roll	xvi
Membership	xviii, xx, xxii
Current Literature	xxii, xxiv
Navy Needs Radio Men	xxvi
Positions Open	xxvi
Army & Navy Tube Requirements	xxviii, xxx
Booklets, Catalogs & Pamphlets	xxxii

DISPLAY ADVERTISERS

A	
Aerovox Corporation	ii
American Lava Corporation	v
American Telephone & Telegraph Co.	viii
Amperex Electronic Products, Inc.	Cover II
B	
Bendix Aviation Corporation	ix
Bliley Electric Company	xxxiv
C	
Centralab	x
Sigmund Cohn	xxxv
Cornell-Dubilier Electric Corp.	Cover III
D	
Daven Company	i
Wilbur B. Driver Company	xxxiv
E	
Eitel-McCullough, Inc.	vii
G	
Galvin Manufacturing Corp.	xvii
General Electric Company	xxi
General Radio Company	Cover IV
H	
Hallicrafters Company	xxxv
Harvey Radio Laboratories, Inc.	xxxv
Heintz & Kaufman, Ltd.	xix
Hewlett-Packard Company	xiv
I	
Industrial Condenser Corp.	xviii
International Resistance Co.	xxv
Isolantite, Inc.	iii
M	
McGraw-Hill Book Company	xxxii
N	
New York Transformer Company	xxxii
O	
Ohmite Manufacturing Company	xxxiii
P	
Par-Metal Products Corp.	xxx
R	
Rauland Corporation	xxvii
Raytheon Manufacturing Co.	xxix
RCA Manufacturing Company, Inc.	iv
Remler Company, Ltd.	xxviii
S	
Shallcross Manufacturing Co.	xxiv
Shure Brothers	xxxix
Sola Electric Company	xxx
Solar Manufacturing Company	xxvi
Sprague Specialties Company	xx
Stackpole Carbon Company	vi
Standard Transformer Corp.	xv
T	
Thordarson Electric Mfg. Company	xvi
Triplett Electrical Instrument Co.	xiii
Turner Company	xxii
U	
United Electronics Company	xxiii
W	
Westinghouse Electric & Mfg. Co.	xxxvi

Dependable

TYPE VP4
BLILEY
CRYSTAL HOLDER
SERIAL NUMBER
FREQUENCY
1714 Kc. 21°C
BLILEY ELECTRIC CO.
MADE IN U.S.A.
ERIE, PA.

... Accuracy and dependability are built into every Bliley Crystal Unit. Specify **BLILEY** for assured performance.

BLILEY ELECTRIC COMPANY
UNION STATION BUILDING ERIE, PA.

Direct Wire to Tokio!

When General Doolittle and his squadrons made their surprise raid over Tokio, they carried a message of things to come—the only type message Japs can understand! Naturally we are proud that the equipment of these planes contained wire made by Wilbur B. Driver Co. The entire facilities of our plant are devoted to producing, as never before, special alloys* (including beryllium-copper) for all war purposes. Consult us for your requirements.

*Available in rod, wire, ribbon, and strip—both hot and cold rolled

WILBUR B. DRIVER CO.
NEWARK, NEW JERSEY

FOR OUTSTANDING ACHIEVEMENT



... The "E" EMBLEM is the highest tribute to the prowess of American labor in the field of shortwave communications. Hallicrafters workers by their unswerving purpose to produce a product that is better, and to exceed their quota in order that production schedules can be maintained, have been awarded this honor.

The accumulative electronic experience gained by Hallicrafters employees will be a dominant factor in future peace time production of advanced designs in shortwave communications receivers.

the hallicrafters co.
Keep Communications Open!

SPEED

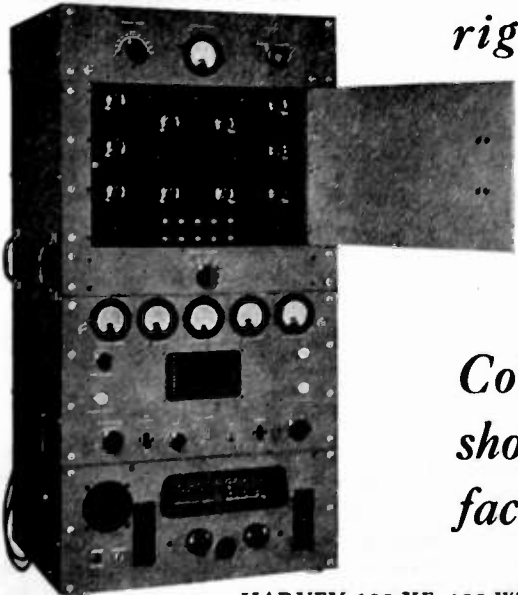

• on special orders with rigid specifications

Complete machine shop and laboratory facilities.

HARVEY 100-XE. 100-Watt Transmitter. Rapid frequency shift. 10 Crystal-controlled frequencies. Withstands extreme climatic conditions.

HARVEY Radio Laboratories, Inc.

445 CONCORD AVENUE, CAMBRIDGE, MASS.

* Micro-Dimensional
WIRE & RIBBON
for
VACUUM TUBES

In a complete range of sizes and alloys for Transmitting, Receiving, Battery and Miniature Tubes

Melted and worked under close supervision to assure maximum uniformity and tensile strength . . .

WIRES
drawn to .0005" diameter

RIBBON
rolled to .0001" thick

SPECIAL ALLOYS
made to meet individual specifications

Inquiries Invited

Write for list of stock alloys

SIGMUND COHN

44 GOLD ST. NEW YORK

SINCE  1901

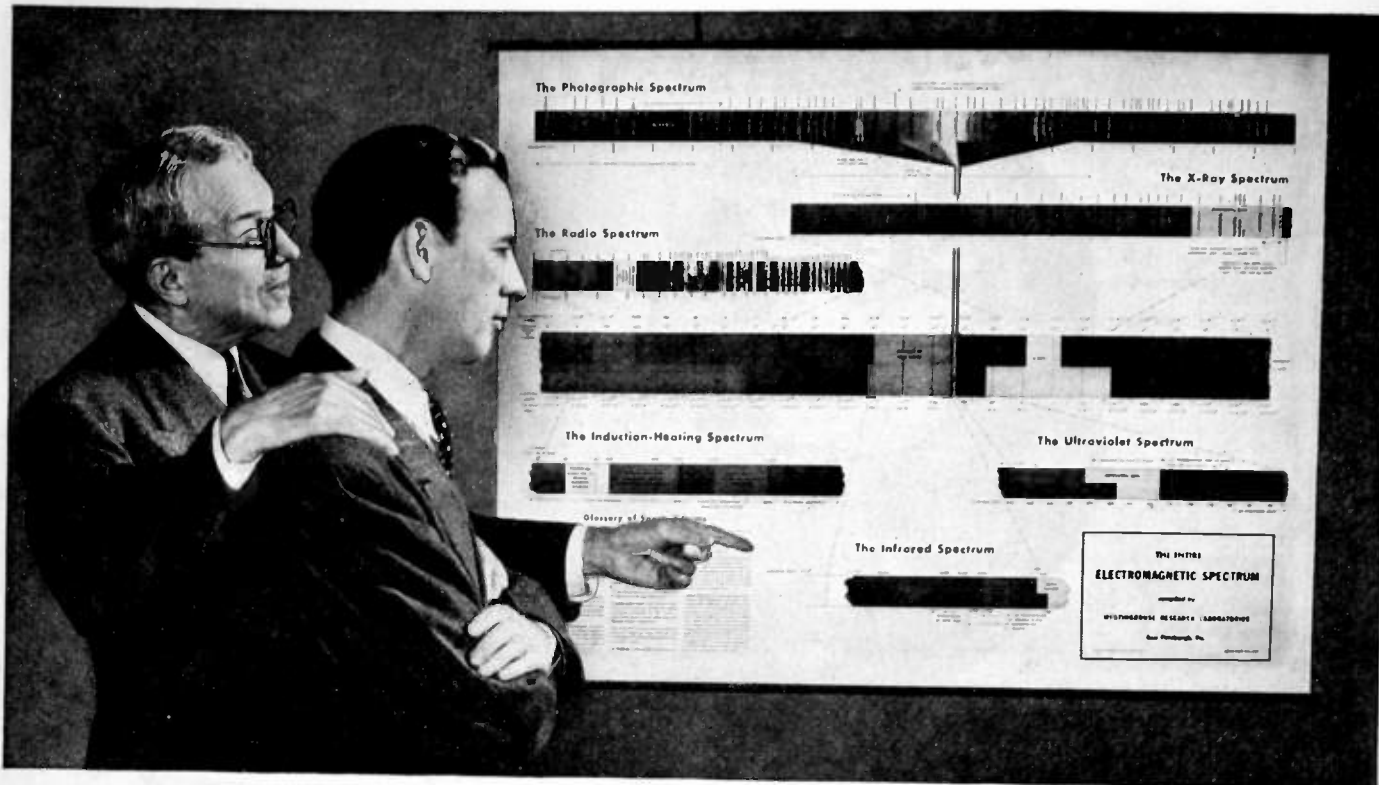

"The Invisible Rainbow that benefits all mankind"

When you look at a rainbow in the sky, you see nature performing a fascinating experiment in optics. Tiny drops of moisture, acting as prisms, have broken the sunlight into its component parts.

The familiar white light we know as sunlight is really a combination of many rainbow bands of color, making up the visible portion of the Photographic Spectrum.

But there's another rainbow in nature . . . an *invisible rainbow* that benefits all mankind.

This is the complete *Electromagnetic Spectrum*, with bands of radiation that stretch out in an infinity of wave lengths on both sides of the Photographic Spectrum.

To the right of the Photographic Spectrum lie the shorter wave lengths of the *Ultraviolet Spectrum*. Here we find the



invisible radiations that make fluorescent tubes glow . . . erythematous rays that tan the skin . . . bactericidal rays that kill air-borne bacteria.

Further to the right is the *X-Ray Spectrum* . . . still shorter radiations that science has harnessed to diagnose and heal many human ailments . . . rays that penetrate heavy armor plate.

At the very end of the scale are the *Cosmic Rays* . . . unknown, mysterious cosmic particles that constantly bombard the earth.

To the left of the Photographic Spectrum are the longer wave lengths of the *Infrared Spectrum* . . . invisible radiant heat



waves from the sun that penetrate window glass . . . rays emitted by electric heaters and steam radiators to help warm our homes.

Next, is the *Radio Spectrum* . . . microwaves that guide planes and ships to their destinations . . . longer waves that

bring us radio and television entertainment.

And finally, the longest waves of all, the *Induction-Heating Spectrum* . . . extensively employed by industry in the annealing and heat treatment of metals.

Westinghouse Research Engineers have played a major part in exploring and putting to useful work the myriad radiations in the Electromagnetic Spectrum.

As a result of the "know how" gained through years of experimental work in the Westinghouse Research Laboratories, these scientists have prepared a full-color chart which illustrates and explains every phase of the complete Electromagnetic Spectrum.

How to get this fascinating chart

The Electromagnetic Spectrum Chart, size 30" x 40", lithographed in 8 colors on heavy linen, is now offered to engineers and scientists for only \$2, postage prepaid. Address: Department 6N-17, Westinghouse Electric & Manufacturing Co., East Pittsburgh, Pa.

Westinghouse

... MAKING ELECTRICITY WORK FOR VICTORY

Proceedings of the I.R.E. November, 1942



MORE MORE!

more planes for victory – more hours of capacitor use per dollar for industry

THIS is an air war. The 60,000 planes Uncle Sam must have in 1942 are a real challenge to American production genius. To the men in aeronautics... to the men in radio communication.

To meet that challenge, Cornell-Dubilier has been preparing for more than thirty-two years. Its capacitors for radio communication, like all C-Ds have *extra* dependability — more than enough to outlast any enemy. And as the world's largest

producer of capacitors exclusively, Cornell-Dubilier has the production facilities to outweigh him.

While you may not now be able to enjoy the finer performance of C-Ds, Cornell-Dubilier's contribution to America's war effort does assure more hours of capacitor use per dollar for industry in time to come.

Cornell-Dubilier Electric Corporation, South Plainfield, New Jersey; New England Division, New Bedford, Mass.



MICA CAPACITORS

Copied, imitated...but never duplicated.

Type 75A Mica Capacitors are designed and widely used for heavy-duty commercial service such as high frequency C. W. furnaces or bombardiers. These units employ the patented radial type stack assembly and are encased in heavy, ribbed wall aluminum castings. Available in capacities from .001 mfd. to .05 mfd. at voltages from 7,500 to 25,000 volts.



Cornell Dubilier Capacitors

MICA • PAPER • STANOL • MET & OXY ELECTROLYTIC CAPACITORS

M O R E I N U S E T O D A Y T H A N A N Y O T H E R M A K E

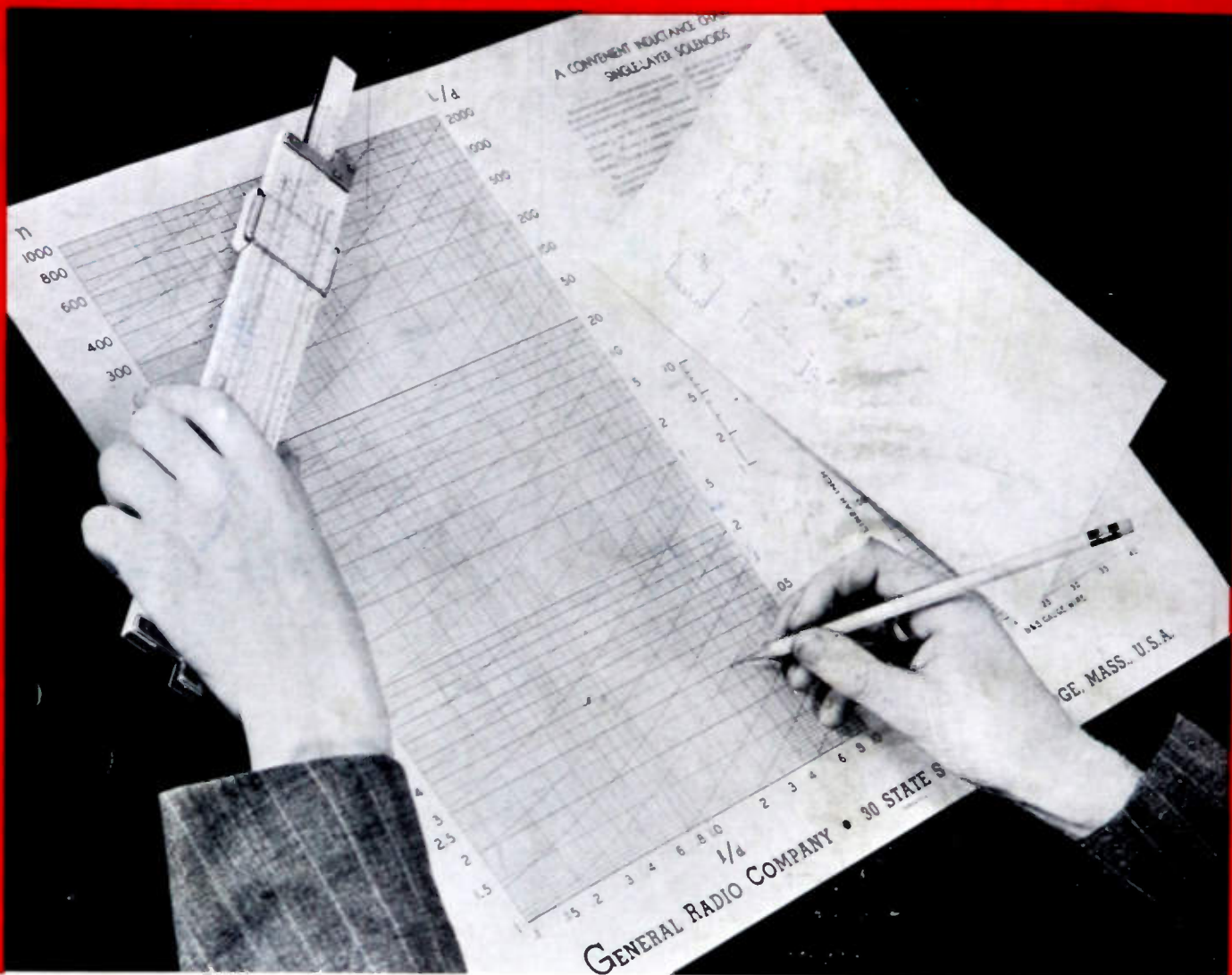

This Chart Saves Time . . .

Designing inductors for use at radio frequencies takes time. Even when accurate formulae are available, computing inductance may be tedious. Practically every radio engineer has to design inductors occasionally; many design them continually.

To save time in our own laboratories, we devised a design chart for single layer coils which gives results to very good accuracy. It is entitled "A Convenient Inductance Chart for

Single-Layer Solenoids," and is 18" x 22" overall, suitable for wall mounting. It is used for determining the number of turns and the size of wire to be used in order to obtain a given inductance on a given winding form. The explanation includes an example.

A number of these charts are available for our friends. If you can use a copy, we shall be glad to send it on request. Ask for Inductance Chart No. 800.



GENERAL RADIO COMPANY • Cambridge, Massachusetts