

Proceedings

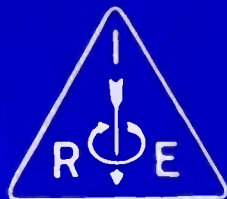

of the

I·R·E

NOVEMBER 1941

VOLUME 29 NUMBER 11

Program-Operated Level-Governing
Amplifier

Detecting the Passage of a Bullet

Voltage-Controlled Electron
Multipliers

Electrostatic Electron Multipliers

Orbital-Beam Secondary-Electron
Multiplier

Institute of Radio Engineers



In a world at war

So that our next generation will not be born to a world of violence, shortages, rationing and sacrifice . . . a world wherein advancements are distorted into mechanics of destruction. . . . A world in which peacetime economies are harnessed to the maintenance of colossal war machines . . . we pledge ourselves and our facilities.

Our nation is engaged in a great task of preparedness for our defense, and our products, transmitting and rectifying tubes, are employed in the establishment and maintenance of vital communications lines. These same tubes, which serve in our broadcasting stations to bring us laughter, music and culture; in research—and in electro-medical apparatus to alleviate suffering and disease; and in many industrial applications; must NOW serve in the protection of our shores. To this end, we cooperate willingly.

We must therefore ask your cooperation in anticipating essential, normal requirements so that we may continue to serve both you and our country to the best of our ability.



AMPEREX ELECTRONIC PRODUCTS
79 WASHINGTON STREET • BROOKLYN, NEW YORK

BOARD OF DIRECTORS

Frederick E. Terman, *President*
Adolfo T. Cosentino,
Vice President
Alfred N. Goldsmith, *Editor*
Haraden Pratt, *Treasurer*
Harold P. Westman, *Secretary*
Austin Bailey
Adolph B. Chamberlain
Ivan S. Coggeshall
Melville Eastham
Harold T. Friis
Virgil M. Graham
O. B. Hanson
Raymond A. Heising
Lawrence C. F. Horle
C. M. Jansky, Jr.
Frederick B. Llewellyn
Browder J. Thompson
Hubert M. Turner
Arthur F. Van Dyck
Harold A. Wheeler
Lynde P. Wheeler

Harold R. Zeamans,
General Counsel

BOARD OF EDITORS

Alfred N. Goldsmith, *Editor*
Ralph R. Batcher
Lloyd V. Berkner
Philip S. Carter
Lewis M. Clement
Elmer W. Engstrom
William L. Everitt
Peter C. Goldmark
Frederick W. Grover
C. M. Jansky, Jr.
John D. Kraus
Frederick B. Llewellyn
Samuel S. Mackeown
Edward L. Nelson
Harry F. Olson
Greenleaf W. Pickard
Haraden Pratt
Conan A. Priest
Leon J. Sivian
Lynne C. Smeby
Browder J. Thompson
Harold A. Wheeler
Lynde P. Wheeler
Laurens E. Whittemore
Gerald W. Willard
William Wilson
Charles J. Young

Helen M. Stote, *Assistant Editor*

William C. Copp,
Advertising Manager

John D. Crawford,
Assistant Secretary

Proceedings

of the I·R·E

Published Monthly by

The Institute of Radio Engineers, Inc.

VOLUME 29

November, 1941

NUMBER 11

Program-Operated Level-Governing Amplifier	W. L. Black and N. C. Norman	573
A Radio-Frequency Device for Detecting the Passage of a Bullet	C. I. Bradford	578
Voltage-Controlled Electron Multipliers	B. J. Thompson	583
The Behavior of Electrostatic Electron Multipliers as a Function of Frequency	L. Malter	587
The Orbital-Beam Secondary-Electron Multiplier for Ultra-High-Frequency Amplification	H. M. Wagner and W. R. Ferris	598
Author's Note on "The Response of Electrical Networks to Nonsinusoidal Periodic Waves," Nathan Marchand		603
Discussion on "The Response of Electrical Networks to Nonsinusoidal Periodic Waves," by Nathan Marchand	Herbert Sherman	603
Correction to "Theory of Antennas of Arbitrary Size and Shape," S. A. Schelkunoff		603
Correction to "Transmission Theory of Plane Electro- magnetic Waves," S. A. Schelkunoff		603
Institute News and Radio Notes		603
Sections		603
Books		
"Radio-Frequency Measurements by Bridge and Resonance Methods," by L. Hartshorn	D. B. Sinclair	606
"Radio Engineering Handbook," edited by Keith Henney	H. M. Turner	606
"Six-Place Tables," by Edward S. Allen	E. W. Allen, Jr.	606
"Radio at Ultra-High Frequencies," published by RCA Institutes Technical Press	J. K. Clapp	607
Contributors		607

Entered as second-class matter October 26, 1927, at the post office at Menasha, Wisconsin, under the Act of February 28, 1925, embodied in Paragraph 4, Section 538 of the Postal Laws and Regulations. Publication office, 450 Ahnalt Street, Menasha, Wisconsin. Editorial and advertising offices, 330 West 42nd St., New York, N. Y. Subscription, \$10.00 per year; foreign, \$11.00.

THE INSTITUTE OF RADIO ENGINEERS

INCORPORATED



New York Meeting—December 3, 1941



Winter Convention, New York, N. Y., January 12, 13, and 14, 1942

Summer Convention, Cleveland, Ohio, June 29, 30, and July 1, 1942

SECTION MEETINGS

ATLANTA
November 21

CLEVELAND
November 24

DETROIT
November 21

LOS ANGELES
November 18

WASHINGTON
December 8

PHILADELPHIA
December 4

PITTSBURGH
December 8

SECTIONS

- ATLANTA**—Chairman, A. W. Shropshire; Secretary, G. M. Howard, 856 St. Charles Ave., N. E., Atlanta, Ga.
- BALTIMORE**—Chairman, V. D. Hauck, Jr.; Secretary, G. J. Gross, Pennsylvania Water and Power Co., 1611 Lexington Bldg., Baltimore, Md.
- BOSTON**—Chairman, J. M. Henry; Secretary, R. O. Oberg, Northeastern University, Boston, Mass.
- BUENOS AIRES**—Chairman, P. J. Noizeux; Secretary, L. C. Simpson, RCA Victor Argentina, Bartolome Mitre, 1961, Buenos Aires, Argentina.
- BUFFALO-NIAGARA**—Chairman, E. H. Roy; Secretary, Leroy Fiedler, 53 Rosedale Ave., Hamburg, N. Y.
- CHICAGO**—Chairman, G. I. Martin; Secretary, R. A. Kay, 4819 Wallbank, Downers Grove, Ill.
- CINCINNATI**—Chairman, J. M. McDonald; Secretary, W. L. Schwesinger, Crosley Corp., Cincinnati, Ohio.
- CLEVELAND**—Chairman, Carl E. Smith; Secretary, W. G. Hutton, 7314 Dorothy Ave., Parma, Ohio.
- CONNECTICUT VALLEY**—Chairman, F. G. Webber; Secretary, C. I. Bradford, 187 Glenarden Dr., Fairfield, Conn.
- DALLAS-FORT WORTH**—Chairman, D. A. Peterson; Secretary, P. C. Barnes, WFAA-WBAP, Grapevine, Tex.
- DETROIT**—Chairman, M. Cottrell; Secretary, Paul Frincke, WJBK, 6559 Hamilton Ave., Detroit, Mich.
- EMPORIUM**—Chairman, R. K. Gessford; Secretary, C. W. Reash, Hygrade Sylvania Corp., Emporium, Pa.
- INDIANAPOLIS**—Chairman, A. N. Curtiss; Secretary, T. N. Rosser, P. R. Mallory & Co., 3029 E. Washington St., Indianapolis, Ind.
- KANSAS CITY**—Chairman, H. K. Morgan; Secretary, G. L. Taylor, Midland Radio School, Power and Light Bldg., Kansas City, Mo.
- LOS ANGELES**—Chairman, W. W. Lindsay, Jr.; Secretary, C. F. Wolcott, 1609 S. Western Ave., Los Angeles, Calif.
- MONTREAL**—Chairman, E. A. Laport; Secretary, W. A. Nichols, Canadian Broadcasting Corp., 1012 Keefer Bldg., Montreal, Que.
- NEW ORLEANS**—Chairman, G. H. Peirce; Secretary, D. W. Bowman, 8327 Sycamore St., New Orleans, La.
- PHILADELPHIA**—Chairman, C. C. Chambers; Secretary, R. L. Snyder, 103 Franklin Rd., Glassboro, N. J.
- PITTSBURGH**—Chairman, P. N. Bossart; Secretary, Ralph Overholt, Jr., 7211 Thomas Blvd., Pittsburgh, Pa.
- PORTLAND**—Chairman, E. R. Meissner; Secretary, L. M. Belleville, 361 N. E. 75th Ave., Portland, Ore.
- ROCHESTER**—Chairman, H. J. Klumb; Secretary, O. L. Angevine, Jr., Stromberg-Carlson Telephone Manufacturing Co., Rochester, N. Y.
- SAN FRANCISCO**—Chairman, L. J. Black; Secretary, Karl Spangenberg, Electrical Engineering Dept., Stanford University, Calif.
- SEATTLE**—Chairman, K. H. Ellerbeck; Secretary, R. J. Gleason, Pacific Alaska Airways, Inc., 3314 White Bldg., Seattle, Wash.
- TORONTO**—Chairman, R. H. Klingelhoefter; Secretary, L. C. Simmonds, 301 King St., E., Toronto, Ont.
- TWIN CITIES**—Chairman, C. A. Culver; Secretary, N. B. Coil, 1664 Thomas St., St. Paul, Minn.
- WASHINGTON**—Chairman, M. H. Biser; Secretary, C. M. Hunt, WJSV, 817 Earle Bldg., Washington, D. C.

THE INSTITUTE serves those interested in radio and allied electrical communication fields through the presentation and publication of technical material.

THE PROCEEDINGS has been published without interruption since 1913 when the first issue appeared. The contents of each paper published in the **PROCEEDINGS** are the responsibility of the author and are not binding on the Institute or its members. Material appearing in it may be reprinted or abstracted in other publications on the express condition that specific reference shall be made to its original appearance in the **PROCEEDINGS**. Illustrations of any variety, however, may not be reproduced without specific permission from the Institute.

STANDARDS reports are published from time to time and are sent to each member without charge. The four current reports are on Electroacoustics, Electronics, Radio Receivers, and Radio Transmitters and were published in 1938.

MEMBERSHIP has grown from a few dozen in 1912 to more than five thousand. Practically every country in the world in which radio engineers may be found is represented in our roster. Dues for the five grades of membership range from \$3.00 to \$10.00 per year. The **PROCEEDINGS** is sent to each member without further payment.

SECTIONS in twenty-six cities in the United States, Canada, and Argentina hold regular meetings. The chairmen and secretaries of these sections are listed on the opposite page.

SUBSCRIPTIONS are accepted for the **PROCEEDINGS** at \$10.00 per year in the United States of America, its possessions, and Canada; when college and public libraries order direct from the Institute, the subscription price is \$5.00. For other countries there is additional charge of \$1.00.

The Institute of Radio Engineers, Inc.
Harold P. Westman, Secretary
330 West 42nd Street
New York, N.Y.

The Institute of Radio Engineers

Incorporated

330 West 42nd Street, New York, N.Y.

To the Board of Directors

Gentlemen:

I hereby make application for ASSOCIATE membership in the Institute of Radio Engineers on the basis of my training and professional experience given herewith, and refer to the sponsors named below who are personally familiar with my work.

I certify that the statements made in the record of my training and professional experience are correct, and agree if elected, that I shall be governed by the Constitution of the Institute as long as I continue a member. Furthermore I agree to promote the objects of the Institute so far as shall be in my power.

.....
(Sign with pen)

.....
(Address for mail)

.....
(City and State)

.....
(Date)

SPONSORS

(Signatures not required here)

Mr.

Address

City and State

Mr.

Address

City and State

Mr.

Address

City and State

REQUIREMENTS for Associate membership are that an applicant must be at least twenty-one years of age, of good character, and be interested in or connected with the study or application of radio science or the radio arts.

SPONSORS who are familiar with the work of the applicant must be named. Preferably these should be three Associates, Members, or Fellows of the Institute. In cases where the applicant is so located as not to be known to the required number of member sponsors, the names of responsible nonmembers may be given.

DUES for Associate membership are six dollars per year. The entrance fee for this grade is three dollars and should accompany the application.

(Typewriting preferred in filling in this form) No.

RECORD OF TRAINING AND PROFESSIONAL EXPERIENCE

Name
(Give full name, last name first)

Present Occupation
(Title and name of concern)

Business Address

Home Address

Place of Birth Date of Birth Age

Education

Degree
(College) (Date received)

TRAINING AND PROFESSIONAL EXPERIENCE
(Give dates and type of work, including details of present activities)

Record may be continued on other sheets this size if space is insufficient.

Receipt Acknowledged Elected Notified

OTHER GRADES are available to qualified applicants. Those who are between the ages of eighteen and twenty-one may apply for Junior grade. Student membership is for full-time students in engineering or science courses in colleges granting degrees as a result of a four-year course. A special application blank is provided and requires the signature of a faculty member as the sole sponsor. Member grade is open to older engineers with several years of experience. Fellow grade is by invitation only. Information and application blanks for these grades may be obtained from the Institute.

BACK COPIES of the PROCEEDINGS may be purchased at \$1.00 per copy where available. Members of the Institute in good standing are entitled to a twenty-five per cent discount.

VOLUMES, bound in blue buckram, may be purchased for \$14.25; \$11.25 to members.

BINDERS are \$1.50 each. The volume number or the member's name will be stamped in gold for fifty cents additional.

INSTITUTE EMBLEMS of fourteen-carat gold with gold lettering on an enameled background are available. The lapel button is \$2.75; the lapel pin with safety catch is \$3.00; and the watch charm is \$5.00. All of these are mailed postpaid.

Program-Operated Level-Governing Amplifier*

W. L. BLACK†, MEMBER, I.R.E., AND N. C. NORMAN†, NONMEMBER, I.R.E.

Summary—In program material, the volume varies momentarily over a wide range. By reducing this range within reasonable limits, it is possible to increase the effective signal output of broadcast transmitters. Amplifier systems designed to reduce the volume range automatically have been in use for some time. The apparatus to be described here is an improvement in this type of device.

IN A commercial signal transmission system depending upon the process of modulation, there is ordinarily an upper limit to the amount of input power level which may be applied. For example, in one type of sound recording the point at which light-valve ribbons clash imposes the limitation. As a further example, in an amplitude-modulated radio transmitter the introduction of excessive harmonics caused by departure from linearity of circuit characteristics imposes a definite limitation. It is, nevertheless, desirable to maintain the highest possible average input level in order to make the most effective use of the available facilities and to avoid degrading effects caused by extraneous factors such as inherent noise level. Fig. 1

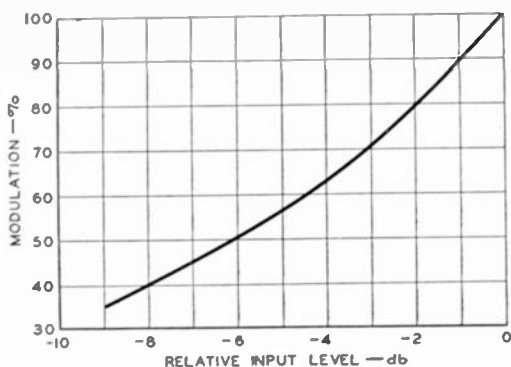

Fig. 1—Input level versus percentage modulation.

shows percentage of modulation versus input level of the modulating voltage in decibels for a theoretical radio transmitter which would be fully modulated at an input of 0 decibels. Thus, a change from 100 per cent modulation to approximately 80 per cent modulation corresponds to a change of 2 decibels in input voltage.

When speech and music are used to furnish the modulating voltage, the peak factor (ratio of peak to root-mean-square values) of the audio-frequency input may be 8 to 10 decibels or even more. Therefore, if overmodulation is to be prevented, the peak voltage must be kept below 100 per cent modulation while at the same time approaching as close to that point as possible, to maintain the optimum average signal level in the receiver. Occasional overmodulation by such peaks may be infrequent enough to cause only spasmodic harmonic distortion which may not be per-

ceptible even to critical observers and, hence, of no immediate concern. More frequent overmodulation may result in observable distortion or because of limitations in the transmitting device (e.g., breakdown voltage of circuit elements of a radio transmitter) may cause interruption of transmission. Furthermore, particularly if a number of such peaks occur in fairly rapid succession, there may well be interference in adjacent transmission channels. This effect has been observed with an amplitude-modulated radio broadcasting transmitter particularly when transmitting the music of dance orchestras characterized by brass instruments such as trombones having relatively high peak powers at high frequencies.¹ This type of program material has caused sufficient extra-band radiation in a channel 30 kilocycles removed from that of the interfering station to make possible identification of the interfering station by a correspondence between the rhythm of dance music and the interfering noise spurts occurring when complete modulation was exceeded.

The problem thus posed in a practical transmission system is threefold. First, it is necessary to control the level of the modulating speech or music to maintain as high an average degree of modulation as possible. Second, it is essential to prevent the occurrence of overmodulation sufficiently to avoid its accompanying undesirable effects, particularly those which are audible either as distortion in the system under control or as noise disturbance in adjacent transmission channels. Finally, too great a reduction of volume range results in unnaturalness of the reproduced program material.

For a relatively long period, the input level control of broadcast transmitters was manually adjusted by a control operator. Practically, this method has been relatively successful in the hands of sufficiently skilled operators at the expense of a compromise whereby the level of the program as indicated by a typical volume indicator has been held at least 8 to 10 decibels below the single-frequency level required for 100 per cent modulation, to allow for the peak factor of the program material. The efficacy of this method is limited by the reaction time of the control operator and by his familiarity with the program being transmitted.

Another approach which suggests itself is the use of a peak chopper to reduce the amplitude of excessive peaks while the average program level as shown by a volume indicator is maintained relatively high. The use of a peak chopper alone as a protective device might be considered objectionable because of the quality degradation inherent in its operation. However, it has been found experimentally that it is possible to

* Decimal classification: R363. Original manuscript received by the Institute, May 26, 1941. Presented, Sixteenth Annual Convention, New York, N. Y., January 11, 1941.

† Bell Telephone Laboratories, Inc., New York, N. Y.

¹ L. J. Sivian, H. K. Dunn, and S. D. White, "Absolute amplitudes and spectra of certain musical instruments and orchestras," *Jour. Acous. Soc. Amer.*, vol. 2, pp. 330-371; January, 1931.

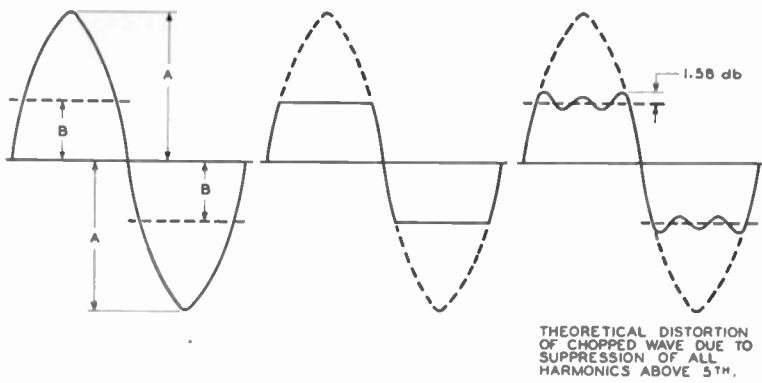

Fig. 2—Effect of chopping sine-wave peaks.

construct a peak chopper which causes much less quality deterioration in the opinions of skilled listeners than that caused by the momentary overloading of a high-quality radio transmitter due to overmodulation. Nevertheless, a peak chopper has the fundamental disadvantage that for a rapid succession of program peaks, such as occur with certain types of music, the audible distortion caused by chopping is cumulative as long as the peaks exceed the point at which the chopping occurs. Even more fundamental, however, is the fact that peak chopping is not completely effective in a practical signal transmission system due to the frequency-response limitations of any such system and to phase shifts beyond the peak-chopping point, both of which tend to restore some of the peaks of the chopped wave. This effect is shown in Fig. 2. The level at which peak chopping occurs, therefore, must be set so far below 100 per cent modulation that some of the advantages of its operating characteristics are nullified to allow for the restoration.

A peak limiter rather than a peak chopper appears to be indicated. A peak limiter is, in accordance with Norwine's definition, applied to "a device whose gain will be quickly reduced and slowly restored when the instantaneous peak power of the input exceeds a predetermined value. The amount of gain reduction is a

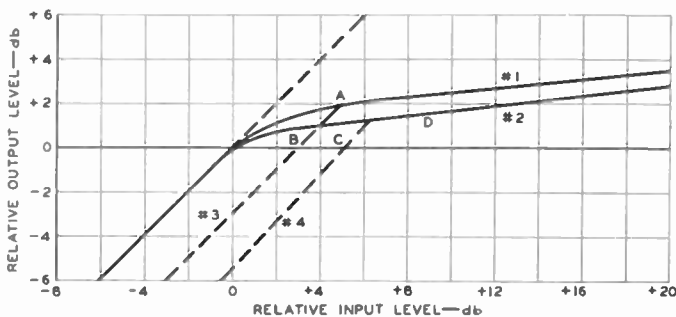

Fig. 3—Load characteristics of typical peak limiters.

function of the peak amplitude and in practice is usually intended to be small to prevent material reduction in the range of intensity of the signal."² Devices of this

² A. C. Norwine, "Devices for controlling amplitude characteristics of telephonic signals," *Bell Sys. Tech. Jour.*, vol. 17, pp. 539-554; October, 1938.

type have been in service in radio broadcasting for several years. A comprehensive study of the application of such a device in modulation systems indicates several fundamental requirements for satisfactory operation in a high-quality signal transmission system.

The most important of these considerations is the slope of the input-output characteristic beyond the point where gain reduction (compression) starts as shown in Fig. 3. This figure shows single-frequency load characteristics of typical peak limiters under steady-state conditions. Curve 1 shows the load characteristic of an early device of this type.³ Point A on this

curve corresponds to the output level necessary for 100 per cent modulation as indicated by a volume indicator. Curve 3 is then the input-output characteristic of a corresponding amplifier without the peak-limiting feature which would be necessary to maintain the same output level at point A for corresponding input levels, and shows that a 3-decibel increase in average input signal level is made possible by the use of a peak limiter having the load characteristic of curve 1. This increase in input level is the effective limit of the increased received signal strength which can be obtained using a peak limiter having the characteristics shown. It should be noted, however, that any peaks exceeding point A will result in overmodulation of an associated radio transmitter. Curve 2 shows a peak-limiter load characteristic having a flatter slope above the point where compression starts. With this flatter load characteristic, it is possible to increase the average received signal level still further without risk of overmodulation. Point C on this curve is arbitrarily chosen as the place where 5 decibels of gain reduction occurs. If the average signal-level input is set so that the peaks just reach point C, the average received signal level may be increased as much as 5 decibels, as compared with an increase of only 3 decibels made possible by the peak limiter of curve 1. The point of greatest interest in connection with curve 2 is the fact that a range of nearly 7 decibels exists between point C and point D, the point where 100 per cent modulation would occur with a peak limiter having the characteristic of curve 2. This margin insures that a much greater degree of protection against overmodulation is afforded by a peak limiter having the load characteristic of curve 2 than by that of curve 1, in spite of the accompanying higher average modulation.

Another important characteristic is the operating time or the time required to reduce the gain of a peak limiter. The input-output characteristics shown on Fig. 3 are obviously steady-state characteristics. If the duration of a peak is short compared to the operating time some portion of it will escape the limiting action. Thus the higher the input frequency the more the danger of

³ O. M. Hovgaard, "A volume limiting amplifier," *Bell Lab. Rec.*, vol. 16, pp. 179-184; January, 1938.

overmodulation, assuming a given operating time. Putting this another way, assuming a top frequency to be transmitted, the faster the operating time the fewer the cycles which will be transmitted with amplitudes higher than the point where 100 per cent modulation occurs.

A third important peak-limiter characteristic is the time required for the gain to be restored to normal after a peak has reduced the gain momentarily. In devices of this type in current use, a wide range of recovery-time values has been used. As a result of observations of peak limiters during actual program transmission, several conclusions may be drawn. First, of course, this release time must not be so short as to allow an appreciable change in gain during one-half cycle of the lowest signal frequency transmitted as this change would produce odd-harmonic distortion. Second, this time must not be so short that it results in an

for gain reduction, and the time required for restoration of gain appear to be the primary considerations in the design of an ideal peak limiter. However, the problem of designing a physically realizable peak limiter is complicated by the fact that all three are interrelated

in such a way that in the limiting case where all three are made small, one cannot be further reduced without increasing at least one of the other two. This relationship is fundamental, as the stability of the device is dependent upon the freedom from longitudinal transmission around the loop containing the vario-losser and the control circuit for all frequencies in the signal band. While infinite amplification around this loop would make possible an absolutely flat input-output characteristic above the point where gain reduction starts, it would necessitate infinite loss in the longitudinal transmission path, which is obviously an impractical condition. Furthermore, since the con-

denser-charging and -discharging circuits usually employed in a peak limiter to determine the attack and recovery time perform the function of a low-pass filter, the loss is a function of the product of the attack and recovery time, and for signal frequencies varies in magnitude directly with this product.

In addition to the primary requirements, a number

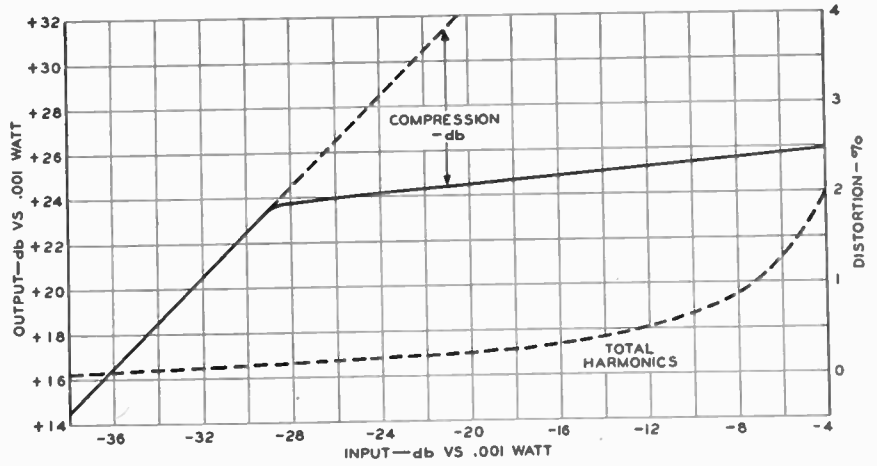

Fig. 5—Input—output characteristic of 1126A amplifier—100 cycles.

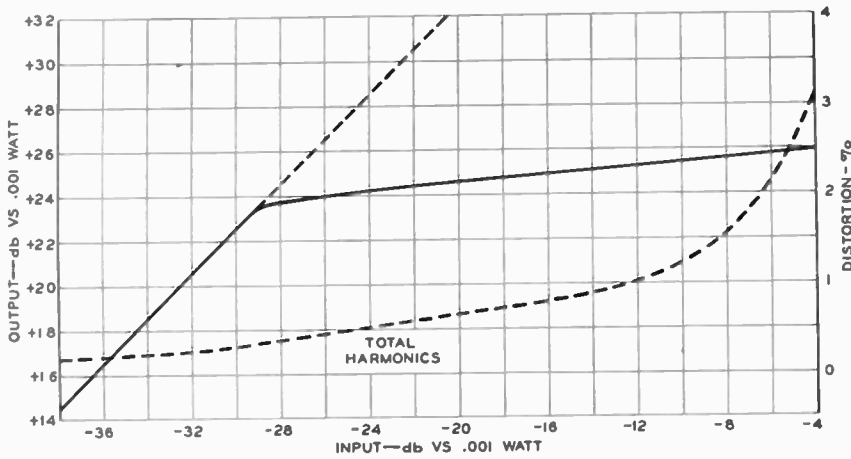

Fig. 4—Input—output characteristic of 1126A amplifier—1000 cycles.

increase in background noise in quiet periods such as pauses between syllables or words of speech following the program peak which causes the gain reduction. Third, the longer this time is, the less will be the frequency of occurrence of peaks causing overmodulation, assuming a given operating setting. Fourth, the longer this time is made, the less will be the effective increase in signal volume, since reduced gain will be in effect a larger proportion of the total time. Fifth, the optimum recovery time may well be different for different types of program material. For example, piano music sounds unnatural when the recovery time is too short, because the effect is similar to inadequate damping of the strings after they are struck or to holding the sustaining pedal too long on the loud notes.

These factors then lead to the conclusion that the compression ratio beyond the knee of the load characteristic, the time required

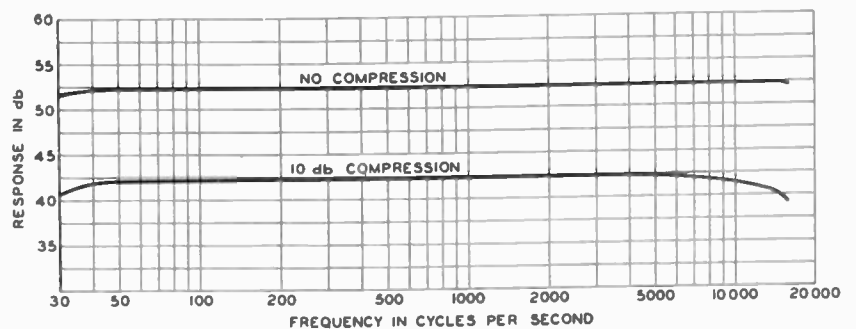

Fig. 6—Gain—frequency response of 1126A amplifier without compression and with compression.

OSCILLOGRAMS OF SINGLE FREQUENCY TONES TRANSMITTED THROUGH A 1126A AMPLIFIER

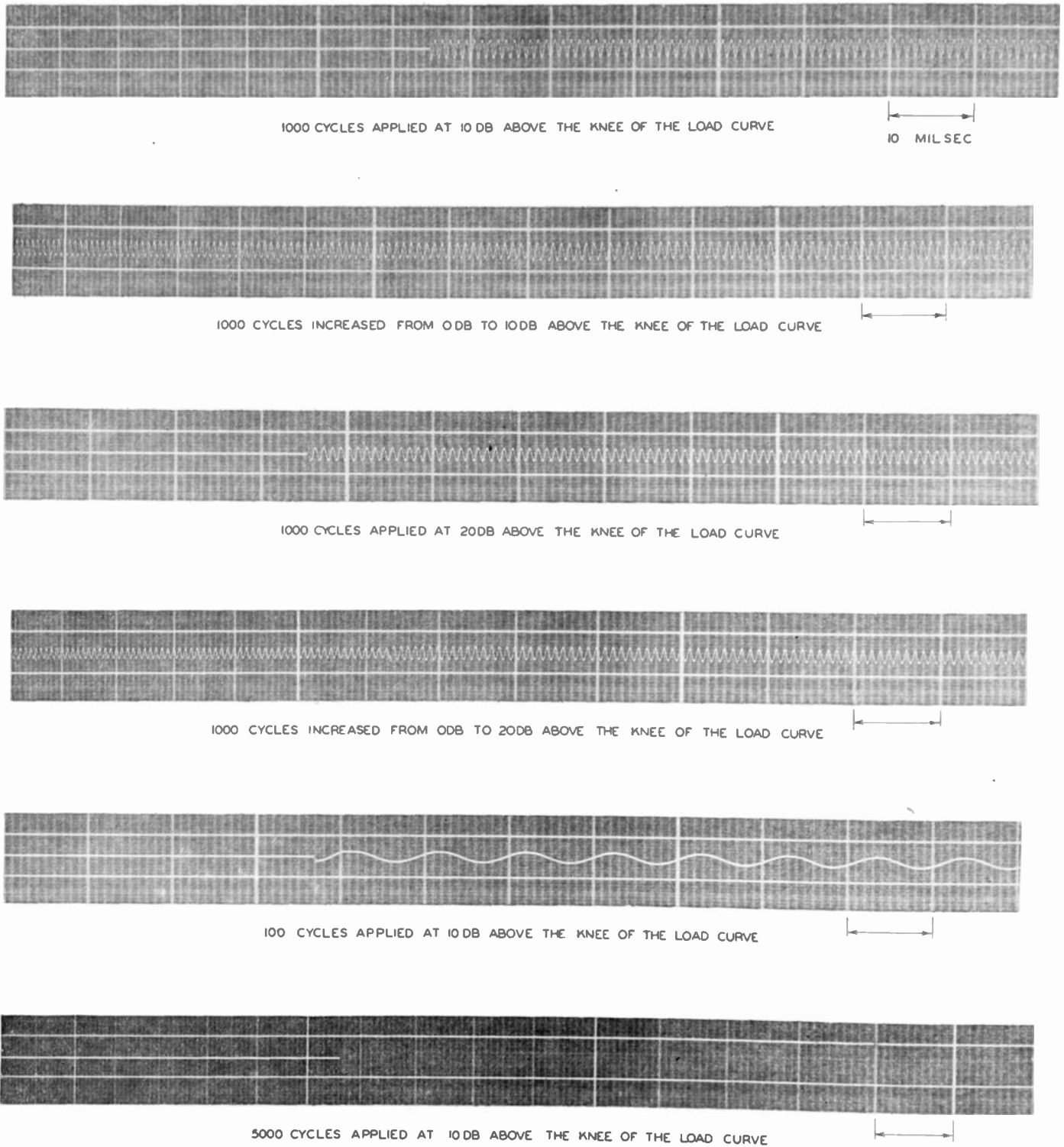

Fig. 7—Oscillograms showing attack time of 1126A amplifier.

of secondary requirements are of practical value. The point at which compression starts should be extremely stable particularly with respect to changes in power-supply conditions. This stability is of particular importance when such a unit is used at a high-power radio

transmitter where sudden changes in power demand occur due to the associated radio transmitter. In addition, the stability of this point simplifies practical operation of the system in which the unit is included, since it serves as a reference point with respect to which

both input and output levels may readily be adjusted. Transmission characteristics (gain—frequency response, harmonic distortion, and output-noise level) should be comparable to a high-quality speech-input amplifier so that the presence of the device cannot be detected by broadcast listeners when it is in the system. A visual indication of its operation should be incorporated to facilitate observation of its performance. Independent control of both input and output levels is necessary. Each of these controls should be in sufficiently small steps to realize fully the capabilities of the device as a means of maintaining a high average modulation without overloading the transmitter on peaks. Finally, the mechanical form should be such that it is adaptable for use under widely varying conditions of physical location, exposure to adverse climatic conditions, and exposure to both electrostatic and electromagnetic fields, while at the same time maintaining appearance standards in keeping with present-day broadcast-station practice.

Recently, there has been developed a program-operated level-governing amplifier to meet these requirements which has been designated the Western Electric 1126A amplifier. Figs. 4 and 5 show its load character-

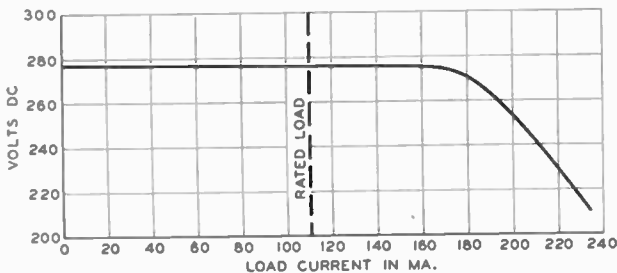

Fig. 8—Voltage regulation characteristic—20A rectifier.

istic and harmonic distortion for steady-state conditions at 1000 cycles per second and at 100 cycles per second, respectively. It should be noted that a compression ration of 10 to 1 is obtained; that is, a change of 10 decibels in input results in a change of only 1 decibel in output level above the point where compression starts. Fig. 6 shows the gain-frequency response of this device both with no compression and with 10 decibels of compression. The noise is at least 70 decibels below the maximum single-frequency output level. Fig. 7 gives oscillograms showing the extremely fast attack time. It should be noted that no observable overshoot occurs even with 5000-cycle single-frequency input. The release time is adjustable in five 0.2-second steps from 0.2 of a second to 1.0 second.

A vacuum-tube voltage-regulated type of plate-supply rectifier coded the Western Electric 20A rectifier is used to supply power so that excellent stability of operating performance is obtained. In addition, this type

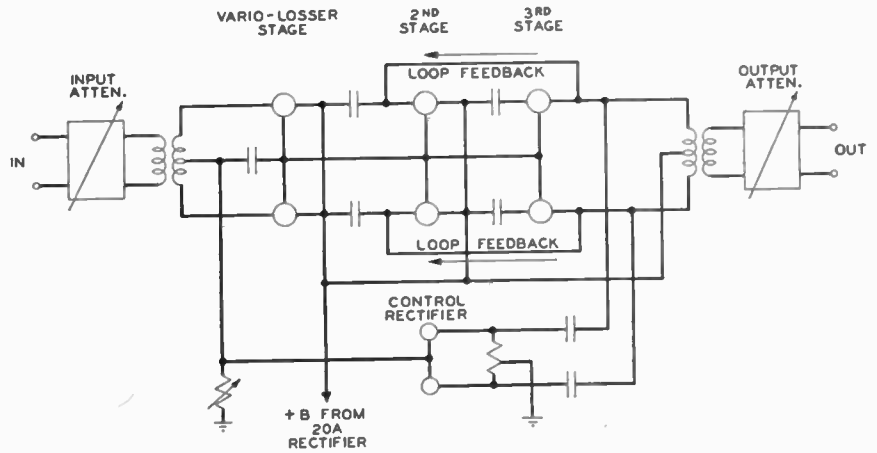

Fig. 9—Functional schematic—1126A amplifier.

of plate supply has the further advantage that it is effectively an extremely low-internal-impedance source of plate-supply voltage so that satisfactory operation of the peak limiter is obtained with the use of a minimum of filter-circuit elements. Fig. 8 shows the output-voltage regulation of this unit with variation in load. The variation in output voltage with plus or minus 10 per cent variation in input line voltage is approximately 0.1 volt.

Fig. 9 shows a functional schematic of the unit, and Fig. 10 shows a photograph in which the compression indicator meter is obvious. In addition, it will be noted that the equipment is arranged in three panels so that the power-supply unit, the amplifier unit, and the control panel may be mounted separately. For example, the control panel may be mounted in a transmitter control console or desk. In this application, the control panel occupies only 5½ inches of mounting space at a location where panel area must be kept at a minimum.

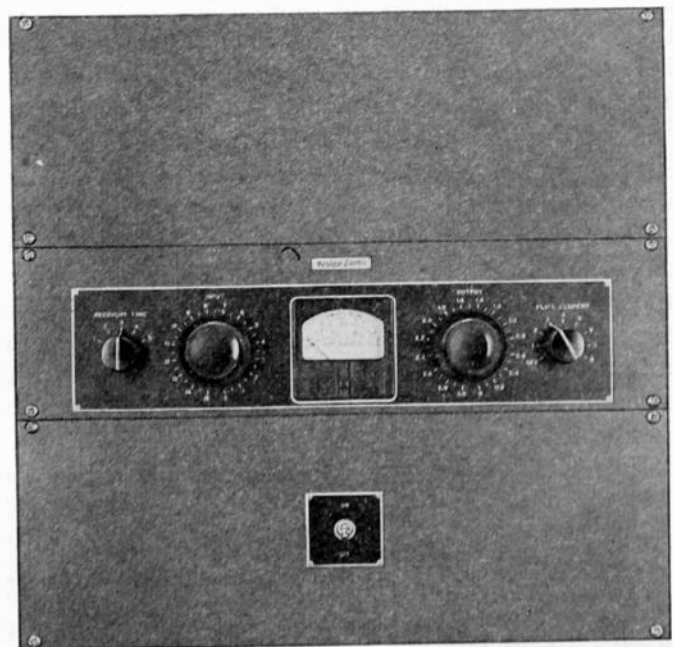

Fig. 10—Front-view photograph—1126A amplifier.

Several models of this equipment have been undergoing field trials in both amplitude- and frequency-modulated broadcasting stations for some time past, and all observations indicate that the application of the principles outlined herein has resulted in a device inherently capable of maintaining a high average signal strength while, at the same time, very effectively eliminating any extra-band radiation. These field trials have included the operation of the equipment where the avoidance of overmodulation has been stressed. In addition, they have included operation where the maximum obtainable increased coverage consistent

with avoidance of disturbing overmodulation has been the principal criterion. In all instances, little or no operating adjustment has been necessary except for initial lining up to insure satisfactory service over relatively long periods.

Controlled listening tests in the laboratory indicate that when using circuits and loud speakers flat to 15,000 cycles per second and comparing direct transmission with transmission through the limiter,⁴ differences in quality of program could be discerned only when the limiting action was 5 decibels or more.

⁴ Tests made with 0.6-second recovery time.

A Radio-Frequency Device for Detecting the Passage of a Bullet*

C. I. BRADFORD†, ASSOCIATE, I.R.E.

Summary—An unusual application of radio engineering is described in which the reaction of a radio-frequency oscillator to the presence of a metallic projectile in a link-coupled coil is utilized in connection with projectile velocity measurements.

In order to obtain the accuracy of signal output required, the circuits are designed for good transient response. In addition, a unique method of differentiating, clipping, and amplifying is utilized in order to obtain a signal with steep wave front when the bullet is at the center of the coil regardless of the weight, shape, or velocity of the bullet.

Pictures are included of the equipment and coils used. High-speed pictures of bullets in the tripping position in the coils and oscillograms of circuit voltages verify that circuit operation is as predicted.

THE measurement of the velocity of bullets and shot charges is an essential test on all small-arms ammunition. These tests are run regularly by the loading companies as a check on the quality of the product. The problem of velocity measurements is one of accurately measuring the time of flight of the projectiles over a known distance. The equipment required falls in two classes. First, an accurate instrument is necessary for the measurement of very short time intervals. The instrument developed at the Remington Arms Company for this service is called the Chronoscope^{1,2} and measures time in terms of the current which flows from the breakdown of one thyatron at the beginning of the interval until the breakdown of another thyatron at the end of the interval. The second part of the equipment required is a device for accurately detecting the arrival or passage of the bullet at a known fixed point. It is this second problem with which this paper is concerned.

Existing devices range from breaking wires and

* Decimal classification: R590. Original manuscript received by the Institute April 21, 1941. Presented, Summer Convention, Detroit, Michigan, June 23, 1941.

† Research Division, Remington Arms Company, Inc., Bridgeport, Connecticut.

¹ C. I. Bradford, "The Chronoscope," *Electronics*, vol. 13, pp. 28-30; November, 1940.

² C. I. Bradford, "The Chronoscope," *American Rifleman*, vol. 89, pp. 12-13; March, 1941.

jarring contacts to photoelectric means, but all have some shortcomings. The ideal device should have the following characteristics:

1. It must trip or produce its signal at precisely the same point along the trajectory regardless of the weight, size, velocity, or position of the bullet.
2. It must make no mechanical contact with the bullet.
3. It should provide a large area through which the bullet may pass.
4. It must be automatically resetting for the next shot.
5. It must be unaffected by microphonics or from the charged gases of the muzzle blast.

With these requirements in mind, a development was started on a device in which the bullet (or shot charge) passes through one or more radio-frequency coils located along the trajectory. Obviously, many arrangements could be devised in which the presence of a lead or copper-jacketed bullet would produce an appreciable influence. The choice of frequency of the radio-frequency source and the resulting coil size and the method of deriving the signal voltage were governed by the usual factors of simplicity of design, signal-to-noise ratio, and the particular requirements of this job.

The circuit design resulting from these factors is shown schematically in Fig. 1.

The circuit associated with tube V_1 is a conventional 3500-kilocycle crystal oscillator. Link-coupled to this oscillator by means of L_4 is a work circuit L_6 , L_7 , and C_3 . L_7 is the inductance which is located along the bullet's trajectory through which the bullet passes. It is tuned on the inductive side of resonance by means of the condenser C_3 . The link coupling and line method

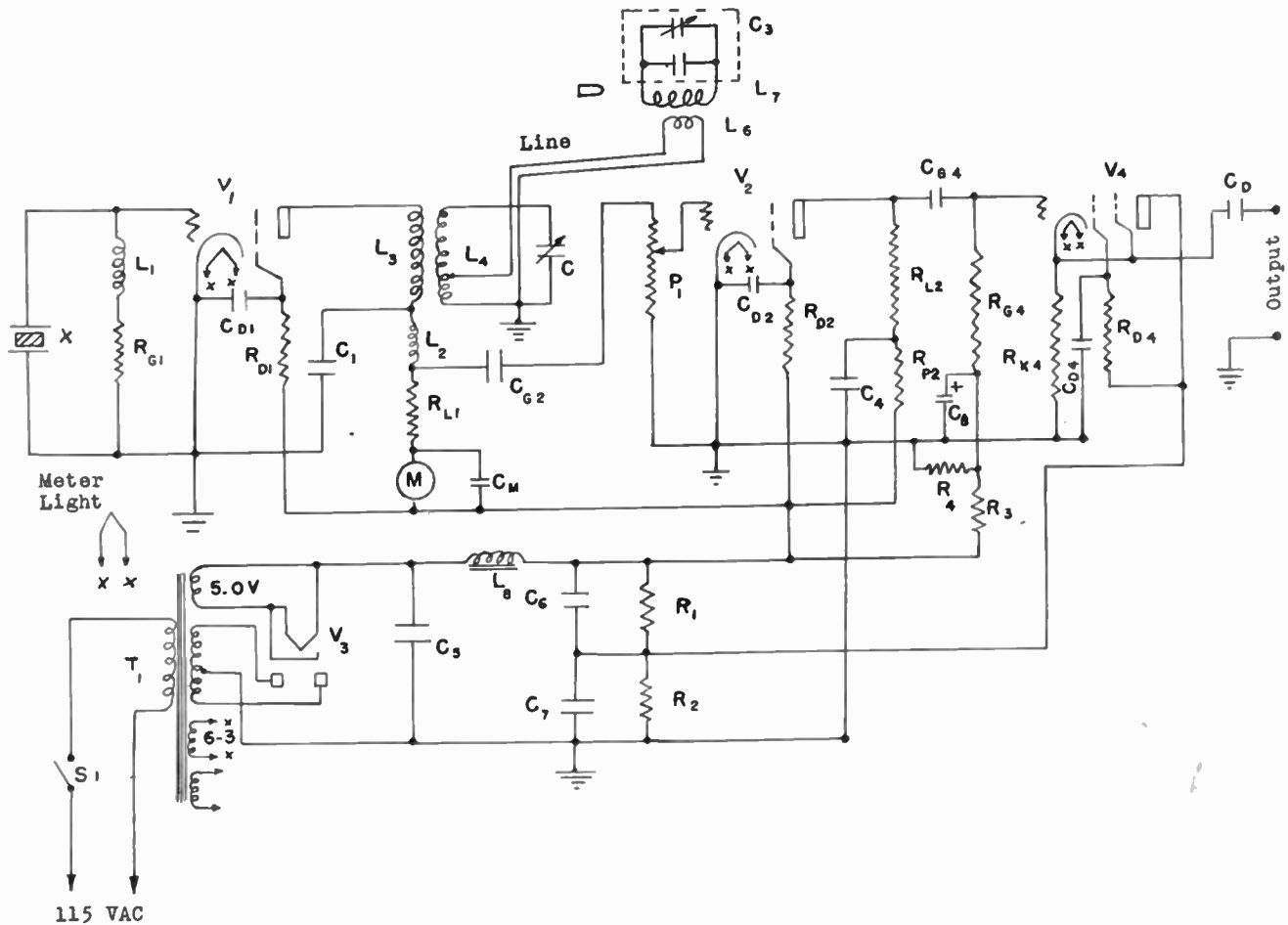

Fig. 1—Schematic of coil disjuncter and amplifier circuit.

is utilized so that the oscillator and associated equipment may be placed some distance from the gun (10 to 15 feet) when the coil L_7 is used close to the muzzle. The variable condenser C is also coupled through L_4 to the plate inductance L_3 and is adjusted so that the oscillator is tuned on the inductive side of resonance on a steep portion of the curve. The meter M is used as an indicator for this tuning. A crystal oscillator with its high degree of frequency stability is used because of the critical adjustment of the circuits. Furthermore, in this case it makes a more simple and economical design.

The bullet entering L_7 alters the tuning in such a direction that the oscillator will take more plate current. The resulting voltage developed across the plate series resistance R_{L1} is in such a direction as to apply a negative signal to the grid of V_2 . This tube acts as a distorting amplifier, insensitive to positive grid signals but highly sensitive to negative signals. Tube V_4 and associated circuits constitute a conventional impedance-matching amplifier to provide low-impedance output. These circuits are all designed to have good transient response for the types of pulses encountered. Consequently, with the passage of a bullet, a positive voltage output is obtained which plotted against time is similar in form to a resonance curve. (See Fig. 2.) The time base shown in this figure is for a bullet with a velocity of 2500 feet per second.

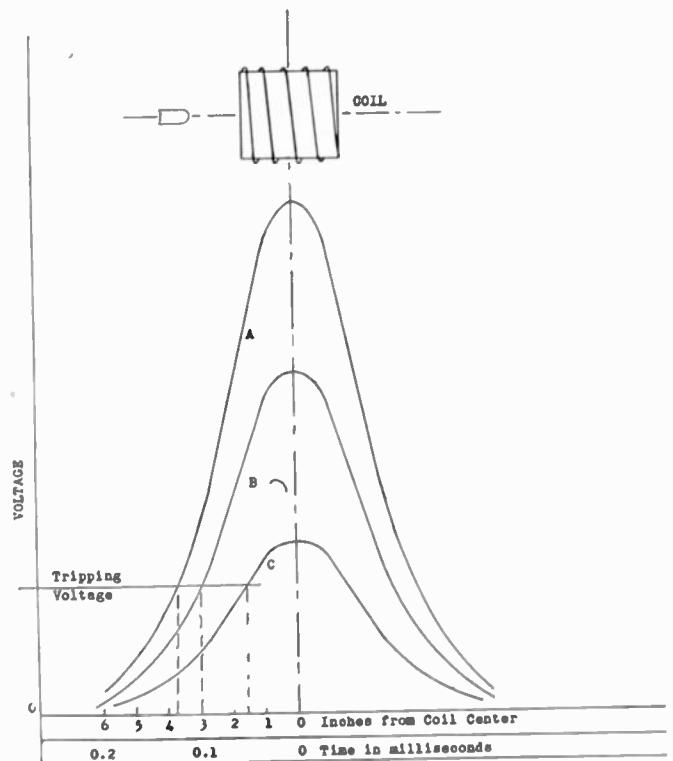

Fig. 2—Output voltage curves of coil-disjuncter unit.

Obviously, this voltage, which is the order of 10 to 50 volts, could be used directly to trigger thyratron tubes in the associated time-measuring equipment.

However, variations in the magnitude and duration of this pulse will influence the point at which the time-measuring device will trip. In measuring velocities and time of flight over longer distances (100 to 150 feet) this uncertainty introduces a negligible error and the above-described circuit functions satisfactorily. For the measurement of velocities over short distances (5 to 15 feet) refinements have been necessary which will be discussed later.

Fig. 3 shows a complete unit as described above with

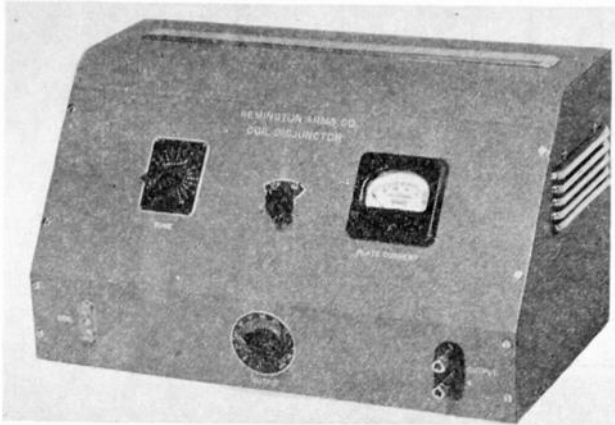

Fig. 3—Coil-disjuncter oscillator unit.

the exception of the bullet coil. A self-contained power supply is provided in this unit. Fig. 4 shows a variety of coils used for different jobs and includes a regular .22 bullet, a .30-caliber, and a regular .50-caliber bullet for comparison. These coils range in size from 1-inch diameter for use with .22-caliber bullets at the muzzle, to 3 inches in diameter for use at 100 yards with .22's. Since the residual pressure at the muzzle at the exit of the bullet on high-power rifles runs as high as 8000 to 10,000 pounds per square inch, one of the major problems in the design of the coils is in obtaining sufficient mechanical strength to withstand the muzzle blast when the coils are placed in close to the muzzle.

One successful design is shown in Fig. 4. The coil with the attached plate has withstood continuous

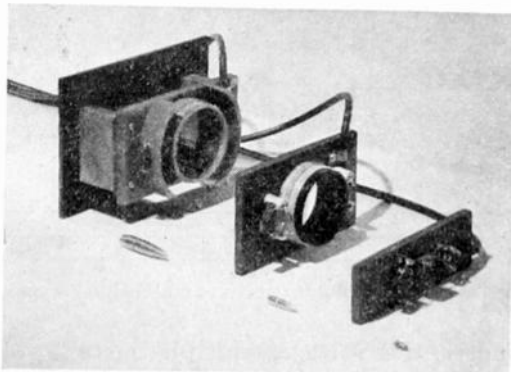

Fig. 4—Coils used along trajectory.

use at the muzzle on routine tests of .30- and .50-caliber ammunition. Fig. 5 shows the design of a 6-inch coil and protective shields for use at 100 to 150 feet from the muzzle on .30-caliber tests. The shields and baffles are protection against gunner's mistakes and are 1-inch and $\frac{1}{2}$ -inch armor plate. The coil is on a polystyrene form and the fixed tuning condenser can be seen. With all coils, every precaution is taken to produce high- Q circuits in order to obtain maximum sensitivity.

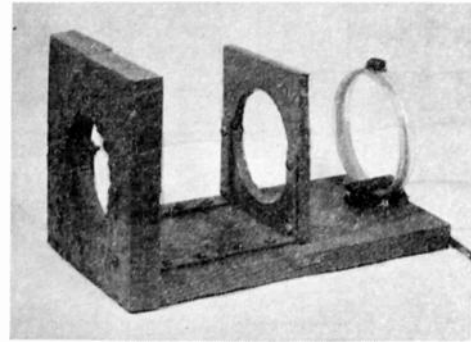

Fig. 5—Six-inch coil with protective plate and baffles.

It was mentioned earlier that an excessive uncertainty is introduced in the tripping point along the trajectory when the above-described device is used alone. This uncertainty can be as great as 3 inches (see Fig. 2, curves *A*, *B*, and *C*) which in 10 feet is 2.5 per cent, whereas it is absolutely necessary that all results be correct to well within 1 per cent. In order to obtain uniform tripping when the bullet is at the center of the coil, regardless of the magnitude of the pulse, an auxiliary device has been developed which functions as follows: Referring to Fig. 6, the curve at *A* is a typical curve of Fig. 2 of the output voltage of the previously described unit versus the position of the bullet as it passes through the coil. This voltage after amplification, is shown at *B*. (None of these curves is intended to be to scale on the ordinate axis.) The derivative of the *B* curve is shown at *C* in which negative values of slope are obtained while the bullet is in the first half of the coil and positive values are obtained while in the latter half. When the voltage at *C* is clipped and amplified, the curve *D* is obtained and if this process is repeated the final curve at *E* is the result. This form of output voltage curve meets the requirements of no output until the bullet reaches the center of the coil and a very rapid build-up at this point.

The amplifying and clipping are accomplished in the usual manner and differentiation is performed by means of a resistance and capacitance in series; the derivative being obtained from the resistance. This method was chosen instead of the usual inductance method ($L \frac{dI}{dt}$) because it is more difficult in the latter method to minimize phase shift.

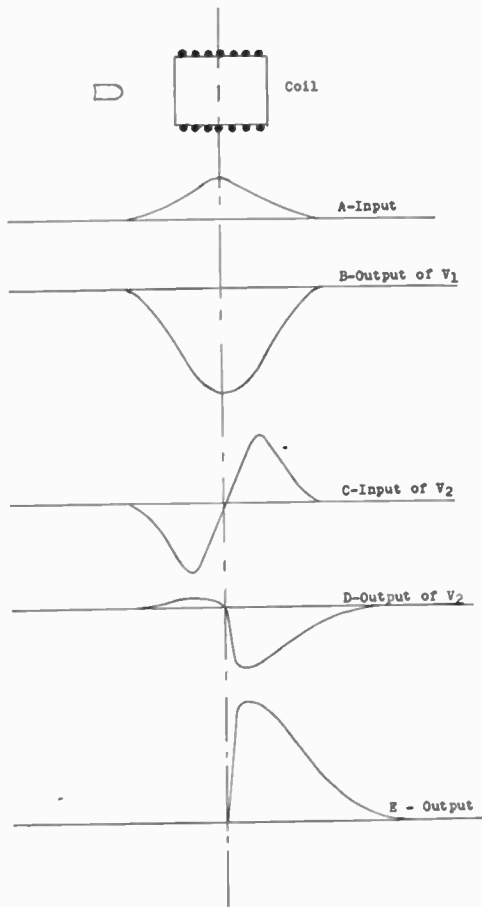

Fig. 6—Action of differentiating trip circuit.

When resistance and capacitance are used, and if the reactance of the condenser to the fundamental frequency of the pulse is very much greater than the series resistance, the current is approximately $i = dQ/dt$.

But since $Q = CE, I = C(dE/dt)$.

Thus the voltage developed across the resistance is

$$E_R = CR(dE/dt). \tag{1}$$

The exact expression³ for the voltage across the resistance is

$$E_R = CR(dE/dt) - C^2R^2(d^2E/dt^2) + C^2R^2e^{-t/CR} \left[E(0) + \int_0^t \dots \right]. \tag{2}$$

The last term can be neglected in our case because its time constant is less than a microsecond. Similarly, the second term is 10^{-7} times the first term and can also be neglected. Thus, (2) reduces to (1) in practice. It is evident from this expression that the amplitude of the derivative is directly proportional to RC and that as this product is made small, increased gain is required.

Fig. 7 shows schematically the circuit developed to accomplish the above-described results. At a glance, this circuit appears to be a more or less conventional 3-stage resistance-capacitance-coupled amplifier. However, the tube V_1 is a very high g_m tube with a low-resistance plate load. Across this load is connected the differentiating circuit, C_d and R_d , which are of quite unconventional values. The capacitance is 250 micromicrofarads and the resistance is 1000 ohms, giving a time constant of 0.25 microsecond. Tube V_2 is operated at high bias to make it insensitive to the negative half of the derivative voltage and sensitive to the later positive half. Conversely, V_3 is operated at zero bias so that it clips positive inputs and amplifies negative swings, thereby producing high positive outputs of 50 to 100 volts.

³ L. C. Roess, "A condenser type high speed engine indicator," *Rev. Sci. Instr.*, vol. 11, pp. 183-195; June, 1940.

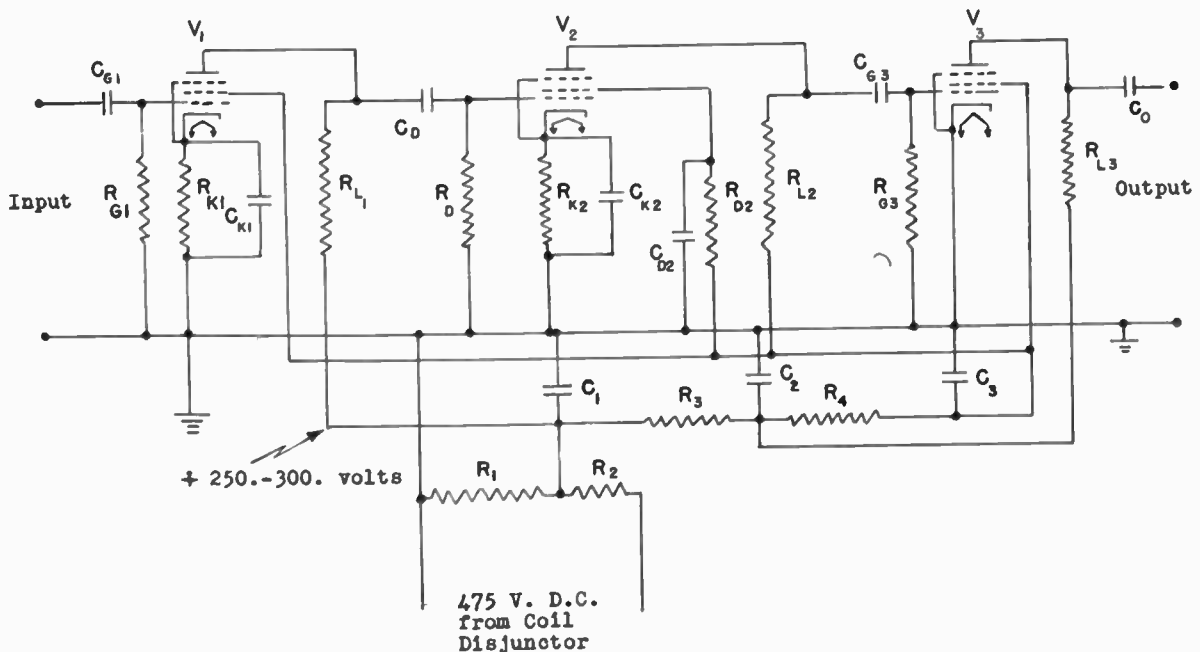

Fig. 7—Schematic of differentiating trip circuit.

Fig. 8 shows an experimental check on the operation of this circuit. The broader curve at *A* is an oscillogram of the output voltage of the coil unit or the input voltage of the differentiating trip unit. The curve at *E* with the steep wave front is an oscillogram of the

nitide when the output of the coil unit reaches a maximum. These curves were obtained on a special single-sweep cathode-ray oscillograph with an accurate method for initiating the sweep.

A further check on the operation of this circuit was

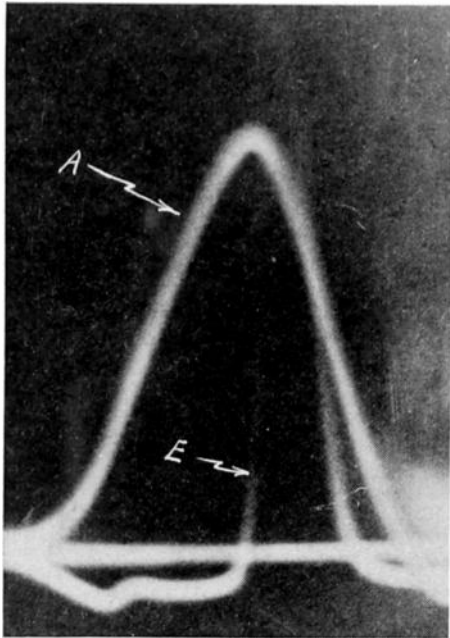

Fig. 8—Oscillogram of input and output voltages of differentiating trip circuit.

output voltage of the differentiating unit on a different voltage scale. Thus, it is apparent from this figure that the device accomplishes the desired result by developing a sharp positive voltage pulse of considerable mag-

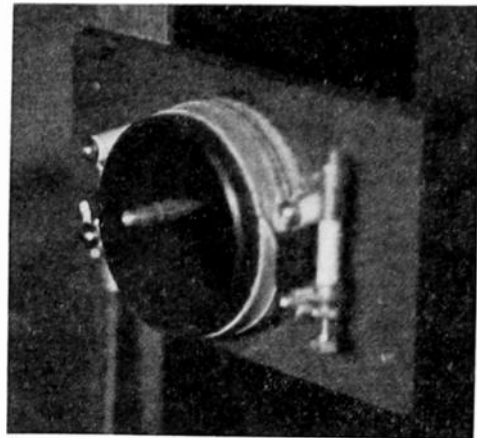

Fig. 11—High-speed picture of .30-caliber bullet in tripping position in 3-inch coil.

made by using the two output voltages to trigger a high-speed flash lamp and to photograph the bullet in the actual tripping position. Fig. 9 is one such high-speed picture with the lamp triggered directly from the

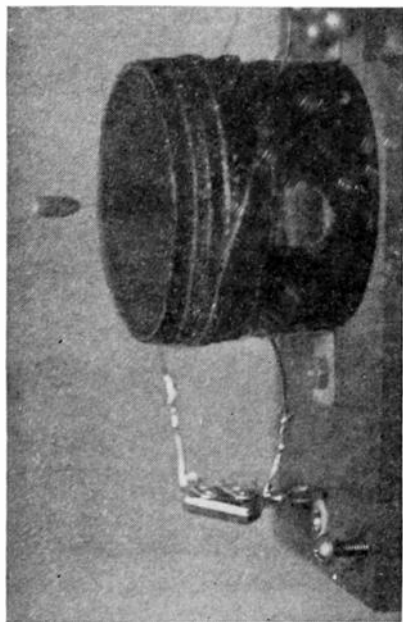

Fig. 9—High-speed picture of bullet with lamp flashed directly from coil disjuncter.

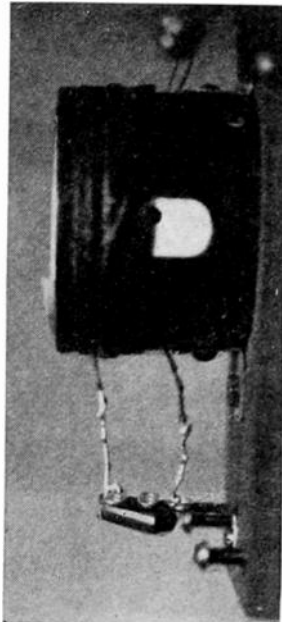

Fig. 10—High-speed picture of bullet with lamp flashed from output of differentiating—trip circuit.

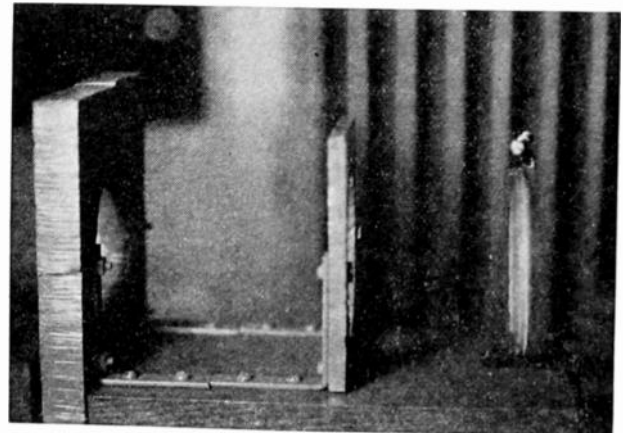

Fig. 12—High-speed picture of .30-caliber bullet in tripping position in 6-inch coil. Note protecting armor plate.

output of the coil unit. Note that the bullet is approximately 3 inches ahead of the center of the coil. Fig. 10 is a similar picture, but in this case, the high-speed lamp was triggered by the output of the differentiator. The coil has been cut away in order to show the bullet in the tripping position. Note that the bullet is within $\frac{1}{8}$ inch of the exact center of the coil. From previous experience it is known that a lag of the order of $\frac{1}{8}$ or $\frac{1}{4}$ inch existed in the lamp triggering circuits. Consequently, this last picture serves as sufficient proof that the device trips when the

bullet is at the center of the coil and that measurements of distance can be made from this point.

In order to obtain velocity measurements within an accuracy of $\frac{1}{2}$ of 1 per cent over 10 feet, the tripping position must be known to within about $\frac{1}{2}$ inch. If this error is negligible the permissible time error for $\frac{1}{2}$ per cent over-all accuracy in measuring a velocity of 2500 feet per second over 10 feet is 40 microseconds. Thus, the necessity for the development of such equipment is evident.

The equipment described has been in constant use in the research ranges at Remington Arms for the past two years and has proved to fulfill the desired requirements set down at the beginning of this paper.

ACKNOWLEDGMENT

The writer wishes to acknowledge the assistance of P. E. Lowe in building the equipment, and the helpful suggestions contributed by Dr. R. E. Evans.

Voltage-Controlled Electron Multipliers*

B. J. THOMPSON†, FELLOW, I.R.E.

Summary—The application of secondary-emission multiplication to conventional grid-controlled amplifier tubes is discussed from the viewpoints of practical voltage gain per stage of amplification, signal-to-noise ratio, and ultra-high-frequency applications. It is pointed out that the gain per stage is limited by the practical output current and the quotient of transconductance by current (N) and that electron multiplication increases the gain only as it permits the attaining of higher values of N . If the output current is assumed to be 20 milliamperes and N is taken as 1 milliamperes per volt per milliamperes, the output transconductance would be 20 milliamperes per volt—little, if any, better than could be achieved without multiplication. If N is assumed to be 11.6 (the theoretical maximum for conventional grid control with a cathode temperature of 1000 degrees Kelvin) the output transconductance could be greater than 200 milliamperes per volt per milliamperes. Higher values of N might be attained by some other method of control. In this case, the ultimate limit of transconductance would be set by the difficulty in stabilizing the effective control-electrode bias voltage.

The signal-to-noise ratio of the voltage-controlled multiplier is determined chiefly by the input system of the multiplier, the multiplier being a relatively noiseless amplifier following this input system. The noise level of the input system is determined by the input transconductance. If the use of a multiplier leads to reduced input transconductance, the noise level will be increased as compared with conventional tubes.

The principal advantages to be attained from the use of the multiplier are found in ultra-high-frequency applications where input loading and input capacitance are serious. The reduction in transconductance of the input system for a given over-all gain which is permissible leads to a corresponding reduction in input conductance (whether arising from electron-transit-time or lead effects) and input capacitance.

INTRODUCTION

THE secondary-emission electron multiplier has been applied widely to increase the effective sensitivity and to improve the signal-to-noise ratio of photoelectric tubes.^{1,2} Multiplier gains higher than 1,000,000 fold have proved useful. Secondary-emission multiplication has been applied to grid-controlled amplifier tubes to increase the transconductance, though so far much smaller multiplier gains have been used.^{3,4}

* Decimal classification: R132. Original manuscript received by the Institute, May 22, 1941. Presented, Sixteenth Annual Convention, New York, N. Y., January 10, 1941.

† R.C.A. Manufacturing Company, Inc., Harrison, N. J.

¹ P. T. Farnsworth, "Television by electron image scanning," *Jour. Frank. Inst.*, vol. 218, pp. 411-444; October, 1934.

² V. K. Zworykin, G. A. Morton, and L. Malter, "The secondary emission multiplier," *PROC. I.R.E.*, vol. 24, pp. 351-375, March, 1936.

³ J. L. H. Jonker and A. J. W. M. v. Overbeek, "The application of secondary emission in amplifying valves," *Wireless Eng.*, vol. 15, pp. 150-156, March, 1938.

⁴ H. M. Wagner and W. R. Ferris, "The orbital-beam secondary-electron multiplier for ultra-high-frequency amplification," *PROC. I.R.E.*, this issue, pp. 598-602.

The questions naturally arise as to how the use of a multiplier affects the voltage gain and the signal-to-noise ratio attainable with voltage-controlled amplifiers, and how much multiplier gain can effectively be used. This paper will discuss these questions.

LIMITATIONS TO INCREASED VOLTAGE GAIN PER STAGE

It has frequently been proposed that the incorporation of a secondary-emission multiplier with a conventional grid-controlled amplifier should permit the attaining of any desired voltage gain in a single stage of amplification.⁵ Let us examine the problem.

The effective over-all transconductance of the conventionalized grid-controlled multiplier shown in Fig. 1 is given by

$$g_{mb} = M g_{ma} \quad (1)$$

where g_{mb} is the over-all transconductance, or output transconductance, g_{ma} is the transconductance of the grid and cathode assembly without multiplication, or

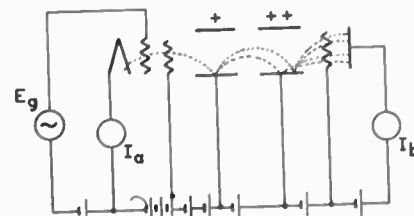

Fig. 1.—Conventionalized grid-control electron multiplier.

input transconductance, and M is the effective secondary-emission multiplication. The output current is given by

$$I_b = M I_a \quad (2)$$

where I_b is the output electrode current and I_a is the cathode current. If we divide (1) by (2), we have

⁵ "Stage of amplification" does not mean "stage of electron multiplication."

$$\frac{g_{mb}}{I_b} = \frac{g_{ma}}{I_a} \equiv N \quad (3)$$

where N , the quotient of transconductance by current, is independent of the factor of multiplication and is a characteristic of the current input system only. From this expression we see that for any output transconductance g_m , there will be a definite output current I_b which can be reduced only by increasing the quotient N .

In usual triodes of the best design, N has a value of little more than 1 milliamperes per volt per milliamperes. The addition of an electron multiplier to such a triode could produce a tube with a transconductance of 100 milliamperes per volt or even of 1000 milliamperes per volt, but at the same time the tube would have an output current of 100 milliamperes or 1000 milliamperes. These currents are much too high to be practical for receiving tubes. If we set 20 milliamperes as an upper limit for output current, we also set an upper limit of 20 milliamperes per volt for the transconductance. This value is not better than could be realized by conventional methods. It becomes apparent that a very high output transconductance cannot be realized in a practical receiving tube unless the quotient N is greatly increased beyond the value cited of 1 milliamperes per volt per milliamperes.

With the conventional control method, the maximum theoretically attainable quotient of transconductance by current is limited by the velocity distribution of the electrons⁶ and is given by

$$N = \frac{e}{kT} \text{ milliamperes per volt per milliamperes} \quad (4)$$

where e is the specific electronic charge, k is Boltzmann's constant, and T is the cathode temperature. On substituting the values for e and k , we have

$$N = \frac{11,600}{T} \text{ milliamperes per volt per milliamperes.} \quad (5)$$

With the usual coated cathodes, T may be taken as 1000 degrees Kelvin. In this case

$$N = 11.6 \text{ milliamperes per volt per milliamperes.}$$

With our previously assumed limit of 20 milliamperes output current and this new value of N , we find that we could achieve a transconductance of more than 200 milliamperes per volt.

It would appear up to the moment that we have no argument for the use of a multiplier, since the theoretical limit to the transconductance is set by the quotient N and the permissible output current, neither of which is altered by the use of a multiplier. But it is much easier to approach the limiting value of N with triodes of very small current than in the case of cur-

rents of the order of 20 milliamperes. There are other advantages, as well, some of which will be discussed later.

We have established a practical transconductance limit of 200 milliamperes per volt for conventional grid control, assuming 20 milliamperes output current. If we could find some other type of control which would afford a higher value of N , higher transconductance could be attained. How high a value of transconductance is it worth while to strive for? The first answer would be that there is no limit. We should encounter practical difficulties, however, in using tubes with extremely high values of N . Fig. 2 shows the control characteris-

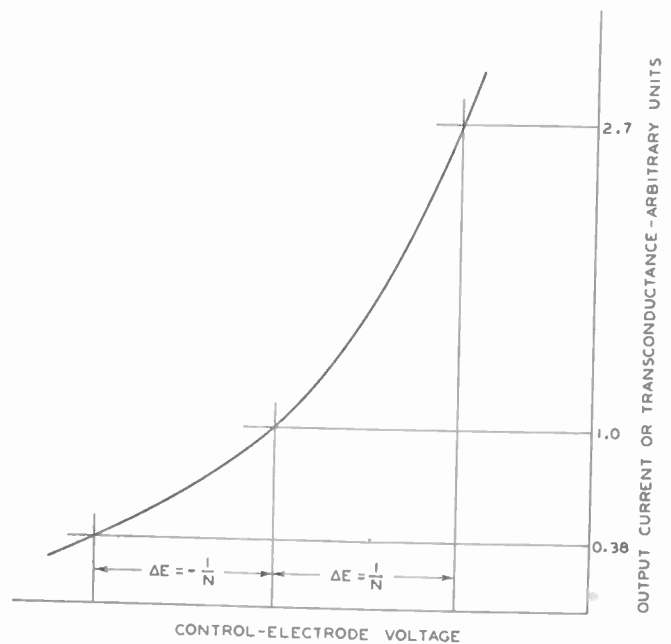

Fig. 2—Control-electrode-voltage—output-current characteristic of tube assumed to have constant quotient of transconductance by current $g_m/I_b = N$ to show effect of a change in control-electrode potential of $1/N$ units.

tic of a tube with constant value of N , plotted in general units. It will be seen that a change in control voltage of $1/N$ volt will change the current and transconductance by a factor e , the Napierian base. Thus, if N be assumed to be 100, a change in control voltage of 0.01 volt will reduce the current and transconductance to 0.38, or increase them to 2.7, times the original values. Maintaining the required control-voltage stability would begin to be a problem. Even here, the output transconductance for 20 milliamperes current would be only 2000 milliamperes per volt. The word "only" is used because a conventional 3-stage amplifier with a voltage gain per stage of 40 in the first two stages would have an over-all effective transconductance of 8000 milliamperes per volt, assuming a last-stage transconductance of 5 milliamperes per volt.

It appears evident that there are serious obstacles to realizing a practical high-gain amplifier consisting of only one stage of amplification, whether or not we use secondary-emission multiplication.

⁶ F. Below, "The theory of space-charge-grid tubes," *Zeit. für Fernmelde-technik*, vol. 9, pp. 113-118 and 136-142, 1928.

NOISE CONSIDERATIONS

The advantage of the secondary-emission multiplier with respect to noise in the case of the amplification of photoelectric emission might be expected to be realized in the case of voltage-controlled multipliers as well. A little consideration will show that the two problems are not similar, however. Figs. 3 and 4 show the comparison of the usual amplifier for photoelectric currents

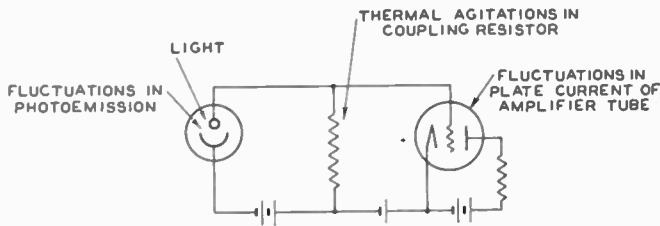

Fig. 3—Conventional triode amplifier for amplification of photoelectric currents, showing the sources of fluctuations.

with a secondary-emission multiplier. As shown in the diagrams, the sources of noise (fluctuations) in the case of the usual amplifier (Fig. 3) are fluctuations in phototube current, thermal agitation in the resistor R , and fluctuations in the current of the amplifier tube. Of these, thermal agitation is normally by far the greatest. The sources in the case of the multiplier (Fig. 4) are

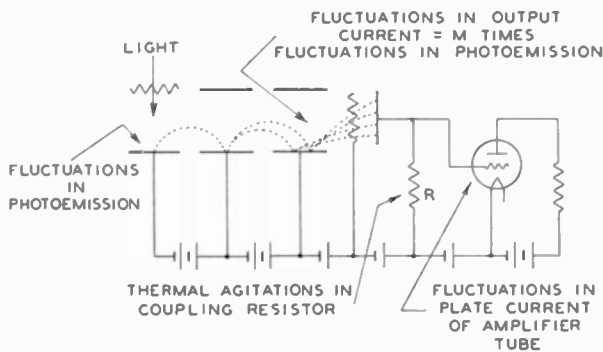

Fig. 4—Secondary-emission multiplier for amplification of photoelectric currents, showing the sources of fluctuations.

practically the same with the difference that the fluctuation in photoelectric emission is multiplied by a factor M along with the useful signal before the thermal agitation noise is added. It is, therefore, possible to arrive at a condition such that the final noise limitation is the inherent noise in the photoemission.

In the case of the voltage-controlled multiplier as compared with the usual amplifier we have a different situation. Figs. 5 and 6 show the comparison. In the usual amplifier (Fig. 5), the sources of noise⁷ are thermal agitation in the input impedance, fluctuations in plate current, and thermal agitation in the output impedance. Of these, the first two are normally the determining sources. The addition of a multiplier to the same cathode and control-grid structure (Fig. 6) multiplies the signal and the first two sources of noise by the factor M . Inasmuch as these were already the determining sources of noise, the signal-to-noise ratio is unchanged by the use of the multiplier.

In all of this discussion it is assumed that the multiplier introduces no noise of its own. This assumption is not strictly true but suffices for most practical purposes. The matter is discussed quantitatively in the Appendix, being omitted here so as not to impede the argument.

We have just said that the use of a multiplier will not change the signal-to-noise ratio. This statement applies only to a given cathode and control-grid struc-

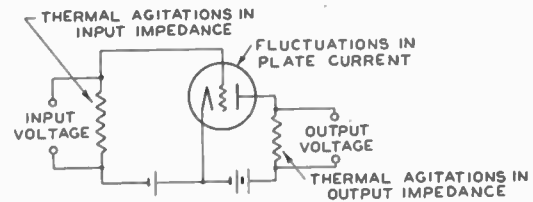

Fig. 5—Conventional triode amplifier for voltage amplification, showing the sources of fluctuations.

ture, and a given space current. We have said previously that the use of a multiplier permits us to obtain higher values of the quotient N by working with smaller values of current from the cathode. In such a case we are not justified in concluding that the signal-to-noise ratio is unchanged by the use of a multiplier.

It has been shown⁷ that the root-mean-square fluctu-

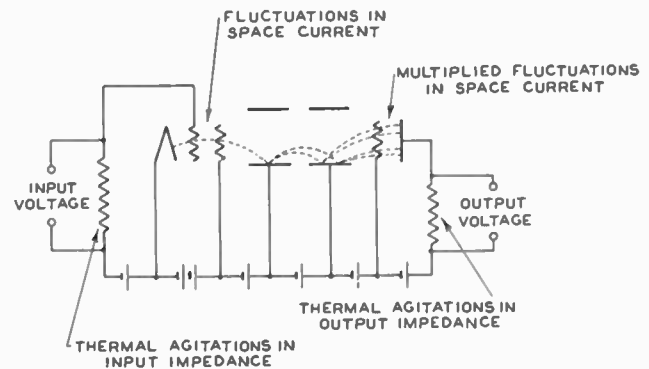

Fig. 6—Secondary-emission multiplier for voltage amplification showing the sources of fluctuations.

ations in plate current of a triode are proportional to the square root of the cathode conductance (nearly the same as the transconductance). The signal component of the space current is proportional to the transconductance. Hence, the signal-to-noise ratio as determined by space-current fluctuations alone is proportional to the square root of the transconductance. In the case of the voltage-controlled multiplier, the transconductance to be considered is, of course, the input transconductance.

We may conclude, then, that in the case of voltage-controlled multipliers using conventional grid control, the noise introduced by the tube will be worse than that introduced by the nonmultiplier tube giving the

⁷ B. J. Thompson, D. O. North, and W. A. Harris, "Fluctuations in space-charge-limited currents at moderately high frequencies—Part I," *RCA Rev.*, vol. 4, pp. 269–285; January, 1940; Part II, vol. 4, pp. 441–472; April, 1940; and vol. 5, pp. 106–124; July, 1940; Part III, vol. 5, pp. 244–260; October, 1940; Part IV, vol. 5, pp. 371–388; January, 1941; Part V, vol. 5, pp. 505–524; April, 1941.

same gain by a factor $M^{1/2}$, the square root of the multiplication factor, and will be the same as that of a nonmultiplier tube of the same input transconductance. The multiplier is to be viewed simply as a noiseless amplifier following the input triode.

We have admitted the possibility of some other type of control than that of the conventional triode which might give higher values of the quotient N . The noise to be introduced by this hypothetical method cannot be foretold. It may be assumed, however, that the current fluctuations need not rise above those corresponding to temperature-limited emission. If we make this assumption we can write the minimum signal-to-noise ratio of the tube itself as follows:

$$\begin{aligned} \frac{\text{signal}}{\text{noise}} &= \frac{E_g N I_a^{1/2}}{(2e\Delta f)^{1/2}} \\ &= \frac{E_g N^{1/2} g_{m_a}^{1/2}}{(2e\Delta f)^{1/2}} \\ &= \frac{E_g N^{1/2} g_{m_b}^{1/2}}{(2e\Delta f)^{1/2} M^{1/2}} \\ &= \frac{E_g N I_b^{1/2}}{(2e\Delta f)^{1/2} M^{1/2}} \end{aligned}$$

where E_g is the signal voltage applied to the control electrode and Δf is the band width over which the measurement is made, the other symbols being as before. We see even here that the signal-to-noise ratio gets worse as we make I_a smaller for a constant value of N . We can keep a constant signal-to-noise ratio by keeping the product $N I_a^{1/2}$ or the quotient $N/M^{1/2}$ constant (assuming constant I_b in the second case).

OTHER CONSIDERATIONS

So far we have made out a poor case for the voltage-controlled electron multiplier. It does not increase the obtainable stage gain very much and it does not improve the signal-to-noise ratio. What, then, are its advantages?

The advantages arise chiefly from the possibility of minimizing certain undesirable high-frequency effects of conventional tubes and of reducing the input capacitance.

Input loading is a very serious factor near the upper frequency limit of conventional tubes, whether the loading is caused by transit-time effects or by lead effects.^{8,9,10} In either case, the input conductance of the tube at a given frequency is proportional to the cathode transconductance (equal to the output transconductance in a conventional tube). The use of a

⁸ W. R. Ferris, "Input resistance of vacuum tubes as ultra-high-frequency amplifiers," *PROC. I.R.E.*, vol. 24, pp. 82-105; January, 1936.

⁹ D. O. North, "Analysis of the effects of space charge on grid impedance," *PROC. I.R.E.*, vol. 24, pp. 108-136; January, 1936.

¹⁰ M. J. O. Strutt and A. van der Ziel, "The causes for the increase of the admittances of modern high-frequency amplifier tubes on short waves," *PROC. I.R.E.*, vol. 26, pp. 1011-1032; August, 1938.

multiplier enables one to obtain a given over-all transconductance with lower cathode transconductance and, therefore, lower control-grid conductance. Also, the input capacitance is related to transconductance, so that lower capacitance may be attained by the use of a multiplier. This is a real advantage for tubes intended to amplify over a wide band.

There may also be some advantage in the reduction in cathode emission required, but this is normally offset by the increased power which must be supplied at relatively high voltage to produce secondary emission.

CONCLUSIONS

We conclude that an electron multiplier increases the voltage gain attainable with a voltage-controlled device only by making possible the use of input structures from which a higher quotient of transconductance by space current may be obtained, the over-all voltage gain being limited by this quotient and by the permissible output current.

From the viewpoint of noise produced in the output circuit, a multiplier tube is always poorer than a similar nonmultiplier tube with the same gain.

The advantages of the multiplier lie in reduced input conductance at high frequencies, reduced input capacitance, and in the possibility of using other types of control than the conventional control grid.

APPENDIX

It is of interest to determine the fluctuation noise introduced in voltage-controlled multipliers by the process of secondary-emission multiplication. It will be assumed that the multiplier consists of a single stage of secondary-emission multiplication giving a gain of m and that the fluctuations inherent in secondary emission are equal to the fluctuations in a temperature-limited current of the same magnitude. This latter assumption has been found to be satisfactorily close to the truth.²

Let I_a represent the cathode current of the control section of the multiplier, θ the fraction of I_a reaching the multiplier electrode [(1- θ) I_a = screen current], and g_{m_a} the transconductance of the control section as a triode. The mean-square fluctuations in I_a are given by¹¹

$$\overline{i_a^2} = B^2(2eI_a\Delta f).$$

where B is the factor of reduction in fluctuations as compared with temperature-limited emission, e the charge of the electron, and Δf is the band width. The mean-square fluctuations in current flowing into the multiplier section (space current passing through the screen electrode) are given by¹²

¹¹ D. O. North "Fluctuations in space-charge-limited currents at moderately high frequencies—Part II," *RCA Rev.*, vol. 4, pp. 441-472, April, 1940, and vol. 5, pp. 106-124; July, 1940. North uses Γ for the factor designated by B in this Appendix.

¹² D. O. North, "Fluctuations in space-charge-limited currents at moderately high frequencies—Part III," *RCA Rev.*, vol. 5, pp. 244-260; October, 1940.

$$\overline{i^2} = B^2\theta^2(2eI_a\Delta f) + (1 - \theta)(2eI_a\Delta f).$$

The fluctuations in output current I_b after multiplication are given by

$$\begin{aligned}\overline{i_b^2} &= m^2 B^2\theta^2(2eI_a\Delta f) + m^2\theta(1 - \theta)(2eI_a\Delta f) + m\theta(2eI_a\Delta f) \\ &= [m^2 B^2\theta^2 + m^2\theta(1 - \theta) + m\theta](2eI_a\Delta f).\end{aligned}$$

The ratio of the fluctuations as given above to the fluctuations without multiplication referred to the same amplification level (or with a noise-free multiplier) is given by

$$\frac{\overline{i_b^2}}{m^2\overline{i^2}} = \frac{m^2 B^2\theta^2 + m^2\theta(1 - \theta) + m\theta}{m^2 B^2\theta^2 + m^2\theta(1 - \theta)} = 1 + \frac{1}{m(B^2\theta + 1 - \theta)}.$$

In practical multipliers m may be taken as about 5 and θ as about 0.8. The quantity B^2 may vary from 1.0 to perhaps as low as 0.01 in practical tubes. If the quotient g_{m_a}/I_a is 0.1 milliamperes per volt per milliamperes, B^2 is about 0.01; for $g_{m_a}/I_a = 1$ milliamperes per volt per milliamperes, B^2 is about 0.12, and for g_{m_a}/I_a of 11.6 or higher B^2 may be taken as unity, assuming a cathode temperature of 1000 degrees Kelvin.¹¹ Let us compute the increase in noise produced directly by the multiplication process for different values of B^2 . The results are tabulated below.

B^2	$(\overline{i_b^2}/m^2\overline{i^2})^{1/2}$
1.0	1.1
0.1	1.3
0.01	1.4

It is seen that, under the assumed conditions, the multiplier increases the root-mean-square noise by 10 per cent under the best conditions and by 40 per cent under the worst conditions. The figure of 30 per cent increase corresponding to $B^2 = 0.1$ is representative of what would be expected with such a tube as the orbital-beam multiplier.⁴ It should be pointed out here that the factor of increase in noise would be worse for lower values of m and would be much worse in the cases of $B^2 = 0.1$ and $B^2 = 0.01$ if the value of θ could be made to approach unity by reducing the screen current. There seems little reason to suppose, however, that good design practice would lead to lower values of m than about 5 or of values of B^2 less than 0.1. It seems probable that developments will trend toward¹³ $B^2 = 1.0$. It does not seem likely that it will be practical to increase θ much above the assumed 0.8. Therefore it is concluded that the addition of an electron multiplier to a voltage-controlled device need not greatly increase the effective noise level. Further, it is concluded that the trends of development will be such as to minimize the effect of the noise added by the multiplier.

¹³ While B^2 represents the fluctuations for a given space-charge-limited current as compared with those for a temperature-limited current of the same magnitude and it might be supposed, therefore, that B^2 should be made as small as possible, the magnitude of the fluctuations is determined only by the cathode conductance (transconductance) and the plate current for a given transconductance, consequently, is lower the higher we can make B^2 .

The Behavior of Electrostatic Electron Multipliers as a Function of Frequency*

L. MALTER†, ASSOCIATE, I.R.E.

Summary—This paper consists of a theoretical and experimental study of the frequency variation of transconductance of electrostatic electron multipliers. It is shown that the decrease of transconductance with frequency up to 500 megacycles, the highest frequency studied, can be ascribed to a spread in transit angle resulting from the emission velocities of secondary electrons and the varying paths of electrons through the stages of the multiplier. The spread in transit angle may be represented by an equivalent angle that is linearly related to the total transit angle unless the latter is quite large.

For a given scale and with multipliers of the form herein studied an upper limit can be set upon the frequency at which multipliers may be profitably employed. A brief analysis of the effects of leads within the tube is included.

An upper limit of 2×10^{-9} second was set upon the time taken for the phenomenon of secondary emission to occur.

I. INTRODUCTION

SINCE about 1934, when the possibility that remarkable current amplifications could be achieved by the application of the phenomenon of second-

ary emission was realized, considerable thought and experimental work have been devoted to the development of high-gain voltage or power amplifiers employing hot cathodes and secondary-emission multipliers. Devices of many sorts have been described, particularly in the patent literature.

More recently, with the increasing interest in ultra-high frequencies, work has been directed towards making use of the phenomenon of secondary emission for obtaining increased amplification at these frequencies. It is the purpose of this paper to examine critically the possibilities and limitations of secondary emission multiplication at ultra-high frequencies. In particular, consideration will be given to the influence of (1) the velocity distribution of the secondary electrons, (2) the transit-time spread between stages of an electron multiplier, and (3) the time taken for secondary emission to occur, upon the transconductance obtainable from voltage-controlled hot-cathode devices incorporating electron multipliers.

* Decimal classification: R139. Original manuscript received by the Institute, March 12, 1941; revised manuscript received, May 12, 1941. Presented, Sixteenth Annual Convention, New York, N. Y., January 10, 1941.

† Research Laboratories, RCA Manufacturing Company, Inc., Harrison, N. J.

II. CONSIDERATIONS REGARDING TRANSCONDUCTANCE

In the conventional grid-controlled thermionic device employing any number of grids, the grid-plate *transconductance* is defined as the rate of change of plate current with respect to control-grid voltage. In conventional grid-control devices, the control functions by space-charge limitation of the emission. The control may, of course, be by other methods as by the deflection of a beam on and off a plate. In any case, the transconductance definition is similar; the differentiation being carried out with respect to the control-electrode voltage.

When the electron current or beam, instead of being permitted to impinge upon a plate, is directed into an electron multiplier, the current and all variations therein are amplified by a factor which at low frequencies is equal to the gain of the multiplier. The rate of change of the current in the output electrode of the multiplier with respect to the control-electrode voltage is defined as the *output transconductance* of the device. The rate of change of current entering the multiplier with respect to control-electrode voltage is defined as the *input transconductance*. As the frequency of the signal applied to the control electrode approaches zero, the ratio of output to input transconductance approaches in value the static gain of the multiplier. The limiting value of the output transconductance at zero frequency will be referred to as the *static transconductance*. At frequencies other than zero, the output transconductance (always less than the static value) will be referred to as the *dynamic transconductance*. The ratio of dynamic to static transconductance is a measure of the frequency variation of transconductance and will be referred to as the *frequency response* of the multiplier.

Consider the case of a conventional three-electrode tube in which the flow of current to the plate is controlled by means of the grid potential. If the grid potential is made increasingly negative with respect to the normal operating point, the transconductance decreases but, in general, the ratio of transconductance to plate current increases. Suppose the current which normally flows to the plate is admitted into a multiplier. The output current of the multiplier can be set at any desired value by adjusting the gain of the multiplier. Thus, when the output current is held constant as the input current is decreased by biasing the grid, the ratio of output transconductance of the multiplier to its output current will increase. Hence, when the current transmitted by a grid is amplified by means of an electron multiplier, the possibility is presented for the attainment of transconductance values higher than those normally attained at some given value of output current. It has been shown that there exists an upper limit to the ratio of transconductance to current in grid-controlled devices.¹

¹ L. H. Germer, "Initial velocities of thermionic electrons," *Phys. Rev.*, vol. 25, pp. 795-807; 1925.

Of course, for attainment of high values of output transconductance at ultra-high frequencies by use of an electron multiplier it is essential that the gain of the multiplier for the high-frequency-current component should not decrease to too low a value. Within the multiplier proper, the chief cause for loss of gain at high frequencies is the spread in transit time of electrons passing through the multiplier. If the spread in transit time becomes appreciable compared to the period of the high-frequency signal, a decrease in signal output results. Three possible contributions to transit-time spread were mentioned in the introduction. These will now be considered in turn.

III. EFFECT OF INITIAL VELOCITIES OF SECONDARY ELECTRONS

A. Relation Between Initial Velocities and Transit Time

In order to isolate the effect of the emission velocity of secondary electrons upon the *frequency response*, we shall postulate the existence of a multiplier wherein the transit times are such that all electrons emitted at any one stage with identical initial velocities take identical times in arriving at the succeeding stage. We neglect, for the present, the effect of differing paths upon the transit time. This will be considered in a later section.

Furthermore, it is assumed that the field between the stages is like that between two parallel planes and that space charge is negligible. In this type of field only the component of emission velocity normal to the surface affects the transit time between stages. Then if,

τ_{\max} = transit time between stages for secondary electrons with zero emission velocity

V_p = potential difference between stages in volts

V_e = secondary-emission velocity normal to surface in equivalent volts

τ = transit time for any electron

then

$$\tau = \tau_{\max} \left[\sqrt{1 + \frac{V_e}{V_p}} - \sqrt{\frac{V_e}{V_p}} \right] \quad (1)$$

$$= \theta \tau_{\max}. \quad (2)$$

In Fig. 1 $\theta = \tau/\tau_{\max} = \sqrt{1 + V_e/V_p} - \sqrt{V_e/V_p}$ is plotted as a function of V_e/V_p .

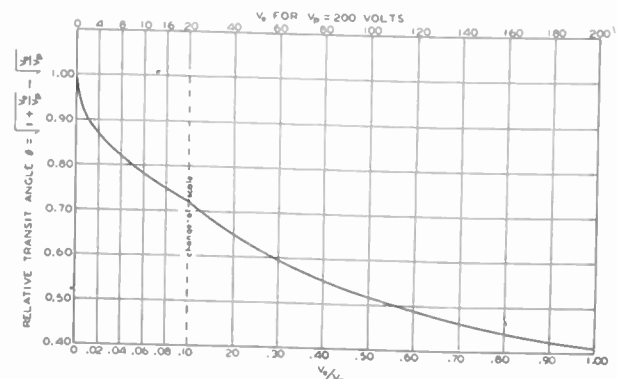

Fig. 1—Effect of initial velocity on relative transit angle.

B. Measurements of Initial Velocities

A knowledge of the velocity distribution of the secondaries in a direction normal to the surface is thus essential for the determination of the *frequency response* of a multiplier. It was obtained for the case of a silver-magnesium alloy surface such as might be used in a practical multiplier by means of a tube as shown in Fig. 2. A magnetic field normal to the plane of the

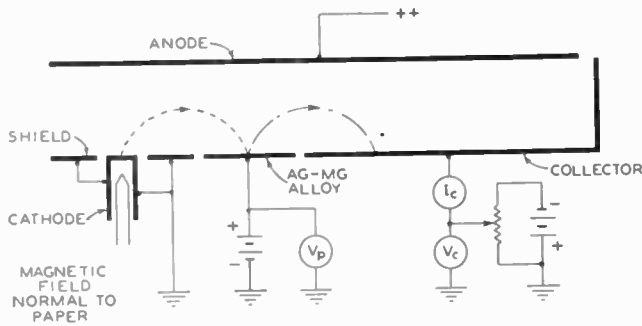

Fig. 2—Means for measuring initial velocity of secondary electrons.

paper causes electrons from the cathode accelerated by the positive anode to strike the secondary emitter *S*. The secondaries from this flow towards the collector. As the potential V_c of the collector is made more and more negative with respect to *S*, fewer of the secondaries have sufficient velocity to reach it. The derivative of the $I_c - V_c$ curve is the desired velocity distribution. Fig. 3 shows the velocity distribution of secondaries from the alloy bombarded by 100- and 200-volt elec-

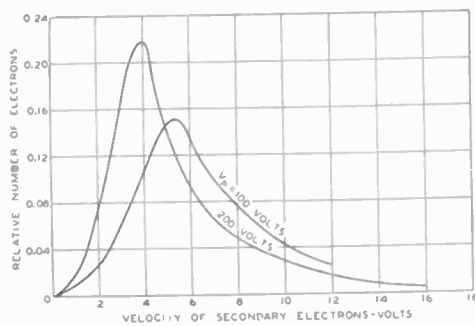

Fig. 3—Velocity distribution of secondary electrons.

trons. The scale has been chosen so that the area under the curve to the left of each point of the curve represents the fraction of secondaries with emission velocities between zero and the abscissa of that point. Consequently

$$\int_0^{V_p} P(V_e) dV_e = 1.$$

C. Transit-Time Distributions

From Figs. 1 and 3 we are enabled to plot a curve of the relative number of electrons in any transit-time interval versus transit time. This is plotted in Fig. 4 for the 200-volt primaries. The vertical scale has been chosen so that the area to the left of any point repre-

sents the fraction of electrons with transit times between zero and the abscissa of that point. The horizontal scale is so chosen that the relative transit time for the electron emitted with zero normal velocity is unity. By means of this choice of scale, we are enabled to speak interchangeably of relative transit time or relative transit angle. When we speak of the transit angle, the horizontal scale will denote the transit angle

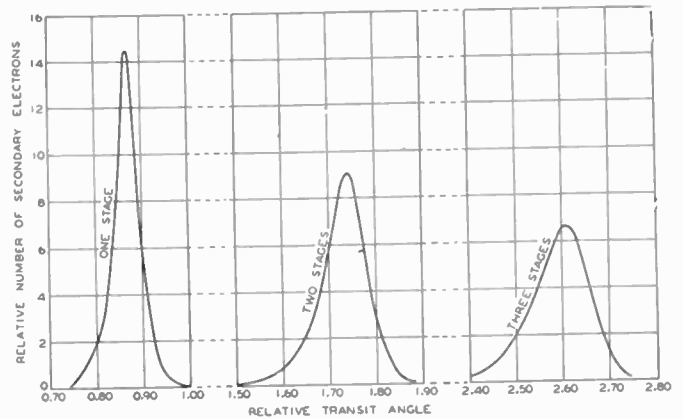

Fig. 4—Relative transit angles due to initial velocities of secondary electrons.

relative to that of the electrons emitted with zero velocity, and the abscissa will be referred to as the relative transit angle θ . Then $\theta = \omega\tau / \omega\tau_{max} = \tau / \tau_{max}$ where τ_{max} is the transit time for electrons emitted with zero velocity. This curve may be considered to represent the relative transit-angle distribution of secondaries, the angle being measured from the moment of departure from a secondary emitter to the moment of

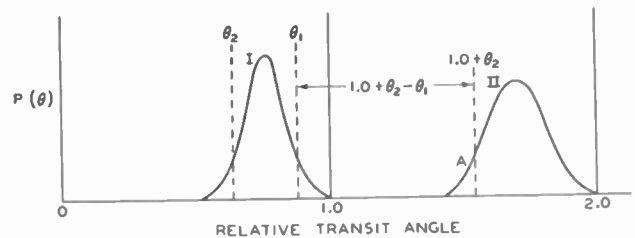

Fig. 5—Relative transit angles due to initial velocities of secondary electrons.

arrival at the next multiplying electrode. The assumptions regarding the nature of the multiplier fields made at the beginning of this section should be constantly borne in mind.

An examination of the left-hand curve in Fig. 4 indicates that when the average transit time between stages becomes appreciable compared to the period of the signal, considerable loss in output results. An extension of the analysis to the case of more than one stage appears desirable. This requires a little thought.

In Fig. 5, curve 1 is the relative transit-angle distribution of electrons after the first stage of an electron multiplier as computed above. These secondaries give rise to a further crop of secondaries whose distribution is given by II. The abscissa point 2.0 in this case

represents the relative transit angle of electrons whose emission velocities in both stages were zero. It is desired to obtain the value of ordinate at point A of curve II. Let the abscissa at this point be $1.0 + \theta_2$. θ_2 thus represents the relative transit angle in the *second stage* for electrons whose relative transit angle in the first stage was 1.0. The total relative transit angle through the multiplier to A is $1.0 + \theta_2$. No electrons of I lying to the left of θ_2 can contribute to A since their relative transit angle in the second stage would be greater than unity. It is merely necessary to compute the contribution to the ordinate at A of I between θ_2 and 1.0. This is given by

$$P_m(\theta_2) = \int_{\theta_2}^{1.0} P_1(\theta_1) P_1(1.0 + \theta_2 - \theta_1) d\theta_1. \quad (3)$$

This function was computed by quadrature and then adjusted to make its total area unity. Then, as before, the area under the curve to the left of any point A represents the fraction of electrons with over-all transit angles between 0 and $1.0 + \theta_2$. This form of representation has the added advantage that it eliminates completely considerations regarding the secondary-emission ratio of the surfaces. The adjusted function denoted by $P_{II}(\theta_2)$ is given in Fig. 4. It should be clearly understood that the over-all relative transit angle is in terms of the maximum transit angle through *one* stage as 1.0. Proceeding in the same manner, $P_{III}(\theta_3)$ is the over-all relative transit-angle distribution for a 3-stage multiplier adjusted in the same way as P_I and P_{II} . Of course, these distributions apply only to the 200-volt emission spectrum of Fig. 3. The fact that in stages following the first, the velocity of all the electrons is not exactly 200 volts exercises so little influence on the results that its effects have been neglected. In general, the smaller the average velocity of the primary electrons the broader the transit-angle distribution curves and vice versa. This is evident from the emission spectrum of secondaries due to 100-volt primaries impinging on the same surfaces, as given in Fig. 3.

If, instead of plotting the transit-angle distribution after any number of stages in terms of the maximum possible transit angle in a *single* stage, we make the plot in terms of the maximum possible transit angle for the given number of stages as 1.0, the curves of Fig. 6 are obtained. These reveal that for a given over-all transit angle it is desirable from the standpoint of transit-angle spread to divide the trip into disjointed segments rather than completing it without any interruptions. In addition, one obtains at the same time the advantages of electron multiplication.

D. Equivalent Transit-Angle Spread

It is shown in Appendix I that the loss in signal resulting from any form of transit-angle spread can be duplicated by means of a uniform spread over an

angle α . Means for computing this angle, referred to as the *equivalent transit-angle spread*, are given there. The signal loss through a complete multiplier is what has been previously defined as the *frequency response*, since it is the ratio of alternating output current under dynamic conditions to the output current at vanishingly low frequencies, the input voltage being the same

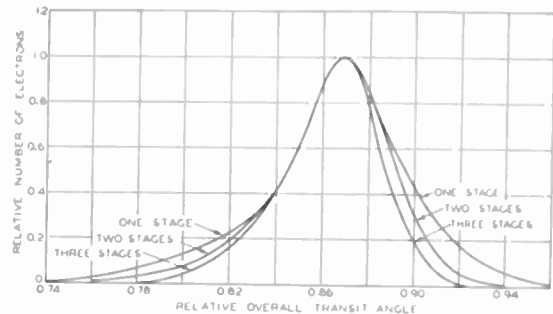

Fig. 6—Relative over-all transit-angle spread due to initial velocities.

in both cases. The signal loss or *frequency response* from an equivalent transit-angle spread α is shown to be given by $\text{frequency response} = (\sin \alpha/2)/(\alpha/2)$ in Appendix I.

It is convenient to effect the transformation from nonuniform to uniform spread in all cases, for the reasons that (1), it enables one to assign a numerical value to the spread and (2), it provides a quantity which can be combined with the corresponding quantities for the spread from other causes to arrive at a total resultant spread.

In applying Appendix I to the results of the preceding section, it is convenient to speak in terms of transit angle rather than transit time. The transit angle is given by $\phi = \omega\tau = 2\omega\tau$, where τ is the transit time. The maximum possible transit angle in one stage of the multiplier $\phi = \omega\tau_{\max}$ is that for secondaries emitted with zero velocity.

Some value is assigned to $\omega\tau_{\max}$. Then, by definition, $F(\omega\tau) = P(\theta)$ where $P(\theta)$ is the relative transit-angle spread function as defined in the preceding section. From (26) of Appendix I, α is then computed. This has been done over a considerable range of $\omega\tau_{\max}$ for the spread $P_1(\theta_1)$ of Fig. 4, and the results are given in Fig. 7. It is seen that α increases linearly with $\omega\tau_{\max}$ up to $\alpha \approx \pi$. In any case for spreads greater than this the transformation from the function F to the uniform distribution undoubtedly becomes less and less valid. Physically, the linearity of this relationship means that for a given transit time, the effective angle α increases linearly with frequency or dimensions up to transit angles of about 10π , or five full periods.

It is convenient to define the ratio $\alpha/\omega\tau_{\max} = R$ as the *relative spread*. It is obvious that $R = t_s/\tau_{\max}$ where t_s is the equivalent *transit-time* spread in analogy with the definition of equivalent transit-angle spread. For the case just discussed $R = 0.11$ over the linear portion of Fig. 7.

IV. EFFECT OF PATH DIFFERENCES OF SECONDARY ELECTRONS

Electrons starting with the same initial velocity at different points on the surface of an electrostatic-multiplier electrode will, in general, take different lengths of time to arrive at the surface of the succeeding electrode except for certain special configurations,

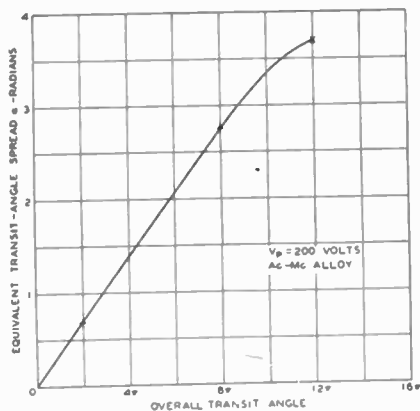

Fig. 7—Equivalent transit-angle spread due to initial velocities.

as for example, when the field between the electrodes is plane-parallel. No such multistage multipliers have been described. Every multiplier is thus a problem unto itself.

Consider a section of a multiplier as shown in Fig. 8. Secondaries emitted from electrode A with zero velocity travel to electrode B along the paths indicated. The equipotentials were obtained by means of an electro-

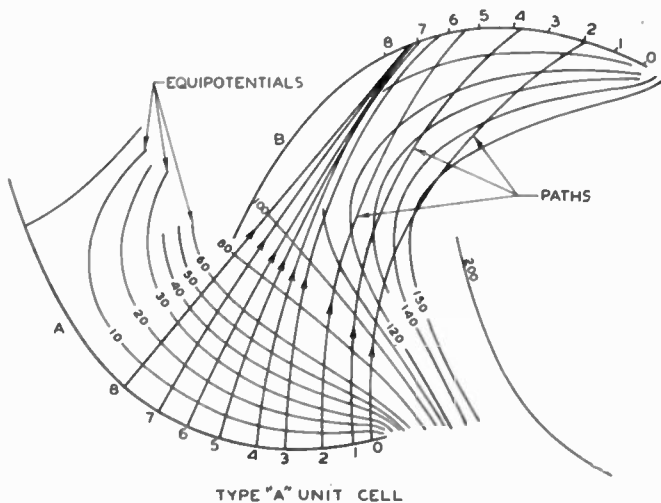

Fig. 8—Unit cell of electrostatic multiplier.

lytic tank and the electron paths by means of a rubber model. In order to simplify the problem of computing transit times, it is assumed that the secondaries are all emitted with zero velocity: The effect of initial velocities in a plane parallel field was determined in the preceding section. The methods of combining the effects produced by these different causes will be considered below.

By dividing each of the electron paths in Fig. 8 into

small segments defined by the equipotentials as drawn, it is possible to compute the total transit time between stages along any of the paths. The transit time for each segment is given by the quotient of the path element to the average velocity along the path element. The sum of the separate transit times for each segment gives the total transit time along the path. The results are

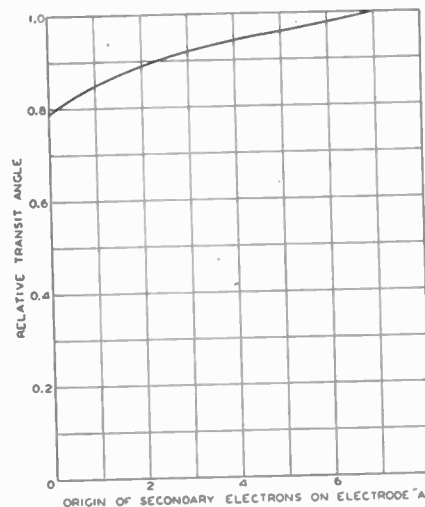

Fig. 9—Relative transit angles in type A unit cell.

plotted in Fig. 9, the vertical scale being such that the maximum of the curve is unity.

If it is assumed that the emission from A is uniform over its surface, then the relative transit-time (or angle) distribution is obtained by plotting the ordinates of Fig. 9 against the corresponding reciprocal of the slopes. This has been done in Fig. 10, the ordinate scale being chosen so that the area under the curve is unity.

The application of the method of Appendix I permits of the computation of the equivalent angle α over

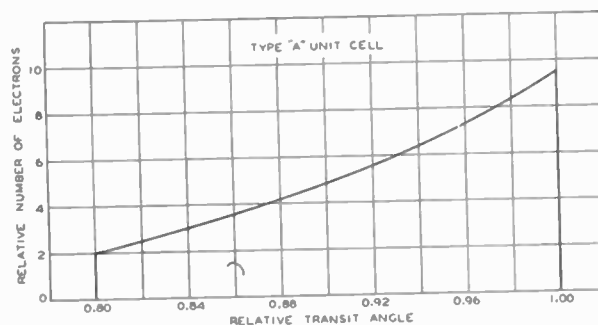

Fig. 10—Relative transit-angle distribution in type A unit cell.

which a uniform distribution would result in the same frequency response as that caused by the distribution of Fig. 10. For a maximum transit angle $\omega\tau_{max}$ of 360 degrees, the angle α turns out to be 74 degrees. Therefore, the relative spread in a multiplier stage of type A resulting from path differences only, is 0.21.

The transit-angle spread from path differences for more than one stage does not necessarily bear any relation to that for one stage only. Thus, if the long-transit-

time electrons in one stage produced secondaries having a short transit time in the following stage, the over-all spread produced by path differences only in the two stages might be less than in the first. This is actually the case for the multiplier of type C described by Rajchman² in which the *relative spread* from path differences alone, subject to the condition of zero emission velocity, is 0.59 in the first stage, 0.31 for two stages, and 0.75 for three stages. In the multiplier of the form of Fig. 8, which was developed with the idea of having a smaller spread, no such alternating effects occur, but theoretically the spread from varying paths increases only very slowly after the first stage, because of the concentration of the beam from stage to stage.³

V. COMBINATION OF INDEPENDENT SPREADS

In practice, the considerations of the preceding paragraph lose their meaning almost completely, since the effects of initial velocities, space charge,⁴ nonuniform emission over the surface, and fringing fields are such as to tend to wash out the effects of crossover and concentration. At most, it can be said that for an n -stage multiplier with some form of concentration, the over-all spread from path differences will be greater than that in the first stage but less than n times that in the first stage. This is proved for the effects of initial velocities in Appendix II. The actual computation of the spread produced by path differences for any particular structure would have to take into account the effects mentioned above. This would be an extremely laborious task, which would not affect the general qualitative conclusions of this paper. It appears safe to apply to spreads from path differences the combination rule arrived at in Appendix III for the spreads from initial velocities. The final combination formula as given in (30), Appendix II, is

$$A = \left[\sum_{p=1}^{p=n} \alpha_p^{4/3} \right]^{3/4} \quad (4)$$

where A is the angle over which a uniform spread would produce the same loss in signal as the separate application of equivalent transit-angle spreads $\alpha_1, \alpha_2, \dots$ up to α_n .

Then if A is the equivalent transit-angle spread of an entire electron multiplier its *frequency response* is given by

$$\text{frequency response} = \frac{\sin \frac{A}{2}}{\frac{A}{2}} \quad (5)$$

² J. A. Rajchman, "Le courant residuel dan les multiplicateurs d'electrons electrostatique," *Archiv de Science de Geneve*, vol. 20, pp. 231-264; September-October; pp. 267-289; November-December, 1938.

³ V. K. Zworykin and J. A. Rajchman, "The electrostatic electron multiplier, Proc. I.R.E., vol. 27, pp. 558-566; September, 1939.

⁴ J. R. Pierce, "Limiting current densities in electron beams," *Jour. Appl. Phys.*, vl. 10, pp. 715-724; October, 1939.

VI. EXPERIMENTAL METHOD

Two 5-stage multipliers employing unit cells of type A as shown in Fig. 8 were constructed, one being made four times the scale of the other.

In the preceding sections, we considered the decrease, from a variety of causes, in the amplitude of a current $I_A \sin \omega t$. If there were no losses in a multiplier, the alternating component of output current from a signal $E \sin \omega t$ applied to the control grid would be

$$I_0 \sin \omega t = g_{ms} E_\gamma \sin \omega t \quad (6)$$

where g_{ms} is the static output transconductance.

Actually, at high frequencies the alternating-current component of output current is decreased to some value I_d where

$$I_d \sin \omega t = g_{md} E_\gamma \sin \omega t \quad (7)$$

where g_{md} is the dynamic output transconductance.

The *frequency response* (FR) has been defined as:

$$FR = \frac{g_{md}}{g_{ms}} = \frac{I_d}{I_0} \quad (8)$$

An angle A has been defined such that

$$FR = \frac{\sin A/2}{A/2} \quad (9)$$

Means for computing A were given in the preceding section thus permitting the theoretical determination of FR to be made. It is now desired to see how g_{ms} and g_{md} may be measured. From these a comparison between theory and experiment is possible.

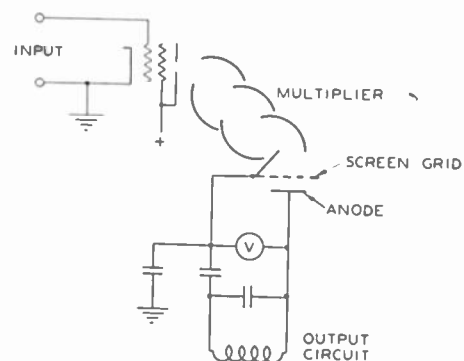

Fig. 11—Experimental setup for measuring frequency response.

The static output transconductance g_{ms} is determined either by measuring the slope of the $I_p - V_g$ curve, where I_p is the output direct plate current and V_g the control-grid voltage or by determining the limiting value of the dynamic transconductance as the frequency of operation approaches zero. Now, (see Figs. 15 and 16)

$$g_{md} = \frac{I_d}{E_\gamma} \quad \text{and} \quad I_d = \frac{E_2}{R_2} \quad (10)$$

Therefore,

$$g_{md} = \frac{1}{R_2} \frac{E_2}{E_\gamma} \quad (11)$$

where I_d is the output alternating plate current and E_2 is the voltage amplitude at the output electrodes, R_2 is the output impedance at the tube output electrodes and E_γ is the alternating-voltage amplitude at the input electrodes. It will be noted that stress is placed upon the fact that the quantities are measured at the electrodes. At high frequencies the effect of lead inductance is such that the voltages measured at the tube terminals differ appreciably from those at the electrodes. The matter is discussed in detail in Appendix III where it is shown that if E_θ and E_1 are the alternating-voltage amplitudes at the input and output terminals, respectively, and E_γ and E_2 the voltage amplitudes across the corresponding electrodes, then

$$E_\gamma = \frac{E_\theta}{\left[1 - \left(\frac{f}{f_{ri}}\right)^2\right]} \quad (12)$$

and

$$E_2 = E_1 \sqrt{\left(\frac{L_1 + L_2}{L_1}\right) \frac{1}{\left[1 - \left(\frac{f}{f_{ro}}\right)^2\right]}} \quad (13)$$

where f_{ri} = the series-resonant frequency of input leads and electrodes

f_{ro} = the series-resonant frequency of output leads and electrodes

f = the frequency of operation

L_2 = the inductance of the output leads

L_1 = the inductance of the external circuit

A method for the determination of input and output circuit resonances has been described by Nergaard.⁶ In the case of f_{ri} the procedure used here was similar to that described by Nergaard for the diode, the tube in this case being biased so as to be nonlinear in response, resonance being then indicated by a change in the output current. In determining f_{ro} it was necessary to connect a diode voltmeter across the output terminals to serve as a resonance indicator. Its capacitance was not sufficiently large to affect the results obtained.

The voltage E_θ impressed across the input terminals was obtained from a signal generator. Below 150 megacycles, a calibrated Ferris microvolter was employed. This supplies a known voltage at the terminals of a properly loaded transmission line. From E_θ , the voltage E_γ may be computed with the aid of (12).

At frequencies above 150 megacycles a negative-resistance magnetron was used as a signal generator. The magnetron output was coupled into a resonant input circuit. E_γ was determined by the so-called slide-

back method. The input circuit was first biased to cut-off with the signal off. The change in direct output current produced by the signal was noted. From the signal voltage at lower frequencies required to produce the same change in output current, the value of E_γ could then be computed.

To determine R_2 at any frequency, one proceeds in the following manner.

1. With a given value of input voltage E_θ , the external output circuit is tuned to resonance and the voltage E_1 across the external circuit measured with a diode voltmeter.

2. A known resistance R_0 is connected across the external circuit, and the external circuit retuned to resonance. The retuning is necessary because of the slight capacitance of the resistor leads to the remainder of the circuit.

3. The resonant voltage across the external output circuit is measured under this condition. It is denoted by E_0 .

4. The resonant impedance of the output circuit at the tube terminals (R_1) is then given by

$$R_1 = R_0 \left(\frac{E_1}{E_0} - 1\right). \quad (14)$$

By substitution of this in (42) there results

$$g_{md} = \frac{1}{R_0 \left(\frac{E_1}{E_0} - 1\right)} \frac{E_1}{E_\theta} \left[1 - \left(\frac{f}{f_{ri}}\right)^2\right] \sqrt{\frac{L_1}{L_1 + L_2} \left[1 - \left(\frac{f}{f_{ro}}\right)^2\right]}. \quad (15)$$

From this set of values of g_{md} and the value of g_{ms} , previously determined, the experimental values of the frequency response can be computed and plotted as a function of frequency.

VII. COMPARISON OF THEORY AND EXPERIMENT

A tube incorporating a 5-stage multiplier made up of unit cells of type A (see Fig. 8) was placed in the circuit shown in Fig. 11 and investigated in the manner described in the preceding section. It was found that

$$f_{ri} = 750 \text{ megacycles}$$

$$f_{ro} = 570 \text{ megacycles}$$

$$L_2 = 16 \times 10^{-9} \text{ henry.}$$

The external output circuit was in the form of a coaxial line so that L_1 could be computed at each frequency from its measured length. The corrections for the effects of input and output leads were computed by the methods outlined in the preceding section.

Measurements of input and output terminal voltages (E_θ and E_1) were made over a range of frequencies. R_2 was determined over the same range. Substitution of

⁶ L. S. Nergaard, "A survey of ultra-high frequency measurements," *RCA Rev.*, vol. 3, pp. 156-195; October, 1938.

all these measured and computed values in (15) yielded values for g_{md} . The ratio g_{md} to g_{ms} is plotted in Fig. 12. The values of g_{ms} at frequencies below 4 megacycles were used for g_{ms} .

For the theoretical computation of the *frequency response*, i.e., g_{md}/g_{ms} , the equivalent spread caused by

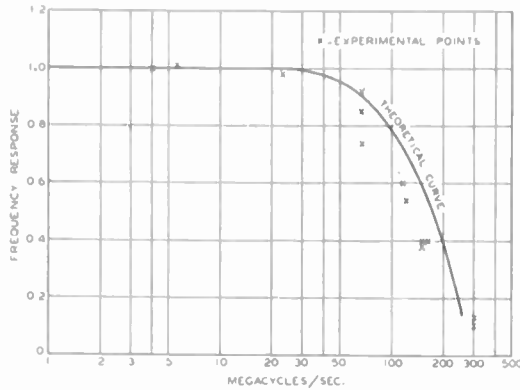

Fig. 12—Frequency response of 5-stage electrostatic multiplier.

initial velocities of secondaries and that caused by path differences must be computed.

Using the methods outlined above, in section III D and section IV, it was found that if the maximum transit angle between adjacent stages is $\omega\tau$, the *equivalent transit-angle spread* from initial velocities is $0.11\omega\tau$. For the structure used, the equivalent spread in any one stage from path difference is $0.21\omega\tau$.

Then from (4) we can compute A , the equivalent transit-angle spread for the entire 5-stage multiplier. This is given by

$$A = [5(0.21\omega\tau)^{4/3} + 5(0.11\omega\tau)^{4/3}]^{3/4} \\ = 0.92\omega\tau.$$

τ , the average transit time per stage, has already been computed in obtaining the transit-time spreads. Consequently, A as a function of frequency can be computed and from that, also determined as a function of frequency, *frequency response* = $(\sin A/2)/(A/2)$. The results are plotted on Fig. 12. The agreement between theory and experiment is as good as could be expected and serves to vindicate the selected combination law for independent transit-angle spreads. The theoretical curve, if extended, would pass through the axis. Negative values of FR merely represent a phase reversal. However, such a transition can occur only for uniform transit-angle distributions. In the case under consideration, the actual nonuniform distribution results in gradual phase changes with finite output at all values of over-all transit angle as indicated by the experimental points.

As was previously mentioned a second tube was built to four times the scale of the first. When operated at the same voltages it should yield a similar *frequency-response* curve whose frequency scale is one quarter as great; provided that the transit-angle spread is

produced principally by initial velocity and path differences. Under these conditions, if the curves in both cases are plotted in terms of transit angle, they should agree. The results for the two tubes are plotted on Fig. (13) as a function of transit angle. The agreement is within the limits of experimental error.

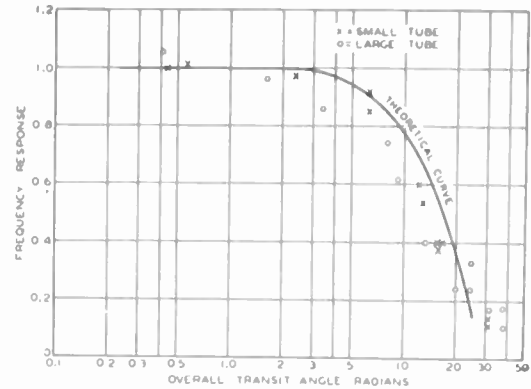

Fig. 13—Transit-angle response of electrostatic multipliers.

Kilgore of these laboratories has investigated the behavior of even smaller-scale multipliers up to frequencies of 500 megacycles. His electrode structures were similar to the form type C described by Rajchman,² which theoretically yield a much greater spread in the initial stage than that of type A, but in which because of crossover of the beam, the spread in more than one stage may be less. Kilgore found that his results, when plotted against the total transit angle through the multiplier, were substantially the same as ours when plotted in the same fashion. The indication thus is that for multistage electrostatic multipliers (in their present form of development) the behavior depends primarily upon the over-all transit angle. This presumes that the unit cell of the multiplier does not differ radically from that studied by Kilgore or by us. It would be expected, however, that the L or T types⁶ or any type without a high positive gradient at the secondary-emitting surface would have a more rapid fall with frequency. This has actually been observed to be the case.⁷

VIII. TIME OF EMISSION OF SECONDARY ELECTRONS

From the fact that the *frequency response* of an electrostatic multiplier depends only on the over-all transit angle and not on the scale to which it is built, an interesting conclusion can be drawn regarding time of emission of secondary electrons. If there were any spread in the time of emission of secondaries comparable to that produced by initial velocities or path differences, a change in the tube scale would result in a difference in the *frequency-response* curve when plotted against over-all transit angle. The fact that there is

⁶ V. K. Zworykin, G. A. Morton, and L. Malter, "The secondary emission multiplier, a new electronic device," *Proc. I.R.E.*, vol. 24, pp. 351-375; March, 1936.

⁷ "The behaviour of the augetron at high frequencies," *Electronics and Television*, vol. 13, p. 131; March, 1940.

no appreciable difference up to 500 megacycles for small tubes as compared with large ones indicates (see Fig. 13) that there is no appreciable time spread for secondary emission of the order of 2×10^{-9} second. From the physical picture of the phenomenon of secondary emission it appears extremely unlikely that the average time taken for the emission to occur can be in excess of the spread in the time of emission. Thus, we conclude that secondary emission from the surfaces studied takes place in less than 2×10^{-9} second. To the best of our knowledge this is a lower experimental limit than has been established by previous observers.

IX. FREQUENCY LIMIT OF ELECTROSTATIC MULTIPLIERS

The application of the results of section VII permits of the setting of an upper frequency limit at which multipliers of the type studied may be operated.

It will be assumed that the upper limit is not set by available output circuit impedance, available input transconductance, or frequency response of the input control circuit but only by the frequency response of the multiplier proper and the smallness of scale at which a structure can be built.

Thus, for example, let it be supposed that for reasons of constructional difficulty and cold emission from closely spaced edges,³ the scale be chosen so that the average path length of electrons between stages is 0.5 centimeter.

A convenient operating voltage for the purposes of this experiment has been found to be 250 volts per stage. This results in a transit time per stage of 10^{-9} second. Assuming that a 3-stage multiplier is required, τ_t , the total transit time, becomes about 3×10^{-9} second. It is assumed further that the upper limit of usefulness is that at which the dynamic transconductance has dropped to 10 per cent of the static value. From Fig. 13 this is seen to occur for an over-all transit angle of about 40 radians.

Then, if f_{max} is the maximum usable frequency

$$2\pi f_{max} \tau_t \approx 40$$

or

$$f_{max} = 2.0 \times 10^9 \text{ cycles per second.}$$

Because of the frequency characteristics of input and output circuits this value of f_{max} is unquestionably high. It should be realized that this limit applies only to multipliers of the general form studied and for the particular scale described.

X. CONCLUSIONS

It has been demonstrated by a comparison of theory with experiment that the decreasing amplification of a multiplier with increasing frequency can be ascribed to the transit-time spread resulting from varying initial velocities of secondary electrons and the differences in paths described by electrons originating at different points on multiplier surfaces.

From the analysis it appears that the upper frequency limit of multipliers as constructed at present is of the order of a few thousand megacycles. If multipliers should be designed which eliminate the effects of path differences upon transit-time spreads, the upper frequency limit would be extended by a factor of about 2. It appears more difficult to eliminate the spreads due to initial velocity distribution.

Subject to the conditions imposed upon multiplier design in this paper, it may be said that the practical upper limits for the application of multistage electron multipliers is in view of being attained. The smallness of scale imposes extreme constructional difficulties and in addition the power-handling ability of output electrodes is already being taxed.

(A similar treatment of magnetic multipliers has been completed. The results are substantially the same as for the case of electrostatic multiplier.)

ACKNOWLEDGMENT

I am indebted to Mr. G. R. Kilgore for assistance and advice in all phases of this work.

APPENDIX I

Relation Between Transit-Angle Spread and Loss in Signal

A. Uniform Transit-Angle Distribution

Consider a sinusoidal signal present as a current variation $I \sin \omega t$ in an electron stream. Now suppose that in going between two points *A* and *B* in a multiplier, a transit-angle spread occurs for any reason whatever. It is desired to compute the amplitude of the current variation at *B*. Let the transit-angle distribution be uniform over an angle of width α as illustrated in Fig. 14. This means that electrons leaving *A* at some

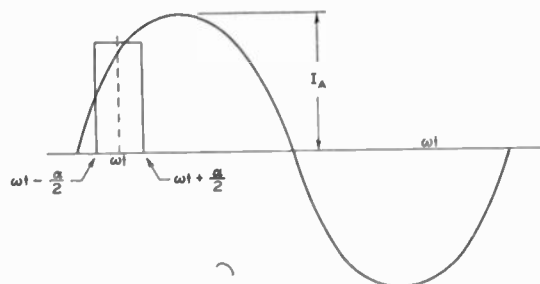

Fig. 14—Uniform transit-angle distribution

instant $t - \tau_{max} + \alpha/2\omega$, (where τ_{max} is the maximum transit time between *A* and *B*) result in the arrival of electrons at a uniform rate at *B* between two later instants, the earlier of which is $t_1 = t - \alpha/2\omega$ and the later of which is $t_2 = t + \alpha/2\omega$. The signal at *B* at any instant is obtained by averaging the current, which leaves *A* between $t - \alpha/2\omega$ and $t + \alpha/2\omega$.

Thus, if the current at *A* is $I_A \sin \omega t$, that at *B* is

$$I_B = I_A \int_{t-\alpha/2\omega}^{t+\alpha/2\omega} \sin \omega t dt / \int_{t-\alpha/2\omega}^{t+\alpha/2\omega} dt \quad (16)$$

$$= I_A \left\{ \frac{\sin \frac{\alpha}{2}}{\frac{\alpha}{2}} \right\} \sin \omega t \quad (17)$$

$$\frac{I_B}{I_A \sin \omega t} = \frac{\sin \frac{\alpha}{2}}{\frac{\alpha}{2}} \quad (18)$$

Now since $I_A \sin \omega t$ is what the current would be at B in the absence of transit-angle spread, $I_B/I_A \sin \omega t$ is the measure of decrease in the alternating amplitude of the current at B caused by the transit-angle spread. If A is located at the input of the multiplier and B at its output, then the ratio $I_B/I_A \sin \omega t$ is also the ratio g_{md}/g_{ms} . This latter ratio has already been defined as the *frequency response*.

Thus, for the case under consideration

$$\text{frequency response} = \frac{\sin \alpha/2}{\alpha/2} \quad (19)$$

Now the actual transit-angle spread is α . The *relative spread* is then defined as $R = \alpha/\omega\tau_{\max}$ where τ_{\max} is the maximum possible transit time between A and B for all electrons.

B. Nonuniform Transit-Angle Distribution

Let $P(\theta)$ (see Fig. 4) be the relative transit-angle distribution between points A and B of a multiplier. The transit-angle distribution is

$$F(\omega\tau) = P\left(\frac{\omega\tau}{\omega\tau_{\max}}\right) = P(\theta) \quad (20)$$

This means that electrons leaving A at any instant t_0 arrive at B between $t=t_0$ and $t=t_0+\tau_{\max}$ at a rate given by

$$F[\omega(t-t_0)] = F(\omega\tau) \quad (21)$$

From section III C it is obvious that

$$\int_0^{\omega\tau_{\max}} F(\omega\tau) d\omega\tau = 1.$$

In this case, since the current leaving A is $I_A \sin(\omega t_0)$, that at B is

$$I_b = I_A \int_{\omega t - \omega\tau_{\max}}^{\omega t} F[\omega(t-t_0)] \sin(\omega t_0) d(\omega t_0) \quad (22)$$

Since $\omega(t-t_0) = \omega\tau$ and since $d(\omega t_0) = -d(\omega\tau)$, it follows that (22) can be rewritten as

$$I_b = I_A \int_0^{\omega\tau_{\max}} F(\omega\tau) \sin \omega(t-\tau) d\omega\tau \quad (23)$$

Upon integration this takes the form

$$I_b = KI_A \sin(\omega t + \lambda) \quad (24)$$

where K is a constant less than unity, and λ is a phase angle. To find K , one proceeds as follows:

1. Assign any value, say ωt_1 , to ωt in $F\omega(t-t_0)$ of (23) and evaluate. The result will be

$$A_1 = K \sin(\omega t_1 + \lambda) \quad (25)$$

2. Then assign the value $(\omega t_1 + \pi/2)$ to ωt and obtain

$$A_2 = K \cos(\omega t_1 + \lambda).$$

Therefore

$$K = \sqrt{A_1^2 + A_2^2} \quad (26)$$

What may be done in practice is to plot $F(\omega\tau)$ and $\sin \omega t$ on the same horizontal scale, disregarding their relative position or "phase" and then evaluate

$$A_1 = \frac{\int_{\omega t - \omega\tau_{\max}}^{\omega t} F(\omega\tau) \sin \omega t d(\omega\tau)}{\int_{\omega t - \omega\tau_{\max}}^{\omega t} F(\omega\tau) d(\omega\tau)} \quad (27)$$

The $F(\omega\tau)$ curve is then shifted 90 degrees on the horizontal scale and A_2 evaluated.

If F is a symmetrical function, its symmetry coordinate can be made to coincide with the maximum of the sine function and one obtains immediately

$$K = \frac{A_1}{I_A} \quad (28)$$

A comparison of (24) with (17) indicates that corresponding to any form of F we can find an angle α , referred to as the *equivalent transit-angle spread*, over which the transit-angle spread is uniform, which yields the same reduction in signal amplitude. The value of α is given by

$$K = \frac{\sin \alpha/2}{\alpha/2} \quad (29)$$

Thus, K of (24) is the *frequency response* of the multiplier whose equivalent transit-angle spread is α .

APPENDIX II

Combination of Independent Spreads

It would be extremely convenient to have some simple rule for combining transit-angle spreads produced by independent causes. In one case, that of section III C the resultant spread caused by the effects of initial velocities in succeeding stages of a multiplier has been computed by quadrature and the results are given in Fig. 4. We now examine the possibility of using these results for establishing an empirical combination formula.

By application of the method of Appendix I, it is found that the *relative transit-angle spread* in terms of the maximum transit angle through a single stage as unity is given by 0.108, and 0.184, and 0.244 for the 1-, 2-, and 3-stage multipliers, successively. Now

$$0.184 = (0.108^{4/3} + 0.108^{4/3})^{3/4}$$

$$\text{and } 0.244 = (0.108^{4/3} + 0.108^{4/3} + 0.108^{4/3})^{3/4}.$$

Thus, for the combination of spreads caused by initial velocities it appears that a suitable law is

$$A = \left[\sum_{p=1}^{p=n} \alpha_p^{4/3} \right]^{3/4} \quad (30)$$

where α_p is the equivalent transit-angle spread for the p 'th stage and A is the equivalent angle for all n stages.

As has been mentioned in section IV, the spread in a 2-stage multiplier from path differences alone may be less than that in 1 stage. However, when all effects are combined in a multistage multiplier, the spread undoubtedly increases with the number of stages but less rapidly than in a linear manner. In the absence of a perfectly general law applicable to all structures we shall attempt to apply (30) to the combination of spreads produced by any cause whatsoever in a multistage multiplier.

In general, while the over-all spread may not be given exactly by (1), we do know that

$$A < \sum \alpha_p \quad (31)$$

where α_p is the individual spread from any cause whatever. This expression serves as a check upon the experimental confirmation of theory by use of the relation

$$\text{frequency response} = \frac{\sin A/2}{A/2}$$

since the frequency response can be measured and A computed.

APPENDIX III

Corrections for Lead and Electrode Resonances

A. Input End

Consider a circuit as shown in Fig. 15. This may be considered as the input end of a voltage-controlled multiplier. A and B are the terminals outside the tube. It is desired to know the actual voltage E_γ across the

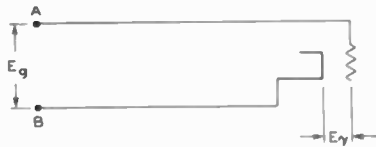

Fig. 15—Input circuit of voltage-controlled multiplier.

control electrodes in terms of E_0 . This problem has been considered by Nergaard⁶ who found that

$$E_\gamma = \frac{E_0}{1 - \left(\frac{f}{f_{r1}}\right)^2} \quad (32)$$

The terms in this expression are defined in section VI.

B. Output End

The output circuit of a multiplier is shown in Fig. 16. This may be represented schematically by the circuit

of Fig. 17 where L_1 and r_1 refer to the external circuit, L_2 is the inductance of the tube leads, r_2 their resistance, and C is the capacitance of the anode to everything else. E_1 is the voltage observed at the tube terminals. E_2 , the voltage between screen and anode, i.e., between L and M , is desired in terms of E_1 .

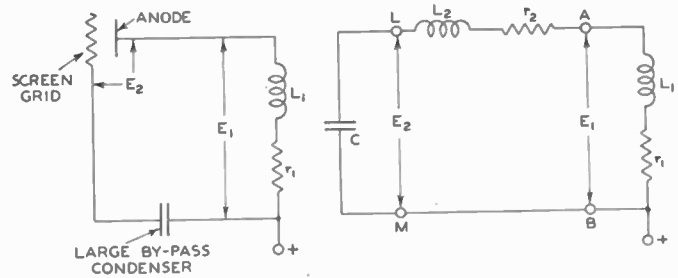

Fig. 16—Output circuit of voltage-controlled multiplier.

Fig. 17—Equivalent output circuit.

The output circuit resonant impedance R_2 is that existing between L and M . An expression for R_2 in terms of voltage readings between A and B is desired.

The impedance Z between A and B is given by

$$\frac{1}{Z} = \frac{1}{r_1 + j\omega L_1} + \frac{1}{r_2 + j\omega L_2 + \frac{1}{j\omega C}} \quad (33)$$

$$= \frac{j\omega r_2 C - \omega^2 L_2 C + 1 + j\omega r_1 C - \omega^2 L_1 C}{(r_1 + j\omega L_1)(1 + j\omega r_2 C - \omega^2 L_2 C)} \quad (34)$$

At resonance,

$$\omega^2(L_1 + L_2)C = 1$$

and in practice,

$$r_1 \ll \omega L_1 \quad \text{and} \quad \omega r_2 C \ll 1 - \omega^2 L_2 C.$$

Then, (34) becomes

$$\frac{1}{Z} = \frac{(r_1 + r_2)C}{L_1(1 - \omega^2 L_2 C)}$$

or

$$Z = R_1 = \frac{L_1(1 - \omega^2 L_2 C)}{(r_1 + r_2)C} = \frac{L_1}{(r_1 + r_2)C} - \frac{\omega^2 L_1 L_2}{(r_1 + r_2)} \quad (35)$$

Now R_2 , the resonant impedance between L and M , is

$$R_2 = \frac{(L_1 + L_2)}{(r_1 + r_2)C} = \frac{L_1}{(r_1 + r_2)C} + \frac{L_2}{(r_1 + r_2)C} \quad (36)$$

Since the power dissipated in the circuit is a fixed quantity,

$$\frac{E_2^2}{R_2} = \frac{E_1^2}{R_1} \quad (37)$$

$$E_2 = E_1 \sqrt{\frac{R_2}{R_1}}$$

Substituting (36) in (38), we obtain

$$E_2 = E_1 \sqrt{\frac{L_1 + L_2}{L_1} \frac{1}{1 - \omega^2 L_2 C}} \quad (38)$$

If the resonant frequency of the output circuit is far removed from that of L_2 and C in series (the series-resonant frequency of the output electrodes and leads) then

$$\omega^2 L_2 C = \left(\frac{f}{f_{ro}}\right)^2 \quad (39)$$

where f_{ro} is the resonant frequency of L_2 and C . (This has been proved by Nergaard.⁵)

The output transconductance (see section VI) is given by

$$g_{md} = \frac{1}{E_\gamma} \frac{E_2}{R_2} = \frac{1}{E_\gamma} \frac{E_1 \sqrt{\frac{R_2}{R_1}}}{R_2} = \frac{1}{E_\gamma} \frac{E_1}{\sqrt{R_2 R_1}} = \left[\frac{1}{E_\gamma} \frac{E_1}{R_1} \right] \sqrt{\frac{L_1(1 - \omega^2 L_2 C)}{L_1 + L_2}} \quad (40)$$

$$g_{md} = \frac{1}{R_1} \frac{E_1}{E_\gamma} \sqrt{\frac{L_1}{L_1 + L_2} \left[1 - \left(\frac{f}{f_{ro}}\right)^2 \right]} \quad (41)$$

Substituting (32) in (41), we finally obtain

$$g_{md} = \frac{1}{R_1} \frac{E_1}{E_0} \left(1 - \left(\frac{f}{f_{r1}}\right)^2 \right) \sqrt{\frac{L_1}{L_1 + L_2} \left[1 - \left(\frac{f}{f_{ro}}\right)^2 \right]} \quad (42)$$

The Orbital-Beam Secondary-Electron Multiplier for Ultra-High-Frequency Amplification*

H. M. WAGNER†, MEMBER, I.R.E., AND W. R. FERRIS†, NONMEMBER, I.R.E.

Summary—A developmental ultra-high-frequency receiving tube in which secondary-emission electron multiplication has been applied to a conventional high-transconductance tube structure to increase the transconductance without a corresponding increase in interelectrode capacitances and input conductance is described. It was designed primarily for wide-band amplification at a frequency of approximately 500 megacycles, as required for television radio relay systems. The tube uses conventional circuits and requires a power supply of less than 400 volts. The structure adopted permits the most efficient use of the secondary-emission multiplier consistent with satisfactory life and good high-frequency performance. The structure also permits the use of beam deflection to provide a convenient gain-control method, free from the input capacitance and conductance variations attending the usual grid-bias control. A novel method of measuring interstage gain, involving the use of transmission lines, is discussed.

DESIGN CONSIDERATIONS OF ULTRA-HIGH-FREQUENCY AMPLIFIER TUBES

THE NEED for a receiving tube for amplification of ultra-high-frequency signals in the neighborhood of 500 megacycles per second, particularly for television relay links and services where a wide band of frequencies is transmitted, has led to the development of a type of tube descriptively called an orbital-beam secondary-emission multiplier. This type of tube has a cathode with a conventional control-grid structure and makes use of secondary emission to augment the transconductance. The increase of transconductance is obtained without a proportionate increase in the capacitances and loading of the input and output circuits. The developmental design, to be described in this paper, is especially suited for amplification at frequencies as high as 500 megacycles, but may

also be valuable as a high-gain amplifier for lower-frequency applications, and tests indicate that the tube may prove useful at even higher frequencies.

For many reasons, it is desirable to have small capacitances between the electrodes of high-frequency amplifier tubes. The input and output capacitances often become a large part of the total capacitance of the circuits which are connected to the tubes and, hence, affect and limit the performance of these circuits. The properties of the tuned circuits which couple one tube to the next tube in a multistage amplifier are governed by the circuit capacitance. For example, a tuned circuit connected across the output of a tube has an impedance which varies over the received band of frequencies. This impedance variation consequently changes the amplification. A given band width can be amplified with a response "flat" to within a prescribed amount, by shunting the tuned circuit with a resistance small enough to satisfy the broad-tuning requirements. In fact, the value of equivalent shunt resistance varies almost inversely as the band width and circuit capacitance. Thus, for a given band width, the larger the capacitance, the smaller the output circuit resistance, and the smaller the amplification. Because the output resistance has to be small to meet wide-frequency-channel requirements, conventional tubes fail to amplify even at relatively low frequencies. In order to obtain sufficient gain per stage over a wide band, tubes designed for this service must have a high transconductance and their input and output capacitances must be as small as possible. A factor that has been used as a figure of merit of a tube is $g_m/\sqrt{C_1 C_2}$, where g_m is the

* Decimal classification: R330×R262.4. Original manuscript received by the Institute April 10, 1941. Presented, Sixteenth Annual Convention, New York, N. Y., January 10, 1941.

† Research Laboratories, RCA Manufacturing Company, Inc. Harrison, N. J.

transconductance and C_1 and C_2 are the effective input and output capacitances of the tube. Of course, the limiting values of circuit capacitances are the capacitances of the tube itself. It is important that the design of an ultra-high-frequency tube satisfy the special requirements for wide-band service in addition to the general requirements of satisfactory ultra-high-frequency operation.

One very effective method of minimizing input capacitance in a tube is to use small input electrodes, for example, a small cathode and a control grid which produces small modulated current, and then to make use of the phenomenon of secondary emission to generate a larger current, thus effectively increasing the transconductance of a low-capacitance input structure. The output capacitance of a tube can be reduced by utilizing beam formation which causes the electrons to be collected by an anode of small area and small capacitance.

THE ORBITAL-BEAM MULTIPLIER

Fig. 1. shows a photograph of a developmental receiving tube in which secondary emission and beam formation are employed. The electrode structure is mounted within a cylindrical glass envelope. The leads are arranged radially and are sealed through an acorn-

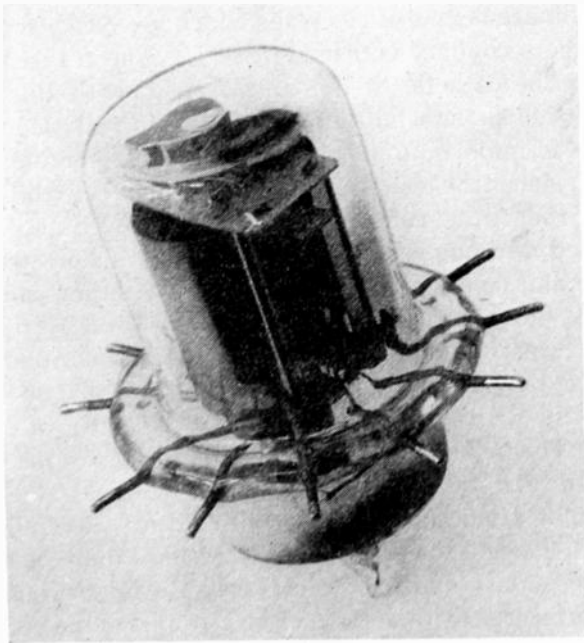

Fig. 1—Photograph of orbital-beam multiplier.

type seal at one end of the bulb. The arrangement of electrodes in a cross-sectional view is illustrated in Fig. 2. The input electrode system consists of a cathode K_1 , control grid G_1 , and the accelerating grid G_2 . The long oxide-coated cathode is placed parallel to the axis of the tube. The opposite faces of the cathode adjoining the control-grid wires are made flat in order to produce two well-defined beams emerging from the cathode in

opposite directions. The positive grid G_2 which is placed near the control grid serves to draw sufficient current from the cathode with the control grid operated at a negative potential. The electron-optical operation of the tube is indicated in the figure. The primary electrons are emitted by the cathode, and pass through the control grid and screen grid as in the usual tetrode. They then follow the curved paths $A-A$ between the

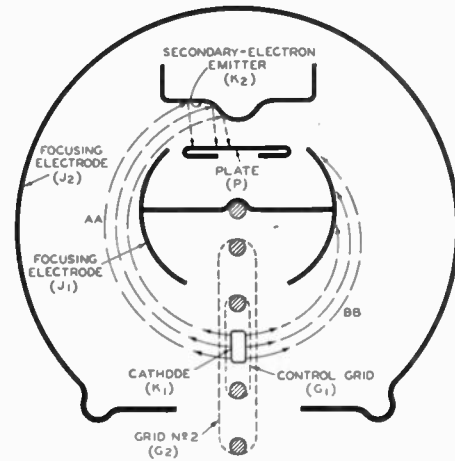

Fig. 2—Schematic cross section of orbital-beam multiplier.

cylinders J_1 and J_2 and strike the secondary-emitter target K_2 where secondary electrons in the proportion of about five secondaries to one primary are emitted. These secondary electrons are attracted by the output anode, which operates at a potential considerably higher than the secondary emitter and performs the function of the plate in a conventional tetrode. A magnetic field is not required for the use of this tube. The electrons follow the paths $A-A$ under the attractive force of the highly positive central electrode J_1 but do not strike it. The shape of these paths is, of course, explained by the centrifugal force acting on the electrons; this force just equals the radial attraction of the central conductor for the electrons. The motion is suggestive of that of a planet in its orbit about the sun, hence, the use of the term "orbital beam."

The radius of the orbit may be conveniently changed by varying the potential of the outer cylinder J_2 . When electrode J_2 operates at zero potential the electrons normally follow the path $A-A$. When J_2 is made negative, the beams follow paths such as $B-B$, and some of the electrons are diverted to the inner cylinder J_1 thus reducing the output plate current. This feature affords a very useful method of volume control. It is particularly useful in high-frequency circuits because its action is not accompanied by changes in the cathode current. Thus, the method avoids the objectionable changes in input capacitance and conductance which the method of controlling volume by variation of the cathode current usually introduces. The deflection volume-control characteristic is shown in Fig. 3.

Other static characteristics of the developmental

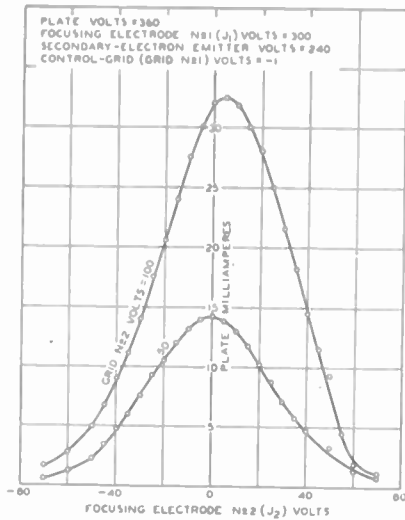

Fig. 3—Volume-control characteristic provided by deflection of the electron beam.

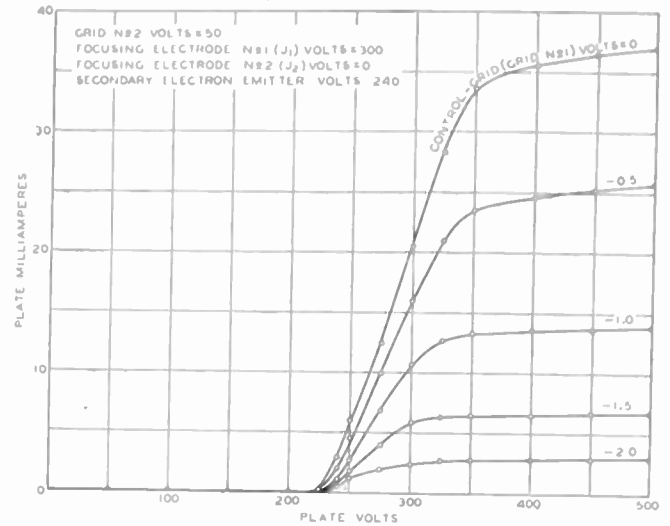

Fig. 5—Plate characteristics of orbital-beam multiplier.

tube are shown in Table I and in Figs. 4 and 5. The figure of merit $g_m/\sqrt{C_1 C_2}$ for this tube is about 3100 (micromhos per micromicrofarad) as compared with 1210 for the RCA-6AC7/1852.

Attention has been given in the tube design to the effect of the transit time of the electrons, not only from the familiar viewpoint of an idealized picture of

a uniform electron flow, but also on the basis of considering the spread in transit times of all the different electrons in their different paths between cathode and anode and the resultant effect on over-all transconductance. In this tube, as in the acorn tubes, the spacings of control grid to cathode and of screen grid to control grid are very close; thus, high transconductance and minimum electron transit time are obtained. The rectangular cathode, coated only on the flat faces, and the parallel-plane grid structure provide narrow rectilinear beams of electrons which are easily focused on the secondary-emitter target K_2 . The transit time from the cathode to the control grid, with this construction, is substantially the same for all electrons. This is important in keeping the input conductance low, since the electrons originating under the grid side rods in a tube having the cathode completely coated, although few in number, have a long transit time and can contribute heavily to the input conductance but contribute very little to or actually reduce the transconductance. The secondary electrons are emitted by the target K_2 with substantially no time lag, but with considerable spread in velocity of emission. The velocity spread, however, is not serious with this design because there is only a single stage of multiplication and because the output electrode P which collects the secondary electrons is quite close to the secondary-emitter target. It is quite important that the total transit time for each electron from the control grid to the output electrode, or rather the sum of the primary- and secondary-electron transit times, be the same for electrons emitted from various parts of the cathode. The use of the rectangular cathode, the narrow beams, and the special shape for the secondary emitter all contribute to this end. If this condition is not met, the contributions of the various electrons to the output current will not be in phase and, therefore, a serious loss in transconductance will result at ultra-high frequencies.

TABLE I
TYPICAL OPERATING CONDITIONS FOR DEVELOPMENTAL MULTIPLIER TUBE

Plate (output anode) voltage	370 volts
Secondary-emitter voltage	240 volts
Outer focusing-electrode voltage	0 volts
Inner focusing-electrode voltage	300 volts
Grid No. 2 voltage	45 volts
Grid No. 1 voltage	-1 volt
Plate current	12 milliamperes
Secondary-emitter current	9.5 milliamperes
Cathode current	3.5 milliamperes
Grid No. 1-plate transconductance	15,000 micromhos
Input capacitance	6.5 micromicrofarads
Output capacitance	3.5 micromicrofarads
Figure of merit	3100 micromhos per micromicrofarad

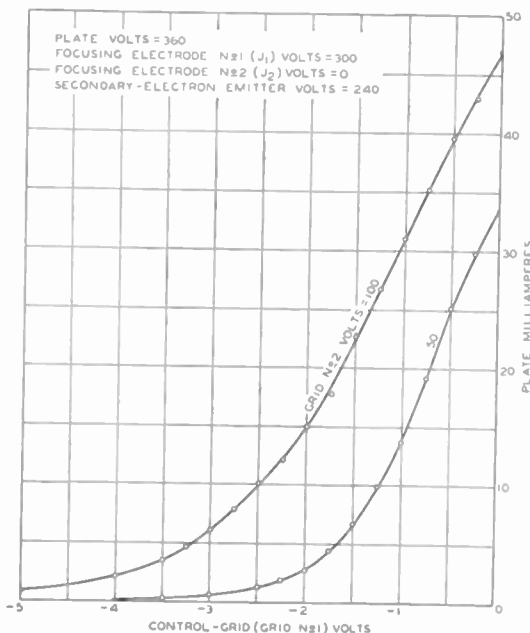

Fig. 4—Transfer characteristics of orbital-beam multiplier.

The cylinders J_1 and J_2 perform functions, already

mentioned, as accelerators, focusing electrodes, and deflecting electrodes for the electron beams. They also serve as highly effective electrostatic shields between the control grid and output anode. Thus, the internal direct capacitance between these electrodes is reduced substantially to zero. These shields also act as baffles to keep materials evaporated or otherwise driven off from the cathode from reaching the secondary emitter. Such materials usually poison secondary-emitting surfaces.

ULTRA-HIGH-FREQUENCY CIRCUITS AND MEASUREMENTS

The arrangement of leads and circuits can be seen in Fig. 6. The arrangement of leads was governed by the requirement of providing a maximum of isolation be-

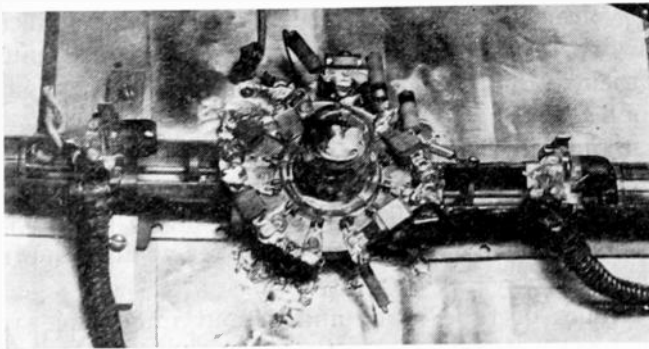

Fig. 6—Experimental amplifier for 500-megacycle measurements on orbital-beam multiplier.

tween the input and the output electrodes, leads, and circuits. In some cases several leads are used for the same electrode in order to minimize lead impedance and to reduce loss produced by circulating currents. Two adjacent leads are used for the control grid G_1 ; two leads outside the grid leads are used for the cathode to provide a low-impedance circuit for the grid-cathode circulating current. The leads for the secondary emitter and the output electrode are placed opposite the control-grid leads in order to provide a maximum of separation. The other electrodes, heater, screen grid, and focusing electrodes, have their leads arranged in intermediate positions. All electrodes other than the control grid and anode are usually by-passed to a radio-frequency ground by means of condensers. At the highest frequencies, special circuits may be used to tune out lead impedances.

Measurements of the performance of the tube as a voltage amplifier were made at ultra-high frequencies. The following data obtained at 500 megacycles are representative of these measurements.

Band width	6 Mc	11 Mc
Voltage gain	7 times	5 times

Of interest are measurements showing that the transconductance at frequencies as high as 500 megacycles is not greatly different from the static value of 15,000

micromhos. That the loss in transconductance is small demonstrates that the time lag of secondary emission (or more accurately the spread of emission lag) is less than 10^{-9} second.

Experimental measuring equipment used in making some of the high-frequency tests on the orbital-beam multiplier is also shown in Fig. 6. The tube is held in a low-loss socket. Two concentric cylindrical transmission lines are placed on opposite sides of the socket. One line is loosely coupled to an oscillator and applies the high-frequency voltage to the control-grid terminals of the tube. The other line is connected to the anode of the tube and receives the amplified output. Both lines are made with sliding short-circuiting bars which are used to tune the lines to the oscillator frequency. A diode vacuum-tube voltmeter mounted on each line can be slid back and forth to measure voltage at any point on the line. Sliding of the voltmeters is made possible by a long slot cut through the outer cylinder of each concentric transmission line. Small high-frequency by-pass condensers connect the socket terminals to a copper base plate and to the outer cylinders of the transmission lines.

The measurement of gain at frequencies of the order of 500 megacycles presents serious difficulties when ordinary methods are employed. The tube capacitances and the inductance of the leads are of such magnitude that they tune to a frequency nearly as low as and often even lower than that of the applied signal.

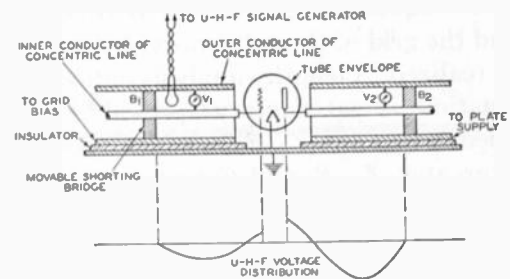

Fig. 7—Schematic diagram showing voltage distribution and voltmeter connection of test amplifier shown in Fig. 6.

This difficulty necessitates the use of coupling schemes which can make the best use of the input power to drive the tube and the output power supplied by it in spite of the fact that voltage nodes occur near or actually inside the tube. Transmission lines with sliding bridges are convenient coupling devices for measurement purposes since they are easily tuned and since voltmeters are easily applied at any point along them.

The transmission lines employed in the testing of these tubes usually were effectively three quarters of a wavelength long. Account must be taken of the leads of the tube and the interelectrode capacitances. The distribution of voltage with this system is indicated qualitatively in Fig. 7. When the characteristic impedance of the lines is much lower than the internal shunt grid or plate resistance of the tube, and also

lower than that of the voltmeters indicated in the figure, the lines have the characteristics of transformers and in addition may be tuned to resonance very satisfactorily.

The actual method of measuring the gain of these tubes with resonant lines is as follows:

A voltage source is loosely coupled to the grid circuit of the tube as indicated in Fig. 7 and the line is tuned by sliding the bridge B_1 to give maximum deflection on the grid voltmeter V_1 . A mental note of the deflection is made and the voltmeter is moved to a new position a few millimeters along the line which is retuned to give a new maximum reading V_1 . This is repeated until a position is found for the voltmeter which produces its greatest possible deflection. In effect, the voltmeter is then located along the line at such a distance from the voltage node that the voltmeter is matched to the line and tube circuit so as to absorb maximum power. There are three positions along a three-quarter-wave line which give this same maximum deflection, one near the short-circuited end of the line and a position on either side of the voltage node near the tube. However, when the tube input capacitance and lead inductance cause a voltage node to appear within the tube or near the end of the line, the position farthest from the tube is ordinarily employed as illustrated by the position of the plate voltmeter in Fig. 7. When the ultra-high-frequency power is introduced near a voltage node and the voltmeter kept out of the coupling field, the maximum voltmeter reading indicates approximately equal power division between the voltmeter and the grid of the tube, provided certain conditions are realized. A lengthy analysis indicates that the approximation is satisfactory, providing a low-loss line is used, when $(1 - Z_0/R)^2 + (Z_0\omega C)$ is of the order unity or greater, Z_0 , R , and C being, respectively, the surge impedance of the line, the shunt resistance, and the capacitance of the tube input. These conditions insure the presence of standing waves on the line. The voltmeter impedance should be larger than the surge impedance of the line. This adjustment of the grid circuit is maintained with the grid voltmeter in place and the plate-circuit transmission line is then similarly tuned and another voltmeter V_2 is likewise moved along

the plate line until a position which gives V_2 its greatest deflection is found. Stray coupling from the output to the input circuit may necessitate a readjustment of the input voltmeter and the input tuning which, in turn, may require a readjustment of the plate circuit, but a few successive trials will enable the best position for the two voltmeters to be found. Then, the power consumed by the voltmeter V_2 is equal to that dissipated by the effective shunt output resistance of the tube under test. The ratio of the reading of the plate voltmeter to that of the grid voltmeter gives the maximum voltage gain possible with the tube under test, when the tube is used as an interstage amplifier between two similar tubes.

The advantages of this method of test are that no exact knowledge of the impedances of the tube under test or of the two voltmeters need be had, provided only that the voltmeters have equal resistance. Neither is it necessary to have an absolute calibration of the voltmeters if their readings are proportional in a known way to the applied voltage.

Band-width measurements have been made in a number of ways but the most straightforward is the use of a calibrated signal generator and a plot of the response curve of the plate voltmeter against the frequency.

Values of tube input and output impedance and transconductance at high frequency can be computed roughly from measurements of the lengths of the transmission lines together with separate measurements of the tube capacitances and voltmeter impedances.

ACKNOWLEDGMENT

The authors wish to acknowledge the contributions of Mr. H. C. Thompson¹ for the information afforded by his work on orbital-beam type structures, of Dr. J. M. Miller for his assistance and valuable suggestions on measurements, and of Dr. L. Malter² for his useful computation of electron transit angles.

¹ Harry C. Thompson, "Electron beams and their applications in low voltage devices," *PROC. I.R.E.*, vol. 24, p. 1295; October, 1936.

² L. Malter, "Behavior of electrostatic electron multipliers as a function of frequency," *PROC. I.R.E.*, this issue, pp. 587-598.

Author's Note

In my article "The Response of Electrical Networks to Non-sinusoidal Periodic Waves"* I stated that current is continuous in any circuit. It has been brought to my attention that this is a confusing statement. What is meant there is that in any circuit which is inductive, the current itself is continuous, and in every capacitance, the accumulation of current or charge is continuous.

Nathan Marchand†

* Proc. I.R.E., vol. 29, pp. 330-333; June, 1941.
† Federal Telegraph Company, Newark, N. J.

Discussion on

"The Response of Electrical Networks to Nonsinusoidal Periodic Waves"*

Herbert Sherman:† Mr. Marchand has presented an interesting method for the solution of single-mesh problems. His method may be extended to the general n -mesh case, but the labor involved in solving anything higher than two meshes becomes considerable because the expansion and solution of two or more determinantal equations is required.

He classifies two methods of solving such problems as the Fourier series method and the "transient series" method. There is a third method which is far more powerful and useful than either of those mentioned. It requires the knowledge of Laplacian transforms and complex integration which are, today, the most powerful tools of the circuit analysts. An exposition of the method of "finite transforms" (a name originated by Jacob Millman of the College of the City of New York) or of "Fourier series obtained operationally" is given by N. W. McLachlan in his book, "Complex Variable and Operational Calculus," Cambridge University Press, 1939, p. 131, or in his article, "Fourier series obtained operationally," *Phil. Mag.*, January, 1938.

The "finite transform" is a method of expressing the non-sinusoidal periodic voltage as a transform over one period thus:

$$\hat{e} = \frac{\int_0^T e(t) \epsilon^{-pt} dt}{1 - \epsilon^{-pT}}$$

where T is the time for one complete period.

This "transformed voltage" may now be used to solve the more general n -mesh problem by conventional transform methods with the solution of only one determinantal equation.

* Proc. I.R.E., vol. 29, pp. 330-333; June, 1941.

† Signal Corps Representative, Bendix Radio Corporation, East Joppa Road, Towson, Md.

Corrections

S. A. Schelkunoff has brought to the attention of the editors the following corrections to his paper "Theory of Antennas of Arbitrary Size and Shape," which appeared in the September, 1941, issue of the PROCEEDINGS on pages 493-521:

On page 494, a section of the last paragraph in the left column reads: "Some writers²⁻⁶ . . . other writers⁷⁻¹²." It should read: "Some writers^{2-5, 12} . . . other writers.⁷⁻¹¹"

On page 509, the parenthetical remark in the second line upward from equation (69) reads: "See footnote 20." It should read: "See Section IX."

Dr. Schelkunoff also calls attention to the following errata in his paper "Transmission Theory of Plane Electromagnetic Waves," which appeared in the PROCEEDINGS for November, 1937, on pages 1457-1492.

Equations (82) and (84) apply if $m \neq 0$ and $n \neq 0$. If $m \neq 0$ and $n = 0$, then (82) should be

$$\alpha_s = \frac{2R}{\eta b} (0.5 + \nu^2)(1 - \nu^2)^{-1/2}$$

Institute News and Radio Notes

Sections

Buffalo-Niagara

L. C. F. Horle, consulting engineer, presented a paper on "Some Aspects of the Impact of War Economy on Civilian Radio." This broad treatment of the subject, which included the manufacture of both parts and sets, was followed by a symposium in which five speakers treated specific divisions of the field.

D. J. Phelps of the General Instrument Company discussed the problem of obtaining material for variable air condensers. The desirability of standardizing condensers to reduce inventories was pointed out. Substitute materials are replacing aluminum and it is anticipated that there will be no shortage in the supply of tuning condensers.

J. T. Hood of P. R. Mallory Company described the case for the electrolytic condenser. Satisfactory substitutes are very difficult to obtain in this field. Aluminum, glyco, glycerin, copper wire, and quality paper are all on the priority list. The trend is toward reducing the quantity of material required for a condenser of given

FORTHCOMING MEETINGS

Winter Convention
New York, N. Y.

January 12, 13, and 14, 1942

Summer Convention
Cleveland, Ohio

June 29, 30, and July 1, 1942

capacitance and it was pointed out that a 74 per cent reduction in aluminum has already been made by the development of etching and spraying processes. Standardization of sizes, shapes, and electrical ratings would be helpful in reducing inventories.

T. S. Trzyna of Quam-Nichols Company discussed loud speakers. The construction, operating principles, and characteristics of the "Permatic" speaker were

described. A comparison was given of a 5-inch Permatic speaker and a permanent-magnet speaker of similar size. It was shown that the new speaker required, on the average, only 59 per cent of the amount of material required for the permanent-magnet speaker.

H. A. Williams of the Stackpole Carbon Company talked on iron-core tuning and powdered iron cores for radio-frequency chokes and intermediate-frequency transformers. He stated that there is not likely to be any shortage of material used in the manufacture of these items.

A paper by H. C. Forbes of the Colonial Radio Corporation on "Receiver Circuit Design" was read by H. C. Tittle of the same organization. In it, the impact of the defense activities in this country on the radio industry were outlined. Substitutes are for many materials used in radio receivers and in some cases the substitutes become unavailable and must be replaced. Tool steel and man-hours are essential if the industry is to continue and will be effective if a forecast of the forthcoming shortages proves correct.

October 10, 1941, E. H. Roy, chairman, presiding.

Chicago

"Direction Finding at Medium High Frequencies and the United Air Lines Ground-Station Direction Finder" was the subject of a paper by P. C. Sandretto, superintendent, and E. P. Buckthal, communications engineer, of United Air Lines Transport Corporation.

Mr. Sandretto introduced the subject with a description of the early long-wave direction finders used on commercial aircraft.

Fading and the deviation of waves were then discussed. The use and behavior of polarized waves were treated.

A description was given of modern aircraft direction-finding equipment. For comparison purposes, pictures of earlier equipment were shown. These included the Adcock antenna and the goniometer. Conventional spaced loops were then described.

The equipment used by the United Air Lines was then described. A double-loop antenna is employed. The operation of the system was considered and it was pointed out that no excessive horizontal errors have been found with it. Although the null indication may be obtained aurally, greater accuracy results from recording with an inked stylus. This recording permits ready detection of fading conditions.

Mr. Buckthal then described the equipment in detail. The coaxial, coplanar loop and its advantages over the Adcock loop were discussed. By employing a vertical antenna and the loop, a cardioid pattern having a sharp null is obtained.

Superheterodyne receivers using crystal filters at the intermediate frequency to obtain high selectivity are used. Additional selectivity is obtained by the use of filters in the audio-frequency section of the receiver. The detector is designed for operating a recorder. The 360 degrees are spread over approximately eleven inches of arc on the record sheet. A special rule marked in degrees differentiates effectively between null and maximum values.

At frequencies below 500 kilocycles, the accuracy of aircraft direction finding varies inversely with the distance. It departs considerably from this inverse law at higher frequencies. With the double-loop system, no error exceeding 7.5 per cent has been found.

September 19, 1941, K. E. Hassell, vice-chairman, presiding.

Cincinnati

"Sound Isolation and Acoustical Treatment of Radio Broadcast Studios" was the subject of a paper by Lon Green, Jr., president of the Acoustical Construction Corporation.

The adjustment of conditions within the studio by means of acoustical treatment was first considered. The best proportions for a studio were stated to be 2 units high, 3 units wide, and 5 units long. Good designs usually incorporate high ceilings and avoid square studios and regular, large, curved surfaces. Smaller curved surfaces are useful in some designs.

Old-style studios and their characteristics were described and compared with modern structures. Curves showing the required characteristics of studios were presented.

By combining various types of construction and acoustical treatments, almost any desired characteristic can be obtained. Low-frequency sound absorption increases as the acoustical base of the studio walls is made thicker. Practically all of the high-frequency absorption takes place at the covering material.

The isolation of outside noises and sound was then considered. Air-conditioning systems are the principal carriers of such sound. Ducts are lined with sound-absorbing material to prevent this. Elevator noises are sometimes carried through such systems.

Most studios are placed in the center of buildings to reduce street noises. Entrance to the studios is through vestibules to provide adequate isolation from outside halls.

September 29, 1941, J. M. McDonald, chairman, presiding.

Cleveland

"Amplifier Characteristics and Their Relation to the Design of Negative Feedback Systems" was the subject of a paper by F. E. Terman, president of the Institute and head of the department of electrical engineering of Stanford University.

Emphasis was placed on radio transmitters but audio-frequency amplifiers were also covered. For feedback in general, a few simple rules were stated. (1) For a large amount of amplification, make the coupling resistance about equal to the screen-grid resistance. (2) For high output voltage, the screen-grid resistor should be about 0.1 to 0.2 of the value of the grid-leak resistor. (3) Resonance, in general will give 180-degree phase shift. (4) Resistance and capacitance will give a 90-degree phase shift. For transmitter work, it should be remembered that the sidebands are shifted from the carrier.

It was stated that when feedback is applied to more than one or two stages, considerable difficulty may be encountered.

A high slope in the transmission characteristic gives a large phase shift. If the slope is not too abrupt, an estimate can be made of the phase shift at a desired frequency. The maximum permissible rate of cutoff in a feedback amplifier is about 10 decibels per octave. If transmission is to include frequencies up to 10 kilocycles, control of frequencies up to 100 kilocycles must be provided and if the transmission is to extend down to 100 cycles, the control must be effective to 7 cycles, in a typical case.

Though consideration was given to the problem of phase shifts, the final discussion concerned only the magnitudes of amplification, feedback, and attenuation in the control of undesired frequencies. It was pointed out that for practical purposes, phase shift need not be considered.

September 17, 1941, Carl E. Smith, chairman, presiding.

Connecticut Valley

A. B. Chamberlain, chief engineer of the Columbia Broadcasting System, presented a paper on "C. B. S. International Facilities."

An outline of the developments in high-frequency broadcasting was first presented. International transmissions from the United States are now on a commercial basis.

The Columbia Broadcasting System is affiliated with 60 stations in Central and South America and has contracted for rebroadcasting of its programs on 29 high frequencies and by 34 transmitters utilizing the regular broadcast band.

The new international high-frequency transmitters are located at Brentwood, Long Island, New York. The programs will originate in some 30 studios in New York City and will be transmitted to Brentwood over 3 frequency-modulated transmitters operating at 330 megacycles.

The transmitting plan consists of 3 exciters and 3 power amplifiers of 50 kilowatts output each. An exciter may be connected to any of the amplifiers. Two high-level modulator units which utilize high-frequency pre-emphasis, are provided. There are 2 rectifier units for supplying power to the amplifiers.

With 2 channels operating simultaneously, an exciter and power amplifier are available for emergency purposes. Instantaneous change-over from one frequency to another in the band from 6 to 22 megacycles is also possible. The output on each channel will be 50 kilowatts at 100 per cent modulation in the range specified above and with an audio-frequency range having variations not greater than 0.5 decibel between 40 and 10,000 cycles.

By means of 39 switches, the power amplifiers may be connected to any of 13 antennas. Some of the antenna arrays are arranged for simultaneous operation at two frequencies.

South America is served by 8 of the antennas and the remaining 5 are used for Central America, Mexico, and Europe. By reversing the functions of the reflectors and radiators, an antenna can be made to operate in either direction. Field-strength measurements at distant points are used to establish the gain of the antennas in relation to radiation from a half-wave dipole.

September 18, 1941, F. G. Weber, chairman-elect, presiding.

Emporium

L. M. Clement, director of engineering and research of the Crosley Corporation, presented a paper on "Engineering Organization with Particular Reference to National Defense."

The general principles of an engineering organization were considered. The analysis was made from the standpoint of the product manufactured by the company and its methods of doing business. The engineering department should be engaged in research, in the development of uses for the company's products, and in the development of new devices for manufacture. It should work with the sales de-

partment so that a marketable product will result from its development and research programs. The problems of customers should be considered as well as the improvement of the existing products.

Standardization, cost reduction, and the development of future products must also be considered. At all times the engineering department must be co-ordinated with the activities of the sales, product-engineering, manufacturing, and other departments.

The organization of the Crosley Corporation and its engineering department were described in detail. The paper was closed with an outline of the course taken in putting a new model into production.

October 2, 1941, R. K. Gessford, chairman, presiding.

Indianapolis

J. M. Whitmore, electronics engineer of Allison engineering division of the General Motors Corporation, presented a paper on "Electronics Measurements in Aircraft-Engine Manufacture."

Just prior to the presentation of the paper, C. G. Cooke, assistant to Mr. Whitmore, presented a sound motion picture entitled "General Motors in Aviation" which showed the production and testing of Allison engines.

The paper covered a discussion of measurements of linear and torsional vibration, dynamic cylinder pressures, and sound. The design of the pickup devices used in making these measurements was described.

September 26, 1941, S. E. Benson, vice-chairman, presiding.

Kansas City

"Design Considerations of Ultra-High-Frequency Aircraft Equipment" was the subject of a paper by J. H. Gardner, chief engineer of the Wilcox Electric Company.

In introducing the subject, it was pointed out that ultra-high-frequency operation was stimulated by the crowded condition of the lower-frequency bands and the relative freedom from noise which the higher frequencies provide.

The government has allocated 6 frequencies in the 130-megacycle band and 25 frequencies in the 140-megacycle band for aeronautical purposes. One channel in the 130-megacycle band is reserved for reception by the pilot and is used by the control towers at airports. The 140-megacycle band is reserved for company two-way communication.

The design of a 10-frequency receiver and a 4-frequency transmitter was then described. The receiver has a sensitivity between 5 and 10 microvolts per meter for a 50-milliwatt output. The transmitter has a 50-watt output with instantaneous selection of any one of 4 frequencies and a frequency tolerance of 0.01 per cent.

In the receivers, spot tuning is provided by means of crystal oscillators, harmonics of which are injected into the cathode circuit for mixing. An intermediate frequency of approximately 6325 kilocycles provides a high image rejection.

Diode detection and a direct-current amplifier are used to provide adequate automatic volume control.

The transmitter uses the new RCA 29 twin tetrode, which requires small driving power and is strong mechanically. The tank circuits are of the conventional coil-and-condenser type. Two antennas are used.

October 2, 1941, Harner Selvidge, chairman, presiding.

As a result of the resignation of Chairman Selvidge, who has moved from the territory of the Kansas City Section, H. K. Morgan, superintendent of communications of Transcontinental and Western Air, Incorporated, was named chairman and C. N. Kimball, chief engineer of Aircraft Accessories, was designated vice-chairman. G. L. Taylor, Midland Radio and Television, Incorporated, continues as secretary-treasurer.

Montreal

An inspection trip was taken to Station CBJ at Vercheres and to the Montreal studios of the Canadian Broadcasting Corporation.

The station engineers and representatives of the companies who constructed the various transmitters acted as guides at the station. A 50-kilowatt high-efficiency broadcast transmitter and a 7.5-kilowatt high-frequency transmitter were inspected. Both vertical radiators and rhombic antennas are used at the station.

After the inspection, the Montreal studios were visited and a short business meeting was held.

The existing officers were re-elected and are E. A. Laport, manager of the engineering and development laboratory of RCA Victor Company (Montreal), as chairman; R. E. Hammond, sales manager for the Northern Electric Company, as vice-chairman; and W. A. Nichols, assistant to the design and construction engineer of the Canadian Broadcasting Corporation, secretary-treasurer.

May 7, 1941, J. A. Ouimet, presiding.

San Francisco

"Modern Marine Communication Equipment" was presented by J. F. McDonald, engineer of the Radiomarine Corporation of America.

A general summary of ship radio installations required by the Communications Act of 1934, as amended, was presented. Various types of equipment developed to meet the legal requirements and to give ship-to-shore voice communication were then described. The equipment included radiotelegraph transmitters, voice-modulated transmitters, portable units, lifeboat sets, the "automatic alarm," direction finders, receivers, and coastal-harbor installations.

In the radiotelephone communication system, privacy is obtained by speech inversion. Operation is automatic by means of voice-controlled relay circuits.

The radiotelephone installation on the *America* was described. The use of iron

cores for inductance tuning was discussed in detail.

After the paper, an inspection tour was made of the radio installation aboard the *Lurline*.

October 1, 1941, L. J. Black, chairman, presiding.

Twin Cities

"The Use of Radio in Modern Air Transports" was the subject of the paper by M. E. Knox, supervisor of aircraft radio of Northwest Airlines, Incorporated.

The special requirements for aircraft radio equipment were first outlined. A description was then given of the radio installation of a Douglas DC-3, 21-passenger plane. The communications receiver is a 10-tube superheterodyne using a crystal-controlled oscillator, with fixed tuning at 8 different frequencies. A radio-range receiver covering the band from 200 to 400 kilocycles uses the superheterodyne circuit and 8 tubes. Two additional receivers provide automatic direction finding and a marker-beacon service at 75 megacycles. The 100-watt transmitter uses electrical band-shift for operation on any of 8 frequencies. A dynamotor power-supply unit provides plate voltage for both the transmitter and the receivers. Power requirements are about 1200 watts. The total weight of the equipment is approximately 340 pounds. The communications receiver and the transmitter were available for inspection.

An antistatic cartridge was displayed. This device permits static charges built up on the body of the plane to be discharged into the air at the tail of the plane through a 5-foot flexible resistor and a thin wire.

The paper was closed with a discussion of the organization of the communications department responsible for radio operations between Chicago and Seattle for Northwest Airlines, Incorporated.

"Telephone Facilities for Radio Broadcasting" was the subject of a paper by H. C. Hawkins, transmission and protection engineer of the Northwestern Bell Telephone Company.

A general outline was presented of the part played by the telephone organization in furnishing program circuits to the radio broadcasting station. The assigning of cables, conductors, and terminals and their connection to establish completed circuits were discussed. The checking for continuity, balance, cross talk, and noise was then considered. Methods of labeling circuits to avoid interruptions or interference with the programs were outlined.

Consideration was given to the requirements for circuits which will presumably be needed for frequency modulation and television.

A discussion was presented of circuits involving both local and toll facilities and the influence of the grade of service, price, and the availability and duration of use of lines. The loading of circuits was discussed in detail.

The paper was closed with a general résumé of the services provided by the

telephone companies for telegraph, carrier current, and other purposes. The use of phantom circuits was described briefly.

October 15, 1941, H. R. Skifter, vice-chairman, presiding.

Washington

R. F. Guy, radio facilities engineer of the National Broadcasting Company, presented a paper on "NBC's International Broadcasting Facilities."

There was first presented a short history of the early international transmissions. Some of the early transmitters were described and contrasted with the modern equipment now in use. Information was given on the population, percentages of radio receivers, and listening habits of the various South American countries. Recordings were presented of noise and the signal intensities of American, English, and German high-frequency transmissions in South America. The signal intensities from the three countries are about equal.

A description of the steerable antennas located at Bound Brook, New Jersey, was given. Their characteristics were shown.

The synchronous operation of two transmitters to produce an output of 100 kilowatts was discussed.

An outline was given of methods used to provide service to particular sections of Central and South America with respect to the language used in these regions.

The paper was concluded with a discussion of the international network of 92 Latin American stations which has been developed by the National Broadcasting Company. A description was given of the New York and Hollywood high-frequency listening posts.

October 13, 1941, E. M. Webster, vice-chairman, presiding.

Books

Radio-Frequency Measurements by Bridge and Resonance Methods, by L. Harts-horn

Published by John Wiley and Sons, Inc., 440 Fourth Avenue, New York, N. Y. 265+xiii pages. 99 figures. 6"×8½". Price \$4.50.

As stated by the author, the purpose of this book is to present, "not an encyclopaedic account of everything that has been written on the subject, but a systematic account of the basic principles and general working ideas, that form the tools of the practising technician." The book fulfills this aim admirably, comprising, as it does, the theory, technique, and concepts that combine to give the necessary "feel" for impedance measurements at high frequencies.

The author follows an orderly approach in his treatment of the subject. Part I contains, first, a discussion of impedance

and admittance, with an exposition of the mathematical and physical relationships that make it desirable to consider certain elements and circuits as series impedances and others as parallel admittances. This is followed by basic analyses of resonance methods, both series and parallel, and of radio-frequency bridge methods. Part II contains a description of generators and detectors and a detailed account of standard capacitors, resistors, and inductors, with the residual parameters that cause departure from idealized behavior. Part III is devoted to a treatment of the measurement of specific quantities by the methods developed in Part I, with equipment composed of the apparatus analyzed in Part II, with an additional chapter on transmission-line methods for very short waves.

In a book developed in this way, it is inevitable that predilections of the author should be evident. In the main, however, exceptions can be taken only on matters of opinion and not matters of fact, with the burden of proof upon the reader in these matters. It is, for instance, the author's opinion that "it would be difficult and probably misleading to assign the methods to individual authors. They have been gradually evolved as the work of many investigators, and when references to original papers are quoted, they are to be regarded merely as examples, selected as convenient sources of further information on special points." The following of this philosophy has led to a rather brief bibliography, containing only thirteen references and a quotation from Hilaire Belloc's "Hills and the Sea"—"Read less, good people, and observe more; and above all, leave us in peace."

The material dealing with generators and detectors is rather general in form and might, with profit, be made more specific. Particularly to be noted is the omission of any discussion of frequency limitations of thermionic voltmeters caused by resonance and by finite electron transit time.

In all important respects, however, the material is complete and concise and the book should be of great value to anyone interested in accurate impedance measurements at high frequencies.

D. B. SINCLAIR
General Radio Company
Cambridge, Massachusetts

Radio Engineering Handbook (Third Edition), edited by Keith Henney

Published by McGraw-Hill Book Company, 330 West 42nd Street, New York, N. Y. 928+x pages+17-page index. 835 figures. 4½"×7¼". Price, \$5.00.

In the third edition of the "Radio Engineering Handbook," a number of changes are noted. Six of the sections have new authors which present a somewhat different point of view or at least a change of emphasis. These sections and two others have been completely rewritten and in most cases the amount of material con-

siderably increased. Power-supply systems, high-frequency transmission and reception, loudspeakers and room acoustics have been increased about 70 per cent and television over 200 per cent. This has made possible the inclusion of a considerable amount of recent data, characteristics, and other information. In several of the other sections the material has been rearranged and some of a historical nature has been eliminated to make room for that which is more useful to the practicing engineer.

A short but useful table of exponential and hyperbolic functions has been included. Tables IV and V, on pages 195 and 196, giving the approximate constants of rectifier instruments will be particularly useful. Another useful table on Attenuators for VU Meters is on page 198.

The value of a handbook is determined by the extent to which it supplies the information sought. In this respect the one under review has been subjected to several random tests and has received a high rating. The index is not as complete as users would desire, they seldom are. For example, high-frequency ammeters are not to be found under high-frequency or ammeter or measurements, but under meters and electrical measurements. Under the letter I, the first three items alphabetically speaking are well down the list and might be missed completely. In a few other cases, they are slightly out of order. One is rather surprised to find no mention of relays in the index and equally surprised to find La Guardia Field included. On page 34, under alternating current, the indiscriminate use of capital letters for instantaneous values and lower case for effective or maximum values is not in accordance with standard practice. On page 71, one finds an error carried over from the second edition, $e = -d\phi/dt$ (without restriction) instead of $e = -n d\phi/dt$. These are minor criticisms. The handbook should be in the hands of every radio engineer.

H. M. TURNER
Yale University
New Haven, Connecticut

Six-Place Tables, by Edward S. Allen

Published by McGraw-Hill Book Company, Inc., 330 West 42nd Street, New York, N. Y. 181+xxiii pages. 7"×4½". Price \$1.50.

This is a handy pocket-size edition of the more frequently used mathematical tables and functions. Its usefulness is increased by the provision of an ingenious indexing system which permits the user to turn instantly to the desired tables. Six-place tables of both natural trigonometric functions and their logarithms are provided as in previous editions. Appearing for the first time are a four-place table of trigonometric functions and their logarithms for radian arguments from 0 to 3.20, a table of common logarithms of factorials from 1 to 100, and a brief table of two elliptical integrals.

The title of the radians and degrees

conversion tables "Corresponding values of degrees, minutes, seconds, radians and hundredths of degrees" appears to be a misnomer. More appropriate would be a title such as "Corresponding values of radians and of degrees, minutes, seconds and their decimal equivalents."

E. W. ALLEN, JR.
Federal Communications Commission
Washington, D. C.

Radio at Ultra-High Frequencies, Part I

Published by RCA Institutes Technical Press, 75 Varick Street, New York, N. Y. 448+vi pages. 284 figures. 6"×9". Price, \$1.00.

This book contains a group of papers by RCA engineers on propagation, transmission, reception, relaying and measurements involving frequencies above 30 megacycles. The papers presented in full have been selected according to a subject-classification plan; space limitations required the publication of correlated material in summary form. Both of these groups are divided arbitrarily in two parts, first, those papers dealing with frequencies below 300 megacycles, and, second, those papers involving frequencies above 300 megacycles. While the majority of the papers are reprinted from various sources,

such as the PROCEEDINGS of the I.R.E., *RCA Review*, *Electronics*, and others, a few original papers are included.

Of the papers given in full in the first group for frequencies below 300 megacycles, the first section on transmitting methods and equipment covers wide-band and directive antenna systems, with particular reference to television, frequency control of transmitters, a cathode-ray frequency-modulation generator, and a discussion on carrier and side-frequency relationships in multitone frequency or phase modulation.

The second section, on propagation and relaying, includes a study of ultra-high-frequency wide-band propagation characteristics, propagation, noise and service characteristics of frequency-modulated transmissions, and descriptions of equipment in ultra-high-frequency relaying. Bibliographies of 48 papers on these subjects are included in this section.

The third section on measurements includes descriptions of wide-band variable-frequency testing transmitter and field-strength-measurement equipment, and papers on a method of measuring impedance at ultra-high-frequencies and a survey of the broad field of such measurements. A bibliography of 25 papers on these subjects is included.

In the fourth section, on reception, papers on vacuum tubes of small dimensions and on antenna and receiver input circuits are given. Few references are given, but one is to a paper including a

rather extensive bibliography on ultra-high-frequency transmitting and receiving circuit technique.

The second group of papers, given in full for frequencies above 300 megacycles, includes one on magnetron oscillators for frequencies between 300 and 600 megacycles, one on an ultra-high-frequency power amplifier, one on transmitters, and one on transmission of 9-centimeter waves. Thirty-four bibliographical references are included.

In summary form there are respectively five, five, four, twelve, and five papers in the categories outlined above. The summaries are sufficiently complete to give a good idea of the subject matter. The medium of publication is given in all cases.

For those whose work lies in these fields, this book should be a most useful basic reference, particularly since the detailed material is drawn from several sources making direct reference to the original publications somewhat inconvenient. An important and useful feature is the rather extensive bibliography including references to other similar bibliographies. The rapid expansion of and developments in the ultra-high-frequency field may make the detailed descriptions of equipment somewhat obsolete, but will not impair the value of the more fundamental material.

J. K. CLAPP
General Radio Company
Cambridge, Massachusetts

Contributors

W. Lindsay Black (M '36) was born on February 8, 1900, at Asbury Park, New Jersey. He was graduated from Pace Institute of Accountancy and Business Administration in 1936. From 1918 to



W. LINDSAY BLACK

1925, Mr. Black was in the engineering department of the Western Electric Company. Since 1925 he has been in the radio

development department (later commercial products development department) of the Bell Telephone Laboratories, where he has been engaged in the development and installation of audio amplifiers, carrier telephony, public-address systems, power-line carriers systems, radio transmitters, and, since 1927, speech input equipment for radio broadcasting and audio-frequency equipment for other applications. He is a member of the Acoustical Society of America, and the American Institute of Electrical Engineers.



C. Irving Bradford (A '37) was born in Newport, New Jersey, on September 5, 1909. He was graduated from Bliss Electrical School in 1929 and served as a technical assistant in the Bell Telephone Laboratories from 1929 to 1930. He received the B.S. degree in electrical engineering from Rutgers University in 1933 and then spent a year at The Ohio State University on a Coffin Research Fellowship, receiving his M.S. degree in 1934. Mr. Bradford then spent three years with Westinghouse as an electronic tube development engineer. Since that time he has

been a member of the research staff of the Remington Arms Company in Bridgeport, Connecticut, and has been engaged in electronic-tube application work. He is the secretary-treasurer of the Connecticut



C. IRVING BRADFORD

Valley section of the Institute of Radio Engineers.

W. Robert Ferris was born at Terre Haute, Indiana, on May 14, 1904. He received the B.S. degree from Rose Polytechnic Institute in 1927 and the M.S. degree from Union College in 1932. Mr. Ferris was in the research laboratory of the General Electric Company from 1927 to 1930; since that date he has been a



W. ROBERT FERRIS

member of the research laboratories, RCA Radiotron Division, of the RCA Manufacturing Company, Inc.



Louis Malter (A '27) received his B.S. degree from the College of the City of New York in 1926 and his M.A. and Ph.D. degrees from Cornell in 1931 and



LOUIS MALTER

1936, respectively. He taught physics at C.C.N.Y. from 1926 to 1928. He was with the acoustic research division of the RCA Manufacturing Co., Inc., from 1928 to 1930 and during the summer of 1931.

From 1933 to 1936 he was in the electronics research division of the RCA Manufacturing Company, Camden, N. J.; from 1936 to 1938 in the high-vacuum section, and from 1938 to date in the research laboratories of the RCA Manufacturing Company at Harrison. Dr. Malter is a member of the American Physical Society and Sigma Xi.



N. C. Norman joined the research department of the Bell Telephone Laboratories immediately after being graduated from Indiana University in 1925 with the B.A. degree in physics. He continued the study of physics on a part-time basis at Columbia University, receiving the M.A. degree in physics in 1928. His work at the Bell Telephone Laboratories has been



N. C. NORMAN

mainly in the field of voice-operated devices as applied to long cable circuits, the transatlantic radiotelephone facilities, and ship-to-shore radio circuits. Contributions made in these arts include the Compandor and the radio noise reducer, devices which have lessened the effects of static on radiotelephone facilities. Recently, Mr. Norman's work has been centered in the development of speech input equipment for broadcast stations.



Browder J. Thompson (A '29-M '32-F '38) received the B.S. degree in electrical engineering from the University of Washington (Seattle) in 1925. He entered the research laboratory of the General Electric Company in 1926, working on vacuum-tube research and development problems. In 1931 Mr. Thompson transferred to the

RCA Radiotron Company in Harrison, New Jersey, in charge of the electrical research section of the research and development laboratory. In 1940 he was appointed associate director of the research laboratories of the RCA Manufacturing Company, Inc. He is a Member of the American Physical Society.



BROWDER J. THOMPSON



Herbert M. Wagner (S '32-A '34-M '40) was born at Boston, Massachusetts, in 1910. He received the B.S. degree from the Massachusetts Institute of Technology in 1932 and the M.S. degree in 1933. During 1933 he was a staff member of the M.I.T. electrical engineering department. Since 1934, Mr. Wagner has been associated



HERBERT M. WAGNER

with the research laboratories of the RCA Manufacturing Company, Inc., Harrison, New Jersey. He is an Associate member of the American Institute of Electrical Engineers.

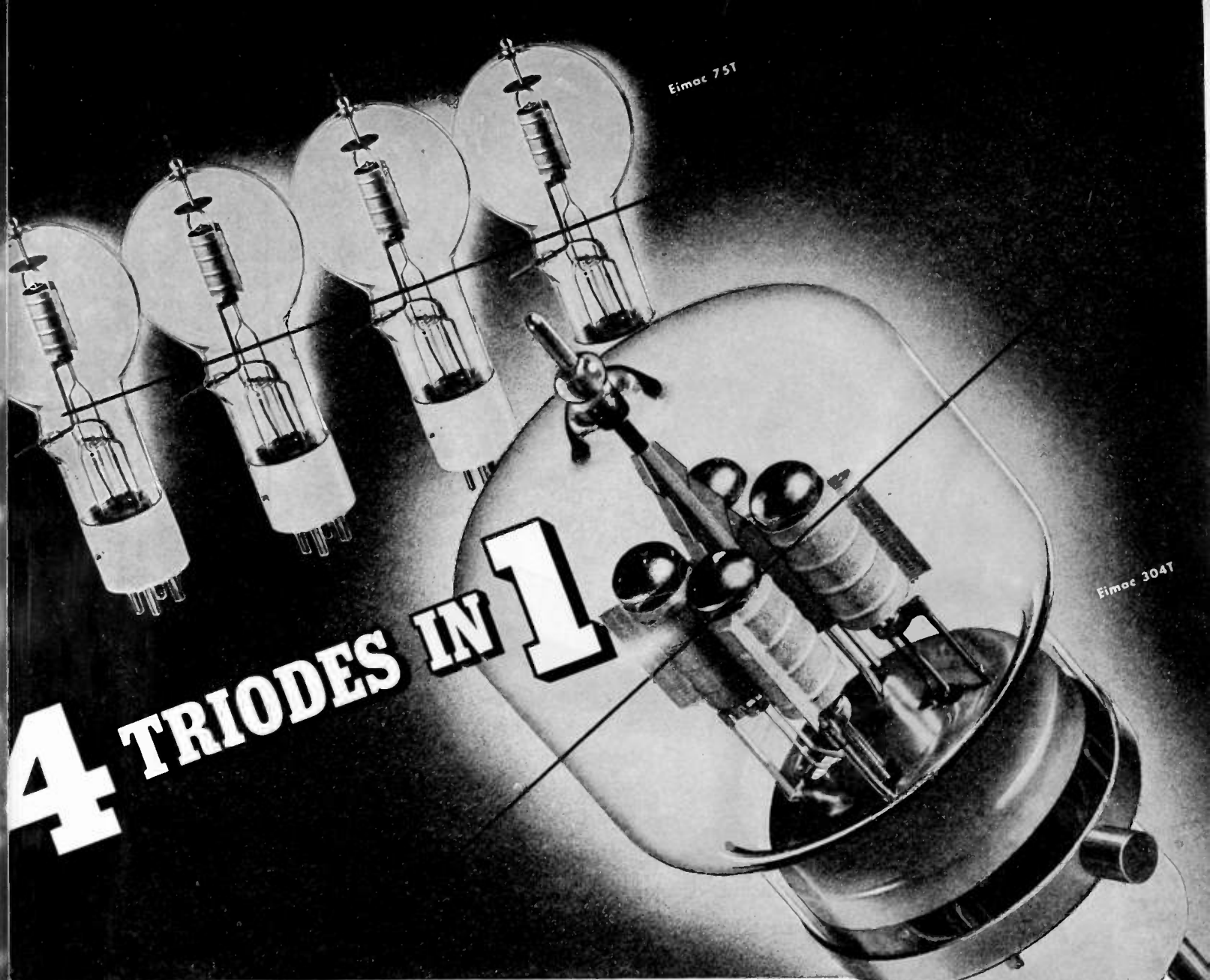

4 TRIODES IN 1

LOW VOLTAGE TUBE...LOW INTERNAL RESISTANCE with a 10 to 1 safety factor

More than a year ago, Eimac announced these Multi-Unit tubes to the industry under the statement "A Revolutionary Change in Vacuum Tube Design." They were developed in the Eimac laboratories for the precise purpose of providing a high power, low voltage (1000 to 2500 volts) tube having an extremely low internal resistance which would operate efficiently up to 200 megacycles. In actual operation Eimac 304T tubes are seeing service with as much as 20,000 volts on the plates...10 times the rated voltage. Where else is there a tube offering such a safety factor? It's just typical of Eimac's leadership... another reason why Eimac tubes are to be found in the key sockets of most of the important radio transmitters throughout the world.

FOLLOW THE LEADERS TO

Eimac
TUBES

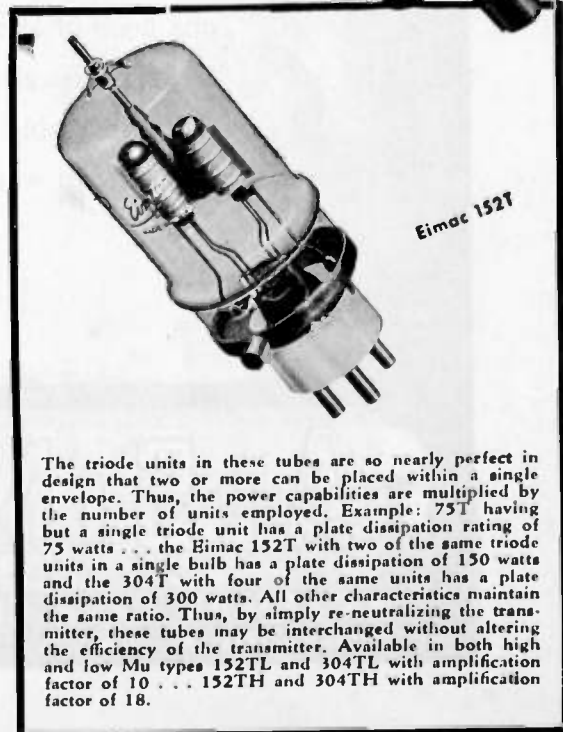

The triode units in these tubes are so nearly perfect in design that two or more can be placed within a single envelope. Thus, the power capabilities are multiplied by the number of units employed. Example: 75T having but a single triode unit has a plate dissipation rating of 75 watts... the Eimac 152T with two of the same triode units in a single bulb has a plate dissipation of 150 watts and the 304T with four of the same units has a plate dissipation of 300 watts. All other characteristics maintain the same ratio. Thus, by simply re-neutralizing the transmitter, these tubes may be interchanged without altering the efficiency of the transmitter. Available in both high and low Mu types 152TL and 304TL with amplification factor of 10... 152TH and 304TH with amplification factor of 18.

Export Agents: FRAZAR & CO., LTD
301 Clay Street, San Francisco, Calif.

Eitel-McCullough, Inc., San Bruno, California

Members of
THE INSTITUTE OF RADIO ENGINEERS
are invited to use
the Services of
THE RESEARCH STAFF
AMERICAN LAVA CORPORATION
CHATTANOOGA, TENNESSEE

THE cornerstone of this organization is a policy of continued improvement through research and development. The Engineering and Production Staffs of American Lava Corporation contain representatives of many of the leading technical institutions of this country. It is typical of this organization that it was the first to meet Specification G of the U. S. Army and Navy on a commercial basis. Four completely equipped new laboratories sweep across one floor of American Lava Corporation's new plant. These four laboratories, electrical, chemical, mechanical and ceramic, are in charge of men whose skill is favorably known to leading engineers in this country and abroad. They are ready to work for you on any problem involving technical ceramics.

★ *39th Year of Ceramic Leadership* ★

ALSiMAG

Trade Mark Reg. U. S. Pat. Off.

FROM CERAMIC HEADQUARTERS

AMERICAN LAVA CORPORATION • CHATTANOOGA • TENNESSEE
CHICAGO • CLEVELAND • NEW YORK • ST. LOUIS • LOS ANGELES • SAN FRANCISCO • BOSTON • PHILADELPHIA • WASHINGTON, D. C.

OIL-FILLED CAPACITORS

with a Choice
of Mountings

● Hyvol Type .09 oil-impregnated oil-filled units have exceptionally compact dimensions for given capacity and working voltages. Widely used for heavy-duty continuous-service applications in transmitters, public-address amplifiers, laboratory power packs, etc. A special Aerovox-developed totally immersion-proof terminal, ideal for use in marine radio equipment or in the presence of salt air, is standard in this type capacitor.

Also note the adjustable mounting bracket providing for universal mounting. Capacitor may be mounted at any height above or below chassis, with terminals at top or bottom, as desired. Side clamps with spade-lug or hole-mounting, or permanent immovable mounting feet or flanges, are also available in certain sized units.

● Keep Up-to-Date . . .



● Many revised pages have just been issued for the Aerovox Transmitter Capacitor Catalog. If you are engaged in commercial or professional radio work, write on business letterhead for a copy right up-to-date. New pages are sent to registered catalog holders from time to time, as issued.



NEW BEDFORD, MASS.,
U. S. A.
Sales Offices in All
Principal Cities

AEROVOX

CORPORATION

In Canada
AEROVOX CANADA LTD.
Hamilton, Ont.
EXPORT: 100 Varick St., N. Y.
Cable 'ARLAB'

Wherever Performance
Is Of Prime Importance

DAVEN ATTENUATORS

The DAVEN catalog lists the most complete line of precision attenuators in the world; "Ladder," "T" type, "Balanced H" and Potentiometer networks—both variable and fixed types—employed extensively in control positions of high quality program distribution systems and as laboratory standards of attenuation.

Due to the specialized nature of high fidelity audio equipment, a large number of requirements are encountered where stock units may not be suitable. If you have such a problem, write to our engineering department.

Special heavy duty type switches, both for program switching and industrial applications are available upon request. These switches employ the same type of high quality materials and workmanship as supplied in Daven attenuators.

Super DAVOHM resistors are precision type, wire-wound units of from 1% to 0.1% accuracy.

To insure precise quality and rugged dependability in your speech input or special laboratory equipment, specify DAVEN components.

THE DAVEN COMPANY
158 SUMMIT STREET • NEWARK, NEW JERSEY

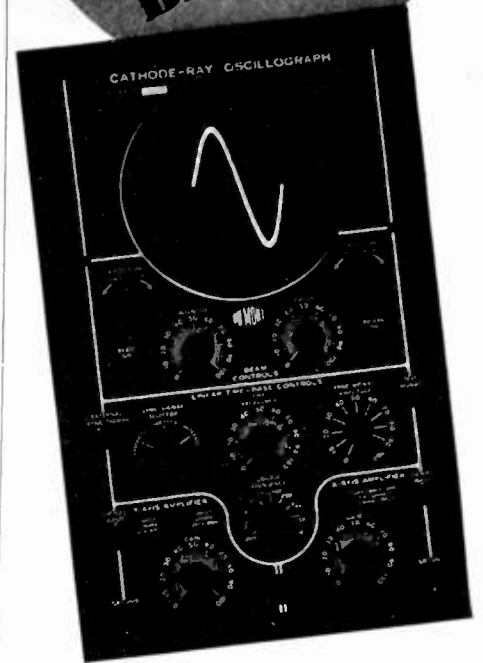
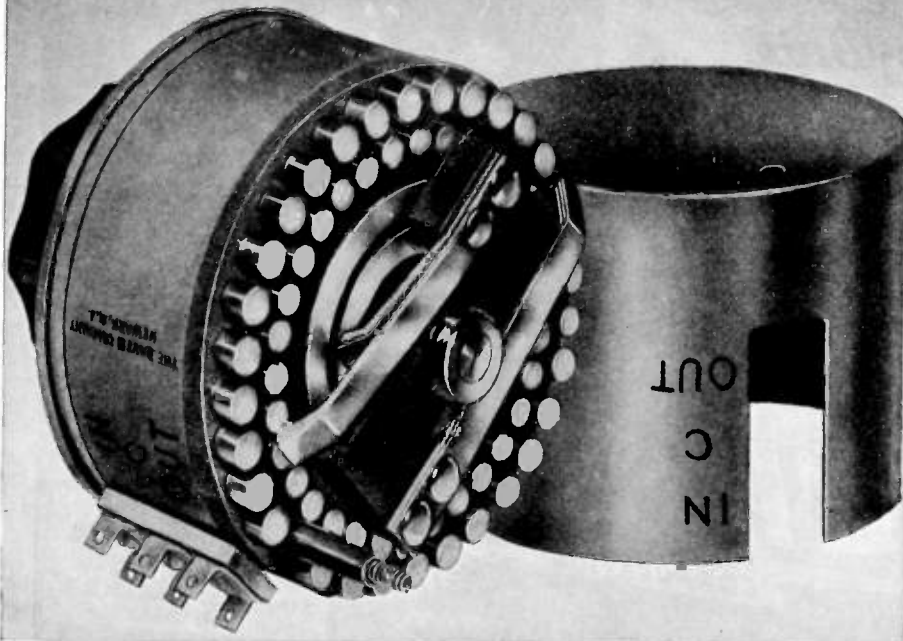

★ Here's an unretouched photo made in pitch blackness of the new *Blackout Panel* now available with the DuMont Type 208 Oscilloscope.

For the first time you are offered an oscilloscope with self-illuminated panel that can be used with equal ease in darkness or in full light. There are times when such an instrument must be used under adverse lighting conditions—or even with no light at all, in which case the *Blackout Panel* is indispensable.

The specially-processed steel panel is treated with luminous paint that retains its maximum luminosity for several minutes after exposure to ordinary light, and can be observed for an hour or more after that. It can be kept activated by ultra-violet light. The *Blackout Panel* is now an optional feature with the DuMont Type 208 Oscilloscope, providing still another refinement in this outstanding general-purpose instrument.

Write for Literature . . .

DU MONT

ALLEN B. DU MONT
LABORATORIES, Inc.

Passaic ★ New Jersey

Cable Address: Wesplexin, New York

**Now
Available
in
THREE
TYPES!**

G · A · W



**CARBONYL
IRON
POWDER**

★ **FOR HIGH EFFECTIVE
PERMEABILITY**

★ **FOR HIGHEST Q VALUE**

THREE types of G.A.W. Carbonyl Iron Powder are now in production. Cores made from these powders are providing a degree of performance that establishes a new high standard in carrier and radio frequency service. ★ For all grades the average particle size is less than 5 microns. Note the spheroidal particle, a characteristic unique with G.A.W. Carbonyl Iron Powder.

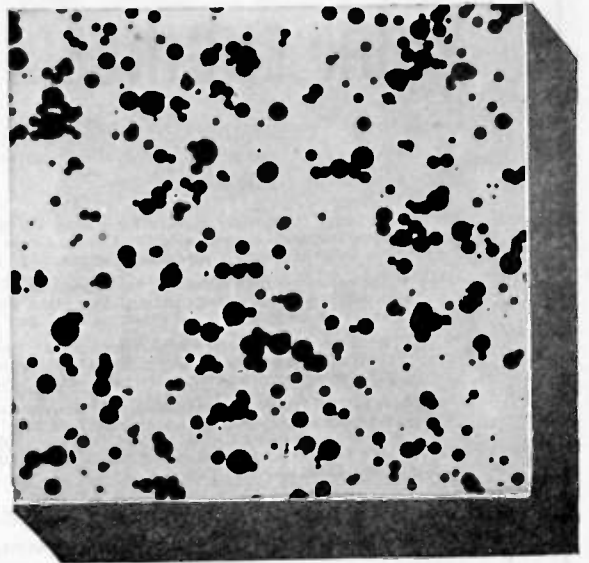

MAGNIFICATION 400 X

FOR INFORMATION ADDRESS THE MANUFACTURER
GENERAL ANILINE WORKS
435 HUDSON STREET NEW YORK CITY

OR THE DISTRIBUTOR

ADVANCE SOLVENTS & CHEMICAL CORPORATION
245 FIFTH AVENUE NEW YORK CITY

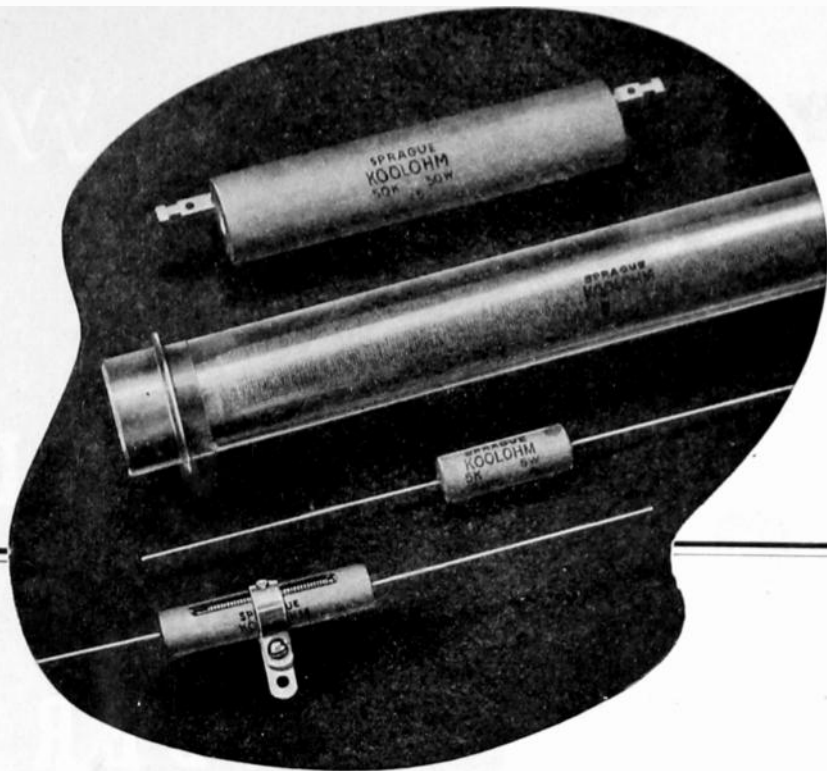

DON'T LET RESISTORS CRAMP YOUR ENGINEERING STYLE

FOR several years Sprague Koolohm resistors have been doing the jobs "that couldn't be done." A few of the outstanding recent applications of these remarkable resistors follow:

- A radio transmitter manufacturer used the simplified and completely ceramic insulated mounting features of Koolohms to reduce size and weight of his unit—and met a previously "impossible" specification.
- The extremely high resistance values available in small Koolohm sizes with high wattage and voltage ratings permitted an instrument manufacturer to redesign his products for great material and cost savings.
- Another manufacturer increased efficiency and lowered costs when we proved that one close tolerance Koolohm of special design would replace eight conventional resistors previously used in his product.
- A user of Precision Meter Multiplier Resistors was pleasantly surprised to find that Koolohm multipliers are rated at 150° C., eliminated the need for special mounting locations, and that 4 megohms could be obtained in a unit 5-5/16" long, completely sealed to withstand even salt water immersion tests.

And so on, in one tough application after another we can almost guarantee that Koolohms will solve your resistor problems. Your inquiry will bring an engineering catalog, samples and complete engineering consultation.



WOUND WITH CERAMIC-INSULATED WIRE . . .
 . . . that is 1000° C. heat-proof and moisture-proof and which affords ample high-voltage insulation. Layer or interleaved windings permit important construction advantages.

SPRAGUE SPECIALTIES CO., RESISTOR DIVISION
 North Adams, Mass.

SPRAGUE KOOLOHMS

Totally Different

Outstandingly Superior

POSITIONS OPEN

The following positions of interest to I.R.E. members have been reported as open on November 1. Make your application in writing and address to the company mentioned or to
 Box No.

PROCEEDINGS of the I.R.E.
 330 West 42nd Street, New York, N.Y.

MANUFACTURING ENGINEER

A prominent and successful midwestern manufacturer in the radio field wants a man with first-hand knowledge of production methods who is capable of assuming major management responsibilities. Detailed specifications available on request. Box 254.

ELECTRICAL ENGINEER

Electrical engineer with good physics background for developmental work wanted by an established eastern manufacturer. Experience with the development of transmitting and measuring equipment desirable. State qualifications and salary desired. Box 255.

TRANSFORMER DESIGNER RADIO ENGINEER

(1) *Audio transformer designer* should have education and experience necessary to establish basic designs and supervise production engineering on both "voice" and "control" applications. Work will be on national defense projects and expanded commercial products after present emergency.

(2) Interesting work on national defense project for a technically trained *radio engineer* having experience in the design and operation of ultra-high-frequency radio apparatus.

Write giving education and experience. All communications will be treated confidentially. Raytheon Manufacturing Co., 190 Willow St., Waltham, Mass.

AUDIO AND ELECTRONIC ENGINEERS

Permanent position and opportunity for development and original work with established company doing national business in audio specialty field.

(1) *Senior engineer* required. Salary \$4,000 to \$6,000 per year with bonus and advancement opportunities. Requirements: electrical engineering degree and considerable audio and electrical experience in design, development.

(2) *Junior engineer*, salary \$200 to \$300 monthly with bonus. Must be graduate electrical engineer with some experience in electronics.

State qualifications: academic, graduate, employment, experience in design, development, and production and any patents in audio and electronic fields. Also give any experience in production and supervision, acoustics, speakers and reproducers, tool and die design, plastics, etc. All replies strictly confidential. Employment to begin January 1st. Box 256.

ELECTRICAL ENGINEER

Young engineer who has specialized on communications wanted for development work with established manufacturer of radio components. Experience desirable but not necessary. Describe training, experience, and aptitudes and state salary desired. Box 257.

POWER TUBE SPECIALISTS

We have openings for the following men: (1) *Electronic Research Engineers* having experience on design of magnetrons and velocity modulation tubes and associated circuits; (2) *Vacuum-Tube Development Engineers* having experience on design and manufacture of high-power transmitter tubes; (3) *Mechanic* with experience on assembly of high-power tubes, spot and arc-welding operations. Apply International Telephone & Radio Laboratories, 67 Broad St., New York, N.Y.



Attention Employers . . .

Announcements for "Positions Open" are accepted without charge from employers offering salaried employment of engineering grade to I.R.E. members. Please supply complete information and indicate which details should be treated as confidential. Address: "POSITIONS OPEN," Institute of Radio Engineers, 330 West 42nd Street, New York, N.Y.

The Institute reserves the right to refuse any announcement without giving a reason for the refusal.

ISOLANTITE UNDERTAKES EXPANSION PROGRAM TO RAISE ITS CERAMIC OUTPUT TO TEN TIMES THE VOLUME OF A YEAR AGO

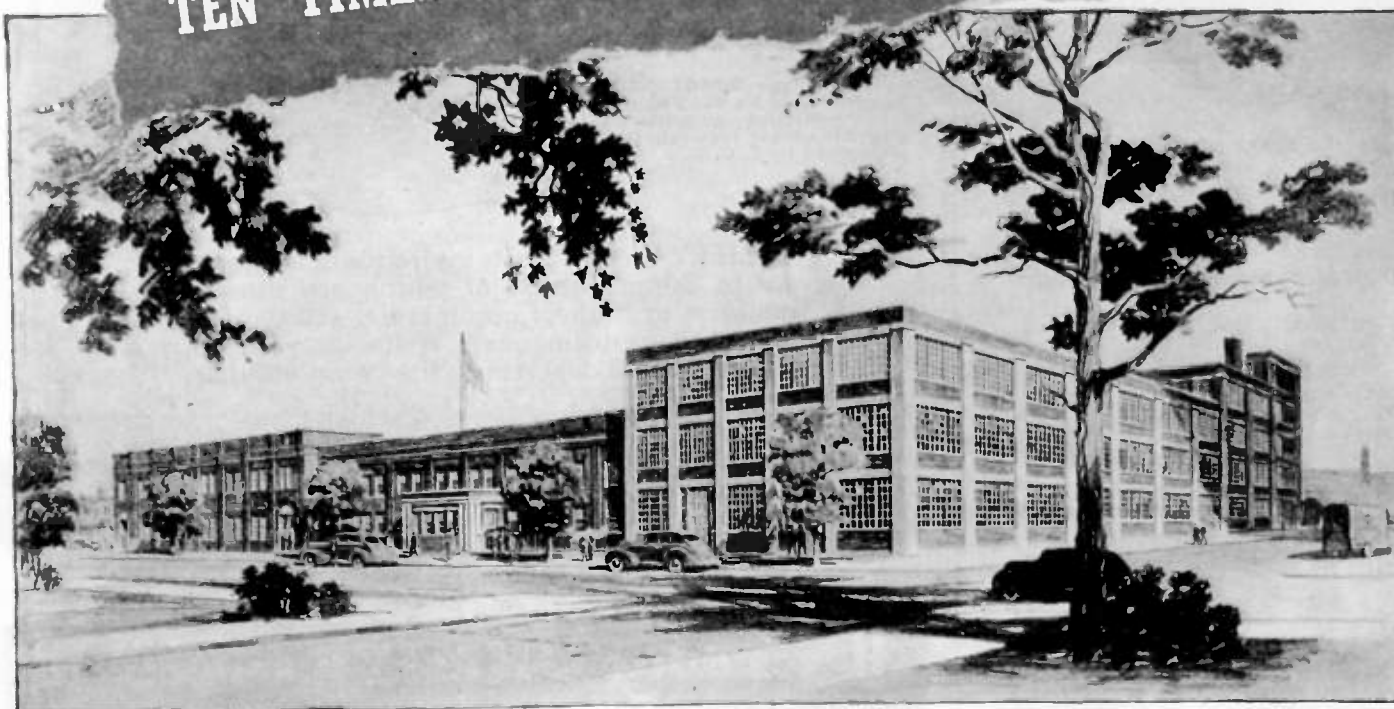

ISOLANTITE, INC. has, within the past year, increased its production of high-quality precision ceramic parts to five times the former output, in order to keep pace with the constantly increasing demand for its products in urgent defense work.

This exceptional increase in output has been made possible by purchase of new equipment which utilizes existing plant facilities to the full, by increasing operations to a twenty-four-hour basis and by effecting every possible economy in manufacturing time.

Large as this increase is, Isolantite recognizes that a still further expansion in output is necessary to anticipate the needs of industry for quality ceramic parts. With this end in view, Isolantite has initiated a program of plant construction and improvement that will double present capacity—raising Isolantite's output to ten times the level of a year ago.

Construction of a new three-story building that will add 80,000 square feet to existing productive areas is a major phase of Isolantite's expansion program. The new building will be provided with machinery of the most modern type, and production lines will be planned to maximum capacity. Rearranged facilities in existing buildings will contribute to the increased flow of Isolantite* products.

Isolantite, Inc. is also concentrating its efforts towards new and improved manufacturing methods. Modern facilities and engineering research will maintain present high quality standards for which Isolantite has been the

leader. New bodies are now in the course of development which will offer to the electronic industry improvements in both electrical and mechanical properties. Personnel is being expanded to meet the demands of these new and broadened facilities.

The recently created "Radio Specialties Division" is constantly developing new items involving metal parts in combination with Isolantite for transmission line, antenna and other important radio and allied products.

Work has already begun on this expansion program. With its completion in the early spring, Isolantite will be ready to render more efficient service in meeting the demand for its ever-growing list of new products.

*Registered trade-name for the products of Isolantite, Inc.

ISOLANTITE

CERAMIC INSULATORS

ISOLANTITE, INC. FACTORY: BELLEVILLE, NEW JERSEY
SALES OFFICE: 233 BROADWAY, NEW YORK, N. Y.

10 heat treatments
PROTECT
TRIPLET PRECISION



In these and similar batteries of electric ovens every Triplet Instrument is subjected to scientific heat treatment during several stages of the assembly process.

Pre-curing of molded parts and heat treatment of all assembled materials is a precaution to eliminate strains and stresses which otherwise would develop after the instrument is in the hands of the user. This is one of the many Triplet methods of insuring your continued satisfaction with Triplet Precision Instruments and Testers. Accurate alignment for dependable performance is thus assured under all normal conditions and usage.

THE TRIPLET ELECTRICAL
 INSTRUMENT CO.

BLUFFTON, OHIO

TRIPLET
 Precision
ELECTRICAL INSTRUMENTS

BLILEY CRYSTAL UNITS

Engineered for Accurate Frequency Control



LEFT: Type M03 temperature controlled unit specially designed for high frequencies.

CENTER: Type M02 unit is ruggedly built for portable and mobile transmitters; 2,000kc. to 30,000kc.

RIGHT: Type BC46T Precision Variable Air Gap Temperature controlled unit primarily for Broadcast frequencies. Approved by F. C. C.



B LILEY Crystal Units for frequencies from 20kc. to 30mc.—three of which are illustrated—conform to highest commercial standards of design and performance. Write for your copy of Catalog G-12 describing the complete line.

BLILEY ELECTRIC COMPANY
 UNION STATION BUILDING
 ERIE, PA.

Here's why OHMITE Resistors are the best answer for Resistance Problems



THE EXTENSIVE RANGE of Ohmite types and sizes makes possible an almost endless variety of regular or special resistors to meet every need. Core sizes range from 2-1/2" diameter by 20" long to 5/16" diameter by 1" long. They are available in fixed, adjustable, wire or flexible lead, tapped, ferrule, Edison base, bracket, cartridge, strip, precision, non-inductive, and other types.

YOU CAN OFTEN SAVE by using Ohmite stock units or calling on the specialized experience of Ohmite Engineers.

OHMITE Vitreous Enameled Resistors have proved their dependability in every climate from the arctic to the tropics. That's why they are so widely used in Industry and in the Armed Forces of the Nation.

Write on company letterhead for complete, helpful 96 page Catalog and Engineering Manual No. 40.

OHMITE MANUFACTURING CO.
 4861 Flournoy St., Chicago, U.S.A.

Be Right with
OHMITE

RHEOSTATS • RESISTORS • TAP SWITCHES

HOW TO START A STATION

Right!

Here's the RCA Transmitter chosen by 84 American Broadcasting Stations!

Starting a *new* station—? Whether your construction permit has already been granted, or your application is still to be filed, choose the transmitter that is America's *first* choice by an impressive margin—the RCA Type 250-K, for efficient, economical, dependable operation at 100/250 watts.

84 stations, built or being built, have purchased this outstanding broadcast transmitter. Foreign purchasers account for nine more. Yet the 250-K has been on the market less than two years!

The *reasons* for such unequalled acceptance are inherent in the 250-K itself. Flat within

1½ db. from 30 to 10,000 cycles, it delivers program-quality difficult to match even at a higher price. High-level Class B Modulation, and efficient RCA-engineered circuits, keep operating costs low. It draws only 1625 watts from your power-line while operating at average program modulation on a 250-watt carrier. Installation is simple and inexpensive; operation is simplicity itself.

And—a thought for the future—the 250-K is easily adapted to 1,000-watt operation at any time, by the simple addition of the RCA amplifier unit, Type MI-7185 and suitable power-supply. Write for complete data today.

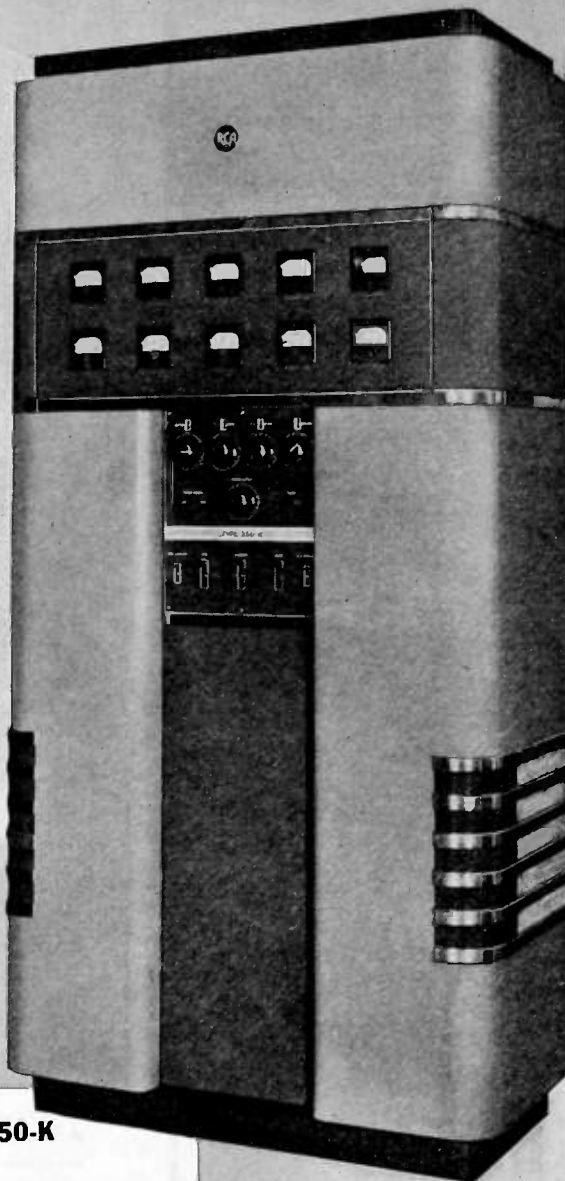

American Broadcasting Stations Equipped with the 250-K

Including 1,000-watt stations using it as a 250-watt exciter unit

KANA	KBIX	KBWD	KBUR	KFBG	KFIZ	KGLO	KFMB	KFIO	KFPW
KFXM	KHAS	KHON	KLS	KLUF	KRJF	KROO	KSKY	KSRO	KUJ
KVFD	KVOE	KWIL	KWRC	KYCA	KYOS	WAJR	WARM	WATN	WBIR
WBTA	WCED	WBOC	WDAS	WDEF	WCBI	WCRS	WDAK	WFDF	WHKY
WFIG	WGTC	WHBQ	WGOV	WISR	WHUB	WFPG	WINX	WIZE	WHYN
WGAC	WLBJ	WKIP	WKMO	WKWK	WKPA	WLAV	WLOK	WMJM	WMRN
WMOB	WMOG	WOSH	WORD	WSAV	WSGN	WSOO	WSRR	WSLB	WSOC
WTHT	WTMA	WTJS	WVNY						

... plus still others to foreign countries, American police installations, and for stations now under construction!

RCA 250-WATT
TYPE 250-K



Broadcast Equipment

RCA Manufacturing Company, Inc., Camden, N. J. • A Service of the Radio Corporation of America
In Canada: RCA Victor Co., Ltd., Montreal



New York: 411 Fifth Ave. Chicago: 589 E. Illinois St. Atlanta: 530 Citizens & Southern Bank Bldg. Dallas: Santa Fe Bldg. San Francisco: 170 Ninth St. Hollywood: 1016 N. Sycamore Ave.

WIRE & RIBBON

For Direct-Heated
ELECTRON EMITTERS
in VACUUM TUBES

In a complete range
of sizes and alloys for:

- TRANSMITTING
- RECEIVING
- BATTERY and
- HEARING AID TUBES

Melted and worked under
close supervision to assure
maximum emissivity, uni-
formity and the highest
tensile strength . . .

WIRES

drawn to .0005" diam.

RIBBON

rolled to .0001" diam.

SPECIAL ALLOYS

made to meet your in-
dividual specifications

Write for list of stock alloys

SIGMUND COHN

44 GOLD ST. NEW YORK
SINCE 1901

RADIO? COMMUNICATIONS? ELECTRIC POWER?

There is a **PRECISION INDUSTRIAL CIRCUIT TESTER**
to meet your **INDIVIDUAL SENSITIVITY REQUIREMENTS**

Ranges to 6000 Volts—60 Amps—10, 20 or 60 Megs—70 DB
1000, 5000 or 20,000 ohms per volt!

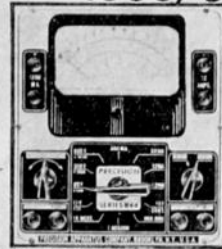

- ★ Series 844 (illustrated above)
1000 ohms/volt AC and DC
- ★ Series 845 5000 ohms/volt DC
Plus 1000 ohms/volt AC and DC
- ★ Series 856 20,000 ohms/volt DC
Plus 1000 ohms/volt AC and DC

★ SELECT THE AC-DC
VOLT-OHM-DECIBEL-MILLIAMMETER
BEST SUITED TO YOUR NEEDS

ADD THE SERIES J ★
MULTI-RANGE A.C. AMMETER



- ★ Series J (illustrated above). Eight
AC ammeter ranges, 300 MA full scale
to 60 AMPS. Available individually or
as companion unit to Series 844, 845
or 856.

- ★ Series 844-J Combination AC-DC Industrial Circuit Tester (center illustration). Complete with ohmmeter batteries and high voltage test leads. Furnished in walnut finished hardwood portable case, size 11 x 15 x 6" \$48.95
- ★ Series 845-J Combination AC-DC Industrial Circuit Tester. Complete as above \$52.95
- ★ Series 856-J Combination AC-DC Industrial Circuit Tester. Complete as above \$59.95

WRITE FOR NEW PRECISION INDUSTRIAL TEST INSTRUMENTS CATALOG No. 42-E

PRECISION TEST EQUIPMENT

INDUSTRIAL · LABORATORY · RADIO · TELEVISION

PRECISION APPARATUS COMPANY • 647 KENT AVENUE • BROOKLYN, N. Y.
Export Division: 458 Broadway, New York City, U. S. A. Cable Address: Morhanex

INDEX

Positions Open vi

DISPLAY ADVERTISERS

<p>A</p> <p>Advance Solvents & Chemical Corporation . . . v</p> <p>Aerovox Corporation iii</p> <p>American Lava Corporation ii</p> <p>American Telephone & Telegraph Com- pany xii</p> <p>Amperex Electronic Products, Inc. Cover II</p> <p>B</p> <p>Bliley Electric Company viii</p> <p>C</p> <p>Cohn, Sigmund x</p> <p>Cornell-Dubilier Electric Corporation Cover III</p> <p>D</p> <p>Daven Company iv</p> <p>DuMont Laboratories, Inc., Allen B. iv</p> <p>E</p> <p>Eitel-McCullough, Inc. i</p>	<p>G</p> <p>General Radio Company Cover IV</p> <p>I</p> <p>Isolantite, Inc. vii</p> <p>O</p> <p>Ohmite Manufacturing Company viii</p> <p>P</p> <p>Precision Apparatus Company x</p> <p>R</p> <p>RCA Manufacturing Company, Inc. ix, xi</p> <p>S</p> <p>Sprague Specialties Company vi</p> <p>T</p> <p>Triplett Electrical Instrument Co. viii</p>
---	--

Typical of RCA Tube values is the RCA-8005 Transmitting Triode de luxe, priced at only \$7 net. Designed for use as a radio frequency amplifier and class B modulator, this tube is capable of handling 300 watts (1CAS) input at 5 meters!

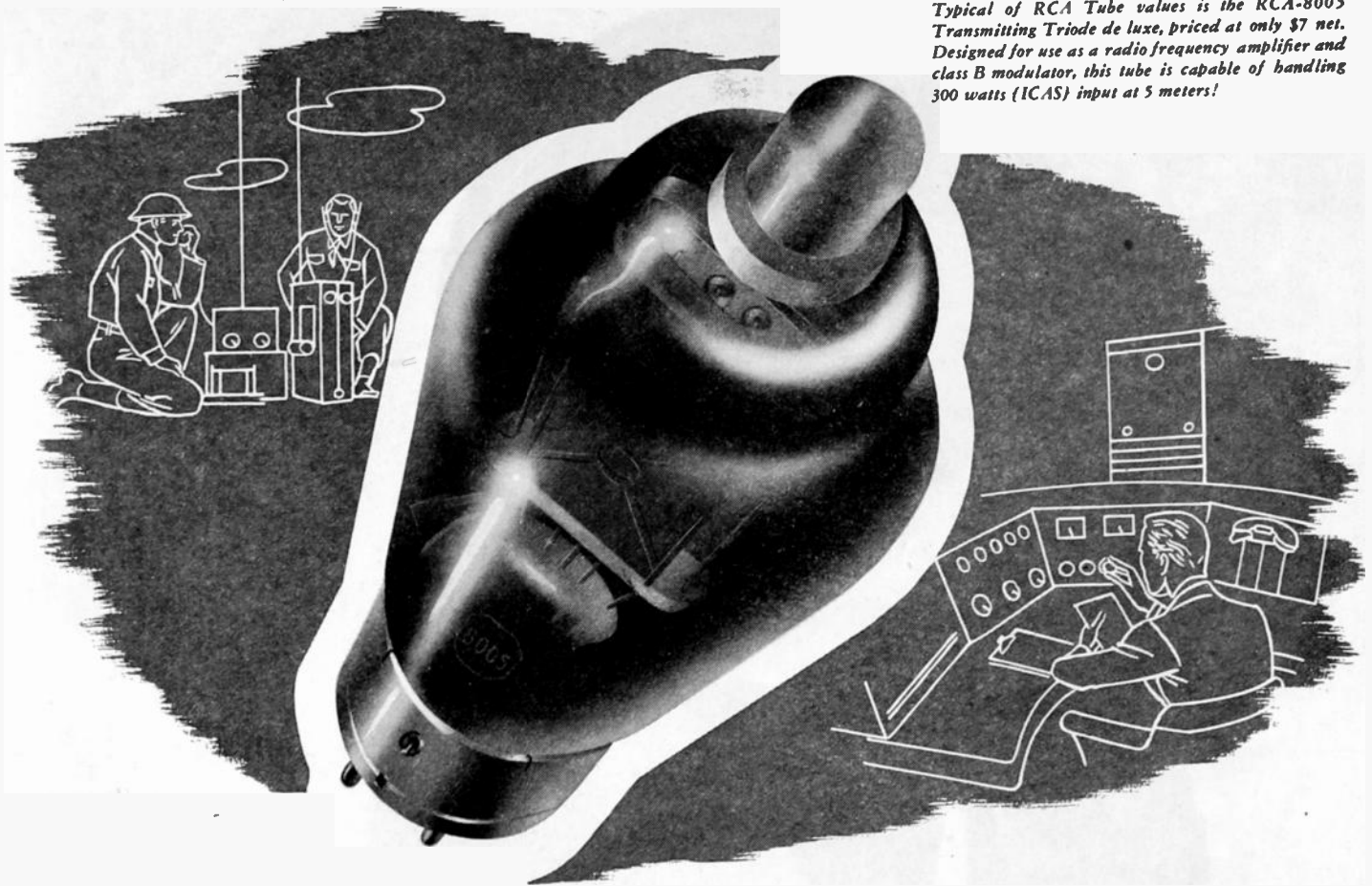

PRODUCTION FOR DEFENSE ... COOPERATION FOR ALL!

Defense production with RCA gets first call—and always will. Suffice to say that a tremendous quantity of RCA Transmitting Tubes is being supplied for a wide variety of defense needs. Meanwhile, although the 1941 total of RCA Transmitting Tubes supplied through our regular distribution channels will exceed that of last year, there is a scarcity of certain types. We know you will understand that this is unavoidable. We know, too, that we can count on your cooperation during these trying times—just as we want our countless friends in all branches of Radio to know that they can count on ours.

RCA Transmitting Tube quality is being rigidly maintained. RCA publications will be kept up-to-date. Ham Tips for amateurs will be continued. New data and construction material will be supplied. Inquiries about RCA Tubes and their applications will be answered promptly. Above all, research and development work is continuing as never before.

Thus, although it may not always be possible to supply the tubes you want during the National Emergency, RCA is still on the job to help wherever and whenever it can!



TRANSMITTING TUBES

RCA MANUFACTURING CO., Inc., Camden, N. J.

A Service of The Radio Corporation of America • For Canadian prices write to RCA Victor Company Limited, Montreal



DEVOTION TO DUTY IS A TELEPHONE TRADITION

High morale, devotion to duty, ingenuity in meeting new circumstances and the ability and will to work with each other and with the public are traditional characteristics of telephone employees.

Times like these not only demand these characteristics, they serve to create and extend them.

Now, more than ever, the creed of telephone workers is expressed in these simple words . . . "We'll do our best to get your call through."



BELL TELEPHONE SYSTEM

"THE TELEPHONE HOUR" is broadcast every Monday evening over the N. B. C. Red Network



What it takes to *keep 'em flying*

Back of the safety record of America's leading airlines is the world's most dependable radio equipment. Significantly, Cornell-Dubilier capacitors are used by all these major airlines both in ground station and aircraft communications. Here is convincing proof that C-Ds have what it takes — *extra* dependability not only to "keep 'em flying", but to meet your most exacting capacitor requirements.

CAPACITORS MAY LOOK ALIKE BUT...

There is extra long life, extra uniformity and dependability built into C-Ds. Next time you specify capacitors, look for the Cornell-Dubilier seal of experienced engineering. And get the *hidden* extras at no extra cost. Send for catalog, Cornell-Dubilier Electric Corporation, 1012 Hamilton Blvd., South Plainfield, New Jersey. New England Div., New Bedford, Mass.



CONRAD ELECTRIC CO. INC.
EQUIPMENT CHART

PART	NO.
BEACON RECEIVER	37718573
AUXILIARY RECEIVER	10533
MICROPHONES	
HEADSETS	
AUXILIARY BAL LOOP	
LOOP AMPLI	
LOOP DRIN	
AZIMUT	



Cornell



Dubilier

... MORE IN USE TODAY THAN ANY OTHER MAKE ...

MAKING INSTRUMENTS DIRECT READING with Variable Resistors

IN RESEARCH and production testing the convenience of having instruments read directly in the quantities they measure has been appreciated for some time by the manufacturer and the user of electrical measuring instruments. So rapid have been the improvements in most direct-reading instruments that they now have considerably greater accuracy than similar units manufactured several years ago without the direct-reading feature.

In general, direct-reading scales are used only with resistors and capacitors; the accuracies obtainable are high, frequently as great as 0.1% of full-scale. In order to maintain high accuracy in a direct-reading instrument, *constant* fractional accuracy must be obtained and the rate of variation of the unknown should be logarithmic. In any *linear* scale the fractional accuracy decreases directly with the quantity varied.

The circuit used with any direct-reading instrument has to be chosen so that the magnitude of the variable element is proportional to the unknown.

One of the most interesting examples of a direct-reading instrument is the Type 650-A Impedance Bridge. This bridge measures five quantities over exceptionally wide ranges with the following *maximum* errors: for resistance, 2%; for capacitance, 2%; for inductance, 10%; for dissipation factor (R/X) 20% and for storage factor (X/R) 20%.

For the measurement of so many different quantities and for the very large ranges obtainable from this bridge, four circuits and a number of multipliers are selected by two multi-position switches. The balances are obtained by the use of two of the four variable resistors.

The semi-logarithmic scales on the four dials . . . the CRL, D, DQ and Q dials . . . are direct-reading. The potentiometers used with these dials are wound on tapered cards. The scales can be made direct-reading either by hand calibration of each point to fit the irregularities introduced by variations in wire size and spacing, or these irregularities can be controlled to fit a pre-engraved scale.

Originally the CRL dial of this bridge was hand calibrated with every line set to its proper resistance value. Later, the calibrations on a production lot were averaged and a master constructed. From this master calibration, other dials were engraved on a pantograph engraving machine. These dials are now photo-etched. In the quantities in which these instruments are now manufactured, it has proven much more economical to provide the CRL potentiometers with the photo-etched dial scale and to compensate for irregularities by means of a flexible cam, than to engrave each dial separately.

Many other General Radio direct-reading instruments use resistors as the variable element. The dial scales are calibrated in a manner similar to those on the Type 650-A Bridge.

GENERAL RADIO COMPANY
Cambridge, Massachusetts

Type 650-A Bridge, direct-reading over these ranges:—

Resistance: 1 milliohm to 1 megohm

Capacitance: 1 micromicrofarad to 100 microfarads

Inductance: 1 microhenry to 100 henrys



The CRL Dial with semi-logarithmic scale.

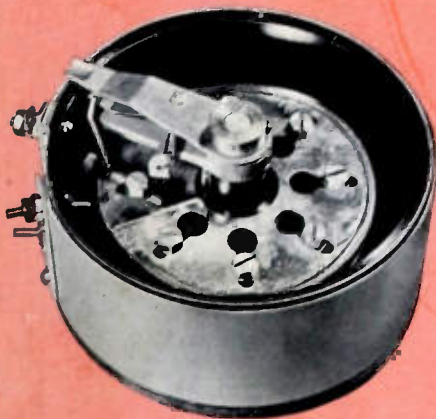

The cam on the CRL potentiometer. The contact arm is not connected directly to the potentiometer shaft, but turns freely on it. At the outer end a spring is pressed against a follower which rides on the cam. The cam follower rocking up and down on the cam changes the angular position of the contact arm and the scale. Adjustment of the eight screws will take up all differences between individual potentiometers and the master potentiometer which itself is an average.