

Proceedings



of the

I·R·E

OCTOBER 1941

VOLUME 29 NUMBER 10

Rochester Fall Meeting

Television—The Scanning Process

50-Kw Broadcast Transmitter

I-F Values for F-M Receivers

Alignment Equipment for F-M
Receivers

Full-Wave Voltage-Doubling Rectifier

Inductively Coupled Frequency
Modulator

High-Frequency Transmission

Institute of Radio Engineers

Ready For Anything

Whether you are interested in Industrial Rectifiers from 1 volt to 250,000 volts and from 1 Ma. to 2500 Amps. . . .

Or if you are interested in small transformers in our Ultra-Compact Ouncer or Sub-Ouncer types (our smallest units weigh only one-third ounce) . . .

Or if you require high power transformer equipment for a 500 Kw. transmitter . . .

Or an industrial application or a special Varitran or Voltage Regulator to suit a specific requirement . . .



*Is the Choice of
Leaders of Industry*

May we assist you in your problem?

A note to our Engineering Division will bring a quick response with details on units to your requirements.



UNITED TRANSFORMER CORP.

150 VARICK STREET ★ NEW YORK, N. Y.
EXPORT DIVISION: 100 VARICK STREET NEW YORK, N. Y. CABLES: "ARLAB"

Proceedings of the I·R·E

Published Monthly by

The Institute of Radio Engineers, Inc.

VOLUME 29

October, 1941

NUMBER 10

Television—The Scanning Process.....	Pierre Mertz	529
A Commercial 50-Kilowatt Broadcast Transmitting Station.....	H. P. Thomas and R. H. Williamson	537
Intermediate-Frequency Values for Frequency-Modulated-Wave Receivers.....	Dudley E. Foster and John A. Rankin	546
Factory Alignment Equipment for Frequency-Modulation Receivers.....	Harry E. Rice	551
The Full-Wave Voltage-Doubling Rectifier Circuit.....	D. L. Waidelich	554
An Inductively Coupled Frequency Modulator.....	Bruce E. Montgomery	559
High-Frequency Radio Transmission Conditions, September, 1941, with Predictions for December, 1941.....		563
Institute News and Radio Notes.....		565
Adolfo T. Cosentino.....		565
Frederick E. Terman.....		565
Rochester Fall Meeting.....		565
Board of Directors.....		565
Executive Committee.....		566
Sections.....		566
Symposia on Nonlinear Circuit Theory and on Wave Filters and Other Networks.....		567
Membership.....		567
Books: "Advanced Electrical Measurements," by W. C. Michels.....	Reviewed by H. M. Turner	568
Committee Personnel.....		568
Institute Representatives in Colleges.....		569
Institute Representatives on Other Bodies.....		570
Contributors.....		571

Entered as second-class matter October 26, 1927, at the post office at Menasha, Wisconsin, under the Act of February 28, 1925, embodied in Paragraph 4, Section 538 of the Postal Laws and Regulations. Publication office, 450 Ahnaip Street, Menasha, Wisconsin. Editorial and advertising offices, 330 West 42nd St., New York, N. Y. Subscription, \$10.00 per year; foreign, \$11.00.

Copyright, 1941, by The Institute of Radio Engineers, Inc.

BOARD OF DIRECTORS

Frederick E. Terman, *President*
 Adolfo T. Cosentino,
Vice President
 Alfred N. Goldsmith, *Editor*
 Haraden Pratt, *Treasurer*
 Harold P. Westman, *Secretary*
 Austin Bailey
 Adolph B. Chamberlain
 Ivan S. Coggeshall
 Melville Eastham
 Harold T. Friis
 Virgil M. Graham
 O. B. Hanson
 Raymond A. Heising
 Lawrence C. F. Horle
 C. M. Jansky, Jr.
 Frederick B. Llewellyn
 Browder J. Thompson
 Hubert M. Turner
 Arthur F. Van Dyck
 Harold A. Wheeler
 Lynde P. Wheeler

Harold R. Zeamans,
General Counsel

BOARD OF EDITORS

Alfred N. Goldsmith, *Editor*
 Ralph R. Batcher
 Lloyd V. Berkner
 Philip S. Carter
 Lewis M. Clement
 Elmer W. Engstrom
 William L. Everitt
 Peter C. Goldmark
 Frederick W. Grover
 C. M. Jansky, Jr.
 John D. Kraus
 Frederick B. Llewellyn
 Samuel S. Mackeown
 Edward L. Nelson
 Harry F. Olson
 Greenleaf W. Pickard
 Haraden Pratt
 Conan A. Priest
 Leon J. Sivan
 Lynne C. Smeby
 Browder J. Thompson
 Harold A. Wheeler
 Lynde P. Wheeler
 Laurens E. Whittemore
 Gerald W. Willard
 William Wilson
 Charles J. Young

Helen M. Stote, *Assistant Editor*

John D. Crawford,
Advertising Manager

THE INSTITUTE OF RADIO ENGINEERS

INCORPORATED



New York Meeting—November 5, 1941



Rochester Fall Meeting, November 10, 11, and 12, 1941

Winter Convention, New York, N. Y., January 12, 13, and 14, 1942

Summer Convention, Cleveland, Ohio, June 29, 30, and July 1, 1942

SECTION MEETINGS

ATLANTA
November 21

LOS ANGELES
November 18

PITTSBURGH
November 10

DETROIT
November 21

PHILADELPHIA
November 6

WASHINGTON
November 10

SECTIONS

ATLANTA—Chairman, A. W. Shropshire, Secretary, G. M. Howard, 856 St. Charles Ave., N. E., Atlanta, Ga.

BALTIMORE—Chairman, V. D. Hauck, Jr.; Secretary, G. J. Gross, Pennsylvania Water and Power Co., 1611 Lexington Bldg., Baltimore, Md.

BOSTON—Chairman, J. M. Henry; Secretary, R. O. Oberg, Northeastern University, Boston, Mass.

BUENOS AIRES—Chairman, P. J. Noizeux; Secretary, L. C. Simpson, RCA Victor Argentina, Bartolome Mitre, 1961, Buenos Aires, Argentina.

BUFFALO-NIAGARA—Chairman, E. H. Roy; Secretary, Leroy Fiedler, 53 Rosedale Ave., Hamburg, N. Y.

CHICAGO—Chairman, G. I. Martin; Secretary, R. A. Kay, 4819 Wallbank, Downers Grove, Ill.

CINCINNATI—Chairman, J. M. McDonald; Secretary, W. L. Schwesinger, Crosley Corp., Cincinnati, Ohio.

CLEVELAND—Chairman, Carl E. Smith; Secretary, W. G. Hutton, 7314 Dorothy Ave., Parma, Ohio.

CONNECTICUT VALLEY—Chairman, F. G. Webber; Secretary, C. I. Bradford, 187 Glenarden Dr., Fairfield, Conn.

DALLAS-FORT WORTH—Chairman, D. A. Peterson; Secretary, P. C. Barnes, WFAA-WBAP, Grapevine, Tex.

DETROIT—Chairman, M. Cottrell; Secretary, Paul Frincke, WJBK, 6559 Hamilton Ave., Detroit, Mich.

EMPORIUM—Chairman, R. K. Gessford; Secretary, C. W. Reash, Hygrade Sylvania Corp., Emporium, Pa.

INDIANAPOLIS—Chairman, A. N. Curtiss; Secretary, T. N. Rosser, P. R. Mallory & Co., 3029 E. Washington St., Indianapolis, Ind.

KANSAS CITY—Chairman, Harner Selvidge; Secretary, G. L. Taylor, Midland Radio School, Power and Light Bldg., Kansas City, Mo.

LOS ANGELES—Chairman, W. W. Lindsay, Jr.; Secretary, C. F. Wolcott, 1609 S. Western Ave., Los Angeles, Calif.

MONTREAL—Chairman, E. A. Laport; Secretary, W. A. Nichols, Canadian Broadcasting Corp., 1012 Keefer Bldg., Montreal, Que.

NEW ORLEANS—Chairman, G. H. Peirce; Secretary, D. W. Bowman, 8327 Sycamore St., New Orleans, La.

PHILADELPHIA—Chairman, C. C. Chambers; Secretary, R. L. Snyder, 103 Franklin Rd., Glassboro, N. J.

PITTSBURGH—Chairman, P. N. Bossart; Secretary, Ralph Overholt, Jr., 7211 Thomas Blvd., Pittsburgh, Pa.

PORTLAND—Chairman, E. R. Meissner; Secretary, L. M. Belleville, 361 N. E. 75th Ave., Portland, Ore.

ROCHESTER—Chairman, H. J. Klumb; Secretary, O. L. Angevine, Jr., Stromberg-Carlson Telephone Manufacturing Co., Rochester, N. Y.

SAN FRANCISCO—Chairman, L. J. Black; Secretary, Karl Spangenberg, Electrical Engineering Dept., Stanford University, Calif.

SEATTLE—Chairman, K. H. Ellerbeck; Secretary, R. J. Gleason, Pacific Alaska Airways, Inc., 3314 White Bldg., Seattle, Wash.

TORONTO—Chairman, R. H. Klingelhoefter; Secretary, L. C. Simmonds, 301 King St., E., Toronto, Ont.

TWIN CITIES—Chairman, C. A. Culver; Secretary, N. B. Coil, 1664 Thomas St., St. Paul, Minn.

WASHINGTON—Chairman, M. H. Biser; Secretary, C. M. Hunt, WJSV, 817 Earle Bldg., Washington, D. C.

THE INSTITUTE serves those interested in radio and allied electrical communication fields through the presentation and publication of technical material.

THE PROCEEDINGS has been published without interruption since 1913 when the first issue appeared. The contents of each paper published in the **PROCEEDINGS** are the responsibility of the author and are not binding on the Institute or its members. Material appearing in it may be reprinted or abstracted in other publications on the express condition that specific reference shall be made to its original appearance in the **PROCEEDINGS**. Illustrations of any variety, however, may not be reproduced without specific permission from the Institute.

STANDARDS reports are published from time to time and are sent to each member without charge. The four current reports are on Electroacoustics, Electronics, Radio Receivers, and Radio Transmitters and were published in 1938.

MEMBERSHIP has grown from a few dozen in 1912 to more than five thousand. Practically every country in the world in which radio engineers may be found is represented in our roster. Dues for the five grades of membership range from \$3.00 to \$10.00 per year. The **PROCEEDINGS** is sent to each member without further payment.

SECTIONS in twenty-six cities in the United States, Canada, and Argentina hold regular meetings. The chairmen and secretaries of these sections are listed on the opposite page.

SUBSCRIPTIONS are accepted for the **PROCEEDINGS** at \$10.00 per year in the United States of America, its possessions, and Canada; when college and public libraries order direct from the Institute, the subscription price is \$5.00. For other countries there is additional charge of \$1.00.

The Institute of Radio Engineers, Inc.
Harold P. Westman, Secretary
330 West 42nd Street
New York, N.Y.

The Institute of Radio Engineers

Incorporated

330 West 42nd Street, New York, N.Y.

To the Board of Directors

Gentlemen:

I hereby make application for ASSOCIATE membership in the Institute of Radio Engineers on the basis of my training and professional experience given herewith, and refer to the sponsors named below who are personally familiar with my work.

I certify that the statements made in the record of my training and professional experience are correct, and agree if elected, that I shall be governed by the Constitution of the Institute as long as I continue a member. Furthermore I agree to promote the objects of the Institute so far as shall be in my power.

.....
(Sign with pen)

.....
(Address for mail)

.....
(City and State)

.....
(Date)

SPONSORS

(Signatures not required here)

Mr.

Address

City and State

Mr.

Address

City and State

Mr.

Address

City and State

Television—The Scanning Process*

PIERRE MERTZ†, NONMEMBER, I.R.E.

Summary—This is a descriptive study of the scanning process in television. It is analyzed in terms of a two-dimensional Fourier series of terms, which are correlated to the frequency components of the transmitted electrical signal. The impairment caused to the detail in the picture by the scanning process is shown to consist of two parts: (a) a blurring of the original image, and (b) the introduction of spurious patterns not in the original picture. A discussion is given of how these influence the reproduction of detail in the vertical and horizontal directions, and their relative importance in impairing the picture. A brief discussion is also given of impairments to the over-all picture caused by the scanning process, chiefly from the intermittent nature of the process.

THE process of transmitting a television picture as used at present consists of a succession of steps which can be generalized with respect to the functions performed in each. The details of the mechanism for effecting these steps vary from system to system, but the individual steps are always carried out. To place the scanning operations, which constitute the steps upon which the study will particularly center, in the over-all process a brief recapitulation will first be set down of the entire sequence.

- (1) The exhibition of the original picture or view in some way before a terminal mechanism.
- (2) The "scanning" of the picture, namely the tracing of a small spot over the picture point by point along some predetermined pattern, which at present consists of a series of closely spaced lines drawn one after the other horizontally across the picture and completely covering it. This step also includes the provision of a mechanism for determining the brightness of the picture at each successive point as it is traced.
- (3) The conversion of this observed brightness value at each instant into a current value, also at that instant, thus forming a current signal varying with time.
- (4) The propagation of this current signal to a distant point.
- (5) The conversion at the receiving end of the current signal, or current value varying from instant to instant, into a light signal, or a value of luminous intensity of some source of light, which varies in a way corresponding to the signal from instant to instant.
- (6) Some means of displacing this light back and forth to retrace a scanning pattern exactly like that covered in step (2) so that an observer can simultaneously see all the points of the original picture side by side in their correct relative brightness and consequently have the sensation of seeing the original picture.

No mention is made here of amplifying steps. These will not be studied particularly and it will be assumed

* Decimal classification: R583. The original manuscript of this invited paper was received by the Institute, July, 7, 1941.

† Bell Telephone Laboratories, Inc., New York, N. Y.

that they are inserted wherever necessary and convenient and their characteristics merged in the generalized step.

In this over-all process we are interested for the present moment in two questions. First, what is the general nature of the signal which in step (4) must be transmitted from one point to another? Second, how will the picture observed in step (6) differ from that exhibited in step (1)? Since we are studying the scanning process we are interested primarily in those differences which are brought about by steps (2) and (6). There exists in the literature ample mathematical study of the scanning process.¹⁻⁶ The present discussion will, therefore, be of a general and descriptive nature, with occasional references to the mathematical papers for derivation of the results described.

In order to describe the picture and the signal and talk about them it is convenient to break them up into what are called "Fourier components." Let us first take up the signal, as it is the easier to study. It is a part of the famous theorem enounced by the French mathematician Fourier that a signal which consists of a current which varies with time over a specified finite interval is made up of the sum of an infinite number of simple harmonic currents of frequencies which are uniformly and consecutively spaced in the frequency spectrum from zero to infinity. In practical cases where it is not necessary to describe or reproduce the signal with absolute exactness over the interval but where a certain amount of finite error may be tolerated, then a large number of the components above are negligible in intensity, and all the useful components are really comprised within a finite band of frequencies.

Two illustrations of some arbitrary signals and how they can be approximated by a very few Fourier components are shown in Fig. 1. The signal designated as I represents a square-tooth signal shaped like a single telegraph dot. The first step at the top shows how the square signal is approximated by a single sine component. The second step below this shows how two components, each shown alone as dotted, give a sum, shown in full lines, which approaches the square signal

¹ Frank Gray, J. W. Horton, and R. C. Mathes, "Production and utilization of television signals," *Bell Sys. Tech. Jour.*, vol. 6, pp. 560-603; October, 1927.

² Pierre Mertz and Frank Gray, "A theory of scanning and its relation to the characteristics of the transmitted signal in telegraphy and television," *Bell Sys. Tech. Jour.*, vol. 13, pp. 464-515; July, 1934.

³ Harold A. Wheeler and Arthur V. Loughren, "The fine structure of television images," *Proc. I.R.E.*, vol. 26, pp. 540-575; May, 1938.

⁴ S. Sabaroff, "Scanning theory," *Jour. Soc. Mot. Pic. Eng.*, vol. 36, pp. 497-513; May, 1941.

⁵ E. D. Cook, "The aperture effect," *Jour. Soc. Mot. Pic. Eng.*, vol. 14, pp. 650-662; June, 1930.

⁶ N. R. Stryker, "Scanning losses in reproduction," *Jour. Soc. Mot. Pic. Eng.*, vol. 15, pp. 610-623; November, 1930.

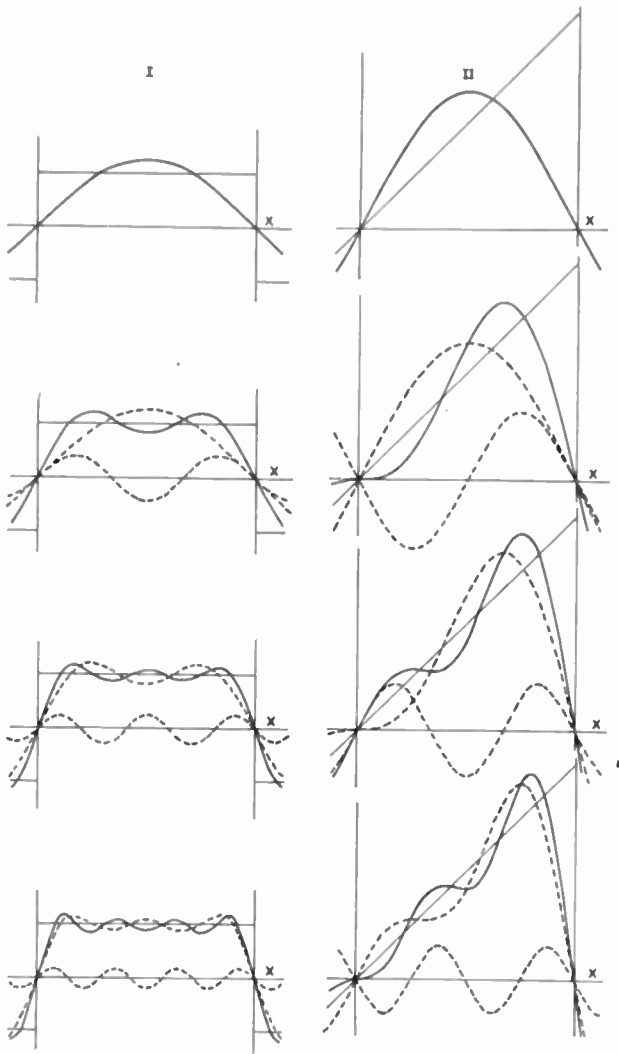

Fig. 1—Harmonic Fourier components added up to produce toothed signals.

much better than the single component. The third step shows how adding a third component, shown

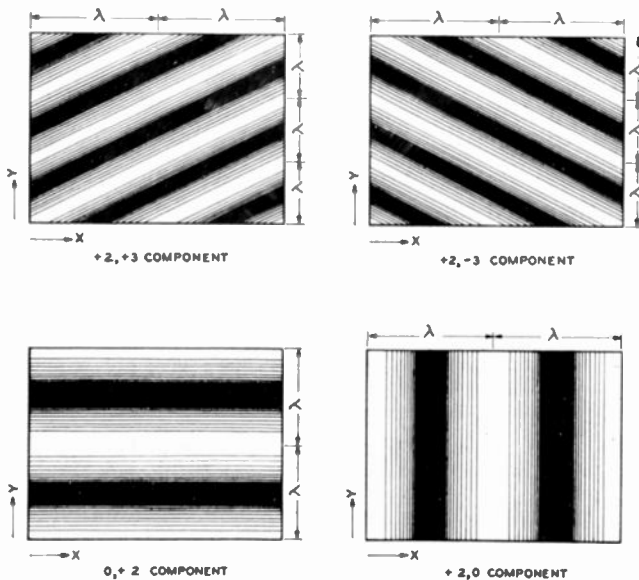

Fig. 2—Each Fourier component of a two-dimensional picture is also two-dimensional. A few such components.

dotted, to the sum of the first two, also dotted, gives a sum in full lines which is a better approximation to the square signal than found in the second step. One additional step is shown, but the process can be carried on indefinitely. In Fig. 1-II a similar set of approximations are shown for a triangular saw-tooth signal.

Where the signal intensity varies over a surface such as a picture which has two dimensions instead of just the single time dimension, it is still possible to make up the picture from the sum of an infinite number of wave components. The wave components in this case each cover the whole picture space, in the same way that in Fig. 1 each component lasts throughout the whole duration of the signal (it will be noted that the mathe-

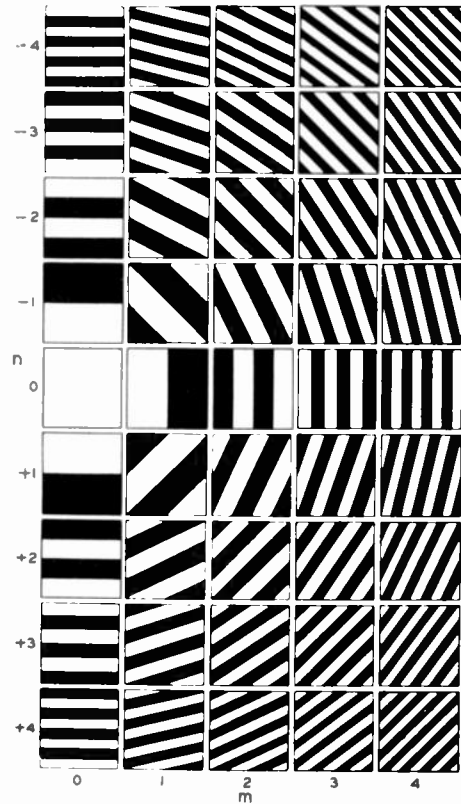

Fig. 3.—A more complete array of the type of components illustrated in Fig. 2.

tical expressions for these components have significance in the entire infinite line or plane, as the case may be, but for the present, consideration will be restricted to the ranges specified). The components for a surface, however, can no longer be characterized by simply one frequency or wavelength but must be identified by two wavelengths, one to be measured along each dimension of the picture. A few such components are illustrated in Fig. 2, where the intensity is shown in terms of a light or dark surface, distributed sinusoidally across the crests and troughs of the waves. The first or m index number characterizing the component indicates the number of whole wavelengths (λ) of the component in the image width and the second or n index the number in the image height. Where the

second index is negative the component simply slopes in the opposite direction to that when it is positive. A more complete array of components is schematically illustrated in Fig. 3. Here, for simplicity in representation, the light and dark shades are not shown as varying sinusoidally across the waves, but change suddenly from black to white and back again. It will be noted further that the same components in Figs. 2 and 3 are not quite alike with regard to their symmetry about the axes. In Fig. 2 the symmetry is what would be called "even," i.e., a white on one side is symmetrical with a white equally displaced on the other side. In Fig. 3 it is more like "odd" symmetry, where a white on one side is symmetrical with a black equally displaced on the other side. The change from one figure to the other may be effected by displacing the component by $1/4$ wavelength across the direction of its crests and troughs. One is therefore said to have a phase shift of 90 degrees with respect to the other. According to Fourier's theorem any picture in light and dark, filling a rectangular frame, can be built up from the superposition of all the individual frames in Fig. 3, in the same manner that in Fig. 1 a signal was built up from the superposition of one-dimensional components.

The wavelengths and inclinations from the axis of the components, which are characterized by the combination of m and n indexes, remain the same whatever may be the picture in the frame. One picture is distinguished from another, however, by virtue of differences in the intensities and phases of the various components.

When a picture consisting of only one Fourier component, such, for example, as any one of the individual frames in Figs. 2 or 3, is scanned by the scanning mechanism, the signal-current output of that mechanism is of a single frequency only. With some exceptions which will be noted, this frequency differs from picture component to picture component. Thus there exists a correspondence between each picture component and each signal component. For simple progressive scanning of the picture, and for a simple 9-line scanning system this correspondence is shown in Fig. 4, where the signal components have been set down in order of frequency. The zero-frequency or direct-current component corresponds to the $0,0$ picture component, which by its value indicates the average shade of the picture. The $0,1$ component, according to Fig. 3, gives, when scanned, a succession of half the total number of scanning lines in light, followed by an equal succession in dark. Thus one complete cycle of light and shade is covered in the scanning of one picture, and the frequency of the signal current is equal to the frequency of repetition of the image. The $1,0$ component, according to Fig. 3 gives when scanned a complete cycle of light changes per scanning line. Therefore the frequency of the signal current is equal to the frequency of line scanning, which is equal to the total number of scanning lines in the system times the

frequency of image repetitions. For a system of greater number of lines than 9 there would be more components between successive multiples or harmonics of the line-scanning frequency.

It is interesting to note that as either index of the image Fourier component becomes large the intensity of the component tends to become small. That is, for example, if one picks out components from the array of Fig. 3 to build up any specific picture, then as one

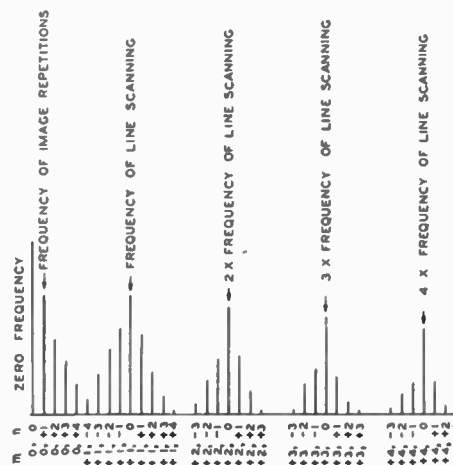

Fig. 4—Schematic frequency spectrum of a television signal.

gets to components of smaller and smaller wavelength the intensity required tends to diminish. This is also quite obviously true of Fig. 1. This is a consequence of the fact that for physically realizable pictures the Fourier series is convergent. That is, as more and more terms or components are added, their sum, for any specific value of the single X variable of Fig. 1, or of the two X and Y variables of Fig. 2, eventually approaches a fixed value. This can only occur if the amplitudes of the later components in the series become indefinitely small.

This observation means that in Fig. 4, as we move far to the right, and increase the first or m index of the component the intensity will tend to diminish. It also means that as we go either left or right from a component which has a second or n index of zero the intensity will again tend to diminish. Thus the frequency spectrum of the signal consists of regions of strong intensity alternating with regions of weak intensity. Some actual frequency analyses of television currents illustrating this are shown in Fig. 5, for a low-definition television system. In this case the individual components are so close together that they cannot be distinguished, and only bands of energy can be seen.

The question that will immediately occur to one examining Fig. 4 is whether it is possible for the outlying edges of adjacent bands of strong energy to get mixed up with each other in the signal. For example, could, in this figure, the $0,+7$ and the $+1,-2$ image components be distinguished from each other in the signal? The answer is that they could not and that they do get mixed up, as will be clear from Fig. 6. This shows broken

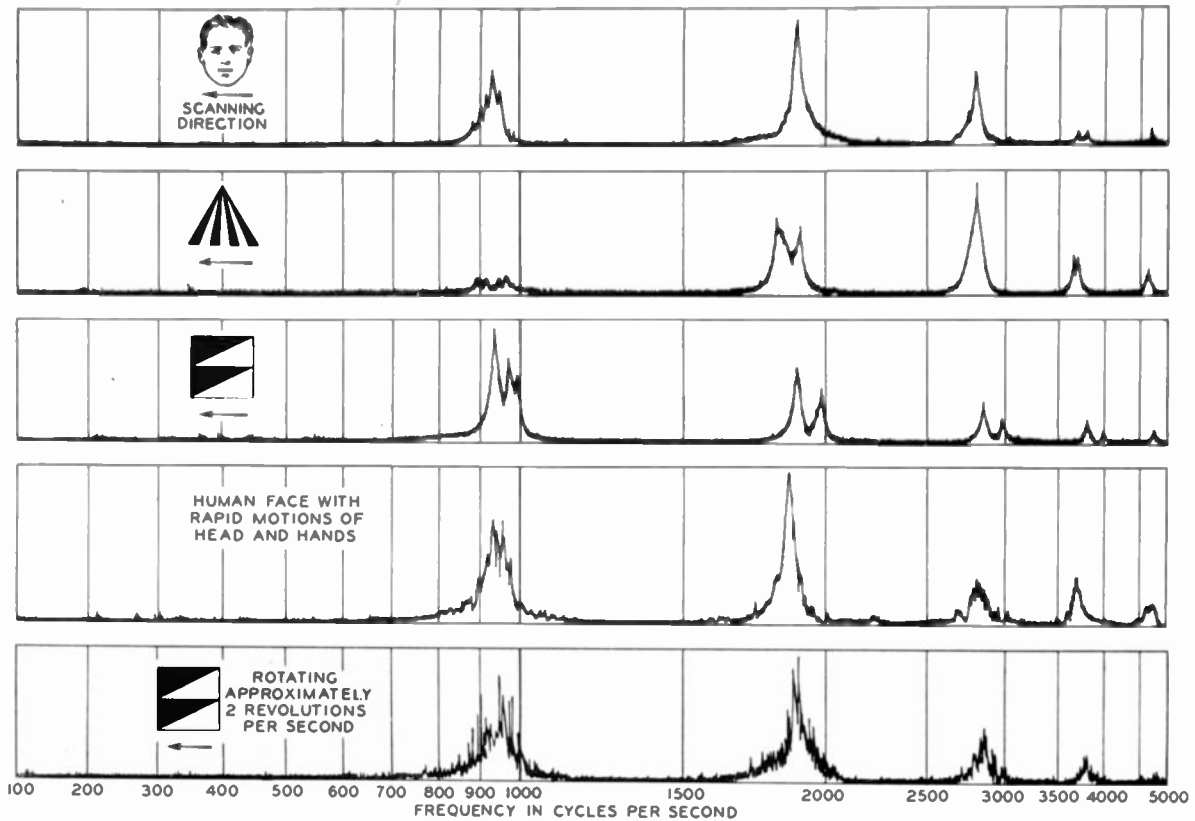

Fig. 5—Experimental frequency analyses of some low-definition television signals. The nature of the picture scanned is shown in the small diagram at the left.

sections of these two picture components in different parts of the frame. The crests of the components are outlined in dotted lines and the troughs in solid lines. It will be noted that the crests and troughs of the two components respectively intersect the path of the scanning spot at exactly the same points. The distance marked d

on the figure indicates the distance measured along a scanning line between a crest and a trough, and represents one-half wavelength of the signal. It will be noted that this is exactly the same for the scanning of component A at the top of the figure as for component B at the bottom. This general discussion makes it clear how the two different picture components give rise to exactly the same signal frequency. The effect which this confusion has on the final received picture will be considered more in detail later.

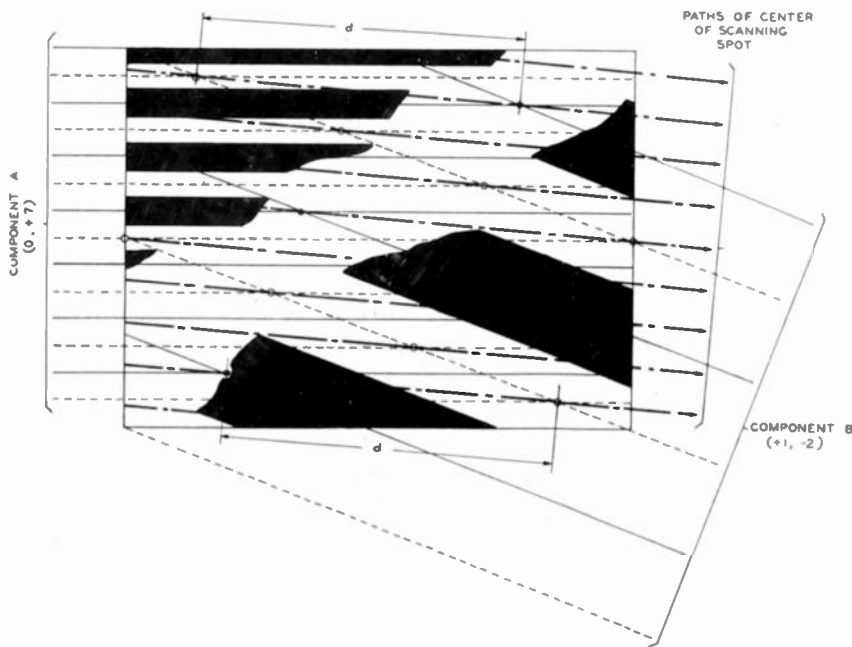

Fig. 6—Showing how two entirely different picture components can give the same line signal, because the scanning paths cross the crests (white) and troughs (black) of the two at exactly the same points. The crest-crossing points are marked with hollow circles, the trough-crossing points with solid dots.

Television as at present contemplated makes use of interlaced scanning. This complicates somewhat the simple picture which we have shown in Fig. 4 of the correlation between the picture components and the signal components. Fig. 7 sketches out in a schematic manner how this correlation is changed.^{7,8} The upper part of Fig. 7 repeats the general diagram of Fig. 4 for a 9-line system of progressive scanning. In order to keep the parts of the various bands better separated,

⁷ H. Koellner, "Ueber die zerlegung un den aufbau eines fernsehbildes," *Telefunken Hausmitteilungen*, vol. 19, pp. 46-60; March, 1938.

⁸ R. D. Kell, A. V. Bedford, and M. A. Trainer, "Scanning sequence and repetition rate of television images," *Proc. I.R.E.*, vol. 24, pp. 559-576; April, 1936.

however, the $+1, n$ band has been shown dotted and plotted below the axis, while the $0, n$ and $+2, n$ bands have been plotted in the normal way.

The lower part of Fig. 7 shows the frequency positions which these signal components take when the scanning is interlaced in the usual way. What happens may be summarized about in the following way:

- (1) The peaks of energy at the multiples of the frequency of line scanning are left unaffected.
- (2) The satellite components about these peaks are spread out away from the peaks at double the previous spacing. Because of the odd number of scanning lines used for the interlacing, the individual satellites of one peak will always interleave between the individual satellites of the peaks of the adjoining bands. Thus, there will be a tendency for successive components in the new frequency spectrum to alternate in intensity.
- (3) The confusion which exists in the progressive system between the components of adjoining bands is eliminated, but replaced by substantially equal confusion between components of bands which are

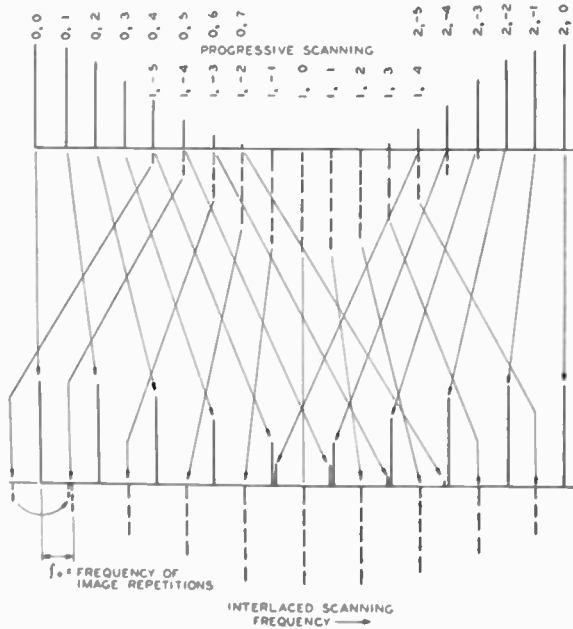

Fig. 7—The transition of a signal spectrum for progressive scanning to one for interlaced scanning (9-line system).

one removed from being adjoining. Thus the confusion (illustrated in Fig. 6) existing in the upper part of Fig. 7 between the $0, +7$ and $+1, -2$ components is eliminated in the lower part of the picture because these are transferred to parts of the spectrum well removed from each other. It is, however, replaced by confusion between the $0, +7$ and

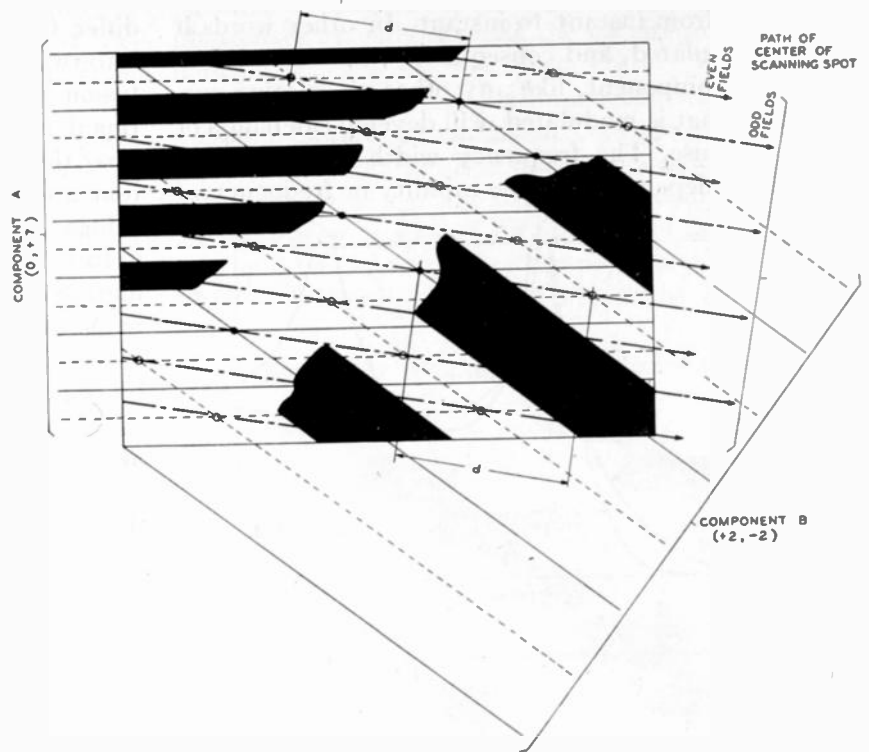

Fig. 8—Analogous diagram to Fig. 6 but for interlaced scanning.

$+2, -2$ components which is substantially as bad. This is illustrated in Fig. 8, which is the counterpart of Fig. 6 for interlaced scanning.

- (4) The signal component having the frequency of complete image repetitions, or frame frequency is changed from one of strong intensity to one of weak intensity. For the case in Fig. 7 it is actually made up both of the $+1, -4$ picture component and a "reflected image" of the $+1, -5$ picture component. A "reflected image" merely means that by applying the simplified rules which have been listed above the frequency of the signal component comes out negative. The actual frequency will then have the same numerical value but be positive (it is also for this reason that negative values of the index m are not necessary, and have not been shown, for example, in Fig. 3). Both of the components discussed fall well away from the peaks in the upper part of Fig. 7 and are of generally weak intensity. The first strong component above zero frequency, therefore, comes at the "field frequency," or frequency of repetition of image scanings which reach from top to bottom of the picture (i.e., twice the frequency of repetition of complete frames).

So far all this description of the line signal has considered that the same image was being scanned over and over at the transmitting end, without depicting any motion. When it does depict motion this means that the pictures in successive scanings will be different. If the successive pictures are different, then the amplitude and phase of a Fourier component with a given set of indexes must change from picture to picture,

and hence from instant to instant. In other words it will be modulated, and consequently, the corresponding signal component, like any other alternating-current wave that is modulated, will develop sidebands or become diffuse. The frequency width of the diffuse component depends upon the rapidity or frequency of

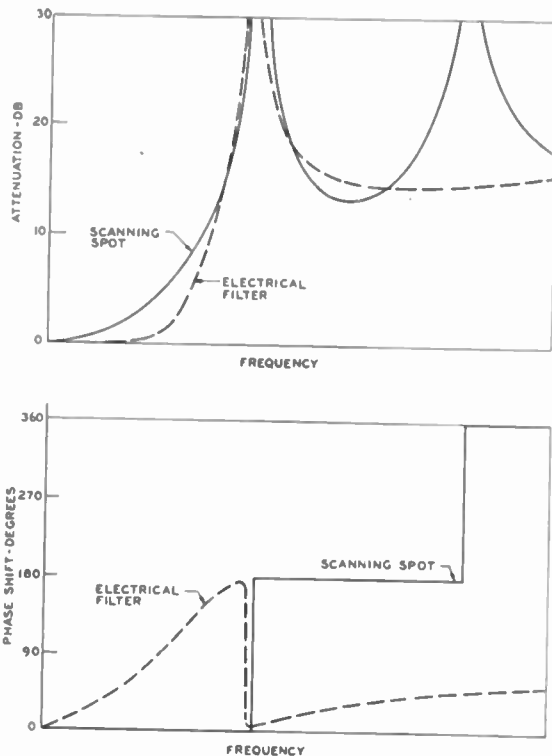

Fig. 9—The scanning spot at both transmitter and receiver acts like a filter. A comparison of the effect of a square spot with that of an actual electrical filter.

modulation. Now the diffuseness will not overlap from component to component unless the frequency of modulation becomes as great as half the frequency of image repetitions. This is about as violent a motion as the television system can possibly expect to reproduce with any reasonable fidelity. For anything less than this extreme condition, however, the Fourier components, though diffuse, will each continue to maintain their own identity and be distinguishable from their immediately adjacent neighbors throughout a television transmission.

Thus it is seen that there is no confusion in general between the individual components of a single band. Except in the case of violent motions, which cannot be faithfully reproduced, the only confusion which exists is that previously described, namely between the components of separate bands, and this occurs whether the picture is still or moving.

So far then, we have answered the first question we set out to consider, namely, what is the general nature of the signal which is transmitted from one point to another. The description has been confined to the elementary or video signal. No discussion will be given of the carrier or radio signal.

The second question, how the received image will

differ from that transmitted, can best be broken up into two steps: first, what happens aside from any confusion in signal components, and second, what additional impairment is caused by this confusion. It is clear that only the effects inherent to the scanning system are to be considered, neglecting all such other things as line and amplifier distortions.

In order to consider the first step it is best to eliminate confusion as far as possible and assume a picture made up only of those Fourier components in the very centers of the bands of energy shown in Fig. 4, which by consultation of Fig. 3, are seen to include only those going straight up and down, or perpendicular to the motion of the scanning spot. The impairment to these components is caused principally by the finite size of this scanning spot. That is, the finer components in the picture have a spacing, from crest to crest, which is comparable in size to that of the spot, so that the variation in light flux to the photoelectric cell caused by one part of the component as the spot passes across it is diluted by the exactly opposite variation in flux caused by another part of the component. Thus the spot acts like a low-pass filter and attenuates the finer or higher-frequency components. A comparison of the amplitude and phase characteristics of a rectangular spot and an actual electrical low-pass filter is shown in Fig. 9, where it is seen that these two are in a general way very similar, with regard to attenuation, though different with regard to phase shift. It might be expected that by changing the shape of the spot it would be possible to effect changes in its filtering action, but the curves of Fig. 10, for a variety of spot shapes, show that for spots

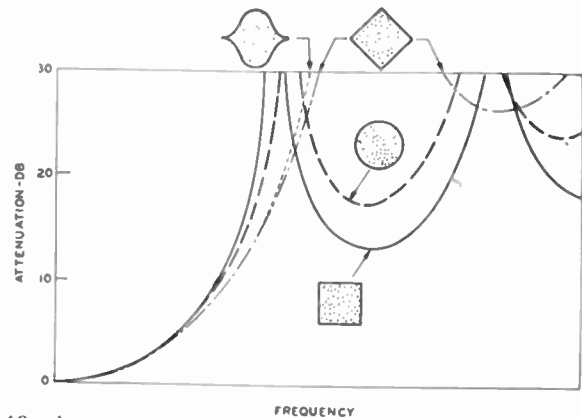

Fig. 10—A comparison of the filtering action of various scanning spots. Marked effect occurs only in the suppressing region.

of any reasonable shape only rather mild changes in filtering action can be obtained in the useful, or pass region of the filter, although radical enough changes can be effected in the suppressing region. It is found that the scanning spots at both the sending and receiving ends act like separate individual filters and the total filtering action obtained is the sum of the two in tandem. To this is to be added whatever selective action, both with regard to amplitude and phase, exists in the electrical circuit which joins the mechanisms and which has so far been considered distortionless.

This filtering action is substantially like that obtained by an ordinary optical system of lenses and mirrors. With such a system to transmit an image from one plane to another, a mathematical point in the original image is translated as a finite and more or less circular patch of light, called a "circle of confusion" in the final image. The blurring which this causes is exactly similar to the blurring or filtering action caused by the scanning spot in the television system.

Examination of the suppressing region of the scanning-spot characteristic in Figs. 9 and 10 discloses a succession of regions in which the suppression is very mild. This causes a somewhat peculiar phenomenon occasionally observed, especially when working with optical simulations of television images.⁹ When the picture pattern or a portion of it consists of a number of closely spaced vertical bars, something like the +4,0 pattern in Fig. 3, or finer, it is found, as to be expected, that as the spacing is made very close, the lines disappear. However, if the spacing be made still closer, the lines are found to reappear, faintly but fairly distinctly. If the pattern actually consists of a single set of gradually converging bars, the effect obtained is that of sharp bars at the coarse end of the wedge which blur at a given point and then reappear on the finer side of this point. Close inspection of the pattern, however, shows that they undergo a phase change in passing through the blurred region—namely, that a black bar on the coarse side turns to a white bar on the fine side, and vice versa. This corresponds, of course, to the 180-degree phase shift indicated in the lower part of Fig. 9. The contribution of these frequency components to the

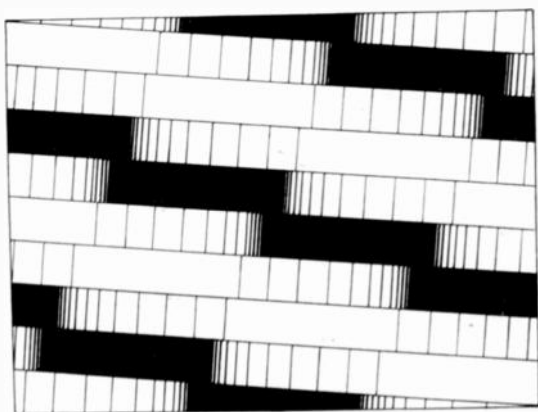

Fig. 11—The picture received from progressive scanning of component *A* in Fig. 6. Component *B* of that figure appears as a strong extraneous pattern.

quality of the picture depends upon the pattern in the latter. In the parallel- or almost-parallel-bar pattern discussed above, the component appears practically alone, and the eye is not very sensitive to any change in phase which may exist. However, in the more usual case where the component appears together with com-

⁹ R. E. Graham and F. W. Reynolds, "A simple optical method for the synthesis and evaluation of television images." Presented, Sixteenth Annual Convention, New York, N. Y., January 11, 1941.

ponents of other frequencies, its addition in the wrong phase may actually degrade the picture instead of enhancing it.

With respect now to the impairment caused to the received picture by confusion between Fourier components the situation is about as follows: As has been described above a single Fourier component in the line signal can be generated by any one of several otherwise quite different picture components in the original picture. When the receiving apparatus receives this

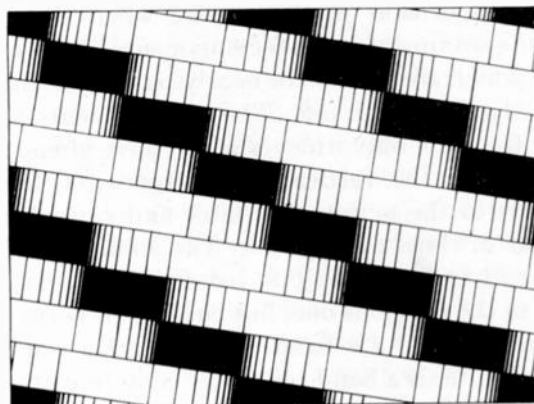

Fig. 12—The picture received from interlaced scanning of component *A* in Fig. 8. Component *B* appears as a strong extraneous pattern.

line signal, it obviously has no information by which it can decide which of these several different picture components actually caused the line component observed. What the apparatus does under these circumstances is then to reproduce every component of the original picture which could possibly have generated it, and superimpose these all together in the received picture. While doing this the receiving scanning spot gives the individual filtering effect to each of these components that it would receive if it actually represented the correct picture. An illustration of this action is seen in Fig. 11, which shows the kind of picture reproduced at the receiver when component *A* in Fig. 6 is exhibited to the television system at the sending end. An outstanding pattern introduced which did not exist in the original picture is obviously component *B* of Fig. 6. Further, component *A* itself, which falls in the highly attenuating region of the equivalent scanning-spot filter in Fig. 9, has practically disappeared. When component *A* is exhibited to a system using interlaced scanning, as was illustrated in Fig. 8, the ultimate reproduced picture is indicated in Fig. 12. Here the extraneous pattern introduced is component *B* of Fig. 8, and again component *A* itself has substantially disappeared.

The effect of this signal confusion is, therefore, to introduce into the reproduced television picture patterns which did not at all exist in the original. In most cases these spurious patterns, though annoying, are more or less minor, such as the serration of diagonal lines, but occasionally and particularly for regular fine-grained patterns in the original, which will tend of

themselves to be much attenuated, an entirely new picture may be produced. Occasional instances can arise in which the conditions, including an exact registry between the original and the scanning lines, are such that the extraneous pattern has just the right phase and amplitude to reduce the over-all distortion in the reproduction. This is very rare, however, and in a general way the signal confusion and resulting spurious pattern contributes an additional impairment to the faithfulness of reproduction of the image.

The extraneous components are most effective in causing impairment in the picture when they result from the scanning of original components like A in Figs. 6 and 8 which are parallel or nearly parallel to the horizontal edges of the frame. These components are not exempt from the impairments which have already been described (for the vertical-line components) as being analogous to the action of a filter and caused by the finite size of the scanning spot. The analogous filter in the present case, for the $0,n$ band, is a low-pass filter similar to the previous one, but cutting off between the $0,n$ band and the $1,n$ band. For the other bands the analogous filter is a band-pass filter centering about the peak component in the band (index $m,0$) and attenuating as the adjacent band is reached in each direction. The over-all effect of the scanning-spot size across its direction of travel is a sort of comb filter having pass bands at the multiples of the line-scanning frequencies and suppression bands between these. This tends to accentuate the peaked characteristic of the frequency spectrum which has already been remarked upon.

Circuit characteristics of a selective nature also have an influence upon picture components nearly parallel to the X axis. In practice those of appreciable effect are usually confined to the $0,n$ band, and the effects most often found are analogous to a high-pass filter; namely, the components with low values of n are attenuated too much or suffer phase-shift distortion as compared with the remainder of the signal.

From the discussion which has just been given it will be seen that details in the original picture made up of vertical lines (more or less perpendicular to the direction of scanning) will be impaired in the reproduction by the finite size of the scanning spot along the direction of scanning and by frequency-band limitation in the electrical circuit. Detail made up of horizontal lines (more or less parallel to the direction of scanning) will be impaired chiefly by the size of the spot across the direction of scanning and by extraneous patterns. The impairments in these two directions are enough different to make it impossible to establish a ratio between them which holds as the original subject is changed. This is borne out by extensive discussions on this subject.^{2,3,10-13} The condition which is particularly ob-

trusive here is when a flat field, with no brightness change, in the original leads to a well-defined pattern of scanning lines in the reproduction. This is caused by a receiving light spot which is so shaped that adjacent scanning lines leave a gap, or show a bright streak, between them.

In spite of the differences in the nature of the impairments, there is a possibility, when not too highly specialized original pictures are used and when the obtrusive pattern reproducing a flat field is reduced enough, of making a reasonably stable subjective comparison.¹³ By this means there is a possibility of finding out how much additional impairment is contributed by the extraneous pattern. It must be expected, however, that this determination will be appreciably altered when a highly specialized test pattern is used for the original picture. It can also be expected to vary according to how many factors the observer is trying to balance, namely, whether he is only looking for a degradation in sharpness of the image or whether he is including annoyance effects with this.

A further question which has received extensive discussion^{3,10-13} is how the impairments in the two principal directions should be proportioned. Experimental work on subjective choices based on the apparent sharpness of the viewed image leads to the conclusion that this proportioning about a condition of equality for the two directions is not very critical.¹³

As has been described previously the points of minimum signal energy and maximum attenuating effect of the scanning spots lies about halfway between the multiples of the scanning-line frequency. In present standard television systems these are separated by over 15,000 cycles per second. It is interesting to note that it is possible to insert entirely independent communication channels in these spaces. A particular use for these has been as pilot-wire channels on wire-line television circuits.¹⁴ This is done without visibly affecting the television picture at all.

The points which have been discussed above cover particularly the relationship between the scanning process and the reproduction of detail. There are, however, additional effects which manifest themselves more as an over-all effect on the picture, and which will be briefly discussed now. These effects follow from the principal distinctions between the direct viewing of a scene, and viewing it through the medium of a television system using a scanning process. The obvious difference is, of course, that the television viewing is intermittent instead of continuous. It is complicated by the fact that the glimpses in the intermittent viewing do not occur at the same instant for all portions of

¹⁰ R. D. Kell, A. V. Bedford, and M. A. Trainer, "An experimental television system—The transmitter," *Proc. I.R.E.*, vol. 22, pp. 1246-1265; November, 1934.

¹¹ J. C. Wilson, "Channel width and resolving power in television systems," *Jour. Telev. Soc.*, vol. 2, pp. 397-420; June, 1938.

¹² R. D. Kell, A. V. Bedford, and G. L. Fredendall, "A determination of optimum number of lines in a television system," *RCA Rev.*, vol. 5, pp. 8-30; July, 1940.

¹³ M. W. Baldwin, "The subjective sharpness of simulated television images," *Proc. I.R.E.*, vol. 28, pp. 458-468; October, 1940.

¹⁴ M. E. Strieby and J. F. Wentz, "Television transmission over wire lines," *Bell Sys. Tech. Jour.*, vol. 20, pp. 62-81; January, 1941.

the field of view. It is still further complicated by the fact that the glimpses of successive portions of a vertical line (when the scanning lines run horizontally) do not proceed continuously along this line, but jump intermittently from one portion to another. The pattern here is a little more complicated for interlaced scanning than it is for progressive scanning.

For simplicity in the discussion the effects can be studied with several elementary types of picture, namely (a) an original which is still, (b) an original in which there is no motion, but in which the brightness varies, and (c) an original which shows motion without variations in average brightness. Two further elementary subdivisions of (b) and (c) can be made according to whether the change is smooth and continuous in one direction or whether it is cyclic.

For a still picture the effect of intermittent viewing is obviously to produce possibilities of flicker. For normal viewing this is not particularly affected by different parts of the field being seen at different times, but blinking may reveal it. The discontinuous scanning jumps along a vertical line produce the very extraneous patterns which have been described above at some length.

For the second type of original, with no motion but with brightness changes, the intermittent viewing makes these jumpy where they were previously continuous, and introduces "stroboscopic flicker" if they were cyclic. "Stroboscopic flicker" means flicker at a frequency which is a beat between the frequency of cyclic variation of the original brightness and the frequency of the glimpses in the intermittent viewing. The fact that different parts of the field are glimpsed at different times means that the whole field will not show jumpy changes or flicker simultaneously. Instead the effect is spread out in space and gives rise to stationary or moving bands across the picture. The fre-

quency of change or flicker of the original brightness is practically likely to be fairly low, as compared, for example, to the scanning-line frequency, so that these bands are in turn likely to be fairly broad (as compared again to the width of a scanning line). Under these conditions there are no particular further effects caused by the discontinuous nature of the scanning along a vertical line.

For the third type of original, which shows motion but no brightness changes, the intermittent viewing makes the motion jerky where previously continuous. Where previously cyclic, it gives the real stroboscopic effect, in which the motion occurs at a new cyclic frequency which is a beat between the original frequency and the frequency of the glimpses. Glimpsing different parts of the field at different times leads to a geometrical distortion of the moving object for either type of motion. The discontinuous nature of the scanning along a vertical line, as in the case of a still, produces extraneous patterns. The motion of the original, however, now causes these to move, but this will in general be with a different velocity, both in magnitude and direction. An additional effect will be produced on an interlaced system when the eye roves over the picture to follow actions occurring in the picture. This effect is that though the interlace in the physical received picture may be perfectly accurate, and the odd-line screen fit exactly into the even-line screen, the motion of the eye may prevent this exact fit from taking place on the retina. This leads to the appearance, then, of an imperfect interlace.

All of these effects on the picture as a whole will vary individually in intensity according to conditions. In particular, in many cases they can be below the threshold of vision. It is the mark of good design from a subjective point of view to have them at least not obtrusive.

A Commercial 50-Kilowatt Frequency-Modulation Broadcast Transmitting Station*

H. P. THOMAS†, ASSOCIATE, I.R.E. AND R. H. WILLIAMSON†, ASSOCIATE, I.R.E.

Summary—A 50-kilowatt frequency-modulation broadcast transmitting station is described. The entire equipment was designed considering simplicity and reliability to be of prime importance. The transmitter consists of a 250-watt exciter, a 3-kilowatt intermediate power amplifier and a 50-kilowatt power amplifier completely self-contained except for the main-rectifier plate transformer, water-cooling unit, and console. Most of the performance characteristics of the transmitter, including fidelity, noise level, and frequency stability, are determined in the exciter unit, where several novel features are incorporated for producing the excellent performance obtained. The 3-kilowatt intermediate power amplifier utilizes forced-air-cooled triodes, while water-cooled triodes are used in the power amplifier. Both tube types are of a new design especially suited to ultra-high-frequency service. An inverse feedback circuit is provided around the final ampli-

fier stage, grid-modulating this stage so as to cancel filament hum. A new design of 3-bay turnstile antenna is fed by a pair of 2½-inch concentric-tube radio-frequency transmission lines. Field strength contours are given to show the coverage expected from the new transmitter, which is located at a high elevation in the Helderberg Mountains west of Albany so as to give line-of-sight transmission to most of the area to be served.

INITIAL CONSIDERATIONS

AFTER the delivery of Armstrong's monumental paper¹ on frequency modulation, the General Electric Company began an extensive re-examination of frequency modulation as applicable to high-frequency broadcasting, and became convinced that

¹ E. H. Armstrong, "A method of reducing disturbances in radio signaling by a system of frequency modulation," PROC. I.R.E., vol. 24, pp. 689-740; May, 1936. Presented, New York meeting, November 6, 1935.

* Decimal classification: R612.1. Original manuscript received by the Institute, April 2, 1941; revised manuscript received, July 18, 1941. Presented, Sixteenth Annual Convention, New York, N. Y., January 11, 1941.

† Radio Transmitter Engineering Department, General Electric Company Schenectady, N. Y.

the system provided outstanding advantages. Extensive field tests^{2,3} were conducted including common-frequency interference measurements, adjacent-channel interference measurements, and reception tests in moving automobiles and airplanes.

On December 12, 1938, the General Electric 150-watt high-frequency broadcast station W2XOY, located on top of the State Office Building at Albany, New York, started experimental transmissions of alter-



Fig. 1—General Electric frequency-modulation and television transmitter station in the Helderberg Mountains near Schenectady, N. Y.

nate frequency-modulation and amplitude-modulation programs on 41 megacycles. These programs were regularly scheduled several hours each week.

When it seemed probable that the Federal Communications Commission would eventually grant licenses to frequency-modulation broadcasters and that suitable home receivers would become commercially available at moderate prices, the need for a frequency-modulation broadcast station operating more hours per week on regular schedules became apparent. Such a station would serve as a proving ground for transmitter and receiver designs and would permit the new studio technique necessary for extremely high fidelity programs to be evolved more or less painlessly, before the listening audience became large. The development of a nucleus of a listening audience also seemed desirable against the day when frequency-modulation broadcasting might be placed on a commercial basis, dependent upon advertising revenue for its existence.

Accordingly, arrangements were made to install a 250-watt frequency-modulation transmitter in the same building with the General Electric television station in the Helderberg Mountains, west of Albany, New York, and overlooking the New York State Capitol district (Fig. 1). This transmitter went on the air with an experimental license for 43.2 megacycles on February 6, 1940, with call letters W2XOY. The licensed power was increased to 1 kilowatt June 13, 1940, and to 2.5 kilowatts (with 3 kilowatts installed capacity) on September 11, 1940.

A 50-kilowatt amplifier is installed in a recently con-

structed addition to the Helderberg station. The 50-kilowatt transmitter may be operated into a dummy antenna, although it is hoped that authority may be obtained to operate on the air at this higher power level. The construction and installation of the transmitter are suitable for commercial service.

GENERAL CIRCUIT DESIGN

All units of the 50-kilowatt transmitter are capable of being adjusted to any operating frequency in the 42- to 50-megacycle high-frequency broadcast band. The circuit efficiencies change very little over this frequency range.

The equipment which is described in this paper comprises a basic exciter unit which will deliver 250 watts of power in the 42- to 50-megacycle band, and two class C amplifier stages which raise this power level without any change of frequency to 50 kilowatts delivered to the output load. Most of the performance characteristics of the equipment are determined in the 250-watt exciter unit.

The system of frequency modulation lends itself ideally to the use of a transmission system employing low-level modulation and class C amplification. The use of class C amplifiers results in high-efficiency operation of the tubes and a relatively large power gain per stage. Performing the modulation process at a fairly low power level makes the problems of frequency stability simpler and permits modulation with small amounts of audio power. Thus the design of a high-power transmitter reduces to the design of a low-power modulation system which will give the required modulation characteristics and frequency stability; frequency-multiplier stages to raise the frequency to that of the final carrier; and a series of class C amplifier stages which will build up the power level to that required at the output.

It is desirable from the point of view of reducing the number of units required for a complete line of transmitters of various ratings to reach final frequency at a power level small enough to be suitable for the lowest-powered transmitter desired in the line. The power output ratings of a line of transmitters should be so chosen that the higher-powered amplifiers may be economically driven by lower-powered transmitters in the "standard" line; ordinarily the desirable ratio of driving power to output power is about 1 to 15. No output rating should be established that does not provide an appreciable increase in service over that of the next lower rating; power-increment ratios of at least 3 to 1 are desirable. Ratings found desirable on the above bases must be then adjusted to the availability of suitable vacuum tubes, the desirability of using not more than two tubes in the final radio-frequency stage and the avoidance of "mongrel" ratings. After careful consideration of these several related factors, the exciter and amplifier output ratings shown in Fig. 2 were established for manufacture.

² I. R. Weir, "Field tests of frequency- and amplitude-modulation with ultra-high frequency waves," *Gen. Elec. Rev.*, vol. 42, pp. 188-191; May, 1939; pp. 270-273; June, 1939.

³ I. R. Weir, "Tests of F-M for aircraft communication," *Electronics*, vol. 13, pp. 34-35, 92; November, 1940.

PHYSICAL LAYOUT

The 50-kilowatt Helderberg transmitter is composed of five self-contained units placed with their front panels in line, as shown in Fig. 3. The units are styled to harmonize with each other. These units are, left to right, a 250-watt exciter, 3000-watt intermediate-power amplifier, 50,000-watt power amplifier, main rectifier for the power amplifier, and a relay and contactor control unit.

components for inspection and maintenance. It is possible to obtain access to any component without disassembly or removal of wiring. The greatest single contributing factor in this improved accessibility is the use of "vertical chassis" construction wherever possible. Vacuum tubes, transformers, etc., are mounted on the front of this vertical chassis or panel and extend horizontally from it, while terminals, wiring, small components and radio-frequency circuits extend to the

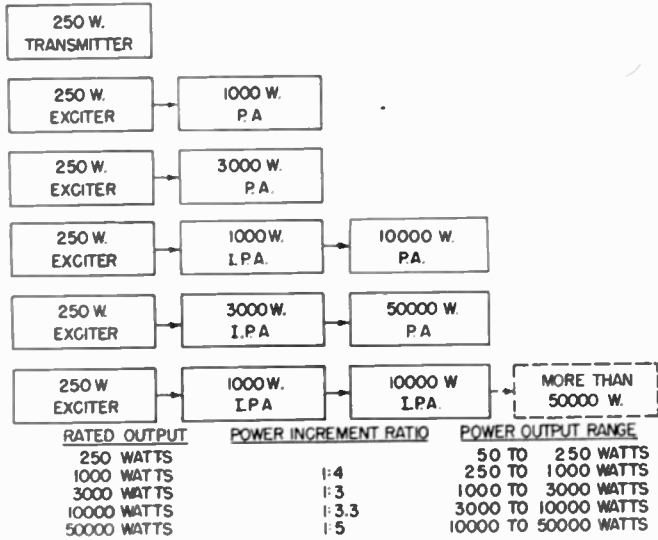

Fig. 2—General Electric frequency-modulation transmitter ratings.

In addition there are three external units: the plate transformer, water-cooler assembly, and the operators' desk or console.

All units are designed for maximum accessibility of

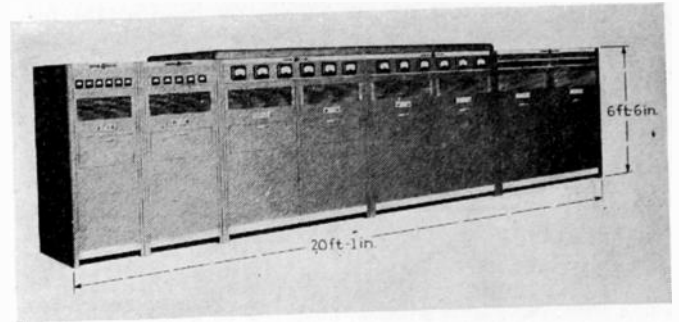

Fig. 3—50-kilowatt frequency-modulation broadcast transmitter.

rear of the vertical chassis. Thus all parts may be reached through either the front or rear access doors.

POWER SUPPLY

The substation requirements for this transmitter are much simpler than for an amplitude-modulated transmitter, since there is no change of load at syllabic frequency to cause power-line regulation difficulties. Of course, reliability is of equal importance in the two cases. The 250-watt exciter operates from a 115-volt,

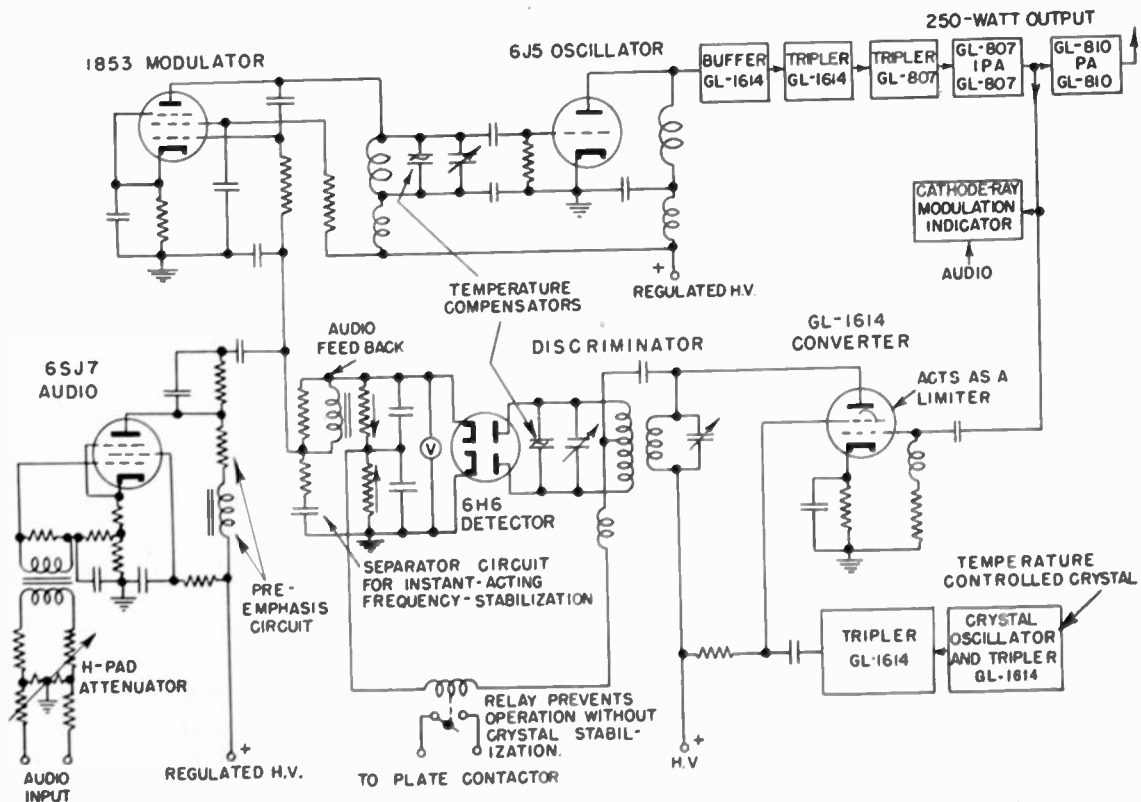

Fig. 4—Simplified schematic diagram for 250-watt frequency-modulation broadcast exciter.

single-phase, 60-cycle power supply and requires 1.25 kilowatts at 90 per cent power factor to produce rated output. The remainder of the transmitter operates from a 230-volt, 3-phase, 60-cycle power supply. The total power required at this voltage is slightly less than 120 kilowatts at 95 per cent power factor, and of course does not change with percentage modulation.

250-WATT EXCITER UNIT

The exciter unit employs the principle of direct frequency modulation of an oscillator having its mean

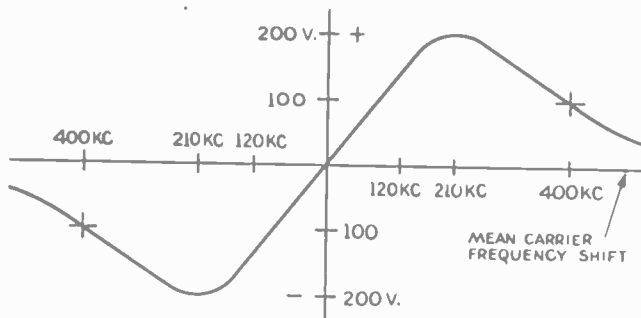

Fig. 5—Discriminator characteristic.

frequency stabilized by a crystal (Fig. 4). The basis of this system of modulation is the use of a reactance tube as a modulator. The reactance tube is merely a tube of the screen-grid type which has its plate circuit connected across the oscillator tank circuit, and has some radio-frequency voltage applied to its grid through a phase-shifting circuit so that the grid is excited 90 degrees out of phase with the radio-frequency voltage on the plate. Now the plate current of a screen-grid tube is practically independent of the plate voltage, but varies with the control-grid voltage, so the radio-frequency plate current drawn by the tube will be 90 degrees out of phase with its plate voltage. Consequently the tube will appear as a pure reactance to the oscillator frequency-determining tank circuit. By applying an audio-frequency voltage to the grid, the plate current of the modulator tube will vary also at an audio-frequency rate and thus produce a modulation of the frequency of the oscillator corresponding to the audio voltage applied to the grid.

Since a plain oscillator will not give the frequency stability required for a high-frequency broadcast transmitter, a feedback circuit is employed to compare the average carrier frequency with that of a crystal oscillator and apply a correcting voltage to the modulator grid proportional to the deviation of the frequency from this standard. The action of this feedback is exactly the same as that obtained with audio feedback; the improvement in carrier-frequency stability is proportional to the loop gain $\mu\beta$, where, in this case, μ is the kilocycle change in carrier frequency caused by 1 volt change of modulator grid voltage, and β is the number of volts developed by the frequency-comparison circuit for 1-kilocycle carrier frequency change.

In order to produce a direct voltage from a frequency

deviation, a frequency-comparison circuit is used, consisting of a crystal oscillator, mixer tube, discriminator, and detector. The mixing of the transmitter and crystal outputs produces an intermediate frequency which is applied to the discriminator. The discriminator is the same as the type of circuit commonly used in receivers for automatic frequency control, and produces an output voltage proportional to the deviation of the carrier frequency from the assigned value. The output of this circuit will consist of a direct current having a magnitude and sign dependent upon the deviation of the mean carrier from the assigned frequency, and audio-frequency components resulting from the demodulation of the frequency-modulated signal. This combined signal is passed through a network which passes the direct-current component with no attenuation, and passes frequencies from about 20 to 1000 cycles with approximately 20 decibels attenuation. Frequencies above 1000 cycles are attenuated still further in accordance with a 100-microsecond de-emphasis curve. The output of this network is applied to the modulator grid as a degenerative signal. The result of this feedback is that the direct-current component improves the frequency stability of the oscillator by a factor of approximately 100, which assures an over-all carrier stability of ± 1000 cycles. Frequencies in the lower audio-frequency range, where most of the noise due to power-supply ripple will be found, are degenerated about 15 to 1, so that an over-all noise level of better than 70 decibels below ± 75 -kilocycle modulation can be obtained. Of course, in order to have the frequency correction independent of modulation and to prevent the introduction of distortion by the audio feedback, the discriminator circuit must be linear over a range of frequencies somewhat greater than that employed in normal modulation. The circuit employed in this transmitter has peaks separated by 420 kilocycles, resulting in a linear region sufficient to permit modulation of ± 100 kilocycles with less than 2 per cent distortion from the transmitter (less than 1.5 per cent up to ± 75 kilocycles) with sufficient margin to take care of the requirements of frequency correction of the carrier as well (Fig. 5). A zero-center direct-current voltmeter is connected across the output of the discriminator for tuning, and some of the audio output is used to operate a cathode-ray-tube modulation indicator.

A relay is connected to the discriminator in such a way that any failure of the frequency-correction circuit will cause the relay to drop out and shut down the transmitter, thus preventing any possibility of operation of the transmitter without the frequency stabilization.

Audio voltage is supplied to the modulator from a single audio-amplifier tube which incorporates an inductance-resistance pre-emphasis network in its plate circuit. The over-all audio-frequency response is within ± 1 decibel of the desired Federal Communications Commission 100-microsecond pre-emphasis standard from 30 to 16,000 cycles.

The oscillator output passes through a class A buffer stage, two tripler stages, and a push-pull intermediate power amplifier to the 250-watt output stage. Sufficient power-supply filter is provided to reduce the amplitude ripple of the carrier to more than 60 decibels below 100 per cent amplitude modulation.

Only the output stage requires neutralization, which may be accomplished by means of an insulating rod. Once the circuit is neutralized, no further adjustment is necessary for any frequency in the band or when tubes are changed.

Natural-draft ventilation is provided.

No temperature control is necessary, except inside the crystal thermocell. However, temperature-compensated capacitors are provided for the oscillator tank circuit and the discriminator secondary circuit.

A 2.5-ampere, panel-mounted radio-frequency ammeter indicates the output current when this 250-watt exciter is used as a transmitter. This instrument was recently developed specifically for this application. A suitable high-frequency thermocouple is connected directly in the radio-frequency circuit, while the direct current for operating the indicating instrument is conducted through external leads which are effectively isolated from radio-frequency voltages by radio-frequency choke coils inside the thermocouple assembly. The measured over-all accuracy over the frequency range 42 to 50 megacycles is within 2 percent of full scale.

In addition to the radio-frequency output ammeter, indicating instruments are provided for the filament voltage, plate voltage (output stage), frequency deviation (discriminator direct-current output), and two plate milliammeters with transfer switches.

3-KILOWATT INTERMEDIATE POWER AMPLIFIER

This unit contains mountings for two type GL-8002-R forced-air-cooled triodes (Fig. 6) operating as class C amplifiers in a balanced push-pull circuit. This tube was specially developed for high-frequency broadcasting and television service. Its plate dissipation is 1200 watts. It may be operated at its maximum input rating up to 120 megacycles and at reduced input up to 200 megacycles. Small dimensions make possible the short connecting leads and symmetrical circuits so essential to stability at high frequencies. In order to reduce common-inductance effects which make neutralizing difficult and may introduce parasitic oscillations, this tube has three grid leads and a center-tapped filament, making possible low-impedance radio-frequency paths.

The input excitation circuit to the 3-kilowatt amplifier is inductively coupled to the grid tank circuit. The output circuit is inductively coupled to the plate tank circuit with a loading control provided for variation of coupling with power applied.

The two neutralizing capacitors are adjustable with power on by means of an insulating rod.

Forced-air cooling for the amplifier tubes is furnished

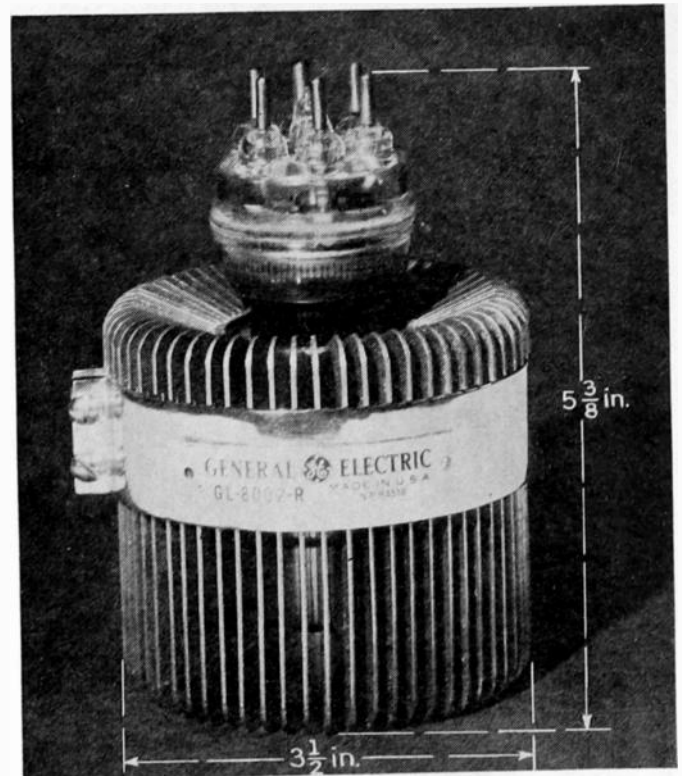

Fig. 6—Type GL-8002-R transmitter tube.

by a rubber-mounted centrifugal blower located directly below the tubes. This blower draws air through a glass-wool filter and forces the cleaned air upward through a heavy fabric duct which feeds each of the cooling radiators equally. The cooling fins on the radiators were especially designed to reduce air-rush noise to a minimum. The radiators are at plate potential and are insulated from the ground by hollow ceramic insulators which form air passages between the fabric duct and the finned radiators. A large grating in the top of the cabinet allows the heated air from the radiators to be expelled from the cabinet.

Filament voltage is obtained from a 3-phase to a 2-phase Scott-connected transformer, with one amplifier filament on each phase. This transformer has high reactance so as to limit the filament starting current to a safe value. The filament center tap on the tube is used for radio-frequency plate-current return, but not for heating current.

The plate voltage of approximately 3300 volts is obtained from a conventional 3-phase, full-wave rectifier utilizing 6 Type GL-872-A hot-cathode, mercury-vapor rectifier tubes. Bias voltage is a combination of grid leak and cathode self-bias.

Indicating instruments are provided for the filament voltage, grid current, plate voltage, total plate current (with provision for switching instrument to either tube), and the radio-frequency output current.

50-KILOWATT POWER AMPLIFIER AND MAIN RECTIFIER

This unit contains mountings for two type GL-880 water-cooled triodes (Fig. 7) operating as class C

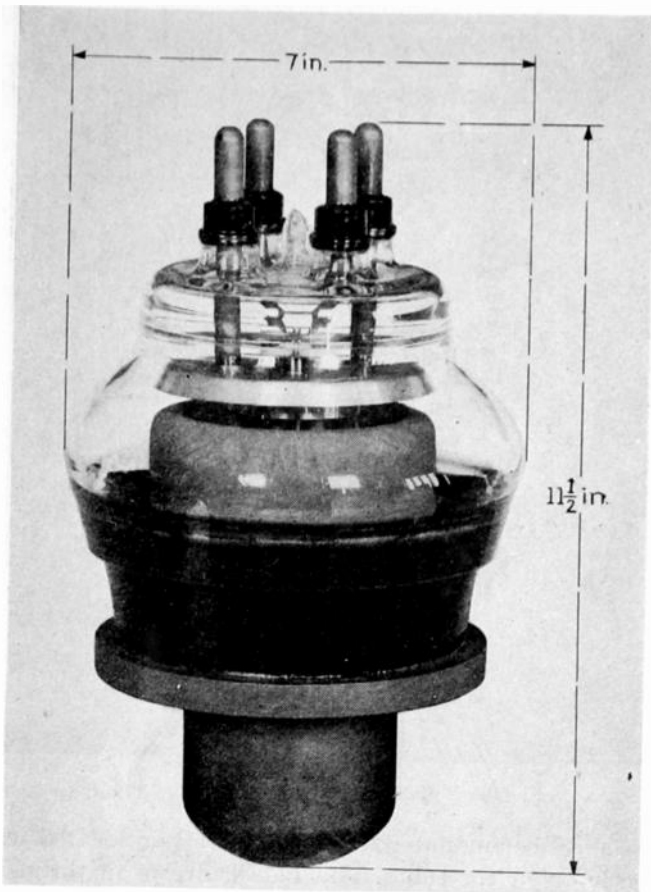

Fig. 7—Type GL-880 transmitter tube.

power amplifiers in a balanced push-pull circuit. This tube was specially developed for high-frequency broadcasting and television service. It may be operated at its maximum input rating up to 25-megacycles, 75 per cent input to 50 megacycles (class C telegraph rating), and at further reduced input up to 100 megacycles. The tube has the new re-entrant anode, which makes possible extremely small size for the plate dissipation rating of 20,000 watts. The internal lead length has been reduced 10 inches as compared with conventional designs. The small tube size permits relatively short connecting leads and symmetrical circuits. This vacuum tube has double grid terminals to reduce common inductance effects.

The input excitation circuit from the 3-kilowatt amplifier is coupled directly to the grid tank circuit of the 50-kilowatt power amplifier through blocking capacitors. The grid tank circuit is a half-wave, open-circuited transmission line shunted by a variable tuning capacitor at the end remote from the tubes. The plate tank circuit is a quarter-wave resonant transmission line with adjustable shorting bar and a "trimmer" variable capacitor. The grid and plate variable capacitors are provided with front-of-panel controls to permit precise tuning with power applied. The output circuit is inductively coupled to the plate tank circuit, with provision for variation of both tuning and coupling of the output circuit from the front panel.

The two neutralizing capacitors are adjustable with power on by means of an insulating rod.

Cooling water for the vacuum tubes is applied at the low radio-frequency voltage end of the transmission-line plate tank circuit so that the insulating water columns have to withstand only the direct voltage of approximately 7500 volts. These insulating columns are provided in U-shaped runs through Pyrex glass. The water pump, radiator-blower-type heat exchanger, and distilled-water storage tank are combined in a single assembly, external to the transmitter. In this assembly, space is provided for a spare water pump which may be added at some future time.

A blower provides forced-air cooling of the power-amplifier tube grid and filament seals. Another blower in the rectifier unit furnishes cooling air to the lower portion of the glass envelope of each active rectifier tube so that mercury condensation near the bottom of each tube is assured.

Filament voltage is obtained from a 3-phase to 2-phase Scott-connected transformer, with 1 power-amplifier filament on each phase. This transformer has high reactance so as to limit the filament starting current to a safe value.

The 90-degree phase displacement of the filament-heating current of one tube with respect to that of the other tube materially reduces amplitude-modulated "filament hum" on the carrier. However, the heating current of 320 amperes necessary for each power-amplifier tube magnetically produces amplitude "hum" modulation to a degree which might prove objectionable under some conditions of operation. To improve this situation, a simple feedback circuit is provided to cancel partly the filament hum and any other amplitude-modulated noise which may be present. The feedback circuit consists of a diode radio-frequency rectifier, inductively coupled to the plate tank, followed by a 2-stage resistance-capacitance-coupled audio amplifier, the output of which is connected across the power-amplifier grid-leak resistors with proper polarity for hum cancellation. This grid modulation is possible due to the fact that the power-amplifier grid circuit is driven to slightly less than complete saturation. The use of the feedback amplifier also results in a decrease in the size of the main-rectifier filter. The amplitude-modulated noise is at least 60 decibels below 100 per cent amplitude modulation.

The direct-current output of the diode rectifier is also used to energize a relay operating a "carrier-off" alarm and "time-of-carrier-off" electric clock.

Plate voltage for the power amplifier is furnished from a 3-phase, full-wave rectifier utilizing 6 Type GL-869-B hot-cathode, mercury-vapor rectifier tubes mounted in a separate unit.

The circuit is conventional except that a 3-phase filament supply is used with 2 filaments on each phase; the filament circuits are phased out with respect to the plate circuits in such a manner that the filament voltage

on each tube passes through zero approximately at the center of the firing-time angle. Such a condition causes the load-current electrons to be drawn uniformly from the entire length of the filament rather than predominantly from one end. The rectifier output rating is 7.5 kilovolts, 12 amperes; this current rating is appreciably higher than would be possible with conventional single-phase filament heating. A spare rectifier tube is maintained at operating temperature in the "heater" position ready for immediate replacement of any active rectifier tube. This "heater" position is non-interlocked so as to assure minimum interruption of program time in case of tube replacement. The external plate transformer has primary tap switches to permit initial testing of tubes at 50 per cent voltage and to provide correct plate voltage at low, normal, or high line voltage. This plate transformer is available also with nonflammable Pyranol for cooling, which will permit indoor installation without a specially constructed fire vault.

To permit maximum continuity of operation, two solenoid-operated "cutback" switches are provided to permit the operator to transfer instantly the antenna feed circuit from the output of the 50-kilowatt amplifier to that of the 3-kilowatt amplifier in case servicing operations in the high-power units are necessary during normal program time. An operator may, with complete safety, enter the high-power units while operating "cutback" to 3-kilowatt power.

Normal operating bias is obtained from a separate adjustable grid leak for each power-amplifier tube. A small bias rectifier located in the main rectifier furnishes sufficient "holding" bias voltage to limit the plate dissipation to a safe value in case excitation is lost.

A panel-mounted radio-frequency ammeter indicates the output current to the radio-frequency transmission line. The instrument is used in conjunction with a new design of radio-frequency current transformer and high-frequency thermocouple located in the radio-frequency circuit. The current transformer and thermocouple are assembled inside a shielded enclosure, which also houses the gastight terminations for two $2\frac{3}{8}$ -inch coaxial lines. The accuracy of the instrument is not affected by the proximity of objects which may be adjacent to the current transformer.

Other instruments on the power-amplifier and rectifier units measure the two power-amplifier grid currents, the two power-amplifier plate currents (including grid current), power-amplifier filament voltage, total power-amplifier plate current, power-amplifier plate voltage, rectifier filament voltage, line voltage, rectifier line current, bias rectifier voltage, power-amplifier tube hours, and the rectifier tube hours.

CONTROL CIRCUITS

All power circuits of the transmitter are operated by a control system which permits either manual step-by-

step startup and shutdown, semiautomatic control, or completely automatic control. The various control circuits are interlocked so that each successive operation must take place in its proper sequence. Complete protection to apparatus and operating personnel is provided by the control system.

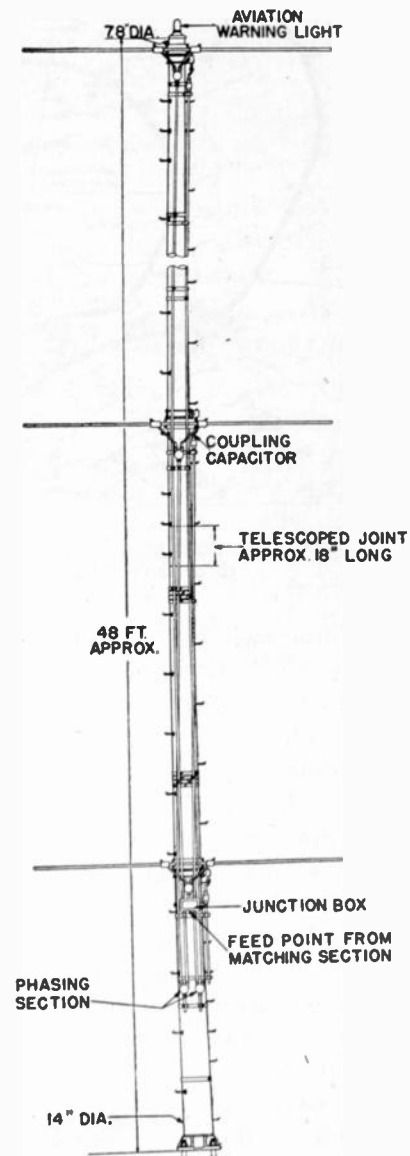

Fig. 8—Three-bay turnstile antenna.

The control system provides protection to apparatus from the following types of misoperation: overheated cooling water, stoppage of cooling water, blower failure, radio-frequency tube overcurrent (each tube in 3-kilowatt and 50-kilowatt units), direct-current overloads in exciter rectifiers, alternating-current overloads in rectifiers for 3-kilowatt and 50-kilowatt units, and main-rectifier filament undervoltage.

Each tube in the main rectifier has an arcback indicator which enables the operator to determine in which tube an arcback has occurred. These indicators may be reset during operation.

All 230- and 115-volt power and branch circuits are protected by separate, hand-operated, circuit-breaker-

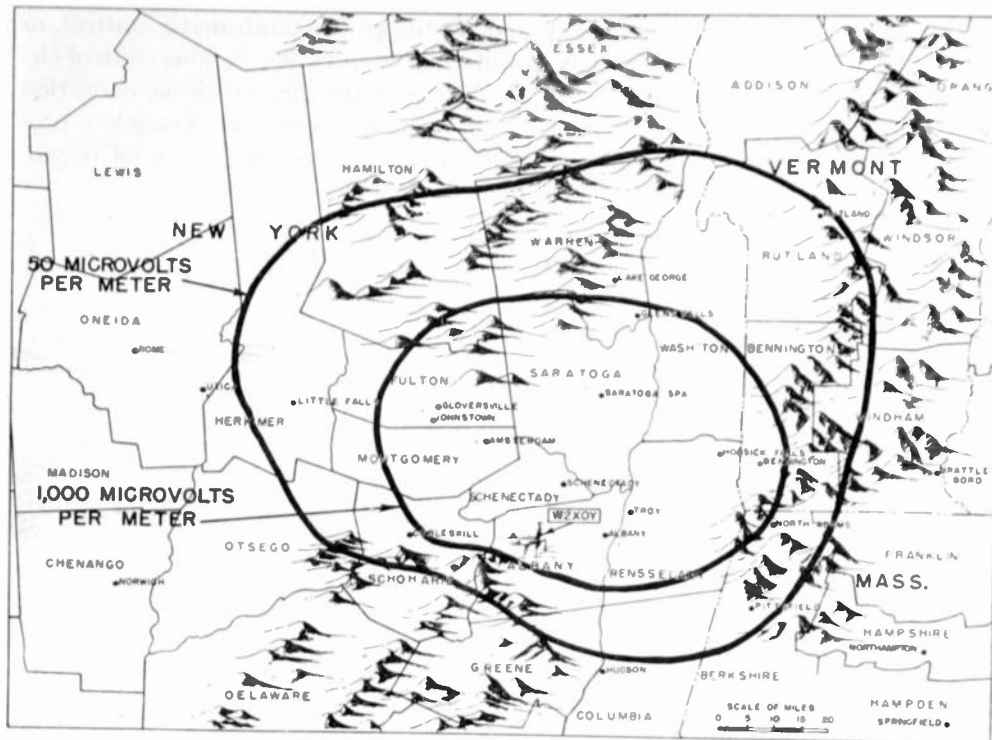

Fig. 9—Field-strength-contour map for W2XOY, adjusted for 50-kilowatt power and directional 3-bay turnstile antenna.

type switches. These switches provide full protection against overloads and short circuits without the use of fuses. When tripped, a switch can be instantly reset from the front panel.

Separate time-delay relays of the Telechron-motor type are used in all three radio-frequency units to prevent premature application of plate voltage; provision is made for a quick tube change in the main rectifier without waiting for the normal delay, when required during operation. Another timing relay maintains air and water cooling on the 50-kilowatt power-amplifier unit for two minutes after operating voltages are removed at transmitter "shutdown."

Each of the various push buttons for transmitter "start-stop" and plate "on-off" has an internal status-indicator light, visible through the colored translucent material of which the button is composed.

When an alternating- or direct-current overload relay operates in any unit, removing plate voltage, a plate-recloser relay automatically reapplies plate voltage immediately (providing plate voltage has been "on" 15 seconds or more before the overload occurs). If a second interrup-

tion occurs within 15 seconds after the first, the plate power must be reapplied manually by the "plate-on" push button. After 15 seconds of normal operation, the recloser device resets itself in readiness for another automatic reclosure.

A separate filament rheostat is provided for each unit of the transmitter, acting as a master rheostat for all tubes in the unit.

OPERATORS' CONSOLE

The panel of the operators' console is assembled as an integral part of a metal desk. The various transmitter-control switches and status-indicator lights on the transmitter panels have their circuits extended to the console to permit centralized control. Controls and instruments for the audio-line volume indicator, frequency monitor, modulation monitor, and aural monitor are also extended to this desk.

Three Telechron clocks are located on the console, so connected that one indicates standard or station time, one indicates time of carrier "off" and the third indicates total time of carrier "off," in case of an outage during normal operation.

SAFETY TO OPERATING PERSONNEL

All high-voltage apparatus is mounted inside

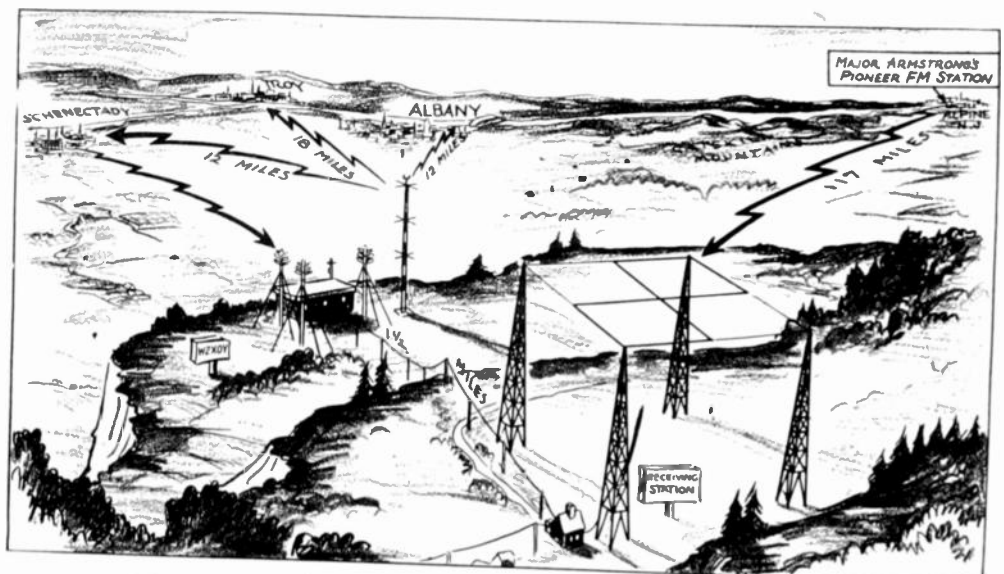

Fig. 10—Frequency-modulation program-relaying routes and broadcast coverage for W2XOY.

grounded metal cabinets with access doors so interlocked as to remove dangerous voltages before doors are opened. The various door interlocks are connected so as to remove plate voltage not only on the unit entered, but also on the next lower-power stage, excepting the special provisions for low-power operation when "cutback" to 3-kilowatt power output. All filter capacitors have adequate bleeders.

As an additional precaution, door-operated, safety grounding switches are provided on the front and rear doors of each transmitter unit which ground the various high-voltage supply leads mechanically whenever a door is opened.

All instruments are in low-voltage circuits as a safety measure.

No bare copper-bus high-voltage leads are required for wiring between the external plate transformer and the rectifier unit, since these high-voltage alternating-current circuits are carried in lead-covered cable attached to the transformer through wiping sleeves.

ANTENNA

The present antenna system (Fig. 8) consists of a 3-bay turnstile, the bays separated vertically by 270 electrical degrees, giving a field gain of about 1.6 as compared to a half-wave dipole antenna. The radiating elements are shunt fed through coupling capacitors from 6 twin-conductor balanced lines. These lines are connected together through phasing sections located on the pole below the antenna proper, and fed from a pair of 2 $\frac{5}{8}$ -inch lines through matching sections. The entire antenna system is mechanically designed to meet the rather stringent requirements of the building code of New York City. The antenna proper is mounted on a short tubular steel section, resulting in a self-supporting pole having a height of 70 feet above ground.

FIELD STRENGTH

The location chosen for this station is near the edge of an escarpment running approximately northwest and southeast. This results in an effective antenna height of 1200 feet to the northeast, in which direction are located the cities of Albany, Schenectady, and Troy, with a combined population of about 300,000, as well as a considerable rural population.

The field strength contours expected from this station are shown on the map of the area (Fig. 9). These calculated contours are based on actual field strength measurements made when transmitting at a lower

power level with a nondirectional single-bay turnstile antenna. Calculations were made to locate the contours shown in Fig. 9 by suitable adjustments for a power level of 50 kilowatts and the use of a 3-bay turnstile antenna modified to produce a slightly directional radiation pattern. However, the unsymmetrical location of the field contours about the transmitter is due largely to the nature of the terrain, as the high hills southwest of the station reduce the field strength in that direction to a low value. While the nondirectional antenna shown in Fig. 8 is now in use, modifications are contemplated to provide the directional pattern used to obtain the field contours shown in Fig. 9. This antenna will be oriented so as to provide maximum radiation slightly east of north, since that is the direction of the principal service area.

SOURCES OF PROGRAMS

The transmitter can be supplied with programs from two sources. The first is the studio, about 12 miles distant in Schenectady, which is connected with the transmitter through a frequency-modulated radio relay link operating experimentally on 161.775 megacycles. The other source of programs is a receiving station located a little over a mile from the transmitter, which is equipped to receive programs from other frequency-modulation stations and send them to the transmitter over a short telephone line. The general scheme of program routing is shown in Fig. 10.

CONCLUSION

The 50-kilowatt transmitter which has been described in the paper is a commercial type of equipment which will meet all the performance requirements for frequency-modulation broadcast service. The operation and control of the equipment has been kept as simple as possible while still maintaining all the features which are customary in standard broadcast equipment. The fundamental basis for the design of the transmitter has been simplicity and ease of maintenance from both a mechanical and electrical point of view.

ACKNOWLEDGMENT

A number of individuals have contributed to the electrical and mechanical design of this transmitter, particularly Howard M. Crosby, J. E. Keister, and M. C. Cisler, all of the radio transmitter engineering department.

Intermediate-Frequency Values for Frequency-Modulated-Wave Receivers*

DUDLEY E. FOSTER†, MEMBER, I.R.E., AND JOHN A. RANKIN‡, ASSOCIATE, I.R.E.

Summary—The selection of an intermediate frequency for a superheterodyne receiver involves consideration of the signal frequency, the tuning range, the pass-band width, the minimizing of spurious responses, regeneration stability, and frequency stability. The consideration of the frequency-modulation broadcast band of 42 to 50 megacycles illustrates the manner in which these several factors affect the choice of intermediate frequency.

LIKELIHOOD OF SPURIOUS RESPONSES IN FREQUENCY-MODULATION RECEIVERS

FREQUENCY-MODULATION receivers are subject to spurious responses as are amplitude-modulation receivers, and because of the probable frequency-modulation-transmitter locations, the spurious responses are likely to be worse than on the present broadcast band. The superheterodyne type of receiver is used almost universally today because of its great advantage in sensitivity and selectivity, but it is subject to spurious responses. The selectivity requirements in the 42- to 50-megacycle frequency-modulation band are so severe that the use of the superheterodyne is even more necessary there than in the standard broadcast band.

Stations may be assigned to alternate channels in the frequency-modulation band in a given locality. Since the channels are 200 kilocycles wide this permits assignments 400 kilocycles apart. At the mean frequency-modulation band frequency of 46 megacycles a separation of 400 kilocycles is the same per cent separation as 10 kilocycles at 1150 kilocycles so that selectivity becomes a prime consideration.

Since the service area of a frequency-modulation transmitter is essentially limited by the horizon, transmitter antennas will have as great a height as possible. In large cities this means that the tendency will be to place the transmitter antenna on the tallest building available. Since tall buildings are generally in the center of the city, it is likely that many frequency-modulation transmitters will be located in close proximity to each other near the center of population of the area. With transmitters so located, high field intensities will occur at many receiving locations, a condition which favors generation of spurious responses.

TYPES OF SPURIOUS RESPONSES

Spurious responses may be of several types, some of which are unique to superheterodyne receivers, others exist in any type of receiver. The types of spurious responses which may exist in frequency-modulation

* Decimal classification: R361 × R414. Original manuscript received by the Institute, March 14, 1941; revised manuscript received, July 7, 1941. Presented, Sixteenth Annual Convention, New York, N. Y., January 9, 1941.

† Formerly, RCA License Laboratory, New York, N. Y.; now, Rogers-Majestic, (1941), Ltd., Toronto, Ont., Canada.

‡ RCA License Laboratory, New York, N. Y.

receivers are 1. image response, 2. direct intermediate-frequency response, 3. response from two stations separated by the intermediate frequency, 4. combination of signal and oscillator harmonics, 5. half-intermediate-frequency image response, 6. cross modulation, and 7. intermediate-frequency harmonic response.

Cross modulation, whether within the receiver or of the external type, does not depend upon the type of receiver. The other forms of spurious responses occur only in superheterodynes. Therefore the choice of intermediate frequency does not influence this category of spurious response.

IMAGE RESPONSE

Image response in frequency-modulation receivers is similar in nature to that in amplitude-modulation receivers. Since the band extent is only 8 megacycles (42- to 43-megacycle educational and 43- to 50-megacycle commercial broadcasting) any intermediate-frequency over 4 megacycles will prevent image response from frequency-modulation stations. Consideration must also be given to image response from other radio services, but except for television transmitters and possibly amateur and police transmitters, the location will make image response unlikely. Furthermore, the greater frequency separation of such transmissions will aid the radio-frequency attenuation of the image-frequency response.

DIRECT INTERMEDIATE-FREQUENCY RESPONSE

Transmission of signals having the same frequency as the intermediate frequency through the radio-frequency system is not believed to be a serious factor in frequency-modulation receivers. Virtually any intermediate frequency chosen will be so far different from the radio-frequency tune frequencies, that attenuation at the first-detector input will be considerably better than in the case of the 455 kilocycles on the standard broadcast band. Nevertheless, all other things being equal, choice of a frequency to minimize direct intermediate-frequency response is desirable.

RESPONSE FROM TWO STATIONS SEPARATED BY THE INTERMEDIATE FREQUENCY

In this type of response one of the signals acts at the first detector as the local oscillator for the other signal, the detector output being the intermediate frequency. This type of response is likely to be serious on frequency modulation when a low intermediate-frequency value is used, because stations may be allocated every 400 kilocycles in a given territory, and the per cent frequency separation is small with respect to

the signal frequency. This type of response is particularly troublesome, because in localities where two strong signals exist separated by the intermediate frequency, they will be heard throughout the tuning range of the receiver.

COMBINATION OF SIGNAL AND OSCILLATOR HARMONICS

Most oscillators have appreciable harmonic content, so that if conditions exist under which signal harmonics occur in the first detector, spurious responses will result. The most common condition for signal-harmonic production is when the signal exceeds the bias. Many frequency-modulation receivers have not used automatic volume control, depending upon the limiter to maintain a uniform signal at the second detector. Under such conditions, particularly with a radio-frequency amplifier present, relatively low-intensity signals will generate harmonics. Even with automatic volume control, harmonics may be generated by an undesired signal of high intensity when the receiver is tuned to a weaker desired signal. Whenever the difference frequency between the harmonics of signal and oscillator is equal to the intermediate frequency, a spurious response will occur.

HALF INTERMEDIATE-FREQUENCY IMAGE

This type of response in which the interfering signal differs from the oscillator by half the intermediate-frequency value, depends upon production of the second harmonic of this difference frequency in the converter plate circuit. The second-harmonic generation in the converter is usually sufficiently small so that this type of response is not serious despite the fact that the radio-frequency separation of interfering and desired signals necessary for its production is small.

INTERMEDIATE-FREQUENCY HARMONIC RESPONSE

Response at frequencies which are harmonics of the intermediate frequency may be generated in the converter, but, unless an unusually high intermediate-frequency value is used, only high harmonic orders can fall within the frequency-modulation band. As the amplitude of the harmonics decreases rapidly with harmonic order, little difficulty is to be expected in practice from this type response.

INFLUENCE OF INTERMEDIATE FREQUENCY ON SPURIOUS RESPONSES

The value of intermediate frequency chosen has a large influence on the number of spurious responses produced. It is evident that, with a frequency range of 8 megacycles, an intermediate frequency higher than 4 megacycles will eliminate image response due to frequency-modulation stations. Similarly an intermediate frequency higher than 8 megacycles will eliminate responses from two stations separated by the intermediate frequency and an intermediate frequency

higher than 16 megacycles will eliminate the half-intermediate-frequency image.

The effect of intermediate frequency on combinations of signal and oscillator harmonics is not as obvious, and detailed analysis is required to determine them.

Any combination of signal and oscillator harmonics which results in the chosen intermediate frequency will produce a spurious response. It is assumed that the receiver can be tuned to any frequency between 42 and 50 megacycles. Also only signals between 42 and 50 megacycles are considered. The analysis of the number of spurious responses produced is made without regard to the radio-frequency selectivity. That is, for any signal between 42 and 50 megacycles any tune point in the same range may be chosen. It is, therefore, necessary to consider every possible tune frequency for every signal frequency in the range.

In determining the number of spurious responses, consideration of the relative magnitudes is reserved for later discussion. The lowest frequency channel is 42.1 megacycles and the highest frequency 49.9 megacycles, a total of 40 in all. It is assumed that the total number of spurious responses from any cause is additive. That is, if for any given tune frequency there are three different signal frequencies which can cause a spurious response, three spurious responses are counted for that tune frequency. Thus, for some values of intermediate frequency, while there are 40 frequency-modulation channels, the number of spurious responses is appreciably higher than 40. This form of analysis is more illuminating than indicating only the actual channels on which interference can occur without regard to the frequencies causing the interference. This is so because spurious responses will be caused mainly by strong signals, and a condition which will permit interference from any one of three undesired signals will be three times as liable to interference as one where there is possibility of spurious response from only one undesired signal. In the latter case the undesired signal might be too weak to cause a spurious response, whereas in the former case, if any one of the three undesired signals is strong enough a spurious response will occur. It is further assumed that tuning is continuous between 42 and 50 megacycles, but that signals are confined to definite channels.

Let

S = signal frequency

O = oscillator frequency

I = intermediate frequency

T = tune frequency

M = signal-harmonic order

N = oscillator-harmonic order

Then, for spurious response to occur,

$$MS \pm I = NO$$

$$T = O \pm I$$

$$MS \pm I = NT \pm NI$$

$$\frac{M}{N}S \pm I\left(1 \pm \frac{1}{N}\right) = T$$

$$\frac{M}{N}S + I\left(1 \pm \frac{1}{N}\right) = T$$

if the oscillator is lower than the tune frequency.

$$\frac{M}{N}S - I\left(1 \pm \frac{1}{N}\right) = T$$

if the oscillator is higher than the tune frequency.

The method of analysis consists in assuming values of signal and oscillator harmonics, that is, M and N , and then for each value of intermediate frequency determining the number of signal-frequency channels between 42 and 50 megacycles which will satisfy the expression for all tune frequencies between 42 and 50 megacycles. It is apparent that consideration should be given to the oscillator higher than the tune fre-

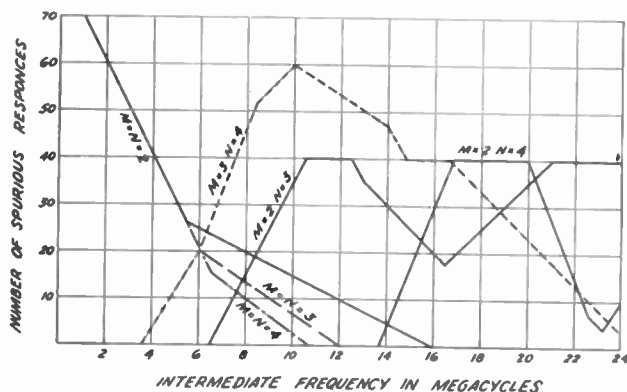

Fig. 1—Spurious responses caused by harmonic combinations of signal and oscillator versus intermediate frequency. Signals: from 40 channels between 42 and 50 megacycles. Tuning: from 42 to 50 megacycles. M = signal-harmonic order. N = oscillator-harmonic order. Oscillator lower than tune frequency.

quency separately from the condition for oscillator lower than the tune frequency, since the oscillator cannot change from one side to the other during the tuning process.

To illustrate, suppose a receiver has an intermediate frequency of 4.0 megacycles and is tuned to 49 megacycles, the oscillator is then at 45 megacycles and its second harmonic is 90 megacycles. If the second harmonic of the signal is at either 86 or 94 megacycles, the resultant intermediate frequency is 4.0 megacycles and a spurious response occurs. That is, the fundamental of the signal may be either 43 or 47 megacycles.

From an examination of the above expressions it may be seen that variation of spurious responses with intermediate frequency is a linear function, so that a plot of the variation of spurious responses with intermediate frequency will consist of a series of straight lines.

A plot of the number of spurious responses as a function of intermediate frequency for the case where the oscillator frequency is lower than the tune frequency is

shown in Fig. 1 and for the case where the oscillator frequency is higher than the tune frequency in Fig. 2.

An examination of the expressions for spurious responses as a function of intermediate frequency, along with the plots of Fig. 1 and 2 reveals, that for the same harmonic order of signal and oscillator frequency, the number of spurious responses as a function of intermediate frequency is the same for the oscillator frequency higher or lower than the tune frequency. Further, the spurious responses due to second harmonics of signal and oscillator go to zero at an intermediate frequency of 16 megacycles and do not recur at any higher intermediate frequency. The spurious responses due to the third harmonic of signal and oscillator drop out at an intermediate frequency of 12 megacycles, while the spurious responses due to the fourth harmonic of signal and oscillator drop out at 10.6 megacycles.

When different harmonic orders of signal and oscillator are involved, the number of spurious responses is different when the oscillator frequency is higher than the tune frequency than that for the oscillator frequency lower than the tune frequency.

When the oscillator frequency is lower than the tune frequency, as shown in Fig. 1, no spurious responses occur for any value of intermediate frequency if the oscillator-harmonic order is lower than the signal-harmonic order. When the oscillator frequency is higher than the tune frequency, as shown in Fig. 2, no spurious responses occur for any value of intermediate frequency if the oscillator-harmonic order is higher than the signal-harmonic order.

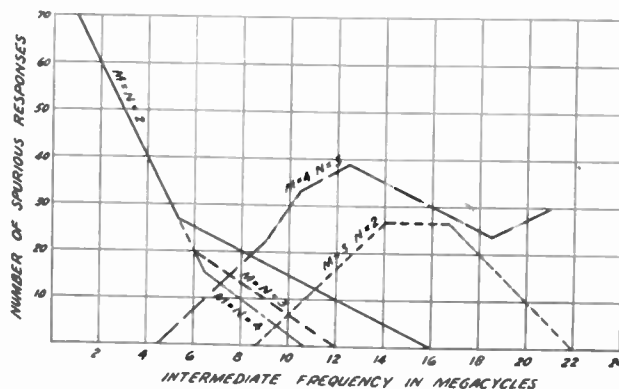

Fig. 2—Spurious responses caused by harmonic combinations of signal and oscillator versus intermediate frequency. Signals: from 40 channels between 42 and 50 megacycles. Tuning: from 42 to 50 megacycles. M = signal-harmonic order. N = oscillator-harmonic order. Oscillator higher than tune frequency.

A plot of the number of spurious responses due to the image and to two stations separated by the intermediate frequency is shown in Fig. 3.

Note that these curves consider stations on each channel as having the ability to produce image responses, responses from two stations separated by the intermediate frequency, and spurious responses caused by oscillator and signal harmonics. In actual practice,

stations will not be so allocated in any given location, but the curves are valid in determining the best intermediate frequency to be used to reduce the number of responses, regardless of how many stations are assigned in any particular location, provided of course the stations are uniformly located in the band.

The relative severity of spurious responses is difficult to evaluate exactly without data as to the magnitude of signal-harmonic generation in the converter, which in turn depends upon the signal amplitude. However, an estimate may be made of the effect of oscillator harmonics and instructive deductions made therefrom.

In a typical converter of the pentagrid type, the amplitude of oscillator harmonic has been found to be approximately proportional to $1/N^2$, where N is the order of the harmonic. The conversion gain is not constant with respect to oscillator amplitude but reaches a maximum, usually a broad maximum (the conversion gain is substantially constant over an appreciable oscillator range) at some value of oscillator voltage. For values of oscillator voltage below this maximum the conversion is, to a first approximation, proportional to the oscillator voltage. Since the oscillator amplitude is $1/N^2$ and the conversion proportional to amplitude, the conversion is approximately proportional to $1/N^2$ if the converter is operated so that the fundamental does not exceed the optimum. If the fundamental somewhat exceeds the optimum conversion point, there will be no appreciable decrease in conversion from the optimum value. But under these conditions the second

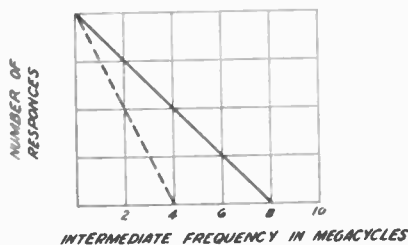

Fig. 3—Interference caused by the image response and by two stations separated by the intermediate frequency versus intermediate frequency. Signals: from 40 channels between 42 and 50 megacycles. Tuning: from 42 to 50 megacycles. Oscillator either higher or lower than tune frequency. ----- image. — two stations separated by the intermediate frequency.

harmonic may produce as much conversion gain as the fundamental. Consequently to minimize harmonic generation it is desirable to limit the oscillator injection to a value only sufficient to develop maximum conversion. With the oscillator injection limited to such value, the probability of a given signal causing a spurious response is inversely proportional to the square of the oscillator-harmonic order involved. This factor may be applied to the calculations for signal- and oscillator-harmonic combinations.

Considering the image response; this is due to the fundamental of the signal and the oscillator so should

not be decreased by any factor as are the harmonic combinations.

In applying weighting to the case of two signals separated by the intermediate frequency, the oscillator is not involved but the strength of the spurious response is proportional to the strength of the signals involved. This response will in general be less than that for the image. Accordingly a factor of 0.5 was applied to the two signals separated by the intermediate frequency, giving it a weight between the image and harmonic combinations due to the second harmonic of the oscillator.

When weighting factors are applied we can no longer say that the ordinates represent the number of spurious response signals. The ordinates in this case represent the probability of spurious responses for various intermediate-frequency values in a receiver having no

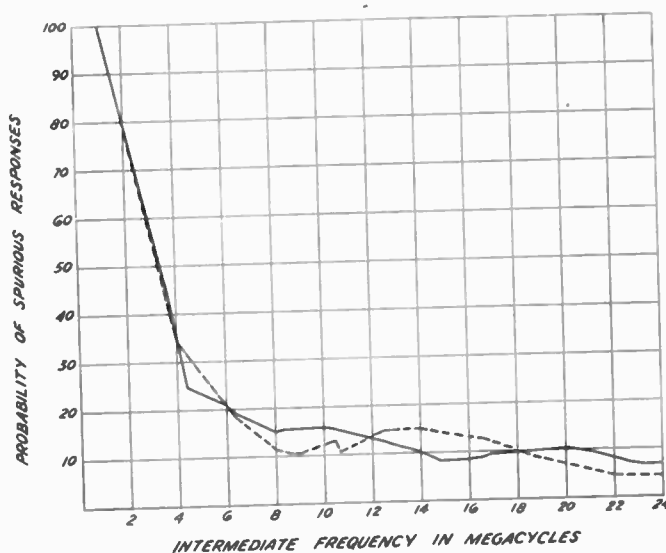

Fig. 4—Probability of spurious responses due to image, two signals separated by the intermediate-frequency and harmonic combinations of signal and oscillator for different intermediate frequencies. Image weighting factor = 1.0. Two stations separated by the intermediate-frequency weighting factor = 0.5. Spurious responses due to N th harmonic of oscillator weighting factor = $1/N^2$. Probability of spurious responses for 1.0-megacycle intermediate-frequency taken as 100. — oscillator lower. ----- oscillator higher.

selectivity ahead of the converter, with the probability for an intermediate frequency of 1 megacycle considered to be 100. The variation of likelihood of interference is shown in Fig. 4. This figure combines the weighted effect of image, two signals separated by the intermediate frequency, and oscillator-signal harmonic combinations up to the fourth of both signal and oscillator.

It illustrates that the probability of interference decreases rapidly with increasing intermediate frequency at first and then more slowly, and that over the entire range of intermediate frequency there is little choice between oscillator lower and oscillator higher conditions. It does not indicate definitely any best intermediate

frequency but does show that a high intermediate frequency is better. While, as has been stated, direct intermediate-frequency interference is not believed to be a major factor, and as the image ratio for any intermediate frequency over 8 megacycles should be adequately high for any receiver having more than one tuned circuit ahead of the converter, nevertheless it is well to minimize spurious response from these sources where no other disadvantage accrues therefrom.

In considering spurious responses, one characteristic of frequency modulation, not heretofore mentioned, should be borne in mind, namely, that such responses when they occur on the frequency of a desired signal do not cause an audible whistle as they do on amplitude modulation but appear essentially as cross talk.

The types of signals, other than frequency-modulation stations, likely to cause interference are those where the transmitter may be located in a populous district. These are amateurs, television, and police signals mainly and possibly international broadcasting.

If image response from other frequency-modulation stations is to be eliminated an intermediate frequency of at least 4 megacycles has been seen to be necessary. To minimize direct intermediate-frequency interference, a frequency range of some 200 kilocycles free from types of services likely to cause such interference is required. The lowest such range above 4 megacycles is at 4.3 megacycles to which are allocated government, general communication, and coastal-harbor transmitters. Another intermediate frequency in that general range which appears relatively free from direct intermediate-frequency interference is at 5.38 megacycles, where are allocated government, fixed, and general communication channels.

A frequency of 8.25 megacycles has been widely used as the intermediate frequency for the sound channel of television receivers, which suggests its use for frequency modulation in order to minimize component types. Examination of frequency allocations shows that 8.26 megacycles is somewhat better than 8.25 megacycles over a 200-kilocycle width. And that to 8.26 megacycles are allocated ship-telegraph and government services, neither likely to cause interference. On the score of image, however, with the oscillator higher, both the 5-meter amateur and the second television bands fall within the image range. With the oscillator lower, we find 10-meter amateur, police, and government frequencies. It would appear therefore that this frequency, particularly with the oscillator lower, will be satisfactory in receivers having enough selectivity preceding the converter to insure good image ratio.

In receivers in the lower-price classes, where selectivity ahead of the converter is not high, it would seem desirable to operate with the oscillator lower than the tune frequency to avoid the television channels, and to use an intermediate frequency that would not

permit interference from the amateur bands. This requires an intermediate frequency of over 11 megacycles. At 11.45 megacycles we find government, fixed, and aviation allocations, and for the image, fixed, government, and broadcast stations, so that this frequency is comparatively free from likelihood of spurious responses.

It is not likely that frequencies appreciably higher than about 14 or 15 megacycles will be useful, because of decreasing stability and gain limitation due to tube and circuit capacitances.

INFLUENCE OF INTERMEDIATE FREQUENCY ON SELECTIVITY AND STABILITY

The value of intermediate frequency does not affect the selectivity if the Q of the intermediate-frequency circuits is varied proportional to the intermediate frequency, thus for the same band width, the Q for 8.26 megacycles should be 1.9 times as great as the Q for 4.3 megacycles intermediate frequency. The necessary Q values for 200-kilocycle channels are readily obtainable for any practical intermediate frequency so selectivity considerations do not influence the choice of an intermediate-frequency value.

Considerations of both frequency stability and regeneration stability are involved in the choice of an intermediate frequency. Both are poorer with a high intermediate frequency than with a low one. In an amplifier of N stages the over-all stable gain with regard to regeneration varies inversely as the $N/2$ power of the intermediate frequency. It is more difficult to analyze frequency stability quantitatively because of the several diverse design factors involved but in general the frequency drift is proportional to the intermediate frequency. This influence of intermediate-frequency value on frequency and regeneration stability is the principal difficulty involved in the use of a high intermediate frequency and must be weighed against the advantage of high intermediate frequency in reducing spurious responses. Design expedients, such as impedance distribution or neutralization may be used to minimize the regeneration stability influence and expedients such as cathode degeneration used to minimize frequency-stability problems.

CONCLUSIONS

It has been shown that the use of an intermediate-frequency value higher than 4 megacycles materially reduces the probability of spurious responses, but at the same time may entail some sacrifice in gain and frequency stability.

It would appear therefore, that for receivers designed to operate on weak signals, where spurious responses are unlikely, a relatively low intermediate frequency of 4.3 megacycles or 5.38 megacycles is preferable. However for a considerable part of the service area, where signal intensities are high and spurious responses likely, high sensitivity is not required and

an intermediate frequency of 8.26 megacycles or even 11.45 megacycles has much to recommend it. Where a receiver is designed to operate over a wide range of signal intensities, it may be preferable to use a rela-

tively high intermediate-frequency value to minimize spurious responses, using impedance distribution or neutralization principles, and if necessary an additional stage to obtain the required high gain with stability.

Factory Alignment Equipment for Frequency-Modulation Receivers*

HARRY E. RICE†, ASSOCIATE, I.R.E.

Summary—A description of some of the problems arising in the alignment of frequency-modulated receivers is given and a method of meeting these problems with a minimum of difficulty and complexity is shown. The method adopted is that of providing a central signal-generating equipment with a number of remote alignment positions with individual attenuators and oscilloscopes.

THIS paper deals with the design and development of a method of aligning and testing frequency-modulated receivers under factory production conditions. In addition to requiring speed in order that the somewhat involved alignment operation should not slow down production, a method of securing a quantitative limit check, comprising sensitivity, fidelity, and distortion, had to be provided.

The idea of providing each alignment and final-test position with a complete signal generator and associated equipment was considered and discarded as being too cumbersome and costly, inasmuch as a total of 22 positions was required. A centralized distribution system was then adopted. In order to determine the requirements of the centralized system, it became necessary to consider the operations at each position, the number of types of positions, and their physical location in the particular factory.

The production schedule necessitated 10 alignment positions for aligning the intermediate-frequency and radio-frequency portions of frequency-modulated receivers only. In addition to this, 5 repair positions had to be equipped and as these positions handle both frequency-modulated and amplitude-modulated chassis indiscriminately, additional amplitude-modulation equipment was required. Five final-test booths also had to be equipped and here it was necessary to provide a means of making sensitivity and fidelity checks on the chassis after they had been installed in the cabinets. An additional final-repair room, handling rejects from the final-test booths, and having 2 positions was also required. Having given the requirements we shall now describe the system as constructed.

The central signal-generating equipment is housed in a single rack. Fig. 1 shows a picture of this rack containing the complete apparatus. On the top shelf is located the 4.3-megacycle intermediate-frequency

equipment. This unit has its own self-contained power supply. A motor-driven condenser plate as part of the oscillator tank circuit supplies the sweep 4.3-megacycle signal. This is amplified by a resistance-coupled stage and fed to a 6Y6G output tube. The output stage has a 75-ohm plate load and a 75-ohm unby-passed cathode resistor. The output is taken from plate to cathode of this tube to feed a balanced 150-ohm line. Output level is controlled by the variation of the screen voltage of the buffer amplifier. A diode vacuum-tube voltmeter is inserted across the output and by means of a switch on the front panel indicates voltage on each line to ground. Also located on this chassis is a 4.3-megacycle crystal-controlled oscillator which is used to supply a transmission line through a suitable output coupling network and also to supply a marker indication. A portion of the output of this oscillator is fed through the signal grid of a 6SA7 tube whose oscillator section functions as a 75-kilocycle oscillator. The output from the plate of this tube is coupled through 2 tuned circuits to the 4.3-megacycle sweep-oscillator's output. This supplies markers at 4.3 megacycles and at 4.3 ± 0.075 megacycles for indicating intermediate-frequency pass-band characteristics in a receiver. The meter on the right of this panel indicates the output voltage of the unmodulated 4.3-megacycle signal as fed to one transmission line, while that on the left indicates the sweep-frequency-generator output voltage fed to another line.

The third, fourth, and fifth shelves from the top each house one of the frequency-modulated generators. These units are identical, save for frequency. Fig. 2 shows a block diagram of the unit. It will be noted that the Crosby system of frequency control is employed. The generators can be 100 per cent amplitude- or ± 75 -kilocycle frequency-modulated by a switch located on the front panel. Another switch allows the meter to read either per cent modulation or output voltage. The output of each generator is 1 watt maximum. As can be noted in the figure, the frequency of the oscillator is doubled twice so that both the crystal and the electronic frequency-modulated control oscillator are at relatively low frequencies. The difference between the two oscillators is set at 1 megacycle and this signal fed to a discriminator unit. The direct-

* Decimal classification: R261. Original manuscript received by the Institute, April 21, 1941. Presented, Summer Convention, Detroit, Mich., June 23, 1941.

† Stromberg-Carlson Telephone Manufacturing Company, Rochester, N. Y.

current output of this unit varies as the controlled oscillator drifts, and is applied to control the basic frequency of the controlled oscillator in much the same manner that the automatic-frequency-control circuits of receivers operate. Of course, a long-time-constant filter is employed in order that the control shall not oppose the modulation frequencies. Frequency-drift characteristics of these generators have proved very satisfactory.

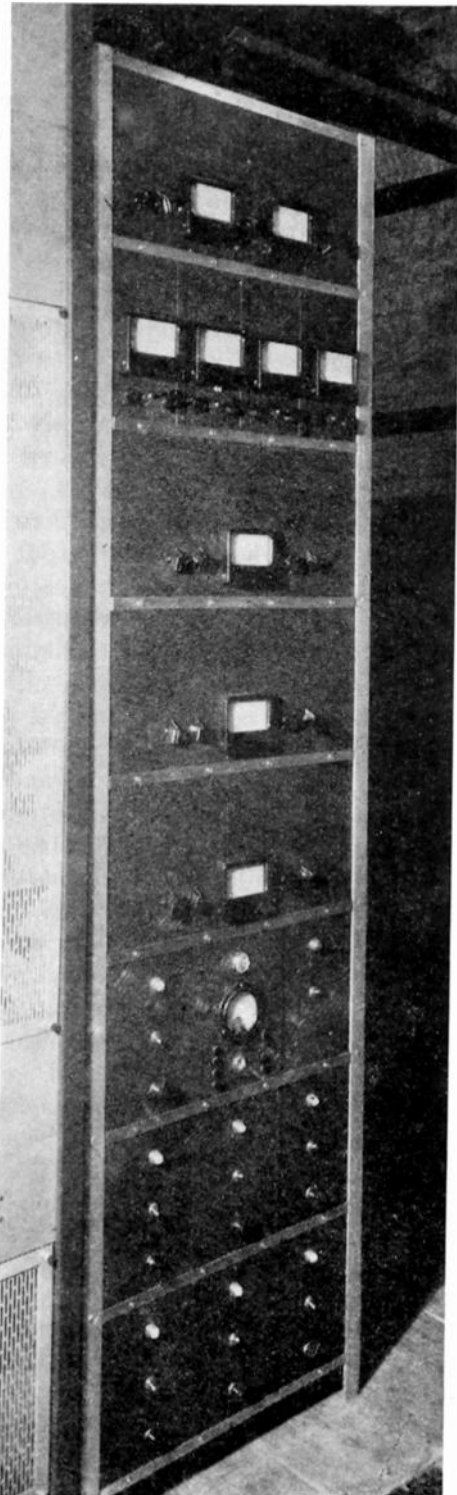

Fig. 1—Central generating equipment.

On the second shelf down are located from left to right three audio-frequency generators, 70, 400, and 10,000 cycles per second, and the final output stage for the frequency-modulated generators. The audio generators are identical in design with output frequency controlled by means of plug-in resistor and condenser networks in a multivibrator circuit. These units are small, simple, and compact. The meters indicate output voltage which can be controlled from the front panel.

The final output stage located at the extreme right of this second shelf consists of 3 6L6 tubes connected with a common 42- to 50-megacycle band-pass plate

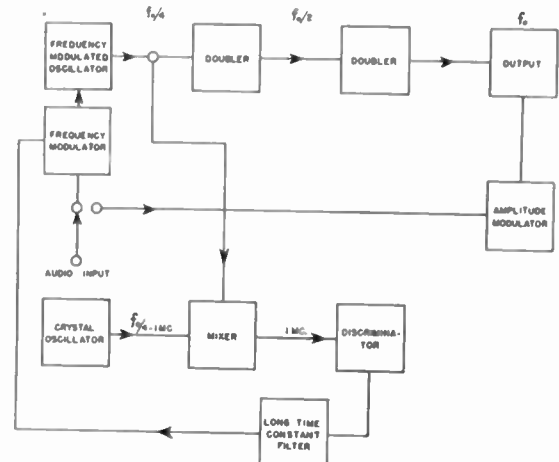

Fig. 2—Block diagram of frequency-modulated generator.

load. Their signal grids are fed by 3 frequency-modulated generators located on the 3 shelves below. The output level of this stage is controlled by a potentiometer in the screen circuit. The output is coupled to the plate load by a single-turn link feeding a balanced transmission line. A vacuum-tube voltmeter with switching arrangement indicates voltage either side of the line to ground. It is possible with this arrangement to get 5 volts from line to ground although in practice only 2 volts are required to supply the attenuators. Normally, this voltage is fed to the line at the generator and is attenuated by line losses to approximately 1.5 volts 200 feet from the generator.

On the lower three shelves are located 7 electronically regulated power supplies, 1 for the final output stage, 3 for the audio generators, and 3 for the frequency-modulated generators. These units are of a conventional type employing the plate resistance of 2 triode-connected 6Y6G tubes in parallel to regulate the voltage. A 6AC7 control tube is used. On the third shelf from the bottom with the power supplies is located a motor-driven switch which changes the modulation frequency of the 46-megacycle generator. This switch is merely a 1-revolution-per-minute motor driving 3 cams which actuate switches and permit each audio frequency to reach the signal generator for one-third revolution. Also, on this shelf there are a meter and 7 push buttons allowing the operator to read the plate voltage on each chassis. Located here, too, is the

line filter which prevents leakage of high frequencies out into the power lines.

It was found necessary to locate the whole rack in a shielded room and to take special precautions in grounding arrangements in order to minimize radiation. The radiation is now at a point where satisfactory alignment can be carried out.

At each alignment position a total of 5 signals are provided and fed to an attenuator over 3 lines, which are designated *A*, *B*, and *C*. These lines can be selected with push buttons on the attenuator. Fig. 3 shows a typical attenuator installation. The attenuator unit itself has a high-impedance input (10,000 ohms) employing a 6AG7-type tube connected as a cathode fol-

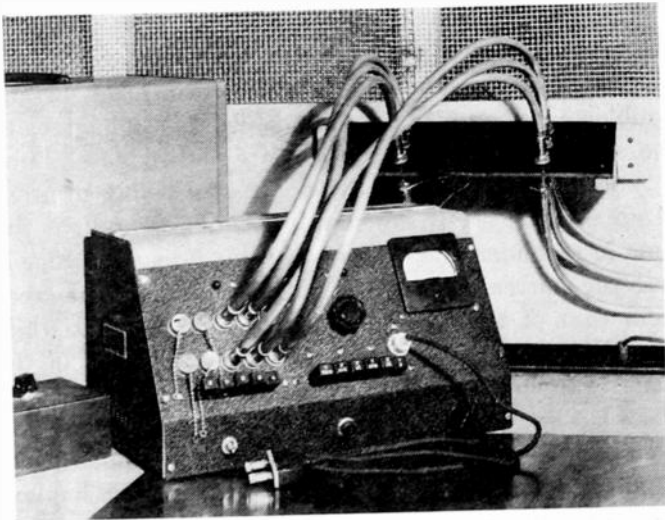

Fig. 3—Test-position attenuator unit.

lower—the cathode resistor being a 100-ohm potentiometer. Across the arm of the potentiometer and ground are connected a vacuum-tube voltmeter and a ladder attenuator network. The voltmeter is calibrated from 1 to 10 while the ladder-network selecting buttons are in steps of 20 decibels from “times 1” to “times 10,000” with a last button reading “times 50,000.” Suitable precautions were taken in the attenuator design to hold leakage to a minimum. The output is brought out as a flexible line to a 37-ohm terminating resistor.

It is readily apparent from the type of attenuator unit used that many or few can be bridged across a low-impedance line without affecting its properties. Hence it was possible to run lines as far as desired and terminate them in their image impedance at the end point. In order to minimize leakage each line is physically run through each attenuator and selected in the attenuator. Also at each position a cathode-ray oscilloscope is provided for visual intermediate-frequency alignment, an electronic volt-ohmmeter, an output meter, and a phase-shifting network. Fig. 4 shows a complete alignment position installed. The phase-shifting network is a simple device for furnishing 60-cycle synchronizing voltage with the correct phase relationship from a 60-cycle line in order to center the

oscilloscope pattern. The central sweep oscillator is actuated by the supply line which is one leg of a 3-phase system. Some of the alignment positions are on different legs and hence some means of phase synchronization is necessary. Fig. 5 shows a circuit dia-

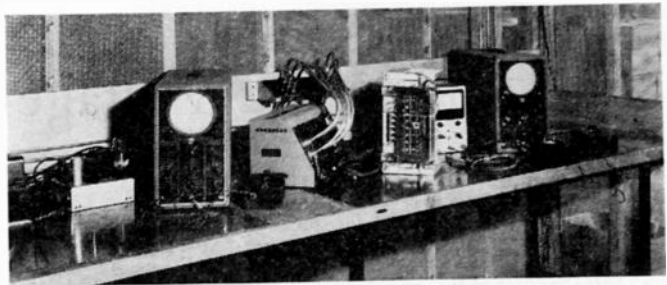

Fig. 4—Complete alignment position installed.

gram of the network which gives about 350 degrees phase shift.

The lines selected to carry the signals to each position are of the double-coaxial or twin-axial type. Prior investigators had reported that the attenuation possible with a single coaxial conductor where the outer shield was used as a ground return was not as satisfactory as a 2-conductor balanced line encased in a copper shield. About 1500 feet of this type of conductor is in use in this system and permits leakage of less than 1 microvolt.

The lines themselves are divided as follows: Line *A* carries three frequencies, 48.5 megacycles frequency-modulated at 400 cycles per second with a swing of

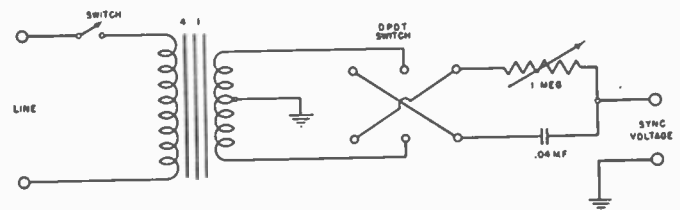

Fig. 5—350-degree 60-cycle phase shifter.

± 22.5 kilocycles, 46 megacycles frequency-modulated at 70, 400, and 10,000 cycles per second for periods of 20 seconds each with a swing of ± 22.5 kilocycles, and 43 megacycles amplitude-modulated 30 per cent at 400 cycles per second. Line *B* carries 4.3 megacycles swept at 60 cycles per second ± 150 kilocycles with a crystal-controlled marker superimposed giving a mark on the oscilloscope pattern at 4.225, 4.3, and 4.375 megacycles. Line *C* carries an unmodulated 4.3-megacycle signal, for discriminator alignment.

It is thus readily apparent that with these 5 signals plus the attenuators, the complete requirements set forth before can be met, that is, alignment, sensitivity, and fidelity measurements. In addition, the 400-cycle amplitude modulated signal on the 43-megacycle carrier gives an indication of discriminator balance for

noise. Distortion measurements are possible inasmuch as the percentage distortion of the generator signals at 48.5 megacycles has been reduced to 3 per cent.

ACKNOWLEDGMENT

Acknowledgment is made to my associates. The

general plan of design and construction was under the direction of Mr. Clyde E. Ingalls, and some of the original mechanical designs were made by Mr. Walter S. Swift. Mr. J. Minter of Measurements Corporation developed and supplied the individual-position attenuators.

The Full-Wave Voltage-Doubling Rectifier Circuit*

D. L. WAIDELICH†, ASSOCIATE, I.R.E.

Summary—An analysis of the full-wave voltage-doubling rectifier circuit is made in this paper with the main assumption that the tube drop is zero when conducting. Both the output and the input performance characteristics of the circuit are presented, and several of the characteristics are compared with experimental results. The analysis shows that polarized electrolytic condensers may be used if the circuit is not loaded too heavily. The currents to be expected on short circuit are also discussed.

INTRODUCTION

THE full-wave voltage doubler has been used recently as a power-supply circuit for small radio receivers, and several types of tubes especially adapted for use in this circuit are now manufactured. As a high-voltage supply, the circuit is used in cathode-ray oscillographs, X-ray systems, and electron micro-

scopes. Lately it has been suggested to use the circuit as a vacuum-tube voltmeter and as a diode detector.¹

Several papers,²⁻⁴ have dealt with the analysis and the characteristics of this circuit, and in the present paper the method of analysis is much like that of Roberts.³ The purpose of this paper is to present the results of this analysis graphically and to compare some of the theoretical results with experimental results.

ANALYSIS

The circuit of the voltage doubler is shown in Fig. 1(a), and the current and voltage wave forms of the doubler are shown in Fig. 2. In Fig. 2, 180 degrees of the alternating supply voltage are shown as e . Tube T_1 starts to conduct at the angle $\omega t = \alpha$ and stops at $\omega t = \beta$ where $\omega/2\pi$ is the supply frequency and t is the time in seconds. The current of tube T_1 is i_P in Fig. 2, and the current of tube T_2 is displaced 180 degrees from that of tube T_1 . Condenser C_1 is charged while tube T_1 is conducting and is discharged the rest of the cycle. The voltage of C_1 is e_c in Fig. 2, and the voltage of C_2 has exactly the same shape but is displaced 180 degrees. The load current i_L through the load resistor R is indicated in Fig. 2, and the load voltage has exactly the same shape as i_L as long as the load is a pure resistance. The voltages across the two condensers add to produce the load voltage. The current i_P has been reduced in Fig. 2 to one tenth its size for convenience.

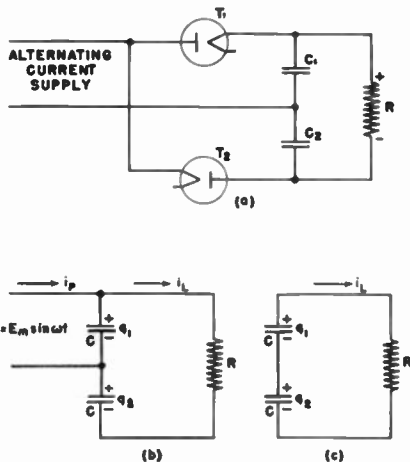

Fig. 1

- (a) The circuit diagram of the voltage doubler.
- (b) The equivalent circuit with tube T_1 conducting.
- (c) The equivalent circuit with neither tube conducting.

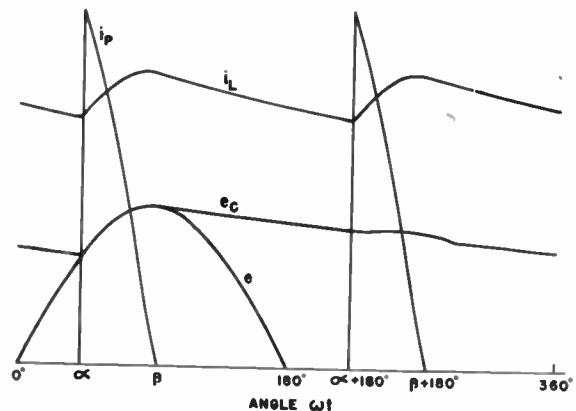

Fig. 2—Voltage and current wave forms of the voltage doubler.

For simplification of the analysis the following assumptions are made: (1) the applied alternating voltage is sinusoidal, and the source has no impedance; (2) when conducting the tube drop is zero, and when not conducting the tube resistance is infinite; (3) the condensers have zero power factor and are both the same size; and (4) the load resistance has no inductance. The most serious assumptions are those of tube drop and source impedance, and it is hoped in a later

* Decimal classification: R337. Original manuscript received by the Institute, April 30, 1941. Presented, Summer Convention, Detroit, Michigan, June 23, 1941.

† University of Missouri, Columbia, Missouri.

¹ M. A. Honnell, "Applications of the voltage doubler rectifier," *Communications*, vol. 20, p. 14; January, 1940.

² R. W. Armstrong, "Polyphase rectification special connections," *Proc. I.R.E.*, vol. 19, pp. 78-102; January, 1931.

³ N. H. Roberts, "The diode as half-wave, full-wave, and voltage-doubling rectifier," *Wireless Eng.*, vol. 13, pp. 351-362; July, 1936; and pp. 423-430; August, 1936.

⁴ H. J. Reich, "Theory and Applications of Electron Tubes," McGraw-Hill Book Company, New York, N. Y., 1939, pp. 542-544.

paper to take account of these effects. When tube T_1 is conducting from angle α to angle β , the equivalent circuit is that of Fig. 1(b) in which E_m is the maximum value of the alternating-voltage supply and C and R are in farads and ohms, respectively. From angle β to angle $(\alpha + 180$ degrees), when the tubes are not conducting, the equivalent circuit is shown in Fig. 1(c). It is necessary to consider only 180 degrees since the load-voltage wave form will be repeated in each successive 180 degrees.

The method of analysis is carried out in detail in Appendix II, and the first part of the analysis consists in determining the angle α at which the tube T_1 starts to conduct, the angle β at which the tube stops conducting, and the angle γ representing the length of time that the tube is conducting. The analysis also shows that the three angles, α , β , and γ , depend only on the product (ωCR) . These angles have been calculated for several values of (ωCR) , and the results are indicated in Fig. 3. At light loads (large values of

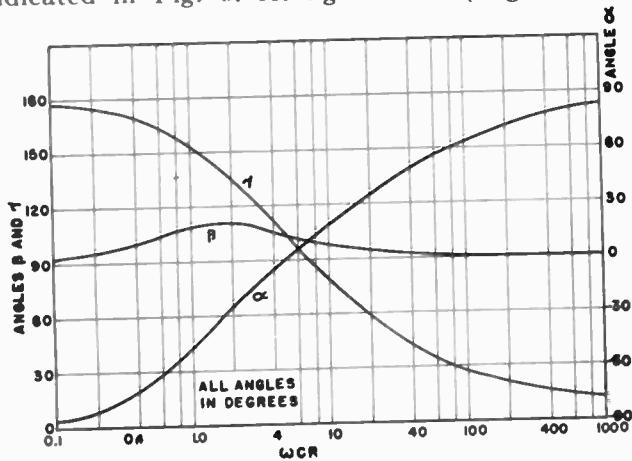

Fig. 3—The angles α , β , and γ .

ωCR) both α and β are very close to 90 degrees, while γ is nearly zero degrees. As the load is increased (ωCR decreased), angle α becomes smaller and approaches -90 degrees, angle β increases at first to a maximum of approximately 110 degrees and then decreases toward 90 degrees, and angle γ increases toward 180 degrees.

CHARACTERISTICS

The most important characteristic of this circuit, perhaps, is the average output voltage for various loads. The ratio of the average output voltage to the maximum value of the alternating voltage applied to the circuit IR/E_m is shown in Appendix II to be a function of (ωCR) alone and has been calculated for various values of (ωCR) . This ratio is given as the solid line in Fig. 4, and it decreases from a maximum of 2 for light loads toward zero for heavy loads.

The output voltage contains a certain amount of ripple voltage, and the percentage ratio of the effective value of this ripple voltage to the average output voltage is defined as the per cent ripple r . The ripple frequencies are even multiples of the supply frequency, and the most important of the ripple frequencies is the

one of twice the supply frequency. It was found that in determining the per cent ripple all harmonics other than the second harmonic could be neglected in comparison to the second. The expression for the per cent ripple r is derived in Appendix II, and it is also dependent only on (ωCR) . The calculated results are

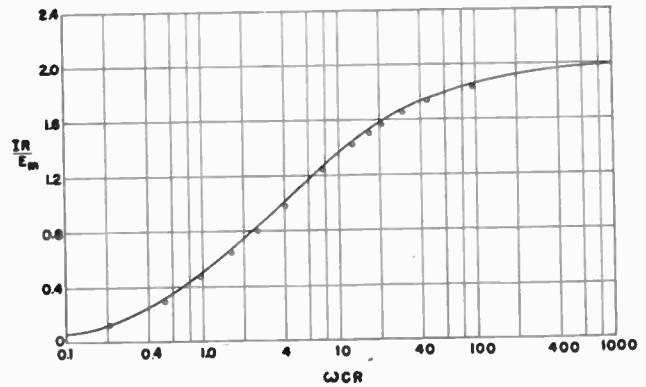

Fig. 4—The ratio of the output average voltage to the maximum value of the alternating supply voltage (IR/E_m). The circles are experimental points.

shown as the solid line in Fig. 5, and r increases from zero at light loads and approaches approximately 48.3 per cent at heavy loads. At light loads for (ωCR) greater than 10, the per cent ripple is given by

$$r = \frac{131}{\omega CR}$$

The effective input current I_e and the input power factor are important since they determine the effect of the circuit on the alternating-voltage supply. The ratio of the effective input current to the average output current (I_e/I) and the power factor depend on (ωCR) alone, and these quantities are shown in Fig. 6. At

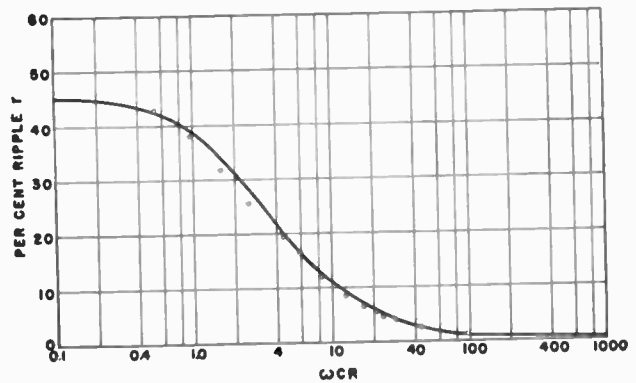

Fig. 5—The per cent ripple r . The circles shown are experimental points.

light loads the ratio (I_e/I) is very large since the tube current is highly peaked, and at heavy loads the ratio approaches 2.22. The power factor is very nearly zero for light loads since the input current is peaked. It increases to a maximum of 59 per cent as the load increases, and then decreases toward zero for heavy loads, since the circuit then acts very much like a condenser charging and discharging.

In choosing tubes for the circuit, a knowledge of the average current, maximum current, and peak inverse

voltage of the tubes is needed. The average current of each tube is I , while the maximum current of each tube is i_m . The average current may be obtained from Fig. 4, and the ratio of the maximum current to the average current (i_m/I) is shown in Fig. 7. The ratio

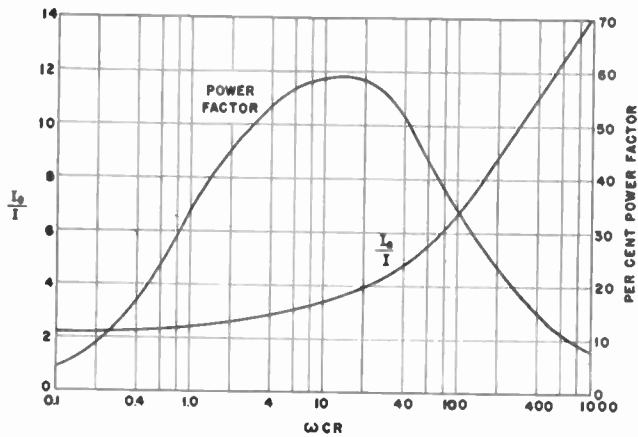

Fig. 6—The ratio of the effective input current to the average output current (I_e/I) and the input power factor.

decreases from large values at light loads to 3.142 at heavy loads. The ratio of the peak inverse tube voltage to the maximum value of the alternating supply voltage (e_p/E_m) is given in Fig. 7, and this decreases from 2.0 at light loads toward zero at heavy loads.

As a check on these calculated characteristics, some experimental results are also included and are shown as the small circles in Figs. 4 and 5.

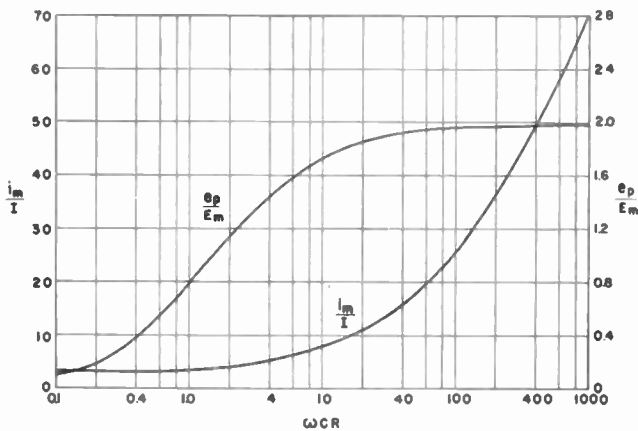

Fig. 7—The ratio of the maximum tube current to the average tube current (i_m/I) and the ratio of the peak inverse tube voltage to the maximum value of the alternating supply voltage (e_p/E_m).

CONDENSERS

The maximum voltage that each of the condensers must withstand is the maximum value of the alternating-voltage supply E_m . The analysis showed that the voltage across the condensers will reverse over part of the cycle if the doubler circuit is loaded heavily enough. This occurs if the angle α is less than zero, and from Fig. 3 occurs when (ωCR) is less than 4.794. Polarized electrolytic condensers should then be used only as long as (ωCR) is greater than this number, while nonpolarized condensers may be used for any

value of (ωCR) . From Fig. 4 the value of (IR/E_m) corresponding to the above (ωCR) is 1.078, and this value of (IR/E_m) may be used to decide whether or not a given doubler circuit is operating above this point.

OPERATION ON SHORT CIRCUIT

When the doubler is short-circuited, each tube is conducting alternately one half of each cycle. The analysis shows that the average output current on short circuit is

$$I = (2/\pi)\omega CE_m$$

and the effective input current is

$$I_e = \sqrt{2}\omega CE_m$$

The average tube current is the same as the average output current. These predicted short-circuit currents have been found to agree very well with experimental values.

ACKNOWLEDGMENT

The author wishes to acknowledge with thanks the help of Mr. Brice Miller who did much of the numerical and experimental work of this investigation.

APPENDIX I

Nomenclature

- $\omega/2\pi$ = frequency of the alternating-voltage supply
- t = time in seconds
- e = the instantaneous value of the alternating-voltage supply
- E_m = the maximum value of the alternating-voltage supply
- i_T = the current flowing through tube T_1
- i_L = the current flowing through the load resistance R
- q_1 = the charge on condenser C_1
- q_2 = the charge on condenser C_2
- e_c = the instantaneous voltage of condenser C_1
- R = the load resistance in ohms
- C = the capacitance in farads of condensers C_1 and C_2
- α = angle in radians at which the tube T_1 starts to conduct current
- β = angle in radians at which the tube T_1 stops conducting
- γ = $\beta - \alpha$ = angle in radians during which the tube T_1 is conducting
- Z = $\sqrt{R^2 + (1/\omega C)^2}$
- λ = $\tan^{-1}(\omega CR)$, $0 \leq \lambda \leq (\pi/2)$
- i_α = current i_L at angle α
- i_β = current i_L at angle β
- $q_{1\alpha}$ = charge q_1 at angle α
- $q_{1\beta}$ = charge q_1 at angle β
- $q_{2\alpha}$ = charge q_2 at angle α
- I = average direct current through the load resistance R
- r = per cent ripple
- λ_1 = an angle such that $\tan \lambda_1 = 2 \tan \lambda$, $0 \leq \lambda_1 \leq (\pi/2)$
- I_e = effective input current

- P = average input power
- i_m = maximum tube current
- θ_m = angle at which the maximum tube current occurs
- e_P = peak inverse voltage that the tube must withstand
- θ_P = angle at which the peak inverse voltage occurs across the tube

APPENDIX II

Analysis

(a) Angles at Which Tube Starts and Stops Conducting

From angle α to angle β , Fig. 1(b) shows the equivalent circuit to be used. The circuit equations are solved, and the initial conditions at angle α are substituted in the results to give

$$i_L = \frac{E_m}{Z} \cos(\omega t - \lambda) + \left[i_\alpha - \frac{E_m}{Z} \cos(\alpha - \lambda) \right] e^{-(\omega t - \alpha) \cot \lambda} \quad (1)$$

$$i_P = \frac{E_m \cos \omega t}{Z \cos \lambda} + i_L \quad (2)$$

$$q_1 = CE_m \sin \omega t. \quad (3)$$

At angle β , $i_L = i_\beta$, $i_P = 0$, and $q_1 = q_{1\beta}$. Substituting these conditions in (1), (2), and (3), gives

$$\frac{Ri_\beta}{E_m} = \sin \lambda \cos(\beta - \lambda) + \left[\frac{Ri_\alpha}{E_m} - \sin \lambda \cos(\alpha - \lambda) \right] e^{-(\beta - \alpha) \cot \lambda} \quad (4)$$

$$\frac{Ri_\beta}{E_m} = -\cos \beta \tan \lambda \quad (5)$$

$$q_{1\beta} = CE_m \sin \beta. \quad (6)$$

From angle β to angle $(\alpha + 180$ degrees), Fig. 1(c) applies, and the current and charge are expressed by the following equations:

$$i_L = i_\beta e^{-2(\omega t - \beta) \cot \lambda} \quad (7)$$

$$q_1 = q_{1\beta} - \frac{1}{\omega} \int_\beta^{\omega t} i_L d(\omega t). \quad (8)$$

At angle $(\alpha + 180$ degrees), $i_L = i_\alpha$, $q_1 = q_{2\alpha}$, and these conditions are substituted in (7) and (8).

$$\frac{Ri_\alpha}{E_m} = \left(\frac{Ri_\beta}{E_m} \right) e^{-2(\alpha - \beta + \pi) \cot \lambda} \quad (9)$$

$$q_{2\alpha} = q_{1\beta} + \frac{\tan \lambda}{2\omega} (i_\alpha - i_\beta). \quad (10)$$

In addition, at angle α ,

$$q_{1\alpha} = CE_m \sin \alpha \quad (11)$$

$$q_{1\alpha} + q_{2\alpha} = i_\alpha \frac{\tan \lambda}{\omega}. \quad (12)$$

From (4), (5), and (9) and with $\gamma = \beta - \alpha$

$$A_1 \sin \beta + A_2 \cos \beta = 0 \quad (13)$$

where

$$A_1 = \sin \lambda - \sin(\gamma + \lambda) e^{-\gamma \cot \lambda}$$

$$A_2 = \frac{1}{\cos \lambda} [1 - e^{(\gamma - 2\pi) \cot \lambda}] + \cos \lambda - \cos(\gamma + \lambda) e^{-\gamma \cot \lambda}.$$

From (5), (6), (9), (10), (11), and (12) and with $\gamma = \beta - \alpha$

$$B_1 \sin \beta + B_2 \cos \beta = 0 \quad (14)$$

where

$$B_1 = 1 + \cos \gamma$$

$$B_2 = \frac{\tan \lambda}{2} [1 + e^{-2(\pi - \gamma) \cot \lambda}] - \sin \gamma.$$

Equations (13) and (14) will have a solution if

$$F(\gamma) = A_1 B_2 - A_2 B_1 = 0. \quad (15)$$

For a given value of λ or $(\omega CR) = \tan \lambda$, the corresponding value of γ may be determined by solving $F(\gamma) = 0$ for its root. This root may be found by using Newton's method.⁵ The two angles α and β may then be calculated from $\beta = \tan^{-1}(-A_2/A_1)$ and $\alpha = \beta - \gamma$. Thus the three angles, α , β , and γ are functions of (ωCR) alone.

(b) Average Load Voltage

The average load current I is

$$I = \frac{1}{\pi} \int_\alpha^{\alpha + \pi} i_L d(\omega t)$$

$$= \frac{1}{\pi} \frac{E_m}{R} (2 \sin \beta + \tan \lambda \cos \beta) \tan \lambda. \quad (16)$$

The integral is evaluated by using (1) and (7) and is then simplified by the use of (4) to (6) and (9) to (12), inclusive. The ratio of the average load voltage to the maximum value of the alternating voltage applied IR/E_m is

$$\frac{IR}{E_m} = \frac{\tan \lambda}{\pi} (2 \sin \beta + \tan \lambda \cos \beta) \quad (17)$$

and this ratio is a function only of (ωCR) .

(c) Per Cent Ripple

The instantaneous load current i_L may be represented as a Fourier series

$$i_L = I + M_1 \sin 2\omega t + N_1 \cos 2\omega t + M_2 \sin 4\omega t + N_2 \cos 4\omega t + \dots \quad (18)$$

For reasons given previously only M_1 and N_1 are calculated as follows:

⁵ L. E. Dickson, "First Course in the Theory of Equations," John Wiley and Sons, New York, N. Y., 1922, pp. 96-98.

$$\left. \begin{aligned} M_1 &= \frac{2}{\pi} \int_{\alpha}^{\alpha+\pi} i_L \sin 2\omega t d(\omega t) \\ N_1 &= \frac{2}{\pi} \int_{\alpha}^{\alpha+\pi} i_L \cos 2\omega t d(\omega t). \end{aligned} \right\} \quad (19)$$

The evaluation of the integrals is carried through, and by use of (4) to (6) and (9) to (12), inclusive, the following expressions are obtained:

$$\begin{aligned} \frac{M_1 R}{E_m} &= \frac{\sin \lambda}{\pi} \left\{ \frac{\cos(3\alpha - \lambda) - \cos(3\beta - \lambda)}{3} \right. \\ &\quad \left. + \cos(\alpha + \lambda) - \cos(\beta + \lambda) \right\} \\ &\quad - \frac{1}{\pi} \left[\frac{Ri_{\beta}}{E_m} - \sin \lambda \cos(\beta - \lambda) \right] \sin(2\beta + \lambda_1) \sin \lambda_1 \\ &\quad + \frac{1}{\pi} \left[\frac{Ri_{\alpha}}{E_m} - \sin \lambda \cos(\alpha - \lambda) \right] \sin(2\alpha + \lambda_1) \sin \lambda_1 \\ &\quad + \frac{\sin \lambda}{\pi} \left[\frac{Ri_{\beta}}{E_m} \sin(2\beta + \lambda) - \frac{Ri_{\alpha}}{E_m} \sin(2\alpha + \lambda) \right] \quad (20) \end{aligned}$$

$$\begin{aligned} \frac{N_1 R}{E_m} &= \frac{\sin \lambda}{\pi} \left\{ \frac{\sin(3\beta - \lambda) - \sin(3\alpha - \lambda)}{3} \right. \\ &\quad \left. + \sin(\beta + \lambda) - \sin(\alpha + \lambda) \right\} \\ &\quad - \frac{1}{\pi} \left[\frac{Ri_{\beta}}{E_m} - \sin \lambda \cos(\beta - \lambda) \right] \cos(2\beta + \lambda_1) \sin \lambda_1 \\ &\quad + \frac{1}{\pi} \left[\frac{Ri_{\alpha}}{E_m} - \sin \lambda \cos(\alpha - \lambda) \right] \cos(2\alpha + \lambda_1) \sin \lambda_1 \\ &\quad + \frac{\sin \lambda}{\pi} \left[\frac{Ri_{\beta}}{E_m} \cos(2\beta + \lambda) - \frac{Ri_{\alpha}}{E_m} \cos(2\alpha + \lambda) \right] \quad (21) \end{aligned}$$

where

$$\begin{aligned} \frac{Ri_{\alpha}}{E_m} &= 2(\sin \beta + \sin \alpha) + \cos \beta \tan \lambda \\ \frac{Ri_{\beta}}{E_m} &= -\cos \beta \tan \lambda. \end{aligned}$$

The per cent ripple is

$$r = \frac{100}{\sqrt{2}} \frac{(M_1 R)^2 + (N_1 R)^2}{(IR/E_m)} \quad (22)$$

and by examination depends only on (ωCR) .

(d) Effective Input Current and Input Power Factor

The effective input current I_e is calculated from

$$I_e = \sqrt{\frac{1}{\pi} \int_{\alpha}^{\alpha+\pi} i_P^2 d(\omega t)} \quad (23)$$

and when evaluated is

$$\begin{aligned} \left(\frac{I_e R}{E_m} \right)^2 &= \frac{\beta - \alpha}{2\pi} (3 \sin^2 \lambda + \tan^2 \lambda) \\ &\quad + \frac{\sin 2\beta - \sin 2\alpha}{4\pi} (\sin^2 \lambda \cos 2\lambda + 2 \sin^2 \lambda + \tan^2 \lambda) \\ &\quad - \frac{\cos 2\beta - \cos 2\alpha}{4\pi} (\sin^2 \lambda \sin 2\lambda + 2 \tan \lambda \sin^2 \lambda) \end{aligned}$$

$$\begin{aligned} &- 2 \sin^2 \lambda \left[\cos \beta + \frac{\cos(\beta + \lambda)}{\cos \lambda} \right] \left[\frac{Ri_{\beta}}{E_m} - \sin \lambda \cos(\beta - \lambda) \right] \\ &\quad + 2 \sin^2 \lambda \left[\cos \alpha + \frac{\cos(\alpha + \lambda)}{\cos \lambda} \right] \left[\frac{Ri_{\alpha}}{E_m} - \sin \lambda \cos(\alpha - \lambda) \right] \\ &\quad - \frac{1}{2} \tan \lambda \left\{ \left[\frac{Ri_{\beta}}{E_m} - \sin \lambda \cos(\beta - \lambda) \right]^2 \right. \\ &\quad \left. - \left[\frac{Ri_{\alpha}}{E_m} - \sin \lambda \cos(\alpha - \lambda) \right]^2 \right\}. \quad (24) \end{aligned}$$

The ratio (I_e/I) is found by dividing $(I_e R/E_m)$ by (IR/E_m) .

The average input power P may be found from

$$P = \frac{1}{\pi} \int_{\alpha}^{\alpha+\pi} (E_m \sin \omega t) i_P d(\omega t) \quad (25)$$

and

$$\begin{aligned} \frac{PR}{E_m^2} &= \frac{\sin \lambda}{2\pi} \left\{ (\beta - \alpha) \sin \lambda + \left(\cos \lambda + \frac{1}{\cos \lambda} \right) (\sin^2 \beta - \sin^2 \alpha) \right. \\ &\quad \left. + \frac{\sin \lambda}{2} (\sin 2\beta - \sin 2\alpha) \right. \\ &\quad \left. + \left(\frac{Ri_{\alpha}}{E_m} \right) \sin(\alpha + \lambda) - \left(\frac{Ri_{\beta}}{E_m} \right) \sin(\beta + \lambda) \right\}. \quad (26) \end{aligned}$$

The input power factor in per cent is

$$\text{per cent power factor} = 100 \sqrt{2} \left(\frac{PR}{E_m^2} \right) / \left(\frac{I_e R}{E_m} \right) \quad (27)$$

(e) Maximum Current and Peak Inverse Voltage of the Tube

When (ωCR) is less than 6.362, the ratio of the maximum tube current to the average tube current (i_m/I) is

$$\frac{i_m}{I} = \frac{\tan \lambda}{(IR/E_m)} \left[\frac{\cos(\theta_m + \lambda)}{\cos \lambda} + \cos \theta_m \right] \quad (28)$$

where θ_m is the angle of maximum tube current and may be obtained from

$$\begin{aligned} &[\sin \theta_m \tan \lambda + \sin \lambda \sin(\theta_m - \lambda)] e^{\theta_m \cot \lambda} \\ &\quad + (\cot \lambda) \left[\frac{Ri_{\alpha}}{E_m} - \sin \lambda \cos(\alpha - \lambda) \right] e^{\alpha \cot \lambda} = 0. \quad (29) \end{aligned}$$

When (ωCR) is more than 6.362

$$\frac{i_m}{I} = \frac{2(\sin \alpha + \sin \beta) + (\cos \alpha + \cos \beta) \tan \lambda}{(IR/E_m)} \quad (30)$$

The ratio of the peak inverse voltage to the maximum value of the supply voltage (e_P/E_m) is

$$\frac{e_P}{E_m} = \tan \lambda \cos \theta_P \quad (31)$$

where θ_P is the angle of peak inverse voltage and may be obtained from

$$\begin{aligned} &e^{\theta_P \cot \lambda} \sin(\theta_P - \lambda) \\ &\quad + \frac{\cot \lambda}{\sin \lambda} \left[\frac{Ri_{\alpha}}{E_m} - \sin \lambda \cos(\alpha - \lambda) \right] e^{\alpha \cot \lambda} = 0. \quad (32) \end{aligned}$$

An Inductively Coupled Frequency Modulator*

BRUCE E. MONTGOMERY†, ASSOCIATE, I.R.E.

Summary—The frequency modulator described here allows the engineer to design a frequency-modulated oscillator that has more power output and will operate on a higher fundamental frequency than conventional modulators in use at present. It consists of an inductance, capacitance, and resistance in parallel coupled inductively to the frequency-controlling circuit of the self-excited oscillator. Variations in the parallel resistance reflect reactance and resistance changes into the oscillator inductance thereby causing frequency variations.

In the experimental setup used, the parallel resistance is the plate circuit of a 6F6 tube. Variations in the alternating-current plate resistance of the 6F6 tube are accentuated by the proper placement of a resistor in the plate circuit.

Calculated curves are given showing the variations of the introduced reactance and resistance as the parallel resistance is varied. Experimental curves are given showing the performance of the system at 2.5 megacycles.

INTRODUCTION

THE reactance-tube method of producing frequency modulation and controlling oscillator frequency has been described by several authors in the last few years.¹⁻⁴ In this method, variations of voltage on the grid of a tube cause proportional variations in the reactance introduced in the frequency-controlling circuit of a self-excited oscillator. The authors referred to make use of the fact that a vacuum tube will appear as a reactance if the grid is supplied with a voltage that bears a 90-degree phase relation to the voltage in the plate circuit.

In this paper there will be described a method for introducing variable reactance into an oscillating circuit by inductive coupling and without the use of phase-shifting circuits which are required in the other methods to which reference is made.

MATHEMATICAL ANALYSIS

Let us consider Fig. 1. Here are inductance, capacitance, and resistance in parallel inductively coupled to another inductance that may be part of the controlling circuit of a self-excited oscillator. It will now be shown

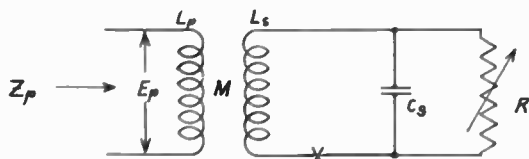

Fig. 1—Fundamental frequency-modulator circuit.

that variations in the parallel resistance will cause variations of resistance and reactance to appear in the primary circuit.

* Decimal classification: R355.8. Original manuscript received by the Institute, April 1, 1941.

† United Air Lines, Chicago, Ill.

¹ Charles Travis, "Automatic frequency control," *Proc. I.R.E.* vol. 23, pp. 1125-1141; October, 1935.

² D. E. Foster and S. W. Seeley, "Automatic tuning, simplified circuits, and design practice," *Proc. I.R.E.* vol. 25, pp. 289-313; March, 1937.

³ I. R. Weir, "Field tests of frequency and amplitude modulation with U.H.F. waves," *Gen. Elec. Rev.*, vol. 42, pp. 188-191; May, 1939; and pp. 270-273; June, 1939.

⁴ C. F. Sheaffer, "Frequency modulator," *Proc. I.R.E.*, vol. 28, pp. 66-67; February, 1940.

In the discussion of Figs. 1 and 2, the symbols listed below will be used.

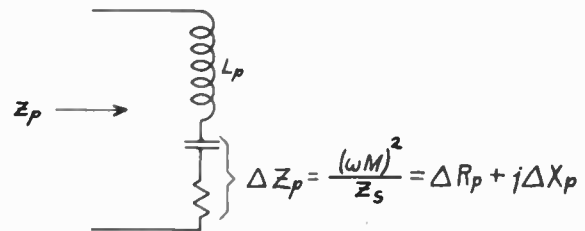

Fig. 2—Equivalent circuit of Fig. 1.

E_p = voltage across L_p

I_p = current in L_p

I_s = current in L_s

X_{L_p} = reactance of L_p (with L_s removed)

X_{L_s} = reactance of L_s (with L_p removed)

X_{C_s} = reactance of C_s

M = mutual inductance between L_p and L_s

Z_p = impedance across L_p (with L_s present)

Z_s = series impedance at point X in secondary circuit (with L_p removed)

R = resistance, variable from zero to infinity

ΔR_p = increment of resistance in L_p caused by secondary circuit

ΔX_p = increment of reactance in L_p caused by secondary circuit

$\Delta Z_p = \Delta R_p + j\Delta X_p$

Two equations may be written for the voltages in the primary and secondary circuits⁵ of Fig. 1.

$$E_p = I_p X_{L_p} + j\omega M I_s \quad (1)$$

$$I_s Z_s + j\omega M I_p = 0 \quad (2)$$

Solving (1) and (2) to eliminate I_s gives

$$E_p = I_p \left(X_{L_p} + \frac{\omega^2 M^2}{Z_s} \right) \quad (3)$$

It is seen then, that Fig. 2 is equivalent to Fig. 1. Returning to Fig. 1,

$$Z_s = jX_{L_s} - j \frac{RX_{C_s}}{R - jX_{C_s}} = \frac{X_{L_s}X_{C_s} + jR(X_{L_s} - X_{C_s})}{R - jX_{C_s}} \quad (4)$$

From (4) and Fig. 2,

$$\Delta Z_p = \frac{(\omega M)^2}{Z_s} = \frac{(\omega M)^2 (R - jX_{C_s})}{X_{L_s}X_{C_s} + jR(X_{L_s} - X_{C_s})} \quad (5)$$

By rationalizing and simplifying, (5) becomes

$$\frac{\Delta Z_p}{(\omega M)^2} = \frac{X_{C_s}^2 R - j[X_{L_s}X_{C_s}^2 + R^2(X_{L_s} - X_{C_s})]}{X_{L_s}^2 X_{C_s}^2 + R^2(X_{L_s} - X_{C_s})^2} \quad (6)$$

⁵ F. E. Terman, "Radio Engineering," McGraw-Hill Book Company, New York, N. Y., 1932, p. 65.

From Fig. 2,

$$\Delta Z_p = \Delta R_p + j\Delta X_p \quad (7)$$

Then from (6) and (7)

$$\frac{\Delta R_p}{(\omega M)^2} = \frac{X_{C_s}^2 R}{X_{L_s}^2 X_{C_s}^2 + R^2 (X_{L_s} - X_{C_s})^2} \quad (8)$$

and

$$-\frac{\Delta X_p}{(\omega M)^2} = \frac{X_{L_s} X_{C_s}^2 + R^2 (X_{L_s} - X_{C_s})}{X_{L_s}^2 X_{C_s}^2 + R^2 (X_{L_s} - X_{C_s})^2} \quad (9)$$

Equations (8) and (9) are statements of the relationship between the resistance and reactance introduced in L_p by the coupled secondary circuit of inductance, capacitance, and resistance in parallel.

Let the circuit elements X_{L_s} and X_{C_s} be replaced in (8) and (9) in the following manner:

$$\left. \begin{aligned} X_{L_s} X_{C_s}^2 &= A \\ X_{L_s} - X_{C_s} &= B \\ X_{L_s}^2 X_{C_s}^2 &= C \\ X_{C_s}^2 &= D \end{aligned} \right\} \quad (10)$$

Then (8) and (9) become

$$\frac{\Delta R_p}{(\omega M)^2} = \frac{DR}{C + B^2 R^2} \quad (8a)$$

and

$$-\frac{\Delta X_p}{(\omega M)^2} = \frac{A + BR^2}{C + B^2 R^2} \quad (9a)$$

The equations of (8a) and (9a) establish the relationship between ΔR_p and R and ΔX_p and R as all circuit elements except R are held constant. Observe that in (8a) ΔR_p will vary in exactly the same way whether B is positive or negative. On the other hand, in (9a) ΔX_p will vary in a negative direction if B is positive, and in a positive direction if B is negative.

By differentiating (8a) with respect to R , a determination may be had of the value of R at which ΔR_p is a maximum.

$$\frac{1}{(\omega M)^2} \frac{d(\Delta R_p)}{dR} = \frac{(C + B^2 R^2)(D) - (DR)(2B^2 R)}{(C + B^2 R^2)^2} = 0 \quad (11)$$

Solving for R^2 ,

$$R^2 = \frac{C}{B^2} = \frac{X_{L_s}^2 X_{C_s}^2}{(X_{L_s} - X_{C_s})^2} \quad (12)$$

and

$$R_{(\max \Delta R_p)} = \pm \frac{X_{L_s} X_{C_s}}{X_{L_s} - X_{C_s}} \quad (13)$$

Equation (13) defines the value of R (Fig. 1) at which ΔR_p (Fig. 2) is a maximum.

By differentiating (9a) twice with respect to R , a determination may be had of the value of R at which the rate of change of ΔX_p is greatest.

$$-\frac{1}{(\omega M)^2} \frac{d(\Delta X_p)}{dR} = \frac{2(BC - AB^2)R}{(C + B^2 R^2)^2} \quad (14)$$

Taking the second derivative of (14), and setting the result equal to zero,

$$-\frac{1}{2(BC - AB^2)(\omega M)^2} \frac{d^2(\Delta X_p)}{dR^2} = \frac{(C + B^2 R^2)^2 - 2R(C + B^2 R^2)(2B^2 R)}{(C + B^2 R^2)^4} = 0 \quad (15)$$

Reducing,

$$C - 3B^2 R^2 = 0 \quad (16)$$

Solving for R^2 ,

$$R^2 = \frac{C}{3B^2} = \frac{X_{L_s}^2 X_{C_s}^2}{3(X_{L_s} - X_{C_s})^2} \quad (17)$$

and

$$R_{(\max d(\Delta X_p)/dR)} = \pm \frac{X_{L_s} X_{C_s}}{\sqrt{3}(X_{L_s} - X_{C_s})} \quad (18)$$

Equation (18) defines the value of R that gives the greatest rate of change of ΔX_p (Fig. 2).

In (13) and (18) the positive sign is used when $(X_{L_s} - X_{C_s})$ is positive and the negative sign is used when $(X_{L_s} - X_{C_s})$ is negative since R must at all times be positive.

CALCULATED RESULTS

In Fig. 1, reasonable values of L_p , L_s , and C_s were selected for a frequency of 2.5 megacycles. The value of M was determined by assuming that the maximum value of ΔR_p coupled into L_p by the secondary circuit should be of such a magnitude as to cause the Q of L_p to decrease from 200 to an effective value of 100. The following numerical values for the circuit elements were obtained:

$$\begin{aligned} M &= 0.75 \text{ microhenry, or } \omega M = 11.8 \text{ ohms} \\ L_s &= 37.4 \text{ microhenrys, or } X_{L_s} = 588 \text{ ohms} \\ C_s &= 96 \text{ micromicrofarads, or } X_{C_s} = 662 \text{ ohms} \\ R &= 0 \text{ to } 20,000 \text{ ohms} \end{aligned}$$

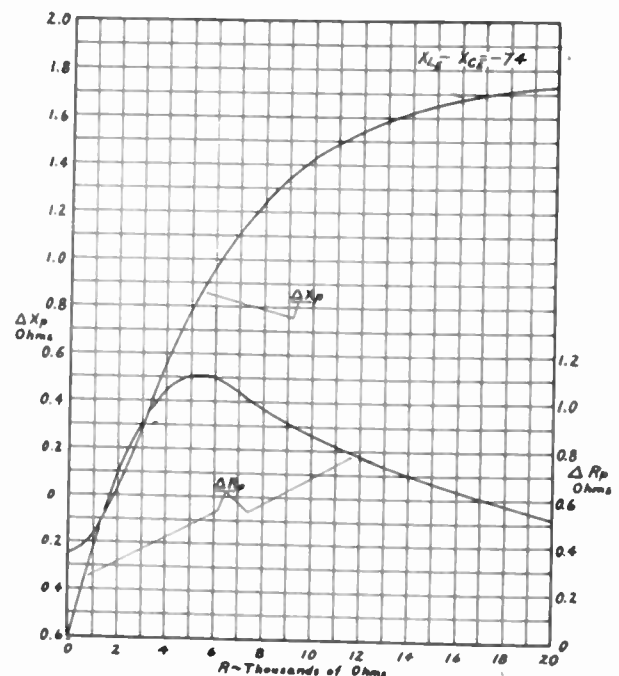

Fig. 3—Calculated curves showing variations in ΔR_p and ΔX_p when the net reactance of $L_s C_s$ is inductive.

These values were used in (8) and (9) to calculate the way ΔR_p and ΔX_p vary with R and the results are plotted in Fig. 3. It will be observed that when R is zero ΔR_p is also zero. As R increases from zero ΔR_p increases to a maximum as predicted by (13) and then decreases again to zero when R reaches infinity. It will also be observed that ΔX_p varies continuously from a negative reactance at $R=0$ to a positive reactance at $R=20,000$ ohms and more.

X_{C_s} is now changed to 528 ohms ($C_s=120.8$ micro-microfarads) and the variations of ΔR_p and ΔX_p with a varying R are again calculated. The results are plotted in Fig. 4. The curve showing the variation of ΔR_p is identical with the one shown in Fig. 3. It will be further observed that the variation of ΔX_p is opposite from what it was in Fig. 3, but that the shape of

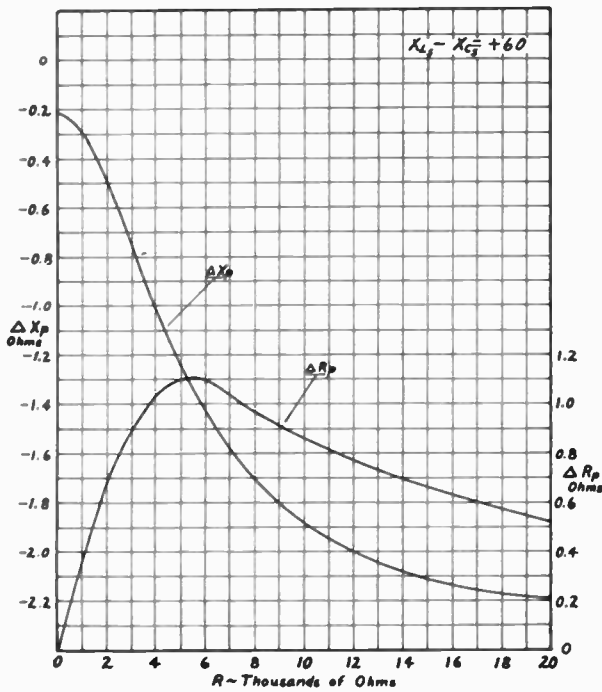

Fig. 4—Calculated curves showing variations in ΔR_p and ΔX_p when the net reactance of $L_s C_s$ is capacitive.

the curve and the total amount of reactance variation are exactly the same. Therefore if L_p is part of an oscillator circuit, and $L_s C_s$ is tuned to a frequency higher than the oscillator frequency, the oscillator frequency will decrease as R is increased. If on the other hand $L_s C_s$ is tuned to a frequency lower than the oscillator frequency, the oscillator frequency will increase as R is increased. The above value of X_{C_s} was chosen specifically to show that as $L_s C_s$ is tuned from one side of resonance to the other the curve of ΔR_p does not change, and that the curve of ΔX_p changes only in direction of variation.

EXPERIMENTAL RESULTS

The chief practical difficulty in this method of reactance variation is in causing R to vary properly in accordance with an audio voltage. Inspection of the I_p-E_p characteristic curves for pentodes shows that a

variation in alternating-current plate resistance occurs to a certain degree. The 6F6 tube was chosen as most suited and the circuit of Fig. 5 shows the method of

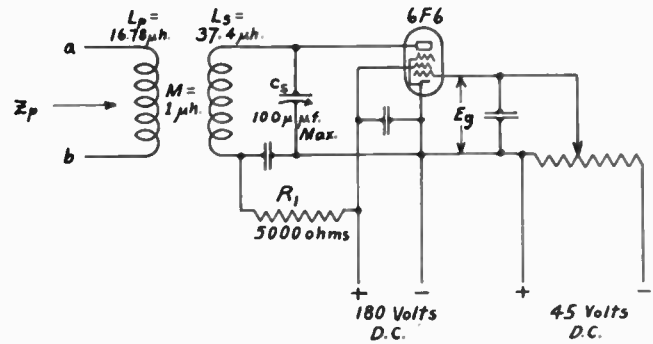

Fig. 5—The circuit used to measure variations in Z_p as E_g is varied.

connection. The 5000-ohm resistor R_1 is placed in the plate circuit of the 6F6 to accentuate the variations in the alternating-current plate resistance as the grid voltage varies. Fig. 6 shows why this occurs. This is the usual plate characteristic of a 6F6 tube with two load lines drawn in as shown. It will be seen that the alternating-current plate resistance varies over a much wider range as the grid voltage is varied with either the 3300-ohm or 5000-ohm resistor in place at R_1 than it would vary had R_1 been omitted. In the latter case the load line would be vertical from the 250 plate-voltage point.

Terminals a and b of Fig. 5 were connected to a Boonton Q meter and measurements of varying series resistance and reactance in L_p were made as the grid voltage was varied by small increments. The measurements were made at 2.5 megacycles. From these data were constructed curves of ΔR and Δf plotted against E_g . These are shown in Fig. 7. It will be observed that the $\Delta f-E_g$ curve is quite linear over its central portion.

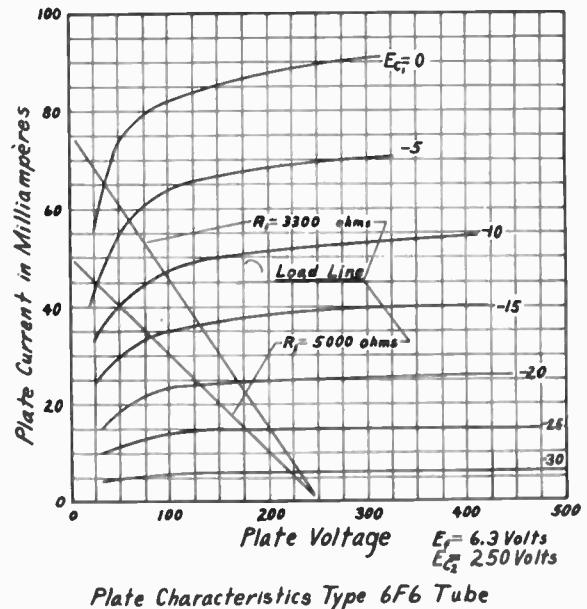

Fig. 6—Demonstration of the accentuation of alternating-current plate-resistance variation caused by the introduction of R_1 as shown in Fig. 5.

Fig. 7 indicates that with the particular circuit constants of Fig. 5 built into a frequency-modulated-oscil-

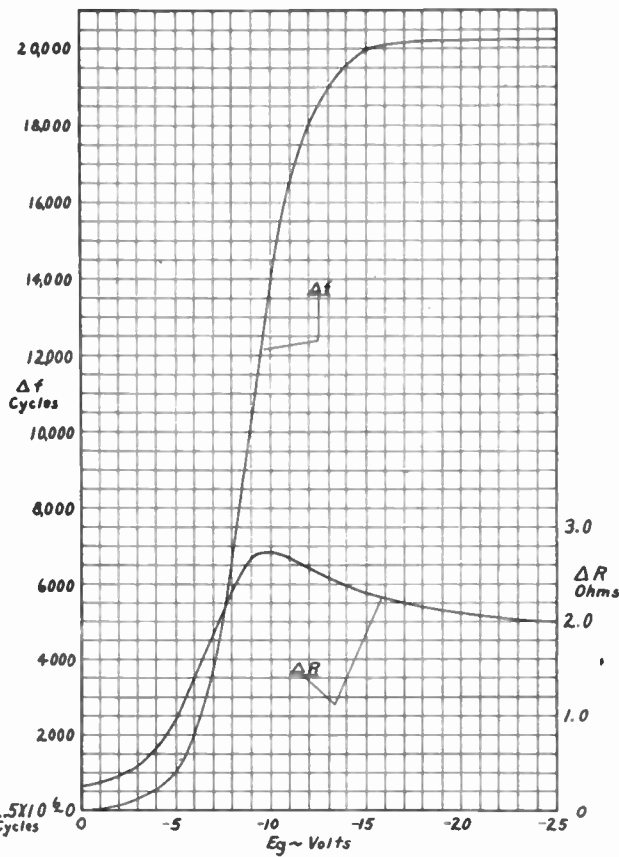

Fig. 7—Curves constructed from data taken on a Boonton Q meter using the circuit of Fig. 5.

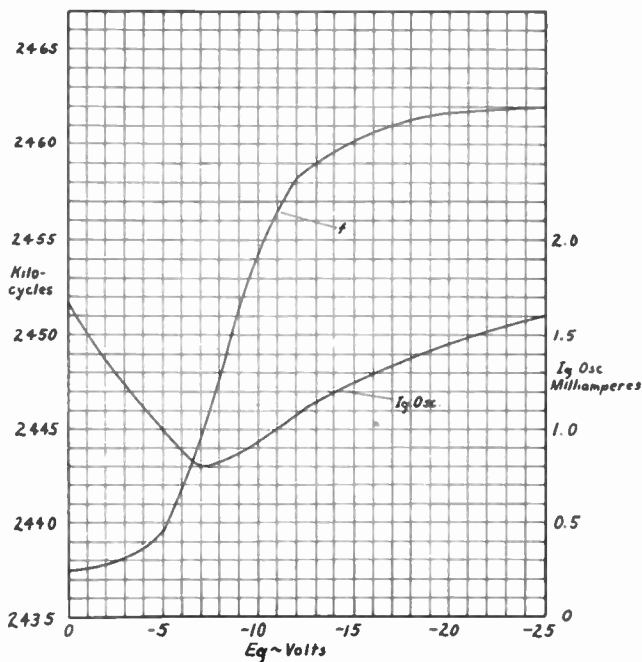

Fig. 8—Variation of oscillator frequency and oscillator grid current of Fig. 3 as the modulator grid voltage is varied.

lator arrangement, about 20 kilocycles total frequency variation can be obtained at 2.5 megacycles. Fig. 8

demonstrates that a total frequency variation of 24.5 kilocycles is actually obtained. The curves of Fig. 8 are the performance of Fig. 9. This is the circuit of Fig. 5 with L_p becoming part of the frequency-controlling circuit of an electron-coupled oscillator and R_1 being changed to 3300 ohms. It should be pointed out that the total 24.5-kilocycle variation could not be used for modulation purposes because this would bring the highly curved portions of the curve into use and excessive distortion would result. Inspection of the curve shows that about a 17-kilocycle variation would be available for modulation purposes. This would give a deviation of ± 175 kilocycles at 50 megacycles and is considerably more than can be used in practice.

The variation of oscillator grid current ($I_{g \text{ Osc}}$) as the modulator grid voltage (E_g) was varied is also shown. This variation in grid current is caused by the resistance being coupled into the oscillating circuit by the modulator. As this coupled resistance increases, it decreases the amplitude of the oscillations, and thus decreases the rectified oscillator grid current. This effect produces amplitude modulation on the fre-

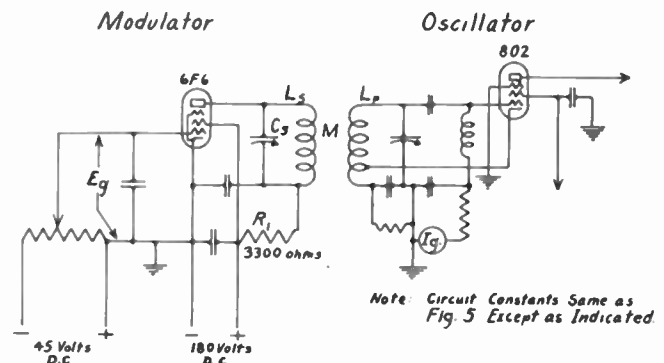

Fig. 9—Schematic of frequency modulator and self-excited frequency-modulated oscillator operating at 2.5 megacycles.

quency-modulated output, but the limiting action of the following frequency-multiplier stages will remove this amplitude modulation and leave frequency modulation only at the output frequency.

CONCLUSIONS

The inductively coupled frequency modulator described here has been used on 2.5 megacycles only, but there appear to be no serious limitations to its use on much higher frequencies. The circuit shown in Fig. 9 is capable of delivering more power than can be secured from a reactance-tube frequency modulator which normally uses receiving-type tubes. The use of even larger oscillator and modulator tubes in this inductively coupled system would allow considerably more power to be delivered to succeeding frequency-multiplying stages. This combination of higher-frequency operation and increased power output would allow the design of more compact and economical transmitting equipment by eliminating frequency-multiplying stages.

ACKNOWLEDGMENT

The author wishes to thank Mr. P. C. Sandretto, Superintendent of the United Air Lines Communications Laboratory, for his encouragement during the

preparation of this paper, and to thank Mr. C. G. Hylkema of the Purdue University Electrical Engineering Department for his excellent criticisms of the manuscript.

High-Frequency Radio Transmission Conditions, September, 1941, with Predictions for December, 1941*

NATIONAL BUREAU OF STANDARDS, WASHINGTON, D. C.

THE radio transmission data herein are based on observations at Washington, D. C., of long-distance reception and of the ionosphere. Fig. 1 gives the September average values of maximum usable frequencies, for undisturbed days, for radio

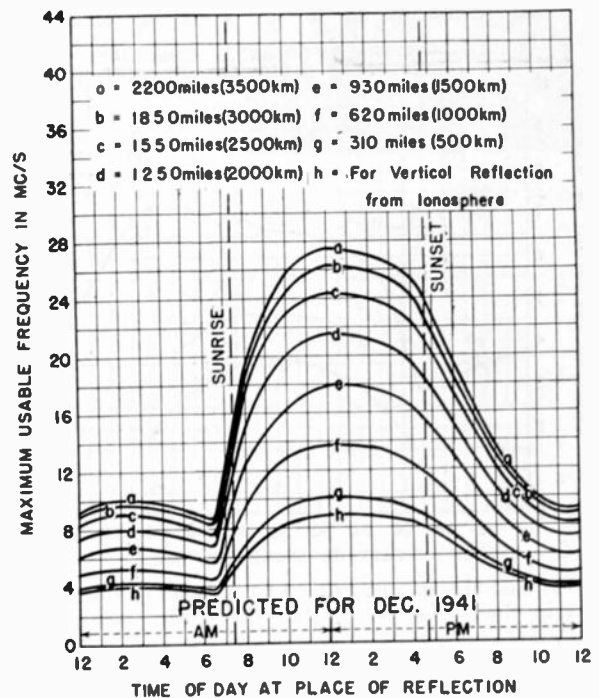
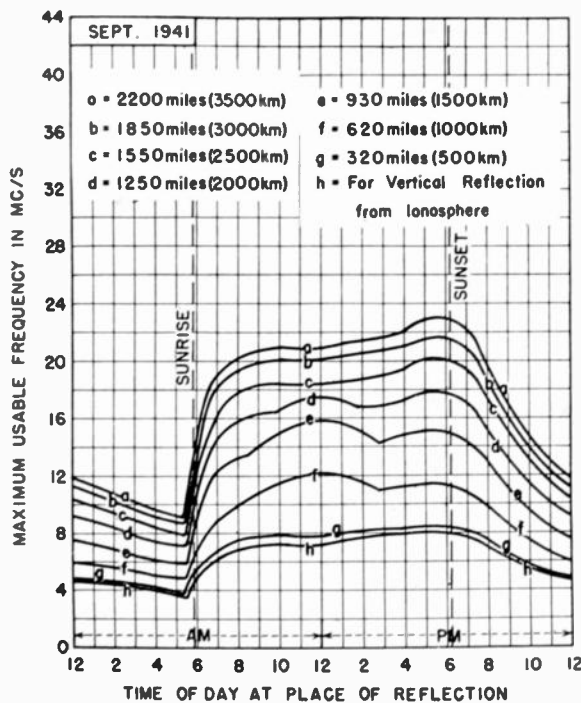

Fig. 1—Maximum usable frequencies for dependable radio transmission via the regular layers, average for undisturbed days, for September, 1941. The values shown were somewhat exceeded during irregular periods by reflections from clouds of sporadic E layer (see Table III). These curves and those of Fig. 2 also give skip distances, since the maximum usable frequency for a given distance is the frequency for which that distance is the skip distance.

Fig. 2—Predicted maximum usable frequencies for dependable radio transmission via the regular layers, average for undisturbed days, for December, 1941. For information on use in practical radio transmission problems, see the pamphlets "Radio transmission and the ionosphere" and "Distance ranges of radio waves," obtainable from the National Bureau of Standards, Washington, D. C., on request.

transmission by way of the regular layers of the ionosphere. The regular-layer maximum usable frequencies were determined by the F layer at night and by the E and F₂ layers during the day. Fig. 2 gives the expected values of the maximum usable frequencies for radio transmission by way of the regular layers, average for undisturbed days, for December, 1941.

Average critical frequencies and virtual heights of the ionospheric layers as observed at Washington, D. C., during September are given in Fig. 3. Critical

* Decimal classification: R113.61. Original manuscript received by The Institute, October 3, 1941.

TABLE I
IONOSPHERIC STORMS

Day and hour E.S.T.	h_p before sunrise (km)	Minimum f_p^o before sunrise (Mc)	Noon f_p^o (Mc)	Magnetic character ¹		Ionospheric character ²
				00-12 G.M.T.	12-24 G.M.T.	
Sept. 18 (from 0100)	3	3	3	5.6	8.0	9
19	3	3	3	7.6	4.6	8
20	3	3	5.7	4.3	2.9	6
21	344	1.5	7.0	3.8	2.6	4
22 (through 0600)	300	1.7	—	1.9	0.9	3
For comparison: average for undisturbed days	286	2.71	6.59	2.1	2.0	1.7

¹ Average for 12 hours of American magnetic K figure determined by seven observatories, on an arbitrary scale of 0 to 9, 9 representing the most severe disturbance.

² An estimate of the ionospheric storminess at Washington, on an arbitrary scale of 0 to 9, 9 representing the greatest disturbance.

³ No reflections observed above 1.7 megacycles.

frequencies for each day of the month are given in Fig. 4.

Ionospheric storms are listed in Table I. Noon and midnight critical frequencies observed during the

ionospheric storms listed in Table I are indicated by circles in Fig. 4. A great ionospheric storm began about 0100 E.S.T. on September 18. No vertical-incidence reflections were recorded above 1.7 megacycles be-

tween 0530 on the 18th and 0500 on the 19th, between 0830 and 1700 on the 19th, and between 2130 on the 19th and 0400 on the 20th. Great absorption or low critical frequencies or both caused this effect. The storm was characterized by disruption of normal sky-wave propagation for long periods and over various paths. The storm occurred during a period of extreme solar activity manifested by a very large group of active sunspots which was crossing the central meridian of the

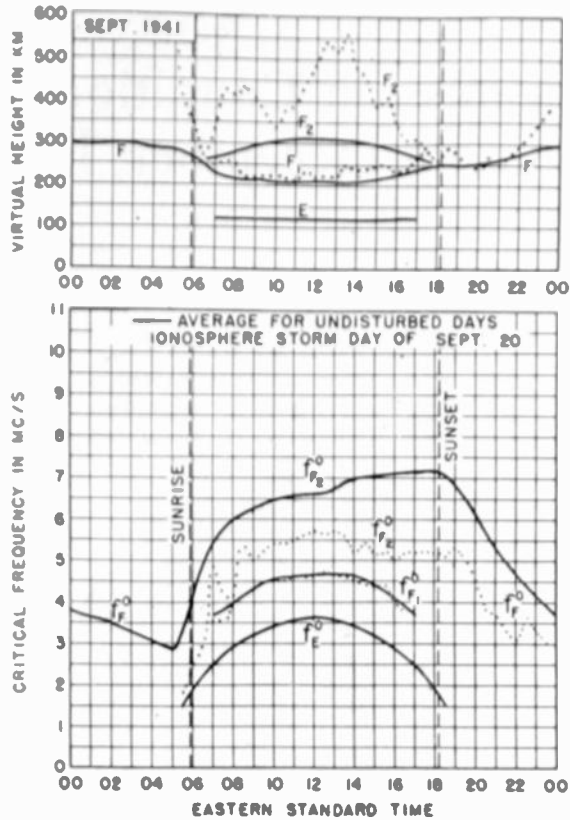

Fig. 3—Virtual heights and critical frequencies of the ionospheric layers observed at Washington, D. C., September, 1941.

TABLE II
SUDDEN IONOSPHERIC DISTURBANCES

Day	G M T		Location of transmitters	Relative intensity at minimum ¹
	Beginning	End		
Sept 17	1623	1632	Ohio	0.1
25	2100	2300	Ohio, D. C.	0.05

¹ Ratio of received field intensity during fade out to average field intensity before and after for station WAXAL, 6080 kilocycles, 650 kilometers distant

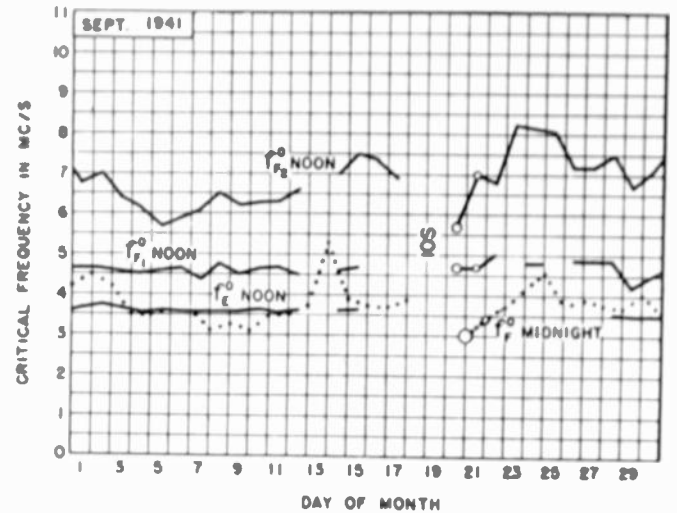

Fig. 4—Midnight and noon critical frequencies for each day of September. Open circles indicate critical frequencies observed during ionospheric storms. Size of circle roughly indicates relative severity of storm. The letters 10S indicate ionospheric storm on September 18, 19, and 20; it was a very severe one and prevented regular reflections from the ionosphere.

sun on the 16th and 17th. At Washington an unusual and very vivid display of the aurora borealis was observed on the evening of the 18th.

Sudden ionospheric disturbances are listed in Table II. Table III gives the approximate maximum usable frequencies for good radio transmission by means of sporadic-E reflections (as observed at Washington; sporadic-E conditions are patchy, not uniform over wide areas).

TABLE III
APPROXIMATE MAXIMUM USABLE FREQUENCIES IN MEGACYCLES, FOR RADIO TRANSMISSION BY MEANS OF STRONG SPORADIC E REFLECTIONS, AT WASHINGTON¹

Day	Hour, F S T																							
	00	01	02	03	04	05	06	07	08	09	10	11	12	13	14	15	16	17	18	19	20	21	22	23
Sept 1	40	45	18																					
2																								
3	18					16																		
4			15	15	14																			
5																								
6																								
7																								
8																								
10																								
11										NR														
13										NR														
16																								
17																								
20					15	15																		
21				23																				
23																								
25																								
26																								

¹ "NR" indicates recorder not operating.

Institute News and Radio Notes



ADOLFO T. COSENTINO
Vice President, 1941

Adolfo T. Cosentino was born in Buenos Aires, Argentina, on November 18, 1898.

In 1929 he organized the radio communications section of the General Post Office and is now Director of Radio Communications. He has represented the Argentine Administration at ten international conferences dealing with radio and telecommunications. He is a member of the Permanent Argentine Committee of Aeronautics and Meteorology and the Secretary of the Organizing Committee of the School of the Air.

Mr. Cosentino joined the Institute as an Associate in 1937, transferring to Fellow in 1940. He is a charter member of the Buenos Aires Section and has served as its chairman. He has been a contributor to the PROCEEDINGS.

1941 Rochester Fall Meeting

Sagamore Hotel, Rochester, New York
November 10, 11, 12, 1941

Technical Program Monday, November 10

9:30 A.M.

- "A Method of Introducing Good Synthetic Bass Response Into Small Receivers" (with demonstration), by F. H. Shepard, Jr., Revelation Patent Holding Corporation.
- "The Design of a Solid-Dielectric Flexible Radio-Frequency Transmission Line," by Harner Selvidge, American Phenolic Corporation.
- "Some New Aspects of Radio Engineering Economics," by E. L. Hulse, General Electric Company.

2:00 P.M.

- "Design Considerations for A Video Signal Generator With Monoscope Signal Source," by O. H. Schade and H. De

Ryder, RCA Manufacturing Company, Radiotron Division.
"The Skin Effect and The Depth of Penetration," by H. A. Wheeler, Hazeltine Service Corporation.

8:00 P.M.

- "A 300-Kilovolt Electron Microscope," by V. K. Zworykin, J. Hillier, and A. W. Vance, RCA Manufacturing Company, Victor Division.

Tuesday, November 11

9:30 A.M.

- "Annual Message of RMA Director of Engineering," by W. R. G. Baker, General Electric Company, Radio Department.
- "Discussion of Tube Noise Phenomena," by W. L. Krahl, Hygrade Sylvania Corporation.
- "Design of a Frequency-Modulated Signal Generator," by C. J. Franks, Boonton Radio Corporation.

2:00 P.M.

- "New Magnetic Materials," by W. E. Ruder, General Electric Company.
- "Design of a Modern 400-Megacycle Signal Generator," by John M. Van Beuren, Measurements Corporation.
- "New Advances in Iron Cores," by W. J. Polydoroff, Consulting Engineer.

Wednesday, November 12

9:30 A.M.

- "Some Observations Concerning The Transient Behavior of Radio Noise Meters," by C. M. Burrill, RCA Manufacturing Company, Victor Division.
- "The Use of Plastics in the Radio Industry," by H. M. Richardson, General Electric Company.
- "Civilian Receiver Design, 1942," by Dorman D. Israel, Emerson Radio and Phonograph Corporation.

2:00 P.M.

- "Alternate Carrier Synchronization in Television," by F. J. Bingley, Philco Corporation.
- "Receiver Controlled by Transmitted Signal—Alert Receiver," (with demonstration), by S. W. Seeley and H. B. Deal, RCA License Laboratory.

FORTHCOMING MEETINGS

Rochester Fall Meeting
November 10, 11, and 12, 1941

Winter Convention
New York, N. Y.
January 12, 13, and 14, 1942

Summer Convention
Cleveland, Ohio
June 29, 30, and July 1, 1942



FREDERICK E. TERMAN
President, 1941

Frederick Emmons Terman was born on June 7, 1900, at English, Indiana. He received from Stanford University in 1920 the A.B. degree and in 1922 the degree of Engineer. Massachusetts Institute of Technology conferred the degree of Sc.D. on him in 1922.

He has taught at Stanford University from 1925 to date. His first two years were as an instructor and the next three as an assistant professor. From 1930 to 1937 he served as an associate professor, being appointed professor and head of the electrical engineering department in 1937.

Dr. Terman joined the Institute as an Associate in 1925, transferring to Fellow in 1937. He has contributed a number of papers to the PROCEEDINGS and has been active both in the San Francisco Section and the management of the Pacific Coast Conventions. He served the Institute as vice president during 1940.

Board of Directors

A regular meeting of the Board of Directors was held on October 1 and was attended by Haraden Pratt, chairman; Melville Eastham, H. T. Friis, Alfred N. Goldsmith, Virgil M. Graham, R. A. Heising, C. M. Jansky, Jr., F. B. Llewellyn, B. J. Thompson, H. M. Turner, A. F. Van Dyck, H. A. Wheeler, L. P. Wheeler, and H. P. Westman, secretary.

Approval was granted of ninety-six applications for Associate, five for Junior, twenty for Student, and four for transfer to Associate.

The Sections Committee at its annual meeting on June 25, adopted two changes in the Constitution for Sections. These revisions were approved by the Board of Directors and are now effective. They follow:

Section 1 of Article III is modified to read "The territory of the Section shall be set by the Board of Directors, and may be enlarged, reduced, or otherwise altered by the Board at any time."

A new section to be known as Section

4, has been added to Article IV and reads "The Section may require nonmembers who wish to be placed on the mailing list for notices to pay in advance for the estimated cost of such notices."

Executive Committee

The Executive Committee met on September 15. Those present were F. E. Terman, president; Haraden Pratt, W. C. Copp (guest), Alfred N. Goldsmith, R. A. Heising, B. J. Thompson, and H. P. Westman, secretary.

The dates for the 1942 Winter Convention were set as January 12, 13, and 14. Headquarters will be at the Hotel Commodore in New York City.

The problem of obtaining increased advertising in the PROCEEDINGS was discussed and a possible arrangement under which Mr. Copp would make his services available for this purpose was considered.

The Executive Committee met on September 25 and those present were Haraden Pratt, chairman and treasurer; Melville Eastham, Alfred N. Goldsmith, R. A. Heising, B. J. Thompson, and H. P. Westman, secretary.

A schedule for the development of the program and publicity on the 1942 Winter Convention was approved.

Sections

Emporium

R. M. Wise, chief radio tube engineer for the Hygrade Sylvania Corporation, presented a paper on "The Radio Industry in War Time."

A comparison was drawn between the first World War and the present conflict. The degree of preparation for war and our attitude toward it on September, 1941, and April, 1917, were outlined. The stage of development of radio in 1917 was described and the progress that has been made in both tubes and sets since then was considered.

The rigid requirements for military radio equipment make it very difficult to change over modern set assembly lines for the manufacture of war equipment.

This war puts great emphasis on motion rather than position and a reliable communication system is a necessity. Much development work is being done in the higher frequencies and should be extremely useful in times of peace. If these possibilities are kept in mind, the readjustment period after the war should be less difficult.

September 10, 1941, R. K. Gessford, chairman, presiding.

Los Angeles

"The Radio Alarm for Civilian Defense" was the subject of the paper by A. F. Van Dyck and H. B. Deal of the RCA License Laboratories.

The development of the device was outlined by Mr. Van Dyck. It was initially intended as a means of remotely controlling the type or class of broadcast program being received. Obstacles, chiefly of a com-

mercial nature, blocked its widespread adoption.

The usefulness of the device as a Radio Alarm in the Civilian Defense Program was recognized. Demonstrations were made in this country and, through an international broadcast, to listeners in England. These demonstrations show the effectiveness of the device for blanket contact service and the dissemination of vital information and instructions to workers in strategic areas.

Two radio alarm units were set up and through the co-operation of KFI-KECA a demonstration of how they could be used to issue instructions to two separate groups, or their facilities combined, was made.

Mr. Deal discussed the technical characteristics of the equipment and these will be found in the report on this same paper given before the San Francisco Section.

August 26, 1941, W. W. Lindsay, Jr., chairman, presiding.

A paper on "Compact Radio Equipment for Aircraft Ferry Service" by Paul Holmes of the Stoddard Aircraft Radio Company, and Frederick Ireland of the General Radio Company was presented by Mr. Ireland.

The special conditions for which this equipment was designed were outlined. Emphasis was placed on measurements leading to the proper design of the transmitter output circuit. Radiation-resistance measurements were discussed and calculations given for proper loading over the required frequency range.

In the discussion, attention was given to the variations in the adjustment of the equipment under the conditions that the ship be on the ground and in the air. It was the consensus that whereas an insulation safety factor of 1 may be satisfactory at sea level, it should be approximately 2.2 at 30,000 feet above sea level.

The second paper was by F. A. Everest, of the faculty of Oregon State College. It was entitled "Horizontal-Polar-Pattern Calculator for Directional Broadcast Antennas."

There was first presented the mathematical solution of the horizontal-polar-pattern problems as applied to complicated broadcast antenna arrays. The vector analysis was then tied in with the function of the mechanical calculator.

Typical problems were set up on the calculator and the resulting patterns resolved merely by operating a crank. These patterns were circulated among those attending the meeting. The equipment was available for inspection at the close of the meeting.

September 9, 1941, C. F. Wolcott, secretary, presiding.

San Francisco

A. F. Van Dyck and H. B. Deal, of the RCA License Laboratories, presented a paper on "The Radio Alarm."

A general description of the device and its usefulness was given by the first-named author. Operated from a standard broadcast station, the device may be arranged to ring a bell and turn on a loud speaker.

Its usefulness in civilian-defense activities to enable instructions to be issued to large numbers of workers at unpredictable times from a single source was pointed out.

The second-named author described the technical characteristics of the device. Frequencies of 24 and 36 cycles are used to turn the device off and on. Requiring only about 5 per cent modulation of the broadcast transmitter, these transmissions cannot be heard even in receivers of the highest fidelity and, thus, do not interfere with normal program operation.

The control frequencies are obtained by multiplying and dividing the 60-cycle power-line frequency. For frequency division, a counter-type arrangement which is not frequency selective is used.

In the receivers, tuned-reed relays are used to actuate a larger relay. The reeds have a Q of about 250 and take about 4 seconds to operate. The relay system is interlocking so that when the receiver has been turned on by a 36-cycle note, it can be turned off only by a 24-cycle note. The receiver consumes about 20 watts and probably can be made to require even less power.

The meeting was closed with a demonstration. Each of two receivers was operated from the control studios of KPO-KGO. A series of bell signals were also given.

August 28, 1941, L. J. Black, chairman, presiding.

"The C.A.A. Transmitting and Receiving Station at Belmont, California" was described by E. Mathews, chief radio electrician of the Civil Aeronautics Authority. The station is designed to receive hourly weather reports from points in the Western Hemisphere and the Pacific Ocean. On a 360-acre area, there are 25 receiving antennas. Of these, 22 are sloping V's and 3 are reversible diamonds. The diamonds are aimed at Auckland and Manila. There are 13 transmitting antennas which are double-bay horizontal doublets with parasitic reflectors.

"The Short-Wave Directive Antenna System—Transmitting Antennas" was the subject of Sidney Pickles, engineer for the Civil Aeronautics Authority, who was at his home about 30 miles away and spoke to the audience over telephone lines and a public-address system.

The adjustment of doublet length, reflector spacing, bay spacing, and antenna height to give best operation at each of several frequencies was described. Gains of about 12 decibels over a half-wave doublet can be realized with these structures.

William Farinon, junior radio engineer of the Civil Aeronautics Authority, gave additional information on the adjustment of antennas. Stub lines are used to flatten the characteristics of the feeding lines and are replaced by closely coupled short-circuited sections when once adjusted. By the use of building-out sections, antennas may be adjusted to operate on 2 or even 3 frequencies. Reflectors are adjusted by means of a large loop and detector device with which the front-to-back ratio of the fields can be readily obtained.

September 17, 1941.

Washington

"Civilian Communications under War-time Conditions" was the subject of a paper by D. S. Leonard, captain of the Michigan State Police and consultant to the Office of Civilian Defense.

Captain Leonard recently returned from a visit to London where he observed the functioning of civilian communications under the difficult conditions of air raids.

The lack of self-powered transmitters and receivers for portable and mobile use was stressed. Preparations had not been made for emergency communication under conditions of complete disruption of telephone facilities.

The paper concluded with the presentation of three motion-picture films entitled "Law and Order," "Burning of London," and "Stop that Fire."

September 10, 1941, Mark H. Biser, chairman, presiding.

Symposia on "Nonlinear Circuit Theory" and on "Wave Filters and Other Networks"

Two symposia are offered by the New York Section of the American Institute of Electrical Engineers. The Basic Science Group has arranged for six monthly lectures starting on November 5 on the following topics:

1. "General Nature of the Problem of Nonlinear Circuits and Outline of the Various Methods of Attack," by Professor Ernst Weber, Polytechnic Institute of Brooklyn.
2. "Power-Series Solutions," by Dr. L. A. MacColl, Bell Telephone Laboratories.
3. "Fourier-Series Solutions," by W. R. Bennett, Bell Telephone Laboratories.
4. "Graphical Methods," by Albert Preisman, R.C.A. Institutes.
5. "Numerical Step-by-Step Method," by Professor Alan Hazeltine, Stevens Institute of Technology.
6. "Analytical Methods," by Dr. P. Le Corbeiller, Harvard University and New York University.

The series of weekly lectures on "Wave Filters and Other Networks" starting on October 20 is sponsored by the Communications Group and includes:

1. "Functions of Filters and Other Networks," by H. A. Affel, Bell Telephone Laboratories.
2. "General Network Theory," by Professor E. A. Guillemin, Massachusetts Institute of Technology.
3. "General Wave-Filter Theory," by Professor Guillemin.
4. "Filter Design Practice," by A. J. Grossman, Bell Telephone Laboratories.
5. "Crystal Elements in Wave Filters," by A. R. D'heedene, Bell Telephone Laboratories.
6. "Attenuation and Phase Equalizers," by Mr. Grossman.
7. "Coaxial-Line Elements Applied to Filters and Networks," by C. W. Hansell and P. S. Carter, R.C.A. Communications.

The fee to members of the Institute of

Radio Engineers for the first symposium will be \$1.50 and for the second, \$3.00 for the course or \$1.50 for individual lectures. Further information may be obtained from H. E. Farrar, American Institute of Electrical Engineers, 33 West 39th Street, New York, N. Y.

Membership

The following admissions or transfers (where indicated as such) to Associate grade were approved by the Board of Directors on October 1, 1941.

- Ahlstrom, G. A., 20 Curtis St., San Francisco, Calif.
 Anderson, R. L., 5116-10th Avenue, S., Minneapolis, Minnesota. (Transfer)
 Anderson, R. T., 28 Harte St., Baldwin, N. Y.
 Andrews, G. B., 351 Front St., Hempstead, L. I., N. Y.
 Arrowsmith, R., 219 E. Carroll St., Macomb, Ill.
 Asbury, R. T., Bon Air Apartments, Catonsville, Md.
 Beardslee, C. E., Montana Power Co., Montana St. Laboratory, Butte, Mont.
 Bernhard, J. E., Jr., Box 1412, St. Augustine, Fla.
 Bernhard, E. C., 116 N. Pennsylvania St., Belleville, Ill.
 Bezer, L. H., 150 E. 19th St., Brooklyn, N. Y.
 Bidwell, H. H., 465 Kenilworth Ave., San Leandro, Calif.
 Blake, N. H., 8 Bank Row, Pittsfield, Mass.
 Blankmeyer, W. H., 1935 Whitman Ave., Butte, Mont.
 Born, L. W., 1020-4th St., S. E., Mason City, Iowa
 Bousquet, P. C., 604 W. 112th St., New York, N. Y.
 Brown, E. B., U.S.S. *Hatfield* (231), c/o Comdt. 13th Naval District, Seattle, Wash.
 Burch, L., Radio Station WMRO, Aurora, Ill.
 Burton, D. A., 420 Alden Rd., Muncie, Ind.
 Carne, G. G., 162 Walnut, Montclair, N. J.
 Castrignano, R., 68 Thompson St., New York, N. Y. (Transfer)
 Colton, A. J., Sperry Gyroscope Co., Inc., Garden City, N. Y.
 Couch, W. J., c/o Radio Station CFGP, Grande Prairie, Alta., Canada
 Covell, A. E., 805 Stuart Ave., Kalamazoo, Mich.
 Croy, J. R., 1368 Northview Ave., N. E., Atlanta, Ga.
 Cumming, H. R., Jr., 350 W. 85th St., New York, N. Y.
 Curtis, L. R., 111 McEwen Rd., Rochester, N. Y.
 Dahl, E. A., 11 S. Adams St., Hinsdale, Ill.
 Davidson, J. A. B., Brook Cottage, Farnborough, Kent, England
 De Waal, J. J., 306 Carlton Ave., Brooklyn, N. Y.
 Dostal, R. J., 5241 W. 25th St., Cicero, Ill.

- Edwards, C. L., 1722 Spruce St., Philadelphia, Pa.
 Erickson, K. W., 1327-28th St., S. E. Washington, D. C.
 FitzCharles, H. V., Radio Station WHIP, Hammond, Ind.
 Florman, E. F., Box 4835, Cleveland Park, Washington, D. C.
 Fuqua, F. H., Route 8, Box 151, Seattle, Wash.
 Getliffe, R., "Moray," London Rd., Retford, Notts., England
 Glantz, L. L., 430 Allenhurst Ave., Ridgeway, Pa.
 Goldman, A., Y.M.C.A., Dayton, Ohio
 Grieg, D. D., 186 Avenue "A", New York, N. Y.
 Griesse, R. H., 2186 N. W. Irving St., Portland, Ore.
 Hales, F. B., 56 Woodside Ave., Waterbury, Conn.
 Hamilton, O. W., 18 Naples Rd., Brookline, Mass.
 Hansford, R. N., 21 Montagu Gardens, Wallington, Surrey, England
 Hartong, H. H., 2122 Santa Clara Ave., Alameda, Calif.
 Holland, H. S., c/o Radio Station WFBM, 48 Monument Circle, Indianapolis, Ind.
 Hylkema, C. G., Electrical Engineering Dept., Purdue University, W. Lafayette, Ind. (Transfer)
 Iverson, F. A., 1915 Bradley Pl., Chicago, Ill.
 Killian, L. G., 4531 N. Ashland Ave., Chicago, Ill.
 Kinsell, P., Sperry Gyroscope Company, Garden City, N. Y.
 Kluender, E. C., 2000 Grand Blvd., Schenectady, N. Y.
 Kovarik, H., 1129 Teller Ave., Bronx, New York, N. Y.
 Krisberg, N. L., Headquarters Puerto Rican Department, San Juan, Puerto Rico
 Lauraitis, A. J., 5417 Andrews Ave., Maspeh, L. I., N. Y.
 Lee, H. E., 280 Delaware, Dayton, Ohio
 McClymonds, C. C., Box 204, West Liberty, W. Va.
 Morse, T. M., Route 1, Box 2, Carlinville, Ill.
 Murphrey, I. G., 108 N. Franklin St., Rocky Mount, N. C.
 Partridge, P. N., Burtonsville, Md.
 Perry, R. P., Puerto Rico Advertising Co., Inc. (WPRA), Mayaguez, Puerto Rico
 Phillips, T. J., 302 W. 4th St., Emporium, Pa.
 Plowman, F. R., Senate Pl., Larchmont, N. Y.
 Quantz, R. G., Box 55, Olympia, Wash.
 Ragsdale, M. M., 315 W. Beau. Ave., San Angelo, Texas
 Restaino, J. J., 139 Dahlgreen Pl., Brooklyn, N. Y.
 Robbins, L. G., 2505 Palmer Pl., S. E., Washington, D. C.
 Ross, W. T., 68a N. Algoma St., Port Arthur, Ont., Canada
 Rust, W. M., 18 Delrey Ave., Catonsville, Md.
 Rychlik, R. F., 209 Wroe Ave., Dayton, Ohio
 Schilling, M. O., Hygrade Sylvania Corp., Loring Ave., Salem, Mass.

- Schlegel, W. R., 139 Park Blvd., Malverne, L. I., N. Y.
 Schmitz, W., Box 92, Window Rock, Ariz.
 Schulz, R. F., R.R. 9, St. Paul, Minn.
 Schuster, H. E., New Baden, Ill.
 Scott, C. M., 44 Prome Rd., Rangoon, Burma
 Sears, P. R., 2519 Wilkens Ave., Baltimore, Md.
 Sense, R. J., 1567 Winnetka Ave., Northfield, Northbrook, Ill.
 Sheard, J. R., R.A.F. Great Bromley, Nr. Colchester, Essex, England
 Shope, C. E., S. Maple St., Emporium, Pa.
 Shorland, H., 131 Upper Elmers End Rd., Beckenham, Kent, England
 Siblesz, G. M., Norte 8, No. 5, Caracas Venezuela, S. A.
 Smith, K. A. H., 407 N. Piedmont St., Arlington, Va.
 Smith, P. L., Naval Research Laboratory, Washington, D. C.
 Speight, J. W., 8 Strachan Ave., Toronto, Ont., Canada
 Squire, F. M., 9125-195th St., Hollis, L. I., N. Y.
 Suter, H., Route 3, Box 726, Cincinnati, Ohio
 Swain, Carroll W., c/o Civil Aeronautics Authority, Anchorage, Alaska (Transfer)
 Thomas, M. E., Box 1285, Bartlesville, Okla.
 Vanderbilt, S., Western Electric Co., Specialty Products Division, 300 Central Ave., Kearny, N. J.
 Varnum, W. B., 1712 Estes Ave., Chicago, Ill.
 Webber, H. E., Sperry Gyroscope Co., Garden City, N. Y.
 Wentz, J. F., 180 Varick St., New York, N. Y.
 Wildermuth, J. L., Jr., 903 Raymere Ave., Interlaken, N. J.
 Williams, C., 444-14th St., Santa Monica, Calif.

Books

Advanced Electrical Measurements, by W. C. Michels

Published by D. Van Nostrand Co., 250 Fourth Avenue, New York, N. Y. 347 pages. 155 figures. Price \$3.50.

This is a revision and expansion of the laboratory manual by Smythe and Michels, published in 1932, for use in advanced electrical measurement courses in physics. It consists of sixty experiments of which approximately one third are on the usual application of Wheatstone bridges, galvanometers, electrometers, and potentiometers to the direct-current measurement of resistance, inductance, capacitance, current, potential difference, and charge. Of the remainder about half are directly or indirectly of interest to radio engineers. These are on the characteristics of electron tubes, amplifiers, oscillators, voltmeters, cathode-ray oscillographs, thermocouples, radiation, and alternating-current measurements.

H. M. TURNER
 Yale University
 New Haven, Conn.

Committee Personnel—1941

ADMISSIONS COMMITTEE

H. M. Turner, *Chairman*

- | | |
|-------------------|------------------|
| C. B. Aiken | Melville Eastham |
| W. R. G. Baker | H. T. Friis |
| H. H. Beverage | D. E. Harnett |
| A. B. Chamberlain | L. C. F. Horle |
| I. S. Coggeshall | C. W. Horn |
| F. W. Cunningham | G. T. Royden |

AWARDS COMMITTEE

Melville Eastham, *Chairman*

- | | |
|---------------|-------------------|
| Ralph Bown | E. W. Ritter |
| F. R. Lack | B. E. Shackelford |
| Haraden Pratt | B. J. Thompson |
| H. M. Turner | |

BOARD OF EDITORS

Alfred N. Goldsmith, *Chairman*

- | | |
|-------------------|------------------|
| R. R. Batcher | H. F. Olson |
| L. V. Berkner | G. W. Pickard |
| P. S. Carter | Haraden Pratt |
| L. M. Clement | C. A. Priest |
| E. W. Engstrom | L. J. Sivian |
| W. L. Everitt | L. C. Smeby |
| P. C. Goldmark | B. J. Thompson |
| F. W. Grover | H. A. Wheeler |
| C. M. Jansky, Jr. | L. P. Wheeler |
| J. D. Kraus | L. E. Whittemore |
| F. B. Llewellyn | G. W. Willard |
| S. S. Mackeown | William Wilson |
| E. L. Nelson | C. J. Young |

CONSTITUTION AND LAWS COMMITTEE

B. J. Thompson, *Chairman*

- | | |
|-------------------|---------------|
| Austin Bailey | Haraden Pratt |
| R. A. Heising | H. M. Turner |
| C. M. Jansky, Jr. | J. W. Wright |
| H. R. Zeamans | |

MEMBERSHIP COMMITTEE

I. S. Coggeshall, *Chairman*

- | | |
|-------------------|---------------------|
| V. J. Andrew | R. A. Kay* |
| O. L. Angevine* | J. G. Kreer, Jr. |
| Austin Bailey | F. B. Llewellyn |
| P. C. Barnes* | J. P. Minton |
| L. M. Belleville* | W. A. Nichols* |
| D. W. Bowman* | R. O. Ober* |
| C. I. Bradford* | Ralph Overholt, Jr. |
| J. M. Clayton | C. W. Reash* |
| N. B. Coil* | T. N. Rosser* |
| F. W. Cunningham | Bernard Salzberg |
| A. V. Eastman | W. L. Schwesinger* |
| Leroy Fiedler* | L. C. Simmonds* |
| Paul Frincke* | L. C. Simpson* |
| R. J. Gleason* | R. L. Snyder |
| G. J. Gross* | Karl Spangenberg* |
| G. M. Howard* | Sarkes Tarzian |
| C. M. Hunt* | G. L. Taylor* |
| W. G. Hutton* | Ernst Weber |
| D. D. Israel | H. A. Wheeler |
| C. M. Jansky, Jr. | C. F. Wolcott* |

* Ex officio members.

NEW YORK PROGRAM COMMITTEE

H. A. Affel, *Chairman*

- | | |
|-------------------|-------------------|
| C. B. Aiken | Keith Henney |
| Wilson Aull, Jr. | F. A. Hinners |
| A. B. Chamberlain | D. D. Israel |
| E. J. Content | G. T. Royden |
| W. M. Goodall | B. E. Shackelford |

NOMINATIONS COMMITTEE

R. A. Heising, *Chairman*

- | | |
|------------------|-------------------|
| Ralph Bown | C. M. Jansky, Jr. |
| Melville Eastham | C. B. Jolliffe |
| L. C. F. Horle | Haraden Pratt |
| H. M. Turner | |

PAPERS COMMITTEE

William Wilson, *Chairman*

F. B. Llewellyn, *Vice Chairman*

- | | |
|-----------------|----------------|
| H. A. Affel | H. S. Knowles |
| W. L. Barrow | J. G. Kreer |
| L. V. Berkner | D. K. Martin |
| Edmond Bruce | H. R. Mimno |
| N. P. Case | H. K. Morgan |
| J. K. Clapp | A. F. Murray |
| T. A. M. Craven | H. O. Peterson |
| R. B. Dome | R. K. Potter |
| W. G. Dow | R. L. Deitzold |
| W. L. Everitt | Simon Ramo |
| E. B. Ferrell | D. B. Sinclair |
| H. T. Friis | H. M. Turner |
| F. W. Grover | Dayton Ulrey |
| Harley Iams | P. T. Weeks |
| D. D. Israel | W. C. White |
| L. F. Jones | Irving Wolff |

REGULAR PAPERS COMMITTEE

D. D. Israel, *Chairman*

W. L. Everitt, *Vice Chairman*

- | | |
|----------------------|-------------------|
| W. L. Barrow | F. V. Hunt |
| E. L. Bowles | J. K. Johnson |
| J. E. Brown | H. S. Knowles |
| R. S. Burnap | R. H. Manson |
| N. P. Case | H. K. Morgan |
| E. L. Chaffee | D. E. Noble |
| A. B. Chamberlain | A. A. Oswald |
| L. M. Clement | J. R. Popple |
| B. R. Cummings | P. C. Sandretto |
| J. D'Agostino | W. L. Schwesinger |
| E. T. Dickey | H. C. Sheve |
| A. V. Eastman | L. C. Smeby |
| E. W. Engstrom | Karl Spangenberg |
| D. E. Foster | B. J. Thompson |
| T. T. Goldsmith, Jr. | H. M. Turner |
| Virgil M. Graham | A. F. Van Dyck |
| W. G. Grinditch | P. T. Weeks |
| David Grimes | H. A. Wheeler |
| O. B. Hanson | L. P. Wheeler |
| R. M. Wise | |

SPECIAL PAPERS COMMITTEE

B. E. Shackelford, *Chairman*

Alfred N. Goldsmith H. A. Wheeler

PREPAREDNESS COMMITTEE

Haraden Pratt, *Chairman*

- | | |
|-------------------|----------------|
| W. R. G. Baker | C. B. Jolliffe |
| D. G. Fink | H. B. Richmond |
| R. A. Heising | H. M. Turner |
| C. M. Jansky, Jr. | Lincoln Walsh |

PUBLIC RELATIONS COMMITTEE

- A. F. Van Dyck, *Chairman*
- D. G. Fink
- G. W. Gilman
- George Grammer
- O. B. Hanson
- D. D. Israel
- F. X. Rettenmeyer
- E. W. Ritter
- Lincoln Walsh

REGISTRATION OF ENGINEERS COMMITTEE

- H. B. Richmond, *Chairman*
- J. K. Johnson
- R. H. Langley
- E. L. Nelson

SECTIONS COMMITTEE

- R. A. Heising, *Chairman*
- C. N. Anderson
- M. H. Biser*
- L. J. Black*
- P. N. Bossart*
- C. C. Chambers*
- I. S. Coggeshall
- E. D. Cook
- M. Cottrell*
- C. A. Culver*
- A. N. Curtiss*
- K. H. Ellerbeck*
- R. K. Gessford*
- Virgil M. Graham
- V. D. Hauck*
- J. M. Henry*
- L. C. F. Horle
- R. H. Klingelhoefter*
- H. J. Klumb*
- E. A. Laport*
- W. W. Lindsay, Jr.*
- G. I. Martin*
- J. M. McDonald*
- E. R. Meissner*
- J. H. Miller
- P. J. Noizeux*
- D. A. Peterson*
- G. H. Peirce*
- F. A. Polkinghorn
- E. H. Roy*
- G. T. Royden
- Harner Selvidge*
- A. W. Shropshire*
- C. E. Smith*
- E. G. Webber*
- L. P. Wheeler

TELLERS COMMITTEE

- O. B. Hanson, *Chairman*
- Wilson Aull, Jr.
- H. P. Corwith
- W. M. Goodall
- C. E. Scholz

TECHNICAL COMMITTEES

ANNUAL REVIEW COMMITTEE

- L. E. Whittemore, *Chairman*
- J. L. Callahan
- J. H. Dellinger
- D. E. Foster
- Keith Henney
- I. J. Kaar
- H. S. Knowles
- D. E. Noble
- E. G. Ports
- K. S. Van Dyke
- P. T. Weeks
- H. A. Wheeler

ELECTROACOUSTICS COMMITTEE

- H. S. Knowles, *Chairman*
- S. J. Begun
- L. B. Blaylock
- F. V. Hunt
- V. N. James
- Knox McIlwain
- G. G. Muller
- G. M. Nixon
- Benjamin Olney
- H. F. Olson
- H. H. Scott
- L. J. Sivan

* Ex-officio members.

ELECTRONICS COMMITTEE

- P. T. Weeks, *Chairman*
- L. B. Blaylock
- R. S. Burnap
- E. L. Chaffee
- H. P. Corwith
- K. C. DeWalt
- W. G. Dow
- R. L. Freeman
- Ben Kievit, Jr.
- S. B. Ingram
- F. B. Llewellyn
- G. F. Metcalf
- I. E. Mourontseff
- L. S. Nergaard
- G. D. O'Neill
- H. W. Parker
- H. J. Reich
- C. M. Wheeler
- J. R. Wilson

FACSIMILE COMMITTEE

- J. L. Callahan, *Chairman*
- M. W. Baldwin, Jr.
- J. C. Barnes
- W. A. R. Brown
- G. V. Dillenback
- W. G. H. Finch
- John Hancock
- J. V. L. Hogan
- H. C. Knutson
- George Lewis
- R. E. Mathes
- Charles Singer
- L. A. Smith
- R. J. Wise
- C. J. Young

FREQUENCY MODULATION COMMITTEE

- D. E. Noble, *Chairman*
- E. H. Armstrong
- J. E. Brown
- A. B. Chamberlain
- C. C. Chambers
- W. F. Cotter
- M. G. Crosby
- W. L. Everitt
- G. W. Gilman
- C. M. Jansky, Jr.
- C. B. Jolliffe
- V. D. Landon
- H. B. Marvin
- R. M. Morris
- D. B. Smith
- L. P. Wheeler

PIEZOELECTRIC CRYSTALS

- K. S. Van Dyke, *Chairman*
- C. F. Baldwin
- S. A. Bokovoy
- W. L. Bond
- W. G. Cady
- J. K. Clapp
- W. P. Mason

RADIO RECEIVERS COMMITTEE

- D. E. Foster, *Chairman*
- W. M. Angus
- E. H. Armstrong
- L. B. Blaylock
- J. E. Brown
- R. I. Cole
- W. F. Cotter
- L. F. Curtis
- Harry Diamond
- E. T. Dickey
- W. L. Dunn
- C. G. Felix
- H. B. Fischer
- H. C. Forbes
- C. J. Franks
- David Grimes
- D. E. Harnett
- D. D. Israel
- J. K. Johnson
- J. O. Mesa
- H. O. Peterson
- N. F. Shofstall
- A. E. Thiessen
- Lincoln Walsh
- R. M. Wilmotte

STANDARDS COMMITTEE

- H. A. Wheeler, *Chairman*
- W. L. Barrow
- Ralph Bown
- C. T. Burke
- J. L. Callahan
- C. C. Chambers
- J. H. Dellinger
- D. E. Foster
- Virgil M. Graham
- L. C. F. Horle
- I. J. Kaar
- H. S. Knowles
- D. E. Noble
- E. G. Ports
- A. E. Thiessen
- B. J. Thompson
- H. M. Turner
- K. S. Van Dyke
- H. J. Vennes
- P. T. Weeks

SYMBOLS COMMITTEE

- H. M. Turner, *Chairman*
- R. R. Batcher
- M. R. Briggs
- R. S. Burnap
- C. R. Burrows
- J. L. Callahan
- E. L. Chaffee
- J. H. Dellinger
- E. T. Dickey
- J. N. Golten
- H. S. Knowles
- O. T. Laube
- F. B. Llewellyn
- H. W. Parker
- E. W. Schafer
- L. J. Sivan

TELEVISION COMMITTEE

- I. J. Kaar, *Chairman*
- H. S. Baird
- R. R. Batcher
- J. E. Brown
- A. B. DuMont
- P. T. Farnsworth
- D. E. Foster
- G. W. Fyler
- P. C. Goldmark
- T. T. Goldsmith, Jr.
- A. G. Jensen
- R. D. Kell
- L. M. Leeds
- George Lewis
- H. M. Lewis
- A. V. Loughren
- A. F. Murray
- R. E. Shelby
- D. B. Sinclair

TRANSMITTERS AND ANTENNAS COMMITTEE

- E. G. Ports, *Chairman*
- Raymond Asserson
- L. B. Blaylock
- M. R. Briggs
- W. W. Brown
- R. E. Coram
- Harry Diamond
- F. A. Gunther
- Raymond Guy
- W. E. Jackson
- W. B. Lodge
- L. F. Morrison
- D. S. Rau
- J. C. Schelleng
- D. B. Sinclair
- P. E. Watson
- J. E. Young

WAVE PROPAGATION COMMITTEE

- J. H. Dellinger, *Chairman*
- S. L. Bailey
- W. L. Barrow
- L. V. Berkner
- C. R. Burrows
- W. A. Fitch
- G. D. Gillett
- H. R. Mimno
- K. A. Norton
- H. O. Peterson
- H. P. Thomas

INSTITUTE REPRESENTATIVES IN COLLEGES

- Alberta, University of: J. W. Porteous
- British Columbia, University of: H. J. MacLeod
- Brooklyn, Polytechnic Institute of: F. E. Canavaciol
- California Institute of Technology: S. S. Mackeown (Alternate, William Pickering)
- California, University of: L. J. Black
- Carleton College: C. A. Culver
- Carnegie Institute of Technology: R. T. Gabler
- Cincinnati, University of: W. C. Osterbrock
- Clemson Agricultural College: A. B. Credle
- Columbia University: J. B. Russell
- Connecticut, University of: V. S. Carson
- Cooper Union: J. B. Sherman
- Florida, University of: Joseph Weil
- Georgia Institute of Technology: M. A. Honnell
- Harvard University: E. L. Chaffee
- Illinois Institute of Technology: P. G. Andres
- Idaho, University of: C. W. Brown

Illinois, University of: H. J. Reich
Iowa, University of: R. C. Kent

Johns Hopkins University: Ferdinand Hamburger, Jr.

Kansas, University of: S. E. Clements
Kentucky, University of: E. B. Doll

Lawrence Institute of Technology: H. L. Byerly
Lehigh University: H. C. Knutson

Maine, University of: W. J. Craemer, Jr.
Manhattan College: J. F. Reintjes
Massachusetts Institute of Technology: W. H. Radford and
E. Guillemin
McGill University: F. S. Howes
Michigan, University of: L. N. Holland
Minnesota, University of: H. E. Hartig
Montana State College: G. J. Fiedler

New Mexico, University of: H. L. Jones
New York, College of the City of: A. H. Wing, Jr.
New York University: Philip Greenstein
North Dakota, University of: E. J. O'Brien
Northeastern University: G. E. Pihl
Northwestern University: A. B. Bronwell
Notre Dame, University of: H. E. Ellithorn

Ohio State University: W. L. Everitt
Oklahoma Agricultural and Mechanical College: H. T. Fristoe

Pennsylvania State College: G. H. Crossley

Pennsylvania, University of: C. C. Chambers
Pittsburgh, University of: R. C. Gorham
Princeton University: J. G. Barry
Purdue University: R. P. Siskind

Reed College: Marcus O'Day
Rensselaer Polytechnic Institute: H. D. Harris
Rose Polytechnic Institute: H. A. Moench
Rutgers University: J. L. Potter

Southern California, University of: J. K. Nunan
Southern Methodist University: R. E. Beam
Stanford University: F. E. Terman
Stevens Institute of Technology: F. C. Stockwell

Toronto, University of: B. de F. Bayly
Tufts College: J. L. Barnes

Union College: F. W. Grover
Utah, University of: O. C. Haycock

Virginia Polytechnic Institute, W. A. Murray

Washington, State College of: H. L. Libby
Washington, University of: A. V. Eastman
Washington University: R. S. Glasgow
Wayne University: G. W. Carter
Western Ontario, University of: G. A. Wootton
West Virginia University: R. C. Colwell
Wisconsin, University of: Glen Koehler
Worcester Polytechnic Institute: H. H. Newell

Yale University: H. M. Turner

Institute Representatives on Other Bodies

A.I.E.E.—Subcommittee on Radio of the Committee on Applications to Marine Work	T. E. NIVISON AND J. L. PRESTON
American Documentation Institute	C. M. JANSKY, JR.
Committee on Applied Physics	WILLIAM WILSON
Council of the American Association for the Advancement of Science	J. C. JENSEN
Engineering Index National Committee	MELVILLE EASTHAM
Joint Co-ordination Committee on Radio Reception of the N.E.L.A., N.E.M.A., and R.M.A.	C. E. BRIGHAM
Liaison Committee on Aeronautic Radio Research	F. M. RYAN (C. C. SHANGRAW, alternate)
National Advisory Council on Radio in Education, Committee on Engineering Developments	LLOYD ESPENSCHIED, ALFRED N. GOLDSMITH, C. W. HORN, L. M. HULL, AND R. H. MARRIOTT
National Television Systems Committee	ALFRED N. GOLDSMITH (H. A. WHEELER, alternate)
Panel 4	E. G. PORTS
Panel 8	KNOX MCILWAIN
New York City Advisory Board on Industrial Education	H. P. WESTMAN
Planning Committee, National Conference on Educational Broadcasting, American Council on Education	C. M. JANSKY, JR., C. B. JOLLIFFE, AND E. L. NELSON
U.R.S.I. (International Scientific Radio Union) Executive Committee	C. M. JANSKY, JR.
U. S. National Committee, Advisers on Electrical Measuring Instruments	MELVILLE EASTHAM AND HAROLD OLESEN
U. S. National Committee, Advisers on Symbols	L. E. WHITTEMORE AND J. W. HORTON

AMERICAN STANDARDS ASSOCIATION

Board of Directors	HARADEN PRATT
Standards Council	ALFRED N. GOLDSMITH (H. P. WESTMAN, alternate)
Board of Examination	H. P. WESTMAN
Electrical Standards Committee	H. M. TURNER (H. P. WESTMAN, alternate)
Sectional Committee on Acoustical Measurements and Terminology	E. D. COOK AND H. F. OLSON
Sectional Committee on Definitions of Electrical Terms	HARADEN PRATT
Subcommittee on Vacuum Tubes	B. E. SHACKELFORD
Sectional Committee on Electric and Magnetic Magnitudes and Units	J. H. DELLINGER
Sectional Committee on Electrical Installations on Shipboard	I. F. BYRNES AND V. R. RUSS
Sectional Committee on Electrical Measuring Instruments	WILSON AULL
Sectional Committee on Graphical Symbols and Abbreviations for Use on Drawings	AUSTIN BAILEY (H. P. WESTMAN, alternate)
Subcommittee on Communication Symbols	H. M. TURNER
Sectional Committee on Letter Symbols and Abbreviations for Science and Engineering	H. M. TURNER
Subcommittee on Letter Symbols for Radio Use	H. M. TURNER
Sectional Committee on National Electrical Safety Code, Subcommittee on Article 810, Radio Broadcast Reception Equipment	E. T. DICKEY (VIRGIL M. GRAHAM, alternate)
Sectional Committee on Preferred Numbers	A. F. VAN DYCK
Sectional Committee on Radio	ALFRED N. GOLDSMITH, HARADEN PRATT, AND L. E. WHITTEMORE
Sectional Committee on Radio-Electrical Co-ordination	J. V. L. HOGAN, C. M. JANSKY, JR., AND L. E. WHITTEMORE
Sectional Committee on Specifications for Dry Cells and Batteries	H. M. TURNER
Sectional Committee on Standards for Drawings and Drafting Room Practices	AUSTIN BAILEY
Sectional Committee on Vacuum Tubes for Industrial Purposes	B. E. SHACKELFORD

Contributors

Dudley E. Foster (A'26-M'37) was born at Newark, New Jersey, on December 12, 1900. He was graduated from Cornell University in 1922 with the E.E. de-



DUDLEY E. FOSTER

gree. Following his graduation he became associated with the Electrical Alloy Company and Driver-Harris Company. In 1925 he joined the Malone-Lemmon Products Company and the next year became chief engineer of the Case Electric Company. Two years later that company was merged with the United States Radio and Television Company and soon thereafter Mr. Foster was promoted to chief engineer. In 1933 he became chief radio engineer of the General Household Utilities Company and from 1934 to 1941 he was division engineer in the RCA License Laboratory. He was also a lecturer in television engineering in the Graduate School of Stevens Institute of Technology. At the present time Mr. Foster is vice president and technical director of Rogers Majestic, (1941), Limited, Toronto, Ont., Canada.



PIERRE MERTZ

Pierre Mertz was born on April 2, 1897. He received the A.B. degree, specializing in physics, from Cornell University in 1918. Following a short period at the Bureau of Standards, and a few years with the American Telephone and Telegraph Company, he continued his studies at Cornell and received the Ph.D. degree in 1926. After another period with the American Telephone and Telegraph Company, he joined the Bell Telephone Laboratories in 1934. His principal work has been on special wire transmission problems, particularly in telephotography and television.



Bruce E. Montgomery (S'34-A'38) was born on July 11, 1913 at Milan, Missouri. He received the A.B. degree from Park College in 1934 and the B.S. degree in



BRUCE E. MONTGOMERY

electrical engineering from Iowa State College in 1936. In 1937 Mr. Montgomery was a student engineer with the Westinghouse Electric and Manufacturing Company. Since 1937 he has been an engineer in the Communications Laboratory of the United Air Lines Transport Corporation. He is a member of Sigma Pi Sigma and Eta Kappa Nu.



John A. Rankin (A'35) is a native of Michigan. He received the B.S. degree in electrical engineering from Michigan State College in 1934. From 1934 to date Mr. Rankin has been an engineer in the RCA License Laboratory. He is a member of Tau Beta Pi.



Harry E. Rice (A'39) was born on February 6, 1912, and attended Haverford College and Brooklyn Polytechnic Institute. For four years he did safety

engineering work for the American Surety Company of New York. In 1937 after having been graduated from R.C.A. Institutes, he became associated with the Hazeltine



J. A. RANKIN

Service Corporation in their New York laboratories. In 1940 Mr. Rice was employed by the Stromberg-Carlson Telephone Manufacturing Company in their radio products laboratory.



H. P. Thomas (A'34) was born on May 23, 1904, at Boston, Massachusetts. He was an amateur radio operator from 1922 to 1930 and was licensed as a marine operator from 1922 to 1928. He received the A.B. degree from Harvard College in 1925 and an M.S. degree from the Harvard Engineering School in 1927. He has been employed in the radio transmitter engineering department of the General Electric Company since 1927. His engineering activities include two years' work under the direction of Dr. Alexanderson of the



HARRY E. RICE



H. P. THOMAS

Consulting Engineering Laboratory, the development and design of radio apparatus for carrier-current applications, advanced radio development for the United States Government services, and development and installation of frequency-modulation broadcast transmitters.



D. L. Waidelich (S'37-A'39) received the B.S. degree in electrical engineering in

1936 and the M.S. degree in 1938 from Lehigh University. Since 1938 Mr. Waidelich has been an instructor in electrical engineering at the University of Missouri. He is a member of the American Institute of Electrical Engineers and of Tau Beta Pi.



R. H. Williamson (A'31) was born April 6, 1907, at Eagle Grove, Iowa. He was an amateur radio operator from 1921 to 1925 and a broadcast-station operator



D. L. WAIDELICH



R. H. WILLIAMSON

from 1926 to 1928. He received the B.Sc. degree from Iowa State College in 1928 and the M.S. degree in electrical engineering from Union College in 1935. Since 1928 he has been with the radio transmitter engineering department of the General Electric Company, Schenectady, N. Y. Among his engineering activities have been field installation of high-powered transmitters at WGY, WLW, and for the United States Government. Mr. Williamson is a member of Tau Beta Pi and Eta Kappa Nu.

BROWN

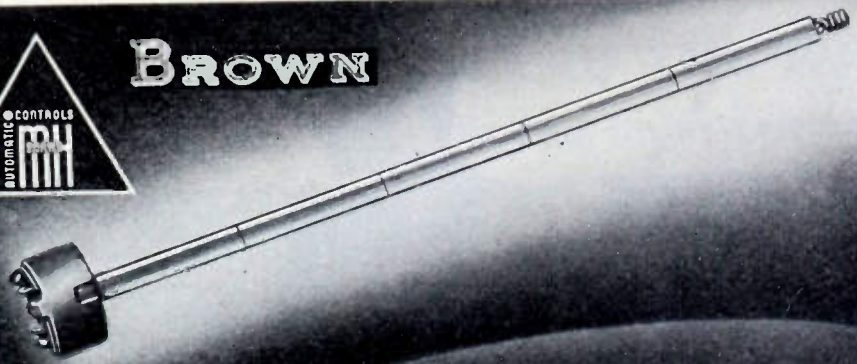
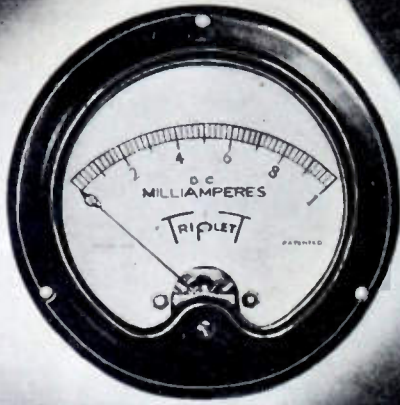

TRIPLET



FOXBORO
RECORDING INSTRUMENTS

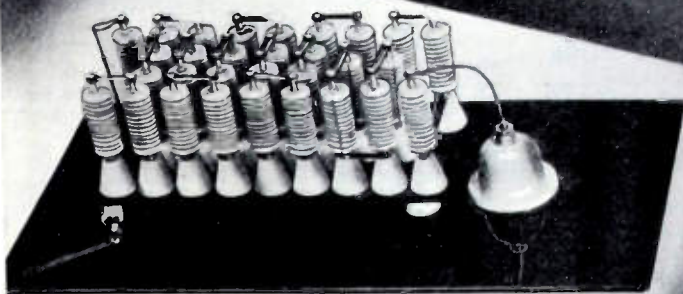

HALLCROSS

Why
INSTRUMENT MAKERS
prefer **AlSiMag**

Instrument makers are most exacting in the selection of materials for instruments. They realize that performance is vitally affected by the materials. No wonder that for non-metallic parts, and ceramic materials in particular, they specify AlSiMag technical ceramics. In doing so, they get:

1. Ceramics custom made to their specifications.
2. Ceramics to close tolerances for economical assembly.
3. Ceramics of defined physical properties selected from a list of standard "bodies" not found anywhere else in such great variety. Send for list.
4. Ceramics produced by engineers whose only purpose is continued improvement.

ALSiMAG

Trade Mark Reg. U.S. Pat. Off.

FROM CERAMIC HEADQUARTERS

AMERICAN LAVA CORPORATION • CHATTANOOGA • TENNESSEE
CHICAGO • CLEVELAND • NEW YORK • ST. LOUIS • LOS ANGELES • SAN FRANCISCO • BOSTON • PHILADELPHIA • WASHINGTON, D. C.

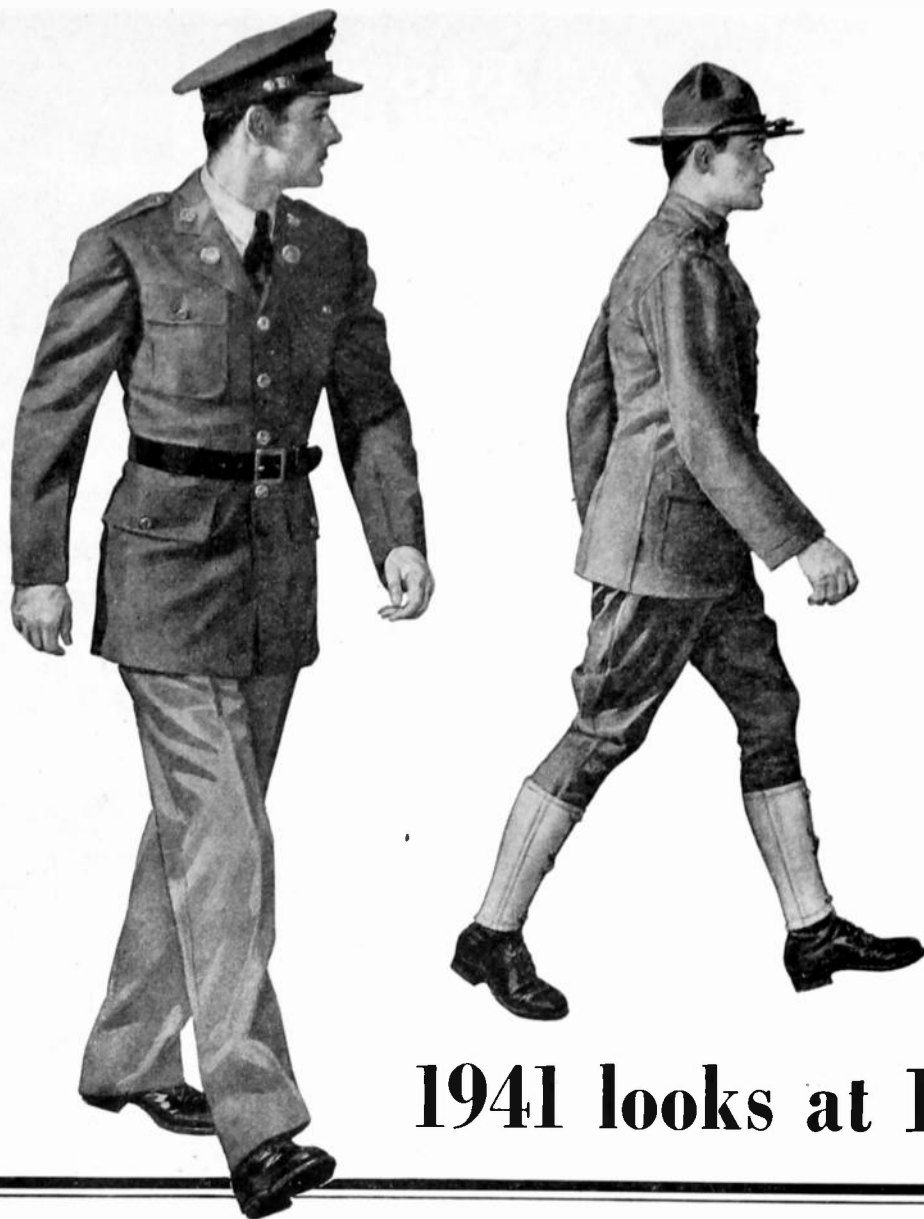

1941 looks at 1916

THINGS have changed a lot in 25 years and yet there is much that is the same.

In 1916 it was Preparedness; in 1941, National Defense. But now the scale is bigger, the pace faster. There was pressure on the telephone business then. The pressure is infinitely greater now. New training camps; new aviation fields; new munitions plants—all need telephones. Every one is moving faster and when a Nation hurries it does it by telephone. The Bell System spent 94 millions on new

construction in 1916. It is spending more than 420 millions in 1941.

The entire Bell System organization is giving “first call” to defense. We believe you would want it that way.



BELL TELEPHONE SYSTEM

“THE TELEPHONE HOUR” IS BROADCAST EVERY MONDAY EVENING OVER THE N.B.C. RED NETWORK.

Again!

KOOLOHMS LEAD THE WAY
with two long awaited improvements



**METER MULTIPLIERS
THAT WITHSTAND 150° C.**

**HIGHER RESISTANCE
VALUES IN LESS SPACE**

Examples: 4 megohms in Type MFB

**THE CONSTRUCTION REVOLUTIONIZED
WIRE WOUND RESISTOR DESIGN**

*Resistance wire touches
but cannot short*

Engineers will be quick to appreciate the many advantages made possible in wire wound resistor construction by the exclusive Koolohm process of insulating the wire itself before it is wound. This permits layer windings for higher resistance in less space; progressive windings for non-inductive resistors that are truly non-inductive even at 50 to 100 Mc.; larger wire sizes; faster heat dissipation; greater stability; extreme accuracy and greater humidity protection. No secondary insulations such as brittle cements or enamels are needed on the windings. For double protection, however, most Koolohm types are encased in a sturdy outer ceramic shell that will not peel or chip and which allows for mounting directly to metal parts. Koolohms are made in a full line of shapes, types and sizes for all needs. Write for the new edition of the Koolohm Catalog, just out.



Koolohm wire with section of ceramic insulation removed.

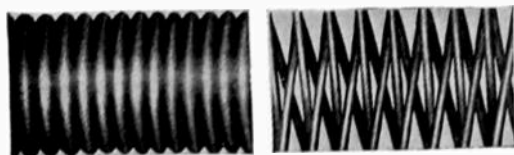

Single layer winding

Progressive winding

In conformity with standard Koolohm Resistor construction, these new Type MFA and Type MFB Meter Multipliers are made with wire that is insulated *before it is wound* with a tough, 1000° C. heat-proof, moisture-proof ceramic material (U. S. Patent No. 2,213,969). They are further protected by a Pyrex glass high-voltage insulator tube, 1/8" thick and heat-treated. By test and in actual use, they have proved their ability to withstand temperatures as high as 150° C.—considerably higher than any other resistors of this type.

APPROVED FOR NATIONAL DEFENSE

These units are approved for exacting defense applications where they have set new standards of performance under adverse salt water immersion conditions. Complete information gladly sent upon request. Sprague engineers will gladly cooperate in helping you choose the proper Koolohm for greater dependability, longer life on practically any wire wound resistor application.

Type MFA KOOLOHM (9-13/16" long) is available in resistance ratings of 3.5, 4.0, 4.5, 5.0 and 6.0 megohms, with voltage ratings of 3.5, 4.0, 4.5, 5.0 and 6.0 KV respectively.

Type MFB KOOLOHM (5-5/16" long) is available in resistance ratings of 1.0, 1.5, 2.0, 2.5, 3.0, 3.5 and 4 megohms, with voltage ratings of 1.0, 1.5, 2.0, 2.5, 3.0, 3.5 and 4 KV.

SPRAGUE SPECIALTIES CO., Resistor Division
NORTH ADAMS, MASS.

SPRAGUE KOOLOHM RESISTORS

Greatest Improvement in Wire Wound Resistors in 20 Years

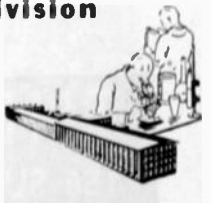

To Serve Well The
Professional Radioman

CREI is the HELPFUL PARTNER



of more than
5000

PROFESSIONAL RADIOMEN

CREI Spare-Time Technical Training is Preparing Alert Radiomen for Better-Paying Positions by Increasing Their Efficiency and Individual Worth to the Industry—

Admirable and creditable to the radio industry are the high-calibre men who do not merely relax into the routine of their jobs, but devote their own spare time and money to become better radiomen. More than 5000 professional radiomen throughout the industry are enrolled for CREI home-study courses in Practical Radio Engineering. They are preparing for advancement by increasing their technical ability. CREI has proved to be a "helpful partner" . . . by enabling such men to successfully step into positions of greater responsibility.

The success of CREI men who have spent their spare time in preparation for promotion should prove an incentive for others to investigate thoroughly the opportunities that this advanced training makes possible. CREI is interested in any serious-minded radioman who realizes the value of a planned program of technical training . . . and we point with pride and proof to the more than 5000 professional radiomen who are now enjoying the benefits of CREI training in Practical Radio Engineering.

Alert engineers are encouraging CREI training for their employees. Your recommendation of our home study courses to your associates will increase the efficiency of your engineering staff. We will be glad to send our free booklet and complete details to you, or to any man whom you think would be interested.

"Since 1927"

CAPITOL RADIO
ENGINEERING INSTITUTE

E. H. Rietzke, President

Dept. PR-10, 3224-16th St. N.W.
Washington, D.C.

Proceedings of the I. R. E. October, 1941

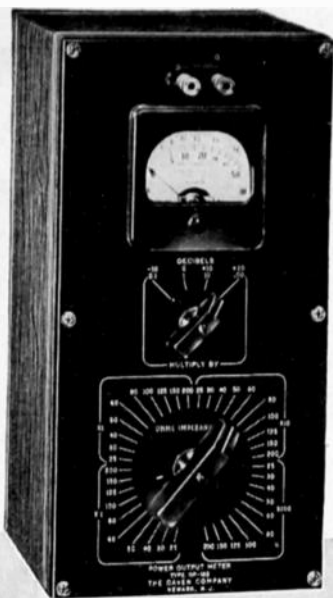

TYPE OP-182



TYPE OP-961

DAVEN OUTPUT POWER METERS

for Accurate Measurement of Power and Impedance

OP-182

Convenient meter reading is provided in this compact, space-saving OP-182 Output Power Meter. It is admirably suited for many power and impedance measurements, such as determining actual power delivered by an audio system to a given load, characteristic impedance or load variation effect on an A.C. source.

Terminal impedance remains essentially resistive over the audio frequency range of 30 to 10,000 cps. Impedances from 2.5 to 20,000 ohms in 40 convenient steps are available.

The indicating meter is calibrated from 0 to 50 mw., and from 0 to 17 db. Zero level at 1 mw. Four ranges of full scale readings from 5 mw. to 5 watts, and from -10 to +37 db. are provided by the meter multiplier. Accuracy within 5% at midscale.

The DAVEN catalog lists the most complete line of precision attenuators in the world; "Ladder", "T" type, "Balanced H" and Potentiometer networks—both variable and fixed types—employed extensively in control positions of high quality program distribution systems and as laboratory standards of attenuation.

Special heavy duty type switches, both for program switching and industrial applications are available.

Super DAVOHM resistors are precision type, wire-wound units from 1% to 0.1% accuracy.

More than 80 laboratory test equipment models are incorporated in this catalog.

OP-961

A rugged, handy Output Power Meter for accurate measurements of audio signal systems having a maximum power output up to 50 watts. Highly recommended for measurements of characteristic impedance, load variation effects, transmission line equalization, insertion losses, filters, transformers, radio receiver outputs, and others.

Reliable readings of power and impedances from 2.5 to 20,000 ohms are guaranteed by a meter multiplier network of constant impedance, in combination with a carefully designed impedance changing network that remains essentially resistive throughout virtually the entire audio range.

Power ranges cover from 0.1 mw. to 50 watts in steps of 0.1 mw. Indicating meter is calibrated from 0 to 50 mw., and from 0 to 17 db., with a 1 mw. zero level. A 20-step multiplier extends the meter power reading from 0.1x to 1,000x scale value, and the db. reading in steps of 2 db., from -10 to +30 db., with full scale at +47 db. Accurate within 2% at midscale.

THE DAVEN COMPANY
158 SUMMIT STREET • NEWARK, NEW JERSEY

**Plug-in
CAPACITORS**



Type AP Plug-In Electrolytics in plain foil and etched foil. Single, dual, triple and quadruple sections. 25 to 500 v. D.C.W. Corrosion-proof internally and externally. No leakage or seepage. Adequate venting. Octal base fits standard octal socket.

Wax-filled Type 71 paper plug-in capacitors in aluminum casing with octal base. Single and multiple sections. 200, 400 and 600 v. D.C.W.

Oil-filled Type 72 plug-in paper capacitors in aluminum-sprayed tin-plate containers of somewhat larger size than foregoing types, and provided with standard UX base. Hermetically sealed. Positively leakage proof. In single and multiple sections. 400 and 600 v. D.C.W.

Note that Aerovox perfected the plug-in capacitor. The unique Aerovox prong-base construction guards against leakage and corrosive action internally and externally alike. Firm seating in socket provides dependable, jar-proof connections. Low-loss connections. Instantly removable from socket for checking and replacement.

For Continuous Service

Because they must be occasionally tested and replaced, radio tubes are provided with plug-in bases. By the same token, then, is it not logical to use plug-in electrolytics in equipment subjected to continuous operation and when continuity-of-service is the prime requisite?

The best answer to that question is found in the ever-increasing use of

Aerovox Plug-In Capacitors. Originally available only in the electrolytic type, these plug-ins are now available in wax-filled and oil-filled paper types as well.

Therefore, if you are designing or maintaining continuous-service equipment, it will pay you to look into this matter of Aerovox plug-in capacitors.

Write for DATA . . .

Engineering data sent on request. Write on your business stationery for specifications, recommendations and quotations covering your particular application.



AEROVOX CORPORATION

New Bedford, Mass.

Sales Offices in All Principal Cities



MEN—YOU'LL FIND TERMINAL A RELIABLE SOURCE FOR ALL RADIO PARTS AND EQUIPMENT—



THEY'RE "TOPS" FOR COMPLETE STOCK AND EXCELLENT SERVICE...I KNOW!

Convince yourself! Place your next order with us and discover why so many engineers and radiomen prefer to deal with New York's largest exclusive radio supply house. Our central location and efficient staff make Terminal the "buy-word" for radio parts and equipment.

NOW—All CANNON plugs & sockets IN STOCK

TERMINAL RADIO CORP.

68 WEST 45th STREET • 80 CORTLANDT STREET
New York City Phone • VAnDerbilt 6-5050

POSITIONS OPEN

The following positions of interest to I.R.E. members have been reported as open on October 10. Make your application in writing and address to the company mentioned or to

Box No. . . .

PROCEEDINGS of the I.R.E.
330 West 42nd Street, New York, N.Y.

Please be sure that the envelope carries your name and address

JUNIOR & SENIOR TRANSMITTER ENGINEERS

A well established manufacturer in the East needs senior and junior engineers for production and installation work on a new industrial device employing a high-power, high-frequency oscillator. Applicants should have had manufacturing and field-service experience on installations at broadcast or higher frequencies. Box 251.

TUBE ENGINEERS AND EXECUTIVES

Experienced power-tube and cathode-ray-tube engineer and production executives are needed for the expanding plant of an established tube manufacturing company. Present staff knows of these openings. Box 252.

TUBE PRODUCTION ENGINEERS

Large New England radio-tube manufacturer has openings for electrical engineers or physicists to work on production problems. Experience preferred but not essential. U. S. citizenship required. Excellent opportunity. Box 253.

RADIO ENGINEERS, ALL BRANCHES

This department receives frequent urgent requests for engineers for national-defense work from various military and civilian branches of the U. S. government. Members and others interested are urged to write to Box 260 for application blanks. Applicants not now engaged in defense work are preferred.



Attention Employers . . .

Announcements for "Positions Open" are accepted without charge from employers offering salaried employment of engineering grade to I.R.E. members. Please supply complete information and indicate which details should be treated as confidential. Address: "POSITIONS OPEN," Institute of Radio Engineers, 330 West 42nd Street, New York, N.Y.

The Institute reserves the right to refuse any announcement without giving a reason for the refusal.

BLILEY CRYSTAL UNITS

Engineered for Accurate Frequency Control



LEFT: Type MO3 temperature controlled unit specially designed for high frequencies.

CENTER: Type MO2 unit is ruggedly built for portable and mobile transmitters; 2,000kc. to 30,000kc.

RIGHT: Type BC46T Precision Variable Air Gap Temperature controlled unit primarily for Broadcast frequencies. Approved by F. C. C.



BILILEY Crystal Units for frequencies from 20kc. to 30mc.—three of which are illustrated—conform to highest commercial standards of design and performance. Write for your copy of Catalog G-12 describing the complete line.

BLILEY ELECTRIC COMPANY
UNION STATION BUILDING ERIE, PA.

High Fidelity at Low Cost!

RCA 1,000 Watt Transmitter

MODEL 1-K



The RCA Model 1-K consists basically of the Model 250-K transmitter plus a matching amplifier unit. 250-watt stations with Model 250-K can increase power to 1,000 watts easily and at very low cost.

- Flat within 1.5 db., 30-10,000 cycles
- High-efficiency Class B Modulation
- Distortion less than 3%, 50-7,500 cycles
- Carrier frequency exact within ± 20 cycles
- Less than 5% Carrier Shift

SIMPLICITY and accessibility... extended frequency-response and low distortion... with extremely low overall operating costs... make the RCA Type 1-K Transmitter your logical choice when you go to 1,000 watts!

Excited by the famous RCA 250-K transmitter unit, the 1-K offers unusual flexibility, operating at 1,000 watts, 500 watts, 500/1000 watts, 250/1,000 watts, and 250/500 watts. Stations already equipped with the 250-K can increase their power to a maximum of 1,000 watts simply by the addition of the amplifier unit (RCA Type MI-7185), and power unit. Write for complete story, yours on request.

Use RCA Radio Tubes in your station for finer performance



Broadcast Equipment

RCA Manufacturing Company, Inc., Camden, N. J. • A Service of the Radio Corporation of America
In Canada: RCA Victor Co., Ltd., Montreal



New York: 411 Fifth Ave. Chicago: 589 E. Illinois St. Atlanta: 530 Citizens & Southern Bank Bldg. Dallas: Santa Fe Bldg. San Francisco: 170 Ninth St. Hollywood: 1016 N. Sycamore Ave.

OHMITE

Doubles Factory Size - Boosts Production
of Rheostats, Resistors, Tap Switches



TO MEET the increased requirements of Industry and National Defense, Ohmite has completed a large new factory addition and greatly expanded production facilities. The enlarged plant, devoted exclusively to the manufacture of quality Rheostats, Resistors, Chokes and Tap Switches, is working day and night to provide dependable units for radio, aviation, electronic, industrial and scientific applications.

Ohmite Products are veterans of service. They are available in the most extensive range of types and sizes to meet each need best. There are over 1000 stock items. Special units are produced to exact specifications or engineered for you.

Write today on company letterhead for helpful 96-page Ohmite Catalog and Engineering Manual No. 40.



OHMITE MANUFACTURING COMPANY
4860 Flournoy Street ★ Chicago, Illinois

Be Right with **OHMITE**
RHEOSTATS • RESISTORS • TAP SWITCHES

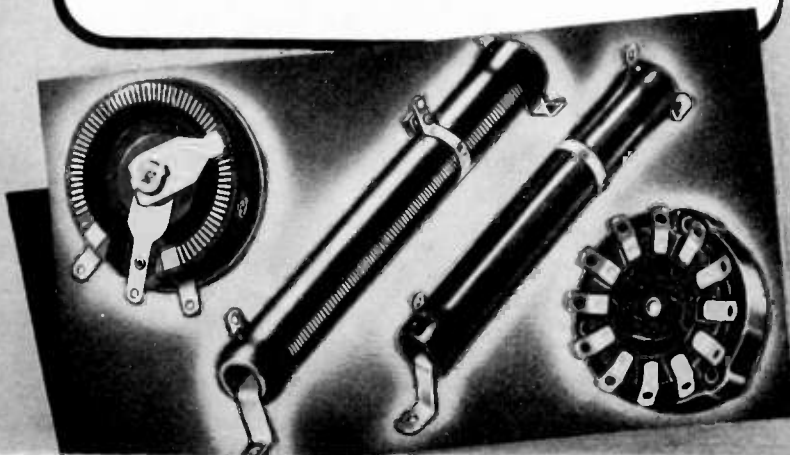

ANSWERS By TRIPLET

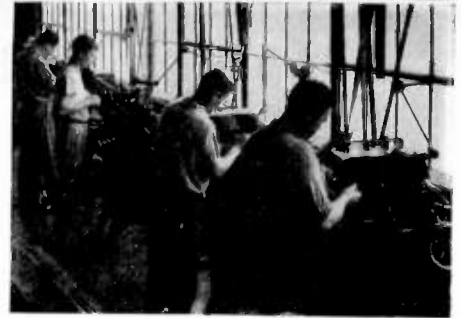

The need for controlled processes and uniform quality in parts has been answered by Triplet in setting up manufacturing facilities that make the company practically self-sustaining in the fabrication of instrument and tester components.

Shown here is a view of one section of the automatic screw machine department in the modern Triplet plant where essential parts—some as minute as the smallest used in watches—are turned out 24 hours a day. More and more, Triplet has turned to wholly automatic fabrication of materials to speed up production and to eliminate any possibility of human error. To assure parts best suited for Triplet needs, company engineers have pioneered in the design and manufacture of countless fabricated materials including switches, bar knobs, resistors, jacks, special adapters, etc.—a complete service intended to give each user the fullest measure of satisfaction.

**THE TRIPLET ELECTRICAL
INSTRUMENT CO.**
Bluffton, Ohio

FEWER PARTS -- FEWER TUBES



when you choose G.E.'s
SIMPLIFIED CIRCUIT

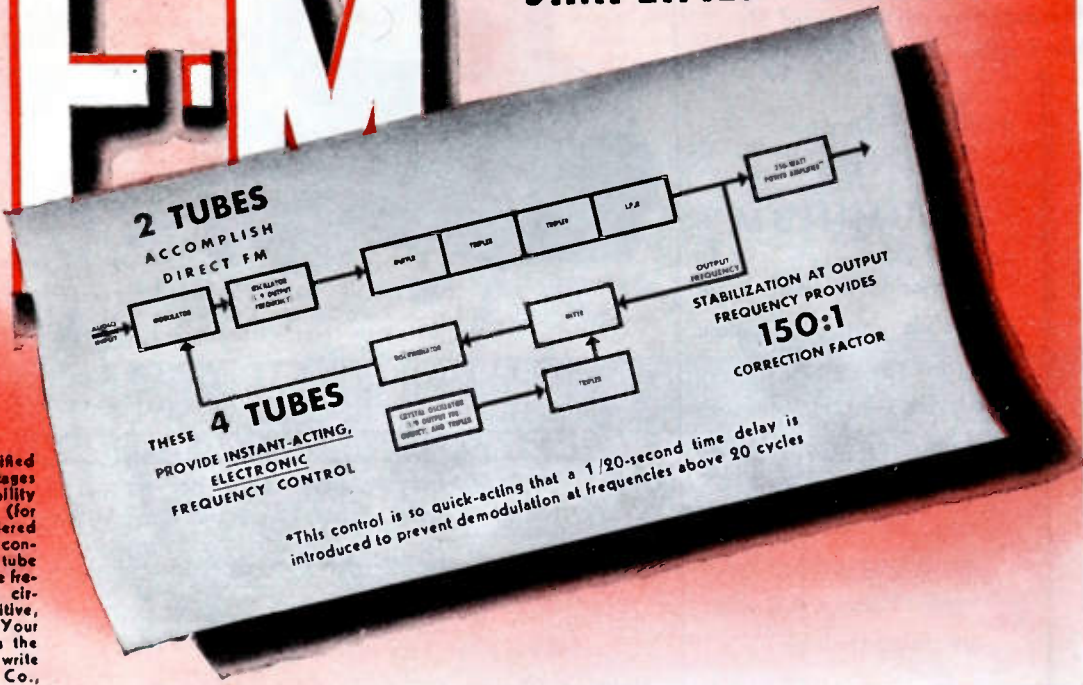

Inherent in this simplified circuit are the advantages of complete accessibility without disassembly (for every tube and soldered joint), low power consumption plus low tube replacement cost. The frequency stabilization circuit is simple, positive, and fast in action. Your nearby G-E man has the complete story. Or write General Electric Co., Schenectady, N. Y.

Engineers, look at this performance!

	GUARANTEED PERFORMANCE CHARACTERISTICS	MEASUREMENTS ON TYPICAL PRODUCTION TRANSMITTERS
FREQUENCY STABILITY	± 1000 cycles over a normal room temperature.	For weeks Station W2XOY, General Electric's FM proving ground, has operated 10 hours a day within ± 200 cycles. Stability was measured every hour, using G.E.'s primary laboratory standard.
FM CARRIER NOISE LEVEL	Down 70 db at 100% modulation.	Production transmitters average 72 db down at 100% modulation.
HARMONIC DISTORTION	At 100% modulation less than 1 1/2% for modulating frequencies between 30 and 7500 cycles.	Actual performance based on units built to date indicates, at 100% modulation, less than 1% harmonic distortion for modulating frequencies between 30 and 16,000 cycles; less than 0.75% at 50% modulation; and less than 0.5% at 25% modulation.
AUDIO-FREQUENCY RESPONSE	The a-f characteristic from 30 to 16,000 cycles is within ± 1 db, with or without pre-emphasis.	Without pre-emphasis, about -0.3 db from 30 to 16,000 cycles; with pre-emphasis, about -0.8 db.

The performance values on the right are not to be construed as G.E. guarantees. They represent typical measurements made on stock transmitters and, as such, reflect General Electric's conservative guarantee policy.

GENERAL ELECTRIC



160-11-6914

PREMAX

Antennas for defense

*Are Meeting Requirements For
Marine, Ship-to-Shore and Mo-
bile Units.*

**STEEL
MONEL
ALUMINUM**

In marine service . . . in mobile units . . . police prowl cars, guard mobile service—in all defense communication work where two-way transmission is essential, the sturdy, rugged but light-weight Premax Antennae are doing their bit.

Fully telescoping and adjustable in steel, monel and aluminum, Premax Antennae have been found to meet the rigid specifications in every detail.

If you have a defense problem which requires light-weight, strong, weather-resisting telescoping antennae and mounts, let us know your requirements.



Premax Products

Division of Chisholm-Ryder Co., Inc.
4215 Highland Ave., Niagara Falls, N.Y.

Where Performance Counts Look to "PRECISION"

Industrial and Laboratory Testers

"PRECISION" manufactured to "PRECISION" standards of accuracy, workmanship and materials guaranteed to give lasting satisfaction under the most exacting conditions of service.



SERIES 844—34 RANGES

AC-DC Volt-Ohm-Decibel-Milliammeter
6000 VOLTS • 12 AMPS
10 MEGOHMS • 70 DB

The Series 844 is representative of a large selection of AC-DC Multi-range testers and industrial circuit testers specifically designed to meet the requirements of laboratory, industrial and production testing.

• Large, easy reading, 400 microampere meter • All commonly employed ranges at only 2 pin jacks. • Rapid, positive rotary range selection • 1% wire wound shunts and matched multipliers • 2% DC—3% AC overall accuracy • Deeply etched panel markings offer maximum resistance to wear.

Series 844L—(Illustrated)—In hardwood open face walnut finished case with leather carrying handle.
Net price (less batteries and test leads) . . . \$24.95

WRITE FOR "PRECISION" INDUSTRIAL AND LABORATORY TEST EQUIPMENT CATALOG 42-1 . . . Tube Testers, Combination Tube and Set Testers, AC-DC Multi-range Testers, Vacuum tube multi-range Testers, Signal Generators, Industrial Circuit Testers, etc.

PRECISION TEST EQUIPMENT

INDUSTRIAL • LABORATORY • RADIO • TELEVISION

PRECISION APPARATUS COMPANY • 647 KENT AVENUE • BROOKLYN, N.Y.
Export Division: 458 Broadway, New York City, U.S.A. Cable Address: Morhanex

INDEX

Positions Open vi

DISPLAY ADVERTISERS

<p>A</p> <p>Aerovox Corporation v</p> <p>American Lava Corporation i</p> <p>American Telephone & Telegraph Co. ii</p> <p>B</p> <p>Bliley Electric Company vi</p> <p>C</p> <p>Capitol Radio Engineering Institute iv</p> <p>Cornell-Dubilier Electric Corp. Cover III</p> <p>D</p> <p>Daven Company iv</p> <p>G</p> <p>General Electric Company ix</p> <p>General Radio Company Cover IV</p> <p>I</p> <p>International Resistance Company xii</p>	<p>O</p> <p>Ohmite Manufacturing Company viii</p> <p>P</p> <p>Precision Apparatus Company x</p> <p>Premax Products x</p> <p>R</p> <p>RCA Manufacturing Company, Inc. vii, xi</p> <p>S</p> <p>Sprague Specialties Company iii</p> <p>T</p> <p>Terminal Radio Corporation vi</p> <p>Triplett Electrical Instrument Company viii</p> <p>U</p> <p>United Transformer Corporation Cover II</p>
--	---

Designed to Keep You Technically Up-to-the-Minute!

RCA TUBE PUBLICATIONS and ENGINEERING DATA

These RCA publications bring you the tube data and engineering help you need—when you need it—and in its most authentic and up-to-the-minute form. For years, RCA engineering has led the way, and these publications keep

you fully abreast of modern tube design and application. They are available through your RCA Tube and Equipment Distributor, or may be ordered direct from RCA, Commercial Engineering Section, Harrison, N. J.

RCA GUIDE FOR TRANSMITTING TUBES

Includes full details on RCA air-cooled transmitting tubes plus circuits and construction data on equipment of interest to experimenters, amateurs, and engineers. 50% larger. Fully illustrated. 72 pages. *Net price, 25c each.*

TT-100 TRANSMITTING TUBE BOOKLET

This attractively illustrated publication shows at a glance the maximum ratings and typical operation conditions of the entire line of RCA Transmitting and Special-Purpose Tubes. Contains 16 pages.

Single copies at no charge

RCA HAM TIPS

RCA's newly little publication devoted exclusively to the radio amateur. Jam-full of how-to-make-it articles, technical data, diagrams, transmitting tube advice, helpful hints. Fully illustrated. Issued seven or eight times a year. Your RCA Tube and Equipment distributor will be glad to supply you with it.

Available at no charge

RCA PHOTOTUBE BOOKLET

Written by RCA engineers to give a clear understanding of phototube theory, construction, and operation. Complete with descriptive text, circuits, curves, and charted information. Booklet contains 16 pages.

Single copies at no charge



MB-3 ALL TYPES TUBE HANDBOOK

Convenient, loose-leaf data, curves, etc., on all RCA transmitting, receiving, cathode ray, television and special-purpose tubes, complete with attractive, durable binders. Available on subscription basis. Write RCA Commercial Engineering Section, Harrison, N. J., for descriptive folder and order form.

RC-14 RECEIVING TUBE MANUAL

Now available with a 38-page supplement covering 99 additional receiving tube types and making the book a virtual encyclopedia, containing a total of 256 pages and covering 333 different receiving tube types. . . . *Net price, complete, 25c*

1275-B RECEIVING TUBE BOOKLET

A handy guide for quick, easy reference. Includes the salient characteristics, socket connections, and a special classification index of the complete line of RCA Receiving Tube types. 16 pages. *Single copies at no charge*

INSTRUCTION BOOKLETS

These booklets contain complete, authorized information on Radio's finest line of Transmitting and Special-Purpose Tubes. They are included in the cartons with RCA Tubes, but bulletins on any tube type are available upon request. *Single copies at no charge*



Radio Tubes

PROVED IN COMMUNICATION'S MOST EXACTING APPLICATIONS

RCA MANUFACTURING CO., Inc., Camden, N. J. • A Service of The Radio Corporation of America

For Canadian prices write to RCA Victor Company Limited, Montreal





RESISTORS FOR DEFENSE

Resistors to satisfactorily meet the government's exacting and unusual requirements are an old story to IRC.

Many years of close collaboration with government agencies in the preparation of resistance specifications and in the development of special resistor types have been a natural result of IRC's acknowledged leadership in a highly-specialized technical field.

Today, with the tempo greatly accelerated in the face of national emergency, this background of specialized experience is proving of immeasurable benefit to defense manufacturers and their subcontractors.

It means informed engineering cooperation. It means the availability of tested and proven resistors of the many types required for the comprehensive defense program. It means elimination of guesswork and experimentation in obtaining with all possible speed the *right* resistor for any particular application.

Bring your fixed and variable resistance problems to IRC. Our engineers will be glad to cooperate.

INTERNATIONAL RESISTANCE COMPANY

431 North Broad Street, Philadelphia, Penna.



Makers of Resistance Units of More Types, in More Shapes, for More Applications Than Any Other Manufacturer in the World.

The Rockies...

*another C-D capacitor
"test laboratory"*

THERE'S EXTRA DEPENDABILITY IN LONGER LASTING C-D CAPACITORS

It's 450 miles from Vancouver to Lethbridge over the Canadian Rockies. Paving this scenic aerial highway, eight radio ranges help guard the safety of Trans-Canada Air Lines passengers. When so much depends on the flawless performance of radio communications equipment, the components chosen must possess something *extra*. Like so many air lines today, Trans-Canada Air uses Cornell-Dubilier capacitors in its aircraft and ground communications equipment. For Cornell-Dubilier's thirty-two years of specialization in the development, manufacture and application of capacitors gives C-Ds an extra measure of dependability. Why not take advantage of this experienced engineering—it costs nothing *extra*.



CAPACITORS MAY LOOK ALIKE BUT . . . *There is extra long life, extra uniformity and*

dependability built into C-Ds. Next time you specify capacitors look for the Cornell-Dubilier seal of experienced engineering. And get the hidden extras at no extra cost. Send for Catalog. Cornell-Dubilier Electric Corporation, 1012 Hamilton Blvd., South Plainfield, New Jersey.

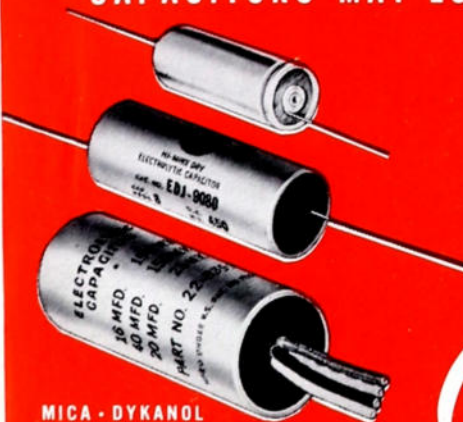

MICA · DYKANOL
PAPER · WET & DRY
ELECTROLYTIC
CAPACITORS

Cornell Dubilier



SOUTH PLAINFIELD, N. J.

NEW BEDFORD, MASS.

. . . MORE IN USE TODAY THAN ANY OTHER MAKE . . .

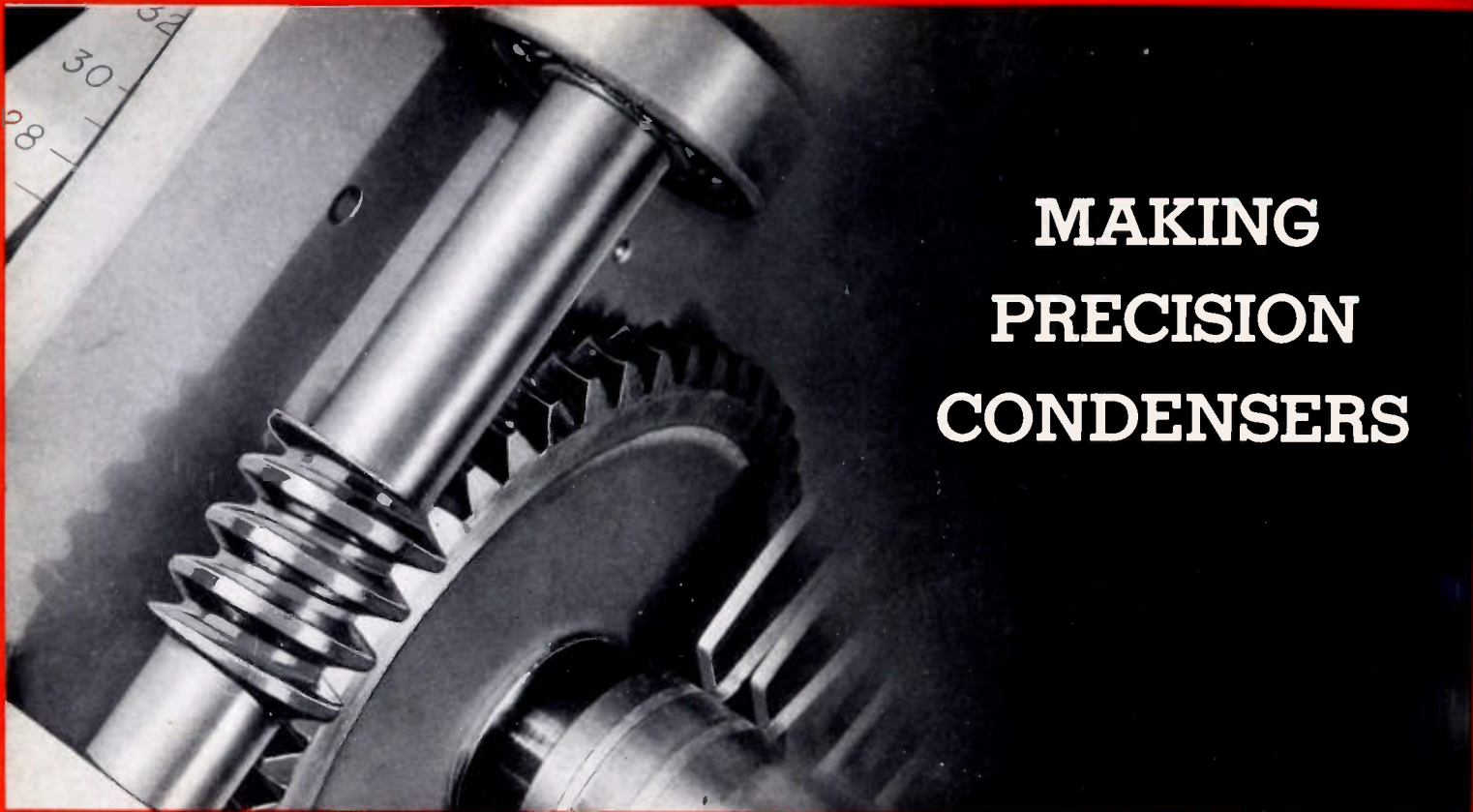

MAKING PRECISION CONDENSERS

ILLUSTRATIVE of the precision employed in the mechanical design of GENERAL RADIO products is the popular Type 722 Condenser series. In the manufacture of precision condensers the mechanical design has considerable bearing upon the ultimate accuracy obtainable.

The Type 722 Condensers can be reset to 1 part in 25,000, an accuracy comparable to that obtained only in the finest type of precision machine. To secure this accuracy of setting, exceedingly close mechanical tolerances are held.

A 50-to-1 worm drive, equipped with a 3½ inch dial, is used for the fine setting adjustment. Backlash in the drive is kept very low (less than one-half worm division) by cutting the worm and worm shaft from an integral steel shaft, thus eliminating eccentricity due to setscrews and misfit.

The worm shaft is held to a tolerance of 0.0004 inch; the radial eccentricity of the worm gear is held to less than 0.002 inch. The main rotor shaft is held to a radial tolerance of 0.0005 inch and its bearing surfaces to 0.0002 inch. Ball bearings are used on the worm and main rotor shafts.

To take full advantage of the mechanical

refinements of the worm drive, correspondingly important electrical and mechanical design features are incorporated in the other parts of these condensers. The main shaft, rotor and stator plates, tie rods and heavy cast frame are all fabricated from aluminum alloy.

A remarkably low temperature coefficient of capacitance of only 0.0022 per cent per degree C. (22 parts per million) results from this construction.

Small, properly placed waxed Isolantite bars insulate the rotor and stator plates. A figure of merit ($R\omega C^2$) of 0.04×10^{-12} , which is constant over the audio-frequency range and remains unchanged up to 75% relative humidity, is thus secured.

After assembly, the completed condensers pass through a number of aging cycles to relieve strains set up . . . strains which otherwise would not appear until

years later. The condensers are then calibrated in our laboratories to an accuracy considerably better than that to which they are rated. These condensers typify the care used in the electrical and mechanical design, production and testing of many General Radio instruments.

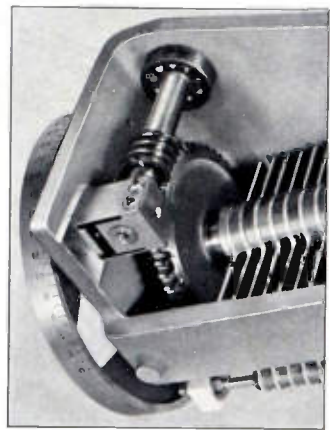

GENERAL RADIO COMPANY
CAMBRIDGE, MASSACHUSETTS
Branches in New York and Los Angeles