

# Proceedings

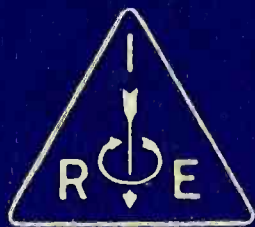

*of the*

# I · R · E

NOVEMBER 1940

VOLUME 28

NUMBER 11

Bridge Impedance

Measurements to 60 Mc.

Solar Emission and Terrestrial  
Disturbances

High-Frequency Atmospheric Noise

Corner-Reflector Antenna

Negative-Resistance Magnetron  
Oscillator

Ionospheric Transmission

Institute of Radio Engineers

# Sixteenth Annual Convention

January 9, 10, and 11, 1941  
Hotel Pennsylvania, New York, N.Y.

---

## CONDENSED PROGRAM

### ● THURSDAY, JANUARY 9

Morning: Addresses by the Retiring and Incoming Presidents

Technical session

Various Subjects

Afternoon: Technical Session

Broadcast Receivers and Magnetic Recording

Trips

### ● FRIDAY, JANUARY 10

Morning: Technical Session

Television and Ultra-High-Frequency Transmitters

Afternoon: Technical Session

Electron Multipliers and Cathode-Ray Developments

Trips

Evening: Annual Banquet

### ● SATURDAY, JANUARY 11

Morning: Technical Session

Television Theory and Testing

Afternoon: Technical Session

Frequency-Modulated-Wave Transmitters and Program Amplifiers

Full Details of the Program will be found on Pages 525-534 of this Issue



New York Meeting—March 5, 1941



Joint Meeting with American Section, International Scientific  
Radio Union, Washington, D.C., May 2, 1941

Summer Convention—Institute of Radio Engineers—Detroit, Michigan  
June 23, 24, and 25, 1941

#### SECTION MEETINGS

ATLANTA February 21	DETROIT February 21	PITTSBURGH March 10
CLEVELAND February 28	LOS ANGELES March 18	WASHINGTON March 10
	PHILADELPHIA March 6	

#### SECTIONS

ATLANTA—Chairman, P. C. Bangs; Secretary, Adolph Andersen, Federal Communications Commission, 411 Federal Annex, Atlanta, Ga.

BALTIMORE—Chairman, Ferdinand Hamburger; Secretary, G. J. Gross, Pennsylvania Water and Power Co., 1611 Lexington Bldg., Baltimore, Md.

BOSTON—Chairman, W. L. Barrow; Secretary, P. K. McElroy, General Radio Co., 30 State St., Cambridge, Mass.

BUENOS AIRES—Chairman, A. T. Cosentino; Secretary, G. J. Andrews, Cia. Standard Electric Argentina, Cangallo 1286, Buenos Aires, Argentina.

BUFFALO-NIAGARA—Chairman, B. E. Atwood; Secretary, Leroy Fiedler, 98 West Ave., Lockport, N. Y.

CHICAGO—Chairman, G. I. Martin; Secretary, R. A. Kay, RCA Institutes, Inc., 1154 Merchandise Mart, Chicago, Ill.

CINCINNATI—Chairman, J. M. McDonald; Secretary, W. L. Schwesinger, Crosley Corp., Cincinnati, Ohio.

CLEVELAND—Chairman, C. E. Smith; Secretary, W. G. Hutton, 7314 Dorothy Ave., Parma, Ohio.

CONNECTICUT VALLEY—Chairman, K. A. McLeod; Secretary, W. M. Smith, 250 Main St., Suffield, Conn.

DALLAS-FORT WORTH—Chairman, D. A. Peterson; Secretary, J. R. Sullivan, WRR, Dallas, Tex.

DETROIT—Chairman, M. Cottrell; Secretary, Paul Frincke, WJBK, 6559 Hamilton Ave., Detroit, Mich.

EMPORIUM—Chairman, R. K. Gessford; Secretary, C. W. Reash, Hygrade Sylvania Corp., Emporium, Pa.

INDIANAPOLIS—Chairman, Arthur Curtis; Secretary, B. V. K. French, P. R. Mallory & Co., E. Washington St., Indianapolis, Ind.

LOS ANGELES—Chairman, W. W. Lindsay, Jr.; Secretary, C. F. Wolcott, 1609 S. Western Ave., Los Angeles, Calif.

MONTREAL—Chairman, E. A. Laport; Secretary, W. A. Nichols, Canadian Broadcasting Corp., 1012 Keefer Bldg., Montreal, Que.

NEW ORLEANS—Chairman, G. H. Peirce; Secretary, D. W. Bowman, 8327 Sycamore St., New Orleans, La.

PHILADELPHIA—Chairman, C. M. Burrill; Secretary, R. L. Snyder, 103 Franklin Rd., Glassboro, N. J.

PITTSBURGH—Chairman, R. E. Stark; Secretary, M. G. Jarrett, Bell Telephone Company of Pennsylvania, Pittsburgh, Pa.

PORTLAND—Chairman, Marcus O'Day; Secretary, Earl Schoenfeld, Route 1, Box 3070, Portland, Ore.

ROCHESTER—Chairman, H. C. Sheve; Secretary, O. L. Angevine, Jr., Stromberg-Carlson Telephone Manufacturing Co., Rochester, N. Y.

SAN FRANCISCO—Chairman, L. J. Black; Secretary, Karl Spangenberg, Stanford University, Calif.

SEATTLE—Chairman, K. H. Ellerbeck; Secretary, R. J. Gleason, Pacific Alaska Airways, Inc., 3314 White Bldg., Seattle, Wash.

TORONTO—Chairman, H. S. Dawson; Secretary, L. C. Simmonds, 301 King St., E., Toronto, Ont.

WASHINGTON—Chairman, M. H. Biser; Secretary, C. M. Hunt, WJSV, 817 Earle Bldg., Washington, D. C.

# Proceedings of the I·R·E

*Published Monthly by*

The Institute of Radio Engineers, Inc.

VOLUME 28

*November, 1940*

NUMBER 11

## BOARD OF DIRECTORS

Lawrence C. F. Horle, *President*  
 Frederick E. Terman,  
*Vice President*  
 Melville Eastham, *Treasurer*  
 Harold P. Westman, *Secretary*  
 Austin Bailey  
 W. R. G. Baker  
 Frederick W. Cunningham  
 Henry C. Forbes  
 Alfred N. Goldsmith  
 Virgil M. Graham  
 O. B. Hanson  
 Raymond A. Heising  
 C. M. Jansky, Jr.  
 Frederick R. Lack  
 Frederick B. Llewellyn  
 Haraden Pratt  
 Browder J. Thompson  
 Hubert M. Turner  
 Arthur F. Van Dyck  
 Harold A. Wheeler  
 Lynde P. Wheeler

## BOARD OF EDITORS

Alfred N. Goldsmith, *Chairman*  
 Ralph R. Batcher  
 Philip S. Carter  
 Elmer W. Engstrom  
 Frederick W. Grover  
 J. Warren Horton  
 Greenleaf W. Pickard  
 Benjamin E. Shackelford  
 Karl S. Van Dyke  
 Harold P. Westman, *ex officio*  
 Harold A. Wheeler  
 Lynde P. Wheeler  
 Laurens E. Whittemore  
 William Wilson

## PAPERS COMMITTEE

William Wilson, *Chairman*  
 Frederick B. Llewellyn,  
*Vice Chairman*  
 Herman A. Affel  
 Edmond Bruce  
 Howard A. Chinn  
 James K. Clapp  
 Tunis A. M. Craven  
 Robert B. Dome  
 Paul O. Farnham  
 Enoch B. Ferrell  
 Elmer L. Hall  
 Dorman D. Israel  
 Loren F. Jones  
 De Loss K. Martin  
 Harry B. Marvin  
 Harry R. Mimno  
 Albert F. Murray  
 Harold O. Peterson  
 Ralph K. Potter  
 Hubert M. Turner  
 Dayton Ulrey  
 Arthur F. Van Dyck  
 Paul T. Weeks  
 William C. White  
 Irving Wolf

A Radio-Frequency Bridge for Impedance Measurements from 400 Kilocycles to 60 Megacycles.....	D. B. Sinclair	497
Notes on the Time Relation Between Solar Emission and Terrestrial Disturbances.....	Clifford N. Anderson	503
Some Studies in High-Frequency Atmospheric Noise at Dacca by the Warbler Method.....	S. R. Khastgir and M. Kameswar Rao	511
The Corner-Reflector Antenna.....	John D. Kraus	513
The Characteristics of the Negative-Resistance Magnetron Oscillator.....	Hsu Chang and E. L. Chaffee	519
The Ionosphere and Radio Transmission, October, 1940, with Predictions for January, 1941.....		523
Institute News and Radio Notes.....		525
Sixteenth Annual Convention.....		525
Membership.....		535
Books		
"An Introduction to Frequency Modulation," by John F. Rider.....	Dorman D. Israel	535
Contributors.....		536

Helen M. Stote, *Assistant Editor*  
 John D. Crawford,  
*Advertising Manager*

Entered as second-class matter October 26, 1927, at the post office at Menasha, Wisconsin, under the Act of February 28, 1925, embodied in Paragraph 4, Section 538 of the Postal Laws and Regulations. Publication office, 450 Ahnalt Street, Menasha, Wisconsin. Subscription, \$10.00 per year; foreign, \$11.00.

condenser  $C_N$ , and a variable condenser  $C_A$ . This feature is of the greatest importance because the fixed resistor<sup>4</sup>  $R_B$  can be made with much smaller residual reactance than can a variable resistor. The variation in resistance balance is secured in this circuit by means of the variable air condenser  $C_A$ . Since the variable

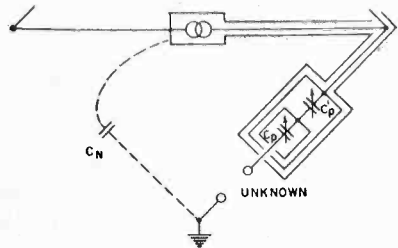

Fig. 2—Triple shielding of reactance-balance assembly.

air condenser can also be made to have very small residual parameters,<sup>5</sup> the equivalent of a continuously variable resistor having negligible residual reactance therefore can be obtained. In addition, since the balance involves the ratio of the variable capacitance  $C_A$  to the fixed capacitance  $C_N$ , a multiplying factor can be obtained that gives an incremental resistance range from zero to a value considerably higher than that of the standard resistor  $R_B$ .

#### DESCRIPTION OF INSTRUMENT

The circuit of Fig. 1 is adequate to explain the fundamental principle of the bridge. Several modifications of this simple circuit, however, must be made to adapt it to the needs of a commercial instrument.

First, while the dial of the condenser  $C_A$  can be calibrated to read resistive ohms directly, independent of frequency, for convenience it must be possible to set this dial to zero for the initial balance with the UNKNOWN terminals short-circuited. A small trimmer condenser  $C_A'$  across the calibrated condenser  $C_A$  has been added to accomplish this result. Choice of the proper value for the resistance  $R_p$  makes it possible to establish an initial balance with the main calibrated condenser set at approximately minimum capacitance and with the trimmer set at mid-scale.

Second, while the dial of the condenser  $C_P$  can be calibrated to read reactance directly at any one frequency, for convenience it must be possible to set this dial to zero for the initial balance with the UNKNOWN terminals short-circuited. Since it is necessary to measure both inductive and capacitive reactances, it is necessary to be able to set zero at either end of the scale. A condenser  $C_P'$ , having the same capacitance range as the calibrated condenser  $C_P$ , has been connected in series with it to accomplish this result.

The problem of shielding is the next to be considered. One of the chief troubles in series substitution

circuits is that of capacitances to ground<sup>6</sup> and these capacitances are particularly troublesome in the lower right-hand arm of the bridge of Fig. 1. To dispose of the stray capacitances it has, in fact, been found necessary to use triple shielding in this arm, as shown in Fig. 2.

The function of the innermost shield in this assembly is simply to localize the variable stray capacitance of the rotor of the calibrated condenser  $C_P$  within the shield so that it cannot fall across the trimmer condenser  $C_P'$  and cause interlocking of the settings of the two condensers. The function of the middle shield is to throw the stray capacitance of the condensers  $C_P$  and  $C_P'$  to the right-hand corner of the bridge, and the function of the outermost shield is to throw the capacitance from the right-hand corner of the bridge to the outer box across the generator where it can do no harm.

This leaves the capacitance from the outer box to ground across the condenser  $C_N$  in the lower left-hand bridge arm. Actually, the physical dimensions of the box are such that this bridge arm is formed almost entirely from the box capacitance to ground, with only a small trimmer condenser connected across it to correct for variations in dimensions between instruments.

With this shielding arrangement, the capacitance of the innermost shield to the middle shield is thrown across the trimmer condenser  $C_P'$ . The minimum capacitance of the trimmer condenser is therefore raised above that of the calibrated reactance condenser  $C_P$  and its reactance range is reduced with respect to that covered by the calibrated condenser. This makes it impossible to obtain an initial balance with the trimmer condenser for all points on the reactance-con-

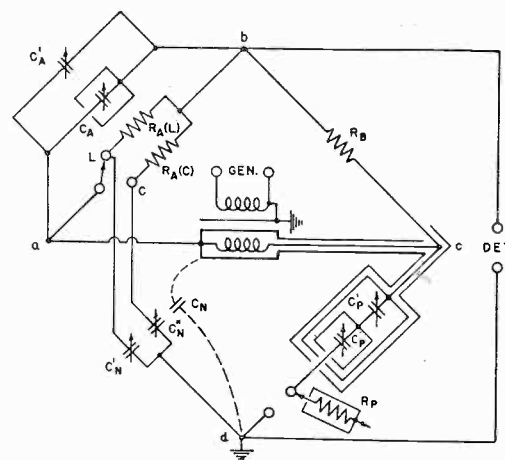

Fig. 3—Complete circuit diagram of bridge. The capacitance  $C_N$  is the stray capacitance to ground of the shielding associated with the reactance-balance assembly and the transformer. The two trimmer condensers  $C_N'$  and  $C_N''$  are used to equalize the capacitance to ground from the left-hand corner of the bridge when the two ratio-arm resistors  $R_A(L)$  and  $R_A(C)$  are switched.

denser scale. As already pointed out, however, it is essential to be able to set the initial balance at opposite ends of the reactance-condenser scale in order to obtain full dial coverage for both inductive and capacitive reactances. To make this possible it has been found necessary to switch the ratio arm  $R_A$ . Equations

<sup>4</sup> D. B. Sinclair, "The type 663 resistor—a standard for use at high frequencies," *Gen. Radio. Exp.*, vol. 13, pp. 6-11; January, 1939.

<sup>5</sup> D. B. Sinclair, "A high-frequency model of the precision condenser," *Gen. Rad. Exp.*, vol. 13, pp. 1-7; October-November, 1938.

<sup>6</sup> See, for instance, M. Reed, "The effect of stray capacitances to ground in substitution measurements," *Wir. Eng.*, vol. 13, p. 284; May, 1936.



(1) and (2) show that this resistance enters only into the reactance balance and does not affect the resistance balance. Proper choice of the resistance therefore permits setting the calibrated reactance condenser initially at maximum, with the trimmer condenser at minimum, or vice versa. When the trimmer condenser is varied, initial balances of the reactance condenser can therefore be obtained at settings in the neighborhood of either maximum or minimum, with only a small region in mid-scale not covered. The complete circuit diagram for the bridge is illustrated in Fig. 3. A panel view of the experimental model is shown in Fig. 4.

As in other types of high-frequency measurement equipment, the limitations imposed upon the bridge with respect to frequency range arise from residual parameters in the circuit elements and in the wiring. To give an orderly approach to a discussion of these unwanted parameters it is convenient to break down the circuit of Fig. 3 and to treat each of the circuit branches connecting points *a*, *b*, *c*, and *d* individually.

#### 1. Circuit *a*-*b*

The resistive part of this circuit serves only to set up the initial balance for reactance. Provided only that reactances caused by residual inductance in series with, and capacitance in shunt with, the resistors  $R_A(L)$  and  $R_A(C)$  are not so large that they cannot be compensated for by the trimmer capacitance  $C_A'$  and that the change of resistance with frequency is not unduly large, satisfactory operation is therefore ob-

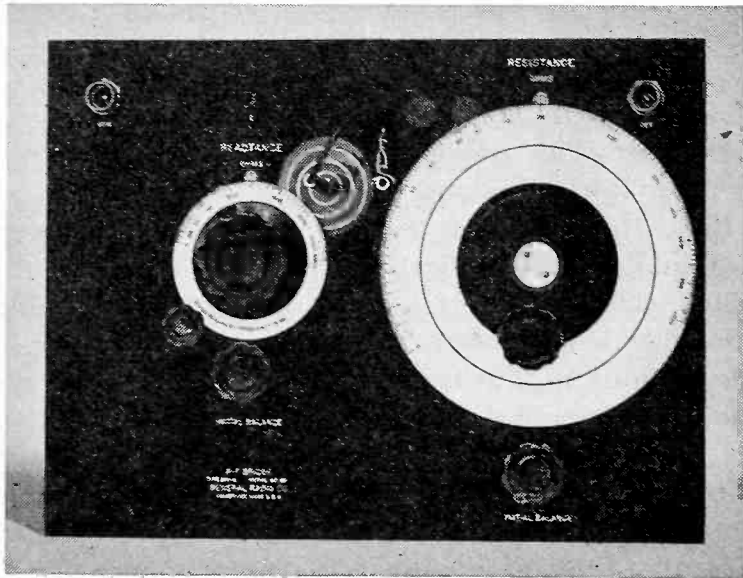

Fig. 4—Panel view of experimental model. The semilogarithmic calibration of the resistance dial, from 0 to 1000 ohms, is obtained with specially shaped rotor plates; that of the reactance dial, from 0 to 4000 ohms at 1 megacycle, is obtained through the inverse relation between reactance and capacitance, with semi-circular rotor plates.

tained. Capacitance from point *b* to ground falls across the detector and is harmless; capacitances from point *a* to ground are equalized in the two switch positions by adjustments of the trimmer condensers  $C_N'$  and  $C_N''$ .

The capacitive part of this circuit is of great impor-

tance since it is directly used to measure the resistance component of the unknown impedance. Careful attention, therefore, must be paid to the variable-condenser design.

As has been previously pointed out,<sup>7</sup> a variable condenser can be represented by the equivalent circuit of Fig. 5.

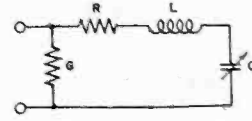

Fig. 5—Equivalent circuit for variable air condenser. The residual resistance  $R$  corresponds to losses in the metallic structure, the residual conductance  $G$  to losses in the dielectric structure, and the residual inductance  $L$  to magnetic flux set up by conduction currents in the metallic structure.

The residual conductance  $G$ , corresponding to dielectric losses in condensers  $C_A$  and  $C_A'$ , falls across the resistors  $R_A(L)$  and  $R_A(C)$ . Since it is constant with dial setting, it causes no error in incremental readings and only a small shift in the initial reactance balance so long as it is small compared with the conductances of these resistors. For the circuit constants used in the bridge under discussion this is true at frequencies as high as 60 megacycles.

The residual resistance  $R$  causes a small reactance error since it produces a variable effective conductance component  $R(\omega C_A)^2$  across the ratio arm  $R_A$ . The variation in this conductance, as the condenser  $C_A$  is adjusted for a resistance balance, introduces a correction term to be included in the reactance-balance equation as follows:

$$X_x = \frac{1}{\omega} \left( \frac{1}{C_{P_2}} - \frac{1}{C_{P_1}} \right) - R \frac{\omega C_N R_x}{R_B} (2R_P + R_x). \quad (4a)$$

The magnitudes of the circuit constants used in the bridge limit the maximum possible reactance error from this source to less than 1 ohm, or to an error in the storage factor  $Q_x = X_x/R_x$  of 0.002. As shown, the error is in the direction to make the unknown reactance appear slightly more inductive than it should.

The residual inductance  $L$  causes the terminal capacitance  $\hat{C}_A$  to differ from the static capacitance  $C_A$  according to the relation

$$\hat{C}_A = \frac{C_A}{1 - \omega^2 L C_A}. \quad (5)$$

The effect of this inductance is to make the bridge read low on resistance components at high frequencies by an amount that increases with the magnitude of the resistance to be measured. This error has been found to be the most serious encountered and has been reduced as far as possible by using the condenser construction described<sup>8</sup> for the twin-T impedance-measuring circuit. A plot of the error in resistance measure-

<sup>7</sup> D. B. Sinclair, "Parallel-resonance methods for precise measurements of high impedances at radio frequencies and a comparison with the ordinary series-resonance methods, Proc. I.R.E., vol. 26, p. 1466-1497; December, 1938. See Fig. 8(b), p. 1477, and footnote 9, page 1476.

ment caused by the residual inductance is shown in Fig. 6.

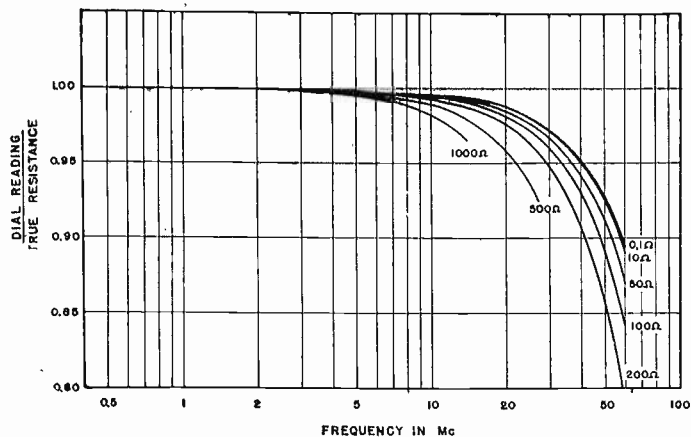

Fig. 6—Plot of error in resistance dial reading caused by residual inductance in condenser  $C_A$  for different values of unknown resistance. The 500- and 1000-ohms curves are not extended beyond the frequencies shown because the 2.6-micromicrofarad bridge terminal capacitance produces a reactance beyond the range of the bridge. For convenience these data can also be plotted in the form of corrections as a function of dial reading, with frequency as parameter.

## 2. Circuit b-c

The resistor  $R_B$  serves as the resistance standard of the bridge. In order to avoid error it is therefore necessary that it should be essentially nonreactive and that its resistance should be independent of frequency.

The unit designed to meet these requirements is shown in Fig. 7. In its design, a balance has been sought between capacitance and inductance, the unit shown being equivalent at frequencies up to 60 megacycles, to a pure resistance of 270 ohms, in parallel with a capacitance<sup>8</sup> of less than 0.4 micromicrofarad. The corresponding storage factor  $Q_B = \omega C_B / G_B$  is less than 0.04 at 60 megacycles.

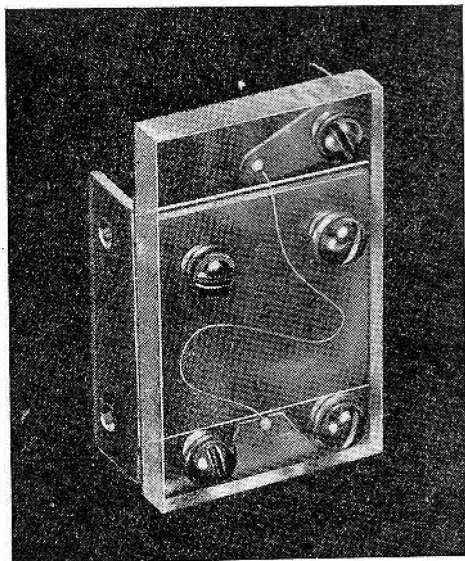

Fig. 7—Resistance standard  $R_B$ . The polystyrene piece clamps a 0.7-mil manganin wire down on a sheet of 1-mil mica cemented to the brass plate.

The residual capacitance of the resistor causes a correction term in the reactance-balance equation as follows:

<sup>8</sup> For a discussion of the effects of small residual inductance and capacitances in high-frequency resistors, see footnote 4.

$$X_x = \frac{1}{\omega} \left( \frac{1}{C_{P_2}} - \frac{1}{C_{P_2}'} \right) - Q_B R_x. \quad (4b)$$

The maximum possible reactance error that can arise from this source is about 10 ohms, with a corresponding error in  $Q_x$  of 0.01. The error is in the direction to make the unknown reactance appear slightly more inductive than it should, as is the error expressed in (4a). It should be noted that the error is of the same order as the variation in measured values caused by changing the position of the connecting clip on the unknown resistor terminal, being equivalent to a capacitance error of about 0.1 micromicrofarad across a 1000-ohm resistance or 1 micromicrofarad across a 100-ohm resistance.

## 3. Circuit c-d

The shielding of the condenser assembly in this circuit has already been described. A further interesting point that has not been discussed in detail, however, is the location of the resistor  $R_P$  that must be included in series with the circuit in order to obtain an initial resistance balance against the zero capacitance of the resistance condenser  $C_A$ .

Since this resistor must remain permanently in circuit, it would be very desirable to mount it within the

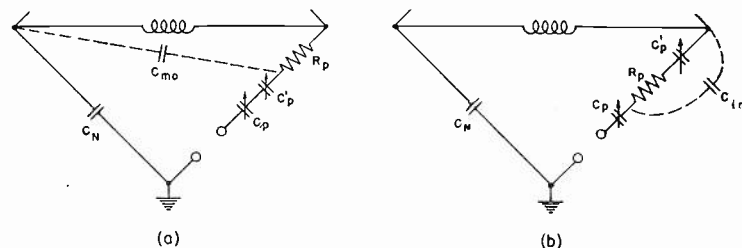

Fig. 8—Equivalent circuits showing the effects of connecting the resistor  $R_P$  inside the reactance-condenser assembly.

instrument. This proves to be not feasible, however, for the following reasons.

If, for instance, the resistor is connected between the middle shield and the right-hand corner of the bridge, the capacitance  $C_{mo}$  between the middle and outer shields falls, not across the transformer where it causes no harm, but from the left-hand corner of the bridge to a point in the lower-right-hand arm that is not at the same potential as the right-hand corner. This condition is illustrated in Fig. 8(a). It causes an interlocking between resistance and reactance balances that leads to serious errors in measurement.

If the resistor is connected in series with the reactance trimmer condenser  $C_{P'}$  between the inner and middle shields, the capacitance  $C_{im}'$  between these shields falls across the series combination of  $R_P$  and  $C_{P'}$ , as shown in Fig. 8(b). The effective resistance of the series-parallel combination changes as  $C_{P'}$  is varied. In itself, this need cause no error in measurement because  $C_{P'}$  is not changed after an initial balance is obtained. For the circuit constants used in the bridge under discussion, however, it was found that it was not possible to obtain an initial resistance bal-

ance over the desired frequency range when  $C_P'$  was varied.

If the resistor is connected in series with the reactance condenser  $C_P$  between the unknown terminal and the inner shield, the construction of the shield assembly results in an appreciable capacitance occurring across the series combination of  $R_P$  and  $C_P$ . This causes not only the deleterious effect on the initial balance previously mentioned but a serious error in resistance measurements at high frequencies because the reactance condenser  $C_P$  is varied during the measurement.

Locating the resistor external to the bridge has been found to offer a satisfactory solution to the problem. For convenience, the resistor has been mounted in the plug unit of the external lead, shown in Fig. 4, and indicated schematically in Fig. 3. The purpose of the metal shield around the resistor, connected to the lead to the unknown, is to minimize the capacitance to ground of the lead from the resistor to the reactance condenser  $C_P$ . Ground capacitance  $\delta C$  at this point causes an error in resistance measurement approximately equal to  $X_x R_p \omega \delta C$ , where  $X_x$  is the reactive component of the unknown impedance. Without the shield, this capacitance is only of the order of 1 micro-microfarad but even this small value can cause an apparent negative resistance reading of nearly 6 ohms when a low-loss 40-micromicrofarad condenser is measured. When the shield is used, the capacitance becomes negligibly small and the error inappreciable.

A further source of error, which sets a practical low-frequency limit to the operation of the bridge, is the dielectric loss in the reactance condenser  $C_P$ . As shown in Fig. 5, the effect of dielectric loss can be simulated by a residual conductance  $G$  in parallel with the capacitance. This conductance is essentially independent of condenser setting and increases linearly with frequency. The effective series resistance  $R_e \simeq G/(\omega C)^2$ , caused by the dielectric loss, therefore, varies inversely as the square of the capacitance and inversely as the frequency.<sup>9</sup> A plot of effective resistance of the reactance condenser  $C_P$  used in the bridge is shown in Fig. 9.

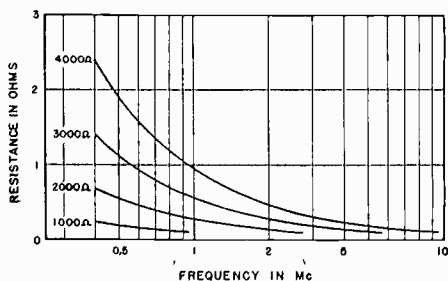

Fig. 9—Plot of effective series resistance of reactance condenser  $C_P$  caused by dielectric loss for different dial settings.

#### 4. Circuit d-a

The major part of the capacitance  $C_N$  is the capaci-

<sup>9</sup> See, for instance, C. T. Burke, "Substitution method for the determination of resistance of inductors and capacitors at radio frequencies," *Trans. A.I.E.E.*, vol. 46, p. 482, 1927.

tance from the outer shield of the reactance-condenser assembly to ground, although a small part occurs between the two shields of the transformer. The two trimmer condensers  $C_N'$  and  $C_N''$  are just large enough to adjust for slight variations in circuit parameters,

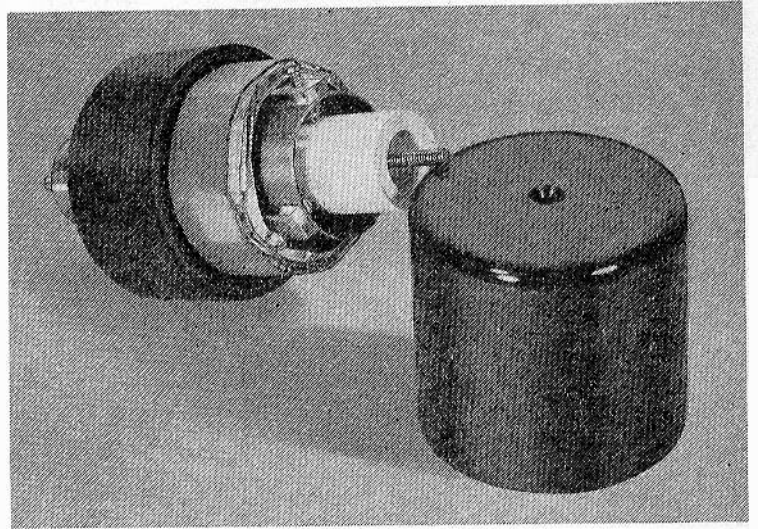

Fig. 10—Shielded transformer. Each winding is completely encased in copper foil, the ends of the foil being overlapped and insulated to prevent the formation of a short-circuited turn in the magnetic field. Two coaxial split brass tubes are interposed between the windings to furnish additional shielding and mechanical support for the secondary. An iron-dust core is used to increase the coupling coefficient.

between instruments, and in capacitance to ground, between switch positions.

Inductance in series with this capacitance causes the net effective capacitance  $\hat{C}_N$  to vary with frequency according to the relation  $\hat{C}_N = C_N / (1 - \omega^2 L C_N)$ . The inductance that exists, however, is so small that no observable variation occurs. Similarly, dielectric loss in the supports used to insulate the outer shield from the panel is so small that the error it contributes to the reactance balance is inappreciable.

#### 5. Circuit a-c

The construction of the shielded transformer used in the bridge has been found to be of great importance in obtaining proper operation. The fundamental shielding requirement is, as may be seen from Fig. 3, that the grounded primary be located within a shield at a ground potential and that the ungrounded secondary be located within a shield connected to the left-hand corner of the bridge. The shielding must prevent energy interchange between the windings through capacitive coupling, it must be located so that the capacitance between the two shields is small compared with the capacitance to ground of the outer shield of the reactance-condenser assembly, and it must not seriously impair the magnetic coupling between the windings. A design that has been found to furnish a satisfactory compromise is shown in Fig. 10. Two 1:1 plug-in transformers of this design furnish adequate sensitivity to cover the frequency range from 400 kilocycles to 60 megacycles.

The most serious source of trouble encountered in



the design of these transformers was found to be the electromotive forces induced in the two split brass tubes used as shields between the primary and secondary. The potential *difference* taken along a radius between these tubes is practically zero at any point so long as the slots in the two tubes are lined up. If, however, the slots are not immediately opposite, over a sector between the two slots the radial potential difference is approximately equal to the electromotive force induced in a single turn in the magnetic field.

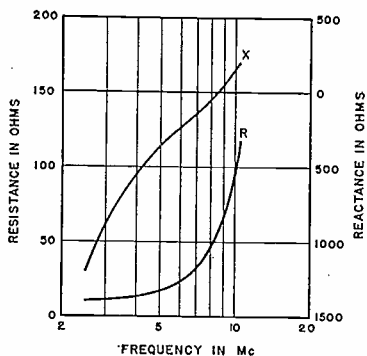

Fig. 11—Reactance and resistance of a vertical-wire antenna with a ground-wire system laid on the surface of the ground.

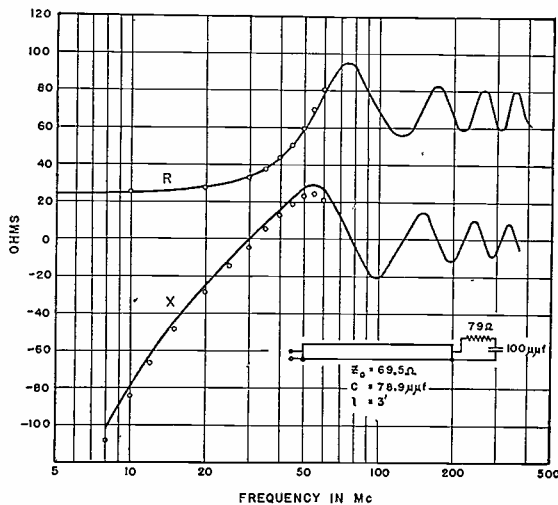

Fig. 12—Input reactance and resistance of a transmission line having the characteristics and termination indicated above. The solid lines are obtained from theoretical computation, the circles from experimental observation.

Capacitive coupling between the two shields over this sector causes a residual component of voltage to be introduced from the left-hand corner of the bridge to ground. This component can easily cause errors of two or three to one in reactance balance at 60 megacycles with a transformer having 6-turn windings.

Locating the leads to the windings directly opposite to the slots, connecting the brass tubes to the coil at the same point, and lining up the slots carefully makes the error from this source negligible. A slight rotation of the outer brass tube with respect to the inner, in fact, can be used as an adjustment to eliminate it.

#### APPLICATION OF BRIDGE

The wide frequency range covered by the new bridge permits convenient and accurate direct measurements of low impedances at frequencies extending up through the frequency-modulated-wave band to the

top of television channel I. Two typical examples of measurements made with the bridge on an antenna and a transmission line at frequencies between 2.5 and 60 megacycles are shown in Figs. 11 and 12.

#### Bibliography

- (1) W. Nernst, "Ueber die Verwendung schneller electrischer Schwingungen in der Brückencombination," *Wied. Ann.*, vol. 60, p. 600; March 15, 1897.
- (2) W. Nernst and F. von Lerch, "Über die Verwendung des electrolytischen Detektors in der Brückencombination," *Ann. der Phys.*, 4, vol. 15, p. 836; December 6, 1904.
- (3) W. Hertwig, "Die Wheatstonesche Brücke bei Anwendung höher Frequenzen," *Ann. der Phys.*, 4, vol. 42, p. 1099; December 23, 1913.
- (4) August Hund, "A new method for the measurement of the logarithmic decrement of condensers," *The Electrician*, vol. 74, p. 458; January 8, 1915.
- (5) August Hund, "Neue Messmethode zur Bestimmung des logarithmischen Dekrements von Kondensatorschwingungen," *Jahr. der draht. Tel. und Tel.*, vol. 10, p. 305; February, 1916.
- (6) A. Hund, "Differential method for the determination of losses in coils," *Elec. World*, vol. 65, p. 1300; May 22, 1915.
- (7) A. E. Kennelly and H. A. Affel, "Skin-effect resistance measurements of conductors," *Proc. I.R.E.*, vol. 4, pp. 523-574; December, 1916.
- (8) August Hund, "Notes on a new method for the determination of the magnetic flux density and permeability," *Proc. I.R.E.*, vol. 5, pp. 43-68; February, 1917.
- (9) August Hund, "Bermerkungen über ein neues Verfahren zur Bestimmung der magnetischen Flussdichte und Permeabilität," *Jahr. der draht. Tel. und Tel.*, vol. 13, p. 462; 1919.
- (10) Carl Englund, "Note on radio frequency measurements," *Proc. I.R.E.*, vol. 8, pp. 326-333; August, 1920.
- (11) F. Trautwein, "Über Verlustmessung bei hohen Frequenzen," *Jahr. der draht. Tel. und Tel.*, vol. 18, p. 261; October, 1921.
- (12) Morris D. Hart, "A bridge method for determining dielectric losses at wireless frequencies," *Jour. I.E.E. (London)*, vol. 61, p. 697; June, 1923.
- (13) August Hund, "Measurements at radio frequency," *Elec. World*, vol. 84, p. 998; November 8, 1924.
- (14) K. Kämpf, "Über eine Technische Hochfrequenzmessbrücke," *Elek. Mach. Tech.*, vol. 2, p. 263; September, 1925.
- (15) J. A. Stratton, "A high frequency bridge," *Jour. Opt. Soc. Amer.*, p. 471; October, 1926.
- (16) W. J. Shackleton, "A shielded bridge for inductive impedance measurements at speech and carrier frequencies," *Bell Sys. Tech. Jour.*, vol. 6, p. 142; January, 1927; also *Trans. A.I.E.E.*, vol. 45, p. 1266; November, 1926.
- (17) H. Bruun, "Messung des Widerstandes von Stromzweigen bei Durchgang von hochfrequentem Wechselstrom," *Elek. Nach. Tech.*, vol. 4, p. 218; May, 1927.
- (18) J. Malsche and M. Wien, "Über eine Null methode zur Messung von Widerständen mit kurzen Stromstößen," *Ann. der Phys.*, 4, vol. 83, p. 305; June 16, 1927.
- (19) B. W. Bartlett, "A shielded bridge for the measurement of inductance in terms of resistance and capacity," *Jour. Opt. Soc. Amer., and Rev. Sci. Instr.*, vol. 16, p. 409; June, 1928.
- (20) K. Kreielsheimer, "Zur Messung der magnetischen Permeabilität von Eisendrähten bei Hochfrequenz in der Wheatstonesche Brücke," *Zeit. für Phys.*, vol. 55, p. 753; July 5, 1929.
- (21) C. Chiodi, "Contributo alla misura dell'angolo di perdita nei diellectrici, in funzione della frequenza," *L'Elettrotecnica*, vol. 16, p. 799; December 15, 1929.
- (22) C. Chiodi, "Contribution à la mesure de l'angle de pertes des diélectriques en fonction de la fréquence," *Rev. Gén. de l'Élec.*, vol. 27, p. 815; May 24, 1930.
- (23) C. P. Boner, "The measurement of capacitance and inductance in terms of frequency and resistance at radio frequencies," *Rev. Sci. Instr.*, vol. 1, p. 243; April, 1930.
- (24) Kurt Schlesinger, "Hochfrequenz-Messeinrichtung zur Bestimmung der Dielektrizitätskonstanten," *Elek. Zeit.*, vol. 17, p. 533; April, 1931.
- (25) K. Kreielsheimer, "Zur Messung des Widerstandes von Drähten bei Hochfrequenz," *Zeit. für Phys.*, vol. 71, p. 260; August 15, 1931.
- (26) A. Hemingway and J. F. McClendon, "An a. c. Wheatstone bridge for audio- and radio-frequency measurements," *Physics*, vol. 2, p. 396; May, 1932.
- (27) Leo Behr and A. J. Williams, "The Campbell-Shackleton shielded ratio box," *Proc. I.R.E.*, vol. 20, pp. 969-988; June, 1932.
- (28) Charles T. Burke, "Bridge methods for measurements at radio frequencies," *Gen. Rad. Exp.*, vol. 6, p. 1; July, 1932.

- (29) W. Geyer, "Verfeinerung der Brückenmethode zur Messung von Elektrolytwiderständen bei hohen Frequenzen," *Ann. der Phys.*, 5, vol. 14, p. 299; July 20, 1932.
- (30) D. W. Dye and T. I. Jones, "A radio-frequency bridge for impedance and power-factor measurements," *Jour. I.E.E.* (London), vol. 72, p. 169; February, 1933.
- (31) C. E. Worthen, "Improvements in radio-frequency bridge methods for measuring antennas and other impedances," *Gen. Rad. Exp.*, vol. 8, p. 1; December, 1933.
- (32) Industrie-Rundschau, "Hochfrequenz-Differentialbrücke für Scheinwiderstandsmessungen im Rundfunk-Frequenzbereich von Siemens und Halske A. G.," *Hochfrequenz. und Elektroakustik*, vol. 46, p. 143; October, 1935.
- (33) C. Austin and A. L. Oliver, "A high-frequency resistance bridge," *Marconi Rev.*, no. 63, pp. 22; November-December, 1936.
- (34) C. H. Young, "A 5-megacycle impedance bridge," *Bell. Lab. Rec.*, vol. 15, p. 261; April, 1937.
- (35) Kenneth S. Cole and Howard J. Curtis, "Wheatstone bridge and electrolytic resistor for impedance measurements over a wide frequency range," *Rev. Sci. Instr.*, vol. 8, p. 333; September, 1937.
- (36) C. L. Fortescue and G. Mole, "A resonance bridge for use at frequencies up to 10 megacycles per second," *Proc. Wireless Sec., I.E.E.*, vol. 13, p. 112; June, 1938.

## Notes on the Time Relation Between Solar Emission and Terrestrial Disturbances\*

CLIFFORD N. ANDERSON†, FELLOW, I.R.E.

*Summary*—Although the correlation between general solar activity and terrestrial disturbances is quite evident, the association of individual storms with specific sunspot groups has never been very satisfactory. Disturbances sometimes have occurred when no sunspots were visible and at other times large sunspots have been unaccompanied by any abnormal disturbances. A possible explanation of such anomalies may lie in longer transit times for the disturbing solar emission than is usually assumed. Some indication is given in this paper that these transit times may range from periods as short as only one or two days to as much as three months. The corresponding velocities for the above transit times are of the order of 2000 and 20 kilometers per second.

*Curves show the approximate relation between the angle of emission, velocity, day of emission, and the days intervening between the passage of a spot through the central meridian of the sun and the corpuscular encounter with the earth.*

### INTRODUCTION

NO DOUBT one of the earliest problems associated with disturbances in the earth's magnetic field was to correlate these disturbances with centers of activity on the sun. As early as 1895, Carrington observed a direct connection between bright chromospheric eruptions and certain typical changes in the earth's magnetic field. In 1935, Dellinger associated certain radio fade-outs with this type of eruption. The "solar-flare" disturbances on the earth's magnetic field are, however, distinctly different from the usual magnetic storms. The former are most pronounced in low latitudes and confined to the sunlit hemisphere of the earth while the latter are most pronounced in high latitudes and occur during night as well.

In 1923, in connection with the systematic measuring program of transatlantic radio transmission inaugurated by the Bell System, the association of abnormal radio transmission and disturbances in the earth's magnetic field was soon discovered and is believed to be the first direct evidence of this kind. The general association of these two phenomena with sunspots has been discussed in many papers. Fig. 1 shows this general relation between sunspots, magnetic activity, long-wave radio field strengths, and short-wave radio disturbance. Three-year moving averages are

\* Decimal classification: R113.5. Original manuscript received by the Institute, July 12, 1940.

† Bell Telephone Laboratories, Inc., New York, N. Y.

used in order to make the trend more evident. The association of either of these two phenomena with individual sunspots has, however, never been satisfactory: disturbances have sometimes occurred when there were no sunspots and sunspots have been observed without disturbances.

There are two types of emissions from the sun which suggest themselves as being responsible for disturbances in the various terrestrial phenomena, namely, radiation and corpuscular. The effect of the former should be more or less simultaneous with the solar disturbance and should be more or less independent of the location of the disturbance on the sun as long as it was within sight of the earth. The latter is similar to hitting a target with a projectile and a "hit" would be a function of the position of the earth, direction, and time of ejection of the particles and their velocity. That particles can achieve velocities sufficient for them to leave the sun (escape velocity 620 kilometers per second) has been observed by Pettit who noted velocities as high as 700 kilometers per second.

This paper discusses in a brief way the position-time-velocity conditions under which particles from the sun may strike the earth and some of the difficulties in obtaining detailed correlation between radio and magnetic disturbances with individual sunspots.

### TIME-VELOCITY RELATIONS

If we imagine ourselves on the sun equipped with a corpuscular machine gun and wish to hit the earth, we shall have to know the position of the earth, its velocity in its orbit, the distance between the sun and earth, the speed of our projectiles, and the tangential velocity component imparted to the projectiles by the rotation of the sun before we can calculate the proper aim:

Distance from the earth to the sun = 150,000,000 kilometers

Earth's velocity in orbit = 0.985 degree per day (360 degrees/365.25) or 2,570,000 kilometers per day.

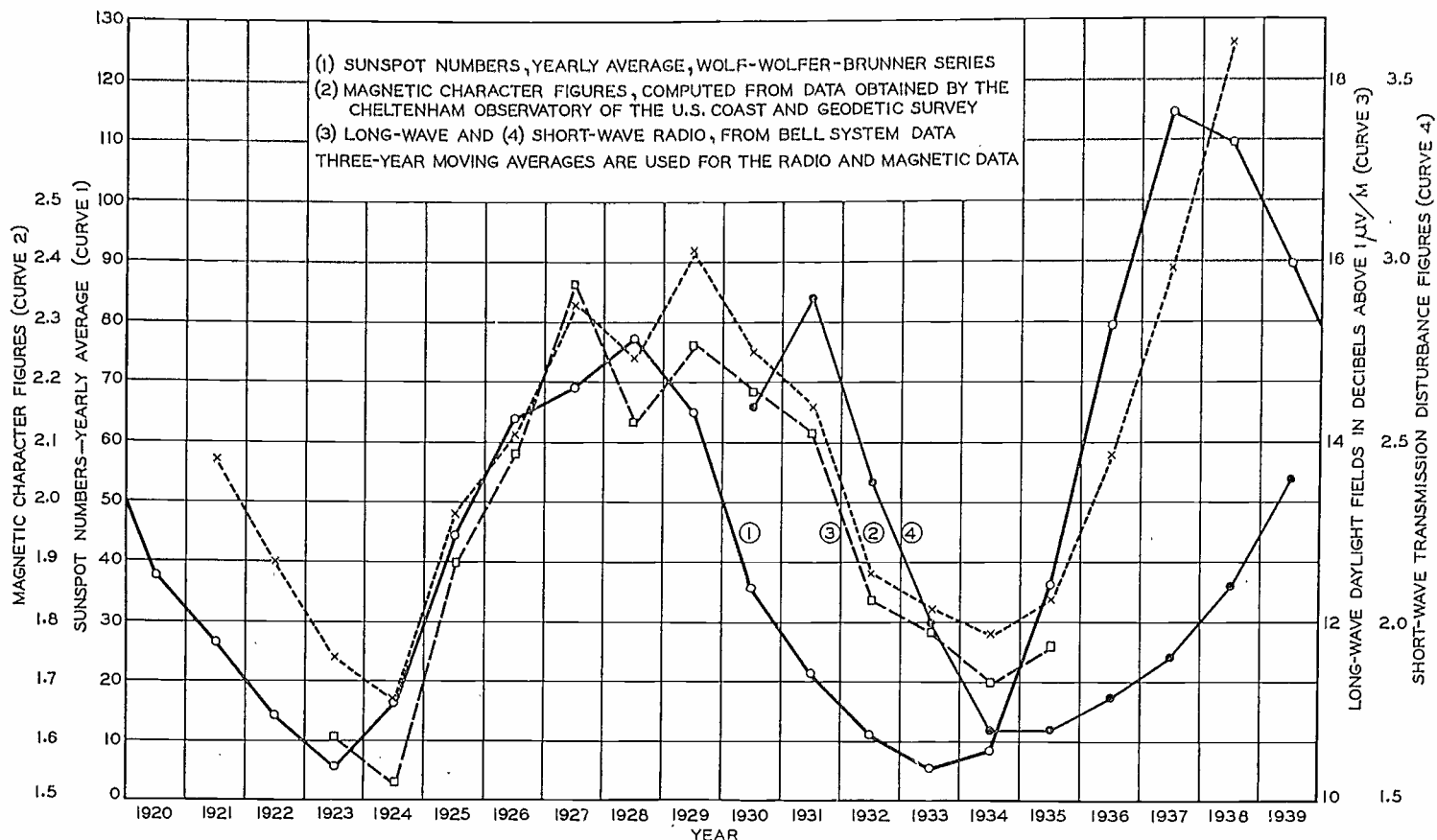

Fig. 1—Correlation of sunspot numbers with radio and magnetic data.

Solar tangential velocity at latitude 15 degrees = 165,000 kilometers per day which at the earth's orbit amounts to 0.064 degree per day (equivalent to 0.065 day of earth travel).

Angular velocity of solar surface = 13.5 degrees (assuming a synodic rotation period of about 27 days).

Since the velocity of the earth in its orbit is 16 times the tangential velocity imparted to the emitted particles by the sun's rotation, radial emission at the instant the spot (assuming it to be the source of emission) is on the central meridian could only reach the earth if the velocity were nearly infinite.

If the emission takes place 24 hours later, (sunspot 13.5 degrees past central meridian) it will take the

earth 13.5/0.985 days (after the sunspot passes the central meridian) to catch up plus the time to travel the displacement due to the tangential velocity imparted by the sun, which in this case will amount to about 0.9 of a day more, making a total of about 14.6 days. The radial velocity to reach the earth's orbit in 13.6 days (ejection was 24 hours after spot passed central meridian) would have to be about 128 kilometers per second (15,000,000 kilometers/13.6 x 86,400 seconds). If the velocity were greater than this, the particles would reach the orbit ahead of time and if slower they would reach there too late.

If the emission takes place 48 hours after the spot has passed the central meridian, the approximate time after the sunspot passed the central meridian when the emission would have to hit the earth, if at all, would be

$$T = \frac{13.5x}{0.985} (1.065) \text{ where } x \text{ in this case is 2 days}$$

$$= 29.2 \text{ days}$$

and the velocity would have to be 64 kilometers per second.

These relations between the time of emission, the number of days after the spots passage of the central meridian when the encounter with the earth must take place, and the velocities of the particles are shown in drawing Fig. 2. This is for the case of radial emission only.

Emission may, however, be in directions other than vertical. Assume, for example, that the emission at the instant of the passage of the spot through the central meridian is 45 degrees from the vertical in the direction

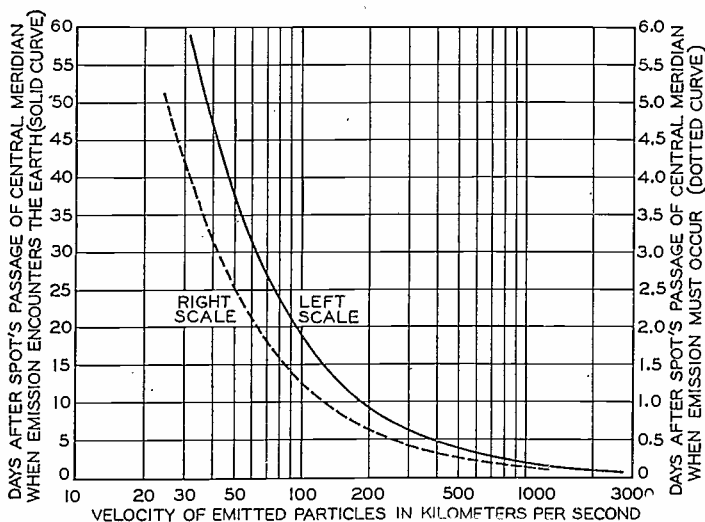

Fig. 2—Approximate relation between solar emission and encounter with the earth. Emission assumed to be radial (perpendicular to sun's surface).

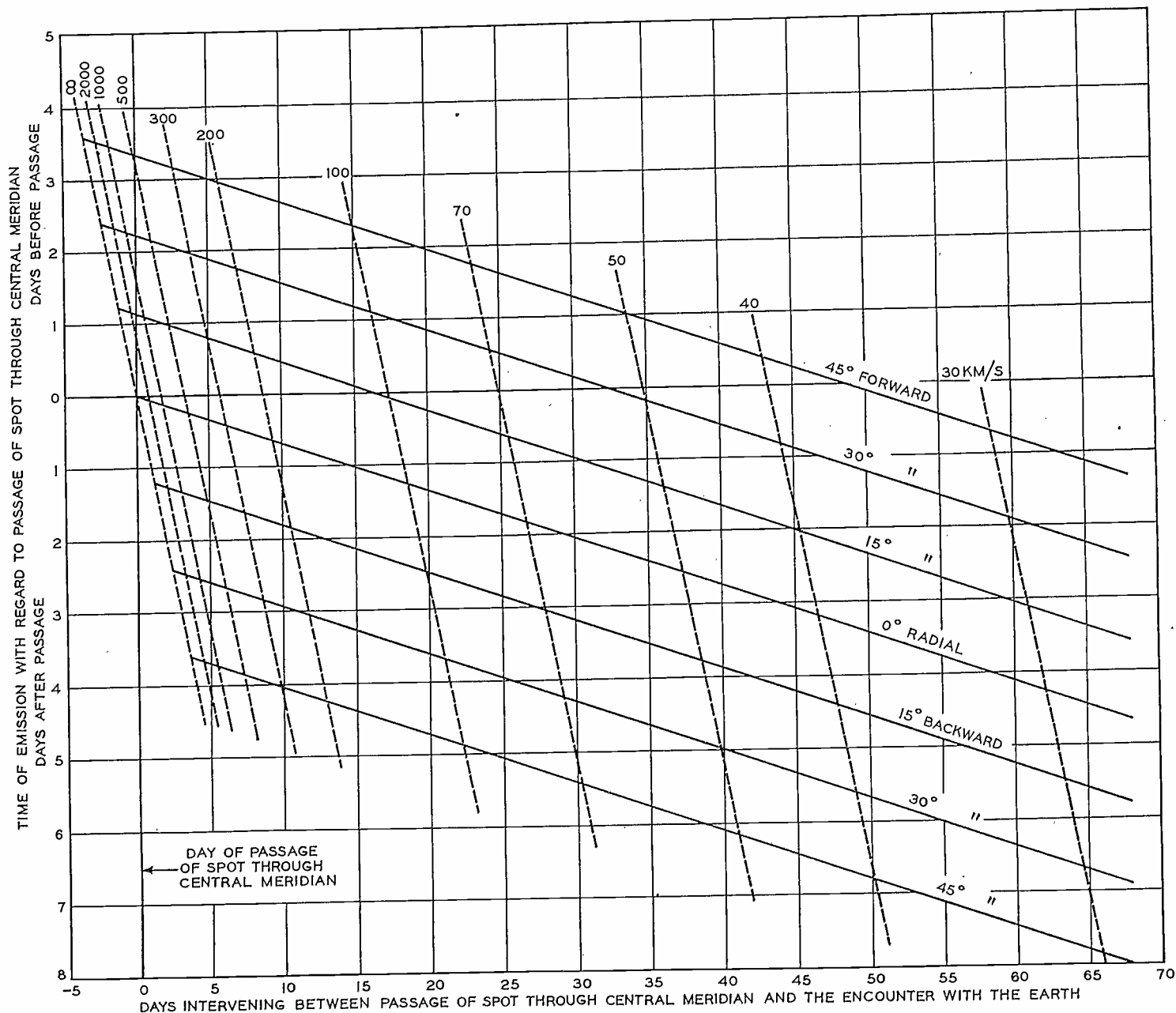

Fig. 3—Approximate relation between time of emission, velocity, and time of disturbance to reach the earth. Solid lines are for various angles of emission from the sun's surface. Dashed lines indicate the velocities of the emitted particles.

of the movement of the sunspot and consequently ahead of the earth. The number of days for the earth to reach the part of the orbit where the emission might be encountered will then be

$$T = \frac{45 \text{ degrees}}{0.985} (1.065) = 48.6 \text{ days}$$

and the velocity of the particles (radial component) would have to be about 36 kilometers per second. If, now, the sunspot at the time of emission was not on the central meridian but one day earlier, the above expression becomes

$$T = \left[ \frac{45 - (13.5 - 0.985)x}{0.985} \right] (1.065)$$

where  $x$  in this case equals 1.  $T$  will be 35 and the velocity would have to be 50 kilometers per second. The above equation can be generalized by

$$T = 1.08[\alpha - 12.51x]$$

where  $\alpha$  is the angle of emission from the perpendicular in the direction of rotation and  $x$  is the number of days prior to passing the central meridian when the emission takes place. Curves showing the above relation for various angles and for various times of emission are shown in Fig. 3. It is of interest to note that the corpuscles can reach the earth before the source crosses the central meridian but the velocity has to exceed, say, 500 kilometers per second and the direction of emission has to be away from the perpendicular in the direction of travel.

It is evident that a given position of the sunspot with respect to the central meridian and a given angle of emission immediately dictates the velocity required if the particles are to encounter the earth and also the number of days after the sunspot's passage of the central meridian when the encounter would have to take place. Or, a given angle of emission and a definite velocity requires that the emission take place with the sunspot at a definite position on the sun with respect to the central meridian in order that the emission may

encounter the earth. The angles and velocities change from hour to hour, however, so that it seems likely in the course of the week or two that the spot may be visible to the earth that the correct combination will be encountered. In fact, it is quite possible that several such combinations might occur for each spot.

#### POSSIBLE ASSOCIATIONS OF SUNSPOTS AND TERRESTRIAL DISTURBANCES

Because of the many factors which determine whether or not a given solar eruption will or will not cause a terrestrial disturbance, when it will occur, and with what intensity, it is generally very difficult to associate a given spot with a given disturbance. As long as it is impossible to tag somehow the emission as it leaves the sun, any association is, in the last analysis, speculative but, of course, some are more so than others. During periods of numerous sunspots and considerable terrestrial disturbances, it is only rarely that a given association can be stated with any assurance. In cases where both spots and disturbances are isolated as to number or intensity the uncertainty is somewhat less and an association may be assumed.

One of the severest disturbances on record occurred from May 13 to 17, 1921. Auroras were particularly brilliant and observed at very low latitudes. Grounded telegraph circuits were rendered inoperative due to excessive earth potentials which operated line protectors and broke down condensers and insulation. The

disturbance in the earth's field was so violent that the magnetometer traces were off scale for hours and the needles thrown out of balance. Radio transmission was very seriously affected.

On May 14 at 1600 G.M.T. a large sunspot group directly on the equator (area 1500 millionths of the sun's visible hemisphere) passed within about  $2\frac{1}{2}$  degrees of the center of the disk, the largest spot on the equator in the previous half century. The magnetic disturbance began, however, 27 hours earlier at which time the leading spot was  $11\frac{1}{2}$  degrees east of the central meridian and the following spot 19 degrees. The greatest intensity of the disturbance was about 0500 G.M.T. on May 15 and a second maximum occurred May 16 at 0800 G.M.T.

The May 14 sunspot group was the largest by far during 1921; on May 10 its area was about 2200. Previous medium-sized spots passed the central meridian March 27, February 8, January 15, and January 9, but there were no large spots other than the one of May 14 which could reasonably be associated with the May 13 to 17 disturbance. The velocities of the emission must have been of the order of 500 to 2000 kilometers per second.

The association of sunspots with the disturbances of January, 1924, lead to an entirely different order of magnitude for the velocities and the time intervening between the passage of the sunspot and the terrestrial effect. From December 28, 1923, to February 25, no

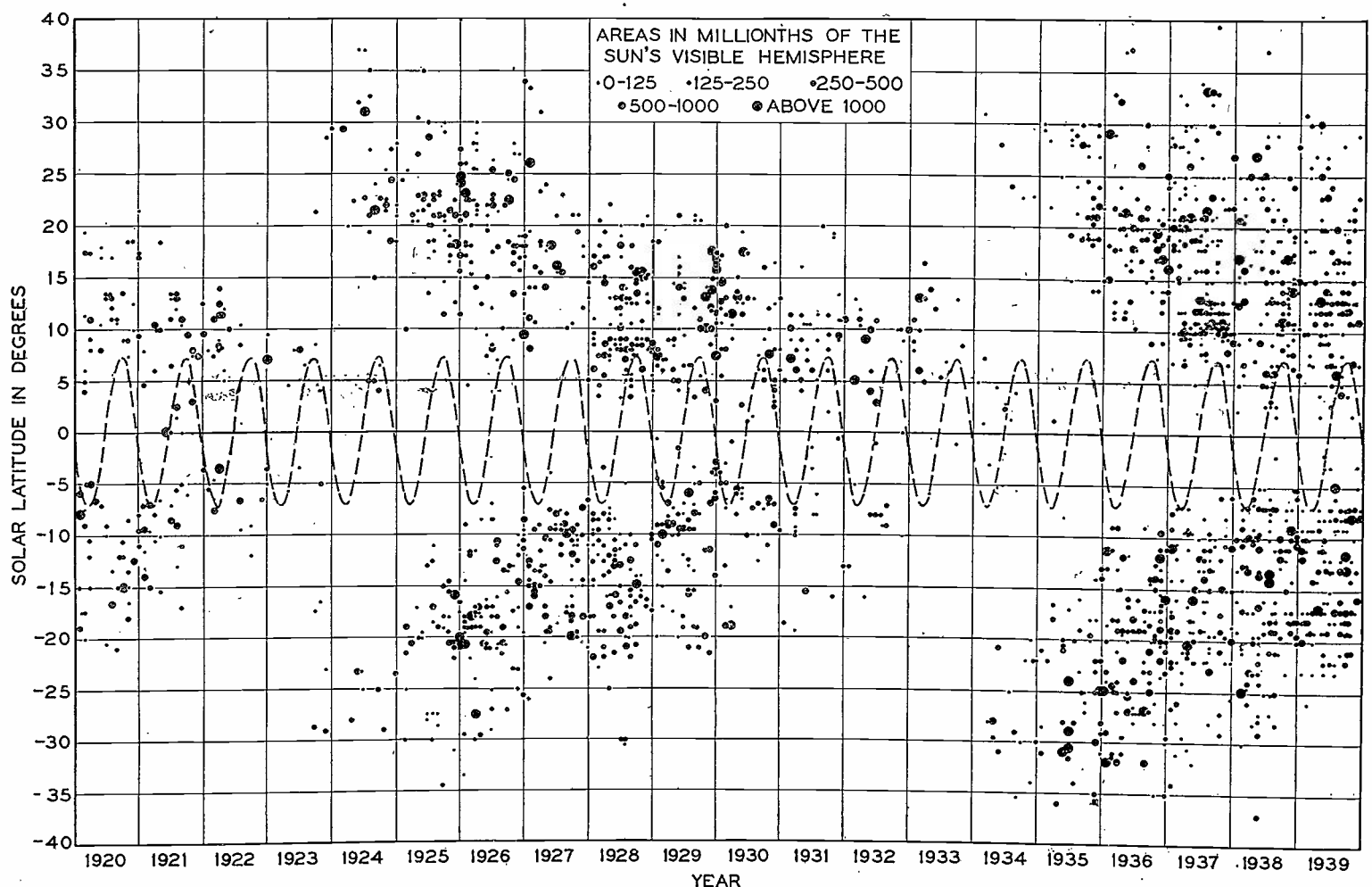

Fig. 4—Sunspot distribution. Based on reports of the United States Naval Observatory. Dashed line indicates latitude of the center of the solar disk.



sunspots were observed. Yet during this period one major disturbance (January 29) and several minor disturbances were noted (January 10 and 23 and February 5). Furthermore, the only sunspot group observed in December, 1923, was a small one (area 140) passing the central meridian on December 22 and 32 degrees from the center of the disk. In October and November, 1923, five sunspot groups passed the central meridian as follows: October 14 (area 100, distance 2 degrees), October 24 (area 310, distance 10 degrees), October 27 (area 50, distance 22 degrees), November 2 (area 290, distance 33 degrees), and November 10 (area 200, distance 25 degrees). Associating the January 10, 23, and 29 and February 5 disturbances with the sunspot groups of October 14 and 24 and November 2 and 10, respectively, the intervals in days are 88, 90, 88, and 87. With such transit times, the velocity of the emission (radial component) must have been only of the order of 20 kilometers per second.

The data for 1921 to 1939 were studied to obtain other cases where an association between sunspots and terrestrial disturbances might be indicated. The areas of the sunspot groups were taken as a measure of their activity although it was realized that area alone was not necessarily the best criterion. Consideration was given to whether the activity was increasing or decreasing and also the solar latitude of the group. The importance of the latter can be seen from the butterfly distribution pattern of Fig. 4. The sine curve with maximum amplitude of 7.25 degrees on either side of the equator represents the variation in latitude of the center of the solar disk showing how the sunspot belts swing in and out of the central zone and account for the equinoctial maxima often found in radio, magnetic, and auroral disturbances. The shape of the butterfly pattern accounts for the lag in the terrestrial disturbances evident in Fig. 1. Usually when large sunspot groups pass more than 15 degrees from the center of the disk, their effects appear to be less than might otherwise be expected. With small groups this seems to be even more restricted. Relatively few sunspots pass through or near the center of the disk so that some emission at angles from the vertical can probably be assumed. It might be mentioned, however, that if the emission occurs several days before or after the sunspot's passage through the central meridian, the angle of emission with the plane of the ecliptic is different from what might be inferred from Fig. 4.

A detailed discussion of a number of possible cases of associated sunspots and terrestrial disturbances is given in the Appendix and is summarized in Table I.

Intervals of from 27 hours before the passage of the sunspot group to 90 days after are indicated. Although most of the velocities are in the range of 20 to 60 kilometers per second, it is not felt that the distribution is significant because of the inadequacy of the sample. Admittedly speculative in varying degrees, the figures nevertheless represent the sort of answer one

obtains in trying to attribute terrestrial disturbances to specific sunspot groups. Assumption of time intervals of as much as several months between the passage of a sunspot group and the terrestrial effect seems at first hard to accept in view of customary notions.

TABLE I  
SUMMARY OF POSSIBLE ASSOCIATION BETWEEN SUNSPOT GROUPS AND TERRESTRIAL DISTURBANCES

Sunspot Passage	Disturbance	Days Intervening	Approximate Radial Velocity (kilometers per second) 1000-2000
May 14, 1921	May 13, 1921	27 hours preceding	27
July 6, 1922	September 19, 1922	70 days	25
July 22	October 5	75	26
November 10, 1922	January 20-23, 1923	71-74	23
December 4 and 7	February 25-27	82-83	22
December 28	March 24	86	90
September 4, 1923	September 26	22	22
October 14, 1923	January 10, 1924	88	21
October 24	January 23	90	22
November 2	January 29	88	22
November 10	February 5	87	22
May 14-15, 1924	May 21-22	7	260
June 5	June 10	5	360
June 12	June 19	7	260
January 18.5, 1927	April 14 or March 9 or February 9	85 49 21	23 39 90
May 11	June 26 or July 21-22	46 71	41 26
June 7.5	June 26 or July 21-22 or August 20	18 46 74	100 41 25
August 13.5	August 20	6	300
September 13.5	October 12	29	64
February 21, 1928	March 11, 1928	19	95
May 8	May 28	20	93
July 11-12	August 4-6	25	75
June 28	July 7-8	9	200
September 23.5	October 18	24	78
September 27	October 24	26	72
October 13	November 2	20	93
October 21	November 10-13	20	93
January 12, 1930	February 12-13, 1930	32	58
January 17.5	February 16	31	60
January 27	February 25	29	65
February 8	March 12	32	58
March 7	April 8	32	58
March 16.5	April 20	34	55
April 1	May 5	34	55
May 7	June 16	40	47
February 8, 1931	February 13, 1931	5	375
February 20	February 24	4	450
May 13	June 2	20	93
May 20	June 8	19	95
June 5	June 26	21	90
February 23-24, 1932	March 28, 1932	33	56
February 26	March 30	33	57
March 3.5	April 7	34	54
April 24.5	March 29	34	54
May 13	June 25	43	44
May 18	July 3	46	41
May 22	July 6	44	43
May 26	July 9	44	43
August 2	August 27	25	75
August 25	September 19	25	75
August 29	September 23	25	75
December 12, 1932	January 23, 1933	42	45
January 8-12, 1933	February 19-24	42	45
February 1 or February 7	March 18-24	45 38	42 50
February 7	May 1	82	23
March 5-6	April 17	43	44
March 27.5	May 1	34	55
October 26, 1933	January 1, 1934	67	28
February 15, 1934	March 5, 1934	18	100
June 2	July 30	40	47
July 12	August 26	45	42
July 17	September 2	47	40
August 12-14	September 24-25	43	44
September 12	October 24	42	45
September 27	November 7	41	46
October 17	December 3	47	40
November 7	December 24	47	40
November 26	December 29	33	57
June 29, 1935	July 25, 1935	26	72
August 19-20	September 11	22	85
September 4-6	September 23-25	19	100

However, velocities attained in the solar atmosphere are probably generally below the escape velocity and with anything like a normal-law distribution of velocities we should expect a maximum number of cases of very low emission velocities and only exceptional cases of very high velocities. These cases of very

high velocities would ordinarily be associated with large and violent storm centers and in turn would be responsible for the severe disturbances in terrestrial phenomena. It might be expected therefore that the intervals between very severe disturbances and the passage of the sunspots producing them will be shorter than in the case of the minor disturbances.

One disturbing aspect of the long transit times is the relatively short duration of the terrestrial disturbances. Magnetic disturbances generally last only one or two days and seem to be a function of the rate of change in the ionosphere. Short-wave radio disturbances last from a day to a week and seem to be subject more to the state of ionization (not only day to day but over the sunspot cycle as well). Long-wave radio disturbances last even longer, from one to several weeks. It is possible that there may be less mutual repulsion and scattering of the particles than one might assume; or, that the earth for the most part encounters only the outer regions of the cloud or stream. The effects of sunspots of a given area seem to be greater during the inactive periods of the sunspot cycle, which suggests that the state of the ionosphere may affect the penetration of the corpuscular emission and limit the time of the terrestrial disturbance.

In conclusion, the attempts to associate terrestrial disturbances with specific sources on the sun indicate that the transit times may be considerably longer than usually assumed. If this be the case, it may explain why sunspots are sometimes observed without concurrent terrestrial disturbances and why terrestrial disturbances sometimes occur without visible sunspots. It also indicates the difficulty of trying to forecast the occurrences of individual terrestrial disturbances.

#### APPENDIX

The bases for associating certain terrestrial disturbances with specific sunspot groups are discussed below. Areas are given in millionths of the sun's visible hemisphere and the distances are from the center of the solar disk in degrees at the time of passing the central meridian.

##### 1922

The two severest magnetic disturbances of the year occurred September 14 and October 5. For several months prior to these disturbances, there were very few spots and only two of any size that came near the central meridian, namely, July 22 (area 530, distance 11.5 degrees) and July 6 (area 190, distance 5 degrees). The time intervals between July 6 and September 14 and between July 22 and October 5 are 70 and 75 days, respectively.

##### 1923

The two outstanding disturbances during the early part of the year were those of February 25 to 27 and March 24. Both of these occurred when there were no sunspots visible and except for a little around January 20 to 25, represented the only activity during January, February, March, and part of April. A very small spot (area 20) had been visible near the center of the disk (minimum distance 17 degrees) for two days, February 14 and 15, and another spot of about the same size had been visible near the receding edge

of the disk for two days, January 29 and 30. These were the only visible spots between January 5 and the latter part of March. A very large sunspot group (area 1550, distance 10 degrees) passed the central meridian December 28, 1922. Prior to this spot, a very small spot (area 90, distance 5 degrees) and a somewhat larger spot (area 210, distance 3.5 degrees) passed the central meridian on December 7 and December 4, respectively. Prior to those was a medium-sized spot (area 440, distance 9.5 degrees) on November 10.5. If the two above-mentioned major disturbances are to be associated with visible sunspots, it is almost necessary to link the sunspot group of December 28 with the severe disturbance of March 24 (86 days intervening) and the sunspots of December 4 and 7 with the February 25 to 27 disturbance (83 and 82 days). The minor activity January 20 to 23 might be associated with the November 10 spot (71 to 74 days).

Only two small spots were visible during the period July 4 to August 31. A corresponding quiet magnetic period prevailed from about August 3 to September 26 (displaced about 30 days). At the time of the major magnetic disturbance of September 26 and 27 a sunspot group (area 315, distance 25 degrees) had been visible since September 24. Even on September 26 it was 48 degrees from the central meridian which it passed September 29, and it is doubtful if this group could possibly have been responsible for the storm. Three other spots were visible during September, namely, those passing the central meridian September 17 (area 35, distance 1.5 degrees), September 12 (area 140, distance 14.5 degrees) and September 4 (area 350, distance 36 degrees). The activity of all of these was diminishing at the time of passing the central meridian and none appear to be particularly suitable for association with the disturbance. The large group was far from the center of the disk and the ones close to the center were small. However, the next preceding sunspot group of any appreciable area passed the central meridian June 27, or 91 days prior to the disturbance. This is of the same order of magnitude as the intervals mentioned in connection with the February and March disturbances, but not consistent with the association of the undisturbed periods at the beginning of this paragraph. The association of the disturbance with the September 4 sunspot group is therefore more probable with 22 days intervening.

The severest magnetic disturbance of the year occurred June 10 and another disturbance of nearly equal severity occurred May 21 and 22. A disturbance of medium severity took place June 19. The largest sunspot group of the year (area 1400, distance 31 degrees) passed the central meridian June 5. Although rather far from the center of the disk, there is no reason for not associating it with the June 10 disturbance, 5 days later. In this case, a sunspot group (area 580, distance 19 degrees) passing the central meridian May 14 and 15 would probably be associated with the May 21 and 22 disturbance, 7 days later, and a group (area 300, distance 22 degrees) on June 12 would be associated with the June 19 disturbance, also 7 days later.

##### 1927

June was the quietest month of the year from the standpoint of the number of spots. A major-sized spot (area 956, distance 16 degrees) passed the central meridian June 7.5. This was the largest-sized spot of the year. The only magnetic disturbance in a very quiescent period from June 5 to July 17 occurred on June 26, 18.5 days after. The disturbance was only fair intensity but the next really intense disturbance did not occur before July 21 and 22 or 46 days after the passage of the June 7 spot followed by the next to the severest disturbance of the year on August 20, or 74 days later.

The severest magnetic disturbance of the year occurred October 12. Two days previous a fair-sized spot (area 278, distance 19 degrees) crossed the central meridian but otherwise the spots in October and as far back as September 14 were small and not closer than 15 degrees, from the center of the disk. On September 13.5, the fifth largest spot of the year (area 700, distance 27 degrees) passed the central meridian, 29 days before the October 12 dis-

turbance. This 29-day period following the passage of this spot was unusually quiet magnetically.

The second largest spot of the year passed the central meridian May 11. Its area on the day of passage was 340 but the next day it had developed to 911. The distance from the center of the disk was 22 degrees. Except for three minor disturbances May 20, May 28, and June 5 (9, 17, and 25 days later, respectively) the first disturbance of at least medium severity was the June 26 disturbance mentioned above, 46 days later. The first major storm was that of July 21 and 22, 71 days later.

The fourth largest spot of the year (area 804, distance 31 degrees) passed the central meridian January 18.5. The period following January 7 was very quiet magnetically even though January had five fair-sized spots (area 300 to 500) passing from 8 to 14 degrees from the center of the disk. The first ten days of February had four more. Nevertheless the first severe disturbance following January 7 did not occur before April 14, (85 days after January 19) with medium disturbances March 27, March 16, and March 9 (49 days) and minor disturbances February 24 and February 9 (21 days) intervening. The January 18 spot was of course quite far from the center of the disk and the activity was decreasing so that a severe disturbance might not be expected.

A spot crossing the central meridian August 13.5 (area 216, distance 16 degrees) developed to an area of 872 the following day. This might be responsible for second severest magnetic disturbance of the year on August 20, 6 days later.

#### 1928

1928 was characterized by two very severe magnetic disturbances, one on May 28 and one on July 7 and 8. Although two small-sized spots (area about 200 and distance 15 degrees) passed the central meridian May 27, no other spots had passed since two very small spots on May 10. A spot (area 680, distance 13 degrees; area 1000 on May 10) passed May 8, the largest in April, May and June, 20 days prior to the May 28 magnetic disturbance. Several other active spots also passed the meridian about May 8.

Regarding the disturbance July 7 and 8, two medium-sized spots (areas 525 and 580; distances 3 and 4 degrees) passed the central meridian July 11 and 12. It is not likely that these caused the July 7 and 8 disturbance as the angle of emission would have had to be very low and the velocity very high. It is more likely that these spots were the cause of the following disturbance, one of medium intensity on August 4, 5, and 6, 25 days later. Neither is it likely that the two smaller spots (areas 435 and 290) passing on July 7 were responsible for in addition to the low emission angle and high velocity required, the spots were 32 degrees from the center of the disk. A very active group passed the meridian on June 28. Although 22 degrees from the center of the disk, its area on passage was 725 increasing to about 1000 on July 3 and was probably the cause of the July 7 and 8 disturbance. Nine days intervened.

The period from September 8 to October 18 was quiet magnetically. During this period two very large sunspot groups (areas 1043 and 2300, distance 8.5 and 22 degrees) passed the central meridian on September 23.5 and 27, respectively. Twenty-four and 26 days later on October 18 and 24 occurred two severe magnetic disturbances. Although a sunspot group (area 460, distance 0 degrees) passed the central meridian October 13 and another (area 410, distance 10 degrees) passed October 21, it is believed these were responsible for minor disturbances November 2 and November 10 to 13, 20 days later in each case.

A sunspot group which had been very active (area up to 1400 on February 17) passed the meridian February 21 (area 460, distance 14.5 degrees). It was still quite active as it passed off the disk and was possibly the cause of the minor disturbance March 11 (19 days later) which ended a very quiescent period of nearly three months.

#### 1930

The largest spot of 1930 passed the central meridian January 11.5. At the time of passage its area was 731 but on January 14 the

area was reported as being 1230. Its distance from the center of the disk was 11.5 degrees. On January 12 a spot with area 516 passed within 3 degrees of the center of the disk. On January 17.5 a group with an area of 1080 (decreasing intensity) passed rather far from the center, 19.5 degrees. There were two other fair-sized spots in January and February, one on January 27 (area 384, distance 19.5 degrees) and one on February 8 (area 580, distance 12.5 degrees). All of these are mentioned as they occurred during the period January 7 to February 12 which was relatively quiet from both the radio and magnetic standpoints. If one assumes that the disturbance of nearly major intensity February 12 and 13 was due to the large spot of January 11.5 and possibly also the spot of January 12 (32 days intervening between passage and disturbance), one is led to associate the spot of January 17.5 with a secondary disturbance February 16 (31 days), the spot of January 27 with a minor disturbance February 25 (29 days), and the spot of February 8 with the major disturbance March 12 (32 days).

With regard to the March 12 disturbance it is to be noted that a large sunspot group passed the central meridian March 7 (area 780, distance 12 degrees) and another on March 16.5 (area 580, distance 18.5 degrees). Following the line of reasoning in the previous paragraph, these two spots would then be associated with disturbances April 8 (32 days) and April 20 (34 days). An April 1 group (area 580, distance 1 degree) would be associated with a May 5 storm (34 days) and a May 7 group (area 720, distance 21 degrees) would be associated with the June 16 disturbance (40 days).

#### 1931

The largest sunspot group of the year passed the central meridian on February 20 (area 1570 increasing to 2180 on February 21, distance 14 degrees). On February 8 a fair-sized group (area 430, distance 16.5 degrees) passed the central meridian. These were the only large-sized groups in January and February and none of the smaller groups were materially closer to the center of the disk. Magnetic disturbances on February 13 and February 24, though minor, were the outstanding ones during the first four months of the year. The number of days intervening between the passage of the sunspot groups and the disturbances are 5 and 4, respectively. There is, of course, the possibility that the disturbances might have been associated with two small spots January 9.5 and January 19.5 (34 and 35 days intervening, respectively) but the areas are too small to make this probable.

A number of small spots passed the sun's central meridian between July 4 and 10, a pair about August 1, and another pair about September 1. During the intervening times the spots were very very small. It was very quiet from both magnetic and radio standpoints between June 26 and July 23 and between July 28 and August 25. The time between July 4 and July 23 is 19 days and between August 1 and August 25, 24 days.

In view of the foregoing paragraph, it might be assumed that the three most severe disturbances of May and June (June 2, June 8, and June 26) were associated with the three largest spots for that period (May 13, May 20, and June 5) with intervals of 20, 19, and 21 days, respectively.

#### 1932

The largest magnetic disturbance of the year occurred May 29. The largest spot, by far, passed the central meridian April 24.5 (area 725 increasing to 900 the next day, distance 13.5 degrees). The number of days intervening is 34.5. There were five other spots between April 25 and May 29, namely, on May 13, 18, 22, and 26. The largest was that of May 22 (area 580, distance 12 degrees). The May 26 spot was 5 degrees from the equator (area 390 diminishing). It is suggested, however, that these were responsible for the disturbances, very marked in the radio, on June 25, July 3, 6, and 9 (43, 46, 44, and 44 days intervening, respectively). The association of the April 25 spot with the May 29 disturbance is further substantiated by the following paragraph.

A group of magnetic disturbances on March 28, 30, and April 7

ended a period of low activity and were the severest disturbances thus far in 1932. The radio case was in some respects even more marked although the disturbance peaks occurred 2 or 3 days later than the magnetic disturbances. The next to the largest sunspot group of the year (area 625 increasing to 725 the following day, distance 12 degrees) passed the central meridian February 26. A very small spot (area 50) was observed February 23 and 24 within about 5 degrees of the center of the disk. A larger spot (area 490, distance 18 degrees) passed the central meridian March 3.5. Prior to the February 23 spot there were no spots observed on the sun whatsoever between February 7 and February 23 except a very small spot observed February 10 and 11 close to the center of the disk. The size of the February 26 group and the two weeks of no sunspots are a reasonable explanation for the long quiet interval followed by the severe disturbance. The intervals between the three sunspots and the three disturbance peaks mentioned above are 33.5, 33, and 34.5 days.

A major magnetic disturbance (second severest of the year) occurred August 27 which ended a period of several weeks of relative quiet. Several periods of "no spots" occurred at this time of year: July 13 to 26, August 12 to 22, September 3 to 26 (except September 12, 21, and 22) and October 8 to 11. September had disturbances, with no visible spots, September 6 to 8, September 19, and September 23 to 25. The radio disturbances during these periods were quite severe but the magnetic disturbances were only of medium intensity. A reasonably good correlation is obtained if we assume the largest and most active spot at this time of year, August 2 (area 200, distance 15), to be associated with the August 27 disturbance (25 days intervening). The August 25 and 29 spots would then probably account for the September 19 and September 23 disturbances (25 days intervening in each case). The "no-spot" periods correspond with the inactive periods with this same interval.

#### 1933

Magnetically, the severest disturbance of the year was May 1. This was in the middle of a long period in which no spots were observed on the sun from practically April 3 to May 17. If this storm is to be associated with a sunspot it must be with one which had long since passed. A small spot was observed April 19 about 20 degrees from the center of the disk. The next preceding spots were two spots of areas about 90 and over 20 degrees from the center of the disk on March 5 and 6. The spot before these two was one of February 7. This was by far the largest sunspot group of the year (area February 5, 1850; February 7, 1650; distance 19.5 degrees). The time intervening between February 7 and May 1 is 82 days. It may be, however, that the May 1 disturbance was caused by one of the later sunspot groups. The April 19 spot was visible only one day and rather far from the center of the disk and is ruled out in favor of the next preceding spot which passed the central meridian March 27.5 (area 200, distance 12.5 degrees). Thirty-four days intervene between March 27.5 and May 1.

On the assumption that the May 1 disturbance was associated with the March 27 sunspot group, the large spot of February 7 mentioned above together with the spot of February 1 (area 340, distance 12 degrees) and February 5 (area 120, distance 16 degrees) may be assumed to account for the disturbance March 18 to 24 which was the most severe *radio* disturbance of the year. The number of intervening days was 45.

The spots of March 5 and 6 mentioned above were then probably associated with the disturbance centering around April 17 (43 days).

In view of previously indicated associations, the four spots passing the central meridian January 8 to 12.5 (largest area 240, distance 15 degrees) are probably associated with the disturbance February 19 to 24. The number of intervening days is 42.

A small magnetic disturbance but rather severe from the radio standpoint started January 23. A fairly large spot (area 600, distance 10 degrees) passed the central meridian December 12, 1932, 42 days previously. Except for a small spot near the western limb,

December 27 to 30, this was the only spot between December 3 and spots mentioned in the previous paragraph.

#### 1934

The greatest magnetic disturbance during the first part of the year occurred March 5 (possibly March 2 to 7). No spots were observed from about February 20 to March 8 and no spots crossed the central meridian between February 15 and March 9. The February 15 spot was really the only one observed between February 3 and March 8. It was not very large (area 150 on February 11, 75 on February 15) and rather far from the center of the disk (14.5 degrees). It was, however, the largest spot from October, 1933, to April, 1934. The time interval between February 15 and March 5 is 18 days.

A disturbance of medium intensity occurred on January 1. During November, December, and up to January 10, no sunspots were observed except on December 11 and November 24. The sunspot group on December 11 had an area of about 40 and was 20 degrees east of the center of the disk. It was only observed that one day and not in a favorable position for affecting the earth. The sunspot of November 24 was barely visible with an area of only 7 millionths of the area of visible hemisphere of the sun. It was about 25 degrees west of the center of the disk and there is a possibility (remote of course, because of its small size) that it might have affected the earth. Prior to November 24, a fairly large spot (for 1933, area 200) developed almost at the center of the solar disk on October 26 and was visible until it passed off the west edge on November 1. The time interval between October 26 and January 1 is 67 days.

One of the largest disturbances, both radio and magnetic, occurred July 30. It was preceded by a quiet period of seven weeks or more. During June and July there were really only three spots which might be associated with the disturbance, namely those of July 17 (area 85, distance 3 degrees), July 12 (area 170, distance 20 degrees) and June 20 (area 270, distance 1 degree). Of these the one passing the central meridian June 20 seems to be the most likely because of the large size and being so close to the center of the disk. The time interval between June 20 and July 30 is 40 days.

The July 12 spot might then account for a disturbance beginning August 26 (45 days) and the July 17 spot might be associated with a disturbance September 2 (47 days).

A large disturbance on September 24 and 25 occurred with no visible sunspots present and, except for one spot observed September 14, 15, and 16 just before it passed off the disk and a very small one September 12, no spots had been observed since August 18 and none had passed the central meridian since one on August 14 (area 50, distance 2.5 degrees) and one on August 12 (area 300, distance 36 degrees). The time interval between August 12 and 14 and September 24 and 25 is 43 days.

The disturbance of September 24 and 25 was followed by a quiet period up to October 24 when a disturbance of medium severity occurred. Another disturbance occurred on November 7, a major disturbance (for 1934) on December 3, a minor disturbance December 24, and a major disturbance on December 29. There are such few sunspots following August 14, that taking them as they come we have September 12, September 27, October 17, November 7, November 26, and then a few spots at the end of December. Associating the above disturbances and spots, respectively, we get intervals of 42, 41, 47, 47, and 33 days. The spots are generally small and 20 degrees or more from the center of the disk but any other pairing off is subject to the same difficulties.

#### 1935

The period from July 25 to October 15 was very quiet magnetically with the exception of a disturbance of medium intensity on September 11 and a severe disturbance from September 23 to 25. The largest spots from the first of July to late in October passed the central meridian August 19 (area 700 on August 23; minimum distance, 21 degrees) and September 4 (area 300 on September 4, 600 on September 7; distance 14 degrees). All other spots during July and August except one on August 20 (area 170, dis-

tance 12 degrees) were small and in general 25 degrees or more from the center of the disk. A spot on September 6 (area 150, distance 12 degrees) and spots on September 21 (area 100, distance 13 degrees) and September 23 (area 100, distance 18 degrees) were the only other spots in September of any size or within 20 degrees of the center of the disk. Associating the disturbance on September 11 with August 19 and 20 spots and the disturbance of September 23

to 25 with the September 4 to 6 spots the intervals are 22 days and 19 days, respectively.

The largest sunspot prior to August 19 was that of June 29 (area developed to 1000, distance 27 degrees) and might be associated with the July 25 disturbance after which there was the lull in activity preceding the September 11 disturbance. The time interval between June 29 and July 25 is 26 days.

## Some Studies in High-Frequency Atmospheric Noise at Dacca by the Warbler Method\*

S. R. KHASTGIR†, MEMBER, I.R.E., AND M. KAMESWAR RAO‡, NONMEMBER, I.R.E.

*Summary*—In this investigation the warbler method was followed in measuring the atmospheric noise at Dacca during the month of June within the range of frequencies from 250 to 1500 kilocycles. Attention was directed to (1) the study of high-frequency atmospheric noise (both day and night) as a function of frequency, and (2) the study of the diurnal characteristics of high-frequency atmospheric noise with special reference to the sunrise and sunset times.

### I. INTRODUCTION

IN THE present investigation on atmospherics carried out at Dacca, attention was directed to the measurements of high-frequency atmospheric noise expressed as a function of frequency and to the diurnal variations of the noise strengths with special references to the sunset and sunrise times. The measurements were made during the monsoon time in June, 1939, following the well-known warbler method. The frequency in these experiments ranged from 250 to 1500 kilocycles. In the work of Espenschied, Anderson, and Bailey,<sup>1</sup> a lower frequency range (15 to 55 kilocycles) was investigated.

### II. EXPERIMENTAL PROCEDURE

The frequency of a signal generator was caused to "warble" about 1000 cycles on both sides of the radio frequency by means of a motor-driven rotating condenser in parallel with its main tuning condenser. A tuned coupling unit permitted an adjustable and measured volume of artificial noise to be fed into the antenna circuit of a receiving set. With the receiver tuned to the signal generator, the artificial noise and atmospherics could be heard. The volume of the artificial noise was then adjusted until the atmospheric noise was just masked by the artificial noise. When the matching of this noise with the atmospheric noise was made, the voltage of the artificial noise was measured with a calibrated sensitive valve voltmeter. The field strength of the atmospherics was then calculated from a knowledge of this voltage.

An outdoor inverted-L aerial was employed. For the range of frequencies from 428.6 to 1500 kilocycles the

aerial was tuned by inserting a suitable coil and a variable condenser in series with it. From 250 to 428.6 kilocycles the aerial was untuned as its fundamental frequency of about 2000 kilocycles was very much higher than the operating frequency.

### III. EXPERIMENTAL RESULTS—MEASUREMENTS OF THE ATMOSPHERIC NOISE AS A FUNCTION OF THE FREQUENCY

The period of experimentation was so chosen that the number of the atmospherics heard was fairly uni-

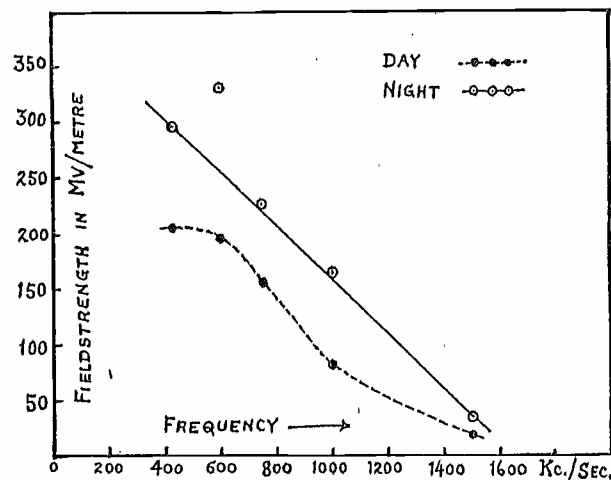

Fig. 1—Typical day- and nighttime frequency distributions of atmospheric noise as measured in South India during local thunderstorms—428.6 to 1500 kilocycles.

form and persistent. A typical set of results for daytime and night experiments are shown in Fig. 1. The frequency ranged from 428.6 to 1500 kilocycles and a tuned aerial was used. During these experiments there were local thunderstorms with lightning flashes. Two sets of results for day and night observations for the frequency range from 250 to 428.6 kilocycles are illustrated in Fig. 2. Three curves are shown in this figure: (1) field strength of the atmospheric noise against frequency, (2) field strength against the reciprocal of the square of frequency, and (3) the logarithm of field strength against frequency.

The following features are to be noted in regard to these observations:

(1) During the time of local electrical storms, the field strengths of the atmospherics received at night

\* Decimal classification: R272. Original manuscript received by the Institute, May 29, 1940.

† Dacca University, Dacca, East Bengal, India.

‡ All India Radio, Trichinopoly, South India.

<sup>1</sup> Lloyd Espenschied, C. N. Anderson, and Austin Bailey, "Transatlantic radio telephone transmission," Proc. I.R.E., vol. 14, pp. 7-56; February, 1926.



decreased almost *linearly* with an increase of frequency. This linear relation was not found to hold during the day.

(2) For distant origins of the daytime atmospheric, the field strengths varied *inversely* as the *square* of the

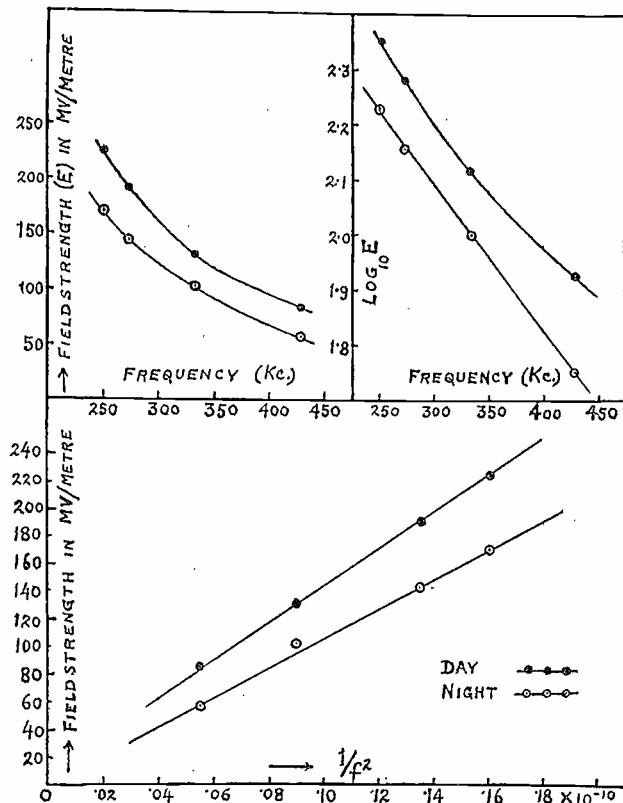

Fig. 2—Typical day- and nighttime frequency distributions of noise during local thunderstorms—250 to 428.6 kilocycles. Upper left: Field strength versus frequency. Upper right: Log of field strength versus frequency. Lower: Field strength versus reciprocal of frequency squared.

frequency. The inverse-square relation was approximate for the night observations which, however, showed an exponential decrease of field strength with an increase of frequency.

Working with still higher frequencies, Potter<sup>2</sup> previously had observed an inverse relation between the atmospheric-noise strength and the frequency during the time of local thunderstorms. The night observations of Espenschied, Anderson, and Bailey<sup>1</sup> with lower frequencies had also shown an exponential decrease of atmospheric noise.

The wave forms of the atmospheric as received in an oscillograph from different distances are now well known. The recorded wave forms of atmospheric of distant origin are somewhat similar to damped sinusoidal waves. Following Burch and Bloemsmas<sup>3</sup> in the Fourier analysis of such waves, it is evident that for frequencies much higher than the frequency of the received atmospheric waves, the amplitude of the particular term involving the frequency to which the receiving set responds is inversely proportional to the square of the

<sup>2</sup> R. K. Potter, "High-frequency atmospheric noise," PROC. I.R.E., vol. 19, pp. 1731-1765; October, 1931.

<sup>3</sup> C. R. Burch and J. Bloemsmas, "On an application of the periodogram to wireless telegraphy," *Phil. Mag.*, vol. 49, pp. 484-503; February, 1925.

frequency. Such a relation is, therefore, expected to hold for distant atmospheric if there are no disturbing agencies. Usually however, there are disturbing effects, viz., (1) the effect of different attenuation for different frequencies and (2) the effect of reflections from the ionosphere. In our experiments with frequencies from 250 to 428.6 kilocycles the attenuation could be regarded as practically constant and since, during the day, the ionospheric reflections would only contribute to a very inappreciable extent, the inverse-square relation between the field strength of the atmospheric and the frequency, as observed in our day experiments, is what is theoretically expected. During the night, however, the reflection from the ionosphere would cause a variation from the inverse-square relation. Our night observations showed an exponential decrease of field strength with an increase of frequency.

Regarding the atmospheric of near origin it is now known that the field strength abruptly rises to a peak value after which it falls extremely slowly. The expected variation of amplitude of such atmospheric with frequency could, however, be found, if Fourier analysis of such pulses could be made.

#### IV. DIURNAL VARIATION OF ATMOSPHERIC NOISE ON 600 AND 1000 KILOCYCLES

Fig. 3 shows a typical diurnal characteristic of 1000- and 600-kilocycle noise as measured on June 16, 1939. The day was clear and the diurnal characteristic could be taken as a fairly representative one for the month of

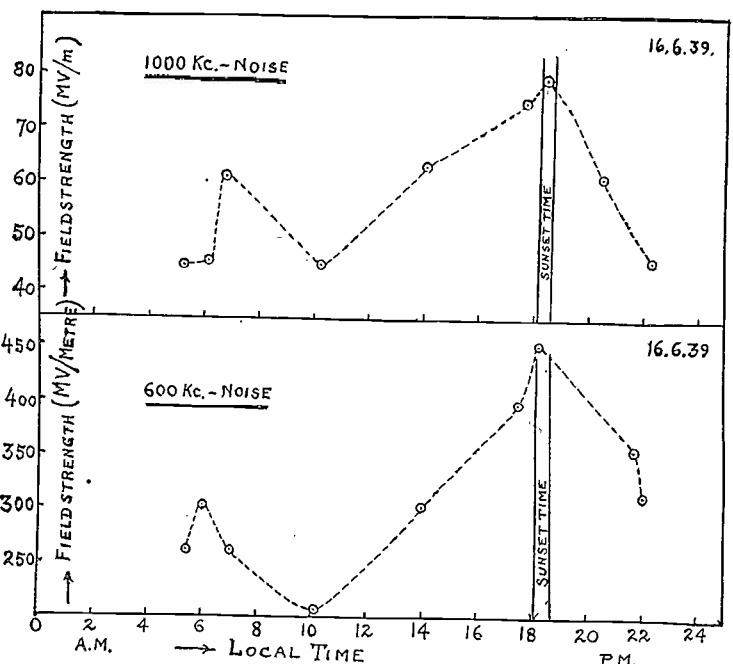

Fig. 3—Typical diurnal variation of noise field strength—1000 and 600 kilocycles.

June. Fig. 4 shows the diurnal characteristic of 600-kilocycle noise for June 19, 1939. There were thunder and lightning on that night. In Fig. 5 are shown a typical set of sunset observations.

Some of the features in the diurnal characteristics of the atmospheric noise for this time of the year are as follows:

(1) There is a definite maximum in the strength of the atmospheric noise at or immediately after the local sunset time.

(2) There is indication of a gradual rise of the atmospheric noise after local sunrise showing a small maximum an hour or two after sunrise.

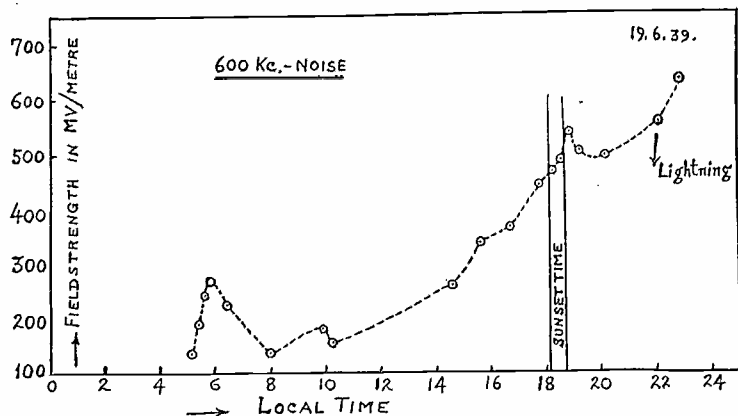

Fig. 4—Diurnal variation of noise field strength as affected by local storms.

(3) The atmospheric noise increases gradually in intensity usually from about 2 in the afternoon rising to a maximum value about the local sunset time.

The sunrise and sunset effects had been previously recorded by Espenschied, Anderson, and Bailey and also by Potter. The latter had observed in some cases a sharp decrease of the atmospheric noise immediately after sunrise followed by a maximum. Evidence of one maximum before sunrise and another after it had also been obtained by Potter. According to him the sunrise

and the sunset effects depend largely on the relative location of the source of the noise, the point of measurement, and the frequency at which measurements are made. This explanation would be valid only when the noise sources are both east and west of the reception point. When noise comes from more than one

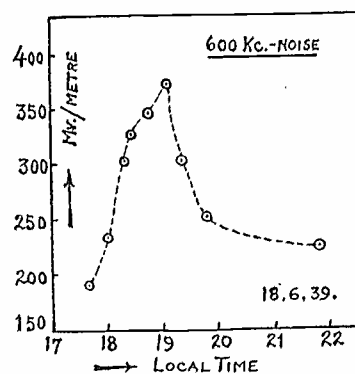

Fig. 5—Typical variation of noise on 600 kilocycles during sunset period.

direction, the sunrise and the sunset effects on the noise intensity on a nondirectional aerial become complicated. In our experiments the length of the inverted-L aerial was due east-west, so that the observed effects could partly at any rate be explained according to Potter's idea.

#### ACKNOWLEDGMENT

Our sincere thanks are due to the Head of the Physics Department of Dacca University for all the facilities provided during the course of this investigation.

## The Corner-Reflector Antenna\*

JOHN D. KRAUS†, ASSOCIATE, I.R.E.

**Summary**—A beam antenna called the corner, V, or sphenoidal reflector type is described. This antenna consists essentially of a driven radiator or dipole and a reflector constructed of two flat, conducting sheets, or their electrical equivalent, which meet at an angle forming a corner. The radiator is usually located in the plane bisecting the corner angle.

The performance of the antenna is analyzed mathematically. Gain curves are presented, showing the effect of antenna-to-corner spacing, corner angle, and losses. Computed and measured directional patterns are in good agreement. Dimensions and design data for practical corner antennas using grid-type reflectors are included.

The corner reflector is particularly suitable for use on the ultra-high frequencies and microwaves where structures 1 or 2 wavelengths in maximum over-all dimensions are practical. It is simple in construction and can be readily built to fold into a compact portable unit.

Multielement corner reflectors for higher gain and a bidirectional type for broadcast use are mentioned. The application of a single corner reflector with two off-center radiators to a radio range beacon or an airport runway localizer is discussed.

THE USE of reflecting surfaces in directional antenna systems is well known. Although a parabolic surface has generally been assumed to produce greatest directivity, it has been found that a highly effective directional system results from the use

of two flat, conducting sheets arranged to intersect at an angle, forming a corner.<sup>1,2</sup> An arrangement of this type, called a corner reflector, is shown in cross section or end view in Fig. 1(A) and in perspective in Fig. 1(B). The driven dipole or antenna is usually located in the plane bisecting the corner and at a distance  $S$  from it.

When the corner angle is 90 degrees, the reflecting sheets intersect at right angles, forming a "square-corner" reflector.<sup>1</sup> Corner angles both greater and less than 90 degrees can be used, the gain, in general, being greater for smaller corner angles.

A 180-degree "corner" is equivalent to a single flat-sheet reflector and may be considered as a limiting case of the corner reflector. A system of this kind is shown in Fig. 2(A). The ground is frequently considered to be a flat-sheet reflector in antenna problems. The application of a single flat-sheet reflector to a directional

\* Decimal classification: R325.1. Original manuscript received by the Institute, August 28, 1940. Presented in part before Fourteenth Annual Convention, New York, N. Y., September 20, 1939.

† Ann Arbor, Michigan.

<sup>1</sup> J. D. Kraus, "The square-corner reflector," *Radio*, no. 237, pp. 19-23, 75-76; March, 1939.

<sup>2</sup> J. D. Kraus, "The corner reflector," *Proc. I.R.E.*, vol. 27, p. 613, September, 1939 (Abstract).

antenna has been discussed by G. H. Brown,<sup>3</sup> who has shown that when the sheet is assumed to be a perfect conductor and infinite in extent, a gain of about 7 decibels is obtained over a comparison free-space half-wave dipole having the same power input. This is

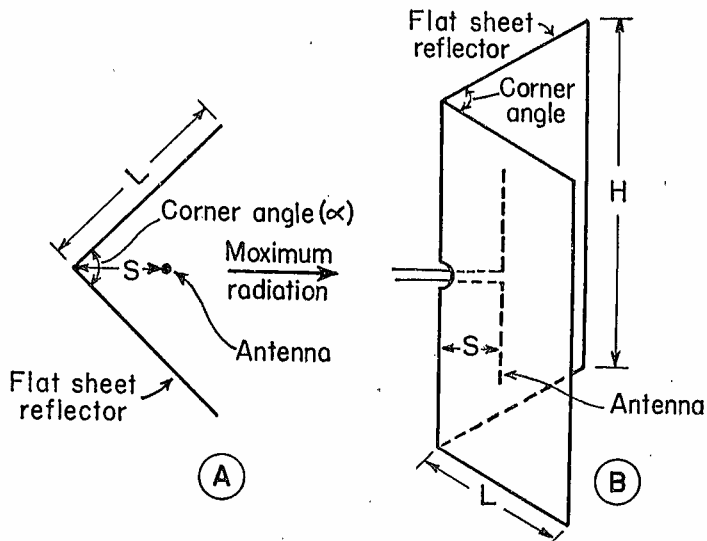

Fig. 1—Corner reflector in cross section (A) and in perspective (B).

with an antenna-to-sheet spacing of about 0.1 wavelength.

Reflectors in the form of a common cylindrical parabola with the antenna placed at the focus have often been used.<sup>4</sup> A half-wave dipole antenna with parabolic reflector is shown in cross section or end view in Fig. 2(B).

A parabolic reflector antenna is a radio application of the analogous reflector system familiar in optics. Rigorously, however, the analogy to optics holds only

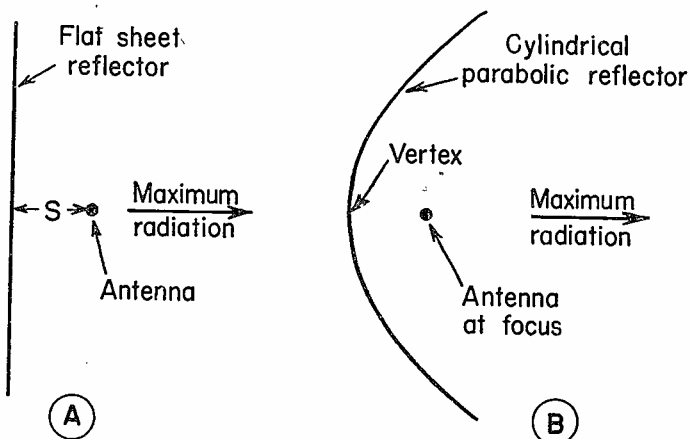

Fig. 2—Single flat-sheet reflector (A) and parabolic reflector (B).

where the distance from the vertex to the focus of the parabola is large compared to a wavelength. When the vertex-focus distance is of the same order as the operating wavelength or less, as a quarter wavelength, the analogy to optics is no longer complete since at these relatively small spacings, the antenna at the focus

<sup>3</sup> George H. Brown, "Directional antennas," *Proc. I.R.E.*, vol. 25, p. 122; January, 1937.

<sup>4</sup> A. Wheeler Nagy, "An experimental study of parasitic wire reflectors on 2.5 meters," *Proc. I.R.E.*, vol. 24, pp. 233-254; February, 1936. This paper gives experimental data of tests with parabolic reflectors. Many references to previous articles are also listed.

and the reflector are coupled by mutual impedances, which are not negligible.

The use of flat, as contrasted to curved, reflecting surfaces has been suggested for shielding a receiving antenna.<sup>5</sup> Also a few wires disposed in planes approximating a parabolic contour have been used as a reflector.<sup>6</sup> However, it had not been shown previously that a corner reflector consisting of two flat, conducting sheets, or their equivalent, constitutes a distinct type of reflector system, capable of substantial gains and possessing many unique characteristics.

It is the purpose of this article to discuss the characteristics of the corner reflector, its advantages, limitations, and a few applications. Owing to its shape, the term "corner" reflector is used in this paper, although other names such as V reflector or "sphenoidal" (wedge-shaped) reflector might also be appropriately employed.

### ANALYSIS

By assuming that the reflecting planes of a corner antenna are perfectly conducting and infinite in extent, a first approximation of the performance of the antenna can be obtained analytically in a relatively simple manner. Such an assumption may appear to be of theoretical significance only. However, it is also of practical value since measurements on corner reflectors with over-all dimensions of only a few wavelengths agree closely with the performance calculated on the above assumption.

Assuming perfectly conducting infinite planes, the method of images can be used. This method is applicable for corner angles equal to  $180^\circ/n$ , where  $n$  is any positive integer. This is a well-known fact in electrostatics.<sup>7</sup> Corners of 180 degrees (flat sheet), 90, 60, 45 degrees, etc., can be treated by this method. The performance of corner reflectors of intermediate angles can not be determined by this method but can be interpolated approximately from the others.

For a 90-degree or square-corner reflector there are three images, 2, 3, and 4, located as shown in Fig. 3(A). The dashed lines represent the corner, but in the analysis the planes forming the corner must be extended as indicated by the dotted lines. The currents in the driven dipole (1) and its three images are equal in magnitude. The currents in 1 and 4 are in-phase and 180 degrees out-of-phase with the currents in 2 and 3. All elements are assumed to be 180 degrees in electrical length. This four-element configuration is equivalent to a special case of a spatial array which has been described.<sup>8</sup>

To illustrate the method of analysis of the corner reflectors, it will be given for the case of a 90-degree or square-corner reflector. The method is similar to

<sup>5</sup> Schröter, United States Patent No. 1,830,176.

<sup>6</sup> Yagi, United States Patent No. 1,745,342.

<sup>7</sup> James Jeans, "Mathematical Theory of Electricity and Magnetism," Cambridge University Press, London, Fifth edition, p. 188.

<sup>8</sup> J. D. Kraus, "Antenna arrays with closely spaced elements," *Proc. I.R.E.*, vol. 28, pp. 76-84; February, 1940. See p. 83.

one described for the "flat-top beam" antenna,<sup>9</sup> which in turn follows one used by Brown.<sup>3</sup>

The gain of the square-corner reflector will be referred to a single 180-degree dipole in free space oper-

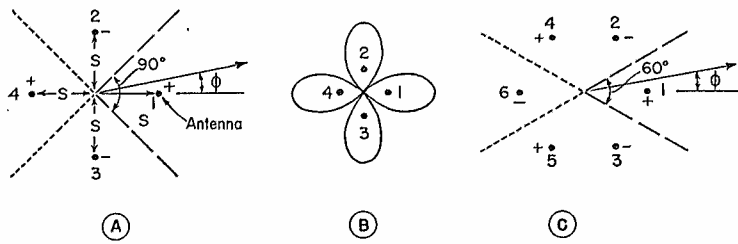

Fig. 3—Driven element with 3 image elements for analysis of square-corner reflector (A) with 4-lobed pattern of this configuration (B). Arrangement of images for 60-degree corner reflector (C).

ating with the same power input  $P$ . The field intensity from this dipole antenna at a distance  $D$  at right angles to the dipole is

$$F = k \sqrt{\frac{P}{R_{00} + R_{0L}}}, \quad (1)$$

where

- $k$  = constant involving the current distribution on the dipole, the distance  $D$ , etc.,
- $R_{00}$  = self-resistance of the dipole, and
- $R_{0L}$  = equivalent loss resistance of the dipole, measured at the current loop.

Next consider a point at a distance  $D$  in the plane at right angles to the elements used in the analysis of the square-corner reflector. The expression for the field intensity from the square-corner reflector at  $D$  in a direction making an angle  $\phi$  with the line bisecting the corner angle (see Fig. 3(A)) is,

$$F' = kI_1 2 \left| \left[ \cos(S^\circ \cos \phi) - \cos(S^\circ \sin \phi) \right] \right|, \quad (2)$$

where

- $I_1$  = current in each element,
- $S^\circ$  = spacing in electrical degrees of each element from the corner, and
- $k$  = same constant as in (1).

Continuing, we may write for the voltage  $V_1$  at the terminals (current loop) of the driven dipole or element 1,

$$V_1 = I_1 Z_{11} + I_1 Z_{1L} + I_1 Z_{14} - 2I_1 Z_{12}, \quad (3)$$

<sup>9</sup> See page 78 of footnote reference 8.

where

- $Z_{11}$  = self-impedance of element 1,
- $Z_{1L}$  = equivalent loss impedance of element 1,
- $Z_{12}$  = mutual impedance of elements 1 and 2, and
- $Z_{14}$  = mutual impedance of elements 1 and 4.

Similar expressions can be written for  $V_2$ ,  $V_3$ , and  $V_4$ . Taking the real part of the impedances and by symmetry, we obtain for the total power in all elements,

$$4P = I_1^2 4 [R_{11} + R_{1L} + R_{14} - 2R_{12}] \quad (4)$$

and for the current in each element,

$$I_1 = \sqrt{\frac{P}{R_{11} + R_{1L} + R_{14} - 2R_{12}}}. \quad (5)$$

Substituting the value of  $I_1$  as given in (5) in (2) and dividing this expression by (1) we obtain the equation for the gain in field intensity of the square-corner reflector as compared to the reference half-wave dipole as follows:

$$\text{Gain, } 90^\circ \text{ corner reflector} = \frac{F'}{F} = \sqrt{\frac{R_{00} + R_{0L}}{R_{11} + R_{1L} + R_{14} - 2R_{12}}} 2 \left| \left[ \cos(S^\circ \cos \phi) - \cos(S^\circ \sin \phi) \right] \right|. \quad (6)$$

This expression gives both the gain and directional pattern. This pattern is in the plane at right angles to the sheets of the corner reflector or the elements in the analysis. In this analysis the pattern has four lobes as indicated in Fig. 3(B). However, in the actual case when the corner is present, lobes 2, 3, and 4 are negligible and only lobe 1 is of importance.

The gain-pattern expressions for corner angles of 60 degrees, 45 degrees, etc., can be obtained in a manner similar to that given above for the 90-degree corner. For the 60-degree corner a total of 6 elements is used in the analysis, 1 radiator and 5 images as shown in Fig. 3(C). For the 45-degree corner a total of 8 elements is employed. They are numbered in the same sequence as for the 90- and 60-degree types.

Table I lists the gain-pattern expressions for corner reflectors of 45, 60, 90, and 180 degrees. By evaluating the equations of Table I, curves can be obtained giving the approximate gain for reflectors of various corner

TABLE I

Corner Angle	Number of Elements in Analysis	Gain
Degrees		
180	2	$\sqrt{\frac{R_{00} + R_{0L}}{R_{11} + R_{1L} + R_{12}}} 2 \sin(S^\circ \cos \phi)$
90	4	$\sqrt{\frac{R_{00} + R_{0L}}{R_{11} + R_{1L} - 2R_{12} + R_{14}}} 2 \left  \left[ \cos(S^\circ \cos \phi) - \cos(S^\circ \sin \phi) \right] \right $
60	6	$\sqrt{\frac{R_{00} + R_{0L}}{R_{11} + R_{1L} - 2R_{12} + 2R_{14} - R_{16}}} 2 \left  \left[ \sin(S^\circ \cos \phi) - \sin[S^\circ \cos(60^\circ - \phi)] - \sin[S^\circ \cos(60^\circ + \phi)] \right] \right $
45	8	$\sqrt{\frac{R_{00} + R_{0L}}{R_{11} + R_{1L} - 2R_{12} + 2R_{14} - 2R_{16} + R_{18}}} 2 \left  \left[ \cos(S^\circ \cos \phi) - \cos[S^\circ \cos(45^\circ - \phi)] - \cos[S^\circ \cos(45^\circ + \phi)] + \cos[S^\circ \cos(90^\circ - \phi)] \right] \right $

angles as a function of the antenna-to-corner spacing  $S$ . A set of such curves is shown in Fig. 4. The gain is given for the direction  $\theta=0$  degrees. This is the direction of the line bisecting the corner angle. For each corner angle, two curves are given. The upper curve in each case ( $0^\omega$ ) is computed for zero losses. The lower curves ( $1^\omega$ ) are for an assumed equivalent loss resistance of 1 ohm ( $R_{0L}=R_{1L}=1$ , in the equations of Table I) to illustrate the effect of loss resistance. Hence, for efficient operation it is evident from the curves that too small a spacing  $S$  should not be used.

A typical directional pattern for a square-corner reflector is shown in Fig. 5(A). With the antenna on the line bisecting the corner angle, the maximum radiation is also along this line. Patterns of this type are

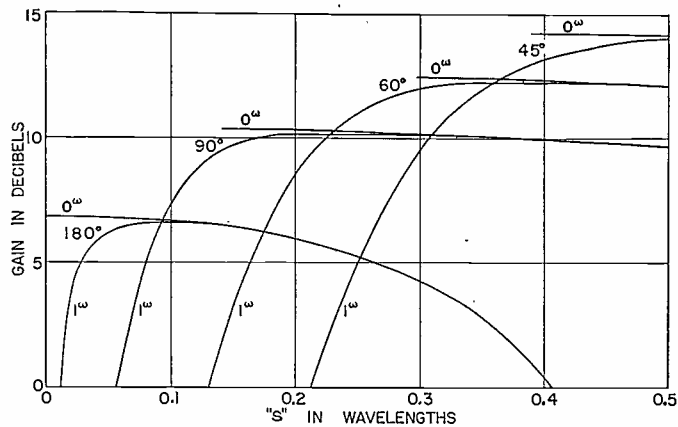

Fig. 4—Computed gain of corner reflectors over a comparison half-wave dipole in free space as a function of the antenna-to-corner spacing  $S$ . The curves ( $0^\omega$ ) are for zero assumed losses and the curves ( $1^\omega$ ) for an assumed loss resistance of 1 ohm.

obtained if the antenna-to-corner spacing  $S$  is not too large. If  $S$  exceeds a certain value, a pattern with more than one main lobe is obtained. Thus, for example, a 90-degree corner with  $S$  equal to 1 wavelength has the directional pattern shown in Fig. 5(B). There is, accordingly, an upper limit to the spacing  $S$ , which it is generally not desirable to exceed.

Thus, both a lower and an upper limit exists for the antenna-to-corner spacing  $S$ . For different types of corner reflectors, it is usually desirable that  $S$  lie between the following lower and upper limits:

Angle of Corner in Degrees	Limits of $S$
180 (flat sheet)	0.1 – 0.3 wavelength
90	0.25 – 0.7 wavelength
60	0.35 – 0.75 wavelength
45	0.5 – 1.0 wavelength

The curves of Fig. 4 show that an ideal 90-degree corner is capable of more than 10 decibels and an ideal 60-degree corner of over 12 decibels gain over the maximum radiation from a free-space half-wave antenna operating with the same power input.

In designing antenna systems, it is of value to know the radiation resistance at the terminals of the driven dipole. The radiation resistance at the current loop of a 180-degree single-conductor dipole is given in Fig. 6

as a function of the spacing  $S$  for reflectors of various corner angles.

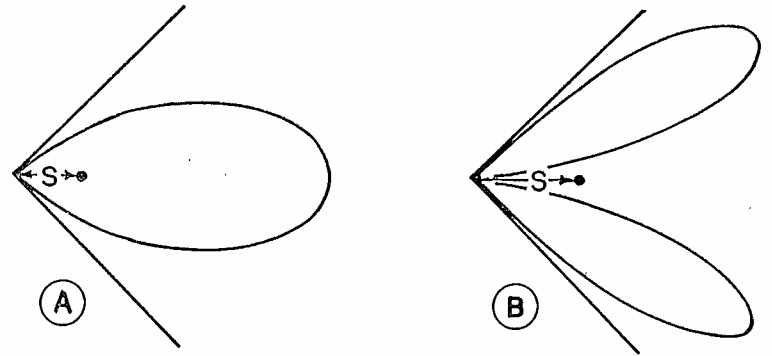

Fig. 5—Typical directional pattern for square-corner reflector (A). Double-lobed pattern obtained when  $S$  is large (B). The patterns are computed and in terms of relative field intensity.

In considering the performance of corner reflectors, a very simple approximate formula is sometimes of value. This formula may be written:

$$\text{Power Gain} = 4 \left( \frac{300^\circ}{\alpha} \right)$$

where  $\alpha$  = corner angle in degrees.

The gain is, of course referred to a single half-wave dipole in free space with the same power input.

#### TESTS

To investigate the actual performance of corner reflectors, measurements were made with corner reflectors built for operation on about 56 megacycles (5.3 meters) and about 227 megacycles (1.32 meters). In the 227-megacycle tests the antenna with the

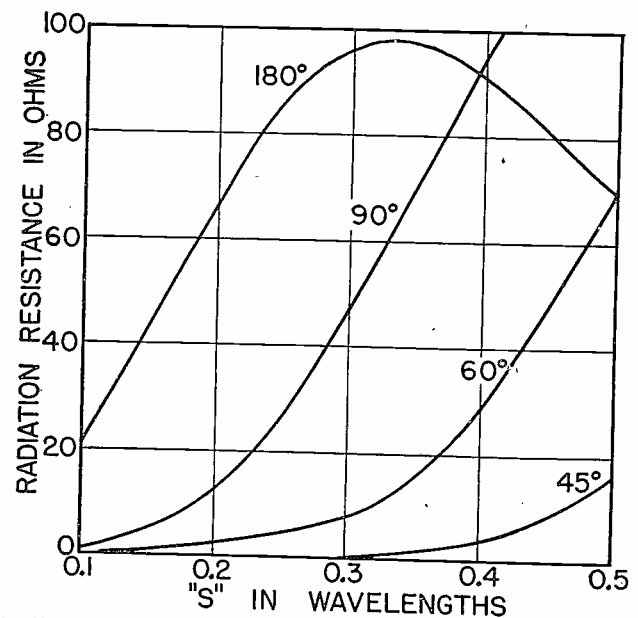

Fig. 6—Radiation resistance of driven half-wave dipole as a function of the dipole-to-corner spacing  $S$  when used with corner reflectors of various angles.

transmitter was situated on a rotatable platform. A calibrated field-intensity meter was located at a distance of about 10 wavelengths and measurements taken of the relative field intensity as the corner-reflector antenna was rotated to various positions. Vertical polarization was used.



Instead of using solid sheets as the reflecting planes, a number of parallel wires or conductors forming a gridlike structure can be employed to advantage as illustrated in Fig. 7. The length of the side is designated as  $L$ , the length of the individual reflecting conductors as  $H$ , and the spacing between conductors as

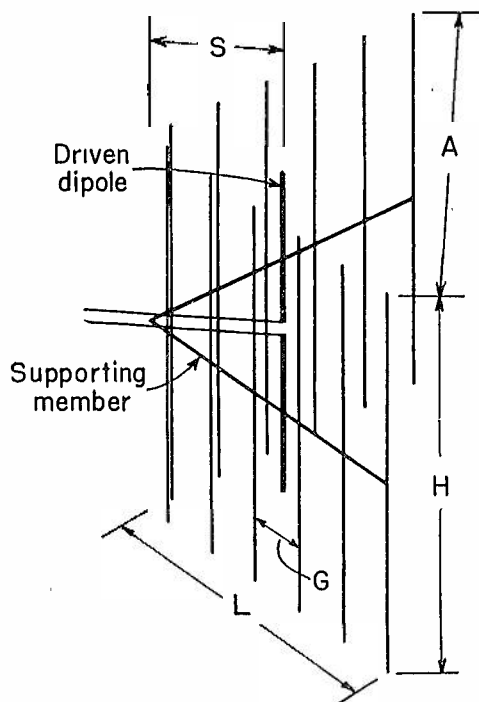

Fig. 7—Grid-type corner reflector having spaced parallel wires or conductors.

$G$ . The reflector aperture is  $A$ . The supporting member joining the mid-points of the reflector conductors may be either a conductor or an insulator.

The measured directional pattern for a 90-degree corner antenna with a grid-type reflector is shown in Fig. 8 by the solid curve. The computed pattern is shown by the dashed line and agrees well with the measured pattern. The computed pattern was, of course, obtained on the basis of perfectly conducting reflecting sheets of infinite extent. For the corner employed in the test,  $L$  was 2.3 wavelength and  $H$ , 0.94 wavelength. The spacing  $S$  was about 0.6 wavelength.

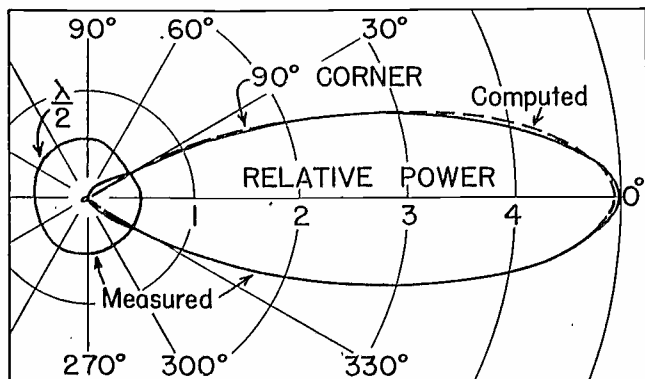

Fig. 8—Measured and computed directional patterns for a square-corner reflector, and also the pattern for a single half-wave dipole.

The parallel wires forming the grid-type reflector were insulated from each other and were spaced about 0.06 wavelength apart. When the corner reflector was removed and the driven half-wave radiator adjusted to

approximately the same power input as with the corner reflector, the approximately circular pattern shown in Fig. 8 was obtained.

The measured directional pattern for a 60-degree corner reflector is shown in Fig. 9 by the solid line. The computed curve, in this figure, is identical with the measured one. The same grid-type corner reflector was used as in the test on the 90-degree corner. The spacing  $S$  was about 0.7 wavelength.

Further tests were made on corner-reflector antennas to determine the variation in performance as a function of the reflector dimensions  $L$ ,  $H$ , and  $G$  (see Fig. 7). The aperture  $A$  of a corner reflector is, of course, directly proportional to  $L$ . The tests indicated that for a 90-degree reflector, suitable dimensions are

$$\begin{aligned} L &= 1.0 \text{ wavelength} & G &= 0.1 \text{ wavelength} \\ H &= 0.6 \text{ wavelength} & S &= 0.35 \text{ wavelength.} \end{aligned}$$

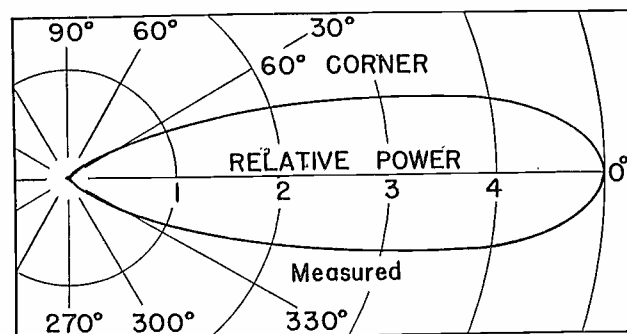

Fig. 9—Directional pattern for a 60-degree corner reflector.

None of these dimensions is at all critical. In some cases a small improvement in directivity may be obtained by making  $G$  slightly smaller and  $L$  and  $S$  slightly larger.

Since the reflecting surfaces of a corner antenna are flat, the reflector can readily be built to fold into a compact unit which is easily transported. Two views of a portable, folding-type square-corner reflector are shown in Fig. 10. One view shows the system in operating condition, while the inset shows the antenna folded for transport. The antenna is designed for operation on 600 megacycles (0.5 meter). The scale is given by the 1-foot rule. The members supporting the reflector conductors are hinged at three points, so that the reflector can be easily folded.

Tests indicate that the over-all dimensions of the 90- and 60-degree corner reflectors need not exceed about 2 wavelengths in order to obtain performance closely approaching that predicted for infinite sides. Comparisons between corner reflectors and cylindrical parabolic reflectors of comparable size indicate that the latter show no substantial improvement in directivity over the corner type. Likewise, when comparing radiating systems of 2 wavelengths or less in over-all dimensions, it appears that electromagnetic horns<sup>10-14</sup>

<sup>10</sup> W. L. Barrow and F. D. Lewis, "The sectoral electromagnetic horn," *Proc. I.R.E.*, vol. 27, pp. 41-51; January, 1939.

<sup>11</sup> W. L. Barrow and L. J. Chu, "Theory of the electromagnetic horn," *Proc. I.R.E.*, vol. 27, pp. 51-64; January, 1939.

show little improvement over corner-reflector antennas of comparable size. Whereas the action of the corner reflector can be predicted on the basis of reflection theory, Barrow<sup>10-12</sup> has shown that the concen-

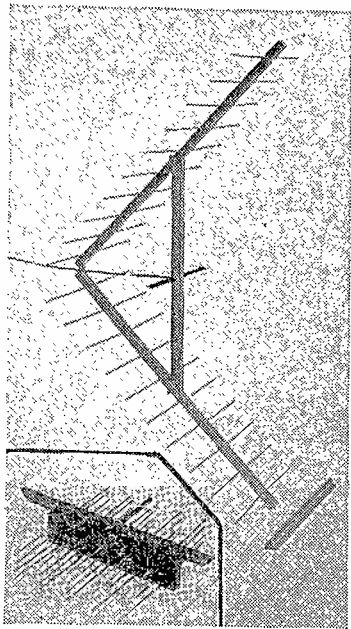

Fig. 10—Portable square-corner reflector for 600 megacycles (50 centimeters). The vertical member carries the driven dipole which is fed by the transmission line extending through the corner. The scale is given by the 1-foot rule. The inset shows the antenna folded for transport.

trating action of the electromagnetic horn is based on a guiding process.

It should be pointed out in comparing the gains of corner-reflector antennas with the gains for the horn types given by Southworth and King,<sup>13</sup> that 2.15 decibels either should be subtracted from the electromagnetic-horn gains or added to the corner-reflector gains, since the horns are referred to a spherically nondirectional radiator while the corner reflector is referred to a half-wave dipole.

#### APPLICATIONS AND SPECIAL CORNER TYPES

Corner-reflector antennas are especially suitable for point-to-point communication and radio relay links. Since the reflector dimensions are not critical as regards the frequency, the antennas are well adapted for the transmission and reception of relatively broad frequency bands, such as employed in television and wide-band frequency modulation. The frequency characteristics of a corner-reflector antenna depend largely on the particular type of driven dipole employed. The corner-reflector antenna is equally well suited for sending or receiving either vertically or horizontally polarized radiation.

<sup>12</sup> W. L. Barrow and Carl Shulman, "Multiunit electromagnetic horns," *PROC. I.R.E.*, vol. 28, pp. 130-136; March, 1940.

<sup>13</sup> G. C. Southworth and A. P. King, "Metal horns as directive receivers of ultra-short waves," *PROC. I.R.E.*, vol. 27, pp. 95-102; February, 1939.

<sup>14</sup> Grote Reber, "Electromagnetic horns," *Communications*, vol. 19, p. 13; February, 1939.

By combining several corner-reflector antennas into a multiple-unit structure, an antenna of higher gain can be obtained. Fig. 11(A) shows two 60-degree reflectors arranged side-by-side with the driven dipoles of both fed in-phase.

In radio broadcasting, a more or less uniform directional pattern in the horizontal plane is generally desired. Patterns of this kind can be obtained by employing a number of corner-reflector antennas, oriented in different directions.

A modified or bidirectional corner reflector is shown in Fig. 11(B), in cross section. For equal radiation in both directions along the bisecting plane, the driven dipole is located at the exact center of the system (point 1 in Fig. 11(B)). By moving the driven dipole slightly to the right of center, as to point 2, greater radiation is obtained to the right than to the left of the corner reflector. This feature is useful where a nonuniform directional pattern is desired. For broadcasting with horizontal polarization, a pair of such bidirectional corners are stacked and turned at right angles to each other, the driven dipoles being fed 90 degrees out-of-phase as in the familiar "turnstile" arrangement.<sup>15</sup>

An interesting property of the square-corner reflector is that when the driven dipole is displaced to one

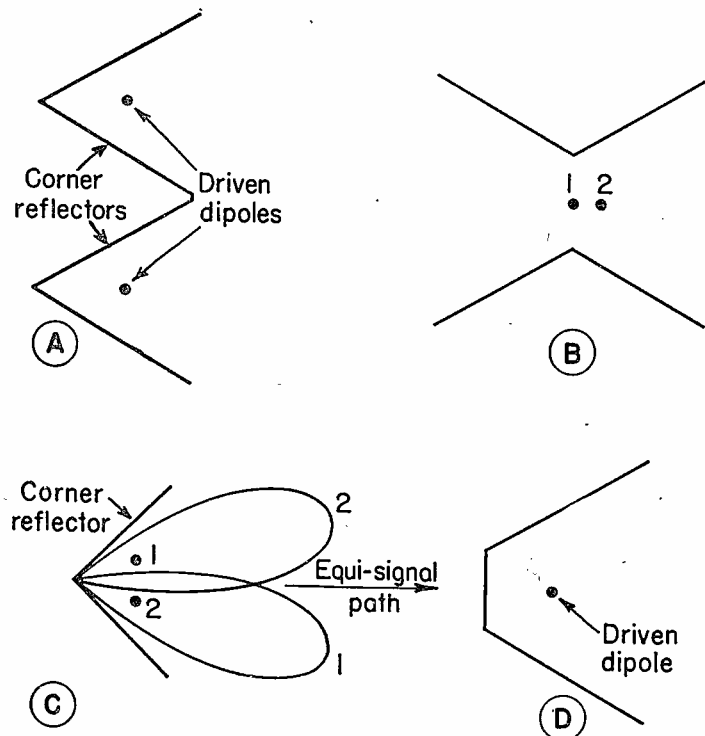

Fig. 11—Two-unit corner reflector (A) and a bidirectional type (B). Single square-corner reflector with two off-center driven dipoles producing a double beam applicable to a radio range beacon or airport runway localizer (C). Modified corner reflector with three intersecting planes (D).

side of the plane bisecting the corner angle, the maximum of the directional pattern is displaced to the opposite side. Thus, by using two suitably displaced dipoles, 1 and 2, as shown in Fig. 11(C), two directional patterns are obtained having their maxima dis-

<sup>15</sup> G. H. Brown, "The 'turnstile' antenna," *Electronics*, vol. 9, p. 14; April, 1936.

placed to opposite sides of the bisecting plane. Possible applications of this arrangement are to a single-course radio range beacon or an airport runway localizer. With equal power input to both dipoles, dipole 1 produces pattern 1 and dipole 2, pattern 2. Under these conditions, any point on the bisecting plane of the corner angle receives equal field intensity from dipoles 1 and 2. This plane forms, then, an equisignal path for guiding the airplane, in the same manner as in systems employing the well-known principle of double modulation and overlapping directional patterns. By varying the positions of the driven dipoles within the reflector, the separation of the two beams and also the direction of the equisignal plane can be controlled, while maintaining the power input to both dipoles constant. Making the power input to the two dipoles unequal would, of course, also change the direction of the equisignal plane.

For the radio range beacon or runway localizer using a single corner reflector and two off-center dipoles, vertical polarization would be employed. If horizontal polarization is desired, two corner-reflector antennas each with a single driven dipole are required.

Fig. 11(D) shows the cross-section view of a modified corner-reflector antenna. Instead of extending the two reflecting sides of a 60-degree corner to their point of

intersection, the reflector structure is shortened through the use of a third reflecting plane as shown.

#### CONCLUSION

Important features of the corner reflector may be summarized as follows:

(1) The corner-reflector antenna provides an effective directional system on frequencies where structures of 1 or 2 wavelengths over-all dimension are practical to build.

(2) The dimensions are not critical. There is no "focus" point for the driven dipole and the action of the reflector is not critical as to frequency.

(3) The radiation resistance of the driven dipole can be varied by adjusting the antenna-to-corner spacing.

(4) The gain and directional pattern can be changed by varying the corner angle.

(5) The flat sides are simple to construct and can be made to fold into a small, portable unit.

(6) Parabolic reflectors and electromagnetic-horn radiators provide little or no improvement over corner reflectors of comparable size.

(7) The gain of the antenna, directional pattern, radiation resistance of the driven dipole, and the effect of losses are readily computed to a first-order approximation.

## The Characteristics of the Negative-Resistance Magnetron Oscillator\*

HSU CHANG†, ASSOCIATE, I.R.E., AND E. L. CHAFFEE†, FELLOW, I.R.E.

*Summary*—This paper describes new methods of determining the characteristics of a split-plate negative-resistance magnetron oscillator from static characteristic curves and by 60-cycle experimental tests. The performance charts are presented in the form of contour diagrams and optimum curves. Verification at a wavelength of 5 meters is outlined.

THE magnetron is a vacuum tube having a cylindrical plate and coaxial filament, with a magnetic field parallel to the electrode axis.<sup>1</sup> The plate is usually split axially into two semicircular cylinders, in which case it is called the split-plate magnetron. Such a magnetron stands out as one of the most promising tubes in generating ultra-high-frequency oscillations.

One type of the oscillations depends on the existence of a static negative resistance between the two plates.<sup>2</sup> The two plates are connected to the external circuit as shown in Fig. 1. The magnetic field strength is made greater than the critical value where the electrons just

graze the plate and return to the filament. The oscillation period is essentially determined by the natural period of the external circuit. The electron transit time should be kept one tenth or less of the oscillation period in order to obtain good efficiency.

These negative-resistance magnetron oscillators are of importance because they are capable of generating oscillations with large power output and high efficiency. They are particularly useful in the range of wavelengths extending roughly from 5 meters to 30 centimeters. It has been reported<sup>3,4</sup> that air-cooled tubes of this type are capable of generating power of the order of 50 watts at a wavelength of 50 centimeters, and water-cooled tubes can deliver an output of more than 450 watts with an efficiency between 40 and 60 per cent.

It is possible to analyze the operation of the split-plate magnetron by the same methods used for the conventional triode power tube. The performance can

\* Decimal classification: R253. Original manuscript received by the Institute, June 24, 1940.

† Cruft Laboratory, Harvard University, Cambridge, Massachusetts.

<sup>1</sup> Hull, "The effect of a uniform magnetic field on the motion of electrons between coaxial cylinders," *Phys. Rev.*, vol. 18, pp. 31-57; July, 1921.

<sup>2</sup> Habann, "A new vacuum-tube generator," *Zeit. Hochfrequenz.*, vol. 24, p. 115, 1924.

<sup>3</sup> Pfetscher and Puhlmann, "Habann generators of high power for ultra-short waves," *Hochfrequenz. Elek.*, vol. 47, pp. 105-115; April, 1936.

<sup>4</sup> Kilgore, "The magnetron as high-frequency generator," *Jour. App. Phys.*, vol. 8, pp. 666-676; October, 1937.

be calculated from the static characteristic curves, or the operating characteristics can be obtained by measurements at a frequency of 60 cycles. Contour diagrams can then be plotted. The purpose of this paper is to illustrate the application of these methods.

The static characteristics can be obtained in direct current by the point-by-point method. A number of papers<sup>3-23</sup> dealing with this phase of the test have been

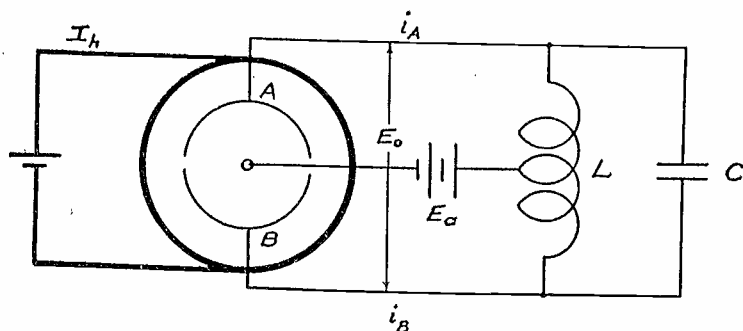

Fig. 1—Fundamental circuit of the magnetron oscillator.

published. The currents to the two plates are measured when the potential on one of the plates is increased by small increments and the potential on the other plate is decreased simultaneously by the same increments, so as to simulate the conditions during oscillation. The sum and difference of the currents of the two plates

<sup>5</sup> Megaw, "An investigation of the magnetron short-wave oscillator," *Jour. I.E.E.* (London), vol. 8, pp. 72-94, 1933.

<sup>6</sup> Ponte, "Use of magnetic fields for the production of ultra-short waves," *L'Onde Elec.*, vol. 13, pp. 493-523; December, 1934.

<sup>7</sup> Slutzkin, "Theory of split-anode magnetron," *Phys. Zeit. der Sow.*, vol. 6, pp. 280-292; 1934.

<sup>8</sup> Muller, "Theory of split-anode magnetron oscillator," *Elek. Nach. Tech.*, vol. 12, pp. 131-142; May, 1935.

<sup>9</sup> Grunberg and Lukoschkow, "Theory of split-anode magnetron," *Tech. Phys. (U.S.S.R.)*, p. 482, 1935.

<sup>10</sup> Bovscheverov, "Split-anode magnetron characteristics," *Tech. Phys. (USSR)*, p. 567; 1935.

<sup>11</sup> Fritz, "Generation of oscillations with the Habann tube," *Hochfrequenz. Elek.*, vol. 46, pp. 16-22; July, 1935.

<sup>12</sup> G. R. Kilgore, "Magnetron oscillators for the generation of frequencies between 300 and 600 megacycles," *PROC. I.R.E.*, vol. 24, pp. 1140-1157; August, 1936.

<sup>13</sup> Gill and Britton, "The action of a split-anode magnetron," *Jour. I.E.E.* (London), vol. 11, pp. 127-134, 1936.

<sup>14</sup> Megaw, "Magnetron valves for ultra-short wavelengths," *Gen. Elec. Journ.*, p. 94, May, 1936.

<sup>15</sup> Herriger and Hulster, "Oscillations of magnetic-field valves and their elucidation," *Telefunken Röhre*, vol. 7, pp. 71-93; July, 1936.

<sup>16</sup> Carrara, "Micro waves, electronic theory of valves for the highest frequencies, micro-wave generators," *Alta Freq.* p. 691, November, 1936.

<sup>17</sup> Brenev, "On the calculation and geometrical construction of the static characteristics of a split-anode magnetron; an investigation of the magnetron oscillator on the basis of its static characteristics," *Jour. Tech. Phys. (USSR)*, vol. 6, p. 302 and p. 677, 1936.

<sup>18</sup> Dudnik, "On the design calculations of a magnetron from energy considerations," *Izvestiya Elektroprom Slab Toka*, p. 11, 1936.

<sup>19</sup> Zuhrt, "Magnetron characteristics," *Hochfrequenz. Elek.*, vol. 49, pp. 23-25; January, 1937.

<sup>20</sup> Gundlach, "Habann valve and its uses for generation of decimeter waves," *Elek. Tech. Zeit.*, vol. 58, pp. 653-658; June, 1937.

<sup>21</sup> Lerbs and Lammachen, "Static characteristic curves of the Habann valves," *Hochfrequenz. Elek.*, vol. 51, pp. 60-66; February, 1938.

<sup>22</sup> Gundlach, "The behavior of the Habann valve as a negative resistance," *Elek. Nach. Tech.*, vol. 15, pp. 183-200; June, 1938

<sup>23</sup> Harvey, "Output and efficiency of the split-anode magnetron oscillating in the dynatron regime," *Jour. I.R.E.* (London), p. 863, June, 1939.

are then plotted against the difference of potential, as shown in Fig. 2. It is obvious that in a certain portion of the curve, more current flows to the plate of lower potential, resulting in a negative resistance which is responsible for generating oscillations. From such static curves, the performance of the oscillator can be calculated.

Power input,  $P_{in} = E_a I_{av}$

power output,  $P_{out} = -\frac{1}{2T} \int_0^T (i_A - i_B) E_0 \sin \omega t dt$   
 $= \frac{E_0 I_{m1}}{4}$

efficiency,  $\eta = \frac{P_{out}}{P_{in}}$

load resistance,  $R_b = \frac{E_0^2}{2P_{out}}$

where  $E_a$  is the direct plate voltage,  $E_0$  is the difference of potentials on the two plates and is the oscillation amplitude,  $I_{av}$  is the average value of the sum current  $i_A + i_B$ , and  $I_{m1}$  is the amplitude of the fundamental component of the difference current  $i_A - i_B$ . Both  $I_{av}$  and  $I_{m1}$  can be obtained from the static characteristic curves by means of an harmonic analysis method.<sup>24</sup>

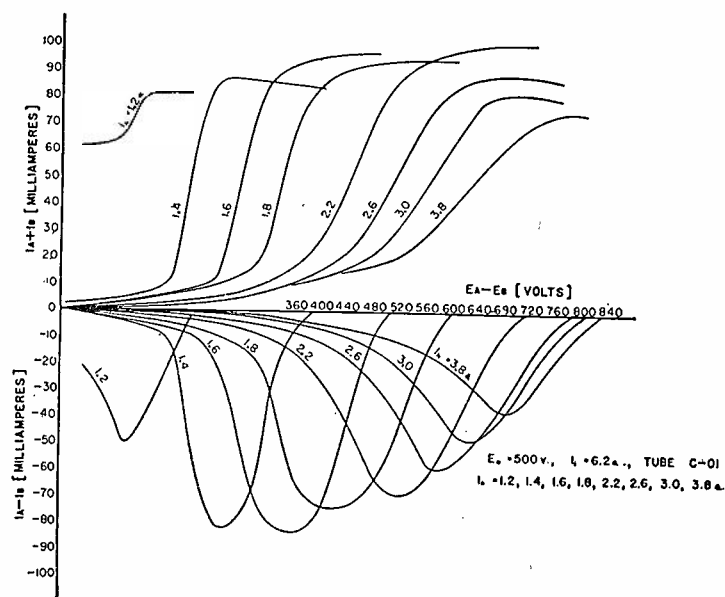

Fig. 2—Static characteristic curves.

These performances can also be obtained directly by experimental tests using voltages of low frequency such as 60 cycles per second from the regular power source. This 60-cycle method had been used in testing the conventional power tubes.<sup>25,26</sup> The application to the magnetron is made possible for two reasons. First, the negative-resistance oscillator is operated at a fre-

<sup>24</sup> Chaffee, "A simplified harmonic analysis," *Rev. Sci. Instr.*, vol. 7, pp. 384-389; October, 1936.

<sup>25</sup> Chaffee and Kimball, "A method of determining the operating characteristics of a power oscillator," *Jour. Frank. Inst.*, vol. 221, pp. 237-250; February, 1936.

<sup>26</sup> Chaffee, "The operating characteristics of power tubes," *Jour. App. Phys.*, vol. 9, pp. 471-482; July, 1938.

quency such that the electron transit time is less than one tenth of the oscillation period. Second, the alternating plate potential is sinusoidal and the instantaneous potentials on the two plates are exactly 180

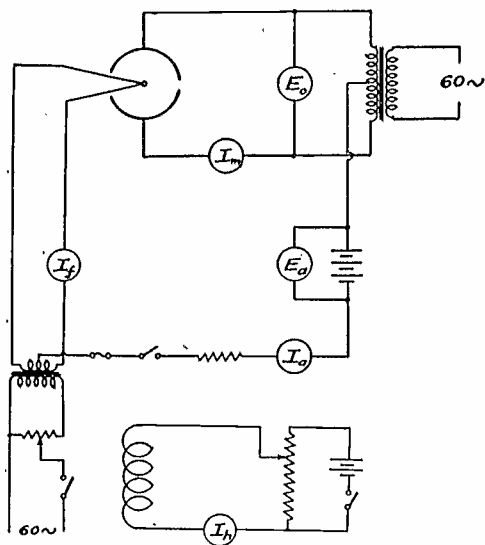

Fig. 3—Schematic of the 60-cycle method.

degrees out of phase. The experimental arrangement is shown in Fig. 3. It consists of one power transformer, with the secondary winding connected to the two plates and with the center tap of the secondary connected to the filament through a direct-current plate supply. The alternating plate voltage is measured at  $E_0$  by an electrostatic voltmeter. The fundamental component of the alternating plate current is measured at  $I_m$  by a wave analyzer tuned to 60 cycles. The power output of the tested oscillator is the product of the alternating plate voltage and the fundamental com-

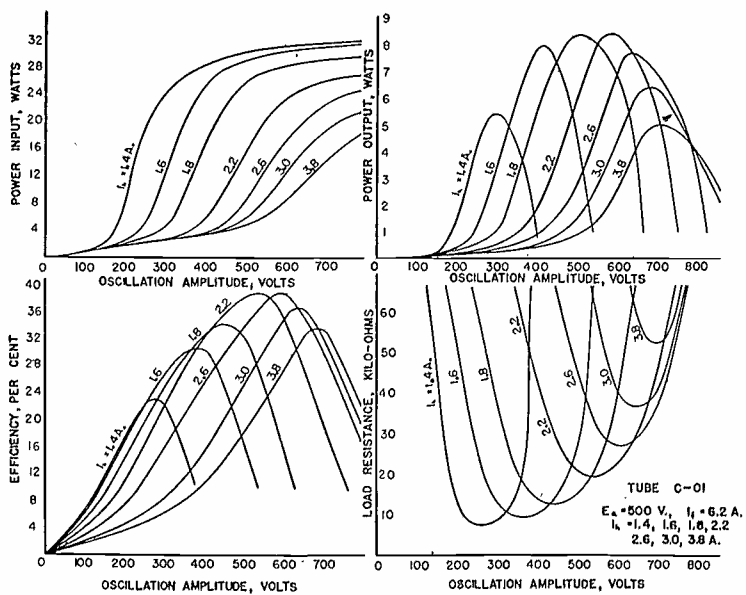

Fig. 4—Intermediate curves of power input, power output, efficiency, and load resistance.

ponent of the alternating plate current. While this 60-cycle method is much more flexible in operation, less laborious in calculation, and more economical in time than calculation from static characteristics, it has been shown that consistent and good accuracy is found in both methods.

The performances, such as power input, power out-

put, efficiency, and load resistance, can be plotted as intermediate curves, against the oscillation amplitude, at various magnetic field strengths and plate voltages. One typical set of these curves is shown in Fig. 4. A further step is to analyze these performances by the use of contour diagrams.<sup>26</sup> There are a great number of

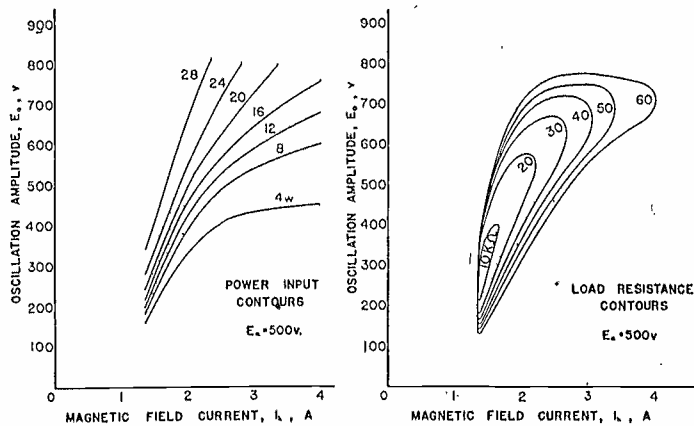

Fig. 5—Contour diagrams, power input, and load resistance.

contour diagrams which may be plotted for the magnetron oscillator, including power-input contours, power-output contours, efficiency contours, load-resistance contours, and many others. Typical sets are shown in Figs. 5 and 6. They are plotted on the oscillation-amplitude—magnetic-field-current plane at a certain value of plate voltage. It is obvious that there are definite sets of values of oscillation amplitude and magnetic-field current at which the power output is a maximum, efficiency is a maximum, and load resistance is a minimum. These occurrences of the maxima and minimum are similar although not exactly coincident with each other. It is also seen that there are two values of oscillation amplitude giving the same power output,

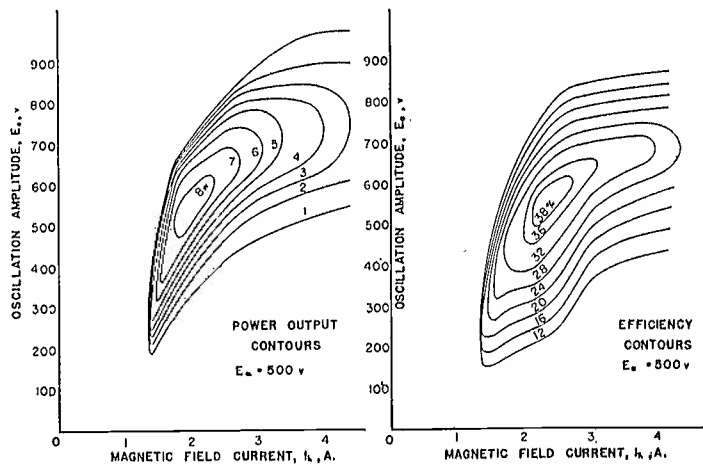

Fig. 6—Contour diagrams, power output, and efficiency.

efficiency, or load resistance, at certain values of magnetic-field current. Only one of these two values represents stable operation. It is further noted that the contours do not extend below certain values of the magnetic-field current. This is the critical value at which the electrons just graze the plate, and no oscillations can be generated for magnetic-field strengths less than this value.

Similarly these contours can be plotted on the oscillation-amplitude—plate-voltage plane at a certain



value of magnetic-field current. These two groups of contour diagrams can be combined to form a three-dimensional contour diagram, with oscillation amplitude, plate voltage, and magnetic-field current as co-

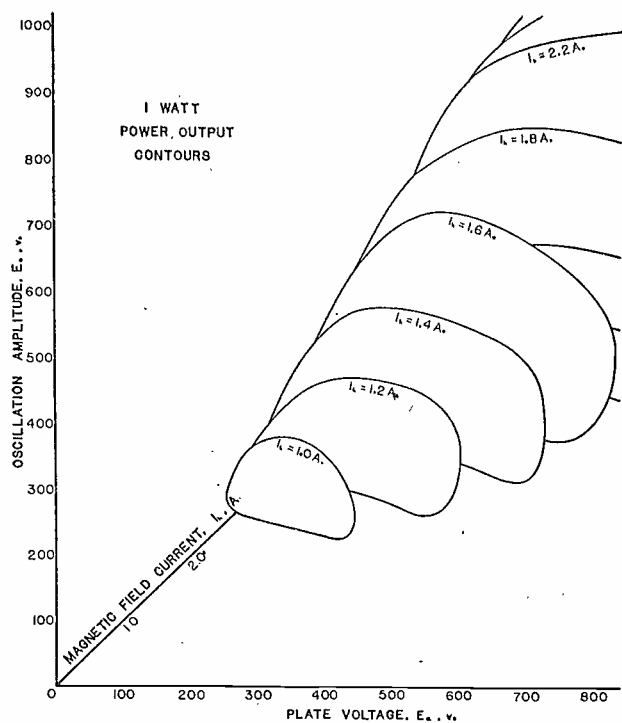

Fig. 7—Three-dimensional contour diagram of power output.

ordinates. One typical three-dimensional contour diagram is shown in Fig. 7 for a particular value of power output.

The main application of these contour diagrams is to select or locate the best operating conditions for best performance. There is a definite value of oscillation amplitude at which the power output is a maximum for each value of the magnetic-field current.

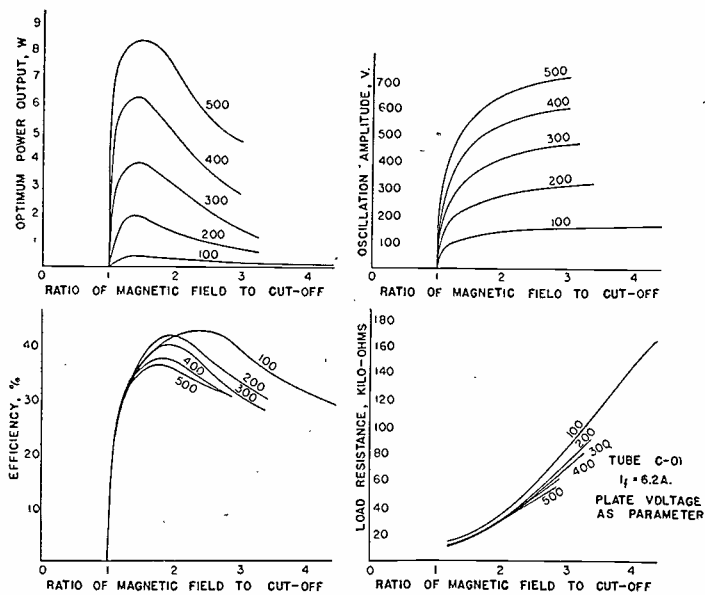

Fig. 8—Maximum power output versus ratio of magnetic-field current to cutoff value.

These maximum conditions can then be plotted against the ratio of magnetic-field current to the cutoff value, as shown in Fig. 8. There is a definite value of magnetic-field current at which the power output is optimum. These optimum values of power output and efficiency

vary as the plate voltage varies. They are finally plotted against the plate voltage, as shown in Fig. 9.

The following general statements express the results of this analysis. (a) The optimum power output bears a parabolic relation to the plate voltage. (b) The optimum efficiency decreases slightly as the plate voltage increases. (c) The magnetic-field strength for optimum power output or optimum efficiency bears a linear relation to the plate voltage within a certain range. (d) The ratio of the magnetic-field strength to the cutoff value is approximately 1.5 for optimum power output, and is substantially independent of the plate voltage. (e) The load resistance for optimum power output does not change very much with respect to the plate voltage. (f) The oscillation amplitude for optimum power output and efficiency bears a linear relation to the plate voltage.

These conclusions are based on the results obtained with a particular tube which has the following dimen-

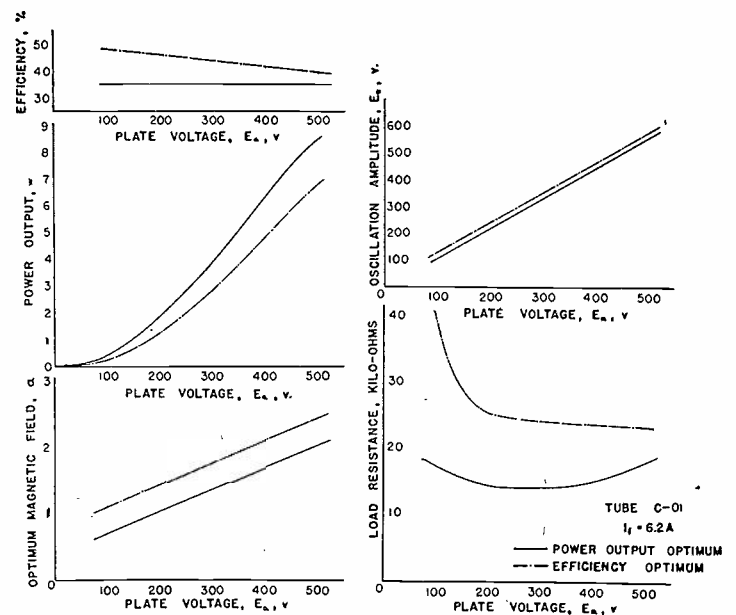

Fig. 9—Optimum power output and efficiency versus plate voltage.

sions: filament, tungsten, diameter 10 mils, length 2 inches; plate, molybdenum, diameter  $\frac{1}{2}$  inch, gap width  $\frac{1}{8}$  inch, length  $2\frac{1}{2}$  inches, lead spacing  $1\frac{1}{2}$  inches. With tubes of different construction, the results may be different. For example, the efficiency is found to decrease slightly as the plate voltage increases in this experiment and is similarly reported in another paper.<sup>23</sup> This is contradictory to that reported by some others.<sup>3</sup>

The effect of the magnetic-field distribution on the performance has been investigated. The magnetic-field coils used in this experiment are of air core. They are so mounted that the magnetic-field axis can be readily tilted in any angle with respect to the tube-electrode axis. They are arranged in Helmholtz form so that the magnetic-field strength is extremely uniform in the central portion of the coil axis, but decreases toward the two ends. When the tube is moved longitudinally along the coil axis toward the end, the uniformity of the magnetic-field strength along the tube plate is impaired. It is found that both these two effects, tilted field and nonuniform field, reduce the power output

and efficiency. The tilted field, while essential to transit-time oscillations, is not helpful to the generation of negative-resistance oscillations. The nonuniform field, however, helps to improve the linearity of modulation.

The magnetron was operated in actual oscillation at a wavelength around 5 meters. The relation between

the plate voltage and magnetic-field current for optimum power output at a wavelength of 5.7 meters was in good agreement with that obtained by the static characteristic method and the 60-cycle method. It was also demonstrated that linear modulation cannot be obtained by varying either the plate voltage or the magnetic-field current alone.

# The Ionosphere and Radio Transmission, October, 1940, with Predictions for January, 1941\*

NATIONAL BUREAU OF STANDARDS, WASHINGTON, D. C.

**A**VERAGE critical frequencies and virtual heights of the ionospheric layers as observed at Washington, D. C., during October are given in Fig. 1. Critical frequencies for each day of the month are given in Fig. 2. Fig. 3 gives the October average

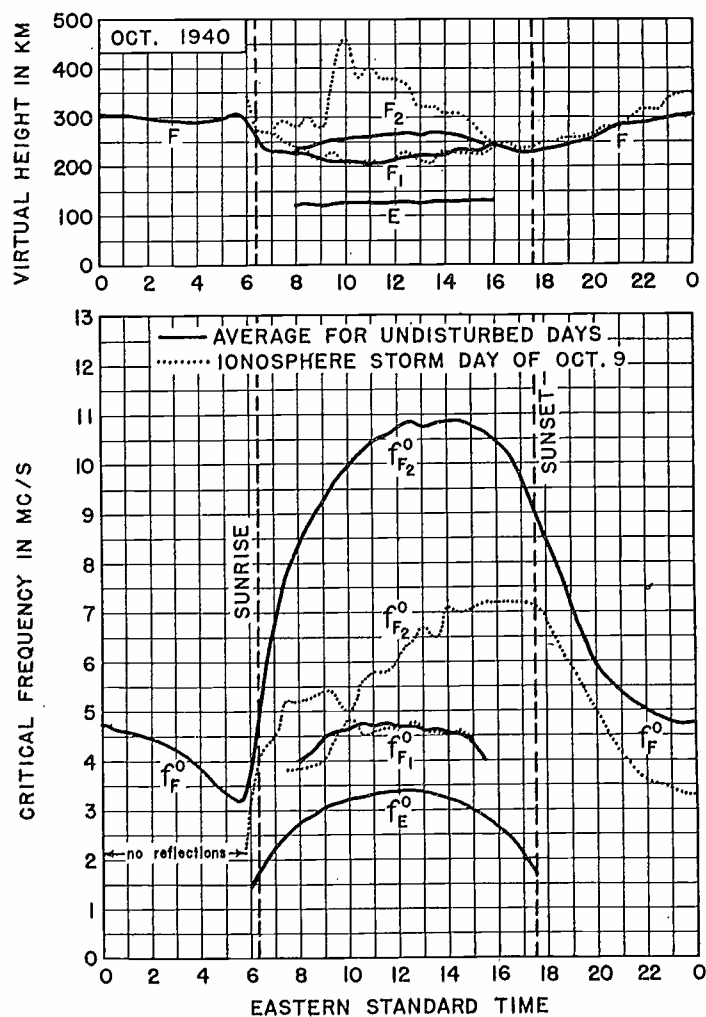

Fig. 1.—Virtual heights and critical frequencies of the ionospheric layers, observed at Washington, D.C., October, 1940.

values of maximum usable frequencies, for undisturbed days, for radio transmission by way of the regular layers. The maximum usable frequencies were

\* Decimal classification: R113.61. Original manuscript received by the Institute, November 12, 1940. These reports have appeared monthly in the PROCEEDINGS starting in vol. 25, September, 1937. See also vol. 25, pp. 823-840; July, 1937. Publication approved by the Director of the National Bureau of Standards of the U. S. Department of Commerce. Report prepared by N. Smith, A. S. Taylor, and F. R. Gracely of the National Bureau of Standards.

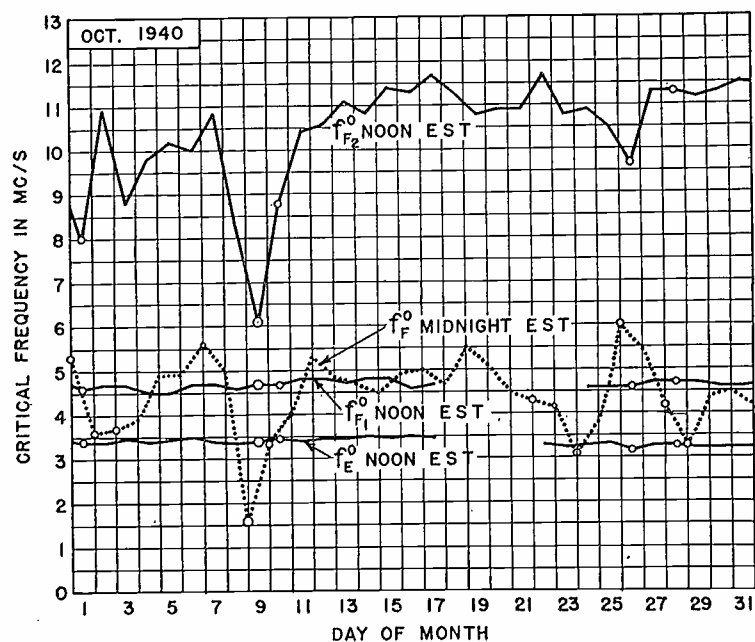

Fig. 2—Midnight  $f_F^0$  and noon  $f_{E^0}$ ,  $f_{F_1^0}$ , and  $f_{F_2^0}$  for each day of October. Open circles indicate critical frequencies observed during ionospheric storms. Sizes of circles represent approximate severity of storms.

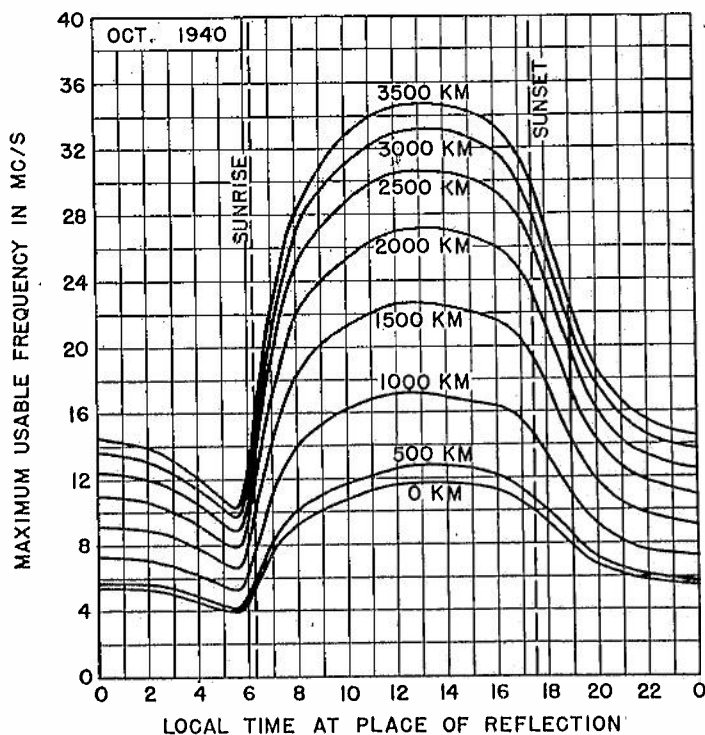

Fig. 3—Maximum usable frequencies for dependable radio transmission via the regular layers, average for undisturbed days for October, 1940. These curves also give skip distances, since the maximum usable frequency for a given distance is the frequency for which that distance is the skip distance.

determined by the F layer at night and by the F<sub>2</sub> layer during the day. Fig. 4 gives the expected values of the maximum usable frequencies for radio transmission by way of the regular layers, average for undisturbed

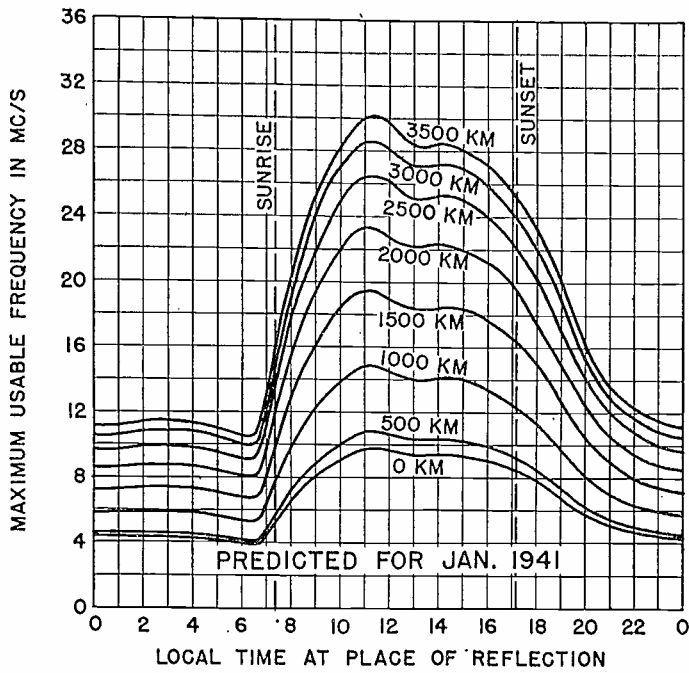

Fig. 4—Predicted maximum usable frequencies for dependable radio transmission via the regular layers, average for undisturbed days, for January, 1941. For information on use in practical radio transmission problems, see Letter Circulars 614 and 615 obtainable from the National Bureau of Standards, Washington, D. C., on request.

days, for January, 1941. All of the foregoing are based on the Washington ionospheric observations, checked by quantitative observations of long-distance reception.

Ionospheric storms and sudden ionospheric disturbances are listed in Tables I and II, respectively.

TABLE I  
IONOSPHERIC STORMS (APPROXIMATELY IN ORDER SEVERITY)

Day and hour E.S.T.	h <sub>F</sub> before sunrise (km)	Minimum f <sub>F<sup>o</sup></sub> before sunrise (kc)	Noon f <sub>F<sup>o</sup></sub> (kc)	Magnetic character <sup>1</sup>		Ionospheric character <sup>2</sup>
				00-12 G.M.T.	12-24 G.M.T.	
October						
8 (from 2000)	—	—	—	1.1	0.7	1.0
9	— <sup>3</sup>	— <sup>3</sup>	6100	0.1	0.0	1.6
10	343	2700	8800	0.0	0.1	1.1
11 (through 0630)	293	2700	—	0.1	0.2	0.3
1	311	2500	8000	0.8	0.3	1.1
2 (through 0630)	353	1700	—	0.4	0.6	0.7
25 (from 1900)	—	—	—	0.1	1.1	0.8
6 (through 1300)	327	4400	9700	0.8	1.1	0.7
27 (from 2230)	—	—	—	0.5	0.4	0.1
28	317	2600	11300	0.4	0.4	0.5
29 (through 0700)	287	3000	—	0.2	0.0	0.4
2	—	—	—	0.4	0.6	0.1
3 (through 0600)	351	1800	—	0.5	0.5	0.6
6 (from 2100)	—	—	—	0.3	0.6	0.4
7 (through 0700)	326	3400	—	0.8	1.2	0.4
22 (from 1600)	—	—	—	0.9	0.3	0.3
23 (through 0900)	289	3000	—	0.0	0.0	0.4
23 (from 2030)	—	—	—	0.0	0.0	0.3
24 (through 0900)	296	2500	—	0.0	0.0	0.4
21 (from 2100)	—	—	—	0.4	0.6	0.2
22 (through 0900)	361	2000	—	0.9	0.3	0.4
25 (0130 through 0530)	280	3100	—	0.1	1.1	0.1
For comparison: average for undisturbed days	295	3330	10740	0.3	0.3	0.0

<sup>1</sup> American magnetic character figure, based on observations of seven observatories.  
<sup>2</sup> An estimate of the intensity of the ionospheric storm at Washington, on an arbitrary scale of 0. to 2, the character 2 representing the most severe disturbance.  
<sup>3</sup> No reflections observed on frequencies above 2500 kilocycles per second.

TABLE II  
SUDDEN IONOSPHERIC DISTURBANCES

Day	G.M.T.		Locations of transmitters	Relative intensity at minimum <sup>1</sup>	Other phenomena
	Beginning	End			
October 7	1344	1420	Ohio, D. C., Italy	0.1	
8	1732	1900	Ohio, D. C., Italy, England	0.0	
8	2025	2100	Ohio, D.C., Kentucky, Italy, England	0.0	Ter. mag. pulse, <sup>2</sup> 2030 to 2105
18	1535	1600	Ohio	0.1	
18	1729	1800	Ohio	0.1	

<sup>1</sup> Ratio of received field intensity during fade-out to average field intensity before and after; for station W8XAL, 6080 kilocycles, 650 kilometers distant.  
<sup>2</sup> As observed on Cheltenham magnetogram of United States Coast and Geodetic Survey.

The details of one ionospheric storm day are shown in Fig. 1. The open circles in Fig. 2 indicate the noon and midnight critical frequencies observed during the ionospheric storms listed in Table I. The sizes of the circles roughly represent the severity of the storms. Table III gives the approximate upper limit of fre-

TABLE III  
APPROXIMATE UPPER LIMIT OF FREQUENCY IN MEGACYCLES OF THE STRONGER SPORADIC-E REFLECTIONS AT VERTICAL INCIDENCE

Day	00	01	02	03	04	05	06	07	08	09	10	11	12	13	14	15	16	17	18	19	20	21	22	23
October 1																								
2																								
3				3	4	5			4	4	4													
4																								
5						4																		
6																								
7																								
8																								
9		4																			6		3	3
10																								
11					4	4	3			4	4	4	4	4	4	4	4				4	4		
12									4	5	5										4	4		
13																								
14											5	6	4		4	4					5	7	3	3
15																								
16		4	4	4																				
17			4	3			4			4	4	5												
18																								
19																								
20																								
21																								
22																								
23																								
24						7	8																	
25							4	10	4						4									
26		4																						3
27			3																					
28		4	4			4		6	10														3	5
29		4	4			4	4								4	4					4	4	5	3
30																								
31		4				3	3	4	5	5	4											4	9	3

quency of strong sporadic-E reflections at vertical incidence.

Instead of being sharp and well-defined, the F-layer critical frequencies, especially at night, were frequently obscured by diffuse and complex reflections. These diffuse reflections often were observed over a frequency range of 1000 kilocycles or more. This effect is associated with ionospheric storms. It has been observed to be greater and more frequent during the winter than during the summer. In this connection, analysis shows that the ranges of frequencies over which the diffuse reflections are observed correspond to ranges of ionization densities which are approximately the same, both in winter and summer. The total ionization density is in general less during the winter night than during the summer night. Thus the relative effect of the diffuse reflections on radio transmission is augmented during the winter.

# Institute News and Radio Notes

## SIXTEENTH ANNUAL CONVENTION

January 9, 10, and 11, 1941

New York, N. Y.

The first three conventions of the Institute were held in New York City because that location was most convenient for the membership in general. As a result of the interest shown by several sections in having conventions in their localities, the next eight meetings occurred in various cities in the United States and Canada. Also, during the past four years our Pacific Coast Sections have co-ordinated their efforts in the holding of conventions each year.

The Twelfth, Thirteenth, and Fourteenth Annual Conventions were in New York and indicated that the attendance there is two or three times as large as in any other city. However, the Institute desires to provide conventions not only to the largest number of members but also to those widely separated geographically. In an attempt to do this, a new policy has been established. Under it, the Annual Convention will be held each year in January in New York and a Summer Convention will be held elsewhere in June. The Pacific Coast Conventions will continue, their dates and places not being fixed as they are held coincidentally with conventions of the American Institute of Electrical Engineers.

The headquarters for our Sixteenth Annual Convention will be in the Hotel Pennsylvania in New York City. Information on trips and the women's events is given at the end of the program. Twenty-eight technical papers will be presented during sessions held each morning and afternoon of the three days. There will be no duplicate sessions. No papers are available in preprint form nor is there any assurance that any of them will be published in the PROCEEDINGS in the future. The following program is final and no changes in it are expected.

### PROGRAM

Thursday, January 9

9:00 A.M.

Registration

10:30 A.M.—12:30 P.M.

Address by L. C. F. Horle, retiring president, and introduction of F. E. Terman, president for 1941. Technical session, President Terman presiding.

1. "Recent Developments in the RCA Electron Microscope," by J. Hillier and A. W. Vance, RCA Manufacturing Company, Inc., Camden, N. J.

2. "The Handling of Telegrams in Facsimile," by R. J. Wise and I. S. Coggeshall, Western Union Telegraph Company, New York, N. Y.
3. "Measurements of the Delay and Direction of Arrival of Echoes from Near-by Short-Wave Transmitters," by K. G. Jansky and C. F. Edwards, Bell Telephone Laboratories, Inc., New York, N. Y.
4. "An Evaluation of Radio-Noise-Meter Performance in Terms of Listening Experience," by C. M. Burrill, RCA Manufacturing Company, Inc., Camden, N. J.

2:30 P.M.—4:30 P.M.

Technical Session, H. A. Wheeler presiding.

5. "Spurious Responses in Superheterodyne Receivers," by E. Kohler and C. Hammond, Ken-Rad Tube and Lamp Corporation, Owensboro, Ky.
6. "Intermediate-Frequency Values for Frequency-Modulated-Wave Receivers," by D. E. Foster and Garrard Mountjoy, Radio Corporation of America, License Division Laboratory, New York, N. Y.
7. "Signal-to-Noise Relations in High-Transconductance Tubes," by J. R. Nelson, Raytheon Production Corporation, Newton, Mass.
8. "Improvements in B-Battery Portability," by H. F. French, National Carbon Company, Inc., Cleveland, Ohio.
9. "Magnetic Recording and Some of Its Applications in the Broadcast Field," by S. J. Begun, The Brush Development Company, Cleveland, Ohio.

Friday, January 10

10:00 A.M.

Registration

10:30 A.M.—12:30 P.M.

Technical Session, O. B. Hanson presiding.

10. "New 1-Kilowatt Television Picture Transmitter," by J. Ferguson, Farnsworth Television and Radio Corporation, Fort Wayne, Ind.
11. "Versatile Multichannel Television Control Equipment," by D. E. Norgaard and J. L. Jones, General Electric Company, Schenectady, N. Y.

12. "New Designs of Television Control-Room Equipment," by J. Schantz and W. Ludwick, Farnsworth Television and Radio Corporation, Fort Wayne, Ind.
13. "A Coaxial Filter for Vestigial-Sideband Transmission in Television," by H. Salinger, Farnsworth Television and Radio Corporation, Fort Wayne, Ind.
14. "Three New Ultra-High Frequency Triodes," by K. C. DeWalt, General Electric Company, Schenectady, N. Y.
15. "A Recently Developed Circuit for the Generation of Power at Ultra-High-Frequencies," by A. L. Nelson, Farnsworth Television and Radio Corporation, Fort Wayne, Ind.

2:30 P.M.—4:30 P.M.

Technical Session, F. R. Lack presiding.

16. "Radio-Frequency-Operated High-Voltage Supplies for Cathode-Ray Tubes," by O. H. Schade, RCA Manufacturing Company, Inc., Harrison, N. J.
17. "After-Acceleration and Deflection," by J. R. Pierce, Bell Telephone Laboratories, Inc., New York, N. Y.
18. "Analysis of Voltage-Controlled Electron Multipliers," by B. J. Thompson, RCA Manufacturing Company, Inc., Harrison, N. J.
19. "Behavior of Electron Multipliers as a Function of Frequency," by L. Malter, RCA Manufacturing Company, Inc., Harrison, N. J.
20. "The Orbital-Beam Secondary-Electron Multiplier for Ultra-High-Frequency Amplification," by H. M. Wagner and W. R. Ferris, RCA Manufacturing Company, Inc., Harrison, N. J.

### Saturday, January 11

10:00 A.M.

Registration

10:30 A.M.—1:00 P.M.

Technical Session, President Terman presiding.

21. "Some Factors Affecting Television Transmis-



The frequency-modulated-wave transmitting station, W2XOR, which will be open for inspection during the Convention. The control desk may be seen at the left.

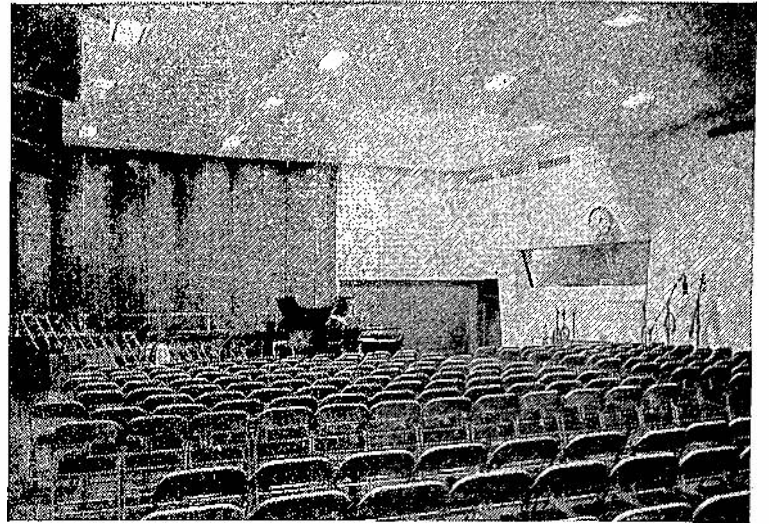

The largest of the new Columbia Broadcasting System New York studios is pictured above. The vertical panels at the front of the studio are of hard material and may be opened by remote control from the monitoring booth to uncover highly absorptive material and thus change the acoustic response of the room. The bottoms of some of these panels which are open may be seen in the upper left-hand corner.

- sion," by M. E. Strieby and C. L. Weis, Bell Telephone Laboratories, Inc., New York, N. Y.
22. "Brightness Distortion in Television," by D. G. Fink, McGraw-Hill Publishing Company, New York, N. Y.
23. "A Phase-Curve Tracer for Television," by B. D. Loughlin, Hazeltine Service Corporation, Little Neck, L. I., N. Y.
24. "Special Oscilloscope Tests for Television Waveforms," by A. V. Loughren and W. F. Bailey, Hazeltine Service Corporation, Little Neck, L. I., N. Y.

2:30 P.M.—4:30 P.M.

Technical Session, C. M. Jansky, Jr., presiding.

25. "Program-Operated Level-Governing Amplifier," by W. L. Black and N. C. Norman, Bell Telephone Laboratories, Inc., New York, N. Y.
26. "Drift Analysis of the Crosby Frequency-Modulated Transmitter Circuit," by E. S. Winlund, RCA Manufacturing Company, Inc., Camden, N. J.
27. "Frequency-Modulated Emergency Equipment," by G. M. Brown, General Electric Company, Schenectady, N. Y.
28. "Commercial 50-Kilowatt Frequency-Modulated-Wave Broadcast Transmitting Station," by H. P. Thomas and R. H. Williamson, General Electric Company, Schenectady, N. Y.

### AWARDS

The Institute Medal of Honor for 1941 will be presented to Alfred Norton Goldsmith for his contributions to radio research, engineering, and commercial development, his leadership in standardization and his unceasing devotion to the establishment and upbuilding of the Institute and its PROCEEDINGS.

Seven Institute members will be transferred to the



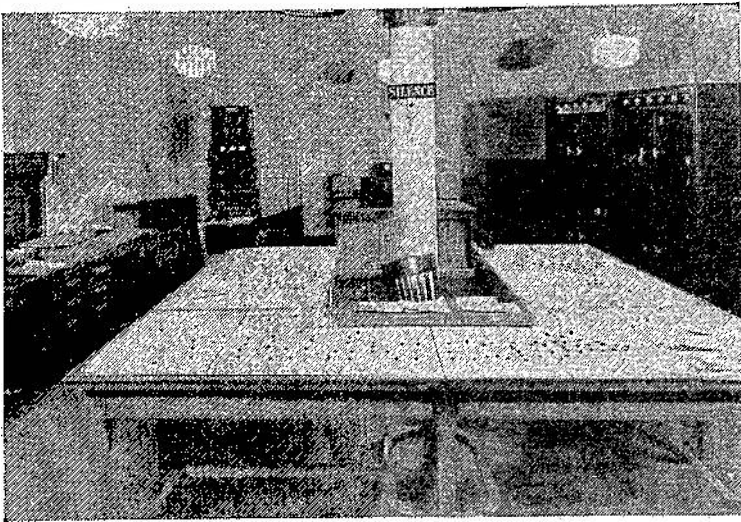

The New York City Police Department radio system is operated from this room. Some of the transmitting equipment is visible in the background. The U-shaped table gives rapid access to a map of the city. The "checkers" represent the cars on duty and indicate the general location of each one at any time of the day or night. It is the key to the dispatching system.

grade of Fellow and will receive diplomas attesting thereto. They are Marcus A. Acheson, Edmond M. Deloraine, Austin V. Eastman, Oscar B. Hanson, Ira J. Kaar, Arthur S. McDonald, and Ralph K. Potter.

### BANQUET

Our annual banquet will be held on Friday evening, January 10. At it, President Terman will present the awards to the recipients. The principal speaker will be Doctor Gano Dunn, a Fellow of the Institute, president of the J. G. White Engineering Corporation. Doctor Dunn has been active in the work of the National Defense Committee and will speak on the engineer and the national defense program.

### EXHIBITION

Our new convention policy calls for the Institute sponsoring only one exhibition of radio equipment, components, testing and measuring devices, and manufacturing aids each year. This will be at our Annual Convention in New York. The exhibition will be located near the meeting room and the registration desk. Booths will be in charge of exhibitors accustomed to discussing the problems of radio engineers.

### WOMEN'S PROGRAM

Because of possible inclement weather, we have arranged most of the women's program to be indoors. The events for Thursday and Friday are at places close to the hotel and we shall use the subways for transportation. The Saturday trip to the airport will be by automobile.

#### Thursday, January 9

##### FANTASIA

The Disney-Stokowski picture, *Fantasia*, that much-discussed production in which classical music is not only played but portrayed by motion-picture interpre-

tation, will be the first entertainment for our women guests. Although the matinee starts at 2:40 P.M., which requires leaving the Hotel Pennsylvania between 2:00 and 2:15, it will be necessary to distribute the tickets before noon to insure that everyone will be accommodated.

#### Friday, January 10

##### RADIO CITY

The women will meet in the Women's Headquarters at 10:30 Friday morning. Members of the Women's Committee will take small groups by the new Sixth Avenue subway to Rockefeller Center for a tour of the buildings, including the lobby of the Music Hall, and terminating on the Observation Roof of the RCA Building, 65 stories above the street. Luncheon will be served at the Stockholm Restaurant after which a visit will be made to Pedac (Permanent Exhibition of Decorative Arts and Crafts).

#### Saturday, January 11

##### LA GUARDIA MUNICIPAL AIRPORT

Forty lucky women will be the guests of American Airlines, Inc., who have generously offered to take them for an aerial view of New York City. Regular American Airline transports will take off from La Guardia Field, circle the city, and return to the field in time for luncheon at the Terrace Restaurant. Lots for the sky trip will be drawn at the Hotel Pennsylvania on Saturday morning.

### TRIPS

Instead of devoting an entire afternoon to trips, we are arranging for informal visits during Thursday and Friday afternoons to several places of interest. This will permit an individual to see more than one place and to arrange his visit in relation to the papers program. The several places to which we are invited are:

Columbia Broadcasting System studios.

New York City police radio operating room.



A bank of machines which handle some of the three hundred thousand messages transmitted by Western Union facsimile each year are shown above. This equipment and the general telegraph operating facilities will be seen on one of the visits scheduled during the Convention.



tween capacitance, efficiency, and transit time, electrode spacings are obtained which result in optimum performance. Exceptionally short lead lengths allow better neutralization and stable amplifier operation at the higher frequencies.

## 10. A NEW 1-KILOWATT TELEVISION PICTURE TRANSMITTER

J. FERGUSON

(Farnsworth Television & Radio Corporation, Fort Wayne, Ind.)

This paper deals with the development and design of a 1-kilowatt television transmitter intended for commercial use. It discloses a number of development and design considerations and the solutions applied thereto.

## 22. BRIGHTNESS DISTORTION IN TELEVISION

D. G. FINK

(McGraw-Hill Publishing Company, New York, N. Y.)

Brightness distortion, a term analogous to harmonic distortion in sound transmission, refers to nonlinearity and/or linear displacement of the brightness transfer characteristic of a television system. The brightness transfer characteristic is the curve relating the brightnesses in the televised object to the corresponding brightnesses in the received image. Specifically, brightness distortion is defined as occurring "whenever the brightness transfer characteristic departs from a straight line passing through an origin corresponding to black in the object and the image." The purpose of this paper is to present a unified theory of brightness distortion and to show its beneficial as well as its detrimental effects. A rational terminology is developed and a general graphical method of evaluating the visual effect of the distortion is presented.

The paper presents, first, the definition of the brightness transfer characteristic and shows its utility in evaluating visual effects. The advantages of plotting the characteristic on log-log paper are shown by reference to the Weber-Fechner law relating visual stimulus and sensation. Definitions relating to the gradient and intercepts of the log-log plots are given. The relationship of these graphical quantities to visual contrast range, the contrast gradient, and tonal saturations are illustrated.

The several types of brightness distortion are then investigated with a view to their beneficial or adverse effects. The admissible types of brightness distortion are shown to be those associated with the following nonlinear relationship

$$\text{image brightness} = k_0 (\text{object brightness})^{g_0}$$

It is shown that the corresponding log-log plots, representing visual sensation, are always straight lines. This linearity insures that the visual sensation of an observer in the studio has a one-to-one correspondence with the visual sensation of the viewer of the final

image. The possibility of employing values of  $g_0$  greater than unity to increase the visual contrast without increasing the dynamic range of the system is pointed out.

The inadmissible types of brightness distortion are then discussed. These fall in three main categories: (1) general curvature on the log-log plots which produces differential variation in contrast gradient so that the tonal range in the shadow portions of the picture is different from that in the high lights; (2) sharp curvature at the knee and/or shoulder of the log-log plots which introduces saturation of the shadows and/or high lights, respectively; and (3) displacement of the curve from the black origin. Since the log-log plots have no origin in the strict sense, this last type of distortion is treated in the linear plots and its effect on the log-log plots shown to be similar to that of (1) above, producing differential variations in contrast or in severe cases over-all changes in contrast gradient.

The second half of the paper deals with the practical aspects of the matter, namely the effect on brightness distortion of the design and operation of apparatus. First a typical system of television transducers (camera, video-frequency amplifiers, clipping stages, modulator, transmitter radio-frequency amplifier, receiver radio-frequency and intermediate-frequency amplifiers, demodulator, video-frequency amplifier, and picture tube) is analyzed. On the assumption that the input-output transfer curves of these transducers can be expressed as

$$\text{output}_1 = k_1 (\text{input}_1)^{g_1},$$

it is shown that the over-all contrast gradient  $g_0$  is equal to the product of the transfer exponents, that is,

$$g_0 = g_1 g_2 g_3 \dots g_n$$

where  $g_1, g_2$ , etc., are the transfer exponents of the individual transducers. The advantage of employing an exponent product less than unity in the transmitter to gain an advantage in signal-to-noise ratio is pointed out. The type of compensation necessary at the receiver (exponent product greater than unity) is discussed as is the desirability of setting up a standard value of exponent product in the receiver.

The effect of amplitude distortion inherently present in typical transducers is then investigated. Typical curves of elements contributing most to the distortion (camera tubes, clipping stages, modulators, demodulators, and picture tubes) are given.

Brightness distortion due to improper operation of the system is then discussed. Nonlinearity due to overload in modulators and amplifiers is first treated. This is followed by consideration of displacement of the origin due to improper setting of the brightness control at the transmitter or receiver or to improper operation of the automatic-brightness-control circuits. The related effect of ambient illumination at the receiver is also treated.

Practical uses of intentional brightness distortion

are given, including the compressing of brightness range in outdoor scenes, obtaining artistic effects, compensating for ambient illumination, improving signal-to-noise ratio, and compensating inherent non-linearity in apparatus.

The paper concludes with several suggestions for research to reduce the limitations of present apparatus and to permit controlled compensation of these limitations.

## 6. INTERMEDIATE-FREQUENCY VALUES FOR FREQUENCY-MODULATED-WAVE RECEIVERS

D. E. FOSTER AND GARRARD MOUNTJOY

(Radio Corporation of America, License Division Laboratory, New York, N. Y.)

The considerations which lead to the selection of the intermediate frequency in frequency-modulated-wave receivers are studied and shown to differ in several respects from those applying to standard-band broadcast receivers. They include gain, band width, stability, economy, and freedom from spurious response.

Methods of securing high gain with good stability and economy by proper distribution of impedance and the influence of intermediate-frequency value thereon are discussed.

The several types of spurious responses are studied in detail and their relations to intermediate-frequency values described.

Correlation of all factors leads to the selection of recommended optimum intermediate-frequency values.

## 8. IMPROVEMENTS IN B-BATTERY PORTABILITY

H. F. FRENCH

(National Carbon Company, Inc., Cleveland, Ohio)

Some marked advances in the reduction of size and weight of B batteries for portable receivers are discussed. By volume savings effected through new design developments, the package size per unit of capacity has been lowered by about 50 per cent. These improvements enhance portability and are reflected in such developments as the personal receiver.

## 1. RECENT DEVELOPMENTS IN THE RCA ELECTRON MICROSCOPE

J. HILLIER AND A. W. VANCE

(RCA Manufacturing Company, Inc., Camden, N. J.)

A description is given of the limitations in resolving power of microscopes indicating the reason for the 50- to 100-times greater resolving power of the electron microscope over the optical instrument. This is followed by a treatment of the basic principles involved in the electron microscope. A detailed description is given of the newly developed RCA electron microscope which, although equal or superior in performance

to any previous microscope, occupies a much smaller space, is completely self-contained, and can be readily handled by an inexperienced operator. Examples of the work done by this new instrument are shown. The extremely compact power-supply system for the microscope is described. The reduction in size is obtained chiefly by the use of a radio-frequency-actuated rectifier system. By the use of radio frequency and an especially designed voltage divider, excellent stability of the order of 0.004 per cent of 60 kilovolts output at 0.5 milliampere drain is obtained.

## 3. MEASUREMENTS OF THE DELAY AND DIRECTION OF ARRIVAL OF ECHOES FROM NEAR-BY SHORT-WAVE TRANSMITTERS

K. G. JANSKY AND C. F. EDWARDS

(Bell Telephone Laboratories, Inc., New York, N. Y.)

This paper gives the results of a series of experiments conducted at Holmdel, N. J., between January 11 and September 6, 1939, in which measurements were made of the delay and direction of arrival of echoes from high-power transmitters located at Lawrenceville, N. J. Three different types of echoes are described and each is shown to arise from a different cause. Of these, the multiple-echo type is shown to be the most persistent, occurring at nearly all times and coming from directions corresponding to the direction of the transmitted beam. Components were observed returning from regions up to 4000 miles distant. Conclusions drawn from the data indicate that these echoes are caused by scattering at the earth's surface. Data are also presented showing that similar echoes may be observed from more-distant transmitters provided the receiver is within the skip zone.

Similarities between multiple echoes and southerly deviated waves from European transmitters are pointed out which indicate that the same phenomena may be responsible for both.

## 5. SPURIOUS RESPONSES IN SUPER-HETERODYNE RECEIVERS

E. KOHLER AND C. HAMMOND

(Ken-Rad Tube & Lamp Corporation, Owensboro, Kentucky)

The paper will give a theoretical discussion of these spurious responses through the use of the power series. Practical data will then show the variations in these responses given by converters with different types of mutual characteristics, such as the triode, the pentode, and the pentagrid. Practical data will be given showing the effect of oscillator amplitude on these responses. A graphical method of predicting the high-order spurious responses (such as that resulting from the sixth harmonic of a signal and the fifth harmonic of an oscillator) for any intermediate frequency will be shown. The paper will also consider the effects of automatic volume control and of the gain and selec-

tivity of the radio-frequency and the intermediate-frequency systems as they affect spurious responses.

### 23. A PHASE-CURVE TRACER FOR TELEVISION

B. D. LOUGHLIN

(Hazeltine Service Corporation, Little Neck, L. I., N. Y.)

This is a system for showing on the screen of a cathode-ray tube the phase curve of any network, plotted against frequency from 0.1 to 5 megacycles. The test frequency is changed to a fixed frequency of 50 kilocycles for phase comparison and the phase shift is converted to a time shift. A rectangular field on the screen is scanned in vertical lines, one for each test frequency. A bright spot is produced on each line at a vertical distance proportional to the phase angle of the circuit under test. Frequency and phase co-ordinate lines are superimposed. The full scale of phase indication is adjustable in multiples of 360 degrees by switching.

### 24. SPECIAL OSCILLOSCOPE TESTS FOR TELEVISION WAVE FORMS

A. V. LOUGHREN AND W. F. BAILEY

(Hazeltine Service Corporation, Little Neck, L. I., N. Y.)

The adjustment and maintenance of a prescribed relation in television signals is facilitated by carefully chosen tests on a special oscilloscope. The "pulse-cross" pattern shows the timing of all synchronizing and blanking pulses on a scanned field, each pulse appearing as a horizontal white line and the scanning phase being shifted so all the pulses together form a cross in the field. In another test, originated by H. M. Lewis, two horizontal traces representing corresponding parts of alternate fields are displaced vertically to remove the confusion of superimposed unlike traces. This test shows the time relations involved in interlacing. An integration test on the Radio Manufacturers Association field-synchronizing pulses gives a sensitive indication of some defects which may occur in the width and timing of these pulses.

### 19. BEHAVIOR OF ELECTRON MULTIPLIERS AS A FUNCTION OF FREQUENCY

L. MALTER

(RCA Manufacturing Company, Inc., Harrison, N. J.)

An experimental and theoretical investigation was carried out for the purpose of determining the source of loss in amplification of multipliers with increasing frequency.

It was demonstrated that the effect can be ascribed to the transit-time spread resulting from the varying initial velocities of secondary electrons and from the differences in paths described by electrons originating at different points on the multiplier surfaces. The theoretical and experimental results agreed within the limits of experimental error. Results obtained on a number of tubes of different scale permit the making

of predictions of the performance of tubes made to other scales.

It was found that for a given over-all transit angle through a multiplier the behavior of the conventional electrostatic type<sup>1</sup> and the "magnetic" type<sup>2</sup> are practically the same as regards frequency.

Incidental to this work an upper limit of  $3 \times 10^{-9}$  second was set upon the time taken for the phenomenon of secondary emission to occur.

### 15. A RECENTLY DEVELOPED CIRCUIT FOR THE GENERATION OF POWER AT ULTRA-HIGH FREQUENCIES

A. L. NELSON

(Farnsworth Television & Radio Corporation, Fort Wayne, Ind.)

This paper discusses a novel system for the efficient production of power at ultra-high frequencies by using tubes of conventional design in frequency-multiplying circuits of relatively high efficiency depending on the phase characteristic of associated circuits.

### 7. SIGNAL-TO-NOISE RELATIONS IN HIGH-TRANSCONDUCTANCE TUBES

J. R. NELSON

(Raytheon Production Corporation, Newton, Mass.)

The use of two-gang receivers with no high-frequency stage preceding the first detector makes it desirable to examine the possibilities of obtaining lower noise values than are usual with pentagrid converter tubes. In the broadcast band the conventional input circuit contributes considerable noise but in the higher-frequency bands the tube is the main source of noise so any improvement in the converter-tube noise results in a large improvement in the over-all noise. It is also desirable to have a low-noise detector if the radio-frequency-stage gain is low so the first-detector noise is an appreciable part of the total noise.

Triodes and pentodes, including some recent high-transconductance pentodes are examined experimentally for the noise existing with initial bias and with additional bias due to automatic-volume-control action and compared with the conventional pentagrid converter tubes and it is shown that the initial bias conditions may be improved somewhat and the other bias conditions considerably by the use of triodes or high-transconductance pentodes. Methods of coupling into the mixer tube are discussed and it is shown that cathode coupling may cause considerable induced voltage across the signal grid unless suitable precautions are taken. Formulas are given to compare the the possible gain figures of the various tubes with each other.

<sup>1</sup> V. K. Zworykin and J. A. Rajchman, "The electrostatic electron multiplier," PROC. I.R.E., vol. 27, pp. 558-566; September, 1939.

<sup>2</sup> V. K. Zworykin, G. A. Morton, and L. Malter, "The secondary emission multiplier—a new electronic device," PROC. I.R.E., vol. 24, pp. 351-375; March, 1936.

## 11. VERSATILE MULTICHANNEL TELEVISION CONTROL EQUIPMENT

D. E. NORGAARD AND J. L. JONES

(General Electric Company, Schenectady, N. Y.)

The production of high-definition television programs has necessitated the development of equipment which is particularly adapted to both the technical requirements of the system and the operating requirements of program presentation.

This paper describes control-room apparatus which is suited to modern television-program technique by its flexibility, ease of control, and dependability. The division and grouping of the operating controls and indicators are such as to co-ordinate the action of the several operators effectively, yet providing for a wide variety of effects and precision of control. Provision is made for switching cameras into and out of the line, fading up or down, and lap-dissolving any two channels in any order or type of change-over desired.

The circuits used and the arrangement of equipment within the control room are such that the expansion of facilities (such as addition of new channels) can be accomplished without disturbing existing equipment. Improvement of program service by such expansion is expected in most installations because the initial equipment must be simplified as far as possible and yet be capable of continuous use at peak performance.

Interesting features of the many components of a complete studio control setup are pointed out and described briefly. These include the pulse generator, video-frequency amplifiers, camera sweeps, channel and line monitors, picture quality controls, control console, cue equipment, and audio-frequency equipment.

## 17. AFTER-ACCELERATION AND DEFLECTION

J. R. PIERCE

(Bell Telephone Laboratories, Inc., New York, N. Y.)

Deflection sensibility of a cathode-ray tube is defined as the change in deflecting voltage or current required to move the spot one spot diameter on the screen. By deflecting the electron beam in a region of low potential and afterwards accelerating the beam to screen potential, deflection sensibility can be improved in the case of electrostatic deflection but cannot be improved in the case of magnetic deflection. Any improvement achieved by after-acceleration results only from the lowering of the potential in the region of deflection and not to the peculiar electron-optical properties of the particular scheme employed.

## 13. A COAXIAL FILTER FOR VESTIGIAL-SIDEBAND TRANSMISSION IN TELEVISION

H. SALINGER

(Farnsworth Television & Radio Corporation, Fort Wayne, Ind.)

This paper deals with the problem of building a filter of ladder or lattice type wherein the elements are re-

placed by coaxial lines. The problem is shown to be largely one of geometrical arrangement. A method of construction and properly designing such filters is described. Using this attack, an experimental filter of the ladder type has been built for the television channel of 66 to 72 megacycles. It has at 66 megacycles a cutoff sharpness of 32 decibels per per cent of frequency change. This can be achieved with a very compact filter structure. The general performance and range of usefulness of this filter type in television channels is discussed.

## 16. RADIO-FREQUENCY-OPERATED HIGH-VOLTAGE SUPPLIES FOR CATHODE-RAY TUBES

O. H. SCHADE

(RCA Manufacturing Company, Inc., Harrison, N. J.)

The operation of tuned step-up transformers in self-excited oscillator circuits as high-voltage sources for kinescopes is analyzed. General information and data are given for optimum radio-frequency-transformer design and operating conditions with specified rectifier loads. Constructional details are illustrated on practical high-voltage supplies ranging from 1 to 50 kilovolts with power output values of  $\frac{1}{4}$  watt to 50 watts, respectively. The performance of these supplies in television equipment is discussed.

## 12. NEW DESIGNS OF TELEVISION CONTROL-ROOM EQUIPMENT

J. SCHANTZ AND W. LUDWICK

(Farnsworth Television & Radio Corporation, Fort Wayne, Ind.)

This paper deals with what are believed to be novel design and development conceptions which have led to the construction of television control-room equipment for commercial use.

## 21. SOME FACTORS AFFECTING TELEVISION TRANSMISSION

M. E. STRIEBY AND C. L. WEIS

(Bell Telephone Laboratories, Inc., New York, N. Y.)

This paper will discuss the various characteristics which we have found important in the transmission of television signals over wire lines. It will be accompanied by a demonstration of 441-line, 30-frame interlaced television transmission around a 200-mile loop over the New York-Philadelphia coaxial cable.

The various forms of distortion and interference to be dealt with in the transmission of television signals will be discussed and certain methods of measurement described. The effect of measured amounts of these as seen on a particular receiving tube will be demonstrated. The characteristics of this tube will be given and the effect of changed or improved types of receiving tubes or transmitter characteristics will be pointed out in relation to the above-mentioned data,

In particular, the following matters will be taken up:

1. Effect of noise. This will cover random noise and single-frequency interference including power-frequency sidebands.
2. Attenuation distortion within the transmitted band and stability of transmission.
3. Multiple images, echoes, phase distortion, and delay distortion as produced in wire lines will be discussed in relation to the New York-Philadelphia circuit.
4. General methods of measurement will be outlined and our particular applications shown.
5. Frequency band width. This will be discussed briefly with reference to the paper by Baldwin<sup>1</sup> and the accompanying demonstration in which 4-megacycle local transmission will be compared with 2.75-megacycle transmission around the Philadelphia loop.

## 28. COMMERCIAL 50-KILOWATT FREQUENCY-MODULATED-WAVE BROADCAST TRANSMITTING STATION

H. P. THOMAS AND R. H. WILLIAMSON  
(General Electric Company, Schenectady, N. Y.)

The 50-kilowatt frequency-modulated-wave broadcast transmitting station to serve the New York capital district is described. The transmitter building is located at a high elevation in the Helderberg Mountains west of Albany so as to give line-of-sight transmission to most of the area to be served.

The transmitter consists of a 250-watt exciter, a 3-kilowatt intermediate power amplifier, and a 50-kilowatt power amplifier completely self-contained except for the main-rectifier plate transformer and the water-cooling unit.

Most of the performance characteristics of the transmitter, including fidelity, noise level, and frequency stability, are determined in the exciter unit, where several novel features are incorporated for producing the excellent performance obtained. The entire equipment was designed considering simplicity and reliability to be of prime importance.

The 3-kilowatt intermediate power amplifier utilizes forced-air-cooled triodes and water-cooled triodes are used in the power amplifier. Both tube types are of a new design especially suited to ultra-high-frequency service. An inverse-feedback circuit is provided around the final amplifier stage, grid-modulating this stage so as to cancel filament hum.

A new design of 3-bay turnstile antenna is fed by a pair of  $2\frac{5}{8}$ -inch concentric-tube radio-frequency transmission lines.

Field-strength measurements at 43.2 megacycles are given to show the coverage from the new transmitter.

## 18. ANALYSIS OF VOLTAGE-CONTROLLED ELECTRON MULTIPLIERS

B. J. THOMPSON

(RCA Manufacturing Company, Inc., Harrison, N. J.)

Electron multiplication has been applied recently to improve the performance of voltage-controlled electronic devices, as distinguished from devices controlled by light. The question arises as to the limitations affecting such applications.

This paper shows that the voltage amplification attainable in a practical device is limited by the ratio of transconductance to space current and not directly by the factor of electron multiplication. The sensitivity as determined by noise considerations depends on the transconductance (or, in some cases, space current) measured at the input to the multiplier. From this aspect, the use of multiplication cannot be an advantage and will be a disadvantage if the input transconductance is greatly reduced. The usefulness of electron multiplication therefore lies in advantages in ratio of transconductance to current and in high-frequency characteristics.

## 20. THE ORBITAL-BEAM SECONDARY-ELECTRON MULTIPLIER FOR ULTRA-HIGH-FREQUENCY AMPLIFICATION

H. W. WAGNER AND W. R. FERRIS

(RCA Manufacturing Company, Inc., Harrison, N. J.)

A development tube in which secondary-emission electron multiplication has been applied to a conventional high-transconductance tube structure to increase the transconductance without a corresponding increase in interelectrode capacitances and input conductance is described. It was primarily designed for wide-band amplification at a frequency of approximately 500 megacycles, as required for television radio relay systems. The tube uses conventional circuits and requires a power supply of less than 400 volts. The structure adopted permits the most efficient use of the secondary-emission multiplier consistent with satisfactory life and good high-frequency performance.

## 26. DRIFT ANALYSIS OF THE CROSBY FREQUENCY-MODULATED TRANSMITTER CIRCUIT

E. S. WINLUND

(RCA Manufacturing Company, Inc., Camden, N. J.)

Component drift, sensitivity, and band-width expressions are combined in an over-all expression for frequency stability of the Crosby circuit. Using experimentally obtained constants in this expression, an equation is derived for drift in terms of frequencies and frequency multiplications open to choice by the designer. The results are shown as design curves. The equation is checked against actual conditions existing in a Crosby exciter unit.

<sup>1</sup> M. W. Baldwin, "The subjective sharpness of simulated television images," *Proc. I.R.E.*, vol. 28, pp. 457-467; October, 1940.



## 2. THE HANDLING OF TELEGRAMS IN FACSIMILE

R. J. WISE AND I. S. COGGESHALL

(Western Union Telegraph Company, New York, N. Y.)

The adaptation of facsimile scanning and recording apparatus to the handling of commercial telegrams has

dictated the use of several expedients to accelerate the the processing, among them being higher speed of trace and scanning rate, minimization of wasteful scanning, dry-process recording, and automatic loading and discharge. Apparatus incorporating these features is in daily use, having a capacity of 50 telegrams per hour.

# Membership

The following indicated admissions to membership have been approved by the Admissions Committee. Objections to any of these should reach the Institute office by not later than January 31, 1941.

### Admission to Associate (A), and Student (S)

Bergren, L., (S) 1004 W. Fourth St., Lawrence, Kan.  
Bermudez, J., (A) B. Perez Galdos 9, Buenos Aires, Argentina  
Blackman, B. A., (S) 315 Duck St., Stillwater, Okla.  
Boughtwood, J. E., (A) Western Union Telegraph Co., 60 Hudson St., New York, N. Y.  
Bousky, S., (A) 343 S. Main St., Ann Arbor, Mich.  
Brouard, A. P., (A) Monasterio 1448, Vicente Lopez, Argentina  
Caird, K., (A) 2431 N. Tripp Ave., Chicago, Ill.  
Coulter, J., (A) Piedras 605, Buenos Aires, Argentina  
Crockford, C. J., (A) Detroit Edison Co., 2000 Third Ave., Detroit, Mich.  
Crowe, H. H., (A) 115 S. Clinton St., Dallas, Tex.  
Dabrowski, H. L., (A) 162 Armstrong Ave., Jersey City, N. J.  
Davis, R., (S) 906 N. Vendome St., Los Angeles, Calif.  
Dike, S. H., (S) 2100 Eton St., Albuquerque, N. M.  
Dixon, F. C., (A) 98-76 Queens Blvd., Forest Hills, N. Y.  
Dorsey, S. E., (S) 215 E. Hawthorne Ave., College Park, Ga.  
Duncan, H. S., (S) P.O. Box 618, Stanford University, Calif.  
Glattli, E., (A) B. Perez Galdos 9, Buenos Aires, Argentina  
Goldfus, S., (A) 6213 Kenmore, Chicago, Ill.  
Gunter, F. B., (A) 1101 Frederick Rd., Catonsville, Md.  
Hargesheimer, F. G., (A) W2XMN, Alpine, N. J.  
Harris, H. F., (S) R.F.D. 3, Eaton Rapids, Mich.  
Hemmes, R. T., (A) 1451 Park Rd., N.W., Washington, D. C.  
Higgins, D. F., (S) 109 Roanoke St., Seattle, Wash.  
Hill, C. F., (S) 10646 Avenue F, Chicago, Ill.  
Hoadley, C. B., (A) 121 Eighth Ave., Sea Cliff, N. Y.  
Joseph, J., (S) 2772 Yale Station, New Haven, Conn.

Kazan, B., (A) 131 Hudson Ave., Red Bank, N. J.  
King, R. I., (A) Box 582, Burlington, N. C.  
Kirkland, G. I., (S) 701 Mifflin Rd., Hays, Pa.  
Kohler, F. L., (S) 1321 Holman Rd., Oakland, Calif.  
Krahulec, F., (S) 2507 Ridgeland Ave., Berwyn, Ill.  
Lago, G., (S) 324 W. Lutz, West Lafayette, Ind.  
Levin, R., (A) 940 Fox St., New York, N. Y.  
Liedholz, G. A., (S) 1315 Fountain St., Ann Arbor, Mich.  
Lindsay, B., (S) 1404 S. Newton St., Sioux City, Iowa  
Mingorance, F. M., (A) Sarmiento 54, Bahia Blanca, Argentina  
Murugesan, V. G., (A) Marconi Wireless College, Arbour Lane, Chelmsford, Essex, England  
Nonnekens, J. C. A., (A) San Lorenzo 971, Olivos, Buenos Aires, Argentina  
O'Brien, D. J., (S) 2313 Sixth Ave., Troy, N. Y.  
Pardee, O. O., (S) 17530 Tenth, N.W., Seattle, Wash.  
Polster, N. E., (S) 2617 Euclid Heights Blvd., Cleveland Heights, Ohio  
Pradal, H. A., (A) Rua Justianiano Rocha 131, Vila Isabel, Rio, Brazil  
Pybus, A. W. L., (A) c/o Radio Physics Lab., University Grounds, City Rd., Sydney, N.S.W., Australia  
Rehberg, C. F., (S) 25-28-84th St., Jackson Heights, L. I., N. Y.  
Rivera Savagnac, F., (A) Av. Bulnes 80, Depto. 77, Santiago, Chile  
Scheiern, K. J., (A) 4763 Sheridan, Detroit, Mich.  
Schoenbaum, J. R., (A) 24 Mitchell Ave., Roseland, N. J.  
Seideman, I. M., (S) 2214 Wightman St., Pittsburgh, Pa.  
Shipley, E. D., (A) University of Tennessee, Knoxville, Tenn.  
Stevenson, J. M., (S) 1205 Bluemont, Manhattan, Kan.  
Stone, S. M., (S) 352 E. 46th St., Brooklyn, N. Y.  
Tamaki, K., (S) 1305 Banchi, 2 Chome, Setagaya Machi, Setagaya-Ku, Tokyo, Japan  
Toulis, W. J., (S) 4-243 Massachusetts Institute of Technology, Cambridge, Mass.  
Trench, C. E., (A) Venezuela 613, Buenos Aires, Argentina  
Weston, J. D., (A) 62 Manor Rd., Barnet, Herts., England  
Wigington, W. H., Jr., (S) Box 1373, Clemson, S. C.

Yorioka, U., (S) 710 Lane St., Seattle, Wash.  
Young, C. W., (A) 583 Euclid Ave., El Centro, Calif.

## Books

### An Introduction to Frequency Modulation, by John F. Rider.

Published by John F. Rider Publisher, Inc., 404 Fourth Avenue, New York, N. Y. 136 pages. 76 figures. 5½×8 inches. Price, \$1.00.

Dedicated to the radio serviceman, this book is, nevertheless, a valuable addition to the library of the radio engineer, serviceman and inquisitive layman. The author chapters the subject under six headings:

- I. Frequency Modulation
- II. What Happens at the Transmitter
- III. What Happens in the Receiver
- IV. The Transmission of F-M signals
- V. F-M Receiving Antennas
- VI. Servicing F-M Receivers

Mr. Rider uses his gift for clarity in an effective exposition of the nature of frequency modulation as compared to amplitude modulation in the first chapter. This description is particularly valuable to the serviceman and technical layman.

The author avoids detail in his description of transmitter operation and design. This is intentional because the book is planned for those primarily interested in receiver technique and service. The receiver chapter is much more complete. It suffers from lack of illustration but the writing date, March, 1940, was unfortunate from the point of view of illustrating the receiver chapter on the basis of latest receivers and allocations. Nevertheless, the fundamentals are all handled in a non-mathematical and interesting manner. The chapters on transmission or propagation and on receiving antennas are short and, for the most part, a review of the author's previous television writings.

The servicing section goes into considerable detail but of course cannot be construed as a service manual. The serviceman will certainly learn the general technique of frequency-modulated-receiver performance and trouble shooting. The nature of equipment that he will need is explained and its use illustrated.

DORMAN D. ISRAEL  
Emerson Radio and Phonograph Corp.  
New York, N. Y.

# Contributors

Clifford N. Anderson (A19-F' 34) was born at Scandinavia, Wisconsin, on September 22, 1895. He received the Ph.B.



C. N. ANDERSON

degree from the University of Wisconsin in 1919 and the M.S. degree in 1920. From 1913 to 1917 Mr. Anderson was the supervising principal of schools at Amery, Wisconsin, and from 1917 to 1918 he served as an Ensign of Aircraft Radio in the United States Naval Reserve Force. From 1919 to 1920 he was an instructor in engineering physics at the University of Wisconsin, and from 1920 to 1921 he was in the standardizing laboratory of the General Electric Company at Lynn, Massachusetts. After spending the year 1921-1922 in Norway as a Fellow of the American Scandinavian Foundation, he entered the Department of Development and Re-

search of the American Telephone and Telegraph Company where he stayed until 1934. Since then he has been with the Bell Telephone Laboratories.



Emory Leon Chaffee (M'17-F'21) received his B.S. degree from Massachusetts Institute of Technology in 1907, and his A.M. and Ph.D. degrees from Harvard University in 1908 and 1911, respectively. He is a Fellow of the American Physical Society, American Academy of Arts and Sciences, and a member of the International Scientific Radio Union. He is



E. L. CHAFFEE

Rumford professor of physics, Gordon McKay professor of physics and communication engineering, and director of Cruft Laboratory, Harvard University.

Hsu Chang (S'36-A'40) received his S.B. degree from Chiao-Tung University, Shanghai, China, in 1934, and his S.M. and



HSU CHANG

S.D. degrees from Harvard University in 1937 and 1940, respectively. He was research assistant in the National Research Institute of Physics, Academia Sinica, from 1934 to 1936, and came to the United States as a Tsing-Hua fellow during 1936-1938, and instructor in physics and communication engineering at Harvard University during 1938 to 1940. At present, he is joining the Central Institute of Technical Training, Ministry of Communications, Chungking, China.



For a biographical sketch of John D. Kraus, see the PROCEEDINGS for February, 1940; for D. B. Sinclair, July, 1940.

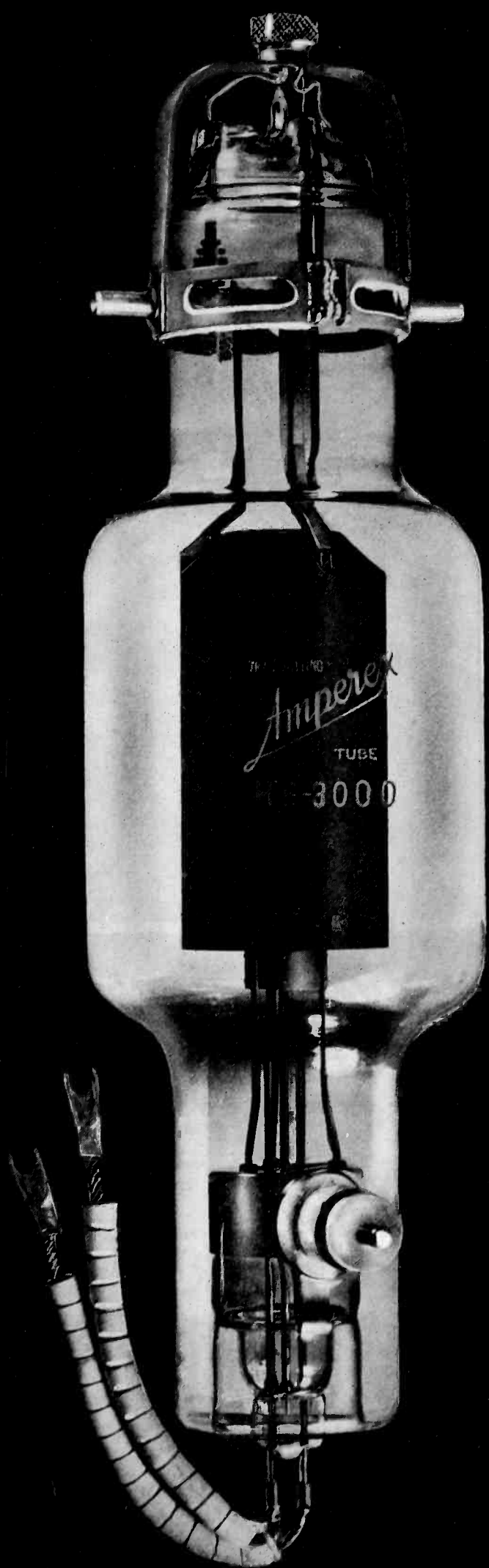

## **Bottleneck?**

With huge orders for national defense and private industry placing a severe strain upon productive capacity, many engineers, perhaps even you, have become reconciled to accepting delays that seem unavoidable.

Fortunately, AMPEREX facilities are restricted solely to the design and manufacture of vacuum transmitting tubes.

Here you'll find thousands of "bottles." But not a single engineering or production "bottleneck."

AMPEREX is a transmitting tube manufacturer with no other interests to divert it from maintaining its rigid standards. No promises of greener pastures elsewhere can lure it from this concentration of effort.

AMPEREX has met and will continue to meet all demands upon its engineering and production facilities. Provided these demands are for tubes.

More than one hundred types of tubes for use in commercial broadcasting, point to point communication, ultra high frequency transmission, electro medical apparatus high voltage rectification and many industrial applications.

AMPEREX remains your immediate and dependable source of supply.

**AMPEREX ELECTRONIC PRODUCTS, Inc.**

**WASHINGTON STREET**

**BROOKLYN, NEW YORK**

**DIVISION DE EXPORTACION: 100 VARICK STREET, NEW YORK, E. U. A. CABLEGRAMAS: "ARLAB".**

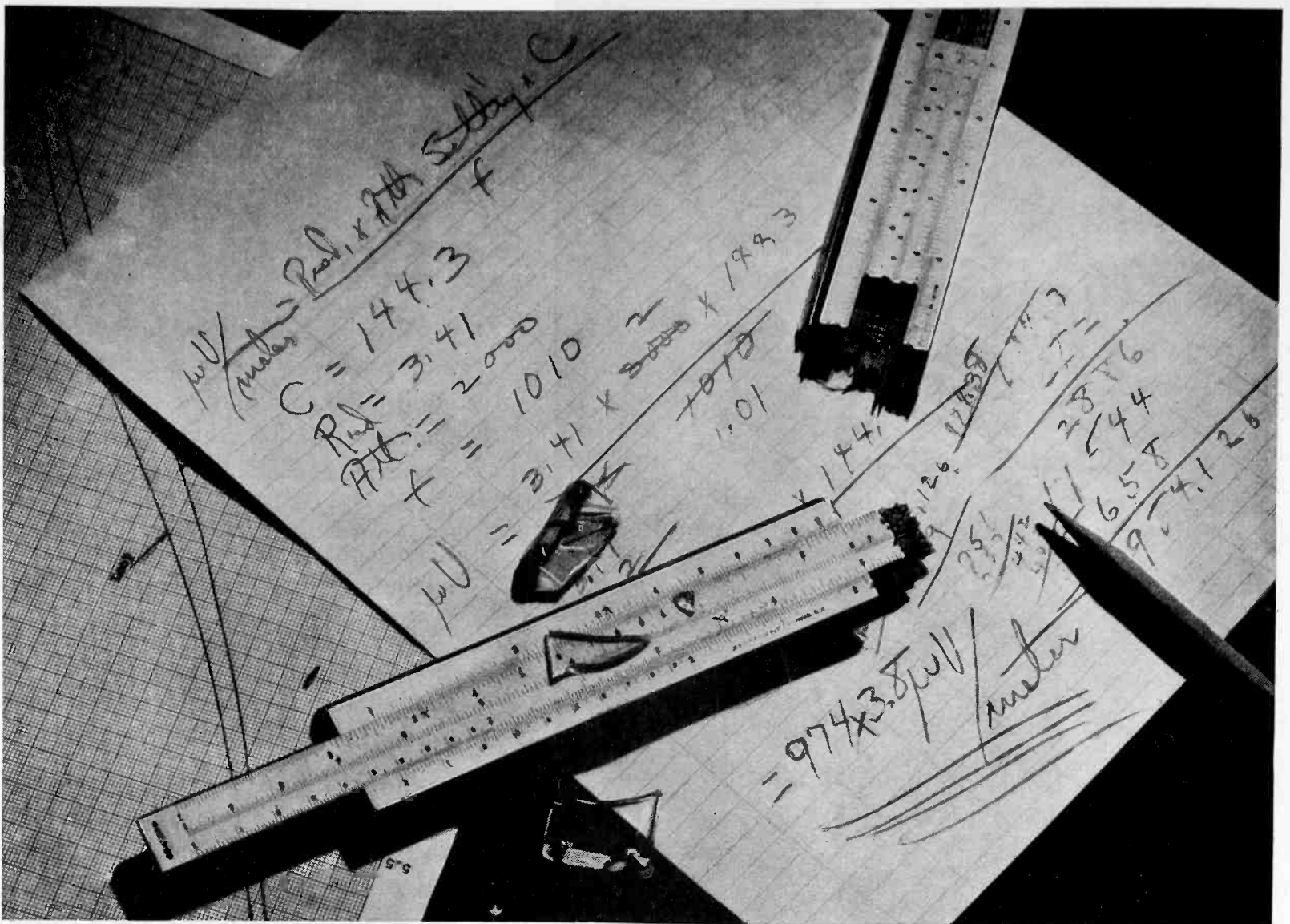

# HERE'S AN END TO CALCULATIONS!

## New RCA Direct-Reading Field Intensity Meter

PUT away your slide-rule and the much-nibbled pencil... here's a wide-range, *direct-reading* instrument that measures radio-signal field intensities *without* calculations—the new RCA Model 308-A! It's easy to carry and simple to use... and *more* accurate than any previous portable measurement system.

Coverage surveys as well as proof of performance tests on directional antenna systems are easy with the 308-A. To make a measurement takes only a moment—you can cover more territory per hour.

Three easily interchangeable shielded loops cover 6 bands—120 kcs. to 18,000 kcs. Wide intensity-range, from 20 microvolts per meter to 10 volts per meter, permits measurement of signals barely above the noise-level... or within a stone's throw of the antenna itself!

*Write for complete data and descriptive literature on this time-saving new RCA instrument.*

Use RCA Tubes in your measuring equipment for greater precision.

- ★ Reads directly in Microvolts per Meter
- ★ Light-Weight — Portable — Convenient
- ★ Wide, Accurate Frequency Range: 120 to 18,000 Kc.
- ★ Wide Intensity Range: 20 microvolts to 10 volts/meter

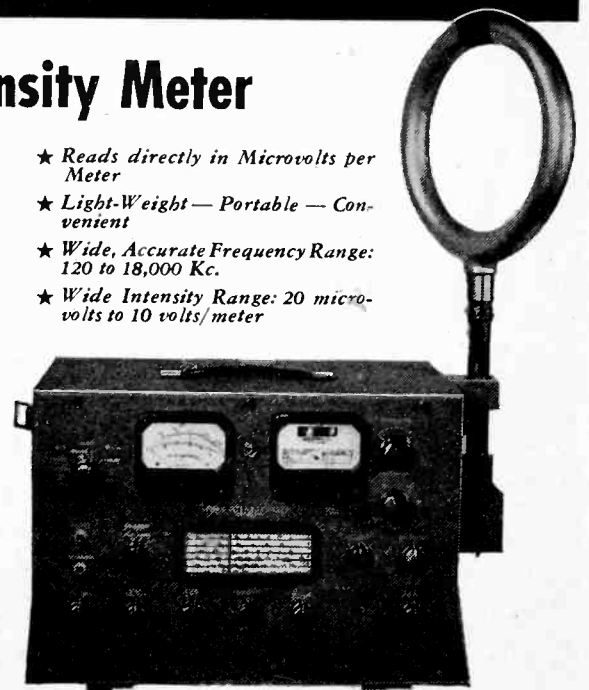

# Measuring Equipment

RCA Mfg. Co., Inc., Camden, N. J. • A Service of the Radio Corporation of America



# The INSULATED RESISTOR *Marches On!*



**T**his chart depicts the sales growth of Type BT and Type BW Insulated Resistors since 1934 when IRC pioneered and introduced bakelite insulation construction in the resistance field. Based on the sale of many millions of units the first year, it shows plainer than words the rapidity of the trend toward the use of insulated resistors. Based to a major extent on sales to the largest, most exacting buyers in the radio and electrical industries, it proves beyond question the ability of this modern and exclusively IRC resistance development to combine economy with dependability.

**INTERNATIONAL RESISTANCE COMPANY**  
431 North Broad St. Philadelphia, Pa.



## INSULATED RESISTORS

Type BT ("Metallized" Element)

Type BW (Wire Wound)



# HIGH STRENGTH AND LOW

# DIELECTRIC LOSS

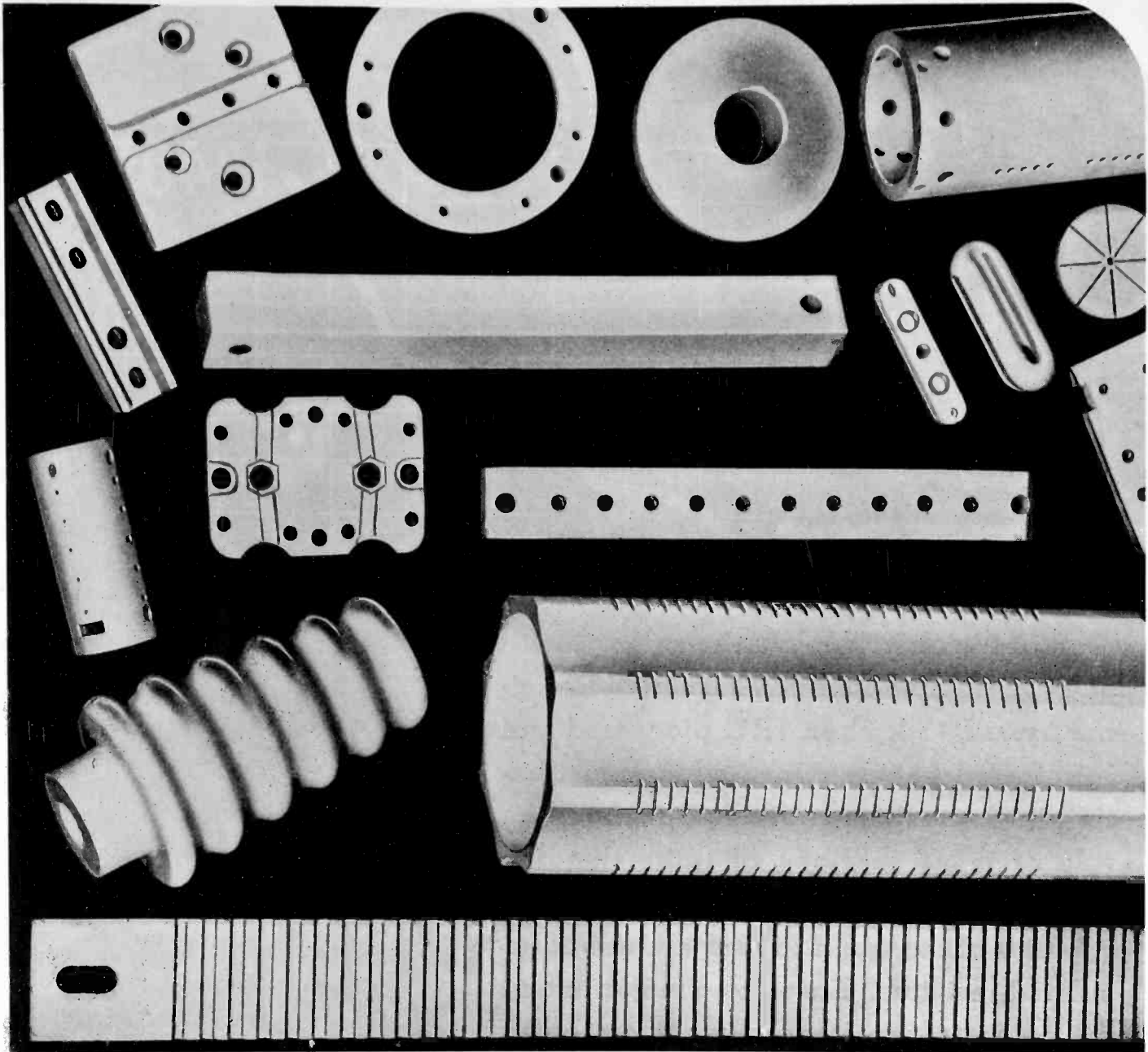

ALSiMAG insulation, custom-built to your design, offers two outstanding advantages. ALSiMAG is one of the strongest ceramic materials available. Its low dielectric loss is seldom equaled.

You may choose from a wide variety of "bodies" of different physical character-

istics. The ALSiMAG Property Chart (which will be sent you on request) gives accurate and complete physical properties.

Custom-building enables you to have pieces that work to best advantage in your product. Your blue print is followed accurately.

Your inquiry will bring the complete story.

## ALSiMAG

Trade Mark Reg. U.S. Pat. Off.

FROM CERAMIC HEADQUARTERS

AMERICAN LAVA CORPORATION • CHATTANOOGA • TENNESSEE  
CHICAGO • CLEVELAND • NEW YORK • ST. LOUIS • LOS ANGELES • SAN FRANCISCO • BOSTON • PHILADELPHIA • WASHINGTON, D. C.

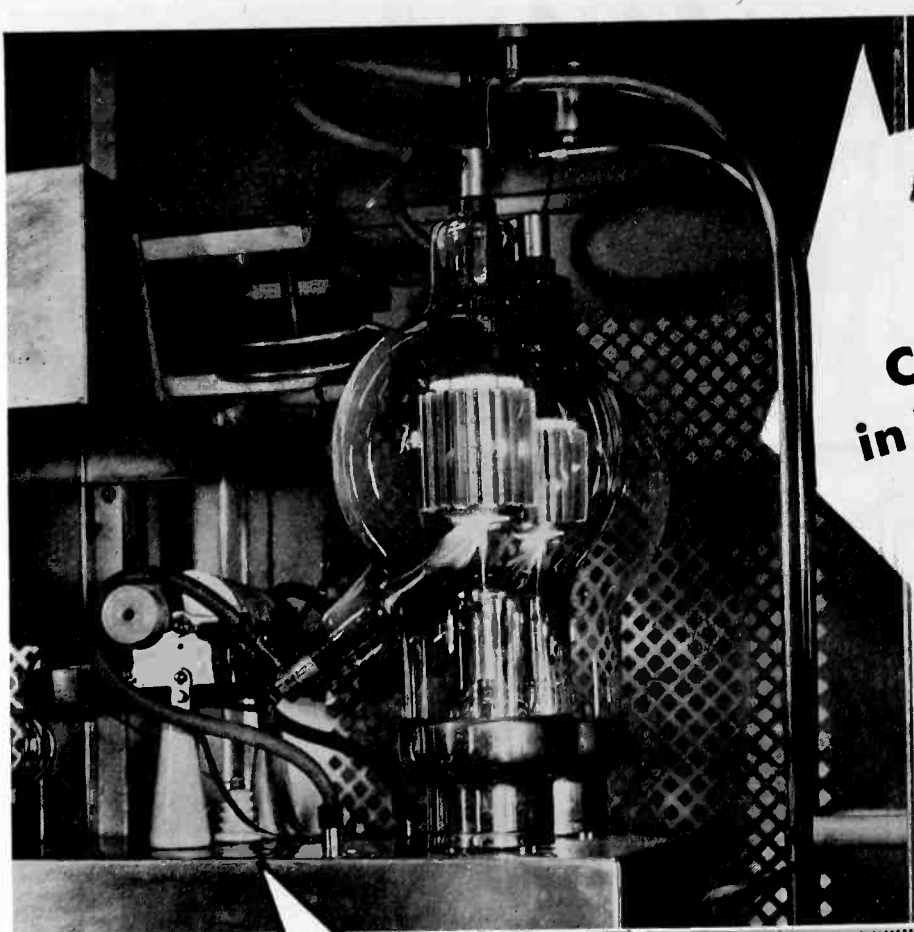

**ZENITH**  
**RADIO**  
 Chooses the Zenith  
 in Vacuum Tubes for FM  
 Eimac 1500T Tubes tried  
 and proven for the job

**ZENITH**  
 RADIO  
 LONG DISTANCE  
 TRADE MARK REG.  
**1KW FM STATION**  
**W9XZR**  
 A pair of Eimac 1500T's in the  
 final driven by a pair of Eimac  
 152TL's and a pair of 35T's

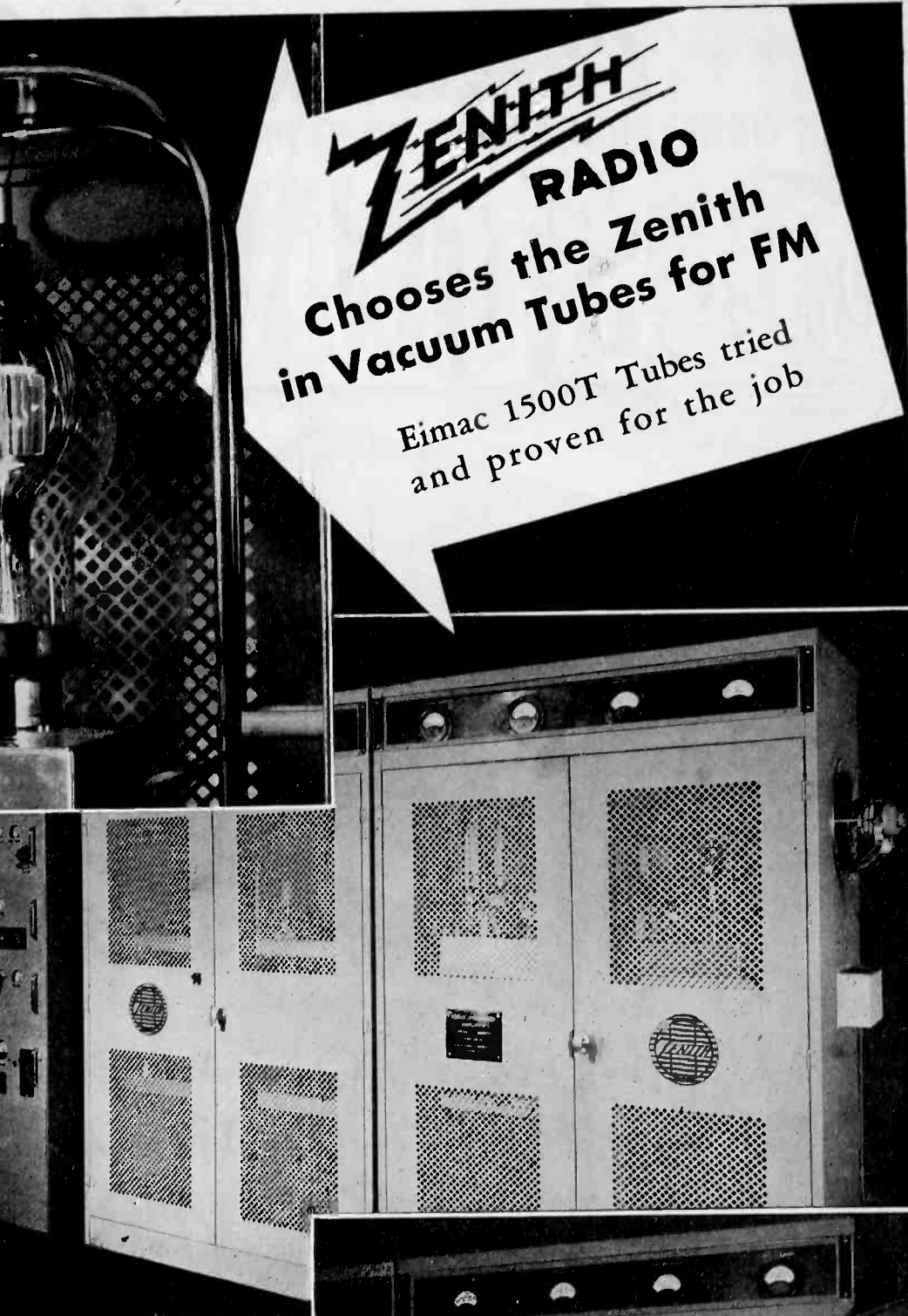

Zenith Radio Corporation in selecting Eimac tubes for their FM station took no chances with untried tubes. Eimac tubes have been in FM almost from the time experiments were begun. Major Edwin E. Armstrong's revolutionary Frequency Modulation scheme has put them to the tests for a matter of years. Now you can save time and money by simply following the leader in selecting the tubes for your new FM Station.

Eimac tubes have been consistently out in front in the outstanding NEW developments in radio. It will pay you to investigate their many advantages. See advertisement in September Electronics for list of representatives or write direct for further information.

In Use by  
 Practically  
 every Major  
 Airline

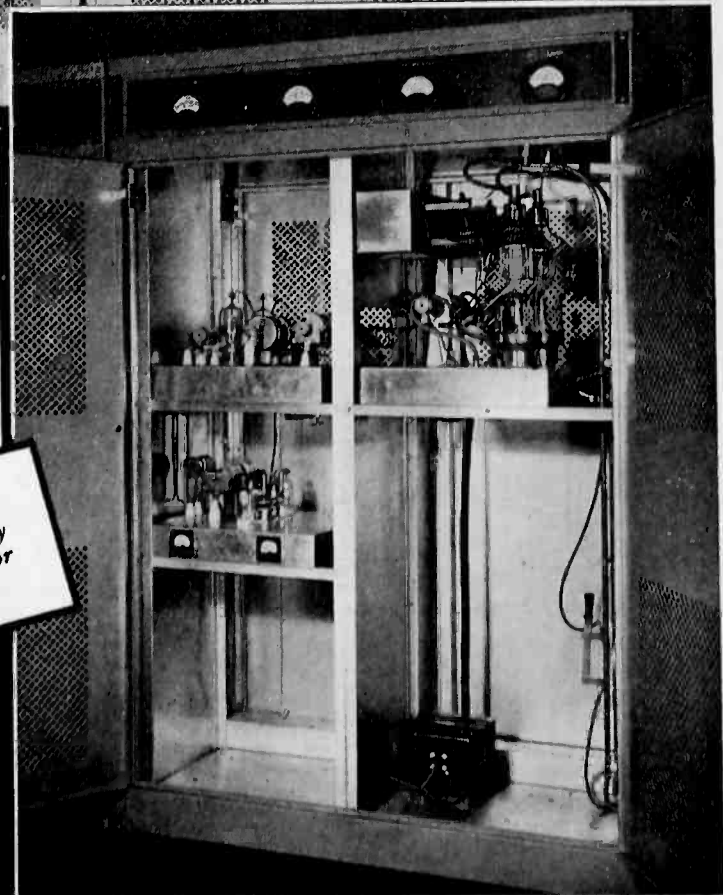

**Eimac**  
**TUBES**  
 EITEL-McCULLOUGH, INC. San Bruno, California

# Constant Voltage

FOR YOUR LABORATORY, YOUR PRODUCT, OR YOUR PRODUCTION LINE



# STEAD I-VOLT

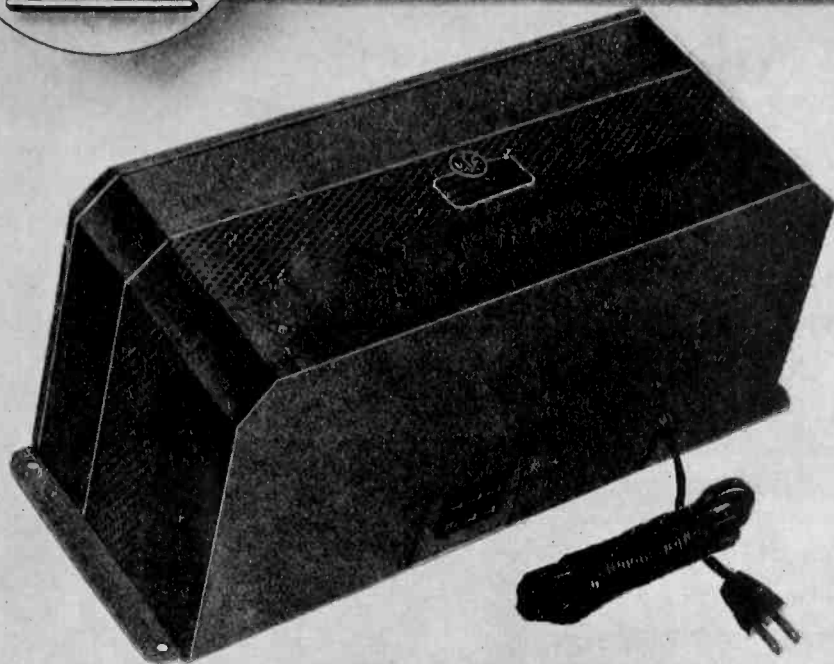

- ★ ACCURACY 1%
- ★ INDEPENDENT OF LOAD
- ★ NO MOVING PARTS
- ★ HIGH POWER FACTOR
- ★ HIGH EFFICIENCY
- ★ NEGLIGIBLE TIME CONSTANT
- ★ LOW DISTORTION
- ★ LOW TEMPERATURE RISE

## AUTOMATIC VOLTAGE REGULATORS 95-130 VOLT INPUTS . . . 110, 115, 120 VOLTS OUTPUT $\pm$ 1%

The UTC automatic voltage regulator is NEW. It involves no moving parts and effects instantaneous correction for either transient or chronic line voltage fluctuations.

### STANDARD TYPES

Type No.	Capacity VA — 60 Cyc.	Net Price
AR-1	15	\$12.00
AR-2	30	15.00
AR-3	60	21.00
AR-4	120	28.00
AR-5	250	46.00
AR-6	500	67.00
AR-7	1000	110.00
AR-8	2000	200.00

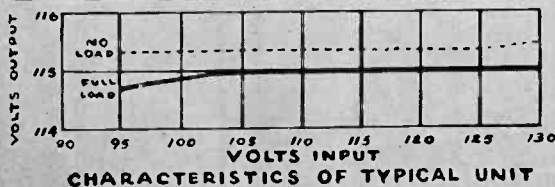

Designs for 220 volt service available at 25% increase in price, for 50 cycle units increase price 25%; for 42 cycles, 35% increase; for 25 cycles, increase price 100%. Special secondary voltages available to customers' specifications at small increase in price.

### SPECIAL UNITS

The unique design of these regulators makes possible the construction of special units with relative ease. The output can be arranged to provide filament and plate voltage, or any other special voltages that may be required. Write for details.



# UNITED TRANSFORMER CORP.

150 VARICK STREET ★ NEW YORK, N. Y.  
EXPORT DIVISION: 100 VARICK STREET NEW YORK, N. Y. CABLES: "ARLAB"



**PRACTICAL DATA**  
for those who design and  
build Transmitters . . .

**transmitting**  
**AEROVOX**  
**capacitor catalog**

Capacitors for the design, construction, testing and maintenance of radio transmitters, electronic devices, laboratory apparatus, fine instruments and similar work.

● This new loose-leaf catalog and engineering manual is available to engineers, designers and builders of commercial-grade transmitters, P-A systems, electronic and allied equipment. It contains page after page of listings of extra-quality heavy-duty capacitors of such types as mica, paper, oil, and plug-in electrolytics, of particular interest to those who build to last and to safeguard envious reputations.

Aerovox has extended its already outstandingly complete choice to include these extra-quality heavy-duty capacitors. What were special types yesterday now become standard Aerovox capacitors today, in taking care of the most critical buyers of radio components.

A copy of this limited-edition Aerovox Transmitting Capacitor Catalog is available *only* to professional engineers, designers or builders of radio or electronic equipment, writing us on their business letterhead.

**AEROVOX CORPORATION**  
*New Bedford, Mass.*

Sales Offices in All Principal Cities

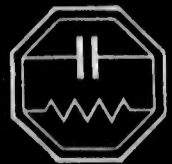

A  
C  
C  
U  
R  
A  
T  
E

*Bliley*

D  
E  
P  
E  
N  
D  
A  
B  
L  
E



Bliley Quartz Crystals and Mountings are precision-made for all frequencies between 20Kc. and 30Mc. Catalogue G-11 describes the complete line. Write for your copy.

# QUARTZ CRYSTALS

FOR GENERAL COMMUNICATION FREQUENCIES

## BLILEY ELECTRIC COMPANY

UNION STATION BUILDING

ERIE, PA.

# DAVEN

The Most Complete Line of  
Precision Attenuators  
in the World

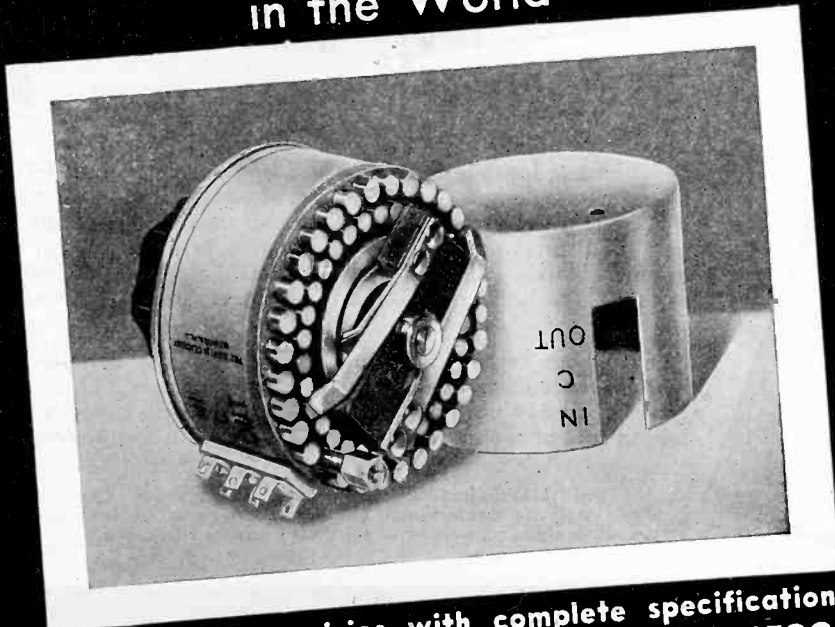

Send us your inquiries with complete specifications.  
We can probably fill your requirements FROM STOCK.

## THE DAVEN COMPANY

158 SUMMIT STREET NEWARK, NEW JERSEY

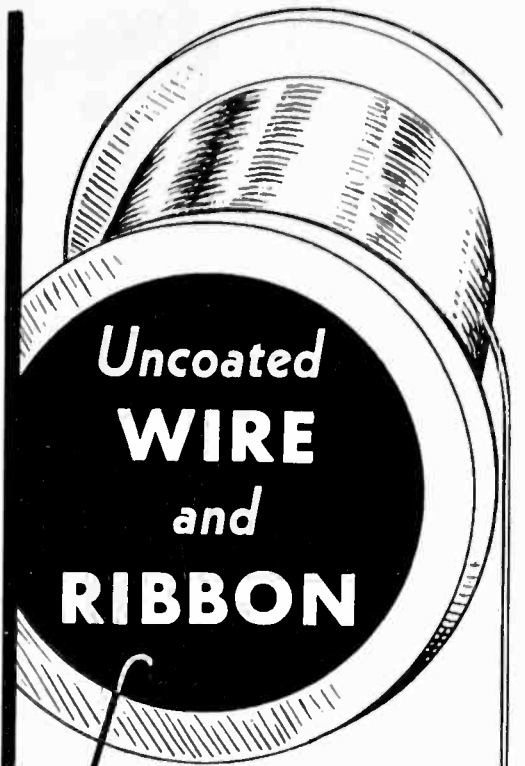

# Uncoated WIRE and RIBBON

for direct Heated  
**ELECTRON  
EMITTERS**  
in VACUUM TUBES



All specifications rigidly controlled from ingot to finished product



A complete range of SIZES and ALLOYS for:

- TRANSMITTING TUBES
- RECEIVING TUBES
- BATTERY TUBES
- HEARING-AID TUBES



Close supervision assures:

- MAXIMUM EMISSIVITY
- CONSISTENT UNIFORMITY
- HIGHEST TENSILE STRENGTH

WIRES—drawn to .0004" diameter

RIBBON—rolled to .0001" diameter

Special Alloys made to individual specifications—Write for list of stock alloys

## SIGMUND COHN

44 GOLD ST. NEW YORK

SINCE  1901

# IRE membership offers many services to the radio engineer

**Proceedings**—An outstanding publication in the radio engineering field. Over a quarter of a century of service to the world in publishing important radio engineering discoveries and developments, the PROCEEDINGS presents exhaustive engineering data of use to the specialist and general engineer. A list of its authors is a "Who's Who" of the leaders in radio science, research, and engineering.

**Standards**—Since 1914 our standards reports have stabilized and clarified engineering language, mathematics, graphical presentations, and the testing and rating of equipment. They are always in the process of revision and thus remain up to date.

**Meetings**—In twenty-two cities in the United States and Canada, meetings of the Institute and its sections are held regularly. Scores of papers on practically every branch of the field are presented and discussed. Several convention meetings are sponsored by the Institute and add materially to its effectiveness in distributing data of value to engineers.

## The Institute of Radio Engineers

Incorporated

330 West 42nd Street, New York, N.Y.

To the Board of Directors

Gentlemen:

I hereby make application for ASSOCIATE membership in the Institute of Radio Engineers on the basis of my training and professional experience given herewith, and refer to the sponsors named below who are personally familiar with my work.

I certify that the statements made in the record of my training and professional experience are correct, and agree if elected, that I shall be governed by the Constitution of the Institute as long as I continue a member. Furthermore I agree to promote the objects of the Institute so far as shall be in my power.

.....  
(Sign with pen)

.....  
(Address for mail)

.....  
(City and State)

.....  
(Date)

### SPONSORS

(Signatures not required here)

Mr. ....

Address .....

City and State .....

Mr. ....

Address .....

City and State .....

Mr. ....

Address .....

City and State .....



# Associate membership affiliates you with the Institute and brings you the PROCEEDINGS each month as well as notices of meetings held near you.

(Typewriting preferred in filling in this form) No.....  
**RECORD OF TRAINING AND PROFESSIONAL EXPERIENCE**

Name .....  
 (Give full name, last name first)

Present Occupation .....  
 (Title and name of concern)

Business Address .....

Home Address .....

Place of Birth ..... Date of Birth ..... Age .....

Education .....

Degree .....  
 (College) (Date received)

**TRAINING AND PROFESSIONAL EXPERIENCE**  
 (Give dates and type of work, including details of present activities)

---

---

---

---

---

---

---

---

---

---

---

---

---

---

---

---

---

---

---

---

---

---

---

---

Record may be continued on other sheets this size if space is insufficient.

Receipt Acknowledged ..... Elected ..... Notified .....

**Requirements**—For Associate membership, an applicant must be at least twenty-one years of age, of good character, and be interested in or connected with the study or application of radio science or the radio arts.

**Sponsors**—Three sponsors who are familiar with the work of the applicant must be named. Preferably these should be Associates, Members, or Fellows of the Institute. In cases where the applicant is so located as not to be known to the required number of member sponsors, the names of responsible nonmember sponsors may be given.

**Dues**—Dues for Associate membership are six dollars per year. The entrance fee for this grade is three dollars and should accompany the application.

**Other Grades**—Those who are between the ages of eighteen and twenty-one may apply for Junior grade. Student membership is available to full-time students in engineering or science courses in colleges granting degrees as a result of four-year courses. Member grade is open to older engineers with several years of experience. Information on these grades may be obtained from the Institute.

---

---

# COMPLETE YOUR FILES OF

## PROCEEDINGS of The Institute of Radio Engineers

### WHILE BACK ISSUES ARE STILL AVAILABLE

Now is the time to fill out the gaps on your *Proceedings* shelf and replace lost or borrowed copies. Already, more than 25% of all back numbers are no longer available. Order from the following list (subject, of course, to prior sale) :

1913-1915	Volumes 1-3	Quarterly	\$1.00 per copy		
1913	Vol. 1	Jan. (a reprint).	1915	Vol. 3	Dec.

1916-1926	Volumes 4-14	Bi-monthly	\$1.00 per copy		
1916	Vol. 4	June, Aug.	1922	Vol. 10	All 6 issues
1917	Vol. 5	Apr., June, Aug., Oct., Dec.	1923	Vol. 11	All 6 issues
1918	Vol. 6	Feb., Apr., June, Aug., Dec.	1924	Vol. 12	Aug., Oct., Dec.
1919	Vol. 7	Apr., Dec.	1925	Vol. 13	Apr., June, Aug., Oct., Dec.
1920	Vol. 8	Apr., June, Aug., Oct., Dec.	1926	Vol. 14	All 6 issues
1921	Vol. 9	All 6 issues			

1927-1940	Volumes 15-28	Monthly	\$1.00 per copy		
1927	Vol. 15	Apr. to July, inc., Oct., Dec.	1934	Vol. 22	All 12 issues
1928	Vol. 16	Feb. to Dec., inc.	1935	Vol. 23	All 12 issues
1929	Vol. 17	Apr. to June, inc., Aug., Dec.	1936	Vol. 24	Jan. to April, inc., June
1930	Vol. 18	Jan., Feb., Apr. to Dec., inc.	1937	Vol. 25	Feb. to Dec., inc.
1931	Vol. 19	All 12 issues	1938	Vol. 26	All 12 issues
1932	Vol. 20	Jan., March to Dec., inc.	1939	Vol. 27	All 12 issues
1933	Vol. 21	All 12 issues.	1940	Vol. 28	Jan. to date

#### I.R.E. MEMBERS . . . PUBLIC AND COLLEGE LIBRARIES

I.R.E. members in good standing are entitled to a discount of 25% from the above prices. Information about discounts to accredited public and college libraries will be supplied on request.

#### POSTAGE

Prices include postage in the United States and Canada. Postage to other countries: 10 cents per copy.

Remittance should accompany your order

THE INSTITUTE OF RADIO ENGINEERS, Inc.  
330 WEST 42nd STREET, NEW YORK, N. Y.

# TRIPLET POCKET SIZE

## "Little Triplets"

The Little Testers with the Big 3-Inch Instruments



MODEL 666

AC - DC Pocket Size Volt-Ohm-Milliammeter  
Dealer Net Price . . . \$14.00



MODEL 670

AC Ammeter . . .  
0-1; 0-2.5; 0-5;  
0-10; 0-25  
Dealer Net Price  
\$9.00



MODEL 671

Five ranges: 0-5;  
0-10; 0-25; 0-50;  
0-100; 0-250;  
0-500; 0-1000;  
AC Milliamperes  
Dealer Net  
Price . . . \$9.00

The "Little Triplets" comprise a series of matched instruments available in single units or in combination to answer every servicing or electrical analyzing problem. Models available in addition to the above are as follows:

- Model 672—0-150; 0-300; 0-750 AC Volts . . . \$9.00 Dealer Net
- Model 673—0.5; 0-10; 0-25; 0-50; 0-100; 0-250; 0-500; 0-1000 AC Volts (Rectifier type) . . . \$9.00 Dealer Net
- Model 674—0-1; 0-2.5; 0-5; 0-10; 0-25 DC Amperes, \$9.00 Dealer Net
- Model 675—0-1; 0-5; 0-10; 0-25; 0-100; 0-250; 0-500; 0-1000 DC Milliamperes, \$9.00 Dealer Net
- Model 676—0.50; 0-100; 0-250; 0-500; 0-1000 DC Microamperes, \$9.00 Dealer Net
- Model 677—0-1; 0-2.5; 0-5; 0-10; 0-25; 0-50; 0-100; 0-250; 0-500; 0-1000 DC Volts at 1000 ohms per volt . . . \$9.00 Dealer Net
- Model 678 Ohmmeter, Self-contained batteries for 0-1000 Ohms (10 Ohms Center Scale) 0-10,000 Ohms (100 Ohms Center Scale); 0-100,000 Ohms; 0-1 Megohm; 0-10 Megohms . . . \$9.00 Dealer Net

For full cooperation with the National Defense Program, Triplet engineering and production facilities are being rapidly expanded to continue the service and delivery to which our trade is accustomed.

Write for Catalog—  
Section 2111, Harmon Drive

**TRIPLET ELECTRICAL INSTRUMENT CO.**  
Bluffton, Ohio

## INDEX DISPLAY ADVERTISERS

### A

- Aerovox Corporation . . . . .vii
- American Lava Corporation . . . . .iv
- American Telephone & Telegraph Company . . . . .xiii
- Amperex Electronic Products, Inc. . . . .i

### B

- Bliley Electric Company . . . . .viii

### C

- Cohn, Sigmund . . . . .viii
- Cornell-Dubilier Electric Corporation . . . . .xiv
- Coward-McCann, Inc. . . . .xii

### D

- Daven Company . . . . .viii

### E

- Eitel-McCullough, Inc. . . . .v

### G

- General Radio Company . . . . .Cover IV

### I

- International Resistance Company . . . . .iii

### R

- RCA Manufacturing Company, Inc. . . . .ii, Cover III

### T

- Triplet Electrical Instrument Company . . . . .xii

### U

- United Transformer Corporation . . . . .vi

## He Fought Your Battle!

"... It is ironic that among the hundreds of thousands of young radio engineers whose commonplaces of theory rest on what Professor Fessenden fought for bitterly and alone, only a handful realize that the battle ever happened."

—From an editorial in  
*The New York Herald Tribune*

Get the book that tells the true story of America's greatest Radio Pioneer—

# FESSENDEN

## BUILDER of TOMORROWS

by

**Helen M. Fessenden**

As a radio engineer you owe it to yourself to know the human as well as the scientific side of the development of your industry—and of the life-long and triumphant fight that this man made to put across the ideas that make modern radio possible. Here for the first time is the whole story of Fessenden.

### THE MAN WHO:

- Invented the wireless telephone.
- Made the first radio broadcast in history.
- First spanned the Atlantic with two-way radio.
- Revolutionized navigation by the electric depth-finder for ships and the wireless compass.
- Solved the problem of the U-Boat menace in the last war.
- Blazed the trail in short-wave radio.

Here, for the first time, is the authentic story of America's greatest radio pioneer—Reginald A. Fessenden, one of the most interesting personalities in modern science. It shows the principles underlying his work and pictures the early trials of an industry that has become, largely through his amazing vision, the world-changing force it is today. An exciting biography, this book reveals frankly what happens to the independent inventor who pits himself against Big Business. Portrait frontispiece. Map end-papers. \$3.00

**COWARD-McCANN, INC.**  
2 West 45th Street, New York



# Courtesy



We want your telephone service to be good and quick and cheap. But there's more to it than that. We want it to be courteous too.

No matter what the occasion, there's always time for a cheery "please" and a pleasant word of thanks. That is the Bell System way. It is one of the fine traditions of the telephone business.

**BELL TELEPHONE SYSTEM**



**PREPAREDNESS—THE BELL SYSTEM IS PREPARED TO DO ITS PART IN THE NATION'S PROGRAM OF NATIONAL DEFENSE**

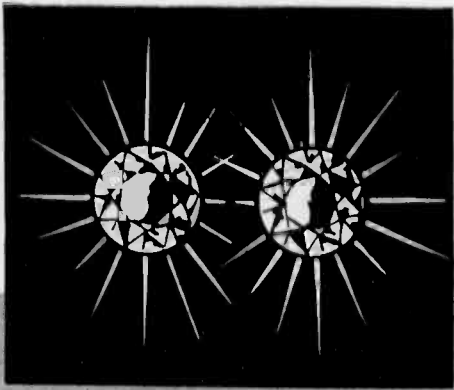

TO YOU these diamonds may look alike. But to the diamond expert, able to see beyond surface similarities, there is a difference in quality. And so it is with capacitors. The things that lie *hidden* are the things that count most in determining value.

# HIDDEN EXTRAS!

*That's the difference...*

AND THAT'S THE REASON FOR THE  
EXTRA PERFORMANCE IN C-D CAPACITORS

**M**OST capacitors look alike. But engineers know there's a big difference in C-Ds. Built into these capacitors are extra quality ... long life ... economy — extra VALUE! Specify Cornell-Dubilier capacitors and enjoy these hidden extras at no extra cost. Learn what a difference thirty years of capacitor specialization can make. Learn why there are more Cornell-Dubilier capacitors in use today than any other make — proof of extra stamina, stability, and surviving soundness in C-Ds.

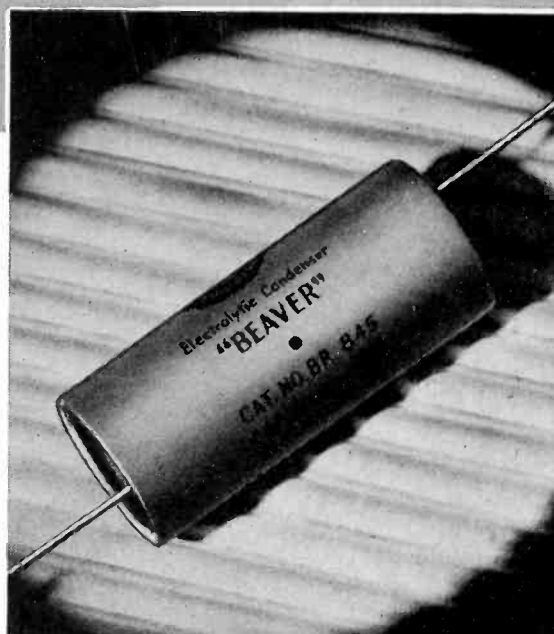

Only Cornell-Dubilier Electrolytics offer all these EXTRA FEATURES!

- Special high voltage paper separator
- C-D etched plate
- Special C-D electrolyte
- Special high formation process



For complete technical information, write for engineering bulletin 170.

**CORNELL-DUBILIER  
ELECTRIC CORPORATION**

1006 HAMILTON BLVD. • SO. PLAINFIELD, N. J.

**REMEMBER!** Only C-D union-made capacitors give you the EXTRAS at no extra cost.

*Get the extras*

— WITH CORNELL-DUBILIER CAPACITORS!



# 36 TYPES = 27,000,000 TUBES

## FOR 5,000,000 OF THIS YEAR'S NEW RECEIVERS!

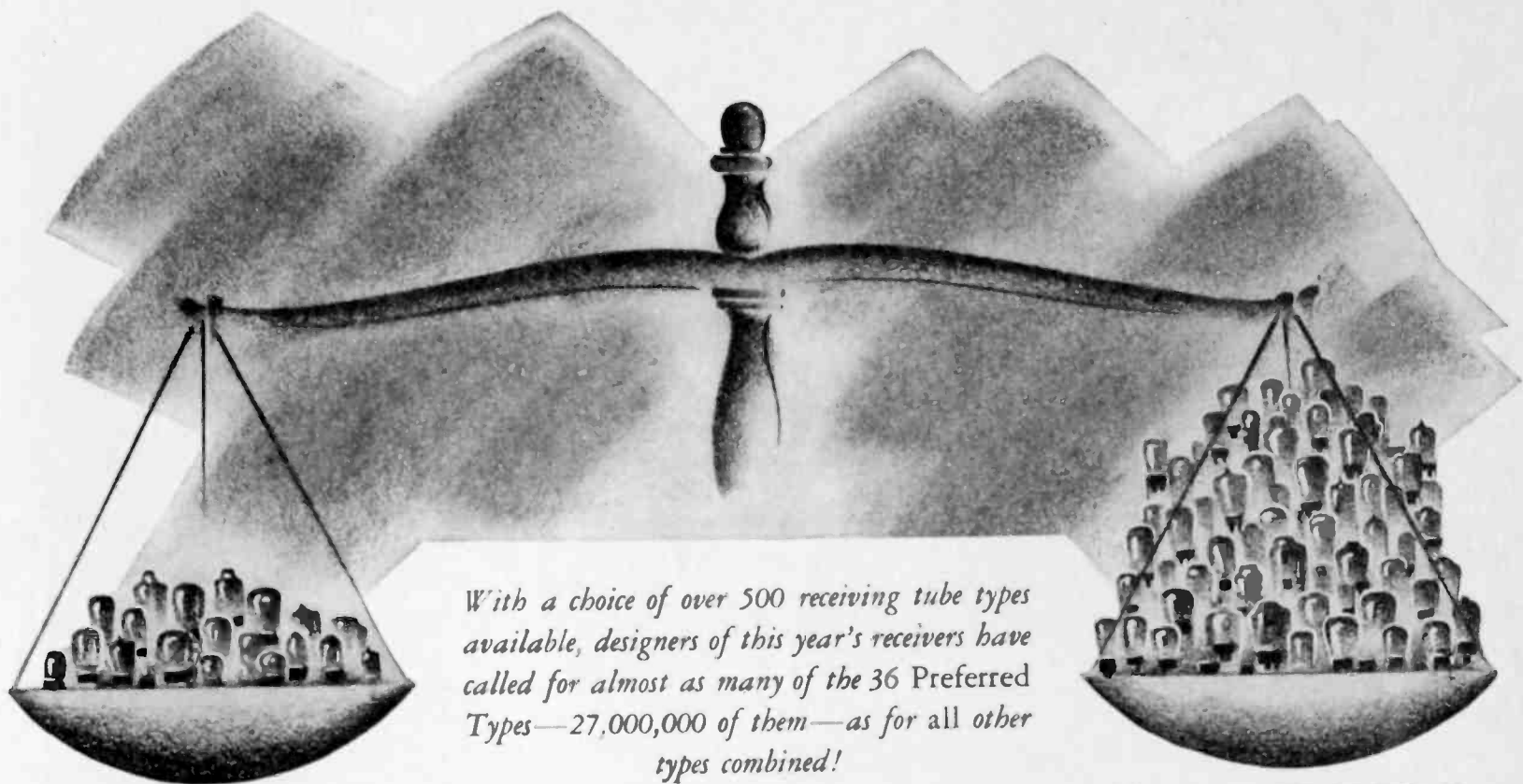

*With a choice of over 500 receiving tube types available, designers of this year's receivers have called for almost as many of the 36 Preferred Types—27,000,000 of them—as for all other types combined!*

**"36 PREFERRED TYPES"**

**"490 OTHER TYPES"**

OF ALL RCA TUBES now being supplied to set manufacturers for new radios, *better than 9 out of 10* are now Preferred Types! Of all tubes of *every* make, by *every* tube manufacturer supplying tubes for new radios, nearly half are Preferred Type numbers!

This is a good thing! Good for us. Good for *you*. It means that this year's 5,000,000 receivers using Preferred Type Tubes will simplify replacement-tube inventories for distributor, dealer and serviceman alike...will give increased turnover of fewer, faster-moving tube types—faster deliveries, from manufac-

turers' stock—and better, more uniform tubes!

18 important radio manufacturers have endorsed and adapted the RCA Preferred Type Tubes Program because they, too, have benefited. Practically any type of receiver can be designed for finest performance at lowest ultimate cost. The RCA Preferred Type Tubes Program is not only the *best* suggestion ever advanced to solve the headache of "too many tube types"...it is the *only* constructive step so far offered! It deserves your support—for your own benefit!

*Over 380 million RCA Radio Tubes have been purchased by radio users.*



# Preferred Type Tubes

RCA MANUFACTURING CO., INC., CAMDEN, N. J.  
A Service of the Radio Corporation of America



# New WAVEMETER for ULTRA-HIGH FREQUENCIES

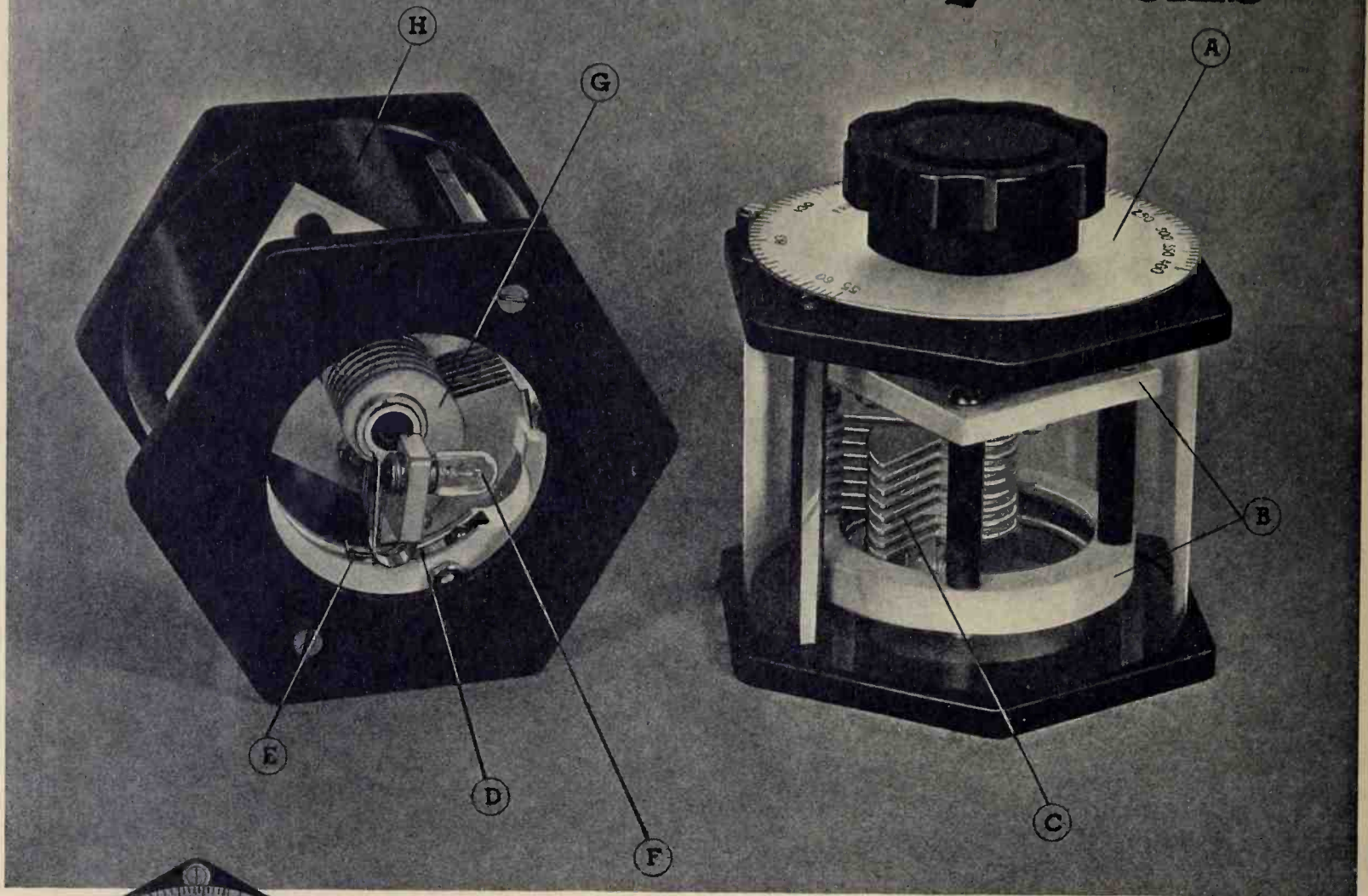

Direct-reading dial calibrated from 55 to 400 Mc, with open scale. Six-sided end plates for resting wavemeter horizontally in a number of positions

## From 55 to 400 Megacycles

**F**OR SOME TIME there has been an increasing demand for a simple, small, accurate and portable wavemeter of the tuned-circuit absorption type for use at the very high frequencies. General Radio now announces the new Type 758-A Wavemeter to meet these needs.

Unique design involves the use of a variable single-turn inductance the value of which is changed continuously as the capacitance is changed. The condenser shaft is equipped with a positive sliding contact which bears on a single turn of flat strip, thus changing capacitance and inductance simultaneously and providing an enormous frequency range from a single coil.

When used with circuits generating some power a lamp indicator, coupled to the wave-meter circuit through a fixed loop, is used for resonance indication. For measuring very low power oscillators or receiving circuits, resonance is indicated by the usual absorption-type wavemeter means such as plate or grid milliammeter dip.

### Design and Construction Features Include:

- A EXTREMELY WIDE RANGE**—55 Mc to 400 Mc
- B GOOD INSULATION**—Isolantite of small area
- C NEW CONDENSER**—extra heavy, silver-plated brass plates
- D SINGLE TURN INDUCTOR**—flat silver strip securely fixed in Isolantite ring
- E VARIABLE INDUCTANCE**—2-finger silver spring making low resistance contact with single turn
- F LAMP RESONANCE INDICATOR**—small lamp coupled to wave-meter circuit through fixed loop
- G STRAIGHT-FREQUENCY-LINE PLATES**—of heavy construction
- H TRANSPARENT PROTECTIVE CASE**—resonant illumination of lamp can be seen in any position of wavemeter

*This wavemeter, with an accuracy of 2%, is priced at only \$28.00*

**WRITE FOR BULLETIN 627 FOR INFORMATION**

# GENERAL RADIO COMPANY

**CAMBRIDGE, MASSACHUSETTS**  
Branches in New York and Los Angeles



