

# Proceedings

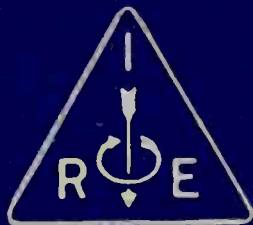

*of the*

# I·R·E

OCTOBER 1940

VOLUME 28

NUMBER 10

Radio Transmission Anomaly  
Generation of Spurious Signals  
Transmitter Design for Frequency  
Modulation  
Portable Television Pickup  
Equipment  
Sharpness of Simulated Television  
Images  
Propagation of Ultra-Short Radio  
Waves  
Coil Reactance in the 100-Mc  
Region  
Short-Wave Loop Aerials  
Ionospheric Transmission

Institute of Radio Engineers



Sixteenth Annual Convention  
New York, N.Y., January 9, 10, and 11, 1941  
Joint Meeting with American Section, International Scientific  
Radio Union, Washington, D.C., May 2, 1941

SECTION MEETINGS

ATLANTA January 17	DETROIT January 17	PITTSBURGH January 13
CLEVELAND January 21	LOS ANGELES January 21	WASHINGTON January 13
	PHILADELPHIA January 2	

SECTIONS

- ATLANTA—Chairman, P. C. Bangs; Secretary, Adolph Andersen, Federal Communications Commission, 411 Federal Annex, Atlanta, Ga.
- BALTIMORE—Chairman, Ferdinand Hamburger; Secretary, G. J. Gross, Pennsylvania Water and Power Co., 1611 Lexington Bldg., Baltimore, Md.
- BOSTON—Chairman, W. L. Barrow; Secretary, P. K. McElroy, General Radio Co., 30 State St., Cambridge, Mass.
- BUENOS AIRES—Chairman, A. T. Cosentino; Secretary, W. J. Andrews, Cia. Standard Electric Argentina, Cangallo 1286, Buenos Aires, Argentina.
- BUFFALO-NIAGARA—Chairman, B. E. Atwood; Secretary, Leroy Fiedler, 98 West Ave., Lockport, N. Y.
- CHICAGO—Chairman, E. H. Kohler; Secretary, P. C. Sandretto, United Air Lines Transport Co., 5936 S. Cicero Ave., Chicago, Ill.
- CINCINNATI—Chairman, C. H. Topmiller; Secretary, W. L. Schwesinger, WSAI, Cincinnati, Ohio.
- CLEVELAND—Chairman, R. L. Kline; Secretary, J. D. Woodward, WGAR, Hotel Statler, Cleveland, Ohio.
- CONNECTICUT VALLEY—Chairman, K. A. McLeod; Secretary, W. M. Smith, 250 Main St., Suffield, Conn.
- DETROIT—Chairman, J. D. Kraus; Secretary, Paul Frincke, WJBK, 6559 Hamilton Ave., Detroit, Mich.
- EMPORIUM—Chairman, C. R. Smith; Secretary, H. L. Ratchford, Hygrade Sylvania Corp., Emporium, Pa.
- INDIANAPOLIS—Chairman, Arthur Curtis; Secretary, B. V. K. French, P. R. Mallory & Co., E. Washington St., Indianapolis, Ind.
- LOS ANGELES—Chairman, A. C. Packard; Secretary, J. N. A. Hawkins, 3239 Laclede Ave., Los Angeles, Calif.
- MONTREAL—Chairman, H. M. Smith; Secretary, W. A. Nichols, Canadian Broadcasting Corp., 1012 Keefer Bldg., Montreal, Que.
- NEW ORLEANS—Chairman, G. H. Peirce; Secretary, D. W. Bowman, 8327 Sycamore St., New Orleans, La.
- PHILADELPHIA—Chairman, C. M. Burrill; Secretary, R. L. Snyder, 103 Franklin Rd., Glassboro, N. J.
- PITTSBURGH—Chairman, R. E. Stark; Secretary, M. G. Jarrett, Bell Telephone Company of Pennsylvania, Pittsburgh, Penna.
- PORTLAND—Chairman, Marcus O'Day; Secretary, Earl Schoenfeld, 1627 S. E. Elliott Ave., Portland, Ore.
- ROCHESTER—Chairman, H. C. Sheve; Secretary, O. L. Angevine, Jr., Stromberg-Carlson Telephone Manufacturing Co., Rochester, N. Y.
- SAN FRANCISCO—Chairman, Carl Penther; Secretary, H. E. Held, 420 Market St., San Francisco, Calif.
- SEATTLE—Chairman, R. M. Walker; Secretary, L. B. Cochran, University of Washington, Seattle, Wash.
- TORONTO—Chairman, G. J. Irwin; Secretary, L. C. Simmonds, 301 King St., E., Toronto, Ont.
- WASHINGTON—Chairman, L. C. Young; Secretary, E. M. Webster, Federal Communications Commission, Rm. 5319, New Post Office Bldg., Washington, D. C.

BOARD OF DIRECTORS  
 Lawrence C. F. Horle, *President*  
 Frederick E. Terman,  
*Vice President*  
 Melville Eastham, *Treasurer*  
 Harold P. Westman, *Secretary*  
 Austin Bailey  
 W. R. G. Baker  
 Frederick W. Cunningham  
 Henry C. Forbes  
 Alfred N. Goldsmith  
 Virgil M. Graham  
 O. B. Hanson  
 Raymond A. Heising  
 C. M. Jansky, Jr.  
 Frederick R. Lack  
 Frederick B. Llewellyn  
 Haraden Pratt  
 Browder J. Thompson  
 Hubert M. Turner  
 Arthur F. Van Dyck  
 Harold A. Wheeler  
 Lynde P. Wheeler

BOARD OF EDITORS  
 Alfred N. Goldsmith, *Chairman*  
 Ralph R. Batcher  
 Philip S. Carter  
 Elmer W. Engstrom  
 Frederick W. Grover  
 J. Warren Horton  
 Greenleaf W. Pickard  
 Benjamin E. Shackelford  
 Karl S. Van Dyke  
 Harold P. Westman, *ex officio*  
 Harold A. Wheeler  
 Lynde P. Wheeler  
 Laurens E. Whittemore  
 William Wilson

PAPERS COMMITTEE  
 William Wilson, *Chairman*  
 Frederick B. Llewellyn,  
*Vice Chairman*  
 Herman A. Affel  
 Edmond Bruce  
 Howard A. Chinn  
 James K. Clapp  
 Tunis A. M. Craven  
 Robert B. Dome  
 Paul O. Farnham  
 Enoch B. Ferrell  
 Elmer L. Hall  
 Dorman D. Israel  
 Loren F. Jones  
 De Loss K. Martin  
 Harry B. Marvin  
 Harry R. Mimno  
 Albert F. Murray  
 Harold O. Peterson  
 Ralph K. Potter  
 Hubert M. Turner  
 Dayton Ulrey  
 Arthur F. Van Dyck  
 Paul T. Weeks  
 William C. White  
 Irving Wolff

Helen M. Stote, *Assistant Editor*  
 John D. Crawford,  
*Advertising Manager*

# Proceedings of the I·R·E

*Published Monthly by*  
 The Institute of Radio Engineers, Inc.

VOLUME 28	<i>October, 1940</i>	NUMBER 10
•		
A Radio Transmission Anomaly; Co-operative Observations between the United States and Argentina . . . . . J. H. Dellinger and A. T. Cosentino		431
The Generation of Spurious Signals by Nonlinearity of the Transmission Path . . . . . Austin V. Eastman and Lawrence C. F. Horle		438
A New Broadcast-Transmitter Circuit Design for Frequency Modulation . . . . . J. F. Morrison		444
The RCA Portable Television Pickup Equipment . . . . . G. L. Beers, O. H. Schade, and R. E. Shelby		450
The Subjective Sharpness of Simulated Television Images . . . . . M. W. Baldwin		458
Experiments on the Propagation of Ultra-Short Radio Waves . . . . . A. H. Waynick		468
The Measurement of Coil Reactance in the 100-Megacycle Region . . . . . Ferdinand Hamburger, Jr., and C. Frank Miller		475
Radiating Characteristics of Short-Wave Loop Aerials . . . . . Everard M. Williams		480
The Ionosphere and Radio Transmission, September, 1940, with Predictions for December, 1940 . . . . .		485
Institute News and Radio Notes Board of Directors Committees Sections Membership		487 487 487 487 492
Books "Television, The Electronics of Image Transmission," by V. K. Zworykin and G. A. Morton . . . . . Albert F. Murray		492
Contributors		495

Entered as second-class matter October 26, 1927, at the post office at Menasha, Wisconsin, under the Act of February 28, 1925, embodied in Paragraph 4, Section 538 of the Postal Laws and Regulations. Publication office, 450 Ahnaip Street, Menasha, Wisconsin. Subscription, \$10.00 per year; foreign, \$11.00.

## THE INSTITUTE

The Institute of Radio Engineers serves those interested in radio and allied electrical-communication fields through the presentation and publication of technical material. In 1913 the first issue of the PROCEEDINGS appeared; it has been published uninterruptedly since then. Over 1800 technical papers have been included in its pages and portray a currently written history of developments in both theory and practice.

### STANDARDS

In addition to the publication of submitted papers, many thousands of man-hours have been devoted to the preparation of standards useful to engineers. These comprise the general fields of terminology, graphical and literal symbols, and methods of testing and rating apparatus. Members received a copy of each report. A list of the current issues of these reports follows:

Standards on Electroacoustics, 1938  
Standards on Electronics, 1938  
Standards on Radio Receivers, 1938  
Standards on Radio Transmitters and Antennas, 1938.

### MEETINGS

Meetings at which technical papers are presented are held in the twenty-three cities in the United States, Canada, and Argentina listed on the inside front cover of this issue. A number of special meetings are held annually and include one in Washington, D. C., in co-operation with the American Section of the International Scientific Radio Union (U.R.S.I.) in April, which is devoted to the general problems of wave propagation and measurement technique, the Rochester Fall Meeting in co-operation with the Radio Manufacturers Association in November, which is devoted chiefly to the problems of broadcast-receiver design, the Pacific Coast Convention, which is held each year during the summer months and is supervised by a joint committee of our four Pacific Coast sections, and the Annual Convention, which will be held in New York City during January.

### MEMBERSHIP

Membership has grown from a few dozen in 1912 to more than five thousand. Practically every country in the world in which radio engineers may be found is represented in our membership roster. Approximately a quarter of the membership is located outside of the United States. There are several grades of membership, depending on the qualifications of the applicant. Dues range between \$3.00 per year for Students and \$10.00 per year for Members. PROCEEDINGS are sent to each member without further payment.

### PROCEEDINGS

The contents of each paper published in the PROCEEDINGS are the responsibility of the author and are not binding on the Institute or its members. Material appearing in the PROCEEDINGS may be reprinted or abstracted in other publications on the express condition that specific reference shall be made to its original appearance in the PROCEEDINGS. Illustrations of any variety may not be reproduced, however, without specific permission from the Institute.

Papers submitted to the Institute for publication shall be regarded as no longer confidential. They will be examined by the Papers Committee and Board of Editors to determine their suitability for publication. Suggestions on the mechanical form in which manuscripts should be prepared may be obtained from the Secretary.

### SUBSCRIPTIONS

Annual subscription rates for the United States of America, its possessions, and Canada, \$10.00; to college and public libraries when ordering direct, \$5.00. Other countries, \$1.00 additional.

The Institute of Radio Engineers, Inc.

Harold P. Westman, Secretary

330 West 42nd Street

New York, N.Y.



# A Radio Transmission Anomaly; Co-operative Observations between the United States and Argentina\*

J. H. DELLINGER†, FELLOW, I.R.E., AND A. T. COSENTINO‡, FELLOW, I.R.E.

*Summary*—Beginning in 1935 a joint study of radio transmission has been in progress. This involved radio measurements in Argentina and the United States, co-ordinated with similar measurements in Europe. A remarkable anomaly in long-distance broadcast transmission had been indicated by certain observations in 1932, viz, much lower received wave intensities for transmission across the North Atlantic Ocean between Europe and North America than for transmission over the same distances within North America or Europe or Asia. The present study was made to determine what happens on transmission paths between South America and the other continents and has yielded an explanation of the North Atlantic anomaly.

## I. INTRODUCTION

ARRANGEMENTS were made in 1935 by the two authors for a joint study of radio transmission at broadcast frequencies (550 to 1600 kilocycles per second). The study of transmission between the two countries was co-ordinated with a study of transmission between Europe and the two Americas. Such study was needed to determine at what distances broadcast stations interfere with one another, in order that governments might determine what frequencies could be assigned satisfactorily to particular broadcast stations. The work has continued each year since 1935.

A remarkable anomaly in long-distance broadcast transmission had been indicated by certain observations in 1932. As a result of some measurements made for the Madrid radio conference in that year, it appeared that such transmission resulted in much lower received wave intensities for transmission across the North Atlantic Ocean between Europe and North America than for transmission over the same distance within North America or Europe or Asia.<sup>1</sup> It became important to determine what happens on transmission paths between South America and the other continents. This has been done in five series of measurements made in successive years since 1935, and this work has yielded an explanation of the North Atlantic anomaly.

The work was confined to the northern-hemisphere winters or southern-hemisphere summers because it is only at that time of year that there is an opportunity to make observations in the Americas on radio broadcasting from Europe. Radio transmission at broadcast frequencies occurs over great distances only at night. The daily period when it is night throughout the region

between Europe and eastern North America or Argentina ends at about 0400 G.M.T. (11 P.M. at Washington and midnight at Buenos Aires) in June (northern summer or southern winter); the European transmissions are not receivable prior to this time of night because of interference from the local broadcast stations. Since however most broadcast stations shut down not long after midnight, the European transmissions are receivable in December (northern winter or southern summer) because at that time of year night continues throughout the region until about 0800 G.M.T. (3 A.M. at Washington and 4 A.M. at Buenos Aires). This is the reason the work was confined to December and adjacent months.

A few of the powerful European stations start operating as early in the day as 0600 G.M.T. and could be received in the Americas. To supplement these, arrangements were made with R. Braillard, Director of Technical Service, International Broadcasting Union, Brussels, Belgium, for special emissions from some other stations in Europe between 0600 and 0830 G.M.T. Braillard also participated in the measurement program and arranged for a number of the European laboratories to participate by making measurements upon received intensities of North and South American stations.

North American stations are receivable in Europe and in Argentina at times when there is not destructive interference from local stations, so no special emissions from North American stations were necessary. It was however necessary to have some special emissions from South American stations between 0600 and 0830 G.M.T. to insure reception in North America without interference.

The work was of great difficulty. As will be shown, it was hampered by the short time each day that the received intensities were high enough to observe, by the inconvenience of the observing hours, by fading, atmospherics (particularly in South America), ionospheric storms (particularly in North America), and interference from other stations. Notwithstanding these hindrances it was possible to derive useful results and to attain conclusions of value.

## II. METHODS OF MEASUREMENT AND COMPUTATION

### *Washington Measurements*

During the hours when the European and South American stations were receivable without destructive interference, usually between 0600 and 0830 G.M.T.

\* Decimal classification. R113.7. Original manuscript received by the Institute, July 29, 1940. Presented, Eighth American Scientific Congress, Washington, D. C., May 17, 1940. Publication approved by the Director of the National Bureau of Standards of the United States Department of Commerce.

† Chief, Radio Section, National Bureau of Standards, Washington, D.C.

‡ Jefe, Servicio Radiocomunicaciones, Ministerio del Interior, Buenos Aires, Argentina.

<sup>1</sup> Documents de la Conférence Radiotélégraphique Internationale de Madrid, vol. 2, p. 1011, 1932.

(between 1:00 and 3:30 A.M. Eastern Standard Time), the waves from selected stations were received and continuously recorded on graphical recorders. The equipment used comprised a calibrated antenna, a radio receiving set, and a recorder of potentiometer type, the assemblage<sup>2</sup> constituting a recording radio field-intensity meter. This equipment was located at the National Bureau of Standards receiving station, near Washington, D.C.

Graphs of the type shown in Fig. 1 were produced by the equipment. The ordinates may be either the electromotive force produced in the receiving antenna, as in Fig. 1, or radio field intensity (microvolts per

severely weakened by an ionospheric storm; this effect is discussed later herein.

The third record, for Rennes, January 14, 1937, illustrates another difficulty of this work. A station in the United States was on the air part of the time and its greater intensity prevented a record of Rennes from 0200 to 0225 and from 0255 to about 0330 E.S.T. Rennes was thus recorded only from 0100 to 0200 and from 0225 to 0255. As in the other cases, nothing but atmospherics was recorded after about 0330.

Besides the difficulties of fading, ionospheric storms, and interference from local stations, another difficulty is the combination of low received intensities and

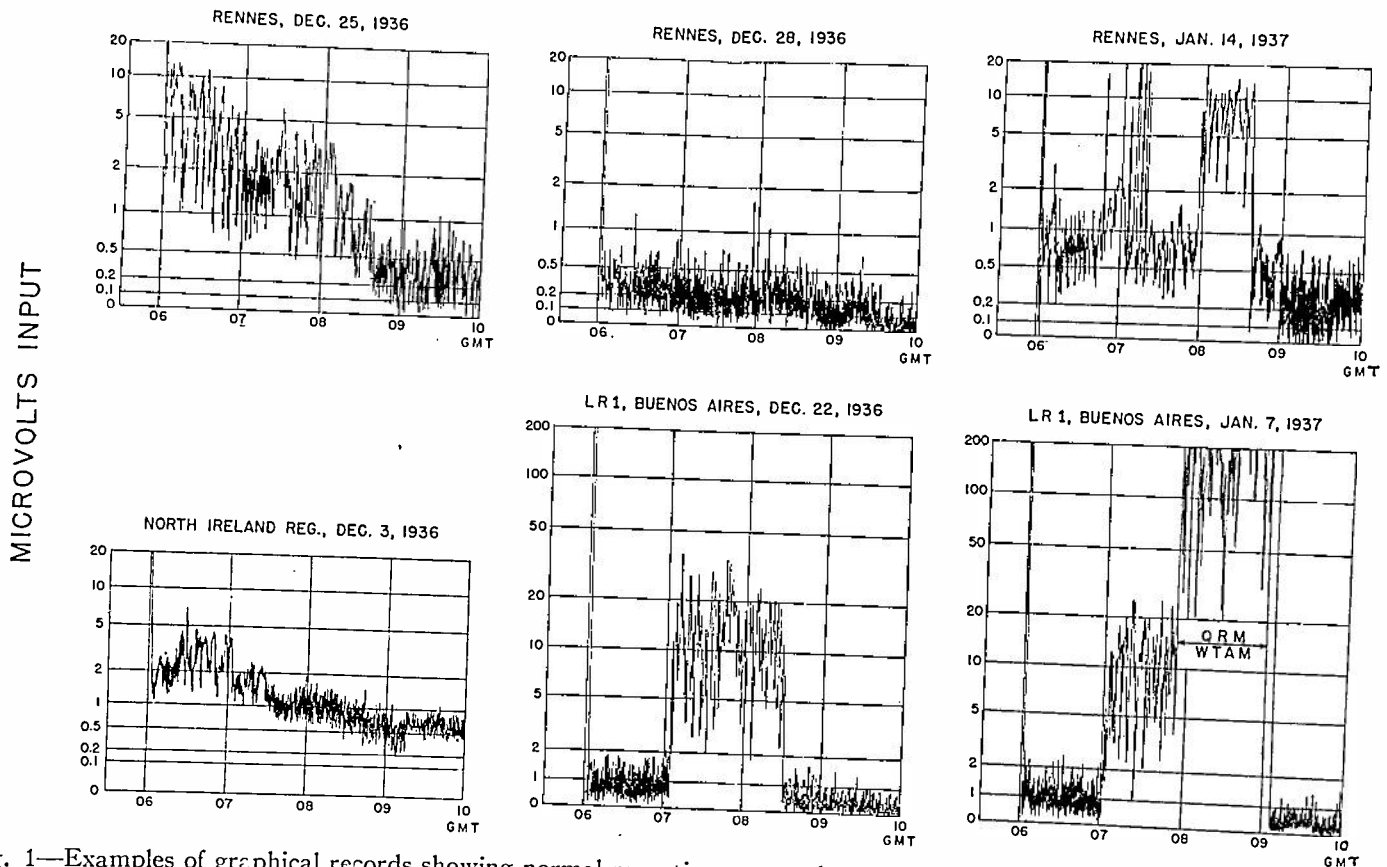

Fig. 1—Examples of graphical records showing normal reception, atmospherics, interference, etc., observed in Washington.

meter of antenna height), as in Fig. 2. The abscissas are hours of the day. Fig. 1 shows the records obtained on a few typical days at Washington, from a French station, an Irish station, and an Argentine station. Fading, or fluctuation of received wave intensity, was present at all times. The ordinates scale is approximately logarithmic throughout a considerable part of its range, so the changes of wave intensity shown are large.

The first record, for the transmitting station at Rennes, France, on December 25, 1936, shows how the wave intensity diminishes after about 0300 E.S.T. because of sunrise at the eastern end of the transmission path; after 0330 E.S.T. the graph shows only noise (atmospherics, "static"). The second record, for December 28, 1936, shows nothing but atmospherics the whole time. On that date the wave intensity was

times of high-intensity atmospherics. This is illustrated in the fourth record, for an Irish station, December 3, 1936. The station was not recordable above the intensity of the atmospherics after about 0230.

The fifth and sixth records are for an Argentine station. They began their special emissions at 0200 E.S.T., and the records show merely atmospherics before that time. Although they were much farther away and the radiated power was less than for the European stations, the received intensity was several times greater. The sixth record shows the Argentine station completely eliminated from the record by interference from a United States station after about 0250 E.S.T.

#### Buenos Aires Measurements

For reception in Buenos Aires special transmissions were not necessary from North American stations, these being receivable regularly after 0300 G.M.T., in the course of their normal working schedule, after

<sup>2</sup> K. A. Norton and S. E. Reymer, "A continuous recorder of radio field intensities," *Nat. Bur. Stand. Jour. Res.*, vol. 11, pp. 373-378; September, 1933.

Argentine stations had closed down their daily service.

Observations in the 1935–1936 observing period were made on a pier extending about 300 meters into the River Plata, which was favorable for reception on account of the absence of electrical noise. A field-intensity measuring set equipped with a loop antenna was used, and systematic measurements on a number of North American stations were made. It was not possible to hear the European transmissions, even with the help of auxiliary observing stations. On several occasions continuous weak carriers were heard on frequencies corresponding to these stations but they could not be identified.

In the 1936–1937 observing period a smaller number of stations were selected for measurements, with the object of making the work simpler. Also, it was arranged to simplify identification of the stations. These observations and the subsequent ones were made by the monitoring station "Villa Real" belonging to the Argentine administration which is located near Buenos Aires. The recorded emissions were those of WABC and KDKA in the United States, and of the Rennes and North Ireland stations in Europe. WABC (860 kilocycles per second, 50 kilowatts) was 8500 kilometers distant, and Rennes (1040 kilocycles per second, 120 kilowatts) 11,000 kilometers. The measurements were made both with the equipment used previously and with another measuring set with a calibrated antenna. To obtain a more objective comparison, the results of the observations were plotted in graphical form; these graphs were published in "Documents du Comité Consultatif International des Radio-communications, Bucarest," vol. 1, pp. 495–514, 1937. Values were recorded every 15 seconds. In the graphs the average noise level was indicated. North American stations were received between 0400 and 0600 G.M.T. and European stations between 0700 and 0800 G.M.T. The recording was done for 30 minutes in each case.

In the 1938–1939 observing period the same apparatus was used as in the previous tests but in addition a recorder combined with a linear amplifier and a field-intensity measuring set was used which gave an automatic record and gave clear evidence of the fading characteristics of the received waves. The 1939–1940 series of measurements were made at the above-mentioned monitoring station using the method employed in 1938–1939.

Graphs of the types shown in Figs. 2 and 3 were obtained with the equipment used in 1938–1939 and 1939–1940. In these figures only a short period of observation is recorded, but such a record is representative of normal receiving conditions throughout the observations lasting 30 minutes.

#### Computation Methods

From the graphical records, the quasi-maximum value of field intensity was computed for each night's transmission. The quasi-maximum is a kind of average

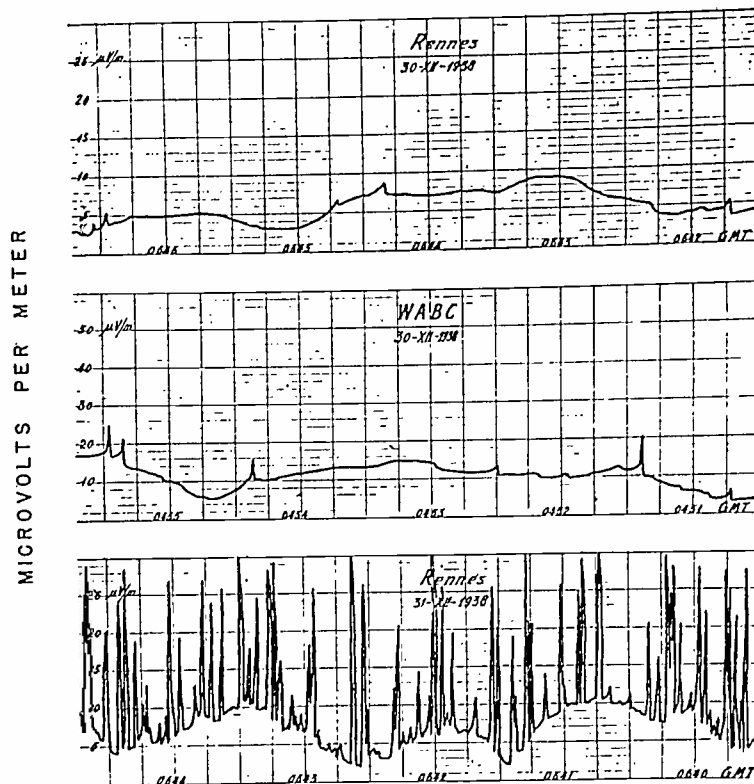

Fig. 2—Examples of short-time records of Rennes (France) and WABC (New York), observed in Buenos Aires.

which makes it possible to deal with widely fluctuating values. It is the value of field intensity which is exceeded by the instantaneous value 5 per cent of the time. This value may be computed rapidly with fair

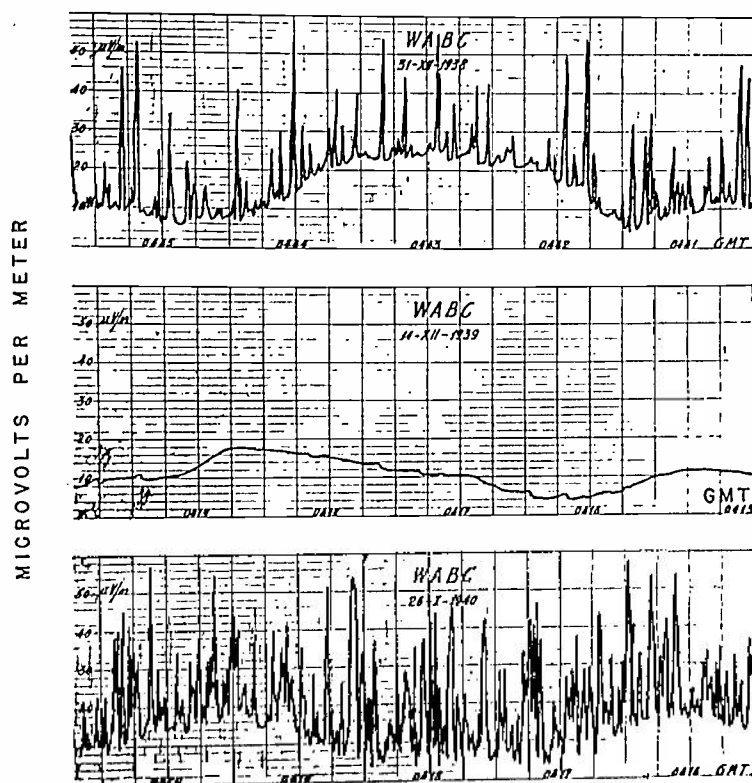

Fig. 3—Examples of short-time records on days of high and low atmospheric conditions, observed in Buenos Aires.

accuracy by averaging the peak values of successive 10-minute intervals.

In order to express results from different stations on a comparable basis, the values of field intensity were reduced to a radiated power of 1 kilowatt. This was done by dividing the field intensity by the square root

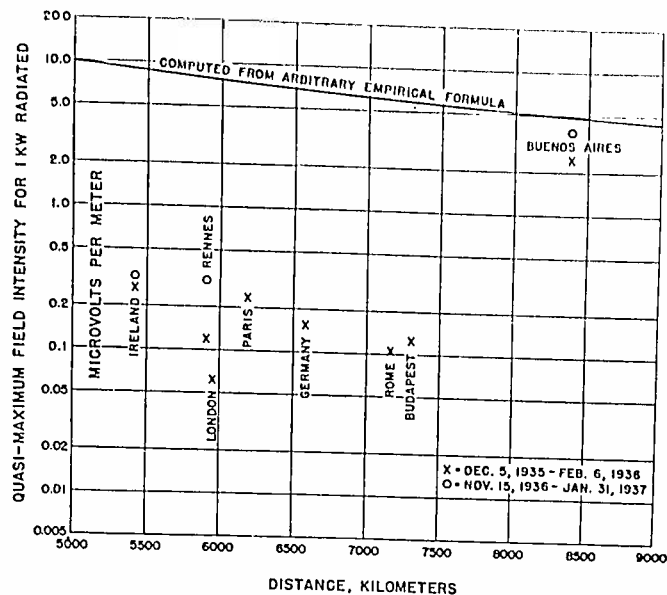

Fig. 4—Average intensities observed in Washington in 1935-1936 and 1936-1937.

of the power radiated by the transmitting station in kilowatts.

Some of the Washington results were compared with computed values based on an arbitrary empirical formula. This allowed ready comparison of results over widely different distances. The empirical formula used was devised<sup>3</sup> in earlier work of the National Bureau

### III. RESULTS OF MEASUREMENT

#### At Washington

The results of the first two series of measurements (1935-1936 and 1936-1937) are summarized in Fig. 4. A grand average of the quasi-maximum field intensities for all dates of observation within the periods indicated was calculated for each station which was recorded. These values are plotted against distance. For comparison, computed values from the arbitrary empirical relation (1) are shown as a smooth curve. The Buenos Aires values were fairly close to this curve, both years, but the European stations all had values very far from the curve ranging from 1/25 to 1/130 of the values given by the curve. As the South American values averaged about 6/10 of the value given by the curve, it results that the received intensities of the South American stations ranged from about 15 to 80 times the received intensities of the European stations.

The results of three of the series of measurements (1936-1937, 1937-1938, 1938-1939) are summarized in Figs. 5, 6, and 7. They are shown, for each station, as ratios of observed quasi-maximum field intensities to the arbitrarily computed quasi-maximum field intensities from (1), for successive days. Circles indicate measured values on the days indicated. In the graphs

for the European stations, there are a number of points without circles where the graph changes direction. On those days the received intensity was below the level of the atmospherics and therefore not determinable; in such cases the station intensity was arbitrarily taken to be half the level of intensity of noise (atmospherics).

In these three figures there is also given the magnetic character figure for each day, and on two of them the ionospheric character figure also. These are drawn in the opposite direction from the usual, i.e., they have zero at the top and maximum value (2) at the bottom. Thus magnetically (or ionospherically) quiet days are shown at the top of the graph and days of great magnetic (or ionospheric) storminess at the bottom.

Several facts stand out from these graphs. In the first place, the values for the South American stations were always much greater than for the European stations. In 1936-1937 (Fig. 5) the South American intensities averaged 15 times the European, in 1937-

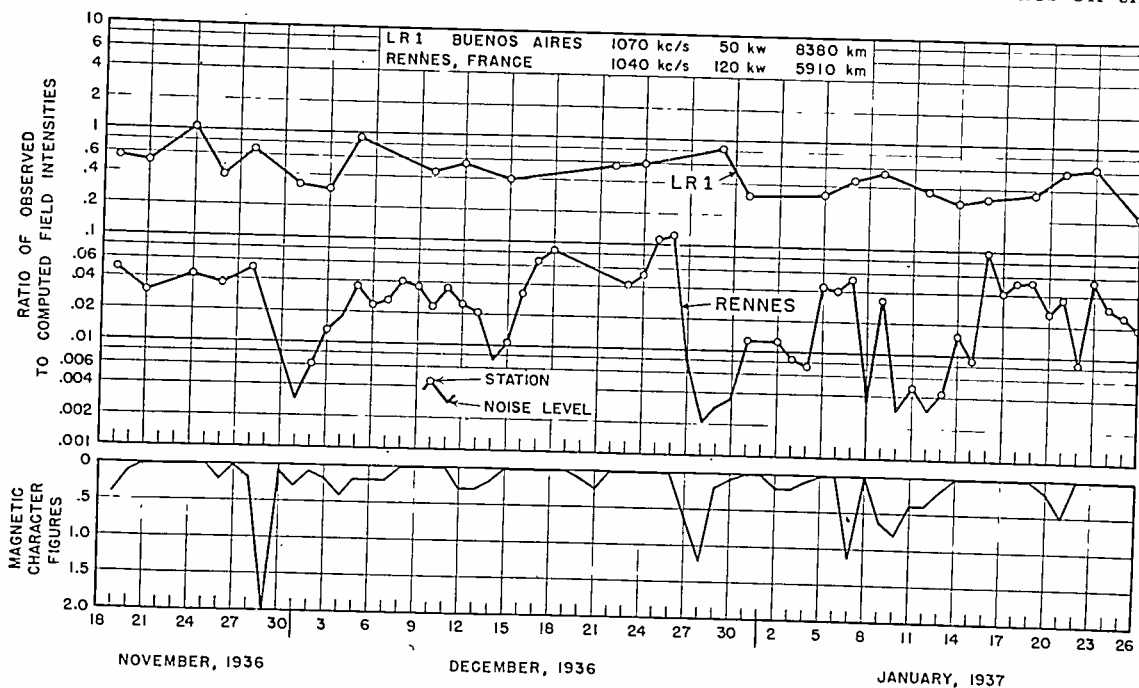

Fig. 5—Average intensities observed in Washington and magnetic character figure, for successive days, 1936-1937.

of Standards, from observations on night sky-wave transmission at broadcast frequencies, and is as follows:

$$\mathcal{E} = 300,000 \cdot \sqrt{P} \frac{1600 + d}{4,410,000 - 11,000d + 10d^2} \quad (1)$$

where  $\mathcal{E}$  = field intensity in microvolts per meter,  
 $P$  = radiated power in kilowatts, and  
 $d$  = distance in kilometers

<sup>3</sup> K. A. Norton, S. S. Kirby, and G. H. Lester, "An analysis of

continuous records of field intensity at broadcast frequencies," *Nat. Bur. Stand. Jour. Rec.* vol. 13, pp. 897-910; December, 1934; *Proc. I.R.E.*, vol. 23, pp. 1183-1200; October, 1935.





QUASI-MAX. FIELD INTENSITY FOR 1 KW RADIATED

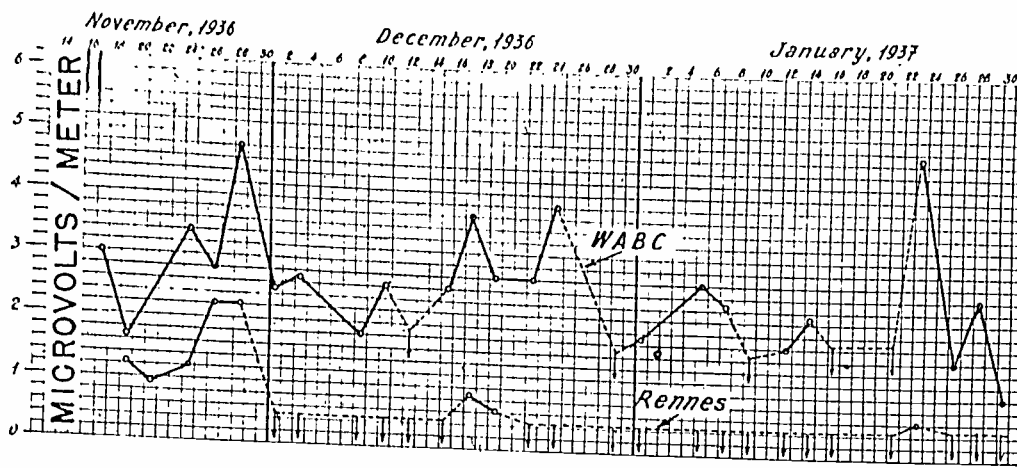

Fig. 8—Average intensities observed in Buenos Aires, for successive days, 1936–1937.

QUASI-MAX. FIELD INTENSITY FOR 1 KW RADIATED

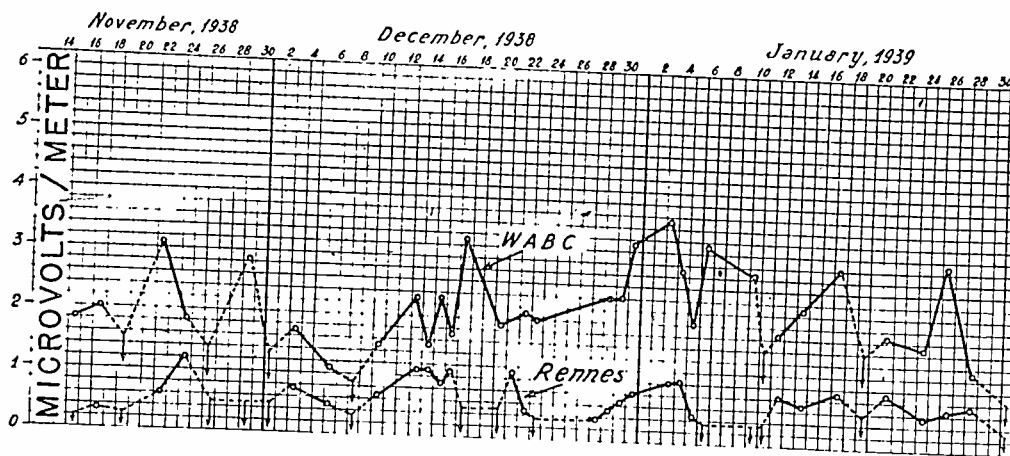

Fig. 9—Average intensities observed in Buenos Aires, for successive days, 1938–1939.

QUASI-MAX. FIELD INTENSITY FOR 1 KW RADIATED

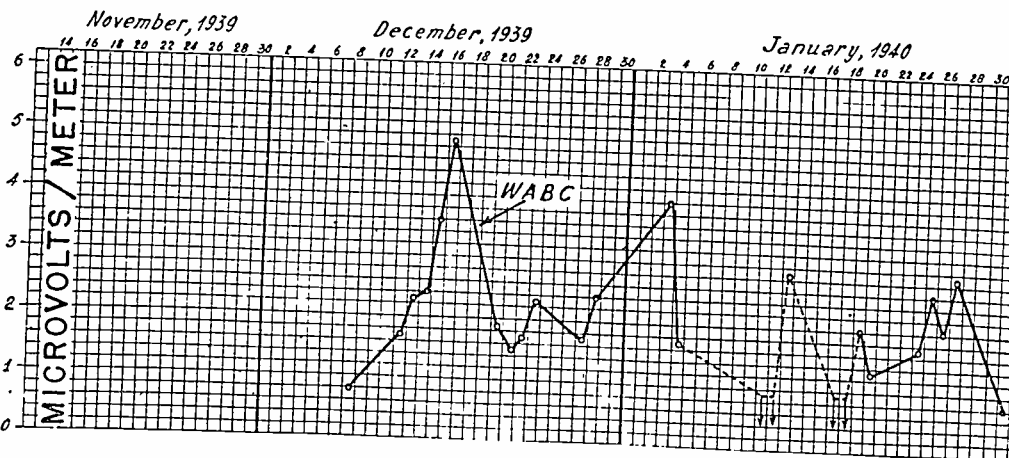

Fig. 10—Average intensities observed in Buenos Aires, for successive days, 1939–1940.

stations were heard and identified and their signals were recorded with a certain regularity at the monitoring station "Villa Real." However, it was only possible to record Rennes' emissions during 8 of the 24 days of observation and the emission from North Ireland was heard only once. After the tests had begun, special transmissions from Nice, Paris, and Toulouse were tried; but it was only possible to hear their weak car-

cept a few days. The quasi-maximum field intensity was about the same as in the previous period and was between 0.4 and 1.6 microvolts per meter for 1 kilowatt radiated (see Fig. 9). The atmospheric noise level was variable. The average level varied between 5 and 15 microvolts per meter. The graphs of Fig. 2 show two records of one day of very low noise level, on which the received stations were perfectly audible despite their

riers. The North American stations showed a quasi-maximum field intensity for 1 kilowatt radiated of 1.5 to 6.7 microvolts per meter (see Fig. 8) which surpassed that obtained during the 1935–1936 series by 1.1 to 2 times. In Figs. 8, 9, and 10, the arrows pointing downward signify values below the noise level. The quasi-maximum field intensity for Rennes, for 1 kilowatt radiated was 0.6 to 1.2 microvolts per meter (see Fig. 8). This result agrees with values recorded in Europe for emissions from Buenos Aires. The values recorded in Buenos Aires are only slightly lower for Rennes than for North American stations. As Rennes is more distant (11,000 kilometers) as compared with the North American stations measured (8500 kilometers), we may conclude that transmission conditions are about the same between South America and North America as between South America and Europe.

In the 1937–1938 measurement period special emissions were made for the United States but no recording was done in Argentina.

In the 1938–1939 series of measurements the Rennes and WABC emissions were measured between November 15, 1938, and the end of January, 1939. The WABC emissions were received regularly and gave values similar to those recorded in previous years. The emissions from Rennes were received more regularly than in previous years, being audible on all ex-

low intensity of 1 to 2 microvolts per meter. On a few occasions the noise was greater than 30 microvolts per meter so that the recording was useless. Graphs of Figs. 2 (lower) and 3 (upper) show typical records for Rennes and WABC, respectively, in which the average noise level was higher than the signals.

In the 1939-1940 series of measurements only the WABC emissions were recorded in Buenos Aires, as special transmission schedules were not arranged from Europe. The reception of this North American station showed values similar to those recorded in previous years. In this case too, the average noise level was between 5 and 15 microvolts per meter. On some days it reached 25, and even this value was surpassed, reaching 40 microvolts per meter during January 11, 12, and 17, for which reason no record of the station was obtained. In the graphs of Fig. 3, two records of WABC are shown, one corresponding to reception free from noise and the other with noise peaks over 30 microvolts per meter. The graphs of Fig. 10 show the quasi-maximum field intensities for 1 kilowatt radiated, as observed in 1939-1940. Station WABC was perfectly receivable almost every night between 0400 and 0430 G.M.T.

It must be taken into account that all of the measurements in Argentina were made in the summer, when receiving conditions are least suitable owing to the high atmospheric noise level. It is conspicuous in Figs. 8, 9, and 10 that the regularity of reception of North American stations is excellent, a regularity which is limited only by the high atmospheric noise level in January, that is, in midsummer.

#### IV. DISCUSSION

This work has definitely established the fact that radio transmission between South America and either North America or Europe is relatively free from influences that seriously impair transmission between North America and Europe. This difference in transmission conditions is enormous. For the time of year at which the measurements were made (northern winter or southern summer), this study has shown that the received intensities for transmission between

North America and South America average approximately 25 times the intensities between North America and Europe, that the received waves are only about 1/15 as variable, and that ionospheric storms depress the intensities of radio waves transmitted between North America and Europe but have little effect on the other transmission paths.

These conclusions lead directly to an explanation of the great differences in transmission conditions. The conditions of low and variable intensity on the North America-Europe transmission path are characteristic of radio transmission over any path at times of ionospheric storms. Ionospheric storms have their maximum effects, in general, near the magnetic pole and auroral zone, these effects being less and less at greater distances therefrom. The North America-Europe transmission path is near the magnetic pole and auroral zone and is thus markedly subject to ionospheric storms, even relatively slight ones which would have no effect on transmission over paths farther south. This disparity of effect of ionospheric storms is known not only from the evidence secured in this investigation, but is a matter of extensive experience in long-distance radiotelegraph service. Indeed, during ionospheric storms propagation is so poor over the North America-Europe transmission path that radiotelegraph traffic on high frequencies (short waves) has to be relayed through Buenos Aires, whose circuits to Europe and to North America are affected only very slightly or not at all.

The effect of ionospheric storms upon radio transmission between North America and Europe is magnified by the fact, demonstrated in this work, that the radio effects of ionospheric storms at broadcast frequencies persist for several days after the magnetic effects. Thus the North America-Europe transmission path is almost never free from the effects of recurring ionospheric storms, while the transmission path between South America and either North America or Europe is little affected thereby. This gives a complete explanation of the superior radio transmission between South America and either North America or Europe as compared with the inferior radio transmission between Europe and North America.

# The Generation of Spurious Signals by Nonlinearity of the Transmission Path\*

AUSTIN V. EASTMAN†, MEMBER, I.R.E., AND LAWRENCE C. F. HORLE‡, FELLOW, I.R.E.

*Summary*—This paper reports a portion of the work done in the investigation of spurious signals associated with broadcasting in and about Seattle, Washington. By suitable equipment and procedure the influence of such spurious signals as were generated in either the transmitting or receiving equipment was avoided and such spurious signals as originated external to the equipment and, hence, were presumably due to nonlinearities in the transmission path, were evaluated. The phenomena here involved are commonly termed "external cross modulation." It was found that spurious signals of this kind were observed in those locations where a suitably computed product of the field strengths of the associated real signals, termed the "field product," exceeded a critical value. It is suggested that the evaluation of "field products" and "susceptibility factors" provides the basis for predetermining the probable incidence of spurious signals due to external cross modulation.

WITHIN the last few years a new form of interference with radio transmissions has become increasingly prevalent. This phenomenon is commonly characterized by the generation of spurious signals by the transmissions of radio stations on frequencies to which the stations are *not* assigned, thus producing interference with other stations regularly assigned to those frequencies or, at best, producing

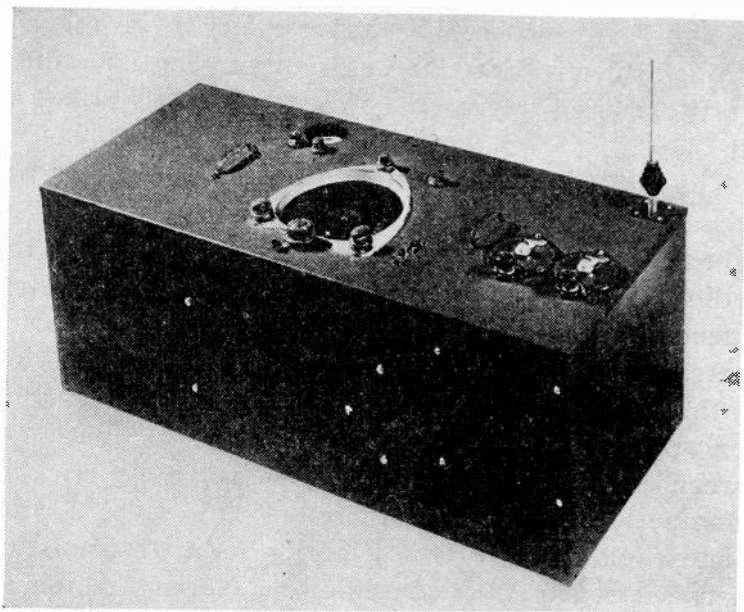

Fig. 1—Special measuring apparatus used.

confusion due to the multiplicity of received signals. This phenomenon results from the presence of nonlinearity somewhere in the radio system. It is commonly termed "cross modulation" and, where the seat of the phenomenon is outside the transmitting and receiving equipment, is more specifically termed "external cross modulation."

Among the earliest reports on this phenomenon are the publications by van der Pol and Eckersley concerning their observations of ionospheric cross modulation.

\* Decimal classification: R170. Original manuscript received by the Institute, July 24, 1940.

† University of Washington, Seattle, Wash.

‡ Consulting engineer, New York, N. Y.

tion now known as the Luxembourg effect. More recently several groups of American investigators have called attention to the spurious signals of the cross modulation type. Thus, in 1935 B. V. K. French and D. E. Foster reported the presence of spurious signals in the vicinity of Newark, N. J., the modulation of which associated them with the local broadcast station. A subsequent survey strongly indicated that the presence in the signal fields of a certain antique but still usable electric system accounted for their generation. Some time later similar observations made in the Cincinnati area by Johnson and Kilgour again indicated that spurious signals were being generated in poorly bonded and grounded electric wiring.

Efforts of the early workers in this field seem to have been directed largely toward the qualitative study of the phenomenon and toward the development of means for the prompt elimination of these spurious signals. The major purpose of the investigation here reported was the establishment of some of the quantitative relations involved in their generation. Such an investigation obviously required the collection of quantitative data on the magnitude of the spurious signals and on other correlative factors. These data were gathered as a portion of an extended investigation of cross-modulation interference sponsored by the Radio Manufacturers Association and co-operatively conducted by the several sectors of the engineering department of the Radio Manufacturers Association.

Preliminary qualitative investigations were made in Boston, Buffalo, Houston, Des Moines, and Seattle, the latter revealing such constancy and severity of interference that the subsequent quantitative investigations were confined to the vicinity of that city.

The investigation in Seattle was complicated by the fact that two of the broadcast stations (KOMO and KJR) employ a single radiator. It was, therefore, necessary to ascertain carefully the extent, if any, to which the observed cross modulation was due to such joint antenna usage. It was necessary, also, to minimize and to evaluate such cross modulation as might be generated in the equipment used in making measurements.

For this reason special measuring apparatus was provided as shown in Fig. 1. This consisted of a high-quality battery-operated broadcast receiver equipped with a two-stage preselector and a suitable output indicator. The entire unit, including a six-volt storage-battery power supply was enclosed in a metal shielding case.

A precise determination of the amount of spurious signal attributable to the joint antenna usage of sta-

tions KJR and KOMO depended upon the avoidance of all other possible sources of cross modulation. Therefore, not only was it necessary that excessive signal input to the measuring equipment be avoided, but it was necessary also that observations be made at points remote from all sources of external cross modulation such as power wires and other conducting structures.

Data were, therefore, gathered in two series of locations. One set was gathered along the top of Magnolia Bluff overlooking Elliott Bay (the city's harbor) at points at least one-half block from the nearest power or telephone line (see points I, II, III, and IV in Fig. 2). The second set was taken aboard a launch on the Bay and waterways (see points 1 to 8 inclusive, Fig. 2). The hull and superstructure of the launch were wooden and in order that assurance might be had that no interference was being generated in the engine, wiring, and other metallic parts of the launch, the measuring set was removed to a small wooden skiff at one point on the bay and check observations made. This showed conclusively that no cross modulation was being generated on the launch.

The observations made both on Magnolia Bluff and on Elliott bay showed spurious signals at frequencies of 870, 1020, 1220, and, to a lesser extent, 1320 kilocycles.<sup>1</sup> The first two frequencies are due to the interaction of KOMO and KJR while the latter two are due to the interaction of KOMO, KJR, and KOL the carrier frequencies of which are respectively 920, 970, and 1270 kilocycles. The proximity of the transmitters may be seen from Figs. 2 and 3.

With respect to the signals observed at the several observation points on Elliott Bay on 870 and on 1020 kilocycles as well as on the assigned frequencies of KOMO and KJR, it was found that a fair approximation to constancy obtained in the ratio between the observed signal strength and the inverse of the distance between the point of observation and the transmitter location. Thus the source of the spurious signals was indicated as being within the vicinity of the transmitting equipment.

On the other hand the signal on 1220 kilocycles, which could *not* be attributed solely to KOMO and KJR and their joint employment of a single radiator, was found, in general, to be at least as strong as the signals on 870 and 1020 kilocycles. Thus it appears that the spurious signals observed on Elliott Bay were not necessarily attributable to the simultaneous use of a single antenna but, more probably, were originating in some conducting structure or structures in the immediate vicinity of the three transmitters.

Later an attempt was made to localize more narrowly the source of the spurious signals by making observations in the immediate vicinity of the antennas.

<sup>1</sup> Readings on 1320 kilocycles were difficult to obtain because of the presence of KMO, Tacoma, on 1330 kilocycles, about 25 miles away. The tests made seem to indicate that the signal on 1320 kilocycles may be of the same order of magnitude as that on 1220 kilocycles.

This failed, however, because of the extremely intense fields there present and the consequent generation of spurious masking signals within the measuring equipment itself. Fortunately the intensity of the spurious signals was sufficiently low as to minimize the importance of localizing their source. For example, the ratio of the magnitude of the signals on 870 and 1020 kilocycles to the signals on the assigned frequencies of KOMO and KJR was about  $10^{-4}$ .

In the subsequent investigation within the city it was necessary to differentiate between those spurious signals generated near the transmitter locations and those that were locally generated. For this purpose it was assumed that the transmitted signals on 870 and 1020 kilocycles would suffer the same attenuation in their transmission as that experienced by the signals transmitted on 920 and 970 kilocycles.

Thus in making the subsequent measurements of locally generated spurious signals, the signals on 920 and 970 kilocycles were measured and the magnitude of the transmitted spurious signals estimated to be  $1 \times 10^{-4}$  times the average of these measured values. In this work, however, only such observed values of the spurious signals as exceeded the estimated values of the transmitted spurious signals by 20 decibels or more were given consideration.

The remainder of the investigation was directed toward the development of the rationale and the quantitative relations involved in the generation of spurious signals by cross modulation external both to the transmitting and receiving equipment. While a complete study of the phenomena here discussed would require a city-wide survey, the limitations imposed on the work were such as to require resort to "sampling." Therefore, there were chosen five typical, conventional broadcast receiver installations characterized by spurious signal interference ranging from what was considered as practically negligible at location B to very severe at location D of Fig. 2. At these locations the normally present broadcast receiver was replaced by the measuring set, and the frequencies and intensities of the various spurious signals were measured.

The field strengths of the signals of the six Seattle broadcast stations were also measured at these five locations—not, however, without some difficulty since, at those locations characterized by the higher levels of spurious signals, such serious field distortion was found as might be expected in the presence of high values of induced signal currents in extensive near-by conductors. At these locations, therefore, the measurements were made at such short distances from the receiver installations as served to avoid the field distortion.

The data so gathered were then analyzed in an attempt to reach an understanding of the rationale involved. As a first step in this process an expression for the nonlinearity producing the cross modulation was set up. This, of course, takes the well-known form of a

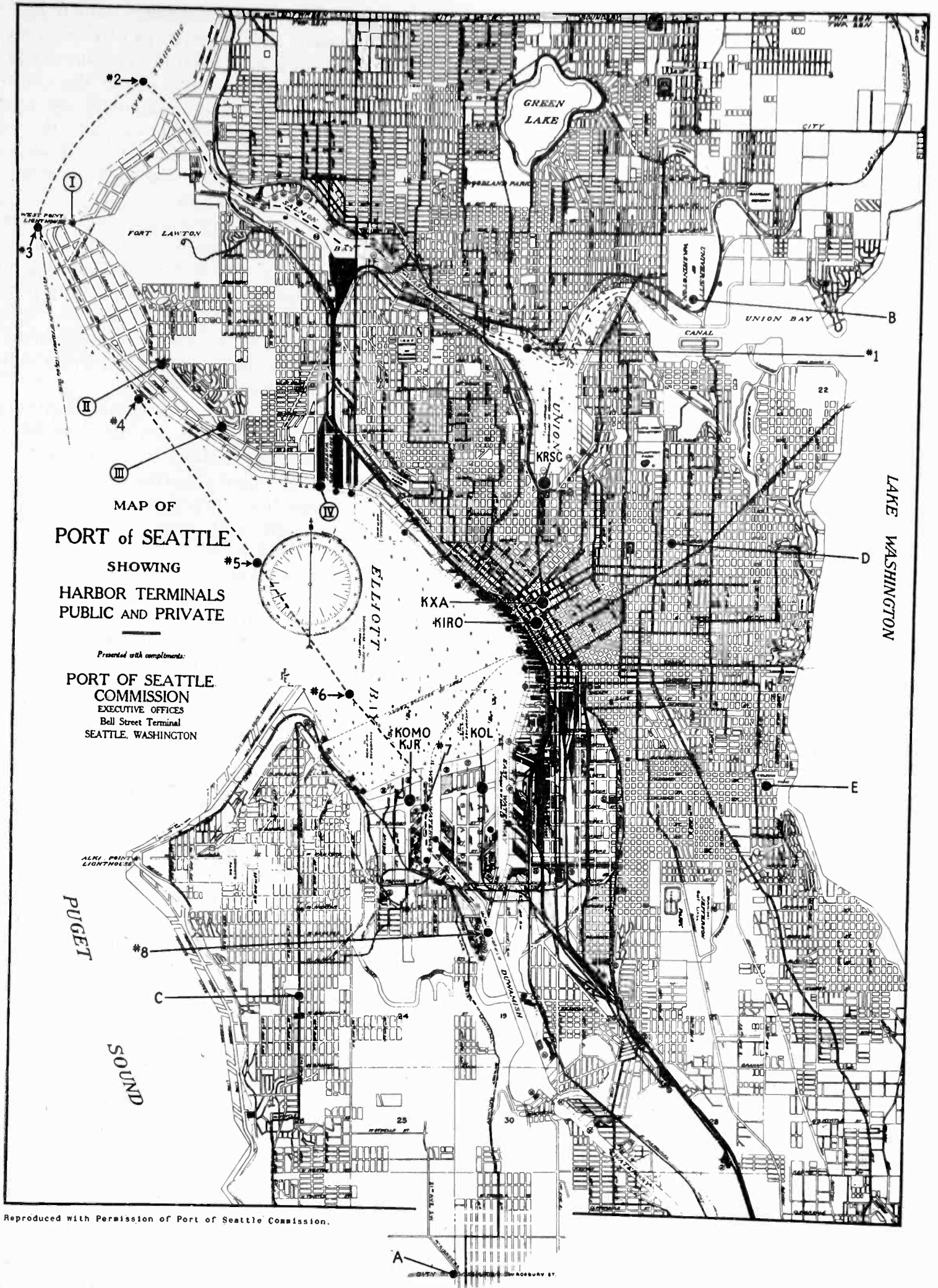

Reproduced with Permission of Port of Seattle Commission.

Fig. 2—Map of Seattle showing locations of broadcast stations and locations at which measurements were made.

power series, in which the current is expressed as a power series of the voltage applied to the nonlinearity. In the practical case the voltage here involved may be the space voltages of the radio waves, sinusoidal in form and of the frequencies assigned to the local broadcast stations. When two or more of these sinusoidal terms are introduced into the power series and the resulting terms reduced to simple functions it is found that the current flowing through the nonlinearity consists of a large number of sinusoidal terms most of which differ in frequency from the original voltage wave components.

For the purpose of this part of the analysis the first five terms of the power series have been so treated and, because the determination of the value of all possible cross-modulation frequencies requires that the analysis be made of the presence of as many simultaneously applied sinusoidal voltages as the order of the term, the analysis of the first five terms has been carried through with five applied frequencies.

A preliminary comparison of the results of this analysis with the Seattle data shows immediately that the only terms of importance result from the expansion and reduction of the second- and third-order terms of the power series. These are:

From the second-order term

$$1/2 BE_1^2 \cos 2\omega_1 \quad (1)$$

$$BE_1E_2 \cos (\omega_1 \pm \omega_2) \quad (2)$$

and from the third-order term

$$3/4 CE_1^2E_2 \cos (2\omega_1 \pm \omega_2) \quad (3)$$

$$3/2 CE_1E_2E_3 \cos (\omega_1 \pm \omega_2 \pm \omega_3) \quad (4)$$

in which the signal voltages  $E_1$ ,  $E_2$ ,  $E_3$  are those of frequencies  $\omega_1$ ,  $\omega_2$ , and  $\omega_3$ , respectively, and  $B$  and  $C$  are the coefficients of the second- and third-order terms of the basic power series.

The form of these several expressions immediately suggests their usefulness for purposes of analysis of field data. Thus each of these terms comprises three component factors. These are, in the reverse order of their appearance above,

(a) *The frequency factor* included in the trigonometric term in each equation.

(b) *The field product* which includes the voltage terms, raised to their appropriate powers, and the numeric (i.e.,  $3/2E_1E_2E_3$  in (4)).

(c) *The susceptibility factor* which comprises the coefficient  $B$  or  $C$ .

#### THE FREQUENCY FACTOR

Evaluation of this term from (1) to (4) and the assigned station frequencies provides the basis for differentiating between that portion of the field data which is of interest to this investigation and that which was either erroneously observed or arose from other causes than cross modulation.

#### THE FIELD PRODUCT

The values of the field products in (1) to (4) were computed from the measured values of field intensities for each possible spurious frequency resulting from the second- and third-order terms which fell within the broadcast band. This computation was made for every such possible spurious frequency as might result from



Pacific Aerial Surveys, Inc.

Fig. 3—Photograph looking northeast from West Seattle. The KOMO-KJR radiator may be seen in the foreground while the KOL radiator appears somewhat indistinctly in the right center of the picture on Harbor Island.

the operation of the six Seattle stations, the assigned frequencies of which are:

KIRO	710	KJR	970
KXA	760	KRSC	1120
KOMO	920	KOL	1270

The immediately useful portion of this series of computations is given in Fig. 4.

At locations *A* and *B* the measured values of the spurious-signal intensities was not sufficiently great as compared with the computed value of the intensities of the spurious signals of the same frequencies originating at or near the transmitter to allow it to be safely assumed that their values were attributable largely to conditions at these locations. At location *D* the noise level was such as to cast grave doubt on the validity of any conclusions to be drawn from data gathered at this point. For these reasons Fig. 4 concerns itself only with the observations at locations *C* and *E* and the data given on Fig. 4 is for obvious reasons further limited to such possible spurious frequencies as correspond to computed field products in excess of 0.0002 (volt per meter)<sup>3</sup>. In this figure the dots indicate the frequencies, and the corresponding field products, of possible spurious signals at which *no* signal was heard on the measuring set. The circles indicate the frequencies and the corresponding field products of the spurious signals which *were* observed on the measuring set. Thus, it may be seen that there is a fairly sharp line of demarcation, at a field product of about 0.001

(volt per meter)<sup>3</sup>, above which substantially all computed cross-modulation signals were observed, while virtually none was observed below this value. It is of considerable interest to note also that this line of demarcation occurs at substantially the same value of field product at both locations, even though the two locations were so widely separated.

The data obtained in this investigation are probably too meager to permit any generalizations as to the value of the field product which must not be exceeded if severe cross modulation is to be avoided. Yet the

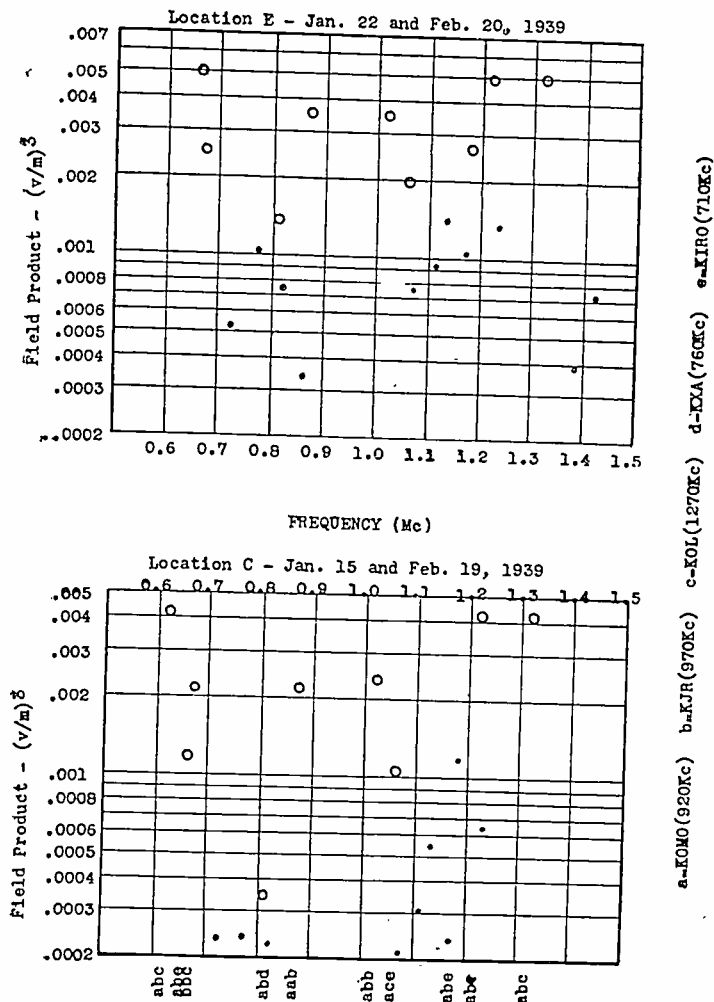

Fig. 4—Graphs showing the magnitude of the field product computed for locations *E* and *C*, by means of (1) to (4) and the measured field strength of each station. Circles indicate the signals actually heard at each location, while dots indicate those signals not heard.

evidence points strongly to the conclusion that there is such a value and that, to the extent that the "sampling" process reported herein is indicative, that value is of the order of 0.001 (volt per meter)<sup>3</sup>.

To increase the usefulness of Fig. 4 a coded alphabetical indication of the stations involved in producing each spurious frequency is given at the bottom of the figure with the key to the code given at the side. From this it will be noted that while KOMO and KJR each contribute to nine of the ten observed spurious signals and KOL contributes similarly to five, KXA and KIRO make their lesser but by no means negligible contribution. The lesser contribution of KOL to the number of spurious signals here reported as compared with that of KOMO and KJR is, in part, at

least, due to the choice of its operating frequency as the result of which fewer of the possible spurious frequencies to which it contributes fall within the broadcast band.

It might here be pointed out that whether or not the attempted quantitative evaluation of the critical value of the field product here made is sound the fact that there is a critical value of the field product offers additional support for the conclusions of other workers in this field who have pointed out the likelihood of cross-modulation interference where radio transmitters are so located as to result in the overlapping of the high field-strength portions of their service areas. Wherever in such overlapping areas the field products exceed whatever may there be the critical value, the generation of spurious signals is, of course, the inevitable concomitant; and, where such areas of high field products coincide with areas of high population density, the degradation of the radio service rendered to that area is, as a purely practical matter, almost completely unavoidable.

Such an unfortunate combination of population and field-strength distribution is typified by the area here considered. Thus, as shown by Fig. 2 and Fig. 3, the three most powerful Seattle stations, KOL, KJR, and KOMO, all lie within about one-half mile of each other so that their field patterns are substantially coincident. Additionally, the central business district and a very large portion of the residential area, especially that of West Seattle, lies in the area of excessive field products. Finally, the frequency assignments of these three stations is such that a large number of their cross-modulation products lie within the broadcast spectrum. To these several factors must be attributed the widespread, high intensity, and relative constancy of the spurious signals which originally prompted the concentration of this study of the problem on the Seattle area.

It is interesting to note that prior to the removal of KJR from a point several miles to the north of the city to its present location, little cross modulation was reported, notwithstanding the fact that KOMO and KOL were already located in such close proximity that their field products were doubtless above the critical value over a considerable area. A study of the frequency factors of (1) to (4) supplies an explanation of this in that the only possible spurious frequency within the broadcast band to be anticipated from the operation of KOMO and KOL coincides with the frequency of 570 kilocycles assigned to KVI, a 5-kilowatt station located about ten miles south of Seattle, the operations of which, then as now, largely mask this spurious signal.

This suggests that one method for the avoidance of the cross-modulation interference lies in the assignment of local stations to frequencies which differ one from the other by the same amount. Thus, all spurious signals generated by cross modulation would lie on the



assigned frequency of some other local station and so would presumably be masked. There is, of course, the possibility that such spurious signals would constitute a disagreeable background interference and, while in the study here reported it was not possible to gather quantitative data on this point, it is felt that this may be the lesser of two alternative evils.

#### THE SUSCEPTIBILITY FACTOR

In accordance with (1) to (4), the susceptibility factor may be defined as the ratio of the spurious-signal input to the receiver to the field product in the vicinity of the receiver. As so defined, it has been computed from the values of the field products and the measured values of the spurious-signal inputs at locations *C* and *E* and is plotted in Fig. 5. In this figure small vertical lines have been drawn through the points at 870 and 1020 kilocycles to indicate the range of ambiguity introduced by the spurious signals originating at or near the transmitters. The "effective heights" of the receiving antennas used at these two locations are given for such interest as there may be in such information.

Even a casual inspection of Fig. 5 shows that the susceptibility factor varies throughout a rather wide range. This is of course not unexpected since the factor may be affected by all conducting materials in the vicinity of the receiver, including such high-*Q* circuits as power lines and the like. In fact, it is highly probable that the simple contours shown in Fig. 5 are not actually indicative of the variations in the susceptibility factor but it is hoped that they will convey some indication of its general magnitude.

Aside from this it is to be noted that since the susceptibility factor, as here determined, falls within the range of 0.01 to 0.20, spurious signals having the indicated minimum interfering field product of 0.001 (volt per meter)<sup>3</sup> will evidently have an actual magnitude of from 10 microvolts to even as high as 1 millivolt. Such signals fall within the range of operation of the automatic volume control of the modern receiver and may, therefore, give rise both to interference with desired signals and to multiple reception of these signals with consequent confusion and complaint.

A complete analysis would involve an attempt to correlate the values of the susceptibility factor as here reported with the physical and electrical conditions characterizing the test locations. Unfortunately, however, neither time nor opportunity allowed the gathering of sufficiently comprehensive data for such a correlation. It is hoped that other workers in this field

will find opportunity for the gathering and analyzing of quantitative data in this field to the end that a sound engineering basis may ultimately be laid for the predetermination of the possible incidence of cross-modulation interference under a wide variety of conditions.

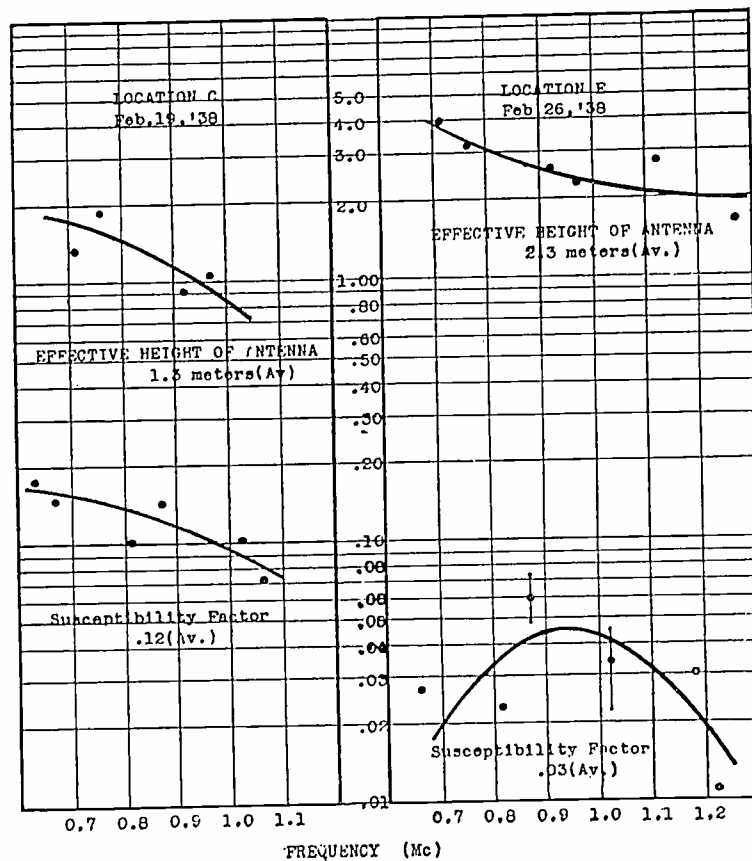

Fig. 5—Graphs of susceptibility factors at locations *C* and *E*. Evidently the extent of the sampling is sufficient to indicate general magnitudes only and the shape of the curves shown is not significant.

#### ACKNOWLEDGMENT

In conclusion, the authors are glad to have this opportunity to acknowledge the assistance of the many who contributed to the work. The support of the project by Dr. W. R. G. Baker, Director of Engineering of the Radio Manufacturers Association, in the sponsoring of the project by the Radio Manufacturers Association: the preliminary observations made in Boston, Buffalo, and other cities by Messrs. C. T. Burke, H. C. Forbes, and N. H. Foster: the design and construction of the measuring equipment by Mr. G. E. Gustafson and his associates of the Zenith Radio Corporation: the calibration of the equipment and the interpretation of the field data by Mr. D. E. Foster and his associates of the RCA License Laboratory: and the assistance of Myron H. Swarm of the University of Washington in the measurements made at Seattle; are all gratefully acknowledged.

# A New Broadcast-Transmitter Circuit Design for Frequency Modulation\*

J. F. MORRISON†, MEMBER, I.R.E.

*Summary*—The problem of generating wide-band frequency-modulated waves is first reviewed in order to ascertain specifically the desired performance capabilities for a commercial transmitter circuit. The factors which influence or limit these performance capabilities in the two methods available for the generation of frequency-modulated waves, compensated phase modulation, and direct frequency modulation, are then explored. It is found that each method possesses desirable fundamental characteristics not present in the other, but with the circuits now generally employed with either method the modulation characteristics and carrier frequency stability are interrelated so that one has a limiting effect upon the other.

A new circuit is described in which these two important characteristics are independent of each other. Owing to this independence and to other circuit refinements the modulation capabilities are unrestricted with low distortion over an exceedingly wide range.

A balanced electric oscillator operating at one eighth the radiated frequency is modulated by balanced reactance-control tubes and negative feedback is used to minimize amplitude modulation and harmonic distortion. A system of frequency division is employed together with a crystal-controlled oscillator and synchronous motor in such a manner as to control mechanically the mean frequency of the modulated wave with the same stability as that of the crystal-controlled oscillator. The carrier, or mean, frequency stability is that of a single crystal-controlled oscillator and is independent of any other circuit variations. A carrier frequency stability of 0.0025 per cent is possible without the use of temperature-controlled crystals or apparatus.

THIS paper describes a radio transmitter circuit developed for use in wide-band frequency-modulation systems. The potentialities of frequency modulation for aural broadcasting in the ultra-high-frequency bands are being studied by many engineers, and preparations are being made to take advantage of the possibilities offered toward improved broadcast service for the public. A number of comprehensive papers on this method of radio signaling have appeared in the literature. Most of these papers deal principally with either the theoretical or the systems aspect of the subject while information on transmitter circuits for the generation of frequency-modulated waves is rather sparse. It is felt, therefore, that a brief and non-mathematical review of the transmitter phase of the subject and the problems involved would also be welcomed at this time.

The broad problem confronting the designer of a transmitter for producing wide-band frequency-modulated waves is the development of a circuit which will permit a rhythmic variation of the frequency of the transmitted wave symmetrically about an assigned carrier frequency at a rate corresponding to the signal frequency and with an amplitude proportional to the amplitude of the signal. Broadcasters have required transmitting equipment designed for amplitude modulation to be capable of transmitting with low harmonic distortion all signal frequencies between 30 and 10,000 cycles per second. Owing largely to the greater channel width in the case of frequency modulation, provision is generally being made to extend the signal

\* Decimal classification: R355.21×R414. Original manuscript received by the Institute, July 26, 1940. Presented, Fifteenth Annual Convention, Boston, Mass., June 29, 1940.

† Bell Telephone Laboratories, Inc., New York, N. Y.

range to still higher audio frequencies. Such an extension requires that even more attention be given to the matter of harmonic distortion throughout the entire range. The carrier frequency, or line of symmetry in the modulated wave, must be maintained within limits prescribed by the Federal Communications Commission, the present limits requiring a stability of 0.01 per cent or better. Experience in the low-frequency broadcast band indicates that any circuit developed at this time for frequency modulation should provide for far closer maintenance of the carrier frequency in anticipation of more rigid requirements in the future.<sup>1</sup>

In one sense this requirement may at first appear paradoxical, for on the one hand a very stable frequency is asked for, while on the other it is stated that the frequency is to be varied over a wide range during modulation. It can be shown,<sup>2,3</sup> however, that for most degrees of frequency modulation there is present in the transmitted wave energy at the carrier frequency plus energy at many side frequencies which are symmetrically disposed about the central carrier. Although the total energy in the transmitted wave remains constant irrespective of the degree of modulation, the relative energy at the carrier frequency and sideband frequencies varies greatly. In the absence of modulation all the energy is at the carrier frequency, while with some degrees of modulation it is zero at that frequency and appears largely at the side frequencies near the remote ends of the band. This is illustrated in the top diagram of Fig. 1. Drifting of the carrier from its assigned frequency causes a displacement of all frequencies in the spectrum and thus a large portion of the wave energy is moved toward or into the adjacent channel. Furthermore, serious distortion is generated when the frequency spectrum of the wave is displaced beyond the band-width capabilities of the receiver.

The real difficulty that arises in the generation of frequency-modulated waves is that if we directly couple to a frequency generator a modulator which is capable of changing the frequency, the stability of the generator no longer depends solely upon its own circuit characteristics but also upon the characteristics of the modulator. Furthermore, the factors that steady the frequency of a generator tend to prevent a free variation over a wide range and this places restrictions upon the modulation capabilities.

<sup>1</sup> Since this paper was prepared, the Federal Communication Commission has promulgated Engineering Standards requiring a carrier frequency stability of  $\pm 2000$  cycles, approximately 0.005 per cent.

<sup>2</sup> J. R. Carson. "Notes on the theory of modulation," *PROC. I.R.E.*, vol. 10, pp. 57-64; February, 1922.

<sup>3</sup> B. van der Pol, "Frequency modulation," *PROC. I.R.E.*, vol. 18, pp. 1194-1205; July, 1930.

In the case of amplitude-modulated systems no major refinements in the two most important transmitter performance characteristics, modulation capability and frequency stability, were made until means were found which completely divorced their actions and brought about an independence in the control of both. It is apparent that this independence of action and control is also essential in the case of frequency modulation, possibly to an even greater extent than with amplitude modulation if one desires to achieve the optimum performance in either one or both of these two important characteristics.

It can be shown that a frequency-modulated wave is a special form of a phase-modulated wave, wherein the phase libration, in radians, caused by modulation is plus and minus the frequency deviation divided by the signal frequency. That is, the wave is advanced and then retarded in phase by the amount  $\phi = F_d/F_A$  radians. This relation gives rise to the circuit described by Armstrong<sup>4</sup> wherein a constant-frequency wave is obtained from a crystal-controlled generator and first amplitude modulated by the signal to a degree which is inversely proportional to the signal frequency. The carrier wave is then separated from the two sidebands and shifted 90 degrees in phase, after which it is recombined with the sidebands. The resulting wave has all the characteristics of one which has been frequency modulated. The frequency of the generator can be made independent of the action of the modulator by well-known circuit arrangements now used in amplitude-modulated systems and, furthermore, the carrier frequency stability is that of the crystal-controlled oscillator.

For harmonic distortion, as low as 5 per cent, this modulator circuit is capable of a maximum phase libration of  $\pm \frac{1}{2}$  radian while with wide-band frequency modulation the transmitted wave is advanced and retarded in phase many thousand degrees. For example, with a frequency deviation of  $\pm 100$  kilocycles at a signal frequency of 30 cycles the transmitted wave is advanced and retarded in phase by an amount equal to  $100,000/30$ , or about 3333 radians. To produce large phase librations the initially modulated wave is passed through a series of frequency multipliers, reduced to a low frequency by the beating-oscillator method, and then multiplied further.

With a maximum initial phase libration of  $\pm \frac{1}{2}$  radian, a frequency multiplication of 6666 is required for a 100-kilocycle deviation at a signal frequency of 30 cycles. With present methods this degree of multiplication is not only unwieldy but introduces a difficult noise problem. By taking special precautions, however, a frequency multiplication of about 3000 has been successfully used; with this multiplication and a 5 per cent distortion limitation the circuit is capable of a

maximum frequency deviation of  $\pm 45$  kilocycles with a 30-cycle signal or  $\pm 75$  kilocycles with a 50-cycle signal.

The use of the intermediate oscillator and beating process affects the frequency stability of the transmitted carrier because it is no longer that of either the original or the beating oscillators but is that of the modulation product obtained by the beating process.

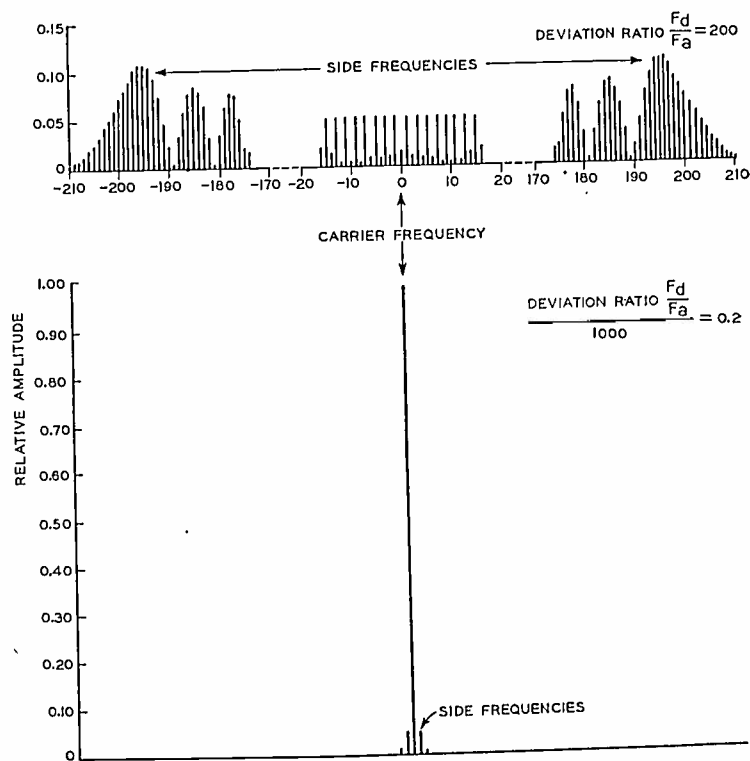

Fig. 1.—Spectrum of a frequency-modulated wave before and after the wave is passed through a system of frequency dividers.

The possible drift of the carrier frequency is equal to the sum of the drifts of the two oscillators increased in each case in proportion to the total number of times the frequency is multiplied. With a practical circuit employing a frequency multiplication of 3000, both the initial and beating oscillators must have an over-all stability, including the effects of variations in temperature, vacuum tubes, operating voltages, and other circuit elements, of about  $\pm 3$  parts in a million, 0.0003 per cent, in order to permit the designer to guarantee the present 0.01 per cent carrier-stability requirement.<sup>5</sup> This is a more severe requirement than now prevails in the regular broadcast band, where the Federal Communications Commission ruling requiring  $\pm 20$  cycles calls for an oscillator stability of  $\pm 13$  parts in a million at the high-frequency end of the band and  $\pm 40$  at the low-frequency end.

If a greater frequency multiplication is employed in order to extend the range of modulation, it becomes increasingly more difficult to obtain the required frequency stability. To this extent, then, the modulation characteristics and carrier frequency stability are interrelated so that one has a limiting effect upon the other.

<sup>5</sup> In order to permit the designer to guarantee the more recent frequency-stability requirement of the Federal Communications Commission, both the initial and beating oscillators must have an over-all stability of about  $1\frac{1}{2}$  parts in a million.

<sup>4</sup> E. H. Armstrong, "A method of reducing disturbances in radio signaling by a system of frequency modulation," *Proc. I.R.E.*, vol. 24, pp. 689-740; May, 1936.

Shelby<sup>6</sup> has reported that linear phase shifts of about  $\pm 15$  radians could be obtained when converting an amplitude-modulated wave into a phase-modulated wave by making use of a specially designed cathode-ray tube. The use of such a device would reduce the frequency multiplication required for the full modulation range to about 450. To the writer's knowledge, however, this device has not been applied to commercially designed transmitters.

Another method of accomplishing frequency modulation which has been found to be practicable and efficient consists in applying the signal current to vary the tuning of the frequency-determining circuit of a vacuum-tube oscillator by use of the commonly termed "reactance-control tube."<sup>7</sup> With certain refinements this method permits frequency variations of large amplitudes linearly related to the signal voltages to be obtained. The frequency of the transmitted carrier wave may be equal to or several times the operating frequency of the modulated oscillator as required to meet a particular transmitter design and minimize electronic and microphonic noise. However, this method is subject to the disadvantage that oscillators of the types that can be modulated by the signal currents to produce large frequency excursions are likely to be sensitive to other influences also. Drifting of the carrier or mean frequency is therefore likely to occur and some auxiliary control arrangement becomes necessary in order to hold the carrier within the assigned frequency limits.

An automatic-frequency-control system similar to the type described by Travis<sup>8</sup> for automatic tuning of receivers has been used for this purpose. This circuit involves the following fundamental characteristics which must be considered in connection with controlling the carrier frequency of broadcast transmitters:

1. The stability of the carrier frequency depends upon the stability of a frequency discriminator (slope circuit) and the gain of a control rectifier, as well as the stability of a beating oscillator. These three independent circuit elements must be carefully controlled in order to maintain the carrier frequency within the assigned limits.
2. The frequency correction effected can never be complete. This introduces what might be termed a "frequency-correction error." The magnitude of this correction error depends upon the extent of the frequency drift of the modulated oscillator. This is analogous to what occurs in feedback amplifiers where it is known that the feedback can never reduce the distortion to zero or there would be no distortion to be fed back.
3. The carrier frequency control is accomplished by a change in the bias voltage applied to the react-

ance-control tube, and since modulation is also effected by varying the bias of this tube, the frequency control acts to limit the effective range of modulation.

There remains, then, the problem of obtaining a controlled carrier frequency having a precision which depends solely upon the performance of a single crystal-controlled oscillator and which is independent of the modulation action. This problem has confronted all engineers who have engaged in the study of frequency modulation, and the new circuit about to be described accomplishes this purpose.

When the frequency excursion due to modulation is large compared to the signal frequency the modulated wave consists of a multiplicity of sidebands accompanied by only a vestigial component of the carrier frequency. Selection of the carrier becomes manifestly impracticable under such conditions. However, when the modulation excursion is reduced, by means of *frequency division*, to a degree less than the lowest signal frequency, the character of the spectrum is greatly altered. It then consists of a strong mean-frequency component accompanied by essentially only two sidebands, upper and lower, the amplitudes of which are relatively small. This effect is illustrated in Fig. 1. The enhancement of the mean-frequency component with respect to the side-frequency components renders it readily available for synchronizing purposes.

The frequency modulation of the subharmonic frequency takes place at the same audio-frequency rate as the modulation of the carrier wave from which it is derived, but the extent of the frequency deviation is diminished in proportion to the reduction of the frequency. When the frequency reduction is carried sufficiently far, the modulation of the subharmonic frequency appears principally as a small phase libration, the amplitude of which is substantially less than one radian and is generally of the order of a few degrees. On the other hand, the phase change or progression of the subharmonic frequency caused by a drift in the carrier from its assigned frequency is cumulative with respect to a constant-frequency standard.

To effect frequency control the subharmonic of the carrier is modulated by a standard-reference frequency derived from a crystal-controlled oscillator in such a manner as to produce two phase beat currents. These currents are applied to a synchronous motor which controls a variable condenser connected across the high-frequency modulated-oscillator circuit. As long as the subharmonic and reference frequencies remain in synchronism the armature of the motor will not rotate. If the modulated oscillator should drift from the assigned carrier frequency the subharmonic will no longer be in synchronism with the reference frequency and the motor armature will rotate in a direction depending on the sense of the drift and bring about a precise correction of the carrier frequency. By this process the

<sup>6</sup> R. E. Shelby, "A cathode-ray frequency modulation generator," *Electronics*, vol. 13, pp. 14-18; February, 1940.

<sup>7</sup> Chireix et al, U. S. Patent 2,076,264.

<sup>8</sup> C. Travis, "Automatic frequency control," *Proc. I.R.E.*, vol. 23, pp. 1125-1141; October, 1935.

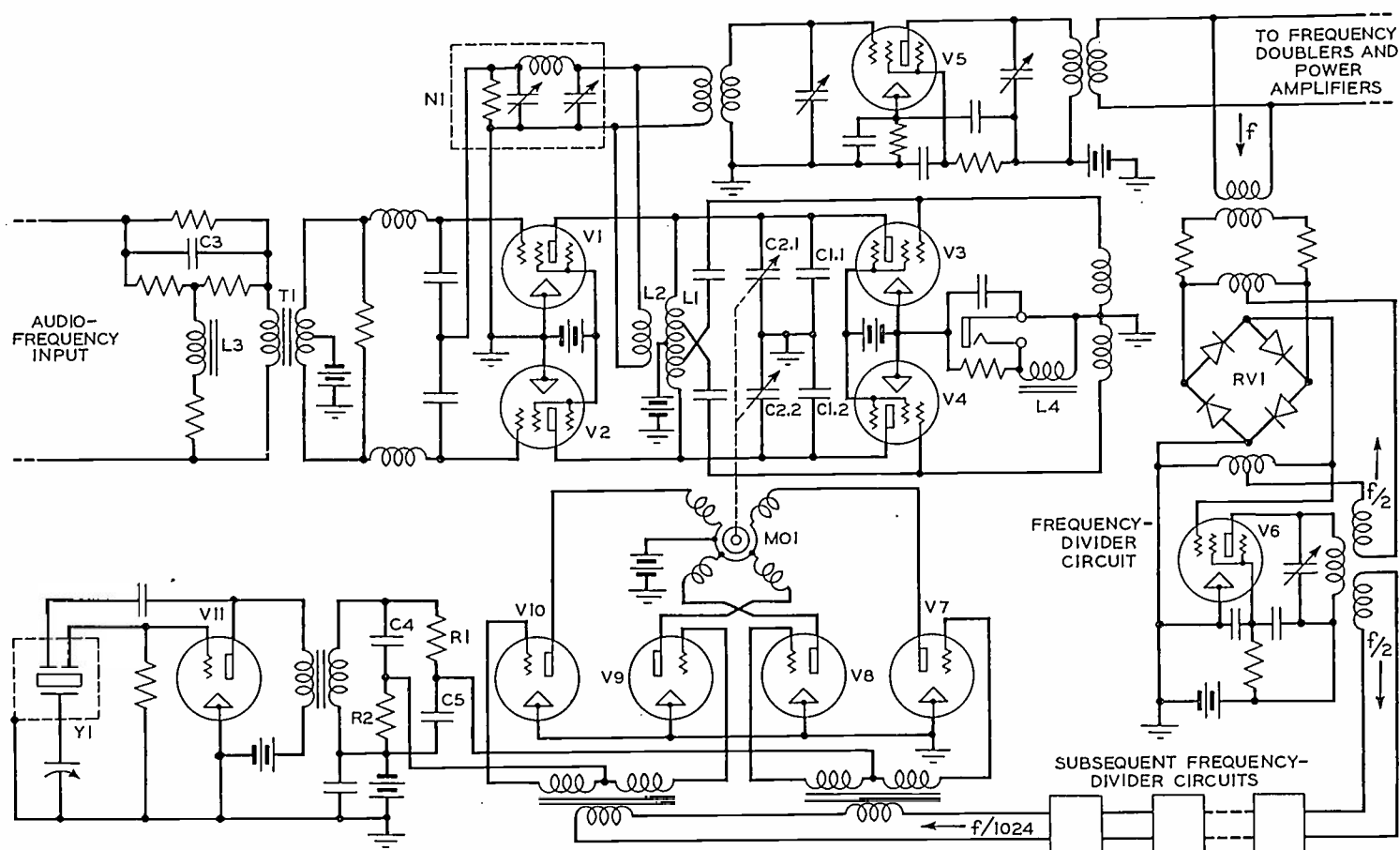

Fig. 2—Modulation- and carrier-frequency stabilizing circuit for a frequency-modulation transmitter.

control maintains a constant average phase relation between the reference and subharmonic waves.

The operation of the system will be described with reference to Fig. 2 and a particular example illustrative of the application of the circuit in a frequency-modulated transmitter designed for operation at a frequency of about 40 megacycles. The oscillator, consisting of the vacuum tubes  $V3$  and  $V4$ , coil  $L1$ , and condensers  $C1$  and  $C2$ , generates a carrier wave at a relatively high frequency. It will be assumed that the oscillator frequency has a normal value of 5120 kilocycles per second which is multiplied eight times to provide a radiation frequency of 40,960 kilocycles per second. The maximum frequency deviation of the radiated wave due to the signal modulation will be taken as 100 kilocycles per second above and below the normal carrier frequency. This corresponds to a deviation of 12.5 kilocycles in the oscillator frequency. Modulation of the oscillator is effected by means of control tubes  $V1$  and  $V2$ , the plates of which are connected in push-pull across the tuning inductance  $L1$ , and the grids of which are also connected in push-pull through the audio-frequency transformer  $T1$ . The bridged-T network consisting of  $L3$ ,  $C3$ , and the associated resistances is a signal-frequency pre-emphasizer which has a transmission characteristic in close accord with the Radio Manufacturers Association standards adopted for the speech channel used in connection with television.

A radio-frequency coupling between the oscillator tuned circuit and the grids of the control tubes is provided through the coil  $L2$  and the adjustable phase-

shifting network  $N1$ . This network is adjusted to produce at the input terminals of the control tubes a radio-frequency voltage in exact phase quadrature with the voltage across the oscillator tuning coil.

At this time it will be of interest to point out a characteristic of a reactance-control-tube modulator circuit which warrants consideration for low distortion of the modulated wave. The magnitude of the artificial impedance presented to the oscillator tuning circuit by the control tube is a function of the amplitude of both the audio- and radio-frequency voltages applied to its grid circuit. It is important, therefore, that the radio-frequency voltage remain constant during the audio-frequency cycle because otherwise the artificial impedance variations would not follow the contour of the audio-frequency wave. If the radio-frequency plate current of the control tube is not in exact phase quadrature with the oscillator voltage the artificial impedance will have a variable resistive component which will cause amplitude modulation of the oscillator output. With this condition the radio-frequency voltage applied to the control-tube grid will be increased during one half of the audio-frequency cycle and decreased during the other half. This causes unsymmetrical frequency modulation; that is, although the frequency deviation may be linear it will be greater in one direction from the assigned carrier than in the other, as illustrated by the dotted curve of Fig. 3. The solid curve of this figure was obtained with an exact 90-degree adjustment while the dotted curve was obtained with about an 85-degree adjustment.

Obviously distortion introduced as a result of any

amplitude variations of the oscillator voltage cannot be avoided by amplitude limiting in the amplifiers following the modulated oscillator but it can be substantially eliminated by suppressing these amplitude variations through the use of negative feedback in the oscillator circuit.<sup>9</sup> In the circuit described here the feedback is provided by means of the retard coil *L4*.

A precise adjustment of the 90-degree relation is indicated by zero amplitude modulation of the modulated oscillator which is easily observed by listening for minimum tone in a headset connected across *L4*.

The use of a balanced oscillator and control-tube circuit permits a wide frequency excursion while using only a small and linear portion of the reactance-control-tube mutual-conductance—grid-bias characteristic. Because of this wider range of modulation provided by the balanced circuit, critical adjustments are not necessary to obtain consistently good results over the range required in practice. Furthermore, even-order distortion products and noise in power-supply potentials are minimized because of the balanced audio-frequency circuit.

The frequency-modulated wave is passed through a buffer amplifier *V5* and thence to three frequency-doubler stages and power amplifiers. A branch connection at the output of the buffer amplifier diverts part of

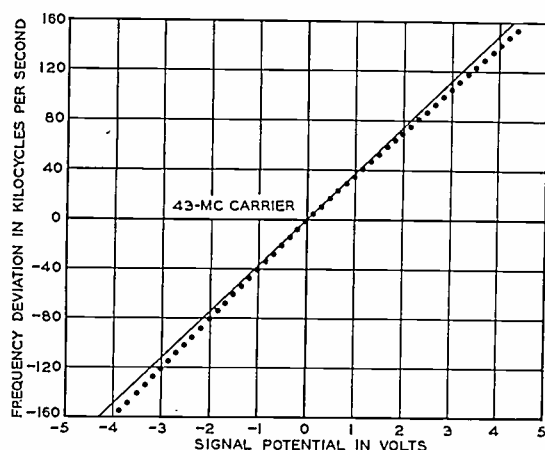

Fig. 3—Frequency deviation as a function of the signal voltage applied to the reactance control tubes.

the energy to the frequency-divider system consisting of ten 2-to-1 stages which gives a total frequency division of 1024. The circuit of these frequency-divider stages employs the principle of regenerative modulation whereby a subharmonic frequency is obtained by a modulation process.<sup>10</sup> Since the output energy is obtained by a modulation process involving both the input and output waves, it will appear only when an input wave is applied and bears a fixed frequency ratio with respect to it. The circuit employed here makes use of copper-oxide modulators *RV1* and the output circuit is tuned to one half the input frequency. The tuned circuits are made sufficiently broad to permit a sub-

stantial output voltage when the radiated carrier frequency departs from the assigned-value by as much as  $\pm 600$  kilocycles; this permits the control system to function over a wide frequency range.

In the illustrative example the output frequency of the divider stages would be 5000 cycles per second. For a modulation of the radiated wave of  $\pm 100$  kilocycles per second, the diminished modulation of the subharmonic frequency will be only  $\pm 11.5$  cycles per second. Assuming that this modulation is produced at the lowest signal frequency, 30 cycles per second, the phase change of the subharmonic frequency will amount to only  $\pm 24$  degrees. This subharmonic wave is applied to two balanced modulator circuits consisting of the vacuum tubes *V7-V8* and *V9-V10*. A crystal-controlled reference-frequency oscillator *V11* delivers a fixed frequency of 5000 cycles per second in phase quadrature to each modulator. If the subharmonic of the modulated carrier wave remains in synchronism with the 5000-cycle reference oscillation, the beat current impressed on the windings of the motor *MO1* will have zero frequency but will be subject to an alternating phase shift of about 24 degrees or less occurring at the signal frequency rate. No continuous rotation of the motor will result but some slight rapid oscillations of the field will take place because of the phase librations. These are suppressed by the inertia and friction of the motor and connecting mechanical parts. In the event of the modulated oscillator drifting in frequency from its assigned value, the frequency of the beat current impressed on the windings will be finite and the motor armature will rotate in a direction depending upon the sense of the carrier frequency drift. This rotation will be transmitted to the variable condenser connected across the modulated oscillator tuned circuit and bring about an adjustment of the oscillator frequency in such a direction as to correct the drift.

This method of frequency control possesses a unique feature in that the motor armature is actuated only by a rotation of the magnetic field. Changes in the intensity of either the reference or subharmonic waves will not actuate the motor armature and, therefore, the frequency of the radiated carrier is unaffected by variations in circuit gain. If there is a progressive change in the relative phase of these two waves, no matter how slight, as a result of a drift of the carrier or reference frequencies, the currents through the motor windings will progressively rise and fall and cause a rotation of the magnetic field. The accuracy of control and reliability of performance of this motor control unit have been long established by its use in connection with frequency-synchronization equipment designed for other purposes.

It is to be expected that the frequency-determining elements of a modulated oscillator circuit will vary from their initial values over long periods. Unlike others, this new circuit automatically maintains the correct carrier frequency by an actual mechanical adjust-

<sup>9</sup> The application of negative feedback for this purpose was pointed out to the writer by J. G. Chaffee and O. E. DeLange.

<sup>10</sup> R. L. Miller, "Fractional-frequency generators utilizing regenerative modulation," Proc. I.R.E., vol. 27, pp. 446-456; July, 1939.

ment of the oscillator tuning condenser. Because of this mechanical link the balance and intensity of the electric currents in the modulator and frequency-control circuits are undisturbed from their optimum adjustment, even though the control should be called upon to correct a frequency drift corresponding to many megacycles in the transmitted wave. Furthermore, should a failure of the automatic frequency control occur it will not interrupt the continuity of program transmission.

There is another important consideration in any automatic-frequency-control system, namely, the frequency range over which the control will operate should a sudden departure in the carrier frequency occur due to the failure of apparatus, such as reactance-control tubes, etc. This range is limited in the new circuit by the maximum speed of the rotating field that the motor will follow. The motor used will operate when the beat frequency applied to its winding is as high as 50 cycles per second and this corresponds to  $50 \times 2^{13}$  cycles per second, or about  $\pm 400$  kilocycles at the transmitted carrier frequency. As already stated, the tuned circuits of the frequency-divider stages are sufficiently broad so as to permit this range of control.

The features of this development may be summarized as follows:

(1) The factors and circuit elements which control the modulation capabilities and those that control the carrier frequency stability are completely isolated in their action.

(2) The electrical circuits used in the process of controlling a high-frequency generator with a stable low-frequency oscillator are not in the program transmission path and, therefore, their adjustments do not affect the character of the transmitted wave.

(3) The application of a balanced electric oscillator and reactance-control-tube circuit permits wide frequency excursions while using only a small and linear portion of the reactance-control-tube mutual-conductance—grid-bias characteristic.

(4) Negative feedback in the modulated oscillator circuit minimizes distortion that otherwise results from amplitude modulation of the wave applied to the reactance-control-tube grids.

(5) Because of (1) to (4) a high degree of linearity is obtained in the modulation characteristics over a frequency-deviation range of  $\pm 150$  kilocycles. This large linear range obviates the need for critical circuit ad-

justments to obtain consistently low harmonic distortion over the smaller range required in practice. For the frequency deviation of  $\pm 75$  kilocycles, suggested for use in practice, the measured root-mean-square harmonic distortion was found to be less than 2 per cent for all signal frequencies between 30 and 15,000 cycles per second.

(6) The carrier frequency stability is that of a single crystal-controlled oscillator and is independent of any other circuit variations.

(7) Since the carrier frequency stability is that of a single crystal-controlled oscillator, a stability of 0.0025 per cent is possible over a range of 40 degrees centigrade without the need for temperature-controlled apparatus. A closer stability could be obtained if necessary by the use of a temperature-controlled crystal.

#### ACKNOWLEDGMENT

The author wishes to acknowledge the valuable assistance of his colleagues in the Bell Telephone Laboratories and in particular those assigned to the Whippany laboratory who have contributed generously to this development.

#### Additional Bibliography

- (1) H. Roder, "Über Frequenzmodulation," *Telefunken-Zeit.*, vol. 10, pp. 48-54; December, 1929.
- (2) A. Heilmann, "Einige Betrachtungen zum Problem der Frequenzmodulation," *Elek. Nach. Tech.*, vol. 7, pp. 217-225; June, 1930.
- (3) T. L. Eckersley, "Frequency modulation and distortion," *Exp. Wireless and Wireless Eng.*, vol. 7, pp. 482-484; September, 1930.
- (4) W. Runge, "Untersuchungen an amplituden- und frequenzmodulierten Sendern," *Elek. Nach. Tech.*, vol. 7, pp. 488-494; December, 1930.
- (5) H. Roder, "Amplitude, phase, and frequency modulation," *Proc. I.R.E.*, vol. 19, pp. 2145-2175; December, 1931.
- (6) V. J. Andrew, "The reception of frequency-modulated radio signals," *Proc. I.R.E.*, vol. 20, pp. 835-840; May, 1932.
- (7) W. L. Barrow, "Frequency modulation and the effects of a periodic capacity variation in a nondissipative oscillatory circuit," *Proc. I.R.E.*, vol. 21, pp. 1182-1202; August, 1933.
- (8) W. L. Barrow, "On the oscillations of a circuit having a periodically varying capacitance; contribution to the theory of nonlinear circuits with large applied voltages," *Proc. I.R.E.*, vol. 22, pp. 201-212; February, 1934; also *M. I. T. serial 97*, October, 1934.
- (9) J. G. Chaffee, "The detection of frequency-modulated waves," *Proc. I.R.E.*, vol. 23, pp. 517-540; May, 1935.
- (10) M. G. Crosby, "Frequency-modulation propagation characteristics," *Proc. I.R.E.*, vol. 24, pp. 898-913; June, 1936.
- (11) M. G. Crosby, "Frequency-modulated noise characteristics," *Proc. I.R.E.*, vol. 25, pp. 472-514; April, 1937.
- (12) H. Roder, "Noise in frequency modulation," *Electronics*, vol. 10, pp. 22-25, 60, 62, 64; May, 1937.
- (13) J. R. Carson and T. C. Fry, "Variable frequency electric circuit theory with application to the theory of frequency-modulation," *Bell Sys. Tech. Jour.* vol. 16, pp. 513-540; October, 1937.

# The RCA Portable Television Pickup Equipment\*

G. L. BEERS†, MEMBER, I.R.E., O. H. SCHADE‡, NONMEMBER, I.R.E., AND  
R. E. SHELBY§, MEMBER, I.R.E.

**Summary**—Spot news, athletic events, parades, etc., form an important source of television program material. In the spring of 1938, field experiments were started in New York City with mobile television pickup equipment. Two telemobile units were used each of which was about the size and shape of a 25-passenger bus and weighed 10 tons. The limitations of these telemobile units are discussed. Lightweight television pickup equipment has recently been developed. The new equipment includes a small iconoscope camera, camera auxiliary, camera-control, and synchronizing-generator units, and an ultra-high-frequency relay transmitter and receiver. Most of the units are about the size of a large suitcase and weigh between 40 and 70 pounds. Each of the units is described and some of the practical applications of the equipment are indicated.

## INTRODUCTION

IN THE spring of 1938 field experiments were started in New York City with mobile television pickup equipment. Two telemobile units were used, one of which contained standard rack-mounted equipment for two cameras and the other housed a 159-megacycle 300-watt transmitter. Each unit was about the size and shape of a 25-passenger bus and weighed 10 tons. The total power required to operate both units was approximately 20 kilowatts. Field tests with the mobile units have definitely proved their usefulness in providing entertaining television programs. The size, weight, and power requirements of these units, however, have imposed definite restrictions on their use. In order to minimize these restrictions lightweight portable television pickup equipment has re-

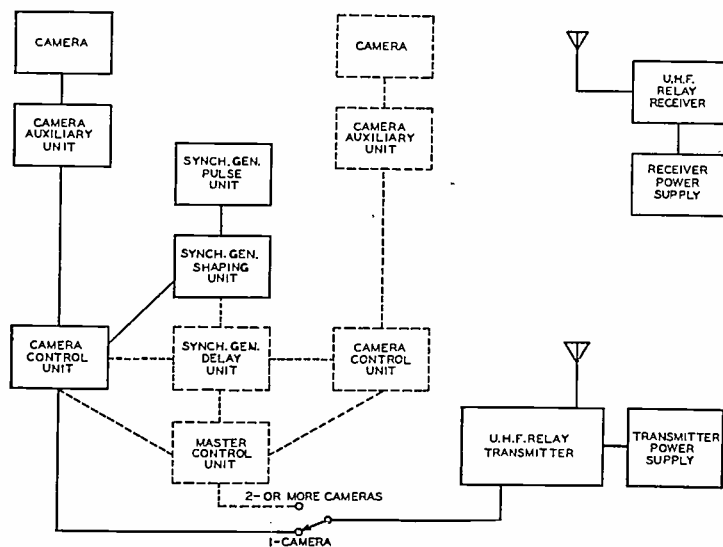

Fig. 1—Block diagram of complete portable television pickup system.

cently been developed. It is the purpose of this paper to describe the several units of this equipment and indicate some of its possible applications.

\* Decimal classification: R583. Original manuscript received by the Institute, July 29, 1940. Presented, New York Meeting, April 3, 1940.

† RCA Manufacturing Company, Inc., Victor Division, Camden, N. J.

‡ RCA Manufacturing Company, Inc., RCA Radiotron Division, Harrison, N. J.

§ National Broadcasting Company, Inc., New York, N. Y.

## GENERAL CHARACTERISTICS OF THE EQUIPMENT

Past experience with all types of television pickup equipment has shown that it is desirable to locate all the control equipment at some central point if effective program supervision with a minimum of personnel is to be obtained. It is therefore essential that provision be made in portable television pickup equipment so that long lengths of camera cable can be used between the control equipment and the cameras. This requirement was responsible, to a considerable extent, for the division of the equipment into the several units shown in the block diagram in Fig. 1. In this diagram the units for a complete system with a single camera are outlined by the solid lines. The additional units required for a second camera are shown by the dotted

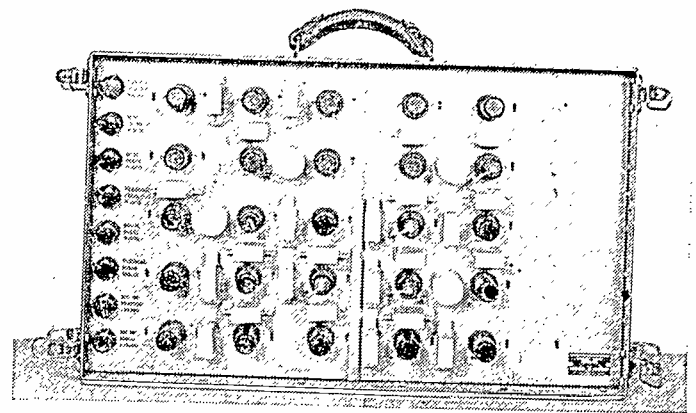

Fig. 2—Synchronizing-generator shaping unit—tube side, cover removed.

lines. The only units which must be duplicated to add a third camera are the camera auxiliary and camera-control units. The receiver shown in the diagram is normally located at or near the main television transmitter and is therefore not a part of the equipment which must be transported to the remote pickup point.

The equipment is designed to produce synchronizing signals in accordance with the Radio Manufacturers Association standards. All the video-frequency amplifiers are adjusted to pass a frequency band from 30 cycles to 5 megacycles. Lengths of camera cable up to 500 feet can be used between the camera and camera-control equipment so that any two cameras can be separated by distances up to 1000 feet.

The equipment operates from any suitable 110-volt, 60-cycle, single-phase power-supply system. The power consumption for the portable equipment with one, two, and three cameras is 1400, 2000, and 2500 watts, respectively.

All the units are designed to make the tubes and circuit components as accessible as possible. The suitcase type of construction which is used for the camera



auxiliary, camera-control, master-control, and three synchronizing-generator units is illustrated by Figs. 2 and 3. These photographs show both sides of the synchronizing-generator shaping unit. The accessibility of the tubes on one side of the unit and the circuit components on the other is clearly illustrated. The central chassis portion of the unit is welded to the outside case to form a rigid unit. A view of the complete unit with the side covers in place is shown in Fig. 4. The over-all dimensions of the suitcase-type units are  $8 \times 15 \times 25$  inches and their weights vary between 45 and 72 pounds. The camera weighs 28 pounds and its tripod 30. The weights of the transmitter and its power-supply unit are 60 and 190 pounds. The total weights of the portable pickup equipment less interconnecting cables for one, two, and three cameras are 550, 850, and 1050 pounds, respectively. These weights can each be reduced by 250 pounds when the equipment is used at locations from which the television signals can be

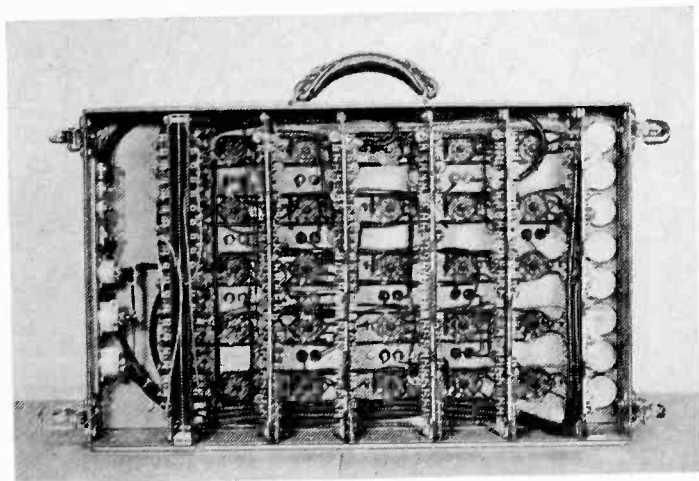

Fig. 3—Synchronizing-generator shaping unit—circuit component side, cover removed.

sent by coaxial cable to the main transmitter. The camera cable used with the equipment weighs approximately 0.6 pound per foot. If 500-foot cables are used with each of three cameras the total weight of these cables is approximately the same as the total weight of the equipment units.

The functions of the individual units are discussed in the descriptions which follow.

#### CAMERA

In order to keep the camera dimensions as small as possible the camera was designed to use the new  $4\frac{1}{2}$ -inch iconoscope.

Development work on small iconoscopes has been in progress for several years. As the dimensions of an iconoscope are made smaller with a corresponding reduction in the mosaic area a loss in resolution and sensitivity is normally expected. A new gun structure which has recently been developed has made it possible to obtain adequate resolution from the  $4\frac{1}{2}$ -inch iconoscope. Tests on this tube have also shown that its operating sensitivity when using a lens of a given

aperture is substantially the same as that of the standard iconoscope. This unexpected sensitivity is attributed to the smaller spacing between the several tube elements which results in a more-efficient collection of the secondary electrons. This increase in the electron-

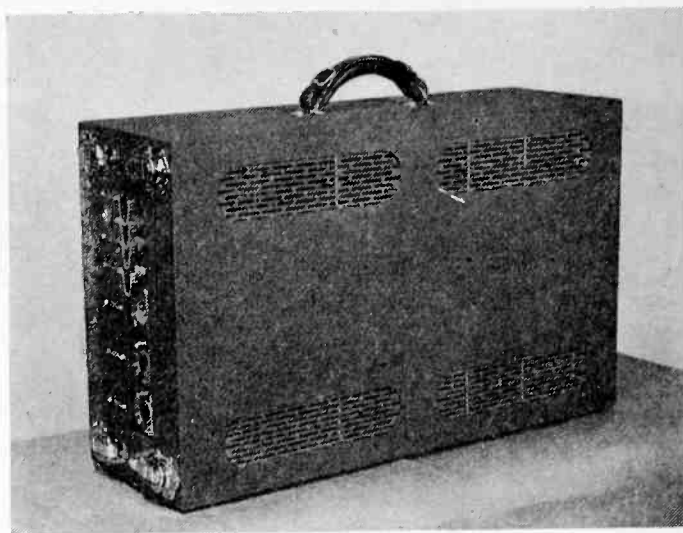

Fig. 4—Synchronizing-generator shaping unit with covers in place.

collecting efficiency enables the tube to be operated at a higher average beam current for a given ratio of signal to dark-spot voltage.

Fig. 5 is a photograph of the camera mounted on a standard motion-picture tripod and shows the wire-

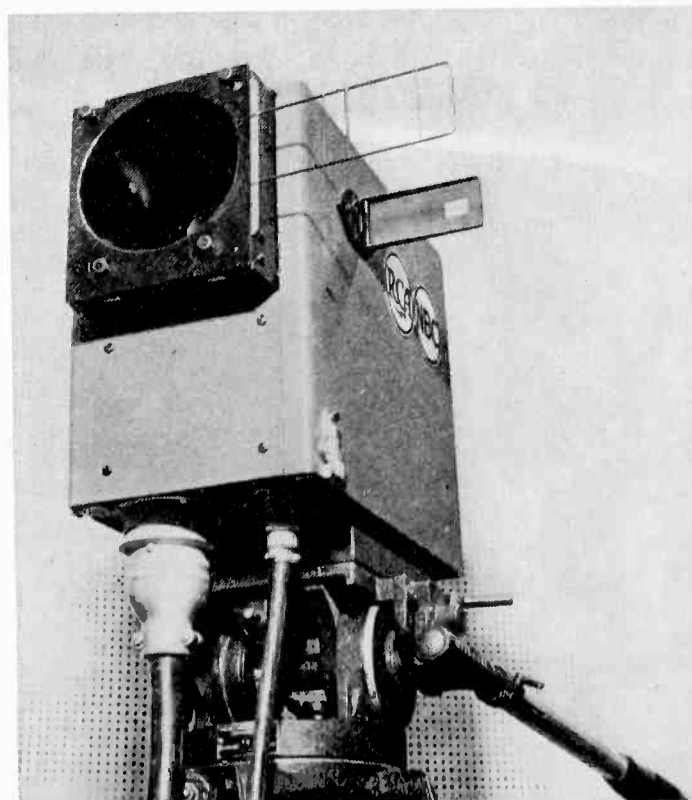

Fig. 5—Portable television camera on tripod.

frame view finder which is used by the cameraman to keep the scene to be televised within the field of the camera. Focusing is done remotely by observing the picture on the kinescope in the camera-control unit. A Selsyn motor at the camera-control unit is used to

operate a similar motor in the camera which in turn drives the lens carriage.

The internal construction of the camera is shown by the photographs in Figs. 6 and 7. The focusing motor

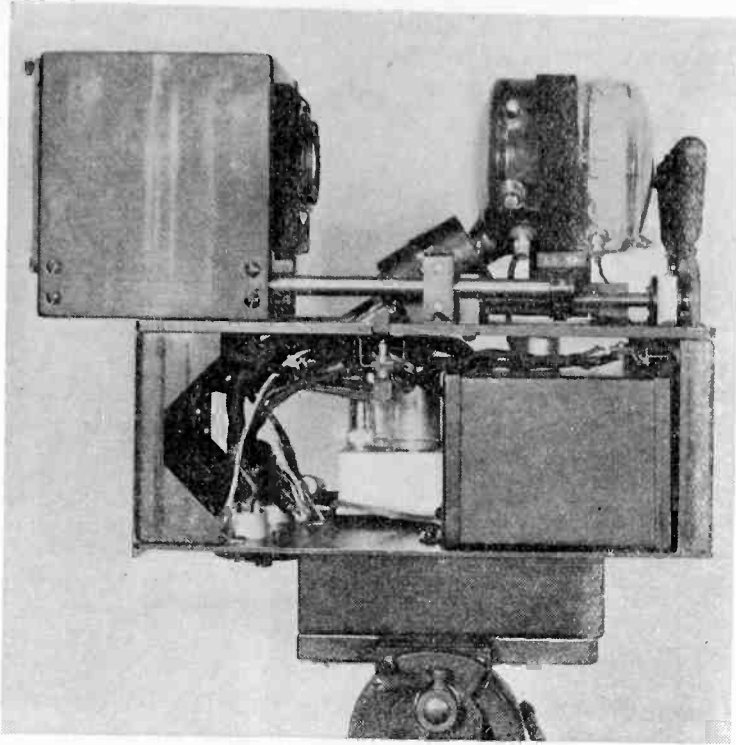

Fig. 6—Right side of portable television camera, cover removed.

is housed within the rectangular shield which is visible in the lower right-hand corner of Fig. 6. The two-stage pre-amplifier which can be seen in Fig. 7 is used to raise the picture signals derived from the iconoscope

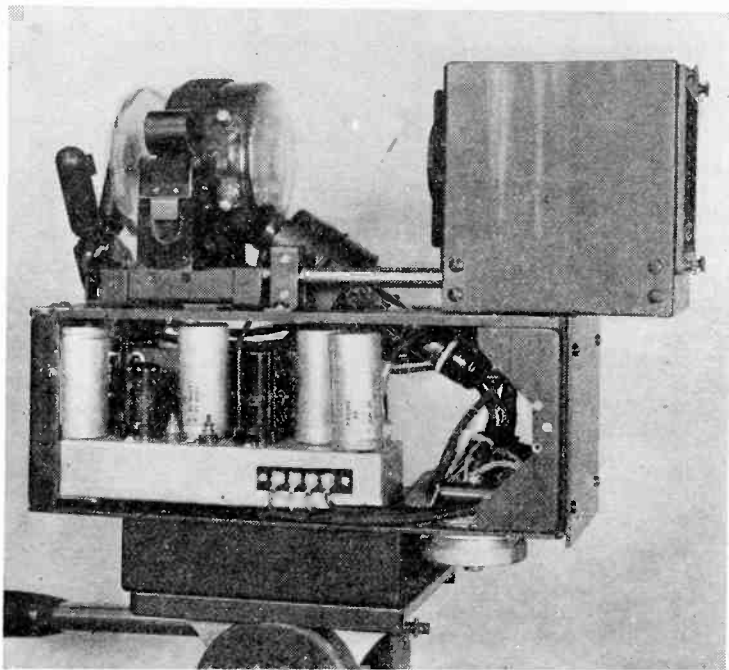

Fig. 7—Left side of portable television camera, cover removed.

to a satisfactory level to transmit over a short length of coaxial cable to the camera auxiliary unit. The iconoscope with its deflection yoke, the lens carriage, and the two shielded bias lights, which are mounted in

back of the iconoscope, are all clearly shown in this photograph.

Fig. 8 shows the lens-mounting arrangement. Lenses are interchanged by loosening the four thumbscrews shown in the photograph and then rotating the lens mounting slightly in a counterclockwise direction. The complete lens-mounting assembly can then be removed by pulling it forward. Another lens is attached to the camera by reversing the procedure.

#### CAMERA AUXILIARY UNIT

The problem of obtaining satisfactory deflection of the iconoscope beam when a long length of camera cable is used is greatly simplified when the horizontal deflection power is developed in or near the camera. The use of a camera auxiliary unit makes it possible to meet this requirement and at the same time keep

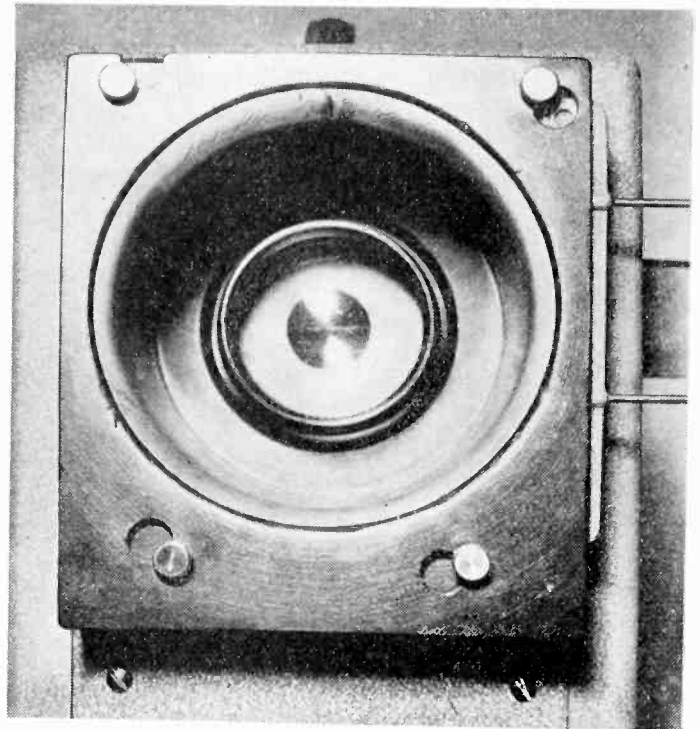

Fig. 8—Portable television camera—lens mounting.

the dimensions and weight of the camera as small as possible. In addition to the horizontal-deflection circuits the camera auxiliary unit contains a four-stage video-frequency amplifier, iconoscope blanking and protection circuits, and a power-supply rectifier. This unit is connected to the camera through an eight-foot length of camera cable and is usually located between the legs of the camera tripod.

The video-frequency amplifier which contains both a high-frequency peaking and low-frequency losing circuit is used to raise the video-frequency signal from the pre-amplifier in the camera to a sufficient level so that a satisfactory signal-to-noise ratio is obtained at the receiving end of a 500-foot length of camera cable. This amplifier is assembled as a complete unit on a small chassis which is flexibly mounted in an opening in the main chassis of the camera auxiliary unit. The construction of the amplifier and the method of mount-

ing are illustrated in Figs. 9 and 10. It will be noted that this construction maintains the general arrangement of having all the tubes accessible from one side of the unit and the circuit components and wiring accessible from the other.

The voltage wave developed across the iconoscope deflection yoke is used to produce a vertical iconoscope blanking pulse. A protective circuit is provided by which the grid of the iconoscope receives a high negative bias if for any reason the deflection of the iconoscope beam is interrupted thereby preventing damage to the iconoscope mosaic. Horizontal saw-tooth waves produced in the camera-control unit are transmitted to the camera auxiliary unit over a flexible coaxial line included in the main camera cable. These waves are amplified by a two-stage amplifier in this unit and fed to the iconoscope deflecting yoke through a step-down transformer. The power-supply rectifier in the camera auxiliary unit supplies anode potentials to all the tubes in both this unit and the camera. A 15-conductor

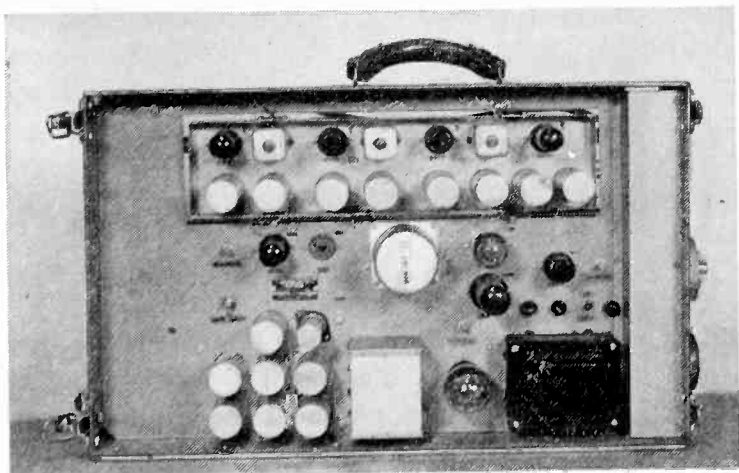

Fig. 9—Camera auxiliary unit—tube side, cover removed.

rubber-covered camera cable is used to provide the electrical connections between the camera auxiliary and camera-control units. The outside diameter of this cable is slightly under one inch. As previously stated, lengths of camera cable up to 500 feet can be used between the camera auxiliary and camera-control units.

CAMERA-CONTROL UNIT

The camera-control unit is normally the central control point at which all the operating adjustments are made while the equipment is in use. The several functions of this unit are indicated by the block diagram shown in Fig. 11. The video-frequency system shown in this diagram amplifies the video-frequency signals received over the camera cable from the camera auxiliary unit. Blanking and shading signals are inserted in this portion of the system. The shading signals which are used are saw-tooth and parabola waves at both line and field frequencies. Controls are provided for varying both the amplitude and phase of these signals. In case only a single camera is used synchronizing signals can be inserted in the video-frequency system

of the camera-control unit. Suitable signal potentials are supplied to the seven-inch kinescope which is used to monitor the picture and the two-inch oscilloscope which is used to observe the wave shapes of the picture

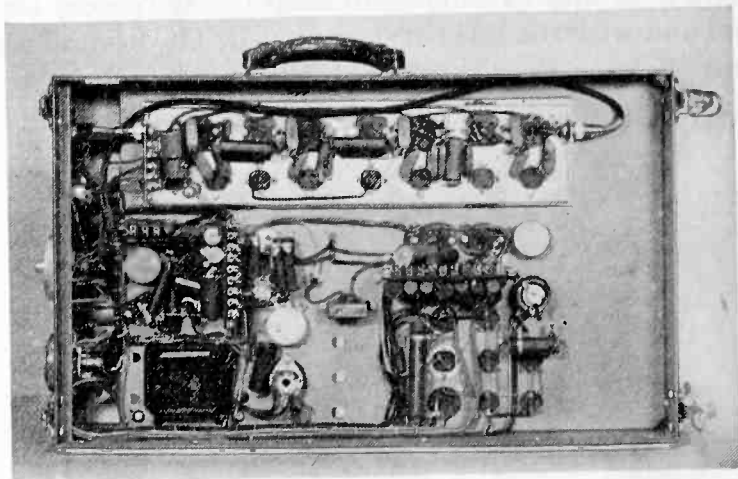

Fig. 10—Camera auxiliary unit—circuit-component side, cover removed.

signals. The video-frequency system is also designed to feed a two-volt peak-to-peak signal to a 75-ohm coaxial cable. Controls are provided for varying the video-frequency gain and the amplitude of the kinescope blanking signals.

In the deflection system line and field-frequency impulses received from the synchronizing generator are used to produce saw-tooth waves which are supplied to the iconoscope, kinescope, and oscilloscope. Provision is made in the synchronizing-generator delay unit for delaying the kinescope horizontal-deflection impulses with respect to the iconoscope impulses. Facilities are included in the camera-control unit for keystoneing the horizontal deflection of the iconoscope. A switch is provided so that horizontal deflection of

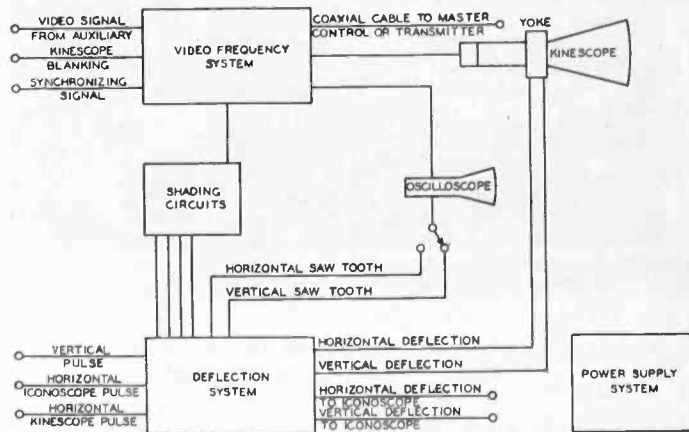

Fig. 11—Block diagram of camera-control unit.

the oscilloscope at either line or field frequency can be obtained. Kinescope and iconoscope width, height, and centering controls are included. The line and field-frequency saw-tooth waves produced in the deflection system are also used as shading signals in the video-frequency system.

The power-supply system includes a high-voltage rectifier for supplying anode potentials to the iconoscope and kinescope. A low-voltage rectifier is used to

supply anode potentials to all the other tubes in the camera-control unit. Focus and bias controls for the kinescope and iconoscope are included in this portion of the system.

Figs. 12 and 13 show both sides of the camera control unit with the side covers removed. The front of this unit showing the kinescope, oscilloscope, and the several control knobs is illustrated by the photograph in

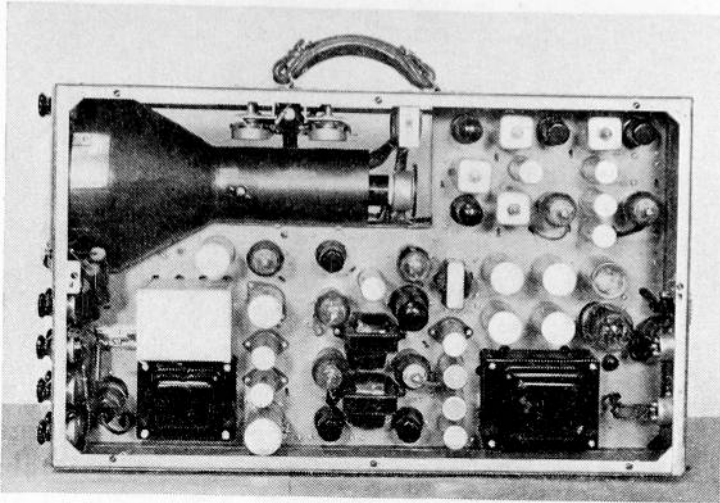

Fig. 12—Camera-control unit—tube side, cover removed.

Fig. 14. A metal cover is supplied which protects these tubes and knobs when the equipment is not in use.

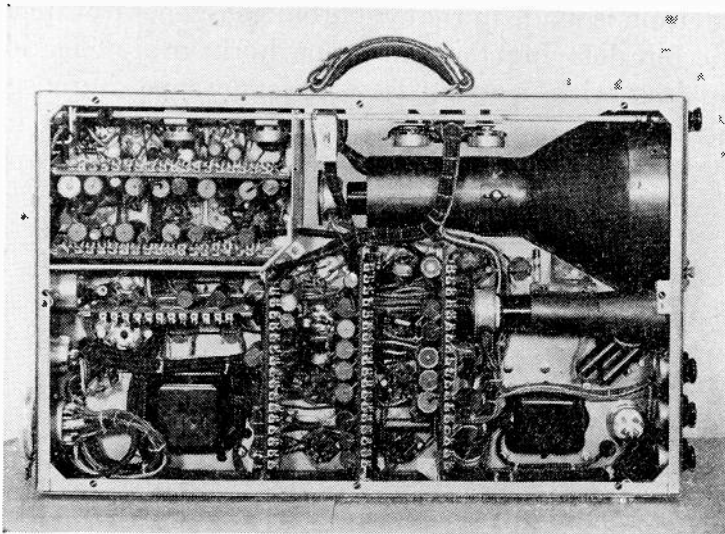

Fig. 13—Camera-control unit—circuit-component side, cover removed.

#### MASTER-CONTROL UNIT

When more than one camera is used to televise a desired scene some means must be provided for switching from one camera to another and for monitoring the "on-the-air" picture. In the portable pickup equipment these requirements are filled by the master-control unit. The block diagram in Fig. 15 shows the several functions of this unit. The video-frequency system amplifies the signals received from the camera-control unit and supplies them to the kinescope and oscilloscope. Synchronizing signals are normally in-

serted in the video-frequency system of the master-control unit. The line amplifier in this unit is designed to provide a four-volt peak-to-peak signal across a 75-ohm line. A separate 75-ohm output circuit is included which can be used to feed an additional monitor

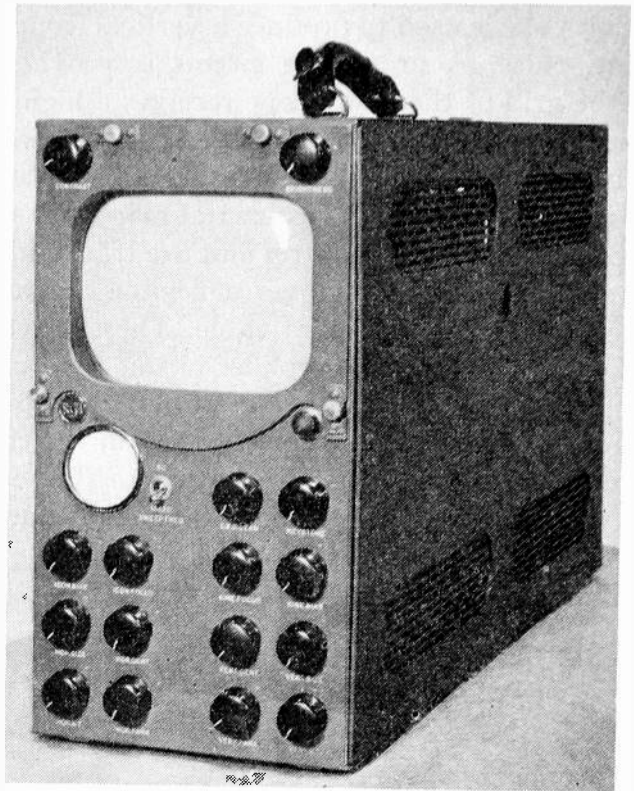

Fig. 14—Camera-control unit—front view.

unit. The video-frequency system is provided with an interlocked switching arrangement by which any one of four input signals can be selected, amplified, monitored, and fed to the outgoing line. Indicator lights on both the master-control unit, each camera-control unit, and camera show which camera is "on the air."

The deflection system for the master-control unit employs synchronizing and deflection circuits which are essentially the same as those used in television receivers. The picture observed on the kinescope in

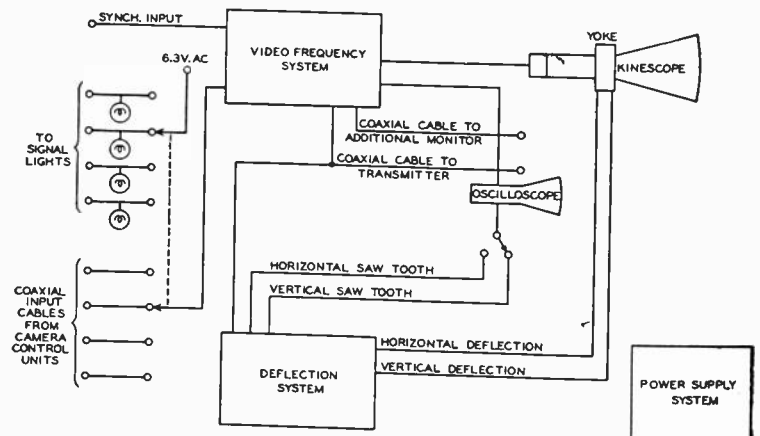

Fig. 15—Block diagram of master-control unit.

the master-control unit is therefore an indication of the performance to be expected at the receiving locations.

The low-voltage and high-voltage rectifiers used in the master-control unit are similar to those included in

the camera-control unit. Fig. 16 is a front view of the master-control unit and shows the switching and indicator-light arrangement.

#### SYNCHRONIZING GENERATOR

The portable synchronizing generator is designed to produce pulses in accordance with the standards of the Radio Manufacturers Association. The synchronizing generator is divided into three units, the pulse unit, the shaping unit, and the delay unit.

#### PULSE UNIT

The pulse unit contains an electromechanical pulse generator for producing 26,460- and 60-cycle pulses. This type of pulse generator was used because it gave the desired electrical characteristics with a minimum of equipment. This generator consists of a brass disk having 441 peripheral teeth and rotated by a 3600-revolution-per-minute synchronous motor. This disk revolves inside a stationary brass ring having 441 teeth on its inner circumference. The clearance between the teeth on the rotor and stator is approximately 0.012 inch. A single radial fin is used on the rotating disk in conjunction with a similar stationary fin to produce the 60-cycle pulses. Direct polarizing voltage is applied between the stators and rotating disk through resistors. The current variations through the resistors in accordance with the changes in capaci-



Fig. 16—Master-control unit—front view.

tance produce the desired voltage pulses. The use of a large number of teeth on both the rotor and stator minimizes the effect of inaccuracies in the width of the teeth and the spacing between them since each pulse is produced by the average change in capacitance caused by each of the 441 teeth on the rotor and stator. In addition to the pulse generator the pulse unit contains

tubes and associated circuits for shaping the pulses and for obtaining pulses at line frequency by selecting every other one of the 26,460 pulses. A power-supply rectifier to provide anode potentials for the complete synchronizing generator is also included in the pulse unit.

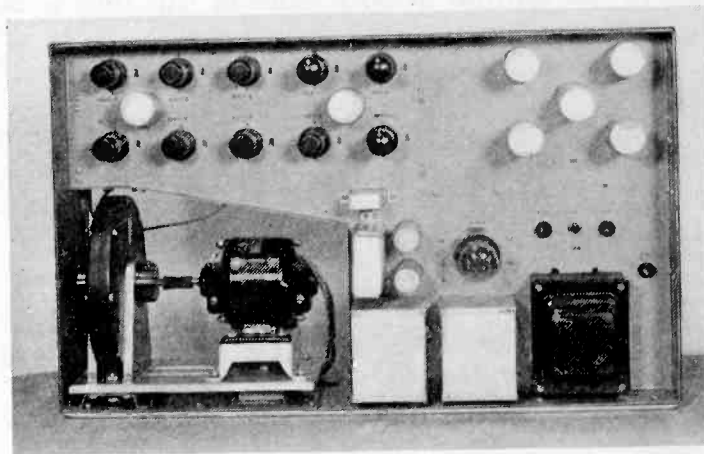

Fig. 17—Synchronizing-generator pulse unit—tube side, cover removed.

Fig. 17 shows the tube side of the pulse unit. The pulse generator is shown in the lower left-hand corner of the figure. The rotor and stator are completely surrounded by a bakelite housing.

#### SHAPING UNIT

The shaping unit receives 60-, 13,230-, and 26,460-cycle pulses from the pulse unit. Four sets of pulses are provided by the shaping unit as follows:

- Iconoscope horizontal driving pulses
- Iconoscope vertical driving pulses
- Blanking pulses
- Synchronizing pulses

Although the synchronizing pulses are formed by combinations of several pulses the leading edge of each pulse is the leading edge of a 26,460-cycle pulse. Controls are provided for varying the width of the several pulses. Photographs of the shaping unit with the side covers removed have been previously shown in Figs. 2 and 3.

#### DELAY UNIT

When two or more cameras are used and they are connected to the control equipment through cables which differ greatly in length it is necessary to delay the driving pulses to the camera connected to the shortest cable so that the pulses returning to the control equipment from this camera correspond in time with those returning from the camera connected to the longest cable. The synchronizing-generator delay unit contains an artificial line which is used to delay the driving pulses to any one of three cameras by an amount corresponding to any normal length of camera cable up to 500 feet. Buffer tubes are used between the switches and the artificial line so that the characteristics of the line are not affected by the various lengths of camera cable. Switch positions are provided for 50-, 100-, 200-, 300-, 400-, and 500-foot lengths of

cable. Fig. 18 is a photograph of the tube side of the delay unit and shows the switch knobs for varying the delay for each camera. The photograph shown in Fig. 19 illustrates the construction of the artificial line and the circuit components used with the buffer tubes. The space in the bottom of both sides of this unit is used to carry spare tubes.

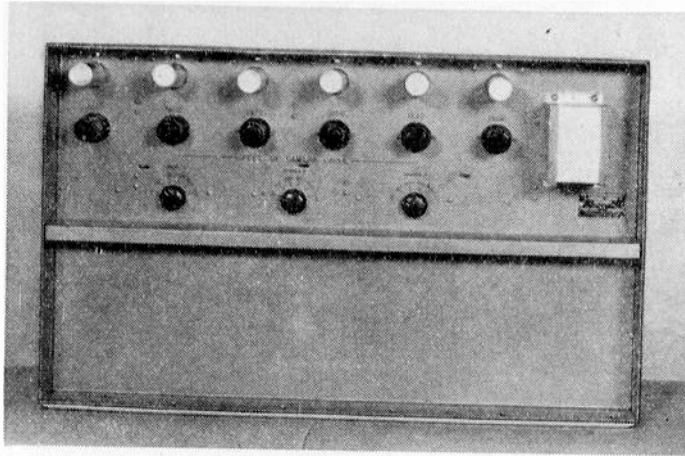

Fig. 18—Synchronizing-generator delay unit—tube side, cover removed.

#### RELAY TRANSMITTER

One of the requirements of any portable pickup system is that some provision must be made for conveying the signal from the remote point to the location where it can be utilized. The wide frequency band used in television makes this problem especially difficult. One obvious solution is of course a portable transmitter for relaying the signal from the remote pickup point to a suitable receiving location near the main transmitter. An ideal transmitter for this type of work must be reasonably rugged, light in weight, and deliver sufficient power to provide a satisfactory service range. The ultra-high-frequency television relay transmitter was designed to meet these requirements. This trans-

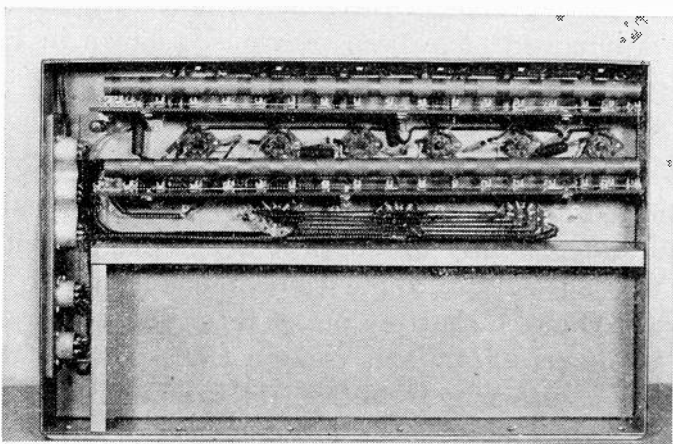

Fig. 19—Synchronizing-generator delay unit—circuit component side, cover removed.

mitter is crystal-controlled and will deliver a peak power of 25 watts at any specified frequency between 280 and 340 megacycles. The radio-frequency portion of the transmitter consists of four stages; crystal oscillator, two multiplier stages, and the power-

amplifier stage. Two neutralized 1628 triodes are used in the power amplifier. All the circuits which are resonant at carrier frequency are "transmission-line circuits." All the other radio-frequency circuits are conventional *L-C* circuits.

The video-frequency portion of the transmitter consists of three stages which are adjusted to pass the frequency band between 30 cycles and 5 megacycles. An input of 2 volts, peak to peak, is sufficient to grid-modulate the power-amplifier stage completely. The direct-current component of the video-frequency signal is restored in the grid circuit of the modulator stage, and direct-current coupling is employed between the modulator plate and the power-amplifier grids.

The monitoring system in the transmitter consists of a diode rectifier, a video-frequency amplifier, and a two-inch oscilloscope. Provision is made so that the output

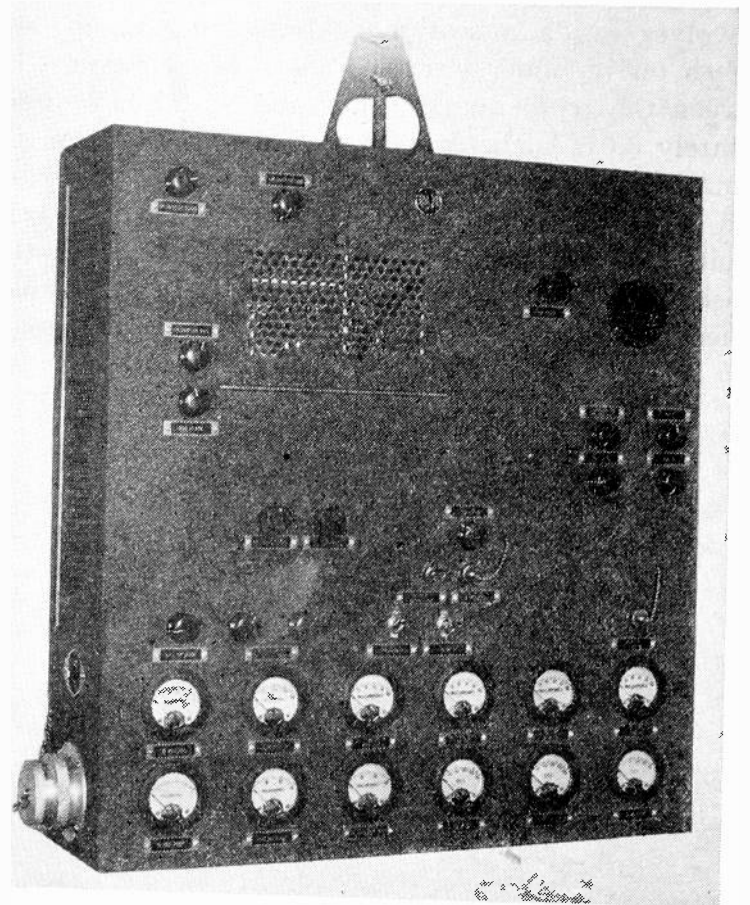

Fig. 20—Ultra-high-frequency relay transmitter—front view.

of the video-frequency amplifier can be fed to a master-control unit so that the complete picture can be monitored.

The transmitter output system is so arranged that either a coaxial line or balanced feeder system may be used. Small antennas having high directivity are readily obtainable at the transmitter frequency. A uni-directional array using eight half-wave elements has given a measured power gain of 12 in field tests.

Fig. 20 is a front view of the transmitter. The overall dimensions of this unit are 6×24×26 inches. The antenna transmission-line clamping unit is shown extending from the top of the transmitter unit. The moni-

toring oscilloscope is viewed through the circular opening in the upper right-hand corner of the picture. The meters at the bottom of the unit indicate the currents in the various tubes.

The rear view of the transmitter with the doors open is shown in Fig. 21. The location of the various circuit

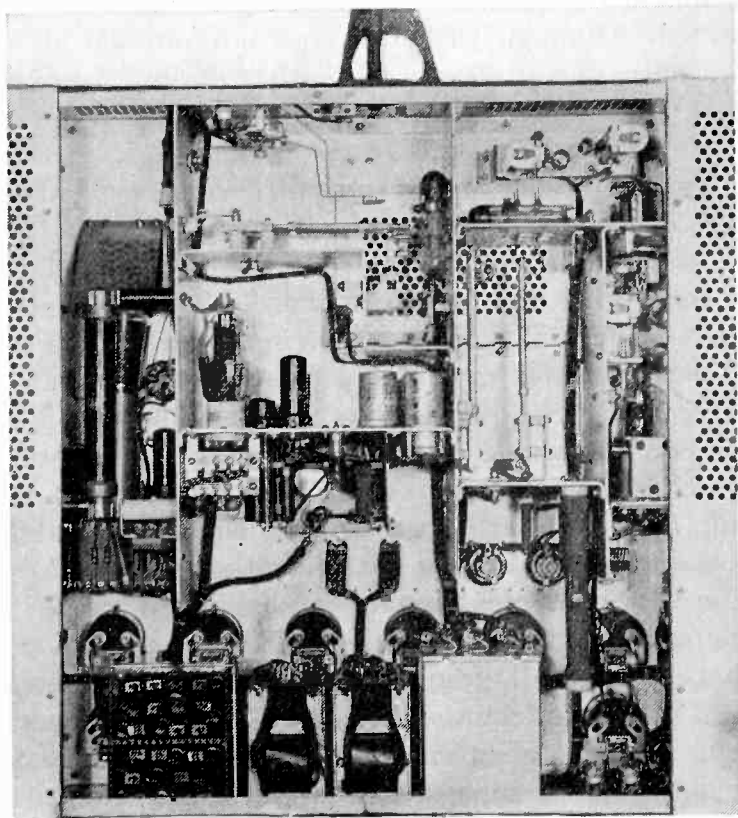

Fig. 21—Ultra-high-frequency relay transmitter—rear view, doors open.

components, tubes, and transmission lines can be seen in this photograph.

#### TRANSMITTER POWER-SUPPLY UNIT

This unit contains two rectifier systems which furnish all the direct voltages necessary for the operation of the transmitter. Fig. 22 shows a view of this unit.

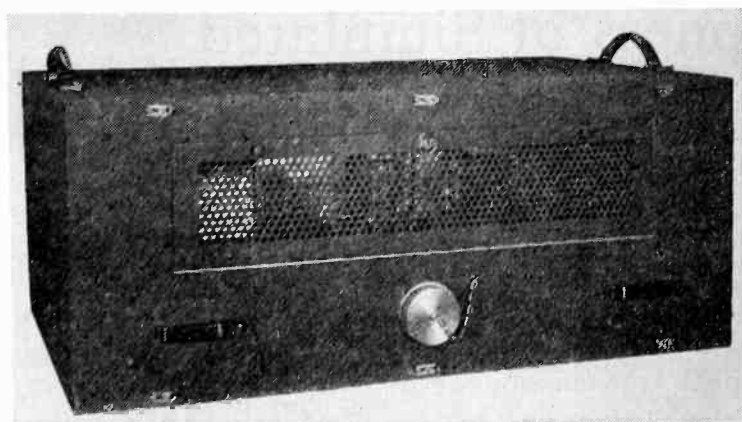

Fig. 22—Ultra-high-frequency relay transmitter power-supply unit.

#### RELAY RECEIVER

The relay receiver is a superheterodyne designed to operate from a 150-ohm antenna transmission line. Coupled fixed-tuned "transmission-line" circuits are used in the input system of the receiver. These circuits are adjusted to pass a frequency band of 12 megacycles

in the range between 280 and 340 megacycles. The oscillator circuit is also of the "transmission-line" type. The intermediate-frequency amplifier consists of seven transformer-coupled stages. The second-detector circuit is direct-current coupled to the automatic-gain-

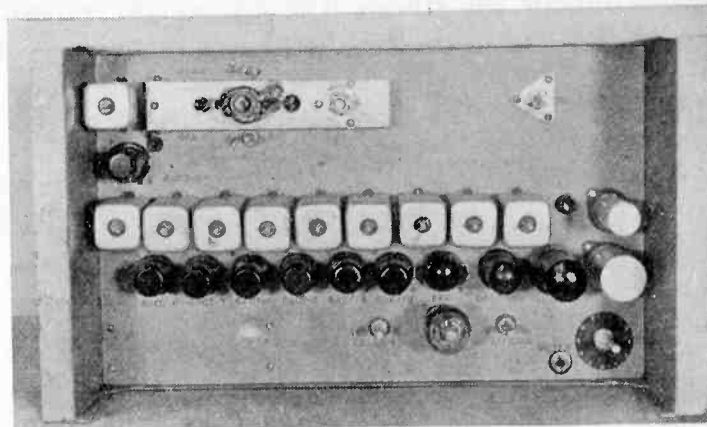

Fig. 23—Ultra-high-frequency relay receiver—front view.

control rectifier, so that the automatic-gain-control voltage is proportional to the peak value of the incoming video-frequency signal, i.e., synchronizing peaks. Provision is made for disconnecting the automatic gain control and using manual gain control if desired. The video-frequency amplifier supplies an output of about 2 volts, peak to peak, across a 75-ohm line. Figs. 23 and 24 show the front and rear views of the receiver. The front view of the power-supply unit is given in Fig. 25.

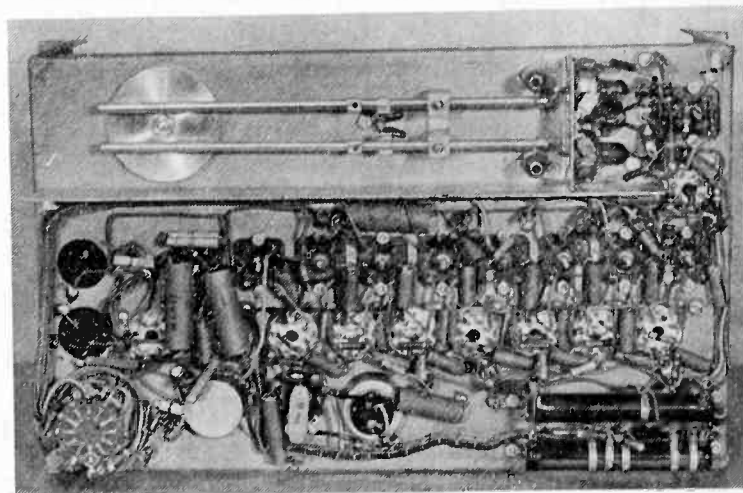

Fig. 24—Ultra-high-frequency relay receiver—rear view.

#### PRACTICAL APPLICATIONS OF THE EQUIPMENT

Television programs have been broadcast as a public service during the past year. The telemobile units previously mentioned have been used in many "on-the-scene" pickups and these have almost all been very popular. The pickup of many potentially interesting programs has been impractical because of the size, weight, and power requirements of the mobile units. Although the cameras associated with these units can be operated at distances up to 500 feet from the unit housing the control equipment, this in many instances is not sufficient because the control unit cannot be

placed in an advantageous location. The alternating-current input power, especially the three-phase for the transmitter unit, frequently has been very difficult to obtain.

The new "suitcase" type of portable pickup equipment, therefore, greatly increases the program potentialities outside the studio. The size, weight, power requirements, and flexibility of the equipment are such

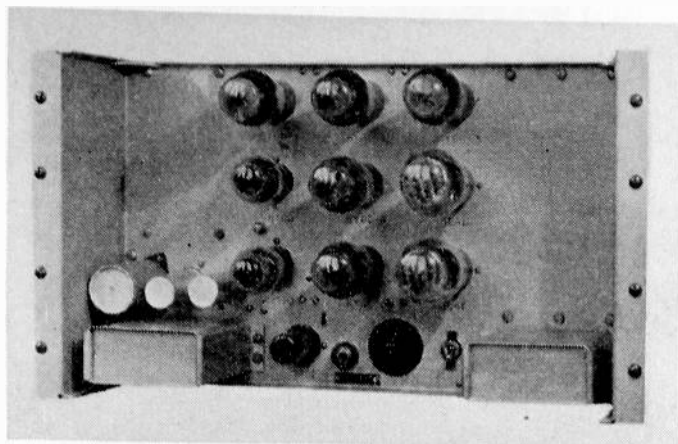

Fig. 25—Ultra-high-frequency relay receiver power-supply unit.

that for the first time program pickups aboard airplanes, boats, and automobiles, while in motion, are possible. The program possibilities which the equipment creates are thus evident for it is obvious that the extension of the television eye to points outside the studio is an even greater boon to television than was the corresponding extension of the microphone in sound broadcasting. The new equipment has recently been used aboard an airplane to pick up scenes of New York and transmit them to Radio City for a program broadcast from the transmitter in the Empire State Building.

It is quite possible to carry the complete pickup apparatus into any building, amusement park, theater,

etc., in order to televise events which are inaccessible to pickup equipment mounted permanently in a truck. The few kilowatts of single-phase alternating-current power which are required for the entire equipment can be obtained in most locations.

Another important application of the new equipment is the televising of regular sound broadcast programs in the studios in which they are normally presented. Although such use does not provide all the flexibility of a studio permanently equipped for television, it does permit a very useful extension of pickup facilities for certain types of programs.

The portability of the transmitter is a great advantage in remote pickup work. In many locations it is necessary to erect an antenna on the roof of a building or some other high structure in order to obtain line-of-sight transmission to the receiving point. In the case of a transmitter mounted permanently in a truck a rather long radio-frequency transmission line is required. The problem of adjusting such a line to carry television signals without serious reflections is a difficult one, even in a permanent installation and for portable or mobile work the difficulties are still greater. The new equipment makes it possible to locate the transmitter on the roof or upper floor of a building so that a short radio-frequency transmission line can be used to the antenna. In this case the transmitter is connected to the pickup equipment by means of a flexible coaxial cable or other video-frequency line. The transmission of the video-frequency signals over a suitable line presents a considerably less serious problem than the transmission of radio-frequency power over a line of equivalent length.

#### ACKNOWLEDGMENTS

The authors wish to acknowledge the individual and co-operative efforts of the many engineers who participated in the development of this equipment.

## The Subjective Sharpness of Simulated Television Images\*

M. W. BALDWIN, JR.†, ASSOCIATE, I.R.E.

*Summary*—Small-sized motion pictures, projected out of focus in simulation of the images reproduced by home television receivers, are used in a statistical study of the appreciation of sharpness. Sharpness, in the subjective sense, is found to increase more and more slowly as the physical resolution of the image is increased. Images of present television grade are shown to be within a region of diminishing return with respect to resolution. Equality of horizontal and vertical resolutions is found to be a very uncritical requirement on the sharpness of an image, especially of a fairly sharp one.

### I. INTRODUCTION

OF THE many factors which influence the quality of a television image, the one which is generally indicative of the value of the image and the cost of its transmission is the resolution, or sharpness.

\* Decimal classification: R583. Original manuscript received by the Institute, September 16, 1940.

† Bell Telephone Laboratories, Inc., New York, N. Y.

This resolution factor has always been reckoned in purely objective terms, such as the number of scanning lines, or the number of elemental areas in the image, or the width of the frequency band required for electrical transmission at a given rate. The subjective value of sharpness has not previously been considered. Some recent tests with a small group of observers, using out-of-focus motion pictures in a basic study of the visual requirements on images of limited resolution, have thrown new light on the evaluation of resolution and sharpness. The results appear of sufficient interest, particularly when interpreted in terms of television images, to warrant this presentation. The word "sharpness" will be used in the sense of a subjective or



psychological variable, with a strict technical significance in keeping with our experimental method, and the word "resolution" will be used in the sense of an objective or physical variable.

We find that as images become sharper, their sharpness increases more and more slowly with respect to the objective factors. We find also that as images become sharper the need for equal resolution in all directions becomes less and less, and that with images of present television grade the tolerance for unequal horizontal and vertical resolutions is already remarkably wide. These conclusions are supported by our experiments with small-sized motion pictures viewed at a distance of 30 inches, about four times the picture height. It would not be safe to extrapolate the results of these experiments to the large-screen conditions of motion-picture theaters because the visual acuity of the eye may be expected to increase with distance in the range in question,<sup>1</sup> and for other reasons.

## II. EXPOSITION OF METHOD

Image sharpness is to be measured by subjective test, employing psychometric methods<sup>2</sup> which have been widely used in the measurement of other subjective values. Test images are to be projected onto a screen from 35-millimeter motion-picture film in such a way that the resolution of the image can readily be varied over a substantial range, and with provision for making the horizontal resolution different from the vertical. The use of motion pictures instead of actual television images permits sharpness to be studied independently of other factors and facilitates the experimental procedure.

The relationship between the television image and the motion picture which simulates it will be determined on the basis of their subjective equality in sharpness. For that purpose, a television image reproduced by an apparatus<sup>3,4</sup> of known characteristics is to be compared with a projected out-of-focus motion picture of the same scene, under the same conditions of size, viewing distance, brightness, and color. (The motion picture will, in general, be superior in the rendition of tone values and in respect to flicker, and will of course not show the scanning-line structure of the television image or any of the degradations commonly encountered in electrical transmission.) When the two images are judged to be equally sharp by the median one of a group of observers, the size of the figure of confusion of the motion picture is to be taken as the

measure of the resolution of the compared television image.

The figure of confusion of the motion picture is that small area of the projected image over which the light from any point in the film is spread. Every point produces its own figure of confusion, of proportionate brightness, and the overlapping of the figures in every direction accounts for the loss of sharpness. When the projection lens is "in focus", the figure of confusion is a minimum one set by the aberrations of the optical system and by diffraction effects. As the lens is moved away from the "in-focus" position, the figure of confusion becomes larger and assumes the shape of the aperture stop of the projection lens. If the illumination of the aperture stop is uniform, this larger figure of confusion is a well-defined area of uniform brightness. We used a rectangular aperture stop, at the projection lens, whose height and width could be varied reciprocally so as to maintain constant area of opening, and we used a calibrated microscope to measure the departure of the lens from the "in-focus" position. Thus we could produce images of various degrees of sharpness and of unequal horizontal and vertical resolutions.

This method of specifying the resolution of an image in terms of the size of the figure of confusion affords an important advantage. It avoids the necessity for postulating any particular relation between the resolution and the spatial distribution of brightness values about originally abrupt edges in the image. The variety of such relations assumed by others<sup>5-9</sup> has led to a variety of conclusions with respect to resolution in television. We find subjective comparison of images to yield results of fairly small dispersion.

Let us consider now the measurement of sharpness in subjective terms. Here we find no familiar units of measurement, no scales or meters. We find no agreement as to the meaning of a statement that one image looks twice as sharp as another. We can say of two images only that (a) one image looks sharper than the other, or (b) the two images look equally sharp. When the images are quite different, there will be agreement by a number of observers that the one image is the sharper. When the images are not different in sharpness, there may be some judgments that one of them is the sharper, but these will be counterbalanced in the long run by an equal number of judgments that the other is the sharper. When the images are only slightly

<sup>5</sup> R. D. Kell, A. V. Bedford, and M. A. Trainer, "An experimental television system—the transmitter," *Proc. I.R.E.*, vol. 22, pp. 1246-1265; November, 1934.

<sup>6</sup> P. Mertz and F. Gray, "A theory of scanning and its relation to the characteristics of the transmitted signal in telephotography and television," *Bell Sys. Tech. Jour.*, vol. 13, pp. 464-515; July, 1934.

<sup>7</sup> Harold A. Wheeler and Arthur V. Loughren, "The fine structure of television images," *Proc. I.R.E.*, vol. 26, pp. 540-575; May, 1938.

<sup>8</sup> J. C. Wilson, "Channel width and resolving power in television systems," *Jour. Telev. Soc.*, vol. 2, pp. 397-419; June, 1938.

<sup>9</sup> R. D. Kell, A. V. Bedford, and G. L. Fredendall, "A determination of optimum number of lines in a television system," *RCA Rev.*, vol. 5, pp. 8-30; July, 1940.

<sup>1</sup> M. Luckiesh and Frank K. Moss, "The dependency of visual acuity upon stimulus-distance," *Jour. Opt. Soc. Amer.*, vol. 23, pp. 25-29; January, 1933.

<sup>2</sup> J. P. Guilford, "Psychometric Methods," McGraw-Hill Book Company, New York, N. Y., 1936.

<sup>3</sup> The television apparatus comprised a mechanical film scanner and an electronic reproducing tube designed specifically for television. A description of it is given in reference 4.

<sup>4</sup> H. E. Ives, "The transmission of motion pictures over a coaxial cable," *Jour. Soc. Mot. Pic. Eng.*, vol. 31, pp. 256-276; September, 1938.

different in sharpness, an observer may reverse his judgment from time to time on repeated trials, and he may sometimes disagree with the judgment of another observer. It is within this region of small sharpness differences, in the interval of uncertain judgments where the observer is sometimes right and sometimes wrong with respect to the known objective difference, that it becomes possible to set up, on a statistical basis, a significant quantitative measure of sharpness difference.

Suppose that in judging two images of almost equal sharpness the observers have been instructed to designate either one or the other of the images as the sharper; that is, a judgment of "equally sharp" is not to be permitted for the present. An observer who dis-

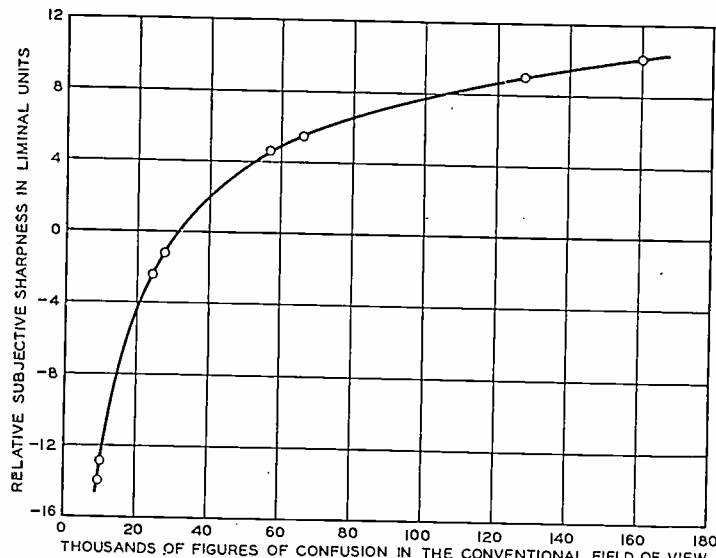

Fig. 1—Sharpness of small-sized motion pictures as a function of resolution. The conventional field of view is a rectangle whose height is  $1/4$  the viewing distance and whose width is  $4/3$  the height. Reference sharpness is approximately that of a 240-line, 24-frame-per-second, 806-kilocycle television image. Curve based on 1080 observations at a viewing distance of 30 inches.

cerns no difference in sharpness is thus compelled to guess which image is sharper, and his guess is as likely to be right as it is to be wrong, with respect to the known objective difference. Suppose, further, that the sharpness difference has been made so small that only 75 per cent of the judgments turn out to be right, the remaining 25 per cent being wrong. On the basis that these wrong judgments are guesses, we must pair them off with an equal number of the right judgments, so that 50 per cent of the total are classed as guesses. The other 50 per cent are classed as real discriminations. (The pairing of an equal number of the right judgments with the wrong judgments goes back to the equal likelihood of right and wrong guesses; it affords the best estimate we can make of the number of guesses.) When real discrimination is thus evidenced in one half of the observations, that is, when 75 per cent of the judgments are right and 25 per cent of them are wrong, we shall designate the difference in resolution as the *difference limen*.<sup>10</sup>

<sup>10</sup> The term "limen" is frequently used in psychometry in lieu of older terms such as "just-noticeable-difference," "threshold value,"

It is seen that the value of the limen is arrived at statistically, taking into account the variability of individual judgments. Smaller differences than the limen are not always imperceptible, nor are larger differences always perceptible.

The difference in sharpness, or in sensory response, which corresponds to a difference of one limen in resolution, may be said to be one unit on the subjective scale of measurement. We shall designate this as a *liminal unit*.<sup>11</sup> It will be understood that the word *liminal* has here a particular and precise significance, by reason of the one-to-one correspondence between the liminal unit and the statistically derived value of the difference limen. A liminal unit of sharpness difference may be considered as the median of a number of values of sensory response to a difference of one limen in resolution.

### III. SHARPNESS AND RESOLUTION

Fig. 1 shows how we find the sharpness of an image to vary as the number of elemental areas in the image is changed. Sharpness is expressed in liminal units, based on measurements of the limen at four different values of resolution, indicated by the four pairs of points on the curve. Resolution is expressed as the number of figures of confusion in a rectangular field of view whose width is four thirds of its height and which is viewed at a distance of four times its height.<sup>12</sup> This conventional field of view was chosen as typical of viewing conditions for motion pictures and television images. (The conventional field is 19 degrees wide by 14 degrees high.) The range of the curve in Fig. 1 may be stated very roughly as from 150-line to 600-line television images.

The significant feature of this curve is its rapidly decreasing slope with increasing sharpness. It shows that sharpness is by no means proportional to the number of elemental areas in the image, and demonstrates that the use of objective factors as indexes of sharpness should be regarded with more than the usual amount of caution. It shows that images of present television grade are well within a region of diminishing return

"perceptible difference," etc. It has the virtue that its meaning may be precisely defined in terms of the particular experimental method under consideration, without the extraneous significance which might attach to the more commonplace words.

<sup>11</sup> There seems to be no accepted name for such a unit. Guilford<sup>2</sup> calls it simply "a unit of measurement on the psychological scale." In discussing the measurement of sensory differences which are equal to each other but not necessarily of liminal size, the terms "sensory value" and "scale value" have been used.

<sup>12</sup> We have used relative values here in order that our results might be applied to other images not too different in size from the small ones we actually used. Other values of aspect ratio in the neighborhood of 4 to 3, and other values of viewing distance in the neighborhood of four times the picture height, may be brought within the scope of our data on the assumption that the sharpness is the same if the solid angle subtended by the area of the figure of confusion is the same. For example, a square field of view containing 60 thousand figures of confusion, and viewed at five times its height, would be equal in sharpness to our conventional field containing 125 thousand figures of confusion

$$\left[ 125 = 60 \times \frac{4}{3} \times \left( \frac{5}{4} \right)^2 \right].$$

with respect to resolution, a region, however, whose ultimate boundary is still well removed. (We estimate that the sharpest image our motion-picture machine could project would be represented in Fig. 1 by a point in the neighborhood of +18 units.) It must be remembered that the curve represents judgments made by trained observers under optimum conditions for distinguishing small differences, and that a change as small as one liminal unit, under the conditions of ordinary television viewing, would probably be largely unnoticed.

A better understanding of the meaning of this curve relating sharpness to resolution may be had by examining the experiment in detail. An individual observation was made when one of the observers, watching the projected image, caused the projection lens to be moved from a reference position to a neighboring one and reported which position he judged to yield the sharper image. The motion-picture scene was a close-up of a fashion model turning slowly against a plain neutral background, and was repeated every quarter minute. The observer could have the lens moved whenever and as often as he wanted to before reporting, so that he soon acquired the habit of observing only the most critical portions of the scene. As soon as his report was recorded, completing that observation, he was shown a new pair of lens positions, the same reference one with a different neighboring one, and asked again to report which he judged to yield the sharper image.

We believe that there were no contaminating influences and that only the size of the figure of confusion was varied. No change in brightness or in magnification could be detected. A minute lateral shifting of the image, because of play in the focusing mount of the lens, was completely masked by the continual weave of the film in the gate and the natural motion of the model. Any significance of the position of the observer's control key was destroyed by reversing its connections from time to time, between observations, without the observer's knowledge. No telltale sound accompanied the small motion of the lens, and none of the operator's movements could be seen by the observer.

Each one of 15 observers made 84 separate observations of sharpness difference. Expressing the resolution in terms of the angle at the observer's eye subtended by the side of the square figure of confusion, there were four main reference values, namely 0.71, 1.1, 1.7, and 2.8 milliradians (1 milliradian is equal to 3.44 minutes of arc). At each of these reference values there were seven neighboring values, namely 0, 0.045, 0.090, 0.13, 0.18, 0.22, and 0.27 milliradians greater than the reference value. (The 0 in that set means that the reference value was shown against itself, or that the observer was asked to judge a null change; this was intended to keep him on his guard and alert, not to furnish primary data.) Each pair of values was presented to each observer three times, so that there were 45 observations on every pair. The pairs were presented in irregular

order according to a schedule, the variation about one reference value being completed before going on to the next. The differences were set up on the basis of preliminary trials to include some which almost none of the observers could detect and some which almost all could. It was explained that some of the differences to be judged would probably be too small for discernment, and that a "no choice" response would be permitted whenever reasonable effort failed to establish a definite choice.

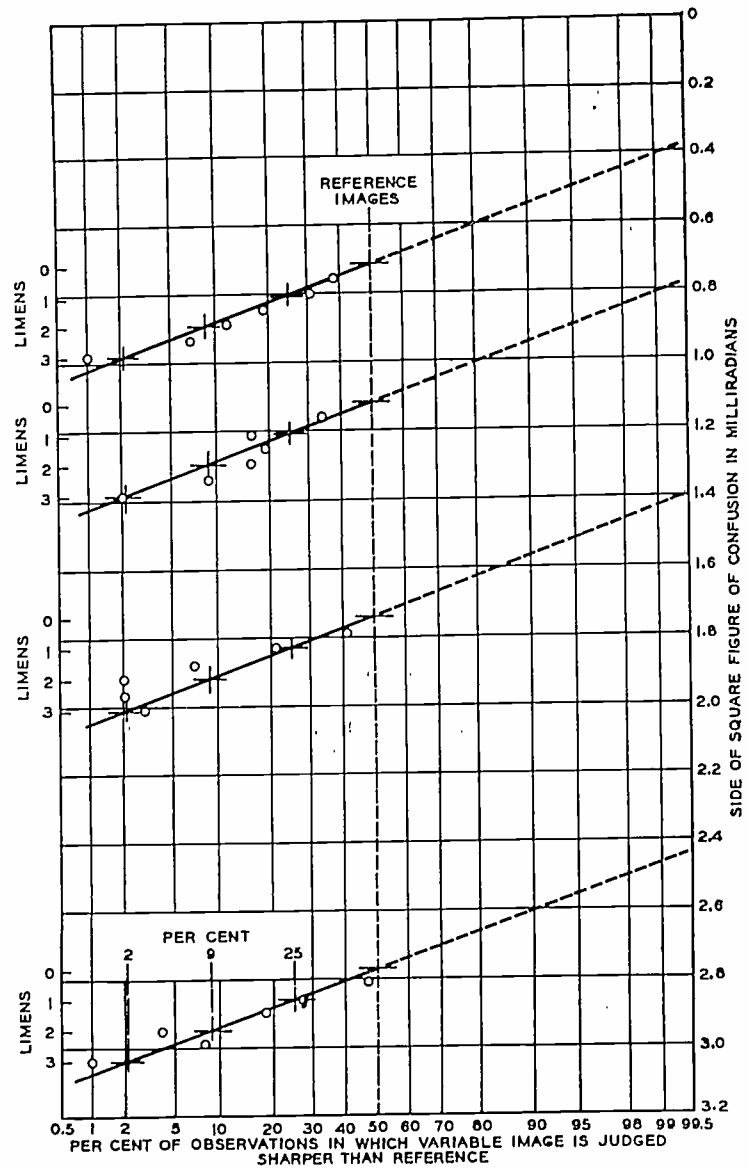

Fig. 2—Distributions of judgments of sharpness differences. The scales of limens denote subjectively determined units, as explained in the text. Each point represents 45 observations of a small-sized motion picture at a viewing distance of 30 inches.

The primary data are shown in Fig. 2. Each point shows the proportion of the observations in which the variable image, which had the poorer resolution by reason of its larger figure of confusion, was nevertheless judged to be sharper than the reference image. Such a judgment would, of course, be classed as wrong. All reported "no choice" judgments have been distributed equally between the "right" and "wrong" classes. It will be noticed that there was some discrimination at even the smallest change made, that is 0.045 milliradian, and that there was lack of complete discrimination at the largest change, that is 0.27 milliradian. The "no choice" judgments comprised 15 per cent of the

total at the smallest change and only 2 per cent at the largest.

It is interesting to note that for the null changes the "no choice" judgments comprised only 17 per cent of the total, indicating either that the observers were reluctant to admit that they were guessing or that they were judging coincidental small changes in the film due to its bending in the gate or to its photographic process-

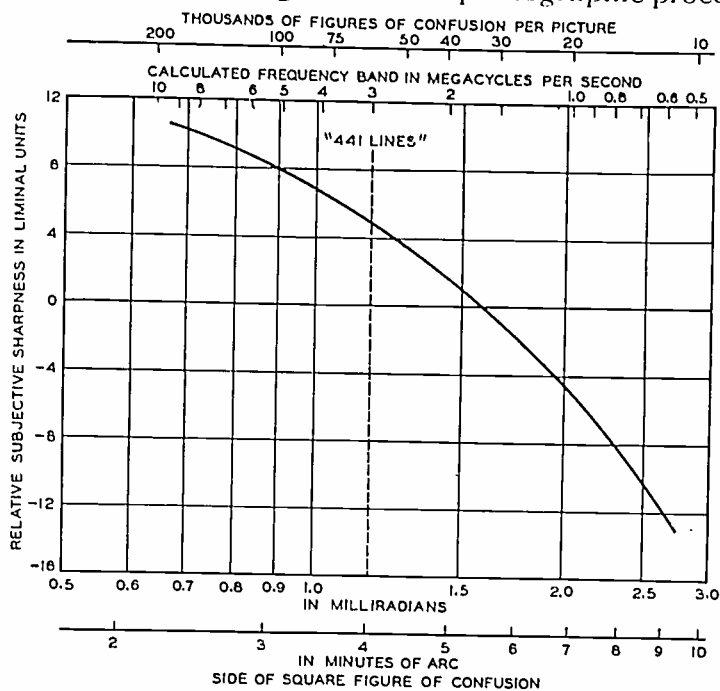

Fig. 3—Sharpness of small-sized motion pictures at a viewing distance of 30 inches. The frequency band is calculated on the basis of a 10-inch by 7½-inch television picture, 30 frames per second, with 15 per cent horizontal and 7 per cent vertical blanking, under the condition of equal horizontal and vertical resolutions.

ing. (We did observe, in establishing the lens position for sharpest focus, that film at the start of a reel required a slightly different lens setting from that at the end of the reel, and we ascribed it to the varying tension during projection, or to the varying degrees of curvature in storage on the reel.)

The four sets of points in Fig. 2 exhibit rather striking similarities. Each set may be fairly represented by a normal error curve (straight line on this arithmetic probability paper). We have drawn in four such normal curves, passing each one through the 50 per cent point at the null change and giving each a common slope. The appropriate value of slope was determined by inspection of an auxiliary plot in which the four reference values were superimposed and the four sets of points were plotted to a common ordinate scale of differences. These normal curves are considered to represent the data as well as any more elaborate relations that might have been used.

We varied the resolution only in the direction of decreasing it with respect to the reference values. We presume that had the variation been in the opposite direction the data would have been represented equally well by the same normal curves, which are accordingly extended in dotted lines.

In Fig. 2 we have indicated the magnitude of a difference of one limen by means of supplementary scales

of ordinates. Since the four normal curves have a common slope, the difference limen turns out to have a constant value, 0.090 milliradian (0.3 minute of arc), independent of the size of the figure of confusion in the range from 0.71 to 2.8 milliradians. Why this should be so is a problem of physiological optics which is rather beyond the scope of this paper. The supplementary scales also serve to illustrate the meaning of differences 2 and 3 times as large as the difference limen. That is, a change in the side of the figure of confusion of 0.18 milliradian would be twice as large as the limen of 0.090 milliradian, and would result in wrong judgments in 9 per cent of the observations, corresponding to real discrimination in 82 per cent of them. Likewise a change of 0.27 milliradian would result in real discrimination in 96 per cent of the observations. Any change larger than about three times the limen would be discriminated in practically every instance, under the conditions of our experiment.

Figs. 3 and 4 show the curve of Fig. 1 replotted in terms of some additional objective variables. A scale of nominal frequency band width required for transmission of the image signal over a video-frequency circuit has been worked out on the basis of our comparison of the out-of-focus motion picture with a television image of known characteristics, to be described in section V. We see that in order to effect an increase in

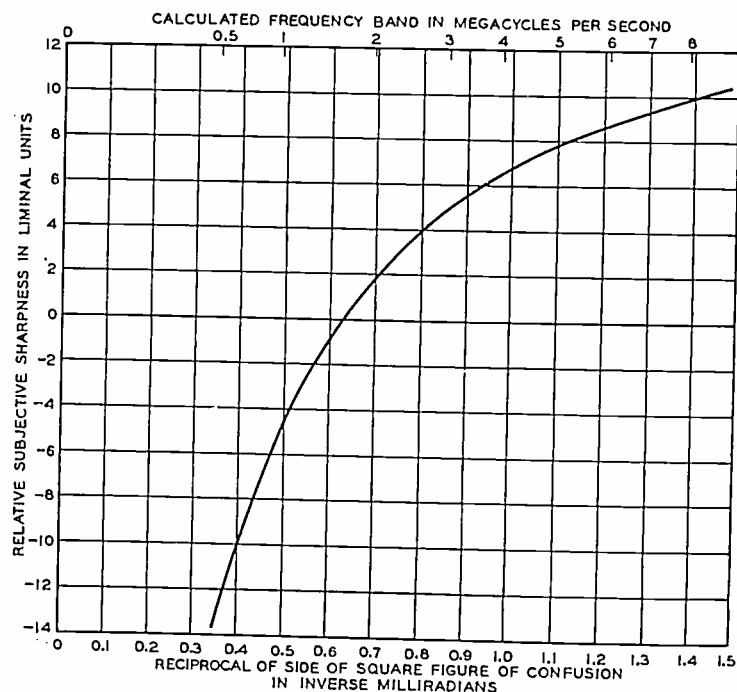

Fig. 4—Sharpness of small-sized motion pictures at a viewing distance of 30 inches. The frequency band is calculated on the same basis as in Fig. 3.

sharpness which would be practically always discriminated under our experimental conditions, that is, a change of 3 or 4 liminal units, the frequency band would have to be increased from say 2.5 megacycles to about 4.5 megacycles. To effect an additional increase of the same subjective amount would require that the frequency band be increased from 4.5 megacycles to about 10 megacycles. The diminishing return in sharpness is possibly better illustrated by the con-

tinually decreasing slope of the curve in Fig. 4, in which the abscissa is proportional to the square root of the frequency band, a factor which may perhaps be interpreted to represent roughly the cost of electrical transmission over a long system. We might infer from this curve that transmission costs are likely to increase faster than image sharpness, other things being equal.

#### IV. HORIZONTAL AND VERTICAL RESOLUTIONS

The effect of unequal horizontal and vertical resolutions upon sharpness is shown in Fig. 5. The various rectangular figures of confusion, which were inter-compared in a manner which will be described presently, are shown along the axis of abscissas, positioned according to the logarithm of the ratio of width to height, for the sake of symmetry. Three curves are shown, each for a different constant value of the area of the figure of confusion, which determines the sharpness for the central square shape (as in Fig. 1). At the right the relative areas are illustrated and specified in terms of the number of figures of confusion in the conventional field of view, whose width is four thirds of its height and which is viewed at four times its height.

Sharpness, the subjective variable, is plotted along the axis of ordinates in liminal units. This unit denotes a difference in sharpness which corresponds to a difference of one limen in the shape of the figure of confusion. When two images, characterized by different shapes of figure of confusion, are judged by a number of observers, the proportion of the observations in which one image is said to be sharper than the other affords a significant measure of the evaluation of the difference between them. When 25 per cent of the observations show that shape *A* yields a sharper image than shape *B*, we say that shapes *A* and *B* are different by one limen, and that the image *A* is less sharp than the image *B* by one liminal unit. All "no choice" or "equally sharp" judgments are distributed equally between the judgments for *A* and those for *B*.

In order to evaluate other than unit differences, we have assumed that a normal error curve describes accurately enough the distribution of sharpness differences in liminal units. Thus, image *A* is less sharp than image *B* by two liminal units when it is reported to be sharper than image *B* in 9 per cent of the observations. The difference is three liminal units when it is reported to be sharper in 2 per cent of the observations. Any difference larger than about three liminal units would indicate practically complete agreement that the one image is less sharp than the other, under our experimental conditions. A distribution of this nature was found to hold for sharpness differences resulting from changes in the area of the figure of confusion, as shown in Fig. 2.

Each shape of a figure of confusion was compared with each of the four other selected shapes, and the sharpness differences were expressed in liminal units by the procedure just discussed. A fifth difference, corre-

sponding to a null change, or a shape compared with itself, was presumed to be zero. The average value of these five sharpness differences, averaged in liminal units, measured the relative sharpness of that particular shape with respect to the average sharpness of all five shapes, an unvarying reference. In Fig. 5, the sharpness scales have been shifted so that zero denotes the most preferred one of the shapes, which happened in each case to be the square.

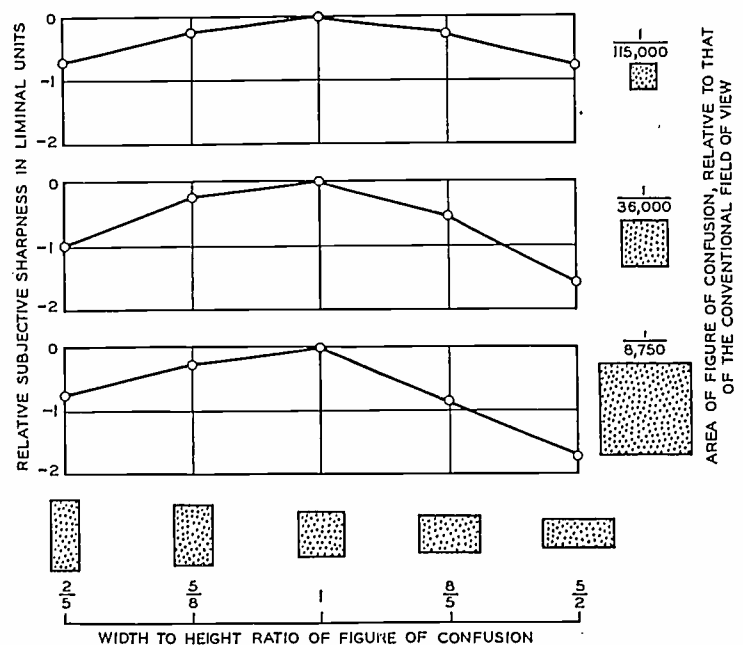

Fig. 5—Sharpness of small-sized motion pictures as a function of the relative values of horizontal and vertical resolutions. The conventional field of view is a rectangle whose height is  $1/4$  the viewing distance and whose width is  $4/3$  the height. Each point represents 150 observations at a viewing distance of 30 inches.

The sharpness curves are found to be slightly skewed with respect to the logarithm of the width:height ratio, there being a small preference for figures of confusion whose long dimension is vertical rather than horizontal. This is believed to be the first evidence of an asymmetric requirement on resolution. It suggests the possibility that the square figure might not have been the most preferred, had we tested other shapes nearer to the square than the ones we did use. With a more searching experiment we might have found that the eye prefers resolution in the horizontal direction to be just a little better than in the vertical direction. Inasmuch as the effect is fairly small, and found only with the less sharp images, we shall leave it as another problem in physiological optics.

With an actual television image this small skewness would probably be reversed by the attendant coarsening of the scanning-line structure. We do not know how much to allow for annoyance caused by visibility of the line structure. Taking our best estimate<sup>13</sup> of the height

<sup>13</sup> Engstrom<sup>14</sup> estimates that the scanning-line structure becomes just noticeable when the spacing of the lines subtends an angle of 2 minutes at the observer's eye. In section V we show that the equivalent figure of confusion has a height 1.9 times as great as the spacing of the scanning lines.

<sup>14</sup> E. W. Engstrom, "A study of television image characteristics," Proc. I.R.E., vol. 21, pp. 1631-1651; December, 1933.

of the figure of confusion which would be equivalent in vertical resolution to a just-noticeable pattern of scanning lines, we may say that for the uppermost curve in Fig. 5 the scanning-line structure would not be noticeable except possibly for the shape marked 2/5. For the central curve the line structure would be noticeable for all shapes except possibly the one marked 5/2. It appears that the skewness and the line structure vanish together as the sharpness is increased.

Fig. 5 demonstrates that equality of horizontal and vertical resolutions is a very uncritical requirement on the sharpness of an image, especially of a fairly sharp one. An image somewhat better than present television grade, exemplified by the uppermost curve in Fig. 5, shows a remarkably wide tolerance in this respect. Its figure of confusion could be three times as high as wide, or three times as wide as high, yet any intermediate shape between those two extremes would yield an equally sharp image to within one liminal unit. Under the ordinary conditions of television viewing the difference would be even less marked than that. This would imply that if the square figure of confusion simulates a television image of say 500 lines, then the number of lines could be changed to any value from about 300 to about 850 without altering the sharpness by as much as one liminal unit, under the condition, of course, that all the other pertinent factors, such as frequency band width and number of frames per second, remain unchanged.

The curves in Fig. 5 represent the averaged responses of 15 observers each viewing 5 different motion-picture scenes. Each one of the 5 selected shapes of figures of confusion was shown with each other one as a pair, a total of 10 pairs. The observer was asked to identify which member of each pair he judged to yield the sharper image, or to report "no choice" if he judged them to be equally sharp. The pairs were scheduled in irregular order, and the observer could have the aperture shape shifted at will. The observers were instructed to consider the whole image area without undue regard for some features to the neglect of others.

#### V. COMPARISON OF THE OUT-OF-FOCUS MOTION PICTURES WITH A 240-LINE TELEVISION IMAGE OF KNOWN CHARACTERISTICS

The motion-picture machine was arranged to project out-of-focus pictures onto a screen set up beside the cathode-ray receiving tube of a laboratory television apparatus<sup>4</sup> of excellent design. Duplicate films were run in the two machines, and the images were made equal in size and approximately equal in color and brightness. Special low-pass filters in the video-frequency circuit limited the frequency band without transient distortion, and permitted the trial of three different band widths. The conclusion was reached that the nominal band width of the video-frequency circuit, expressed in cycles per frame period, was equal to 1.3

times the number of figures of confusion in the frame area.

A group of observers compared the two images, each observer being allowed to adjust the focus of the projection lens until he judged the images to be equal in sharpness. The distribution of lens positions, in terms of microscope scale divisions, was found to follow a normal error curve fairly well, and the median value for the group was used in computing the sizes of the figure of confusion. The external aperture shape was always square.

Since the television film scanner had been designed without regard for the unused space between frames on sound film, it became necessary to modify some of the dimensions of the out-of-focus projection system in order to make the two images equal in size. Fig. 6

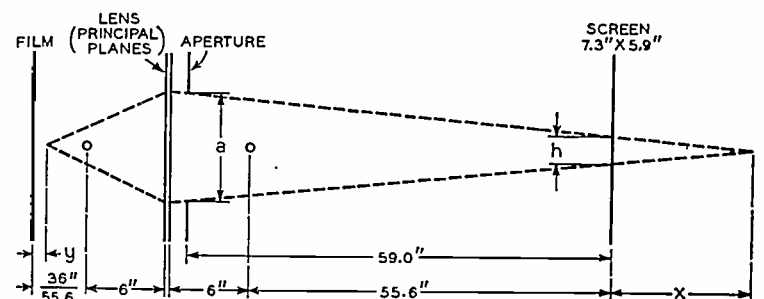

Fig. 6—Essential dimensions of the motion-picture optical system as used for the correlation with a 240-line television image. For this case  $a^2 = 1.00$  square inch.

$$y = \frac{36}{55.6} \cdot \frac{x}{55.6 + x} \quad \frac{h}{a} \doteq 1.45 y$$

shows the modified dimensions. Comparison with Fig. 7, which gives the dimensions used in the main experiments, will show that the magnification was reduced from 12 to 9.3, the area of the external aperture was increased from 0.49 square inch to 1.00 square inch, and the aperture was mounted 2.6 inches instead of 1.3 inches from the principal planes of the projection lens.

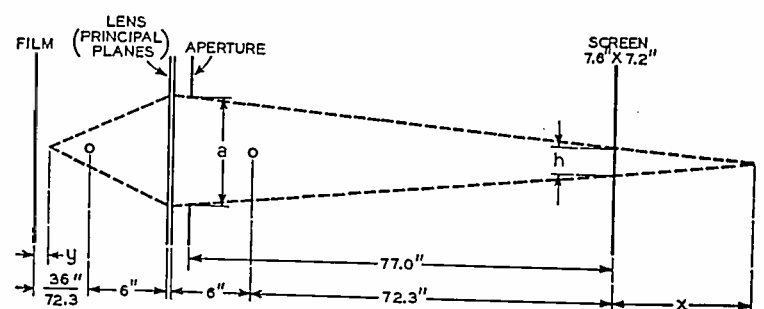

Fig. 7—Essential dimensions of the motion-picture optical system as used for the subjective sharpness tests. For this case  $a^2 = 0.49$  square inch.

$$y = \frac{36}{72.3} \cdot \frac{x}{72.3 + x} \quad \frac{h}{a} \doteq 1.88 y$$

The television apparatus was designed for 240 lines, 24 frames per second, and a width:height ratio of 7:6. Actually 20 per cent of the frame time was consumed in scanning the blank space between sound-film frames and 10 per cent of the line time was used up by the return sweep in the receiver. The television image, which was the same size as the projected motion pic-

ture, was 5.6 inches high. This dimension was 20 per cent less than the height of the entire 240-line field including the blank portion, which was, therefore, 6.9 inches. The width of the entire field including return trace was  $6.9 \times 7/6$  or 8.1 inches, and the width of the television image was 10 per cent less than this, or 7.3 inches. Thus, the total area transmitted per frame period was  $6.9 \times 8.1$  or 56 square inches; the useful image area was  $5.6 \times 7.3$  or 41 square inches.

The three amplitude-frequency characteristics used in the video-frequency circuit are shown in Fig. 8. Curve *A* is for two square scanning apertures in tandem, one transmitting and one receiving, each having the height of one scanning line. No electrical band limitation was effective in this case. Curves *B* and *C* are for the addition of each of two special low-pass filters which were carefully phase-equalized and designed for gradual cutoff. In each case the nominal band width was taken to be the same as that for the aperture effect alone, namely, the frequency at which the loss is 7.8 decibels greater than at low frequency. The addition of a low-pass filter could thus be considered equivalent to an increase in the length of each of the scanning apertures in the ratio of the nominal band widths, as illustrated by the dotted curves.

The results of the comparison were as follows. The number of figures of confusion in the area of the frame was reckoned by dividing the entire area of the television frame, including the blank portion and the return trace, by the observed area of one figure of confusion of the equally sharp motion picture. The number of cycles per frame period was the nominal band width of the video-frequency circuit, in cycles per second, divided by the number of frames per second, or 24.

	Case A	Case B	Case C
Figures of confusion per frame	22,400	18,900	14,800
Cycles per frame period	33,600	26,200	18,800
Ratio	1.50	1.38	1.27

The ratio in case *A* was suspected to be too large because of unaccounted-for small defects in the film scanner which degraded the image sharpness more than was indicated by the aperture effect alone. The difference in ratio between cases *B* and *C* was no larger than the measured probable error of each set of observations. Making allowance for these things, we concluded that the ratio between the number of cycles per frame period and the number of figures of confusion per frame area had been found to be 1.3.

This factor of 1.3 gave us a basis for calculating the television aperture loss in the direction normal to the scanning lines and enabled us to compute the nominal video-frequency band required to yield an image having equal horizontal and vertical resolutions.

The stepped nature of the brightness variation across the scanning lines of a television image, in contrast to its continuous nature along the lines, gives rise to the requirement that for equal resolution in the two directions the scanning apertures must be longer

in the scanning direction than they are across it. The extent of this departure from squareness has been estimated<sup>6-9</sup> at from 1.2 to 1.9, mostly on theoretical grounds. Our comparison of a television image of known characteristics with a controlled out-of-focus motion picture furnished a subjective measurement of the effect which yielded the value 1.4 for the ratio of width to height of the scanning apertures for equal resolution. We take width to mean the dimension along the scanning lines, and height to mean the dimension normal to them.

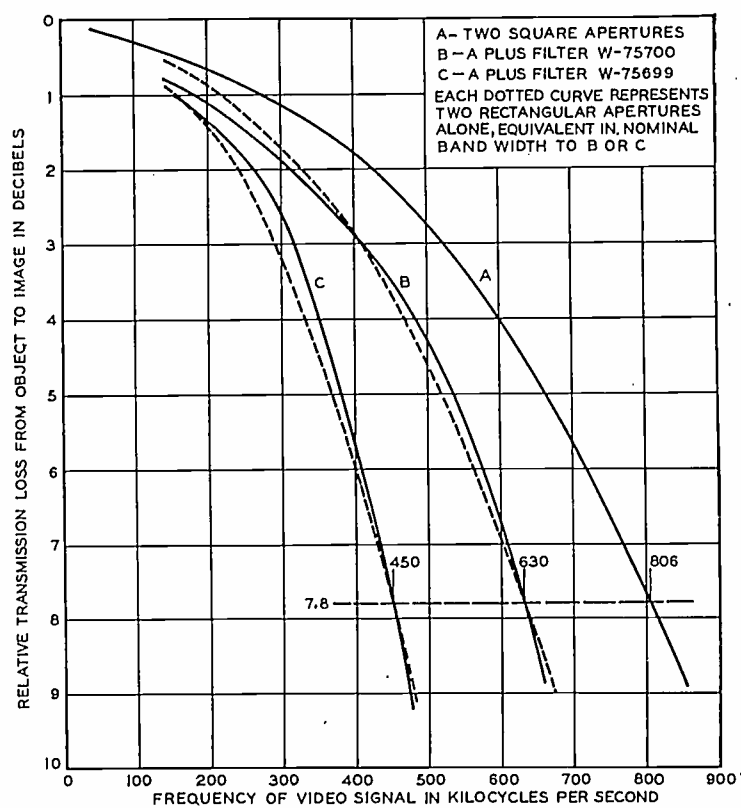

Fig. 8—Amplitude-frequency characteristics of the television system used for correlating the motion-picture projection with a television image.

We found that the nominal video-frequency band width of a television signal, in cycles per frame period, was 1.3 times the number of figures of confusion per frame area in the equally sharp motion picture. This meant that the area of each figure of confusion was 1.3 times as great as the area of one scanning line over a (scanned) length of one cycle. By the adopted definition of nominal video-frequency band width, the length of one cycle was just twice the length of each one of the pair of rectangular scanning apertures which were considered equivalent to the actual square apertures plus the filter. According to the scanning theory of Mertz and Gray,<sup>6</sup> the pair of apertures in tandem was equivalent, in frequency limitation, to a single aperture 1.35 times as long as either one of the pair. Taking the width of this single aperture (1.35 times the length of one half cycle) equal to the width of the figure of confusion, the height of the figure of confusion was calculated from its area to be 1.9 times the height of one scanning line or one scanning pitch. This was the measure by subjective comparison of the resolution across the scanning lines.

Under the condition of equal resolution along and across the scanning lines, the figure of confusion would have to be square and its width would then also be 1.9 times the scanning pitch. The width of each one of the pair of equivalent tandem scanning apertures would be 1.9/1.35 or 1.4 times the scanning pitch. That is, two rectangular scanning apertures, each 1 line high and 1.4 lines wide, used in tandem without electrical band limitation, would yield an image having equal resolution along and across the scanning lines.

The nominal frequency band associated with such scanning apertures is 1/1.4 times that associated with square apertures. That is, the nominal video-frequency band, in cycles per frame period, required for equal horizontal and vertical resolutions is 0.70 times one half the number of square scanning elements per frame area, reckoning a square scanning element as an area of height and width equal to the scanning pitch, or spacing between scanning lines.

For comparison with the value 0.70 which we have just found, the following values of nominal bandwidth coefficient have been lifted from their contexts in the references:

(a) Kell, Bedford, and Trainer (1934)	0.64
(b) Mertz and Gray (1934)	0.53
(c) Wheeler and Loughren (1938)	0.71
(d) Wilson (1938)	0.82
(e) Kell, Bedford, and Fredendall (1940)	0.85

#### ACKNOWLEDGMENT

This work has been done under the direction of Dr. P. Mertz and with the extensive assistance of Mr. T. R. D. Collins. To them, and to my other colleagues who have given of their time and counsel, I wish to extend my appreciation of their help.

#### APPENDIX

##### I. DETERMINATION OF THE SIZE OF THE FIGURES OF CONFUSION

The image was put out of focus by moving the projection lens nearer to the film gate, throwing the plane of sharp focus beyond the viewing screen. Assuming for the moment that the optical imagery was perfect, each point of the film gave rise to a pyramidal volume of light whose base was the opening of the external aperture and whose apex was the point's image in the new focal plane beyond the screen. The intersection of this pyramid with the viewing screen was the geometrical figure of confusion for that point. The shape of the figure was geometrically similar to that of the aperture, and the side of the figure was to the corresponding side of the aperture as the distance from focal plane to screen was to the distance from focal plane to aperture.

The distance of the focal plane beyond the screen was related to the displacement of the lens from the "in-focus" position by means of the simple lens formula and this relation was verified by actual meas-

urement of the distances. The geometrical area of the figure of confusion was thus known in terms of the lens displacement, as shown in Fig. 9.

Efforts to check this relationship by direct measurement of the dimensions of the figure of confusion in the plane of the screen were nullified by the aberrations of the optical system, especially by the residual chromatic aberration. A comparison method was, therefore, devised in which the out-of-focus image of a very

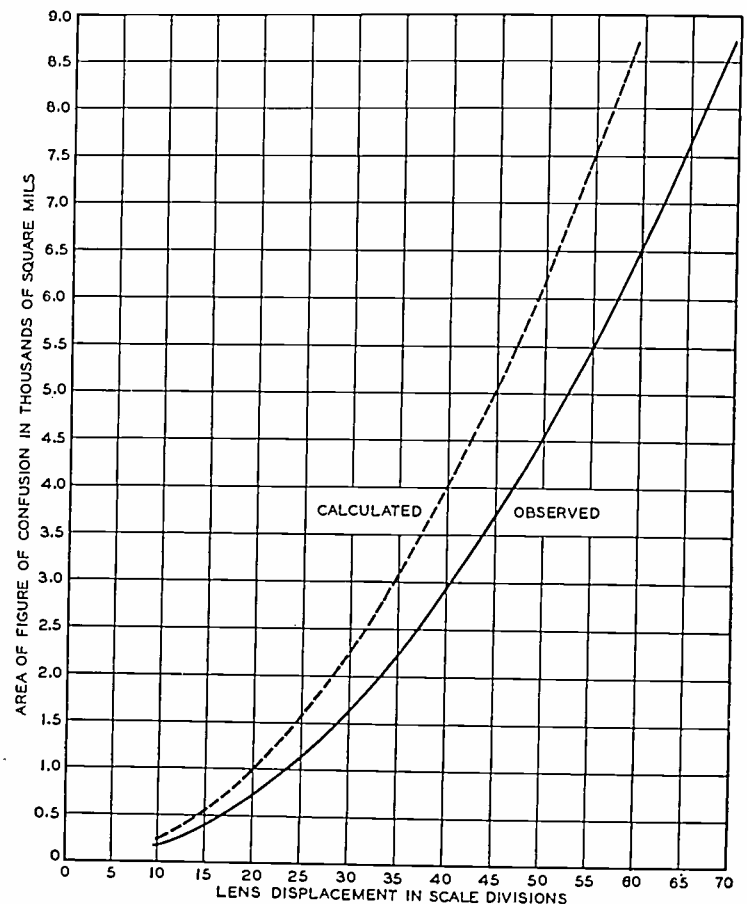

Fig. 9—Calibration curve for the motion-picture optical system as used for the subjective sharpness tests.

thin vertical slit was compared with an actual slit in the plane of the screen. In the film gate was placed a glass plate bearing a sputtered layer of gold with a razor-blade scratch not wider than 0.0001 inch in selected portions. In the plane of the screen was placed a back-lighted slit made by cementing the two halves of a cut piece of thin black paper onto a piece of translucent white paper. This slit had sharp, parallel edges and uniform brightness over its width, which was easily made as small as 0.005 inch. A set of these slits was prepared, ranging in width up to 0.100 inch, and each one was observed, without optical aid, close beside the projected out-of-focus image of the scratch in the gold film. The apparent brightnesses were equalized by means of neutral-tint filters behind the paper slit.

The ranges of values of lens displacement and of external aperture shape which were used in the experiments were tested in this way, by adjusting the out-of-focus images to subjective equality with the sharp-edged slits. In every case the measured width of the comparison slit turned out to be about 15 per cent less



than the calculated geometrical width of the projected image. As this seemed to be a not unreasonable measure of the effect of the aberrations, it was adopted as a factor for converting geometrical sizes into subjective sizes of the figures of confusion.

Fig. 9 shows both the calculated geometrical area and the observed subjective area of the figure of confusion in terms of the displacement of the lens from its sharp-focus position. The lens displacement is expressed in microscope-scale divisions, the working variable. Fig. 7 shows the dimensions of the optical system.

II. EQUIPMENT AND CONDITIONS OF THE EXPERIMENT  
*Light Source*

A ground-glass screen,  $\frac{1}{2}$  inch behind the film, illuminated by a 1000-watt projection lamp and double condensing lens system. This served to break up the image of the lamp filament which otherwise would have been formed near the principal planes of the projection lens and would have destroyed the uniformity of illumination within the figures of confusion of the out-of-focus image on the screen. The screen brightness was about 10 foot-lamberts with the projector running without film.

*Projection Machine*

Acme portable, with two-bladed shutter. There was no provision for reproducing the sound track. The screen image, in sharp focus, was said by competent judges to represent very good motion-picture-projection practice.

*Projection Lens*

Bausch and Lomb Series "0," 6.00-inch focus. There was fitted over the lens barrel a brass ring with an extremely sharp turned edge to serve as an index for the measurement of lens displacement. The lens could be set to the nearest 0.0003 inch by means of the focusing mechanism. The image was put out of focus by moving the lens toward the film. At sharp focus the linear magnification was 12 times.

*Measuring Microscope*

Mounted rigidly on the frame of the projector, and fixed with respect to the film gate. The micrometer scale was focused on the index mark on the barrel of the projection lens. A lens displacement of 0.060 inch caused the index to traverse 50 divisions of the scale.

*External Aperture*

An adjustable black paper mask mounted  $1\frac{1}{2}$  inches from the principal planes of the lens, on the screen side. The opening was rectangular, with sides horizontal and vertical, of constant area 0.49 square inch. The ratio of height to width could be varied continuously from 2.5 to 0.40 without changing the area. The

opening was uniformly filled with light under all conditions.

*Viewing Screen*

White Bristol board, 7.2 inches high by 7.6 inches wide (the image size of an available television receiver to be used for comparison). The screen was hung at the back of a black-velvet-lined box 18 inches high, 22 inches wide, and 12 inches deep. The viewing distance was always 30 inches.

The viewing room was completely darkened except for a little stray light from the projection machine.

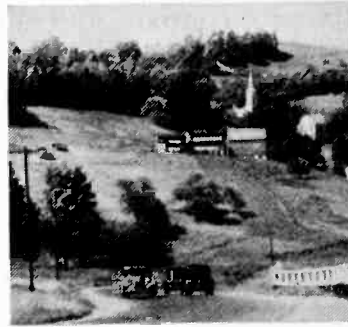

Scene 1



Scene 2



Scene 3



Scene 4

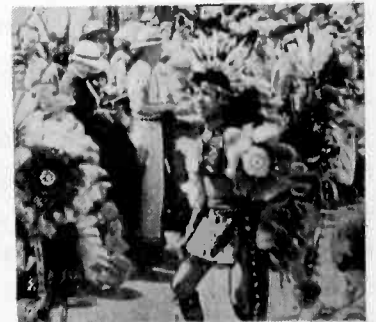

Scene 5

Fig. 10

Scene 1 reproduced by courtesy of Loucks and Norling.  
Scenes 2 and 3 reproduced by courtesy of Fox Movietone News.  
Scenes 3 and 4 reproduced by courtesy of Paramount News.

*The Observers*

The observers were almost all engineers associated with television research and transmission problems in this laboratory. The average observer devoted about one hour to the experiment on unequal horizontal and vertical resolutions, and about three hours (in two sessions) to the experiment on small differences in resolution. Each observer was carefully instructed with regard to the purpose and the mechanism of the

experiments, and was allowed to examine trial pictures to see clearly the effects of changing the shape and size of the figure of confusion.

#### *Motion-Picture Film*

Standard 35-millimeter black-and-white sound film on safety base. The area projected onto the screen was 0.600 inch high by 0.633 inch wide.

For the experiment on unequal horizontal and vertical resolutions, five different scenes were used. Sample frames from them are shown in Fig. 10. For the experiment on small resolution differences, scene 3 was selected as the most suitable on the basis of photographic excellence and picture content, and this alone was used. Each of the scenes was about one quarter of a minute in length, and was shown repeatedly. Brief descriptions follow:

Scene 1: A countryside landscape, with trees and

fields. A center of interest is the tall steeple of a white church on the distant hillside. A concrete highway flanked by a white fence carries cars into and out of the picture. There is no fast motion.

Scene 2: A full-length view of a girl modeling an evening dress, moving slowly against a dark, fluted backdrop. A large vase of flowers is a secondary center of interest.

Scene 3: A close-up view of a girl modeling a hat, turning slowly against a plain, neutral background.

Scene 4: A street scene of an Indian parade, with a background of store windows and signs. The parade moves rather rapidly, and there is some motion among the bystanders.

Scene 5: A closer view of some of the Indians in the parade. There is much fine detail in the costumes, and the motion is rapid.

## Experiments on the Propagation of Ultra-Short Radio Waves\*

A. H. WAYNICK†, NONMEMBER, I.R.E.

*Summary*—Experiments on the propagation of 41.5 and 45-megacycle waves are described. Correlations of signal variations and meteorological conditions are noted. A correlation between strong signal conditions and a low-temperature tropopause is indicated. Variations in the horizontal direction of arrival are observed.

### INTRODUCTION

THIS paper describes preliminary experiments on the propagation of 41.5- and 45.0-megacycle waves over a distance of 71.3 kilometers. The transmissions of the Alexandra Palace television station in London were recorded at the Cavendish Field Laboratory of Cambridge University in Cambridge England.

The following experiments were carried out to determine 1, signal strength versus time; 2, signal strength versus time of day and day to day; 3, simultaneous signal strengths at two receivers as a function of separation; 4, direction of arrival in the horizontal plane; 5, signal strength versus height of receiving aerial above ground; and 6, reflection of ultra-short-wave pulses.

### PREVIOUS WORK

R. Jouaust<sup>1</sup> first reported fading of ultra-short-wave signals received beyond the optical limit over a sea path. He noted fading towards sunset on bright sunny days but not on overcast days or after sunset. He, therefore, attributed fading to density variations of the air.

\* Decimal classification: R113. Original manuscript received by the Institute, July 9, 1940.

† Formerly, Cambridge University, Cambridge, England. Now, Cruft Laboratory, Harvard University, Cambridge, Mass.

<sup>1</sup> R. Jouaust, "Some details relating to the propagation of very short waves," *Proc. I.R.E.*, vol. 19, pp. 479-488; March, 1931.

R. A. Hull<sup>2</sup> obtained first meteorological correlation with signal strength of ultra-short-wave signals received beyond the optical limit. High signals were noted when temperature inversions existed.

C. R. Englund, A. B. Crawford, and W. W. Mumford<sup>3</sup> culminated a series of experiments over a period of several years by noting reflection of ultra-short-wave signals from heights of 2 to 4 kilometers. They indicated the possibility of reflections from lower heights which their apparatus could not detect. The heights of observed reflections were found to coincide with dielectric-constant discontinuities.

### ANTENNAS AND LOCATIONS

The transmissions from Alexandra Palace have been described in several papers by the designers<sup>4</sup> and staff. The 41.5-megacycle transmissions are ordinary amplitude-modulated signals. The 45-megacycle transmission is of the negative direct-current-modulated type and is the vision channel.

The receiving aerials were half-wave doublets and those used for day-to-day variations employed reflectors. For the 41.5-megacycle signals ordinary superheterodyne receivers were used. For the 45-megacycle transmissions a wide-band tuned-radio-frequency receiver was obtained. Vertical polarization was used.

<sup>2</sup> R. A. Hull, "Air mass conditions and bending of u.h.f. waves," *QST*, vol. 19, pp. 13-18; June, 1935.

<sup>3</sup> C. R. Englund, A. B. Crawford, and W. W. Mumford, "Ultra-short-wave transmission and atmospheric irregularities," *Bell Sys. Tech. Jour.*, vol. 17, pp. 489-519; October, 1938.

<sup>4</sup> A. D. Blumlein, C. O. Browne, N. E. Davis, and E. Green, "The Marconi-E.M.I. television system," *Jour. I.E.E.* (London), vol. 83, pp. 758-801; December, 1938.

A profile of the transmission path is shown in Fig. 1. The heights above sea level are multiplied by a factor of 100 while the distances below sea level are divided by 100 for ease of drawing. The path is 0.9 kilometer

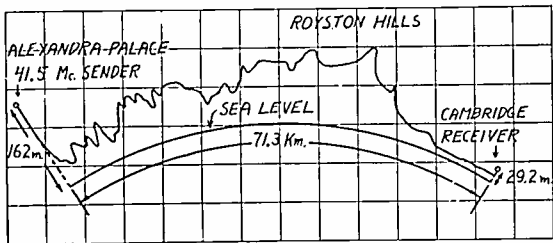

Fig. 1—Profile of London-to-Cambridge, England, path.

beyond the optical limit for a spherical earth. The receiving antenna is well in the shadow of the Royston Hills.

#### SIGNAL STRENGTH VERSUS TIME

The signal induced in a half-wave doublet with reflector whose center was 47 feet above ground level was fed by a concentric transmission line to a short-wave superheterodyne receiver. The rectified direct-current output of the diode second detector was followed by a

each record. This was found necessary since day-to-day variations in the signal were generally small.

Four photographic records of the oscilloscope spot illustrating extreme types of fading noted are shown in Fig. 2. Signal amplitude is measured from the dotted 5-minute time marks. The calibration signal is noted at the beginning and end of each record. The first record (a) indicates a constant signal. This was taken on an afternoon transmission while a heavy rain was falling. The second record (b) shows extremely fast fading of comparatively large amplitude. This was obtained on the morning signal while about 30 per cent massive cumulus clouds were noted with a strong gusty wind. The third record (c) shows a slow type of fading with enormous change in amplitude. The average signal is far above the normal as indicated by the calibration marks. At one point the signal dropped below the minimum level of the receiver; 1 microvolt. This record was obtained on the evening signal with no clouds and no wind. Cold-front conditions of large magnitude were noted. The fourth record (d) shows a large-amplitude slow fading upon which a fast fade is superposed. This was also obtained in the evening and

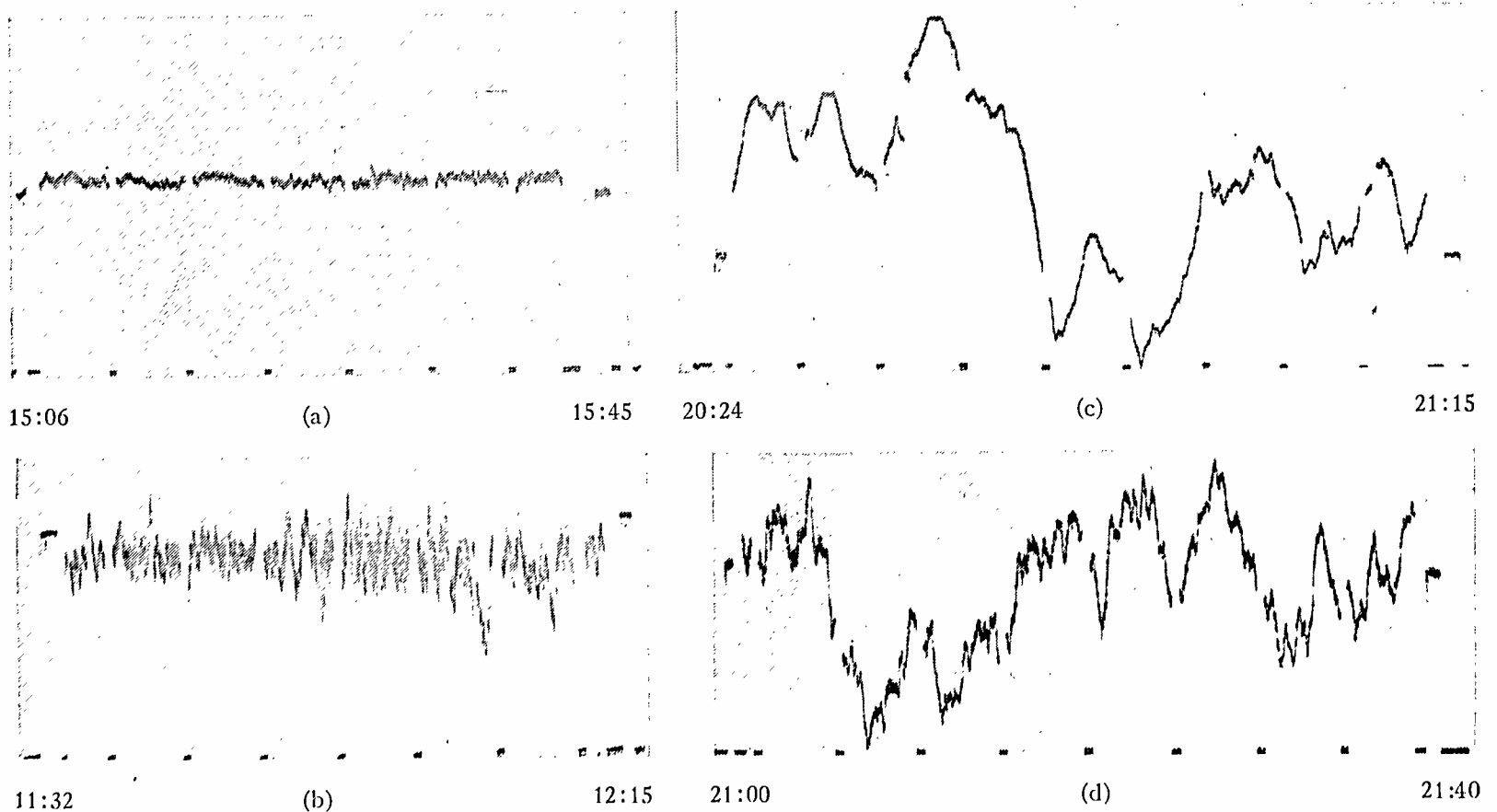

Fig. 2—Signal strength versus time records.

(a)—June 6, 1939  
(b)—July 6, 1939  
(c)—May 29, 1939  
(d)—July 28, 1939

filter to remove the audio-frequency envelope. This was followed by a stabilized direct-current amplifier whose output voltage was applied to the deflection plates of an oscilloscope tube. The oscilloscope deflection was linear with respect to radio-frequency voltage applied to the receiver input.

A standard-signal generator was employed to obtain a known calibration point at the beginning and end of

a cold-front cloud structure and temperature change noted.

It appears from these records that two general types of fading are evident; 1, a fast, moderate to low amplitude, fading of the order of one-half minute and 2, a slow, large amplitude, fading of the order of 5 minutes or more. Evidence relating the type of fading to meteorological conditions will be given later.

SIGNAL STRENGTH VERSUS TIME OF DAY AND DAY TO DAY

The above records were averaged at half-minute intervals over a given record. The resulting averages are plotted in Fig. 3, for a period of four months.

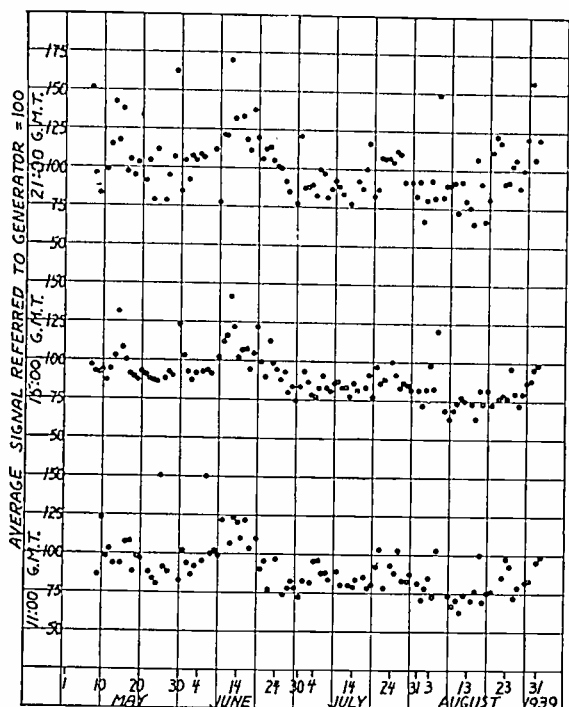

Fig. 3—Average signal strength versus time of day and day to day.

As indicated, the 11:00, 15:00 and 21:00 o'clock signals are plotted separately. It is apparent that the same trend of signal strength is followed in each case. The highest signals occurred in the evening while the morning and afternoon signals are nearly the same. It is also evident that the afternoon signal shows least variation. The significance of the high signal levels on May 14, May 30, June 12, and August 5 afternoon signals will be discussed later. The smooth afternoon signal variations during the month of May are associated with a remarkably, for England, uniform change in weather conditions. The points indicate a general reduction in signal strength during July and the first part of August.

Fig. 4 shows the average 1-kilometer lapse rate<sup>5</sup>

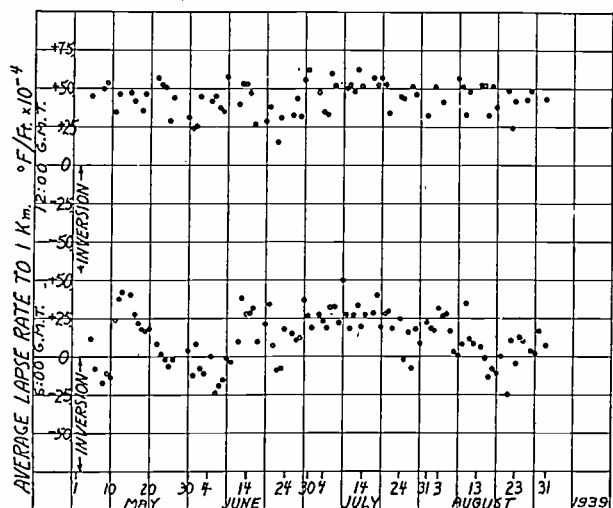

Fig. 4—Average lapse rate of 1 kilometer  $^{\circ}F/F_i \times 10^{-4}$  Mildenhall airport.

obtained from airplane flights at Mildenhall Airport, 15 miles from Cambridge, and given in the Air Ministry free-air data. The times at which the flights were made are indicated. The remarkable correlation of afternoon signal and 6:00 lapse rate during the first three weeks in May, when weather changes were uniform, is obvious. Fig. 5 illustrates this in more detail. There is no apparent correlation with the 11:00 lapse rate and signal at any time on these curves.

In Fig. 6 the slow fading observed is shown. The length of the vertical line for any record illustrates the amplitude of the largest slow fade while the dot is the average amplitude of the slow fading. It is apparent that slow fading nearly always occurred at 21:00 and 11:00 but on many occasions did not occur on the 15:00 signal and was generally of relatively small amplitude when it did occur.

EFFECT OF REFRACTION

The day-to-day variation of signal strength provides a check on a possible meteorological correlation. Since the receiving aerial is beyond the optical horizon a constant diffracted signal and a, probably variable, refracted signal are to be expected. At these frequencies and for the distances involved reflection from the ionosphere is not to be expected.

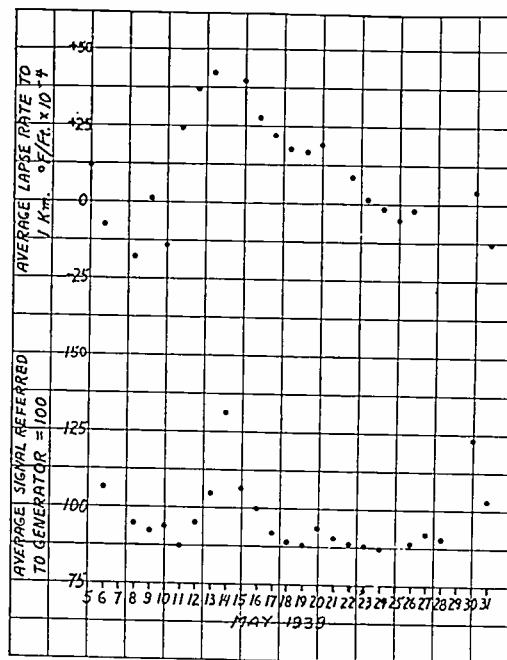

Fig. 5—Correlation between 6:00 G.M.T. lapse rate and 15:00 G.M.T. average signal.

The diffracted signal has been determined from extensions of Watson's classical analysis by van der Pol and Bremmer, Wwedensky, and Eckersley and Millington.<sup>6</sup> Curves based on the later analysis have been given by T. L. Eckersley.<sup>7</sup> This analysis is of particular value in that it provides a correction factor for the

<sup>5</sup> Ratio of temperature change to change of height in 1 kilometer height.

<sup>6</sup> T. L. Eckersley and G. Millington, *Phil. Trans.*, vol. 237, pp. 237-309, 1938.

<sup>7</sup> T. L. Eckersley, "Ultra-short-wave reflection, refraction, and diffraction," *Jour. I.E.E. (London)*, vol. 80, pp. 286-304; December, 1937.

effect of a negative dielectric-constant gradient above a spherical earth surface.

The correction factor involves (a) the radius of curvature of the ray from the transmitter to the receiver in terms of  $-de/dh$  where  $e$  is the dielectric constant and  $h$  the height above the earth's surface at the point in question, (b) the  $(e-1)$  Debye relation for gases, (c) space transformation and equivalent earth radius to make the transformed ray path linear so that the diffraction analysis is essentially applied to an earth of larger radius, and (d) the resulting factor accounting for refraction.

(a)  $R_1$ , the radius of curvature of the ray, is given in Pedersen "Propagation of Radio Waves" by

$$R_1 = - \frac{2e_0}{\partial e / \partial h}$$

where  $e_0$  is the dielectric constant at the earth's surface and  $\partial e / \partial h$  is the gradient of dielectric constant above the earth's surface and is here assumed uniform.

(b)  $e$  for gases is given in Debye "Polar Molecules" as  $(e-1)/(e+2) = 4\pi n\alpha/3$  where, for gases,  $e+2 \approx 3$  and  $\alpha = a+b/T$ . Here  $n$  is the number of molecules per cubic centimeter and  $a$  and  $b$  are constants for a given gas. Hence  $e-1 = 4\pi n(a+b/T)$ .

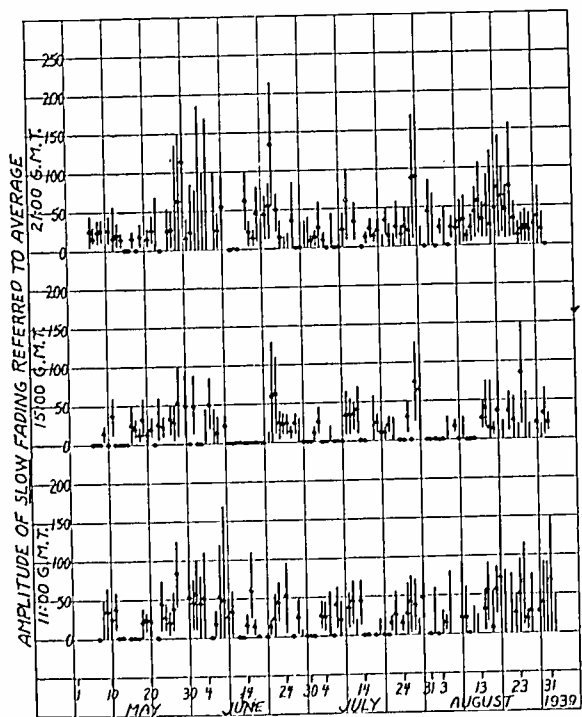

Fig. 6—Slow fading versus time of day and day to day.

For linear, homogeneous gaseous mixtures  $(e-1)$ 's are additive.

For dry air the polarization due to distortion is zero. From the Smithsonian Meteorological Tables

$$e - 1 = 158 p/T \cdot 10^{-6} \text{ electrostatic units for dry air.}$$

From Stranathan (P. R. 48, 538-544, 1935)

$$e - 1 = 137 \left( 1 + \frac{5430}{T} \right) \frac{p}{T} \cdot 10^{-6}$$

electrostatic units for water vapor.

Where  $p$  is in millibars and  $T$  is in degrees Kelvin.

(c)  $R_{eq}$ , the equivalent earth radius mentioned above, is given in the second Eckersley reference as

$$R_{eq} = \frac{R_0 R_1}{R_0 - R_1}$$

where  $R_0$  is real earth radius and  $R_1$  the radius of curvature of the ray.  $R_{eq}$  has been found to vary from 1.1 to

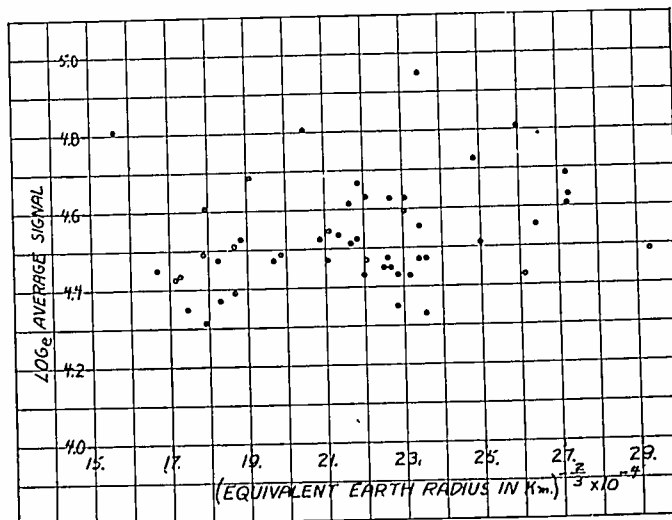

Fig. 7—Check of relation  $\log_e(\text{signal}) \propto (\text{equivalent earth radius})^{-2/3}$ . 11:00 G.M.T. signal—12:00 G.M.T. free-air data. Assumes linear  $e$  gradient. All days recorded from May 5, 1939, to July 21, 1939.

2.3 times  $R_0$  for the days on which it has been calculated.

(d) From the Eckersley and Millington analysis we obtain

$$E(\text{signal}) = A e^{-[(2\pi/\lambda)^{1/3} / \beta_n d / R_{eq}^{2/3}]}$$

where  $A$  is the diffracted signal without refraction,  $\beta_n$  a factor from the diffraction analysis involving the number of terms used in the expansion, and  $d$  is the angular distance between the receiver and transmitter.

Hence  $\log_e E = k/R_{eq}^{2/3}$  for a signal of a given wavelength  $\lambda$  and a constant distance between the transmitter and the receiver.

Fig. 7 is a plot of the above relation for all the days indicated on Fig. 3. Only the 11:00 signal and 12:00 free-air data were used for this graph. The equivalent earth radius was calculated from  $e_0$  at the ground and  $e$  at a height of 1000 feet. Certain days are omitted due to the fact that free-air data are not available for every day.

Fig. 8 is a plot of selected days upon which only slow fading was observed. The reduction in scatter is obvious. The theoretical slope is calculated by employing the first term of the expansion mentioned above. The experimental curve is considered a definite check on the refractive effect. The discrepancy in slope may be due to (a) nonspherical earth path, (b) nonuniform  $e$  gradient, and (c) greater heights than 1000 feet effective in calculation of ray curvature. The latter factor is supported by the next experimental result.

### LOW-TROPOPAUSE-TEMPERATURE CORRELATION WITH HIGH AFTERNOON SIGNAL

Fig. 9 shows Air Ministry free-air data for (a) normal day in which the temperature gradient is as customarily noted and (b) abnormal day in which the temperature gradient is much larger for the upper troposphere regions, that is, a low-temperature tropopause. Byers "Synoptic and Aeronautic Meteorology" relates such temperature distributions with a cold

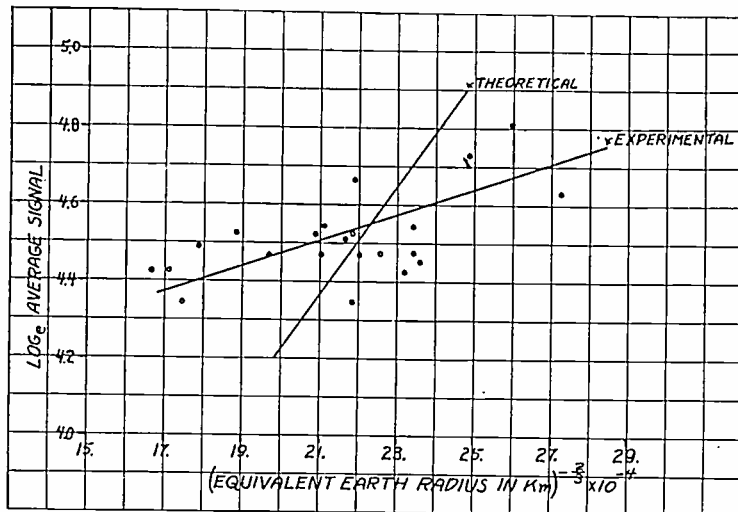

Fig. 8—Days from Fig. 7 upon which only slow fading was observed.

front followed by a cold dome extending to the tropopause region, Fig. 9(c).

On the four days mentioned of high afternoon signal and on and near these days only the abnormal temperature distribution indicated was noted.

W. H. Dines (Meteorological Office Geophysical Memoirs nos. 2 and 13) shows (a) high positive correlation coefficient of temperature versus pressure from 4 to 8 kilometers and none near the ground and (b) high positive correlation of 0 to 4 kilometers temperature versus total water vapor in the troposphere. These days of high signal did not vary greatly with respect to (b) nor with respect to ground-level pressure from near-by days.

Hence we can conclude: (1) Water-vapor content is not the deciding factor. (2) The temperature at ground level and lapse rates opposed the bending and, therefore, are not the deciding factors. (3) From (a) the pressure gradient to 8 kilometers was enormous and in direction to give increased bending.

Thus (1) the high signal level is due primarily to density gradient of free air and (2) the high signal peaks are related to refractive effects.

### SIMULTANEOUS FADING ON TWO SPACED RECEIVERS

Two receivers similar to the one described with reference to measurement of signal strength were employed with vertical half-wave doublets whose centers were one-half wavelength above ground. The antennas were placed in a line perpendicular to the direction of

the transmitter. The direct-current outputs, proportional to the signal strength as before, were fed over lines to a switching mechanism which alternately connected the cathode-ray-tube deflecting plates to the lines. The records appear continuous due to spot size.

Fig. 10 shows sample records for antenna spacings of 3, 27, and 100 wavelengths. Many intermediate distances were used for recording. The upper records are referred to the upper time marks while the lower records are with reference to the lower time marks. Hence, discrepancies between the signals may be observed by noting a difference in spacing between the records.

From the examination of many records similar to the above the following facts have emerged.

(a) Both fast and slow fading correlate identically to 3 wavelengths separation.

(b) Beyond 3 wavelengths separation there is no apparent fast correlation. The slow fading, however, continues to correlate to 50 wavelengths separation.

(c) Beyond about 50 wavelengths separation there is poor slow-fading correlation which becomes smaller until at 100 wavelengths there is relatively none.

This experiment is essentially a measure of the planeness of the wave front over a period of time. By means of an auxiliary experiment it was observed that reflections from dielectric discontinuities were not noted when many of the above records were taken. Hence we can conclude that fading is probably due to a change in the direction, and perhaps magnitude, of ray curvature with time. Further, that fast fading results from small regions while slow fading results from large regions affecting the curvature.

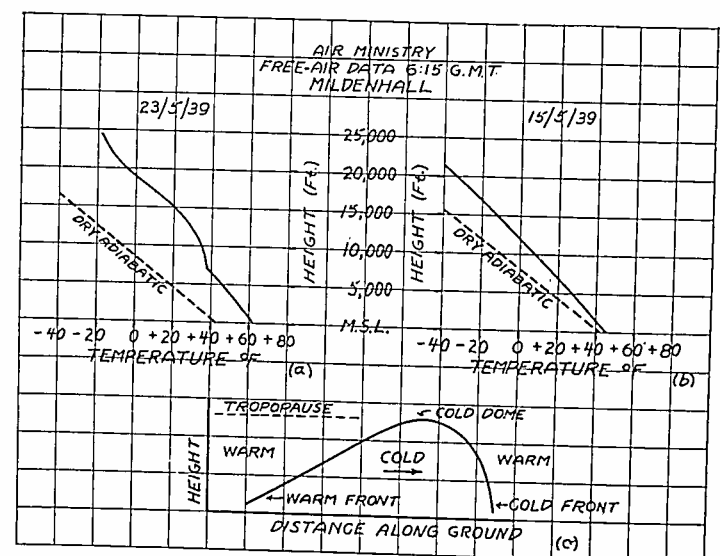

Fig. 9.

### BEARING OBSERVATIONS

Relative bearing of the transmitter was determined by a loop set. Fig. 11 shows the circuit of the loop and its associated amplifier. Symmetry and shielding were found to be very important. Proper operation was checked by a polar diagram, depths of nulls, and 180-degree spacing of the nulls. The output of the balanced

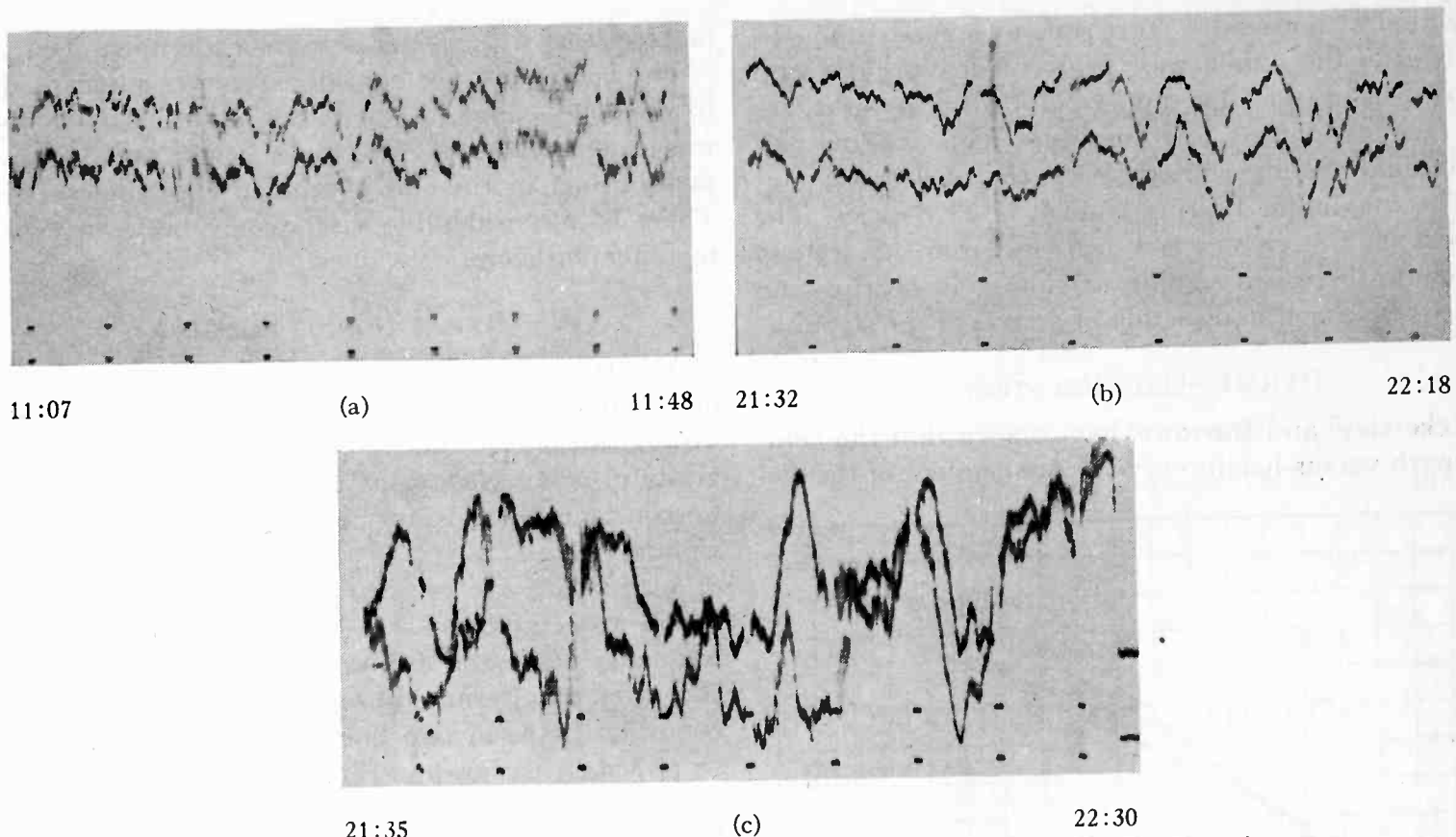

Fig. 10—Simultaneous fading on two receivers in a plane perpendicular to the direction of the sender as a function of separation of the receivers.  
 (a)—May 6, 1939. Separation of  $3\lambda$  perpendicular to the direction of propagation.  
 (b)—July 3, 1939. Separation of  $27\lambda$  perpendicular to the direction of propagation.  
 (c)—August 17, 1939. Separation of  $100\lambda$  perpendicular to the direction of propagation.

loop amplifier was fed by a shielded transmission line to a sensitive receiver which was used to locate the nulls.

apparatus. (1) On many runs a horizontal half-wave antenna was employed at various heights to check for a horizontally polarized component. On no occasion was such a component noted. (2) A portable oscillator

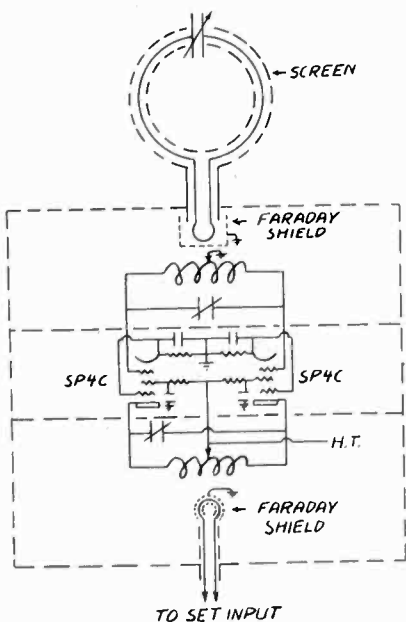

Fig. 11—Circuit of 41.5-megacycle direction finder.

Fig. 12 shows the relative bearings obtained over an interval of two months. As indicated, different times of day are plotted separately. Each point is an average of five readings taken on both nulls. Individual readings did not vary by more than 2 degrees. Total averages are indicated by solid lines to the right. These are seen to be the same within 2 degrees.

When large changes in bearing became evident two auxiliary experiments were employed to check the

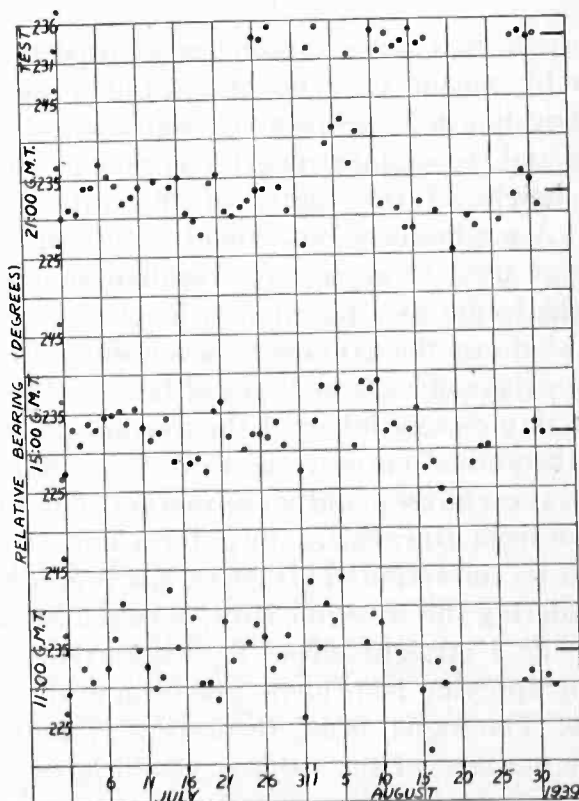

Fig. 12—Relative bearing versus time of day and day to day.

with a quarter-wave current-fed antenna was used as a test source. It was placed, on the ground, 8 wavelengths away from the loop in approximately the true

direction of the sender. Test runs were made immediately after the sender was turned off leaving the loop apparatus in tune. The upper points, marked test, are the results obtained. Readings were made as above and individual readings varied by less than 1 degree.

The maximum bearing change is 23 degrees. The maximum test change is 4 degrees. From this we can conclude there is a significant change in bearing and hence of horizontal direction of arrival of the signal.

### HEIGHT—GAIN RELATION

Eckersley<sup>7</sup> and Burrows<sup>8</sup> have shown that the field-strength-versus-height curve is independent of the dis-

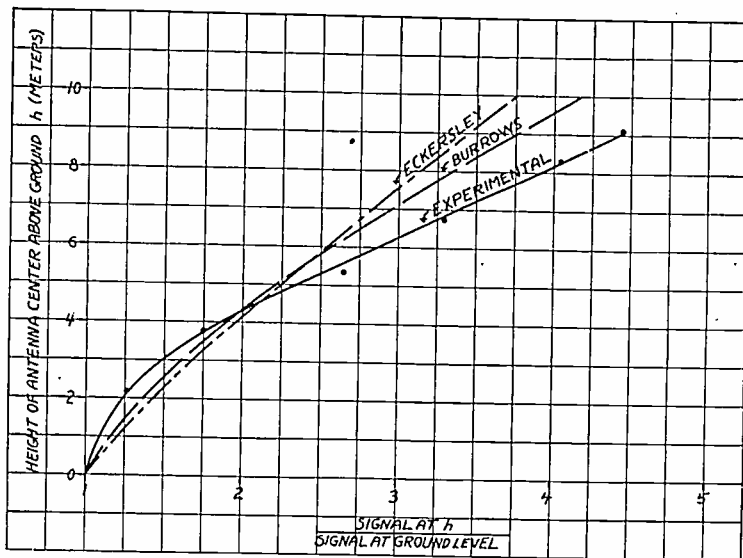

Fig. 13—Height—gain curves.

tance away from the sender for large distances of separation.

A vertical half-wave antenna was raised to various heights by means of a boom-and-pulley system. A concentric line fed the received signal to a sensitive receiver and the signal strength recorded as a function of the height of the center of the antenna above ground. A preliminary experiment with a dummy antenna was used to correct for residual signal picked up by the feeder as a function of height.

Fig. 13 shows the average of seven different experiments for days of various types of fading. The results for each day closely followed the average curve.

The theoretical curve from Eckersley's data is for a spherical earth  $e = 5$  and no refraction. The theoretical curve from Burrows' data is for a flat earth with  $e = 4$  and no refraction. This curve has been corrected by considering the Royston Hills, between sender and receiver, as a straight edge. The correction was obtained by applying Knochenshaurs' form of the Fresnel integrals. The signal was, theoretically, reduced to about 40 per cent of the value it would have without the hills present. The shape of the height—gain curve is but little affected over the range of heights employed. However, the correction was in a sense to give

<sup>8</sup> C. R. Burrows, "Radio propagation over plane earth—field strength curves," *Bell Sys. Tech. Jour.*, vol. 16, pp. 45-75, January, 1937.

better fitting with reference to the experimental curve.

The curves are not considered very significant due to the small range in heights obtained. A balloon set was constructed to give a greater height range but was not finished in time to obtain an experimental run. There is a considerable discrepancy between experimental and theoretical values.

### REFLECTION OF PULSES

An attempt was made to determine reflections by employing the pulses sent out by the 45-megacycle vision transmitter under conditions of no-vision signal. Grateful acknowledgment is made in this connection for considerable assistance by the British Broadcasting Company staff.

A 45-megacycle receiver with a 4-megacycle band width was employed. This was followed by a video-frequency stage and a linear sweep circuit which synchronized on alternate line scans so that the no-signal condition between two lines appeared on the oscilloscope screen as shown in Fig. 14(a).

Observations were made on seventeen occasions. Reflections were noted on two occasions. These resulted in the patterns of Fig. 14(b). Heights of ledges shown are for peak values since these changed slowly with time due to phase relation. The measurements indicate path differences of 300 and 1800 meters. If reflection is assumed to take place at the mid-point these give heights of reflector of 3.5 to 8.1 kilometers, respectively. The theoretical resolution obtainable is a path difference of 37 meters.

From this experiment we can conclude that reflections are a relatively rare phenomenon over this path

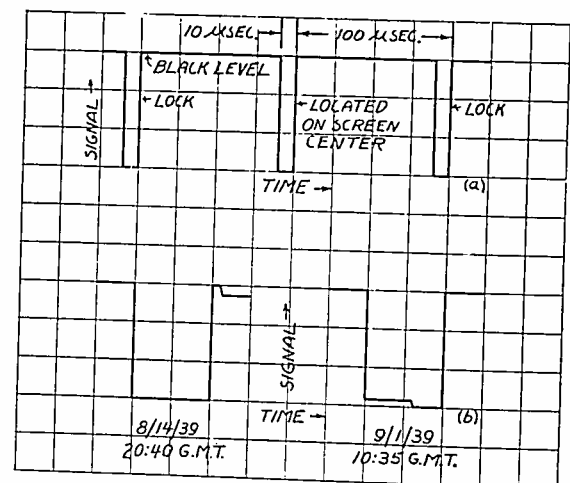

Fig. 14—Pulse shapes of vision-channel transmissions.

during the time of day on which observations were made.

### GENERAL CONCLUSIONS

(1) Fading over this path is comprised of two general types, a fast, moderate to low amplitude, fading of the order of one-half minute; a slow, moderate to large amplitude fading of the order of 5 minutes or more.



(2) A gradual change in weather conditions, as indicated by the 6:00 lapse rate, is accompanied by a gradual change in received signal strength, as indicated by the 15:00 signal, during the month of May, 1939.

(3) An experimental correlation between signal strength and meteorological conditions is established.

(4) Days on which meteorological conditions favor bending of the ray path result in strong signals.

(5) Cold-front conditions are accompanied by strong signals.

(6) A correlation between days of peak signal strength and low tropopause temperature is noted.

(7) From this we conclude that the water-vapor content and temperature are not important; at least on these occasions. That high signal levels are due primarily to the density gradient of free air and hence to refractive effects.

(8) Fading, at least in part, is probably a refractive effect, fast fading due to small regions and slow fading to large regions.

(9) There is considerable variation in the horizontal direction of arrival of ultra-short-wave signals over this path.

(10) There may be a discrepancy between theoretical and experimental height—gain relations.

(11) Reflections are seldom noted over this path during the times of day that these experiments were carried out.

#### ACKNOWLEDGMENTS

I wish to thank most sincerely Dr. E. V. Appleton for suggesting this problem and Mr. J. A. Ratcliffe for his invaluable advice and help throughout all stages of the work.

## The Measurement of Coil Reactance in the 100-Megacycle Region\*

FERDINAND HAMBURGER, JR.†, MEMBER, I.R.E., AND C. FRANK MILLER‡, NONMEMBER, I.R.E.

*Summary*—This paper describes apparatus and measuring technique which have been developed to permit a more reliable measurement of reactance in the 100-megacycle region. Experimental data taken on single-layer solenoids indicate that the distributed capacitance is seriously reduced by skin effect and proximity effect. The results question the validity of the Palermo<sup>1</sup> equation in the ultra-high-frequency region when large wire sizes are involved.

#### INTRODUCTION

IN THE lower part of the radio-frequency spectrum, experiment has shown that the solenoid is electrically equivalent to a pure inductance shunted by a pure capacitance, at least for most practical purposes. The “natural frequency” of the solenoid is the frequency at which the self-inductance  $L$  and the distributed capacitance  $C_d$  attain resonance. In this region the apparent inductance  $L_e$  may be calculated at a particular frequency and is numerically equal to the measured reactance divided by the angular velocity of the exciting voltage. In terms of the self-inductance and the distributed capacitance, the apparent inductance  $L_e$  is given by the approximate relation<sup>2</sup>

$$L_e = \frac{L}{1 - \omega^2 C_d L} \quad (1)$$

or in terms of the natural frequency  $f_0$

$$L_e = \frac{L}{1 - \left(\frac{f}{f_0}\right)^2} \quad (2)$$

\* Decimal classification: R225. Original manuscript received by the Institute, April 17, 1940; revised manuscript received, September 3, 1940. Presented, Fifteenth Annual Convention, Boston, Mass., June 28, 1940.

† Associate in Electrical Engineering, Johns Hopkins University, Baltimore, Md.

‡ Graduate student, Johns Hopkins University, School of Engineering, Baltimore, Md.

A satisfactory theoretical analysis of the behavior of the single-layer solenoid would, in the words of Palermo,<sup>1</sup> “entail prohibitively complicated mathematics” at frequencies well above the so-called “natural frequency.” In this frequency range there is a rather general agreement that the solenoid behaves like a transmission line<sup>1,3</sup> with nonuniformly distributed constants.<sup>1</sup> The experimental work of Lee<sup>4</sup> of the Westinghouse Company reveals this type of behavior.

The purpose of this paper is to describe, in some detail, measuring apparatus and methods employed to measure the reactance of inductance coils in the 100-megacycle region and to present the results of some of these measurements. The results are discussed with reference to the considerations set forth above assuming that in the ultra-high-frequency region the coil is represented by a pure inductance shunted by a pure capacitance.

#### METHOD OF MEASUREMENT

A survey of the literature indicates that the most practical method of measuring reactance over a range of ultra-high radio frequencies is by means of the quarter-wave open line. The transmission line with the receiving end open, loosely coupled to the signal gen-

<sup>1</sup> A. J. Palermo, “Distributed capacity of single-layer coils,” Proc. I.R.E., vol. 22, pp. 897–905; July, 1934.

<sup>2</sup> A. Hund, “High-Frequency Measurements,” p. 242, McGraw-Hill Book Company, New York, N. Y., 1933.

<sup>3</sup> J. M. Miller, “Electrical oscillations in antennas and inductance coils,” Proc. I.R.E., vol. 7, pp. 299–326; June, 1919.

<sup>4</sup> R. Lee, “A study of r-f choke coils,” *Electronics*, vol. 7, pp. 120–121; April, 1934.

erator, is adjusted to resonance by means of an adjustable short circuit. The unknown reactance is then placed across the open end of the line and the short circuit moved a distance  $l_0$  to restore resonance. The unknown reactance is then<sup>2</sup>

$$X = Z_0 \cotan \left\{ 90^\circ \frac{l_0}{\lambda/4} \right\} \quad (3)$$

where  $Z_0$  is the characteristic impedance of the transmission line and  $\lambda$  is the wavelength of the exciting voltage.

If the unknown reactance that is being measured is in the form of a solenoid, then its apparent inductance  $L_e$  will be given by<sup>2</sup>

$$\omega L_e = Z_0 \cotan \left\{ 90^\circ \frac{l_0}{\lambda/4} \right\} \quad (4)$$

$$L_e = \frac{\sqrt{L_0/C_0}}{2\pi f} \cotan \left\{ 90^\circ \frac{l_0}{\lambda/4} \right\} \quad (5)$$

Since the phase velocity is given by

$$v = 1/\sqrt{L_0 C_0}, \text{ it follows that } f = 1/\sqrt{L_0 C_0} \lambda$$

and (5) may be written

$$L_e = \{ \lambda L_0 / 2\pi \} \cdot \cotan \left\{ 90^\circ \frac{l_0}{\lambda/4} \right\} \quad (6)$$

$$= 0.636 \lambda / 4 \cdot L_0 \cotan \left\{ \frac{90^\circ l_0}{\lambda/4} \right\} \quad (7)$$

For reasons which are both electrical and mechanical it is desirable to use tubing of relatively large diameter for the transmission line and to use an axial spacing which is not large compared to the conductor diameter. It is necessary, therefore, to take into account the proximity effect in calculating  $C_0$ ,  $L_0$ , and  $Z_0$ , the line constants. Therefore, as shown by Reukema<sup>5</sup>

$$C_0 = \left\{ \frac{1}{4 \ln \left\{ \frac{D}{2r} + \sqrt{\left(\frac{D}{2r}\right)^2 - 1} \right\}} \right\} \cdot \frac{1}{9 \times 10^{11}} \text{ farads per centimeter} \quad (8)$$

where  $D$  is the axial spacing and  $r$  is the conductor radius, and at high radio frequencies

$$L_0 = \left\{ 4 \ln \left( \frac{D}{2r} + \sqrt{\left(\frac{D}{2r}\right)^2 - 1} \right) \right\} 10^{-9} \text{ henry per centimeter} \quad (9)$$

$$Z_0 = \sqrt{L_0/C_0} = 120 \ln \left\{ \frac{D}{2r} + \sqrt{\left(\frac{D}{2r}\right)^2 - 1} \right\} \text{ ohms.} \quad (10)$$

<sup>5</sup> Lester E. Reukema, "Transmission lines at very high frequencies," *Trans. A.I.E.E.*, vol. 57, pp. 104-107; February, 1938; and vol. 56, pp. 1002-1011; August, 1937.

The constants of the line employed in these experiments are

$$D = \text{spacing} = 1.25 \text{ inches}$$

$$r = \text{radius of conductors} = 0.3125 \text{ inch}$$

$$\frac{D}{2r} = 2.$$

From (8)

$$C_0 = 2.11 \times 10^{-13} \text{ farad per centimeter.}$$

From (9)

$$L_0 = 5.26 \times 10^{-9} \text{ henry per centimeter}$$

and  $Z_0 = 157.5$  ohms.

#### APPARATUS AND MEASURING TECHNIQUE

The measuring apparatus consists of the transmission line with its sliding short circuit, several signal generators, and a resonance indicator to indicate line resonance.

The transmission line is made of  $\frac{5}{8}$ -inch outside-diameter type "M" copper tubing. The tubes are three meters long. Low-loss separators are employed to maintain an axial separation of  $1\frac{1}{4}$  inches. Three meter sticks are secured end to end along the line and an indicator attached to the sliding bridge indicates the line length (measured from the open end to the short-circuiting bridge). Fig. 1 shows the open end of the

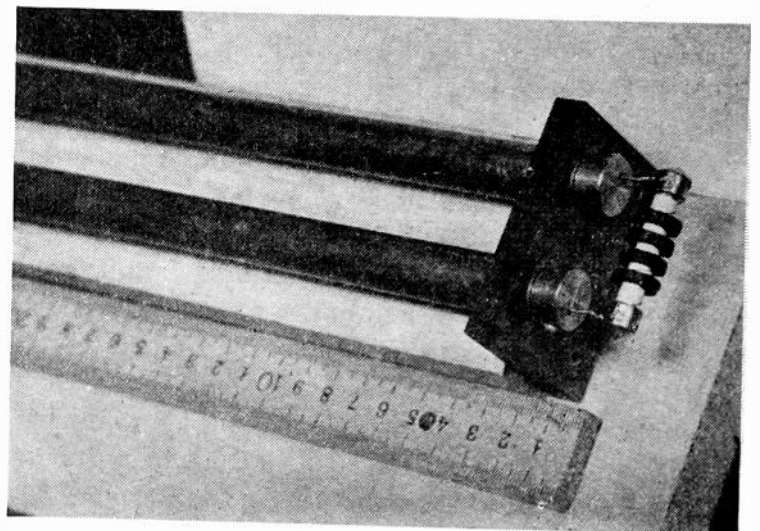

Fig. 1—Transmission line with a commercial reactor in position for measurement.

line with a commercial-type choke in position for measurement. The unknown reactances are arranged for rapid connection to the line. This is accomplished by attaching the reactance to  $\frac{5}{8}$ -inch outside-diameter brass plugs which are turned down to form a neat sliding fit with the inside diameter of the line tubing. The turned portion of each plug is about  $\frac{3}{4}$  inch long and the  $\frac{5}{8}$ -inch diameter part is exactly 1 centimeter long. To make the line-length indicator read directly, a set of blank plugs (identical to those attached to the reactance) are inserted when the reactance is removed

to determine the length of a quarter wave at the exciting frequency.

The resonance indicator consists of an RCA Type 955 tube connected as a diode rectifier (see Fig. 2). The rectified voltage obtained from the diode is amplified by a two-stage direct-current amplifier. The amplifier employs two high-gain triodes with positive feedback from the plate circuit of the second stage to the grid circuit of the first stage. The indicator with its power supplies is shown in Fig. 3. A circuit diagram of the rectifier amplifier is given in Fig. 4. The purpose of this indicator is to make possible very loose coupling between the signal generator and the line. A very satisfactory indication of the line resonance may be obtained in this manner with the oscillator-to-line coupling still too loose to affect the oscillator grid current when the line is tuned through resonance. This avoids the irregular data obtained as a result of interaction between the line and signal generator.

The signal generators are conventional. A check point in the vicinity of 30 megacycles is obtained from a crystal oscillator and doubler combination. The two high-frequency oscillators employ Western Electric type 316-A triodes in tuned-plate tuned-grid circuits. Quarter-wave concentric lines form the tank circuits of one of the oscillators. Self-resonant chokes with adjustable taps are used to tune the grid and plate circuits of the other oscillator. The self-resonant chokes are wound with No. 16 B & S gauge bare copper wire.

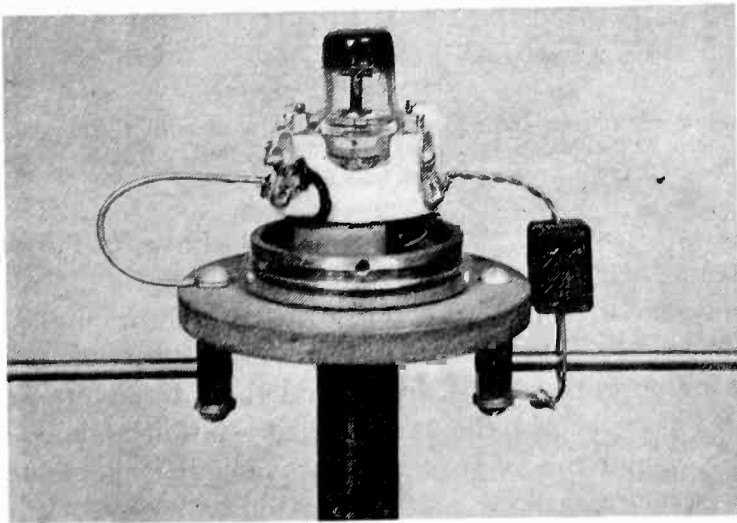

Fig. 2—Diode rectifier (with shield removed) and dipole antenna.

The windings are supported at both ends by ceramic standoff insulators. No forms are used and the adjustable clips can be placed anywhere on the windings. The plate and grid windings are identical and the oscillator is properly tuned when the plate and grid clips tap off equal turns. Power supplies for the three oscillators incorporate electronic voltage regulators. A high degree of frequency stability is attained in both self-excited circuits.

The actual measurement of an unknown reactance was carried out in the following manner. The resonance

indicator just described was located several feet from the transmission line with its dipole antenna parallel to the line and in the plane containing the axes of the line conductors. Very loose capacitive coupling was used between the signal generator and the line. After the two blank plugs were inserted in the ends of the line tubes the bridge was moved along the line until the

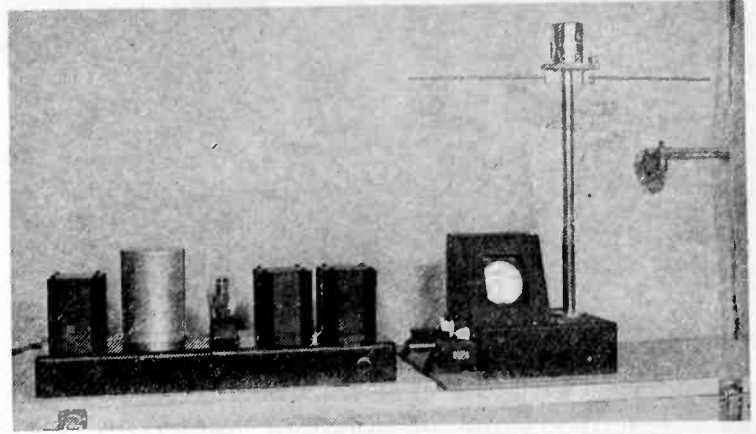

Fig. 3—Complete resonance indicator and power supply.

resonance-indicator meter showed maximum line radiation. The distance from the open end of the line to the short circuit was then read from the metric scale attached to the transmission-line assembly. When corrected for the inductance of the sliding bridge,<sup>6</sup> this distance gave the length of a quarter wave of the exciting voltage ( $\lambda/4$  in (7)) thus giving the frequency of the measurement. The blank plugs were then replaced by the pair of plugs to which the unknown reactance was attached. The bridge was moved until the line and attached reactance were tuned to resonance. The distance from the end of the line to the new position of the bridge was read on the metric scale. The difference between the two bridge positions (in centimeters) gave  $l_0$  in (7). The unknown reactance  $X$  was

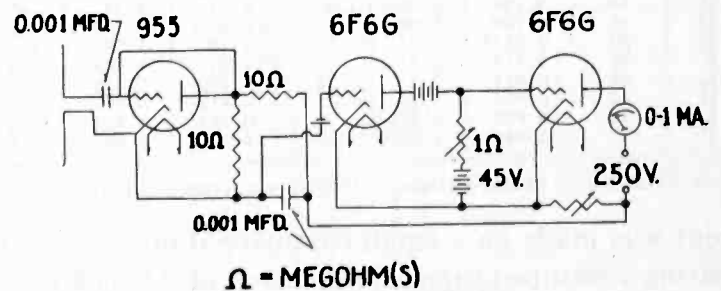

Fig. 4—Circuit diagram of resonance indicator.

then calculated from (3) or the effective inductance  $L_0$  from (7).

#### EXPERIMENTAL RESULTS

Using the procedure described above, measurements were made on a series of test coils some of which are shown in Fig. 5. Table I gives data on the coil dimensions together with the computed values of the coil

<sup>6</sup> L. S. Nergaard, "A review of u-h-f measurements," *RCA Rev.*, vol. 3, pp. 156-195; October, 1938.

inductance, the distributed capacitance, and the natural frequency.

The experimental data for each of the coils *A* through *F* are given in the form of a plot of apparent inductance against wavelength. On the same set of

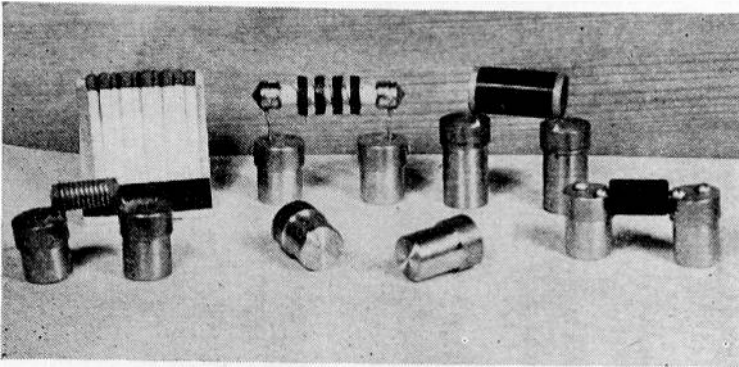

Fig. 5—Reactors prepared for measurement.

co-ordinates with the experimental results is plotted the calculated value of apparent inductance  $L_e$  as computed by (1) given in the first section of the paper. The value of inductance  $L$ , used in (1) for  $L_e$  was obtained from formula (153) of the Bureau of Standards Circular 74. The value of the distributed capacitance  $C_d$  was calculated by means of the Palermo equation.<sup>1</sup> The results obtained with coils *G* through *J* confirm the findings with coils *A* through *F* and in the interest of brevity no plots are included for the *G* through *J* coils.

In addition to the measurements of coil reactance, as a matter of general interest, the same measurement method described above was employed for the determination of a capacitive reactance. The measure-

TABLE I

Test Coil	Wire Size B & S Gauge	Coil Radius Centimeters	Coil Length Centimeters	No. of Turns	Computed Value of		$f_0$ Mega-cycles
					$L$ Microhenrys	$C_d$ Micro-microfarads	
A	22	0.4025	1.41	10	0.362	0.456	392
B	36	0.390	1.41	10	0.342	0.220	582
C	18	0.780	5.08	40	6.67	2.23	46.6
D	36	0.780	5.08	40	6.67	0.453	91.0
E	20	0.8175	1.27	10	1.32	1.59	112
F	36	0.775	1.27	10	1.21	0.452	215
G	36	0.921	1.27	5	0.399	0.436	380
H	22	0.952	1.27	5	0.419	0.810	272.5
I	36	0.921	1.27	7	0.782	0.480	260
J	22	0.946	1.27	7	1.12	0.966	159

Note: All coils were wound on Bakelite Polystyrene forms using copper wire.

ment was made on a small commercial mica capacitor bearing a stamped capacitance value of 0.00005 microfarad. At a wavelength of 137 centimeters the measured capacitance was 0.0000453 microfarad. At the oscillator-crystal check point ( $\lambda = 958.8$  centimeters) the measured capacitance was 0.0000448 microfarad. The difference between these two values is only about 1 per cent.

#### DISCUSSION OF RESULTS

Test coil *A* was the first solenoid examined experimentally with the results shown in Fig. 6. Note that at  $\lambda = 120$  centimeters the apparent reactance was found to be only about 50 per cent of the calculated value.

At longer wavelengths the difference between calculated and experimental values was found to decrease as shown by the curves. It is well known that at high radio frequencies there is a tendency for the current to crowd toward the line of contact between the conductor and coil form. Calculation of the inductance on the assumption that the current flows entirely along the trace of the conductor on the coil form shows that the reduction in inductance which thus occurs is not sufficient to account for the difference between calculated and experimental results. An examination of the Palermo equation, however, shows that such a distribution of current (and charge) along the trace of the conductor would have a more serious effect on the distributed capacitance. It is evident from an examination of this equation that the smaller the wire size (for a given winding pitch), the smaller will be the upset in the distributed capacitance.

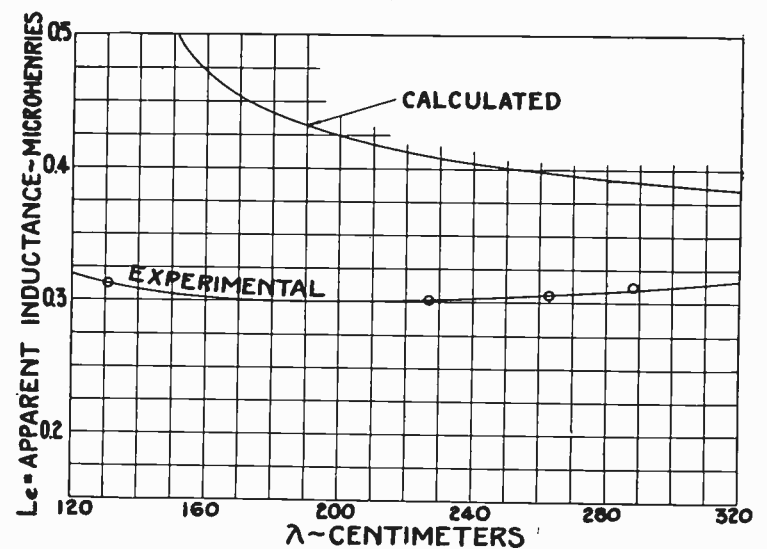

Fig. 6—Apparent inductance—wavelength of coil *A* wound with No. 22 B & S copper wire.  $L = 0.362$  microhenry (calculated) and  $C_d = 0.456$  micromicrofarad (calculated)

As a result of the considerations above, coil *B* was wound with No. 36 B & S wire (which has a diameter only one fifth the diameter of the conductor employed on coil *A*). The pitch and number of turns were the same on both coils *A* and *B* and their diameters were also very nearly the same. The results are shown in Fig. 7 and the very great improvement in agreement between measured and calculated values is clearly shown. This is directly in line with the previous reasoning since the formulas for the computed values should be much more accurate for the smaller size wire.

Coil *C* was wound with 40 turns of No. 18 B & S wire. The inductance, distributed capacitance, and resonant frequency were calculated as shown in Table I. Experiment showed that the actual resonant frequency was about three times as high as the calculated value.

One would immediately expect that this high value of measured resonant frequency was not the true value, but was a result of multiple resonance. To test this the reactance curve for coil *C* was carried over a sufficiently wide range of frequencies ( $\lambda = 120$  to

$\lambda = 720$  centimeters) to show conclusively that no multiple resonance was present and the actual measured natural frequency represented the true value for the coil. Using this measured resonant frequency to compute the apparent inductance yields the curve of

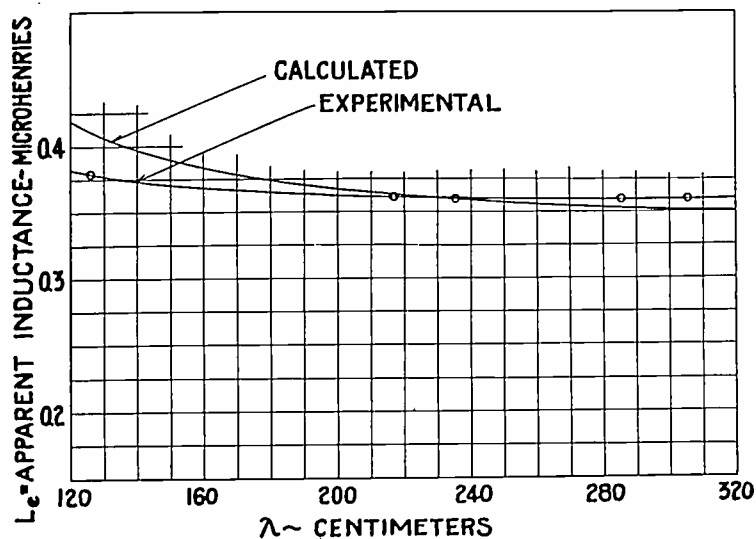

Fig. 7—Apparent inductance—wavelength of coil B wound with No. 36 B & S copper wire.  $L = 0.342$  microhenry (calculated) and  $C_d = 0.220$  micromicrofarad (calculated).

Fig. 8 which is in quite fair agreement with the experimentally determined values.

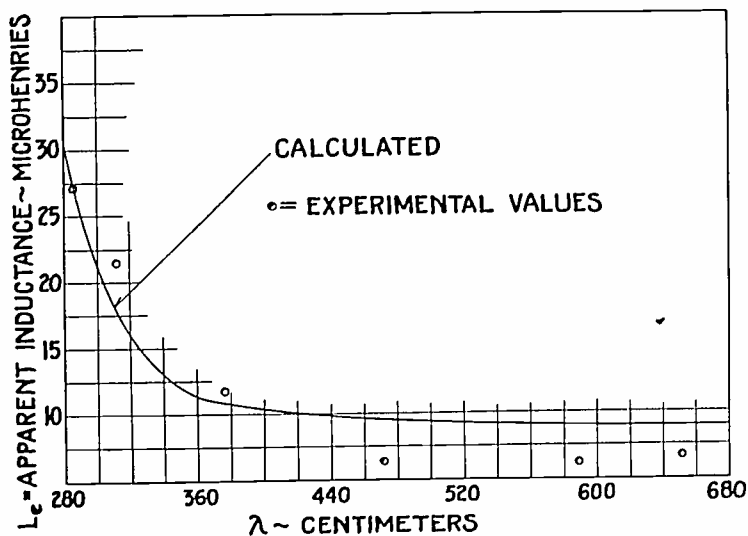

Fig. 8—Apparent inductance—wavelength of coil C wound with No. 18 B & S copper wire.  $L = 6.67$  microhenrys (calculated) and  $C_d = 2.23$  micromicrofarads (calculated). Calculated curve is based on measured value of  $f_0$  (equation (2))

The evidence here also points to an upset from the computed values of distributed capacitance as a result of the tendency of the current to follow the trace of the coil. The variation between computed and experimental values due to this cause would be greater for larger diameter wires. As a further check on this point, coil D was wound using the same number of turns and the same winding pitch as in the coil C, but using No 36 B & S wire (one eighth the diameter of No. 18 wire). The diameter to the conductor centers was made the same for both coils. The calculated value for the inductance was the same for both coils but the computed distributed capacitance for coil D was approximately one fifth that for coil C.

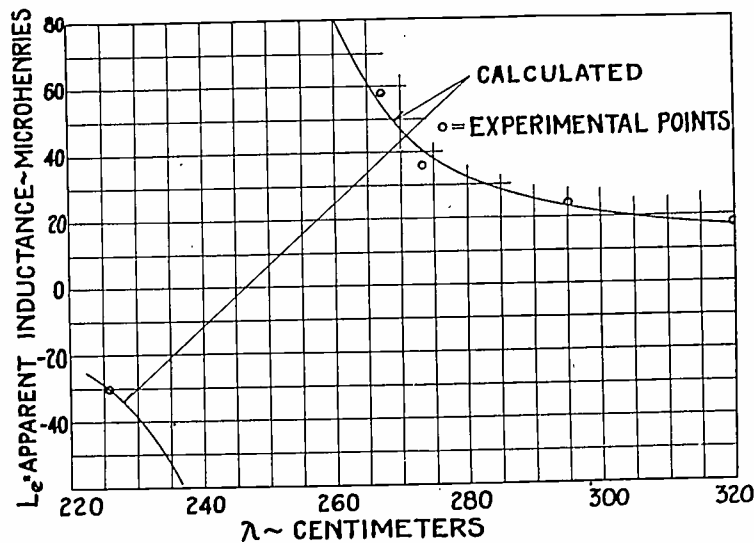

Fig. 9—Apparent inductance—wavelength of coil D wound with No. 36 B & S copper wire.  $L = 6.67$  microhenrys (calculated) and  $C_d = 0.453$  micromicrofarad (calculated). Calculated curve is based on measured value of  $f_0$  (equation (2)).

The computed values of the resonant frequency for coils C and D were 46.6 and 91.0 megacycles, respectively. For all practical purposes the measured resonant frequency was the same for both coils, that is, approximately 120 megacycles. There is still an error evident in the computed value of resonant frequency which definitely indicates an inaccuracy in the computation of distributed capacitance. Fig. 9 shows the experimental data for coil D together with a curve of apparent inductance based on the measured value of the resonant frequency. The agreement between the curve and the experimental points is very good.

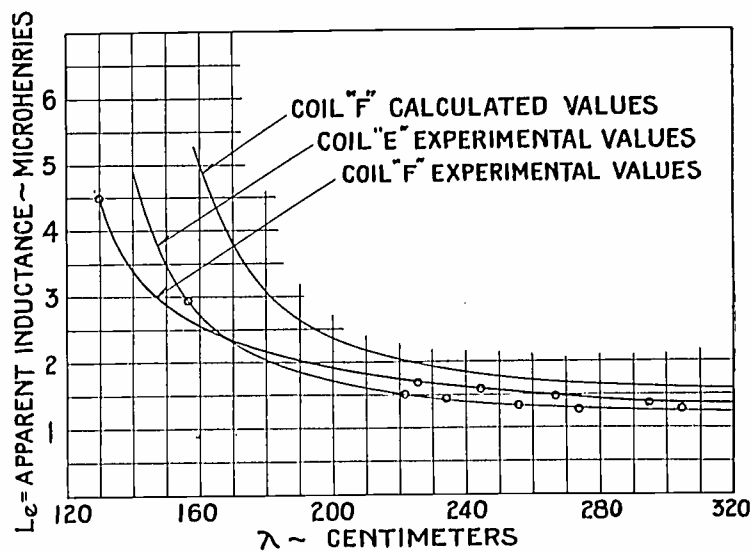

Fig. 10—Apparent inductance—wavelength of coils E and F. Coil E wound with No. 20 B & S copper wire.  $L = 1.32$  microhenrys (calculated) and  $C_d = 1.59$  micromicrofarads (calculated). Coil F wound with No. 36 B & S copper wire.  $L = 1.21$  microhenrys (calculated) and  $C_d = 0.452$  micromicrofarad (calculated).

Coils E and F were wound with the same number of turns, the same winding pitch, and the same inside diameter. Coil E was wound with No. 20 B & S wire and coil F was wound with No. 36 B & S wire. The experimental results are shown in Fig. 10 together with the calculated curve for coil F. The calculated curve for coil E falls off the curve sheet. Here again appears

the tendency for the experimental curves for large and small wire sizes to agree and to differ from the calculated values to a small degree for small and a larger degree for large wire sizes.

As was noted earlier the results obtained with coils *G*, *H*, *I*, and *J* confirm the conclusions based on the coils *A*, *B*, *C*, *D*, *E*, and *F* discussed above.

#### CONCLUSIONS

A satisfactory method and technique for measuring

## Radiating Characteristics of Short-Wave Loop Aerials\*

EVERARD M. WILLIAMS†, STUDENT, I.R.E.

**Summary**—An experimental method of measuring current distribution and time-phase relations in short-wave single-turn rectangular loops is described and the results used to classify these antennas in three groups according to the ratio of their perimeter to the wavelength. The space characteristics of these loops are discussed and it is shown that in the first of these groups radiation may be calculated by ordinary loop theory; in the second, radiation may be calculated from information given in this paper; and in the third, radiating characteristics are best obtained by measurement. It is also shown that loops in the third group have unidirectional characteristics which, when accentuated by loading, give the loop some signal gain over other types of antenna of comparable dimensions.

ALTHOUGH loop aerials have had widespread use for a number of years little has been known of their properties as short-wave radiators. Evidence that these properties might be very different from those at medium and long wavelengths appeared in recent reports<sup>1</sup> by radio amateurs of single-turn short-wave loop radiators with unidirectional characteristics, for which the ordinary loop theory supplies no explanation. Preliminary tests by the author substantiated the existence of these unidirectional properties under some conditions and since it appeared that both these unidirectional properties and other special properties might be of interest a general study of the radiation patterns of single-turn short-wave loops was undertaken.

The ordinary loop theory is that of J. H. Dellinger<sup>2</sup> who derived the transmitting and receiving properties of loop aerials in which the dimension-to-wavelength ratio was so small that "standing-wave effects" could be neglected. In the transmitting case this size limitation led to an assumption of uniform current distribution with the current in phase throughout the loop. It may be said that calculated results were in excellent agreement with experimental studies at the wavelengths then in use. No figures have been presented

\* Decimal classification: R125.3. Original manuscript received by the Institute, July 24, 1940. This paper is part of a dissertation presented for the degree of Doctor of Philosophy, Yale University, (1939).

† The Pennsylvania State College, State College, Penna.

<sup>1</sup> J. L. Reinartz, "Half-wave loop antennas," *QST*, vol. 21, pp. 27-29; October, 1937.

<sup>2</sup> J. H. Dellinger, "Principles of transmission and reception with antennas and coil aerials," *Sci. Pap. U. S. Bur. Stand.*, vol. 15, pp. 435-495; December, 1919. For modern developments of this theory see A. Hund, "Phenomena in High Frequency Systems," McGraw-Hill Book Company, New York, N. Y., 1936.

reactance in the 100-megacycle region has been developed.

Measurements of the reactance of coils show that computed values based on present available formulas can be in considerable error for large wire sizes.

Even with small wire sizes the measured resonant frequency is higher than the calculated value, but the agreement is greatly improved.

concerning the critical dimension-to-wavelength ratios above which appreciable errors might be expected.

More recently, other investigators have made calculations dealing with the effective height and resistance<sup>3,4</sup> and terminal impedance<sup>5,6</sup> of single-turn loops of large dimension-to-wavelength ratio using assumed sinusoidal-current distribution with the current in phase throughout and with results agreeing closely with their experiments. These assumptions, however, are presumably not accurate for all calculations since they provide no basis for the derivation of unidirectional patterns and there is no indication that radiation patterns could be derived using these assumptions even in cases in which there are no unidirectional characteristics. In this paper there are described an experimental method of measuring actual current conditions, the results of experimental tests upon a number of loops, and the use of these results in calculating radiating patterns.

#### EXPERIMENTAL TESTS

Experimental tests were conducted at frequencies between 20 and 120 megacycles with single-turn rectangular loops. Their height above ground was increased until current distribution was apparently independent of height and throughout each test they were supplied with constant and balanced terminal currents. These tests are outlined below.

#### Measurements of Current Distribution

Current measurements were made by shunting high-frequency ammeters directly across loop segments. Current-distribution curves were constructed from the ratios of ammeter readings at a number of segments around the loops to the reading of the same ammeter

<sup>3</sup> V. I. Bashenoff, and N. A. Mjasoedoff, "The effective height of closed aerials," *PROC. I.R.E.*, vol. 19, pp. 984-1018; June, 1931.

<sup>4</sup> V. I. Bashenoff and N. A. Mjasoedoff, "Effective resistance of closed antennas," *PROC. I.R.E.*, vol. 24, pp. 778-801; May, 1936.

<sup>5</sup> L. S. Palmer, and D. Taylor, "Rectangular short-wave frame aerials for reception and transmission," *PROC. I.R.E.*, vol. 22, pp. 93-114; January, 1934.

<sup>6</sup> S. S. Banerjee, "On the critical dimensions of tuned transmitting circular loop aerials," *Phil. Mag.*, vol. 27, pp. 174-181; February, 1939.

when shunted across the segments at the terminals of the loops.

Some error was due to disturbance of current distribution by the ammeter placed on the wire. Its magnitude was estimated from tests in which one ammeter was fixed in position, an identical meter moved around the loop, and the maximum disturbance determined from the resulting fixed-meter readings. These fixed-meter readings differed in most cases by less than 2 per cent from the reading with the movable meter removed. Other sources of error, such as variation of current division between loop segment and shunting meter near loop corners, appeared to be of the same magnitude as or inseparable in effect from an inconsistency in repeated readings of about 2 per cent. The effect of this inconsistency was reduced by using averages of a number of current readings.

#### Field-Strength Measurements

Relative field-strength measurements were made to determine (a) horizontal radiation pattern (horizontal component of electric vector) with the antenna horizontal and (b) horizontal radiation pattern with the antenna vertical. Measurements were made at a distance from the antenna of about 2 wavelengths and at a distance of at least 10 wavelengths from any obstruction.

From the radiation patterns with the loop horizontal it was possible to determine whether current was in the same time phase throughout the loops since a front-to-rear signal ratio different from unity along any axis in the loop plane indicated that the current in one segment on the axis was reaching a maximum before or after the current in the opposite segment. In addition,

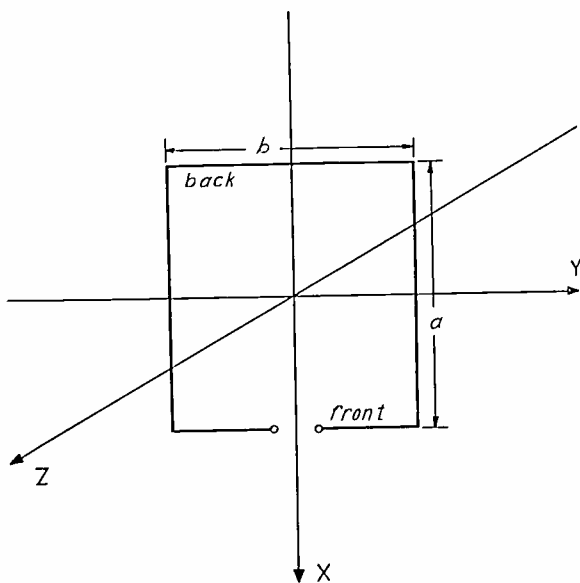

Fig. 1—Orientation of loops with reference to co-ordinate system.

since the shape of the patterns obtained in the above manner is approximately the same as the corresponding patterns in free space, these measured patterns provide a check on derived free-space patterns.

In describing current distribution in a particular loop (see Fig. 1) it is convenient to use three differ-

ences relating the terminal current to the average currents in the front, back, and sides and defined as follows:

$$d_1 = \frac{\text{average back current} - \text{terminal current}}{\text{terminal current}}$$

$$d_2 = \frac{\text{average front current} - \text{terminal current}}{\text{terminal current}}$$

$$d_3 = \frac{\text{average side current} - \text{terminal current}}{\text{terminal current}}$$

By average current in a side  $x_1$  is meant

$$\frac{1}{x_1} \int_0^{x_1} Idx.$$

In current-distribution curves the co-ordinate  $p/\lambda$  represents the ratio of the distance of the point in question

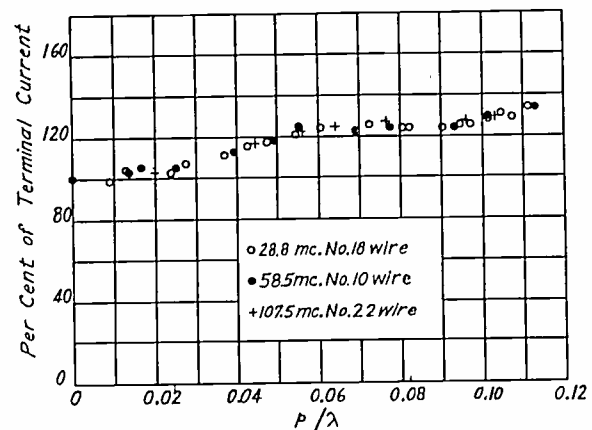

Fig. 2—Current distribution curves for three loops in which  $P/\lambda$  is equal to 0.23. Because of symmetry one half of the curves has been omitted.

from the terminals along the loop perimeter to the wavelength.

From the test results it appeared that single-turn rectangular transmitting loops can be classified according to the ratio of loop perimeter  $P$  to wavelength  $\lambda$  and ratio of length  $a$  to width  $b$  in the following way:

(a) When  $P$  is less than about  $0.08\lambda$  current distribution is uniform and time phase is constant. Loops of this size are sufficiently accurately described by ordinary loop theory.

(b) When  $0.08\lambda < P < \text{about } 0.25\lambda$  time phase is constant and current distribution is a function only of  $a/b$  and  $P/\lambda$ . In this range loops of the same  $a/b$  and  $P/\lambda$  have the same current distribution at widely different frequencies as is shown, for example, for three loops in Fig. 2. Values of  $d_1, d_2, d_3$  vary from a minimum at  $a/b \ll 1$  to a maximum at  $a/b \approx 1$ . Experimental curves of these at  $a/b = 1$  are plotted in Fig. 3. With  $a/b > 1, d_1, d_2,$  and  $d_3$  remain approximately constant, approaching values which may be determined from transmission-line theory (sinusoidal current distribution) at  $a/b \gg 1$ . Although these results have been demonstrated only for 20 to 120 megacycles and solid-copper wire sizes between No. 8 and No. 22 they imply the existence of a model relation which may be more

widely applicable. Formulas for the field strength of loops for which  $P < 0.25\lambda$  are derived in this paper.

(c) When  $P$  is greater than about  $0.25\lambda$  there appears to be no model relation.<sup>7</sup> Both current distribution and time phase vary widely with  $P$ ,  $a/b$ , wire size,

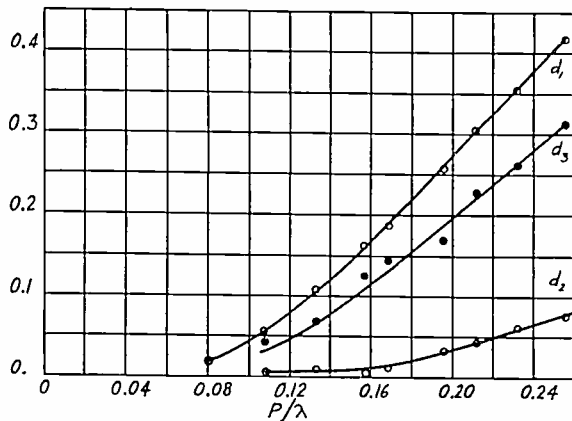

Fig. 3—Values of the current distribution factors  $d_1$ ,  $d_2$ , and  $d_3$  in square loops.

and frequency. Useful properties of loops of this size are discussed under the heading of loop aerials with unidirectional characteristics.

#### CALCULATION OF PATTERNS OF LOOPS WITH UNIFORM CURRENT TIME PHASE

The derivation of patterns which follows will be confined to loops in class (b) above, i.e., loops in which the current distribution may vary in any way but in which the current reaches a maximum at the same time in all parts of the loop. Characteristics will be derived for the antenna remote from earth and in the discussion of loop effectiveness the copper losses in the antenna will be neglected.

The field strength produced at a point by currents in an antenna is generally calculated from the expression

$$H = \int \frac{2\pi I \sin \theta}{\lambda r} \cos \omega(t - r/c) dL \quad (1)$$

centimeters-gram-second electromagnetic units

integrated over the length of the antenna in which  $r$  is the distance from the point to the segment  $dL$  carrying the current  $I \sin \omega t$ ,  $\theta$  the angle between  $r$  and the segment, and  $\lambda$  and  $\omega$  the wavelength and angular frequency. In calculating loop radiation it is usually assumed<sup>2</sup> that in any side the variation of  $\cos \omega(t - r/c)$  over the range of integration will be negligible and therefore that the field-strength component at a point due to each individual side will be obtained from the expression

$$H = \frac{2\pi L_0 \sin \Theta I_{av} \cos \omega(t - R/c)}{\lambda R} \quad (2)$$

in which  $R$  is the distance from the center of the side to the point,  $L_0$  the length of the side,  $\Theta$  the angle be-

<sup>7</sup> For a discussion of factors involved in antenna models, see J. Tykocinski-Tykociner, "Investigation of antennas by means of models," *Univ. of Illinois Bull.*, vol. 22, no. 147, May, 1925.

tween  $R$  and the segment, and  $I_{av}$  the average value of  $I$  in the side. For all values of  $\Theta$  except 90 degrees the use of (2) instead of (1) introduces error even if current distribution is uniform. This error may be estimated from comparison of field strengths calculated using

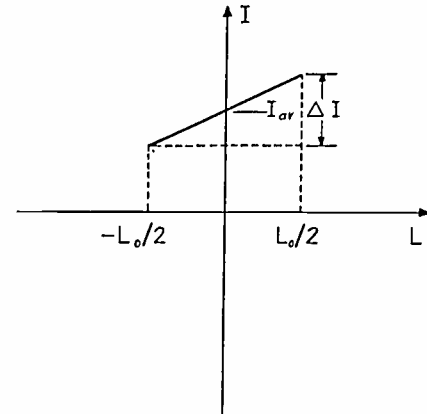

Fig. 4

the exact method of (1) and the approximate method of (2) for an antenna with the current distribution sketched in Fig. 4.

Since

$$I = \frac{\Delta I}{L_0} L + I_{av}$$

$$H = \frac{2\pi}{\lambda R} \sin \Theta \int_{-L_0/2}^{L_0/2} \left[ \frac{\Delta I}{L_0} L + I_{av} \right] \cdot \cos \omega \left[ t - \frac{R + L \cos \Theta}{c} \right] dL$$

from (1) to a sufficient degree of accuracy.

The result of integration is

$$H = \frac{2\pi}{\lambda R} I_{av} L_0 \sin \Theta \left[ \frac{\sin \beta}{\beta} \sec \Phi \right] \cos (\omega t - \omega R/c - \Phi)$$

in which

$$\beta = \left[ \frac{L_0}{\lambda} \right] \pi \cos \Theta \quad D = \Delta I / 2I_{av}$$

$$\Phi = \arctan \left[ D \left( \frac{1}{\beta} - \cot \beta \right) \right]$$

For accuracy, therefore, (2) should have a coefficient  $(\sin \beta / \beta) \sec \Phi$  and an additional retard angle  $\Phi$ . Curves of these functions are plotted in Fig. 5 for

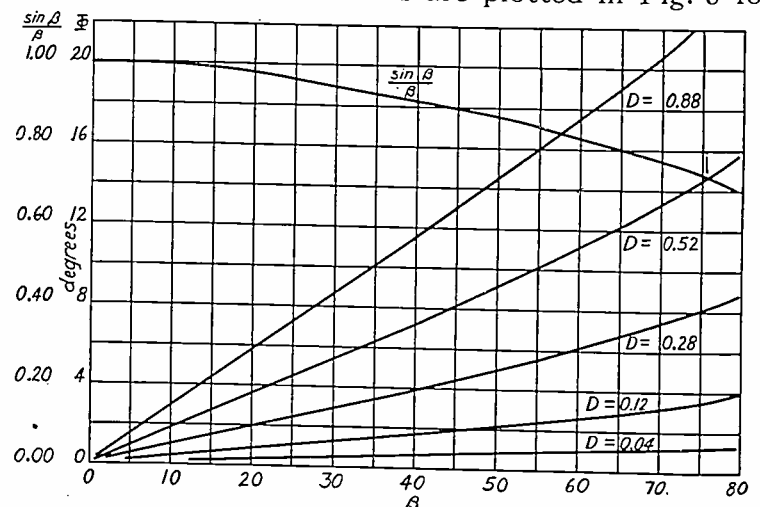

Fig. 5—Values of the error functions  $\sin \beta / \beta$  and  $\Phi$  for some values of  $D$ .



use with antennas or elements having approximately the current distribution of Fig. 4. These curves may also be used to determine maximum error in applying (2) to systems having sinusoidal current distribution since the actual error will be less than that estimated from the curves. When  $P < 0.25\lambda$  in the loops of this study the estimated error with measured values of  $D$  does not exceed 2 per cent. In view of the probable experimental error in determining current distribution the constants  $d_1$ ,  $d_2$ , and  $d_3$  may be used with (2) in the place of an involved integration using (1) and actual current-distribution curves with no sacrifice of accuracy. Formulas for loop radiation along the  $X$ ,  $Y$ ,  $Z$  axes<sup>8</sup> are derived as follows: From (2) at a distance  $x$  along the  $X$  axis

$$H = \frac{2\pi b}{\lambda x} \left[ I_{\text{back}} \cos \omega \left( t - \frac{x + a/2}{c} \right) - I_{\text{front}} \cos \omega \left( t - \frac{x - a/2}{c} \right) \right].$$

Let 
$$t_1 = t - \frac{x - a/2}{c}.$$

When  $d_1$ ,  $d_2$ , and  $d_3$  are substituted for the differences they represent and  $I_t$  (the terminal current) is introduced

$$H = \frac{2\pi b}{\lambda x} I_t \left[ \left( \cos \omega t_1 \left\{ \cos \frac{\omega a}{c} - 1 \right\} + \sin \omega t_1 \sin \frac{\omega a}{c} \right) + (\cos \omega t_1) \left( d_1 \cos \frac{\omega a}{c} - d_2 \right) + (\sin \omega t_1) \left( d_1 \sin \frac{\omega a}{c} \right) \right].$$

For the small values of  $a$  involved  $\sin(\omega a/2c) = \omega a/2c$ . If a second time function  $t_2$  is used, differing from  $t_1$ , by a time interval depending upon  $(d_1, d_2, x, a)$  the form of  $H$  above may be reduced to

$$H = \frac{2\pi I_t}{x} \left[ \frac{2\pi \text{ area}}{\lambda^2} \left\{ \sin \omega t_2 + A \sin \omega(t_2 + \psi) \right\} \right]$$

in which

$$A = \frac{\lambda}{2\pi a} \left[ d_1^2 + d_2^2 - 2d_1d_2 \cos \frac{2\pi a}{\lambda} \right]^{1/2}$$

$$\psi = \arctan \left[ \cot \frac{2\pi a}{\lambda} - \csc \frac{2\pi a}{\lambda} \right] - \arctan \left[ \cot \frac{2\pi a}{\lambda} - \frac{d_2}{d_1} \csc \frac{2\pi a}{\lambda} \right].$$

It may be shown similarly, using time functions  $t_3$  and  $t_4$  differing from  $t$  by small intervals: along the  $Y$  axis at a distance  $y$

<sup>8</sup> Information for the purposes of the discussion in this paper can be obtained from a consideration of radiation along the coordinate axes alone. The data which have been given, however, are sufficient for the derivation of formulas for the radiation in any direction.

$$H = \frac{2\pi}{y} I_t \left[ \frac{2\pi \text{ area}}{\lambda^2} (1 + B) \right] \sin \omega t_3$$

in which  $B = d_3$ ;

along the  $Z$  axis at a distance  $z$

$$H = \frac{2\pi}{z} I_t \left[ \frac{b}{\lambda} C \right] \sin \omega t_4$$

in which  $C = d_1 - d_2$ .

If  $A = B = C = 0$  the above reduce to the ordinary formulas for the single-turn loop.

Since the ordinary loop theory predicts no field along the  $Z$  axis, relative field-strength measurements of the ratio of radiation in the  $Z$  direction to that in the  $X$  direction provide a simple check, although not a complete one, on the theory developed here. Measurements of  $X/Y$  radiation also provide some check on the results. Calculations using  $d_1, d_2, d_3$  as plotted in Fig. 3 have been checked with field-strength measurements of square loops ( $a = b$ ). Calculated and measured values are shown in Table I.

TABLE I

$P/\lambda$	Calculated $H_z/H_x$	Measured $H_z/H_x$
0.112	0.33	0.40
0.176	0.55	0.55
0.220	0.62	0.60
0.288	0.60	0.70
$P/\lambda$	Calculated $H_y/H_x$	Measured $H_y/H_x$
0.25	0.84	0.78

## DISCUSSION OF RESULTS

In most antenna applications it is desirable that as much of the radiation be concentrated in one direction as possible. It can be seen that for  $P < 0.08\lambda$  the ratio of radiation in the best direction to total power radiated is the same for all loops but that when  $P > 0.08\lambda$  because of the power radiated in the  $Z$  direction this ratio decreases and the antenna is less effective for most purposes. Furthermore this  $Z$  radiation, which may be as much as 70 per cent of the  $X$  and  $Y$  radiation, is in such a direction as to interfere with the use of the aerial in direction-indicating applications unless provision be made for discrimination according to the polarization of signals. Since the plotted values of  $d_1, d_2, d_3$  represent approximately the largest values which these quantities may have at a given  $P/\lambda$  the maximum value that the  $Z$  radiation may have may be estimated from the data and formulas of this paper.

The results of this study should not be applied without further investigation to the loops used in long-wave radio beacons<sup>9</sup> since it is probable that in this case current distribution and possibly time-phase relations are influenced by proximity to the ground.

<sup>9</sup> For loops in which proximity to ground is important see footnote references 3 and 4.

### LOOPS WITH UNIDIRECTIONAL CHARACTERISTICS

As stated earlier, single-turn loops for which  $P$  is larger than about  $0.25\lambda$  have nonuniform current distribution and usually some current time-phase difference between sides. They therefore radiate in all directions and have unidirectional characteristics in the  $XX'$  direction to the extent that current distribution and time-phase difference happen to combine to produce this effect. Since radiation in all directions implies poor effectiveness, study of these loops was

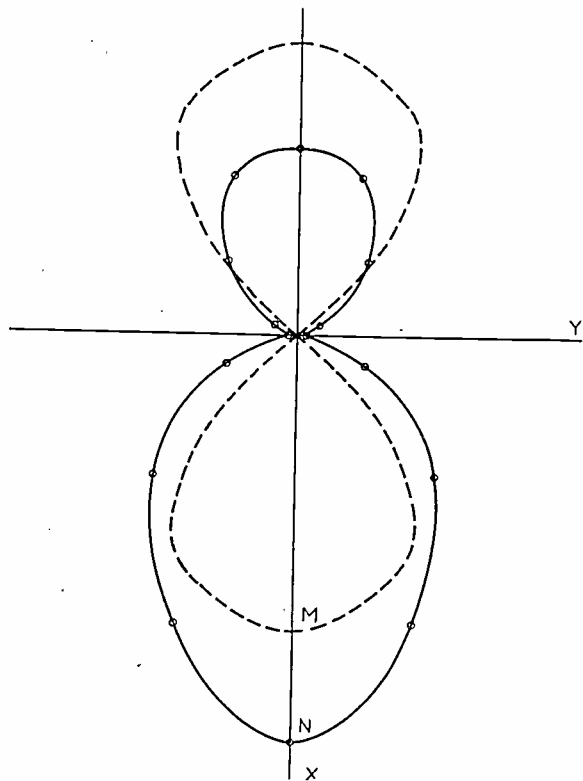

Fig. 6—Comparison of the power-radiation patterns in space of the half-wave doublet ( $M$ ) and the loaded loop ( $N$ ) described by the author.

carried out with a view to determining whether in any case characteristics could be obtained sufficiently directional that a loop of this size would compare favorably with an ordinary radiator of comparable dimensions such as a half-wave doublet. This study included both simple loops and loops in which the current conditions are controlled by adding inductance or capacitance.

In the range  $0.25\lambda < P < \lambda$  no simple loop tested had a front-to-rear ratio of more than 1.3, and even this loop had a signal strength in its best direction of about 3 decibels less than the half-wave doublet.

In a loop, for which  $P = \lambda/2$ , which had capacitance inserted in the center of its rear side, radio amateurs have claimed some gain over the simple loop. Owing to an unfavorable current distribution, in which the current in the sides is high and that in the front and back low, this loop has, at best, actually about only a

2-decibel gain over the simple loop.

The author has obtained a substantial gain in a loop with current distribution controlled by means of inductive loading. A desirable current distribution is one in which the current is high in the front and back and low in the sides, resulting in high radiation in the  $X$  direction and low radiation in the  $Y$  direction. This corresponds to the current distribution in a half-wavelength transmission line so that one would suspect that it could be obtained in the range  $0.25\lambda < P < \lambda$  through increasing the loop's electrical length by means of inductive loading. Although in a highly attenuated half-wave transmission line the ratio of the currents in the sides to the currents in the front and back would be appreciable, the radiation in the  $Y$  direction would be small because of the large difference in time phase between the ends of the sides, corresponding to the large shift in time phase near the center of such a line. If the loop is made equivalent to a half-wave line, transmission-line theory also predicts that the optimum time-phase difference between front and back for unidirectional  $X$  radiation can be obtained with an inductance in the center of the back of the loop, corresponding to an inductive reactance as the receiving impedance of the line. Actual reactance values, of course, would have to be determined experimentally.

This method was applied to a square loop for which  $P = \lambda/2$ . Lumped loading was used rather than distributed loading because of the necessity for ready adjustment during experimental tests. The reactances were placed in the center of the loop back and in the sides at the corners nearest the back of the loop. With field measurements at 58 megacycles the optimum values of these reactances were found to be 360 ohms for the sides and 180 ohms for the back. In Fig. 6 the radiating pattern of this loop in the  $XY$  plane is compared with that of the half-wave doublet, showing that this loaded loop has a gain of about 1 decibel over the half-wave doublet. It will be noted that the radiation of the loaded loop was not reduced to zero in the rear direction; there is reason to suppose, however, that with either the use of more reactances, or possibly with the same number of reactances placed at different points, the radiation in the rear direction could be reduced to zero and the gain over the half-wave doublet considerably increased. Development of such an antenna would require further experimental work.

#### ACKNOWLEDGMENT

The author wishes to acknowledge his indebtedness to Professor F. T. McNamara of Yale University for his constructive criticism and encouragement during the course of this study.

# The Ionosphere and Radio Transmission, September, 1940, with Predictions for December, 1940

NATIONAL BUREAU OF STANDARDS, WASHINGTON, D. C.\*

AVERAGE critical frequencies and virtual heights of the ionospheric layers as observed at Washington, D. C., during September are given in Fig. 1. Critical frequencies for each day of the month are given in Fig. 2. Fig. 3 gives the September

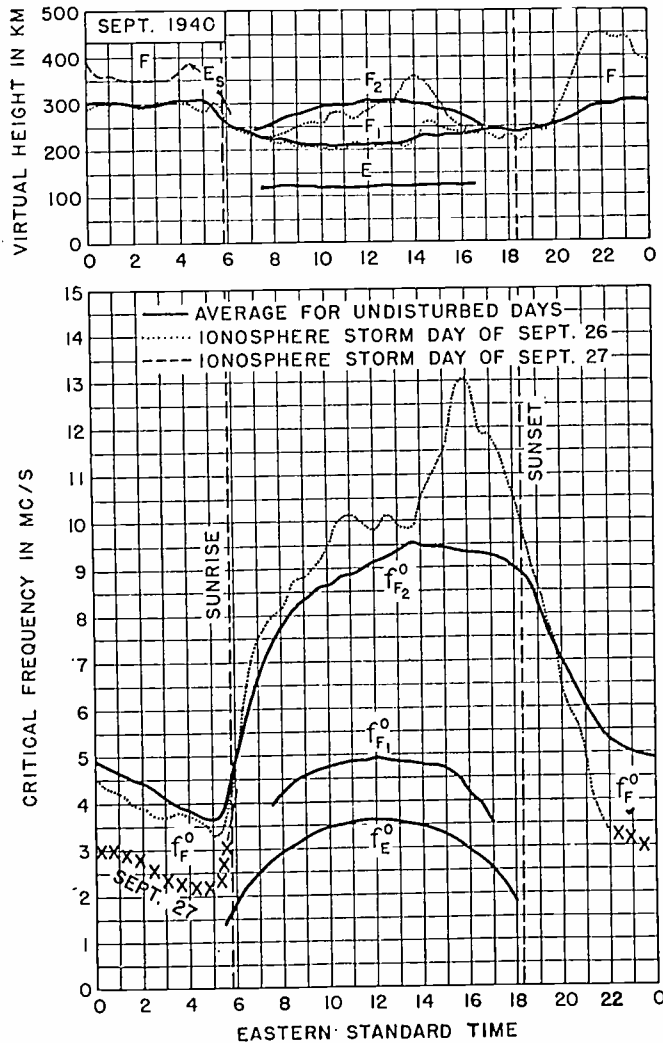

Fig. 1—Virtual heights and critical frequencies of the ionospheric layers, observed at Washington, D.C., September, 1940. The X's in the graphs of the F-layer critical frequencies on the night of September 26 and 27 indicate that the reflections were diffuse and the critical frequencies poorly defined.

average values of maximum usable frequencies, for undisturbed days, for radio transmission by way of the regular layers. The maximum usable frequencies were determined by the F layer at night and by the F<sub>2</sub> layer during the day. Fig. 4 gives the expected values of the maximum usable frequencies for radio transmission by way of the regular layers, average for undisturbed days, for December. All of the foregoing are based on

\* Decimal classification: R113.61. Original manuscript received by the Institute, October 10, 1940. These reports have appeared monthly in the PROCEEDINGS starting in vol. 25, September, 1937. See also vol. 25, pp. 823-840; July, 1937. Report prepared by S. S. Kirby, N. Smith, F. R. Gracely, and A. S. Taylor.

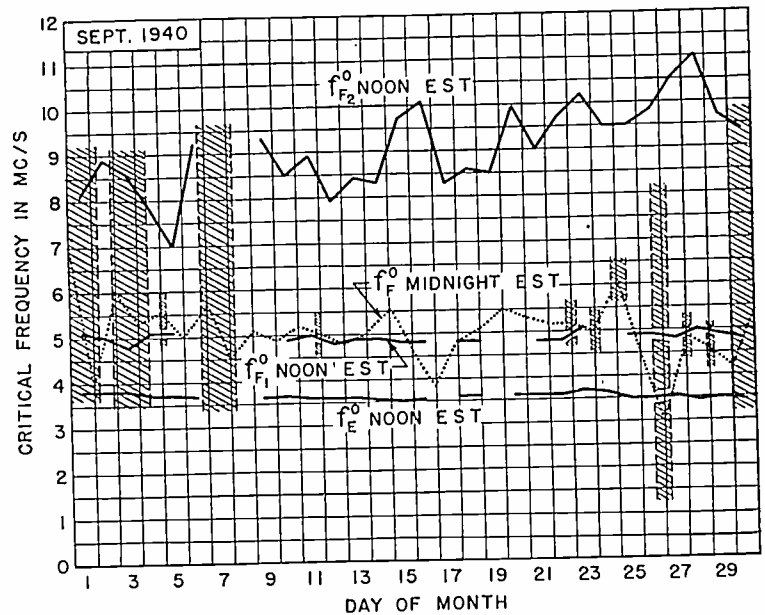

Fig. 2—Midnight  $f_F^0$  and noon  $f_{F_2}^0$ ,  $f_{F_1}^0$ , and  $f_E^0$  for each day of September. The times during which ionospheric storms occurred are indicated by the cross-hatched sections.

the Washington ionospheric observations, checked by quantitative observations of long-distance reception.

Ionospheric storms and sudden ionospheric disturbances are listed in Tables I and II, respectively. The details of one ionospheric storm are shown in Fig. 1, and the times during which all ionospheric storms occurred are indicated by the cross-hatched sections. The small night storms which did not affect the noon critical frequencies are indicated by cross hatching over only a short vertical range. The more severe storms and those which affected both noon and

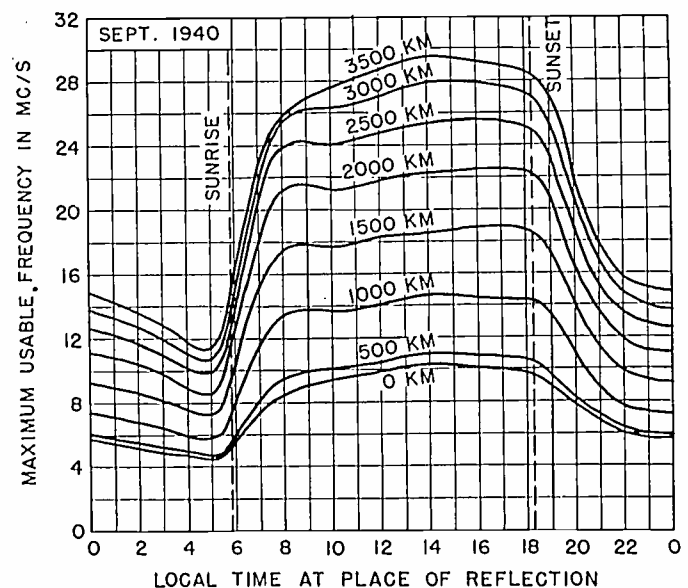

Fig. 3—Maximum usable frequencies for dependable radio transmission via the regular layers, average for undisturbed days for September, 1940.



# Institute News and Radio Notes

## Board of Directors

A regular monthly meeting of the Board of Directors was held on Wednesday, November 6, 1940. Those present were L. C. F. Horle, president; Melville Eastham, treasurer; Austin Bailey, W. R. G. Baker, F. W. Cunningham, Alfred N. Goldsmith, Virgil M. Graham, O. B. Hanson, R. A. Heising, C. M. Jansky, Jr., F. R. Lack, F. B. Llewellyn, Haraden Pratt, H. M. Turner, A. F. Van Dyck, H. A. Wheeler, and H. P. Westman, secretary.

The waiver of the payment of a new entrance fee in the case of former members who desire to re-enter the Institute, without paying the dues for the time during which their membership lapsed, was canceled. All such cases are to be handled exactly as though they were applications for new memberships.

Applications for transfer to Member grade in the following names were approved: H. W. Appel, C. E. Burnett, T. R. W. Bushby, N. M. Cooke, D. K. de Neuf, C. E. Haller, T. J. Henry, W. M. James, A. P. Kauzmann, R. L. Kelly, L. M. Leeds, S. G. Lutz, P. H. Nelson, and R. M. Walker. The following individuals were admitted to Member grade: J. W. Downie, T. S. Farley, J. G. Kreer, Jr., O. H. Schade, R. B. Vandergrift, Sidney White, Jr., and Ross Wood.

Nineteen applications for Associate and nine for Student grade were approved.

As a result of the report of the Tellers Committee, F. E. Terman was declared elected President for 1941, A. T. Cosentino as Vice President for 1941, and H. T. Friis, O. B. Hanson, and L. P. Wheeler, will serve as Directors for the period 1941 to 1943.

A report on the Pacific Coast Convention which was held in Los Angeles on August 28, 29, and 30, indicated a total attendance of 356 of whom 24 were women. The Board expressed its appreciation of the effective work of the convention committee.

## Committees

### Admission

The Admission Committee at a meeting on September 4, approved thirteen of eighteen applications for transfer to Member and seven of eight applications for admission to that grade. One application in the latter group was tabled. Those who were present at the meeting were A. F. Van Dyck, chairman; F. J. Bingley, Ralph Bown, C. M. Jansky, Jr., I. J. Kaar, H. M. Turner, and H. P. Westman, secretary.

### Board of Editors

### Co-ordinating

The Co-ordinating Committee of the

Board of Editors, which makes a final review of all papers being considered for publication, held a meeting on August 20 and another meeting on October 15. Alfred N. Goldsmith, chairman; P. S. Carter, Helen M. Stote, assistant editor; and H. P. Westman, secretary, attended both meetings; in addition, H. A. Wheeler was present at the August meeting.

### Convention Policies

A meeting of the Convention Policies Committee was held on September 4 and attended by H. P. Westman, chairman; Alfred N. Goldsmith, L. C. F. Horle, and C. M. Jansky, Jr.

### New York Program

Arrangements for the October, November, and December, 1940, New York meetings were made by the New York Program Committee on September 10. Those present were: A. B. Chamberlain, chairman; H. A. Affel, Austin Bailey, I. S. Coggeshall, E. J. Content (representing J. R. Poppele) D. G. Fink (representing Keith Henney), W. M. Goodall, D. E. Harnett, D. D. Israel, Wallace James, G. T. Royden, B. E. Shackelford (representing R. R. Beal), A. F. Van Dyck, and H. P. Westman, secretary.

### Preparedness

The National Resources Planning Board of the United States Government, is preparing a Roster of Scientific and Specialized Personnel in order to make available with the least waste of time the records of professional workers whose service may be of value to those working on national-defense problems. All professional workers will be asked to fill in questionnaires which will be concerned chiefly with their experiences and education.

The Preparedness Committee in a series of four meetings during October and early November prepared a check list of fields of activities in radio and its allied arts. This check list will be incorporated into the questionnaires which will be mailed to Institute members.

Haraden Pratt, chairman; D. G. Fink, R. A. Heising, C. B. Jolliffe, H. B. Richmond, H. M. Turner, Lincoln Walsh, and H. P. Westman, secretary; were present at the October 3 meeting. At the October 15 meeting there were Haraden Pratt, chairman; D. G. Fink, R. A. Heising, C. M. Jansky, Jr., H. M. Turner, and H. P. Westman, secretary. On October 24, the meeting was attended by Haraden Pratt, chairman; D. G. Fink, R. A. Heising, C. B. Jolliffe, C. M. Jansky, Jr., Lincoln Walsh, and H. P. Westman, secretary; and those present at the November 6 meeting were Haraden Pratt, chairman; D. G. Fink, R. A. Heising, L. C. F. Horle, ex officio; C. M. Jansky, Jr., H. M. Turner, Lincoln Walsh, and H. P. Westman, secretary.

### Public Relations

The Public Relations Committee met on September 18 and those present were Virgil M. Graham, chairman; D. G. Fink, G. W. Gilman (guest), O. B. Hanson, D. D. Israel, H. C. L. Johnson, I. J. Kaar, Lincoln Walsh, J. D. Crawford, assistant secretary; and H. P. Westman, secretary. This was the first meeting of the Committee which was recently organized and general methods of preparing and distributing publicity releases on Institute activities were considered. Subcommittees were appointed for the preparation of publicity releases, an annual review for distribution to the press, and for the program of the Sixteenth Annual Banquet.

A second meeting of the Committee was held on October 16 and was attended by Virgil M. Graham, chairman; D. G. Fink, G. W. Gilman (guest), O. B. Hanson, D. D. Israel, A. F. Van Dyck, Lincoln Walsh, J. D. Crawford, assistant secretary; and H. P. Westman, secretary. The activities of the subcommittees appointed at the first meeting was reviewed and further preparations were made in the advancing of their work.

### Tellers

The Tellers Committee met on October 29 and counted the ballots cast in the election for officers. Those present were H. W. Houck, chairman; F. R. Lack, I. G. Malloff, E. W. Schafer, H. M. Turner, Lincoln Walsh, and H. P. Westman, secretary.

## Sections

### Atlanta

"A New Type of Vacuum-Tube Voltmeter of High Accuracy" was the subject of a paper by M. A. Honnell, instructor of electrical engineering at Georgia Institute of Technology and of the engineering staff of WGST.

The circuit arrangement and operating characteristics were described. The accuracy depends chiefly on the calibration of a direct-current milliammeter and a standard resistor.

The instrument is self-calibrating, the direct-current milliammeter is protected from excessive currents, and the circuit may be operated from either alternating or direct current power. A model of the device was demonstrated.

June 21, 1940, G. S. Turner, vice chairman, presiding.

D. F. Simmons, captain in the Georgia Department of Public Safety, presented a paper on "Radio as an Aid to Public Safety."

Although only one radio station is now being used, the efficiency of the patrol service has been increased 25 per cent. Five out of seven hit-and-run drivers are now apprehended and 70 per cent of the stolen cars are recovered.

As a result of the showing of the present station, the construction of two additional stations has been started and one of these will be placed in operation shortly.

September 20, 1940, P. C. Bangs, chairman, presiding.

## Baltimore

J. F. Morrison of the Bell Telephone Laboratories, presented a paper on the "Design Features of a Frequency-Modulated Transmitter." The formal paper by this author appears in this issue.

October 18, 1940, Ferdinand Hamburger, Jr., chairman, presiding.

## Buenos Aires

This meeting was devoted to an inspection tour of the Saavedra factory of the RCA Victor Company (Argentina). Among the manufacturing processes which were observed were the large-scale production of broadcast receivers, bakelite molding, the pressing of phonograph records, and the construction of various types of radio transmitters.

July 12, 1940, A. T. Cosentino, chairman, presiding.

"Ultrasonics and Their Application in Echo Sounding" was the subject of a paper by I. C. Grant.

The generation and reception of waves of frequencies which are above audibility were described. Magnetostriction and piezoelectric systems were considered in detail.

Reference was made to the Langevin-Chilowsky echo sounder which uses a steel-quartz projector in water for both transmission and reception. Reading of the depth of the water under the hull of a ship can be obtained either by visual means or by recording on electrolytic paper.

When the sounding is taken in shallow water, the time intervals between the transmitted and reflected waves is very small. The accuracy can be improved by using twin projectors for transmission and reception and by increasing the speed of the recording mechanism.

It was stated that the greater energy capacity of a nickel magnetostriction projector, as compared with the steel-quartz unit, permits the former to work through the steel plates of a ship. This avoids dry docking the vessel for installation or repair of the projector.

August 23, 1940, A. T. Cosentino, chairman, presiding.

J. P. Arnaud, professor of electrical engineering, spoke on "Standardization and Selection of Vacuum Tubes."

The basic functions required from each type of receiving tube were analyzed to establish a criterion for the selection of tubes. A series of charts was shown on which the different types of tubes could be indicated and their chief characteristics ascertained clearly. By accepting comparative figures of merit for each function, 19 types were selected out of 143 as providing a basic group of tubes most suited for the Argentine.

September 13, 1940, A. T. Cosentino, chairman, presiding.

## J. R. Carson Dies

John Renshaw Carson, research consultant in the Circuit Research Department of the Bell Telephone Laboratories, died on October 31, 1940 at his home in New Hope, Pennsylvania, at the age of fifty-four.

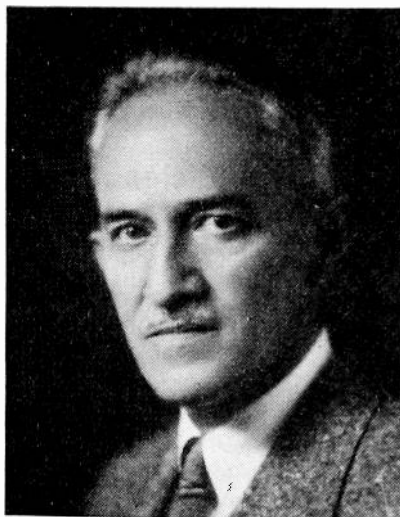

Blackstone Studios

JOHN RENSHAW CARSON

Born in Pittsburgh, Mr. Carson was graduated from Princeton University in 1907, and received a degree in electrical engineering in 1909. After two years with the Westinghouse Electric and Manufacturing Company, he taught at Princeton for two years. In 1914, he entered the American Telephone and Telegraph Company and in 1934 he transferred to the department of development and research in the Bell Telephone Laboratories.

Mr. Carson's outstanding contribution to the communication art was his invention of the single-sideband, carrier-suppression system of carrier-current operation. In recognition of his work in this field the Institute awarded him the Morris Liebmann Memorial Prize in 1924.

While some twenty-five patents on specific inventions stand in Mr. Carson's name, his most important work was in the application of mathematical theory to transmission problems. His book "Electric Circuit Theory and the Operational Calculus" is a classic in the field of operational calculus.

Mr. Carson held the degree of Master of Science from Princeton. He was a member of Phi Beta Kappa and the American Mathematical Society; a Fellow of the American Institute of Electrical Engineering and of the Royal Society of Arts in London. In 1936 he received the honorary Master of Science degree from Brooklyn Polytechnic Institute and in 1939 the Elliott Cresson Medal of the Franklin Institute "in consideration of outstanding contributions to the art of electrical communication." In 1916 Mr. Carson joined the Institute as a Member and transferred to Fellow grade in 1938.

"Basic Problems of Telephone Transmission" were discussed by Alejandro Nadosy, assistant to the general manager, Compania Internacional de Telefonos. It presented a general picture, especially adapted to the radio engineer's point of view, of the decisive factors involved in wire telephony.

Five basic parameters of telephone transmission are volume, band width, linear and nonlinear distortion, and noise. They are limited by the characteristics of the carbon microphone and the electromagnetic receiver. A short analysis of the technical and economic factors showed the impossibility of replacing these instruments with electrodynamic, piezoelectric, or condenser-type units.

Fidelity is not accepted as the sole criterion of valuation in telephony. Difficulties of testing a system for articulation or intelligibility of the transmitted sound were mentioned. Developments in the establishment of international standards were outlined.

Long-distance lines and the laws on which their design are based were described using the terminology common to radio engineering. It was pointed out that echo, phase distortion, and phase delay demanded a minimum of loading of cables and in some cases precluded all use of loading circuits. Modulated and lightly loaded circuits are in considerable use as the cost of a multichannel system for short distances is greater than the cost of providing additional lines.

October 4, 1940, A. T. Cosentino, chairman, presiding.

## Buffalo-Niagara

B. V. K. French, engineer of P. R. Mallory and Company, presented a paper on "Photo-Radio Analogies."

Vacuum-tube characteristic curves were compared with curves of the emulsion of photographic films. The variable-mu tubes have their counterpart in films having more than one layer of emulsion of varying sensitivity. The fidelity curves of negative emulsions parallel the graphs of receiver fidelity. The band-pass filters used in radio are comparable to the color filters of photography.

The superheterodyne principle is also applied in photography. A film using several layers of emulsion and utilizing an ultraviolet-sensitive layer converts light of these wavelengths into other colors for which the photographic materials are more sensitive.

October 9, 1940, B. E. Atwood, chairman, presiding.

P. G. Fritschel, engineer of the General Electric Company, presented a paper on "Frequency Modulation."

Comparisons were made of frequency and amplitude modulation. It was pointed out that the sensitivity of frequency-modulated-wave receivers has been greatly increased and satisfactory signals can be received at a radius considerably beyond the line of sight. With the same power, the service area of a frequency-modulated-wave transmitter was much greater than

for an amplitude-modulated-wave transmitter.

The transition areas between two frequency-modulated waves were discussed. The range of transition is very definite and a directional antenna will permit the selection of either signal without interference from the other.

Both the Armstrong and General Electric systems were described.

October 16, 1940, B. E. Atwood, chairman, presiding.

## Chicago

"Methods of Detecting and Prosecuting Illegal Radio Stations" were discussed by H. T. Gallaher, inspector in the Federal Communications Commission Chicago office, at the short session which is held just before the regular section meeting. The Commission depends especially on licensed amateurs and the public to inform it of violations by unlicensed operators. In one locality an investigation disclosed 24 unlicensed stations.

The regular meeting was devoted to "Some Aspects of High-Fidelity Sound Reproduction" by H. S. Knowles, vice president and chief engineer of the Jensen Radio Manufacturing Company.

As part of the problem, the author considered the listener and his environment as well as the source of reproduction and its environment. The problem is to produce the original pressure-space-time pattern at both listener's ears which would exist if the listener were located near the original source of the sound. This involves binocular hearing of necessity.

The paper was concluded by a demonstration in which by means of filters the higher frequencies fed to a high-quality loud speaker were progressively reduced. The reaction of the audience as indicated by a show of hands, established that all frequencies up to 8500 cycles were desired.

September 27, 1940, E. Kohler, chairman, presiding, W. Kenworth, presiding at preliminary meeting.

## Cincinnati

"A Push-Button-Operated High-Power, High-Efficiency, Multiband Directive-Antenna System" was described by W. S. Alberts, propagation engineer of the Crosley Corporation.

The usual method of obtaining a directional field is to use a number of stacked half-wave elements. For the number of frequencies to be utilized by WLWO, such an arrangement would be bulky and expensive and so a rhombic antenna was considered superior. Ordinarily, about one third of the power supplied to a rhombic antenna is dissipated in the matching resistor. For a 50-kilowatt output this waste would be nearly 20 kilowatts; to avoid this an antenna was designed which reintroduces the ordinarily wasted power back into the input of the antenna. The antenna provides a beam about 35 degrees wide which covers almost all of South America.

The input transmission line has a surge impedance of 600 ohms. In place of the terminating resistor at the far end of the



E. W. RITTER

*E. W. Ritter (M'30), has been elected vice president of the RCA Manufacturing Company, and placed in charge of all of the company's manufacturing and production engineering activities.*

*Mr. Ritter was born in 1902 in Orangeville, Indiana. He received the B.S. degree in electrical engineering from Purdue University in 1925. After five years with the General Electric Company, he transferred to the research and development engineering division of RCA Radiotron in 1930. From 1934 to 1938 he was head of that department and then became manager of the entire Radiotron division. Early this year he was made manager of engineering for the RCA Manufacturing Company, and his new position puts him in charge of all manufacturing and production engineering.*

diagonal, there is connected a 600-ohm transmission line which is called the return line. At the end of this return line two matching sections are installed. These sections produce a voltage at the end of the line equal in value and phase to the voltage at the input side of the antenna. An additional matching section is located at the end of the 300-ohm transmission line which feeds the transmitter just at the point where the return line is connected to the antenna input. The two 600-ohm lines effectively paralleled each other at the point of connection.

Trouble was experienced in mismatching of the transmission lines at the point where they left the coupling house and the transmitter house. There was enough capacitance between the corona shields and ground of the lead-in insulators to change the surge impedance with resultant mismatch. Series coils were installed at each end of the lead-in insulators and the greatest mismatch was about 20 per cent with most cases being around 10 per cent.

September 24, 1940, C. H. Topmiller, chairman, presiding.

"Measurements of Noise and Vibration" were described by H. H. Scott, engineer for the General Radio Company.

It was pointed out that the ear has a range of approximately 120 decibels. There are ordinarily three volume levels at which intensive and frequency relationship are obtained and in sound analysis, these levels must be specified.

Sound-analyzing equipment was then discussed and its use in the design of industrial and household equipment was outlined. As the sound given off by equipment is reduced, the efficiency of workers increases. Vibration measurements are important factors in such work. This applies particularly to the aircraft industry. It was pointed out that when analyzing the sound output of a machine, the tone given off by an individual part may differ when the part is operated separately from when the entire equipment is running. The reason for this is that the individual tone may be modulated by frequencies generated in other parts of the equipment.

October 22, 1940, P. B. Taylor, vice chairman, presiding.

## Connecticut Valley

J. A. Matthews, Jr., head field engineer of the Hammond Manufacturing Company, presented a paper on "The Novachord."

The author presented first an analysis of musical sounds. The three important factors, volume, pitch, and timbre, were discussed.

In the original Hammond organ the final tones were built up by combining sound waves and it was found that the three factors mentioned above were not the only important requirements to be met. Some other factors such as attack, which concerns itself with the rise and decay of the envelope shape, is a fourth characteristic. In the Novachord this has been made variable. Also, the tremolo may be of two types. The organ uses amplitude variation while the Novachord uses variable frequency and thus simulates a stringed instrument. It has been found that wider frequency modulation is desired for some notes than for others and each of the 12 master oscillators has a different rate of vibrato.

The Novachord uses 12 master oscillators with 7 2:1 frequency dividers driven by each. A subtractive system permits sine-wave output to be obtained over selected parts of the keyboard but the tones are essentially saw tooth in shape. A tube controlled from each key determines the attack characteristic. By varying the attack any of the standard orchestral instruments can be simulated.

Although 163 tubes are employed, they are operated at reduced heater voltage and offer long-life results.

September 19, 1940, K. A. McLeod, chairman, presiding.

"Plastics in Radio" was the subject of a paper by J. R. Turnbull, of the Monsanto Chemical Company, plastics division.

A review of the plastics field began with a discussion of celluloid which is a cellulose-nitrate product. It has good strength characteristics, takes color excellently but is highly inflammable. The development of bakelite provided material of excellent strength and one which may be colored but not too effectively. In 1920 the introduction of cellulose nitrate, a plastic having good strength and coloring ability resulted

in a tremendous influence on the plastic industry. The material softens with heat and may fail in some uses because of this.

Ten years later brought modern injection molding in which the granular plastic material is heated and forced into dies under pressure of one or two tons per square inch. Its production involves no waste of material and usually several pieces are usually made simultaneously. It increased the use of plastics many times and reduced costs substantially.

Urea, under the commercial name of Plascon and Beetle, is a thermosetting plastic. Once heated and formed, further heat will not affect its shape. It is not transparent, is brittle, and finds a ready market for many purposes.

Cast phenol plastics are useful for the manufacture of small quantities. Like Bakelite, they are produced by a slow version of the catalytic process, requiring four days baking at 85 degrees centigrade. Dies are cheap and little attention need be paid to their finish.

Polystyrene has excellent dielectric strength but is mechanically weak. Its low melting point makes manufacturing difficult. Each piece must be made in a die and as dies for injection molding are expensive, it is restricted to large-production items.

Vinyl resins are a thermoplastic, having a broad range of potential forms and are developed from 200 or 300 basic formulas. They provide a wealth of new materials, some of which already in use are Nylon, Formex, and Vinyl tapes.

October 22, 1940, K. A. McLeod, chairman, presiding.

## Detroit

R. M. Wise, chief engineer of the Hygrade Sylvania Corporation, presented a paper on "Recent Radio-Tube Developments." Among the developments discussed were the 1.4-volt tubes which are designed to operate with only 45 volts on the plate. Developments in high mutual-conductance tubes were also outlined. An advancement in tube-production methods and experiences in the development of cathode-ray tubes were given.

June 21, 1940, J. D. Kraus, chairman, presiding.

## Emporium

An inspection visit was made to the Wellsboro and Corning plants of the Corning Glass Company. At the former plant envelopes for lamp and radio tubes were manufactured as well as novelties and specialty products such as Christmas-tree ornaments. Continuous-molding equipment is used in the manufacture of electric-light bulbs at a rate of 400 to 500 per minute.

At the Corning plant, samples of the products from all the varied activities of this organization were seen. The production of hand-blown as well as machine-pressed, Pyrex cooking utensils was inspected. A number of automatic and semi-automatic machines are used in the production of a variety of glass articles. An automatic process used in the manufacture and sorting for gauge of various sizes of



E. W. ENGSTROM

*E. W. Engstrom (A'25-M'38-F'40), has been appointed manager of all the research activities of the RCA manufacturing Company.*

*Mr. Engstrom was born in 1901 in Minneapolis, Minnesota. He was graduated from the University of Minnesota in 1923, and went to work for the General Electric Company in Schenectady. He joined the RCA Manufacturing Company in 1930 as an engineer in the Photophone division and was later appointed director of general research. His new position makes him responsible for all research activities of the company.*

glass tubing attracted considerable attention.

September 21, 1940, C. R. Smith, chairman, presiding.

B. J. Thompson, associate director of the research laboratories of the RCA Manufacturing Company, presented a paper on "More Work for the Electron." It concerned the recent developments in the field of electronics.

New ultra-high-frequency relay stations operating at about 500 megacycles are being substituted for wire lines for the commercial transmission of messages. The stations are automatic in operation and located within the "line of sight" of each other. A large number of code and telephone messages may be transmitted simultaneously.

The development of television pickup tubes and the problems of increasing sensitivity and picture definition were discussed. Various tubes developed for this purpose were described.

Tubes for the reproduction of television images were then considered and new developments in the field outlined. The Scopphony television system which utilizes mechanical-optical methods was described.

The operating principles, design, and constructional features of the electron microscope were then covered. Voltages as high as 80 kilovolts which must be kept constant to within one part in 60,000 are required. Magnification of 25,000 diameters is readily obtained and as high as 100,000 diameters is possible.

October 24, 1940, C. R. Smith, chairman, presiding.

"Fluorescent Materials" by B. S. Ellefson, and "Fluorescent Lighting" by W. P. Lowell, Jr., both of the Hygrade Sylvania Corporation, were the subjects of papers presented before a joint meeting of the Emporium section and the Erie section of the American Institute of Electrical Engineers, in Ridgway, Pennsylvania.

Dr. Ellefson described the principles involved in producing light of various colors by activating fluorescent materials with ultraviolet radiation. The graphs used in the lecture were prepared with fluorescent materials and were illuminated with ultraviolet light.

Mr. Lowell's talk covered fluorescent lamps and auxiliaries for their operation. Various types of lamps and reflectors were described. The lamps are rated at 10 watts per foot of length and are much more efficient than tungsten lamps of similar ratings.

The effect of the color of light in falsifying the color value of objects being examined was demonstrated. Fluorescent lamps provide a method of simulating closely the color of daylight.

October 26, 1940, I. C. Smith, of the American Institute of Electrical Engineers, presiding.

## Montreal

H. W. Parker, chief engineer of Rogers Radio Tubes, presented a paper on "The Time Factor in Radio Design."

April 10, 1940, A. B. Oxley, chairman, presiding.

"Recent Improvements in Sound Recording for Motion Pictures" was the subject of a paper by G. T. Lorange, of Electrical Research Products. Among the factors which were considered were the signal-to-noise ratio, fine-grain film, pre- and postequalization, and the use of directional microphones.

April 24, 1940, A. B. Oxley, chairman, presiding.

At the annual meeting of the Montreal section the following officers were elected: Chairman, H. M. Smith of the Canadian Broadcasting Corporation; Vice Chairman, R. E. Hammond of the Northern Electric Company; and Secretary-Treasurer, W. A. Nichols of the Canadian Broadcasting Corporation.

May 29, 1940, A. B. Oxley, chairman, presiding.

E. A. Laport, in charge of transmitter and special products design, for the RCA Victor Company (Montreal), presented a paper on "Recent Development in Radio Aids for Instrument Flying on Civil Airways."

The development of a four-course low-frequency radio range with high-frequency "cone-of-silence" marker and fan markers was first described. The advantages of ultra-high frequencies over low frequencies were discussed. A description was given of a two-course ultra-high-frequency range. The instrument landing system used in Indianapolis was then considered.

In the discussion of the paper, Mr. Knox of the Department of Transport



outlined his experiences with blind-landing systems. The early history of the work done by the National Bureau of Standards was described and the relative merits of various systems now in use were discussed.

October 16, 1940, H. M. Smith, chairman, presiding.

## Philadelphia

R. F. Guy and R. M. Morris, of the National Broadcasting Company, presented a paper and demonstration on "NBC's Field Tests of Frequency Modulation."

Mr. Guy covered the theory, the method of making the tests, and the results. Mr. Morris demonstrated various effects met in a frequency-modulated-wave system by means of records. The demonstration included the noise threshold effect, the operation of shared-channel stations with various power ratios, and the reception at various distances under varying conditions.

Comparison was made between amplitude modulation and frequency modulation with various frequency deviations. The relative performance of the two systems was described and the reasons for the differences were analyzed. It was shown that a deviation of 15 kilocycles, frequency modulation, has an advantage of about 12 decibels in the matter of noise suppression. With a deviation of 75 kilocycles, the advantage is about 26 decibels.

Various aspects of standard broadcasting and the use of frequency-modulated waves for such purposes were considered in detail, with particular reference to their limitations and possibilities for providing public service.

October 3, 1940, C. M. Burrill, chairman, presiding.

## Pittsburgh

"Application of Recent Developments to 1941 Radio Receivers" was the subject of a paper by J. G. O'Shea, service manager for the Midwest Radio Corporation. It considered the improvements appearing in recently announced models of home radio receivers and phonographs. The status of television standards and frequency modulation were reviewed.

Dr. Buhl of the Mellon Institute, outlined advances which have been made in high-permeability core materials for use in radio- and intermediate-frequency transformers.

October 14, 1940, R. E. Stark, chairman, presiding.

## Portland

H. H. Scott, engineer for the General Radio Company, presented his paper on "Measurements of Noise and Vibration" which is summarized in the report of the Cincinnati section in this issue.

September 19, 1940, Marcus O'Day, chairman, presiding.

A paper "Modern Practice in Aviation Radio" was presented by C. E. Belinger,

communication engineer for the Northwest Airlines.

November 4, 1940, Marcus O'Day, chairman, presiding.

## San Francisco

"Square Waves and Square-Wave Testing" was the subject of a paper by David Packard and W. R. Hewlett of the Hewlett-Packard Company.

In testing equipment by the use of square waves, a deficiency in the low-frequency response is indicated by a sloping top of the square wave. High-frequency deficiencies affect the vertical front of the wave.

The application of square waves to the testing of audio-frequency amplifiers, attenuators, and pads was discussed. A rapid means of comparing amplifiers under production conditions was suggested. An amplifier considered to be standard is connected to one pair of plates of an oscilloscope and the amplifier under test to the second pair. The figure appearing on the screen of the oscilloscope indicates the degree of similarity of the characteristics of the two amplifiers.

Square waves may be generated by the use of a multivibrator circuit, thyatron tubes, and sine-wave generators and clipping tubes. In the latter type, the necessity of handling high voltages may be eliminated by interspersing clipping stages with the gain stages and not leaving the clipping to the final operation.

September 18, 1940, Carl Penther, chairman, presiding.

This was a seminar meeting at which the paper on a "Phase-Shifting Device for the Determination of Amplifier Characteristics" by Karl Spangenberg and Winslow Palmer was discussed. Dr. Spangenberg led the review and discussion of it.

The authors of the paper were awarded a prize of \$10 by the section for the best paper published in the PROCEEDINGS by a member of the San Francisco section.

A sound motion picture entitled "Copper from Mine to Market" was presented by the Phelps Dodge Copper Products and illustrated the manufacture of wire, coils, cables, tubing, and similar products.

October 2, 1940, Carl Penther, chairman, presiding.

"Television-Receiver-Test Procedure" was the subject of a paper by C. F. Wolcott, chief television engineer for Gilfillan Brothers.

The methods of measuring the characteristics of television receivers were described. The design of oscillators to avoid large frequency shifts with changes in temperatures was then considered. The design of band-pass networks was discussed. Another subject considered was the method of stripping and obtaining synchronizing pulses from the video-frequency signal. The paper was closed with a brief discussion of the methods used for the transmission and reception of television images in color.

October 18, 1940, Carl Penther, chairman, presiding.

## Seattle

"An Introduction to the Federal Communications Commission" was given by L. C. Herndon, who is inspector in charge of the fourteenth district of the Federal Communications Commission.

It was pointed out that a transmitter and receiver did not guarantee successful radio communication unless there is suitable co-ordination and freedom from interference. Regulations are required to bring about co-ordination and to minimize interference.

The early history of marine-radio communication was given. The first approved radio legislature in the United States became law in 1910. It was superseded by the Radio Act of 1912 which, as a result of the sinking of the *Titanic*, required the carrying of more than one operator on a passenger vessel and the equipping of freighters for radio communication. During the next 14 years the orderly growth of radio regulation in the United States was retarded by the World War and by adverse court decisions concerning the 1912 law.

The Federal Radio Commission was established in 1927 and in 1934 the present Federal Communications Commission came into existence. It united under one head the regulation of all forms of electrical communication. Its regulations control about 65,000 transmitters of which about 54,000 are of amateur status.

May 24, 1940, R. M. Walker, chairman, presiding.

The paper "Measurements of Noise and Vibration" by H. H. Scott, of the General Radio Company, which is summarized in the report of the Cincinnati Section, was presented at this meeting.

September 20, 1940, R. M. Walker, chairman, presiding.

"Building the World's Farthest-North Broadcast Station" was described by J. W. Wallace, chief engineer of the Puget Sound Broadcasting Company.

Radio plays an important rôle in Alaska where wire facilities are rare. KFAR, located in the center of Alaska at Fairbanks, offered many problems in its construction. Concrete is more valuable than gold ore and temperatures drop as low as 50 to 60 degrees below zero.

Although erected thousands of miles from radio-supply centers, the station has a 300-foot vertical antenna and uses dual diversity reception for picking up international broadcasts for retransmission.

The service range seems limited only by the absolute sensitivity of the receiver. Consistent daytime service over 300 or 400 miles is obtained as is a nighttime range of 1000 miles. Frequency of transmission is 610 kilocycles and 1000 watts of power are used.

The presentation was closed with the showing of several reels of colored motion pictures depicting scenes at the station and of its operation.

October 7, 1940, R. M. Walker, chairman, presiding.

## Washington

W. D. George, of the radio section of the National Bureau of Standards presented a paper on "Standard Frequency Broadcasts of the National Bureau of Standards."

These broadcasts provide standards for time intervals, audio frequencies, and radio frequencies. The transmitters operate on 5 megacycles and harmonics of this frequency up to and including 20 megacycles, with a power output ranging from 15 to 30 kilowatts. Since the service was first inaugurated, the accuracy of the standards has been steadily increasing and is now better than one part in 10 million.

The second paper on "Application of Ionospheric Data to Practical Radio Problems" was presented by N. Smith of the radio section of the National Bureau of Standards. Methods of measuring the height of the ionosphere and the apparatus employed in these measurements were described. The relation between oblique and vertical transmission, the effects of ionospheric irregularities, and the prediction of optimum frequencies for radio communication were considered.

December 9, 1940, L. C. Young, chairman, presiding.

"Problems Involved in Designing and Building Radio Transmitting Equipment from the Mechanical Engineering Standpoint" were discussed by E. A. Leach, chief of radio in the mechanical design section of the radio engineering division of the General Electric Company.

There was discussed first the administrative procedure followed in contacting a customer, determining his needs, preparing bids and specifications, and producing the equipment.

The characteristics of various installation materials such as steatite, mycalex, phenolics, mica, glass, and rubber were discussed in detail with particular reference to the relationship between corona effects and the flashover voltages encountered at radio frequencies in comparison to commercial frequencies. The characteristics of various metals used in radio transmitting equipment were then outlined. Materials such as beryllium-copper, tertiary alloy, and various aluminum alloys were considered.

A number of specimens of radio transmitting component parts were available for inspection.

October 14, 1940, L. C. Young, chairman, presiding.

## Membership

The following indicated admissions to membership have been approved by the Admissions Committee. Objections to any of these should reach the Institute office by not later than December 31, 1940.

## Admission to Associate (A), and Student (S).

- Andrews, B. A., (A) 16 S. Sixth St., Kansas City, Kan.  
 Barritt N. F., (A) U. S. Communication Station Municipal Airport, Dallas, Tex.  
 Bender, J. D., (S) 500 Sunset, Manhattan, Kan.  
 Bird, L. T., (A) 318 Monmouth Ave., Mount Royal, Que., Canada  
 Buck, I. E., Jr., (A) 420 N. Broad St., Emporium, Pa.  
 Cox, E. R., (A) 4045 Hanover St., Dallas, Tex.  
 Ferguson, C. M., (S) 113 Hiester St., State College, Pa.  
 Fraser, C. H., (A) 3957 First St., S.W., Washington, D. C.  
 Goveia, J. R., (A) 5 N. Main St., North Easton, Mass.  
 Hieronymus, T. G., (A) 417 E. 70th Terr., Kansas City, Mo.  
 Jones, L. C., (A) 125 Valley Rd., Kenley, Surrey, England  
 Jones, R. E., (A) 1645 Hennepin Ave., Minneapolis, Minn.  
 Kelley, R. W., (A) 1903 Broad St., Hartford, Conn.  
 Loughlin, B. D., (A) 52 New St., East Orange, N. J.  
 McNally, H. R., Jr., (A) 300 Allegheny Ave., Towson, Md.  
 Ohtani, Y., (S) c/o Mr. Narita, 217 Hara-juku 3-tyome, Shibuya-ku, Tokyo, Japan  
 Rao, M. K., (A) c/o Dr. N. Alahasingari, Maharanipetta, Vizagapatam, South India  
 Reash, C. W., (A) Box 11, Emporium, Pa.  
 Redcay, P. W., (A) 401 Spring St., Reading, Pa.  
 Rogoff, M. D., (S) 1102 Peoples Ave., Troy, N. Y.  
 Romano, B. A., (S) 408 E. Main St. Lancaster, Ohio  
 Shaw, C. E., (S) College Rd., Bryan, Tex.  
 Simpson, O. D., (A) Broadcast Station KWTO, Springfield, Mo.  
 Sullivan, P. H., (A) 140-30 Beech Ave., Flushing, L. I., N. Y.  
 Tarantino, V. D., (S) 3679 19th St., San Francisco, Calif.  
 Tyson, F. C., (A) 16 Rosemont St., Springfield, Mass.  
 Winkle, L., (S) Memorial Dormitory, Cincinnati, Ohio  
 Wrye, W. F., Jr., (S) Radio Station WSB, Biltmore Hotel, Atlanta, Ga.

## Books

### Television, The Electronics of Image Transmission, by V. K. Zworykin and G. A. Morton.

Published by John Wiley and Sons, Inc., 440 Fourth Ave., New York, N. Y.

646 pages, XI, 494 illustrations. 6 $\frac{1}{4}$ ×9 $\frac{1}{4}$  inches. Price, \$6.00.

It is with gratification that scientists in the fields of electronics, physics, and communications welcome a book such as this because it will serve as a cornerstone in building the needed structure of technical American literature on television. And even the engineering student (who, reading for pleasure, can skip the mathematics) will profit from this volume.

The authors, well known in their RCA Electronics Research Laboratory connections, have pioneered in the invention and development of the electronic devices that have made television what it is today. Readers interested in obtaining knowledge of these things can do no better than learn of them at first hand from the originators—especially when they tell the results of their researches so simply, clearly, and comprehensively.

Looking deeper we find this book covers much more territory than this. Being the first integrated book on television from RCA it reports the findings of more than one hundred television specialists working in various groups of an organization which has spent over one and a half millions of dollars to find, among other things, the answers to the problems discussed in the pages of "Television." Without giving away trade secrets, helpful, practical answers to questions arising in various parts of the television system are discussed. Also the procedure in constructing camera and picture tubes is detailed—not, of course, to the extent found in a laboratory manual.

"Television" serves also the useful purpose of an historical milestone in the progress of the art. It covers the past ten years, the most active years of RCA research in radiovision. For reference purposes there is definite value in collecting worth-while technical papers in book form, especially where their contents has been as deftly edited and knit together as has been done by Zworykin and Morton.

Now as to the contents, Part One relates to fundamental physical principles: Emission of Electrons from Solids, Fluorescent Materials, Electron Optics, and Vacuum Practice. Part Two: Picture Transmission, Reproduction of High-Definition Pictures, Video Pickup Devices, and Picture Reproducing Systems. Part Three: Iconoscope, Kinescope, the Electron Gun, Video Amplifiers, Scanning and Synchronizing, Television Transmitter, and Receiver, Part Four: RCA Television Project, Empire State Transmitter, and Conclusion.

Detailed discussion of individual topics is not feasible. The illustrations are very clear and very numerous. The highlight of the book to me is the chapter on the iconoscope. This is a volume to which television engineers will refer often during the next ten years, but we hope we shall not have to wait that long for the next volume by these authors.

ALBERT F. MURRAY  
 Haddonfield, N. J.

## Committee Personnel—1940

### ADMISSIONS COMMITTEE

A. F. Van Dyck, *Chairman*

F. J. Bingley	C. M. Jansky, Jr.
Ralph Bown	I. J. Kaar
J. E. Brown	H. B. Marvin
A. B. Chamberlain	H. B. Richmond
F. W. Cunningham	J. S. Smith
R. A. Hackbusch	F. E. Terman
C. W. Horn	H. M. Turner
	R. M. Wise

### AWARDS COMMITTEE

H. M. Turner, *Chairman*

W. R. G. Baker	R. H. Manson
B. de F. Bayly	H. B. Marvin
Ralph Bown	Haraden Pratt
J. E. Brown	F. E. Terman
Virgil M. Graham	A. F. Van Dyck

### BOARD OF EDITORS

Alfred N. Goldsmith, *Chairman*

R. R. Batcher	B. E. Shackelford
P. S. Carter	K. S. Van Dyke
E. W. Engstrom	H. A. Wheeler
F. W. Grover	L. P. Wheeler
J. W. Horton	L. E. Whittemore
G. W. Pickard	William Wilson

### CONSTITUTION AND LAWS COMMITTEE

H. M. Turner, *Chairman*

Austin Bailey	C. E. Scholz
Ralph Bown	B. J. Thompson
Alfred N. Goldsmith	J. W. Wright
Virgil M. Graham	H. R. Zeamans

### CONVENTION POLICIES COMMITTEE

H. P. Westman, *Chairman*

Ralph Bown	Alfred N. Goldsmith
F. W. Cunningham	L. C. F. Horle
	C. M. Jansky, Jr.

### MEMBERSHIP COMMITTEE

E. D. Cook, *Chairman*

Adolph Andersen	P. K. McElroy
G. J. Andrews	W. A. Nichols
O. L. Angevine, Jr.	L. G. Pacent
Nathaniel Bishop	J. R. Poppele
E. L. Bowles	H. L. Ratchford
D. W. Bowman	F. X. Rettenmeyer
W. W. Brown	C. R. Rowe
L. B. Cochran	Bernard Salzberg
I. S. Coggeshall	P. C. Sandretto
F. W. Cunningham	Earl Schoenfeld
H. F. Dart	C. E. Scholz
E. T. Dickey	W. L. Schwesinger
Leroy Fiedler	L. C. Simmonds
B. V. K. French	J. E. Smith
Paul Frincke	W. M. Smith
H. C. Gawler	R. L. Snyder
G. J. Gross	F. E. Terman
J. N. A. Hawkins	H. J. Vennes
R. M. Heintz	E. M. Webster
H. E. Held	J. D. Woodward
M. G. Jarrett	J. S. Webb

### NEW YORK PROGRAM COMMITTEE

A. B. Chamberlain, *Chairman*

H. A. Affel	D. E. Harnett
Austin Bailey	Keith Henney
R. R. Beal	D. D. Israel
I. S. Coggeshall	Wallace James
G. C. Connor	J. R. Poppele
W. M. Goodall	G. T. Royden
	A. F. Van Dyck

### NOMINATIONS COMMITTEE

Alfred N. Goldsmith, *Chairman*

E. H. Armstrong	C. M. Jansky, Jr.
Ralph Bown	R. H. Manson
Virgil M. Graham	H. B. Richmond
	W. C. White

### PAPERS COMMITTEE

William Wilson, *Chairman*

F. B. Llewellyn, *Vice Chairman*

H. A. Affel	D. K. Martin
Edmond Bruce	H. B. Marvin
H. A. Chinn	H. R. Mimno
J. K. Clapp	A. F. Murray
T. A. M. Craven	H. O. Peterson
R. B. Dome	R. K. Potter
P. O. Farnham	H. M. Turner
E. B. Ferrell	Dayton Ulrey
E. L. Hall	A. F. Van Dyck
D. D. Israel	P. T. Weeks
L. F. Jones	W. C. White
	Irving Wolff

### SPECIAL PAPERS COMMITTEE

B. E. Schackelford, *Chairman*

Alfred N. Goldsmith H. A. Wheeler

### PREPAREDNESS COMMITTEE

Haraden Pratt, *Chairman*

W. R. G. Baker	C. B. Jolliffe
D. G. Fink	H. B. Richmond
R. A. Heising	H. M. Turner
C. M. Jansky, Jr.	Lincoln Walsh

### PUBLIC RELATIONS COMMITTEE

Virgil M. Graham, *Chairman*

J. E. Brown	D. D. Israel
E. W. Engstrom	H. C. L. Johnson
D. G. Fink	I. J. Kaar
G. W. Gilman	R. H. Manson
George Grammer	A. F. Van Dyck
R. A. Hackbusch	Lincoln Walsh
O. B. Hanson	H. A. Wheeler

### REGISTRATION OF ENGINEERS COMMITTEE

H. B. Richmond, *Chairman*

L. M. Hull	R. H. Langley
J. K. Johnson	E. L. Nelson
	A. F. Van Dyck

### SECTIONS COMMITTEE

J. H. Miller, *Chairman*

V. J. Andrew	Virgil M. Graham
I. S. Coggeshall	R. M. Heintz
E. D. Cook	C. E. Scholz

### TELLERS COMMITTEE

H. W. Houck, *Chairman*

Austin Bailey	E. W. Schafer
F. R. Lack	H. M. Turner
I. G. Maloff	Lincoln Walsh

### TECHNICAL COMMITTEES

#### ANNUAL REVIEW COMMITTEE

L. E. Whittemore, *Chairman*

J. L. Callahan	I. J. Kaar
J. H. Dellinger	H. S. Knowles
D. E. Foster	E. G. Ports
Keith Henney	P. T. Weeks
	H. A. Wheeler

#### ELECTROACOUSTICS COMMITTEE

H. S. Knowles, *Chairman*

L. B. Blaylock	G. G. Muller
R. P. Glover	George Nixon
V. N. James	Benjamin Olney
Knox McIlwain	H. F. Olson
	L. J. Sivian

#### ELECTRONICS COMMITTEE

P. T. Weeks, *Chairman*

L. B. Blaylock	F. R. Lack
R. S. Burnap	F. B. Llewellyn
H. H. Buttner	G. F. Metcalf
E. L. Chaffee	A. F. Murray
H. P. Corwith	L. S. Nergaard
K. C. DeWalt	G. D. O'Neill
W. G. Dow	H. W. Parker
R. L. Freeman	Balth. van der Po
Ben Kievit, Jr.	J. R. Wilson

#### FACSIMILE COMMITTEE

J. L. Callahan, *Chairman*

J. C. Barnes	C. E. Kilgour
W. A. R. Brown	H. C. Knutson
G. V. Dilenbeck, Jr.	George Lewis
E. S. Fergusson	R. E. Mathes
W. G. H. Finch	P. Mertz
John Hancock	J. W. Milnor
J. V. L. Hogan	J. R. Poppele
	C. J. Young

#### FREQUENCY MODULATION COMMITTEE

D. E. Noble, *Chairman*

E. H. Armstrong	G. W. Gilman
J. E. Brown	C. M. Jansky, Jr.
A. B. Chamberlain	C. B. Jolliffe
C. C. Chambers	H. B. Marvin
W. F. Cotter	D. B. Smith
Murray Crosby	L. P. Wheeler

#### PIEZOELECTRIC CRYSTALS COMMITTEE

K. S. Van Dyke, *Chairman*

W. L. Bond	C. B. Jolliffe
J. K. Clapp	W. P. Mason

## RADIO RECEIVERS COMMITTEE

D. E. Foster, *Chairman*

M. W. Angus	Virgil M. Graham
E. H. Armstrong	David Grimes
L. B. Blaylock	D. E. Harnett
R. I. Cole	R. S. Holmes
W. F. Cotter	D. D. Israel
L. F. Curtis	J. O. Mesa
Harry Diamond	H. O. Peterson
E. T. Dickey	N. F. Shofstall
W. L. Dunn	A. E. Thiessen
H. B. Fischer	H. J. Tyzzer
C. J. Franks	Lincoln Walsh
R. M. Wilmotte	

## STANDARDS COMMITTEE

H. A. Wheeler, *Chairman*

W. R. G. Baker	R. M. Morris
W. L. Barrow	D. E. Noble
J. L. Callahan	E. G. Ports
J. H. Dellinger	F. E. Terman
D. E. Foster	A. E. Thiessen
Virgil M. Graham	H. M. Turner
I. J. Kaar	H. J. Vennes
H. S. Knowles	P. T. Weeks
William Wilson	

## SYMBOLS COMMITTEE

H. M. Turner, *Chairman*

R. R. Batcher	J. N. Golten
M. R. Briggs	H. S. Knowles
R. S. Burnap	O. T. Laube
C. R. Burrows	George Lewis
J. L. Callahan	F. B. Llewellyn
E. L. Chaffee	H. W. Parker
J. H. Dellinger	E. W. Schafer
E. T. Dickey	L. J. Sivian

## TELEVISION COMMITTEE

I. J. Kaar, *Chairman*

H. S. Baird	T. T. Goldsmith, Jr.
R. R. Batcher	A. G. Jensen
J. E. Brown	L. M. Leeds
A. B. DuMont	George Lewis
E. W. Engstrom	H. M. Lewis
P. T. Farnsworth	A. V. Loughren
D. E. Foster	A. F. Murray
G. W. Fyler	R. E. Shelby
P. C. Goldmark	D. B. Sinclair

## TRANSMITTERS AND ANTENNAS COMMITTEE

E. G. Ports, *Chairman*

Raymond Asserson	W. E. Jackson
L. B. Blaylock	W. B. Lodge
M. R. Briggs	J. F. Morrison
W. W. Brown	R. E. Poole
Harry Diamond	D. S. Rau
F. A. Gunther	J. C. Schelleng
Raymond Guy	P. E. Watson
J. E. Young	

## WAVE PROPAGATION COMMITTEE

J. H. Dellinger, *Chairman*

N. I. Adams	G. D. Gillett
S. L. Bailey	H. R. Mimno
L. V. Berkner	W. H. Moffat
C. R. Burrows	K. A. Norton
W. A. Fitch	H. O. Peterson
H. P. Thomas	

## Institute Representatives on Other Bodies

A.I.E.E.—Subcommittee on Radio of the Committee on Applications to Marine Work.....	T. E. NIVISON AND J. L. PRESTON
American Documentation Institute.....	C. M. JANSKY, JR.
Committee on Applied Physics.....	WILLIAM WILSON
Council of the American Association for the Advancement of Science.....	J. C. JENSEN
Engineering Index National Committee.....	MELVILLE EASTHAM
Joint Co-ordination Committee on Radio Reception of the N.E.L.A., N.E.M.A., and R.M.A.....	C. E. BRIGHAM
Liaison Committee on Aeronautic Radio Research.....	F. M. RYAN (C. C. SHANGRAW, alternate)
National Advisory Council on Radio in Education, Committee on Engineering Developments.....	LLOYD ESPENSCHIED, ALFRED N. GOLDSMITH, C. W. HORN, L. M. HULL, AND R. H. MARRIOTT
National Television Systems Committee.....	ALFRED N. GOLDSMITH (H. A. WHEELER, alternate)
Panel 4.....	E. G. PORTS
Panel 8.....	KNOX MCILWAIN
New York City Advisory Board on Industrial Education.....	H. P. WESTMAN
Planning Committee, National Conference on Educational Broadcasting, American Council on Education.....	C. M. JANSKY, JR., C. B. JOLLIFFE, AND E. L. NELSON
Radio Broadcasting Committee, American Engineering Council.....	MELVILLE EASTHAM
U.R.S.I. (International Scientific Radio Union) Executive Committee.....	C. M. JANSKY, JR.
U. S. National Committee, Advisers on Electrical Measuring Instruments.....	MELVILLE EASTHAM AND HAROLD OLESEN
U. S. National Committee, Advisers on Symbols.....	L. E. WHITTEMORE AND J. W. HORTON

## AMERICAN STANDARDS ASSOCIATION

Board of Directors.....	HARADEN PRATT
Standards Council.....	ALFRED N. GOLDSMITH (H. P. WESTMAN, alternate)
Board of Examination.....	H. P. WESTMAN
Electrical Standards Committee.....	H. M. TURNER (H. P. WESTMAN, alternate)
Sectional Committee on Acoustical Measurements and Terminology.....	E. D. COOK AND H. F. OLSON
Sectional Committee on Definitions of Electrical Terms.....	HARADEN PRATT
Subcommittee on Vacuum Tubes.....	B. E. SHACKELFORD
Sectional Committee on Electric and Magnetic Magnitudes and Units.....	J. H. DELLINGER
Sectional Committee on Electrical Installations on Shipboard.....	I. F. BYRNES AND V. R. RUSS
Sectional Committee on Electrical Measuring Instruments.....	WILSON AULL
Sectional Committee on Graphical Symbols and Abbreviations for Use on Drawings....	AUSTIN BAILEY (H. P. WESTMAN, alternate)
Subcommittee on Communication Symbols.....	H. M. TURNER
Sectional Committee on Letter Symbols and Abbreviations for Science and Engineering.....	H. M. TURNER
Subcommittee on Letter Symbols for Radio Use.....	H. M. TURNER
Sectional Committee on National Electrical Safety Code, Subcommittee on Article 810, Radio Broadcast Reception Equipment.....	E. T. DICKEY (VIRGIL M. GRAHAM, alternate)
Sectional Committee on Preferred Numbers.....	A. F. VAN DYCK
Sectional Committee on Radio.....	ALFRED N. GOLDSMITH, HARADEN PRATT, AND L. E. WHITTEMORE
Sectional Committee on Radio-Electrical Co-ordination.....	J. V. L. HOGAN, C. M. JANSKY, JR., AND L. E. WHITTEMORE
Sectional Committee on Specifications for Dry Cells and Batteries.....	H. M. TURNER
Sectional Committee on Standards for Drawings and Drafting Room Practices.....	AUSTIN BAILEY
Sectional Committee on Vacuum Tubes for Industrial Purposes.....	B. E. SHACKELFORD

# Contributors



MILLARD W. BALDWIN

Millard W. Baldwin, Jr., (A'40) was born at Port Ewen, New York, on December 20, 1902. He received the E.E. degree from Cornell University in 1925 and the M.A. degree from Columbia University in 1928. Mr. Baldwin has been a member of the technical Staff of Bell Telephone Laboratories since 1925, working in the field of telephotography and television.



G. L. Beers (A'27-M'29) was born at Indiana, Pennsylvania, in 1899. He received the B.S. degree in electrical engineering from Gettysburg College in 1921. He was in the graduate student course and engineering school of Westinghouse from 1921 to 1922; in the radio engineering department of the Westinghouse Electric and Manufacturing Company, in charge of superheterodyne receiver development, from 1922 to 1930; and section engineer in the research department of the RCA Manufacturing Company from 1930 to date.



Adolfo T. Cosentino (A'37-F'40) was born in Buenos Aires, Argentina, on November 18, 1898. In 1929 he organized the radiocommunications section of the



A. T. COSENTINO

General Post Office. He is now the Director of Radiocommunications. Mr. Cosentino is president of the Buenos Aires section of the I. R. E.; a member of the Permanent Argentine Committee of Aeronautics and Meteorology; and secretary of the Organizing Committee of the School of the Air. He has represented the Argentine Administration in ten international conferences connected with radio and telecommunications. Mr. Cosentino is vice-president-elect of the Institute of Radio Engineers.



John Howard Dellinger (F'23) was born on July 3, 1886, at Cleveland, Ohio. He was educated at Western Reserve University from 1903 to 1907, and in 1908 he received the A.B. degree from George Washington University. In 1913 he received the Ph.D. degree from Princeton University and in 1932 the D.Sc. degree from George Washington University. Dr. Dellinger joined the staff of the National Bureau of Standards as physicist in 1907. From 1928 to 1929 he was chief engineer of the Federal Radio Commission; chief of the radio section, research division,



AUSTIN V. EASTMAN

aeronautic branch, Department of Commerce from 1926 to 1934; and chief of radio section, National Bureau of Standards, 1919 to date. Since 1921 he has been the United States representative at numerous international radio and electrical conferences. He was vice president of the Institute of Radio Engineers in 1924 and president in 1925.



Austin V. Eastman (A'23-M'32) was born at Seattle, Washington, on May 16, 1902. He received the B.S. degree in electrical engineering in 1922 and the M.S. degree in 1929 from the University of Washington. From July, 1922, to September, 1924, he was in the employ of the General Electric Company in the radio engineering department. During the last six months of this period he was in charge of carrier-current-control development. In 1924 Mr. Eastman went to the University of Washington as an instructor in charge of communication work, later becoming assistant professor, and now associate professor. He is a member of the American Institute of Electrical Engineers, the Society of the Sigma Xi, and the Society for the Promotion of Engineering Education.



G. L. BEERS



J. H. DELLINGER



C. FRANK MILLER



JOHN F. MORRISON

C. Frank Miller was born on October 19, 1910, at Westminster, Maryland. He received the B. E. degree in electrical engineering from Johns Hopkins University in 1935. From October, 1935, to June, 1938, he was a full-time graduate student in electrical engineering at the Johns Hopkins University. Since leaving the university he has been employed by Price Brothers, Inc., at Frederick, Maryland, and the Western Electric Company, at Baltimore, Maryland.



John F. Morrison (A'29-M'36) was born at Buffalo, New York, on March 14, 1906. From 1923 to 1926 he was associated with the Federal Telephone and Telegraph Company, and during 1927, with the American Telephone and Telegraph Company. Mr. Morrison was vice president and technical director of the Buffalo Broadcasting Corporation from 1927 to 1929. Since 1929 he has been a member of the technical staff of the Bell Telephone



O. H. SCHADE

Laboratories, assigned to the Radio Development and Research Departments.



Otto H. Schade was born on April 27, 1903, at Schmalkalden, Germany. He was graduated from the Reform-Real-Gymnasium, Halle, Germany, in 1922. From 1922 to 1924 he was with the Telephonfabrik A. G. vorm. J. Berliner, Berlin and Düsseldorf; from 1924 to 1925, in charge of the laboratory in the radio manufacturing company "Ratag" in Berlin; from 1926 to 1931, in the engineering department of the Atwater Kent Manufacturing Company; and since 1931 Mr. Schade has been in the research and engineering department of the RCA Manufacturing Company, RCA Radiotron Division.

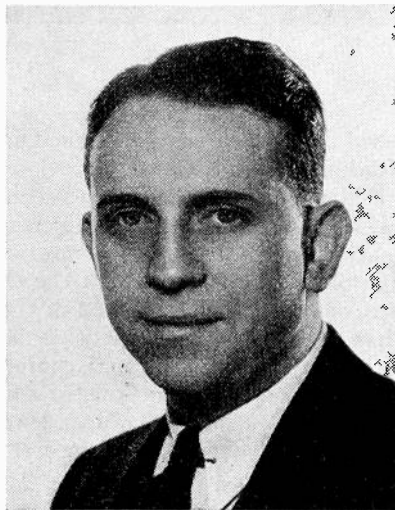

ROBERT E. SHELBY

Robert E. Shelby (A'29-M'36) was born at Austin, Texas, on July 20, 1906. He attended the University of Texas from 1923 to 1929 where he received the B.A. degree in electrical engineering and the M.A. degree in physics. In 1929 he joined the engineering department of the National Broadcasting Company where he has specialized on television, ultra-high frequency, and frequency modulation in the development group. From 1931 to 1935 he was in charge of the experimental television and ultra-high-frequency station in the Empire State Building, and from 1935 to 1939 he was television supervisor. At present Mr. Shelby is television operations engineer for the National Broadcasting Company. He is a member of Tau Beta Pi, Phi Beta Kappa, Eta Kappa Nu, and Sigma Xi.



Arthur H. Waynick was born on November 9, 1906, at Spokane, Washington. He received the B.Sc. degree in physics in 1935 and the M.Sc. degree in 1937 from Wayne University. From 1938



ARTHUR H. WAYNICK

to 1939 he did research work on radio wave propagation at Cavendish Laboratory, Cambridge University, England. During 1940 Mr. Waynick did research work on propagation in the ionosphere at Cruft Laboratory, Harvard University, and at present he is at Wayne University in Detroit.



Everard M. Williams (S'36) was born on February 2, 1915. He received the B.E. degree in 1936 and the Ph.D. degree in 1939 from Yale University. During the summer of 1937 he was employed on the General Electric test course at Schenectady. Since 1939 he has been an instructor in the electrical engineering department of the Pennsylvania State College. He is a member of Sigma Xi and Tau Beta Pi.



For a biographical sketch of Ferdinand Hamburger, Jr., see the Contributors section of the PROCEEDINGS for April, 1940; for L. C. F. Horle, see the Institute Notes section for July, 1940.



EVERARD M. WILLIAMS

**VIEWED FROM**

**ANY ANGLE**

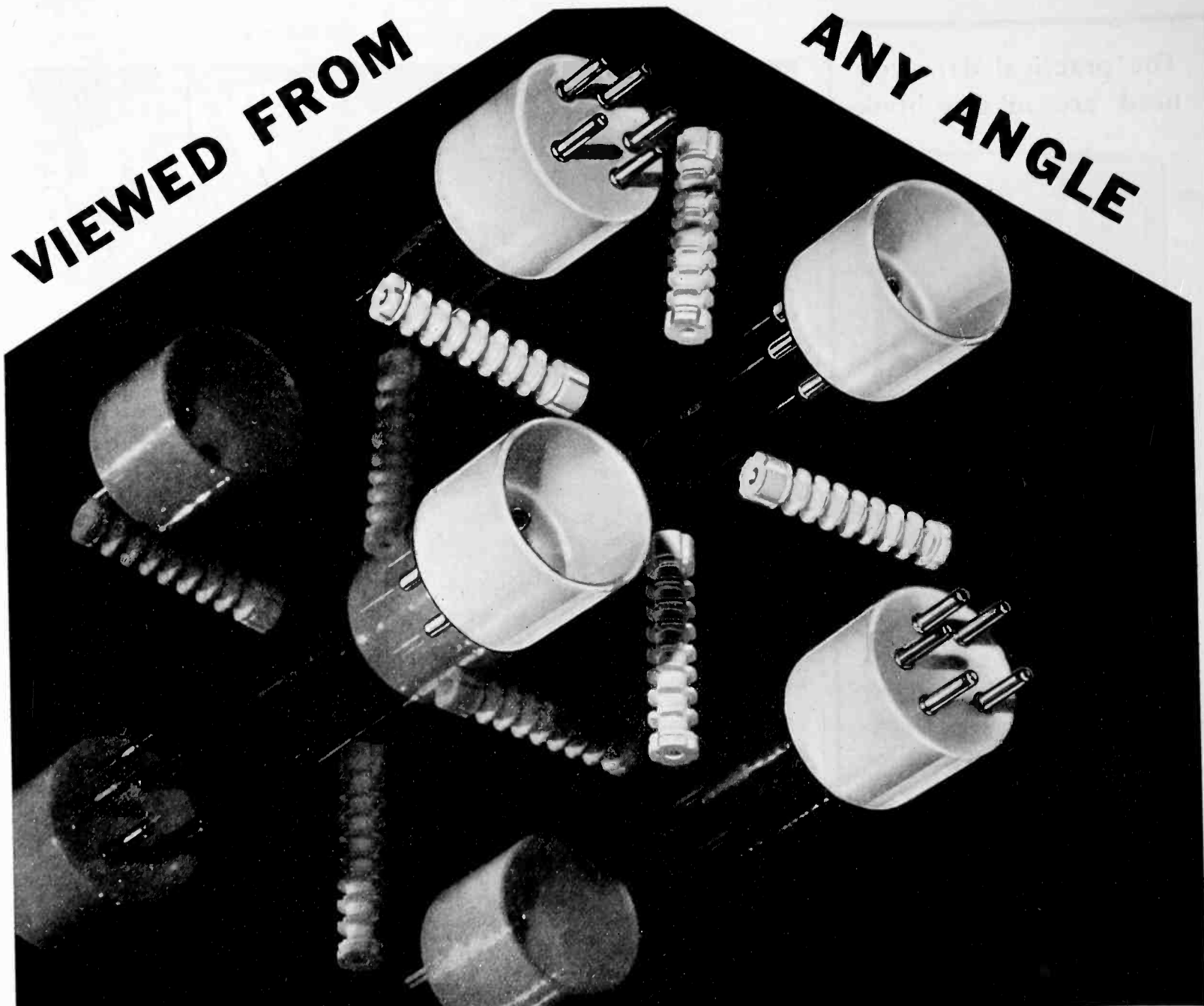

Viewed from any angle, AlSiMag is usually the best answer to any insulation problem.

From the Property Chart (sent on request) you can select the "body" that has the physical characteristics you need. You don't have to guess how these materials will work, their physical properties are well identified.

There is no design problem. AlSiMag pieces are made to your blue print by a staff with 38 years of specialized experi-

ence. This staff will advise on designs, if you wish.

Custom-built steatite ceramic insulators of AlSiMag involve no cost penalty. In most instances you obtain greater efficiency and lower assembled cost than can be obtained by the use of so-called "standard" parts.

Check it from every angle—see if you don't get more from AlSiMag. It takes only a minute to inquire. Your letter will have careful attention.

**ALSiMAG**

Trade Mark Reg. U.S. Pat. Off.

**FROM CERAMIC HEADQUARTERS**

**AMERICAN LAVA CORPORATION • CHATTANOOGA • TENNESSEE**  
CHICAGO • CLEVELAND • NEW YORK • ST. LOUIS • LOS ANGELES • SAN FRANCISCO • BOSTON • PHILADELPHIA • WASHINGTON, D. C.

The practical data you need are in this book

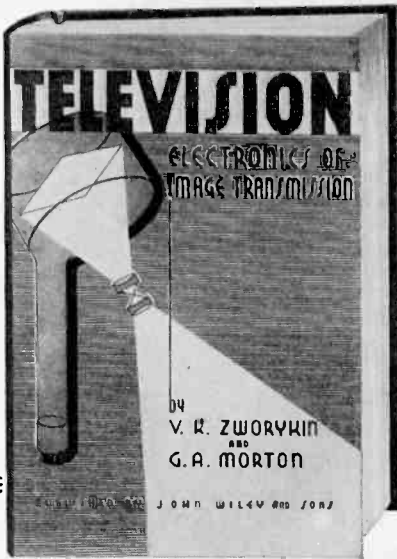

*YOUR book on the important principles of television, written in engineering language by men who know whereof they speak*

ZWORYKIN AND MORTON'S  
**TELEVISION**

Published 1940

Note these features: Fundamental physical principles involved in electronic engineering: electron emission from solids (i.e., photoelectric emission, thermionic emission, secondary emission, shot effect, etc.), electron optics, and fluorescent materials. Analysis of fundamentals of picture transmission and resolution. Various forms of pick-up tubes, viewing tubes and other electronic terminal tubes used in television. Problems of video amplification, radio transmission and reception, etc. The description of a practical television system: the RCA-NBC television project.

"This book is indeed an excellent exposition of the present state of the art and will probably become a classic in its field. . . . I am recommending the text to my friends and associates in the communication industry as the most complete and authoritative treatment of this subject which I have seen."

—PROFESSOR JOHN R. MARTIN,  
Case School of Applied Science

646 pages      6 x 9      \$6.00

ON APPROVAL COUPON

John Wiley & Sons, Inc.  
440 Fourth Avenue, New York, N.Y.

Kindly send me a copy of ZWORYKIN AND MORTON'S "TELEVISION," on ten days' approval. At the end of that time, if I decide to keep it I will remit \$6.00 plus postage; otherwise, I will return the book postpaid.

Name .....

Address .....

City and State .....

Employed by .....

IRE 10-40

NEW Attenuators...at NEW Low Prices

**DAVEN**



- Noise level below microphonics.
- Excellent frequency characteristics.
- Low in price; small in size.
- Complete with dial, knob and shield.
- Now ready for immediate shipment.

**Series LA-800**

Ladder Network

Compact low impedance mixing controls for use in portable broadcast equipment and public address systems, similar in construction to larger and costlier units.

Because of the low price they may readily be adapted as mixer or master gain controls in popular priced systems. Outstanding advantages are: dependability of service, accuracy of control, noiseless operation, and constant impedance over a large part of the operating range.

Price \$5.75

20 Steps

SERIES	DECIBEL PER STEP	Attenuation	
		CHARACTERISTIC	DECIBEL TOTAL
LA-800	2.0	Tapered	Infinite
LA-801	1.5	Linear	Infinite
LA-802	2.0	Linear	Infinite
LA-803	2.0	Linear	40 Db.

**Series CP-800**

High Impedance Potentiometers

These are designed for use as gain controls in portable amplifiers and public address systems. They are rugged, compact, and are readily adaptable to popular priced systems. Long and trouble-free service can be obtained from this type of attenuator, thus eliminating the necessity of periodic replacement of the volume control.

Price \$5.75

20 Steps

SERIES	DECIBEL PER STEP	Attenuation	
		CHARACTERISTIC	DECIBEL TOTAL
CP-800	2.0	Linear	Infinite
CP-802	1.5	Linear	Infinite
CP-803	3.0	Linear	Infinite
CP-804	2.0	Tapered	Infinite



**FIXED ATTENUATOR (Pads)**

Impedances may be secured from 30 to 600 ohms.



"TEE" Network

Type T950 .... \$2.50

Size .... 11/16 x 1 5/8

Overall Height

Balanced

"H" Network

Type H950 .... \$3.00

Size .... 11/16 x 1 5/8

Overall Height

WRITE FOR CATALOG

**THE DAVEN COMPANY**

158 SUMMIT STREET

NEWARK, NEW JERSEY





## The Challenge of Change

Change, with all its problems, offers opportunities as well.

Men in every branch of the great Radio Industry face changes so rapid and drastic that last year's outlook is this year's history.

Through the years, our policy has been directed toward helping men IN the Radio Industry to be better engineers in better jobs . . . by providing modern technical training that equips the ambitious man to keep pace with this surging industry. The fact that there are CREI students and graduates in over 350 broadcasting stations is evidence that our training is worthwhile.

CREI is anxious to assist all sincere Radiomen convert the problems of Change into Opportunities.

May we send you our new illustrated booklet?



This booklet tells in detail the complete outline of our Home Study courses in Practical Radio and Television Engineering. In writing please state briefly your radio experience, education and present position.

**Capitol Radio**  
ENGINEERING INSTITUTE

E. H. RIETZKE, Pres.  
Dept. PR-10  
3224 Sixteenth St., N.W.  
Washington,  
D.C.

## Current Literature

New books of interest to engineers in radio and allied fields—from the publishers' announcements.

A copy of each book marked with an asterisk (\*) has been submitted to the Editors for possible review in a future issue of the Proceedings of the I.R.E.

\* **ELECTRODYNAMICS.** BY LEIGH PAGE, Professor of Mathematical Physics and NORMAN ISLSEY ADAMS, JR., Associate Professor of Physics, Yale University. New York: D. Van Nostrand Company, Inc., 1940. xii+501+4 index pages, illustrated, 6×9 inches, cloth. \$6.50.

\* **FUNDAMENTALS OF ELECTRICITY AND ELECTROMAGNETISM.** BY VERNON A. SUYDAM, Professor of Physics, Beloit College. New York: D. Van Nostrand Company, Inc., 1940. xix+681+8 index pages, illustrated, 5½×8½ inches, cloth. \$4.75.

\* **GETTING ACQUAINTED WITH RADIO.** BY ALFRED MORGAN. New York: D. Appleton-Century Company, July, 1940. x+279+5 index pages, illustrated, 5¼×8 inches, cloth. \$2.50.

\* **INTRODUCTION TO A.I.E.E. STANDARDS: General Principles Upon Which Temperature Limits are Based in the Rating of Electrical Machinery and Apparatus.** New York: American Institute of Electrical Engineers, June, 1940. 19 pages, illustrated, 7¼×10½ inches, paper. 40 cents.

\* **THE MUSICAL EAR.** BY L. L. S. LLOYD, Principal Assistant Secretary to the Department of Scientific and Industrial Research. New York: Oxford University Press, July, 1940. ix+87 pages, illustrated, 5½×8½ inches, cloth. \$1.50.

\* **MATHEMATICS APPLIED TO ELECTRICAL ENGINEERING.** BY A. G. WARREN, Research Department, Woolwich. New York: D. Van Nostrand Company, Inc., 1940. xv+379+5 index pages, illustrated, 5½×8½ inches, cloth. \$4.50.

\* **QUARTZ OSCILLATORS AND THEIR APPLICATIONS.** BY P. VIGOUREUX, formerly of the National Physical Laboratory. New York: The British Library of Information, 1939. vi+128+3 index pages, illustrated. 5½×8½ inches, cloth. \$1.35.

\* **RADIO OPERATING QUESTIONS AND ANSWERS.** BY ARTHUR R. NILSON, Chief Instructor, Nilson Radio School and J. L. HORNUNG, formerly Radio Instructor, New York University. New York: McGraw-Hill Book Company, 1940. ix+392+23 index pages, illustrated, 4¼×7¼ inches, cloth. \$2.50.

\* **RECOMMENDED PRACTISE FOR ELECTRICAL INSTALLATIONS ON SHIPBOARD (1940 Revision).** Prepared by the Committee on Applications to Marine Work. New York: American Institute of Electrical Engineers, July, 1940. 98 pages, 8×10¼ inches, paper. \$1.50.

\* **SAFETY RULES FOR ELECTRIC FENCES: Comprising Part 6 of the Fifth Edition National Electrical Safety Code, National Bureau of Standards Handbook H36.** Washington: Superintendent of Documents, 1940. 18 pages, 5×7½ inches, paper. 5 cents.

\* **STANDARDS FOR MEASUREMENT OF TEST VOLTAGE IN DIELECTRIC TESTS.** New York: American Institute of Electrical Engineers, June, 1940. 23 pages, illustrated, 7¼×10½ inches, paper. 40 cents.

\* **TELEVISION BROADCASTING.** BY LEONOX R. LOHR, President, National Broadcasting Company. New York: McGraw-Hill Book Company, July, 1940. xiv+269+4 index pages, illustrated, 6×9 inches, cloth. \$3.00.

A  
C  
C  
U  
R  
A  
T  
E
Bliley
D  
E  
P  
E  
N  
D  
A  
B  
L  
E

**QUARTZ  
CRYSTALS**

FOR GENERAL COMMUNICATION FREQUENCIES

**BLILEY ELECTRIC COMPANY**

UNION STATION BUILDING ERIE, PA.

Bliley Quartz Crystals and Mountings are precision-made for all frequencies between 20Kc. and 30Mc. Catalogue G-11 describes the complete line. Write for your copy.



*Your General Purpose  
Public Address Projector*

When the new Type "S" Peri-Dynamic Projector was introduced at the June Trade Show, immediate and wide acceptance throughout the public address industry was prophesied. All of these predictions have now materialized with even greater emphasis than was prophesied. High power handling capacity (15 to 25 watts), low cost and outstanding ability to reproduce both speech and music with a crisp clean cut quality fully justifies sustained leadership in this new product. Public address dealers and engineers who are not familiar through experience with this new product will do well to place their orders immediately. A steady increase in factory production permits prompt delivery.

Dealers' price, Type "S" Peri-Dynamic Projector (No. SPH-81) complete with Permanent Magnet Speaker installed, \$31.20 Net (mounting standard extra). Dimensions: 24-inch bell; 30 inches overall length.

*Jensen*

**Jensen**  
4551 SOUTH LARAMIE AVENUE - CHICAGO  
CABLE ADDRESS: JENAD, CHICAGO

# V. U. METERS

by **TRIPLET**

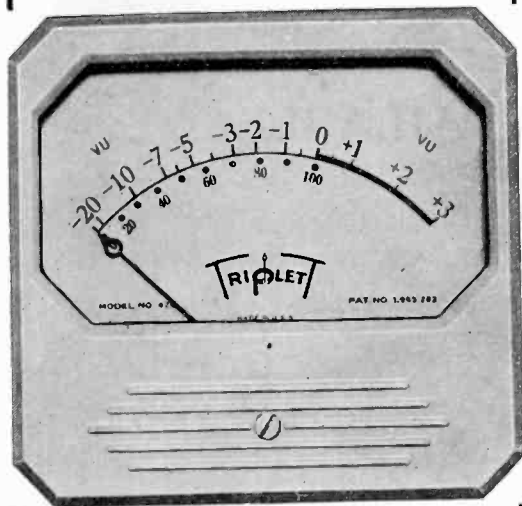

## MODEL 426

### FOUR INCH SQUARE CASE

Volume Unit Meters are for measurement of sound or noise levels including broadcast monitoring use with public address or communication systems, etc. Ballistic characteristics comply with specifications formulated as a result of standardization recommendations of NBC, CBS and Bell Telephone Laboratories. Steady state reference level of 1 Milliwatt. Calibrated for 600 ohm line. Has 0-100% scale and also reads minus 20 V.U. to zero level in black numerals; from zero to plus 3 V.U. in red numerals. Furnished in Model 426 modernistic case. Illuminated or non-illuminated types available.

*Write for complete circular on volume level measuring instruments. Triplet manufactures electrical measuring instruments in more than 25 case styles and a complete line of radio test equipment. Literature on request. Write Section 2110, Harmon Drive.*

**TRIPLET ELECTRICAL INSTRUMENT CO.**  
Bluffton, Ohio

# 96 PAGES OF VALUABLE DATA ON RESISTANCE PROBLEMS

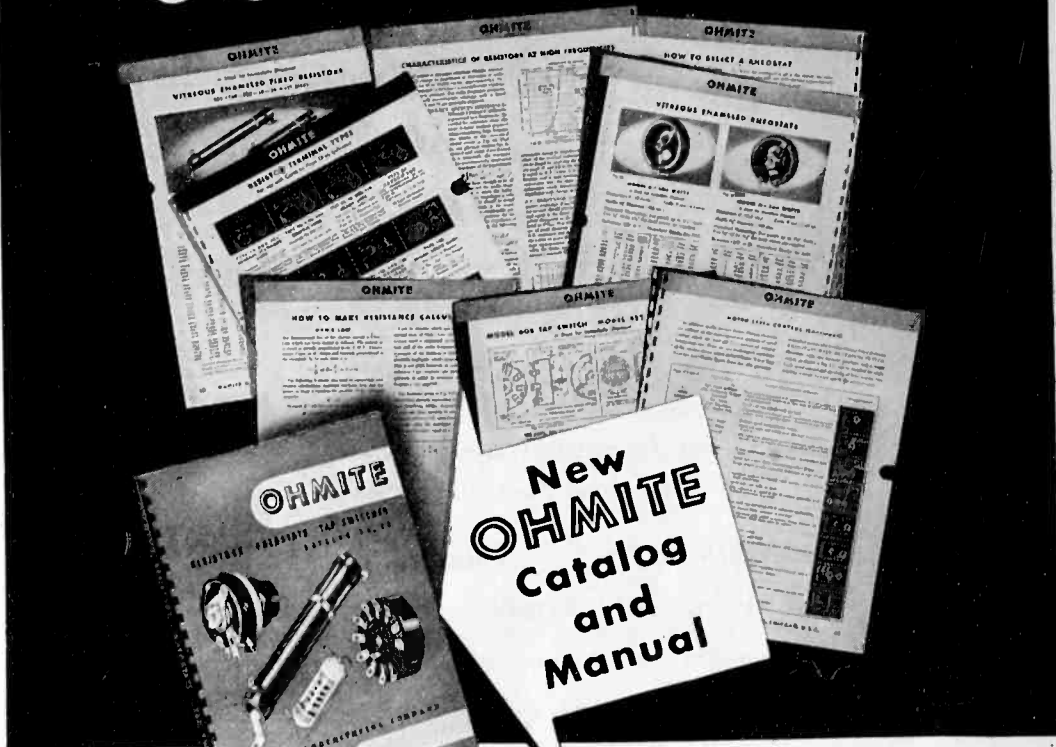

**H**ERE'S a book that really works for you! The new Ohmite Catalog and Engineering Manual No. 40 is a complete handy reference on resistance application problems. It contains useful reference tables, complete dimensional drawings, valuable engineering data and a manual of resistance measurements. It describes the most complete line of stock units and special units for Industrial, R. F., and Precision applications. It tells you how to select the right units for your needs.

Design and Application Engineers! . . . Laboratory Men! . . . Production Managers! . . . Purchasing Departments! . . . You'll find it an invaluable guide on the use of Resistors, Rheostats, Tap Switches, Chokes, and Attenuators in radio and electronic equipment in products, machine tools and special applications—in the control of motor speed, of heat and light, of signal and supervisory circuits—in instrument rooms, maintenance and production—in laboratories and electrical equipment.

You'll want it handy for ready reference—and you can have it without charge. Send for it now. Just clip this coupon to your company letterhead and send it in today.

**OHMITE MANUFACTURING CO.**  
4860 Flournoy St., Chicago, U.S.A.

Please Send Catalog 40.

Company .....

Individual .....

Position .....

Address .....

City ..... State .....

IR-10

*Be Right with* **OHMITE**  
RHEOSTATS • RESISTORS • TAP SWITCHES

---

# COMPLETE YOUR FILES OF

## PROCEEDINGS of The Institute of Radio Engineers

### WHILE BACK ISSUES ARE STILL AVAILABLE

Now is the time to fill out the gaps on your *Proceedings* shelf and replace lost or borrowed copies. Already, more than 25% of all back numbers are no longer available. Order from the following list (subject, of course, to prior sale):

1913-1915	Volumes 1-3	Quarterly	\$1.00 per copy
1913 Vol. 1	Jan. (a reprint).	1915 Vol. 3	Dec.

1916-1926	Volumes 4-14	Bi-monthly	\$1.00 per copy
1916 Vol. 4	June, Aug.	1922 Vol. 10	All 6 issues
1917 Vol. 5	Apr., June, Aug., Oct., Dec.	1923 Vol. 11	All 6 issues
1918 Vol. 6	Feb., Apr., June, Aug., Dec.	1924 Vol. 12	Aug., Oct., Dec.
1919 Vol. 7	Apr., Dec.	1925 Vol. 13	Apr., June, Aug., Oct., Dec.
1920 Vol. 8	Apr., June, Aug., Oct., Dec.	1926 Vol. 14	All 6 issues
1921 Vol. 9	All 6 issues		

1927-1940	Volumes 15-28	Monthly	\$1.00 per copy
1927 Vol. 15	Apr. to July, inc., Oct., Dec.	1934 Vol. 22	All 12 issues
1928 Vol. 16	Feb. to Dec., inc.	1935 Vol. 23	All 12 issues
1929 Vol. 17	Apr. to June, inc., Aug., Dec.	1936 Vol. 24	Jan. to April, inc., June
1930 Vol. 18	Jan., Feb., Apr. to Dec., inc.	1937 Vol. 25	Feb. to Dec., inc.
1931 Vol. 19	All 12 issues	1938 Vol. 26	All 12 issues
1932 Vol. 20	Jan., March to Dec., inc.	1939 Vol. 27	All 12 issues
1933 Vol. 21	All 12 issues.	1940 Vol. 28	Jan. to date

#### I.R.E. MEMBERS . . . PUBLIC AND COLLEGE LIBRARIES

I.R.E. members in good standing are entitled to a discount of 25% from the above prices. Information about discounts to accredited public and college libraries will be supplied on request.

#### POSTAGE

Prices include postage in the United States and Canada. Postage to other countries: 10 cents per copy.

Remittance should accompany your order

**THE INSTITUTE OF RADIO ENGINEERS, Inc.**  
330 WEST 42nd STREET, NEW YORK, N. Y.

# IRE membership offers many services to the radio engineer

**Proceedings**—An outstanding publication in the radio engineering field. Over a quarter of a century of service to the world in publishing important radio engineering discoveries and developments, the PROCEEDINGS presents exhaustive engineering data of use to the specialist and general engineer. A list of its authors is a "Who's Who" of the leaders in radio science, research, and engineering.

**Standards**—Since 1914 our standards reports have stabilized and clarified engineering language, mathematics, graphical presentations, and the testing and rating of equipment. They are always in the process of revision and thus remain up to date.

**Meetings**—In twenty-two cities in the United States and Canada, meetings of the Institute and its sections are held regularly. Scores of papers on practically every branch of the field are presented and discussed. Several convention meetings are sponsored by the Institute and add materially to its effectiveness in distributing data of value to engineers.

## The Institute of Radio Engineers

Incorporated

330 West 42nd Street, New York, N.Y.

To the Board of Directors  
Gentlemen:

I hereby make application for ASSOCIATE membership in the Institute of Radio Engineers on the basis of my training and professional experience given herewith, and refer to the sponsors named below who are personally familiar with my work.

I certify that the statements made in the record of my training and professional experience are correct, and agree if elected, that I shall be governed by the Constitution of the Institute as long as I continue a member. Furthermore I agree to promote the objects of the Institute so far as shall be in my power.

.....  
(Sign with pen)

.....  
(Address for mail)

.....  
(City and State)

.....  
(Date)

### SPONSORS (Signatures not required here)

Mr. ....

Address .....

City and State .....

Mr. ....

Address .....

City and State .....

Mr. ....

Address .....

City and State .....

# Associate membership affiliates you with the Institute and brings you the PROCEEDINGS each month as well as notices of meetings held near you.

(Typewriting preferred in filling in this form) No.....

## RECORD OF TRAINING AND PROFESSIONAL EXPERIENCE

Name .....  
(Give full name, last name first)

Present Occupation .....  
(Title and name of concern)

Business Address .....

Home Address .....

Place of Birth ..... Date of Birth ..... Age .....

Education .....

Degree .....  
(College) (Date received)

### TRAINING AND PROFESSIONAL EXPERIENCE

(Give dates and type of work, including details of present activities)

---

---

---

---

---

---

---

---

---

---

---

---

---

---

---

---

---

---

---

---

---

---

---

---

Record may be continued on other sheets this size if space is insufficient.

Receipt Acknowledged ..... Elected ..... Notified .....

**Requirements**—For Associate membership, an applicant must be at least twenty-one years of age, of good character, and be interested in or connected with the study or application of radio science or the radio arts.

**Sponsors**—Three sponsors who are familiar with the work of the applicant must be named. Preferably these should be Associates, Members, or Fellows of the Institute. In cases where the applicant is so located as not to be known to the required number of member sponsors, the names of responsible nonmember sponsors may be given.

**Dues**—Dues for Associate membership are six dollars per year. The entrance fee for this grade is three dollars and should accompany the application.

**Other Grades**—Those who are between the ages of eighteen and twenty-one may apply for Junior grade. Student membership is available to full-time students in engineering or science courses in colleges granting degrees as a result of four-year courses. Member grade is open to older engineers with several years of experience. Information on these grades may be obtained from the Institute.



For applications where  
**CONTINUITY  
 OF SERVICE**  
 is the prime essential

## Just Plug in . . .

Special octal base designed and made by Aerovox, to fit standard octal socket.

Nickel-plated brass prongs engage with metal socket contacts of similar metal, for low-resistance, corrosion-free connections.

Junction of brass prongs and aluminum studs imbedded in molded bakelite, immune to corrosive effects.

Hi-purity aluminum tabs from electrolytic section bonded to aluminum studs of octal base, for corrosion-free aluminum-to-aluminum joints.

Hermetic sealing achieved by can edge spun over soft-rubber gasket and bakelite cover plug. Vented cover for full protection.

Available with plain foil and with etched foil. Two can sizes for electrolytic type: 1 7/8" and 1 5/32" dia.; 2 1/2" to 4 1/4" high. Single, dual, triple and quadruple section units. 25 to 500 v. D.C.W.

Also in paper section—Oil-impregnated oil-filled, and wax-impregnated wax-filled. Single and multiple sections. .05 to 2 mfd. 200, 400 and 600 v. D.C.W.

Costs are fully in line with usual standard electrolytics and paper units.

● Now available in both electrolytic and paper sections, these AEROVOX PLUG-IN CONDENSERS are rapidly becoming standard equipment for assemblies designed primarily for *continuity of service*. Commercial and Government radio equipment, aircraft and police radio, sound systems, constantly used laboratory and test equipment, electronic devices operated hour after hour and day in and day out—such applications definitely call for these readily removable, tested and replaceable octal-base condensers.

Provable economies can be effected with these unique condensers. There are savings in assembly, since only standard octal sockets need be mounted and wired, while the condensers are plugged in at any time. There are savings in condenser inventories, since condensers are required only at the time of final inspection and shipment, or even at the actual installation. There are economies in having positively fresh electrolytics, particularly for overseas trade. There are economies in simplified servicing and maintenance of equipment in use, particularly in auto-radio sets.

Above all, this latest advance in the condenser art, applied to your assemblies, provides that *new talking point* which your sales force seeks for next season's line.

## Submit Your Problems . . .

● Engineering data on Aerovox Plug-In Condensers cheerfully sent on request. Also samples, specifications, quotations, to responsible parties. Meanwhile, submit your condenser problems for A.A.E. (Aerovox Application Engineering service.)



# AEROVOX CORPORATION

New Bedford, Mass.



Sales Offices in All Principal Cities

# POSITIONS OPEN

The following positions of interest to I.R.E. members have been reported as open on December 15. Make your application in writing and address to the company mentioned or to

Box No. ....

**PROCEEDINGS of the I.R.E., 330 West 42nd Street, New York, N.Y.**

*Please be sure that the envelope carries your name and address*

## RADIO ENGINEER

A manufacturer has an opening for an engineer experienced in circuits and equipment for radio- and power-frequency work. He should be familiar with radio—receiver and transmitter design and theory, and be used to handling laboratory and test equipment. Capacitor experience is desirable. Present staff knows of this opening. Box 227.

## ELECTRICAL ENGINEERS

For transmitter or receiver designing on radio or special apparatus. Opening for U.S. Citizens only. Offering excellent opportunities to men with experience in the design of radio or special electrical apparatus. In reply state experience, education, age, present salary, etc. Box 228.

## ENGINEERS

### Mechanical Designers

Needed by radio manufacturer. Splendid opportunities for men with radio or equivalent experience such as required for designing the mechanical features of speakers, receivers, transmitters or special apparatus. Steady work, large manufacturer located in Eastern part of United States. Write for interview, giving full qualifications. Box 229.

## DEVELOPMENT ENGINEER

A position is open for a development engineer on production instruments and high frequency circuits, capable of doing practical work himself in the construction of instruments and machines for high speed testing of small resistors and condensers after he has originated and designed the instrument himself. He should be an engineering graduate who has specialized in electronic and communications work and must be capable of attacking problems from the production man's point of view. Present staff knows of this opening. Box 230.

## BROADCAST ENGINEER

A consulting engineer requires the services of a field engineer. He should preferably have had broadcast-engineering experience and must be familiar with measuring techniques. Some travel. Present staff knows of this opening. Box 231.

## PATENT ATTORNEY

A patent lawyer in New York with a practice consisting largely of radio, electronic and communications work needs an experienced patent attorney to help conduct a general practice: prepare and prosecute cases before the Patent Office, etc. Box 232.

## ENGINEERS AND TECHNICIANS

The National Research Council of Canada invites applications from British subjects for positions in the radio laboratory, division of physics and electrical engineering.

## ENGINEERS

Qualifications—graduation in honours physics, engineering physics or electrical engineering from a recognized university. Post-graduate training and experience in radio desirable. Experience in the design and operation of radio-frequency equipment. Experience in transmitter design and construction. Mathematical ability in the theoretical type of calculations arising from radio work.

## TECHNICIANS

Qualifications—technical school training or equivalent in radio, practical machine shop training an asset. Ability to construct transmitters or receivers and carry out preliminary tests. For information concerning the form that the application should take, address the Secretary-Treasurer, National Research Council, Ottawa, Ontario, Canada.

## RADIO ENGINEER

A position is open for a good all-around versatile engineer with a B.S. degree in engineering. A young man is preferred; one who has taken advanced studies in communications and who has had from 3 to 5 years of commercial experience of diversified design and development of special receivers, transmitters or precision equipment to meet government specifications. Applicants should be American born and have an agreeable personality, and be able to cooperate well. (This same manufacturer also wants to employ a draftsman, Box 222.) Box 221.

## RADIO DESIGN DRAFTSMAN

An equipment manufacturer wishes to obtain an experienced radio design draftsman who has either an electrical- or a mechanical-engineering degree and 3 to 5 years of commercial experience in drafting and design work on communication equipment. (This same manufacturer wants to employ a radio engineer, Box 221.) Box 222.

## TRANSMITTER ENGINEER

A transmitter engineer is required to assist in the design and construction of low-power, high-frequency transmitter. He should have had a considerable amount of experience, but a college degree is not essential. He must be an American citizen. Present staff knows of this opening. Box 223.

## JUNIOR ENGINEER

An Eastern research and development organization has an opening for an engineering graduate with an aptitude in physics and mathematics. He should have sufficient drafting experience to enable him to prepare graphical presentations of engineering data. Box 224.

## BROADCAST RECEIVER ENGINEER

An experienced engineer is wanted to supervise the design and production of broadcast receivers and phonograph combinations in a small eastern organization. Box 225.

## CONDENSER-DESIGN ENGINEER

A manufacturer of components and special equipment has an opening for an engineer capable of assisting in the design of special variable air condensers. Box 226.

## RADIO AND MECHANICAL ENGINEERS

Engineers with two or more years radio design experience wanted. Apply stating education, experience and salary required. Colonial Radio Corporation, 254 Rano Street, Buffalo, N.Y.

## DISPLAY ADVERTISERS

### A

Aerovox Corporation .....ix  
American Lava Corporation .....i  
American Telephone & Telegraph Company .....xi

### B

Bliley Electric Company .....iii

### C

Capitol Radio Engineering Institute .....iii  
Cornell-Dubilier Electric Corporation .....xii

### D

Daven Company .....ii

### G

General Radio Company .....Cover IV

### J

Jensen Radio Manufacturing Company .....iv

### O

Ohmite Manufacturing Company .....v

### R

RCA Manufacturing Company, Inc. ....Cover III

### T

Triplett Electrical Instrument Company .....v

### W

John Wiley & Sons, Inc. ....ii





**“AT THE LOWEST  
POSSIBLE COST”**

Keeping rates low, in the face of rising costs, has been one of the outstanding achievements of the Bell System.

This would not have been possible without efficiency all along the line, economies resulting from centralized research and manufacture, and a sincere desire to serve the best interests of the public.

**BELL TELEPHONE SYSTEM**



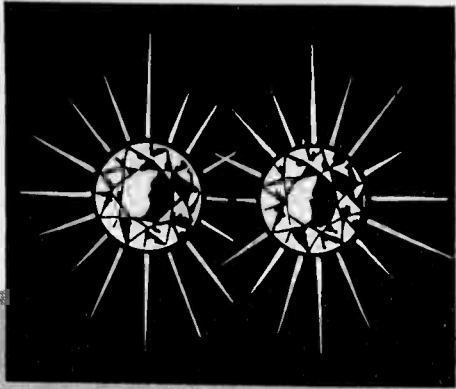

TO YOU these diamonds may look alike. But to the diamond expert, able to see beyond surface similarities, there is a difference in quality. And so it is with capacitors. The things that lie *hidden* are the things that count most in determining value.

# HIDDEN EXTRAS!

*That's the difference...*

AND THAT'S THE REASON FOR THE  
EXTRA PERFORMANCE IN C-D CAPACITORS

**M**OST capacitors look alike. But engineers know there's a big difference in C-Ds. Built into these capacitors are extra quality ... long life ... economy — extra VALUE! Specify Cornell-Dubilier capacitors and enjoy these hidden extras at no extra cost. Learn what a difference thirty years of capacitor specialization can make. Learn why there are more Cornell-Dubilier capacitors in use today than any other make — proof of extra stamina, stability, and surviving soundness in C-Ds.

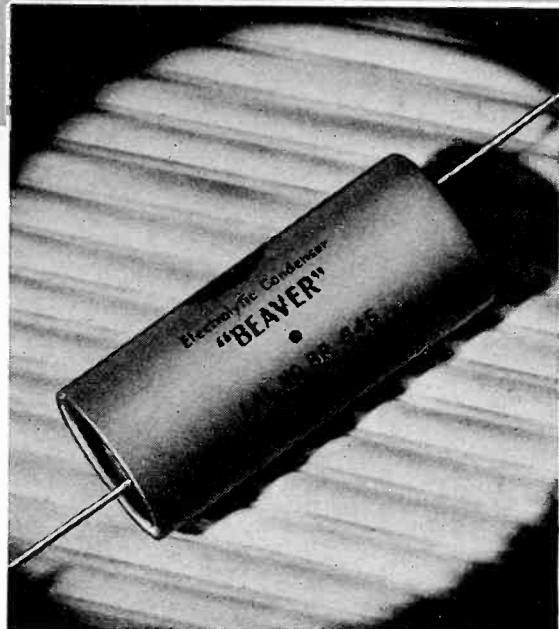

Only Cornell-Dubilier Electrolytics offer all these EXTRA FEATURES!

- Special high voltage paper separator
- C-D etched plate
- Special C-D electrolyte
- Special high formation process



For complete technical information, write for engineering bulletin 170.

**CORNELL-DUBILIER  
ELECTRIC CORPORATION**

1006 HAMILTON BLVD. • SO. PLAINFIELD, N. J.

**REMEMBER!** Only C-D union-made capacitors give you the EXTRAS at no extra cost.

*Get the extras*

— WITH CORNELL-DUBILIER CAPACITORS!

**RATINGS UP..PERFORMANCE IMPROVED..PRICE UNCHANGED**



# RCA - 833 - A

**R-F POWER AMPLIFIER, CLASS B MODULATOR**  
**1.6 KW\* Maximum Power Output at Frequencies up to 20 Mc**

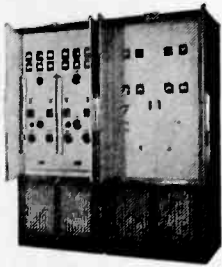

**Chosen for RCA'S  
 Outstanding New AVT-22  
 Communications Transmitter**

A typical example of the capabilities of the RCA-833-A is found in the new, ultra modern RCA AVT-22 General Communications Transmitter. Using two 833-A's in the final class C power amplifier and two 833-A's in the class B modulator, this equipment has a maximum power output of 2½ kw on frequencies of from 2½ to 12 megacycles, and an output of 2 kw from 12 to 19 megacycles. Power output of the AVT-22 can be doubled by using two additional 833-A's, in both the modulator and final stages. The unit, employing a total of eight RCA-833-A's, is then known as the AT-22A.

Measured by every characteristic from long life to power output—or any other factor by which tubes are judged—the RCA-833 has long enjoyed a reputation unexcelled. Now, with the famous RCA Zirconium-coated plate and with other processing refinements, a new, improved form of this type—the RCA-833-A—offers even greater value for r-f amplifier or class B modulator service. The 833-A provides an increased maximum plate dissipation of 450 watts (ICAS) *at no increase in price*. It can be operated in class C telegraph service with a maximum input of 2000 watts, (ICAS) at frequencies as high as 20 megacycles. (Forced air ventilation is required with ICAS ratings.) With CCS ratings, the maximum input is 1800 watts.

Small and compact, the 833-A offers Kilowatts of power in a tube less than 9" in over-all height and 4⅝" in diameter! By employing forced-air cooling, it can

be used to boost power substantially in applications now served by the popular RCA-833. Because of its high perveance, this new tube operates at high plate efficiency with low driving power. The plate, grid and filament are supported by their respective post terminals. This design provides a rugged structure which makes bases unnecessary.

**MAXIMUM RATINGS AS R-F POWER  
 AMPLIFIER — CLASS C TELEGRAPHY**

	Natural Cooling	Forced-air Cooling	
	CCS	CCS	ICAS
D-C Plate Voltage	3000	4000	4000 volts
D-C Plate Current	500	500	500 milliamperes
D-C Grid Current	75	100	100 milliamperes
Plate Input	1250	1800	2000 watts
Plate Dissipation	300	400	450 watts

*List Price \$85.00*

*\*ICAS Ratings for class C telegraph service.*



## Transmitting Tubes

**PROVED IN COMMUNICATIONS' MOST EXACTING APPLICATIONS**

RCA MANUFACTURING COMPANY, INC., CAMDEN, N. J. • A Service of the Radio Corporation of America

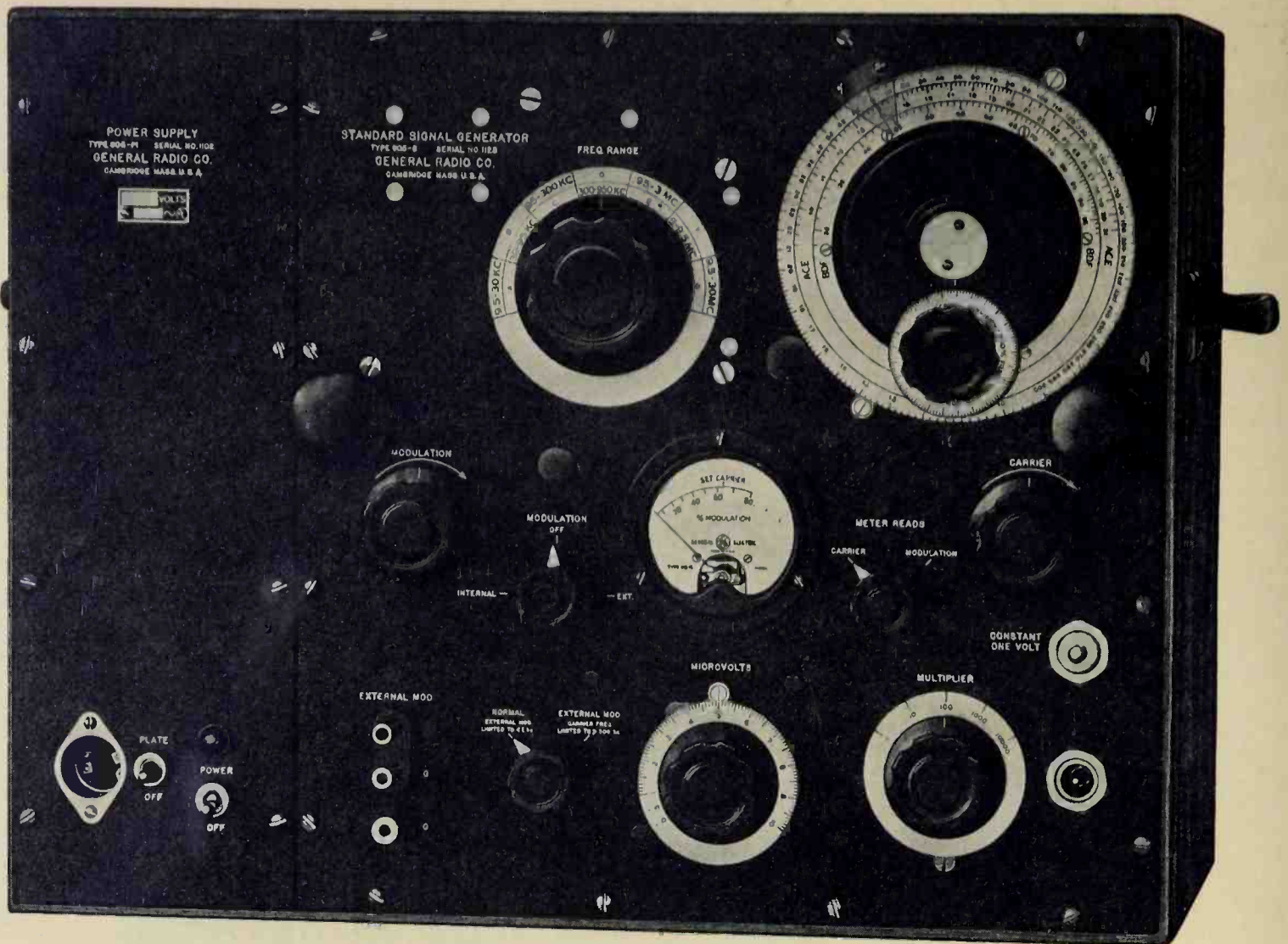

## SPEED UP RECEIVER PRODUCTION WITH THIS STANDARD-SIGNAL GENERATOR

Accurate • Convenient to Use • Gives the Answer Quickly

**A**LL of the basic receiver characteristic measurements can be made very simply and quickly with the G-R Type 605-B Standard-Signal Generator, so simply in fact that any technician can supervise the obtaining of the following measurements with assured accuracy:

- SENSITIVITY
- SELECTIVITY
- DISTORTION
- TUNING RANGE
- TUNING CALIBRATION
- FREQUENCY RESPONSE
- INTERFERENCE
- OUTPUT
- TUNING TRACKING
- I. F. ALIGNMENT
- AVC CHARACTERISTICS
- AFC CHARACTERISTICS

A number of the design features of the G-R Signal Generator are exclusive; all of its features combine to make it the best standard-signal generator on the market at the moderate price of \$415.00.

### OPERATING FEATURES

- DIRECT-READING CARRIER RANGE: 9.5 kc to 30 Mc
- LOGARITHMIC FREQUENCY DIAL: with geared slow-motion, smooth action incremental dial reading to 0.02% for selectivity measurements
- OUTPUT CONTINUOUSLY ADJUSTABLE: 0.5  $\mu$ v to 0.1 v
- SEPARATE ONE-VOLT OUTPUT JACK
- MODULATION CONTINUOUSLY ADJUSTABLE TO 80%
- INTERNAL MODULATION: 400 cycles  $\pm$ 5%
- EXTERNAL MODULATION: flat from 30 cycles to 15 kc
- NEGLECTIBLE FREQUENCY MODULATION
- NO ATTENUATOR REACTION ON FREQUENCY
- EXCELLENT SHIELDING
- A-C OPERATION with built-in voltage regulator

WRITE FOR BULLETIN 648 FOR COMPLETE DATA

# GENERAL RADIO COMPANY

CAMBRIDGE, MASSACHUSETTS  
Branches in New York and Los Angeles

