

Proceedings

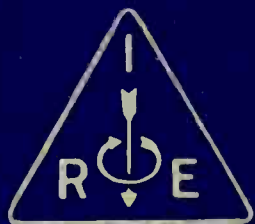

of the

I·R·E

JANUARY 1940

VOLUME 28

NUMBER 1

Volume Indicator and
Reference Level

Engineering Administration

Bridged-T and Parallel-T
Null Circuits

Electron Optics of Cylindrical Fields

Ionospheric Characteristics

Institute of Radio Engineers

Joint Meeting with American Section, International Scientific Radio Union

Washington, D.C., April 26 and 27, 1940



New York Meeting—Engineering Societies Building—February 7

33 West 39th Street, New York, N. Y.



Fifteenth Annual Convention

Boston Mass., June 27, 28 and 29, 1940

SECTION MEETINGS

DETROIT

January 19

ATLANTA

January 19

LOS ANGELES

January 16

PITTSBURGH

January 16

CLEVELAND

January 25

PHILADELPHIA

February 1

WASHINGTON

January 8

SECTIONS

ATLANTA—Chairman, Ben Akerman; Secretary, J. G. Preston, 125 Vance Cir., Marietta, Ga.

BALTIMORE—Chairman, C. A. Ellert; Secretary, Alexander Whitney, 105 Shady Nook Ct., Catonsville, Md.

BOSTON—Chairman, W. L. Barrow; Secretary, P. K. McElroy, General Radio Co., 30 State St., Cambridge, Mass.

BUENOS AIRES—Chairman, A. M. Stevens; Secretary, E. E. Kapus, Bolivar 1743, Buenos Aires, Argentina.

BUFFALO-NIAGARA—Chairman, H. C. Tittle; Secretary, E. C. Waud, 235 Huntington Ave., Buffalo, N. Y.

CHICAGO—Chairman, V. J. Andrew; Secretary, G. I. Martin, RCA Institutes, 1154 Merchandise Mart, Chicago, Ill.

CINCINNATI—Chairman, C. H. Topmiller; Secretary, W. L. Schwesinger, Radio Station WSAI, Cincinnati, Ohio.

CLEVELAND—Chairman, S. E. Leonard; Secretary, H. C. Williams, Rm. 1932, 750 Huron Rd., Cleveland, Ohio.

CONNECTICUT VALLEY—Chairman, E. R. Sanders; Secretary, W. R. G. Baker, General Electric Co., Bridgeport, Conn.

DETROIT—Chairman, J. D. Kraus; Secretary, Paul Frincke, WJBK, 6559 Hamilton Ave., Detroit, Mich.

EMPORIUM—Chairman, C. R. Smith; Secretary, H. L. Ratchford, Hygrade Sylvania Corporation, Emporium, Pa.

INDIANAPOLIS—Chairman, I. M. Slater; Secretary, B. V. K. French, P. R. Mallory & Co., E. Washington St., Indianapolis, Ind.

LOS ANGELES—Chairman, F. G. Albin; Secretary, M. T. Smith, General Radio Co., 1000 N. Seward St., Hollywood, Calif.

MONTREAL—Chairman, A. B. Oxley; Secretary, W. A. Nichols, Canadian Broadcasting Corp., 1012 Keefer Bldg., Montreal, Que.

NEW ORLEANS—Chairman, G. H. Peirce; Secretary, D. W. Bowman, 8327 Sycamore St., New Orleans, La.

PHILADELPHIA—Chairman, R. S. Hayes; Secretary, R. L. Snyder, 103 Franklin Rd., Glassboro, N. J.

PITTSBURGH—Chairman, Joseph Baudino; Secretary, Gary Muffly, Gulf Research and Development Corp., Drawer 2038, Pittsburgh, Penna.

PORTLAND—Chairman, H. C. Singleton; Secretary, E. R. Meissner, United Radio Supply, Inc., 203 S. W. Ninth Ave., Portland, Ore.

ROCHESTER—Chairman, W. F. Cotter; Secretary, H. C. Sheve, Stromberg-Carlson Telephone Manufacturing Co., Rochester, N. Y.

SAN FRANCISCO—Chairman, Carl Penther; Secretary, H. E. Held, 420 Market St., San Francisco, Calif.

SEATTLE—Chairman, R. M. Walker; Secretary, L. B. Cochran, University of Washington, Seattle, Wash.

TORONTO—Chairman, G. J. Irwin; Secretary, N. Potter, Canadian National Carbon Co., Ltd., 805 Davenport Rd., Toronto, Ont.

WASHINGTON—Chairman, L. C. Young; Secretary, E. M. Webster, Federal Communications Commission, Rm. 5319, New Post Office Bldg., Washington, D. C.

Proceedings of the I·R·E

Published Monthly by

The Institute of Radio Engineers, Inc.

VOLUME 28 *January, 1940* NUMBER 1

A New Standard Volume Indicator and Reference LevelH. A. Chinn, D. K. Gannett, and R. M. Morris	1
Engineering Administration in a Small Manufacturing Company.....C. T. Burke	17
Bridged-T and Parallel-T Null Circuits for Measure- ments at Radio Frequencies.....W. N. Tuttle	23
Electron Optics of Cylindrical Electric and Magnetic Fields.....Albert Rose	30
Characteristics of the Ionosphere at Washington, D. C., November, 1939, with Predictions for February, 1940.....T. R. Gilliland, S. S. Kirby, and N. Smith	40
Institute News and Radio Notes.....	42
Board of Directors.....	42
I.R.E.-U.R.S.I. Meeting.....	42
Broadcast Engineering Conference.....	42
Standard Frequencies and Other Services Broad- cast by National Bureau of Standards.....	42
Rochester Fall Meeting.....	42
Committees.....	42
Sections.....	43
Membership.....	45
Books.....	46
"Cathode Modulation," by Frank C. Jones.....Loren Jones	
Contributors.....	47

BOARD OF DIRECTORS

- Raymond A. Heising, *President*
- Peder O. Pedersen, *Vice President*
- Melville Eastham, *Treasurer*
- Harold P. Westman, *Secretary*
- Harold H. Beverage
- Ralph Bown
- Frederick W. Cunningham
- Alfred N. Goldsmith
- Virgil M. Graham
- O. B. Hanson
- Alan Hazeltine
- Lawrence C. F. Horle
- C. M. Jansky, Jr.
- Ira J. Kaar
- Frederick B. Llewellyn
- Albert F. Murray
- Haraden Pratt
- Browder J. Thompson
- Hubert M. Turner
- Arthur F. Van Dyck

BOARD OF EDITORS

- Alfred N. Goldsmith, *Chairman*
- Ralph R. Batcher
- Philip S. Carter
- Frederick W. Grover
- J. Warren Horton
- Greenleaf W. Pickard
- Benjamin E. Shackelford
- Karl S. Van Dyke
- Harold P. Westman, *ex officio*
- Lynde P. Wheeler
- Laurens E. Whittemore
- William Wilson

PAPERS COMMITTEE

- William Wilson, *Chairman*
- Herman A. Affel
- Edmond Bruce
- Howard A. Chinn
- James K. Clapp
- Tunis A. M. Craven
- Paul O. Farnham
- Enoch B. Ferrell
- Elmer L. Hall
- Loren F. Jones
- Frederick B. Llewellyn
- De Loss K. Martin
- Harry R. Mimno
- Albert F. Murray
- Harold O. Peterson
- Ralph K. Potter
- Hubert M. Turner
- Paul T. Weeks
- Harold A. Wheeler
- William C. White
- Irving Wolff

Helen M. Stote, *Assistant Editor*
John D. Crawford,
Advertising Manager

Entered as second-class matter October 26, 1927, at the post office at Menasha, Wisconsin, under the Act of February 28, 1925, embodied in Paragraph 4, Section 412 of the Postal Laws and Regulations. Publication office, 450 Ahnapp Street, Menasha, Wisconsin. Subscription, \$10.00 per year; foreign, \$11.00.

THE INSTITUTE

The Institute of Radio Engineers serves those interested in radio and allied electrical-communication field through the presentation and publication of technical material. In 1913 the first issue of the PROCEEDINGS appeared; it has been published uninterruptedly since then. Over 1800 technical papers have been included in its pages and portray a currently written history of developments in both theory and practice.

STANDARDS

In addition to the publication of submitted papers, many thousands of man-hours have been devoted to the preparation of standards useful to engineers. These comprise the general fields of terminology, graphical and literal symbols, and methods of testing and rating apparatus. Members received a copy of each report. A list of the current issues of these reports follows:

Standards on Electroacoustics, 1938
Standards on Electronics, 1938
Standards on Radio Receivers, 1938
Standards on Radio Transmitters and Antennas, 1938.

MEETINGS

Meetings at which technical papers are presented are held in the twenty-three cities in the United States, Canada, and Argentina listed on the inside front cover of this issue. A number of special meetings are held annually and include one in Washington, D. C., in co-operation with the American Section of the International Scientific Radio Union (U.R.S.I.) in April, which is devoted to the general problems of wave propagation and measurement technique, the Rochester Fall Meeting in co-operation with the Radio Manufacturers Association in November, which is devoted chiefly to the problems of broadcast-receiver design, and the Annual Convention, the location and date of which are not fixed.

MEMBERSHIP

Membership has grown from a few dozen in 1912 to more than five thousand. Practically every country in the world in which radio engineers may be found is represented in our membership roster. Approximately a quarter of the membership is located outside of the United States. There are several grades of membership, depending on the qualifications of the applicant. Dues range between \$3.00 per year for Students and \$10.00 per year for Members. PROCEEDINGS are sent to each member without further payment.

PROCEEDINGS

The contents of each paper published in the PROCEEDINGS are the responsibility of the author and are not binding on the Institute or its members. Material appearing in the PROCEEDINGS may be reprinted or abstracted in other publications on the express condition that specific reference shall be made to its original appearance in the PROCEEDINGS. Illustrations of any variety may not be reproduced, however, without specific permission from the Institute.

Papers submitted to the Institute for publication shall be regarded as no longer confidential. They will be examined by the Papers Committee and Board of Editors to determine their suitability for publication. Suggestions on the mechanical form in which manuscripts should be prepared may be obtained from the Secretary.

SUBSCRIPTIONS

Annual subscription rates for the United States of America, its possessions, and Canada, \$10.00; to college and public libraries when ordering direct, \$5.00. Other countries, \$1.00 additional.

The Institute of Radio Engineers, Inc.

Harold P. Westman, Secretary

330 West 42nd Street

New York, N.Y.



Copyright, 1940, by The Institute of Radio Engineers, Inc.



A New Standard Volume Indicator and Reference Level*

H. A. CHINN†, MEMBER, I.R.E., D. K. GANNETT‡, MEMBER, I.R.E.,
AND R. M. MORRIS§, ASSOCIATE, I.R.E.

Summary—In recent years it has become increasingly difficult to correlate readings of volume level made by various groups because of differences in the characteristics and calibrations of the volume indicators used. This paper describes a joint development by the Columbia Broadcasting System, National Broadcasting Company, and Bell Telephone Laboratories which resulted in agreement upon, and standardization in the respective broadcast and telephone plants of a new copper-oxide-rectifier type of volume indicator having prescribed dynamic and electric characteristics; a new reference level based on the calibration of the new instrument with a single-frequency power of 1 milliwatt; and a new terminology, the readings being described in "vu." It is hoped that other users of volume indicators will join in the adoption of these new standards.

The paper gives in considerable detail the technical data and considerations on which was based the choice of the characteristics of the new volume indicator and the other features of the new standards. Particular attention is paid to the technical data supporting the decision to make the new volume indicator approximately a root-mean-square rather than a peak-reading type of instrument.

INTRODUCTION

THE student of electrical engineering, when introduced to alternating-current theory, learns that that there are three related values of a sine wave by which its magnitude may be expressed. These are the average value, the root-mean-square (or effective) value, and the peak (or crest) value. Certain fundamental electrical measuring devices provide means for determining these values. As the student's experience broadens, he becomes familiar with complex, non-sinusoidal periodic waves and finds that these waves have the same three readily measured values. He learns how to determine from the problem under consideration whether the average, the root-mean-square, or the peak value of the wave is of primary importance.

If the student later enters the field of communication engineering, he immediately encounters waves which are both very complex and nonperiodic. Examples of typical speech and music waves are shown in the oscillograms of Fig. 1. When an attempt is made to measure such waves in terms of average, root-mean-square, or peak values, it is found that the results can no longer be expressed in simple numerical terms, as these quantities are not constant but variable with time and, moreover, are apparently affected by the characteristics of the measuring instrument and the technique of measurement. However, the communications engineer is vitally concerned with the magnitude of waves of the sort illustrated, as he must design and operate systems in which they are amplified by

vacuum tubes, transmitted over wire circuits, modulated on carriers, and otherwise handled as required by the various communication services. He needs a practical method of measuring and expressing these magnitudes in simple numerical fashion.

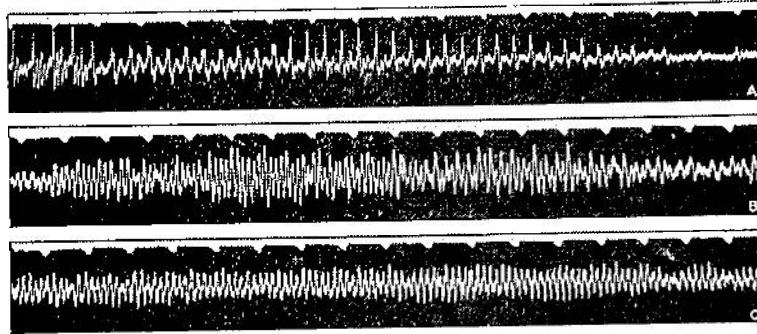

Fig. 1—Examples of program wave forms.

- A—Male speech ("How many")
- B—Male solo with orchestral accompaniment
- C—Dance orchestra

Note: Frequency of timing waves is 60 cycles per second.

This need may be better appreciated by considering the communication systems employed for broadcasting. These are very complicated networks spread over large geographical areas. A typical network may include 15,000 miles of wire line and hundreds of amplifiers situated along the line and in the 50 to 100 connected broadcast stations. Every 15 minutes during the day the component parts of such a system may be shifted and connected in different combinations in order to provide for new points of origin of the programs, and for the addition of new broadcast stations and the removal of others from the network. In whatever combination the parts of the system are put together, it is necessary that the magnitude of the transmitted program waves, at all times and at all parts of the system, remain within the limits which the system can handle without impairment from overloading or noise. To accomplish this, some convenient method of measuring the amplitude of program waves is needed.

These considerations led to the conception of a fourth value, known as "volume," whereby the magnitude of waves encountered in electrical communications, such as telephone speech or program waves, may be readily expressed. This value is a purely empirical thing, evolved to meet a practical need. It is not definable by means of a precise mathematical formula in terms of any of the familiar electrical units of power, voltage, or current. Volume may be defined in terms of the reading of an instrument known as a volume indicator, which has specified dynamic and

* Decimal classification: R243. Original manuscript received by the Institute, June 29, 1939; revised manuscript received, August 14, 1939. Presented, Pacific Coast Convention, San Francisco, Calif., June 29, 1939, and Fourteenth Annual Convention, New York, N. Y., September 20, 1939.

† Columbia Broadcasting System, Inc., New York, N. Y.

‡ Bell Telephone Laboratories, Inc., New York, N. Y.

§ National Broadcasting Company, New York, N. Y.

other characteristics and which is calibrated and read in a prescribed manner. Because of the rapidly changing character of the program wave, the *dynamic characteristics* of the instrument are fully as important as the value of sine-wave power used for calibration. The readings of volume have been customarily expressed in terms of decibels with respect to some volume level chosen as the "reference" level.

In the past, because of a lack of complete understanding of the matter, there has been little uniformity in the design and use of volume indicators, although attempts have been made by some organizations toward standardization. The devices used were of the root-mean-square and peak-reading types having slow, medium, or high pointer speeds; half- or full-wave rectifiers; critically to lightly damped movements, and reference to levels based on calibrations with 10^{-9} , 1, 6, 10, $12\frac{1}{2}$, or 50 milliwatts in 500 or 600 ohms. This great array of variables led to considerable confusion and lack of understanding, especially when an attempt was made to correlate the measurements and results of one group with those of another.

To remedy this situation, the Bell Telephone Laboratories, the Columbia Broadcasting System, and the National Broadcasting Company entered upon a joint development effort during January, 1938, with the object of pooling their knowledge and problems, of pursuing a co-ordinated development program, and of arriving at a uniform practice of measuring volume levels. The outcome of this work is a new volume indicator, a new reference volume level, and new terminology for expressing measurements of volume level. The results of this development work have been discussed with, and approved by, more than 24 other organizations, and were presented at an open round-table conference at the Annual Convention of the Institute of Radio Engineers on June 17, 1938. During May, 1939, it was adopted as standard practice by the above two broadcast companies and the Bell System, and it is hoped that they will be joined by others. It is the purpose of this paper to describe the new standards and the considerations which led to their adoption.

EARLY HISTORY OF VOLUME INDICATORS

As a background for understanding the present development, it will be helpful to review briefly the early history of volume indicators. The particular occasion for the development of the first volume indicator was the setting up of the public-address system which enabled the ceremonies attendant upon the burial of the Unknown Soldier on Armistice Day, 1921, to be heard by large audiences at Arlington, New York, and San Francisco.¹ It was noted in some of the preliminary tests that distortion due to overloading of an amplifier was more objectionable when heard in

a loud speaker than when heard in an ordinary telephone receiver. Consequently, to avoid overloading the telephone repeaters when they were used on the public-address circuits, a device was proposed which would give visual indication on an instrument when the speech level was such as to cause the telephone repeaters to overload.

Further development of this idea led to the experimental device which was used in the Armistice Day ceremonies and which later, with no fundamental change, became the well-known 518 and 203 types of volume indicator. This device consisted of a triode vacuum tube functioning as a detector, to the output of which was connected a direct-current milliammeter. Associated with the input was a potentiometer for adjusting the sensitivity in 2-decibel steps. The method of using the device was to adjust the potentiometer so that the maximum movement of the milliammeter needle reached the mid-scale point on an average of about once every 10 seconds, occasional greater deflections being disregarded. The volume level was then read from the setting of the potentiometer which was marked in decibels with respect to a reference volume level.

The reference level was chosen as that level of speech which, when transmitted into the long telephone circuits, would cause the telephone repeaters with which they were equipped to be just on the verge of overloading as evidenced by audible distortion. The gains of the telephone repeaters were normally adjusted so that the level at their outputs was 10 decibels higher than at the sending end of the circuit. Reference volume was therefore specifically defined as 10 decibels below the maximum speech level which could be satisfactorily transmitted through the particular amplifier and vacuum tubes used in the telephone repeaters. This level was determined experimentally and the potentiometer steps of the volume indicator were marked accordingly. This reference volume was also approximately the volume delivered over a short loop by the then standard subscriber's telephone set when spoken into with a fairly loud voice.

It is apparent that the volume indicator was born in response to a definite need, and it has filled an important niche in the rapidly growing radio broadcast industry and in other communication fields. Large numbers of volume indicators similar to this early type have continued in service to the present time.

Frequently, it is characteristic of a rapidly expanding art that at first standards multiply, and finally a point is reached where simplification and agreement upon a single standard becomes imperative. This has occurred in connection with volume indicators and since the development of the first one, a variety of instruments have been produced by the various manufacturers and have come into service in the plants of the different companies. These instruments had differ-

¹ W. H. Martin and A. B. Clark, "Use of public address system with telephone lines," *Trans. A.I.E.E.*, vol. 42, p. 75; February, (1923).

ent calibrations and characteristics and there was little correlation between their readings.

A further divergence occurred, regarding the philosophy of the calibration of the original type of volume indicator. One view recognized no correlation between the point at which the galvanometer was normally read on peaks (the 30-division point on the scale, Fig. 12) and the power of 6 milliwatts used for calibration. When calibrating the instrument on 6 milliwatts of sine-wave energy in 500 ohms, the galvanometer would read 22 divisions with the associated sensitivity switch on step zero. There was not intended to be any correlation between this calibrating power and reference volume. Nevertheless, many people were led by this technique of calibration to refer to the volume indicator as a 6-milliwatt instrument. This idea was furthered by the fact that the vacuum tube, to whose speech-carrying capacity the reference volume was originally referred, has a nominal full-load capacity on sine waves of 60 milliwatts. The reference volume being defined as 10 decibels below the maximum output of this tube, it was natural to try to relate this reference volume to the corresponding figure of 6 milliwatts for sine waves.

A second view was based on the experimental fact that when the potentiometer controlling the sensitivity was set at "0 decibels," a sine-wave potential of 2.5 volts (root-mean-square) applied to the volume indicator caused a deflection to mid-scale (scale reading of 30 divisions). This was equivalent to 12.5 milliwatts in a 500-ohm circuit, and the supporters of this view therefore referred to the volume indicator as a 12.5-milliwatt instrument.

Thus the same volume indicator, having the same sensitivity and giving the same readings of volume level, was variously referred to as a 6-milliwatt and a 12.5-milliwatt device. This increased the difficulty of co-ordination between the plants of the different companies which are interconnected in rendering broadcast service.

Some degree of standardization of the technique of reading volume levels had already been made within different organizations both here and abroad. The importance of the present development lies not only in the particular merits of the proposed standards, but also in the fact that they have been jointly developed and adopted by three of the larger users of volume indicators, and have been approved by many others. Thus there is a good prospect that the needed standardization is about to be realized, and that all will shortly use the same instruments, the same reference levels, the same terminology, and the same nominal value of circuit impedance.

CHOICE OF PEAK VERSUS ROOT-MEAN-SQUARE TYPES *General*

The first important decision to be made and one which would affect the entire character of the develop-

ment was whether the new volume indicator should be of the root-mean-square or of the peak-reading type. These two types of instrument represent two schools of thought. The peak-reading instrument is favored for general use by many European engineers and is specified by the Federal Communications Commission for use as modulation monitors in this country. The root-mean-square type has, however, been commonly employed in this country on broadcast program networks and for general telephone use. In view of the importance of the decision and the difference of opinion that has existed, the data on which the choice was made are given below in considerable detail.

In accord with common practice, the terms "root-mean-square" and "peak-reading" are used rather loosely throughout this paper. The essential features of a root-mean-square instrument are some kind of rectifier or detector and a direct-current milliammeter. The latter is not especially fast, generally requiring tenths of a second to reach substantially full deflection. If a sufficiently slow wave is applied, say one whose frequency is one or two cycles per second, the instrument can follow it and the true peaks of the wave will be indicated, but when much higher frequency waves are applied, such as the complex speech or program waves, the instrument is too slow to indicate the instantaneous peaks but averages or integrates whole syllables or words. As shown by tests and practical experience, it is of secondary importance whether the detector actually has a root-mean-square (or square-law) characteristic, or has a linear or some intermediate characteristic.

A peak-reading instrument capable of truly indicating the sharpest peak which might occur in a high-quality program wave would have to respond to impulses lasting only a very small fraction of a millisecond. Cathode-ray oscilloscopes or gas-tube trigger circuits are capable of doing this and, therefore, might be used as peak-reading volume indicators. However, the so-called peak-reading volume indicators used in practice, designed to give a visual indication on an instrument, are far from having the above speed although they are much faster than the root-mean-square instruments. They generally respond to impulses whose duration is measurable in hundredths or thousandths of a second and, therefore, truly indicate the peaks of sine-wave voltage whose frequency does not exceed, say, 50 to 100 cycles per second. They are similar to the root-mean-square instruments in that they are not fast enough to indicate the instantaneous peaks of speech or program waves but tend to average or integrate a number of peaks of the wave.

A feature of the usual peak-reading instrument which from the analytical standpoint is of secondary importance, is that it is usually given a characteristic of very slow decay as well as rapid response. This is

usually accomplished by a circuit such as illustrated in Fig. 2 which shows the principle of the experimental instrument used in the tests described later. The 0.01-microfarad condenser is charged through a full-wave vacuum-tube rectifier, the rates of charge and discharge being determined by the resistances. The direct-current amplifier and direct-current milliammeter indicate the charge on the condenser. The advantage of making the discharge rate of the condenser very slow is that the direct-current milliammeter need not then be particularly fast and, moreover, the ease of reading the instrument is greatly increased.

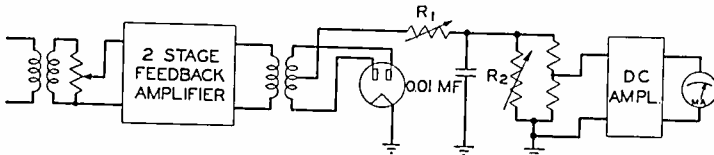

Fig. 2—Schematic diagram of experimental peak-reading volume indicator.

From the above analysis it is seen that the root-mean-square and the peak-reading instruments are essentially similar and differ principally in degree. Both indicate peaks whose durations exceed some value critical to the instrument and both average or integrate over a number of peaks the shorter, more rapid peaks encountered in speech or program waves. Either may have a linear or a square-law detector, or one of some intermediate characteristic. The important difference between the two types lies in the speed of response as measured by the length of impulses to which they will fully respond, that is, in the time over which the complex wave is integrated.

A general-purpose volume indicator may be called upon to serve a number of uses, such as:

- (a) Indication of a suitable level for a speech or program wave to avoid audible distortion when transmitted through an amplifier, program circuit, radio transmitter, or the like.
- (b) Checking the transmission losses or gains in an extended program network by simultaneous measurements at a number of points on particular peaks or impulses of the program wave which is being transmitted.
- (c) The indication of the comparative loudness with which programs will be heard when finally converted to sound.
- (d) The indication of a satisfactory level to avoid interruption of service due to instantaneous overloads tripping protective devices in a radio transmitter, damage to sound recording systems, etc.
- (e) Sine-wave transmission measurements.

These services are different in nature and the ideal requirements for an instrument for each may not necessarily be the same. One instrument to serve them all must, therefore, be a compromise. From the standpoint of the companies engaged in this development, items (a), (b), and (c) in the above list were considered

to be the most important and therefore attention was first directed to the relative merits of the two types of volume indicators with respect to them.

Aural Distortion Due to Overload

Tests of volume indicators as overload indicators with aural distortion as the criterion (item (a)) had previously been made on a number of occasions and more tests were undertaken during the present development. The general procedure in such tests is to determine for some particular amplifier the volume level at its output at which distortion due to overloading can just be heard by a number of observers on each of a variety of programs. The volume levels thus determined are read on the various volume indicators which are being compared. The best instrument is considered to be the one whose readings are most nearly alike for all the programs when overloading can just be detected.

The sole criterion of distortion due to overloading is the judgment of observers, since it is the final reaction on listeners which is of importance. This judgment is not subject to exactness of measurement, but is in fact somewhat of a variable, even with conditions unchanged and with the most experienced observers. For significant results to be obtained, therefore, a careful technique of conducting the tests is required, many observations must be made, and statistical methods of analyzing the resultant data must be employed.

The arrangement of equipment and circuits used in these tests is shown in simplified form in Fig. 3. A source of program, which may be a phonograph pickup, a direct microphone pickup, or a program circuit, is connected through control circuits to the amplifier which is to be overloaded, and thence through additional circuits to a loud speaker. The loud speaker employed in the tests reported here was a special high-quality two-unit loud speaker having a response which is substantially flat from 40 to 15,000 cycles per second.² Including the power amplifier used with it, the over-all response of the system was substantially uniform from 40 to 11,000 cycles.

The arrangement of the circuit is such that the volume level at the output of the test amplifier may be raised or lowered while keeping the over-all gain of the system constant. Two controls are provided for this purpose. One, operated by a key, transfers a 15-decibel loss from ahead to behind the test amplifier. This permits comparing a test condition with a reference condition in which the load on the amplifier is 15 decibels lower, while the loudness with which the program is heard remains the same for either condition. The other control, represented in Fig. 3 by the coupled attenuators, permits the load on the amplifier for the test condition to be varied, also without changing the

² E. C. Wentz and A. L. Thuras, "Auditory perspective—loud speakers and microphones," *Elec. Eng.*, vol. 53, pp. 17-24; January, (1934).

loudness. The volume indicators to be compared are connected for convenience, to a point where the volume level is unaffected by the controls. Their readings are corrected for each test by the measured loss or gain between the point where they are situated and the output of the test amplifier, so as to express the levels which would be read at the amplifier output.

Two techniques were employed for conducting tests with this equipment. In one, the individual method, a single observer at a time listens to the program and adjusts the volume level at the output of the amplifier by means of the coupled attenuators, until he determines the point at which distortion due to overloading is just audible, when the key is operated from the reference to the test condition. This is repeated for a number of different programs and observers until a large number of observations have been obtained. The volume levels indicated by the different volume indicators at the amplifier output are determined for each observation. These are found to have a considerable spread, due not only to the differences in the nature of the programs but also to differences in the acuity of perception of the distortion by the various observers. The method of analyzing the data is described later.

In the second technique, the group method, a group of observers simultaneously listens to a program which is repeated with the key operated alternately to the test and reference positions. The two conditions are distinguished to the observers (but not identified as to which is which) by a letter associated with each condition in an illuminated sign. The letters *A*, *B*, and *C* are used, two being chosen at random for each test. A vote is taken as to which condition, designated

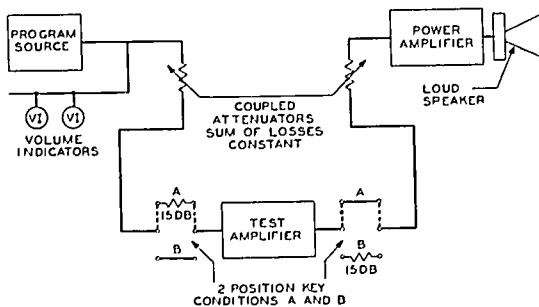

Fig. 3—Arrangements for determining volume level at which overload of amplifiers is audible.

by one of the two letters employed in the particular test, is preferred with respect to freedom from distortion. A number of such tests, covering the range from a level below the point where distortion can be detected by anyone to a level high enough for all to observe distortion, establishes a curve between the per cent of observers correctly choosing the reference condition as having the least distortion, and the amplifier output level as read by each volume indicator used in the tests. Similar curves are determined for a number of kinds of program material, and for purposes of comparison the overload point for each program is taken

from the point on the curve for each volume indicator, where 80 per cent³ of the observers voted correctly.

As noted, judgment tests of this sort require many observations and checks to obtain reliable results. A larger volume of data is available for the individual method, so the results from tests made by that method have been chosen to be reported here. Some tests have also been made with the group method and, while the results are less conclusive, they substantiate those recorded below.

Tests by the individual method to compare peak-reading and root-mean-square volume indicators have been carried out a number of times during the past two years. In each of these tests a number of observers have taken part and a number of samples of program material of a variety of types have been employed. For the majority of the tests, the sources of program were high-quality recordings, convenient because of the ease and exactness with which the programs could be repeated. For some of the tests, however, actual speakers and musical instruments were employed with direct microphone pickup.

A number of the types of volume indicators in common use were represented in these tests. Since the 700A volume indicator was common to all of the tests, it has been chosen to represent the root-mean-square type of volume indicator in the data presented below. The peak-reading type was represented by the especially constructed experimental instrument, whose fundamental circuit is shown in Fig. 2. The resistances controlling the rates of charge and discharge of the condenser were adjustable, permitting a range of characteristics to be obtained. The adjustments for which the data referred to below were obtained, correspond to a rate of charge of the condenser such that impulses of single frequency applied to the input for 0.025 second would give a reading within 2 decibels of the reading obtained with a sustained wave of the same amplitude. The rate of discharge of the condenser was about 19 decibels per second. These rates are generally similar in magnitude to those specified by the International Consulting Committee on Telephone Transmission (the C.C.I.F.) for broadcast service, and by the Federal Communications Commission for modulation monitors.

The direct-current amplifier and direct-current milliammeter which indicates the charge on the condenser included features, not shown in the simplified sketch, which made the response logarithmic. The instrument had a substantially uniform decibel scale covering a range of 50 decibels.

The data from four different series of tests, made at different times, were collected in one body, and distribution curves were plotted showing the relative frequency of occurrence among the data of the different levels at which incipient overload was detected.

³ W. B. Snow, "Audible frequency ranges of music, speech and noise," *Jour. Acous. Soc. Amer.*, vol. 3, pp. 155-166; July, 1931.

Curves for tests on a Western Electric 94B amplifier, which is an amplifier designed with negative feedback and therefore having a relatively sharp cutoff, similar to a radio transmitter, are illustrated in Fig. 4. It will be noted that the curve obtained with the root-mean-square volume indicator has a slightly greater spread than that for the peak-reading volume indicator. Twelve different observers took part in these tests, and 13 samples of program were employed, including male and female speech, dance music, piano, violin, and brass-band selections.

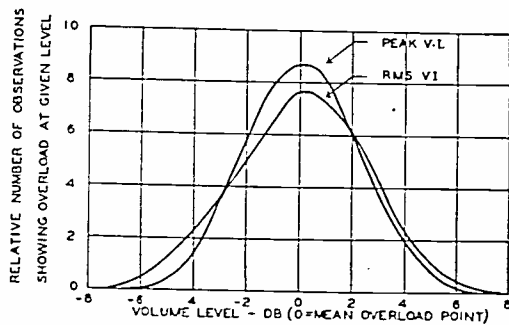

Fig. 4—Distribution of overload points.

The data may more readily be interpreted when plotted in the form of cumulative distribution curves, obtained by integrating the above distribution curves. Cumulative curves for the data just referred to are shown in Fig. 5. For convenience and ease of interpretation, these curves have been plotted on "probability" rather than rectangular co-ordinates, as probability co-ordinates have the property of making data whose distribution follows a normal law⁴ form a straight line. It will be noted that the experimentally determined points actually fall so nearly on straight lines that it is reasonable to assume straight lines to represent them. It is likely that, with a greater volume of data, still greater conformity to the straight lines drawn would be obtained.

In order to superpose the curves for the two volume indicators, the levels are plotted in decibels with respect to the average overload level determined from the tests. When calibrated to read alike on the same sine-wave power, the experimental peak-reading instrument (with the adjustments described above) reads on the average 7.4 decibels higher on actual programs than the root-mean-square instrument used in the tests.

Now let it be imagined that the test amplifier is the one critical link in a broadcast network and that an operator is given the duty of satisfactorily adjusting the volume levels through the amplifier using either of the two volume indicators tested. If he lets the louder portions of the programs just reach the volume level marked "0 decibel" on the curves, it will make no difference which volume indicator he uses. In either case, on the average, half of the listeners will hear distortion when the program is loudest. However, this result would probably be considered too poor, so

⁴ The "normal" law has the form $y = Ae^{-ax^2}$.

suppose the maximum level is lowered 3.5 decibels. Referring to the curves, it is seen that if the peak-reading volume indicator is used, only about 5 per cent of the listeners will now, on the average, hear distortion on the loudest program passages, while if the root-mean-square instrument is used, about 10 per cent will hear distortion. To reduce the latter figure to 5 per cent would require lowering the maximum volume level another decibel. Thus with this criterion, the peak instrument has a slight advantage, as it would permit the transmission of a 1-decibel higher average volume level for the same likelihood of distortion being heard.

The above statements assume that the observers and programs used in the tests just described were representative of the listening public and the programs they hear. Actually, the observers were trained by experience in making many tests and were no doubt much more critical than the average listener. Moreover, the conditions under which the tests were performed, with the availability of frequent comparison with the undistorted reference condition, were more conducive to critical detection of overload than are average listening conditions. These facts, together

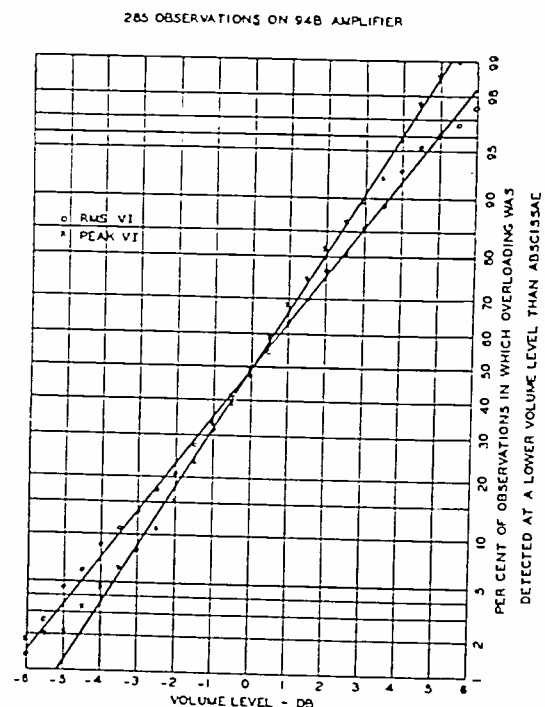

Fig. 5—Comparison of peak versus root-mean-square volume indicators as overload indicators (using Western Electric 94B amplifiers).

with the inevitable inability of the control operator in practice to make his adjustments perfectly in anticipation of the coming changes in the programs, tend to make the real practical advantage of one instrument over the other considerably less than shown by the tests. A further factor reducing the importance of the small differences shown by the tests is the growing use of volume-limiting amplifiers at critical points in a broadcast system, such as at the radio broadcast stations, which automatically prevent the transmission of excessive levels.

Another cumulative distribution curve is shown in Fig. 6, representing similar tests on a Western Electric 14B program amplifier. This is a simple push-pull triode amplifier without negative feedback and therefore having a more gradual cutoff than the 94B. (The gain-versus-output-power-level curves at 1000 cycles per second are shown in Fig. 7 for the two amplifiers.) It will be seen from Fig. 6 that the data for the two volume indicators show no significant difference and that the single curve equally well represents either set of data in the region of interest. Somewhat fewer data are represented by this curve and the agreement with the normal law is not quite so close as in the previous case.

The peak-reading instrument with the adjustment used in these tests, although having characteristics

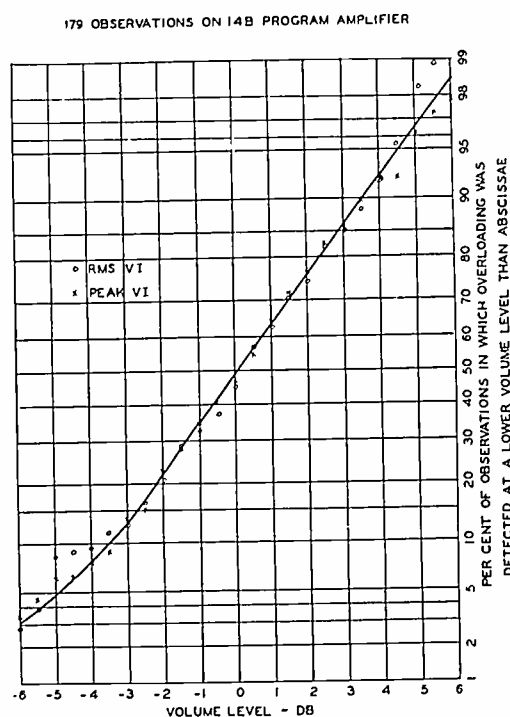

Fig. 6—Comparison of peak versus root-mean-square volume indicators as overload indicators (using Western Electric 14B program amplifiers).

similar to those usually proposed for this type of device, is still far too slow in response to indicate the true instantaneous peaks of the program wave. The question naturally arises, therefore, whether any greater difference would be indicated if the peak-reading instrument were made sufficiently fast in response to indicate the actual instantaneous peaks. To check this point, some tests similar to those described above were made, using a gas-tube trigger circuit capable of measuring the true instantaneous peaks. The results of these tests, using the 94B amplifier, are shown in Fig. 8. Although a smaller number of observations are included in these data, the results show conclusively that there is no substantial difference between the experimental peak-reading volume indicator and the faster trigger-tube arrangement, in their performance on actual program waves.

The data from the tests have been presented above

in the form which most directly indicates the comparative performance of the two types of volume indicators. However, a breakdown of the data with respect to the types of program may be of interest and is shown in Tables I and II for the data on the 94B amplifier shown previously in Figs. 4 and 5.

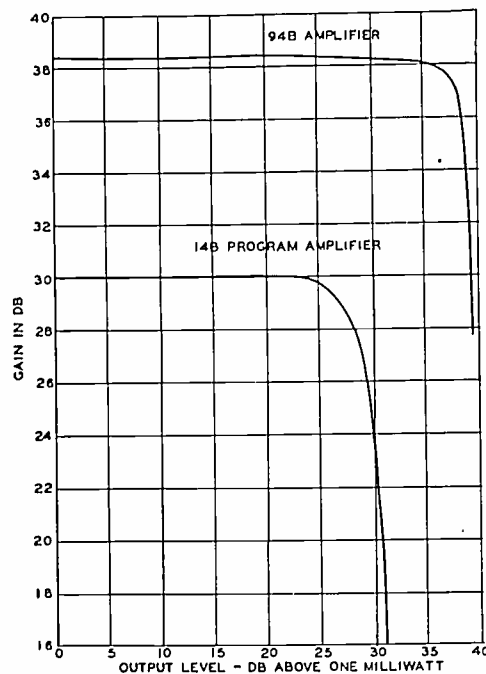

Fig. 7—Gain-versus-load characteristics of amplifiers.

It will be observed in Table I that the average overload points for the different types of programs fall within a range of about 2 decibels for either volume

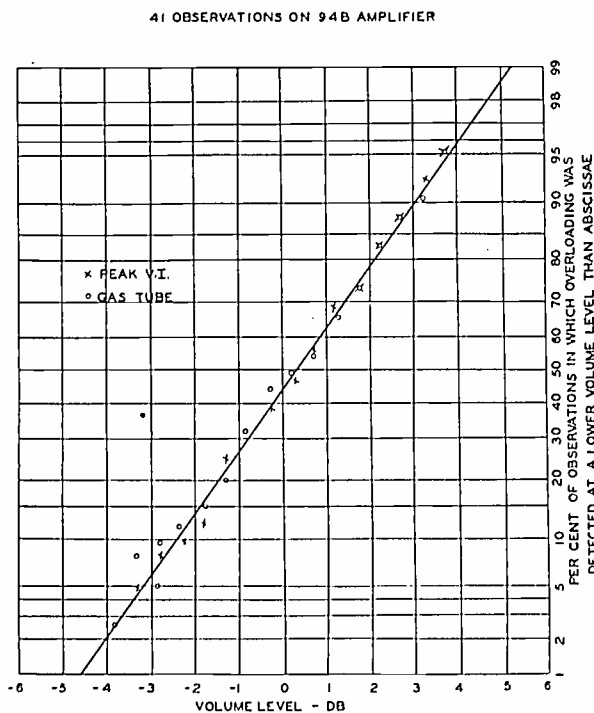

Fig. 8—Comparison of experimental peak-volume indicator with gas-tube-trigger device as overload indicator.

indicator. However, it will be noted that with the root-mean-square instrument the average overload point for speech is about 2 decibels lower than for music, while there is no significant difference with the peak instrument. This undoubtedly is because speech waves have a higher "peak-factor" (ratio of peak to root-mean-square values) than music.

Table II shows the spread of the overload points (difference between highest and lowest values) for the various tests on each type of program whose average is given in Table I. Most of the types of program show a significantly narrower spread for the peak than the root-mean-square instrument. For comparison with values taken from Figs. 5 and 6, discussed above, these spreads should be divided by two to show the difference between the lowest and the mean values.

TABLE I
AVERAGE OVERLOAD POINTS OF DIFFERENT KINDS OF PROGRAM
MEASURED AT THE OUTPUT OF THE 94B AMPLIFIER

Character of Program	Number of Tests	Total Number of Observations	Average Overload Point ¹	
			Root-Mean-Square Volume Indicator	Peak Volume Indicator
Male speech	8	81	decibels	decibels
Female speech	8	82	22.1	31.9
Piano	5	40	22.8	30.1
Brass band	4	25	24.1	30.9
Dance orchestra	5	42	24.1	31.0
Violin	1	15	24.7	29.4
			25.8	31.1
Average speech	16	163	22.4	31.0
Average music	15	122	24.5	30.5
Grand average	31	285	23.3	30.7

¹ These tests antedated the new standards, and the values given are in decibels with respect to a reference point based on a single-frequency calibration of 0.006 watt in 600 ohms.

TABLE II
SPREAD OF OVERLOAD POINTS WHOSE AVERAGES
ARE GIVEN IN TABLE I

Character of Program	Root-Mean-Square Volume Indicator	Peak Volume Indicator
	decibels	decibels
Male speech	6.1	3.7
Female speech	4.6	2.5
Piano	3.6	4.9
Brass band	4.0	3.9
Dance orchestra	3.7	2.4
All types	7.3	5.9

It is concluded from the tests just described that the disadvantage in using root-mean-square instead of peak-reading volume indicators for controlling volumes to avoid aural distortion due to overloading, is substantially none when the overloading device does not have too sharp an overloading characteristic, and only slight when it does overload sharply. The explanation probably lies in the physiological and psychological factors involved in the ear's appreciation of overload distortion, which permit to pass unnoticed considerable amounts of distortion on rarely occurring instantaneous peaks of very short duration.

Peak Checking

A very important use of volume indicators is that of checking the transmission losses or gains along a program network by measurements made on the transmitted program material (item (b) in the list given earlier). The program circuits which make up the large program networks, are in continuous use for many hours each day and during that period are switched together in many combinations as required by the operating schedules. It is not convenient to interrupt service for sine-wave transmission measurements, hence, to check the transmission conditions

during service hours, it is the custom to take simultaneous readings at two or more points in the program networks on particular impulses of whatever program wave is being transmitted, co-ordinating these readings by the use of an order wire. On such readings, the root-mean-square type of instrument is far superior to the peak-reading type, because of phase distortion and slight nonlinearity in the program circuits. These effects are undetectable to the ear, but change the wave shape of the program peaks sufficiently to cause serious errors in the readings of the peak-type instrument. On the other hand they have no noticeable effect on the root-mean-square instruments.

Tests were made on this effect by taking readings on several kinds of programs at the beginning and end of a program circuit extending from New York to Chicago and return (about 1900 miles). The circuit was lined up so that either volume indicator read the

TABLE III
ERRORS RESULTING FROM USE OF PEAK-TYPE VOLUME INDICATOR
ON A LONG PROGRAM CIRCUIT

	Upper Frequency Limit of Program	
	5000 Cycles	8000 Cycles
	Decibels	Decibels
Male speech	-3.5	-4.5
Female speech	-1.5	-3.0
Dance orchestra	-2.0	-1.5
Brass band	-3.0	-2.0
Piano	-0.5	-1.5

same at both ends of the circuit on a 1000-cycle sine wave. In all the tests, the readings obtained on program material with the root-mean-square instrument at the two ends of the circuit agreed within a very few tenths of a decibel. The readings of the peak instrument, however, disagreed by the values shown in Table III, when the program material was applied to the circuit at the normal maximum operating level.

It is of interest that the errors shown by Table III are affected by the frequency range of the program material transmitted, being greater for the broader band. The frequency range was controlled by the use of low-pass filters inserted between the source of program and the line before the point at which the sending-end levels were read. Tests were also made of the effect of a 180-degree phase reversal at the center of the loop. This was found to increase the errors in some cases and to decrease them in others.

The large errors indicated in the table are, of course, intolerable. The effect of the line on the reading of the peak instrument is partly due to the cumulative effects of the slight nonlinearity in the many vacuum-tube amplifiers and loading coils in the circuit, and partly to phase changes which alter the wave front and amplitude of the peaks. It might be thought that phase changes which destroy some peaks would tend to create others. However, a Fourier analysis of a sharp peak will show that an exact phase relationship must exist between all of the frequency components. The probability that phase shift in a line will chance to cause all of the many frequency components of a

complex wave to align themselves in the relationship necessary to create a peak where none existed before, is very slight—indeed infinitesimal compared to the probability of the occurrence of a peak in the original wave.

Loudness

Another important consideration is the correlation between volume levels and the comparative loudness of different types of programs (item (c) in the list given earlier). This was tested by a method similar to the "group method," described above in connection with the tests on aural overload distortion. A group of observers was permitted to listen to alternate repetitions of a test program and a reference program, and was asked to vote upon which appeared the louder. A particular selection of male speech was used as the reference program for all of the tests and its level was kept constant. The test programs included several different types and several samples of each type of program. The samples of program were about 30 seconds in length. Each test program was presented at a number of levels covering a range from a low level where all the observers judged the reference program to be the louder to a higher value where all of them judged the test program to be the louder.

Thus, a curve was established for each type of program between the per cent of observers judging the test program to be the louder, and the level of the test program. A sample of such a curve is shown in Fig. 9. The 50 per cent point on the curve is interpreted as indicating the level of the test program at which it appears to the average observer to have the same loudness as the reference program. The test program is then set at this "equal-loudness" volume level and the levels of both test and reference programs are read with each of the types of volume indicators of interest. In this way, the figures given in Table IV were determined.

TABLE IV

Type of Program	Volume Indicator Readings for Same Loudness as Male Speech	
	New Volume Indicator	Peak Volume Indicator
Male speech	0	0
Female speech	-0.1	-2.2
Dance orchestra	+2.8	-2.2
Symphony orchestra	+2.7	-2.3
Male singing	+2.0	-2.5

It is evident from the figures in the table that there is no significant advantage for either type of volume indicator where loudness is the criterion.

Table IV shows that when the new volume indicator is used the musical programs must be 2 to 3 decibels higher than speech to sound equally loud. It is of interest to note that according to Table I this same difference was shown to exist between the average overload point of the 94B amplifier on speech and music, when measured with the root-mean-square

volume indicator. This would seem to indicate that if allowance is made for this difference between speech and music in controlling the volume levels to avoid overloading, they will also then sound equally loud to the listeners.

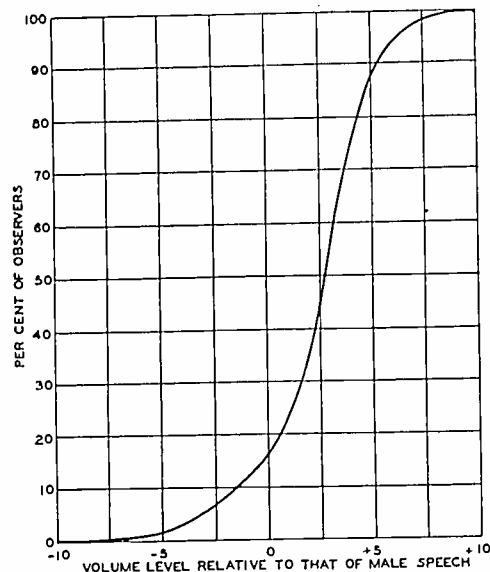

Fig. 9—Per cent of observers choosing symphony music at indicated volume levels to be louder than the male speech reference.

Choice of Type

The tests of aural distortion due to overload showed so slight a disadvantage for the root-mean-square instrument and the experiments on peak checking showed such a marked advantage for this type as compared with the peak instrument, that it was decided to develop the root-mean-square type of instrument. Other considerations were, that with the advances in copper-oxide types of instruments, it has become possible to make root-mean-square instruments of sufficient sensitivity for most purposes without the use of vacuum tubes and their attendant need of power supply, an advantage not shared by peak-reading instruments, at least at present. Thus, the root-mean-square instrument has advantages of comparative low cost, ruggedness, and freedom from the need of power supply, and can, moreover, be readily made in portable forms when desired.

DYNAMIC AND ELECTRICAL CHARACTERISTICS

It will be appreciated from the earlier discussion that for a volume indicator to be truly standard, its dynamic and electrical characteristics must be controlled and specified so that different instruments will read alike on the rapidly varying speech and program waves. Therefore, the next step in the development was to determine suitable values for these characteristics.

In deciding upon the dynamic characteristics, an important factor included in the consideration was the ease of reading the instrument and the lack of eye-strain in observing it for long periods.

First, a number of existing instruments were studied, including some experimental models constructed inde-

pendently for the two broadcast companies prior to the start of this joint development. In this, the opinions of technicians, accustomed to reading volume indicators as a part of their regularly assigned duties, were sought, as well as those of the engineers. The instruments studied included a considerable range of speeds of response and of damping. From this work, the following conclusions were reached:

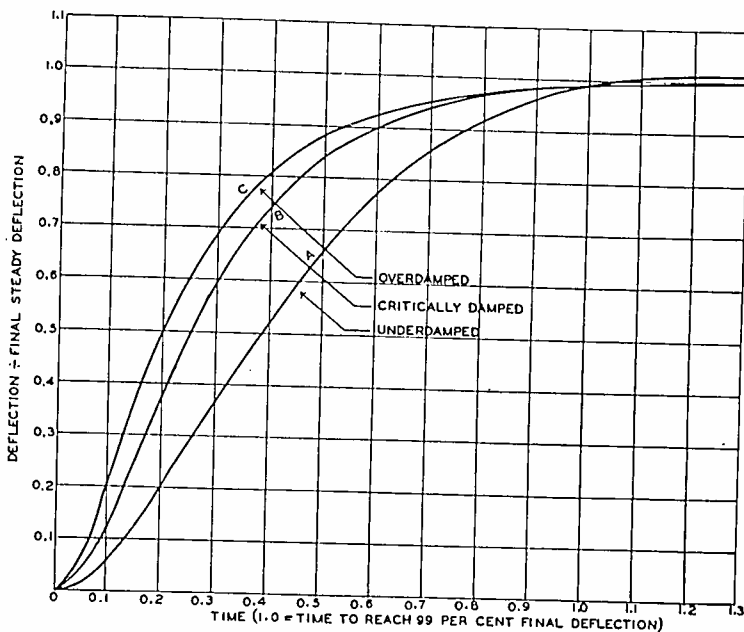

Fig. 10—Effect of damping on instrument characteristics.

(a) For ease of reading and minimum of eye fatigue, the movement should not be too fast. As a result of observations under service conditions and other tests the requirement was adopted that the sudden application of a 1000-cycle sine wave of such amplitude as to give a steady deflection at the scale point where the instrument is to be read, shall cause the pointer to read 99 per cent of the final deflection in 0.3 second.

(b) The movement shall be slightly less than critically damped, so that the pointer will overswing not less than 1 per cent nor more than 1.5 per cent when the above sine wave is suddenly applied.

This last point deserves further discussion. It was noted that on speech or program waves, instruments which were critically damped or slightly overdamped had a more "jittery" action than instruments slightly underdamped, and the strain of reading them was greater. The reason for this will be understood by reference to the theoretical curves shown in Fig. 10. These curves represent, for three different degrees of damping, the deflection versus time following the sudden application of a steady sine wave. Curve *A* is for a movement underdamped by the amount specified above. Curve *B* is for a critically damped movement, while curve *C* is for a movement which is overdamped by the same factor that *A* is underdamped. It is assumed that the periods of the three movements are so adjusted that all reach a deflection of 99 per cent in the same time and that the sensitivities of each are the same.

It will be noted that the velocity of the pointer in curve *A* is more nearly uniform than in the other curves, and that the maximum velocity in *A* is only about half that in *C*. Because of the lower and more uniform velocity, there will be much less eyestrain in watching pointer *A*, as it dances about in response to program waves, than either of the others. Moreover, the same curves inverted will equally well represent the motion of the pointers when the applied wave is suddenly stopped. It is evident, by inspection of the region shown near zero, that pointers *B* and *C* will start downward very rapidly whereas pointer *A* will pause for a moment and then start downward more slowly. This is of importance since it is the maximum excursions of the pointer which must be observed in reading volume levels. The tendency to pause at the top of the swing before starting downward makes *A* easy to read, and the failure to do so explains the observed "jittery" motion of instruments such as *B* and *C*.

As a further part of this study, high-speed moving pictures were taken of the available volume indicators, showing their response to suddenly applied sine waves. The pictures were taken at 400 frames a second and included on the edge of each frame was a photograph of a clock device which indicated time in thousandths of a second. From measurements made on these films, the data plotted in Fig. 11 were obtained. It is interesting to observe how lightly damped are the oscillations of the 203C volume indicator, which until the advent of the new instrument has been in use in considerable numbers. The curve for the peak volume indicator on Fig. 11 must not be mistaken for the true speed of

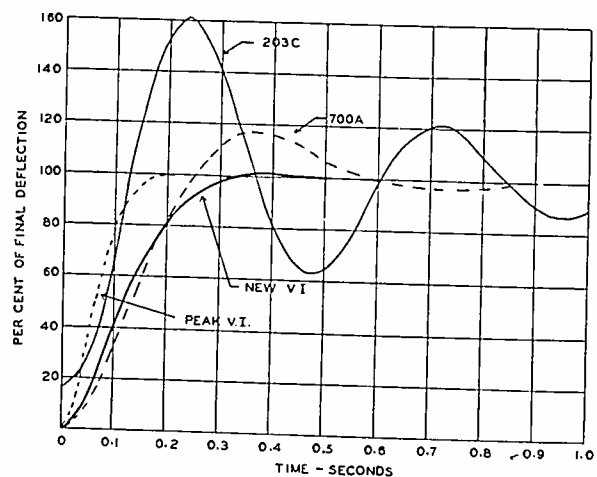

Fig. 11—Deflection of volume indicators to suddenly applied sine wave.

response but is merely the speed with which the instrument reads the charge on the condenser (see Fig. 2). The charge builds up quite rapidly, but the instrument follows in more leisurely fashion as shown. The instrument, as noted earlier, will actually give a reading of 80 per cent on an impulse of sine wave as short as 0.025 second.

The above characteristics were decided upon only after many tests corroborated by field trials under

actual working conditions. The validity of the conclusions reached in the tests of earlier root-mean-square volume indicators was checked with respect to the new instrument by further tests.

The question of whether the rectifier should be half wave or full wave needs little discussion. The oscillogram of the speech wave shown in Fig. 1 shows a very marked lack of symmetry. Evidently if a volume indicator is to give the same reading no matter which way its input is poled, a balanced full-wave rectifier is required.

Throughout this paper, the term "root-mean-square" has been used loosely to describe the general type of instrument under consideration. Some tests were made to determine the actual law of addition of the new volume indicator.

The procedure was based on determining the exponent p in the equation $i = ke^p$ which is equivalent to the actual performance of the instrument for normal deflections. (In the equation i is the instantaneous current in the instrument coil and e is the instantaneous potential applied to the volume indicator.) Two methods were employed. One consisted in determining the ratio of the magnitudes of the sine-wave alternating- and the direct-current potentials which when applied to the volume indicator give the same deflection. The second method consisted in determining the ratio of the single-frequency potential to the potential of each of two equal amplitude, nonharmonically related frequencies which when simultaneously applied give the same deflection.

Without going into the mathematics involved, a number of the new volume indicators were found to have exponents of about 1.2. Therefore, their characteristics are intermediate between linear ($p=1$) and square-law or "root-mean-square" ($p=2$) characteristic. Applying the second method to a Western Electric 1G volume indicator, which is considered to be a "root-mean-square" instrument, the exponent was found to be 1.89.

INSTRUMENT SCALE

Among the more important features to be considered in the development of a volume indicator is the design of its scale. In broadcast studios, volume indicators are under observation almost continuously by the control operators, and the ease and accuracy of reading and the degree of eyestrain are of major importance.

Prior to the adoption of the new standard volume indicator there was a wide variety of volume-level indicator scales in use by the electrical communications industry. This, coupled with the use of a number of different kinds of instruments, reference levels, etc., resulted in considerable confusion when volume measurements were involved.

Volume-level indicators, as already explained, are used (a) as an aid in compressing the wide dynamic range of an original performance to that of the asso-

ciated transmission medium and (b) for locating the upper part of the dynamic range just within the overload point of an equipment during its normal operation. For the first of these uses, a scale having a wide decibel range is preferable. For the latter purpose, a scale length of 10 decibels is usually adequate. Since a given instrument may be used for both applications, neither too large nor too small a range is desirable in a volume-level indicator for the above purposes. A usable scale length covering 20 decibels appears to be a satisfactory compromise.

It is evident that the instrument scale should be easy to read in order that the peak reached by the needle under the impetus of a given impulse may be accurately determined. The instrument scale, therefore, should be as large as practical since, in the case of the broadcast and motion-picture applications, attention is divided between the action in the studio and the volume indicator.

The instrument-scale graduations should convey a meaning, if possible, even to those not technically inclined but who are, nevertheless, concerned with the production of the program material.

Finally, the scale must be properly illuminated so that the relative light intensity on the face of the instrument is comparable to that on the sound stage. Unless this condition prevails, the eye will have difficulty in accommodating itself with sufficient rapidity to the changes in illumination as the technician glances back and forth from the studio to the volume-indicator instrument.

Existing Scales

The volume-indicator scales most commonly employed in the past are shown in Figs. 12, 13, 14, and 15. It is evident that all these scales differ from each other in one or more respects.

The color combinations employed for the scale shown in Fig. 12 and the simplicity of its markings are outstanding virtues. The division markings and the numerals of the main scale are black on a yellow background. The decibel divisions and associated numerals are in red and considerably less conspicuous than the main scale.

However, the 0-to-60 scale, which is used on both of the instruments shown in Figs. 12 and 13, is an arbitrary one bearing no simple relation to the electrical quantity being measured. Because of this, some of the nontechnical persons concerned with program production are prone to request that a certain "effect" which they desired to transmit at a louder-than-normal level, be permitted to swing the indicating needle beyond the normal reference point of "30" on the scale. It is not evident to them from the instrument scale that the normal reading of "30" corresponds to maximum "undistorted" output of the system.

The scale shown in Fig. 14, on the other hand, was primarily intended for steady-state and not volume-

level-measurement purposes. Consequently, this scale has little, if anything, to commend it for program monitoring use. Nevertheless, the simplicity and the fine electrical features of this type of instrument, together with its relatively reasonable cost, has resulted in its general application to volume-indicator service. It is evident, however, that the scale card which con-

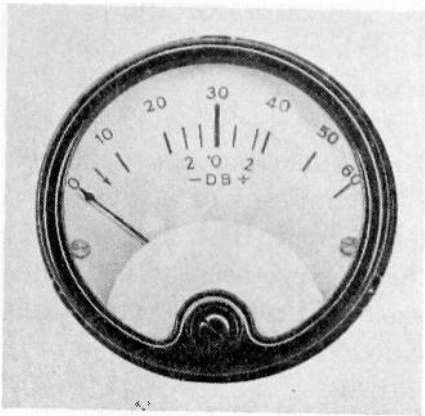

Fig. 12—Scale on 203C volume indicator.

tains all kinds of identification data, is entirely too confusing for quick, accurate observations as the needle swings rapidly back and forth across the scale.

The scale shown in Fig. 15 has the merit of simplicity and easy readability. It is, however, somewhat limited in the decibel range appearing on the scale.

New Scale

Both vu^5 and markings proportional to voltage are incorporated in the new instrument scale. The need for the former is obvious, but the philosophy which leads to the inclusion of the latter requires an explanation.

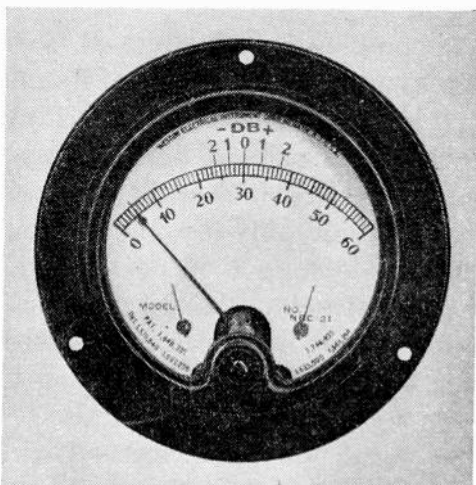

Fig. 13—Scale on type 21 volume indicator.

It is evident, assuming a linear system, that the voltage scale is directly proportional to percentage modulation of a radio transmitter upon which the program is finally impressed. If the system is adjusted for complete modulation for a deflection to the 100

⁵ Defined below.

per cent mark, then subsequent indications show the degree of modulation under actual operating conditions. In the interests of best operation, it may be desirable, of course, to adjust the system for somewhat less than complete modulation when the 100 per cent indication is reached.

In any event, the indications on the voltage scale always show the *percentage utilization of the channel*. This is a decided advantage because everyone involved has a clear conception of a percentage indication: Furthermore, since the scale does not extend beyond the 100 per cent mark (except in the form of a red warning band) and since it is impossible to obtain more than 100 per cent utilization of the facilities, there is no incentive on the part of nontechnical people connected with program origination, to request an extra loud "effect" on special occasions.

Actually, two scales, each containing both vu and voltage markings, have been devised. One of these known as the type-A scale, Fig. 16, emphasizes the vu markings and has an inconspicuous voltage scale. The second, known as the type-B, Fig. 17, reverses the emphasis on the two scales. This arrangement permits the installation of the instrument which features the scale that is most important to the user, while retaining the alternate scale for correlation purposes.

The new scale retains the simplicity and the general color scheme of the former Fig. 12 scale. The main divisions markings and the associated numerals are, in each case, in black. The secondary data are smaller (and in one case, are in red) and therefore less conspicuous than the others. All irrelevant markings have been omitted from the scale.

The color of the scale card, which is a deep cream,

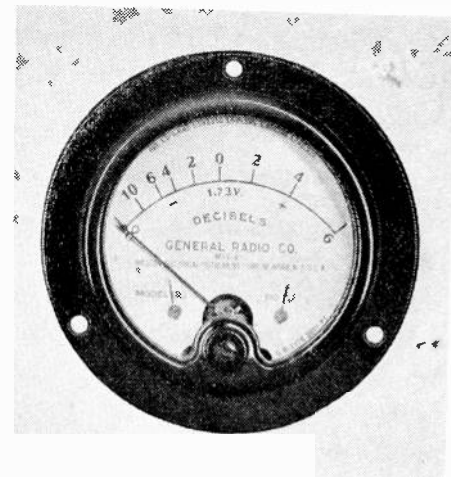

Fig. 14—Scale on type 586 power-level indicator.

seems to be a satisfactory compromise between high contrast and reduced eyestrain and fatigue. This choice is based upon the preference of a large group of skilled observers and upon the reports of certain societies for the improvement of vision. The use of matte-finished instrument cases having fairly high reflection

coefficients, such as light grey, is also desirable for ease of vision.

The location of the "reference" point is such that 71 per cent of the total scale length is utilized as compared to only 42 per cent in former instruments. This feature, combined with the use of a larger sized instrument results in a useful scale more than 2.5 times the length of former scales.

Although the reference point is no longer in the traditional vertical or near-vertical position, it has been found that even those who have long been accustomed to the old arrangement, soon discover the advantages of the new scale. This is attested, in the case of the broadcast application, by the general acceptance of this scale by the personnel of stations located in all sections of the country.

A small but important feature of the new scale is the use of an arc to connect the lower extremities of the vertical black division marks. This arc affords a natural path along which the eye travels as it watches the needle flash up and down the scale. The omission of this arc would result in a number of vertical division marks, hanging in space, as obstacles to the free back-and-forth motion of the eye.

It is evident upon comparison of Figs. 12, 13, 14, and 15 with Figs. 16 and 17 that the dynamic volume range visible on the scale is at least twice as great as on former instruments. This range, as already explained, is a good median value for general use.

Mention was made of the opinions of a group of skilled observers. This group consisted of more than 80 broadcast technicians who, in the performance of

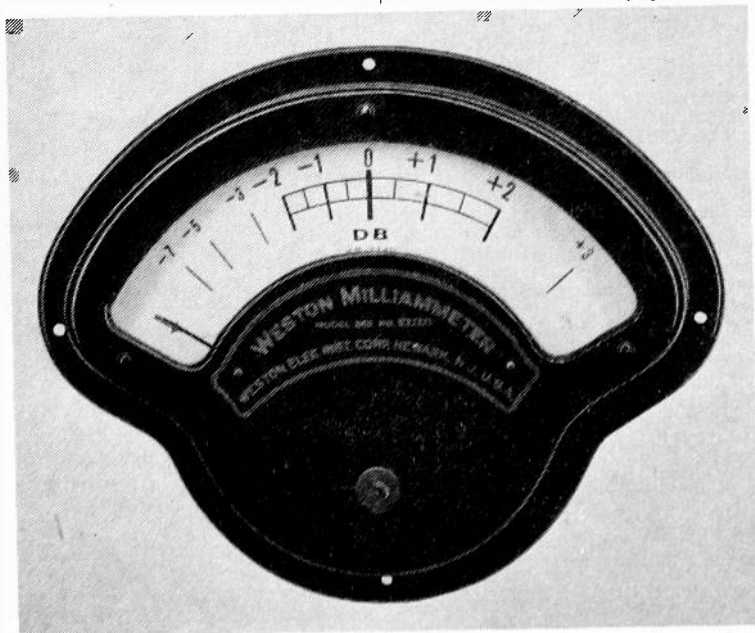

Fig. 15—Type of scale used on 1G and 700A volume indicators.

their duties, watch volume-indicator instruments almost continuously throughout the working day. The opinions of this group were obtained by submitting working models for their individual considerations. It is believed that some of the results of these observations are of interest.

(a) 83 per cent preferred the cream in place of a white scale card.

(b) 90 per cent preferred the "0-100" scale to the "0-60" scale.

(c) 92 per cent preferred the longer scale length (3.5" versus 2.36").

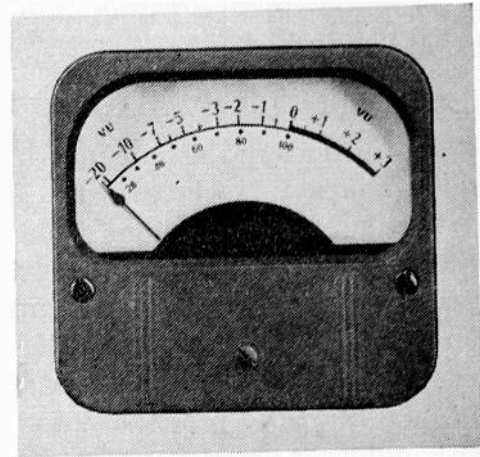

Fig. 16—New volume indicator—A scale.

(d) 97 per cent preferred the numerals placed above the arc.

(e) 50 per cent preferred the spade pointer to the lance type.

(f) 93 per cent agreed on the adequacy of 3-decibel leeway above the reference point.

NEW REFERENCE LEVEL AND TERMINOLOGY

Having agreed on the characteristics of the new standard volume indicator, the interests of complete standardization call for agreement, as well, upon a uniform method of use and a uniform terminology. Agreement upon a uniform method of use must include establishing the reference-volume or zero-vol-

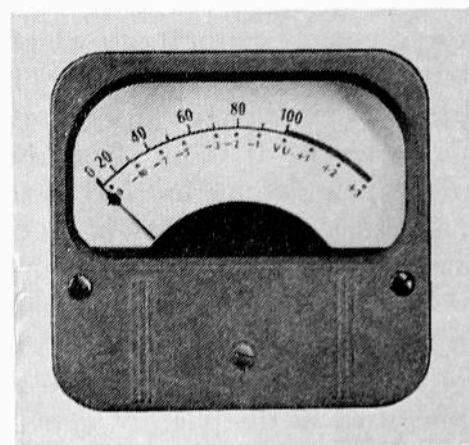

Fig. 17—New volume indicator—B scale.

ume level to which the readings are to be referred and agreeing upon the technique of reading the volume indicator.

It is important to appreciate that "reference volume" is a useful practical concept, but one which is quite arbitrary and not definable in fundamental

terms. For example, it cannot be expressed in any simple way in terms of the ordinary electrical units of power, potential, or current, but is describable only in terms of the electrical and dynamic characteristics of an instrument, its sensitivity as measured by its single-frequency calibration, and the technique of reading it. In other words, a correct definition of reference volume is *that level of program which causes a standard volume indicator, when calibrated and used in the accepted way, to read 0 vu.*⁷

It is especially cautioned that reference volume as applied to program material should not be confused with the single-frequency power used to calibrate the zero volume setting of the volume indicator. If a volume indicator is calibrated so as to read zero on a sine-wave power of, say, 1 milliwatt in a stated impedance, a speech or program wave in the same impedance whose intensity is such as to give a reading of zero will have instantaneous peaks of power which are several times 1 milliwatt and an average power which is only a small fraction of a milliwatt. It is therefore, erroneous to say that reference volume in this case is 1 milliwatt. Only in the case of sine-wave measurements does a reading of 0 vu correspondent to 1 milliwatt.

It should be emphasized that although it is convenient to measure the performance of amplifiers and systems by means of single frequencies there is no exact universal relationship between the single-frequency load-carrying capacity indicated by such measurements, and the load-carrying capacity for speech and program waves expressed in terms of volume level. This relationship depends upon a number of factors such as the rapidity of cutoff at the overload point, the frequency band width being transmitted, the quality of service to be rendered, etc.

It has already been brought out that in the past there have been a multiplicity of reference volumes differing from each other not only because of the various single-frequency calibrations which have been employed, but also because of the dissimilar dynamic characteristics of the different instruments used to measure volume levels. It is also apparent that the introduction of a new volume indicator whose characteristics are not identical with any of its predecessors inherently means the introduction of a new reference volume no matter how it is calibrated. Therefore, there did not seem to be any compelling reason to make the calibration of the new instrument agree with any of the calibrations used in the past. Moreover, to many there seemed to be some advantage in setting the new reference level at a sufficiently different order of magnitude from those which had been in most common use, so that there will be little chance of confusing the new standards with any of those that went before.

After much thought and discussion, it was agreed that the new reference volume should correspond to the reading of the new volume indicator when calibrated with 1 milliwatt in 600 ohms across which the

volume indicator is bridged. Other calibrating values considered were 10^{-10} watt, 6 milliwatts, and 10 milliwatts, in 600 ohms or in 500 ohms. The value chosen was preferred by a majority of a large number of people who were consulted and in addition was found to be the only value to which all could agree. Some of the reasons for choosing 1 milliwatt (10^{-3} watts) were: (a) It is a simple round number, easy to remember; (b) 10^{-3} is a preferred number⁶; (c) 1 milliwatt is a much-used value for testing power for transmission measurements, especially in the telephone plant, so that choice of this value, therefore, permits the volume indicators to be used directly for transmission measurements.

The choice of the standard impedance of 600 ohms was influenced by the fact that, considering all of the plants involved, there is more equipment designed to this impedance than to 500 ohms.

The question may very well be raised why the reference volume has been related to a calibrating *power* rather than to a calibrating *voltage*, inasmuch as a volume indicator is generally a high-impedance, voltage-responsive device. A reference level could conceivably be established based on voltage and the unit of measurement might be termed "volume-volts." However, volume measurements are a part of the general field of transmission measurements, and the same reasons apply here for basing them on power considerations as in the case of ordinary transmission measurements using sine waves. If the fundamental concept were voltage, apparent gains or losses would appear wherever impedance-transforming devices, such as transformers, occur in a circuit. This difficulty is avoided by adopting the power concept, making suitable corrections in the readings when the impedance is other than 600 ohms.

Having chosen the zero point to which the new volume readings would be referred, the next question to be decided was the terminology to be employed in describing the measurements. As has been pointed out, the past custom of describing the volume measurements as so many decibels above or below reference level has been ambiguous because of differences in instruments and standards of calibration. It was thought, therefore, that there would be less confusion in adopting the new standards if a new name were coined for expressing the measurements. The term selected is "vu," the number of vu being numerically the same as the number of decibels above or below the new reference-volume level. It is hoped that in the future *this new term will be restricted to its intended use so that, whenever a volume-level reading is encountered expressed as so many vu, it will be understood that the reading was made with an instrument having the characteristics of the new volume indicator and is expressed with respect to the new reference level.*

⁶ A. Van Dyck, "Preferred numbers," Proc. I.R.E., vol. 24, pp. 159-179; February, (1936).

The procedure for reading the new volume indicator is essentially the same as that which has always been employed, with the exception that, since the instrument is very nearly critically damped, there need be tolerated fewer overswings above the prescribed deflection. One who is familiar with the use of volume indicators will instinctively read the new instrument correctly. The procedure may be described by stating that the adjustable attenuator, which is a part of the volume indicator, should be so adjusted that the extreme deflections of the instrument needle will just reach a scale reading of 0 on the vu scale or 100 on the per cent voltage scale. The volume level is then given by the designations numbered on the attenuator. If, for any reason, the deflections cannot be brought exactly to the 0-vu mark or 100 per cent mark, the reading obtained from the setting of the attenuator may, if desired, be corrected by adding the departure from 0 shown in the vu scale of the instrument.

Since program material is of a very rapidly varying nature, a reading cannot be obtained instantaneously but the volume indicator must be observed for an appreciable period. It is suggested that a period of 1 minute be assumed for program material and 5 to 10 seconds for message telephone speech, so that the volume level at any particular time is determined by the maximum swings of the pointer within that period.

SUMMARY OF CHARACTERISTICS

In the preceding sections of the paper the considerations which led to the selection of the more-important characteristics of the new volume indicator have been discussed in some detail. In this section a summary will be made, first of the fundamental requirements which must be conformed to by any instrument if it is to be a standard volume indicator according to the new standards and second, of other requirements which have been specified for the new volume indicators which are perhaps matters more of an engineering than of a fundamental nature. These requirements are a condensation of the more important features of the specifications for the new instrument. The Weston Electrical Instrument Corporation generously co-operated in the development, but it is emphasized that the specifications are based on fundamental requirements and are not written on the product of a particular manufacturer. The complete requirements are available to any interested party, and, as a matter of fact, at least one other manufacturer has produced an instrument which meets the requirements.

(A) Fundamental Requirements

1. Rectifier

The volume indicator must employ a full-wave rectifier.

2. Scales

The face of the instrument shall have one of the two scale cards shown in Figs. 16 and 17. Both cards shall have a "vu" scale and a "percentage voltage"

scale. The reference point at which it is intended normally to read the instrument is located at about 71 per cent of the full-scale arc. This point is marked 0 on the vu scale and deviations from this point are marked in vu to +3 and to -20. The same point is marked 100 on the other scale which is graduated proportionately to voltage from 0 to 100.

3. Dynamic Characteristics

If a 1000-cycle voltage of such amplitude as to give a steady reading of 100 on the voltage scale is suddenly applied, the pointer should reach 99 in 0.3 second and should then overswing the 100 point by at least 1.0 and not more than 1.5 per cent.

4. Response versus Frequency

The sensitivity of the volume-indicator instrument shall not depart from that at 1000 cycles by more than 0.2 decibel between 35 and 10,000 cycles per second nor more than 0.5 decibel between 25 and 16,000 cycles per second.

5. Calibration

The reading of the volume indicator (complete assembly as shown schematically in Fig. 18) shall be 0 vu when it is connected to a 600-ohm resistance in which is flowing 1 milliwatt of sine-wave power at 1000 cycles per second, or n vu when the calibrating power is n decibels above 1 milliwatt.

(B) Specific Requirements

1. General Type

The volume indicator employs a direct-current instrument with a noncorrosive full-wave copper-oxide rectifier mounted within its case.

2. Impedance

The impedance of the volume indicator arranged for bridging across a line is about 7500 ohms when measured with a sinusoidal voltage sufficient to deflect the pointer to the 0-vu or 100 mark on the scale. Of this impedance 3900 ohms is in the meter and about 3600 ohms must be supplied externally to the meter.

3. Sensitivity

The application of a 1000-cycle potential of 1.228 volts root-mean-square (4 decibels above 1 milliwatt in 600 ohms) to the instrument in series with the proper external resistance causes a deflection to the 0-vu or 100 mark. The instrument, therefore, has sufficient sensitivity to be read at its normal point (0 vu or 100) on a volume level⁷ of +4 vu.

⁷ There should be no confusion because certain instruments deflect to a scale marking of 0 vu when a level of +4 vu is applied to them. As in previous volume indicators, the 0-vu point on the vu scale is merely an arbitrary point at which it is intended nominally to read the instrument, and the rest of the vu scale represents deviations from the 0-vu point. The volume level is read, not from the scale, but from the indications on the associated sensitivity control when the latter is so set as to give a scale deflection to the 0-vu mark. If a deflection other than 0 vu is obtained, the volume level may be corrected by the deviation from 0 vu shown on the instrument scale. In the present art, it is difficult to make an instrument of the desired characteristics having a sensitivity greater than that indicated.

4. Harmonic Distortion

The harmonic distortion introduced in a 600-ohm circuit by bridging the volume indicator across it is less than that equivalent to 0.2 per cent (root-mean-square).

5. Overload

The instrument is capable of withstanding, without injury or effect on calibration, peaks of 10 times the voltage equivalent to a deflection to the 0-vu or 100 mark for 0.5 second and a continuous overload of 5 times the same voltage.

6. Color of Scale

The color of the scale card, expressed according to the Munsell⁸ system of color identification is 2.93 Y (9.18/4.61).

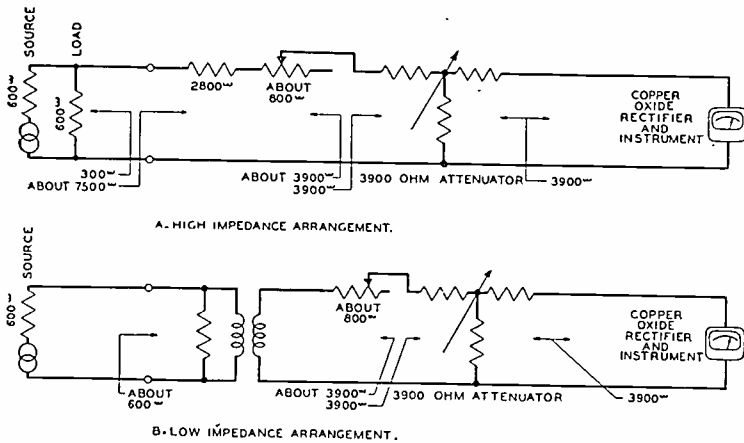

Fig. 18—Circuits for new volume indicator.

7. Presence of Magnetic Material

The presence of magnetic material near the movements of the instruments as now made will affect their calibrations and dynamic characteristics. This is because it has been necessary to employ more powerful magnets than usually required for such instruments to obtain the desired sensitivity and dynamic characteristics, and any diversion of flux to near-by magnetic objects effectively weakens the useful magnetic field beyond the point where these characteristics can be met. The instruments should not, therefore, be mounted on steel panels. (The effect is only slight if they are mounted on 1/16-inch panels with the mounting hole cut away as far as possible without extending beyond the instrument area.)

8. Temperature Effects

In the instruments now available, the deviation of the sensitivity with temperature is less than 0.1 decibel for temperatures between 50 degrees Fahrenheit and 120 degrees Fahrenheit, and is less than 0.5 decibel for temperatures as low as 32 degrees Fahrenheit.

DESCRIPTION OF CIRCUITS

The new instrument by itself does not constitute a complete volume indicator but must have certain

⁸ "Munsell Book of Color," Munsell Color Company, Baltimore, Maryland, (1929).

simple circuits associated with it. Two forms which these circuits may take are illustrated in Fig. 18. One volume indicator may, of course, have both circuits with arrangements to select either by means of a key or switch.

Fig. 18A shows a high-impedance arrangement intended for bridging across lines. As noted above about 3600 ohms of series resistance have been removed from the instrument and must be supplied externally in order to obtain the required ballistic characteristics. This was done in order to provide a point where the impedance is the same in both directions, for the insertion of an adjustable attenuator. A portion of the series resistance is made adjustable as shown by the slide-wire in the diagram. This is for the purpose of facilitating accurate adjustment of the sensitivity to compensate for small differences between instruments and any slight changes which may occur with time. The particular arrangement shown in the diagram has an input impedance of about 7500 ohms and a range of +4 to +26 vu for readings at the 0-vu or 100 mark on the instrument scale.

Fig. 18B shows a low-impedance arrangement in which by adding a transformer the sensitivity has been increased by 10 vu at the expense of decreasing the input impedance to 600 ohms. The circuit is so designed that the impedance facing the instrument is the same as in diagram A, so that the proper dynamic characteristics are obtained. This arrangement, being of low impedance, cannot be bridged across a through

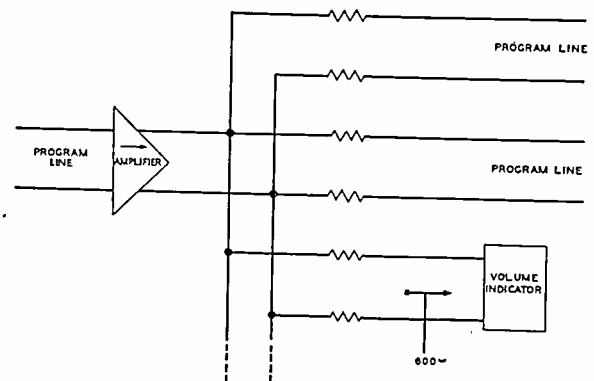

Fig. 19—Program bridge for feeding several lines from one line.

line, but must be used where it can terminate a circuit. It is useful for measuring the transmission loss or gain of a circuit on sine-wave-measuring currents, and also for measurements of volume level where it is connected to a spare outlet of a program bridge circuit, as shown in Fig. 19. Program bridge circuits, one form of which is illustrated in the figure, are commonly employed in the Bell System when it is desired to feed a program from one line simultaneously into a number of other lines. The bridge circuit which is illustrated consists of a network of resistances so designed that the volume level into each of the outgoing lines is the same, that the impedance presented to each is the correct value of 600 ohms, and that the attenuation through the network between any two of the outlets is great.

A picture of a volume indicator which is provided with both of the circuits shown in Fig. 18 is illustrated in Fig. 20.

Fig. 21 shows a group of new standard volume indicators installed in a network key station.

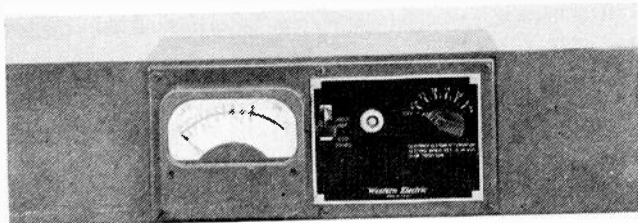

Fig. 20—754B volume indicator equipped with new standard instrument having scale A.

CONCLUSION

This paper has described a new volume indicator which is inexpensive and whose characteristics are thought to represent a good practical compromise for a general-purpose instrument of this kind. It has been commented upon favorably by all who have had any experience with it. It has been adopted as standard by the two largest broadcast companies and the Bell System, and it is hoped that other users of volume indicators will be sufficiently impressed by the merits of the new instrument and by the desirability of standardization in this field to join in its adoption. The new standards are being submitted to the standards committees of the various national organizations for adoption.

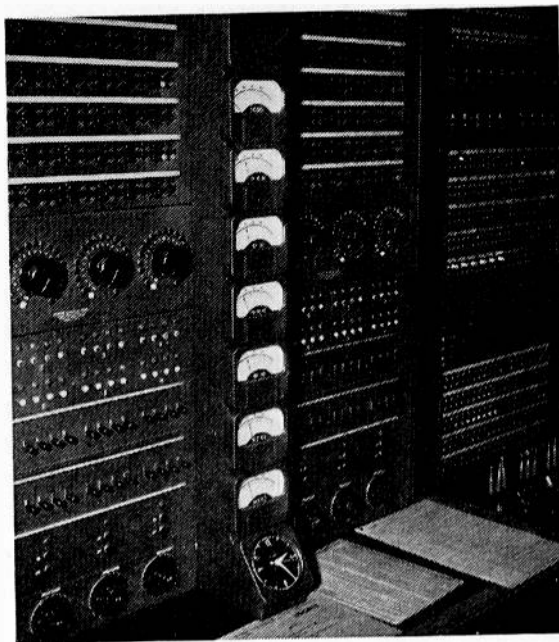

Fig. 21—New standard volume indicators installed at a network key station.

ACKNOWLEDGMENT

Many people contributed to the development which has been described: In particular the authors wish to express their appreciation to Messrs. Robert A. Bradley of the Columbia Broadcasting System, George M. Nixon of the National Broadcasting Company, and S. Brand and Iden Kerney of the Bell Telephone Laboratories, for their important share in the work, and to the Weston Electrical Instrument Corporation for its valued co-operation.

Engineering Administration in a Small Manufacturing Company*

C. T. BURKE†, FELLOW I.R.E.

Summary—In a company manufacturing measuring instruments, engineering must permeate every company activity. This paper describes the engineering organization and administration of such a company.

Company policies (such as the maintenance of employment stability) affecting the operation of the Engineering Department are outlined and data are given on the relative proportion of engineering and other factors in the total cost of the product.

The method of handling development projects, planning costs, placing of responsibility, supervision, and engineering are considered.

Engineering relationships with other departments are described with particular attention to the method of handling production and testing of first lots of a new product.

AT THE outset the writer wishes to disclaim any ambition to generalize in the field of management. The material presented is in the nature of a laboratory report rather than an exposition of principles. This too must be his apology for following so closely the practices of a particular organization.

* Decimal classification: R 005 X R 700. Original manuscript received by the Institute, October 18, 1939. Presented, Fourteenth Annual Convention, New York, N. Y., September 22, 1939.

† Engineering Manager, General Radio Company, Cambridge, Mass.

The company considered is a manufacturer of measuring equipment. The product is sold primarily to technicians and covers a wide variety of applications and industries. It must meet rather exacting requirements of accuracy and dependability. The company is large enough to have world-wide distribution, but not too large to retain a relatively simple organization form.

From the purely practical point of view of those responsible for the management of any department, the first and last problem of management is to produce results satisfactory to those controlling company policies. It is, therefore, necessary to consider first what engineering is expected to contribute to the company plan.

The development of new products on a basis which maintains the company position and provides a basis for profitable operations is an obvious function of this department. In our case, however, engineering plays a vital part in another fundamental company policy—employment stability in all departments of the plant.

This policy, which takes precedence over immediate profits, greatly affects the direction of engineering, and we take some satisfaction in the fact that it is nine years since a man was discharged for lack of work. Since our product is to a degree engineering service, engineering influence must make itself felt in every department, and the engineering department embraces much wider territory than is usual. Sales, for example, are considered an engineering activity, and the sales department is a part of the engineering department.

Our factory workers are a skilled group. No female labor is employed. Adaptability is a necessary requirement for bench workers, since each will work on many different types of instruments in the course of a year. These characteristics are largely gained through long experience in the company employ. Labor turnover is negligible. It is contrary to company policy to make staff reductions because of lack of work, and the last removal for this cause occurred in 1930. At that time discharges were confined to those in the company employ less than one year. As a necessary corollary, caution is exercised in the addition of workers in busier periods. While this policy insures a skilled-labor supply of high morale, it obviously greatly increases the necessity for careful administrative planning. As a matter of fact, the burden rests largely on the engineering department, and its productivity with respect to new instruments is a principal factor in securing stability of employment for the entire plant. Needless to say, we are not in sympathy with the proposal for a moratorium on new developments. The remarkable record of employment stability is in fact due more to constant new developments than to any other factor. Generally about one half of the instruments sold in a given year will have been developed or radically redesigned within two years.

The total staff is just above 200. Of this number, somewhat less than one half are directly "productive" workers. About twenty per cent of the total staff have college degrees, most of them in the engineering field. A substantial proportion have graduate degrees, and there would now be considerable hesitation in employing men without some graduate work for the engineering department.

Obviously these figures imply a formidable overhead factor as applied to direct labor. Fortunately, the company management has recognized that high overhead is a characteristic of good management, and the effort is toward the increase rather than the reduction of this factor. The overhead factor of an organization may be regarded as the ratio of brains to brawn in the product price. It measures the use of machinery and good direction. It is the only dependable source of profit, since labor and material are available to all at about the same price. A manufacturer should get his profit from manufacturing, not from the resale of labor and material. The problem is the effective utilization of overhead rather than its reduction. This is funda-

mentally the problem of management, and so far as it concerns engineering, is the subject matter of this paper.

We are, fortunately, far removed from the situation where profitable company operations depend upon timely purchasing and the manufacturing process is a mere nuisance, conducted at a loss and consisting mostly of labor.

TABLE I
COMPARISON OF EXPENSES IN TERMS OF SALES DOLLAR

	Instrument (one company)	Textile (one company)	Electrical (industry average)	Radio (industry average)
Productive	0.12	—	0.21	0.19
Supervisory- Clerical	0.188	—	0.06	0.043
Total Wages	0.308	0.416	0.27	0.233
Development Engineering Salaries	0.09	—	—	—
Total Engineering Salaries	0.136	—	0.015	0.016
Administration, Sales, General Expense	0.221	0.077	—	—
Salaries Officers	—	—	0.008	0.007
Materials	0.225	0.295	0.40	0.55
Miscellaneous, Depreciation, Taxes, Profits	0.11	0.212	0.32*	0.20*

* Includes administration, sales, and general expenses.

These points are illustrated by comparison of the breakdown of the sales dollar in various industries, shown in the table. Unfortunately, the available figures were not classified so as to permit exactly parallel comparisons, but they are sufficiently detailed to show the general distribution of income. The interesting points are the relationship of productive wages to supervisory and administrative expenses in the several types of companies. It is particularly worth noticing that the amounts paid out in salaries and wages are quite similar in the different industries. The tendency in instrument manufacture is to have a larger proportion of the total payroll in supervisory and technical skills.

It is worth noting that while the material item looms quite large in the expense of the instrument manufacturer, the purchased materials are so numerous and represent in most cases such limited quantities of a single type that large purchasing economies are not possible, and purchasing is directed rather to quality and the location of suitable materials than to price.

It will be remembered that in the plant under consideration only male labor is employed. The result of these policies is the lowest wage cost per dollar of product of any company examined, yet the average annual earnings of shop workers, excluding foremen, is approximately \$2000 during full-time operation.

The object of the engineering administration must be to achieve the company objectives while allowing the widest possible latitude for individual initiative by development engineers. It seems to us that the military type of organization, for example, where the individual contributions of members are completely subordinate to the organization objectives, is particularly unsuited to the management of a group of specialists,

each thoroughly competent in his field. From the narrowest point of view, it is to the organization's advantage to encourage every bit of creative effort on the part of development engineers. Furthermore, any one who is acquainted with the type of individual capable of creative effort in the engineering field will realize that satisfaction with life and working conditions is essential for a high degree of productivity.

With these factors in mind a very loose organization has been developed. While there are loose groupings for administrative and accounting purposes, there is no chief engineer, and no such thing as an organization chart exists. Direction is at a minimum, and a very great responsibility is placed on individuals, not only with respect to immediate problems, but also to a degree as to their own future development. The direction of engineering development consists to a large extent of the co-ordination of effort in harmony with company plans rather than the supervision of technical details.

A type of functional organization has been developed which centralizes responsibility and authority by functions and such authority may be exercised where no personnel authority exists. For example, functional authority over wide ranges of activity is centered in the two committees whose work is shortly to be described.

Obviously, such an organization cannot succeed without a high degree of co-operation. This co-operation does exist, and the interest of the individual engineer in company success is no doubt enhanced by participation in company ownership and profits by all engineers.

The relative success of company operations is brought home to engineers in several ways, most promptly through the monthly pay-roll adjustment known in the organization as "K".

It has been found necessary to impart some flexibility to the engineering pay roll, which is one of the largest items in the company budget. Reduction in engineering personnel in periods of reduced company activity is obviously suicidal in an organization which depends for its existence on the development of new products, indeed engineering personnel is frequently added to in such times in order to speed up the development program. This flexibility has been obtained by monthly salary adjustments. Late in the month, when figures are sufficiently complete to estimate the month's sales total, the "K" factor is set. "K" is a multiplying factor applied to basic monthly salaries. Within a considerable operating range, it is unity. If sales figures indicate operations below the break-even point, "K" is set on a sliding scale below unity. When operations indicate a profit above a certain amount, "K" becomes more than unity. In recent years, it has varied between 0.8 and 1.2, but has averaged slightly above 1. This arrangement permits reduction in expense when necessary, but automatically restores salaries to normal

levels when conditions improve, and yields a bonus "K" in times of abnormal activity. It has so operated that all engineers have averaged slightly better than basic salaries over the two cycles since the system was originated in 1933. Use of the "K" factor has provided all necessary budget flexibility, and no general salary reductions have been made.

In addition to the "K" adjustment, semiannual bonuses are paid when earnings justify it, and company stock is made available to engineers after they have been with the company for a few years.

The planning of the engineering program is a vital function. This responsibility has been entrusted to the Engineering Planning Committee, which includes representatives of management, manufacturing, engineering, and sales. The primary function of this committee is to utilize the engineering time available to best advantage, and to develop a well-balanced program of engineering, consistent with the company program and its manufacturing and sales facilities.

In general a new project is first referred to the Chairman of the Engineering Planning Committee, who makes sufficient preliminary investigation for a comprehensive presentation to the Planning Committee.

The first question asked about a proposed new instrument will probably be whether it is the type of product which is adapted to the company's manufacturing methods. It is obvious from what has been said of the organization that a device requiring no development, which would be manufactured in large quantities to meet a price, with materials representing a large part of the cost, would not be considered suitable for manufacture. Neither would a device which would sell in very small quantities and require excessive individual engineering attention. There is no profit in being a scientific job shop, nor have we found it possible to combine a consulting service with manufacturing. The engineering department must each year turn out enough material to keep the factory employed. Some rough ratio between engineering time and manufacturing time (during the life of the instrument) must be maintained. Referring again to the breakdown of the sales dollar, nine cents worth of development engineering salary must on the average produce twelve cents worth of productive shop wages; otherwise work in the shop will become slack, and it should be remembered that constant level of shop employment is a primary company objective. The ideal instrument is one having a fairly large market and sufficient complexity to give room for the exercise of a reasonable amount of engineering ingenuity. The typical manufacturing lot is 50, and the total manufacture for the life of an instrument is 200 to 2000. The latter figure is rare.

The general status of business is also considered. If the prospects are good for full-shop production, attention will be directed to long-range projects, while a need for shop work will result in concentration on proj-

ects which can be brought quickly to completion.

The matter of marketing must also be considered. We do not have distributors, and if the proposed product is in a field with which our sales organization is not in touch, the expense and possibility of remedying this deficiency must be considered. If it requires excessive individual demonstration or service, the device will generally not be manufactured.

By far the most difficult problem is the relationship of market to development cost. Fortunately, a large part of the market is concentrated or related to known factors (for example, the number of broadcast stations). Past experience with similar instruments, or instruments appealing to the same groups, supplemented by sample inquiries, and a judicious allowance for general business conditions and the outlook for foreign sales, permits a sufficiently accurate estimate of sales to indicate whether or not the project warrants development, and to establish a basis for the distribution of development costs.

The feasibility of estimating in advance the cost of developing an instrument where perhaps only the performance specifications have been established is disputed. Certainly high accuracy in such estimates cannot be expected, and sometimes they will be wide of the mark. But in spite of the admitted difficulty of predicting imponderables, cost records tell us that consistently an instrument of such complexity as to sell for \$500 will cost \$12,000 to \$15,000 to develop. Plans can safely be made on that basis.

The same ratio of development cost to sales price seems to hold roughly over a considerable range of instrument complexity, but it should not be concluded that a device selling for \$10 will cost only \$300 to develop. Parts selling for a few dollars are considered on a different basis from instruments and may involve quite large development costs. They are, of course, not undertaken unless a large market seems available or they are required in our own production.

The cost referred to here is the total cost of development engineering assignable to the project. It includes not only the salary of development engineers, but shop cost of models and the share of building, administration, and general expenses chargeable to engineering. It does not include drafting, supervision of new-instrument production, or similar costs incidental to putting a new product into the plant. For purposes of pricing, development cost is expected to be absorbed in two years' sales.

As a result of its discussion, the Planning Committee may decide (1) that the proposed device should not be developed, (2) that more information is needed (committee members may be delegated to obtain it, or preliminary engineering investigation may be authorized), or (3) that it shall be approved for development and its priority agreed upon.

If it is agreed that a project warrants development, an expenditure is authorized, based on the probable

value and probable cost of the development. The Planning Committee then discusses the general characteristics of the instrument. Specification of design is avoided at this point, but certain basic specifications may be laid down. It might be felt, for instance, that it was futile to produce the device at all unless it had a certain minimum frequency range or a certain maximum error or that the market would be seriously reduced if the price exceeded a certain maximum.

At this point, responsibility for the development is taken over by the Design Committee which consists of the engineering and sales representatives on the Planning Committee. The function of the Design Committee is to detail specifications, and to supervise development with the object of securing an instrument which meets the intentions of the Planning Committee. It is further responsible for co-ordination of design and appearance, the sanctioning of standard practices, and other questions affecting general design. A member of the Design Committee is responsible for the patent policy, including the checking of any existing patents in the field as well as the prosecution of patents when developments justify them.

The project is assigned to an engineer who is rather completely responsible for results. Usually a member of the Design Committee is assigned as a liaison with the development engineer to keep the committee informed as to progress. As a rule, a mechanical engineer is also assigned to advise the development engineer on mechanical design, and to assist in the selection of materials. This mechanical engineer follows the construction of the model in the model shop and also keeps in touch with the new instrument as it progresses through the drafting and trial-production stages.

After the development engineer has had some opportunity to familiarize himself with the problem, he meets with the Design Committee to discuss it, and detailed specifications are laid down. These must, of course, frequently be modified in the course of the development, but in no important detail without the agreement of the Design Committee.

During the course of the development, the Design Committee will review the project as often as necessary. The normal development leads up to a final design conference, which includes the Design Committee, the Development Engineer, and the engineer responsible for supervision of the Drafting Department. At this conference, the instrument is gone over carefully. Its performance in relation to the specifications is considered. Its convenience in use is examined, as well as the general construction. An effort is made to anticipate service and shipping difficulties, and the general appearance is made to harmonize with other instruments of the company's manufacture. The instrument is then approved for drafting and manufacture, with whatever changes have seemed necessary. In the event of unusual difficulties, an increase in the authorized expenditure must be considered, and in exceptional

cases a project may be discontinued. Final action in such cases would usually be taken by the Planning Committee on recommendation of the Design Committee.

There is at present no hard and fast rule as to the condition in which an instrument is turned over to the drafting department. Sometimes a layout of the bread-board type is sufficient, while on other instruments the difficulty in predicting behavior of high-frequency circuits may make necessary the construction and testing of an exact working model before the development can be regarded as complete.

Electrical development of an instrument is usually carried through by a single engineer who may have available the services of an engineering assistant for circuit work and testing. The development engineer works out his problem very largely according to his own ideas within the specifications laid down. Sometimes the instrument is of a type to make it advisable to divide the total development into several sections which are assigned to different engineers, resulting in the speeding up of the development. When a development is so divided, one of the engineers concerned assumes over-all responsibility for it.

More than one, but generally not more than three projects are assigned to an engineer for active work at a time. It is assumed that not all of the engineer's time will be devoted to assigned subjects. For purposes of estimating time for completion of a project, it is assumed that 60 per cent of the engineer's time is spent on assigned projects. Not only will time be taken for correspondence, and such activities as preparation of papers for and attendance at engineering meetings, but it is expected that some time will be devoted to preliminary investigations of projects in which the engineer may become interested. Engineers are, of course, expected to exercise reasonable restraint in spending time on jobs without committee authorization.

Engineers work in individual laboratories about 10 × 20 feet equipped with a desk and the usual facilities of bench and storage space. A completely equipped model shop, staffed by seven mechanics, is adjacent to the engineering laboratories.

Strictly speaking, the development is finished when the instrument is given to the drafting department, but actually a great deal more engineering time must go into the instrument before it is ready for the shipping room. Experience shows, in fact, that some 25 per cent of the total engineering expense comes after the instrument is turned over to the drafting department.

While the progress of the new instrument from this point on depends on other departments, engineering relations with them are necessarily close. As drawings are made, frequent conferences are held between the draftsmen and the engineers concerned. The amount of detailed supervision of the drafting process which is required is, of course, a function of the condition in which the instrument was turned over to drafting. The

drafting department is also responsible for incorporating into designs general standards and practices which the Design Committee has established.

Engineering relations with productive departments have presented some problems. The system by which the development engineer went into the shop and got the man at the bench to incorporate afterthoughts in the design had the advantage of directness, but resulted in confusion in later manufacture. It has been found advisable to limit informal contact of this sort and to require all instructions to production departments to clear through formal channels. All production workers are now under strict orders not to pay any attention to informal instructions by engineers.

Drawings are turned over when completed to the regular production department for a small first lot (usually 10 units) to test drawings and tools and to iron out production difficulties. The important point about this arrangement is that this lot is manufactured under regular production conditions. While special production supervision is required, the instrument is out of the control of the engineering department, and out of reach of the development engineer for special nursing. It must go together under production-shop conditions without benefit of the sympathetic touch of the master. When difficulties arise, and they usually do, the development engineer is, of course, called in, and the production department cannot make any significant changes without his consent, but when the changes have been made, the instrument must be built by regular shop labor. As a result of this practice, it is known when this first lot has been completed and passed its tests that a workable instrument, in practicable form for production is available, and production of larger quantities can be undertaken with confidence.

The importance of inspection and testing in the manufacture of instruments need hardly be emphasized. While there are some inspection points in the plant for parts and incoming material, inspection on finished instruments is combined with testing and calibration in the calibration laboratory. The importance and size of this department has grown steadily, both absolutely and in relation to the rest of the organization, as the complication of measuring apparatus has increased.

The calibration laboratory, which includes about 5 per cent of the total personnel, is organized as a division of the production department. Engineering supervision is provided for by an engineer who is responsible for supervision of test methods and equipment. While care and accuracy are the first requirements in this department, much attention has also been given to the development of efficient methods of calibration. A lot of 25 to 50 instruments is generally calibrated at one time, and procedure and equipment are worked out for each instrument to result in a minimum of lost motion and repetition of settings. Detailed test specifications are worked out by the test engineer in co-opera-

tion with the development engineer, for each instrument. Each test is outlined as to method, procedure, equipment, and results.

The treatment of new instruments in the calibration laboratory is analogous to that in the production department. Preliminary testing specifications are worked out between the development and test engineers. It is the responsibility of the latter to see that they are adequate in the light of the established performance specifications of the instrument. The tests are made by the calibration-laboratory personnel, although the development engineer works closely with the calibration laboratory on new instruments; otherwise much time might be lost in searching out circuit difficulties which one familiar with the instrument could spot instantly. The important division of authority is preserved, however. The instrument is in production and out of the development engineer's control. He must make it work so that it will meet the specifications to the satisfaction of the calibration laboratory. Changes in specifications or, unless very minor, in construction cannot be made without the approval of the Design Committee.

It has already been pointed out that engineering directs the products of the company from the inception of an idea until a finished instrument reaches the user. When the new instrument has passed every laboratory test, the engineering department picks it up again. The development engineer has not completed his job until an instruction book has been written, and on some instruments which are complex in nature and diverse in application, that is no small assignment. An engineering publication is maintained having a circulation approaching 20,000 and engineers are expected to furnish material on their activities for it.

Catalogs are another important function. The accurate and complete presentation of specifications in convenient form is essentially an engineering job. It may be of interest that the cost of the company's latest catalog was approximately equal to the original invested capital. Advertising is carried on extensively to many industries. Engineering co-operation is expected, and advertisements are checked by the engineer responsible for the instrument described.

Another group of engineers is engaged in correspondence and applications work, some of them in outside offices. These men must not only advise on applications for current instruments, but are relied upon to

convey information on new developments to the plant.

Another engineering responsibility is the control of inventory, and the issuance of productive orders to the factory. Engineering judgment is especially important in a rapidly developing field where possibility of obsolescence is an important factor in considering inventory. The proper inventory policy is of particular importance in view of the policy of stabilized employment. Employment is sustained during business declines by building up inventories, the existence of which makes it possible to carry over abnormally active periods without hiring additional short-time labor. With some 200 items selling at different rates, and with factors of obsolescence and market saturation to be considered, this function entails many engineering problems.

The Service Department is also a division of the Engineering Department, and reports of trouble in the field are quickly conveyed to the development engineer. Complete records of all service adjustments are maintained and periodically checked.

While purchasing is a production function, close engineering relationship is essential. Purchase specifications are set up on some requirements and are being extended. In other cases, where detailed specifications have not been set up, a source of supply may be specified, and approved sources of supply for many products are being listed.

The organization described has developed to meet a somewhat unique situation, yet the influence of engineering in company management seems certain to increase in all manufacturing companies. The methods have developed, for the organization has to a large degree been molded by conditions and is still developing. Such an organization requires as many types of engineer as there are functions, for it is not to be expected that the talents necessary to cover so wide a field of activities will be found in a single individual. Thus we find some of the old distrust between the development-minded engineer and the application-minded engineer which has always existed between the engineering and sales departments. It is the particular function of the committee form of administration to break down this feeling. The committee, meeting frequently and regularly, provides opportunity for full discussion of differing points of view; since all committee members speak the same language, a solution reasonably satisfactory to all is usually arrived at.

Bridged-T and Parallel-T Null Circuits for Measurements at Radio Frequencies*

W. N. TUTTLE†, ASSOCIATE, I.R.E.

Summary—Bridged-T and parallel-T null circuits may, under some circumstances, be preferable to bridge circuits for radio-frequency measurements as no transformer is required and the generator and detector can have a common grounded terminal. An analysis of the circuits can be made in terms of the transfer impedances of the various possible component T networks so that the nature of possible null conditions becomes evident by inspection. The circuits considered include arrangements suitable for the measurement of resistance, reactance, and frequency, and of the power factor of dielectrics. Some of the circuits, particularly suited to high-frequency work, employ neither coils nor variable resistors.

INTRODUCTION

THE bridged-T circuit is now widely employed in wave-filter design as it provides the equivalent of a symmetrical lattice or bridge network under certain limitations and under conditions where balanced-to-ground operation is not required. In common with the lattice, certain bridged-T structures permit a choice of element values to obtain perfect suppression of a single frequency, even when considerable dissipation is present in the components. This fact is evident from the equivalence relationships between lattice and bridged-T networks developed by Bartlett¹ taken with the familiar conditions of balance of a lattice or bridged network.

This property of true null balance of the bridged-T network has been employed by several investigators^{2,3,4} to improve the rejection characteristics of wave filters, the result being usually accomplished by adding resistances to the filter without making other changes from the design on a pure reactance basis. Moreover, since it can be balanced to give a null indication, the bridged-T network can evidently be used in the same manner as a bridge for alternating-current measurements. The fact that one terminal is common to the input and output circuits is an important advantage, particularly at high frequencies, as no shielded transformer or Wagner ground connection is required.

These two applications of bridged-T null circuits are different in several important respects. In filter design, for example, the reactive elements must be proportioned in such a way as to give desired transmission characteristics over a band of frequencies which may be very wide. The requirements for null transmission

at a single frequency, however, are all that need be considered when the network is used to replace a bridge for measurement purposes. In consequence, the networks which are preferable in the measurement field do not, as a rule, have transmission characteristics which are useful in wave filters. Some of the measuring circuits are essentially reactive networks but resemble compensated resonant circuits rather than compensated filter sections. Others of the circuits make a

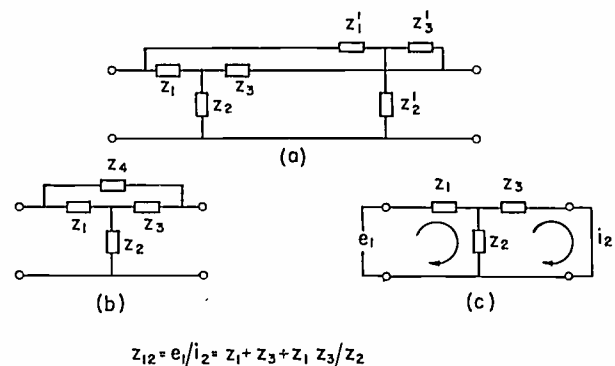

Fig. 1.—The general bridged-T and parallel-T circuits at (b) and (a), respectively, and at (c) the equivalent circuit from which the transfer impedance of a component T network, forming part of a complete circuit, is computed.

more fundamental use of resistance and are analogous to the bridge circuits of measuring technique which have one or more resistive arms, rather than to the lattice sections of filter theory. In view of differences of this kind, it seems desirable to examine in a general way from the measuring-circuit standpoint the possibilities of the bridged-T configuration and of the similar more general parallel-T arrangement in which two or more T-networks have their corresponding terminals connected in parallel.

CONDITIONS FOR ZERO TRANSMISSION

The network marked (a) in Fig. 1 comprises two T sections in parallel and includes as a special case the bridged-T circuit, indicated at (b). When the circuit is balanced to give zero transmission, each of the component T networks plays its part independently of the other, and the null condition is simply that corresponding to equal and opposite transmission through the two components. This is evident from the fact that, as in the case of a balanced bridge, neither the impedance of the generator ahead of the junction point nor that of the common output circuit can affect the balance conditions. At the input, the source impedance must affect equally the voltage applied to both T's, and at the output, no voltage can be developed across the output impedance because, at balance, no current flows through it. In computing the transmission of

* Decimal classification: R 204. Original manuscript received by the Institute, September 26, 1939. Presented, Thirteenth Annual Convention, New York, N. Y., June 16, 1938.

† General Radio Company, Cambridge, Mass.

¹ A. C. Bartlett, "Extension of a property of artificial lines," *Phil. Mag.*, vol. 4, pp. 902-907; November, (1927).

² H. W. Bode, U. S. Patent No. 2,002,216, May 21, 1935.

³ Vernon D. Landon, "M-derived band-pass filters with resistance cancellation," *RCA Rev.*, vol. 1, pp. 93-101; October, (1936).

⁴ W. P. Mason, "Resistance compensated band-pass crystal filters for use in unbalanced circuits," *Bell Sys. Tech. Jour.*, vol. 16, pp. 423-436; October, (1937).

each component T, therefore, it can be assumed that the driving voltage is applied directly at the input and that the output terminals are shorted, as shown at (c). In this case the transfer impedance is simply

$$c_1/i_2 = z_{12} = z_1 + z_3 + z_1 z_3/z_2. \quad (1)$$

For the parallel combination of the two T networks, shown at (a), the null condition is, therefore,

$$i_2 + i_2' = c_1/z_{12} + c_1/z_{12}' = 0 \quad (2)$$

which gives finally,

$$z_{12} + z_{12}' = z_1 + z_3 + z_1 z_3/z_2 + z_1' + z_3' + z_1' z_3'/z_2' = 0. \quad (3)$$

In the case of the bridged-T, shown at (b), the transfer impedance of the second component is simply the impedance of the bridging arm, and the general null condition (3) becomes

$$z_1 + z_3 + z_1 z_3/z_2 + z_4 = 0. \quad (4)$$

Equations (3) and (4) give the null condition for two T networks in parallel and for a bridged-T, respectively. If more than two components are used, (2) can be extended to include similar terms for the additional components. This expression states that the null condition for any number of components in parallel is, simply, that the sum of the transfer admittances shall be zero. In the case of (3) and (4), which refer to only two component parallel networks, the sum of the transfer impedances is also zero, but this is not true in the more general case. The admittance condition, which holds in general, means that the transfer impedances can be regarded as simple impedances connected in parallel between the source and the output circuit as shown in Fig. 2, which is for three T networks in

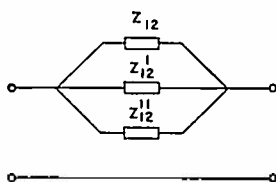

Fig. 2—The null condition for three T networks in parallel corresponds to the three respective transfer impedances in parallel forming an infinite-impedance combination.

parallel. The condition for zero transmission is then evidently that corresponding to infinite impedance of the parallel combination. Analyzing a bridged-T or parallel-T circuit in terms of the transfer impedances of the component elements thus makes it possible to determine by inspection the nature of possible conditions of balance.

It is because the transfer impedances can have properties, such as negative resistance, not realizable in simple impedances that balance conditions are possible. The quotient term appearing in (1) makes evident this possibility. In what follows, the types of transfer impedance which can be obtained with various possi-

ble component T networks will first be discussed, and the properties of parallel combinations then derived by considering the transfer impedances connected in parallel, as in Fig. 2. Although a simplified analysis of this kind does not yield information on the input and output impedances of the combination circuits, and gives only meager information on the transmission properties of the networks at frequencies away from the frequency of balance, it very greatly facilitates the discovery of possible null circuits and the determination of their conditions of balance.

POSSIBLE CIRCUIT ARRANGEMENTS

In Fig. 3 are given schematically the transfer impedances, with formulas, of several T networks which can be employed in combination with each other, or with a simple bridging arm, to form null circuits. The formulas are obtained by straightforward computation from (1).

CONFIGURATION	TRANSFER Z	CONFIGURATION	TRANSFER Z
	$\begin{aligned} C^1 &= C/2 \\ R^1 &= 1/RC^2\omega^2 \\ Q^1 &= 2RC\omega \end{aligned}$		$\begin{aligned} C^1 &= C_1 \\ R^1 &= R(1 + C_2/C_1) \\ Q^1 &= 1/R\omega(C_1 + C_2) \end{aligned}$
	$\begin{aligned} L^1 &= R^2C \\ R^1 &= 2R \\ Q^1 &= RC\omega/2 \end{aligned}$		$\begin{aligned} C^1 &= CR_2/(R_1 + R_2) \\ R^1 &= R_1 \\ Q^1 &= (R_1 + R_2)/R_1 R_2 C\omega \end{aligned}$
	$\begin{aligned} L^1 &= 1/L_p C^2 \omega^4 \\ C^1 &= C/2 \\ R^1 &= -1/R_p C^2 \omega^2 \end{aligned}$		$\begin{aligned} C^1 &= C_1/(2 + C_2/C_1) \\ R^1 &= 1/RC^2\omega^2 \\ Q^1 &= R(2C_1 + C_2)\omega \end{aligned}$

Fig. 3—Transfer impedances with equivalent element values for various T networks suitable as components of bridged-T and parallel-T measuring circuits.

Configuration I is seen to have, at any given frequency, the same transfer impedance as that of a condenser in series with a negative resistance. Configuration II, which employs only resistors and a condenser, has the same transfer impedance as an inductance in series with a positive resistance, and moreover, it is important to note that both the equivalent inductance and the equivalent resistance do not vary with frequency. Configuration III appears to behave like a series-resonant circuit having negative resistance, but the frequency enters into the expressions for both the equivalent inductance and the equivalent resistance. There is, however, a resonant frequency, at which the transfer impedance is a pure negative resistance.

Circuit No. 1

It will be seen, on referring to Fig. 3, that configuration I, consisting of series condensers and a shunt resistor, can be bridged by an arm consisting of a coil alone to form a null circuit. This arrangement is shown in Fig. 4. The balance conditions, which are obtained

immediately by equating to zero the sum of the transfer impedances of the two components, are as follows:

$$L_s = 2/\omega^2 C \quad (5)$$

$$R_s = 1/RC^2\omega^2 \quad (6)$$

from which we obtain for the energy factor

$$Q = L_s\omega/R_s = 2RC\omega. \quad (7)$$

The condition (5) states that the series reactance of the coil must be equal to the reactance of the two condensers in series. This null circuit, therefore, is essentially an antiresonant circuit in series with the line, but having provision for compensating for the effects of dissipation by splitting the condenser and inserting the resistance R .

If the coil has a reasonably large Q so that 1 can be neglected in comparison with Q^2 , condition (6) can be expressed more conveniently in terms of R_p , the equivalent parallel or antiresonant resistance of the coil, as follows:

$$R_p = 4R(1 + 1/Q^2) \approx 4R. \quad (8)$$

This circuit has been found suitable for coil testing and has the following useful properties:

(a) A twin condenser can be calibrated directly in effective tuning capacitance and, except in the case of coils of low Q , a variable resistor can be calibrated in terms of the parallel resistance of the unknown.

(b) Although neither end of the coil under test can be grounded, capacitances to ground from the ends of the coil do not affect the measurements. One of these stray capacitances is across the source and the other is across the detector.

(c) In common with other bridged-T and parallel-T circuits, this arrangement permits the source and detector to have a common grounded terminal and does not require the use of a shielded transformer or Wagner ground connection.

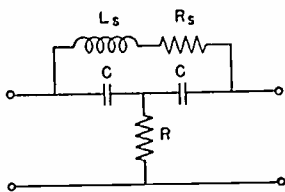

Fig. 4—Circuit No. 1. Bridged-T null circuit equivalent to a compensated antiresonant circuit in series with the line.

(d) The capacitance to ground of one terminal of each condenser does not affect the balance condition for the reason given in (b). One terminal of the resistance is actually at ground potential. Practically the only precautions necessary in the use of the circuit are to prevent direct coupling between the input and output circuits and to prevent excessive stray capacitance from the junction point of the T to ground.

(e) In addition to possible radio-frequency uses, this circuit is particularly suitable for measuring iron-cored coils carrying direct current and operating at specified alternating voltages. If the source and detector can

carry the required direct current, no circuit modification is required. If not, choke coils can be placed across either the input or the output without affecting the balance conditions. At balance, furthermore, no voltage appears across the detector and the entire alternating input voltage appears across the coil. A voltmeter across the input can be used, therefore, to measure the coil voltage without affecting the measurement.

The following properties, on the other hand, may sometimes be disadvantageous:

(a) Since there are no ratio arms, no multiplying factors can be obtained. The condensers must have sufficient range to tune directly any coil that is measured. Moreover, since the two condensers operate in series, the total capacitance required is four times that necessary to tune the coil in a simple resonant circuit.

(b) The balance conditions depend on frequency. The circuit can be made direct reading in inductance only if the frequency is fixed.

(c) When the circuit is balanced for the fundamental frequency of the source it is very greatly out of balance for the harmonics. In many cases a selective detector is required.

(d) The variable compensating resistance, being related to the parallel resistance of the coil, must have a relatively large value and a satisfactory unit may be difficult to obtain.

(e) The stray capacitance from the junction point of the T to ground must be considered when the tuning condensers C are small in value.

The last question needs to be discussed more fully. In (1), the general expression for the transfer impedance, it is seen that z_2 , the impedance from the junction point to ground, appears only once, in the denominator of the third term. If z_2 is paralleled by an additional impedance, z_6 say, the transfer impedance is changed only by the addition of a series term. Since $1/z_2$ is replaced by $1/z_2 + 1/z_6$, then z_1z_3/z_2 will be replaced by $z_1z_3/z_2 + z_1z_3/z_6$. If a stray capacitance C_0 is added in parallel with R in configuration I, the additional series term in the transfer impedance will be

$$z_1z_3/z_2 = -jC_0\omega/C^2\omega^2. \quad (9)$$

In other words, a capacitance having the value C^2/C_0 has been added in series with the previous transfer impedance without any other change. By combining this with the capacitance given in the formula of Fig. 3, a corrected expression can be obtained for the capacitive component of the transfer impedance.

$$C' = (C/2)/(1 + C_0/2C). \quad (10)$$

The stray capacitance C_0 modifies the capacitance term in the transfer impedance without affecting the resistance term. The correction depends only on the ratio of C_0 to the total capacitance of the condensers C , and quickly becomes negligible as the tuning capacitance is increased. Ordinarily it would not be neces-

sary to consider this correction in the case of measurements made with decade condensers at intermediate frequencies. At higher frequencies, where a two-section variable air condenser would ordinarily be employed, the correction can be included, once for all, in the condenser calibration.

This measuring circuit, then, can be set up with two variable elements: one, comprising two condensers operated by a single control, can be calibrated directly in the capacitance required to tune the coil to resonance, and the other, the variable resistance, is a constant factor times the parallel resistance of the coil.

Circuit No. 2

Configuration III in Fig. 3, as has been indicated above, can be adjusted so that its transfer impedance is a pure negative resistance. It can therefore be combined with a bridging arm consisting of a simple positive resistance to form a null circuit. The resulting arrangement is shown in Fig. 5.

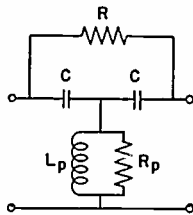

Fig. 5—Circuit No. 2. Bridged-T null circuit equivalent to compensated series-resonant circuit shunting the line.

The condition that the transfer impedance of configuration III shall be a pure negative resistance is satisfied when L' and C' , the equivalent inductance and capacitance of the transfer impedance, are series resonant. Referring to the values given in Fig. 3, this results in the condition

$$L_p = 1/2C\omega^2. \quad (11)$$

The remaining condition of balance is that the bridging resistance R shall be equal to the negative resistance of the transfer impedance of the T giving

$$R_p = 1/RC^2\omega^2. \quad (12)$$

From (11) and (12) the further relation is obtained

$$Q = R_p/L_p\omega = 2/RC\omega. \quad (13)$$

A simple expression can be obtained for the equivalent series resistance R_s of the coil if Q is large.

$$R_s = \frac{R_p}{1 + Q^2} = \frac{R}{4} \left(\frac{Q^2}{1 + Q^2} \right) \approx \frac{R}{4}. \quad (14)$$

Equations (11) to (14) correspond to (5) to (8), respectively, holding for circuit No. 1. The present circuit is essentially a compensated series-resonant circuit shunting the line, just as circuit No. 1 is a compensated parallel-resonant circuit in series with the line. The exact formulas for circuit No. 1 can be ex-

pressed most simply in terms of the series inductance and resistance of the coil, but it is the parallel resistance in the approximate formula that is related directly to the resistive element employed in the network. The relationships are exactly reversed for circuit No. 2, the exact formulas being simplest in terms of the parallel components, and the approximate formula relating the series resistance of the coil directly to the value of the resistive network arm. The numerical factors likewise appear reciprocally in the two circuits.

This circuit, like circuit No. 1, is suitable for measurements of the inductance and resistance of coils, the coil being connected between the junction point of the two elements of a twin condenser and ground. This circuit has several advantages over circuit No. 1, as follows:

(a) Only one quarter as much capacitance is required, as the total of both condenser sections is effective in tuning the coil.

(b) Since the network is the equivalent of a series-resonant circuit shunting the line, the impedance level near balance is low. There is much less possibility of error from electrostatic coupling between the generator and the detector, and there is very little effect on the circuit of the body capacitance of the operator. Adjustments can be made readily without special precautions.

(c) The required variable resistance has a much lower value. An inductively compensated slide-wire or a potentiometer with an Ayrton-Perry type of winding is usually satisfactory.

(d) The variable resistance setting can be read directly as the series resistance of the coil. This is usually preferable to the reading of parallel resistance obtained with circuit No. 1.

In at least one particular this circuit suffers in comparison with circuit No. 1. Stray capacitance from the junction of the T to ground, being directly across the coil, not only makes up part of the total tuning capacitance and so raises the value of the effective minimum that can be obtained, but also disturbs the convenient relationship between the coil series resistance and the resistance of the branch R . The capacitance correction, being an additive constant, is more easily taken into account than in the case of circuit No. 1, the total effective tuning capacitance being simply $2C + C_0$. In fact, as will be clear from Fig. 5, the original calibration can be made to include the correction, and so give directly the total tuning capacitance, by measuring, with the input and output of the network shorted, the total capacitance appearing at the terminals of the shunt arm provided for connection of L_p , R_p , the unknown.

The resistance correction factor can readily be determined. The stray capacitance C_0 is inserted immediately in (11) for the inductance, which then becomes

$$L_p = 1/(2C + C_0)\omega^2. \quad (15)$$

Equation (12) for R_p is unchanged. From (15) and (12), as in (14),

$$R_s = \frac{R}{4} \left(\frac{Q^2}{1+Q^2} \right) \left(\frac{2C}{2C+C_0} \right)^2 \approx \frac{R}{4} \left(\frac{2C}{2C+C_0} \right)^2. \quad (16)$$

The correction term for the resistance unfortunately depends on the setting of the condenser which determines the reactance. This inconvenience limits the usefulness of the circuit for direct measurements of impedance, but has not been found objectionable in an instrument⁵ introduced commercially for the comparison of production coils with a standard sample. In comparing coils of approximately equal inductance, the setting of the resistance R is directly proportional to the coil resistance and inversely proportional to Q . In the commercial instrument referred to, the resistance control is calibrated directly in $R/4$, and a curve is provided giving the resistance correction factor as a function of the condenser setting. The actual coil resistance can be obtained, if desired, by multiplying the reading of the resistance control by the correction factor obtained from the curve.

Circuit No. 2 has an added field of usefulness in substitution measurements. An auxiliary coil can be employed in parallel with a variable condenser in place of the unknown coil indicated in Fig. 5 and a preliminary balance obtained. Coils or condensers of large reactance can then be tested by connecting directly across the condenser and restoring balance by varying only the shunt condenser and the variable resistance R . Suitable fixed condensers can be employed in place of a twin variable condenser for the elements C as they do not have to be varied when the circuit is employed in this manner. The change in the condenser setting gives immediately the parallel reactance of the unknown, and the parallel resistance is obtained from (12) by substituting the increment in R for its total value.

Circuit No. 3

In extending the operation of circuits No. 1 and No. 2 to higher frequencies, one of the most important difficulties is in obtaining a satisfactory variable resistor. Much less difficulty is encountered if fixed resistors are employed and the adjustment of the resistive term obtained by a variable condenser. In Fig. 3 it will be seen that configuration IV offers this possibility. This is an asymmetrical T having one series arm and one shunt arm capacitive, and the other series arm resistive. If the shunt condenser alone is varied the capacitive term of the transfer impedance remains unchanged and the resistive term alone is altered. A parallel-T arrangement combining configurations III and IV is shown in Fig. 6. This circuit is

similar in many respects to circuit No. 2, but avoids the use of a variable resistance.

As in the case of the former circuit, circuit No. 3 can be used either to make direct readings of the reactance and resistance of a coil in terms of the other components of the circuit, or, as shown in Fig. 7, it can be used for substitution measurements with a coil and variable condenser paralleling the unknown. The latter arrangement is particularly convenient, the reactive component of the unknown being in terms of the change in setting of the condenser C_3 and the resistive component in terms of the increment in C_2 .

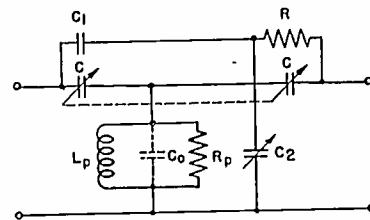

Fig. 6—Circuit No. 3. Parallel-T circuit in which the effect of a variable resistance is obtained by varying the condenser C_2 .

When the circuit is used for direct measurements, as in Fig. 6, the improvement with respect to the resistance adjustment is obtained at the expense of less-simple balance conditions. The constant capacitive term which is now associated with the variable resistive term in the transfer impedance of one of the parallel T's must be compensated for by a detuning of the other component, which contains the coil. The condition on the reactance balance is obtained by equating to zero the sum of the reactive terms of the two components, as given in Fig. 3. The expression for the inductance is

$$L_p = 1/(2C + C^2/C_1)\omega^2 \quad (17)$$

or, taking account of the stray capacitance C_0 from the junction of the condensers C to ground as in (15) for circuit No. 2,

$$L_p = 1/(2C + C^2/C_1 + C_0)\omega^2. \quad (18)$$

The expression for the parallel resistance, as before, requires no correction for the stray capacitance,

$$R_p = 1/R(1 + C_2/C_1)C^2\omega^2. \quad (19)$$

The expression for the series resistance of the coil becomes

$$R_s = \frac{R_p}{1+Q^2} = \frac{R}{4} (1+C_2/C_1) \left(\frac{Q^2}{1+Q^2} \right) \left(\frac{2C}{2C+C^2/C_1+C_0} \right)^2. \quad (20)$$

Although these equations appear complex, the resistance adjustment is accomplished by varying C_2 , and does not affect the reactance balance. The twin condenser C can still be calibrated directly in terms of total effective tuning capacitance. As with circuit No. 2, the resistance reading must be corrected by a factor

⁵ W. N. Tuttle, "A new instrument and a new circuit for coil or condenser checking," *Gen. Rad. Exp.*, vol. 12, pp. 1-7; August-September, (1937).

depending on the condenser setting. The two calibrations which are required can be readily computed from direct-capacitance measurements made at a low frequency, and this preliminary operation is for many applications well justified by the ease with which balance settings can be obtained and by the relative freedom of the network from other sources of error.

When circuit No. 3 is used for substitution measurements, as shown in Fig. 7, an auxiliary coil must be employed, but its constants do not enter into the determination of the unknown impedance, which in this case may be either inductive or capacitive. A balance is first made on the auxiliary coil with the unknown

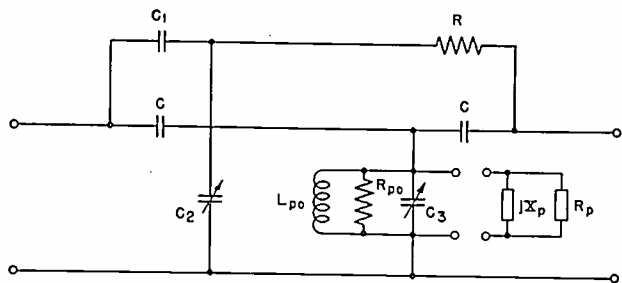

Fig. 7—Modification of circuit No. 3 for substitution measurements.

impedance disconnected, the conditions being then as in Fig. 6 except that the condensers C are fixed and the reactance adjustment is made by varying C_3 across the coil. After the preliminary balance, the unknown impedance is connected in parallel and balance restored by adjustment of the two condensers C_2 and C_3 .

In (18) it has been shown that the total effective tuning capacitance is independent of the value of C_2 . The variation of the condenser C_3 thus measures directly the parallel reactive component of the unknown impedance, for if C_{20} and C_{30} are the capacitance settings of the two variable condensers when balance is obtained on the auxiliary coil L_{p0} , R_{p0} alone, and C_2 and C_3 are the corresponding settings after the unknown impedance R_p , jX_p has been connected in circuit, (18) becomes for the two cases, respectively,

$$1/L_{p0}\omega = (2C + C^2/C_1 + C_{30})\omega \quad (21)$$

and

$$1/L_{p0}\omega + 1/X_p = (2C + C^2/C_1 + C_3)\omega \quad (22)$$

and the difference between these equations gives

$$1/X_p = (C_3 - C_{30})\omega. \quad (23)$$

The parallel resistive component can be similarly calculated from (19), which becomes for the preliminary and final balances, respectively,

$$1/R_{p0} = RC^2\omega^2(1 + C_{20}/C_1) \quad (24)$$

and

$$1/R_{p0} + 1/R_p = RC^2\omega^2(1 + C_2/C_1) \quad (25)$$

the difference giving

$$1/R_p = RC^2\omega^2(1 + (C_2 - C_{20})/C_1). \quad (26)$$

If ΔC_3 and ΔC_2 are introduced in (23) and (26) to designate the increments in the capacitive settings of C_3 and C_2 , respectively, the following expressions for the two components of the unknown impedance are obtained:

$$X_p = 1/\omega\Delta C_3 \quad (27)$$

$$R_p = 1/R(\Delta C_2/C_1)C^2\omega^2. \quad (28)$$

Equation (27) confirms that as far as the reactance balance is concerned circuit No. 3 arranged for substitution measurements operates exactly as does the corresponding arrangement of circuit No. 2. It is evident, however, when (28) is compared with the corresponding equation (12) of circuit No. 2 that the ratio of the increment in the capacitance C_2 to that of the fixed condenser C_1 has been introduced as a multiplying factor for the standard resistance. The setting of the condenser C_2 can thus be taken to determine the resistive component of the unknown impedance and, moreover, the required settings of the two condensers C_2 and C_3 , determining the two components, are independent of one another.

Circuit No. 3 in the form for substitution measurements has proved simple to set up and convenient to operate. Not only are the two components of the unknown impedance determined independently in terms of two variable-condenser settings, but both of these condensers are simple single-element units having one grounded terminal. The general advantages outlined earlier of the bridged-T and parallel-T circuits with respect to the common grounded terminal for source, detector, and unknown seem to be attained without any serious compensating disadvantages. The high-frequency limit of satisfactory operation, as a result of the circuit simplification, becomes essentially the limit at which satisfactory operation can be obtained from the circuit elements themselves. As an example, the residual series resistance and inductance of the condenser employed for the reactance balance affects the results in the same way that it does for the parallel-resonance methods of measurement discussed by Sinclair.⁶ A following paper by him will cover in more detail the effect of residuals in the elements on the accuracy of the results which can be obtained with circuit No. 3 arranged for substitution measurements and will give design details of an instrument suitable for operation at frequencies up to 30 megacycles.

Circuit No. 4

In addition to the circuits which have been described employing one or more coils, parallel-T null combinations are possible which involve only condensers and resistors. Fig. 3 shows that the parallel combination of configurations I and II can be adjusted for null transmission, because the two transfer impedances are,

⁶ D. B. Sinclair. "Parallel-resonance methods for precise measurements of high impedance at radio frequencies and a comparison with the ordinary series-resonance methods," Proc. I.R.E., vol. 26, pp. 1466-1497; December, (1938). See page 1476.

respectively, a capacitive reactance in series with a negative resistance, and an inductive reactance in series with a positive resistance. The resulting combination is shown in Fig. 8. The balance conditions can be obtained, as with the other circuits discussed, by equat-

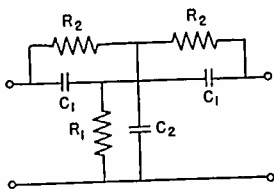

Fig. 8—Parallel-T circuit analogous to the Wien bridge and requiring no coils.

ing the real and imaginary terms of the transfer impedances computed from the equivalent element values of Fig. 3. For the reactive components

$$2/C_1\omega = R_2^2 C_2\omega \quad (29)$$

and for the resistive components

$$1/R_1 C_1^2 \omega^2 = 2R_2. \quad (30)$$

If (29) is divided by (30) the relation is obtained

$$C_2/2C_1 = 2R_1/R_2 = Q^2. \quad (31)$$

The quantity Q , which is the ratio of the reactance to the resistance of the transfer impedance, must be the same for both the component T's at balance. It makes a convenient design parameter, the expressions for three of the impedances in terms of the fourth being as follows:

$$1/C_1\omega = QR_2 \quad (32)$$

$$2R_1 = Q^2 R_2 \quad (33)$$

$$2/C_2\omega = R_2/Q. \quad (34)$$

From these equations it is evident that if Q is made unity a network results for which the reactance of the series condensers of the first component T is equal to the resistance of the series arms of the second component. The shunt impedances of the two networks are likewise equal, but are equal to half the series impedances. From (32) to (34),

$$R_2 = 2R_1 = 1/C_1\omega \quad (35)$$

$$C_2 = 2C_1. \quad (36)$$

The balance conditions for this network are similar to those for the Wien bridge, which has for one arm a condenser in parallel with a resistor, and for another arm a condenser in series with a resistor. The balance conditions of the Wien bridge depend on frequency, balance occurring at the frequency for which the power factors of the two arms referred to are equal. In consequence, this bridge has been used by Field⁷ in an instrument developed for the measurement of audio

frequencies by employing a two-gang resistor, calibrated directly in frequency, as the variable element.

When the parallel-T circuit of Fig. 8 is used like the Wien bridge for frequency measurement, the advantage of not requiring a transformer is partly offset at audio frequencies by the necessity for varying three elements simultaneously instead of only two. The arrangement is perfectly feasible, however, and has been recently adopted by Scott^{8,9} in a degenerative selective amplifier and oscillator where phase shifts in a transformer would make its use undesirable.

At radio frequencies, however, the parallel-T equivalent is more preferable to the Wien bridge and makes possible a very simple frequency meter which does not require any coils. A three-gang variable condenser in conjunction with three fixed resistors is all that is required, and the frequency band can be changed as desired by substituting different sets of resistors. The element values may be chosen to satisfy (35) and (36), corresponding to $Q=1$, or another value of the parameter may be preferable to satisfy particular requirements. For example, all three condensers may be made equal by taking $Q=1/\sqrt{2}$ in (32) to (34), and for this case the series resistances must be four times the value of the shunt resistance. On the other hand the three resistances may be made equal by having the capacitance of the shunt condenser four times that of the series condensers, this arrangement corresponding to $Q=\sqrt{2}$.

In addition to applications for frequency determination and measurement, circuit No. 4 can also be employed for measurements of impedance, such as of resistors and condensers for high-frequency applications. The wide latitude which is possible in the choice of the parameter Q , not only simplifies the selection of suitable circuit elements to make up the network, but also makes it possible to increase the sensitivity of the balance adjustment to whichever component is of the greatest interest.

Since the writer's study of this circuit, his attention has been called to an application by Augustadt¹⁰ to power-supply filtering.

CONCLUSIONS

The examples which have been given of measuring circuits of the bridged-T and parallel-T types show that such circuits can be applied to a wide variety of measurement problems. It is believed that circuits of this kind will be increasingly used and should be considered for possible advantages whenever new measurement problems are encountered, particularly at high or radio frequencies.

⁸ H. H. Scott, "A new type of selective circuit and some applications," *Proc. I.R.E.*, vol. 26, pp. 226-235; February, (1938).

⁹ H. H. Scott, "An analyzer for noise measurement," *Gen. Rad. Exp.*, vol. 13, pp. 6-11; February, (1939).

¹⁰ H. W. Augustadt, "Electric Filter," U. S. Patent No. 2,106,785, February 1, 1938.

⁷ R. F. Field, "A bridge-type frequency meter," *Gen. Rad. Exp.*, vol. 6, pp. 1-3; November, (1931).

Electron Optics of Cylindrical Electric and Magnetic Fields*

ALBERT ROSE†, ASSOCIATE, I.R.E.

Summary—Some preliminary experiments on electron-image formation led to the arrangement of a photocathode and fluorescent target in the same plane and immersed in the magnetic field of a large horseshoe magnet to form an electron image of an optical picture projected on the photocathode. In this arrangement, an opaque photocathode may be used; the fluorescent image may be viewed from the bombarded side; and light from the photocathode is prevented from falling directly on the fluorescent screen. An analysis of the motion of electrons in coaxial, cylindrical electric and magnetic fields shows that electrons originating in a plane passing through the axis of the fields may be brought to a focus at another plane passing through the axis for all values of r (distance from the axis) for which the fields are cylindrical. Two limiting cases are considered: case I, for which electrons start with small random emission velocities and are accelerated by the cylindrical electric field to the anode target; and case II, for which the electrons start with a large initial ϕ velocity in addition to their small random emission velocities and move in an electric-field-free space to the anode target. In both cases a cylindrical magnetic field is used to focus the electrons. The properties of the images formed (cases I and II) are expressed in terms of the order of focus. The most prominent distortion is a shearing of the image in the direction of the axis of the fields. The shear angle varies inversely as the order of focus for both cases I and II. An r magnification is present only in case I and is small, varying inversely as the square of the order of focus. The chromatic aberration for cases I and II is independent of the order of focus for the first five to ten orders (case I) and for the first twenty-five to fifty orders (case II) and is the same as that for a uniform axial electric and magnetic field. For higher orders of focus the chromatic aberration varies inversely as the magnetic field. Case II shows, in addition, a chromatic astigmatism which degenerates into chromatic aberration for high orders of focus. Perturbing electric fields in general cause curvature of the image. The focusing properties, sheer distortion, and chromatic astigmatism are demonstrated by gas-focused electron beams showing the electron paths and their end points. Electron images originating at a photocathode and focused on a fluorescent anode are used to demonstrate shear distortion, variation of resolution over the target, and curvature of the image.

I. INTRODUCTION

IN THE last six years, reports on a variety of vacuum tubes used to form an electron image of an optical picture projected on a photocathode have appeared in the literature.¹⁻¹⁰ While these tubes differ in the particular combination of electric and

* Decimal classification: R 583 X 535.38. Original manuscript received by the Institute, September 21, 1939.

† Research and Engineering Department, RCA Manufacturing Company, Inc., Harrison, N. J.

¹ E. Brüche, "Electron-microscope pictures with photoelectrons," *Zeit. für Phys.*, vol. 86, pp. 448-450; November, (1933).

² G. Holst, J. H. de Boer, M. C. Teves, and C. F. Veenemans, "Transformation of light of long wave-length into light of short wave-length," *Physica*, vol. I, pp. 297-305; February, (1934).

³ P. T. Farnsworth, "Television by electron image scanning," *Jour. Frank. Inst.*, vol. 218, pp. 411-444; October, (1934).

⁴ J. Pohl, "Formation of electron-optical image with photoelectrons," *Zeit. für tech. Phys.*, vol. 15, pp. 579-581; December, (1934).

⁵ W. Schaffernicht, "Conversion of light pictures into electron images," *Zeit. für Phys.*, vol. 93, pp. 762-768; February, (1935).

⁶ W. Heimann, "Electron-optical image-formation of photocathodes as a basis for television pick-up device," *Elekt. Nach.-Tech.*, vol. 12, pp. 68-70; February, (1935).

⁷ W. Kluge, "Suitability of transparent photo-cathodes for electron-optical systems," *Zeit. für Phys.*, vol. 93, pp. 789-791; February, (1935).

⁸ F. Coeterier and M. C. Teves, "Apparatus for transformation of light of long wave-length into light of short wave-length," *Physica*, vol. 3, pp. 968-976; November, (1936).

⁹ V. K. Zworykin and G. A. Morton, "Applied electron optics," *Jour. Opt. Soc. Amer.*, vol. 26, pp. 181-189; April, (1936).

¹⁰ G. A. Morton and E. G. Ramberg, "Electron optics of an image tube," *Physics*, vol. 7, pp. 451-459; December, (1936).

magnetic lenses used to focus the photoelectrons, they are nearly all alike in requiring the optical picture to be projected on a semitransparent photocathode from the back side. It is of interest to consider the type of image tube in which the cathode and target lie in the same plane permitting the optical image to be projected upon an opaque photocathode and the fluorescent image to be viewed on the incident side of the screen.¹¹

In order to arrive at an understanding not only of the operation of this particular type of image tube but also in general of the motion of electrons in curved electric and magnetic fields, an analysis was made of the motion of electrons in the idealized case of cylindrical electric and magnetic fields.

It is the purpose of this paper to present this analysis and to interpret the results of the analysis in terms of experiments performed with image tubes and with electron beams made visible by gas. The problem will be taken up in the following order: solution of the equations of motion for electrons in a cylindrical electric and magnetic field; discussion of the solution; interpretation of the solution in terms of the actual paths made visible by electron beams in gas, and in terms of electron images formed on a fluorescent anode; and discussion of electric perturbation fields.

II. MOTION OF ELECTRONS IN CYLINDRICAL ELECTRIC AND MAGNETIC FIELDS

The problem, with reference to Fig. 1, is to obtain the solution of the equations of motion of an electron starting at r_0 with an initial velocity having compo-

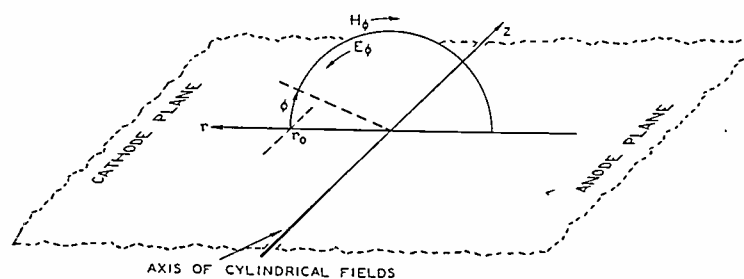

Fig. 1—Co-ordinate system used in the solution for the motion of electrons in cylindrical fields.

nents in three directions, and moving in the cylindrical electric field (E_ϕ) provided by two semi-infinite conducting planes and the cylindrical magnetic field (H_ϕ) provided by two semi-infinite pole faces of infi-

¹¹ During the course of this work, the paper by F. Coeterier and M. C. Teves (footnote 8) appeared in which a type of image tube is described which permits the light to be projected on an opaque photocathode mounted normal to the plane of the fluorescent screen.

nite permeability. The equations of motion in cylindrical co-ordinates are

$$m\ddot{r} - mr\dot{\phi}^2 = H_\phi e \dot{z} \quad (1a)$$

$$mr\ddot{\phi} + 2m\dot{r}\dot{\phi} = -E_\phi e \quad (1b)$$

$$m\ddot{z} = -H_\phi e \dot{r} \quad (1c)$$

where e is the absolute value of the charge of the electron, and m is the mass of the electron.

$$\text{Let } \alpha \equiv \frac{H_\phi e}{m} r = \frac{H_\phi^0 e}{m} \quad (2a)$$

$$\beta \equiv \frac{E_\phi e}{m} r = \frac{E_\phi^0 e}{m} \quad (2b)$$

where H_ϕ^0 and E_ϕ^0 are constants, since H_ϕ and E_ϕ vary inversely with the radius. H_ϕ^0 and E_ϕ^0 are numerically equal to the magnetic- and electric-field intensities at $r=1$. Then (1) becomes

$$\ddot{r} - r\dot{\phi}^2 - \alpha \frac{\dot{z}}{r} = 0 \quad (3a)$$

$$r\ddot{\phi} + 2\dot{r}\dot{\phi} + \beta/r = 0 \quad (3b)$$

$$\ddot{z} + \alpha \frac{\dot{r}}{r} = 0 \quad (3c)$$

Equations (3b) and (3c) may be integrated at once into

$$r\dot{\phi} = -\frac{\beta t}{r} + v_\phi \frac{r_0}{r} \quad (4a)$$

$$\dot{z} = -\alpha \log_e \frac{r}{r_0} + v_z \quad (4b)$$

where v_ϕ and v_z are the initial ϕ and z velocities. Equations (4) and (3a) combine to give

$$\ddot{r} - r \left(-\frac{\beta t}{r^2} + \frac{v_\phi r_0}{r^2} \right)^2 - \frac{\alpha}{r} \left(-\alpha \log_e \frac{r}{r_0} + v_z \right) = 0. \quad (5)$$

Let

$$\lambda \equiv \beta/\alpha^2 \equiv \frac{E_\phi^0}{(H_\phi^0)^2} \frac{m}{e}$$

$$\eta \equiv \frac{r - r_0}{r_0}$$

$$\xi \equiv \frac{\alpha}{r_0} t = \frac{H_\phi^0 e}{m} t$$

$$\dot{\eta} \equiv \frac{d\eta}{d\xi} \text{ etc.}$$

Note: λ is negative since the electric field is negative. Then (5) becomes

$$\ddot{\eta} - \frac{\left(v_\phi - \frac{\beta}{\alpha} \xi \right)^2}{\alpha^2 (1 + \eta)^3} \frac{\log_e (1 + \eta) - \frac{v_z}{\alpha}}{1 + \eta} = 0. \quad (6)$$

The solution of this equation and the corresponding solutions for z and ϕ will be given for the two special cases to be discussed: case I for which the initial velocities are of the order of thermionic- or photoelectric-emission velocities and the electrons are accelerated by a cylindrical electric field; and case II for which the electric field is zero and the electrons start with a large ϕ velocity in addition to their small random emission velocities. The first-approximation solution for case I is

$$\eta = \frac{v_z}{\alpha} (1 - \cos \xi) + \frac{v_r}{\alpha} \sin \xi + (\lambda \xi)^2 \quad (7a)$$

$$\frac{z - z_0}{r_0} = \frac{v_z}{\alpha} \sin \xi + \frac{v_r}{\alpha} \cos \xi - \frac{1}{3} \lambda^2 \xi^3 \quad (7b)$$

$$\phi = \frac{1}{2} \lambda \xi^2 + \frac{v_\phi}{\alpha} \xi \quad (7c)$$

subject to the conditions that λ , v_ϕ/α , v_z/α , and v_r/α are small so that terms of the order of λ^2 , $(v_\phi/\alpha)^2$, etc., $\lambda^{1/2} v_\phi/\alpha$ etc., may be dropped. These conditions state that if the initial velocities are of the order of thermionic- or photoelectric-emission velocities, then the cylindrical magnetic field at $r=1$ centimeter should be at least one hundred gauss. The restriction on λ is satisfied if orders of focus higher than the first are considered.

In case II, the electric field is zero so that $\lambda \equiv \beta \equiv 0$. The first-approximation solution for this case is

$$\eta = \left[\frac{v_z}{\alpha} + \left(\frac{v_\phi}{\alpha} \right)^2 \right] (1 - \cos \xi) + \frac{v_r}{\alpha} \sin \xi \quad (8a)$$

$$\frac{z - z_0}{r_0} = \left[\frac{v_z}{\alpha} + \left(\frac{v_\phi}{\alpha} \right)^2 \right] \sin \xi + \frac{v_r}{\alpha} \cos \xi - \left(\frac{v_\phi}{\alpha} \right)^2 \xi \quad (8b)$$

$$\phi = \frac{v_\phi}{\alpha} \xi \quad (8c)$$

subject to the conditions that v_z/α , v_r/α , and $(v_\phi/\alpha)^2$ are small so that terms of the order of $(v_z/\alpha)^2$, $(v_r/\alpha)^2$, $(v_\phi/\alpha)^4$, may be dropped. As before, for thermionic- or photoelectric-emission velocities, the cylindrical magnetic field at $r=1$ centimeter should be at least one hundred gauss. The restriction on the initial ϕ velocity is satisfied for orders of focus higher than the first.

Returning now to the original notation for the variables, we have the following solutions:

Case I

$$r - r_0 = r_0 \frac{v_z}{\alpha} \left(1 - \cos \frac{\alpha}{r_0} t \right) + r_0 \frac{v_r}{\alpha} \sin \frac{\alpha}{r_0} t + \frac{\lambda^2 \alpha^2}{r_0} t^2 \quad (9a)$$

$$z - z_0 = r_0 \frac{v_z}{\alpha} \sin \frac{\alpha}{r_0} t + r_0 \frac{v_r}{\alpha} \cos \frac{\alpha}{r_0} t - \frac{1}{3} \frac{\lambda^2 \alpha^3}{r_0^2} t^3 \quad (9b)$$

$$\phi = \frac{1}{2} \frac{\beta}{r_0^2} t^2 + \frac{v_\phi}{r_0} t \quad (9c)$$

Case II

$$r - r_0 = r_0 \left[\frac{v_z}{\alpha} + \left(\frac{v_\phi}{\alpha} \right)^2 \right] \left(1 - \cos \frac{\alpha}{r_0} t \right) + r_0 \frac{v_r}{\alpha} \sin \frac{\alpha}{r_0} t \quad (10a)$$

$$z - z_0 = r_0 \left[\frac{v_z}{\alpha} + \left(\frac{v_\phi}{\alpha} \right)^2 \right] \sin \frac{\alpha}{r_0} t + r_0 \frac{v_r}{\alpha} \cos \frac{\alpha}{r_0} t - \frac{v_\phi^2}{\alpha} t \quad (10b)$$

$$\phi = \frac{v_\phi}{r_0} t. \quad (10c)$$

If, in (9) and (10), t is set equal to the transit time T , the equations give $r - r_0$ and $z - z_0$ at the target surface (referred to below as $r_T - r_0$ and $z_T - z_0$). In order that the effects due to the curved fields can be separated out from effects due to the random initial velocities, the transit time taken from (9c) and (10c) without the random initial velocity is used for the distortion terms while the transit time with the random initial velocities is used for the chromatic aberration terms. The terms of (9a, 9b) and (10a, 10b) may be tabulated as below using the appropriate transit times taken from (9c) and (10c).

Distortion

	$r_T - r_0$	<i>Drift Terms</i>	$z_T - z_0$	
Case I	(a)		(b)	
$\left[\begin{array}{l} \text{Initial velocity} = 0 \\ T = \left(\frac{2\pi}{-\beta} \right)^{1/2} r_0 \end{array} \right]$	$-2\pi\lambda r_0$		$-\frac{1}{3}(-\lambda)^{1/2}(2\pi)^{3/2}r_0$	
	(c)	<i>Phase Terms</i>	(d)	
	* $O[\lambda^2 r_0]$		$O[\lambda^2 r_0]$	
Case II	(e)	<i>Drift Terms</i>	(f)	
$\left[\begin{array}{l} \text{Electric field} = 0 \\ T = \frac{\pi}{v_\phi} r_0 \end{array} \right]$	0		$\frac{\pi v_\phi}{\alpha} r_0$	
	(g)	<i>Phase Terms</i>	(h)	
	$\frac{v_\phi^2}{\alpha^2} \left(1 - \cos \frac{\alpha\pi}{v_\phi} \right) r_0$		$\frac{v_\phi^2}{\alpha^2} \left(\sin \frac{\alpha\pi}{v_\phi} \right) r_0$	(11)
Chromatic Aberration	(i)	<i>Initial Velocity v_r</i>	(j)	
$\left[\begin{array}{l} \text{Case I and} \\ \text{Case II} \end{array} \right]$	$\frac{v_r}{\alpha} \left(\sin \frac{\alpha}{r_0} T \right) r_0$		$\frac{v_r}{\alpha} \left(1 - \cos \frac{\alpha}{r_0} T \right) r_0$	
	(k)	<i>Initial Velocity v_z</i>	(l)	
	$\frac{v_z}{\alpha} \left(1 - \cos \frac{\alpha}{r_0} T \right) r_0$		$\frac{v_z}{\alpha} \left(\sin \frac{\alpha}{r_0} T \right) r_0$	

* For $O[\lambda^2 r_0]$ read order of magnitude of $\lambda^2 r_0$.

III. DISCUSSION OF SOLUTION

If the electrons strictly followed the magnetic lines, the image would be a mirror image of the object. Actually, the deviations of the electrons from the magnetic lines give rise to image distortion and to limited resolution. The solution has correspondingly been separated into distortion terms and chromatic-aberration terms. The distortion terms include those

image errors which are present when all the electrons have the same initial velocity. The chromatic-aberration terms include those errors, appearing as limited resolution, which are due to random initial velocities. A further subdivision is made into the two limiting cases: case I (zero initial velocity and finite electric field), and case II (finite initial velocity in the ϕ direction and zero electric field).

Focusing Conditions

A condition of focus is obtained when electrons diverging with random initial velocities from a point on the object plane converge to a point or disk of small diameter on the image plane. Referring to (9a, 9b) and (10a, 10b), we see that this condition will be obtained if the terms involving the random initial velocities as coefficients are made zero or small. These terms are all harmonic in time and all have the same argument $\alpha t/r_0$. If the transit time T is adjusted so that

$$\frac{\alpha T}{r_0} = 2n\pi \quad (n \text{ an integer}) \quad (12)$$

the terms involving the random initial velocities are identically zero. Equation (12) is the condition of focus. From (9c) and (10c) the transit time, if the random component of ϕ velocity is neglected for the purpose of determining the focusing condition, is

$$T = \begin{cases} \left(\frac{2\pi}{-\beta} \right)^{1/2} r_0 & \text{case I} \\ \frac{\pi}{v_\phi} r_0 & \text{case II.} \end{cases} \quad (13a)$$

$$\frac{\pi}{v_\phi} r_0 \quad \text{case II.} \quad (13b)$$

Inserting the transit time from (13) into (12), we get

$$-\lambda = \frac{1}{2\pi n^2} \quad \text{case I} \quad (14a)$$

$$\frac{v_\phi}{\alpha} = \frac{1}{2n} \quad \text{case II.} \quad (14b)$$

These expressions define the n th-order focus. Values of λ and v_ϕ/α are given in Table I, column 2, for the first five orders of focus.

Distortion

It is evident immediately from

$$r_T - r_0 = -2\pi\lambda r_0 \quad (11a)$$

and

$$z_T - z_0 = -\frac{1}{3}(-\lambda)^{1/2}(2\pi)^{3/2}r_0 \quad (11b)$$

that the condition $\lambda \ll 1$ imposed on the solution corresponds to the physical restriction that the electron remain near the magnetic-field line on which it enters. Making use of (14a) and (14b), we can express

TABLE I
SUMMARY OF PROPERTIES OF CYLINDRICAL ELECTRON OPTICAL SYSTEM WHICH DEPEND ON THE ORDER OF FOCUS

Order of Focus	Focusing Condition ¹	Tangent of Angle of Shear Distortion	r Magnification	Amplitude of Phase Terms	Chromatic Astigmatism ²	
Case I	n	$-\lambda = \frac{v}{(H\phi^0)^2} = \frac{1}{11.3 n^2}$	$-\frac{z_T - z_0}{r_0} = \frac{2}{3} \frac{\pi}{n}$	$\frac{r_T}{r_0} = 1 + \frac{1}{n^2}$	$O\left[\frac{r_0}{n^4}\right]$	$\frac{\delta'}{\delta} = \frac{1}{\pi^2 n^3} \left(\frac{\epsilon}{V}\right)^{-1/2}$
	1*	(15.9×10^{-2})	(2.09)	(2)	$(-)$	(<1)
	2	4.0×10^{-2}	1.05	1.25	$(-)$	<1
	3	1.8×10^{-2}	0.70	1.11	$(-)$	<1
	4	1.0×10^{-2}	0.52	1.06	$(-)$	<1
	5	0.6×10^{-2}	0.42	1.04	$(-)$	<1
Case II	n	$\frac{v_\phi}{\alpha} = \frac{V}{(H\phi^0)^2} = \frac{1}{45.2 n^2}$	$-\frac{z_T - z_0}{r_0} = \frac{1}{2} \frac{\pi}{n}$	$\frac{r_T}{r_0} = 1$	$\frac{r_0}{4 n^2}$	$\frac{\delta'}{\delta} = \frac{1.3}{n} \left(\frac{\epsilon}{V}\right)^{-1/2}$
	1*	(0.5)	(1.57)	(1)	$(25 \times 10^{-2} r_0)$	(29)
	2	0.25	0.79	1	$6.2 \times 10^{-2} r_0$	15
	3	0.17	0.52	1	$2.8 \times 10^{-2} r_0$	10
	4	0.12	0.39	1	$1.5 \times 10^{-2} r_0$	7
	5	0.10	0.31	1	$1.0 \times 10^{-2} r_0$	6

¹ The focusing condition has been expressed in terms of the dimensionless quantities λ and v_ϕ/α (column 2) and, for convenience of application to physical problems, in terms of the ratio of the anode potential in volts to the square of the magnetic-field strength in gauss at $r_0 = 1$ centimeter, namely, $V/(H\phi^0)^2$ (column 3).
² The particular value of 2×10^{-3} has been chosen for ϵ/V so as to compute the values of δ'/δ given in the table. $\epsilon/V = 2 \times 10^{-3}$ corresponds, for example, to electrons having a random initial velocity of 1 electron volt and an anode velocity of 500 electron volts.

* The degree of approximation of the solution is less accurate for the first-order focus than for the remaining orders. The quantities relating to the first order have been put in parentheses to indicate this.

the distortion terms (11a) to (11h) in terms of the order of focus n as follows:

$$\left. \begin{array}{l}
 \text{case I} \left\{ \begin{array}{ll}
 \begin{array}{l}
 (a) \text{ Drift Terms} \\
 \frac{r_0}{n^2} \\
 (c) \text{ Phase Terms} \\
 O\left[\frac{r_0}{n^4}\right] \\
 (e) \text{ Drift Terms} \\
 0
 \end{array} &
 \begin{array}{l}
 (b) \\
 -\frac{2}{3}\pi \frac{r_0}{n} \\
 (d) \\
 O\left[\frac{r_0}{n^4}\right] \\
 (f) \\
 -\frac{\pi}{2} \frac{r_0}{n}
 \end{array}
 \end{array} \right\} (15) \\
 \text{case II} \left\{ \begin{array}{ll}
 (g) \text{ Phase Terms} \\
 \frac{1}{4n^2} \left(1 - \cos \frac{\alpha\pi}{v_\phi}\right) r_0 &
 (h) \\
 \frac{1}{4n^2} \left(\sin \frac{\alpha\pi}{v_\phi}\right) r_0
 \end{array} \right\}
 \end{array} \right.$$

With this substitution, an examination of all the distortion terms of cases I and II reveals that

$$z_T - z_0 = -\frac{2}{3}\pi \frac{r_0}{n} \quad \text{case I} \quad (15b)$$

and

$$z_T - z_0 = -\frac{1}{2}\pi \frac{r_0}{n} \quad \text{case II} \quad (15f)$$

are the most significant. These terms represent a pure shear in the z direction shown in Fig. 2. The angle of shear is

$$\frac{z_T - z_0}{r_0} = \begin{cases} -\frac{2}{3} \frac{\pi}{n} & \text{case I} \\ -\frac{1}{2} \frac{\pi}{n} & \text{case II.} \end{cases} \quad (16a) \quad (16b)$$

The values of this angle for the first five orders of focus for cases I and II are given in Table I, column 4.

The physical significance of the z displacement is this: if the electron is to continue in a circle along one of the magnetic lines, then its radial acceleration v^2/r

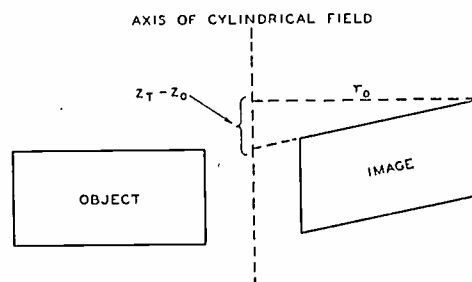

Fig. 2—Schematic diagram of "shear" distortion.

must be maintained by the magnetic force $zeHv_\phi$ arising from motion of the electron in the z direction. The resultant z displacement being proportional to r_0 accounts for the shear distortion. The z displacement is the product of the average z velocity and the transit time. This product turns out, according to (16), to be slightly greater for case I than for case II.

The r -distortion term

$$r_T - r_0 = \frac{r_0}{n^2} \quad \text{case I} \quad (15a)$$

produces a magnification $(1 + 1/n^2)$ of the image along the r axis. Since this term is of the order of $1/n^2$, it will not be as significant as the shear distortion in the z direction. The values of the magnification for the first five orders of focus for case I are given in Table I, column 5. It is to be noted that the corresponding r -magnification term is lacking for case II. The reason for the difference is as follows. Since the electron must maintain each value of radial acceleration v^2/r by a

corresponding magnetic force zeH , then, in case I, the electron must continuously increase its z velocity to maintain its continuously increasing radial acceleration. The resultant acceleration in the z direction, in turn, requires a force reH to maintain it. This velocity in the r direction accounts for the r magnification of case I. By the same argument, case II will show no r magnification since the electron has a constant radial acceleration v^2/r and requires only a z velocity (not a z acceleration) to maintain its radial acceleration.

The terms discussed above have been called "drift terms" because they involve only powers of λ (or n). They are differentiated in this way from the phase terms which have a harmonic factor. Phase distortion is approximately represented by Fig. 3 in which the four circles are cross-section projections on the target plane of the four spiral electron beams originating from the corresponding object points on the left. (See Fig. 8 for a picture of the spiral paths.) According to (11c, d, g, h), the amplitude of the spirals, and consequently the radii of the circles on the target, increase linearly with r_0 . If the electrons originating from the four object points all made an integral number of revolutions before striking the target, they would arrive in phase to form the image line a . If the electrons arrived in phase but made a nonintegral number of revolutions, they would form the distorted image line b . The third possibility represented by c is for the case of the electrons arriving at the target with varying phase. The variation in phase will be present when either the magnetic or electric field is not cylindrical. The amplitude of the phase terms in case I is of the order of r_0/n^4 . Their contribution to distortion is therefore relatively negligible for orders of focus greater than one. Phase distortion is more likely to be evident in case II where the amplitude of the phase terms is $r_0/4n^2$. The amplitude of the phase terms is given in Table I, column 6, for the first five orders of focus of case II. While phase distortion may in general not be noticeable, the same variation in phase which produces phase distortion will be more likely to show itself as a variation in the limiting resolution over the target surface. The following section will make this point clear.

Chromatic Aberration

The condition was imposed in the solution of (1) that $(r-r_0)/r_0 \ll 1$. This insures that the electron will move from cathode to target in a practically constant magnetic field. The approximation is sufficiently good to allow us, for the purpose of computing chromatic aberration, to identify the motion of each electron in the cylindrical field with the motion of an electron in a uniform axial field of the same strength and cathode-anode distance. Further, to the approximation considered here, the mathematical expressions (11i, j, k, l), (9c), and (10c) are of the same form as would

be obtained by starting with a uniform axial magnetic and electric field.¹² For convenience, the derivation of the expressions for chromatic aberration, case I and case II, is given in Appendix A for a uniform axial field. The results are

$$\delta = \begin{cases} 2L \frac{\epsilon}{V} & \text{case I} & (17a) \\ 0.39L \left(\frac{\epsilon}{V}\right)^{3/2} & \text{case II} & (17b) \end{cases}$$

where

δ = diameter of image disk corresponding to a point source

L = cathode-anode distance

ϵ = randomly oriented initial velocity in volts

V = anode potential in volts.

For the case of cylindrical fields, these equations become

$$\delta = \begin{cases} 2\pi r_0 \frac{\epsilon}{V} & \text{case I} & (18a) \\ 0.39\pi r_0 \left(\frac{\epsilon}{V}\right)^{3/2} & \text{case II.} & (18b) \end{cases}$$

The resolution varies across the image inversely as r_0 . If the magnetic or electric field is not truly cylindrical, the condition of focus may not be obtained over the entire target simultaneously. The departures from the condition of focus will appear as areas of reduced resolution.

While the above expressions state that for constant anode voltage the chromatic aberration is independent of the order of focus, this conclusion is true only if the variations in transit time are small compared with the time for one revolution of the electron around the magnetic lines. For thermionic- and photoelectric-emission velocities and for anode potentials of the order of hundreds of volts, this approximation holds

¹² The chief departure from this approximation arises from initial emission velocities in the z direction. These initial z velocities cause the electron to depart on the average from its initial r_0 co-ordinate by a small positive or negative amount Δr . If the radial co-ordinate of the electron is increased the total transit time is increased due to the increase in path length and the decrease in ϕ velocity. The angular velocity of the electron around the magnetic lines is decreased since the electron is in a weaker magnetic field. Conversely, if the radial co-ordinate of the electron is decreased its total transit time is decreased and its angular velocity increased. If we consider the interval between the $n-1$ and n orders of focus to be unity then the fractional departure from focus in the neighborhood of the n th-order focus due to an initial z velocity is of the order of $n(v_z/\alpha)$. The corresponding fractional departure from focus due to an initial ϕ velocity (random component) is of the order of $n(\epsilon/V)^{1/2}$ for case I and $n(\epsilon/V)$ for case II. ϵ is the random initial energy in electron volts and V the anode potential in volts. The approximation considered here is valid, therefore, if

$$\frac{v_z}{\alpha} < \begin{cases} \left(\frac{\epsilon}{V}\right)^{1/2} & \text{case I} \\ \frac{\epsilon}{V} & \text{case II.} \end{cases}$$

for the first five to ten orders of focus, case I, and the first 25 to 50 orders of focus, case II. For higher orders of focus, the variations in transit time are of the order of the time for one revolution of the electron around the magnetic lines, so that the terminal points of the electrons are scattered at random over a disk whose radius is equal to the diameter of the circle formed by an electron moving normal to the magnetic field with a velocity approximately equal to the velocity of emission. The diameter of this circle is mv/He . The resolution in the image plane for sufficiently high orders of focus is, therefore, proportional to the magnetic field strength. Also, at these high orders of focus, the various distortions tend to approach zero (see Table I). To summarize: For sufficiently high orders of focus, that is, when the electric field (case I) or initial ϕ velocity (case II) is made small for a given magnetic field strength, the electrons originating from a point in the object plane substantially move along the magnetic lines in a bundle whose cross section decreases with magnetic field.

Chromatic Astigmatism

The term "chromatic astigmatism" is coined to describe an aberration for which there seems to be no counterpart in the electron optics of thin electron lenses or uniform axial magnetic fields. Astigmatism in the usual thin electron lens is characterized by a difference in focal points between those rays originating from the object point which diverge in a meridian plane and those rays which diverge in a plane normal to the meridian plane. A meridian plane is defined as a plane passing through the optic axis. The significant fact is that a cone of rays diverges from the object point and is focused in general into an ellipse. In the case of cylindrical electric and magnetic fields, the astigmatism in the image is due not so much to the divergence of the cone of rays that leaves the object point as to the difference of ϕ velocities of these rays.

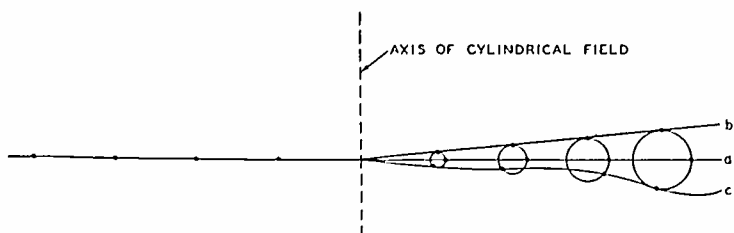

Fig. 3—Schematic diagram of phase distortion.

It is this difference of ϕ velocities which causes the electrons to land at different points on the phase circle (see Fig. 3). For a range of ϕ velocities, then, there corresponds a range of end points along an arc of the phase circle. To each ϕ velocity or each point on the arc of the phase circle, there is associated a set of r and z velocities randomly distributed in magnitude and direction. These r and z initial velocities form a chromatic-aberration disk to be associated with the

corresponding ϕ velocity or end point. The result is that the chromatic-aberration disks due to the r and z velocities are spread out along the arc of the phase circle an amount depending on the spread in ϕ velocities. To see the effect at a glance, one may think first of the chromatic-aberration disks formed in a uniform axial magnetic field. For each ϕ velocity there is a disk; but all of the disks are concentric and go to form a single-image disk. Now, going over to the cylindrical magnetic field, it is found that the same set of disks are present but that they are no longer concentric.

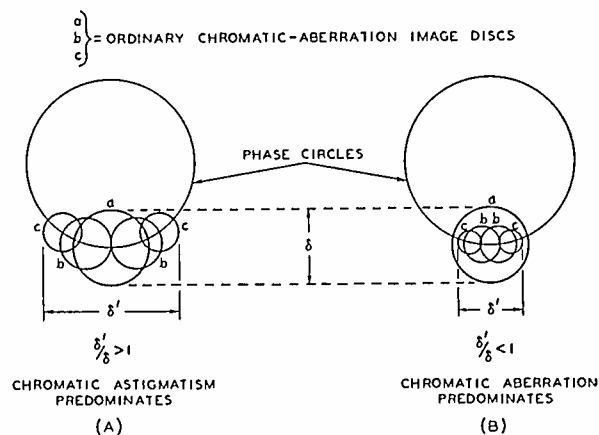

Fig. 4—Two possible types of image errors resulting from random initial velocities of electrons.

The centers of the disks are spread out along an arc of the phase circle an amount depending upon the spread in ϕ velocities. Whether or not a noticeable astigmatism will result will depend upon the ratio of the element of arc δ' along which the image disks are displaced to the diameter of the image disk δ . If this ratio is greater than unity, the image of a point source will appear as in Fig. 4(A). On the other hand, if $|\delta'| < \delta$, the image will be determined by the chromatic aberration discussed in the previous section and appear as a disk (see Fig. 4(B)). For case I, δ'/δ is less than unity for all cases of physical interest because of the small diameter of the phase circle. The size of the image disk will, therefore, be determined by the expressions for chromatic aberration derived in the previous section. For case II, the value of δ'/δ is in general greater than unity and will now be derived.

Since the period of the main spiral (Fig. 8) is the same as that of the spirals formed by initial velocities in the z and r directions, the computation of δ' may be carried out using the same angle ϕ that is computed in Appendix A for δ . While the r (in Appendix A) for δ is mv_n/eH , the r for δ' is the amplitude of the phase terms in expressions (19), namely,

$$\frac{r_0}{4n^2} \quad \text{case II.} \quad (19)$$

The results of this computation are

$$\delta' = \frac{\pi}{2n} \frac{c}{V} r_0 \quad \text{case II.} \quad (20)$$

From (18b) we may write

$$\delta = 0.39\pi r_0 \left(\frac{\epsilon}{V}\right)^{3/2} \quad \text{case II.}$$

Therefore, the ratio δ'/δ is

$$\delta'/\delta = \frac{1.3}{n} \left(\frac{\epsilon}{V}\right)^{-1/2} \quad \text{case II.} \quad (21)$$

The values of δ'/δ are given in Table I, column 7, for the first five orders of focus for case II.

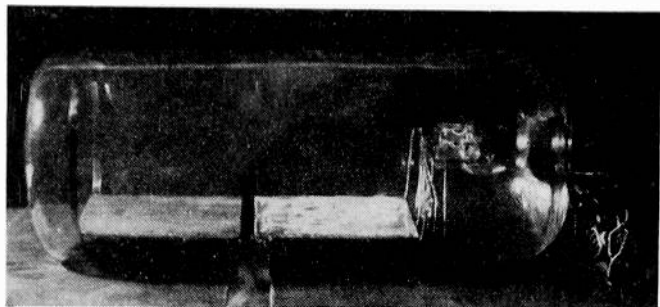

Fig. 5—Tube used to demonstrate electron paths by means of electron beams made visible by gas.

The image of the beam (3) in Fig. 9 shows this chromatic astigmatism clearly. The image appears as a short streak of light on the right. While the images of the other two beams are too diffuse to show this astigmatism in Fig. 9, they do show it when the gas focusing is well adjusted.

IV. EXPERIMENTAL RESULTS

Electron Paths

The tube used to demonstrate the electron paths in a cylindrical magnetic field is shown in Fig. 5. A small

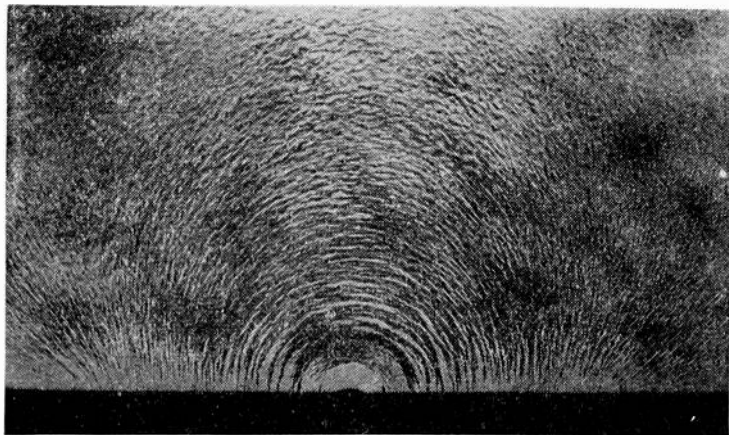

Fig. 6—Iron-filing pattern of magnetic field in the neighborhood of the horseshoe magnet.

electron gun was mounted behind each of three apertures in the plate on the left. The apertures were placed in a line down the middle of the plate parallel with the tube axis. The electron beams were shot into the cylindrical magnetic field provided by the pole faces on which the tube was mounted. The target plate on the right was sprayed with willemite to make the end points of the beams visible. Both plates were

kept at the same anode potential, about +150 volts, and the cathodes of the guns were at ground potential. Several microns of argon in the tube served to make the beams visible. The experimental arrangement in Fig. 5 is thus seen to depart from the conditions set forth in the solution of the equations of motion, not only in that the plates are finite but also in that the electric plates are not in the same plane as the mag-



Fig. 7—Magnetic-field-measuring tube in operation.

netic pole faces. Nevertheless, the important aspects of this type of focusing field are brought out by the electron paths obtained in Figs. 8 and 9.

Fig. 6 is an iron-filing pattern of the magnetic field in which the tube was immersed. For several inches on each side of the axis the field is fairly cylindrical. The magnetic field was further examined for magnitude and orientation throughout the volume of space used in forming the beam paths and electron images by means of the tube shown in Fig. 7. A description of the tube is given in Appendix B because of its unusual convenience as a field-measuring device.

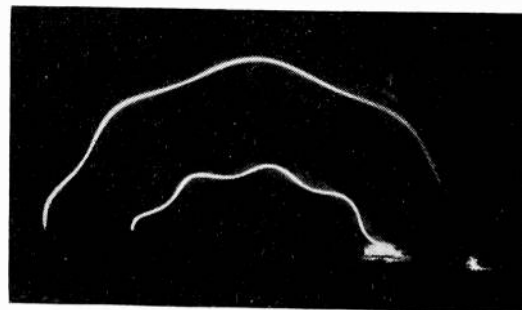

Fig. 8—Paths of electrons in a cylindrical magnetic field.

Fig. 8 shows the paths of two electron beams shot into the cylindrical magnetic field of $300/r$ gauss with 150 volts velocity. Two observations are significant. First, the beams are seen to follow the magnetic lines pictured in Fig. 6. Second, the two paths have the same number of spirals and the spirals are in phase. Equations (10a, b) predict this identity of phase for paths of different radii, providing the magnetic field is cylindrical. The conditions $H=300/r$ gauss and $V=150$ volts correspond to the fourth-order focus which Fig. 8 approximately represents. Fig. 9 shows

the same beams, with the addition of a third beam of smaller radius, as seen from above. The magnetic field has been reduced to $250/r$ gauss to give third-order focus. (The paths of the beams are not as clear as in Fig. 8 due to the difficulty of getting three beams to be in focus at the same time.) The origin and end point of the third inner beam are visible as a light dot on the left and a short streak on the right. This figure shows the drift distortion of the end points in the z direction. The dotted line passing through the three end points has been drawn on the figure to show this drift. Also the distances $z - z_0$ and r_0 have been marked out on the figure. As a rough check of (16b), the ratio $(z - z_0)/r_0$ obtained from the figure may be compared with the ratio computed from (16b) for the third-order focus.

$$\frac{z_T - z_0}{r_0} = \begin{cases} 0.5 & \text{observed} \\ 0.52 & \text{computed.} \end{cases}$$

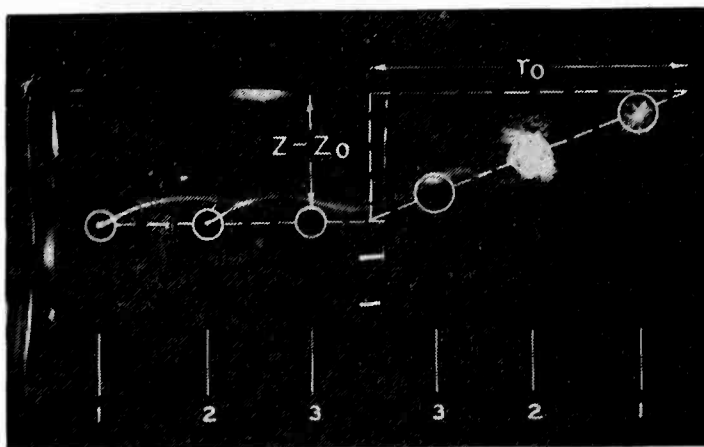

Fig. 9—View looking down on tube in Fig. 5, showing three electron beams starting on the left and ending on the right along a line inclined to the original line (shear distortion).

Another independent check may be obtained by comparing the measured magnetic field strength with the magnetic field strength computed from (14b) for 150-volt electrons and third-order focus. These results are

$$H_\phi = \begin{cases} \frac{250}{r} & \text{gausses observed} \\ \frac{255}{r} & \text{gausses computed.} \end{cases}$$

The agreement is closer than one would expect from the approximations in the experimental arrangement.

Electron Images

The tube used to generate electron images was similar to the tube in Fig. 5 except that the two plates were replaced by a photocathode and a fluorescent screen, both formed on the inside wall of a 4-inch tube. This arrangement allowed the electrodes to be in closer contact with the pole faces of the electromagnet. The tube was thoroughly evacuated.

Fig. 10 shows a single exposure of the optical image on the photocathode (left) and the electron image on the fluorescent screen (right). (Since the photocathode was partially translucent, glass-wall reflection make the optical image appear less sharp than it actually was.) The major type of distortion, a shear in the z direction, is clearly shown. The image was formed with 450 volts on the anode and a magnetic field of $400/r$ gauss. From these values and from measurements on Fig. 10,

$$\frac{z_T - z_0}{r_0} = \begin{cases} 0.37 & \text{computed} \\ 0.32 & \text{observed.} \end{cases}$$

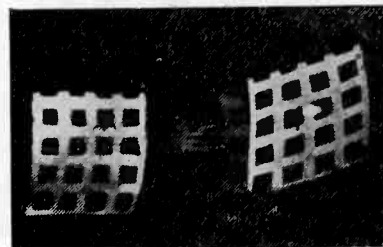

Fig. 10—Shear distortion shown by the electron image on the right of the optical image on the left.

These values are in the neighborhood of the sixth-order focus.

Fig. 11 shows the electron image obtained from a resolution pattern focused on the photocathode. The defocusing on the right and left edges is to be associated with the projection of the original optical image on a curved photocathode, the edges being out of focus when the center is in focus. The resolution is seen to decrease with the increasing r_0 (from bottom to top). Not all of this decrease in resolution is to be

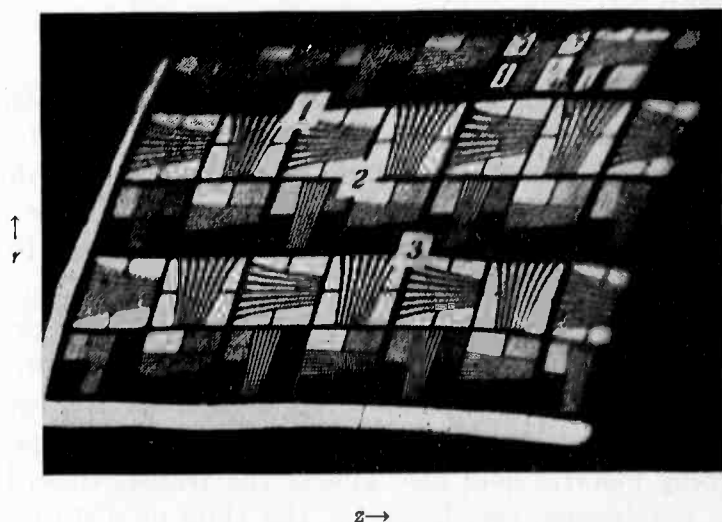

Fig. 11—Electron image of a resolution pattern showing the variation of focus in the r direction and curvature of the image.

accounted for by (18a). Part of it is due to a departure of the electric and magnetic fields from a true cylindrical form. As a result, when the magnetic field was adjusted for good electrical focus near the bottom of the picture, it was slightly off its best focusing value for the top. The resolution at the small end of the smaller wedges corresponds to 100 lines per inch for the 3-inch size of projected picture.

Fig. 12 is a representative electron image¹³ exhibiting the characteristic shear distortion. Both Figs. 11 and 12 were taken at a 450-volt anode potential.

The right edge of Fig. 11 and the lower edge of Fig. 12 instead of forming the straight lines to be expected



Fig. 12—Typical electron image obtained from the image tube using cylindrical fields.

for truly cylindrical fields are actually somewhat curved. The curvature may be ascribed to the perturbation of the end-effect electric field of the finite electrodes. That a relatively uniform perturbing electric field will in general produce curvature of the image can be seen from the argument in the following section.

V. PERTURBING ELECTRIC FIELDS

To a first approximation, an electric field acting on the electron normal to the magnetic field lines will produce a cycloidal drift velocity E/H normal to both the electric and magnetic field. Consider first a uniform perturbing electric field E normal to the magnetic field. Then, since $H_\phi = \text{constant}/r$, the drift velocity will be proportional to r . The observed displacement on the target, however, is the product of the average drift velocity and the transit time. But the transit time is proportional to r also. Consequently, the displacement on the target will be proportional to r^2 or, as stated above, a uniform perturbing electric field will produce curvature of the image. The argument is actually more complex since the perturbing electric field also affects the transit time. In any particular case, however, the type of distortion can be qualitatively predicted knowing the approximate orientation and distribution of the perturbing electric field. In Fig. 12, for example, the right-hand end of the image is displaced laterally more than would be expected from truly cylindrical fields. The sides of the image, instead of being merely inclined, are actually curved near the right end. This type of distortion might be expected because departures of the electric

field from the cylindrical form near the outer ends of the plates provide a perturbing electric field in the radial direction to deflect the image laterally as shown.

VI. CONCLUSIONS

A mathematical analysis shows that coaxial, cylindrical electric and magnetic fields form a true focusing system in the sense that electrons originating in a plane passing through the axis may be reconverged in another plane passing through the axis. A number of orders of focus may be obtained corresponding to a discrete set of values of electric field/(magnetic field)² for electrons starting from rest or of initial velocity/magnetic field for electrons starting with anode velocity. The focusing condition holds for all values of r simultaneously for which the fields are cylindrical. The most noticeable distortion of the image, a shear in the z direction, varies inversely as the order of focus. The other image distortions and aberrations also may be made small by going to high orders of focus.

ACKNOWLEDGMENT

The writer is glad to take this opportunity to thank Dr. D. O. North of this laboratory for the solution of the equations of motion used in the early part of this paper and for many helpful discussions.

APPENDIX A

Calculation of Diameter of Image Disk Corresponding to Point Source of Electrons

Fig. 13 represents a plane cathode and anode separated by a distance L in a uniform magnetic field H . A point source of electrons S is imaged at S' . Elec-

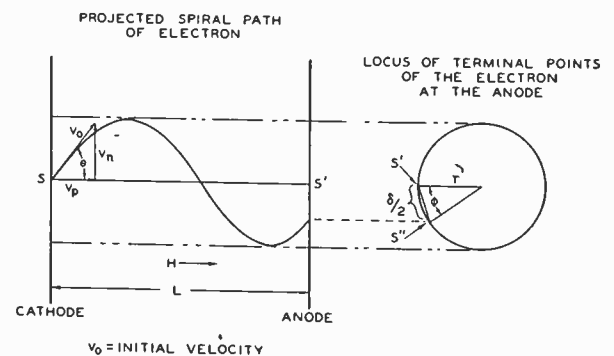

Fig. 13—Chromatic aberration in uniform axial electric and magnetic fields.

trons starting with an initial velocity of ϵ volts at an angle θ to the axis are imaged at S'' where the distance $S'S'' = \delta/2$ is a chord of the circle described by the electron due to its velocity component normal to the field. The radius of this circle is

$$r = \frac{mv_n}{eH} \quad (22)$$

where v_n is the initial velocity of the electron normal to the axis. The problem is to compute δ in terms of ϵ , L and the anode potential V .

¹³ From the subject entitled "The Bandmaster," one of the Krazy Kat series, used by permission of the Columbia Pictures Corporation.

Case of a Uniform Electric Field Between Anode and Cathode

The reason that the electron starting from S with an initial velocity ϵ volts at an angle θ to the axis does not land at S' is that its initial component velocity v_p along the axis causes it to fail to make an integral number of revolutions by an angle ϕ . The procedure then is to relate the angle ϕ to the actual transit time of an electron with $v_p \neq 0$, when conditions are set for an integral number of revolutions for an electron with $v_p = 0$.

The transit time for an electron with $v_p = 0$ is

$$T_0 = \frac{2L}{v_f} \quad (23)$$

where v_f = final velocity.

The transit time for an electron with $v_p \neq 0$ is

$$T = \frac{2L}{v_p + v_f'} \quad (24)$$

where v_f' is again the final velocity.

$$\phi = 2\pi \frac{T_0 - T}{T_0} n \quad \text{where } n \text{ is the order of focus} \quad (25a)$$

$$\doteq 2\pi \frac{v_p}{v_f} n \quad \text{for } \frac{\epsilon}{V} \ll 1 \quad (25b)$$

From Fig. 13 and (22) and (25):

$$\delta = 4r \sin \frac{\phi}{2} \quad (26a)$$

$$= 4\pi n \frac{mv_n}{eH} \frac{v_p}{v_f} \quad (26b)$$

For the n th-order focus

$$T_0 = \text{time for } n \text{ revolutions} \quad (27a)$$

or

$$\frac{2L}{v_f} = \frac{2\pi mn}{eH} \quad (27b)$$

Combining (26) and (27), we obtain

$$\delta = 4L \frac{v_n v_p}{v_f^2} \quad (28)$$

Since $v_n = (2e\epsilon/m)^{1/2} \sin \theta$, $v_p = (2e\epsilon/m)^{1/2} \cos \theta$, and $v_f = (2eV/m)^{1/2}$, and since the maximum value of $\sin \theta \cos \theta$ is $\frac{1}{2}$ for $\theta = \pi/4$, then (28) becomes

$$\delta = 2L \frac{\epsilon}{V} \quad (29)$$

Case of the Electron Starting with an Initial Velocity of V Volts (V = the Anode Potential) Plus the Random Initial Velocity of ϵ Volts

The transit time for an electron with $v_p = 0$ is

$$T_0 = \frac{L}{v_f} \quad (30)$$

where v_f = final velocity.

The transit time for an electron with $v_p \neq 0$ is

$$T = \frac{L}{(v_p^2 + v_f^2)^{1/2}} \quad (31)$$

From (30) and (31)

$$\phi = 2\pi \frac{T_0 - T}{T_0} n \doteq \pi \left(\frac{v_p}{v_f} \right)^2 n \quad \text{for } \frac{\epsilon}{V} \ll 1. \quad (32)$$

From (22) and (32), and Fig. 13

$$\delta = 4r \sin \frac{\phi}{2} \quad (33a)$$

$$= 2\pi \frac{mv_n}{eH} \left(\frac{v_p}{v_f} \right)^2 n. \quad (33b)$$

For the n th-order focus:

T_0 = time for n revolutions

or

$$\frac{L}{v_f} = \frac{2\pi mn}{eH} \quad (34b)$$

Combining (33) and (34), we obtain

$$\delta = L \frac{v_n v_p^2}{v_f^3} \quad (35)$$

Since $v_n = (2e\epsilon/m)^{1/2} \sin \theta$, $v_p = (2e\epsilon/m)^{1/2} \cos \theta$, and $v_f = (2eV/m)^{1/2}$, and since the maximum value of $\sin \theta \cos^2 \theta$ is 0.39, at $\tan \theta = 1/\sqrt{2}$, then (35) becomes

$$\delta = 0.39L \left(\frac{\epsilon}{V} \right)^{3/2} \quad (36)$$

APPENDIX B

The construction of the magnetic-field-measuring tube referred to in the text is illustrated in Fig. 14. It

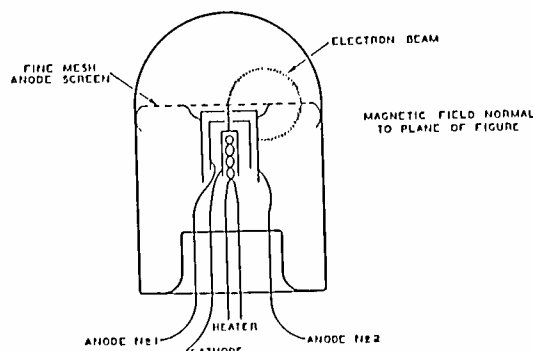

Fig. 14—Schematic diagram of magnetic-field-measuring tube.

consists of a simple electron gun using an indirectly heated cathode and, for focusing, two anode apertures. The final anode is tied to the anode screen which forms

a plane across the tube. The focusing electrode is held at a potential intermediate between cathode and anode. Several microns of argon in the tube serve to make the beam visible and to prevent wall charges from influencing the beam. The tube axis is readily oriented perpendicular to the magnetic field by the simple visual observation of the terminus of the beam on the gun mount. If the tube is not perpendicular to the magnetic field, the beam spirals off to one side of the tube or the other. The magnitude of the field from well-known laws is

$$H = 6.74 \frac{(V)^{1/2}}{d} \text{ gauss}$$

where V is the second-anode potential in volts and d is the diameter in centimeters of the circle formed by the beam and read-off markers on the fine-mesh screen. The orientation of the magnetic field is, of course, normal to the plane of the circle.

For a range of V (50 to 500 volts), the tube may be used to measure magnetic fields in the range from 1 to 350 gauss.

Characteristics of the Ionosphere at Washington, D. C., November, 1939, with Predictions for February, 1940*

T. R. GILLILAND†, ASSOCIATE MEMBER, I.R.E., S. S. KIRBY†, ASSOCIATE MEMBER, I.R.E.,
AND N. SMITH†, NONMEMBER, I.R.E.

DATA on the critical frequencies and virtual heights of the ionospheric layers during November are given in Fig. 1. Fig. 2 gives the monthly

average values of the maximum usable frequencies for undisturbed days, for radio transmission by way of the regular layers. The F_2 and F layers ordinarily determine the maximum usable frequencies during the day and night, respectively. Fig. 3 gives the distribu-

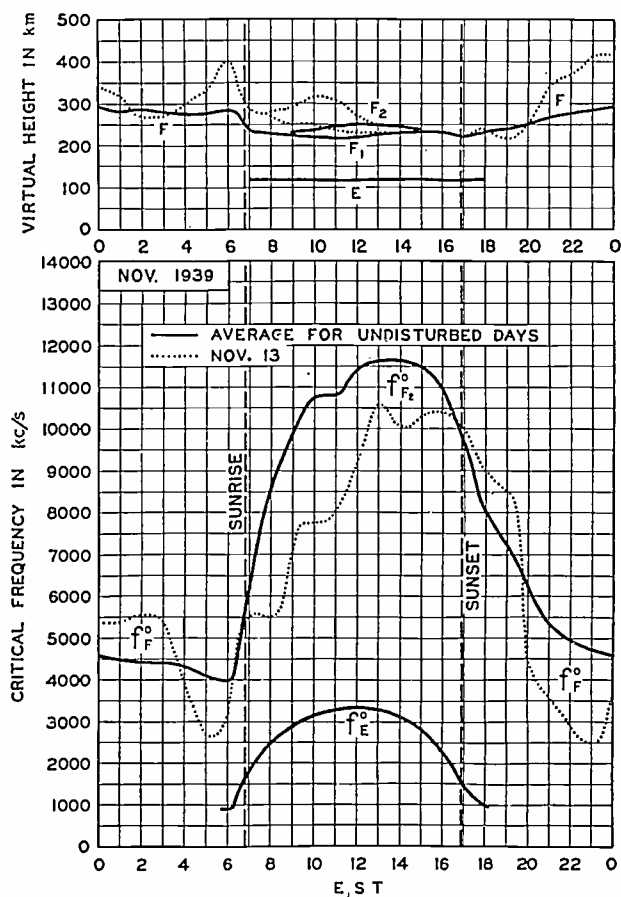

Fig. 1—Virtual heights and critical frequencies of the ionospheric layers, November, 1939. The solid-line graphs are the averages for the undisturbed days; the dotted-line graphs are for the ionospheric storm day of November 13.

* Decimal classification: R113.61. Original manuscript received by the Institute, December 11, 1939. These reports have appeared monthly in the PROCEEDINGS starting in vol. 25, September, (1937). See also vol. 25, pp. 823-840, July, (1937). Publication approved by the Director of the National Bureau of Standards of the U. S. Department of Commerce.

† National Bureau of Standards, Washington, D. C.

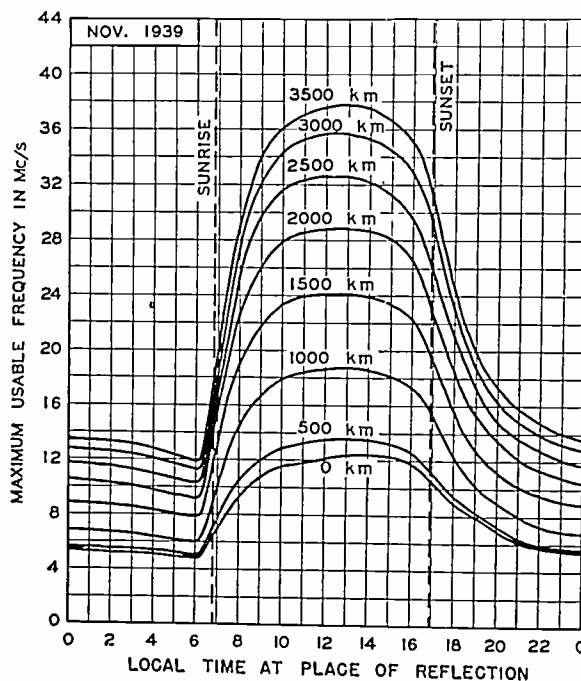

Fig. 2—Maximum usable frequencies for dependable radio transmission via the regular layers, average for undisturbed days for November, 1939.

tion of hourly values of F and F_2 data about the undisturbed average for the month. Fig. 4 gives the expected values of the maximum usable frequencies for radio transmission by way of the regular layers, average for undisturbed days, for February, 1940.

Ionospheric storms occurred as listed in Table I. They were mild and not numerous, and their effects on radio transmission were not great. Nevertheless the D-layer absorption of night sky-wave transmissions at

broadcast frequencies was well marked. This effect was described briefly in the reports of this series for May, 1938, and February, 1939.

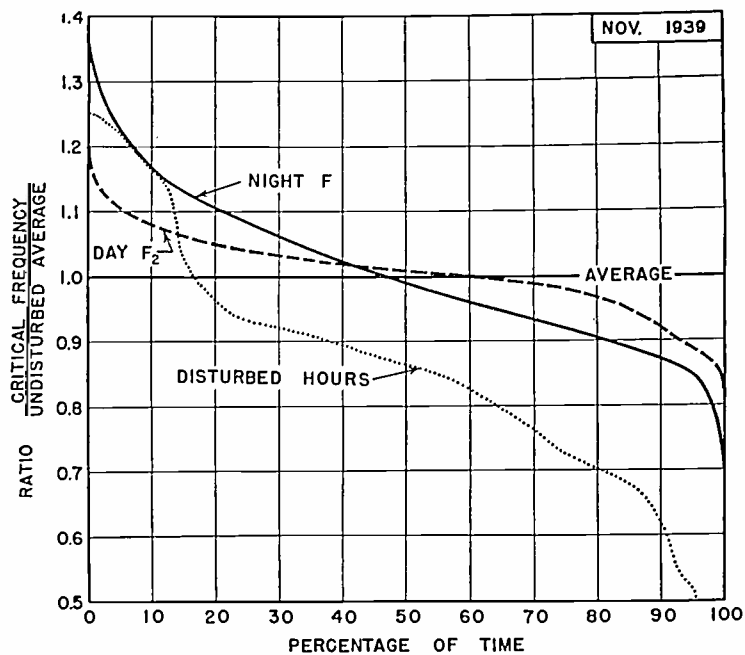

Fig. 3—Distribution of F- and F₂-layer ordinary-wave critical frequencies (and approximately of maximum usable frequencies) about monthly average. Abscissas show percentage of time for which the ratio of the critical frequency to the undisturbed average exceeded the values given by the ordinates. The solid-line graph is for 384 undisturbed night hours of observation; the dashed graph is for 121 undisturbed day hours of observation; the dotted graph is for 42 disturbed hours of observation, listed in Table I.

No sudden ionospheric disturbances occurred in November, insofar as observations in Washington indicated. Strong sporadic-E reflections were rare in November; they were observed up to 8 megacycles at vertical incidence during only four hours of the month.

TABLE I
IONOSPHERIC STORMS (APPROXIMATELY IN ORDER OF SEVERITY)

Day and hour E.S.T.	h_F before sunrise (km)	Minimum f_F^0 before sunrise (kc)	Noon $f_{F_2}^0$ (kc)	Magnetic character ¹		Ionospheric characteristic ²
				00-12 G.M.T.	12-24 G.M.T.	
November						
13	314	2600	9200	0.9	0.9	0.6
14 (until 0600)	310	2900	—	0.5	0.5	0.3
26 (until 0600)	352	2300	—	0.6	0.3	0.6
15 (0300 to 0600)	312	3200	—	0.1	0.0	0.1
For comparison: Average for undisturbed days	281	4000	11400	0.1	0.2	0.0

¹ American magnetic character figure, based on observations of seven observatories.
² An estimate of the severity of the ionosphere storm at Washington on an arbitrary scale of 0 to 2, the character 2 representing the most severe disturbance.

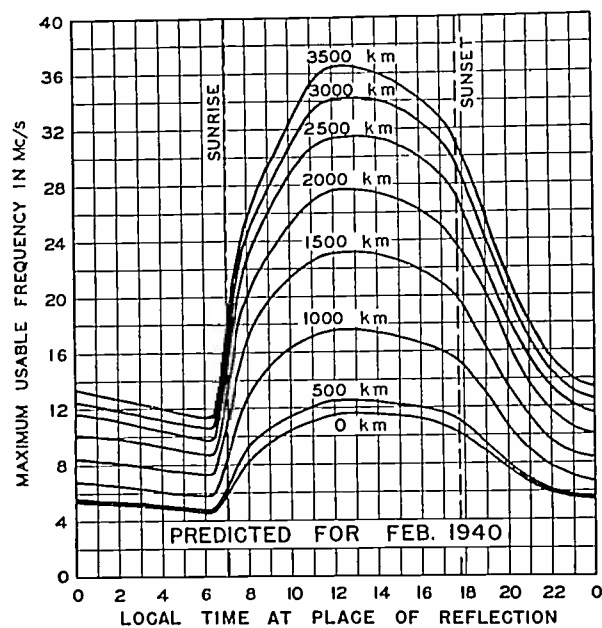

Fig. 4—Predicted maximum usable frequencies for dependable radio transmission via the regular layers, average for undisturbed days, for February, 1940.

Institute News and Radio Notes

Board of Directors

The last regular meeting of the 1939 Board of Directors was held in the Institute office on December 6. It was attended by R. A. Heising, president; L. C. F. Horle, president-elect; Melville Eastham, treasurer; Austin Bailey, director-elect; H. H. Beverage, Ralph Bown, F. W. Cunningham, Virgil M. Graham, Alan Hazeltine, O. B. Hanson, C. M. Jansky, Jr., F. B. Llewellyn, Haraden Pratt, B. J. Thompson, H. M. Turner, A. F. Van Dyck, H. A. Wheeler, director-elect, and H. P. Westman, secretary.

A. G. Clavier and E. H. Ullrich were transferred to Fellow grade.

Twenty-seven applications for Associate membership, two for Junior, and fifteen for Student grade were approved.

President Heising presented a final report on his tour of the Institute sections.

A committee was appointed to submit to the Board of Directors recommendations on policies to guide its publicity activities.

I.R.E.-U.R.S.I. Meeting

The annual joint meeting of the Institute of Radio Engineers and the American Section of the International Scientific Radio Union will be held in Washington, D. C., on April 26 and 27, 1940. This will be a two-day meeting. Meetings of other important scientific societies will be held in Washington during the same week. Those interested are invited to submit papers on the more fundamental and scientific aspects of radio. The program will be published in the April issue of the PROCEEDINGS. This will necessitate the submission of titles to the committee in charge not later than February 21. It is desirable that abstracts of not over 200 words be submitted with the titles. Correspondence should be addressed to S. S. Kirby, National Bureau of Standards, Washington, D. C.

Broadcast Engineering Conference

The Third Annual Broadcast Engineering Conference sponsored by The Ohio State University with the co-operation of the National Association of Broadcasters will be held at Columbus, Ohio, on February 12 to 23, 1940. The National Association of Broadcasters has co-operated this year in the preparation of the program and in the organization of the meetings. The subjects to be treated and the names of the speakers follow.

"Broadcast Station Measurements," by H. J. Schrader, RCA Manufacturing Company.

"Ultra-High-Frequency Propagation," by H. O. Peterson, R.C.A. Communications.

"Studies of Noise," by J. H. DeWitt, Radio Station WSM.

"Round Table on Receivers," by D. D. Israel, Emerson Radio and Phonograph Company; W. F. Cotter, Stromberg-Carlson Telephone Manufacturing Company; and R. M. Wilmotte, Consultant.

"Frequency-Modulated-Wave Transmission and Reception," by E. H. Armstrong, Columbia University; P. A. de Mars, Yankee Network; and H. P. Thomas, I. R. Weir, and R. F. Shea, General Electric Company.

"Microphones," by R. N. Marshall, Bell Telephone Laboratories.

"Transcription Recording and Reproduction," by R. A. Lynn, National Broadcasting Company.

"C.B.S. Broadcasts from Europe," by A. B. Chamberlain, Columbia Broadcasting System.

"W2XBS Television Service of the National Broadcasting Company," by R. F. Guy and R. M. Morris, National Broadcasting Company.

"General Discussion and Question Box," by A. D. Ring, Federal Communications Commission and R. M. Wilmotte, Consultant.

"Foreign Relations in Broadcasting," by G. C. Gross, Federal Communications Commission.

"Some International Aspects of International Broadcasting," by R. F. Guy, National Broadcasting Company.

"Television Measurements Compared with Broadcast Station Measurements," by T. L. Gottier, RCA Manufacturing Company.

"Audio-Frequency Testing by Means of Square Waves," by L. B. Arguimbau, General Radio Company.

"The Lawyer and the Engineer," by A. W. Scharfeld.

An inspection trip will be made to WHAS in Louisville, Kentucky, as a part of the Conference.

Further information and registration details may be obtained by addressing Dr. W. L. Everitt, The Ohio State University, Columbus, Ohio.

Standard Frequencies and Other Services Broadcast by National Bureau of Standards

The National Bureau of Standards broadcasts standard frequencies and other services from its radio station, WWV, at Beltsville, Md., near Washington, D. C. The services include: (1) standard radio

frequencies, (2) standard time intervals in the form of pulses accurately spaced one second apart, (3) standard audio frequency, (4) standard musical pitch, 440 cycles per second, and (5) bulletins of information on the ionosphere and radio transmission conditions.

Information on how to receive and utilize these various services is given in the Bureau's Letter Circular, "Methods of Using Standard Frequencies Broadcast by Radio," and in the Letter Circular "Data on Radio Transmission Conditions and the Ionosphere from the National Bureau of Standards." Either is obtainable on request from the National Bureau of Standards, Washington, D. C.

Rochester Fall Meeting

The Rochester Fall meeting which was held on November 13, 14, and 15, resulted in a total registration of 456. There were 17 technical papers presented at 7 technical sessions and an inspection trip was made to the frequency-modulated-wave transmitting station of the Stromberg-Carlson Telephone Manufacturing Company. An exhibition of material of interest to engineers was part of the meeting.

Committees

Admissions

On December 6 the Admissions Committee met and recommended that twenty applicants be transferred to Member grade and that three of the applicants for admission to Member grade be elected. Those who attended the meeting were F. W. Cunningham, chairman; H. H. Beverage, Melville Eastham, C. M. Jansky, Jr., C. E. Scholz, H. M. Turner, A. F. Van Dyck, and H. P. Westman, secretary.

Board of Editors

Co-ordinating Committee

R. R. Batcher, Helen M. Stote, assistant editor; L. E. Whittemore, and H. P. Westman, secretary; attended a meeting of the Co-ordinating Committee of the Board of Editors on December 6 and considered a number of papers which were pending approval for publication in the PROCEEDINGS.

New York Program

The New York Program Committee met on November 17 and those present were I. S. Coggeshall, chairman; H. A. Affel, Austin Bailey, W. M. Goodall, J. D. Parker (representing A. B. Chamberlain), G. T. Royden, A. F. Van Dyck, and H. P. Westman, secretary.

The arrangements for the December and January New York meetings were agreed upon and recommendations looking

toward one or two additional meetings were prepared.

Electronics

On November 13 a meeting of the Technical Committee on Electronics was held in the Sagamore Hotel, Rochester, N. Y., and those in attendance were P. T. Weeks, chairman; C. H. Bachman (representing K. C. DeWalt, G. F. Metcalf, and O. W. Pike), Ben Kievit, Jr., F. R. Lack, George Lewis, H. E. Mendenhall (representing J. R. Wilson), G. D. O'Neill, H. W. Parker, and H. P. Westman, secretary.

A report was received from the Electronics Conference Committee on the meeting which was held on October 20 and 21 at Stevens Institute of Technology. The attendance was 180.

A schedule was prepared and will be the basis on which the annual review material is developed.

Reports were received from the six subcommittees on their activities in the field of standardization.

Subcommittee on Photoelectric Devices

Ben Kievit, chairman; A. M. Glover, F. W. Reynolds (representing E. F. Kingsbury), and H. P. Westman, secretary, attended a meeting of the Subcommittee on Photoelectric Devices held at the Hotel Sagamore, Rochester, N. Y., on November 13.

A number of items which appeared in the 1938 Electronics Standards Report were considered and recommendations made looking toward minor revisions.

Preliminary arrangements were made for the preparation of the annual review material.

Subcommittee on Ultra-High-Frequency Tubes

The Subcommittee on Ultra-High-Frequency Tubes met on December 1 and those present were F. B. Llewellyn, chairman; R. L. Freeman, L. S. Nergaard, A. L. Samuel, and H. P. Westman, secretary.

The annual review report was prepared.

Changes were recommended in several definitions appearing in the present standards report. In addition, some new material on the measurement of vacuum-tube characteristics was considered.

Radio Receivers

A meeting of the Technical Committee on Radio Receivers was held on November 22 and attended by D. E. Foster, chairman; R. I. Cole, L. F. Curtis, C. J. Franks, R. S. Holmes, Frederick Ireland (representing A. E. Thiessen), C. B. McKennie (representing C. B. Fischer), Lincoln Walsh, J. D. Crawford, assistant secretary; and H. P. Westman, secretary.

This meeting was devoted entirely to the preparation of a partial report for submission to the Annual Review Committee.

Television

The Technical Committee on Television met on November 28 and E. K. Co-han, chairman; R. R. Batcher, D. E.

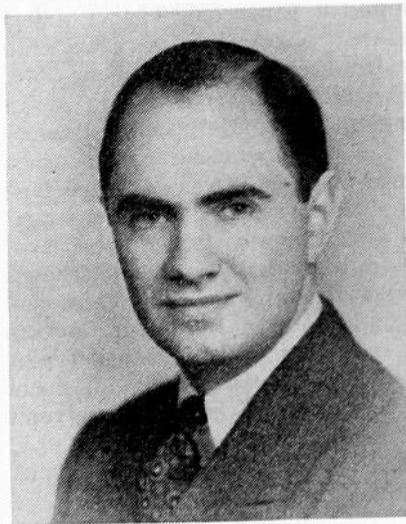

Thomas Studio

LARNED A. MEACHAM

Eta Kappa Nu, the honorary electrical engineering society, has bestowed on Larned A. Meacham (A'38) its 1939 award for being an "Outstanding Young American Engineer."

Mr. Meacham was born on September 3, 1908 in Denver, Colorado. After graduation in 1929, cum laude, from the University of Washington, he did a year of graduate work at Cambridge University in England. In 1930 he joined the technical staff of Bell Telephone Laboratories and a number of patents have resulted from his work in the development of precision crystal oscillators, frequency converters, phase-shifting networks, submaster oscillators, and frequency-measuring equipment. His work on the bridge-stabilized oscillator is outstanding among his contributions and is covered in a paper in the October, 1938, PROCEEDINGS.

Foster, Stanford Goldman (representing I. J. Kaar), P. C. Goldmark, T. T. Goldsmith, Jr., R. S. Holmes (representing E. W. Engstrom), H. M. Lewis, F. W. Reynolds (representing A. G. Jensen), R. E. Shelby, and H. P. Westman, secretary; attended the meeting.

Some consideration was given to the defining of terms used by television engineers. The main portion of the meeting was devoted to the preparation of a schedule and distribution of work which is required in the preparation of the report for the annual review.

Transmitters and Antennas

On November 29 E. G. Ports, chairman; M. R. Briggs, G. W. Fyler, Raymond Guy, J. F. Morrison, R. E. Poole, D. S. Rau, and H. P. Westman, secretary; attended a meeting of the Technical Committee on Transmitters and Antennas.

Action was taken on recommendations from the Technical Committee on Radio Wave Propagation for modification of several definitions which appear in the existing Transmitters and Antennas Report.

A schedule was prepared for the writing of the annual review material.

American Standards Association Sectional Committee on Radio Technical Committee on Transmitters and Antennas

A meeting of the ASA Technical Committee on Transmitters was held on November 21 and attended by Haraden Pratt, chairman; H. A. Chinn, J. L. Finch, D. K. Gannett (representing A. A. Oswald), E. G. Ports, and H. P. Westman, secretary.

The preparation of proposed standards for volume measurements of electrical speech and program waves was completed with the exception of a small amount of material which will be approved by letter ballot. On approval this proposed standard will be circulated to the Sectional Committee on Radio. That organization and the Institute, as sponsor of the project, must approve the report before it can be submitted to the American Standards Association for final action.

Sections

Atlanta

"The Beverage Antenna—Theory and Practice," was the subject of a paper presented by A. Anderson, inspector in the Atlanta office of the Federal Communications Commission.

After a brief historical review of the development of the Beverage antenna was presented, its operation was described. It was pointed out that the height of the antenna does not affect its performance in so far as its directional characteristics are concerned. For use in the broadcast band, the optimum length was considered as being between 1800 and 2000 feet. A length of less than 1000 feet was considered unjustified as comparable results could be obtained with more compact systems of other types.

A two-way Beverage antenna was described in which the induced energy is returned to a receiver located at the end of the antenna which points toward the transmitting station. Methods of reflecting the waves from one end of the line were discussed. A system of coupling the antenna to the receiver which permits reversal of the antenna directivity to be made at the receiver location was described.

Simple methods of determining the surge impedance of these antennas were presented. The design of the coupling and reflecting transformers was also considered. Specifications of the equipment in use at the Grand Island Monitoring Station were given and a discussion of the operation of these antennas at that station concluded the paper.

September 15, 1939, G. S. Turner, vice chairman, presiding.

Ben Akerman, chief engineer of WGST, presented a paper on "Modern High-Power Public-Address Equipment."

The paper was introduced with a definition of a public-address system and va-

rious terms which are used in discussing these systems.

The various types of microphones available and their general characteristics were discussed. It was pointed out that a good microphone is just as essential for public-address work as for broadcasting. An inferior instrument may require greater amplifier gain for satisfactory intelligibility than a satisfactory microphone. The more gain that is required, the greater is the probability of acoustic feedback. While the placement of the microphone and loud speakers is of greatest importance in avoiding feedback, the use of satisfactory equipment is of substantial importance in this matter.

The need for low noise and a large signal-to-noise ratio was stressed. The necessity of proper matching of impedances in connecting input and output terminal equipment to amplifiers was covered. The effect of mismatching impedances was described.

The horn-type loud speaker is usually more efficient than the cone type and this is of particular importance in systems having high power ratings. In these cases multiple-unit speakers are commonly used. The application of speakers of various types to different installation problems was outlined.

Some large installations recently made by the speaker were described and included a discussion of the application of reverse feedback to the amplifiers.

October 20, 1939, G. S. Turner, vice chairman, presiding.

Baltimore

The first meeting of the newly established Baltimore Section resulted in the election of C. A. Ellert as chairman, Ferdinand Hamburger, Jr., of Johns Hopkins University as vice chairman, and Alexander Whitney of the Westinghouse Electric and Manufacturing Company as secretary-treasurer.

Short talks on the Institute and its activities were given by President Heising and Secretary Westman.

A resolution was adopted extending thanks to the Washington Section for relinquishing part of its territory to permit the establishment of a Baltimore Section.

For the past three years, an organization known as the Institute of Radio Conferees has operated in Baltimore and it was agreed that the technical-papers program of that organization would be adopted by the Baltimore Section for its 1939-1940 activities and that all members of the Institute of Radio Conferees would be retained on the mailing list of the Baltimore Section for a period of two years.

President Heising then presented his paper on "Radio Extension Links to the Telephone System" which has been summarized previously in the PROCEEDINGS.

November 10, 1939, C. A. Ellert, chairman, presiding.

Chicago

R. P. Glover and Benjamin Baumzweiger, chief engineer and development engineer, respectively, for Shure Brothers,

presented a paper on "Theory and Performance. Characteristics of Cardioid-Type Unidirectional Microphones."

The historical development of structures giving cardioid response patterns was traced. A new operating principle utilizing acoustic phase shift was described. Several microphones were used to demonstrate the three-dimensional response pattern of the cardioid, hypercardioid, cosine, and circular types. The application of these characteristics to obtain front-rear discrimination, reduction of reverberation pickup, and the desirability of employing the minimum solid angle of pickup for a given subject were discussed.

October 27, 1939, V. J. Andrew, chairman, presiding.

Cincinnati

C. H. Topmiller, chief engineer of WCKY, discussed the "Features of a Modern 50-Kilowatt Broadcast Transmitter."

The paper covered the new high-efficiency 50-kilowatt amplifier which was added to the existing 10-kilowatt transmitter.

The operation of the new amplifier was described. It was pointed out that the distortion which is generated inherently in the amplifier is quite large but is corrected by applying approximately 40 decibels of rectified negative feedback.

The amplifier requires less than 5 kilowatts of excitation power which permits the plate power to the 10-kilowatt stage to be reduced for normal operation. In case of failure of the amplifier, the antenna may be switched to the 10-kilowatt stage which may be operated at normal level.

Bias voltage adjustments control the tube balance and the power output of the final amplifier. Methods of tuning the equipment were described. The amplifier operates at an efficiency of approximately 62 per cent and the total power input to the station is about 250 kilowatts.

November 14, 1939, H. J. Tyzzer, chairman, presiding.

Emporium

C. T. Burke, engineering manager of the General Radio Company, presented a paper on "Engineering Administration in a Small Manufacturing Company." This paper is published elsewhere in this issue.

November 10, 1939, R. K. McClintock, chairman, presiding.

Los Angeles

"Field Intensity at Broadcast Frequencies and Its Measurement," was the subject of a paper by G. W. Curran of the engineering department at KFI-KECA.

The paper was opened with a discussion of the field strength required for both primary and secondary service. It was pointed out that to avoid interference problems, powerful stations should be located away from thickly populated areas. Data were presented comparing the theoretical measured values and field strength for one of the Los Angeles stations.

The fundamentals of electric and magnetic fields and of radiation and radiation resistance were discussed.

Practical information was then presented on the measurement of field strength around a broadcast station. A loop antenna is usually employed since its effective height can be calculated easily. The RCA field-strength measuring equipment was described in detail.

In discussing the making of a survey, the author covered such things as the number of radials on which measurements should be made, the choice of location, possible errors to be expected, precautions to avoid unnecessary errors, and the plotting of data.

As the field strength depends to a large degree on the conductivity and dielectric constant of the soil, the ideal circular pattern may be expected only if soil conditions and topography are uniform. A contour map of a Los Angeles station was exhibited.

The problem of "Field-Intensity Measurements at Ultra-High Frequencies" was discussed by A. C. Packard of the engineering department of the Columbia Broadcasting System.

For this work it is found more convenient to use a dipole antenna. The calibrating signal generator uses a capacitive rather than a resistive attenuator.

Reflection and interference may cause the field strength in relatively closely adjacent positions to vary by a factor as large as 10. This requires more careful selection of measurement location and, at best, the contour map can show only approximately the field strength at a given location.

The paper was closed with a description of a survey made at 43 megacycles and covering an area having a radius of 25 miles from the transmitter.

October 17, 1939, F. G. Albin, chairman, presiding.

Montreal

"Analogies Between Radio and Photography" was the subject of a paper by B. V. K. French, development engineer for P. R. Mallory and Company.

A number of comparisons were given between photographic- and radio-equipment characteristics and included the sensitivity of photographic emulsions compared with vacuum-tube characteristics, photographic filters and electric-wave filters, and electron and optical lenses.

October 18, 1939, A. B. Oxley, chairman, presiding.

"Silicon Steel Sheets and Magnetic Circuits," was the subject of a paper by J. P. Barton, manager of the Bureau of Electrical Sheet Sales of the Carnegie-Illinois Steel Corporation.

The effect on steel of adding various percentages of alloying elements was discussed. Methods of selecting test specimens and of running tests were described. They included hysteresis, surface insulation, tensile strength, and permeability characteristics. Heat treating and annealing both before and after stamping were covered in detail in a discussion of the paper.

November 8, 1939, A. B. Oxley, chairman, presiding.

Philadelphia

C. T. Burke of the General Radio Company presented his paper on "Engineering Administration in a Small Manufacturing Company." This paper appears elsewhere in this issue.

November 2, 1939, R. S. Hayes, chairman, presiding.

Pittsburgh

"Interesting Features Found in Indicating Electrical Instruments" was the subject of a paper by H. L. Olesen of the Weston Electrical Instrument Corporation.

D'Arsonval, moving-vane, and electro-dynamometer types of instruments were described and their characteristics outlined. The evolution of the more-sensitive instruments was described. Manufacturing requirements and methods also were covered.

November 2, 1939, R. E. Stark, vice chairman, presiding.

This meeting was devoted to an inspection trip to the new KDKA transmitter located at Allison Park, Pa. The inspection was under the direction of J. E. Baudino, manager of operations at KDKA.

December 9, 1939, J. E. Baudino, chairman, presiding.

Portland

The "Design Features of a High-Power Broadcast Transmitter" were discussed by L. S. Bookwalter, chief engineer of KOIN-KALE.

November 22, 1939, H. C. Singleton, chairman, presiding.

G. H. Brown, research engineer for the RCA Manufacturing Company (Camden), presented a paper on "Vestigial-Sideband Filters for Use with Television Transmitters."

December 11, 1939, H. C. Singleton, chairman, presiding.

San Francisco

C. F. Elwell, consulting engineer, presented a paper on "Famous Radio Patents and Patent Litigation."

Starting with the early developments in radio communication, the author discussed the Poulsen arc. He then covered the history of the vacuum tube which included its development and its utilization. The development of the superheterodyne principle was then outlined. The patent cases associated with these various developments were discussed.

November 15, 1939, F. E. Terman, chairman, presiding.

At a meeting held jointly with the San Francisco Engineering Council, a paper on "Modern Motor Fuels, their Production and International Significance" was presented by Gustav Egloff, director of research for Universal Oil Products Company.

December 1, 1939, S. Dows, chairman, San Francisco Engineering Council, presiding.

Seattle

"Flying the Pacific as a Radio Operator" was discussed by Ray Runnells, communication representative, Pan American Airways.

He described the radio equipment used on the new Boeing clippers and its application to the problems of navigation.

Two 80-watt continuous-wave transmitters and a 15-watt radiotelephone transmitter are installed with two tuned-radio-frequency receivers and one superheterodyne receiver. Five antennas of various types are provided. One of the most important uses of radio is to obtain hourly weather reports. Another is the obtaining of bearings and positions by direction finding. Several methods were described.

The paper was closed with some motion pictures showing highlights of a flight and the stops at Hawaii, Midway, Wake, Guam, the Philippines, and Hong Kong.

November 17, 1939, R. M. Walker, vice chairman, presiding.

Toronto

H. W. Parker, chief engineer for Rogers Radio Tubes Ltd., presented a paper on "Vacuum-Tube Life Probability versus Consumer Satisfaction."

Field experience with dissatisfied customers of radio tubes indicates that the laws of probability cause bunching of complaints from a few customers. The reason for few complaints from customers having small numbers of tubes in their sets is explained by distribution laws and tube-mortality functions. It was pointed out that uniformity of tube-mortality functions is of more importance to the initial-equipment consumer than to the replacement-equipment consumer.

Field experience has shown that the threshold of consumer complaints is reached when the third tube per set per year fails, regardless of the number of tubes in the set. Most dissatisfaction is indicated by a small percentage of consumers. Consumers having only a few tubes in their sets show little dissatisfaction.

According to one of the laws of probability, the chance of selecting two bad tubes in succession is equal to the product of their probability of selection.

In deriving curves for the tube-mortality function, the departure of the actual curve from the ideal occurs because the emission from an oxide-coated cathode often increases with life reaching its highest value just before the drop preceding failure. A test might, therefore, show higher emission from an old than from a new tube and might lead to a conclusion that the newer tubes are inferior to the old.

Curves were shown indicating that the life expectancy of initial equipment was from two to three times the final steady-state expectancy with tube replacement.

November 20, 1939, G. J. Irwin, chairman, presiding.

Washington

R. L. Campbell, television engineer for the Allen B. Du Mont Laboratories, pre-

sented a paper on "Flexibility in Television Systems and Automatic Synchronization for Receivers."

Receiver circuits were described which were sufficiently flexible to permit the reception of television signals of both the present 441-line type or of an increased number of lines. Such receivers would not become obsolete if the progress of the art should make it advisable to employ greater detail.

A. B. Du Mont discussed informally the present status of television development in the New York area pointing out the desirability of increasing the number of lines transmitted and setting up standards which permit further development without requiring modification of all existing receivers.

November 13, 1939, Gerald C. Gross, chairman, presiding.

A paper on the "Finch Facsimile System" was presented by W. S. Halstead, associate engineer of Finch Telecommunication.

The development of this system and its possible applications in the communications field were outlined.

Detailed information was given on the mechanical and electrical construction and operation of the equipment. Recent developments resulting in increased speed of operation were stressed. It was pointed out that the present limitation on the amount of intelligence which can be transmitted in a given time is largely of a mechanical nature and not electrical. Following a discussion on the paper used for recording, several types of receiving equipment and a transmitting scanner were demonstrated.

This was the annual meeting and L. C. Young was elected chairman, M. H. Biser was named vice chairman, and E. M. Webster was elected secretary-treasurer.

December 11, 1939, Gerald C. Gross, chairman, presiding.

Membership

The following indicated admissions and transfers of memberships have been approved by the Admissions Committee. Objections to any of these should reach the Institute office by not later than January 31, 1940.

Transfer to Member

- Biser, M. H., 3224—16th St., N. W., Washington, D. C.
- Black, D. M., Bell Telephone Labs., Inc., 463 West St., New York, N. Y.
- Burton, E. T., Bell Telephone Labs., Inc., 463 West St., New York, N. Y.
- Friis, R. W., Bell Telephone Labs., Inc., 463 West St., New York, N. Y.
- Fultz, M. E., 43-05—215th St., Bayside, L. I., N. Y.
- Heaton-Armstrong, L. J., c/o Standard Telephones & Cables, Oakleigh Rd., New Southgate, London N. 11, England.
- Howard, E. J., 5 Beach Ave., Madison, N. J.

- Hubbard, F. A., Bell Telephone Labs., Inc., 463 West St., New York, N. Y.
- Ingram, S. B., Bell Telephone Labs., Inc., 463 West St., New York, N. Y.
- Kerwien, A. E., Jr., Bell Telephone Labs., Inc., Deal, N. J.
- King, K. L., Bell Telephone Labs., Inc., 463 West St., New York, N. Y.
- Kircher, R. J., Bell Telephone Labs., Inc., Deal, N. J.
- Norton, F. R., Bell Telephone Labs., Inc., 463 West St., New York, N. Y.
- Rodwin, G., Bell Telephone Labs., Inc., 463 West St., New York, N. Y.
- Roetken, A. A., Bell Telephone Labs., Inc., 463 West St., New York, N. Y.
- Rose, C. F. P., 103 Lincoln Dr., Asbury Park, N. J.
- Selvidge, H., Kansas State College, Manhattan, Kan.
- Shaw, R. C., Bell Telephone Labs., Inc., Deal, N. J.
- Sowers, N. E., Bell Telephone Labs., Inc., Deal, N. J.
- Whitehouse, J. E., R.R. 1, Mason, Ohio.
- Dickinson, W. E., (S) Box 55, Dilworth, Minn.
- Espy, W. D., (S) 407 S. Michigan Ave., Pasadena, Calif.
- Fisher, H. G., (S) 1604 Josephine St., Berkeley, Calif.
- Gassenheimer, W. T., (A) 245 Kinderkamack Rd., Westwood, N. J.
- Gautney, G. E., (A) 1609 E. 44th St., Ashtabula, Ohio.
- George, K. E., (A) 927-C, Bogulkunta, Hyderabad Deccan, India.
- Gerry, E. F., (A) 309 San Fernando Way, San Francisco, Calif.
- Glasser, O. J., (S) Franklin Hall, Ithaca, N. Y.
- Godwin, H. B., (A) Wireless School, R.C.A.F. Station, Trenton, Ont., Canada.
- Haley, J. F., (S) 423 N. 16th St., Corvallis, Ore.
- Hatfield, J. B., (A) 2905—1st Ave., Seattle, Wash.
- Hattangady, V. R., (A) Marconi School of Wireless Communication, Chelmsford, Essex, England.
- Hinkel, H., Jr., (A) 5150 Congress Ave. Oakland, Calif.
- Hoffman, N. R., (S) 224 Linden Ave., Ithaca, N. Y.
- Honnell, M. A., (A) Box 2112, Georgia School of Technology, Atlanta, Ga.
- Hoskins, L. C., (A) 522—5th Ave., N., Saskatoon, Sask., Canada.
- Jackson, H. W., (J) 10 Truman St., Brampton, Ont., Canada.
- Jacobsen, A. B., (S) 4720—9th Ave., N. E., Seattle, Wash.
- Jette, A. H., (S) 612 E. State St., Ithaca, N. Y.
- Kaplan, R., (A) 53 Park St., Binghamton, N. Y.
- Klein, M. M., (A) 119 Bonnie Brae Ave., Brighton, Rochester, N. Y.
- Knudson, L. I., (S) 502 Cayuga Heights Rd., Ithaca, N. Y.
- Linder, E. G., (A) RCA Manufacturing Co., Inc., Camden, N. J.
- Maling, H. F., Jr., (S) 123 Westminster Ave., Arlington, Mass.
- Maxwell, D. E., (A) 2025 Campbell Ave., Schenectady, N. Y.
- McCallum, R., (A) 1804 St. Catherine St., W., Montreal, Que., Canada.
- McDonnell, W. F., (A) Radio Station WHLS, Port Huron, Mich.
- Mealey, K. L., (S) Box 386, Gresham, Ore.
- Miki, S., (A) c/o Nihon-Hoso-Kyokai, Gijutsu-Kenkyujo, Kamata-Machi, Setagaya-Ku, Tokyo, Japan.
- Mounce, G. R., (S) M.I.T. Dormitories, Cambridge, Mass.
- Numans, J. J., (A) 2 Koninginnegracht, The Hague, Netherlands.
- Oriel, C. W., (S) 269 Newark Ave., Union, N. J.
- Peters, E. H., (S) 9th & Bishop, Rolla, Mo.
- Pochmerski, D., (S) 428 E. 14th St., New York, N. Y.
- Prichard, J. S., (S) 1806 Blake St., Berkeley, Calif.
- Raney, J. J., (S) 2375—78th Ave., Philadelphia, Pa.
- Reynolds, V. F., (S) 321 Clifton Ave., Lexington, Ky.
- Riley, G. B., (A) 2549 N. Wood Ave., Linden, N. J.
- Rinaudo, R. F., (S) Route 1, Box 185, Acampo, Calif.
- Runnells, T. R., (A) 6245—30th Ave., N.E., Seattle, Wash.
- Schaller, F. D., (A) 3006 Clifton Ave., Baltimore, Md.
- Schmid, H. B., (S) 1005 Pine, Rolla, Mo.
- Schull, G., (S) 441 N. 8th St., Terre Haute, Ind.
- Seabert, F., (A) 206 S. Darling St., Angola, Ind.
- Snyder, E. H., (A) 2408 S. 8th St., Council Bluffs, Iowa.
- Stephens, F. F., (S) 408 N. Washington St., Gainesville, Fla.
- Stevens, E. F., (A) 830 Southern Bldg., Washington, D. C.
- Taylor, R. S., (S) Box 44, Ellisville, Miss.
- Thatcher, E. V., Jr., (S) 67 Hammond St., Cambridge, Mass.
- Ticknor, R., (A) Munitions Bldg., Washington, D. C.
- Tyrrell, A. J., (A) 4 Ross Rd., London S.E.25, England.
- Ware, R. S., (A) 72 Bank St., New York, N. Y.
- Weant, C. H., (A) 4306 Springwood Ave., Baltimore, Md.
- Weber, B. W., (S) Star Route 2, Box 4, Cle Elum, Wash.
- Zollars, N. I., (A) 14th Air Base, Bolling Field, Washington, D. C.
- Zwick, G., (S) 1508 Leland Ave., New York, N. Y.

Admission to Member

- Dietzold, R. L., Bell Telephone Labs., Inc., 463 West St., New York, N. Y.
- Earp, C. W., c/o Standard Telephones & Cables, Oakleigh Rd., New Southgate, London N.11, England.
- Taranger, A., 46 Ave. de Breteuil, Paris, France.

Admission to Associate (A), Junior (J), and Student (S)

- Anderson, A., (A) 191 Langlands Rd., Glasgow S.W.1, Lanarkshire, Scotland.
- Bailey, J. E., (S) 327-F Men's Dormitory, West Virginia University, Morgantown, W. Va.
- Baum, E., (S) 24 Lenox Ave., Mount Vernon, N. Y.
- Bedford, S., Jr., (S) 927—12th St., Boulder Colo.
- Berglund, P. T., (S) 208 W. 10th St., Rolla, Mo.
- Bernato, F. N., (A) 743 E. 16th St., Ashtabula, Ohio.
- Bowen, W., (A) 407 N. Golden West, Temple City, Calif.
- Brown, P. G., (S) Hawley Hall, Oregon State College, Corvallis, Ore.
- Burnett, E. M., Jr., (S) Box 169, Georgia School of Technology, Atlanta, Ga.
- Burroughs, F. L., (A) 341 Grant St., St. Marys, Pa.
- Collier, W. H., Jr., (S) 1108 Bishop, Rolla, Mo.
- Cushing, T. D., (S) Box 305, Kelowna, B. C., Canada.
- Davis, R. F., (A) American Telephone & Telegraph Co., 195 Broadway, New York, N. Y.
- Deerhake, F. M., (A) 1509 Valencia Rd., Schenectady, N. Y.

Books

Cathode Modulation, by Frank C. Jones

Published by Pacific Radio Publishing Co., Inc., San Francisco, Calif. Price \$1.00

This spiral-bound book is intended primarily for the radio amateur. The text occupies 14 pages; cathode modulation circuits, 23 pages; construction details, 25 pages; advertising, 20 pages. One page is devoted to the "Jones Harmonic Oscillator."

In "cathode" modulation, the modulating voltage is applied in series with the cathode of a radio-frequency amplifier, resulting in a combination of grid-bias modulation and plate modulation. Although the text of this book is at some points neither comprehensive nor technically correct, with significant errors occurring on pages 10 and 17, it does effectively inform the reader of certain worth-while advantages offered by cathode modulation. The sections presenting wiring diagrams, circuit constants, and construction details for amateur transmitters employing low-power and medium-power tubes will prove of great interest to the amateur and of some interest to radio engineers designing commercial equipment.

LOREN JONES
RCA Manufacturing Company
Washington, D. C.

Contributors



C. T. BURKE

Charles T. Burke (A'25-M'27-F'37) was born at Watertown, Massachusetts, in 1902. He received the degrees of S.B. and S.M. in electrical engineering from Massachusetts Institute of Technology in 1924. Since 1924 he has been with the General Radio Company, where he is at present Engineering Manager.



Howard A. Chinn (A'27-M'36) was born in New York City on January 5, 1905. He attended the Polytechnic Institute of Brooklyn, later going to Massachusetts Institute of Technology where he received the B.S. degree in 1927 and the M.S. degree in 1929. From 1927 to 1932 he was a research assistant at Massachusetts Institute of Technology, and from 1932 to 1933, research associate. Mr. Chinn became associated with the Columbia Broadcasting System in 1933 as a radio engineer; from 1934 to 1936 he was assistant to the Director of Engineering; from 1936 to date, he has been Engineer-in-Charge of Audio Engineering.



HOWARD A. CHINN

D. K. Gannett (M '31) was born at Minneapolis, Minn., on November 22, 1894. He received the B.S. degree in engineering in 1916, and the E.E. degree in 1917 from the University of Minnesota. He was a member from 1917 to 1919 of the Engineering Department, and from 1919 to 1934 of the Department of Development and Research, of the American



D. K. GANNETT

Telephone and Telegraph Company. Since 1934 Mr. Gannett has been a member of the technical staff of the Bell Telephone Laboratories, where as Toll Transmission Engineer his responsibility includes the problems of program transmission.



T. R. GILLILAND

T. R. Gilliland (A'28) was born in Danville, Illinois, on March 16, 1903. He received his B.S. degree in electrical engineering at the California Institute of Technology in 1927 and the M.S. degree in communication engineering at Harvard University in 1931. For two years between 1923 and 1927 he was a radio operator aboard ship. From 1928 to 1930 and from June, 1931, to date, Mr. Gilliland has



S. S. KIRBY

been with the Radio Section of the National Bureau of Standards.



S. S. Kirby (A'27) was born on October 27, 1893, at Gandy, Nebraska. He received the A.B. degree from the College of Emporia in 1917 and the M.A. degree from the University of Kansas in 1921. From 1918 to 1919 he was with the Signal Corps of the American Expeditionary Force. He was a high school teacher from 1919 to 1921, and from 1921 to 1926 a professor of physics at Friends University in Wichita, Kansas. Mr. Kirby served as an assistant physicist at the National Bureau of Standards from 1926 to 1930; associate physicist from 1930 to 1938; and physicist from 1938 to date.



K. S. Knol* was born on February 23, 1908, at Eenrum, Holland. He was an assistant in the physics department of the University of Groningen from 1931 to

* Paper published in December, 1939, issue of the PROCEEDINGS.



K. S. KNOL

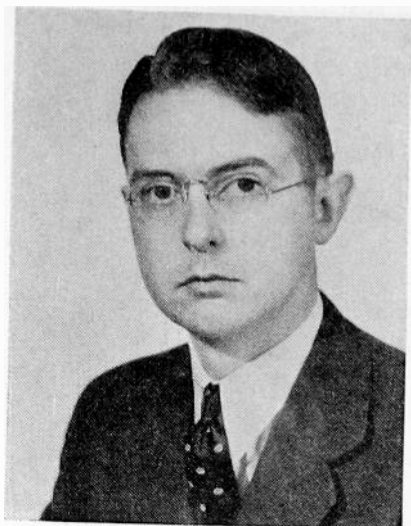

R. M. MORRIS



1937, receiving his D.Sc. degree from there in 1934. Since 1937 Dr. Knol has been a member of the research staff of Philips Incandescent Lamp Works, Ltd.,



R. M. Morris (A'26) was employed by the Western Electric Company after he



ALBERT ROSE

had attended Western Reserve University and the Case School of Applied Science. He became a member of the original staff of WEAf when that station was inaugurated by the American Telephone and Telegraph Company in 1924, and has been closely associated with the technical development of radio broadcasting. Since 1927 he has been in charge of all experimental and developmental activities of the National Broadcasting Company. Mr. Morris is a member of the Acoustical Society of America.



Albert Rose (A'36) was born in New York City on March 30, 1910. He received the A.B. degree from Cornell University in 1931 and the Ph.D. degree in physics in 1935. From 1931 to 1934 he was a teaching assistant at Cornell University and since 1935 he has been a research engineer in the Research and Engineering Department of the RCA Manufacturing Company, RCA Radiotron Division. Dr. Rose is a member of Sigma Xi.



Newbern Smith was born on January 21, 1909, at Philadelphia, Pennsylvania. He received the B.S. degree in electrical engineering from the University of Pennsylvania in 1930, the M.S. degree in 1931, and the Ph.D. degree in physics in 1935. Since 1935 Dr. Smith has been a member of the Radio Section of the National Bureau of Standards.



W. Norris Tuttle (A'26) was born on March 29, 1902, at Croton-on-Hudson, New York. He received the A.B. degree in physics in 1924, the S.M. degree in electric communication engineering in 1926, and the Ph.D. degree in physics in 1929 from Harvard University. Dr. Tuttle was with the Department of Development and Research of the American Telephone and Telegraph Company in the summer of



NEWBERN SMITH



1925 and with the Radio Frequency Laboratories in the summer of 1926. From 1926 to 1927 he was research assistant to Professor P. W. Bridgman at Harvard, and instructor and tutor in physics there from 1929 to 1930. Since 1930 he has been with the General Radio Company.



W. N. TUTTLE



A NATION UNITED BY TELEPHONE

JUST twenty-five years ago, on January 25, 1915, the first transcontinental telephone call was made. East and West were united in dramatic ceremony.

President Wilson talked from the White House across the country, testifying to the nation's pride "that this vital cord should have been stretched across America as a sample of our energy and enterprise."

The inventor of the telephone, Alexander Graham Bell, in New

York, repeated across the continent to San Francisco the first words ever heard over a telephone—"Mr. Watson, come here, I want you"—to the same Thomas A. Watson who had heard them in the garret workshop in Boston in 1876.

That ceremony ushered in transcontinental service twenty-five years ago. At that time it cost \$20.70 to call San Francisco from New York. Now it costs \$6.50 for a station-to-station call and only \$4.25 after

seven in the evening and all day Sunday.

In 1915 it took about half an hour, on the average, to make a connection. Now most calls are put through without hanging up.

These are measures of progress in the never-ending effort of the Bell System to give faster, clearer, more useful and courteous service to the people of the United States.

BELL TELEPHONE SYSTEM



Maintained Leadership in Resistors Since 1921



"Grid Leak"



Type F

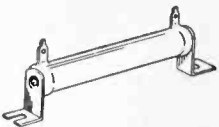

Power Wire Wound
Type "A" Coating



Type "A"
Volume Control



Type BT



Type "B"
Volume Control

1921 The advent of commercial broadcasting—the first dependable "grid leak" is produced, the forerunner of the now-famous metallized filament-type resistance element.

1925 A radical improvement in the filament type resistor—new stable filament embedded in ceramic form with molded metal terminals—the recognized standard of quality for many years.

1932 IRC announces the first moisture-proof cement coating for power wire wound resistors—a coating that, today, remains the standard for difficult applications.

1932 Bakelite resistance element for volume controls—durable and moisture proof—first made commercially available for the industry.

1933 IRC introduces the first bakelite-insulated resistor. This principle has since been adopted almost universally by the resistor industry. Today, IRC is still the only firm making a complete line of insulated low-wattage units.

1934 Multiple Finger Contactor for volume controls—each finger independently acting—resulting in quieter and more uniform controls—first introduced. This principle gradually being adopted by other manufacturers of controls.

1940 The increased scope of IRC specialized engineering activity insures continued leadership as expressed in further important fixed and variable resistor developments.

1936 Departing from conventional designs, IRC produces the first medium-power wire wound resistors with high temperature, molded bakelite insulation—also a complete line of low-power insulated wire wounds.

1937 The Spiral Spring Connector—replacing sliding metal-to-metal contact—is developed to eliminate the last major source of noise in volume controls.

1937 IRC introduces cement coating affording maximum protection against excessive humidity conditions. It withstands the standard U. S. Navy salt immersion cycling tests.

1938 IRC introduces a new type all-metal power rheostat, having practically the same temperature rise with full load across small sections as across entire unit.

1938 IRC announces the first Attenuators with commutator switching device and Spiral Spring Connectors.

1939 The metallized filament principle is applied to large resistor forms. IRC makes commercially available high voltage resistors, for use up to 100 kilovolts, and power resistors for use at high frequencies.

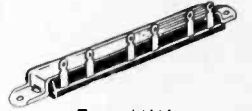

Type MW



Type BW



Type "CS"
Volume Control

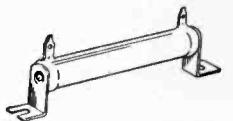

Power Wire Wound
Type "C" Coating

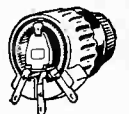

Type PR

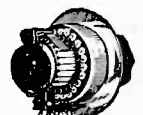

Type A-21



Type MV



Type MP

INTERNATIONAL



RESISTANCE CO.

431 NORTH BROAD ST., PHILADELPHIA, PA.

Makers of Resistance Units of More Types, in More Shapes, for More Applications, Than Any Other Manufacturer in the World

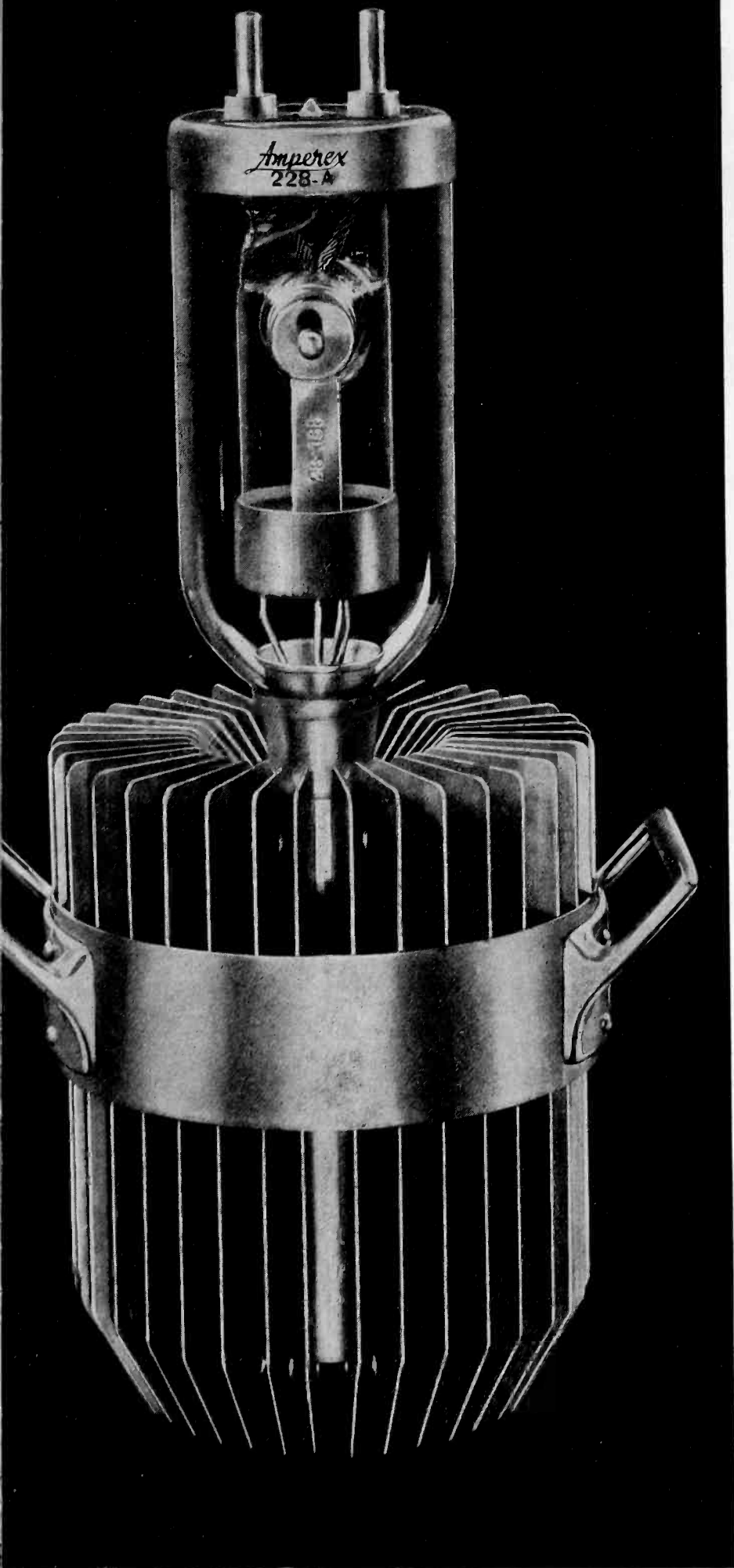

AMPEREX

AIR RADIATORS

For Water Cooled Tubes

AMPEREX laboratories have designed a series of Radiators suitable for the forced air cooling of metal anode power tubes which are ordinarily water cooled.

These Radiators are scientifically designed for the greatest transfer of heat to the air stream. Their structures are simple, yet they are remarkably efficient. In fact, for some high frequency uses, they are far more desirable than water cooling systems.

The installation of air cooling systems and Air Cooled tubes in broadcast and communication transmitters results in simplicity of design, considerable economy in construction and in greatly lowered maintenance costs.

AMPEREX Radiators are available with the 891, 892, 232C, 220C, 228A and can be readily manufactured for many other types of tubes.

Because of the technical skill required for imbedding the anode into the radiator well these radiators are only sold as an integral part of the tube.

AMPEREX ELECTRONIC PRODUCTS, Inc.

WASHINGTON STREET

BROOKLYN, NEW YORK

DIVISION DE EXPORTACION: 100 VARICK STREET, NEW YORK, E. U. A. CABLEGRAMAS: "ARLAB".

THIS LETTER

Speaks
for itself!



KONO

SAN ANTONIO, TEXAS

July 19, 1939

Mr. J.A. McCullough
Eitel-McCullough, Inc.
San Bruno, Cal.

Dear Mr. McCullough:

Last year I wrote to you for some information on using your Eimac 250 TL tubes as Class A modulators in a new transmitter I was building for this station. Your data was very helpful and the modulator, which consists of four 250 TL's in pushpull parallel Class A, has proved a success. At the time you supplied me with the information you asked me to send a photograph of the completed transmitter. I forgot about it until the other day when I began thinking of the good service that the Eimacs had been giving. I decided to send the photo along with some compliments for your tubes.

As you know, continuous Class A operation is the hardest service to which you can subject any tube. The modulators in our transmitter have been working at very nearly their maximum rated plate dissipation for over 2000 hours and are still going strong. Even if the tubes only last 2000 hours, it is more economical for us to use Eimacs, because a comparable tube of other make would cost us \$85 (████). We had used █████s in our other transmitter and got between three and four thousand hours out of them.

In fact, Class A operation using any other make of tubes would be unfeasible economically. Four █████s would cost \$340 as contrasted to \$98 for the four Eimacs. Two █████s would do the job but again the cost would be prohibitive. Furthermore I have found that Eimacs are far more uniform than either █████s or █████s. We have had no difficulty in keeping our pushpull system balanced even though four tubes are used.

Yours sincerely,

George Ing

George Ing, Engineer
Radio Station K O N O

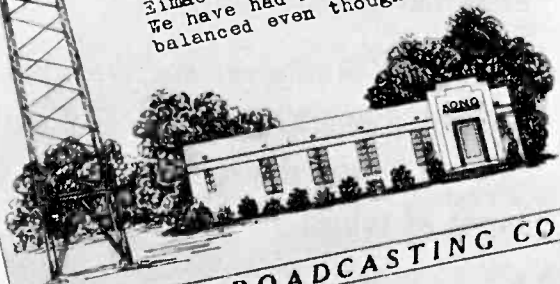

MISSION BROADCASTING COMPANY - 317 ARDEN

Eimac
TUBES

Scores of commercial radio stations are taking advantage of the unusual capabilities of Eimac tubes. It will pay you to investigate.

EITEL-McCULLOUGH, Inc. San Bruno, Calif.

Current Literature

New books of interest to engineers in radio and allied fields—from the publishers' announcements.

A copy of each book marked with an asterisk (*) has been submitted to the Editors for possible review in a future issue of the Proceedings of the I.R.E.

* CUMULATIVE INDEX OF THE JOURNAL OF THE ACOUSTICAL SOCIETY OF AMERICA, VOLUMES 1-10 [October, 1929 through April, 1939]. F. A. FIRESTONE, Editor. New York: American Institute of Physics, November, 1939. vii+131 pages, 8×10½ inches, paper. \$3.00.

* NEMA LAMINATED PHENOLIC PRODUCTS STANDARDS. New York: National Electrical Manufacturers Association, November, 1939. 27 pages, 8×10½ inches, paper. 25 cents.

* NEMA RECOMMENDED PRACTICE FOR MACHINING AND PUNCHING OF LAMINATED PHENOLIC PLATE. New York: National Electrical Manufacturers Association, November, 1939. 2 pages, 8×10½ inches, paper. 10 cents.

* THE PHYSICS OF THE DIVINING ROD. By J. CECIL MABY and T. BEDFORD FRANKLIN, Members of the investigation Committee of the British Society of Divers. London: G. Bell and Sons Ltd., 1939. xv+438+14 index pages, illustrated, 6×9 inches, cloth. 21 shillings.

* RADIO HANDBOOK (Sixth Edition). By the Editors of *Radio*, W. W. SMITH, Editor-in-Chief. Santa Barbara: Radio. Ltd., October, 1939. 621+18 index pages, 6¾×9¾ inches, paper, \$1.50; cloth, \$3.00.

RUTHERFORD. BEING THE LIFE AND LETTERS OF THE RT. HON. LORD RUTHERFORD, O.M. By A. S. EVE, formerly Macdonald Professor of Physics, McGill University. New York: Macmillan Company; Cambridge: University Press, November, 1939. 451 pages, illustrated, 5¾×8¾ inches, cloth. \$5.00.

* THE THEORY AND USE OF THE COMPLEX VARIABLE. By S. L. GREEN, Senior Lecturer in Applied Mathematics at Queen Mary College. New York: Pitman Publishing Corporation, 1939. viii+134+2 index pages, illustrated, 5½×8½ inches, cloth. \$3.00.

VECTOR ANALYSIS. By JAMES HENRY TAYLOR, Professor of Mathematics at George Washington University. New York: Prentice-Hall, Inc., October, 1939. 224 pages, illustrated, 6×9 inches, cloth. \$2.85.

* THE VICTORY OF TELEVISION. By PHILIP KERBY. New York: Harper & Brothers, 1939. x+108+7 appendix+4 index pages, illustrated, 5½×8¼ inches, cloth. \$1.00.

WAVELENGTH TABLES. By GEORGE R. HARRISON, Professor of Physics, and Staff Members of the Spectroscopy Laboratory of the Massachusetts Institute of Technology, assisted by the Works Progress Administration. New York: John Wiley and Sons, Inc., August, 1939. 429 pages, 7½×10¾ inches, cloth. \$15.00.

ANOTHER OUTSTANDING DEVELOPMENT FROM INSTRUMENT HEADQUARTERS

WESTON Type 30
'VU'
Volume
Level
Indicators

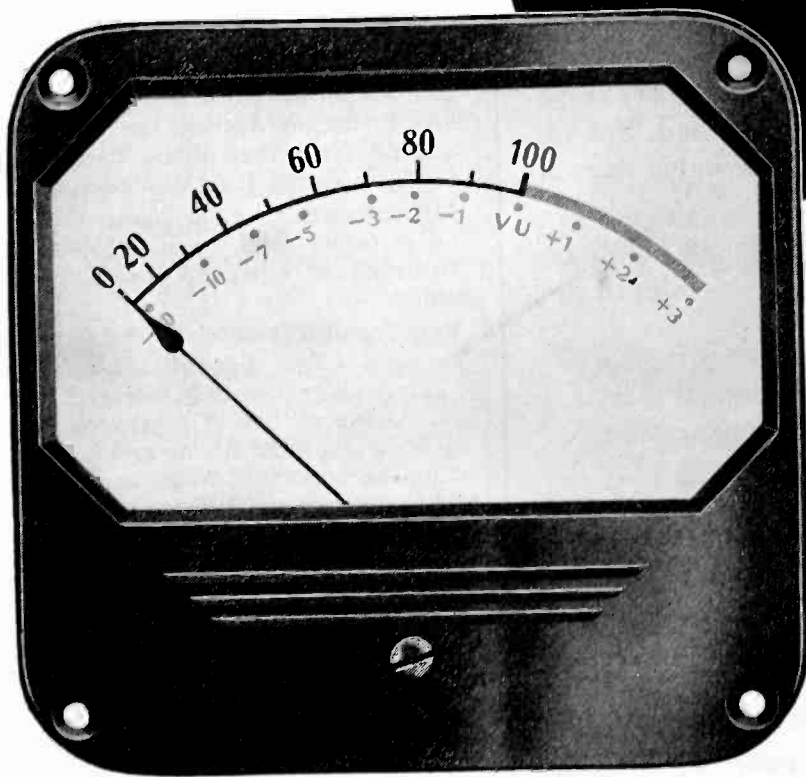

MODEL 802 Type 30-B
(illustrated) . . . Price . . \$37.50

MODEL 862 Type 30-B
with internal illumination by
two 6.3 volt lamps, current rating
0.15 amperes . . . Price . . \$42.50

Type 30 indicators can be supplied
in other shapes and sizes . . . and
with "A" scales.

Developed in the WESTON laboratories in collaboration with leading communications engineers, the Type 30 VU Meter provides a practical solution to the exacting problems of monitoring, frequently with an attendant increase in the average signal level. Recognized as instrument headquarters for over fifty years, industry also recognizes WESTON as "problem headquarters" whenever new or exacting instrument needs arise. Weston Electrical Instrument Corporation, 589 Frelinghuysen Ave., Newark, New Jersey.

WESTON *Instruments*

TYPE 915

VOLUME LEVEL INDICATOR BRIDGING-TERMINATING

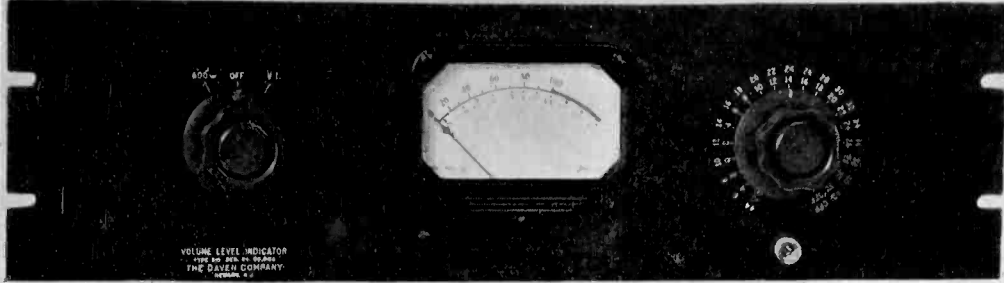

THE DAVEN TYPE 915 VOLUME LEVEL INDICATOR is designed to indicate signal levels in broadcasting, sound recording and allied fields. This instrument uses the new standard of 1 mw into 600 ohms as the reference level. It may be used as either a bridging type V. I. for bridging terminated program lines, or as a loading type for correctly terminating the line.

The indicator is the new Type 30 Volume Level Meter which has been adopted as the standard for monitoring purposes. Two types of scales are available: Type A for special applications, and Type B for broadcast work.

The meter range control is a DAVEN heavy duty "T" network which extends the range of the meter in accurate steps of 2Db. In addition to this range control, an auxiliary screw driver type zero adjustment is provided. This adjustment is a miniature decade unit supplying positive adjustment in steps of 0.1Db for accurate meter calibration.

A heavy duty self-cleaning type switch is provided for selecting the positions of "V. I.", "off" and "600 ohms Terminated".

SPECIFICATIONS

★**INPUT IMPEDANCE:**
V. I. position7500 Ohms
Terminated positions 600 Ohms
The input impedance is constant on all positions of the meter range switch.

★**VOLUME LEVEL RANGE:**
V. I. position From +4 V.U.
Terminated position From -6 V.U.

★**INDICATING METER:**
New Standard Type 30 Meter

★**TERMINALS:**
Screw Type lugs

★**MOUNTING:**
Standard relay rack, panel 5¼" x 19"

★**FINISH:**
Black, dull satin finish. W.E. or RCA
Grey Available upon request.

★**NET WEIGHT:**
7 lbs.

TYPE NO.	RANGE	TYPE SCALE	CODE WORD	PRICE
915-A	+4 to +42 and off -6 to +32 and off	A	DGWE	\$90.00
915-B	+4 to +42 and off -6 to +32 and off	B	DGWF	\$90.00
915-C	+4 to -26 and off -6 to +16 and off	A	DGWG	\$85.00
915-D	+4 to +26 and off -6 to +16 and off	B	DGWH	\$85.00
910-E	+4 to +42 and off -6 to +32 and off	A Illuminated	DGWI	\$95.00
910-F	+4 to +42 and off -6 to +32 and off	B Illuminated	DGWI	\$95.00
910-G	+4 to +26 and off -6 to +16 and off	A Illuminated	DGWK	\$90.00
910-H	+4 to +26 and off -6 to +16 and off	B Illuminated	DGWL	\$90.00

THE DAVEN COMPANY

158 Summit Street

Newark, New Jersey

Booklets, Catalogs and Pamphlets

The following commercial literature has been received by the Institute.

BROADCAST FREQUENCY MONITOR • • • *General Radio Company, 30 State Street, Cambridge, Massachusetts, "The General Radio Experimenter," January, 1940, 8 pages, 6×9 inches.* Contains, in addition to a description of a new frequency monitor, an article on a method of obtaining voltages of the order of one cycle per second from an inverse-feedback oscillator.

BROADCAST TRANSMITTERS • • • *Western Electric Company, 195 Broadway, New York, New York. "Pick-Ups," December, 1939. 26 pages+cover, 8×11 inches.* Contains two survey articles "Transmission Lines and Formulas for Certain Characteristics" and "Neutralization of Radio-Frequency Power Amplifiers."

CONDENSER REPLACEMENTS • • • *Cornell-Dubilier Electric Corporation, 1000 Hamilton Boulevard, South Plainfield, New Jersey. "Capacitor Manual for Radio Servicing" 1939-40 Edition No. 1. 256 pages+cover, 5¼×7¾ inches.* A comprehensive guide to replacement condensers for radio receivers, covering all of the principal models produced to date.

FREQUENCY MODULATION • • • *General Electric Company, Schenectady, New York. Bulletin GEA-3230, 15 pages+cover, 8×10½ inches.* A reprint from the *General Electric Review*: "Field Tests of Frequency and Amplitude Modulation with Ultra-high-Frequency Waves," by I. R. Weir, and "A Noise-Free Radio Receiver" by G. W. Fyler and J. A. Worcester, Jr.

MICROPHONES • • • *The Turner Company, Cedar Rapids, Iowa. 8 pages, 8½×11 inches.* Descriptions of microphones and accessories.

TELEVISION RECEIVERS • • • *Aerovox Corporation, New Bedford, Massachusetts. "The Aerovox Research Worker," August and September, 1939. 4 pages each, 8½×11 inches.* Parts 1 and 2 of an article summarizing the important design and operating characteristics of television receivers.

FUSES • • • *Littlefuse, Inc., 4757 Ravenswood Avenue, Chicago, Illinois. Catalog No. 8, 10 pages+cover, 8½×11 inches.* Specifications on fuses for instrument-protection and other small-current applications.

SQUARE-WAVE TESTING • • • *General Radio Company, 30 State Street, Cambridge, Massachusetts. "The General Radio Experimenter," December 1939, 12 pages, 6×9 inches.* Describes a new square-wave generator for audio- and video-frequency testing.

CONDENSERS • • • *Cornell-Dubilier Electric Corporation, 1000 Hamilton Boulevard, South Plainfield, New Jersey. Catalog No. 162, 15 pages+cover, 8½×11 inches.* Specifications for replacement condensers in motor-starting applications.

LOUD SPEAKERS • • • *Graybar Electric Company, 420 Lexington Avenue, New York, New York. Bulletin T-1650, 8 pages, 8×11 inches.* Description of a loud speaker for wide-angle horizontal coverage in sound distribution systems.



100 Million American Shareholders

As Radio Enters 1940

MORE than 44 million radio sets are owned by some 30 million American families. These families—more than 100 million people—are therefore shareholders in a great American enterprise. No other nation approaches these figures.

Never before has the importance of the American system of radio been so evident. News must be winnowed from propaganda, fact separated from claims. Our own forthcoming presidential campaign raises further need for radio reporting that is fair and unbiased.

Through great music, famous artists and distinguished organizations, radio provides the world's outstanding programs. The poorest man gets free what the richest man could not afford to buy.

RCA, through the National Broadcasting Company, will continue in 1940 to maintain and improve American standards of broadcasting.

But the activities of RCA extend far beyond radio broadcasting. RCA provides swift message service to all parts of the world, and to ships on the seven seas. In the RCA Laboratories research

constantly develops new services for radio. Thus in 1939 RCA made television a reality; in 1940 will extend it further. RCA services also include activities in every other phase of radio. In all of these, the aim of RCA is to provide the maximum service for the minimum cost to the public.

These are the Services of RCA

RCA MANUFACTURING CO., INC.

Builders of RCA Victor Radio sets, RCA Victrolas, RCA Radio Tubes and radio equipment for broadcasting, transmission and many other radio services.

RADIOMARINE CORPORATION OF AMERICA

Manufacturers of radio safety devices for protecting lives and property at sea. Swift message service to and from ships.

NATIONAL BROADCASTING COMPANY

Operating the great Red and Blue Networks, and providing distinguished entertainment, including the famous NBC Symphony Orchestra.

RCA INSTITUTES, INC.

A school offering technical courses in every phase of radio and television.

R.C.A. COMMUNICATIONS, INC.

Radio message service to and from 43 foreign countries, and among principal cities in the United States.

RCA LABORATORIES

Continuous research in every field of radio.



RADIO CORPORATION OF AMERICA

RADIO CITY, NEW YORK

Precision CRYSTALS HOLDERS OVENS

FOR BROADCAST SERVICE

Both the compact BC46T temperature controlled variable air-gap mounting and the low-drift Bliley Crystal are approved by the F.C.C. Correct design and precision manufacture assure full dependability.

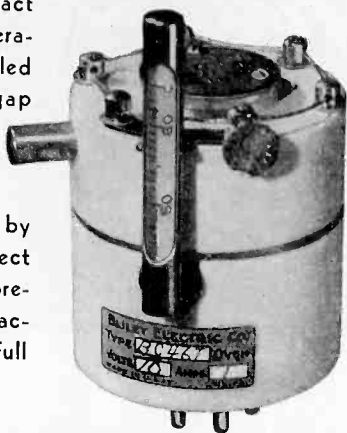

FOR GENERAL SERVICE



The VP4 steatite adjustable pressure holder, complete with Bliley Crystal, is widely employed in general frequency control applications throughout the range from 240kc. to 7.5mc.

FOR HIGH AND ULTRA-HIGH FREQUENCIES

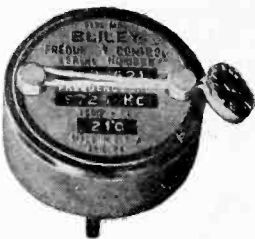

The M02 unit, for crystal frequencies from 7.5mc. to 30mc., is designed to withstand the severe operating conditions encountered in portable and mobile services.

FOR FREQUENCY STANDARDS

Precision frequency control for primary or secondary standards is economically obtained with the SOC100 mounted 100kc. bar. The crystal is rigidly clamped between knife edges and is ground to have a temperature coefficient not exceeding 3 cycles/mc./°C.

Catalog G-11 contains complete information. Write for your copy.



BLILEY ELECTRIC CO.
UNION STATION BUILDING ERIE, PA.

(Continued from page vi)

ALTIMETER • • • *Western Electric Company, 300 Central Avenue, Kearny, New Jersey. Bulletin T-1648, 15 pages+cover, 8×11 inches.* A description of the absolute altimeter for aircraft.

RESISTORS • • • *Sprague Products Company, North Adams, Massachusetts. Bulletin C, 4 pages, 8½×11 inches.* Specifications on a ceramic-covered wire-wound resistor.

INSULATION • • • *General Electric Company, Schenectady, New York. Bulletin GET-903, 8 pages, 8×10½ inches.* Properties and performance characteristics of "mycalex."

CONVERTERS • • • *Electronic Laboratories, Inc., Indianapolis, Indiana. Folder AA 9-38. 8 pages, 8½×11 inches.* Specifications on converters, polarity changers, and vibrators.

FASTENINGS • • • *Elastic Stop Nut Corporation, Elizabeth, New Jersey. Catalog, 57 pages+cover, 8½×11 inches.* Specifications and application data on self-locking nuts.

STANDARD-SIGNAL GENERATOR • • • *General Radio Company, 30 State Street, Cambridge, Massachusetts. "The General Radio Experimenter," November, 1939, 8 pages, 6×9 inches.* Description of "a signal generator for the ultra-high frequencies." Also, a method of measuring the inductance of small loop antennas with a "coil comparator."

CATHODE-RAY OSCILLOGRAPHS • • • *Allen B. Du Mont Laboratories, Inc., 2 Main*

Avenue, Passaic, New Jersey. "Du Mont Oscillographer," October-November, 1939, and December, 1939-January, 1940, 8 pages each, 6×9 inches. Parts 1 and 2 of an article "Study of Phase Displacement in Electrical Circuits from Linearly Expanded Lissajous Figures" by H. D. Brailsford.

TELEVISION TRANSMITTER • • • *Allen B. Du Mont Laboratories, Inc., 2 Main Avenue, Passaic, New Jersey. Bulletin 2-TE-K1 15 pages, 8½×11 inches.* General specifications on a 1-kilowatt television transmitter and auxiliary equipment.

TUBE DATA (RCA) • • • *RCA Manufacturing Company, Inc., Harrison, New Jersey. Application Note No. 105, 8 pages, 8½×11 inches.* "A Change in Maximum Ratings of Receiver Tubes."

SERVICE INSTRUMENTS • • • *Radio City Products Company, Inc., 88 Park Place, New York, New York. Catalog No. 121, 12 pages, 8½×11 inches.* Tube and circuit analyzers.

TRANSMITTER COMPONENTS • • • *E. F. Johnson Company, Waseca, Minnesota. Catalog No. 966, 8 pages, 8½×11 inches.* Condensers, inductors and inductor forms, and ceramic specialties.

INSTRUMENTS • • • *Leeds & Northrup Company, 4991 Stenton Avenue, Philadelphia, Pennsylvania. Catalog E, 1939, 66 pages, 7½×10½ inches.* Descriptions of standards, bridges, galvanometers, etc. for a wide variety of electrical and photometric measurements.

NEW 7-INCH PORTABLES

FOR LABORATORY · COMMERCIAL AND INDUSTRIAL TESTING

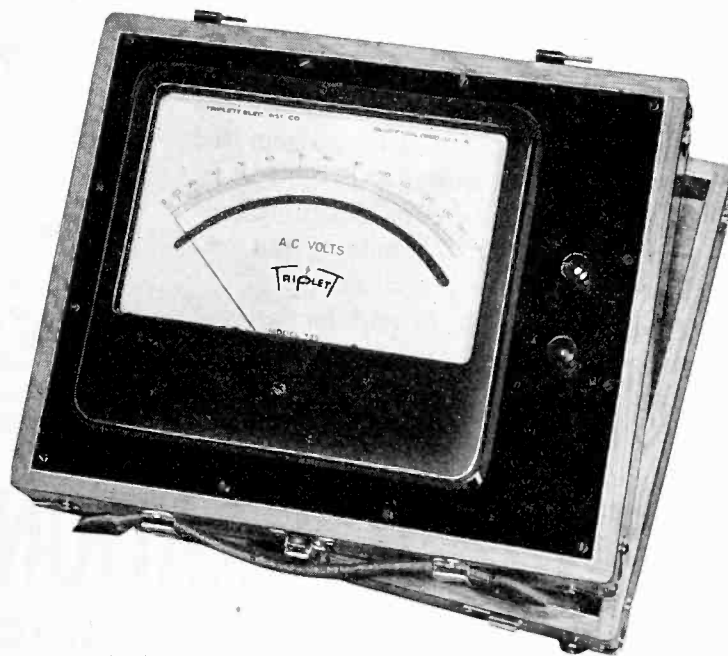

- 7-Inch Instrument with 6-Inch Scale.
- Standard and Special Ranges.
- Mirror Scale Avoids Parallax in Readings.
- Oak Carrying Case with Detachable Cover.
- Special Design to Assure Quick, Accurate Readings.

• Models 725-735 Portables may be obtained in standard and special ranges, including instruments of extreme sensitivity for laboratory use—as well as those for general commercial and industrial testing purposes. The large 7-inch instrument has a long six-inch mirror scale, maximum dial opening, and knife-edge pointer to assure quick accurate readings. Accuracy within 1% (½% for many ranges). Mirror scale eliminates parallax in readings. Available in microammeters, milliammeters, ammeters, voltmeters, millivoltmeters, thermo-ammeters, milliammeters, or single ranges. Case is quarter-sawed golden oak, 11" x 9" x 4", with handle and detachable cover. Black bakelite panel. Write for details on your needs.

FOR MORE INFORMATION WRITE—Section 211, Harmon Drive

THE TRIPLET ELECTRICAL INSTRUMENT CO., Bluffton, Ohio

TRIPLET

ENGINEERS:

Here's the sure cure for your *Directional Headaches!*

Ready-made Antenna Control Units that meet all F.C.C. requirements



Western Electric Antenna Control Units will solve your directional problems painlessly and permanently!

These equipments are capable of operating at any one pre-determined frequency between 550 and 1600 kc. — are suitable for 2 or more element arrays. Shift between day and night patterns can be made by single push button operation.

Combinations of the 33A (combined line branching and phase shifting unit) and supplementary 34A (phase adjusting unit for outdoor mounting) and 35A (line branching unit for outdoor mounting) are for output powers up to 5 KW. The 33B, 34B and 35B units are for powers up to 50 KW.

If you're suffering from directional headaches, call Graybar quickly for a Western Electric unit. You'll find it's just what the doctor ordered!

Western Electric



DISTRIBUTORS: In U.S.A.: Graybar Electric Co., New York.
In Canada and Newfoundland: Northern Electric Co., Ltd.
In other countries: International Standard Electric Corp.

LOOK TO *Farnsworth* FOR YOUR TELEVISION NEEDS



Farnsworth's Fort Wayne plant housing administration offices, research laboratories and special products manufacturing division.

The research laboratories and the transmitter and special products division of the Farnsworth Television & Radio Corporation are now consolidated at the Farnsworth plant in Fort Wayne, Indiana. This plant is admirably adapted for the development and production of special apparatus and equipment in the electronic field. Its operations are independent of those at Farnsworth's plant in Marion, Indiana, which is now in full production, manufacturing Farnsworth radios, radio-phonograph combinations and television receiving sets.

LOOK TO FARNSWORTH when you have need for electronic apparatus—products essential to television (such as the Farnsworth image dissector tube that makes possible startlingly high-fidelity in film transmission), telecine projectors and cameras, photocell multiplier tubes, master timer and pulse generators, complete studio and radio transmitting equipment for both sight and sound.

Flexible manufacturing and unexcelled research facilities, full benefits of Farnsworth ideas and inventions and the knowledge that in the same organization there is available to you engineering counsel who have made television history—these are the factors which can give you confidence when you are confronted with television problems, when you LOOK TO FARNSWORTH FOR YOUR TELEVISION NEEDS.

Get in touch with Farnsworth.

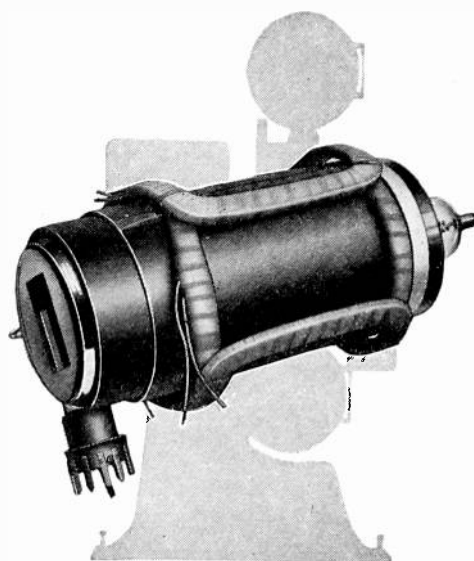

The Farnsworth Image Dissector Tube with its inherent excellence of performance, provides unusually high definition, freedom from shading and simplicity of control. The Farnsworth telecine projector is of the continuous type. There is no intermittent movement. An incandescent lamp is used as a light source.

Farnsworth's Marion, Indiana plant devoted to the manufacture of radios, radio-phonograph combinations and television receivers.

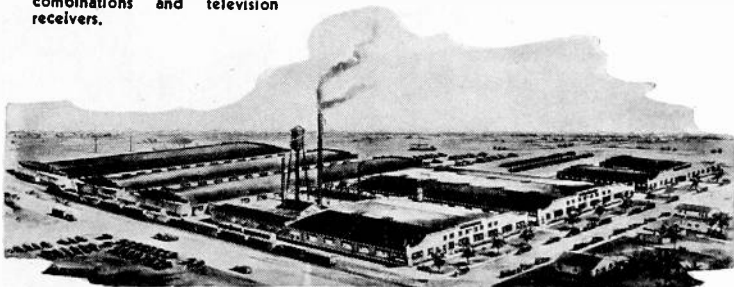

FARNSWORTH TELEVISION & RADIO CORPORATION

FORT WAYNE, INDIANA

Farnsworth - THE GREATEST NAME IN TELEVISION



IRE membership offers many services to the radio engineer

Proceedings—An outstanding publication in the radio engineering field. Over a quarter of a century of service to the world in publishing important radio engineering discoveries and developments, the PROCEEDINGS presents exhaustive engineering data of use to the specialist and general engineer. A list of its authors is a "Who's Who" of the leaders in radio science, research, and engineering.

Standards—Since 1914 our standards reports have stabilized and clarified engineering language, mathematics, graphical presentations, and the testing and rating of equipment. They are always in the process of revision and thus remain up to date.

Meetings—In twenty-two cities in the United States and Canada, meetings of the Institute and its sections are held regularly. Scores of papers on practically every branch of the field are presented and discussed. Several convention meetings are sponsored by the Institute and add materially to its effectiveness in distributing data of value to engineers.

The Institute of Radio Engineers

Incorporated
330 West 42nd Street, New York, N.Y.

To the Board of Directors
Gentlemen:

I hereby make application for ASSOCIATE membership in the Institute of Radio Engineers on the basis of my training and professional experience given herewith, and refer to the sponsors named below who are personally familiar with my work.

I certify that the statements made in the record of my training and professional experience are correct, and agree if elected, that I shall be governed by the Constitution of the Institute as long as I continue a member. Furthermore I agree to promote the objects of the Institute so far as shall be in my power.

.....
(Sign with pen)
.....
(Address for mail)
.....
(City and State)
.....
(Date)

SPONSORS (Signatures not required here)

Mr.
Address
City and State
Mr.
Address
City and State
Mr.
Address
City and State

A

ssociate membership affiliates you with the Institute and brings you the PROCEEDINGS each month as well as notices of meetings held near you.

(Typewriting preferred in filling in this form) No.....
RECORD OF TRAINING AND PROFESSIONAL EXPERIENCE

Name
 (Give full name, last name first)

Present Occupation
 (Title and name of concern)

Business Address

Home Address

Place of Birth Date of Birth Age

Education

Degree
 (College) (Date received)

TRAINING AND PROFESSIONAL EXPERIENCE
 (Give dates and type of work, including details of present activities)

Record may be continued on other sheets this size if space is insufficient.

Receipt Acknowledged Elected Notified

Requirements—For Associate membership, an applicant must be at least twenty-one years of age, of good character, and be interested in or connected with the study or application of radio science or the radio arts.

Sponsors—Three sponsors who are familiar with the work of the applicant must be named. Preferably these should be Associates, Members, or Fellows of the Institute. In cases where the applicant is so located as not to be known to the required number of member sponsors, the names of responsible nonmember sponsors may be given.

Dues—Dues for Associate membership are six dollars per year. The entrance fee for this grade is three dollars and should accompany the application.

Other Grades—Those who are between the ages of eighteen and twenty-one may apply for Junior grade. Student membership is available to full-time students in engineering or science courses in colleges granting degrees as a result of four-year courses. Member grade is open to older engineers with several years of experience. Information on these grades may be obtained from the Institute.

COMPLETE YOUR FILES OF

PROCEEDINGS of The Institute of Radio Engineers

WHILE BACK ISSUES ARE STILL AVAILABLE

Now is the time to fill out the gaps on your *Proceedings* shelf and replace lost or borrowed copies. Already, more than 25% of all back numbers are no longer available. Order from the following list:

1913-1915	Volumes 1-3	Quarterly	\$1.50 per copy
1913	Vol. 1	Jan. (a reprint), Dec.	1915 Vol. 3 Dec.
1914	Vol. 2	June	

1916-1926	Volumes 4-14	Bi-monthly	\$1.50 per copy
1916	Vol. 4	June, Aug.	1922 Vol. 10 All 6 issues
1917	Vol. 5	Apr., June, Aug., Oct., Dec.	1923 Vol. 11 All 6 issues
1918	Vol. 6	Feb., Apr., June, Aug., Dec.	1924 Vol. 12 Aug., Oct., Dec.
1919	Vol. 7	Apr., Dec.	1925 Vol. 13 Apr., June, Aug., Oct., Dec.
1920	Vol. 8	Apr., June, Aug., Oct., Dec.	1926 Vol. 14 All 6 issues
1921	Vol. 9	All 6 issues	

1927-1940	Volumes 15-28	Monthly	\$1.00 per copy
1927	Vol. 15	Apr. to July, Oct. to Dec.	1934 Vol. 22 All 12 issues*
1928	Vol. 16	Feb. to Oct., inc., Dec.	1935 Vol. 23 All 12 issues*
1929	Vol. 17	Apr. to June, inc., Aug., Nov.	1936 Vol. 24 Jan. to June, inc.
1930	Vol. 18	Jan., Feb., Apr. to Dec., inc.†	1937 Vol. 25 All 12 issues*
1931	Vol. 19	All 12 issues* †	1938 Vol. 26 All 12 issues*
1932	Vol. 20	Jan., March to Dec., inc.‡	1939 Vol. 27 All 12 issues*
1933	Vol. 21	All 12 issues*	1940 Vol. 28 Jan. to date

* Price for the set of 12 issues, \$10.00

† Complete 12-issue sets, bound in buckram, are available, \$12.00

‡ Price for set of 11 issues, \$10.00

I.R.E. MEMBERS . . . PUBLIC AND COLLEGE LIBRARIES

I.R.E. members in good standing are entitled to a discount of 25% from the above prices. Information about discounts to accredited public and college libraries will be supplied on request.

POSTAGE

Prices include postage in the United States and Canada. Postage to other countries: 10 cents per copy, \$1.00 for bound volumes and complete sets of unbound 12-issue volumes.

Remittance should accompany your order

THE INSTITUTE OF RADIO ENGINEERS, Inc.
330 WEST 42nd STREET, NEW YORK, N. Y.

ENGINEERING DIRECTORY

Consultants, Patent Attorneys,
Laboratory Services

**BRUNSON S. McCUTCHEN and
CHARLES B. AIKEN**
Consulting Engineers

Technical cooperation with Attorneys in connection with patent litigation—Design and Development work—Audio and radio frequency measurements—Equipment studies—Receiver and transmitter problems—A well equipped laboratory.
75 West Street Telephone
New York City Whitehall 4-7275

Use this directory . . .

when you need consulting services

when you are asked to suggest the name of a specialist on an engineering or patent problem

Consulting Engineers, Patent Attorneys, Laboratory Services . . . Applications for card space in the Engineering Directory are invited. Complete data will be sent on request to

PROCEEDINGS of the I.R.E.

330 West 42nd Street New York, N.Y.

INDEX

BOOKLETS, CATALOGS, AND PAMPHLETS	vi
CURRENT LITERATURE	iv
ENGINEERING DIRECTORY	xiv
POSITIONS OPEN	xiv

DISPLAY ADVERTISERS

A

Aerovox Corporation	xv
American Telephone & Telegraph Company	i
Amperex Electronic Products, Inc.	iii

B

Bliley Electric Company	viii
-----------------------------------	------

C

Cornell-Dubilier Electric Corporation	xvi
---	-----

D

Daven Company	vi
-------------------------	----

E

Eitel-McCullough, Inc.	iv
--------------------------------	----

F

Farnsworth Television & Radio Corporation	x
---	---

G

General Radio Company	Cover IV
---------------------------------	----------

I

International Resistance Company	ii
--	----

R

Radio Corporation of America	vii
RCA Manufacturing Company, Inc.	Cover III

T

The Triplett Electrical Instrument Company	viii
--	------

W

Western Electric Company	ix
Weston Electrical Instrument Corporation	v

POSITIONS OPEN

The following positions of interest to I.R.E. members have been reported as open on December 30. Make your application in writing and address to the company mentioned or to

Box No.

PROCEEDINGS of the I.R.E.
330 West 42nd Street, New York, N.Y.
Please be sure that the envelope carries your name and address

CIRCUIT DESIGNERS

An established manufacturing organization has immediate openings for several experienced radio engineers capable of carrying through the circuit design of special (rather than broadcast) receivers and of radio frequency test equipment with a minimum of supervision.

Applicants should submit full details of their education, experience, health, personal qualifications, etc. in their first letter together with a photograph preferably a full-length snapshot. Box 203.

DESIGN ENGINEERS

The Proceedings is receiving an increasing number of requests from employers for engineers with *commercial—design experience* on various specialized types of radio-communication equipment: receivers and transmitters, audio and video, for the broadcast, police, and aircraft services.

If you are qualified and are interested in openings of this type, we suggest that you file a statement of your education and experience record with I.R.E. headquarters. Write to Box 200 and request a copy of the "I.R.E. Employment Record Form."

TUBE ENGINEERS

An opening is expected to develop shortly in the laboratory of a well known organization for engineers who have had experience with the design of television and vacuum tubes. Men who have had experience in the construction of experimental tubes and who are familiar with the necessary glass-working techniques are required. Present employees know of these openings. Box 204.



Attention Employers . .

Announcements for "Positions Open" are accepted without charge from employers offering salaried employment of engineering grade to I.R.E. members. Please supply complete information and indicate which details should be treated as confidential. Address: "POSITIONS OPEN," Institute of Radio Engineers, 330 West 42nd Street, New York, N.Y.

The Institute reserves the right to refuse any announcement without giving a reason for the refusal

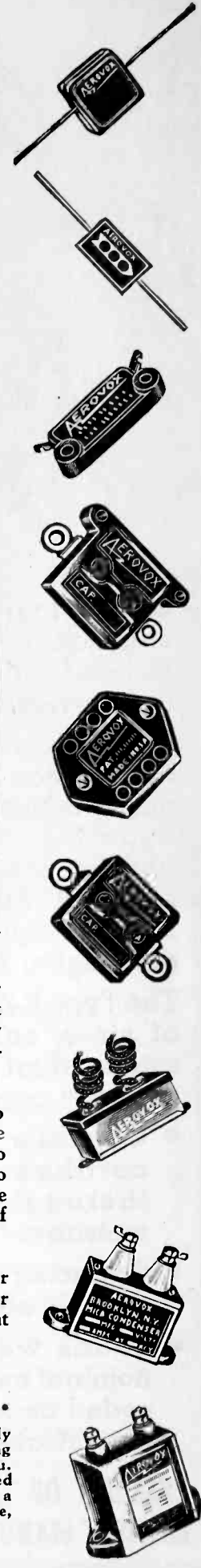
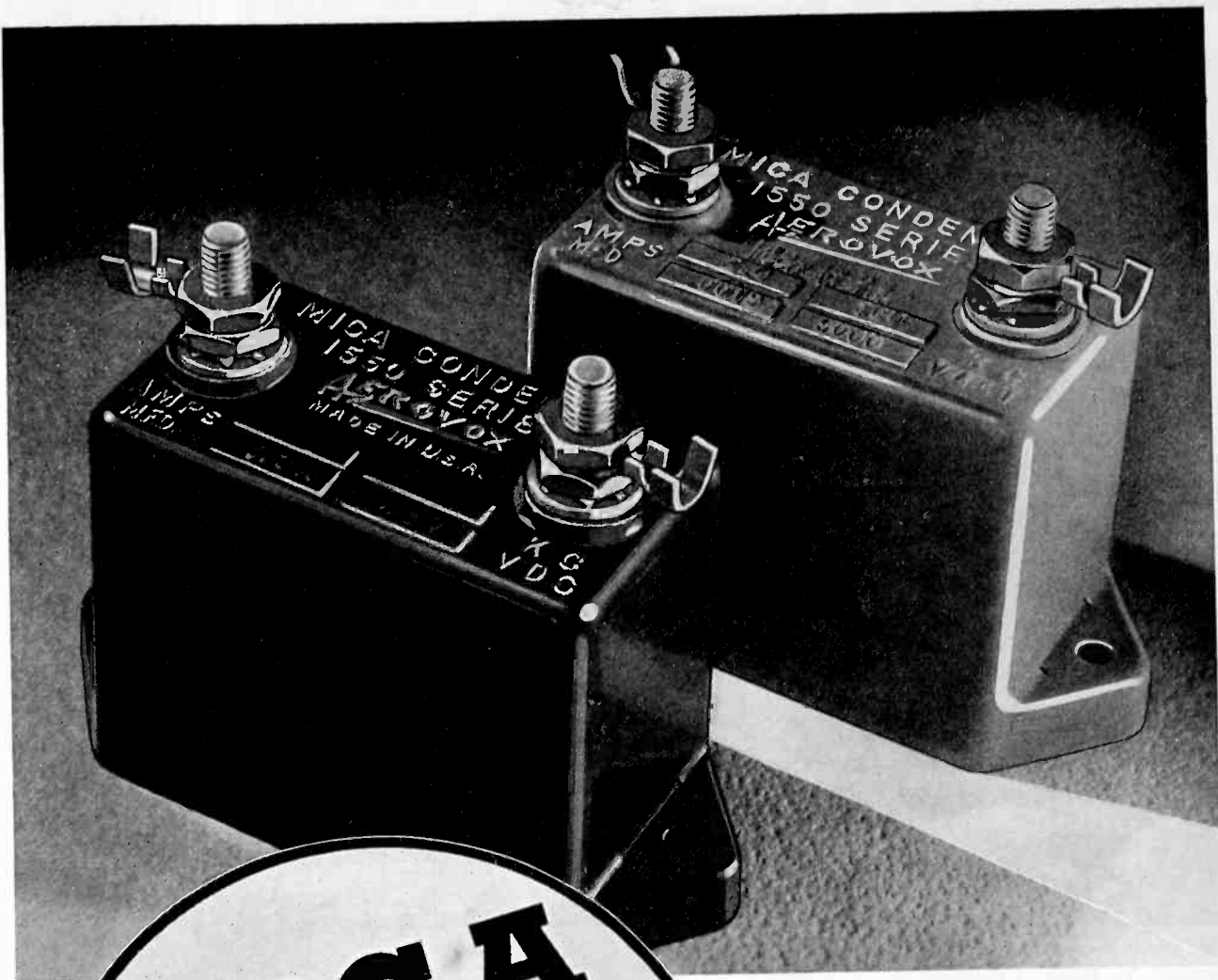

MICA
CAPACITORS
fitted to your
EXACT NEEDS

★ The Mica Department within the giant AEROVOX plant could well be a factory in its own right. Its equipment, production personnel running into the hundreds, specialized engineers and wide range of mica capacitor products, are certainly second to none.

Thus with several dozen standard types of molded bakelite mica capacitors to choose from, you are assured of *any* design, *any* terminals, *any* mounting, *any* capacity and *any* working voltage you may require.

These standard types are available in either the usual brown bakelite or, at a slight price increase, in the mica bakelite (yellow finish) for exceptionally low-loss characteristics.

The AEROVOX mica capacitor line also includes units in large molded bakelite cases (illustrated above) as furnished to commercial radio companies, as well as to electronic equipment builders, etc. Likewise in porcelain cases and several kinds of metal cases.

So no matter what your mica capacitor requirements may be, AEROVOX either has a standard unit or can make just what you need to order. Meanwhile . . .

*Ask for A. A. E. * . . .*

Submit circuit diagrams and complete assembly specs. Let our engineers collaborate in working out the best combination of components for you. Frequently, very considerable savings are effected by this coordinated engineering supported by a tremendous background of experience. At any rate, it doesn't cost you a cent.

* AEROVOX Application Engineering



AEROVOX CORPORATION

New Bedford, Mass.

Sales Offices in All Principal Cities



*A Capacitor for any voltage
and capacity combination*



**CD Etched Foil
TYPE E-Z
ELECTROLYTICS**

One of four types of container construction in which Cornell-Dubilier etched foil dry electrolytic capacitors are provided.

Cornell-Dubilier's continuing research has already accounted for many notable improvements in the Type E-Z. Material reductions in physical size, longer life expectancy, reduced direct current leakage, reduced equivalent series resistance and higher breakdown voltages.

The Type E-Z is available in a variety of sizes, sufficient to encompass single, dual, triple and quadruple capacity combinations.

- Capacitor sealed in impregnated cardboard tube container — thorough protection against moisture.
- Capacitor sections are provided with flexible, insulated leads.
- Leads well anchored against nominal mechanical stresses, color coded as to capacity and voltage classifications.

**PRODUCT OF THE WORLD'S OLDEST AND
LARGEST MANUFACTURER OF CAPACITORS**

PHYSICAL CHARACTERISTICS OF TYPE E-Z

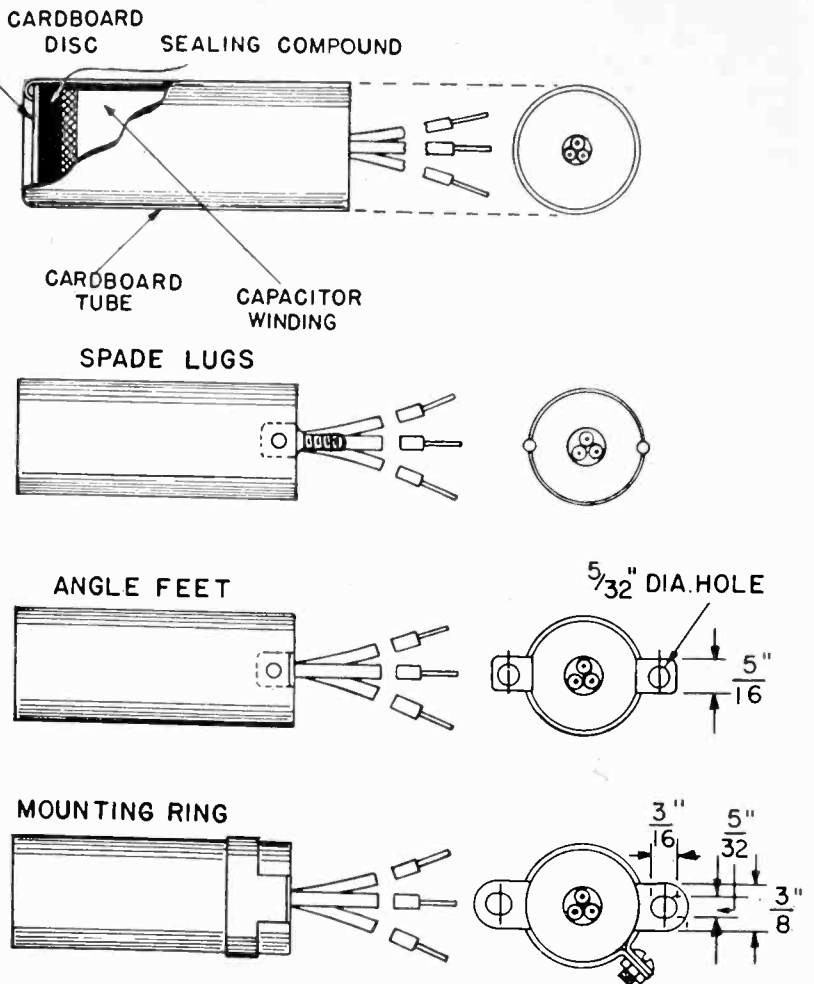

For complete data on physical design and electrical characteristics of Cornell-Dubilier Type E-Z Electrolytic Capacitors for Direct Current applications, send for Engineering Bulletin.

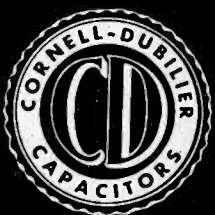

**CORNELL-DUBILIER
ELECTRIC CORPORATION**

1012 Hamilton Boulevard, South Plainfield, New Jersey
Cable Address: CORDU



PREFERRED TYPES of RADIO TUBES

...a Suggestion to Simplify the Tube Picture for
Manufacturers of Radio Sets and Electronic Devices

You may need only one type in ten!

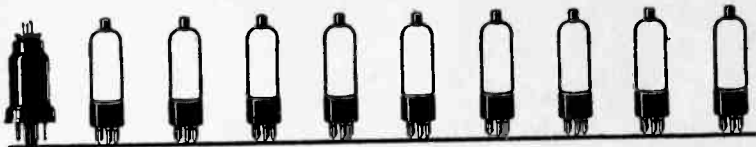

As you know there are 470 types of tubes for radio receivers and electronic devices on the market. A careful study by RCA over a period of months has revealed that 36 preferred types can

meet the requirements of virtually every kind of radio receiver and electronic device being manufactured today. This is less than one-tenth the number of tube types now being used.

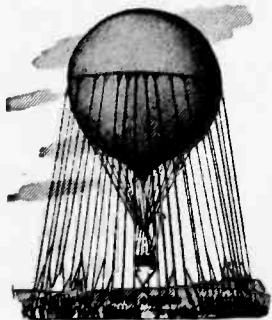

Your company and ours face a situation in regard to radio tubes that parallels an interesting episode which occurred in the French Army back in 1870. A Colonel, with a taste for efficiency, discovered to his utter amazement that somehow the army had amassed a total of 425 different types of cables for the simple purpose of mooring captive balloons. Analysis showed that the job could be done with just 17 preferred types!

If you think the French Army was up in the air in this situation... just consider the facts about radio tubes. Four hundred and seventy types of tubes for radio receivers clutter the industry's warehouses. Four hundred and seventy types... and just 36 preferred types are necessary to meet all the

requirements of practically all radio receivers and electronic devices.

We believe that the RCA "Preferred Types" concentration program will act as a stabilizing influence on the industry and will be helpful to all manufacturers. In spite of the fact that we suggest discarding 9 out of 10 tube types, your engineers are in no way hampered in designing the best radio receivers their ingenuity can contrive—at competitive costs.

This program permits RCA to do more manufacturing for stock with obvious benefits to you. Your inventory of tubes and component parts will be simplified. Deliveries will be speeded up. The whole industry will be benefited. We shall be glad to discuss complete details and point out the specific advantages of the "Preferred Types" plan to you.

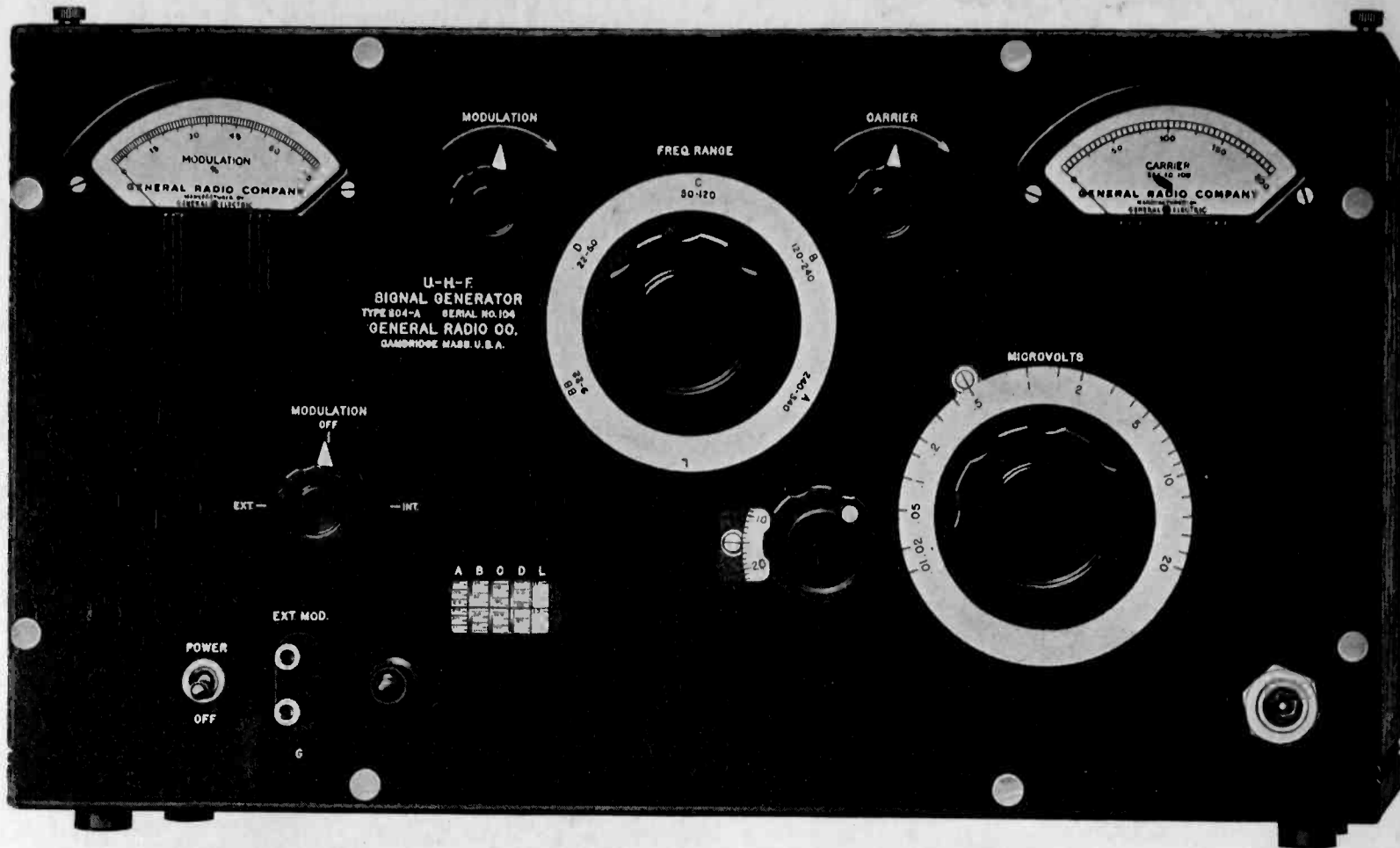

NEW Ultra-High-Frequency Signal Generator

THE development of ultra-high-frequency communication equipment for frequencies up to 300 Mc has been seriously retarded by the lack of satisfactory test equipment.

General Radio announces a new signal generator for use at frequencies between 7.5 Mc and 320 Mc. This signal generator has a number of unique mechanical and electrical features which include very compact oscillator circuit; unique rotatable coil system; new capacitive attenuator with alignment plates to present constant capacitance to the oscillator and eliminate changes in frequency with attenuator setting; very careful mechanical design and construction to obviate changes in calibration from mechanical shock.

The new signal generator features:

- WIDE FREQUENCY RANGE:** in five steps from 7.5 to 330 Mc; unwound plug-in coil provided for any additional frequency range desired by user.
- CONTINUOUSLY VARIABLE MODULATION:** from 0 to 60%. Internal modulation at 400 cycles $\pm 5\%$; external flat to 2 db from 200 to 20,000 cycles.
- ADEQUATE OUTPUT VOLTAGE:** 10 microvolts to 20 millivolts between 7.5 and 120 Mc.
- COMPENSATED CAPACITIVE OUTPUT SYSTEM:** 100 $\mu\mu\text{f}$ capacitance with no attenuator effect on frequency; 90-ohm cable with 90-ohm termination supplied.
- NEGLIGIBLE STRAY FIELD:** not noticeable with receivers of less than 10 μv sensitivity.

Type 804-A Ultra-High-Frequency Signal Generator \$350.00

• WRITE FOR BULLETIN 531

GENERAL RADIO COMPANY
 30 STATE STREET, CAMBRIDGE, MASSACHUSETTS
 Branches in New York and Los Angeles

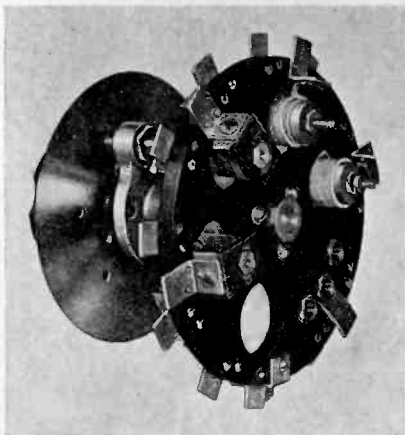

Coil assembly mounted on mycalex disc attached to switch system. Polystyrene coil insulation with unwound plug-in coil form for any additional frequency range desired; excellent electrical contact between silver-plated switch blades and contact springs.

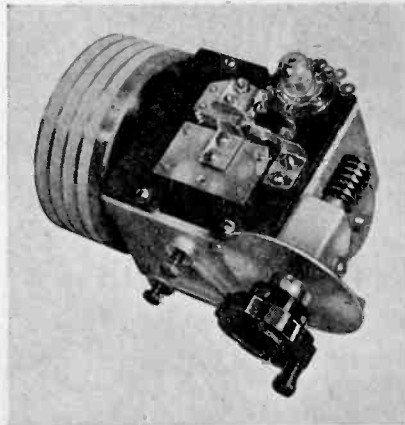

Oscillator circuit built on Type 755-A high-frequency condenser; coil switch contacts mounted directly on condenser; 30 to 1 precision worm drive on condenser with 1500 divisions on main frequency dial; accuracy of setting better than 0.1%.