

characteristic the tube current will experience considerable distortion but the voltage maintained across the tuned circuit may still be very pure. The harmonic components of the latter will not in general be more than two or three per cent under these adverse conditions provided the ratio L/C is kept small.

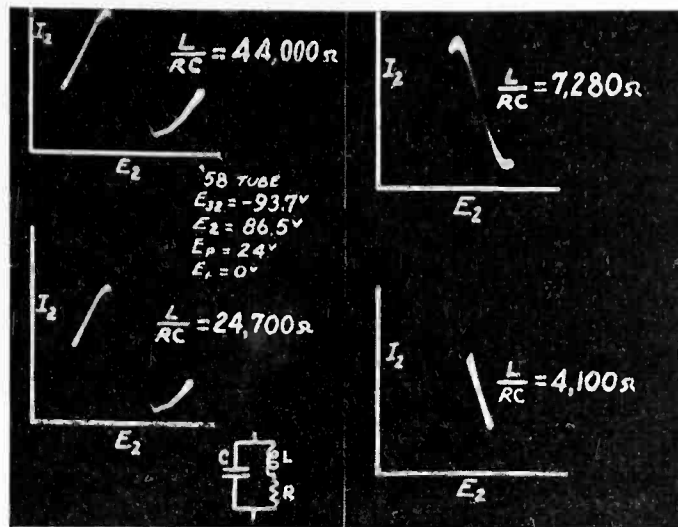

Fig. 5—Cathode-ray oscillograms showing oscillation over the tube characteristic as a function of the quantity L/RC .

Good wave form is accompanied by good frequency stability. The latter is important since when once the tuned circuit parameters are adjusted it is desirable that the frequency remain constant. Notable work on the frequency stability of dynatron oscillators has been carried on by Groszkowski,⁴ Moullin,⁵ van der Pol,⁶ and others. Their results apply equally well to the transitron oscillator. It has been shown that variations in frequency depend directly on the amount of harmonics present in the oscillation voltage. If the voltage contains no harmonics or if the amount of harmonics remains constant the frequency of the system will also remain constant irrespective of any changes in the operating conditions such as changes in the supply voltage. Under normal conditions the transitron oscillator will not experience changes in frequency of more than a few hundredths of one per cent for relatively large variations in the direct anode voltage if the change in tube capacitance is negligible. In these respects it may be compared to a crystal oscillator without temperature control. It may be safely stated that in general the wave form and frequency stability of the oscillations are much better than those of the

⁴ J. Groszkowski, "The interdependence of frequency variation and harmonic content, and the problem of constant-frequency oscillators," *Proc. I.R.E.*, vol. 21, pp. 958-981; July (1933).

⁵ E. B. Moullin, "The effect of curvature of the characteristic on the frequency of the dynatron generator," *Jour. I.E.E.* (London), vol. 73, no. 440, pp. 186-195; August, (1933).

⁶ B. van der Pol, "The nonlinear theory of electric oscillations," *Proc. I.R.E.*, vol. 22, pp. 1051-1086; September (1934).

ordinary back-coupled triode oscillator operating under similar circumstances. The same may also be said for the amplitude of the oscillations. It will be shown later that as the frequency is changed, for example by varying the capacitance C , the amplitude of oscillations will not vary greatly over a wide range of frequency.

FREQUENCY OF OSCILLATION

For general use it is not necessary to calibrate the oscillator, since the frequency may be predicted fairly accurately from the formula

$$f = \frac{1}{2\pi} \sqrt{\frac{1}{LC} - \frac{R^2}{L^2}} \quad (2)$$

This expression, easily derived,^{5,7} is based on the assumption that the tuned circuit is connected to a constant negative resistance satisfying (1). Because of the excellent wave form of the transitron oscillator, equation (2) has been found to hold closely even when operating well over the bends of the tube characteristic. The effect of the curvature of the characteristic on the frequency has been carefully studied and reported in the literature,^{4,5,6} As mentioned previously, the change in frequency is caused by the introduction of slight harmonics as the bends of the characteristic are traversed. The presence of the harmonics causes the frequency to be lower than that given by (2). In extreme cases this correction may amount to fifty cycles in one million. In the audio-frequency range the correction is negligible. For best results the coil resistance R should be as low as possible. The quantity R^2/L^2 is then small in comparison with $1/LC$ and (2) reduces to

$$f \cong \frac{1}{2\pi\sqrt{LC}} \quad (3)$$

Additional factors which influence the frequency may well be noted here. Thus if the coil L consists of an iron-cored choke, changes in the direct anode current flowing through it may change the inductance of the coil two or three per cent. This may be corrected by employing parallel feed for the direct anode voltage or by using air-core coils. The latter is to be preferred if space and weight are not important since the choke required for the parallel feed will still influence the oscillation frequency to some extent. If a variable inductance is to be used to extend the frequency range, short-circuiting out the unused portion of the inductance will serve to cut down har-

⁷ A. W. Hull, "The dynatron, a vacuum tube possessing negative resistance," *Proc. I.R.E.*, vol. 6, pp. 5-37; February, (1918).

Proceedings

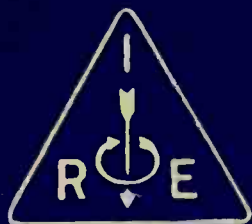

of the

I·R·E

FEBRUARY 1939

VOLUME 27

NUMBER 2

Broadcast studio a-f systems design

Transitron oscillator

Directivity of metal horns

Fixed-focus electron gun

Velocity-modulated tubes

Troposphere, stratosphere ionization

Communication by phase modulation

“Flat-shooting” antenna arrays

Television pickup tube

Low-frequency alternator

Ionosphere characteristics

Institute of Radio Engineers

in these tests to make them a part of the receiver. The relative merits of these horns were determined both from an intercomparison of the received power with and without the horn attached and from the

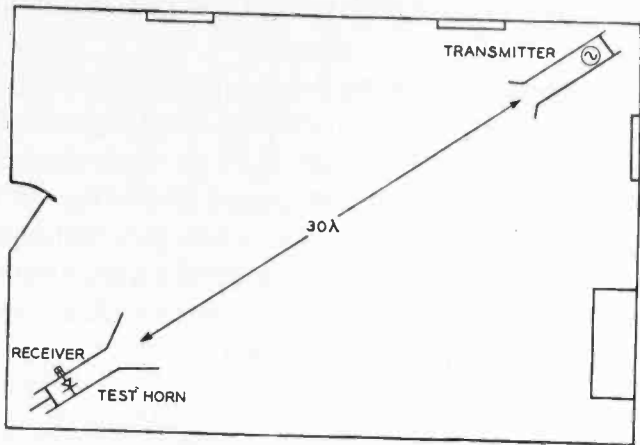

Fig. 2—Arrangement of apparatus used in obtaining directional characteristics of pipes and horns.

sharpness of the directional patterns plotted from measurements made as the horns were pointed at various angles relative to the incoming signal. Together, these two kinds of information supply a fairly complete specification of their properties.

In some cases the transmitter and receiver were located at opposite corners of a room about 20 feet square. In others the test signals were transmitted out of an upstairs window to the receiver located on the ground a 100 or so wavelengths away. Results from the two methods were in general agreement. Fig. 2 shows the general arrangement of the apparatus when the indoor experiments were in progress.

It should be possible to use as the transmitter any of the conventional forms of generators such as, for

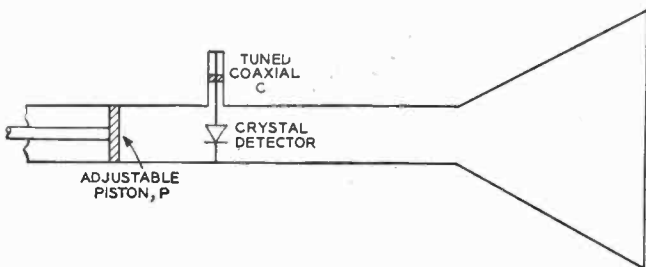

Fig. 3—Schematic of the component parts of the receiver consisting of a conical horn and a cylindrical pipe with tuned detector and adjustable piston.

instance, the Barkhausen, magnetron, or negative-grid types. The one actually used was a wave-guide adaptation of the Barkhausen oscillator. It has already been described.¹ The corresponding receiver is shown in schematic form by Fig. 3. A photograph is shown in Fig. 4. It will be observed that protractors are provided on the two principal axes so that both the angles of azimuth and elevation may be measured.

The receiver proper is of the resonant-cavity type and is made up of a short section of tuned wave guide bounded at one end by a movable piston and at the other by a diametral conductor of adjustable length. This conductor carries a calibrated silicon-crystal rectifier of special construction whose direct-current response, measured either on a potentiometer or a microammeter, enables relative gains to be measured. The construction of the detector and the arrangement of its associated tuned wires are both shown in Fig. 5 for each of two alternate arrangements. This tuning together with the piston adjustment may be regarded as part of the process of matching the detector to the horn pickup device. When this matched condition has been obtained there is not only approximately an optimum of re-

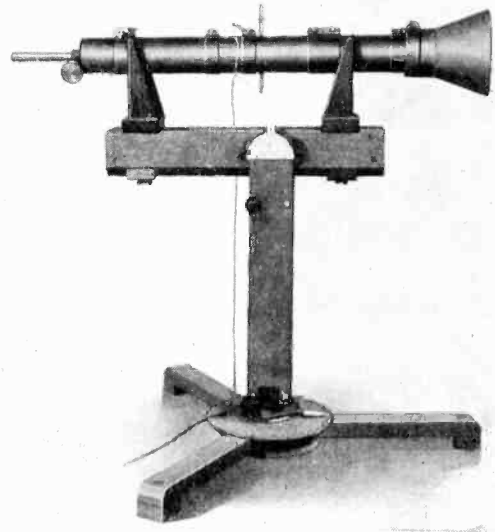

Fig. 4—The complete receiver and mounting.

ceived power but there is also a minimum of standing wave in the space between the horn and the detector. Under this condition the receiver as a whole approximates a perfect absorber.

The condition of minimum reflection may, if necessary, be verified by measurements with a small traveling detector which samples the wave power in the pipe between the cavity and the horn. The construction of the latter device is shown by Fig. 6. It consists of a crystal detector preferably of the form shown as Fig. 5(b) provided with an extremely short pickup wire extending through a narrow slot cut in the top of the pipe. A rack-and-pinion drive permits smooth motion along the slot. A centimeter scale is useful in measuring the position of the detector. The pickup wire on the detector is made just long enough to give a readable deflection on the direct-current microammeter to which the detector is connected and when properly adjusted it offers no appreciable discontinuity to the passing waves and consequently does not

distance without a great increase in cross section, and because of the strong focusing field this system is relatively insensitive to stray fields. In general a length of from 1 to 4 inches is sufficient for most applications unless the frequency of the velocity modulation is very low.

The primary problem in the design of retarding-field collectors is one of shaping the collector so that the effects of orbital velocity of the electrons are reduced to a minimum, and the returning beam is directed at the proper angle. With cylindrical beams it has been found that a collector with spherical shape is quite satisfactory, and yields current-voltage characteristics which have conductances of from 200 to 2000 micromhos per milliampere of beam current. The exact radius of curvature is a function of the

voltage was the order of one volt. Further tests were conducted with tubes having beam currents of 30 milliamperes, in which case about four watts of radio-frequency power were obtained in a lamp load at a wavelength of 50 centimeters.

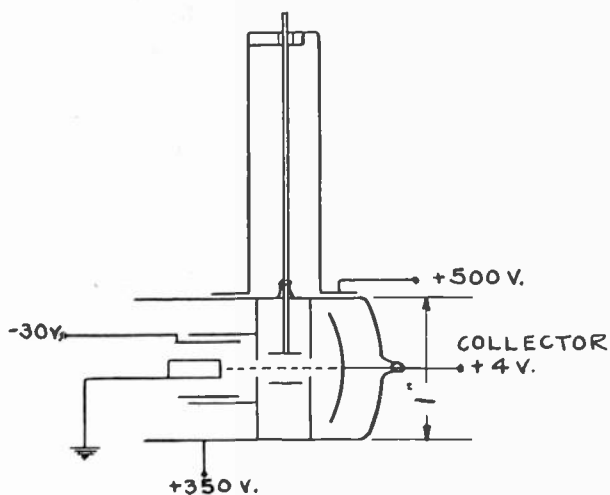

Fig. 7

space-charge density and the focusing fields and is therefore somewhat difficult to calculate. In the receiving tubes tested this radius was from 1/2 inch to 1 inch.

TEST RESULTS

Oscillators

The simplest type of oscillator utilizing the foregoing principles is one using the retarding-field collector in either of the processes previously described. Fig. 7 shows a cross section of the tube with attached circuits, while Fig. 8 is a photograph of the tube with the oscillating circuit in place. This type of tube oscillates with at least a ± 15 per cent range of any voltage at any one frequency and by changing the direct voltage of the radio-frequency grid it will oscillate over a frequency range of 5 to 1. The major portion of the experimental work on this type of tube was done with beam currents of one milliampere or less, but even with this small current, oscillations were easily obtained at a wavelength of 14 centimeters. By observing the anode characteristic during oscillation it is estimated that the beam current was modulated from 30 per cent to 100 per cent and that the output

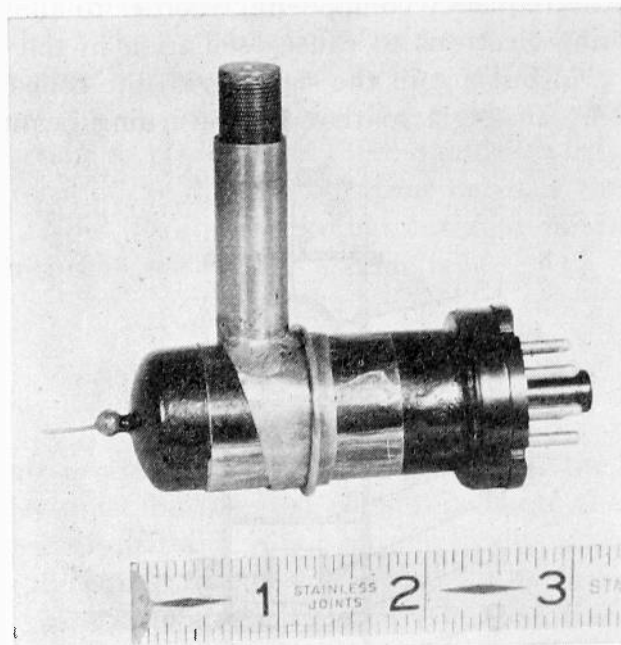

Fig. 8

The major application of this type of oscillator was a superregenerative receiver, the quench frequency being applied on either the collector or the focusing grid. Receivers of this type were tested in

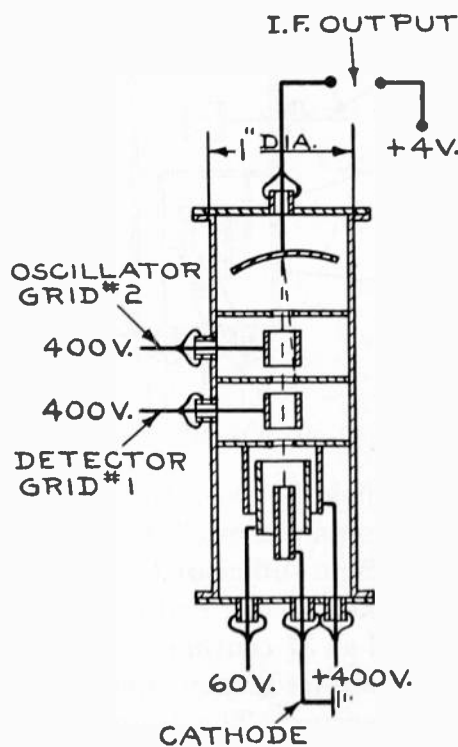

Fig. 9

the field on 37- and 25-centimeter transmission, and proved to be very simple to construct.

Tubes for superheterodyne reception were constructed as shown in Fig. 9. The signal is received

on grid No. 1 which velocity modulates the beam at signal frequency, while grid No. 2 velocity modulates the beam at oscillator frequency. By operating the retarding-field collectors at a point of maximum curvature the current in this element has an intermediate-frequency component. In order to allow the returning electrons to cause oscillation in the oscillator grid but not in the signal grid, the collector is tilted at an angle so that the returning beam will

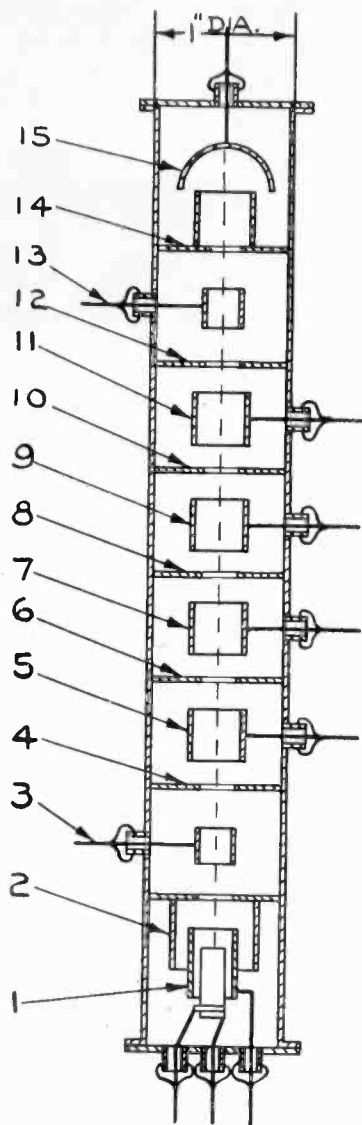

Fig. 10

strike the end shield between these two grids. If it is desired to use a separate oscillator, the collector may be tilted at an angle sufficient to allow the returning electrons to strike the last end shield. Tubes of this type were tested at 37 centimeters with an 18-megacycle intermediate-frequency amplifier and proved to be good converters. The beam current was less than one milliamper and the highest voltage was 350 volts.

RADIO-FREQUENCY AMPLIFIERS

Radio-frequency amplifiers were first tested at 50 to 200 megacycles in order to facilitate accurate

measurement of the radio-frequency voltages. Fig. 10 is a cross section of a radio-frequency amplifier for receiver use in this frequency band utilizing drift-tube sorting. Fig. 11 is a photograph of a similar tube in metal.

The elements numbered 2, 4, 6, 8, 10, 12, 14, and 15 were operated at 300 volts direct current. The direct voltage of radio-frequency grid No. 3 and radio-frequency anode No. 13 were adjusted for maximum output at the frequency used. This usually was about 10 to 30 volts positive. Focusing elements 5, 7, 9, and 11 were connected together and the voltage adjusted to give maximum beam current. This occurred at about 30 volts positive.

The mutual conductance of grid No. 3 to anode No. 13 was measured by first obtaining the voltage gain between them and then measuring the output impedance by cutting the voltage across the output circuit to one half, with a shunt resistance. With a

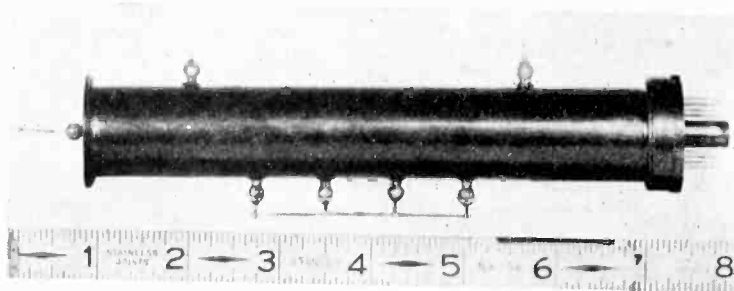

Fig. 11

beam current of 0.8 milliamper and a frequency of 100 megacycles the mutual conductance was about 200 micromhos. This value checked calculations within the accuracy that the average velocity in the drift tube could be estimated. Although the value of mutual conductance obtained in this particular tube was probably too low for practical application at this frequency, it illustrates the principles involved. It is also interesting to note that the operation is not at all critical to voltage, and that both the input and output resistance of the tube were so high as not to affect the attached circuits.

Radio-frequency amplification by means of retarding-field action was also tried. In this case the returning conduction-current-modulated beam was collected on an element at one side of the axis by tilting the collector. The mutual conductance of this type of tube depends almost entirely on the slope of the collector current-voltage characteristic, which in the case of the tube tested was low, the mutual conductance being only 300 micromhos.

Radio-frequency amplifiers using drift-tube sorting, with auxiliary magnetic focusing have proved very effective for high-power outputs. Coils surrounding the tube provide sufficient focusing field so that

or

$$c = C_{\min} + \frac{I}{E\omega} (1 - \cos \omega t). \quad (7)$$

From this expression the maximum value of c becomes

$$C_{\max} = C_{\min} + \frac{I}{E\omega} (2). \quad (8)$$

Solving (8) for I yields

$$I = (C_{\max} - C_{\min}) \frac{E\omega}{2}$$

or

$$I = C\omega E \quad (9)$$

where

$$C = \frac{C_{\max} - C_{\min}}{2}. \quad (10)$$

With resistance added to the circuit the variable condenser will neither completely charge nor discharge during each half cycle, hence (9) may be written thus

$$I < C\omega E. \quad (11)$$

It is now possible to compute the magnitude of the $IR \sin \omega t$ term in the denominator of (5) and to compare it with E . This term should be small compared to E if c is to vary sinusoidally. Hence, from (11),

$$IR < C\omega ER \ll E,$$

whence

$$C\omega R \ll 1. \quad (12)$$

The physical dimensions of the alternator show that (12) can be maintained without making R too small. Hence (5) may be simplified by dropping the second term in the denominator, thus:

$$c = \frac{1}{E} \left[C_0 R I \sin \omega t - \frac{I}{\omega} \cos \omega t + M \right].$$

Combining the sine and cosine terms, yields

$$c = \frac{1}{E} \left[M - \frac{I}{\omega} \sqrt{1 + (C_0 R \omega)^2} \cos(\omega t + \alpha) \right] \quad (13)$$

where $\tan \alpha = C_0 R \omega$. From (13) it is apparent that,

$$C_{\max} = \frac{1}{E} \left[M + \frac{I}{\omega} \sqrt{1 + (C_0 R \omega)^2} \right], \quad (14)$$

and

$$C_{\min} = \frac{1}{E} \left[M - \frac{I}{\omega} \sqrt{1 + (C_0 R \omega)^2} \right]. \quad (15)$$

Using (14) and (15) the expression for C of (10) becomes

$$C = \frac{C_{\max} - C_{\min}}{2} = \frac{I}{E\omega} \sqrt{1 + (C_0 R \omega)^2}. \quad (16)$$

Solving for M/E from (15) and using the value for C from (16) yields

$$M/E = C_{\min} + C. \quad (17)$$

Substituting the values for C from (16) and M/E from (17) into (13) gives the final desired expression for c , namely,

$$c = C_{\min} + C[1 - \cos(\omega t + \alpha)]. \quad (18)$$

If, therefore, the restrictions as set forth by (12) are adhered to, a sinusoidal voltage may be produced across R by giving c a sinusoidal variation; both phase and magnitude relations between current and capacitance are given by (18).

At the lower frequencies considered in this alternator the term $C_0 R \omega$ under the square-root radical in (16) is much smaller than unity. Hence where C is known the current maximum becomes, with but negligible error, from (16)

$$I = CE\omega. \quad (19)$$

It follows, then, that for a given alternator the current output through the grid resistance R is linearly proportional to the battery potential E and to the frequency.

DESCRIPTION OF ALTERNATOR

The assembled view is shown in Fig. 3. The rotor and stator designs are shown in Fig. 4. The stator

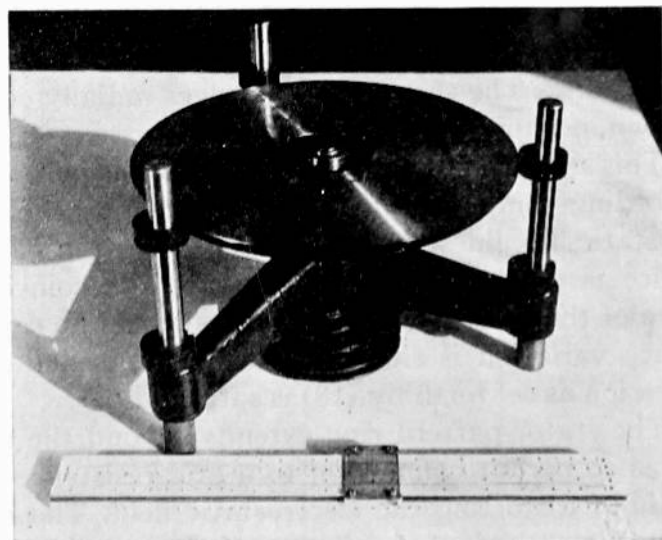

Fig. 3—Assembled view of the electrostatic low-frequency alternator.

consists of a metal-foil pattern mounted on and insulated from a ground steel disk. The foil is insulated from the disk by a thin sheet of paper and a tar-compound adhesive which secures the foil firmly to the paper and the disk.

The ordinates of the pattern are measured from the inside of the ring radially toward the center of

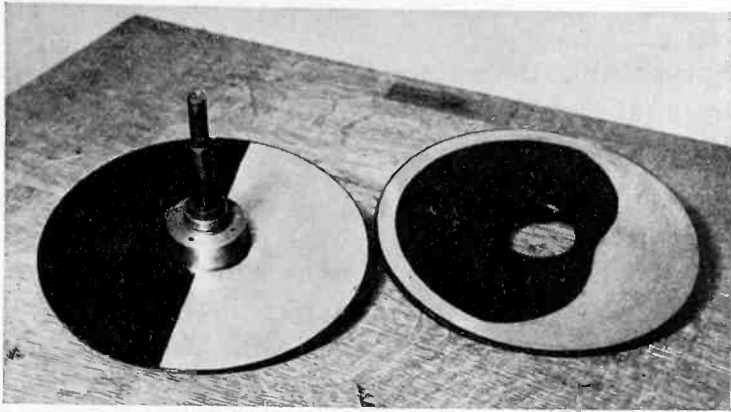

Fig. 4—Rotor and stator designs of the low-frequency alternator.

the disk and are plotted for a total of 180 degrees. The expression for plotting the ordinates is given by

$$y = R - \sqrt{R^2 - (2RH - H^2) \sin \theta}, \quad (20)$$

where y is the ordinate, R the radius from the center of the disk to the inside circumference of the ring, H the maximum ordinate, $\theta = xS/R$ where x is arc length along the circumference having radius R , and S the number of sectors or patterns per disk; in this case $S=1$. The derivation of (20) was given by the authors in a previous paper;¹ it is thus sufficient to state here that the result gives a sinusoidal change in coincident area as the rotor sector passes over the stator pattern.

The rotor sector is mounted on a rotor disk in the same manner as the stator pattern is mounted on the stator disk. The sector with its edges radially cut, as shown, occupies one half of the rotor area.

This type of mounting serves the dual purpose of affording complete shielding and directing the electrostatic flux lines in such a fashion that the capacitance is practically proportional to the coincident area of the rotor and stator sectors; thus the capacitance variation is sinusoidal in nature and the expression as set forth by (18) is satisfied.

The stator-pattern ring extends beyond the rotor so as to permit connection to a grid-resistance lead without distorting the electrostatic field. The rotor sector is connected to a battery for potential supply

¹ E. B. Kurtz and M. J. Larsen, "An electrostatic generator," *Trans. A.I.E.E. (Elec. Eng.)*, vol. 54, pp. 950-955; September, (1935).

by means of a light brush, not shown, which rides on the slip ring. All other parts of the model are grounded.

The stator disk is supported by three hard-rubber rings, each of which has a hole bored off center and slides on a rod so that centering and separation distance from the rotor are easily controlled. The dimensions of the alternator may be estimated by comparison with the foot-scale shown at the bottom of the assembled view. While this model was driven by means of a pulley with belt drive, any drive is satisfactory which does not transmit excessive vibration to the rotor.

CALIBRATION AND OPERATION

The circuit parameters for the alternator just described were approximately

$$\begin{aligned} C &= 50 \text{ micromicrofarads when rotor and stator} \\ &\text{were relatively close,} \\ C_0 &= 200 \text{ micromicrofarads,} \\ R &= 0.5 \text{ megohm or less,} \\ \omega &= 300 \text{ or less, and} \\ E &= 0 \text{ to } 300 \text{ volts.} \end{aligned}$$

These values satisfy the condition imposed by (12) and make $C_0R\omega$ so small that (16) may be written as (19). Thus the voltage across the grid resistor becomes

$$E_g = IR = CER\omega. \quad (21)$$

If facilities are available for measuring C accurately, no further calibration is necessary, assuming, of course, that E , R , and ω are known. C , however, can be measured, using (21), by means of a vacuum-tube voltmeter. The alternator is run at a relatively high speed so that a frequency of 40 or 50 cycles per second is generated; at this frequency the voltmeter, across R , may be read, and knowing the other values, C may be computed. Once found, assuming C is of a value that satisfies (12), it remains the same and may be used in (21) at any frequency. Thus E_g may be controlled by the three remaining independent variables, namely, E , R , and ω .

The wave form will be equally good at all frequencies below the upper limit because the electrostatic field between rotor and stator is purely a space function. Hence frequencies of only fractional periodicity may be generated with assurance that they are relatively pure sine waves.

Broadcast Studio Audio-Frequency Systems Design*

HOWARD A. CHINN†, MEMBER, I.R.E.

Summary—The operating and performance requirements of modern broadcast studio audio-frequency facilities are presented together with specific fidelity characteristics as determined by the present state of the art. A typical studio audio-frequency system design, incorporating the features necessary for practical operations, is also given.

INTRODUCTION

THE design of audio-frequency facilities for broadcast stations divides itself, naturally, into two categories. First, there is the design of the individual circuit components. Second, there is the design of the complete system utilizing these components. System design, furthermore, may be subdivided into studio, portable master control (program distribution), building monitoring, and transmitter audio-frequency facilities.

This paper, which is confined to studio audio-frequency systems, outlines present-day operating and performance requirements. Specific fidelity characteristics are stated and a typical system design presented.

OPERATING REQUIREMENTS

The operating requirements of a complete studio audio-frequency system can readily be outlined. Facilities are required for amplifying the exceedingly low output voltage of present-day microphones to the level that will permit transmission, without impairment of quality, on available program circuits. Furthermore, means are required for combining into one program channel, in any desired proportion, program elements from several sources. This process, which is known as "mixing," provides the multiple-microphone, transition, and "fading" effects which contribute so much to program continuity. Finally, means are needed for adjusting the resulting program material to the desired power level without affecting the "balance" which has been achieved by the mixing operation. A master gain control is used for this purpose.

In order that a fine degree of control may be maintained over the resulting program material, it is necessary to supplement the transmission facilities with visual and aural monitoring apparatus. Volume indicator instruments and loud speakers are used for this purpose.

* Decimal classification: R550. Original manuscript received by the Institute, June 6, 1938; revised manuscript received by the Institute October 5, 1938. Presented before Thirteenth Annual Convention, New York, N. Y., June 16, 1938

† Columbia Broadcasting System, Inc., New York, New York.

"Cue" facilities are also required so that the occupants of both the studio and the control room may hear the program that is in progress prior to the beginning of their own performances. Finally, it is necessary to provide means for communication between the control room and the studio itself during the course of rehearsals. These "rehearsal-break" facilities permit the program producer in the control room to interrupt the cast, rehearsing in the studio, in order to direct them in their work.

One of the foremost requisites of all broadcast facilities is continuity of service throughout the broadcast day. The need for such reliability arises from the psychological reaction of the listener to a program interruption and from the keen competition between the many stations. In planning the facilities it is necessary, therefore, to take many precautionary measures and to provide for the immediate restoration of service in the event that any piece of equipment becomes defective.

Emergency facilities are also required for use in the event that any of the regular power supplies fail. These include the 110-volt alternating-current primary power source as well as any low or high voltage alternating- or direct-current power that is required.

Although the general operating requirements of a complete studio audio-frequency system may thus be simply stated, the actual accomplishment of the desired results sometimes involves rather complex circuit arrangements.

PERFORMANCE REQUIREMENTS

The over-all electrical performance requirements of the complete studio audio-frequency facilities are determined, to a large extent, by such factors as the characteristics of the best commercially available radio receivers, the ability of the ear to detect loss in fidelity, and the economic aspects that are involved. Bearing these factors in mind, the present-day performance requirements of a modern broadcast studio system can be stated readily. It is to be noted that the following characteristics are those of the studio facilities alone, and are not necessarily representative of the over-all performance requirements of a complete broadcast installation.

The response-frequency characteristic of the entire program channel (neglecting any equalization that may be used to correct for shortcomings of associated microphones) should not deviate from the

Contributors



H. G. BOOKER

Henry George Booker was born on December 14, 1910, at Barking, Essex, England. In 1930 he received the B.A. (Hons.) degree from the University of London, and was a scholar of Christ's College, Cambridge, from 1930 to 1934,



CLEDO BRUNETTI

being Wrangler at the University of Cambridge in 1933. Mr. Booker was an Allen Scholar at the University of Cambridge from 1934 to 1935, Smith's Prizeman in 1935, and received the Ph.D. degree in 1936. At the present time he is a Fellow of Christ's College and Faculty Assistant Lecturer in Mathematics at the University of Cambridge. During his sabbatical year, 1937-1938, he engaged in ionosphere research at the Department of Terrestrial Magnetism at the Carnegie Institution of Washington. Mr. Booker is a Fellow of the Cambridge Philosophical Society.

Cledo Brunetti (A '37) was born April 1, 1910, at Virginia, Minnesota. He received the B.E.E. degree from the Univer-

sity of Minnesota in 1932 and the Ph.D. degree in 1937. From 1932 to 1936 he was a Teaching Fellow in the department of electrical engineering at the University of Minnesota and from 1936 to 1937, an instructor. Since 1937 Dr. Brunetti has been an instructor in electrical engineering at



H. A. CHINN

Lehigh University. He is a member of Tau Beta Pi, Eta Kappa Nu, and Sigma Xi.

Howard A. Chinn (A '27—M '36) was born in New York City on January 5,

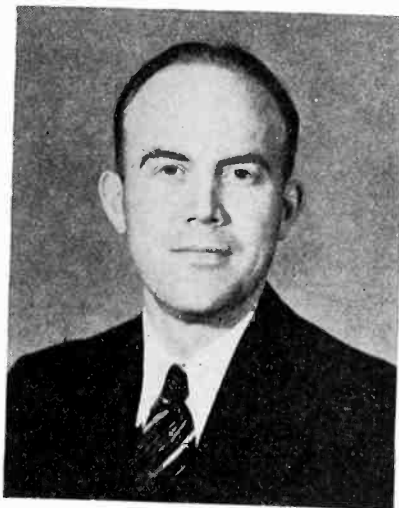

M. G. CROSBY

1906. He attended the Polytechnic Institute of Brooklyn, later going to Massachusetts Institute of Technology where he received the B.S. degree in 1927 and the M.S. degree in 1929. From 1927 to 1932 he was a research assistant at Massachusetts Institute of Technology. In 1932 Mr. Chinn became associated with the Columbia Broadcasting System where from 1932 to 1933 he was research associate; from

1933 to 1934, radio engineer; 1934 to 1936, assistant to the Director of Engineering; and from 1936 to date, Engineer-in-Charge of Audio Engineering.

Murray G. Crosby (A '25—M '38) was born at Elroy, Wisconsin, on September 17, 1903. He attended the University of Wisconsin from 1921 to 1925, and received the B.S. degree in electrical engineering in 1927. From 1925 to 1927 he was with the Radio Corporation of America, and from 1927 to date he has been with R.C.A. Communications, Inc.



H. A. FINKE

Herbert A. Finke was born October 28, 1914. In 1934 he received the degree of Bachelor of Science in Physics. At the present time Mr. Finke is a fourth-year



O. H. GISH

student at the Massachusetts Institute of Technology.

Oliver H. Gish was born at Abilene, Kansas, on September 7, 1883. He received

the B.S. degree from Kansas State College in 1908 and the A.M. degree from the University of Nebraska in 1913. From 1911 to 1918 he was an instructor in mathematics and physics at the University of Nebraska. In 1918 he became research engineer with the Westinghouse Electric and Manufacturing Company leaving there in 1922 to go with the Department of Terrestrial Magnetism of the Carnegie Institution of Washington where he is now Assistant Director and Chief of Section of Terrestrial Electricity. Mr. Gish is a Member of the American Association for the Advancement of Science, American Geophysical Union, Meteorological Society, Philosophical Society of Washington,



W. C. HAHN

Sigma Xi, and Washington Academy of Sciences. He is a Fellow of the American Physical Society.



W. W. HANSEN

W. C. Hahn (A '36) was born in Cedarville, Illinois, in 1901. He received the B.S. degree from Massachusetts Institute of Technology in 1923. In 1922 and 1923 he took the student engineering course at the General Electric Company,

and in 1924 was sent to their Chicago office where he was in the transmission-line and relay engineering department until 1932. Since 1933 Mr. Hahn has been in their engineering general department at Schenectady.



William W. Hansen was born in 1909 at Fresno, California. He received the A.B. degree in 1929 and the Ph.D. degree



L. M. HOLLINGSWORTH

in 1933 from Stanford University. Dr. Hansen was an instructor in physics at Stanford University from 1930 to 1932; National Research Fellow from 1933 to 1934; assistant professor of physics at



HARLEY IAMS

Stanford University from 1934 to 1937; and associate professor from 1937 to date.



Lowell M. Hollingsworth (A '37) was born at Portland, Oregon, on January 8, 1907. He received the B.S. degree in electrical engineering from Oregon State College in 1930 and the E.E. degree from Stanford University in 1935. From 1930

to 1932 Mr. Hollingsworth was with Bell Telephone Laboratories. Since 1936 he has been an instructor in engineering at San Francisco Junior College.



A. P. KING

Harley Iams (A '31—M '38) was born on March 13, 1905, at Lorentz, West Virginia. In 1927 he received the A.B. degree from Stanford University. Mr Iams



E. B. KURTZ

took the student course from 1927 to 1928, and from 1928 to 1930 was in the facsimile and television research department of the Westinghouse Electric and Manufacturing Company. Since 1931 he has been doing television research for the RCA Manufacturing Company.



Archie P. King (A '30) was born in Paris on May 4, 1901. He received the B.S. degree from California Institute of Technology in 1927. From 1927 to 1930 he was in the seismological research department of the Carnegie Institution of Washington, and from 1930 to date he has been with Bell Telephone Laboratories. Mr. King is a Member of the American Institute of Electrical Engineers.

E. B. Kurtz was born in 1894 at Cedarburg, Wisconsin. He received the B.S. degree in electrical engineering in 1917 from the University of Wisconsin; the M.S. degree in 1919 from Union College; and the Ph.D. degree in 1932 from Iowa State College. From 1917 to 1919 he was with the General Electric Company. Dr. Kurtz was at the Iowa State College from 1919 to 1925 and the Oklahoma Agricultural and Mechanical College from 1925 to 1929. Since 1929 Dr. Kurtz has been Professor of



M. J. LARSEN

Electrical Engineering and Head of Department at the University of Iowa. He is a member of Tau Beta Pi, Sigma Xi, Sigma Tau, and Phi Kappa Phi as well as being a Fellow of the American Institute of Electrical Engineers and the American Association for the Advancement of Science.



M. J. Larsen was born in 1909 at Spencer, Iowa. He received the B.S. degree in electrical engineering in 1933; the M.S. degree in 1934; and the Ph.D. degree in

1937 from the State University of Iowa. From 1928 to 1929 he was with the Northwestern Bell Telephone Company and spent the summer of 1937 in the research department of the Central Commercial Company. Since 1937 he has been an in-



G. F. METCALF

structor in electrical engineering at the Michigan College of Mining and Technology. He is a member of Sigma Xi, Eta Kappa Nu, and the Society for Promotion of Engineering Education.



G. F. Metcalf (A '34—M '37) was born on December 7, 1906, at Milwaukee, Wisconsin. He received the B.S. degree from Purdue University in 1928, and that same year took the General Electric Company's student engineering course. From 1929 to 1931 Mr. Metcalf was in the research laboratory of that company and since then has been in their vacuum-tube engineering department.



George C. Southworth (M '26) was born at Little Cooley, Pennsylvania, on August 24, 1890. He received the B.S. degree in 1914 and the M.S. degree in 1916 from Grove City College. In 1923 he was awarded the Ph.D. degree from Yale University. Dr. Southworth was assistant physicist at the Bureau of Standards from 1917 to 1918 and returned to Yale University as an instructor from 1918 to 1923. He joined the research staff on radio communication of the American Telephone



G. C. SOUTHWORTH

and Telegraph Company in 1923 and was transferred to Bell Telephone Laboratories where he has been since 1935. In 1927 and 1930 he was a De Forest (radio) lecturer at Yale University. He is a Member of the American Physical Society and a Fellow for the American Association for the Advancement of Science.



For biographical sketches of T. R. Gilliland, S. S. Kirby, and Newbern Smith, see the PROCEEDINGS for January, 1939.

THEY SPEAK FOR THEMSELVES

Erie SILVER-MICAS



FOR ELIMINATING CONDENSER DRIFT

Erie CERAMICONS

REG. U.S. PAT. OFF.



FOR COMPENSATING FOR FREQUENCY DRIFT

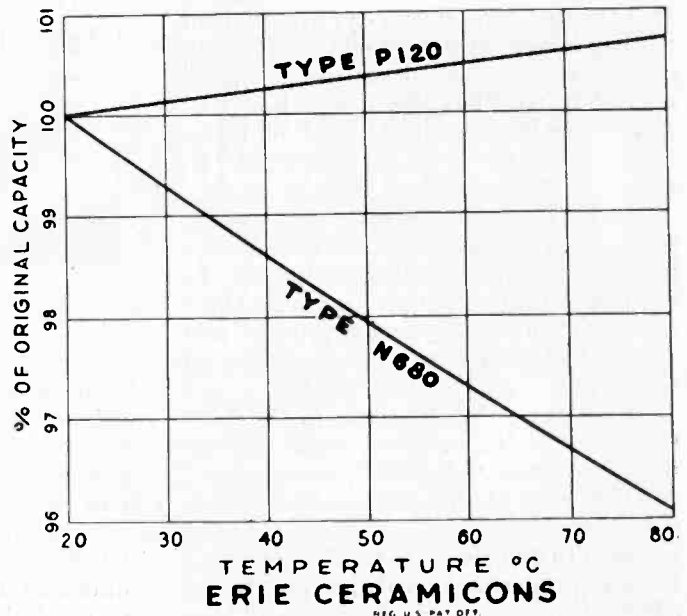
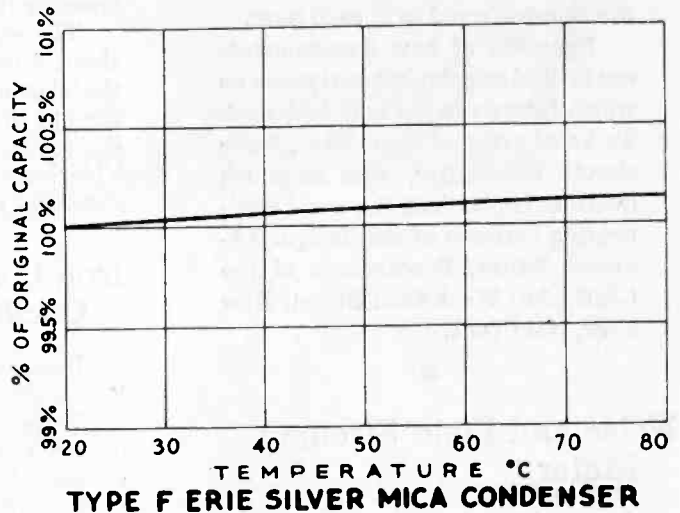

One look at these two charts tells why Erie Silver Mica Condensers and Erie Ceramicons are indispensable for keeping push button tuned receivers "tuned on the nose."

Erie Silver Micas eliminate condenser frequency drift because their temperature coefficient is only $+.000025/^\circ\text{C}$ —negligible for all practical purposes. And when frequency drift is present in other circuit elements, the use of a proper value Erie

Ceramicon can compensate for that change. These silver-ceramic condensers have a definite, linear and reproducible temperature coefficient.

Both of these units have been thoroughly tried and proven in the laboratory and in actual service. Their characteristics are unusually good, and their operation is unbelievably dependable.

Write today for specification booklets that give complete engineering data on these Erie Condensers.

ERIE RESISTOR CORPORATION, *Erie, Pa.*

TORONTO, CANADA • LONDON, ENGLAND • PARIS, FRANCE - J.E. CANETTI CO.

MANUFACTURERS OF RESISTORS • CONDENSERS • MOLDED PLASTICS

Commercial Engineering Developments

These reports on engineering developments in the commercial field have been prepared solely on the basis of information received from the firms referred to in each item.

Sponsors of new developments are invited to submit descriptions on which future reports may be based. To be of greatest usefulness, these should summarize, with as much detail as is practical, the novel engineering features of the design. Address: Editor, Proceedings of the I.R.E., 330 West 42nd Street, New York, New York.

Noise and Field Strength Meter

A portable microvolter has been developed by Ferris* for measuring the field intensity of radio noise and useful signals. It is an amplifier-detector-type instrument with an indicating output meter and a self-contained calibrator for standardizing the over-all gain of the system. Signals may be picked up by a 0.5-meter rod or introduced, voltmeter fashion, at 2 input terminals.

Since noise levels may fluctuate rapidly over wide ranges, the output meter has a logarithmic characteristic, obtained by the use of a variable- μ tube. It covers the 3 decades from 1 to 1000 microvolts or from 100 to 100,000 microvolts, depending on the setting of a multiplier switch.

By means of a panel switch, the characteristics of the rectifier-meter circuits may be changed from the "average-type" response required for carrier-voltage measurements to a quasi-peak type of response required to give readings that are approximately proportional to the interfering effectiveness of a noise wave. These weighted noise readings are stated in terms of equivalent microvolts of carrier; that is, the noise reading in microvolts is that value of carrier which would produce the same meter deflection.

The internal calibrator consists of a voltage generator that produces a uniform

*Ferris Instrument Corporation, Boonton New Jersey.

Ferris radio noise meter

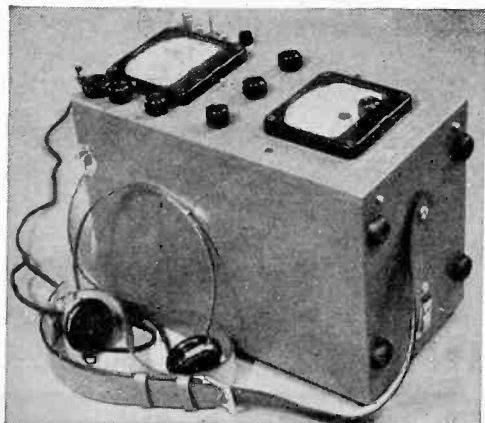

noise spectrum. No tuning of the instrument is required. The signal is derived from the shot noise of a vacuum tube whose space current has been limited by lowering the filament temperature.

The equipment is accurate to within about 3 decibels after standardizing with the shot-noise calibrator. Measurements good to within about 1 decibel are possible if an external calibrating unit is utilized. This is a small, battery-operated signal generator of conventional design.

Iron Cores for Power Oscillators

Because of voltage breakdown problems and heating in the material, efforts to apply powdered iron cores in high-frequency power oscillators have not been so successful as in the radio-receiver field. A core material and a core structure, announced by Mallory* are said to have overcome previous objections.

The material is composed of ferromagnetic particles of extremely small size



Five sections of a powdered-iron core assembled on a threaded rod of insulating material

which are compressed in a binder of insulation material. Grain sizes are such that cores made from it are recommended for general use in high- Q circuits at frequencies up to 3 megacycles. The apparent permeability is approximately 6, and an effective permeability (ratio between inductance values with and without the core) of about 3 can be realized in well-designed coils.

In the larger sizes the cores are made up of a series of annular cylindrical sections from $\frac{1}{2}$ to 2 inches in axial length and from $2\frac{1}{8}$ and $8\frac{3}{8}$ inches in outside diameter. These are assembled on an insulated shaft and insulated from each other by mica washers. Subdividing the core reduces the losses due to circulating currents and permits the use of relatively close-fitting coils in high-voltage transmitter circuits.

Numerous applications are suggested for design features in fixed and mobile transmitters. These are based on the possibility of reducing bulk and losses in inductors and of providing continuous adjustment of circuit tuning over wide frequency ranges.

Another grade of the same core material is available for use at lower frequencies and for applications where losses are of minor importance, such as antenna chokes, modulation transformers and chokes, etc. Its apparent permeability is approximately 8.

* P. R. Mallory & Co., Inc., Indianapolis, Indiana.

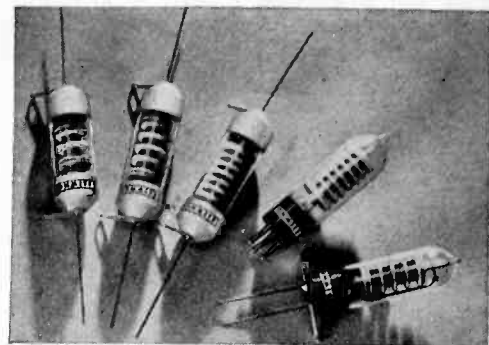

Sealed-in resistors

Resistors Sealed in Glass

Precision-type resistors, hermetically sealed in glass tubes, have been developed by Ohmite* for applications requiring protection against the effects of humid or corrosive atmospheres. They are available in a variety of mounting styles.

The resistors are non inductively wound on 2-, 4-, 6-, or 8-section spools, adjacent pies having the direction of winding reversed. After winding, the unit is baked to drive off moisture and impregnated with a material that increases the dielectric strength and bonds the wire and core together. The unit is then placed in the tube which is then evacuated, filled with a dried gas, and sealed by fusing the end of the tube onto the terminal wires.

Units are rated at 1 watt and are supplied for resistance values in the range between 0.1 ohm and 2 megohms. Although they can be supplied with a closer tolerance when required, they are ordinarily adjusted to within 1 per cent.

* Ohmite Manufacturing Company, 4860 West Flournoy Street, Chicago, Illinois.

Amplifier Gain Measuring Set

A direct-reading "gain indicator" for measuring the gain of audio-frequency power amplifiers is being manufactured by the Monarch Manufacturing Company.*

It consists of a 0- to 15-volt rectifier-type alternating-current voltmeter and a calibrated, constant-impedance attenuation network having an internal input impedance of 500 ohms and an internal output impedance that varies between 200 and 500 ohms, depending on the attenuator setting. The voltmeter can be connected across either the attenuator input or the amplifier load by means of a switch on the panel.

The instrument is intended to be used as follows: Power from an external source is supplied to the amplifier under test through the attenuation network, which is then adjusted until the meter indicates the same voltage for both positions of the meter switch. The power loss in the network is taken to be equal to the gain in the amplifier, and the result of the measurement in decibels is read directly from the attenuator scale. If the load and input im-

* Monarch Manufacturing Company, 3341 Belmont Avenue, Chicago, Illinois.

New speakers bring new significance to the term:

"Presence!"



ASK YOUR ENGINEER

to check-up on these latest pace-setters!

NEW single unit loud speakers by Bell Telephone Laboratories and Western Electric—

That give you high quality reproduction at moderate power levels—

That distribute sound over angles of 30° to 45°—making them admirably suited for monitor or public address applications—

That reproduce so faithfully, that the artists are brought into the "presence" of the listener—

That add crystal clear "definition" that enables monitor operators and production men to better evaluate program balance—

That employ an entirely new diaphragm formation, new type permanent magnet and other new design features.

Ask your engineers about this suitable companion to the Western Electric 94 type amplifier. Or better yet—order one speaker, evaluate its reproduction quality and let your monitor operators and production men tell you how much it helps them! Then you'll order more!

DISTRIBUTORS

Graybar Electric Co., Graybar Building, New York, N. Y.
In Canada and Newfoundland: Northern Electric Co., Ltd.
In other countries: International Standard Electric Corp.

HIGH QUALITY
DIRECTIVE BEAM

make the

750A and 751A

ideal for

MONITORING

Western Electric



RADIO TELEPHONE BROADCASTING EQUIPMENT

BLILEY CRYSTALS

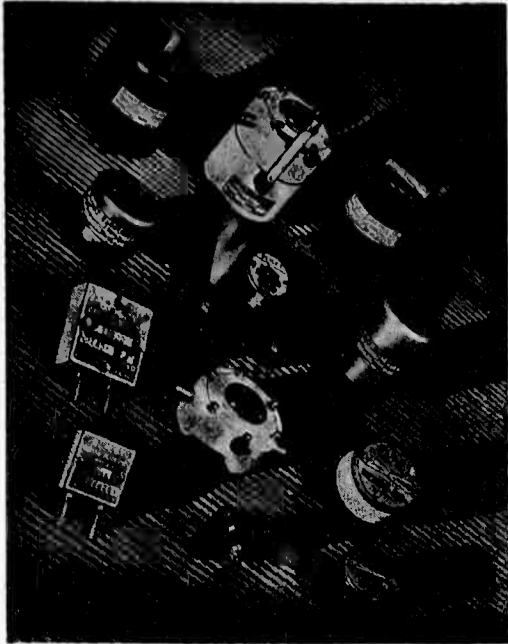

HOLDERS OVENS

ONLY carefully selected Brazilian Quartz is used in the manufacture of Bliley General Communication Frequency Crystals. As each individual crystal passes through its various processing operations, many optical, mechanical and electrical examinations are applied to insure the highest possible standards of precision and quality.

So that proper characteristics and frequency accuracy can be guaranteed, each crystal is finally checked and calibrated in the holder in which it will operate. Bliley crystal holders and oven mountings are engineered particularly for dependable performance of Bliley Crystals from 20kc. to 30mc. Various types are available to suit frequency control requirements throughout the complete crystal frequency range.

A competent engineering staff is maintained for product research and development. Recommendations and quotations covering quartz crystals for any standard or special applications will gladly be extended without obligation. Write for catalog G-10 describing Bliley General Communication Frequency Crystals.

BLILEY ELECTRIC CO.
UNION STATION BUILDING ERIE, PA.

(Continued from page ii)

pedances of the amplifier are not equal, a term ($20 \log \text{impedance ratio}$) is applied to correct for the difference in impedance level. A chart relating the impedance ratio and the correction is supplied with the instrument.

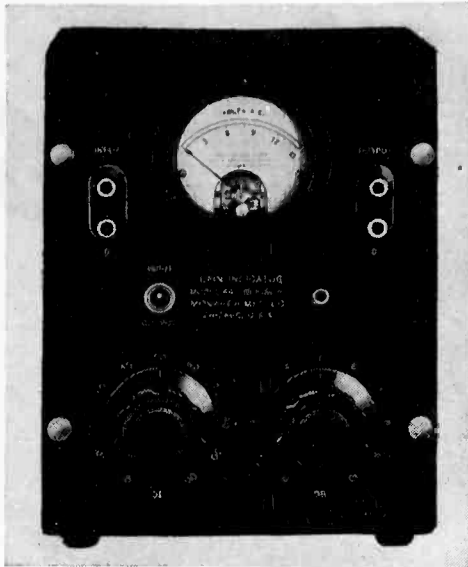

Monarch gain indicator

The attenuator is made up of resistive elements, non-inductively wound on thin cards and individually adjusted. It has a total range of 110 decibels: 10 steps of 10 decibels and 10 steps of 1 decibel.

Standards for High-Frequency Impedance Measurements

In an effort to extend the range of commercially practicable impedance measurements to higher frequencies, the General Radio Company* has developed a fixed resistor of the straight-wire type and improved the characteristics of one of its precision-type variable air condensers.

In condensers of conventional construction, current enters at one end of the rotor and stator stacks. The system was analyzed on the assumption that the current decreases linearly along the rotor shaft and stator-support rods and that the inductance and metallic resistance are uniformly distributed. It was found that by feeding the current into the center of each stack, both the resistance and inductance would be reduced to about $\frac{1}{3}$ of their values in an end-fed system.

The method adopted for feeding current at the center is shown in the accompanying photograph. A heavy strip connector feeds the stator stack, and a circular brass disk with a wide brush contactor feeds the rotor.

In the design of the straight-wire resistor, manganin wire as small as 0.0006 inch in diameter was selected in order to minimize temperature coefficient and the change in effective resistance with frequency due to skin effect. While the small values of inductance and capacitance that are inherent in the straight-wire type of construction were desirable, further studies showed that reducing one reactance parameter at the expense of the other would often materially raise the frequency

* General Radio Company Cambridge, Massachusetts.



• CREI Originated Training in Practical Radio Engineering

CREI Training is Recognized for its high Standard

The manner in which the radio industry has acknowledged CREI men as *well-trained men* is best exemplified by the fact that CREI students and graduates are now employed in more than 275 U. S. broadcasting stations. Among our students are engineers in top positions and those "just breaking in" . . . it is this desire of most radiomen to acquire more technical ability that forms the backbone of a growing industry.

We, too, are keeping pace. Lessons are under constant revision to embody latest developments and advances in every branch of the field. The acquisition of our own well-equipped building is another step in our constant effort to provide increased facilities for modern, practical training.

*"A Tested Plan for a
Future in Practical
Radio Engineering"*

You will find it worthwhile to read this interesting booklet. It contains complete details about our school and courses. Write for your free copy today.

**Capitol Radio
ENGINEERING INSTITUTE**

E. H. RIETZKE, Pres.
Dept. PR-2
3224 SIXTEENTH ST., N.W.
WASHINGTON,
D.C.

AEROVOX

CAPACITY and
RESISTANCE

Bridge



In the best interests of ALL users of condensers, AEROVOX engineers have developed this more critical checking means. Tests and readings, more than any claims and superlatives, best tell the true story of any and all condensers.

Years of experience testing and checking condenser quality have been boiled down to provide this simple, portable, moderately-priced instrument. A handy manual supplied with each instrument (or 50¢ separately) reviews the entire bridge art. You simply can't afford to be without this condenser yardstick.

Ask to See It . . .

- Your local AEROVOX jobber can show you this unique instrument. Or if you prefer, write us direct for descriptive literature.

The Latest in Condenser Checking ...and what it does

1 Meter Range Switch . . . the "brains" of the Aerovox Bridge.

Provides external milliammeter first three positions; external voltmeter next three positions, ranging from 60 to 600 v. at 1000 ohms per volt; "Bridge" indicates power on and balancing position. Also provides vacuum-tube voltmeter and insulation resistance test at "VTV"; leakage test through X terminals at "L 60 MA" and "L 6 MA" positions; and polarizing voltage readings on proper meter range at "PV" position.



2 Polarizing Voltage Control.

Inner knob serves as transformer tap switch. Outer knob is vernier control indicating continuously variable voltage 15 to 600 volts in 3 steps. Voltmeter automatically switched to proper range 0-60, 0-300, 0-600. Variable voltage available between terminals +X and Ground for meter calibration, load tests, amplifiers, etc.



3 Power factor control and switch for insulation resistance test.

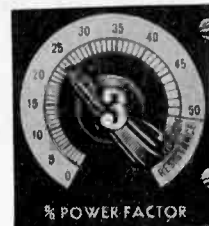

4 Bridge Range control . . . for reading capacity:

- 10 — 100 mfd.
- 1 — 10 mfd.
- .1 — 1 mfd.
- .01 — .1 mfd.
- .001 — .01 mfd.
- .0001 — .001 mfd.

Multiplying factor for both capacity and resistance indicated on face of control.



5 Zero Adjustment for vacuum-tube voltmeter and bridge detector.

6 Push Button for insulation resistance test.

7 Main Dial, linear calibrated, for capacity and resistance readings.



AEROVOX CORPORATION

New Bedford, Mass.

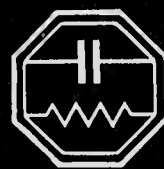

Sales Offices in All Principal Cities

An Outstanding Patented
Circuit Recommended By
the Best Laboratories and
Technicians.

SELF-CALIBRATING VACUUM TUBE VOLTMETER

Model
1252



Only
\$48.33
Net
Price

• The initial operation of adjusting bridge cancels out error independent of the tube emission values or when replacing tubes.

Model 1252 is furnished with the exclusive Triplett tilting type twin instrument. One instrument indicates when bridge is in balance—the other is direct reading in peak volts. Above, below and null point indicated by the exclusive feature of the circuit. Tube on Cable . . . Particularly desirable for high frequency work. . . Ranges: 3-15-75-300 Volts.

Furnished complete with all necessary accessories including 1-84, 1-6P5, 1-76. Case is metal with black wrinkle finish, 7⁷/₈ x 6⁵/₈ x 4⁵/₈ inches. Etched panel is silver and red on black.

Model 1251 same as 1252 but with tube located inside case . . . DEALER PRICE . . . \$47.67

Model 1250 same as 1251 except ranges are 2.5, 10, 50 volts . . . DEALER PRICE . . . \$36.67



The Triplett Electrical Instrument Co.
212 Harmon Ave., Bluffton, Ohio
Please send me more information on—

Model 1252; Model 1251; Model 1250.

Name

Address

City State

(Continued from page iv)

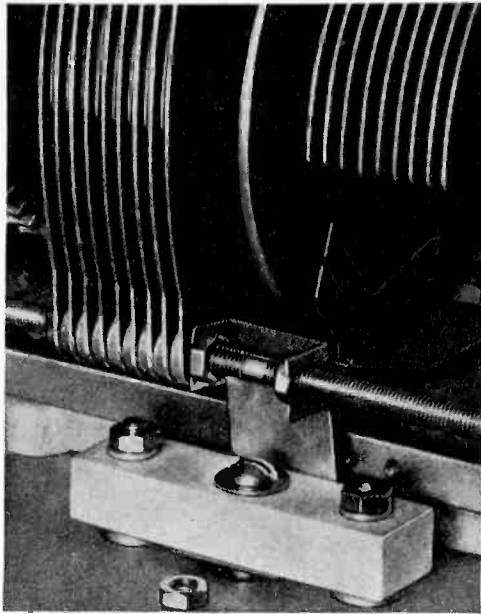

Center-fed condenser (with right-hand stator stack removed to show the method of making connections to the rotor)

limit below which the effective resistance and reactance would remain within satisfactory limits. That is why the construction shown in the following photograph was adopted.

The resistance wire is clamped down on a thin piece of mica, backed by two flat metal plates which also serve as lugs for connections. As a result, the inductance is decreased below what it would be in free space by virtue of the shielding effect of the current in the plates. The plates also help to dissipate heat and improve the power handling ability of the unit.

Resistors of this type are built in 7 sizes between 1 and 100 ohms.

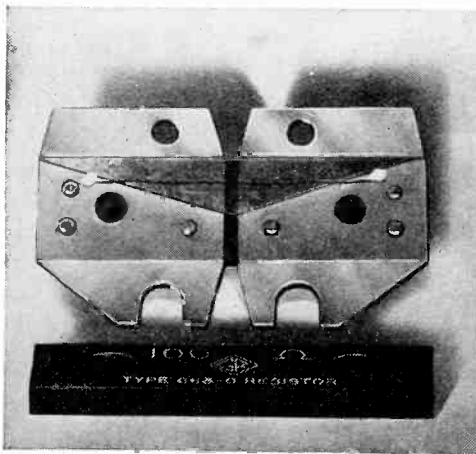

A 100-ohm straight-wire resistor with the clamping plate removed to show the element

Booklets, Catalogs and Pamphlets

The following commercial literature has been received by the Institute.

ELIMINATORS *Electro Products Laboratories, 549 West Randolph Street, Chicago, Illinois. Catalog 1138. 2 pages, 8¹/₂ x 11 inches.* Description of 3 low-hum-level battery eliminators.

INSTRUMENTS *Triplett Electrical Instrument Co., Bluffton, Ohio. Price Sheets 50-I and 50-T, 8 pages, 8¹/₂ x 11 inches.* Indicating instruments and tube- and service-test sets, prices and brief specifications.

INSTRUMENTS *Roller-Smith Company, Bethlehem, Pennsylvania. Catalog 48-a. 8 pages, 8¹/₂ x 11 inches.* Description and dimensions of 3- and 4-inch, round and square panel instruments.

MARINE RADIO TELEPHONE *Western Electric Company, 195 Broadway, New York, New York. Bulletin T1570. 4 pages, 8 x 11 inches.* 2-way radio telephone equipment for inter-ship and ship-to-shore service on small boats.

RADIO RANGE FILTER *RCA Manufacturing Company, Inc., Camden, New Jersey. Data Sheet No. 4. 2 pages, 8¹/₂ x 11 inches.* A unit to separate voice and range signals in an aircraft radio receiver.

RELAYS *C. P. Clare & Co., 4541 Ravenswood Avenue, Chicago, Illinois. Catalog CCL. 10 pages+cover, 8¹/₂ x 11 inches.* Descriptions and specifications on direct-current relays for low-power control service.

MAGNETIC TELEPHONE *Western Electric Company, 195 Broadway, New York, New York. Bulletin T1543. 4 pages, 8 x 11 inches.* A sound-powered telephone for intercommunication service on ship-board.

TRANSFORMERS *Robert M. Hadley Co., 266 So. Chapel Street, Newark, Delaware. Catalog T6. 16 pages, 8¹/₂ x 11 inches.* Power and amplifier-coupling transformers.

TUBE DATA (KEN-RAD) *Ken-Rad Tube & Lamp Corporation, Owensboro, Kentucky. Engineering Bulletin 38-21, 29 pages, 8¹/₂ x 11 inches.* Considerations involved in the application of converter and mixer tubes.

UBET DATA (KEN-RAD) *Ken-Rad Tube & Lamp Corporation, Owensboro, Kentucky, Bulletin, 8 pages, 8¹/₂ x 11 inches.* "Essential Characteristics of Metal, 'G' Series, and Glass Radio Tubes" (tabular data, base connections, and outline drawings.)

TUBE DATA (RCA) *RCA Manufacturing Company, Harrison, New Jersey. Application Note No. 101. 9 pages, 8¹/₂ x 11 inches.* "On Input Loading of Receiving Tubes at Radio Frequencies."

TUBE DATA (RAYTHEON) *Raytheon Production Corporation, Newton, Massachusetts. Data Sheets. 11 pages, 8¹/₂ x 11 inches.* Description and characteristics of 4 permatrons (magnetic-control gas-filled control tubes).

TUBE DATA (WESTINGHOUSE) *Westinghouse Electric & Manufacturing Company, Bloomfield, New Jersey. Bulletin No. 17. 4 pages, 8¹/₂ x 11 inches.* Description and brief summary of characteristics of ignitrons.

VACUUM CONDENSER *Eitel McCullough, Inc., San Bruno, California. Bulletin, 4 pages, 8¹/₂ x 11 inches.* Description and performance data on a vacuum-sealed-in-glass condenser for tank-circuit applications.

CONDENSERS *Tobe Deutschmann Corporation, Canton, Massachusetts. Catalog, 12 pages, 8¹/₂ x 11 inches.* Wet and dry electrolytics and paper condensers, a listing of specifications.

"I Wonder What Time My Daddy Will Telephone?"

"The minute he calls up I'm going to speak to him about Bobby. He's my cousin, and he's just five weeks old. *And they haven't got a telephone where he lives!*

"One of these days his mother's going to run out of his talcum. Or she'll want his father to stop at the drug store on the way home for oil. Or maybe she'll want to ask the doctor about that rash on his back — Bobby's back, I mean.

"Then suppose some week he gains six ounces. Don't they expect to tell their friends news like that?

"Well, how is Bobby's mother going to do all those things besides her marketing?

"I'm going to see if my Daddy can't fix it. He's always saying how good telephone service is — and how cheap."

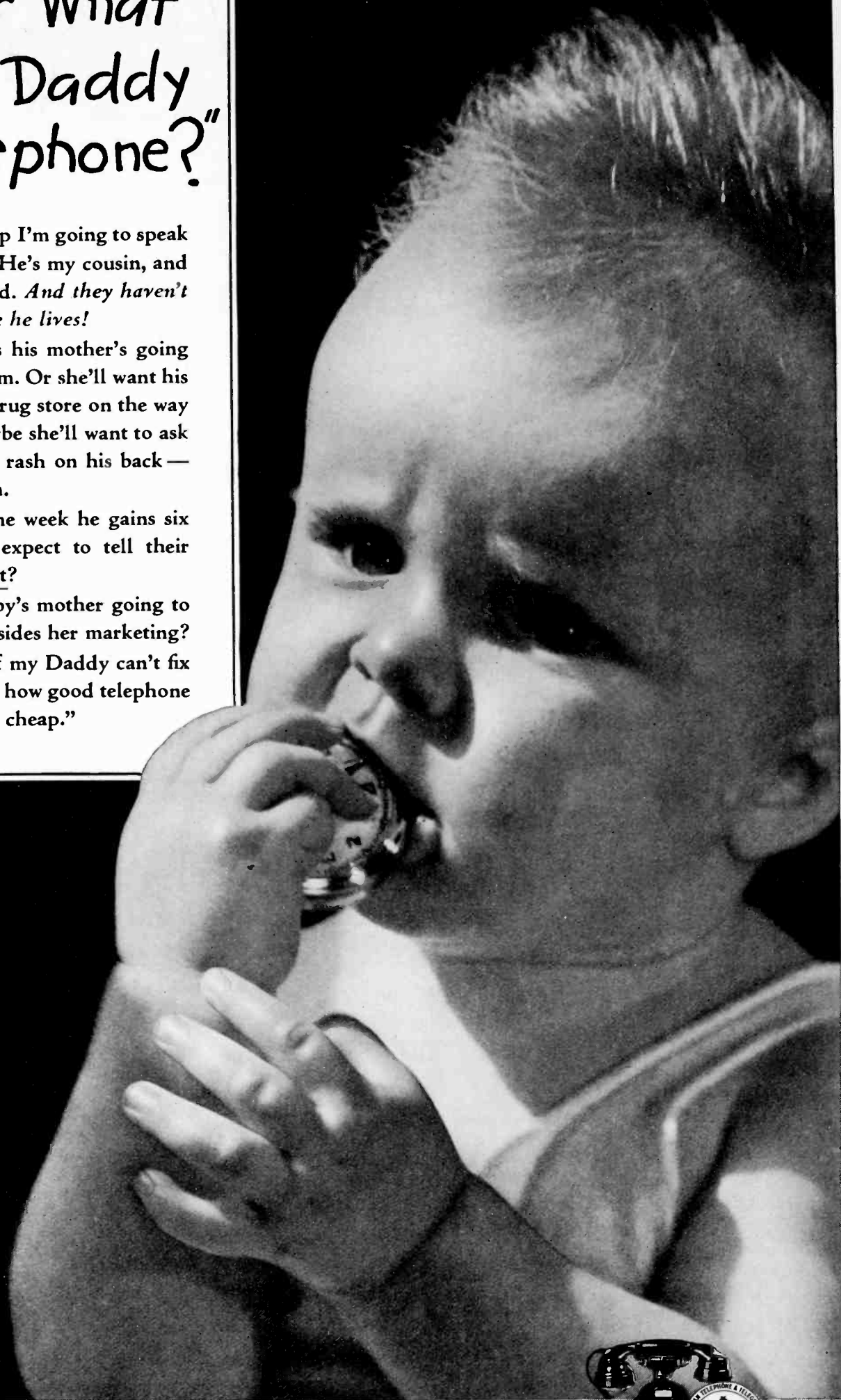

B E L L T E L E P H O N E S Y S T E M

You are cordially invited to visit the Bell System exhibit at the Golden Gate International Exposition, San Francisco



Time Table in Action...

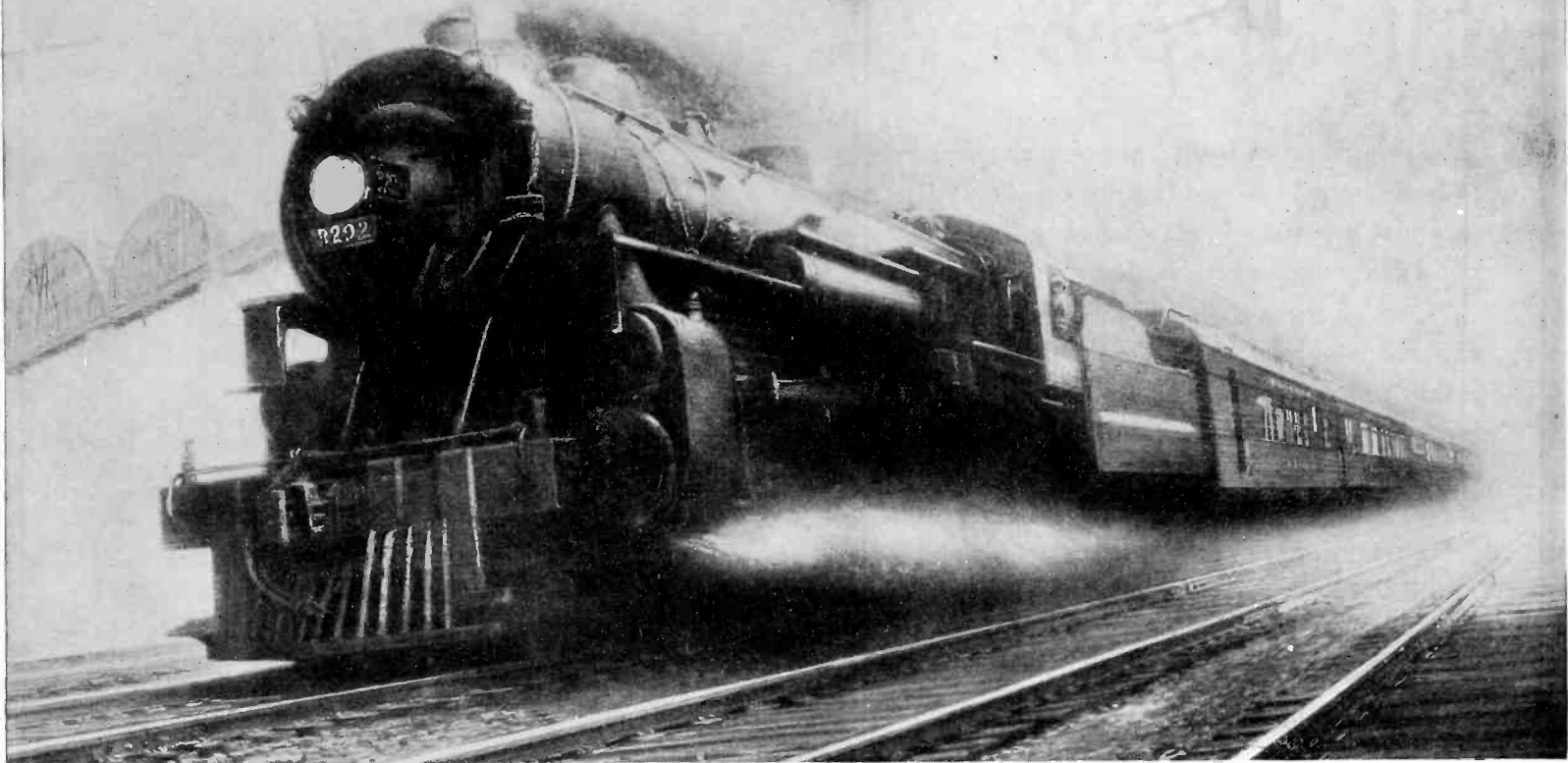

ABOVE PHOTO COURTESY NEW YORK CENTRAL SYSTEM

You'll find the same dependability in C-D Capacitors

Emphasis today is on comfort . . . luxury . . . style. But *ON TIME* is still the first consideration of the nation's railroads. A capacitor, too, may have many fine qualities—each praiseworthy in itself. But unless these add up to *DEPENDABILITY*, your capacitor is not a good investment. Cornell-Dubilier is proud of the fact that, in engineering circles today, the initials of C-D have come to *stand for capacitor dependability*.

C-D engineers will be happy to cooperate with you on your capacitor requirements. Catalog No. 160 listing the entire C-D line is available free of charge. Your inquiries are invited.

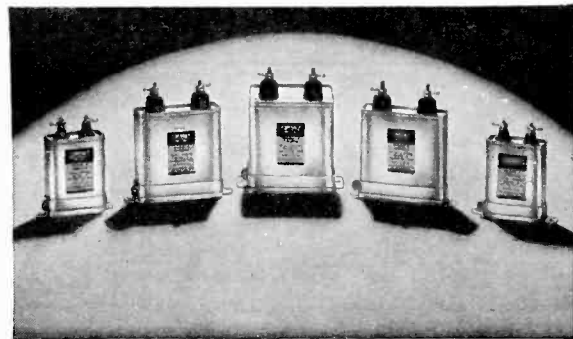

DYKANOL FILTER CAPACITORS • TYPE TJU

Carefully designed, compact, light-weight, safely-rated, furnished with universal mounting clamps, well-insulated terminals, fire-proof, these units are without a doubt the most dependable capacitors offered the radio industry. Type TJU Dykanol capacitors are being used by practically every broadcast and government station in the world. For complete description see Catalog No. 160.

Product of the world's largest manufacturer of capacitors.

MICA • DYKANOL • PAPER
WET AND DRY ELECTROLYTIC CAPACITORS



CORNELL-DUBILIER ELECTRIC CORPORATION

1012 Hamilton Boulevard, South Plainfield, New Jersey

Cable Address: "CORDU"

The Single-Ended Metal Tube

**ANOTHER RCA
ACHIEVEMENT IN
DESIGN!**

There are 6 different types—all of them small—all offering advantages radio set manufacturers will appreciate!

The special construction of the 6SA7 provides excellent oscillator frequency stability. The magnitude of input capacitance of the oscillator grid is not appreciably affected by signal-grid bias. Changes in cathode current and in oscillator transconductance with AVC voltage are small.

RCA 6SK7...this is a new r-f amplifier pentode offering the same features as the 6SA7 plus more stable amplifier operation... greater uniformity of amplifier gain...and higher gain per stage. This tube not only has the same grid plate capacitance as tubes wearing grid caps, but also offers lower input and output capacitance values—plus higher transconductance. Has remote cut-off characteristic and small wafer octal, 8-pin base to fit standard octal socket.

RCA 6SJ7...this is a new r-f amplifier pentode with the same features as the 6SK7 except that this tube has a sharp cut-off characteristic.

RCA 6SF5... a new high-mu triode... and the RCA 6SQ7... a

new duplex-diode high-mu triode, are audio type tubes. They employ the same single-ended construction and have the same characteristic features and advantages as the r-f pentodes. Base-shielding reduces hum voltage picked up by grid lead from heater leads, permits operation with satisfactory hum level.

RCA 6SC7...a new twin triode amplifier designed primarily for phase inverter service. Hum voltage picked up by the grid lead from the heater leads is greatly reduced because of inter-lead shielding between grid and heater within the base. This permits operation with satisfactory hum level.

RCA presents the Magic Key every Sunday, 2 to 3 P.M., E.S.T., on the NBC Blue Network

Over 325 million RCA radio tubes have been purchased by radio users... In tubes, as in radio sets, it pays to go RCA All the Way.

For complete details about any of these tubes write to the address below



Here are some of the fine features of the RCA 6SA7—a new Pentagrid Converter

- Self-shielded envelope
- Complete wiring below set panel
- No grid lead to connect
- Cleaner, neater chassis
- No loose or broken grid leads
- Higher conversion gain
- Small frequency shift at high frequencies
- Economy
- Simplification of tube renewal



Radiotrons

A SERVICE OF THE
RADIO CORPORATION
OF AMERICA

RCA MANUFACTURING COMPANY, INC., HARRISON, N. J.

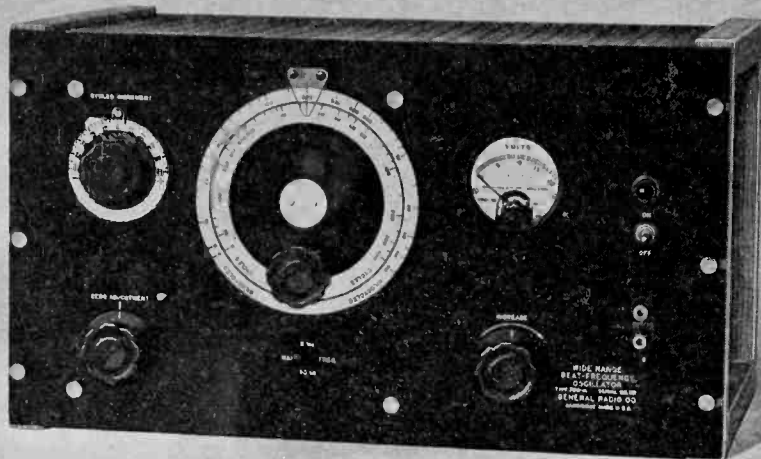
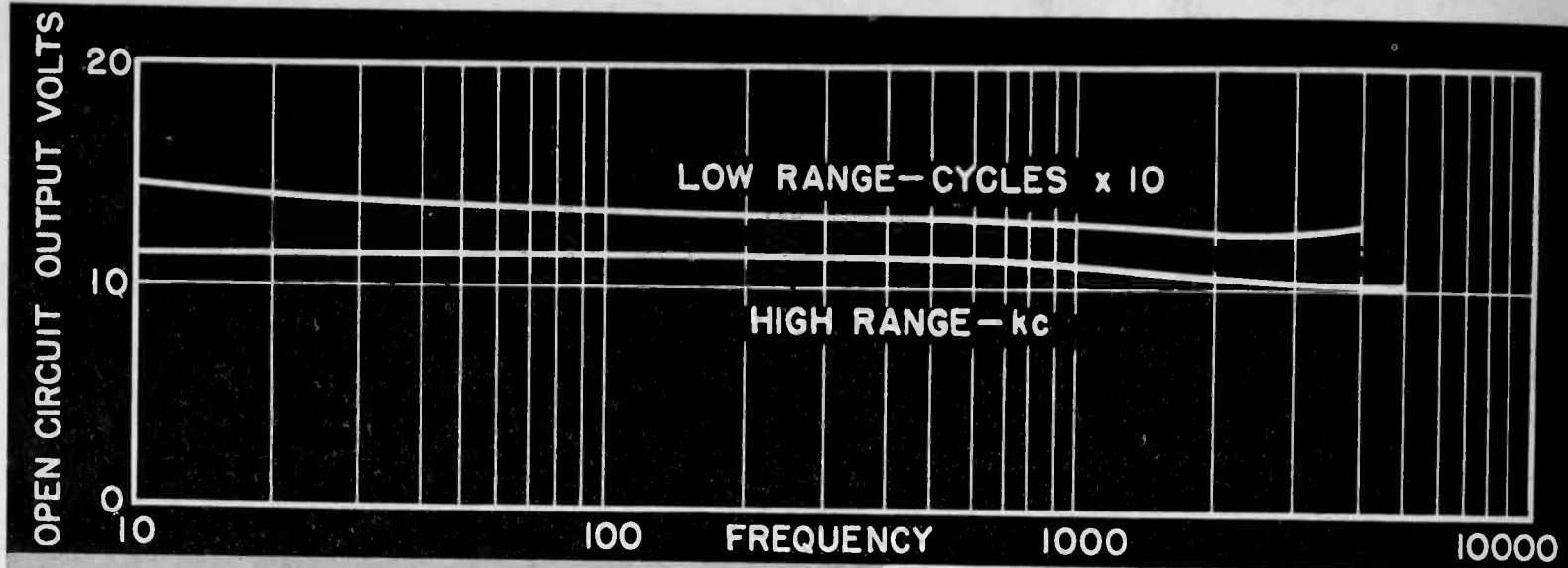

NEW WIDE-RANGE BEAT-FREQUENCY OSCILLATOR

FOR some time there has been need for a wide-range oscillator with substantially constant output of moderate power, not only for general laboratory bridge measurements but also for taking selectivity curves over a very wide range of frequencies, for measuring transmission characteristics of filters and for testing wide-band systems such as television amplifiers and coaxial cables.

The new General Radio Type 700-A Beat-Frequency Oscillator was designed for these applications. Through unique circuit and mechanical design and very careful mechanical construction it has been possible to manufacture an oscillator of good stability, output and waveform at an exceptionally low price.

FEATURES

WIDE RANGE—two ranges: 50 cycles to 40 kc and 10 kc to 5 Mc.

DIRECT READING—scale on main dial approximately logarithmic in frequency. Incremental frequency dial direct reading between -100 and $+100$ cycles on low range and -10 and $+10$ kilocycles on high range.

ACCURATE CALIBRATION—low range: $\pm 2\%$ ± 5 cycles; high range: $\pm 2\%$ ± 1000 cycles; incremental dial: ± 5 cycles low range; ± 500 cycles high range.

GOOD FREQUENCY STABILITY—adequate thermal distribution and ventilation assure minimum frequency drift. Oscillator can be reset to zero beat to eliminate errors caused by small drifts.

GROUNDING OUTPUT TERMINAL—output taken from 1,500 ohm potentiometer.

CONSTANT OUTPUT VOLTAGE—open-circuit voltage remains constant between 10 and 15 volts within ± 1.5 db over entire frequency range.

GOOD WAVEFORM—total harmonic content of open-circuit voltage is less than 3% above 250 cycles on low range and above 25 kc on high range.

A-C OPERATION—power-supply ripple less than 2% of output voltage on either range.

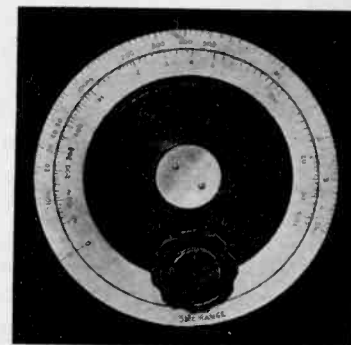

Type 700-A Wide-Range Beat Frequency Oscillator . . . \$555.00

• Write For Bulletin 363 For Complete Information

GENERAL RADIO COMPANY, Cambridge, Mass. New York
Los Angeles

MANUFACTURERS OF PRECISION RADIO LABORATORY APPARATUS

cant when expressed in wavelengths for they are then directly comparable with the cutoff limit of 0.585λ . Below this limit no appreciable power may be propagated through a wave guide.

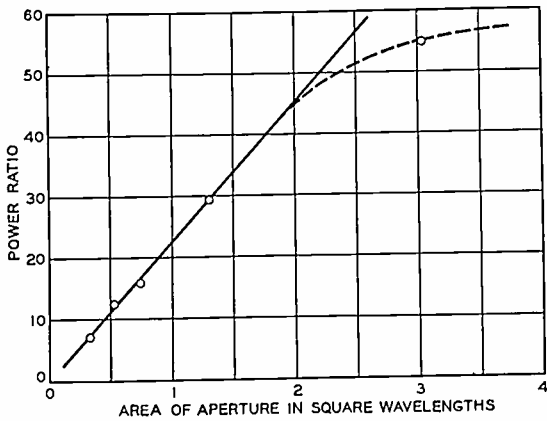

Fig. 9—Measured power improvements of metal pipe radiators, as a function of aperture. Data taken from Fig. 8.

It will be observed that the pattern in the plane of the electric force is in general somewhat sharper than that in the magnetic plane. The rather irregular pattern shown in Fig. 8(d) is probably due to ex-

when the spacings between their elements are large. In the case at hand the difficulty may have been due to the substantial discontinuity that exists at the point in the receiver where the 10-centimeter pipe and the 25-centimeter pipe join.

Fig. 9 shows the measured power improvements from these various pipes plotted against the areas of aperture in square wavelengths. The resulting curve turns out to be linear except for the larger diameters. If the function of a receiving device were merely that of cutting out a section from an advancing wave front and conveying the same, without reflection, back to a completely absorbing detector, then we should expect the power improvement to vary directly with the area of aperture. If, however, there are partial reflections or other effects tending to alter the phase relations between the various components then this optimum gain may not be fully realized. There are evidences of out-of-phase components of this kind in the secondary lobes of Fig. 8(e) and perhaps also in Fig. 8(d). These may account in part for the nonlinearity of Fig. 9.

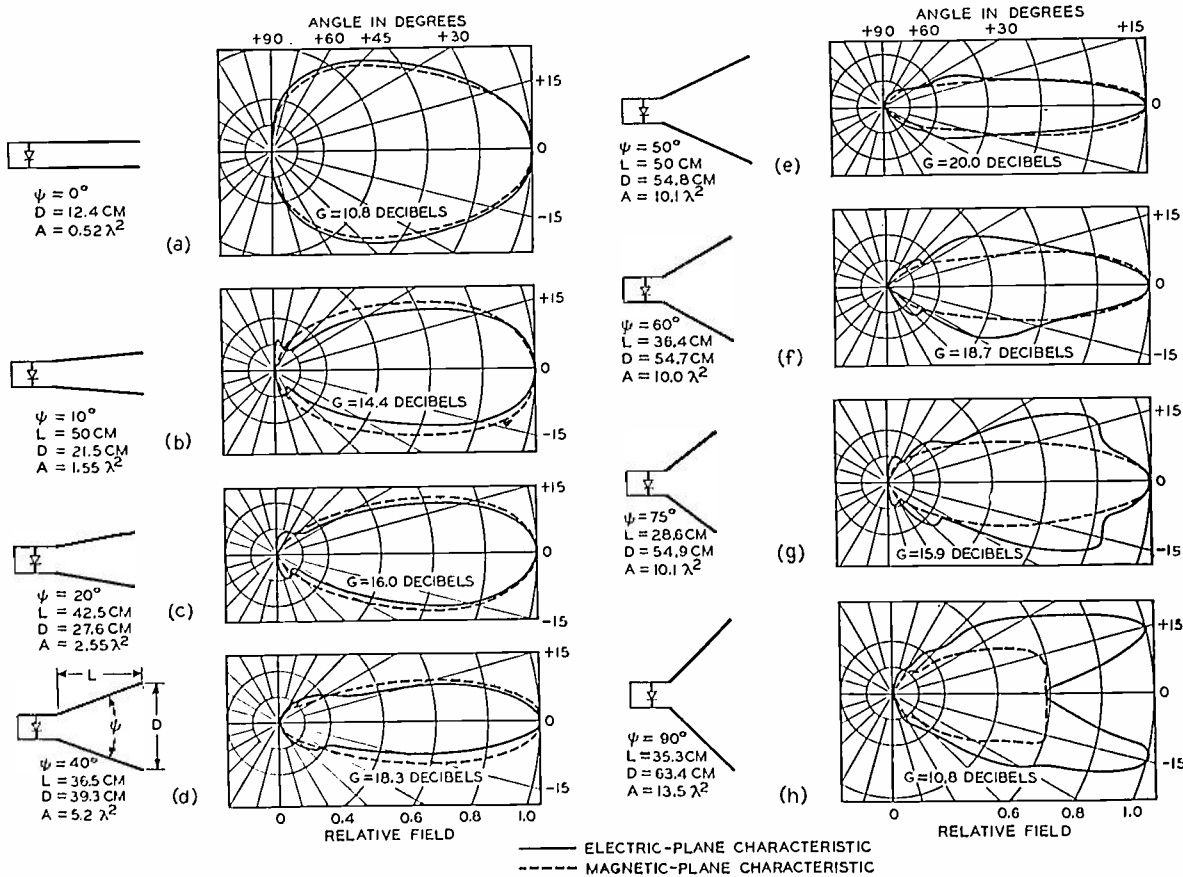

Fig. 10—Directional properties of metal horns of roughly the same length but of various angular openings. Measurements were taken at a wavelength of 15.3 centimeters.

perimental error. It has not been feasible to repeat this experiment under the conditions prevailing for the other sizes of pipe. In the last figure there are the beginnings of some secondary lobes similar in form to those often observed with ordinary antenna arrays

CONICAL HORNS

The work with horns of circular sections proceeded along several different directions. In one case it was desirable to know how the directive properties varied as the angle of flare was increased. In another case

we were interested to see how these properties varied as the area of opening increased keeping the angle fixed at some value which the previous experiment had found to be favorable. Other variations will be evident from the paragraphs that follow.

this desirable condition has been approximated will be noted from the dimensions given in the figure. It is fairly conclusive, however, that the gain has increased progressively with the angle of flare up to an angle about 50 degrees, after which spurious effects have become evident. This observed optimum holds only for the range of lengths noted above. In general longer horns call for smaller optimum angles.

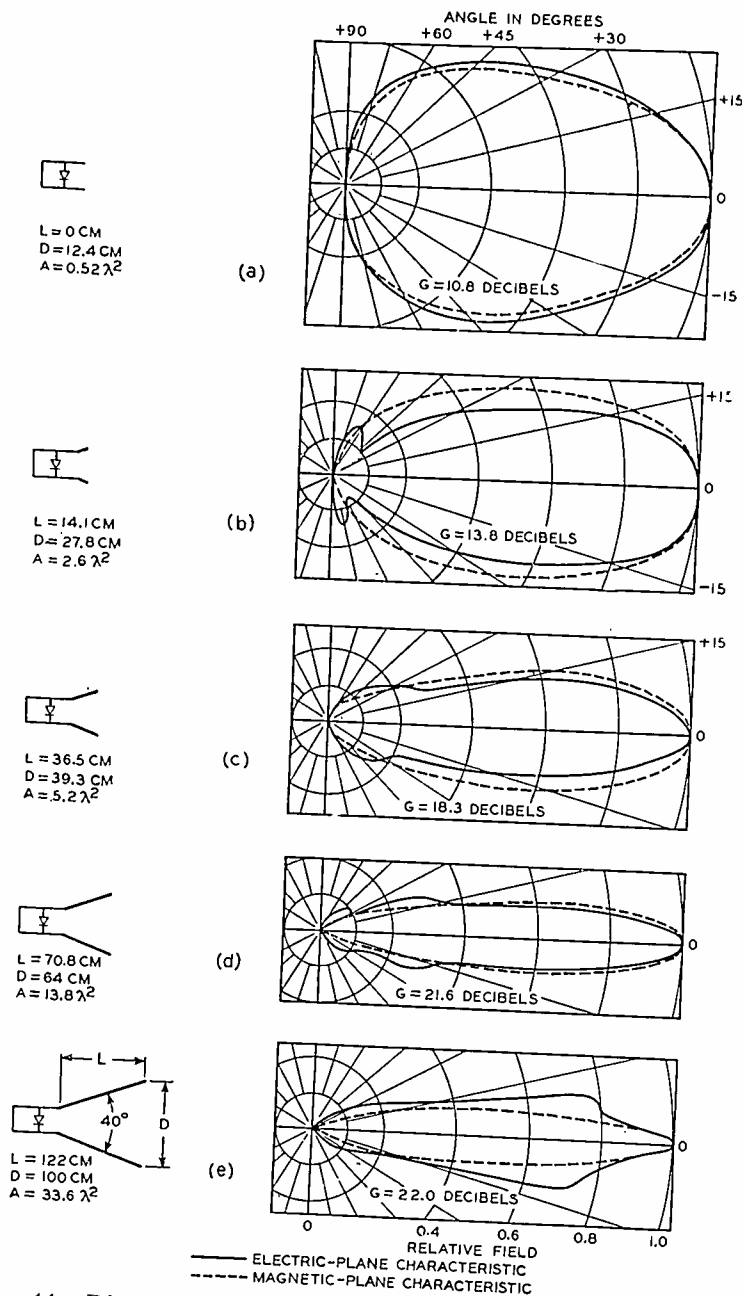

Fig. 11—Directional properties of metal horns each of the same angular opening but of different lengths. Measurements were taken at a wavelength of 15.3 centimeters.

EFFECT OF VARYING ANGLE

The results of the experiments with straight pipes naturally led to work on horns where the angle of flare was increased. It is convenient to regard the straight pipe as a horn of zero angle. Accordingly, measurements were made beginning with zero and continuing in small steps up to 90 degrees. Results were obtained as shown in Fig. 10.

It was not feasible to make the several horns of exactly comparable dimensions. The extent to which

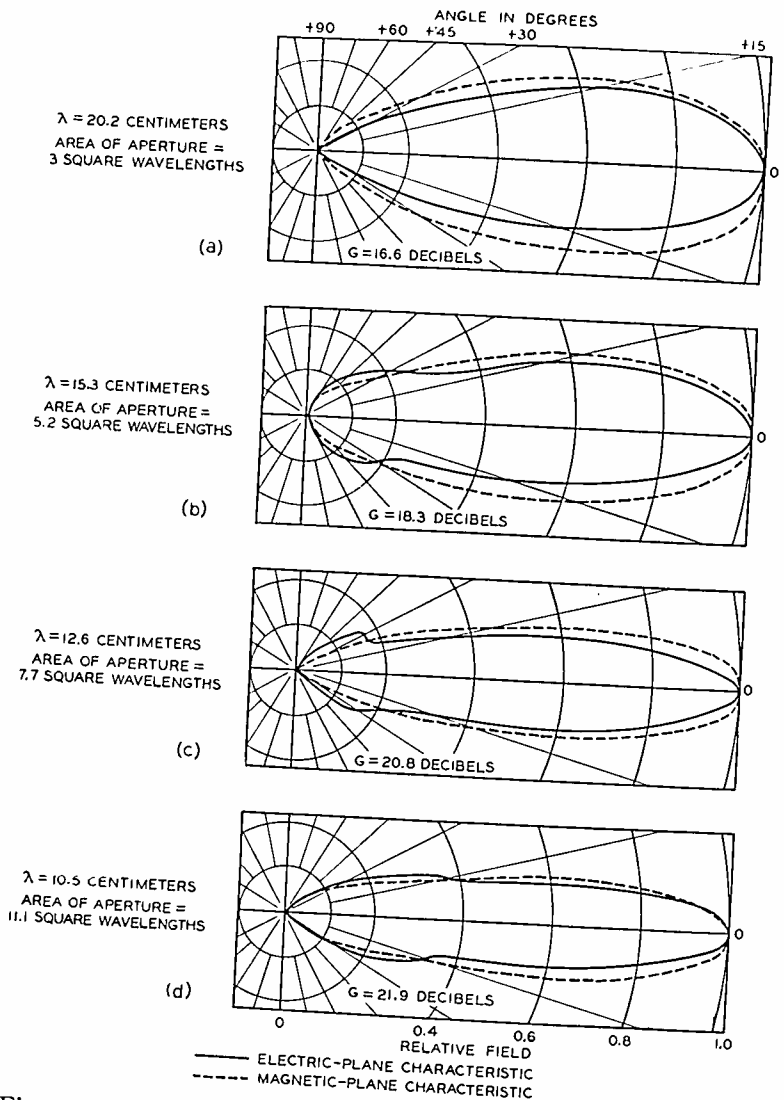

Fig. 12—Directional properties of a metal horn as affected by changes in frequency (wavelength).

EFFECT OF VARYING LENGTH

A somewhat more significant result was obtained from the measurements of several cones each of the same angle (40 degrees) but of different length. It is convenient to think of this series as having been derived from an open pipe to which have been connected 40-degree horns of various lengths. It is apparent from Fig. 11 that, at first, directivity increased progressively with length but that little or no advantage was gained by increasing the size of the horn beyond that shown in the fourth figure. This result was to be expected, for we have not maintained the conditions for optimum angle.

EFFECT OF VARYING WAVELENGTH

From considerations of similitude it would be expected that the most significant features of a directive system would be its dimensions measured in wavelengths. This means that two horns similar in form but differing in absolute dimensions would have identical directive properties provided they are operated on wavelengths proportional to their respective dimensions. As a consequence one should expect, from what has gone before, that the gain of a given horn should, in general, increase as the wavelength is reduced, for, in effect, we have increased the virtual dimensions of the horn by decreasing the operating wavelength. Tests were made on a single horn at each of 4 wavelengths with results as shown in Fig. 12.

SUMMARY OF RESULTS WITH SIMPLE CONICAL HORNS

In order to reduce further the data above, the measured gains, expressed as power ratios, have been plotted against certain significant variables. The curves shown should be regarded as convenient lines of reference for comparing experimental points rather than graphs justified by data.

Fig. 13 shows how the power ratios of the various 40-degree horns increased with the area of the aperture. The results are comparable with those indicated by Fig. 8 for ordinary pipes. As before, the linear relation holds only for the smaller horns. This has already been explained. Fig. 14 shows how the power ratio of one of the 40-degree horns varied with wavelength.

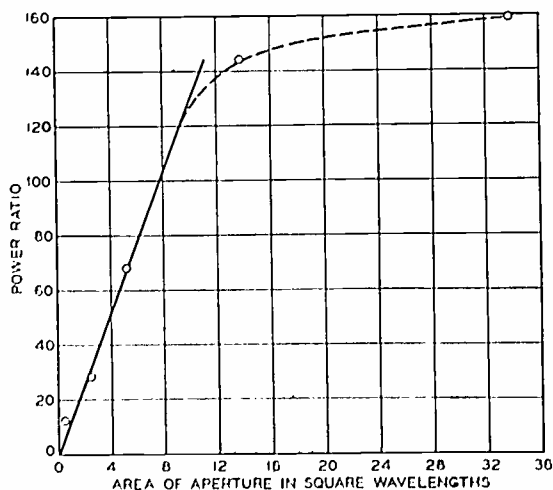

Fig. 13—Measured power improvement resulting from varying the length of a horn, keeping angle of flare and wavelength constant.

Although the work reported by this paper was of an exploratory kind, it has permitted two rather definite conclusions. (1) Radiating pipes and horns constitute simple and convenient means for obtain-

ing directive gains amounting to 20 decibels or more. There is no reason to believe that this is the upper limit. (2) Both in the case of straight pipes and in the case of conical horns this gain, expressed as a power ratio, is within limits roughly proportional to area of

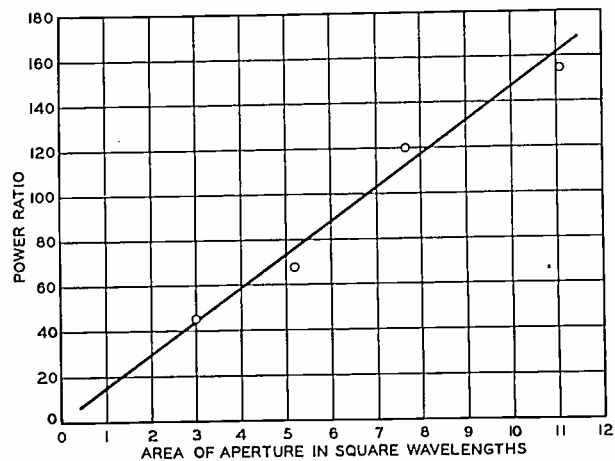

Fig. 14—Measured power improvement resulting from changing wavelength.

aperture. Presumably it holds in a more general way if we make appropriate changes in flare. This is more or less in keeping with experience with ordinary antenna arrays such as for instance those used in transoceanic communication.

The inherent simplicity of the horn antenna makes it particularly useful at ultra-radio frequencies where difficulties are often encountered in maintaining the proper amplitude and phase relations between the various elements of an array. Horns have been operated satisfactorily at frequencies of more than 3000 megacycles ($\lambda=10$ centimeters) with results that seem to indicate that they should be even better at still higher frequencies. The lower limit of operation appears to be dictated mainly by convenience and economic considerations and consequently is not well established at this time. Electromagnetic horns possess an interesting and possibly a very important characteristic. Unlike tuned antenna arrays, these devices do not have critically sharp frequency characteristics. This principle should permit both easy changes in operating frequency and also the simultaneous transmission of a wide frequency band without serious distortion.

APPENDIX

As explained above the gains reported in this paper refer to a hypothetical nondirectional radiator. Such gains may therefore be regarded as absolute. According to this *primary reference standard*, a short doublet radiator such as is sometimes used as a standard in radio work has an absolute gain of 1.76 decibels. Similarly a half-wave antenna in free space has a gain of 2.15 decibels.

Three important steps were taken in referring the gains of these horns back to the primary reference standard. They are as follows: First, the various directional patterns shown above were related quantitatively to Figs. 8(a) and 8(b) by means of a very large number of measurements. Next their power ratios were compared with the areas of their respective directional patterns and a proportionality established. An excellent agreement between these factors was obtained.

It will be noted that the patterns of Figs. 8(a) and 8(b) are not too removed from an ellipsoid and appear almost to have resulted from a progressive sharpening beginning from a sphere. It therefore seemed reasonable to consider a sphere of this kind as an arbitrary *secondary reference standard* and also to assume that the proportionality factor derived above should extend also to the sphere. Such a sphere may be regarded as one of the two spheres generated by $r = A \cos \phi \sin \theta$ where the origin is located at the mouth of the radiating pipe with the conventional x axis coincident with the principal axis of the cylinder.

When the proportionality factor obtained above was extended from Fig. 8(a) to the secondary reference standard, a differential of 0.77 decibel was obtained. It is this quantity that is open to question for ordinarily it is not regarded as good radio practice to assume that the power ratios of directive systems are proportional to the areas of their respective patterns.

The final step consisted in relating the secondary reference standard to the primary standard. This step was mathematical and was based on the following reasoning. The power at a nondirective source necessary to produce a given field intensity at a given point in space is given by

$$P_1 = \frac{c}{4\pi} \int_0^{2\pi} \int_0^\pi E^2 \sin \theta \, d\theta \, d\phi \quad (1)$$

so

$$P_1 = cE^2. \quad (2)$$

The power at the source, necessary for the *secondary reference standard* to produce the same field in-

tensity at the same point in the preferred direction is

$$P_2 = \frac{c}{4\pi} \int_0^\pi \int_0^\pi E^2 \cos^2 \phi \sin^3 \theta \, d\phi \, d\theta \quad (3)$$

$$P_2 = \frac{cE^2}{6}.$$

The ratio of the two powers necessary to produce the same field intensity by the two methods is, therefore,

$$\frac{P_1}{P_2} = 6.$$

This corresponds to a gain of 7.78 decibels. It represents the differential between the primary and secondary reference standards. Adding this figure to the relative gain of say Fig. 8(a) which in this case is 0.77 decibel we obtain 8.55 decibels as the absolute directivity of the latter. Other horns covered by this paper were related to Figs. 8(a) and 8(b) by measurement and accordingly their directivities were expressed absolutely. The errors involved by the approximations made above are not believed to be greater than a tenth of a decibel.

Bibliography

- (1) G. C. Southworth, "Hyper-frequency wave guides—general considerations," *Bell Sys. Tech. Jour.*, vol. 15, pp. 284-309; April, (1936).
- (2) Carson, Mead, and Schelkunoff, "Hyper-frequency wave guides—mathematical theory," *Bell Sys. Tech. Jour.*, vol. 15, pp. 310-333; April, (1936).
- (3) W. L. Barrow, "Transmission of electromagnetic waves in hollow tubes of metal," *Proc. I.R.E.*, vol. 24, pp. 1298-1328; October, (1936).
- (4) G. C. Southworth, "Some fundamental experiments with wave guides," *Proc. I.R.E.*, vol. 25, pp. 807-822, July, (1937).
- (5) G. C. Southworth, "New experimental methods applicable to ultra-short waves," *Jour. App. Phys.*, vol. 8, pp. 660-665, October, (1937).
- (6) W. L. Barrow and F. M. Greene, "Rectangular hollow-pipe radiators," *Proc. I.R.E.*, vol. 26, pp. 1498-1519; December, (1938).
- (7) L. J. Chu and W. L. Barrow, "Electromagnetic waves in hollow metal tubes of rectangular cross section," *Proc. I.R.E.*, vol. 26, pp. 1520-1555; December, 1938.
- (8) W. L. Barrow and F. D. Lewis, "The sectoral electromagnetic horn," *Proc. I.R.E.*, vol. 27, pp. 41-50; January, (1939).
- (9) W. L. Barrow and L. J. Chu, "Theory of the electromagnetic horn," *Proc. I.R.E.*, vol. 27, pp. 51-64; January, (1939).

A Fixed-Focus Electron Gun for Cathode-Ray Tubes*

HARLEY IAMS†, MEMBER, I.R.E.

Summary—Many cathode-ray tubes in use at the present time employ electrostatic focusing of the electron beam. It is customary to supply these tubes with at least two anode voltages, one of which is varied to bring the beam to a focus.

However, an electrostatically focused electron gun can be designed so that only one anode voltage is required, and so that the electron beam remains in focus regardless of that anode voltage. A fixed-focus electron gun may be made by using a focusing field generated by electrodes at a common anode potential and others at cathode potential. The point at which the beam is brought to a focus is determined by the dimensions of the electrodes which make up the electron lens.

Developmental cathode-ray tubes have been built in which the beam was brought to a focus with a single anode voltage, and in which the focus remained substantially constant at any voltage in the test range between 750 and 2500 volts.

WITHIN the last decade, the number of cathode-ray tubes in use by the radio industry has multiplied by many times. Once a scientific curiosity, the cathode-ray tube has now become a useful tool through the improvements effected by a host of workers in the field of electronics. Within the last few years, publications in this journal^{1,2,3,4,5,6,7} and elsewhere have described the basic principles involved in the design of the electron guns used in these cathode-ray tubes. Even in their present improved forms, cathode-ray oscillograph and television tubes require an adjustment of the focus of the electron beam at the time of installation and usually during use. If this adjustment were not necessary, the power supplies for the tube could be simplified, and the tube would be simpler to operate. It is the purpose of this paper to describe an electron gun in which the focus of the electron beam is predetermined by the construction, and in which the focus is substantially independent of anode voltage.

* Decimal classification: R388. Original manuscript received by the Institute, June 17, 1938.

† RCA Manufacturing Company, Inc., Harrison, New Jersey.

¹ V. K. Zworykin, "Description of an experimental television system and the Kinescope," *Proc. I.R.E.*, vol. 21, pp. 1655-1673; December, (1933).

² I. G. Maloff and D. W. Epstein, "Theory of the electron gun," *Proc. I.R.E.*, vol. 22, pp. 1386-1411; December, (1934).

³ R. T. Orth, P. A. Richards, and L. B. Headrick, "Development of cathode-ray tubes for oscillographic purposes," *Proc. I.R.E.*, vol. 23, pp. 1308-1323; November, (1935).

⁴ D. W. Epstein, "Electron optical system of two cylinders as applied to cathode-ray tubes," *Proc. I.R.E.*, vol. 24, pp. 1095-1139; August, (1936).

⁵ V. K. Zworykin and W. H. Painter, "Development of the projection Kinescope," *Proc. I.R.E.*, vol. 25, pp. 937-953; August, (1937).

⁶ R. R. Law, "High current electron gun for projection Kinescopes," *Proc. I.R.E.*, vol. 25, pp. 954-976; August, (1937).

⁷ D. B. Langmuir, "Theoretical limitations of cathode-ray tubes," *Proc. I.R.E.*, vol. 25, pp. 977-991; August, (1937).

A fixed-focus electron gun involves several features, the most important being (1) the use of electrostatic focusing fields between electrodes at cathode potential and electrodes at a common anode potential, and (2) the choice of electrode dimensions such that the electron beam is focused at the desired place. These principles may be illustrated by comparing the design of a well-known type of electron gun with that of a fixed-focus electron gun.

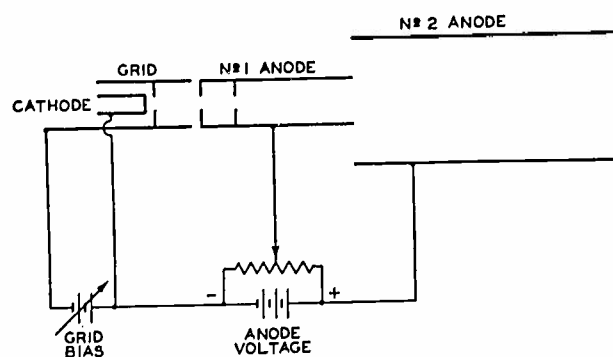

Fig. 1—Well-known type of electron gun.

A type of electron gun which often has been used for high-vacuum television or oscillograph tubes is illustrated in Fig. 1. Electrons emitted from the cathode are controlled by the grid, and accelerated by the electrostatic field from the No. 1 anode. The shape of the field is such as to cause the electrons to cross the axis of the gun a short distance from the cathode. From this point of crossing, the electrons move through the No. 1 anode in somewhat diverging paths. As the bundle of electrons nears the end of the No. 1 anode, it enters an electrostatic field extending from the No. 2 anode. The shape of the electrostatic focusing field is such as to give to the electrons velocities toward the axis proportional to their distance from the axis. When the strength of the electrostatic field is adjusted by the user of the tube so that the electrons converge to a point at the fluorescent screen, the electron beam is said to be in focus.

It is customary to provide some means of controlling the focus of the electron beam, such as connecting the No. 1 anode to a potentiometer across the main anode supply, or supplying the voltage to the No. 1 anode by a separate variable power pack. Such arrangements are useful and desirable for present-day tubes. However, when one of the anode voltages is changed, either through choice, or because of line-

voltage variations, the beam must be brought to a focus again. Also, the focus may change when the tube is used for television reception because the varying loads taken from poorly regulated power packs upset the proportionality of anode voltages.

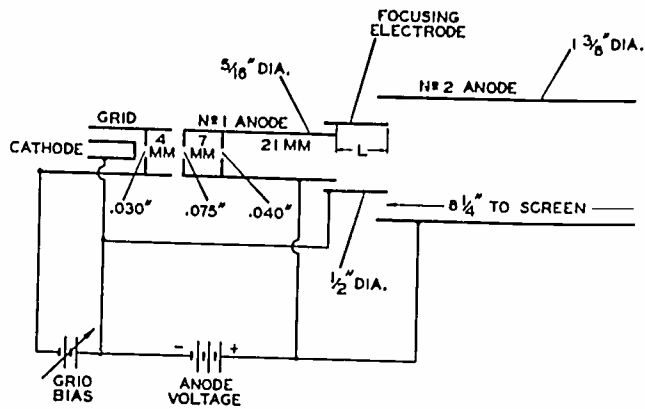

Fig. 2—Fixed-focus electron gun.

In the conventional electron gun, the focus of the beam changes when the ratio of the anode voltages is altered because the relation between momentum of the electrons and forces deflecting them is altered. For example, when the No. 2 anode voltage is held constant and the No. 1 anode voltage is raised, the momentum of electrons entering the focusing field is increased. The strength of the focusing field, however, is lessened, with the result that the beam is focused upon a point more distant from the electron gun. In the same way, the focus is affected by variations of the No. 2 anode voltage.

The electron-gun design of Fig. 1 may be changed to make the focus independent of anode voltage by using for the electron lens electrodes at cathode potential and at a common anode potential. Such an arrangement is shown in Fig. 2. In this case, the electrons from the cathode are controlled and accelerated into the anode region just as in the design shown in Fig. 1. The combination of electrostatic fields between the focusing electrode and the sections of the anode gives to the outermost electrons of the bundle a greater velocity toward the axis than is given to the electrons within the bundle. When the length of the focusing electrode is great, or its diameter small, the beam is brought to a focus near the end of the electron gun, because the radial component of velocity given the electrons is then large. By selection of an appropriate length and diameter for the focusing electrode, the radial velocity can be made just sufficient to bring the bundle to a focus at the desired point.

Once the electron beam has been focused in this way, it remains focused regardless of the anode voltage applied. This fact may be understood by regard-

ing the electrostatic focusing field as a means of deflecting the electrons in the beam so that they all meet in one point. The electrostatic field required to deflect a moving stream of electrons through a fixed angle is proportional to the voltage through which the electron stream has been accelerated. In a fixed-focus electron gun, the focusing field occurs between electrodes at cathode and at anode potential. It follows, then, that the field deflecting the electrons to the point of focus increases linearly with the anode voltage and, hence, that the path of an electron moving under influence of the focusing fields in the electron gun is the same regardless of anode voltage.

Developmental cathode-ray tubes have been built to verify this analysis. Because the computation of shape of electrostatic fields in a complex electrode structure is extremely difficult, and because the accurate tracing of paths of electrons through such fields is tedious, it was found more convenient to determine the dimensions of the electrodes by trial and error. The cathode, grid, and anode structures were chosen from parts conveniently available. They were then arranged so that the maximum beam current, the control characteristic, and the gun-to-screen distance were satisfactory for the desired use. Then the focusing electrode was added, as Fig. 2 shows, between two parts of the anode.

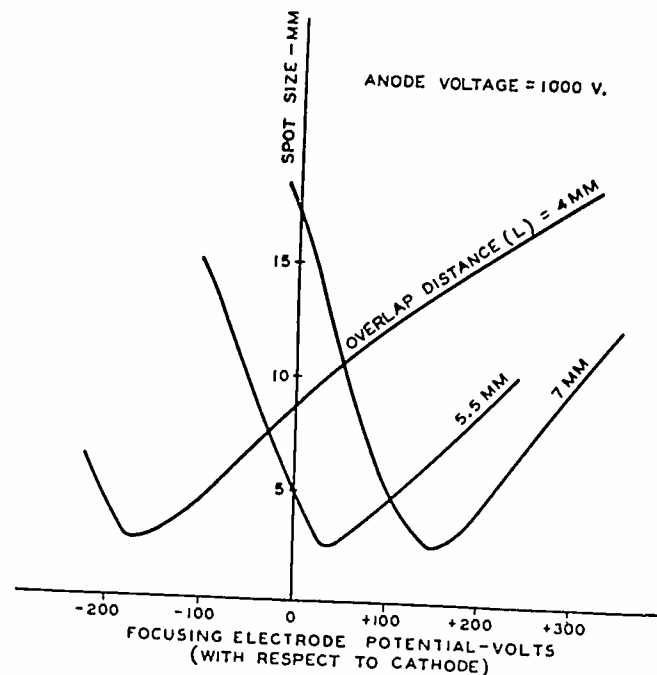

Fig. 3—Spot size as a function of focusing-electrode voltage.

In order to bring the electron beam to a focus on the fluorescent screen when the focusing electrode was at cathode potential, it was necessary to adjust very carefully the distance L by which the focusing electrode extended past the smaller-diameter portion

of the anode. When the overlap distance was too great, a positive voltage (with respect to the cathode) on the focusing electrode was required for best focus of the beam, and when the overlap distance was too small, a negative voltage was needed. Fig. 3 shows the size (with zero grid bias) of the stationary spot on the fluorescent screen as a function of focusing-electrode voltage, for three different overlap distances, as determined for the structure illustrated in Fig. 2. The 5.5-millimeter length, while it was slightly too long for optimum spot size with zero voltage on the focusing electrode, gave results which were satisfactory for many uses. The optimum length was 5.2 millimeters.

Operation of the fixed-focus arrangement was tested by connecting the focusing electrode to the cathode of the electron gun, and varying the anode voltage. The line width of the deflected spot, measured at zero grid bias, was plotted as a function of anode voltage and is shown in Fig. 4. It will be observed that the line width is substantially independent of anode voltage. Other tests showed that a structure which would bring the beam to focus at zero bias would likewise focus it at other values of grid bias.

Fixed-focus electron guns are expected to find their greatest use in oscillograph and television applications in which convenience and simplicity of equipment and operation are of primary importance. Like

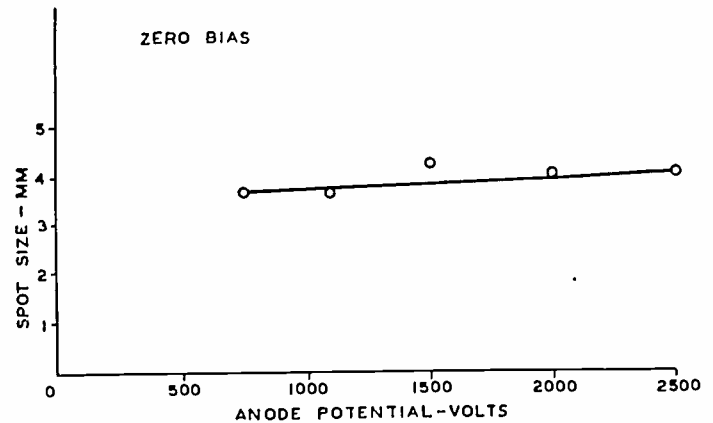

Fig. 4—Spot size as a function of anode voltage.

fixed-focus cameras, which produce good (though not necessarily exceptionally sharp) pictures, developmental cathode-ray tubes having fixed-focus electron guns have been found convenient to use and satisfactory for many purposes.

Velocity-Modulated Tubes*

W. C. HAHN†, ASSOCIATE MEMBER, I.R.E., AND G. F. METCALF‡, MEMBER, I.R.E.

Summary—This paper presents a simplified method of analyzing the operation of vacuum tubes at ultra-high frequencies. In this analysis the effects of electron velocity, conduction current, and induced current are separated. The theory leads to the development of a variety of new tubes.

It is believed that these new tubes will be useful as oscillators, detectors, converters, and amplifiers in the 5-centimeter to 5-meter field. They have been used in receivers as oscillators and as superheterodyne converters at 25 and 37 centimeters; and as oscillating detectors at 5 centimeters. Power oscillators have been built which furnish 10 watts at 80 centimeters. Radio-frequency power amplifiers have been tested at 75 centimeters, with power outputs of 50 watts and plate efficiencies of 20 to 30 per cent.

INTRODUCTION

THE effects of the transit time of the electrons in vacuum tubes operating at high frequencies have been the subject of much study^{1,2,3,4} in recent years. In the analysis of these effects the variations in electron velocity, in addition to the more familiar charge-density variations, play an important rôle. When the theory is so arranged as to allow separate consideration of these variables, a clarification of thought results which points the way to new types of tubes. It is the purpose of this paper to describe this method of analysis and illustrate its application in the building of radio-frequency amplifiers, oscillators, superheterodyne detectors, etc., for wavelengths of 5 centimeters to 5 meters.

GRID IMPEDANCE

While the mutual conductance of ordinary tubes may decrease somewhat at the shorter wavelengths, it is not the limiting factor at present. The condition which usually determines the maximum frequency is absorption of radio-frequency power by the grid and lesser extent by the plate.^{5,6} This energy reappears

* Decimal classification: R130. Original manuscript received by the Institute, June 22, 1938; revised manuscript received by the Institute, September 28, 1938.

† Engineering General Department, General Electric Company, Schenectady, New York

‡ Vacuum Tube Engineering Department, General Electric Company, Schenectady, New York

¹ W. E. Benham "Theory of the internal action of thermionic systems at moderately high frequencies," Part I, *Phil. Mag.*, vol. 5, no. 29, p. 641; March, (1928); Part II, *Phil. Mag.*, vol. 11, no. 70, p. 457; Feb., (1931).

² Johannes Muller, "Electron oscillations in high vacua," *Hochfrequenz und Elektroakustik*, vol. 41, p. 156; May, (1933).

³ F. B. Llewellyn "Vacuum tube electronics at ultra-high frequencies," *PROC. I.R.E.*, vol. 21, pp. 1532-1573; November, (1933).

⁴ F. B. Llewellyn, "Note on vacuum tube electronics at ultra-high frequencies," *PROC. I.R.E.*, vol. 23, pp. 112-127; February, (1935).

⁵ D. O. North, "Analysis of the effects of space charge on grid impedance," *PROC. I.R.E.*, vol. 24, pp. 108-158; January, (1936).

⁶ W. R. Ferris, "Input resistance of vacuum tubes as ultra-high-frequency amplifiers," *PROC. I.R.E.*, vol. 24, pp. 82-104; January, (1936).

as an increase in the average kinetic energy of the electrons to be converted ultimately into heat at the anode. Thus the problem of designing vacuum tubes for ultra-high frequencies is essentially one of finding a new principle of operation in which the structures used as grids and plates have a high impedance, viewed from the external circuit.

In present-day tubes the alternating grid voltage affects directly the field around the cathode, producing a corresponding variation in the charge density of the electrons leaving it. The radio-frequency variation in conduction current is then large, from the cathode all the way to the plate. Each of the electrons approaching the grid induces a current in it; similarly, the electrons leaving the grid plane and approaching the plate or next element induce more current in the grid. If the frequency is low, these two components practically cancel each other, but as the frequency is raised the components move apart in time phase, due to the transit angles involved, and the induced current in the grid increases. This induced current, or rather the component of it in phase with the alternating grid voltage, is responsible for grid losses.

One method of reducing these losses is to reduce the transit angles, and is the method so far used. Another method would be to arrange the grid structure so that the grid voltage does not directly produce conduction-current variations at signal frequency, but varies the velocity of the electron stream. The variations in longitudinal velocity thus produced are then converted into variations in conduction current. By designing the grid structure to produce velocity variations, it has been found possible to keep the conduction-current variation, at signal frequency, low enough so that a grid impedance of 50,000 ohms is readily obtained throughout the wavelength range of 5 meters to 5 centimeters. In fact, for receiving-type tubes the grid impedance is of the order of magnitude of 50,000 ohms at 5 meters, and has a general trend upward with frequency.

Around this new type of grid action have been built tubes fulfilling the more usual functions of radio-frequency amplification, detection, oscillation, etc., as well as various combinations of these functions.

VELOCITY MODULATION

The over-all action of a tube using velocity modulation, or any other high-frequency tube for that

matter, is rather complicated when viewed as a unit. The great simplification introduced by separate consideration of velocity and conduction-current variations allows a reasonably straightforward design procedure. Before taking up the new designs in more detail, it is well to define more accurately certain quantities and introduce some nomenclature.

Consider the electrons passing a fixed point in space within a vacuum tube. At this point they will have a direct-current component of velocity, which is independent of time, as well as an alternating-current component having the frequency of the impressed signal. This velocity variation can be thought of as a time modulation of the direct-current velocity at that point. Similarly the charge density and conduction current have constant direct-current values which are modulated at signal frequency. The point to be noted is that the modulation of these quantities is a time variation of the stream at a fixed point or plane in space, and not the variation in velocity, etc., of a single electron during its passage through the tube.

Conduction-current modulation is based on the direct-current value of conduction current. As this is constant (except for the current intercepted by electrodes), the modulation in per unit, or per cent, is a convenient way of comparing conditions in different parts of the tube. Velocity modulation, on the other hand, is based on the direct-current value of velocity, which varies in different parts of the tube. While it is occasionally convenient to express this in per unit or per cent, comparisons are difficult because of the change of base. For this reason it is usually desirable to express the velocity modulation in electron volts, i.e., excess or deficiency in kinetic energy caused by the impressed signal.

As is usual where nonlinear devices are being analyzed, added simplification is introduced by considering the signal components to be very small compared to the direct-current values. If, in addition, the effects of space charge on the movement of electrons are neglected, the equations are linear, and superposition can be used. These simplifications will be used in this paper unless specific mention is made to the contrary. It is to be noted that only the action of space charge on the movement of electrons in the beam is neglected, but not its effect in inducing currents in the electrodes, which is of great importance.

Velocity-Modulation Grid

In explanation of this new type of grid, use will be made of the four infinite, parallel, conducting permeable planes of Fig. 1. A parallel flow of electrons perpendicular to the planes is assumed. All the planes

have the same direct voltage, for simplicity, and the planes *A* and *D* are grounded for radio frequency while *B* and *C* are connected together and have a radio-frequency sine wave of signal applied. Represent the instantaneous signal voltage by the sine wave of Fig. 2.

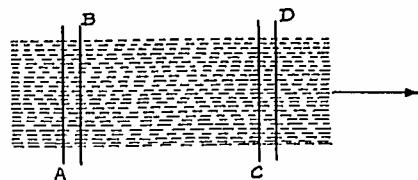

Fig. 1

To start with, assume that the transit angle between *A* and *B* and from *C* to *D* is small and that the electron stream passing plane *A* is not modulated either in velocity or conduction current. An electron entering the space *AB* at the positive maximum on the voltage wave (I in Fig. 2) will be accelerated and gain a kinetic energy in electron volts equal to the signal voltage of plane *B*. When this electron is between planes *B* and *C*, it is not acted on by any field, so that the increased velocity is maintained even though the voltage on *B* and *C* is changing. If it passes from *C* to *D* at the negative maximum (III in Fig. 2), it is again in an accelerating field and the electron gains further kinetic energy equal to the peak signal voltage. If an electron entering at III is chosen,

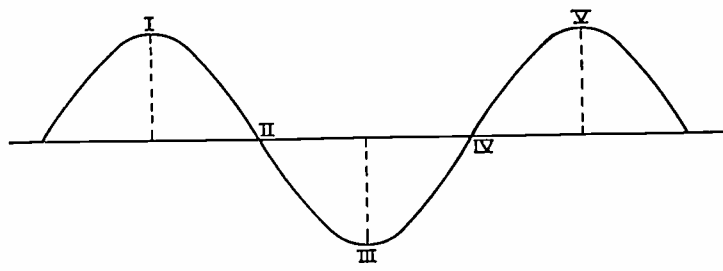

Fig. 2

it loses kinetic energy between *A* and *B*. Between *B* and *C* the energy is unchanged and between *C* and *D* (V in Fig. 2) it again loses energy. Electrons entering at II and IV are unchanged in velocity. If electrons entering at various other points on the voltage wave are investigated, it will be found that on leaving the plane *D* their velocity will have a sinusoidal variation and the peak velocity modulation, measured in volts, will be equal to twice the signal voltage. In other words, planes *B* and *C*, considered as a grid, have produced a velocity modulation of twice the signal voltage. Note that the transit angle between planes *B* and *C* has been assumed to be exactly π radians at signal frequency, and that the signal voltage is small enough so that the change in transit angle produced by the velocity variation is negligible.

It is convenient to think of planes AB as defining a short section in which a gradient, sinusoidal with time, produces velocity modulation. This modulation persists in amplitude along the beam but suffers a retardation in time phase equal to the transit time to any point. Planes C and D also produce a velocity modulation which may be superimposed on that from A and B . The gradient between C and D is the negative of that between A and B and, therefore, if the transit angle between B and C is an odd multiple of π , the total resulting velocity modulation is twice that produced by A and B ; while if it is an even multiple of π , the velocity modulation produced by A and B is canceled by C and D . As shown in Appendix I, the velocity modulation is equal to the signal voltage multiplied by twice the sine of half the transit angle between B and C , and lags the signal voltage by an angle of 90 degrees plus one half this transit angle.

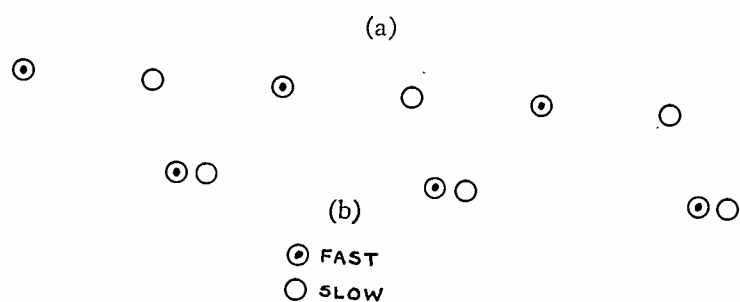

Fig. 3

The type of action so far considered has been idealized to the extent that the transit angle A to B and from C to D has been assumed very small. In these spaces the electron approaches and recedes from the field-free grid space B to C . The spaces A to B and C to D will be called the approach spaces. In actual constructions these spaces cannot be made negligible, and consideration has to be given to their effect. As they are increased in length it will be found that the amount of velocity modulation is decreased from the ideal value of twice the signal voltage, and the angular time lag is changed. For any given geometrical configuration and system of applied direct voltages, a ratio of longitudinal velocity modulation in volts to the applied signal voltage can be found. This ratio expressed as a time vector, is called the longitudinal velocity coefficient of that particular arrangement considered as a grid. Since most actual grids are not planes, the signal voltage also produces gradients perpendicular to the axis of the beam. The ratio of the transverse velocity modulation in volts to the applied signal voltage is called the transverse-velocity coefficient. Ordinarily the longitudinal-velocity coefficient is of most importance and, in the interests of brevity, the word longitudinal will be omitted except

where distinction between the two types is necessary.

It will be noted that the velocity-modulation grid is most effective when the approach and exit spaces have small transit angles. This is another way of saying that the direct-current potentials on planes A , B , C , and D should be made as high as is convenient. This is one of the important differences between this type of grid and the usual type. The latter requires that a voltage minimum shall exist in order that it may create a conduction-current modulation. For this reason the effects of space charge are much less important in the new type of grid control.

In Appendix I formulas for velocity coefficients for the parallel-plane case are derived. Later in the paper typical values of these coefficients are given.

CONVERSION OF VELOCITY MODULATION INTO CONDUCTION-CURRENT MODULATION

There are at least three well-defined methods of converting the velocity modulation produced by the grid to the more readily usable conduction-current modulation. The three methods are deflection, drift tube, and retarding field.

Deflection Conversion

In this method transverse magnetic, or electrostatic fields, or combinations of both are used to separate the high-velocity electrons from the low-velocity electrons. Patches of high-velocity electrons occur regularly every 360 degrees of transit angle down the beam, and if all the low-velocity electrons are removed, there will be left a beam with a variable charge density. This represents 100 per cent conduction-current modulation of half the total beam current. The low-velocity electrons could be removed to form another beam which would also be fully modulated and the effect of the beams can be combined in a push-pull output circuit.

The deflection methods of conversion appear to lead to critical voltages on certain tube elements, as well as sensitivity to external electric and magnetic fields, etc. The other two methods to be described seem to offer at least as much sensitivity to velocity modulation without these disadvantages.

Drift-Tube Conversion

Assume a long field-free space and an entering beam having velocity modulation but no charge-density modulation; that is, the electrons are evenly spaced but the velocity varies from one to another. These entering electrons can be represented by the row in Fig. 3(a). They proceed down the beam and in the course of time the fast electrons tend to catch up on the electrons ahead while the slow electrons lag behind the general average. This tends to group

the electrons as shown in Fig. 3(b). This is another way of saying that charge-density modulation has been created by letting the beam "drift" in a field-free space. In fact, it shows that velocity modulation always tends to create a charge-density modulation, and by this means a conduction-current modulation. High conversion sensitivity is obtained by a long transit time in the drift tube so that a small velocity modulation will have time to sort the electrons into groups.

Although the above explanation is rather imperfect in some respects it serves to bring out the essential features of the process. It will be realized, of course, that as the velocity modulation is sinusoidal, the charge density and conduction-current modulation will be sinusoidal in character. One could imagine that, if the positions shown in Fig. 3(b) were undisturbed and the electrons allowed to drift still farther, the fast ones would overreach the slow ones and the conduction-current modulation begin to decrease. These considerations are somewhat academic, as at this point the sinusoidal character of the charge density is considerably distorted, and space charge will further affect the movements of the electrons. Practically speaking, usable lengths of drift tubes lead to high percentages of conduction-current modulation only in power tubes where large radio-frequency grid voltages are available. In receiving tubes one is interested in the conduction current per unit alternating grid voltage and not necessarily a high-percentage current modulation of the beam.

Equations for the conversion process in drift tubes neglecting space charge are given in Appendix II. It is there shown that the conduction-current modulation produced in a field-free space is proportional to the transit angle. To obtain the highest G_m , therefore, requires long drift tubes which is interesting when contrasted to the requirements for high G_m in ordinary tubes. One is led to the conclusion that here is a method of increasing the G_m of vacuum tubes without any limitation except that of physical size. Actually initial velocities and space charge will impose such limitation. If the drift tube is of such a length that velocity modulation of the order of the average initial velocities would produce 100 per cent conduction-current modulation, the random initial velocities would effectively disorganize any smaller signal modulation. It thus seems probable that the limitation in G_m per milliamperere in the ordinary constructions also holds for this type of tube. Space charge will also introduce a limit to the useful length of drift tubes.

This type of conversion, like velocity modulation itself, can be made effective at the shorter wave-

lengths. Physical size, however, sets a low-frequency limit on this type of tube which, fortunately, allows some overlap with existing types.

Retarding-Field Conversion

If a velocity-modulated beam of electrons is subjected to a retarding field, each electron will be reflected back at a point in the field where the voltage is approximately equal to the kinetic energy of the electron. Two different conversion processes must be distinguished. In the first an electrode close to cathode potential is employed to collect electrons at average or higher than average velocities. Then those at lower than average velocities are reflected; and, as in the deflection case, form a conduction-current-modulated beam. The e_p-i_p characteristic of the collector with no impressed modulation is a function of the initial and orbital velocities and space charge. When velocity modulation is added, the effect is much the same as if the characteristic were shifted back and forth synchronously with the velocity modulation, and the resulting conduction-current modulation can thus be obtained as the velocity modulation multiplied by the slope of the characteristic at the operating point. Thus the product of the slope by the velocity coefficient partakes of the nature of a mutual conductance. For the maximum slope it is usually necessary to collect about half of the beam current.

Another type of conversion process may be visualized by making the retarding field enough negative to reflect all the electrons. The faster electrons obviously travel farther in the field before they are turned around and thus, in the returning beam, lag behind their original position. This gives a sorting effect based on velocity, like that in a drift tube. However, it is in the opposite direction so that too much drift-tube effect cannot be allowed to enter the process. Tubes operated on this type of sorting have shown high conversion efficiency.

The retarding-field action can be made to give very good conversion sensitivity by proper design of the collector shape and other parts of the tube. One of the biggest difficulties is the fact that the returning beam may pass through the grid. As this beam is now conduction-current modulated, the grid impedance will be low. While this is what is wanted for oscillators, it is undesirable for other applications. Tilting of the collector must be resorted to and the reflected beam collected by a suitable electrode as is shown for example in Fig. 9.

RADIO-FREQUENCY PLATES

So far the beam has been velocity modulated, and this modulation has been converted into conduction

current. It now remains to utilize this current in producing a radio-frequency output in the external circuit. The induced current flowing from any electrode to its external circuit is the result of the action of the space charge of the beam on this electrode.

Consider an electron approaching an electrode. Of the total number of lines of force ending on the electron, more and more will have their other end on the electrode. This corresponds to an increase in the induced charge on the electrode; and to supply this, a current must flow to the electrode from an external circuit. According to this idea all current will cease when the electron hits the electrode; and, in effect, current to the electrode is the result of charges in motion near it rather than those which are hitting it. Thus it must be expected that as a conduction-current-modulated beam of electrons approaches an electrode, there will be an induced current in it. However, as the electrons exposed to the electrode have a range of time-phase angles represented by the transit time in the approach space, the total induced current will be somewhat less than the conduction-current modulation times the beam current. Assume plane *B* in Fig. 1 is a solid collector, and plane *A* is a permeable conducting plane with a conduction-current-modulated beam entering from the left. The electrons moving between *A* and *B* cause induced currents which flow in any external circuits connected between *A* and *B*. If the transit angle *A* to *B* is small, the induced current is equal to the entering conduction-current modulation times the beam current. As the angle from *A* to *B* is made larger the induced current drops off just as the velocity modulation did in the case of a grid. Thus, if it is desired to use a plane such as *B* as a radio-frequency plate, a close complementary plane *A* or its equivalent must be used.

Such a combination is not capable of providing any more induced current than 100 per cent of the modulated part of the beam current. If, however, one uses also planes *C* and *D*, making plane *B* permeable, the induced current between planes *A* and *B* is in no wise changed and an additional induced current from *C* to *D*, through their associated external circuits, is also added. If the transit angle from *B* to *C* is made an odd multiple of π , then the induced current is doubled. This is an important feature as, in short-wave practice, high output impedances are hard to obtain; and this feature allows the use of either one fourth the impedance necessary with the single plate, or the production of four times the power for the same modulated beam current.

At first glance this process may seem like getting something for nothing. In the first place it must be

remembered that the mere production of induced current involves only a shifting of lines of force and does not in itself affect the velocity of an electron. The energy expended in the external circuit comes from the kinetic energy of the electron in the following manner. The induced current flowing in the external circuit builds up a radio-frequency voltage across it and thus between electrodes. This voltage produces a gradient through which the beam must pass, which in turn produces a velocity change or velocity modulation in the beam. Since the beam has conduction-current modulation, it presumably has some charge-density modulation. The velocity modulation has such a time-phase relation with respect to the charge-density variations that the places of high charge density are slowed down and those of low-charge density are speeded up. There is thus a net reduction in average speed of the beam which is just sufficient to supply the external power.

Just as in the case of the double-ended grid we obtain a velocity modulation of twice the peak radio-frequency swing, so in the double-ended plate we obtain an induced current of twice the peak value of the modulated-beam current. The above result is shown mathematically in Appendix III.

The use of a double-ended plate not only doubles the induced current, but has an added advantage. The beam leaving plane *D* has been slowed down by the loss in kinetic energy to the load. It can now be collected at a voltage just high enough to keep any electrons from being reflected. Thus the heating loss of the collector is minimized and the plate efficiency of the tube kept at a reasonable figure. While the modulation from the plate decreases the average beam velocity, the electrons at the minimum charge-density spots are increased in velocity. Under these conditions, the plate efficiency of a collector running at just sufficient voltage to collect all the electrons is about 50 per cent.

Consideration of the arguments used in connection with Fig. 1 would indicate that the use of four or six pairs of planes connected in parallel to the load, instead of two pairs, would increase the induced current by factors of 4 or 6. However, a point is soon reached where the complications of paralleling electrodes at the load and of getting the phase angles right, etc., especially at the wavelengths under consideration, become prohibitive. So far a single cylindrical anode has proved a good compromise of simplicity versus efficiency. Perhaps later when the art has progressed further, multiple plates may become more desirable from the circuit standpoint.

Where the double-ended plate is used with a retarding-field type of sorting, it becomes increasingly

difficult to collect the returning beam at the low voltage required for highest collector efficiency. Thus the collector-loss considerations cited above are of most value where drift-tube sorting is used.

SUPERPOSITION OF EFFECTS

It will be realized that the velocity-modulation characteristic, the drift-tube effect, and the induced-current characteristic together form a complete description of the relations of any electrode to the electron stream. As an illustration take the velocity-modulation grid, and again assume no modulation of the incoming beam. The velocity coefficient gives the total velocity modulation produced as a result of a given signal. The signal produces some velocity modulation in the first approach space. In the interior of the grid some conduction-current modulation is produced by drift-tube sorting. In the exit space this induces a current in the grid flowing from the external circuit. This current divided into the signal voltage gives directly the grid impedance. While the numerical calculations may not be shorter than when using a complete formula for the impedance directly, there is considerable advantage from a design standpoint in the segregation of the effects. Thus it can be seen that the grid impedance goes down as the length of the grid is increased, and where a high-impedance grid is desired the shortest length, which gives nearly π as the transit angle, is the best.

If, as the operating frequency is raised, the direct voltage on the grid, and thus the velocity through the grid and end spaces, is raised so as to maintain constant transit angle, the grid impedance has an upward trend. This is because the drift-tube sorting is proportional to the per-unit velocity modulation and the latter is decreasing. A drift tube π radians long does not produce very much conduction-current modulation, so that the grid impedance is easily made high.

In the radio-frequency plate the effect of the incoming modulation of the beam may be simply superimposed as an extra induced current on the effects already produced by the plate considered as a grid driven by the load alternating voltage. In this way it can be seen that the plate impedance is exactly equal to the grid impedance of the same structure.

In a drift tube the conduction current leads the velocity modulation by a time-phase angle of $\pi/2$. Thus, if the grid is π radians long, the grid impedance is not only high but is a pure reactance. In fact, it is equivalent to an added positive capacitance between the grid and the end shields. If, however, the grid is operated at an angle of $\pi/2$, then the grid impedance has become a negative resistance. The possibility of

utilizing this effect in an oscillator was pointed out by Heil.⁷ The difficulty with this type of tube is that the grid is essentially a high-impedance structure, and the resulting negative resistance is also high making it difficult to produce an efficient output circuit.

This sort of negative-resistance action must be distinguished from the negative resistance of temperature-limited diodes as predicted by North.⁵ In the latter case the whole action, production of velocity modulation, drift-tube sorting, and induced current, takes place in the approach space. In this case the resulting negative resistance may be higher than that calculated for Heil's tube.

Finally it should be noted that, although field-free spaces were used in the idealized descriptions so far given, the conceptions are not limited to such spaces. For instance, a space with longitudinal direct-current fields merely varies the transit angle in a more complex fashion. If alternating-current fields are present, the drift-tube sorting applies to each increment of generated velocity modulation as though the alternating-current field were absent in the rest of the space. The total conduction-current modulation can then be expressed as the integral of these increments, due allowance being made for drift-tube sorting.

DESIGNS OF GRIDS

As has been pointed out, the radio-frequency plate and grid use similar structures, and it will be appreciated that a well-designed grid can be used with any desired sorting process. For this reason the design of practical velocity-modulation grids will be taken up first.

In the design of such a structure, a balance must be obtained between the velocity coefficient and its capacitance and inductance. Fig. 4 shows the cross section of the grids used in tubes at 5-meter, 30-centimeter, and 4.8-centimeter wavelengths. The calculated velocity coefficients are 1.6, 1.3, and 0.8, respectively. The cold input capacitances are 3.0 and 1.8 micromicrofarads for the first two, the last grid being part of a concentric transmission line introduces no lumped capacitance. Although the 5-meter grid is only slightly longer than the 30-centimeter grid, they both operate with transit angles of the order of π radians at the applied frequency. This is possible by adjusting the direct voltage on the grid. The 5-meter tube operates at +300 volts on the end shields and +5 volts on the grid, while the

⁷ A. Arsenjewa-Heil and O. Heil "A new method for the production of short undamped, electromagnetic waves of great intensity," *Zeit. für Phys.* vol. 95, no. 11 and 12, pp. 752-762; (1935).

30-centimeter tube has +300 volts on both. The adjustment of this voltage is not critical and may be changed by ± 20 per cent with little change of the velocity coefficient. The 4.8-centimeter design operates at a transit angle of 3π radians at 1200 volts.

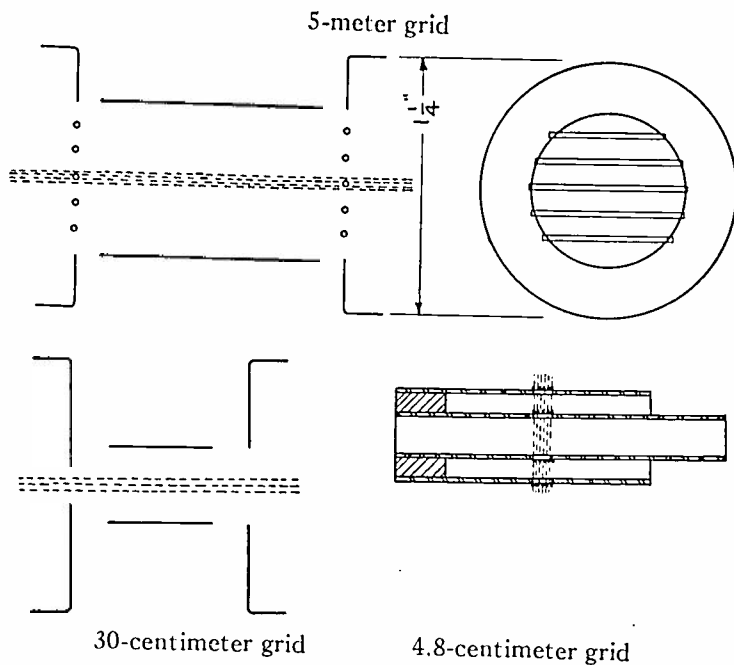

Fig. 4

The particular designs shown in Fig. 4 are not necessarily the optimum, but merely illustrate convenient constructions which were studied extensively.

These grids were used with beam currents of 5 milliamperes or less, depending on the design of the electron-focusing system. The design of grids for transmitting tubes in which much higher beam currents are required, usually lead to larger structures

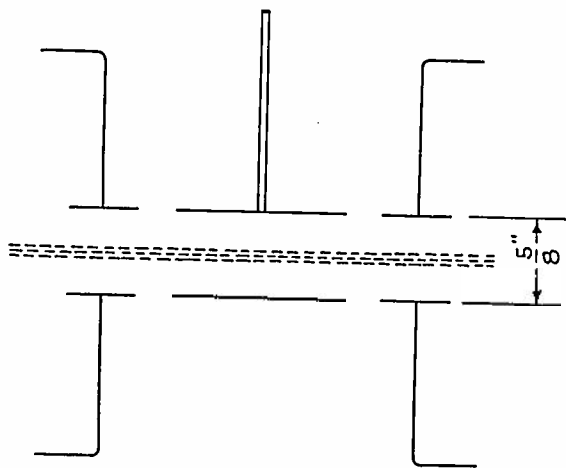

Fig. 5

and higher direct-current potentials, although, as no direct current is necessarily collected on any of these elements, the direct-current power supplied may be very small. Fig. 5 is a cross section of a grid for use in the region from 20 to 40 centimeters with beam currents of 50 milliamperes or more and operating at 3000 volts.

MEASUREMENT OF VELOCITY COEFFICIENTS

The most convenient method of determining velocity-modulation factors is by use of a low-voltage collector. The change of direct-current potential of such a collector, necessary to maintain constant current with and without a known radio-frequency voltage applied to the grid, gives the peak value of the velocity modulation of the electrons. The ratio of this value to the peak input voltage is defined as the velocity coefficient. In order to reduce the effects of orbital motions and other defects of the collector, and to reduce the effects of the returning electrons on the grid itself, the total beam current is kept small.

At the shorter wavelengths it is comparatively difficult to determine the radio-frequency voltage applied to the grid, and here recourse has been had to checking the variation of velocity coefficient with respect to the applied direct voltage and frequency. The checks obtained in this way show that the grids are performing in the expected manner even at wavelengths as low as 5 centimeters. By inference, then,

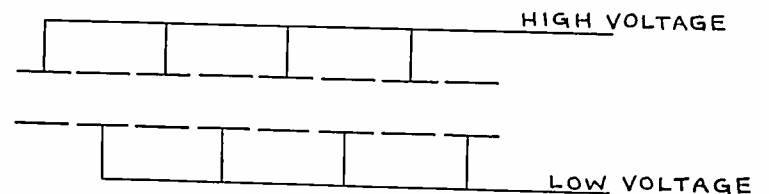

Fig. 6

the calculated values of velocity coefficient should be very close to the actual values. Insofar as the radio-frequency voltages on the grid are concerned, there is some possibility of using the velocity-modulation grid as a voltage-measuring device, whose calibration curve can be calculated.

DESIGN OF SORTING SPACE

The choice of the two methods used for converting velocity modulation into conduction-current modulation, that is, drift-tube sorting and retarding-field action, is dependent on the tube application involved, but the principles of design can best be outlined before this choice is made.

As the drift-tube action is directly proportional to the length of the drift tube and inversely proportional to the electron velocity, the primary problem is to design a structure which will maintain a low-voltage beam in a focused condition for the necessary distance. A structure which does this and also reduces the effect of stray magnetic fields is shown in Fig. 6. The combination of alternate low- and high-voltage electrodes results in a radial focusing field practically throughout the length of the beam. With such a structure a beam of charges may be sent a reasonable

distance without a great increase in cross section, and because of the strong focusing field this system is relatively insensitive to stray fields. In general a length of from 1 to 4 inches is sufficient for most applications unless the frequency of the velocity modulation is very low.

The primary problem in the design of retarding-field collectors is one of shaping the collector so that the effects of orbital velocity of the electrons are reduced to a minimum, and the returning beam is directed at the proper angle. With cylindrical beams it has been found that a collector with spherical shape is quite satisfactory, and yields current-voltage characteristics which have conductances of from 200 to 2000 micromhos per milliampere of beam current. The exact radius of curvature is a function of the

voltage was the order of one volt. Further tests were conducted with tubes having beam currents of 30 milliamperes, in which case about four watts of radio-frequency power were obtained in a lamp load at a wavelength of 50 centimeters.

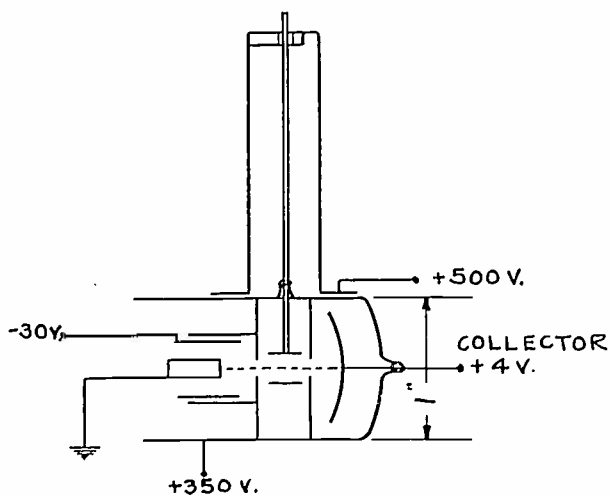

Fig. 7

space-charge density and the focusing fields and is therefore somewhat difficult to calculate. In the receiving tubes tested this radius was from 1/2 inch to 1 inch.

TEST RESULTS

Oscillators

The simplest type of oscillator utilizing the foregoing principles is one using the retarding-field collector in either of the processes previously described. Fig. 7 shows a cross section of the tube with attached circuits, while Fig. 8 is a photograph of the tube with the oscillating circuit in place. This type of tube oscillates with at least a ± 15 per cent range of any voltage at any one frequency and by changing the direct voltage of the radio-frequency grid it will oscillate over a frequency range of 5 to 1. The major portion of the experimental work on this type of tube was done with beam currents of one milliampere or less, but even with this small current, oscillations were easily obtained at a wavelength of 14 centimeters. By observing the anode characteristic during oscillation it is estimated that the beam current was modulated from 30 per cent to 100 per cent and that the output

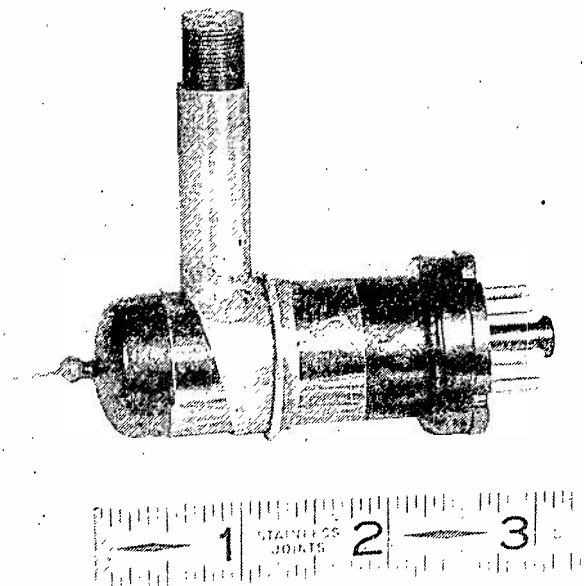

Fig. 8

The major application of this type of oscillator was a superregenerative receiver, the quench frequency being applied on either the collector or the focusing grid. Receivers of this type were tested in

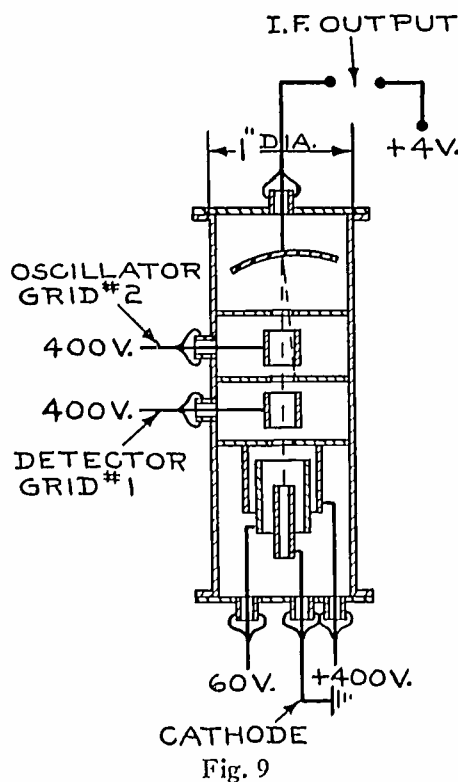

Fig. 9

the field on 37- and 25-centimeter transmission, and proved to be very simple to construct.

Tubes for superheterodyne reception were constructed as shown in Fig. 9. The signal is received

on grid No. 1 which velocity modulates the beam at signal frequency, while grid No. 2 velocity modulates the beam at oscillator frequency. By operating the retarding-field collectors at a point of maximum curvature the current in this element has an intermediate-frequency component. In order to allow the returning electrons to cause oscillation in the oscillator grid but not in the signal grid, the collector is tilted at an angle so that the returning beam will

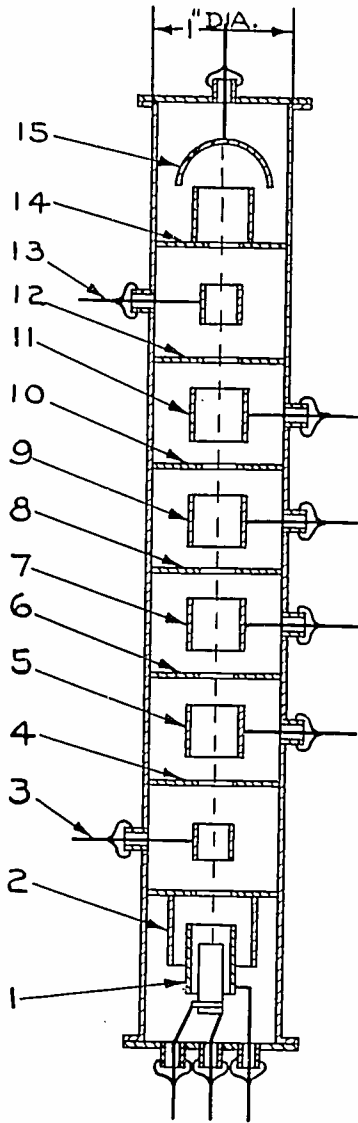

Fig. 10

strike the end shield between these two grids. If it is desired to use a separate oscillator, the collector may be tilted at an angle sufficient to allow the returning electrons to strike the last end shield. Tubes of this type were tested at 37 centimeters with an 18-megacycle intermediate-frequency amplifier and proved to be good converters. The beam current was less than one milliamper and the highest voltage was 350 volts.

RADIO-FREQUENCY AMPLIFIERS

Radio-frequency amplifiers were first tested at 50 to 200 megacycles in order to facilitate accurate

measurement of the radio-frequency voltages. Fig. 10 is a cross section of a radio-frequency amplifier for receiver use in this frequency band utilizing drift-tube sorting. Fig. 11 is a photograph of a similar tube in metal.

The elements numbered 2, 4, 6, 8, 10, 12, 14, and 15 were operated at 300 volts direct current. The direct voltage of radio-frequency grid No. 3 and radio-frequency anode No. 13 were adjusted for maximum output at the frequency used. This usually was about 10 to 30 volts positive. Focusing elements 5, 7, 9, and 11 were connected together and the voltage adjusted to give maximum beam current. This occurred at about 30 volts positive.

The mutual conductance of grid No. 3 to anode No. 13 was measured by first obtaining the voltage gain between them and then measuring the output impedance by cutting the voltage across the output circuit to one half, with a shunt resistance. With a

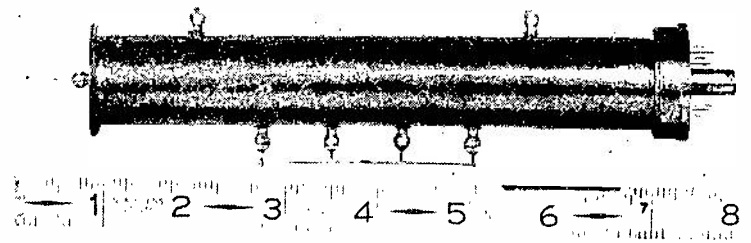

Fig. 11

beam current of 0.8 milliamper and a frequency of 100 megacycles the mutual conductance was about 200 micromhos. This value checked calculations within the accuracy that the average velocity in the drift tube could be estimated. Although the value of mutual conductance obtained in this particular tube was probably too low for practical application at this frequency, it illustrates the principles involved. It is also interesting to note that the operation is not at all critical to voltage, and that both the input and output resistance of the tube were so high as not to affect the attached circuits.

Radio-frequency amplification by means of retarding-field action was also tried. In this case the returning conduction-current-modulated beam was collected on an element at one side of the axis by tilting the collector. The mutual conductance of this type of tube depends almost entirely on the slope of the collector current-voltage characteristic, which in the case of the tube tested was low, the mutual conductance being only 300 micromhos.

Radio-frequency amplifiers using drift-tube sorting, with auxiliary magnetic focusing have proved very effective for high-power outputs. Coils surrounding the tube provide sufficient focusing field so that

less than one per cent of the beam current is lost to the accelerating electrodes. Fifty watts useful output has been obtained, with a collector efficiency of 20 to 30 per cent, and at a frequency of 360 megacycles. At present there seems to be no reason why tubes of this type cannot be built for higher powers and still shorter wavelengths.

Tubes embodying the principles described in the foregoing are not available as yet for commercial distribution.

APPENDIX I

Velocity Coefficient for Parallel Plates

Assume that the grid is composed of four infinite, conducting, permeable, parallel planes as in Fig. 1. Furthermore, let the voltage from planes *A* and *D* to the cathode be simply V_0 , a direct voltage, while the voltage of planes *B* and *C* to the cathode is $V_0(1 + \delta \sin \omega t)$. Planes *B* and *C*, connected together, form the grid, with a signal voltage of $V_0 \delta \sin \omega t$, and planes *A* and *D* are end shields. The transit angle from *A* to *B* and from *C* to *D*, at signal frequency, is taken as negligibly small, while that from *B* to *C* is denoted by θ .

Neglecting space charge, the beam passing between *A* and *B* acquires by reason of the alternating-current gradient, an increased velocity of $V_0 \delta \sin \omega t$ electron volts so that the total velocity at *B* is $V_0(1 + \delta \sin \omega t)$ electron volts. In the space *B* to *C*, however, there is no field and no further velocity change is made until the beam reaches *C*. At this point, the beam velocity, referred to the signal voltage, is $V_0(1 + \delta \sin(\omega t - \theta))$, because the transit angle θ in the grid represents a time delay. In the space *C* to *D* the beam acquires a further velocity of $-V_0 \delta \sin \omega t$ electron volts. The minus sign is used as the gradient is in the reverse direction. Thus the total velocity at *D*, in electron volts, is

$$\begin{aligned} V_0(1 + \delta \sin(\omega t - \theta) - \delta \sin \omega t) \\ = V_0(1 + \delta(\cos \theta - 1) \sin \omega t - \delta \sin \theta \cos \omega t) \\ = V_0 - V_0 \delta (2 \sin \theta / 2) \sin(\omega t - \pi/2 - \theta/2). \end{aligned}$$

Thus the longitudinal velocity coefficient is

$$\beta_e = \frac{V_0 \delta \left(2 \sin \frac{\theta}{2} \right)}{V_0 \delta} \left| -\frac{\pi}{2} \frac{\theta}{2} \right| = 2 \sin \frac{\theta}{2} \left| -\frac{\pi}{2} \frac{\theta}{2} \right|$$

in vectorial form.

APPENDIX II

Drift-Tube Sorting

A drift tube consists of a field-free space of length l . The entering beam has velocity modulation so that

the velocity of neighboring electrons is slightly different. Let an electron enter at time t_1 and another at time $t_1 + dt_1$. Now let the transit time of the first electron be t_0 and the second $t_0 + dt_0$. Then the two electrons will leave at times $t_1 + t_0$ and $t_1 + dt_1 + t_0 + dt_0$. As conduction current is defined as the time rate at which a charge passes a given point, the entering conduction current caused by the two electrons is proportional to $1/dt_1$ while the current leaving is proportion to $1/(dt_1 + dt_0)$, these quantities being the reciprocal of the difference in time between the electrons. Now if I_0 is the actual entering conduction current, then the current leaving is

$$\left[I_0 \frac{1}{1 + \frac{dt_0}{dt_1}} \right]$$

at time t_0 later. It must be observed that the lag in time t_0 must be inserted as it represents the time delay in transit and is not automatically taken care of by the equation.

In case all alternating-current quantities are small, it can be seen that dt_0/dt_1 , being an alternating-current quantity, is small compared to 1.0. Thus the leaving current minus the entering current delayed t_0 seconds is $[-I_0(dt_0/dt_1)]$ at time $(t_0 + t_1)$. Again, when alternating-current quantities are small, their cross products are neglected and thus I_0 can be taken as the direct beam current. Now assume the entering velocity modulation is $V_M \sin \omega t$ in electron volts and the direct voltage of the drift tube is V_d . Then the entering kinetic energy of the electrons is

$$V_d + V_M \sin \omega t_1 \text{ in volts.}$$

Also the velocity in centimeters per second is

$$\begin{aligned} v &= 5.97 \times 10^7 \sqrt{V_d + V_M \sin \omega t_1} \\ &= 5.97 \times 10^7 \sqrt{V_d} \left(1 + \frac{V_M}{2V_d} \sin \omega t_1 \right) \end{aligned}$$

inasmuch as $V_M \ll V_d$. The transit-time t_0 is

$$\begin{aligned} t_0 &= \frac{l}{v} = \frac{l}{5.97 \times 10^7 \sqrt{V_d}} \frac{1}{1 + \frac{V_M}{2V_d} \sin \omega t_1} \\ &\approx \frac{l}{5.97 \times 10^7 \sqrt{V_d}} \left(1 - \frac{V_M}{2V_d} \sin \omega t_1 \right) \end{aligned}$$

and

$$\frac{dt_0}{dt_1} = - \frac{l}{5.97 \times 10^7 \sqrt{V_d}} \frac{V_M \omega}{2V_d} \cos \omega t_1.$$

Assume no entering alternating conduction current and denote the leaving current minus the entering

current by I_d . Then

$$I_d = \frac{lI_0V_M\omega}{5.97 \times 10^7 \times 2 \times V_d^{3/2}} \cos \omega(t_1 + t_0).$$

Now if ϕ is the transit angle from one end of the drift tube to the other, based on the average or direct-current velocity

$$\phi = \frac{l\omega}{5.97 \times 10^7 \times \sqrt{V_d}}$$

and

$$I_d = \frac{\phi I_0 V_M}{2V_d} \cos(\omega t_1 - \phi).$$

Again, the difference current I_d , divided by the entering velocity modulation in volts and by the direct beam current will be called the drift-tube factor. In vectorial notation, this is

$$\alpha_e = \frac{\phi}{2V_d} \left| \frac{\pi}{2} - \phi \right|$$

where α_e is the drift-tube factor and

$$I_d = \alpha_e V_M I_0.$$

APPENDIX III

Radio-Frequency Plates of the Parallel-Plane Type

Consider two planes such as A and B in Fig. 1. From symmetry there are no electron motions or currents flowing parallel to the planes so the problem is essentially one dimensional. The total current, the sum of the conduction current and the displacement current, is solenoidal, that is, in this one-dimensional case, it has the same value simultaneously at all points in the space A to B . If we leave out of consideration the displacement current between A and B due to the capacitance of the planes in the absence of the beam, the rest of the total current must obviously be the induced current due to the beam. This is, then simply the average of the conduction current at all points in the space, taken at any instant of time. In the case to be considered, the transit angle A to B is small so that the induced current then simply be-

comes equal to the conduction current in the beam at a plane midway between A and B .

Assume a double-ended grid using all four planes in Fig. 1. The conduction current in the beam passing through the space A to B is assumed to be

$$I_c \sin \omega t.$$

In this case the induced current from A to B is also $I_c \sin \omega t$. Now if θ is the transit angle between planes B and C , the conduction current passing between C and D is

$$I_c \sin(\omega t - \theta)$$

and the induced current from C to D is the same. The total induced current flowing from planes B and C to the outside circuit is then

$$\begin{aligned} I_c [\sin(\omega t - \theta) - \sin \omega t] \\ = I_c \left(2 \sin \frac{\theta}{2} \right) \sin \left(\omega t - \frac{\pi}{2} - \frac{\theta}{2} \right) \end{aligned}$$

and if $\theta = \pi$, then the peak value of induced current is $2I_c$.

Now assume that an external resistance R is connected from the planes B and C to A and D . Then a voltage

$$I_c R \left(2 \sin \frac{\theta}{2} \right) \sin \left(\omega t - \frac{\pi}{2} - \frac{\theta}{2} \right)$$

is developed and if $\theta = \pi$, this is

$$- 2I_c R \sin \omega t.$$

The velocity modulation produced at plane D by this voltage is, from Appendix I,

$$+ 4I_c R \sin \omega t.$$

The total conduction current in the beam passing through plane D is

$$I_0 + I_c \sin(\omega t - \theta) = I_0 - I_c \sin \omega t.$$

Thus it can be seen that where the conduction current is a maximum, usually indicating high charge density, the electrons are slowed down, and vice versa.

Nonexistence of Continuous Intense Ionization in the Troposphere and Lower Stratosphere*

O. H. GISH†, NONMEMBER, I.R.E., AND H. G. BOOKER†, NONMEMBER, I.R.E.

Summary—Evidence that radio waves are returned from the troposphere and lower stratosphere has been interpreted by Watson Watt and coworkers as pointing "to continuous ionization in sharply bounded thin strata, over long periods of 5×10^{12} ions/cc or more in regions around 6 to 10 km . . . at all times of day, in summer and in winter." Direct observations of the electrical state of the troposphere and lower stratosphere prove that the electrical conductivity of these regions is something like nine orders of magnitude less than that suggested by Watson Watt and coworkers. Continuous recording of electrical conductivity during the flight of the Explorer II up to an altitude of nearly 22 kilometers shows a maximum ionic density of only 5300 ions/cm³ (at 14.8 kilometers). Balloon observations throughout the troposphere show no trace of ionic densities far in excess of 4000 ions/cm³. This evidence is further supported by many years of continuous recording of the electrical state of the troposphere at the Huancayo Magnetic Observatory, 3.3 kilometers above sea level. Moreover, the power required to maintain the electrification postulated by Watson Watt and coworkers is startling when compared with that available from the sun and thunderstorms. The strength of radio echoes from the troposphere would seem to have been greatly overestimated.

I. INTRODUCTION

EVIDENCE that radio waves are returned from low levels in the atmosphere, even as low as one kilometer has been reported in recent years.^{1,2,3,4,5,6,7,8,9} An extensive report⁹ has been published by Watson Watt and coworkers. They find that "the echoes from the lowest heights appear to belong to a system of multiple reflections from sharply defined heights which usually lie above six kilometers and are not infrequently found at ten kilometers." They state that "all the evidence . . . points to 0.7 as a fair approximation to the effective reflection coefficient." This result, if true, is of outstanding importance. But before one can accept its

* Decimal classification: R113. Original manuscript received by the Institute, May 10, 1938. Presented before U.R.S.I.-I.R.E. meeting, Washington, D. C., April 29, 1938.

† Department of Terrestrial Magnetism, Carnegie Institution of Washington, Washington, D. C.

¹ R. C. Colwell and A. W. Friend, "The D region of the ionosphere," *Nature*, vol. 137, p. 782; May 9, (1936).

² R. C. Colwell and A. W. Friend, "The lower ionosphere," *Phys. Rev.*, vol. 50, pp. 632-635; October 1, (1936).

³ R. C. Colwell and A. W. Friend, "Tropospheric radio wave reflections," *Science*, vol. 86, pp. 473-474; November 19, (1937).

⁴ R. C. Colwell, A. W. Friend, N. I. Hall, and L. R. Hill, "The lower regions of the ionosphere," *Nature*, vol. 138, p. 245; August 8, (1936).

⁵ S. K. Mitra, "Return of radio waves from the middle atmosphere," *Nature*, vol. 137, p. 867; May 23, (1936).

⁶ S. K. Mitra, "Some observations on the C regions of the ionosphere," *Nature*, vol. 138, pp. 283-284; August 15, (1936).

⁷ H. Rakshit and J. N. Bhar, "Some observations on the C regions of the ionosphere," *Nature*, vol. 138, p. 283; August 15, (1936).

⁸ R. A. Watson Watt, L. H. Bainbridge-Bell, A. F. Wilkins, and E. G. Bowen, "Return of radio waves from the middle atmosphere," *Nature*, vol. 137, p. 866; May 23, (1936).

⁹ R. A. Watson Watt, A. F. Wilkins, and E. G. Bowen, "Return of radio waves from the middle atmosphere—I," *Proc. Roy. Soc.*, ser. A, vol. 161, pp. 181-196; July 15, (1937).

validity there are several possibilities which must be taken into consideration.

(1) The equipment required for investigating echoes of such short delay time requires careful design. Is it possible that the reported echoes are due simply to imperfections in the equipment? There appears to be fair agreement among the several workers in various parts of the world as to the major features of the reported reflections from the troposphere and lower stratosphere, although they differ as to a number of details. It seems reasonable to assume, therefore, that these echoes are not spurious and do indicate return of part of the radiated energy with delay times corresponding to equivalent semi-paths of the order of 10 to 50 kilometers.

(2) It seems to be assumed that the echoes are being received from directly above the equipment. The possibility that they may be coming from objects on the surface of the earth seems to be ignored. While this assumption may be true, its validity does not seem to have been proved.

(3) Even if the echoes are real and are coming from overhead, there still remains the possibility that the analysis by Watson Watt and coworkers of the various echoes into a system of multiple reflections from sharply defined heights of the order of 10 kilometers may be wrong. They themselves point out that this interpretation would seem to involve "some danger of showing a greater return of energy from the whole atmosphere . . . than was originally incident." That their interpretation does founder on precisely this difficulty has recently been proved by Appleton and Piddington.¹⁰ Moreover, the latter authors have carried out experiments which seem to show that, even if there is any return of radio waves from a height of about 10 kilometers, it is probably from atmospheric scattering patches rather than from sharply defined reflecting strata, and that the amplitude of these echoes is at least four orders of magnitude less than that estimated by Watson Watt and coworkers. The observations of Appleton and Piddington are in complete agreement with the well-established fact that long-distance radio communication is maintained via the E and F regions of the ionosphere.

¹⁰ E. V. Appleton and J. H. Piddington, "The reflexion coefficients of ionospheric regions," *Proc. Roy. Soc.*, ser. A, vol. 164, pp. 467-476; February 18, (1938).

We conclude that there does seem to be some evidence of the return of radio waves from the troposphere and lower stratosphere, but that these echoes are exceedingly weak.

That these reflections are brought about primarily by masses of highly ionized air, as is doubtless the case in the ionosphere proper, is more or less directly implied in several reports. Watson Watt and coworkers state that their results point "to continuous ionization in sharply bounded thin strata, over long periods, of 5×10^{12} ions/cc. or more in regions around six to ten kilometers . . . at all times of the day, in

that suggested by Watson Watt and coworkers. Such a contingency has been indicated by Mitra^{5,6} and by Appleton and Piddington.¹⁰ In view of this direct evidence concerning the electrical state of the troposphere and lower stratosphere it seems quite inadmissible to attribute radio echoes from these regions to continuous ionization over long periods of 5×10^{12} ions per cubic centimeter. One purpose of this paper is to review that direct evidence.

In sections II and III typical observations made in the Andes mountains of Peru at a height of 3.3 kilometers above sea level are described. Sections II

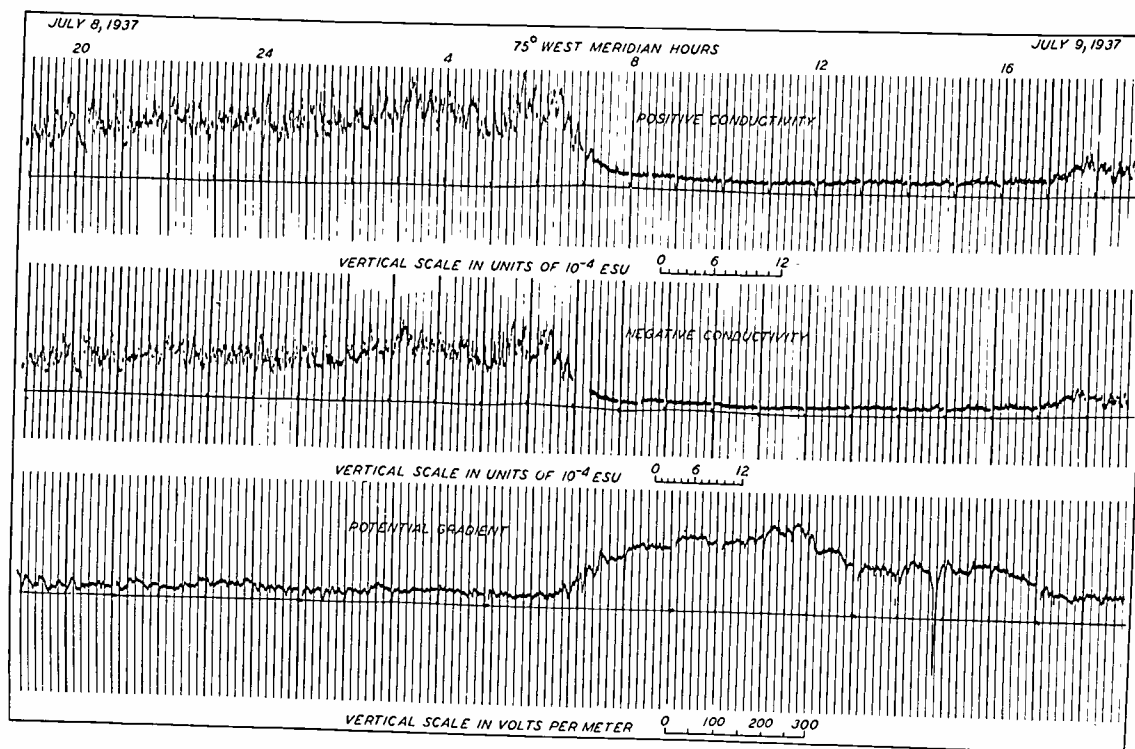

Fig. 1—Electrograms, Huancayo Magnetic Observatory, "quiet" day during dry season.

summer and in winter." They find some evidence that there is no seasonal variation of large amplitude and that "a gradual increase of ionization at tropospheric levels from sunrise to a maximum some hours after noon, with a decrease toward sunset, after which a steady night-time minimum, notably below afternoon value, but frequently still of substantial amount, is suggested." They describe observations made at times of several thunderstorms as being "almost conclusive in establishing a connection between local thunderstorms and the replenishment of stratified electrification at the 15 to 20 km level, or, less probably, at half these heights."

There has been accumulating for many years a large amount of direct evidence concerning the electrical state of the troposphere. A certain amount of direct evidence is also available concerning the electrical state of the lower stratosphere. These direct measurements prove that the electrical conductivity at heights of the order of 10 kilometers is something like nine orders of magnitude less than

and III refer to nonthunder and thundery days, respectively. In section IV the evidence accruing from observations made during balloon flights throughout the troposphere and—on the occasion of the flight of *Explorer II*—well into the stratosphere, is reviewed. In section V the enormous rate of supply of energy required to maintain the low-level electrification postulated by Watson Watt and coworkers is compared with the rate of supply of energy from the sun and from thunderstorms.

II. MOUNTAIN OBSERVATIONS—NO LOCAL THUNDER

Direct evidence concerning the electrical state of the lower atmosphere consists chiefly of measurements of ion density or of electrical conductivity that have been made in the course of investigations of atmospheric electricity throughout most of the troposphere on a number of occasions. On one occasion (the flight of the stratosphere balloon *Explorer II*) conductivity was registered throughout a flight

which reached an altitude of 22 kilometers, and which therefore extended more than 10 kilometers into the stratosphere. The more numerous measurements of the electric field strength in the troposphere should also bear, though less directly, on this matter. Registrations of cosmic radiation made in recent years with sounding balloons that reach well into the stratosphere, a few exceeding the altitude reached by *Explorer II*, should show abundant evidence of any radiation, either corpuscular or photonic, which can reach the levels of the reported intense low-level ionization, and at the same time maintain the enor-

storms and seem to be the result of silent discharge that sets in when the field intensity is great and other conditions suitable.

A few illustrations which typify the more direct types of evidence may be of interest. At the Huancayo Magnetic Observatory of the Department of Terrestrial Magnetism of the Carnegie Institution of Washington continuous registration is made (a) of the magnetic components, (b) of electric currents in the earth, (c) of reflections from the ionosphere, (d) of cosmic radiation, (e) of the electric field strength in the atmosphere, and (f) of the electrical conductivity

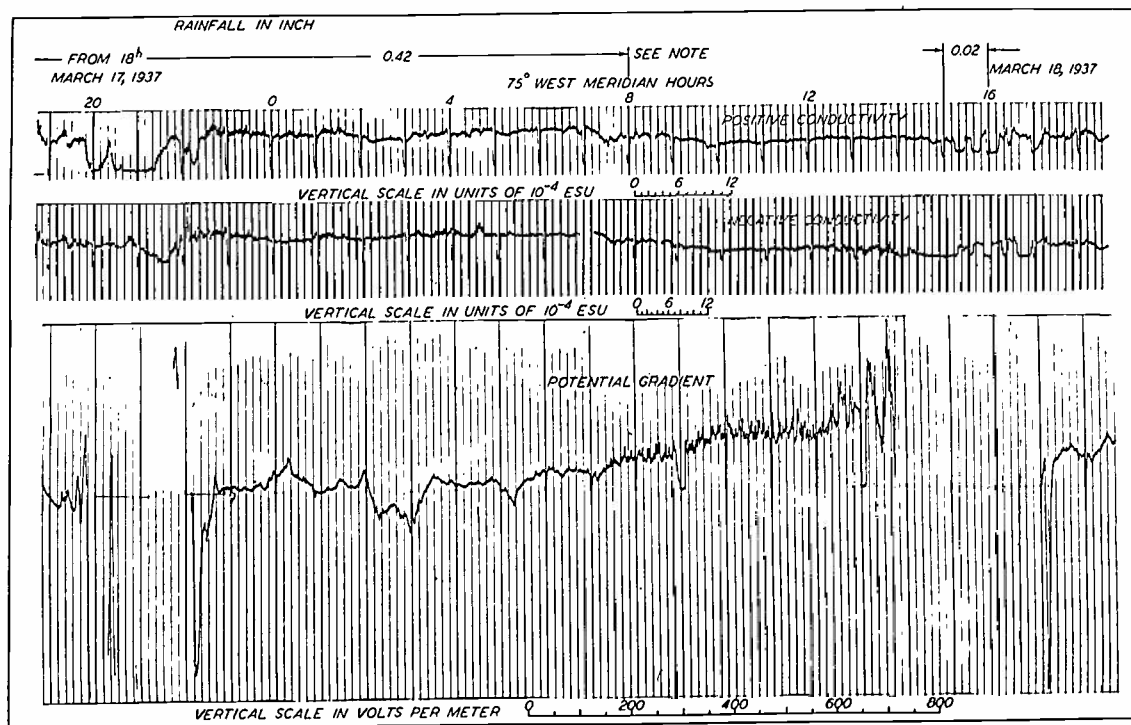

Fig. 2—Electrograms, Huancayo Magnetic Observatory, rainy day (Note: Clearing in morning after 10:05; early afternoon, March 18, increasing cloudiness, distant rain, and thunder to southwest at 14:00).

mous density of ion population required for the reflection in the troposphere or lower stratosphere of radio waves at nearly vertical incidence. Furthermore, measurements of the electric field and other elements of atmospheric electricity made at the surface of the earth, especially in mountains or on elevated plateaus, may also be expected to show evidence of strata of abnormal ion density if such occur at levels as low as three or four kilometers above sea level, because it is not likely that such ionized strata would be everywhere parallel to the earth's surface, but would meet it at places having appropriate altitude. At such places there should be essentially no steady electric field.

A brief review of these several classes of evidence gives no basis for expecting that the density of the ion population in the troposphere ever exceeds a few thousand ion pairs per cubic centimeter, except in the immediate vicinity of storms. These exceptions are comparatively rare at a given place even during

of the air. The situation of this observatory in the Andes mountains of Peru, 12 degrees south of the equator at an altitude of 11,000 feet (3.3 kilometers), is of particular interest in the present consideration because of the high elevation and also because of the frequency at which thunderstorms occur there. On account of the latter circumstance measures of the state of ionization provided by the registrations of air conductivity and of the intensity of cosmic radiation should assist in testing the validity of the suggestion⁹ that it is the "runaway" electrons from thunderstorms which produce the supposed ionized layers in the lower stratosphere and troposphere. The grams for field strength or potential gradient and for air conductivity at Huancayo for two complete days are reproduced in Figs. 1 and 2. Those in Fig. 1 are representative of a day in the dry season that is free from storm. The first part of Fig. 2 is typical of conditions during general rain; the latter part illustrates the effect of a moderately intense local thunder-

storm. There are two grams for conductivity in each figure, one representing the part contributed by positive ions, designated "positive conductivity," the other the part due to negative ions, designated "negative conductivity." The ordinates on these grams, measured from a line through the "hourly zeros," are proportional to the conductivity which may be evaluated in electrostatic units by means of the horizontal scale inserted below each gram. In terms of ions, one division on the scale is equivalent to 338 ions per cubic centimeter in the case of positive conductivity and 264 ions per cubic centimeter in the case of negative conductivity. The abscissas on all the grams correspond to time in hours counted from midnight. The ordinates on the gram for potential gradient, also measured from the time of "hourly zeros," may be evaluated in volts per meter by using the scale inserted at the bottom. The value of gradient is designated positive when the trace is above the line of zeros and negative when below. During fair weather the gradient is generally positive. With rare exceptions, negative values are registered only during storm. When the gradient is positive, according to this convention, positively charged ions move toward the earth, negative ions move away from it, and the surface charge of the earth is negative.

The meteorological notes for the period from the evening of July 8 to the evening of July 9, 1937, (Fig. 1) show that this was a day without storm, almost without cloud, although "hazy and smoky" at least during daylight hours. The gradient was positive throughout the day except for a few minutes following 14:50 (Greenwich Civil Time) on July 9. This negative gradient was doubtless produced by a "whirlwind" in the vicinity of the observatory. During the daylight hours the gradient was large and the conductivity was small, whereas during the night the relation was reversed. The gradient during the night hours averaged 21 volts per meter, or about one fifth the average for daytime. The average conductivity at night was about four times that for the daylight period, or in terms of ions, the average number of positive small ions per cubic centimeter during the night was 2220 and during daytime 560. The maximum was 3790 ions per cubic centimeter at 5:38 on the early morning of July 9.

Despite the contrast in conductivity between daytime and night, the electric-current density, directed from air to earth, was nearly constant during the 24 hours, averaging 3.1×10^{-16} ampere per square centimeter for night and 3.6×10^{-16} ampere per square centimeter for daytime. This current is of about the same magnitude as the average of the numerous ob-

servations made at sea level during the cruises of the yacht *Carnegie*, whereas a value several times as great would be expected at a station that is over three kilometers above sea level unless the conductivity, and hence the corresponding ionic density, at that place *decrease from the surface upwards* for some distance. The extent of this decrease of conductivity with altitude must be sufficient to make the effective resistance of a column of air, from the surface up to the ionosphere or other highly conducting region of world-wide extent, the same as a corresponding column over a sea-level station. These data therefore strongly indicate that on a typical day, during the dry season at Huancayo (like that represented in Fig. 1), the maximum ionic density at the surface (3.3 kilometers above sea level) is about that which could be maintained by the cosmic radiation and the radiations from radioactive matter which escape from the earth into the atmosphere, and that the ionic density above the surface does not increase in the first kilometer or so.

The small ions for which values of density have been given are doubtless aggregates of a comparatively few air molecules. Other ions (large ions) can be formed from polluting substances in the air, for example, smoke. They have a mass more than a million times that of an air molecule, and therefore, cannot appreciably affect the conductivity or the dielectric constant of air. That such large ions are present at Huancayo in greater quantity than the small ions is indicated by indirect observations. Although these make no direct contribution of importance to the conductivity, yet, since they are formed at the expense of small ions, the number of the latter is thereby diminished, possibly in the extreme case, to one fourth¹¹ the value that would be found in the air had it been free from the polluting substances. Although there are indications that the cases of extreme diminution of small ions; through the formation of large ions, are more likely to occur during daytime than at night, yet if it is assumed that in case the air were not polluted the ionic density at night would be greater by a factor of four, then the average density of positive ions derived from the record for the night hours, July 8 to 9, would be 8880 ions per cubic centimeter and the maximum for that night would be 15,400 ions per cubic centimeter. These values would of course be greater than values found at the same altitude over a sea-level station because some ions are certainly produced in the first kilometer or two from the surface by radio-

¹¹ Based on results of an investigation by O. W. Torreson of the relation between nuclei of condensation, air conductivity, etc., at the Huancayo Magnetic Observatory, to be published in a future number of the *Jour. Terr. Mag. and Atmos. Elec.*

active matter in the air, which would, however, be negligible at 3.3 kilometers from the surface.

The greatest ionic density which could possibly be allowed according to this liberal estimate is of the order of 15,000 ions per cubic centimeter for the records here exhibited. None of the other records, which are at hand for nearly every day of the last 13 years, show maximum values that exceed this by more than 10 or 20 per cent. The comparatively few exceptions occur occasionally during storms. This may then be regarded as very close to the maximum allowable ionic density at an altitude of 3.3 kilometers above sea level on days free from storm. Such ionic densities are obviously entirely inadequate to modify the dielectric constant to an extent sufficient to effect the reflection of radio waves at vertical incidence.

III. MOUNTAIN OBSERVATIONS— THUNDERSTORM CONDITIONS

The state of ionization at times of storm may be illustrated by the records for March 17 to 18, 1937, reproduced in Fig. 2. This day was near the end of the wet season which lasts about seven months with light rain nearly every day. There was light rain throughout the night (19:00 March 17 to 8:00 March 18) followed by gradual clearing until shortly after noon of March 18 when the conditions characteristic of the regular afternoon thunderstorm began to develop. At 14:00 the sky was 0.7 clouded with 0.4 cumulo-nimbus and with rain and thunder in the distance. At 15:00 light rain accompanied by thunder began at the observatory lasting about one hour. As is seen from the trace, the potential gradient was considerably disturbed from at least two hours before the afternoon rain began until about one and a half hours after it ended. During this time and during the light rain of the night before the gradient fluctuated between negative and positive values. The gradient was sometimes so great that the spot of light passed off the photographic paper, and sometimes it varied so rapidly that the spot of light left a trace too faint to be followed, especially in the reproduction. The records of conductivity for this day do not show the conspicuous difference between night and day that was noted in Fig. 1, the average nighttime values being somewhat less and those for daytime being appreciably greater than those for the typical day of the dry season. The very small values of either positive or negative conductivity which are registered at intervals during a storm are not considered in this general comparison. They shall be briefly discussed in a following paragraph.

It will be seen at a glance that there is no over-all

increase in the conductivity, and hence of the ionic density, during the time of this storm. This is typical of the records for stormy days at this station. It may be added that this conclusion is borne out by an inspection of records similar to these that have been obtained at the Carnegie Institution's Watheroo Magnetic Observatory, near Watheroo, Western Australia, since 1922, and at the United States Coast and Geodetic Survey's Tucson Observatory, co-operating with the Carnegie Institution of Washington, since 1929. The latter station, located near Tucson, Arizona, at an altitude of 770 meters, lies in a region where intense thunderstorms are frequent, a circumstance which attaches special value to the evidence provided by the records obtained there.

The records of air conductivity at the earth's surface therefore give no support for the view that "runaway" electrons from thunderstorms are a potent ionizing agent in the atmosphere. This is also borne out by the fact that in the registrations of cosmic radiation at Huancayo there is no conspicuous increase in the rate of ionization that is definitely associated with these storms. Such effects as may occur according to the conception of C. T. R. Wilson,^{12,13,14} if as small as indicated by the observations of Schonland and Viljoen,¹⁵ do not concern us here. It seems now to be Wilson's view that fields capable of accelerating electrons to the "runaway stage" can exist only at the tip of a linear discharge about the lower part of a cloud. Since the paths of such discharges are not straight vertical lines but have a zigzag character, some of the electrons would doubtless be sprayed out laterally, and should approach the earth not too far from the storm to be noted at these places. Only a very small fraction of the number required to maintain reflecting layers in the lower stratosphere or troposphere, if approaching close to the surface, would become conspicuous in the registrations of air conductivity. Such effects are not observed, unless certain sudden increases of ionic density that occur rarely and last for brief intervals only are to be ascribed to that source.

Such an event is shown on the record for negative conductivity (Fig. 2) shortly after 22:00, March 17. The trace passed off the sheet but returned again almost instantaneously. The positive conductivity was slightly decreased at the same time. The gradi-

¹² C. T. R. Wilson, "The acceleration of β -particles in strong electric fields such as those of thunderclouds," *Proc. Camb. Phil. Soc.*, vol. 22, pp. 534-538; March 15, (1925).

¹³ C. T. R. Wilson, "Some thundercloud problems," *Jour. Frank. Inst.*, vol. 208, pp. 1-12; July, (1929).

¹⁴ C. T. R. Wilson, "Meeting for discussion of the ionosphere," *Proc. Roy Soc.*, ser. A, vol. 141, pp. 697-722; September 1, (1933).

¹⁵ B. F. J. Schonland and J. P. T. Viljoen, "On penetrating radiation from thunderclouds," *Proc. Roy Soc.*, ser. A, vol. 140, pp. 314-333; May 3, (1933).

storm. There are two grams for conductivity in each figure, one representing the part contributed by positive ions, designated "positive conductivity," the other the part due to negative ions, designated "negative conductivity." The ordinates on these grams, measured from a line through the "hourly zeros," are proportional to the conductivity which may be evaluated in electrostatic units by means of the horizontal scale inserted below each gram. In terms of ions, one division on the scale is equivalent to 338 ions per cubic centimeter in the case of positive conductivity and 264 ions per cubic centimeter in the case of negative conductivity. The abscissas on all the grams correspond to time in hours counted from midnight. The ordinates on the gram for potential gradient, also measured from the time of "hourly zeros," may be evaluated in volts per meter by using the scale inserted at the bottom. The value of gradient is designated positive when the trace is above the line of zeros and negative when below. During fair weather the gradient is generally positive. With rare exceptions, negative values are registered only during storm. When the gradient is positive, according to this convention, positively charged ions move toward the earth, negative ions move away from it, and the surface charge of the earth is negative.

The meteorological notes for the period from the evening of July 8 to the evening of July 9, 1937, (Fig. 1) show that this was a day without storm, almost without cloud, although "hazy and smoky" at least during daylight hours. The gradient was positive throughout the day except for a few minutes following 14:50 (Greenwich Civil Time) on July 9. This negative gradient was doubtless produced by a "whirlwind" in the vicinity of the observatory. During the daylight hours the gradient was large and the conductivity was small, whereas during the night the relation was reversed. The gradient during the night hours averaged 21 volts per meter, or about one fifth the average for daytime. The average conductivity at night was about four times that for the daylight period, or in terms of ions, the average number of positive small ions per cubic centimeter during the night was 2220 and during daytime 560. The maximum was 3790 ions per cubic centimeter at 5:38 on the early morning of July 9.

Despite the contrast in conductivity between daytime and night, the electric-current density, directed from air to earth, was nearly constant during the 24 hours, averaging 3.1×10^{-16} ampere per square centimeter for night and 3.6×10^{-16} ampere per square centimeter for daytime. This current is of about the same magnitude as the average of the numerous ob-

servations made at sea level during the cruises of the yacht *Carnegie*, whereas a value several times as great would be expected at a station that is over three kilometers above sea level unless the conductivity, and hence the corresponding ionic density, at that place *decrease from the surface upwards* for some distance. The extent of this decrease of conductivity with altitude must be sufficient to make the effective resistance of a column of air, from the surface up to the ionosphere or other highly conducting region of world-wide extent, the same as a corresponding column over a sea-level station. These data therefore strongly indicate that on a typical day, during the dry season at Huancayo (like that represented in Fig. 1), the maximum ionic density at the surface (3.3 kilometers above sea level) is about that which could be maintained by the cosmic radiation and the radiations from radioactive matter which escape from the earth into the atmosphere, and that the ionic density above the surface does not increase in the first kilometer or so.

The small ions for which values of density have been given are doubtless aggregates of a comparatively few air molecules. Other ions (large ions) can be formed from polluting substances in the air, for example, smoke. They have a mass more than a million times that of an air molecule, and therefore, cannot appreciably affect the conductivity or the dielectric constant of air. That such large ions are present at Huancayo in greater quantity than the small ions is indicated by indirect observations. Although these make no direct contribution of importance to the conductivity, yet, since they are formed at the expense of small ions, the number of the latter is thereby diminished, possibly in the extreme case, to one fourth¹¹ the value that would be found in the air had it been free from the polluting substances. Although there are indications that the cases of extreme diminution of small ions; through the formation of large ions, are more likely to occur during daytime than at night, yet if it is assumed that in case the air were not polluted the ionic density at night would be greater by a factor of four, then the average density of positive ions derived from the record for the night hours, July 8 to 9, would be 8880 ions per cubic centimeter and the maximum for that night would be 15,400 ions per cubic centimeter. These values would of course be greater than values found at the same altitude over a sea-level station because some ions are certainly produced in the first kilometer or two from the surface by radio-

¹¹ Based on results of an investigation by O. W. Torreson of the relation between nuclei of condensation, air conductivity, etc., at the Huancayo Magnetic Observatory, to be published in a future number of the *Jour. Terr. Mag. and Atmos. Elec.*

active matter in the air, which would, however, be negligible at 3.3 kilometers from the surface.

The greatest ionic density which could possibly be allowed according to this liberal estimate is of the order of 15,000 ions per cubic centimeter for the records here exhibited. None of the other records, which are at hand for nearly every day of the last 13 years, show maximum values that exceed this by more than 10 or 20 per cent. The comparatively few exceptions occur occasionally during storms. This may then be regarded as very close to the maximum allowable ionic density at an altitude of 3.3 kilometers above sea level on days free from storm. Such ionic densities are obviously entirely inadequate to modify the dielectric constant to an extent sufficient to effect the reflection of radio waves at vertical incidence.

III. MOUNTAIN OBSERVATIONS— THUNDERSTORM CONDITIONS

The state of ionization at times of storm may be illustrated by the records for March 17 to 18, 1937, reproduced in Fig. 2. This day was near the end of the wet season which lasts about seven months with light rain nearly every day. There was light rain throughout the night (19:00 March 17 to 8:00 March 18) followed by gradual clearing until shortly after noon of March 18 when the conditions characteristic of the regular afternoon thunderstorm began to develop. At 14:00 the sky was 0.7 clouded with 0.4 cumulo-nimbus and with rain and thunder in the distance. At 15:00 light rain accompanied by thunder began at the observatory lasting about one hour. As is seen from the trace, the potential gradient was considerably disturbed from at least two hours before the afternoon rain began until about one and a half hours after it ended. During this time and during the light rain of the night before the gradient fluctuated between negative and positive values. The gradient was sometimes so great that the spot of light passed off the photographic paper, and sometimes it varied so rapidly that the spot of light left a trace too faint to be followed, especially in the reproduction. The records of conductivity for this day do not show the conspicuous difference between night and day that was noted in Fig. 1, the average nighttime values being somewhat less and those for daytime being appreciably greater than those for the typical day of the dry season. The very small values of either positive or negative conductivity which are registered at intervals during a storm are not considered in this general comparison. They shall be briefly discussed in a following paragraph.

It will be seen at a glance that there is no over-all

increase in the conductivity, and hence of the ionic density, during the time of this storm. This is typical of the records for stormy days at this station. It may be added that this conclusion is borne out by an inspection of records similar to these that have been obtained at the Carnegie Institution's Watheroo Magnetic Observatory, near Watheroo, Western Australia, since 1922, and at the United States Coast and Geodetic Survey's Tucson Observatory, cooperating with the Carnegie Institution of Washington, since 1929. The latter station, located near Tucson, Arizona, at an altitude of 770 meters, lies in a region where intense thunderstorms are frequent, a circumstance which attaches special value to the evidence provided by the records obtained there.

The records of air conductivity at the earth's surface therefore give no support for the view that "runaway" electrons from thunderstorms are a potent ionizing agent in the atmosphere. This is also borne out by the fact that in the registrations of cosmic radiation at Huancayo there is no conspicuous increase in the rate of ionization that is definitely associated with these storms. Such effects as may occur according to the conception of C. T. R. Wilson,^{12,13,14} if as small as indicated by the observations of Schonland and Viljoen,¹⁵ do not concern us here. It seems now to be Wilson's view that fields capable of accelerating electrons to the "runaway stage" can exist only at the tip of a linear discharge about the lower part of a cloud. Since the paths of such discharges are not straight vertical lines but have a zigzag character, some of the electrons would doubtless be sprayed out laterally, and should approach the earth not too far from the storm to be noted at these places. Only a very small fraction of the number required to maintain reflecting layers in the lower stratosphere or troposphere, if approaching close to the surface, would become conspicuous in the registrations of air conductivity. Such effects are not observed, unless certain sudden increases of ionic density that occur rarely and last for brief intervals only are to be ascribed to that source.

Such an event is shown on the record for negative conductivity (Fig. 2) shortly after 22:00, March 17. The trace passed off the sheet but returned again almost instantaneously. The positive conductivity was slightly decreased at the same time. The gradi-

¹² C. T. R. Wilson, "The acceleration of β -particles in strong electric fields such as those of thunderclouds," *Proc. Camb. Phil. Soc.*, vol. 22, pp. 534-538; March 15, (1925).

¹³ C. T. R. Wilson, "Some thundercloud problems," *Jour. Frank. Inst.*, vol. 208, pp. 1-12; July, (1929).

¹⁴ C. T. R. Wilson, "Meeting for discussion of the ionosphere," *Proc. Roy Soc.*, ser. A, vol. 141, pp. 697-722; September 1, (1933).

¹⁵ B. F. J. Schonland and J. P. T. Viljoen, "On penetrating radiation from thunderclouds," *Proc. Roy Soc.*, ser. A, vol. 140, pp. 314-333; May 3, (1933).

ent, although it is not clearly shown, was large and doubtless of negative sign during this interval. One may ascribe aspects like this, in conductivity, to ionization by collision. Sometimes the records of both positive and negative conductivity show such anomalous increases simultaneously. In the case shown here, however, it is thought that the positive ions were driven from the earth by the intense negative field at such a rate that a large density of positive ions could not be maintained.

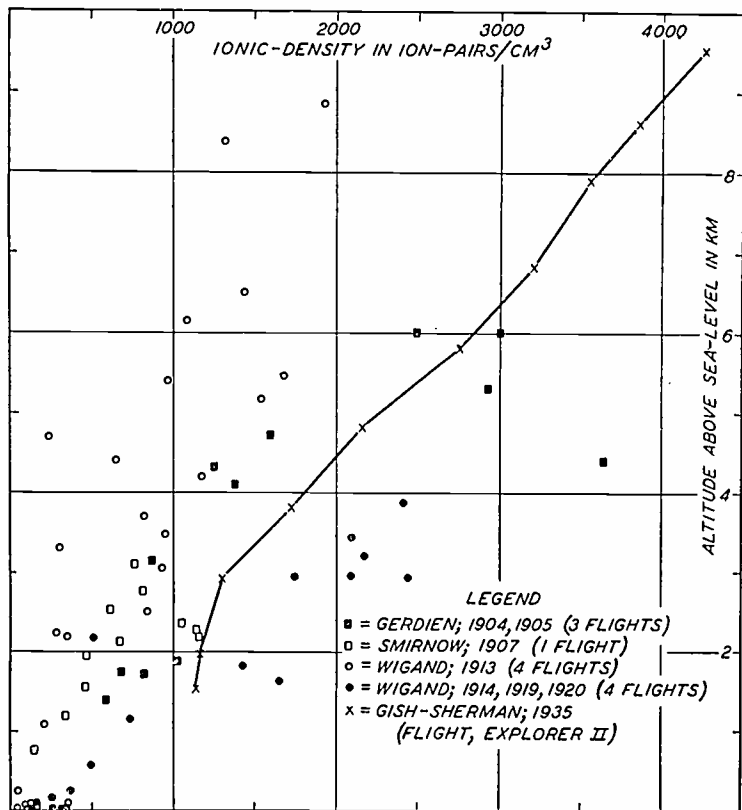

Fig. 3—Ionic density in the troposphere from measurements of air conductivity in 13 balloon flights.

That the field when sufficiently intense removes nearly all the ions of sign opposite to that of the field is abundantly illustrated in Fig. 2. Thus from 20:30 until after 21:20 the positive conductivity was nearly zero. Before the afternoon thunderstorm, from 14:20 until after 15:10, the negative conductivity was nearly zero and thereafter, during the storm, the positive and negative conductivity alternate in that rôle. Bearing this "electrode effect" in mind, one may regard the unusually large value of negative conductivity indicated a few minutes after 22:00 as quite likely due to ionization by collision. Although the possibility of ionization by some other energetic agency on such occasions is not definitely excluded by the evidence now at hand, yet visible evidence of ionization by collision is provided by the luminous phenomenon known as St. Elmo's fire which is repeatedly seen during electrical storms.

IV. OBSERVATIONS IN TROPOSPHERE AND STRATOSPHERE

Measurements of the ionic density in the troposphere made with instruments carried aloft in manned balloons constitute a considerable body of evidence. The results of 15 such flights,^{16,17,18,19,20,21} on which air conductivity was measured with a Gerdien type of apparatus, are shown in Fig. 3 with the altitude as the ordinate and the ionic density, derived from the measure of conductivity, as the abscissa. All observations prior to the flight of the stratosphere balloon *Explorer II* were made manually. The points corresponding to those data generally represent the mean of several successive observations made within a limited range of altitude so that the scatter of the points has thereby been somewhat reduced. The conductivity was registered continuously during the flight of *Explorer II*. The average value of conductivity over approximately uniform altitude intervals was evaluated from the gram. The intervals were 500 feet in the troposphere and parts of the stratosphere, although generally 1000 feet in case of the latter. The points which represent the data in Fig. 3 were derived from data taken from a slightly smoothed graph for conductivity. A more detailed representation of the *Explorer II* data would show much less scatter than is shown by other observations. In no case does the original gram indicate an ionic density differing in order of magnitude from the values shown in Fig. 3.

Balloon flights are of course not usually made in bad weather. Very special conditions, especially low-velocity surface winds and a clear sky, were selected for the flight of *Explorer II*. Some of the flights with smaller balloons were, however, made during periods of disturbed weather. All of Gerdien's three flights were made when the sky was heavily clouded, rain at times falling from clouds below the balloon and with thunderheads in sight. Two of Wigand's eight flights occurred during "cyclonal"

¹⁶ H. Gerdien, "Luftelektrische Messungen bei 2 Ballonfahrten," *Göttingen, Nach. Ges. Wiss.*, Heft 4, pp. 277-299; (1904).

¹⁷ H. Gerdien, "Messungen der Dichte des Vertikalen elektrischen Leitungsstromes in der freien Atmosphäre bei der Ballonfahrt vom 30. VIII. 1905," *Göttingen, Nach. Ges. Wiss.*, Heft 5, pp. 1-12; (1905).

¹⁸ H. Gish and K. L. Sherman, "Electrical conductivity of air to an altitude of 22 kilometers," *Nat. Geog. Soc., Contr. Tech. Papers, Stratosphere Ser.*, no. 2, pp. 94-116; (1936).

¹⁹ D. A. Smirnow, "Vertical electric currents in the atmosphere during balloon flight of July 26, 1907," (Russian), *Bull. Acad. Sci. (St. Petersburg)*, pp. 759-774; (1908).

²⁰ A. Wigand, "Die elektrische Leitfähigkeit in der freien Atmosphäre, nach Messungen bei Hochfahrten im Freiballon," *Ann. der Phys.*, vol. 66, pp. 81-109; November 22, (1921).

²¹ A. Wigand, "Messungen der Ionisation und Ionenbeweglichkeit bei Luftfahrten," *Phys. Zeit.*, vol. 22, pp. 36-46; January 15, (1921).

weather, the others in "anticyclonal" weather. The values of ionic density show no conspicuous association with the state of weather, nor is there a trace of evidence of ionic densities far in excess of 4000 ions per cubic centimeter.

The results from the flight of the *Explorer II* up to nearly 22 kilometers are shown in Fig. 4, where altitude is plotted as the ordinate and ionic density as the abscissa. The ionic density rises from a value of 500 ions per cubic centimeter near the surface to a maximum of 5300 ions per cubic centimeter at an altitude of about 14.8 kilometers, and thereafter diminishes to about 2000 ions per cubic centimeter at the highest altitude reached. The values shown here were derived from a smoothed graph for air conductivity, but the departure of no individual value was great enough to have significance for the present consideration. Obviously nowhere from the surface up to 22 kilometers above sea level did layers of intense ionization come into evidence during the period from 7 A.M. to 3 P.M. on November 11, 1935, while the *Explorer II* was sounding the atmosphere over South Dakota. It has been suggested by Colwell, Friend, Hall, and Hill⁴ that the weakening of radio signals received from the *Explorer II* when she was at altitudes greater than 18 kilometers was a result of reflection outward from a region the top of which was somewhere below the level of the balloon. The observations of electrical conductivity during the flight definitely exclude the possibility of ionic reflection in this case.

From a single direct electrical exploration of the stratosphere one can of course not conclude that highly ionized layers never exist in the region that was explored. A generalization to that effect, however, seems much safer in case of the troposphere, and especially as pertains to the lower levels for which the observational evidence is much more extensive, both in time and in space. There is, however, considerable circumstantial evidence which indicates negation.

V. ENERGY REQUIRED TO MAINTAIN INTENSE LOW-LEVEL IONIZATION

Perhaps the strongest argument for the nonexistence of the ionization postulated by Watson Watt and coworkers at heights of the order of 10 kilometers is based upon estimates of the amount of energy required to maintain ionic densities over a sufficient area and to the depth necessary for a reflection layer of the type which they envisage.

The energy (V_i) expended for each molecular ion formed in air is about 35 electron volts. The rate (q) at which ions must be formed in order to maintain

a given ionic density (n) may be calculated from the condition that the rate of formation must balance the rate of decay, or recombination. When small ions only are involved and positive and negative ions are equally abundant, $q = \alpha n^2$, where α , the coefficient of recombination, depends upon temperature and

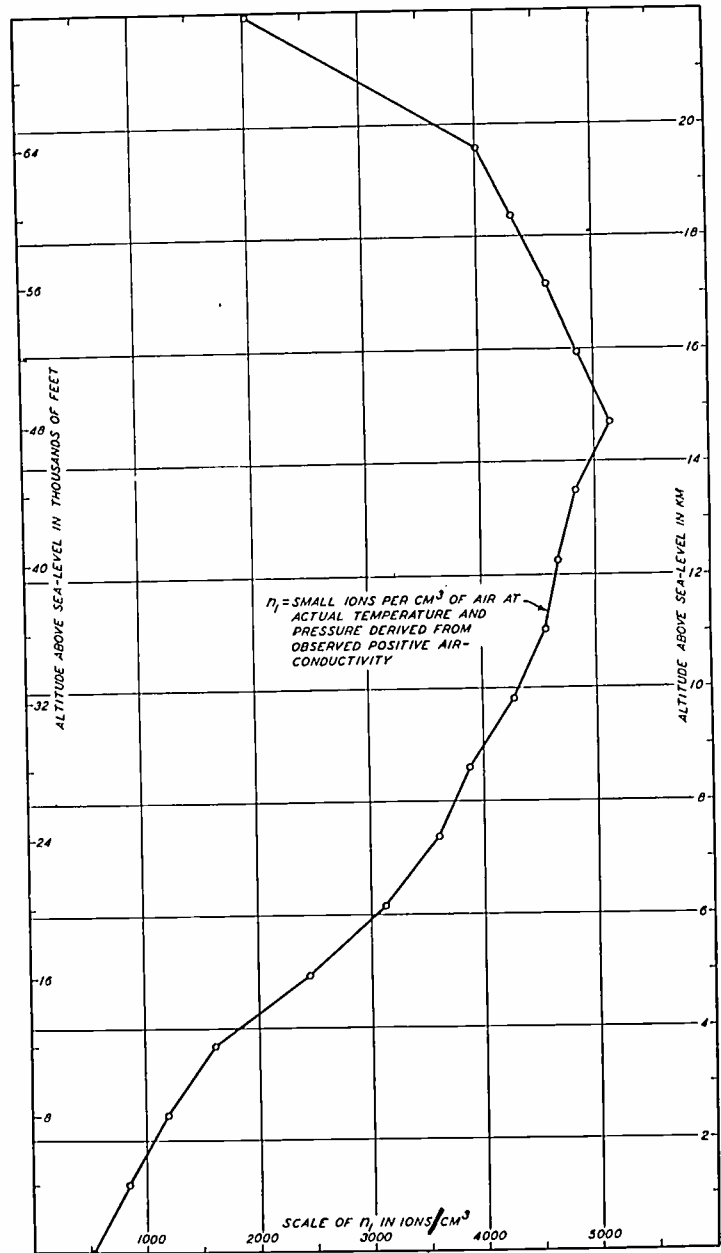

Fig. 4—Ionic density in troposphere and stratosphere to 22 kilometers during flight of *Explorer II* over South Dakota, November 11, 1935 (derived from measurements of air conductivity).

pressure. J. J. Thomson's theory of recombination is usually taken to indicate that below a pressure of one atmosphere the value of α at pressure p and absolute temperature T is given by the relation

$$\alpha = \alpha_0(p/p_0)(T_0/T)^3$$

where α_0 corresponds to a pressure p_0 and temperature T_0 . There is evidence that the exponent of the pressure term should be less than unity,²² but the

²² See footnote reference 18. Other evidence is given in a paper published by these authors "Latitude effect in electrical resistance of column of atmosphere," in *Trans. Amer. Geophys. Union*, 19th Annual Meeting, pp. 193-199; August, (1938).

relation used here yields a conservative estimate. At $p_0=760$ millimeters, $T_0=273$ degrees Kelvin, $\alpha_0 \doteq 1.6 \times 10^{-6}$. For the stratosphere over middle latitudes in summer, $T=220$ degrees Kelvin. It follows that the power P required to maintain an ionic density n is $V_i q$, in electron volts per cubic centimeter per second, or $P=1.59 V_i q \times 10^{-12}$ ergs per cubic centimeter per second, or more explicitly

$$P = 1.59 V_i \alpha_0 (T_0/T)^3 (p/p_0) n^2 \times 10^{-19} \text{ watts per cubic centimeter.}$$

Near the base of the stratosphere, namely, at 11 kilometers, $p/p_0 \doteq 0.20$. After introducing this and other numerical values

$$P = 3.4 n^2 \times 10^{-24} \text{ watts per cubic centimeter.}$$

For an ionic density, $n=5 \times 10^{12}$ ions per cubic centimeter, indicated by Watson Watt, Wilkins, and Bowen, $P=84$ watts per cubic centimeter. This is, however, an exaggeration because the rôle played by free electrons was not taken into account. Since the number of free electrons that are in equilibrium with ions are a greater proportion when the ionization is intense, their rôle cannot be neglected even at the low levels which are considered in this discussion. A more precise consideration follows:

If electrons are set free and positive ions formed at a rate q per cubic centimeter per second; if electrons (N per cubic centimeter) attach to neutral molecules (M per cubic centimeter) at a rate $a_0 MN$ per cubic centimeter per second and recombine with positive ions (n_1 per cubic centimeter) at a rate $a_1 n_1 N$ per cubic centimeter per second, while the positive ions also disappear by combining with negative ions (n_2 per cubic centimeter)—the negative ions being formed only by the attachment of electrons to neutral molecules—then when the electronic and ionic densities are steady, namely, when $dN/dt = dn_1/dt = dn_2/dt = 0$, the relations between them are

$$\text{for electrons: } q = a_0 MN + a_1 n_1 N + b \quad (1)$$

$$\text{for positive ions: } q = \alpha n_1 n_2 + a_1 n_1 N + c \quad (2)$$

$$\text{for negative ions: } a_0 MN = \alpha n_1 n_2 + d \quad (3)$$

where b , c , and d are terms which represent the rate of removal or migration of electrons or ions from a unit volume. From such information as is available about a_1 , the coefficient of recombination of electrons and positive ions, it seems that the term in which it appears may be neglected here because in the most unfavorable case^{23,24,25} ($a_1=10^{-8}$ and $a_0=10^{-14}$)

²³ E. V. Appleton, "Regularities and irregularities in the ionosphere," *Proc. Roy. Soc.*, ser. A, vol. 162, pp. 451-479; October 15, (1937), estimates from the observed decay of electronic density in the ionosphere that $a_1=10^{-8}$ in daytime and approximately

that term would amount to less than one per cent in the lower stratosphere when n_1 is 10^{11} ions per cubic centimeter. No satisfactory estimates of the terms b , c , and d can be made although these are doubtless too large to neglect. They are likely positive, that is, represent loss and not gain of ions and electrons from the region; hence the value of q which is estimated is too small when, as is done here, these factors are neglected.

With these approximations, (1) and (2) give

$$N = (q/a_0 M) \quad (4)$$

$$n_1 n_2 = (q/\alpha). \quad (5)$$

For the conditions which are being considered $n_1 + n_2 \doteq 2\sqrt{n_1 n_2}$. Then from (5)

$$n_1 + n_2 = 2\sqrt{(q/\alpha)}. \quad (6)$$

From the approximate condition for reflection at vertical incidence

$$n_1 + n_2 + (m_i/m_e)N = (m_i/4\pi e^2)\omega^2 = D \quad (7)$$

where m_e is the mass of an electron, m_i is the mass of an ion, $\omega = 2\pi f$ for the frequency f , and D is equivalent ionic density. Then from (4), (6), and (7)

$$\sqrt{(q/\alpha)} = B[\sqrt{(D/B)} + 1] \quad (8)$$

where $B = (m_e/m_i)(a_0 M/\alpha)$. For $D \geq 10^9$ ions per cubic centimeter, $D/B \gg 1$, (8) may be written

$$q \doteq a_0(m_e/m_i)MD. \quad (9)$$

The power required to maintain this state of ionization is

$$P = 1.59 V_i a_0(m_e/m_i)MD \times 10^{-19} \text{ watts per cubic centimeter} \quad (10)$$

$$= 6.9 a_0 M f^2 \times 10^{-26} \text{ watts per cubic centimeter.} \quad (11)$$

The value of a_0 was derived from Bradbury's²⁶ determinations of the probability of attachment (h) of an electron to a neutral molecule in air. Bradbury found that h is independent of pressure but is somewhat dependent on electron energy. The values decrease from 33×10^{-6} at 0.1 volt, the lowest electron energy used, to about 1×10^{-6} in the range 1.2 to

equal to 2×10^{-9} at night.

²⁴ C. Kenty, "The recombination of argon ions and electrons," *Phys. Rev.*, vol. 32, pp. 624-635; October, (1928), finds for 0.4-volt electrons and positive ions in argon, $a_1 = 2 \times 10^{-10}$, which he says may be in error by a factor of 5.

²⁵ N. E. Bradbury, "Ionization, negative-ion formation, and recombination in the ionosphere," *Terr. Mag.*, vol. 43, pp. 55-66; March, (1938), estimates that for electrons in thermal equilibrium at 200 degrees Kelvin in oxygen, $a_1 = 4 \times 10^{-10}$. The values of a_0 are discussed later.

²⁶ Bradbury, "Electron attachment and negative ion formation in oxygen and oxygen mixtures," *Phys. Rev.*, vol. 44, pp. 883-890; December 1, (1933).

1.6 volts, then increase to 5×10^{-9} at 2 volts electron energy after which a slight decrease is shown toward the upper end of the energy range, which in the measurements extended to about 2.1 volts. This decreasing trend at the end, together with other considerations, indicates that for higher electron energies h is less than at two volts. The average number of collisions of an electron with molecules that occur before attachment takes place is $1/h$ and if ν is the collisional frequency of electrons with molecules in air then the time between collisions is $1/\nu$, and the average time required for an electron to become attached, or the average life, is $1/h\nu$. The average life of an electron may also be seen from an examination of equation (1) to be $2/a_0M$. From these equivalent values of the average life, $a_0 = 2h\nu/M$. Since h was found to be independent of pressure while M and ν doubtless vary directly as the pressure, a_0 is thought to be independent of pressure, at least to a first approximation. Hence using the values for M and ν for normal temperature and pressure, namely, 2.70×10^{19} per cubic centimeter and 2.17×10^{11} , respectively, the following values of a_0 are calculated from values of h taken from the graph in Bradbury's paper.

Electron energy (volts)	0.1	0.2	0.4	0.6	0.8	1.2	1.6	2.0
Capture coefficient a_0 in units of 10^{-14}	53	32	14	7.2	4.0	1.6	1.6	8.0

Using the smallest value of a_0 , a critical frequency f of 12 megacycles, one finds that at an altitude of 11 kilometers, where $M = (1/5) 2.70 \times 10^{19}$, the power

necessary to maintain the required ionization would be 0.86 watt per cubic meter. This seems to be the lowest allowable estimate. Several known factors, which could not be taken into account, would have increased it. But even though this seems to be an underestimate, the power required is startling, as may be seen by a comparison with the rate at which energy reaches the earth from the sun, which is 1340 watts per square meter of surface normal to the sun's rays at the "top" of the atmosphere. If this energy were all used to ionize the atmosphere at an average altitude of 11 kilometers, the layer in which the required ionic density is maintained would be at most about 1.5 kilometers thick for places where the sun is in the zenith.

The total electrical power of the thunderstorms of the earth has been estimated at about 2×10^9 kilowatts. If that aggregate power were suitably distributed and used entirely for the formation of ions at an average altitude of 11 kilometers, an ionized layer 25 meters thick for which the critical frequency is 12 megacycles could be maintained over less than one five thousandths of the earth's surface.

It seems then quite apparent from these examinations of more or less direct observations of electrical conductivity, as well as from consideration of the energy requirement, that in seeking an understanding of the apparent return of radio waves from the troposphere and lower stratosphere, variations in the physical properties of the atmosphere other than that involving continuous intense ionization should receive first attention.

Communication by Phase Modulation*

MURRAY G. CROSBY†, MEMBER, I.R.E.

Summary—Practical methods of generating and receiving phase modulation are described which open up the possibility of using phase modulation as a communication system. A new receiver is described which uses an off-neutralized crystal filter and provides a simple practical receiver which has not been heretofore available for phase modulation. Other methods of reception are described and discussed.

Propagation tests which were conducted between California and New York indicate that the propagation characteristics of phase modulation are substantially the same as those of amplitude modulation.

The noise characteristics of phase modulation are considered and it is shown that the signal-noise ratio at the output of the phase-modulation receiver is equal to the product of the phase deviation in radians and the carrier-noise ratio.

The chief advantage of phase modulation is realized at the transmitter where a power gain of about four-to-one is obtained and modulating equipment is reduced by the ability to modulate at a low level without the requirement of linearity in the stages following the modulator. The chief difficulty occurs at the receiver where the susceptibility to microphonics is increased and the circuits are slightly more complicated.

INTRODUCTION

DURING the course of the work on frequency modulation which has been described in previous publications,^{1,2} development work on phase modulation was also carried on by the engineers of R.C.A. Communications, Inc. The results of the frequency-modulation propagation tests pointed the way to phase modulation as a means of eliminating the extreme distortion encountered when frequency

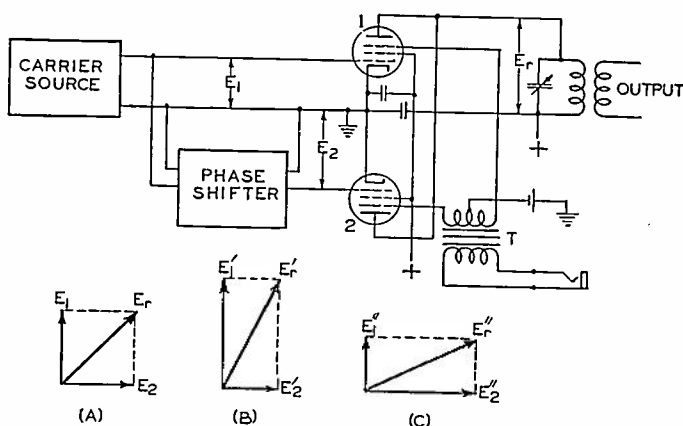

Fig. 1—Differential phase modulator.

modulation is transmitted over a multipath medium such as the ionosphere. This could be done without losing the advantages of frequency modulation with respect to the ease of modulation and the ability to use class C amplification in all the transmitter stages.

* Decimal classification: R148×R410. Original manuscript received by the Institute, June 16, 1938. Presented before Thirtieth Annual Convention, New York, N. Y., June 17, 1938.

† R.C.A. Communications, Inc., Riverhead, Long Island, New York.

¹ Murray G. Crosby, "Frequency modulation propagation characteristics," *Proc. I.R.E.*, vol. 24, pp. 898-913; June, (1936).

² Murray G. Crosby, "Frequency modulation noise characteristics," *Proc. I.R.E.*, vol. 25, pp. 472-514; April, (1937).

Accordingly, in the propagation tests the transmitter was arranged to radiate phase modulation as well as frequency and amplitude modulation so that all three types could be compared. At the receiving end several different types of phase-modulation receivers were developed and given a working test which demonstrated their relative advantages. The results of this work indicated that phase modulation provides a new and important method of communication with many advantages. In the following, the experience received in that work is drawn upon to describe the more practicable methods of generating and receiving phase modulation with the object of placing the system upon a working basis as a means of communication.

THE PHASE MODULATOR

When a wave is phase modulated, its instantaneous phase is deviated from the position it would have taken if the modulation were not present. Such a phase shift may be introduced by passing the wave through a network which imparts a time delay to the wave so that the wave at the output of the network has a phase which is different from that at the input. The problem of generating phase modulation thus becomes a problem of causing the modulating wave to impart time delay to the wave in accordance with the modulating potentials. One method of doing this is shown schematically in Fig. 1. Voltage from the carrier source is fed directly to modulator tube 1. This voltage is represented by the vector E_1 of vector diagram (A) of Fig. 1. Phase-shifted, or time-delayed, voltage is fed to modulator 2 and is represented by vector E_2 . The resultant of these two voltages is formed in the common plate circuit of the two modulator tubes and is represented by E_r . (The amplification effected in the modulator tubes is neglected in the vector diagrams.) The modulator tubes are differentially modulated by energy fed to transformer T . Two instantaneous positions of differential modulation are shown in diagrams (B) and (C) of Fig. 1. It can be seen that the resultant voltage is deviated in phase between limits which are determined by the phase separation of the voltages fed to the two modulator tubes.

In the phase modulator of Fig. 2, use is made of the fact that the phase of the output of a tuned amplifier varies as the tuning is varied. Steady carrier energy is fed amplifier 1 which has tuned circuit TC in its output. The tuning of TC is modulated by reactance

tube 2 which is given a 90-degree phase shift due to the resistance-capacitance phase shifter, R,C . This type of reactance tube is the same type as is used in automatic-frequency-control practice.^{3,4} In the particular circuit of Fig. 2, the modulating potentials are applied to the suppressor grid of the reactance tube.

A simple type of phase modulator, developed by H. E. Goldstine,⁵ takes advantage of the fact that the output of a crystal oscillator may be phase modulated by modulating one of the element voltages in the same manner that the ordinary tuned-circuit oscillator may be frequency modulated by modulating one of the element voltages. Apparently either type of oscillator circuit has some degree of reactance tube effect inherent in it, but in the case of the crystal oscillator the stability of the crystal prevents rapid frequency variations from taking place so that only phase deviations are effected.

The circuit of Fig. 3 shows a method of producing phase modulation in which a transmission line is employed.^{6,7} By modulating the plate resistance of a tube which acts as the terminating impedance of the line, at some point on the line, or for a given length of line, the combination of the incident wave of voltage applied to the line and the variable amount of reflected voltage produces a resultant which varies in phase. This can be seen from the vector diagrams

for the point on the line at which these two voltages are 90 degrees out of phase. The incident wave E_i combines with the reflected wave E_r to form the resultant E when the terminating impedance of the line is such as to allow practically full reflection. When the terminating impedance is modulated to a value which reduces the reflected wave to the value given by E_r' in Fig. 3(B), the resultant voltage takes

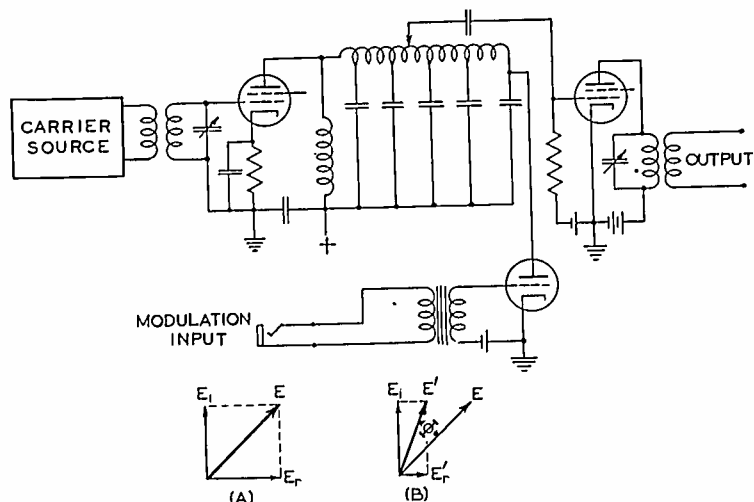

Fig. 3—Phase modulation by modulating the terminating impedance of a transmission line.

the new position E' which is shifted in phase by the amount Φ .

A frequency-modulated oscillator may be arranged to produce phase modulation by the application of a network in the modulating-potential circuit which passes these potentials with an amplitude proportional to their frequency.^{8,9} This system has the advantage that a high degree of phase modulation is obtainable. It was successfully used in the phase-modulation propagation tests during the year 1931, but has the disadvantage that it lacks the stability of the master-oscillator systems which are used with the other methods.

With any of the above phase modulators, the most convenient arrangement is that in which a low degree of modulation is produced at the modulator and higher degrees are obtained by the use of frequency multiplication. Nonlinear distortion and concomitant amplitude modulation are reduced in this way. Concomitant amplitude modulation may be further reduced by the use of limiting in the stages following the modulators. The degree of modulation may also be increased by the use of cascade modulation¹⁰ in which the radio-frequency output of one modulator is fed to the radio-frequency input of another which adds its phase deviation to that of the first.

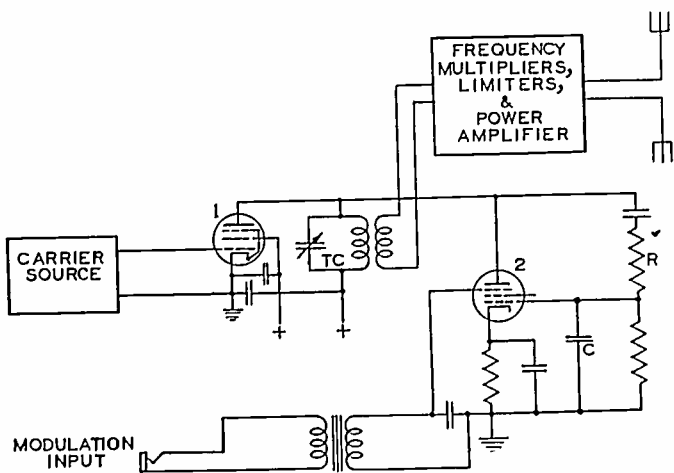

Fig. 2—Phase modulation by modulating a tuned circuit with a reactance tube.

of Fig. 3(A) and (B) which show the vector relations between the incident and reflected waves of voltage

³ D. E. Foster and S. W. Seeley, "Automatic tuning, simplified circuits, and design practice," PROC. I.R.E., vol. 25, pp. 289-313; March, (1937).

⁴ Other types of reactance tubes in this use are described in U.S. Patents No. 2,033,231, No. 2,087,428, and No. 2,012,710.

⁵ U.S. Patent No. 2,111,587.

⁶ U.S. Patent No. 2,085,418 also discloses how amplitude modulation may be produced by the same method.

⁷ A somewhat similar phase-modulating system, employing a transmission-line section to modulate the tuned amplifier, is described by Austin Eastman, "Fundamentals of Vacuum Tubes," McGraw-Hill Book Company, (1937), page 362.

⁸ See U.S. Patent No. 2,085,793.

⁹ Hans Roder has also described this system in a discussion in PROC. I.R.E., vol. 20, p. 887; May, (1932).

¹⁰ U.S. Patent No. 2,104,318.

THE PHASE-MODULATION RECEIVER

In order to receive a wave which is phase modulated, a converting circuit which converts the phase modulation into amplitude modulation is used. Then, in a manner similar to the process used in frequency-modulation reception, the amplitude modulation is detected by ordinary methods.

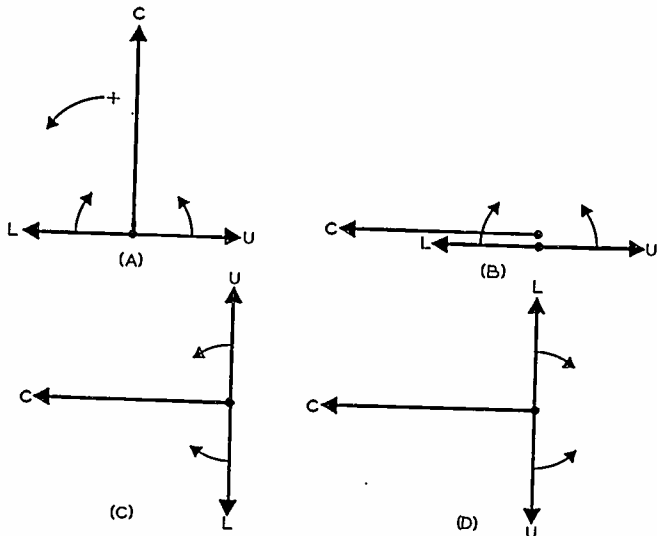

Fig. 4

An approximate explanation of the reason for the converting circuit is given by the following comparison between the carrier and side-frequency relations existing in phase and amplitude modulation: For a given instant of time, the vector relations between the carrier and side frequencies in amplitude modulation are as shown in Fig. 4(A). The phase relation of the three components is such that as the side frequencies rotate with respect to the carrier vector, they combine with the carrier in a manner to add and subtract from the carrier amplitude and thereby vary the resultant amplitude sinusoidally. The relation of the carrier and side frequencies in phase modulation for a given instant of time is as shown in Fig. 4(B). The carrier of the phase-modulated wave is shifted 90 degrees with respect to that of the amplitude-modulated wave. This shift causes the side frequencies to combine with the carrier in such a manner that the amplitude variation produced by one side frequency is canceled by an equal and opposite variation caused by the other side frequency so that only a phase variation of the resultant is produced. (In this approximate explanation, the small amount of amplitude modulation caused by neglecting the side frequencies having an order higher than the first will be neglected.) This phase variation may also be taken as an effective frequency variation since frequency modulation produces the same type of phase variation.

In view of this phase relation existing between the

carrier and side frequencies of phase modulation, it can be seen that the following methods may be used to convert to amplitude modulation for subsequent detection: 1. Phase shifting the carrier with respect to the side bands. 2. Phase shifting the side bands with respect to the carrier. 3. Detecting each side band in combination with the carrier separately. 4. Detecting the phase variation as an effective frequency modulation by the use of a frequency-modulation receiver with an equalizing network which corrects for the frequency distortion encountered.

The receivers of the following sections utilize these methods of receiving phase modulation and are considered in order of the author's opinion of their practicality.

OFF-NEUTRALIZED CRYSTAL-FILTER RECEIVER

In this receiver the inherent properties of a simple crystal filter are utilized to convert the phase modulation into amplitude modulation for detection. It has been found that when a crystal filter of the type in which the holder capacitance is neutralized, is operated in the off-neutralized condition, it is capable of converting phase modulation into amplitude modulation. The conversion is effected either by shifting the phase of the side bands with respect to the carrier or by a single-side-band action which allows the separate detection of the side bands in conjunction with the carrier.

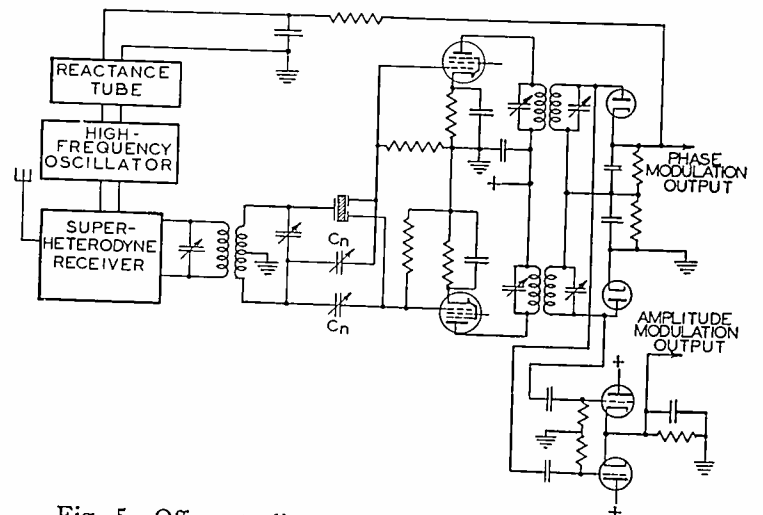

Fig. 5—Off-neutralized crystal-filter phase-amplitude-modulation receiver.

A schematic diagram of this type of receiver is shown in Fig. 5. The type of crystal filter used will be recognized as similar in some respects to that which has been used on amateur single-signal telegraph receivers for some time. A bridge circuit is arranged so that the capacitance of the crystal holder may be over- or underneutralized. One of the holder electrodes is split so as to make it possible to obtain

both the over- and underneutralized outputs from the same crystal. It has been found that there is negligible reaction between the two neutralizing circuits with this arrangement and the two outputs are obtained substantially independent of each other.

The two crystal-filter outputs feed diode driver tubes which feed a differential detecting system for the detection of phase modulation and for obtaining automatic-frequency-control voltage. A pair of parallel-connected infinite-impedance diode detectors are also fed by the diode driver tubes for the purpose of detecting amplitude modulation.

The manner in which the off-neutralized crystal filter converts phase modulation into amplitude modulation may be explained as follows: Fig. 6 shows the simplified circuit of one of the filters. When the neutralizing condenser C_n is made equal to the capacitance of the crystal holder C_h the circuit acts as though C_h were removed. A simple resonance curve is then obtained for the input-output characteristic. When the neutralizing condenser is made less than the holder capacitance, the circuit is said to be underneutralized and acts as though C_h is only slightly reduced. The reactance characteristic of the crystal for this underneutralized condition (assuming zero crystal resistance) is as shown in Fig. 7(A). Since the input voltage is fed to the crystal and R_1 in series, the output across R_1 (assuming a constant input voltage) will be dependent on the impedance of the crystal and will have a characteristic as shown in Fig. 7(B). When a carrier and side bands are passed through this type of filter, with the carrier tuned to the peak frequency F_c , a major portion of

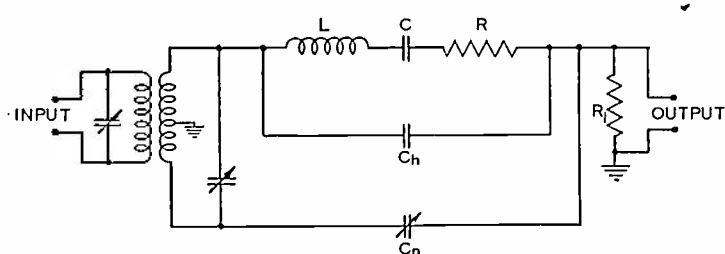

Fig. 6—Equivalent circuit of the neutralized crystal filter. L , C , and R =equivalent constants of the crystal; C_h =holder capacitance; C_n =neutralizing condenser.

the side bands appear in the flat portions of the characteristic on both sides of the carrier frequency and the rejection frequency F_1 . Since the reactance which feeds R_1 is capacitive for these flat portions of the characteristic, the corresponding side bands will be shifted practically 90 degrees in phase while the carrier will be unshifted. Such a shift in phase relations converts the phase-modulated wave represented by Fig. 4(B) to the relation portrayed by Fig. 4(C) so that the relations are proper to produce

amplitude modulation. The side frequencies in the vicinity of the rejection frequency are substantially eliminated so that for these lower-modulation frequencies the phase modulation is converted to amplitude modulation by the removal of one side band. The side frequencies in the immediate vicinity of the carrier frequency are exalted with the carrier so that

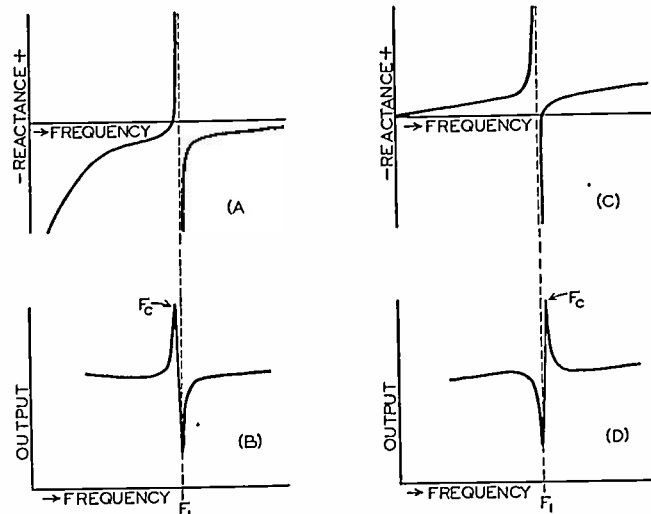

Fig. 7—Reactance and input-output characteristics of off-neutralized crystal filters. (A) and (B)=underneutralized; (C) and (D)=overneutralized.

an increased output might be expected from these modulation frequencies. However, this exaltation is compensated for by the phase shift being smaller in this region and the efficiency of conversion from phase to amplitude modulation being consequently less. Thus, in spite of this combination of single-side-band reception for some modulation frequencies and phase shifting of the side bands for the other modulation frequencies, a flat over-all output may be obtained without equalization. Although it is not indicated on the vector diagrams, a carrier exaltation is also effected by the filter. The degree of this carrier exaltation may be controlled by choice of R_1 (Fig. 6) and choice of Q of the crystal.

When the neutralizing condenser is made larger than the holder capacitance, the filter is said to be overneutralized and the reactance characteristic of the crystal is changed as though the capacitance of the holder were replaced by an inductance. The reactance characteristic is then as shown in Fig. 7(C) and the corresponding filter input-output characteristic is shown in Fig. 7(D). It is seen that the reactance which feeds R_1 is inductive for the range of frequencies below the rejection frequency and above the carrier frequency. Thus the side bands are shifted 90 degrees with respect to the carrier, but in a direction opposite to that effected by the underneutralized filter. This converts the carrier and side frequencies of Fig. 4(B) to the relation shown in

Fig. 4(D). Comparing Figs. 4(C) and (D), it can be seen that the amplitude envelope is approaching a maximum point in the case of the underneutralized filter of Fig. 4(C) and a minimum point in the case of the overneutralized filter of Fig. 4(D). Hence the

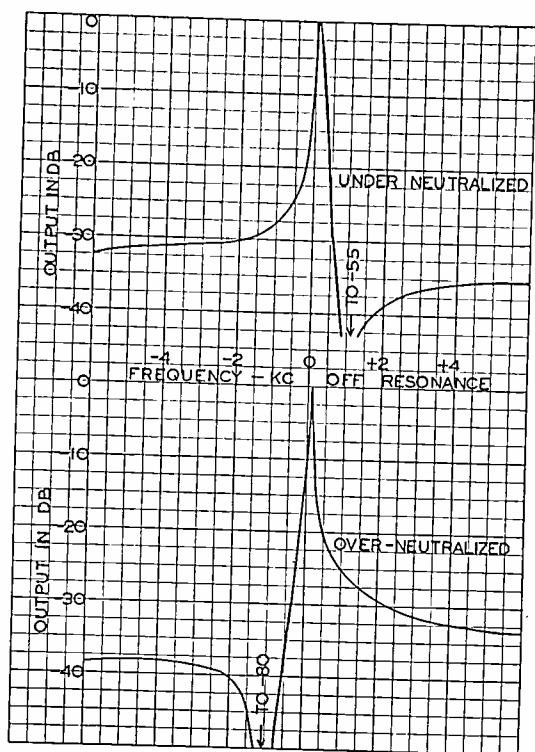

Fig. 8—Typical input-output characteristics of slightly off-neutralized crystal filters. Input held constant.

amplitude envelopes are 180 degrees out of phase and the detected outputs must be combined with a 180-degree phase reversal between them so as to make the outputs additive. This combination cancels amplitude modulation present on the incoming signal. In the circuit of Fig. 5, the phase reversal is effected by grounding the cathode of one of the diodes and making the other cathode the high potential point.

In the above explanation it was assumed that a high degree of off-neutralization was used. That is, the neutralizing condenser was adjusted well beyond the point of equality with the holder capacitance. When this is done, the rejection frequency occurs close to the carrier frequency and practically equal outputs are obtained from the upper and lower side bands which are disposed above the range between the carrier frequency and the rejection frequency. As the neutralizing condenser is adjusted closer to equality with the holder capacitance, the rejection frequency moves out away from the carrier frequency and the side band on the side of the rejection frequency is reduced with respect to the opposite side band. This is shown in Fig. 8 in which typical under- and overneutralized filter characteristics are shown

for the case of a low degree of neutralization. The filters thus effect a single-side-band action as well as a carrier-exalting effect. As a consequence the reception of amplitude modulation is possible on the same receiver by combining the detector outputs in phase. This is done by means of the second pair of detectors of the infinite-impedance type in the circuit of Fig. 5. It has been found that this type of reception of amplitude modulation requires equalization to reduce the overaccentuated low-modulation frequencies. However, a simple equalizer such as a series condenser and a shunt resistance serves the purpose very well.

Adjusting for a low degree of off-neutralization is by far the preferred method of reception since it makes possible the reception of amplitude modulation as well as phase modulation and also allows the detection of a single side band in conjunction with the carrier of either type of modulation. The latter possibility sometimes aids in the reduction of interference.

Automatic-frequency-control energy may be taken from the combined detector output due to the frequency discrimination effected by the fact that the

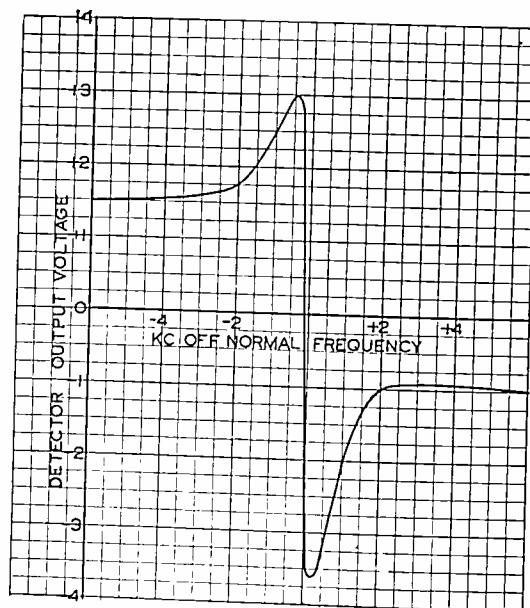

Fig. 9—Typical frequency-discrimination characteristic of off-neutralized crystal filters with diode driver tubes included.

two filter characteristics have their rejection points on opposite sides of the carrier. Hence, as the frequency is varied away from the carrier frequency, the input to one detector decreases at a faster rate than the input to the other. This produces a frequency-discrimination characteristic as shown in Fig. 9. Because of the high selectivity of the crystal filters, automatic frequency control is practically a necessity on this type of receiver.

AUXILIARY-CARRIER RECEIVERS

A receiver of this type is shown schematically in Fig. 10. Part of the incoming modulated wave is fed to a carrier filter which removes the side bands and makes available an unmodulated local carrier which may be combined with the phase-modulated signal so as to produce a resultant voltage which is amplitude modulated. Automatic volume control or limiting may be applied to the filtered carrier and it may be combined with the signal at a level such as to produce a carrier exaltation which eliminates the distortion caused by carrier fading. The vector diagram of Fig. 10(A) shows how the filtered and unfiltered voltages combine for the unmodulated condition. The phase adjuster in the filtered-carrier circuit is adjusted so that the two components of the filtered carrier E_1 and E_2 , which appear on the push-pull detector input transformer, are 90 degrees out of phase with the unfiltered carrier E_s . This produces resultants E_3 and E_4 , which are balanced in amplitude for the unmodulated condition. When the phase of the incoming wave E_s is shifted by the amount Φ as shown in Fig. 10(B), one of the resultants is modulated down in amplitude (E_3') and the other up (E_4'). A phase shift in the opposite direction produces differential amplitude modulation such that E_3 is modulated up and E_4 down. When this differential modulation is detected on the diode detectors,

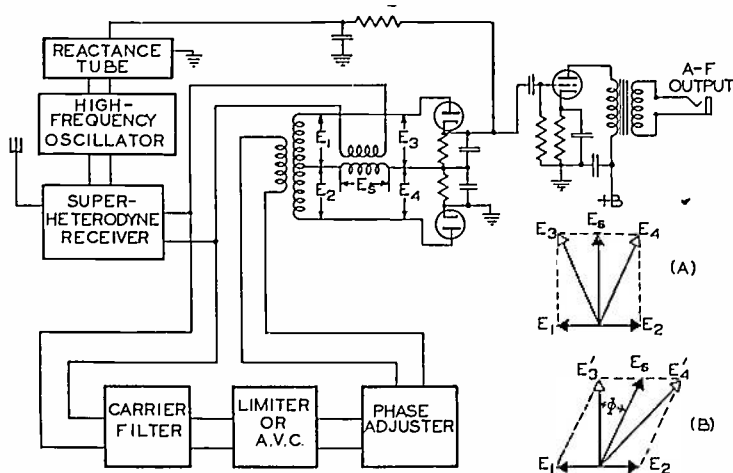

Fig. 10—Auxiliary-carrier phase-modulation receiver.

one of the diode resistors must be reversed with respect to the other so as to combine the detected outputs in push-pull as shown. Differential voltage for automatic frequency control is also available from the diode resistors and may be passed through a time-constant circuit to a reactance tube which controls the tuning of a frequency-converting oscillator of the receiver. Due to the high selectivity of the carrier filter, which is most conveniently a quartz-crystal filter, automatic frequency control is practically a necessity on this type of receiver also.

An alternative to the carrier filter and limiter of the receiver of Fig. 10 is a local oscillator. This local oscillator supplies carrier energy and it is the function of the automatic-frequency-control system to hold the local oscillator in phase synchronism with the incoming carrier. This places a rigid requirement on the automatic-frequency-control system, but it may be eased somewhat by employing a small amount of the incoming carrier to hold the local oscillator barely "in step." Just enough locking voltage is used to maintain phase synchronism, but not

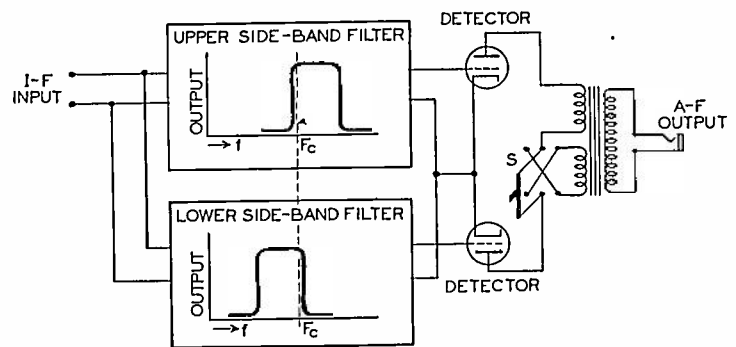

Fig. 11—Single-side-band phase-modulation receiver.

enough to allow the local carrier to follow the modulation on the incoming signal.

An ordinary autodyne detector may be tuned so as to receive phase modulation by using the "zero-beat" method of reception. The strength of the incoming signal is adjusted so as to hold the oscillating detector barely in step, so that the local oscillator does not appreciably follow the phase modulations on the signal. Thus the local oscillator provides a carrier which is phase shifted with respect to the incoming carrier and the resulting amplitude modulation is detected. This type of reception provides a simple receiver for monitoring, but is rather critical to tune unless provided with automatic frequency control, as described above, together with limiting or automatic gain control of the signal.

SINGLE-SIDE-BAND RECEPTION

In addition to the type of single-side-band reception described in connection with the receiver of Fig. 3, the receiver of Fig. 11 shows how conventional single-side-band filters may be employed to receive phase modulation. Two single-side-band filters are arranged to filter the carrier and each side band separately so that each detector detects the combination of the carrier and one side band at a time. This separate detection of the side bands prevents the output caused by one side band from canceling the output due to the other. By the use of the push-pull connection of the detector outputs, the two detector outputs combine in phase. The parallel combination

of the detected outputs, obtained by throwing switch *S*, allows the reception of amplitude modulation.

EQUALIZED FREQUENCY-MODULATION RECEPTION

The arrangement of Fig. 12 shows how a frequency-modulation receiver may be used for the reception of phase modulation. When phase modulation is received on a frequency-modulation receiver, the

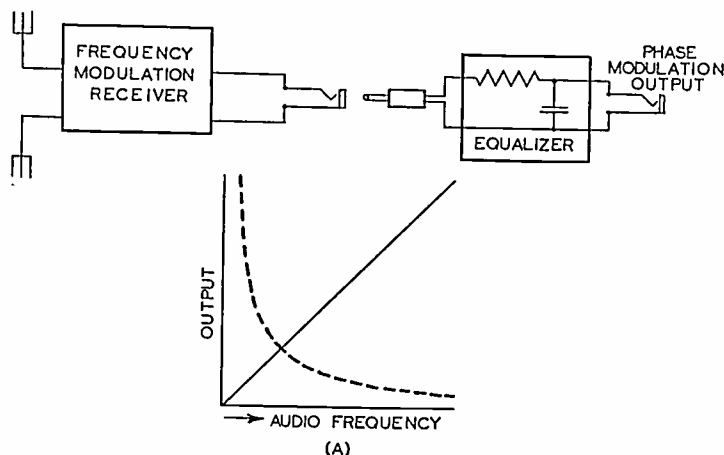

Fig. 12—Frequency-modulation receiver equalized for phase-modulation reception.

inherent difference between frequency and phase modulation makes the audio-frequency output directly proportional to the audio frequency as shown by the solid line of Fig. 12(A). By passing such an output through an equalizing network which passes the audio frequencies inversely proportional to their frequency as shown by the dotted line of Fig. 12(A), the response is equalized so that the over-all output is flat for phase-modulation reception.

PROPAGATION CHARACTERISTICS OF PHASE MODULATION

The general conclusion of the California-to-New York propagation tests was that the propagation characteristics of phase modulation were substantially the same as those of amplitude modulation. If there was any difference between the two systems, it was too small to be detected by the program and tone observations which were applied to phase modulation in the same manner that they were applied to frequency modulation.¹ This would be expected since the side-band characteristics of phase modulation are not radically different from those of amplitude modulation.

Receivers of the off-neutralized crystal-filter and auxiliary-carrier type, as well as the corrected frequency modulation and single-side-band type, were used in the propagation tests. Aside from the power gain resulting in improved signal strengths, the most predominant improvement was that caused by the

carrier exaltation effected by the phase-modulation receivers. When a carrier-exalting amplitude-modulation receiver was set up for comparison, the only difference that could be noticed between the two types of modulation was the difference in signal strengths.

It was found that the equalized-frequency-modulation type of phase modulation receiver is subject to rather extreme fading distortion when selective fading is encountered. The distortion took place during the fading minimums at which time a heavily over-modulated signal seemed to result. When this over-modulated signal was detected on the frequency modulation receiver and passed through the equalizing network which accentuated the lower modulation frequencies, the result was a rough, crunching noise bearing little relation to the applied modulation and having a level far above that of the applied modulation. Removal of the frequency-modulation limiter effected no improvement.

A receiver of the single-side-band type (Fig. 11) was set up using a single filter so that only one side band and the carrier could be received at a time. Filtered carrier was also provided so that carrier-exalted single-side-band reception was also possible. It was found that unless carrier-exalted reception was used, distortion due to the intermodulation between modulation frequencies was rather high. It was also found that this single-side-band reception was more susceptible to fading than the double-side-band systems. Since carrier exaltation was provided on both systems, the difference could only be attributed to a frequency diversity in which the probability of transmitting the signal by two side bands was greater than that in which only a single side band was used. This latter effect was noted on both the amplitude- and phase-modulation transmissions.

PHASE-MODULATION POWER GAIN

The carrier power gain effected by phase modulation over amplitude modulation for the unmodulated condition is the same as that for frequency modulation which is said to be four-to-one. This gain is due to the fact that the phase-modulation transmitter may be run continuously at its peak power output and upward modulation does not have to be provided for. When practicable systems are considered, it is found that the power gain ranges from approximately six-to-one for the most inefficient low-level amplitude modulation systems to about three-to-one for the high-level systems in which the modulating power is about equal to the radio-frequency input power. Thus the theoretical figure of four-to-one may be taken as an average value.

When the power gain is considered for the modulated condition, the magnitude of the signal-phase deviation and the signal-noise ratio must be considered. Since the receiver linearly converts phase deviations of the carrier into output voltages, the signal-noise ratio may be found by determining the ratio between the phase deviation of the signal and that of the noise. The effective phase deviation produced by the noise may be deduced by determining the manner in which the carrier and noise voltages combine to form a resultant, which will be both phase and amplitude modulated. This has been done in the previously published paper on frequency modulation² in which equation (5) of that paper gives the resultant of the frequency-modulated wave and the noise voltage. This equation may be changed to include the phase modulation case by merely substituting the phase deviation Φ for the modulation index F_d/F_m . The equation may also be changed to consider a single sinusoidal component of the noise resultant instead of the complete resultant of the spectrum,¹¹ so that the following equation results:

$$e = K \sin \left[\omega t + \Phi \cos pt + \tan^{-1} \frac{\sin (\omega_{na}t + \Phi \cos pt)}{C/n + \cos (\omega_{na}t + \Phi \cos pt)} \right] \quad (1)$$

in which K represents the amplitude envelope of the wave, $\omega = 2\pi \times$ carrier frequency, $\Phi =$ phase deviation

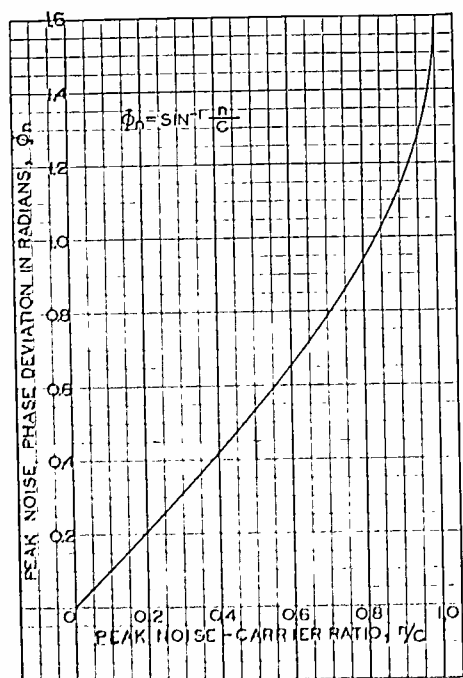

Fig. 13—Relation between the effective phase deviation produced by the noise and the noise-carrier ratio.

of the signal, $\omega_{na} =$ angular velocity of the beat note between the carrier and the noise frequency, $p = 2\pi \times$

¹¹ See page 479 of footnote 2 for description.

modulation frequency, $C =$ peak amplitude of the carrier, and $n =$ peak amplitude of the noise component.

The final term in the phase angle of (1) describes the phase deviation produced by the noise. The condition under which maximum phase deviation occurs may be found by equating the first derivative of that term to zero. When this is done for the unmodulated case ($\Phi =$ zero), it is found that the peak phase deviation

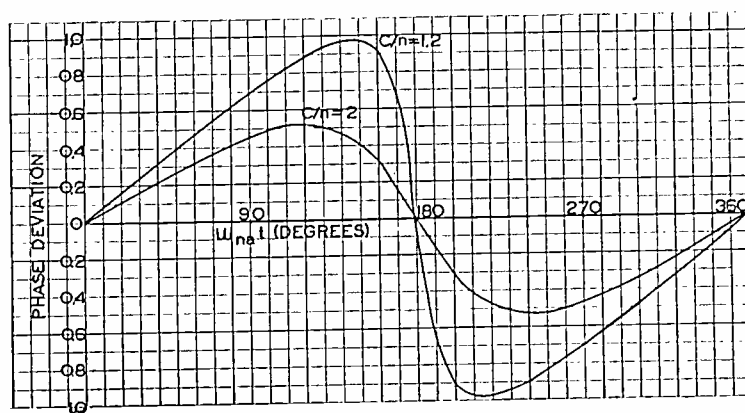

Fig. 14—Wave form of the phase deviation produced by the noise.

tion occurs when the phase angle between the noise and carrier voltages is equal to $\cos^{-1}(-n/C)$. Substituting this value of the phase angle in the original equation, the peak phase deviation due to the noise is found to be

$$\Phi_n(\text{peak}) = \tan^{-1} 1/\sqrt{(C/n)^2 - 1} = \sin^{-1} n/C. \quad (2)$$

When (2) is plotted for various carrier-noise ratios, the curve of Fig. 13 is obtained. It is seen that for the low noise-carrier ratios, the peak phase deviation of the noise in radians is practically equal to the noise-carrier ratio. The curve gradually departs from this equality as the noise-carrier ratio approaches unity, where a peak phase deviation of 1.57 radians (90 degrees) is obtained. This departure from equality occurs mostly in the vicinity of a noise-carrier ratio of unity (at a carrier-noise ratio of one decibel, the departure is less than two decibels). Consequently, for most practical purposes, it may be assumed that the maximum value of the radians of phase deviation produced by the noise is about equal to the peak noise-carrier ratio.

The wave form of this phase deviation produced by the noise has characteristics somewhat similar to the wave form produced by the effective frequency deviation of the noise as plotted in Fig. 4 of the paper on frequency-modulation noise characteristics previously referred to.² This is shown in Fig. 14 in which one cycle of the noise phase deviation is plotted for carrier-noise ratios of 1.2 and 2. The wave

form approaches a saw-tooth shape as unity carrier-noise ratio is approached and approaches a sinusoidal shape as the carrier-noise ratio is made large. This fact will undoubtedly cause the crest factor of the noise to increase in the vicinity of unity carrier-noise ratio. Such being the case, it can be seen that when root-mean-square values are considered, the phase deviation of the noise in radians will be more nearly equal to the noise-carrier ratio.

Knowing the phase deviation of the noise, the next step would be to compare the over-all transmissions of the noise for the cases of phase and amplitude

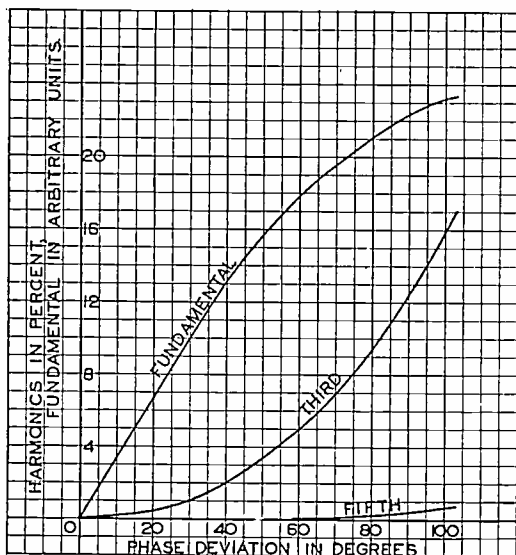

Fig. 15—Theoretically determined fundamental and harmonic outputs of a phase-modulation receiver.

modulation. However, this step is unnecessary since the noise component linearly produces a noise output voltage in the same manner for both systems. Consequently a comparison of the signal-noise ratios effected by the noise components in the two cases will be all that is required. In the case of amplitude modulation, the signal-noise ratio is known to be proportional to the product of the carrier-noise ratio and the modulation factor. In the case of phase modulation the signal-noise ratio will be equal to the signal phase deviation divided by the noise phase deviation. Hence (subscript "p" indicates the phase-modulation system),

$$S_p/N_p \text{ (peak values)} = \Phi/\sin^{-1} n/C \quad (3)$$

or, for most practical purposes,

$$S_p/N_p \text{ (peak values)} = \Phi C/n. \quad (4)$$

Thus the ratio between the signal-noise ratios of the phase- and amplitude-modulation receivers is, for most practical purposes, given by (subscript "a" indicates the amplitude-modulation system)

$$\frac{S_p/N_p}{S_a/N_a} \text{ (peak values)} = \frac{\Phi C_p/N_p}{M C_a/N_a} \quad (5)$$

where M is the modulation factor in the amplitude-modulation system.

From (5) it can be seen that for equal carrier strengths, the ratio between the signal phase deviation in radians and the modulation factor of the amplitude-modulation system gives the ratio of the signal-noise ratios of the two systems. To evaluate this factor, it remains to determine the permissible signal phase deviation used in the phase-modulation system.

It happens that harmonic distortion appearing in the receiver output places a limitation on the phase deviation for the receivers of the type which depend upon phase shifting of the carrier or side bands, or upon a single-side-band action. An analysis of the output of these types of receivers, which the author intends to submit for publication at a future date, indicates that the output consists of the fundamental and only the odd harmonics since the even harmonics are balanced out by the push-pull detection system. The fundamental is proportional to the first-order Bessel function of the phase deviation $J_1(\Phi)$, the third harmonic is proportional to the third-order Bessel function $J_3(\Phi)$, and so on. Thus, by consulting the Bessel function tables, the curves of Fig. 15 are obtained showing the amplitude of the fundamental and harmonics as the phase deviation is varied. From these curves it can be seen that the phase deviation may be carried to about one radian or 57.3 degrees for a harmonic distortion of about 5 per cent. Although for high-fidelity program transmission, less than a radian of phase deviation might be used to keep the distortion down, and for low-quality systems a higher deviation and distortion would be allowable, for most purposes one radian could be considered an average value for power calculations.

Substituting a signal phase deviation of one radian and a modulation factor of unity in (5), it can be seen that for equal carrier-noise ratios the peak signal-noise ratios obtained from the two systems are about equal. Consequently all of the gain caused by phase modulation is effected by the increased carrier-noise ratio which is brought about by the increase in transmitter power of four-to-one. At a carrier-noise ratio of unity, about 4 decibels of this 6-decibel gain are lost, but at a carrier-noise ratio of 1 decibel, less than 2 decibels are lost. This loss would be less apparent if root-mean-square instead of peak values were considered.

ADVANTAGES AND DISADVANTAGES

The main advantage obtained by the use of phase modulation is realized at the transmitter. The reduction of the amount of modulating equipment re-

quired and the power gain obtainable present an advantage which greatly outweighs the small disadvantages which the system has. Since modulation may be accomplished at the master oscillator or its following stage where the level is low, and since the amplitude linearity of the power amplifier may be practically disregarded, many of the troubles encountered in the use of amplitude modulation are eliminated. In general it may be said that for a given complement of tubes in the transmitter, practically four times the carrier-power output can be realized by phase modulation as compared to amplitude modulation and this gain (6 decibels) is fully realized in terms of signal-noise ratio at the receiver.

At the receiver, the main advantage obtained is that caused by carrier exaltation. This, of course, is obtainable with amplitude modulation also. The receiver is somewhat more complicated due to the addition of the carrier-exalting circuits with their requirement of automatic frequency control. However, in the case of the off-neutralized crystal-filter receiver this complication is about the same as that encountered when automatic frequency control is applied to any type of receiver. Furthermore, it is the author's opinion that the improvement effected by carrier exaltation alone makes the added complication worth while.

The main difficulty encountered at the transmitter is the somewhat increased susceptibility to the introduction of alternating-current hum. However, almost this same susceptibility is present with the use of amplitude modulation because fading sometimes converts phase modulation into amplitude modulation.

The chief difficulty at the receiver is the extremely increased susceptibility to microphonics on the oscillators. Apparently most oscillators are being microphonically modulated with frequency modulation which does not show up in amplitude- or frequency-modulation reception, but when this small frequency deviation is received as phase modulation the effective phase deviation is very great. This is especially true in the case of the microphonics having low periods such as produced by bumps or jars of the oscillator tube or circuit. In the case of the ordinary high-frequency oscillator of a superheterodyne receiver receiving a signal in the vicinity of 10 megacycles, the microphonics produced by a person walking around in the room are strong enough to be only a few decibels less than the receiver output due to full modulation. This susceptibility requires special treatment of the high-frequency oscillator. Shock- and soundproofing may be employed together with careful design of the parts of the oscillator circuit to re-

duce the possibility of vibration. Another alternative is the use of a crystal oscillator for the high-frequency oscillator. Such a system requires either a tunable first intermediate frequency or the use of a low-frequency oscillator which heterodynes the crystal oscillator so that a stabilized beat output is obtained. The stabilized beat output acts as the high-frequency oscillator and is variable over the small range covered by the low-frequency oscillator. This alternative eliminates the necessity of soundproofing since the crystal oscillator is stable enough to be free from microphonics and the low-frequency oscillators are oscillating at a low enough frequency so that the

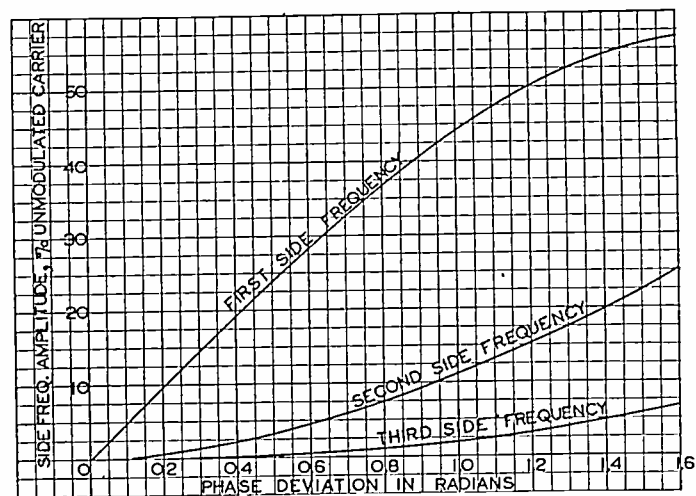

Fig. 16—Side-frequency amplitudes versus phase deviation for single-tone phase modulation.

frequency deviation due to the microphonics is small. However, such systems have the disadvantage of added complication and cost.

It might be contended that the presence of the higher-order side frequencies of phase modulation place this type of modulation at a disadvantage as compared to amplitude modulation with respect to adjacent-channel interference. (See Fig. 16 showing the relative amplitudes of the side frequencies for single-tone phase modulation.) However, the following points dispute that contention:

1. The difference between the higher-order side frequencies produced by slightly overmodulated phase- and amplitude-modulation transmitters is likely to be quite small. Phase modulation does not have the well-defined limit of 100 per cent modulation beyond which all the higher-order side frequencies increase very rapidly.¹² Instead there is a gradual increase of the second side frequency with only a slight amount of third side frequency at the full modulation of one radian.

2. In an analysis of the side frequencies of phase and frequency modulation for the case of more than

¹² I. J. Kaar, "Some notes on adjacent channel interference," Proc. I.R.E., vol. 22, pp. 295-313; March, (1934).

one modulating frequency, which the author has submitted for publication,¹³ it is shown that the presence of the low modulation frequencies in conjunction with the high modulation frequencies reduces the higher-order side-frequency amplitudes. In other words, the presence of a bass viol with a violin tends to reduce the higher-order side frequencies which would be produced if the violin were present alone. This phenomenon is accumulative so that the greater the number of modulating frequencies in the modulating wave, the more will the wave be confined to its channel.

3. The amplitudes of the higher modulation frequencies of program and voice modulation (excluding frequency inverting or other secrecy systems), which produce the out-of-channel interference, are known to be less than those of the lower modulation frequencies. Hence only a small amount of adjacent-channel interference should be caused by the higher-order side frequencies of these higher modulation frequencies. This situation also accentuates the effect mentioned in point number 2.

¹³ Murray G. Crosby, "Carrier and side-frequency relations with multi-tone frequency for phase modulation," *RCA Rev.*, vol. 3, pp. 103-106; July, (1938).

In view of the above points there is some doubt as to which system will produce the most adjacent-channel interference. At any rate, it can be seen that the difference will not be as great as the sinusoidal side-frequency resolution of phase modulation might indicate.

ACKNOWLEDGMENT

The author gratefully acknowledges the helpful suggestions and encouragement received from Messrs H. H. Beverage and H. O. Peterson during the course of this work.

He also wishes to accredit the promotive enthusiasm of Mr. C. W. Hansell together with the inventive contributions of Mr. Hansell and his staff at the Transmitting Design Laboratories of R.C.A. Communications, Inc. at Rocky Point, New York.

Mr. R. E. Schock assisted with the tests and development work at the receiving end.

Mr. J. W. Conklin was active in developing the transmitter which was used in the propagation tests, and handled the transmissions during the early part of the tests. Mr. T. J. Boerner handled the transmissions during the latter part of the tests.

Design of "Flat-Shooting" Antenna Arrays*

W. W. HANSEN†, NONMEMBER, I.R.E., AND L. M. HOLLINGSWORTH‡,
ASSOCIATE MEMBER, I.R.E.

Summary—In a recent paper by Hansen and Woodyard it was pointed out that there are an infinite number of arrays that radiate mostly along the ground and which do not (necessarily) involve high radiating elements. Methods of design were given for two classes of such arrays. The present paper completes the solution of this design problem and gives approximate formulas for the gain and number of array elements of all of these arrays not treated in the previous paper. It is concluded that the two classes previously treated are superior to the intermediate types here considered.

INTRODUCTION

IN A recent paper¹ it was pointed out that a distribution of vertical dipoles with (radial) density $e^{in\phi} J_n(k'\rho)$ out to some radius ρ_0 and zero thereafter would radiate mainly in a horizontal plane. Such a directional characteristic is desirable for broadcast purposes and as arrays of the above type can achieve such desirable radiation patterns without the use of expensive towers it seemed desirable to investigate further their possibilities and this was done so far as was seen to be possible at that time. Actually, of the infinite number of current distributions possible under the above formula, two classes were investigated; one in which $n=0$ and the radius of the array is a wavelength or more; i.e., several rings of antennas are used: and a second class in which n is one or more and the array consists of a single ring of elements in a circle of radius rather smaller than the value corresponding to the first maximum of J_n . For these two classes of arrays satisfactory formulas were given for the gain, and methods for estimating the number of array elements needed were given, and from these it was concluded that useful gains can be obtained from such arrays.

Moreover, study of the above-mentioned results showed that for a given number of array elements sometimes one and sometimes the other of the two types was the better. But how about arrays using several rings of antennas with $n=1, 2$, etc.? This is an important question for it might well be that, in some cases, such arrays might be better than the single ring J_n or the multiple ring J_0 arrays which were singled out for reasons of analytic convenience. Moreover plausible-sounding arguments can be put forward that would seem to show that such intermediate types are superior. For example, suppose we

consider a large array of the J_0 type. Then qualitative arguments can be adduced which show that an array of the same radius, but using a current distribution $e^{i\phi} J_1$, should give almost identical gain. Now one might think that this would be more economical because of the elimination of the center antenna. Moreover it would seem offhand that $e^{i2\phi} J_2$ should be better still as the gain would be about the same and one additional ring of antennas could be dispensed with.

Now one would not like to build an expensive array without being as sure as the state of the art allows that it is the optimum design and so one would, in a practical case, feel impelled to investigate all possibilities. On the other hand such an investigation would be tedious in the highest degree, especially with standard methods, as an array might have say 20 elements and, in addition, at least three values of k' must be tried. Even with the methods of reference 1 the work would be quite boring, to say the least.

It is the object of the present paper to avoid the need for such numerical work, insofar as possible. Specifically we aim to find simple approximate expressions for the number of array elements and the gain as a function of the diameter of the array and the order of the Bessel function associated with the array. Thus we shall be able to decide the question raised above. Unfortunately we shall find in fact that the above qualitative argument is wrong—the intermediate types are not superior.

APPROXIMATE FORMULA FOR NUMBER OF ARRAY ELEMENTS

We first treat the problem of finding the minimum number of elements needed for an array of given n value and radius. Now a really accurate figure for the minimum number of elements would have to take into account the allowable horizontal nonuniformity of coverage and certainly would be quite complex. However the addition of a quite small number of array elements will change an array from very bad to very good in this respect so that if we use some uniform criterion for all arrays the absolute number of antennas in any given array will never be far off while the difference in number between two arrays will be given quite accurately. Now the principal purpose of the present paper is to decide which n

* Decimal classification: R125. Original manuscript received by the Institute, June 21, 1938.

† Stanford University, Stanford, California.

‡ San Francisco Junior College, San Francisco, California.

¹ W. W. Hansen and J. R. Woodyard, "A new principle in directional antenna design," Proc. I.R.E., vol. 26, pp. 333-345; March, (1938). Unless otherwise stated the notation of this article will be used.

value to use for a given array radius and a formula that gives differences well will suffice for this purpose, and we have therefore contented ourselves with a simple formula which does this but may not give the absolute number with precision.

The finding of such a formula for the number of array elements may be divided into three steps. First we find the number of rings needed, next we find the number of elements per ring, and finally we use this information to find, by summation, the total number.

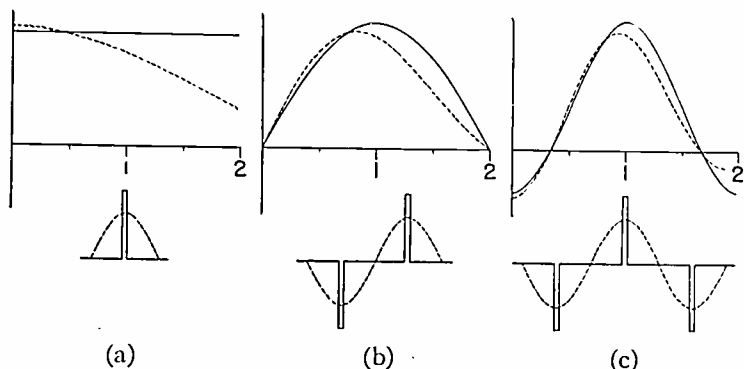

Fig. 1—The lower part of (a) shows a single loop of a cosine function and a single delta function. Above these are shown the corresponding Fourier transforms, plotted to arbitrary scales that make them cross at a point corresponding to $\sin \theta = 1$. (b) and (c) are similar but with two and three loops of sine or cosine functions.

As to the first question it is fairly obvious that there must be at least one ring of antennas per loop of Bessel function in order that large unwanted ears shall not appear on the directional pattern. Moreover it will be found, though this is not so obvious, that increasing the number of rings beyond this point in order to approximate better the assumed continuous distributions actually results in slightly less gain. This last point will bear further investigation, both for its own sake and also because the computations of gain are based on a continuous distribution and it is important to have some idea how the gain so computed will differ from the gain of an actual array.

The problem is easily solved by analogy with certain well-known results in Fourier integrals. Thus, if we let $i_z(\rho, \phi) = i(\rho)e^{in\phi}$ we find that, disregarding constant factors, the electric field as a function of angle (measured from the vertical) is given by

$$E \sim e^{in\phi} \sin \theta \int i J_n(k\rho \sin \theta) \rho d\rho. \quad (1)$$

Thus E is essentially the Fourier-Bessel transform of $\sqrt{\rho} i$ and the question we are interested in is how different are the transforms of two functions $\sqrt{\rho} i$ in one of which $i \sim J_n(k'\rho)$ and the other in which the J_n is replaced by a series of delta functions of appropriate size placed at positions corresponding to the

maxima and minima of J_n ? The answer will certainly be about the same in the corresponding Fourier case and as this is less trouble we have worked it out instead with results given graphically in Fig. 1. Here the lower section of (a) shows a single loop of the function $\cos x$ and also a single delta function. Above are given graphs of the corresponding Fourier transforms. The ordinates have been scaled so that the two curves cross at the point of principal interest which corresponds to $\sin \theta = 1$ (using the optimum value of k' which is determined later). Figs. 1(b) and 1(c) show similar curves with increasing numbers of loops. It will be seen that the two curves rapidly approach each other in the region of interest and that the continuous distribution will give somewhat lower values of gain. We conclude that one ring of antennas per loop of Bessel function is sufficient. Moreover, numerical trial shows only an inconsequential difference in gain between such a distribution and the continuous distribution assumed in estimating the gains.

Now by introducing two assumptions we can find the total number of rings. Namely, we suppose that the innermost ring is at $k\rho = n + 0.81n^{1/3}$ (using Debye's approximation and neglecting the difference between k and k') and that rings follow at intervals of π until $k\rho = k\rho_0 - \pi/2$. Both of these assumptions are simple and quite accurate.

We next ask how many antennas are needed in each ring. To find out, we first note that if there are m evenly spaced antennas in some ring then, as a function of ϕ , the current in that ring will be proportional to

$$e^{in\phi} \sum_l e^{ilm\phi}. \quad (2)$$

Now it is desired that this current when multiplied by $J_{n'}(k\rho \sin \theta)e^{-in'\phi}$ and integrated $d\phi$ shall give a negligible result, except when $n' = n$. The key term is that for $l = -1$; if this is small, those following will be smaller still. Examining this we see we must have $J_{(n-m)}(x) \ll J_n(x)$ for $0 < x < k\rho$ with ρ the radius of the ring in question. This implies $m - n > k\rho$ or $m > k\rho - n$. Just how much greater depends, of course, on the degree of uniformity of horizontal coverage desired, but in general a relatively small excess will suffice.

Now for the innermost ring $k\rho \sim n$, $m > 2n$. This is similar to the J_n antenna with only one ring which was treated in the previous paper and for which it was found that $m \sim 2n + 3$. This puts the array elements a little less than $\lambda/2$ apart. On the other hand, when we go to the outer rings $k\rho$ becomes large compared to n and we have $m > k\rho$; this was noted in the previous paper in the case $n = 0$ where (Fig. 4) it

was found that $m \sim k\rho + 1$ was about right. This makes the antennas about λ apart. For present purposes, then, we shall adopt the value $m = k\rho + n + 1$ for the number of antennas in any given ring.

We may note in passing that, as a result of the above, increasing n increases the number of array elements required in the rings that remain and it will turn out that this more than compensates for the decrease in number due to elimination of central rings. It is for this reason that the qualitative argument sketched in the introduction is incorrect.

Combining the above values for the number of elements per ring with previous assumptions as to the number of rings we find by summation an approximation for the number of elements needed for any array.

$$N = \frac{1}{2\pi} \left[\left(k\rho_0 - \frac{\pi}{2} \right) \left(k\rho_0 + \frac{\pi}{2} \right) - (n + 0.81n^{1/3})(n + 0.81n^{1/3} + 1) + 2(n + 1) \left(k\rho_0 + \frac{\pi}{2} - n - 0.81n^{1/3} \right) \right]. \quad (3)$$

In Fig. 2 we have plotted lines of constant N on the $k\rho_0, n$ plane.

It will be noted that the lines of constant N terminate, leaving the upper left-hand corner of Fig. 2 blank. We have done this because (3) obviously can not hold when $k\rho_0$ is less than about $n + 0.81n^{1/3} + \pi$.

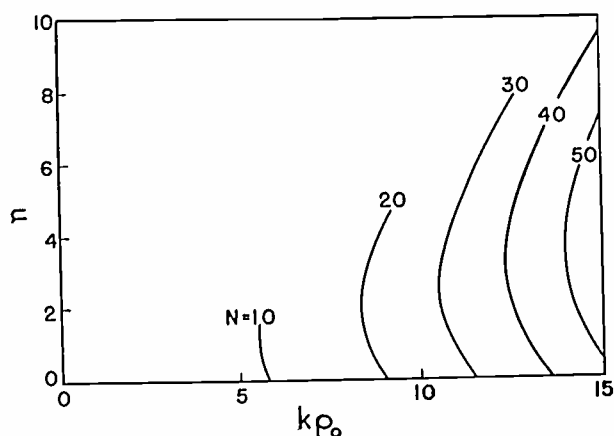

Fig. 2—Values of N , the number of array elements, as given by formula (3).

Thus (3) breaks down in the region of antennas with a single ring. As is better explained later, these antennas are in some respects a class apart and we shall confine ourselves to a remark which, though only qualitative, will suffice for our purpose. That is, we point out that a single ring array of very small diameter needs a minimum of $2n + 1$ array elements and this number rises slowly with increasing array radius. Otherwise said, the constant N curves of Fig. 2 would, if continued, bend to the left and would rise slowly as they approached $k\rho_0 = 0$.

APPROXIMATE FORMULA FOR THE GAIN

We now seek a simple formula for the gain of an (hypothetical) array consisting of a continuous distribution of dipoles of radial density $\rho J_n(k'\rho)e^{in\phi}$ out to some radius ρ_0 and zero outside. Using various formulas from footnote reference 1 we easily find the

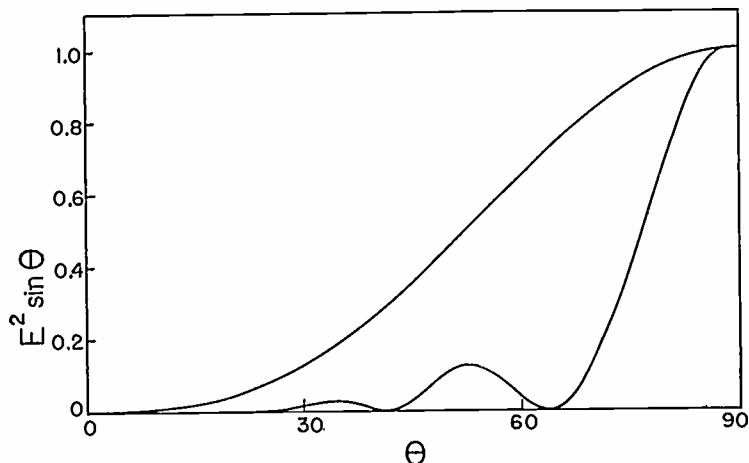

Fig. 3—Plot of the integrand of (5) for $n=0, k'/k=1.14, k\rho_0=13.13$. This is essentially $E^2 \sin \theta$ where E is the field due to a continuous distribution of dipoles that would in practice be approximated by a central antenna and four surrounding rings. Also plotted, for comparative purposes, is $E^2 \sin \theta$ for a single dipole, i.e., $\sin^3 \theta$. The gain can be obtained by planimetry of the two curves and taking the ratio of the results. In this way the gain in this case was found to be 2.48.

gain to be given by

$$\frac{1}{\text{gain}} = \frac{3}{2} \left[\int J_n(k'\rho) J_n(k\rho) k\rho d(k\rho) \right]^{-2} \times \int \left[\int J_n(k'\rho) J_n(k\rho \sin \theta) k\rho d(k\rho) \right]^2 \sin^3 \theta d\theta. \quad (4)$$

The normal place to terminate such an array would be at a point such that $J_n(k'\rho_0) = 0$: indeed if we propose to approximate the continuous distribution using only one ring per loop of Bessel's function we could hardly do otherwise.² Fortunately this simplifies the first integration considerably, the result being

$$\frac{1}{\text{gain}} = \frac{3}{2} \left(\frac{k'^2 - k^2}{J_n(k\rho_0)} \right)^2 \times \int_0^{\pi/2} \frac{J_n^2(k\rho_0 \sin \theta)}{(k'^2 - k^2 \sin^2 \theta)^2} \sin^3 \theta d\theta. \quad (5)$$

This is better but we still cannot do the last integration analytically and when we remember that we would like to explore the possibilities given by (say) $0 \leq n \leq 10, 0 < k\rho_0 < 15$ we see that some way of avoiding numerical integration is highly desirable.

² Note that if the continuous array terminates at some value of $k'\rho_0$, the last ring of the actual array will be at a $k'\rho$ value about $\pi/2$ smaller. Thus the $k\rho_0$ that will appear in various formulas is somewhat larger than the actual radius of the corresponding array.

Thus we must approximate the integrand. Remembering that previous work has shown that the optimum value of k' will nearly equal k we see that the important region of integration is near $\theta = 90$ degrees, and this for three reasons. First, the $\sin^3\theta$ factor renders the region near $\theta = 0$ unimportant. Next, at least for near-optimum choices of k' , the factor $J_n^2(k\rho_0\sin\theta)/(k'^2 - k^2\sin^2\theta)^2$ has a maximum at $\theta = \pi/2$. Finally, the integrand is essentially a function of $\sin\theta$ and $\sin\theta$ varies very slowly with θ when $\theta \sim 90$ degrees, so that the maximum at $\theta = 90$ degrees becomes very wide when plotted on a scale of θ . To illustrate the extent to which the above is true we have prepared Fig. 3 which shows a plot of the integrand for $n=0$, $k'/k=1.14$, $k\rho_0=13.13$. This is a more or less typical case and corresponds to an array having four rings of antennas and giving a gain of about 2.5.

Thus the main thing we need is some simple approximation to J_n that needs be good only when the argument is near $k\rho_0$. This is easy. If in Bessel's equation for $J_n(x)$ we make the substitution $y = \sqrt{x}J_n(x)$ we find

$$\frac{d^2y}{dx^2} + \left[1 - \frac{n^2 - 1/4}{x^2}\right] y = 0. \quad (6)$$

Thus in any sufficiently small region near some point $x_0 > n$ we should have

$$J_n(x) \cong \frac{\text{const}}{\sqrt{x}} \sin \left[\left(1 - \frac{n^2 - 1/4}{x_0^2}\right)^{1/2} x + \text{phase factor} \right]. \quad (7)$$

The excellence of an approximation can, for present purposes, be measured by the accuracy with which it will give the distance between nodes. That (7) does this very well even when x_0 is not much greater than n can be verified by trial. Thus, for $n=5$, this approximation gives 3.59 as the spacing of the first two roots; the correct value is 3.56. Moreover, the approximation gets better as the argument increases until, for example, (7) gives 3.18 as the spacing between the 8th and 9th roots as against a correct value of 3.17.

We conclude that (7) is a sufficiently good approximation and agree to adopt it. The most obvious error introduced by so doing will arise for large values of n when (7) will imply loops in the Bessel function in the region $0 < x < n$ where actually there are none; this would lead to an underestimate of the gain. On the other hand (7) implies a constant curvature toward the axis whereas actually the curvature gets less as x decreases, (7) being right only at $x = x_0$. This

would lead to an error in the opposite direction. However, neither of these will be serious so long as $k\rho_0$ exceeds n by enough so that several loops of the Bessel function are used. This can be seen, for example, in Fig. 3 where we note that the *two* humps in the curve between 0 and 40 degrees are so small as to contribute hardly anything to the area of the curve. But when $k\rho_0$ decreases to the point where two or perhaps only one ring of antennas is used then we can hardly expect an approximation based on (7) to be very good.

From this point on the analysis proceeds in much the same way as that previously used to obtain approximate formula (13) of reference 1. But whereas there we did not then think it desirable to reproduce the analysis we have now changed our minds and are giving the principal steps in the Appendix. Also, we this time have carried the approximation one step further so that the present results are somewhat more accurate than the previous ones.

Copying the final result from the Appendix we find that, for $n+1 \ll k\rho_0$, the gain is given approximately by

$$\text{gain} \cong 0.67 [(k\rho_0 + 2.15)^2 - n^2 + 1/4]^{1/4}. \quad (8)$$

It should be pointed out that, although the above formula gives the gain for all values of $k\rho_0$ and n only certain discrete values of these parameters are possible. That is, n is necessarily an integer and $k\rho_0$ is determined by the relation between $k\rho_0$ and $k'\rho_0$ and the requirement that $k'\rho_0$ be a root of a Bessel function.

Values of gain computed from (8) are given in Fig. 4. Here the heavy lines are lines of constant gain which, we may note, are rectangular hyperbolas. The light lines show possible values of $k\rho_0$ as functions of n . Since only integer values of n are possible the allowed values of $k\rho_0$ are those corresponding to an intersection of one of the light curves with a line $n = \text{integer}$. Thus the upper light curve corresponds to an array with one ring, the next to an array with two rings, etc., etc.

Now (8) and Fig. 4 should certainly be very useful—provided they are sufficiently accurate. It is more or less in the nature of things that one can never know exactly what the error of an approximate formula is without actually finding the exact answer and this is especially true in the present case where a considerable number of approximations lie between the exact starting point and the approximate result. Moreover, a program of numerical work to find the exact results seems not worth while so we have contented ourselves with the following remarks on the accuracy of (8).

First, we have done some numerical work bearing on the accuracy of (8) when $n=0$. We chose $n=0$ because, as will appear presently, this seems to include all cases likely to be important practically but not sufficiently covered in reference 1. To procure an over-all check we should compare the gain given by (8) with that computed for a series of actual antennas. But this would be much more work than computing the gain from (4) which assumes a continuous current distribution and in view of the excellence of this approximation as exhibited for example in Fig. 1 we feel that such labor would be unjustified. We have therefore integrated (4) numerically for a series of cases and will assume that the gain so obtained is correct. In doing this we need in each case to know the ratio between k and k' . We took $k'\rho_0$ to be 1.8 larger than $k\rho_0$ which gives, as we have seen, the optimum value of k' when $k'\rho_0 \gg n$. Of course when $k\rho_0$ is small this will not give quite the value of k' corresponding to maximum gain but it will be found that the resulting gain will differ from the maximum by very little indeed. This is true for three reasons: first, in the region of optimum k' the gain varies only slowly with k' so that small errors in k' make practically no change in the gain; second, numerical trial in the case of the lowest possible value of $k'\rho_0$ gives $k'\rho_0 = 2.4$, $k\rho_0 = 0.6$, gain = 0.995, whereas the optimum values would be $k\rho_0 = 0$, gain = 1.00; and third, besides being nearly the best when $k\rho_0 \rightarrow 0$ the choice $k'\rho_0 - k\rho_0 = 1.8$ is known to be best when $k\rho_0 \rightarrow \infty$. With the above assumptions, then, we com-

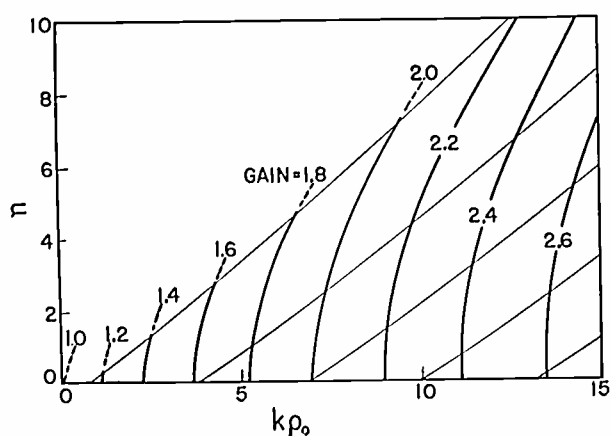

Fig. 4—Heavy lines are lines of constant gain, as given by approximate formula (8). Intersections of the light lines with the lines $n = \text{integer}$ correspond to possible values of $k\rho_0$.

puted the gain for $n=0$, $k'\rho_0 = 2.40, 5.52, 8.65, 11.79, 14.93$, these being the first five arrays of this type. The results are shown as points in Fig. 5, the full curve is computed from approximate formula (8). It will be seen that the agreement is good: we conclude that, at least for $n=0$, the approximations made in the steps between (4) and (8) give a very satisfactory result.

As to the accuracy when $k\rho_0$ comes near to n it will be noted that the lines of constant gain have been terminated on the line corresponding to a single ring of antennas with $k\rho_0 = k'\rho_0 - 1.8$, $J_n(k'\rho_0) = 0$. We have done this because, for two reasons, (8) can hardly be expected to be very good beyond this line, if indeed it is much good there. The reasons are as

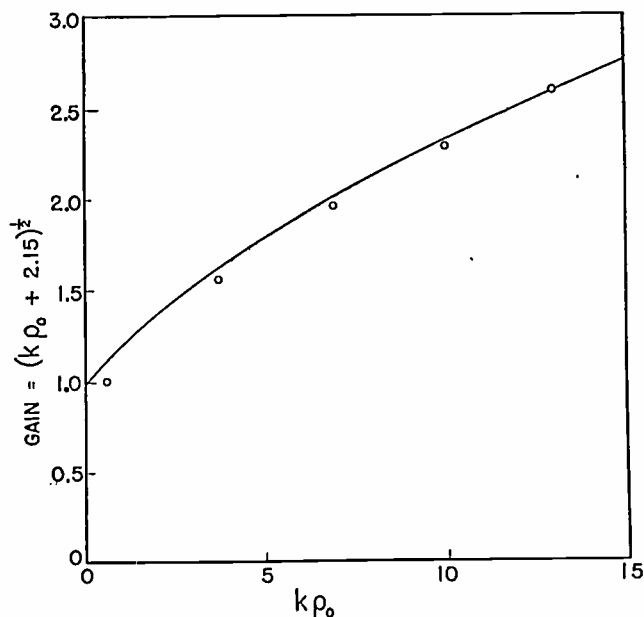

Fig. 5—The full line is a plot of gain as given by the approximate formula (8) for $n=0$, $0 \leq k\rho_0 \leq 15$. The circles give the gain as computed numerically for the first five arrays of this type possible.

follows. First, as $k\rho_0 \rightarrow \sqrt{n^2 - 1/4}$ approximation (7) breaks down completely, and with it (8). Second, (8) is supposed to give the gain for the optimum relation between $k'\rho_0$ and $k\rho_0$ and is actually figured for $k'\rho_0 - k\rho_0 = 1.8$ which, for two or more rings, is quite close, as explained above. But for a single ring the gain is a maximum when $k'/k = \infty$ so that (8) hardly means much in this case.³ On the other hand, numerical trial shows that, even if (8) does not in this case give the best gain it does give a fair approximation to the gain of a single-ring antenna with the assumed values of $k\rho_0$.

One might fill the upper left-hand corner of Fig. 3 by using an approximation like (7) but with the sine replaced by an exponential and with the approximation good when $n > k\rho_0$. This leads to a formula like gain = $0.75[(n + 3/2)^2 - (k\rho_0)^2 - 1/4]^{1/4}$. Using this, one

³ For any fixed number of rings, i.e., given n and $k'\rho_0$, the curve of gain versus $k\rho_0$ has a number of maxima and minima, by far the largest of which occur when $k\rho_0 \rightarrow 0$ and when $k\rho_0 \sim k'\rho_0$. We do not consider the first of these in general because it amounts to a multiple-ring antenna acting as a single ring and gives good gain but very little radiation resistance. But as the number of rings decreases the number of maxima in the gain curve between $k'\rho_0$ and 0 decreases until with a single ring the maximum at $k\rho_0 \sim k'\rho_0$ disappears and the only "best" value of $k\rho_0$ brings with it zero radiation resistance so one must choose $k\rho_0$ by some compromise between gain and ground losses. This introduces new factors, rather hard to put in formulas, so we have to treat the single-ring array on a somewhat different basis from the others.

could plot lines of constant gain that would begin on the n axis of Fig. 4. We have not done this because, as explained above, in going from one ring to two or more there is an essential change in the behavior when trying to maximize the gain as a function of $k\rho_0$. Nevertheless it is worth noting that the above formula also gives constant gain lines of hyperbolic shape but with the rôles of $k\rho_0$ and n interchanged. Thus, if we keep a constant n and start from $k\rho_0=0$ the gain will at first decrease with increasing $k\rho_0$ in the same way that, with fixed $k\rho_0$, the gain also decreases when n is increased from zero.

DISCUSSION AND CONCLUSION

We are now in a position to decide in any given case which type of antenna will give the greatest gain with the smallest number of array elements. Suppose we enter Fig. 4 at $n=0$ and some given $k\rho_0$. Then as we increase n we see that the gain decreases. Looking at Fig. 2 we observe that the number of array elements starts by increasing, though it eventually decreases again. Thus it is obvious that small increases of n away from zero are definitely bad for they both decrease the gain and increase the number of array elements. Moreover, more careful observation, as for example by superposing Figs. 2 and 4, will show that this tendency persists for larger n values: the decreasing number of elements is outweighed by a more rapidly decreasing gain. Thus we conclude: over all the region covered in Figs. 2 and 4 the J_0 -type array is the best.

This leaves the upper left-hand corner, which corresponds to single-ring J_n arrays, to be considered. As explained above we have not completed the charts in this region but it is nevertheless easy to see, using the previous qualitative statements, that, for fixed n , increasing $k\rho_0$ from zero to the maximum value possible for a single-ring array both decreases the gain and increases the number of array elements.

Taken together, these two statements lead one to the conclusion that, using a given number of array elements, the greatest gain will be obtained with either a single-ring J_n array or a multiple-ring J_0 . Which of these two is better depends principally on the gain desired and somewhat on the uniformity of horizontal directivity and radiation resistance desired. Using (3) and (8) we find⁴ the transition point to be between $k\rho_0=6.65$ and $k\rho_0=9.99$.

⁴ In the preceding paper, numerical examples were given only for arrays of rather high gain, so the following numbers for smaller arrays may be of interest. Multiple-ring J_0 arrays of 1, 2, 3, and 4 rings (counting the central element as one ring) give gains of 1.00, 1.54, 1.93, and 2.26, using (approximately) 1-, 4-, 10-, and 19-array elements. These last numbers are in the nature of lower limits; 1, 5, 12, and 22 would certainly be sufficiently large.

Another point which might be the deciding factor between the single ring J_n and the multiple ring J_0 , is the fact that under some conditions it is very undesirable to radiate an appreciable sky wave at fairly high vertical angles due to fading caused by interference between the reflected wave and ground wave. In this connection it should be noted that there are no minor lobes or "ears" on the vertical pattern of the single-ring J_n antenna unlike other antennas of comparable gain.

Thus our final conclusion is that the arrays examined in this paper are inferior to those considered in the first paper. That is, roughly speaking, a minimum lies between the two cases previously considered and not the maximum one might have hoped for. It is unfortunate that so much analysis is needed to reach such a negative conclusion but the authors know of no way of making the answer seem "obvious."

APPENDIX

To find a formula for the gain based on (5) and using approximation (7) we proceed as follows. First, we adjust the phase factor in (7) so that one zero of the Bessel function will fall at $k'\rho_0$, so writing

$$J_n(x) \cong \text{constant times } \frac{1}{\sqrt{x}} \sin \kappa(k'\rho_0 - x) \quad (9)$$

$$\kappa = \left(1 - \frac{n^2 - 1/4}{(k\rho_0)^2} \right)^{1/2}. \quad (10)$$

Next put the above approximation into (5) and make the following changes of variable

$$z = \frac{1}{\kappa k\rho_0}$$

$$u = \kappa\rho_0(k' - k) \quad (11)$$

$$x = \kappa k\rho_0(1 - \sin \theta)$$

when it will be found that (5) becomes

$$\frac{1}{\text{gain}} = \frac{3}{2\sqrt{2}} \sqrt{z} \left(\frac{u(1+uz/2)}{\sin u} \right)^2 \quad (12)$$

$$\times \int_0^{1/z} \frac{(1-xz)^2}{\left(1 - \frac{xz}{2}\right)^{1/2} \left(1 + \frac{u-x}{2}z\right)^2} \left(\frac{\sin(u+x)}{u+x} \right)^2 \frac{dx}{\sqrt{x}}.$$

Now in principle we should minimize this with respect to u ; i.e., find the optimum value of k' , for each value of z . But in practice, as explained in more

detail in the text, practically no error is made if we use a fixed value of u , with that value chosen to give best results when $z \rightarrow 0$. By a certain amount of numerical work we find this optimum value of u to be 1.8.

In reference 1 we stopped at essentially this point. That is, we took the value of all of (12) to the right of \sqrt{z} as independent of z and took for the value of that constant the value determined at $z=0$. But now we wish to get one more term in the expansion of the gain in powers of $1/z$.

To do this we first note that the important part of the integral is that near $x=0$. Now it will be found that, as x approaches zero,

$$\frac{(1-xz)^2}{\left(1-\frac{xz}{2}\right)^{1/2} \left(1+\frac{u-x}{2}z\right)^2} \cong \frac{1}{\left(1+\frac{uz}{2}\right)^2} e^{-3zx/4} \quad (13)$$

and to the order of accuracy here needed we can use this to approximate part of the integrand. Also to the required order we can replace the upper limit by infinity. So we find

$$\frac{1}{\text{gain}} \cong \frac{3}{2\sqrt{2}} \sqrt{z} \left(\frac{u}{\sin u}\right)^2 \times \int_0^\infty e^{-3zx/4} \left(\frac{\sin(u+x)}{u+x}\right)^2 \frac{dx}{\sqrt{x}} \quad (14)$$

Now expand the integrand in powers of z and integrate term by term, retaining the first two only. By so doing we find that

$$\frac{1}{\text{gain}} = \frac{3}{2\sqrt{2}} \sqrt{z} \left(\frac{u}{\sin u}\right)^2 \int_0^\infty \left(\frac{\sin(u+x)}{u+x}\right)^2 \frac{dx}{\sqrt{x}} \times \left[1 - \frac{3}{4} \frac{\int_0^\infty \left(\frac{\sin(u+x)}{u+x}\right)^2 \sqrt{x} dx}{\int_0^\infty \left(\frac{\sin(u+x)}{u+x}\right)^2 \frac{dx}{\sqrt{x}}} \dots \right] \quad (15)$$

Numerical evaluation of the integrals involved leads to

$$\frac{1}{\text{gain}} = 1.49\sqrt{z} (1 - 1.07z \dots) \quad (16)$$

That is, we have the two leading terms in an expansion in z_0 . These two terms can be reduced to one by a change of variable. Thus we find that (16) can be replaced by

$$\text{gain} = 0.67 \left(\frac{1}{z} + 2.15\right)^{1/2} \quad (17)$$

Replacing $1/z$ by its value in terms of $k\rho_0$ and u , and making a few more approximations that depend on $k\rho_0$ being rather large compared to one, we find the formula given in the text.

As to the accuracy of this expression, so many approximations have been made that a numerical over-all check seems to be the only safe method of estimating the accuracy. Such a check is described in the text. As to the analysis we will only say that we are sure it really does give the first two terms correctly at $k\rho_0 \rightarrow \infty$; that is, the error at ∞ is second order. But of course this tells nothing about the lowest usable value of $k\rho_0$.

A Television Pickup Tube*

HERBERT A. FINKE†, NONMEMBER, I.R.E.

Summary—A television pickup tube is described which combines in one device the principles of signal storage, as in the Iconoscope, and of signal multiplication by secondary-electron emission. Calculations indicate that for a given video-frequency signal, this tube will generate a considerably greater electrical signal than any other present pickup device.

AMONG electron optical television pickup tubes, the Iconoscope is characterized by its ability to store the total light received during a picture period as the potential energy of charge on a condenser, and the Farnsworth image dissector and

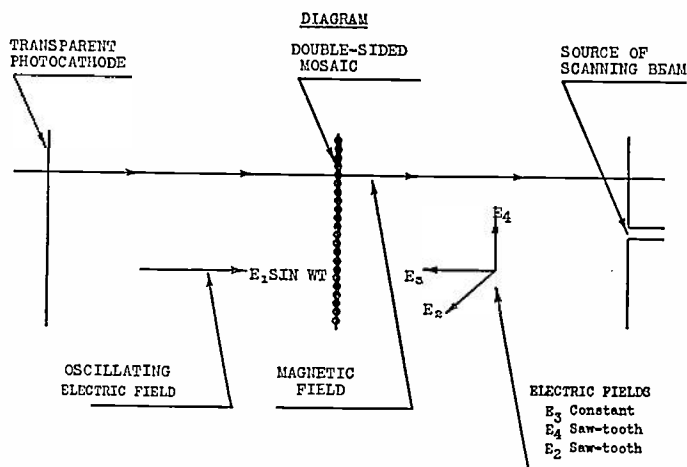

Fig. 1.

multiplier by its ability to take the light of an element period and enormously amplify the subsequent electron beam by secondary-electron multiplication. Both of these principles are highly desirable in any television pickup tube. A satisfactory combination of these two principles in a single device should yield a highly satisfactory video-frequency pickup system.

This combination of signal storage by a mosaic and of signal amplification by secondary-electron multiplication may be effected by a fairly simple design illustrated by Fig. 1.

A double-sided mosaic is employed. Incoming light will fall upon a transparent photocathode supplied with an oscillating voltage. Photoemission from the cathode will be accelerated to the mosaic causing secondary-electron emission of the globules. Timing is such that an electron's transit period from cathode to mosaic will be one and one-half cycles of the oscillating voltage, so that at the instant of mosaic impact the field will be reversing itself and will now

* Decimal classification: R330×R583. Original manuscript received by the Institute, June 1, 1938.

† Massachusetts Institute of Technology, Cambridge, Massachusetts. Admitted October, 1938, as a fourth-year student in electrical engineering. This paper presents the results obtained over the period 1936–1938, during which time the author was not connected with any school or commercial engineering organization.

draw all the secondaries back to the cathode and hence an oscillatory motion will result, increasing the original photoemission at every mosaic and photocathode impact, and thereby causing the mosaic globules to lose increasing amounts of electrons at every mosaic impact. The magnetic field perpendicular to the plane of the mosaic, and running through the device is used for focusing.

Scanning of the mosaic to produce the television signal is accomplished from the other side by an electron beam whose mosaic-impact velocity is close to zero. The purpose of this low-velocity scanning beam is to avoid the production of secondary electrons during mosaic globule discharge. The beam coming from its source with an initial velocity directed perpendicularly to the mosaic will have its velocity cut down to a value close to zero on reaching the mosaic. At the same time, the magnetic field, and the horizontal and vertical electric fields will, by independent deflections, scan the plane of the mosaic. In this device, unlike the present Iconoscope, the mosaic globules are always positively charged.

The device has been outlined. Actually, the operation is rather complicated, and will now be considered in detail. As indicated in the outline, the tube may be considered in two parts, first, the pickup and amplification of the signal, and, second, the electron scanning. The signal pickup and amplification will be considered first.

The transparent photocathode is to be supplied with an oscillating voltage $E_1 \sin \omega t$, and the beam transit-time is to be one and one-half cycles. The photoemitted electrons will not in general come off when the oscillating voltage is just beginning to increase from zero, but may come off at any time ϕ behind this voltage.

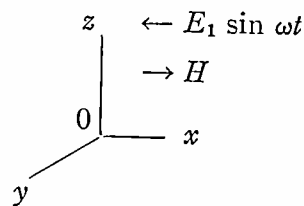

The equations of motion in this part of the device will be, taking the origin at the photocathode,

$$m \frac{d^2 x}{dt^2} = \frac{E_1 e}{d} \sin (\omega t + \phi) \quad (1)$$

$$m \frac{d^2 y}{dt^2} = H e \frac{dz}{dt} \quad (2)$$

$$m \frac{d^2z}{dt^2} = - He \frac{dy}{dt} \tag{3}$$

In these equations, d is the distance between photocathode and mosaic. Also, let \dot{y}_0 and \dot{z}_0 be the initial velocities, neglecting \dot{x}_0 as small compared to the accelerating velocity of the field.

The solution of these equations of motion using the boundary conditions that when t is zero, x , y , and z are zero, and

$$\frac{dx}{dt} = 0, \quad \frac{dy}{dt} = \dot{y}_0, \quad \frac{dz}{dt} = \dot{z}_0, \quad \text{is}$$

$$x = - \frac{E_1 e}{\omega^2 m d} \sin(\omega t + \phi) + \frac{E_1 e}{\omega m d} t \cos \phi + \frac{E_1 e}{\omega^2 m d} \sin \phi \tag{4}$$

$$y = A \cos \left(\frac{He}{m} t + B \right) + \frac{m \dot{z}_0}{He} \tag{5}$$

$$z = - A \sin \left(\frac{He}{m} t + B \right) - \frac{m \dot{y}_0}{He} \tag{6}$$

with A and B being easily determinable by the above boundary conditions.

It is to be observed that the magnetic field will produce a focusing action only for a constant time of transit, that is, for He/m equals 2π . The question becomes how does transit time vary for different values of ϕ , if for ϕ equals zero, the transit-time is one and one-half voltage cycles, or t equals $3\pi/\omega$.

When ϕ equals zero, and ωt equals 3π , x becomes $(E_1 e / \omega^2 m d) \cdot 3\pi$. Letting this be the distance between photocathode and mosaic, then to determine the variation of t with ϕ for this distance, it is necessary to plot the equation

$$3\pi = T \cos \phi + \sin \phi - \sin(T + \phi)$$

letting ωt equal T .

The half-cycle transit-time will also be plotted for comparison purposes. For the half voltage cycle transit-time, the equation to be plotted would be

$$\pi = T \cos \phi + \sin \phi - \sin(T + \phi).$$

TABLE I
ONE AND ONE-HALF CYCLES

$\phi =$	0	10	20	30	40	50	60	70	80	90
$T =$	9.42	9.35	9.36	9.57	10.16	14.3	18.5	22	46.5	∞

ONE-HALF CYCLE

$\phi =$	0	10	20	30	40	50	60	70	80	90
$T =$	3.14	2.99	2.89	2.82	2.80	2.84	3.00	3.50	8.7	∞

The following facts are gleaned from a study of this graph:

1. Only particles less than 90 degrees behind the voltage will reach the mosaic; others will be driven back to the photocathode.

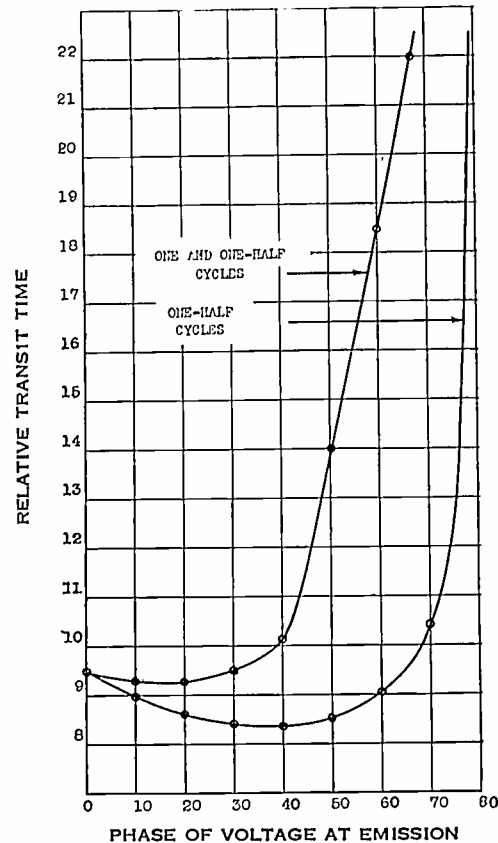

Fig. 2—Variation of transit-time with phase.

2. For the half-cycle transit-time, t shows a constant and considerable variation with ϕ . For the one and one-half cycle transit-time, however, and between $\phi = 0$ and 23 degrees, electrons will reach the mosaic in about the same time, the maximum difference being about 0.7 per cent of the transit-time for $\phi = 0$. Hence these particles will be accurately focused. Also, these particles on each transit will take slightly less time than the $\phi = 0$ particles, and hence their phase angles will be constantly reduced as they are gaining on the voltage phase, and will shortly take on a zero value for ϕ and continue to oscillate.

3. Also, for the one and one-half cycle curve, between $\phi = 23$ and 90 degrees, electrons will take varying amounts of time from the zero phase time to infinity. But these particles take longer than the in-phase time and are constantly falling behind the voltage and their ϕ 's are increasing at every transit, and hence these particles will not oscillate as the first group, but will shortly be captured by either the mosaic or the photocathode.

This nonoscillating group, while acting to decrease globule charge, will, however be negligible in com-

parison to the charge acquired by a globule due to the oscillating group.

This oscillating process has its period limited by space-charge accumulation, and, hence, the multiplying field must be periodically cleared of all space electrons, after which the multiplying process is started anew.

No allowance has been made for initial velocity of secondary emission along x , but corrections could be made for the average value of these velocities.

A typical set of values for this part of the device will be $E=1200$ volts, $f=70$ megacycles, $d=10$ centimeters, $H=18$ gauss, and $t=2.1 \times 10^{-8}$ seconds, one-way transit-time.

The superiority of this device over present pickup systems will obviously depend upon the number of multiplying stages possible before clearing the field, and this in turn will depend upon the space-charge limitation.

The space-charge-limited current for plane parallel plate electrodes in amperes per square centimeter is given by

$$I = 2.336 \times 10^{-6} \frac{E^{3/2}}{d^2}.$$

For the values given above, the maximum possible current will be 9.73×10^{-4} amperes per square centimeter.

If the illumination on the mosaic is taken as 5×10^{-3} lumens per square centimeter the photosensitivity of the photocathode as 10 microamperes per lumen, and the secondary emission ratio taken as 7 to 1, then three stages of multiplication at the mosaic are possible before clearance of the field.

This¹ periodic clearance of the field after every three stages of multiplication may be accomplished by superimposing on every ninth positive swing of the high-frequency electric field a greater negative voltage, such that all the electrons in the field will be driven back to the photocathode where they will remain as the field will continue to oppose their re-emission. With the field cleared the cycle can begin again. The annulment of every ninth positive swing may be accomplished by means of a vacuum tube operated below cutoff, such that plate current will flow during one ninth of a cycle. During this 40-degree interval of plate-current flow, the voltage produced when superimposed on the high-frequency field will act to drive all field electrons back to the photocathode.

Now, if it is assumed that n electrons per square centimeter are emitted during every full-voltage cycle, then in eight voltage cycles, which would be

¹ This paragraph was added to the paper on January 4, 1939.

the time for three stages of multiplication at the mosaic, the ordinary Iconoscope operating at 100 per cent efficiency would pick up $8n$ electrons. This device, however, would pick up

$$\frac{23}{360} \cdot n \{7^5 + 4 \cdot 7^3 + 7 \cdot 7^1\} = 1167n.$$

Hence, comparing ratios, this device will pick up for the values given, 146 times the charge accumulated by the present Iconoscope, and since the mosaic globules are always positive in charge will probably operate at a higher efficiency.

It is to be observed that the term in 7^5 is by far the most important term and for this value practically all the electrons are in sharp focus.

The second part of the device has been outlined. Precisely what happens may be seen from a study of the equations of motion that obtain in the scanning field.

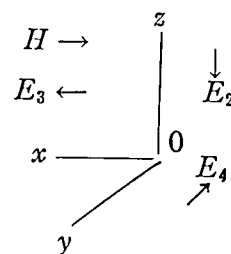

With the fields as indicated, a particle will start from the source, represented by the origin in this coordinate system with an initial velocity along x equal to a centimeters per second.

The equations of motion will be

$$\frac{md^2x}{dt^2} = -\frac{E_3e}{d} \quad (7)$$

$$\frac{md^2y}{dt^2} = \frac{E_4e}{d} + He \frac{dz}{dt} \quad (8)$$

$$\frac{md^2z}{dt^2} = \frac{E_2e}{d} - He \frac{dz}{dt} \quad (9)$$

In these equations, d represents the distance from the source to the mosaic.

The solution of these equations of motion is

$$x = -\frac{E_3e}{md} \frac{t^2}{2} + at \quad (10)$$

$$y = -A \cos \left(\frac{He}{m} t + B \right) + \frac{E_4m}{H^2ed} + \frac{E_2}{Hd} t \quad (11)$$

$$z = A \sin \left(\frac{He}{m} t + B \right) + \frac{E_2m}{H^2ed} - \frac{E_4}{Hd} t. \quad (12)$$

where

$$\frac{E_3 m}{H^2 e d} - A \cos B = 0$$

and

$$\frac{E_2 m}{H^2 e d} + A \sin B = 0.$$

Hence, when

$$\begin{aligned} \frac{He}{m} t &= 2\pi \\ y &= \frac{E_2}{Hd} \cdot \frac{2\pi m}{He} \\ z &= -\frac{E_4}{Hd} \cdot \frac{2\pi m}{He} \end{aligned}$$

It will then be seen that the y and z deflections are independent of each other, and if the cycloid period time is made to equal the time to bring the electron to rest along x , then any type of area scanning may be accomplished by the independent voltage de-

flections. The horizontal and vertical deflections must be linear with time and saw-tooth voltage wave forms must be used.

It is to be pointed out that for initial velocities along y and z , the final displacement at the end of the cycloid period will have the same value, although the curve itself will be distorted.

A consideration of the motion from the source to the mosaic will reveal that it is parabolic, and that for zero velocity at the mosaic, the vertex of the parabola will be at the mosaic, and hence grazing incidence will occur in scanning. To avoid this, the impact velocity must be several volts.

By this method the mosaic will be accurately scanned by a low-velocity beam. The excess electrons in the beam will be drawn back from the mosaic by the existing fields and collected uniformly with time.

Here again the mosaic globules remain positive throughout the operation.

An approximate idea of the order of magnitude of the fields used here is given by $H=18$ gauss, $a=9.4 \times 10^8$ centimeters per second, $d=10$ centimeters, $E_3=260$ volts constant, $E_2=450$ volts saw-tooth, and $E_4=450$ volts saw-tooth.

A Low-Frequency Alternator*

E. B. KURTZ†, NONMEMBER, I.R.E. AND M. J. LARSEN‡, NONMEMBER I.R.E.

Summary—An electrostatic alternator is described which is essentially a variable condenser whose capacitance is made to vary sinusoidally. Sinusoidal wave form can be maintained at all frequencies from zero up to approximately 50 cycles.

INTRODUCTION

THE electrostatic alternator described herein was designed especially for the end of the audio-frequency band where other types have not been particularly suitable. Sinusoidal wave form can be maintained at all frequencies from zero up to approximately 50 cycles per second.

The alternator is essentially a variable condenser whose capacitance is made to vary sinusoidally, thus causing a charging and discharging current to flow through a suitable circuit in which the input resistance of an amplifier is included. The theoretical aspects are treated in sufficient detail to indicate the most acceptable circuit parameters to be used consistent with good wave form.

The simplicity and reliability of this alternator suggest that it may have a variety of uses wherever a sinusoidal, low-frequency, low-power source is needed. As an oscillator it can serve excellently at the lower frequencies where vacuum-tube oscillators generally have poor wave form.

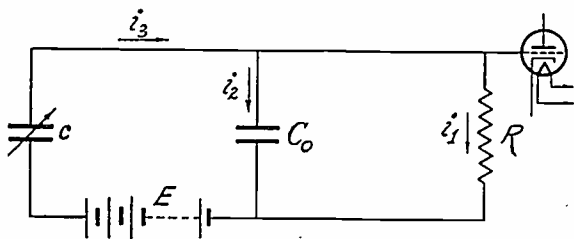

Fig. 1—Electrical circuit of the low-frequency alternator.

THEORY

The electrical circuit of the model described herein is given in Fig. 1. The resistance R represents the grid resistance of an amplifier tube; c is the variable condenser capacitance; C_0 represents the fixed capacitance existing between the grid sector of the variable capacitance and ground, as well as the capacitance of a shielded input lead to the grid resistance; and E is a constant potential source.

Since a sinusoidal voltage is desired across the grid

* Decimal classification: R381. Original manuscript received by the Institute April 23, 1938.

† Electrical Engineering Department, The State University of Iowa, Iowa City, Iowa.

‡ Formerly Electrical Engineering Department, The State University of Iowa, Iowa City, Iowa. Now, Electrical Engineering Department, Michigan College of Mining and Technology, Houghton, Michigan.

resistance, the current through R must then be given by

$$i_1 = I \sin \omega t. \quad (1)$$

The problem is to find the expression for c which will produce the required current. The following conditions of equilibrium will exist

$$i_1 + i_2 - i_3 = 0, \quad (2)$$

$$\int \frac{i_3 dt}{c} + i_1 R - E = 0, \quad (3)$$

$$\int \frac{i_2 dt}{C_0} - i_1 R = 0. \quad (4)$$

Solving these equations simultaneously for c yields

$$c = \frac{C_0 R I \sin \omega t - \frac{I}{\omega} \cos \omega t + M}{E - IR \sin \omega t}, \quad (5)$$

where M is the integration constant.

An inspection of this expression shows that if c is to have a sinusoidal variation, the $IR \sin \omega t$ term in the denominator must be very small compared to E . This term may be kept small by keeping the value of R low. If for purposes of preliminary analysis we should let R be zero, the expression for c would reduce to

$$c = \frac{M}{E} - \frac{I}{E\omega} \cos \omega t. \quad (6)$$

A plot of c showing its variation with time is shown in Fig. 2.

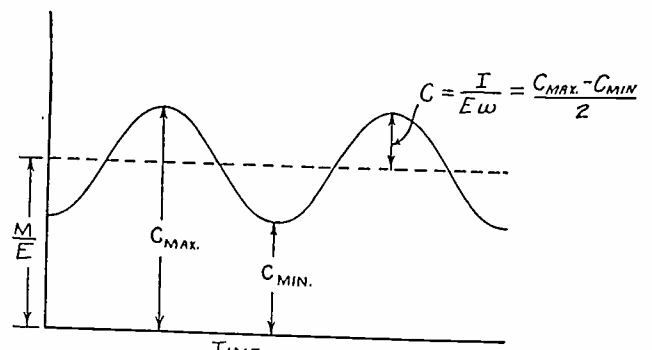

Fig. 2

Expressed in terms of its minimum value the expression for c may be written

$$c = C_{\min} + \frac{I}{E\omega} - \frac{I}{E\omega} \cos \omega t$$

or

$$c = C_{\min} + \frac{I}{E\omega} (1 - \cos \omega t). \quad (7)$$

From this expression the maximum value of c becomes

$$C_{\max} = C_{\min} + \frac{I}{E\omega} (2). \quad (8)$$

Solving (8) for I yields

$$I = (C_{\max} - C_{\min}) \frac{E\omega}{2}$$

or

$$I = C\omega E \quad (9)$$

where

$$C = \frac{C_{\max} - C_{\min}}{2}. \quad (10)$$

With resistance added to the circuit the variable condenser will neither completely charge nor discharge during each half cycle, hence (9) may be written thus

$$I < C\omega E. \quad (11)$$

It is now possible to compute the magnitude of the $IR \sin \omega t$ term in the denominator of (5) and to compare it with E . This term should be small compared to E if c is to vary sinusoidally. Hence, from (11),

$$IR < C\omega ER \ll E,$$

whence

$$C\omega R \ll 1. \quad (12)$$

The physical dimensions of the alternator show that (12) can be maintained without making R too small. Hence (5) may be simplified by dropping the second term in the denominator, thus:

$$c = \frac{1}{E} \left[C_0 R I \sin \omega t - \frac{I}{\omega} \cos \omega t + M \right].$$

Combining the sine and cosine terms, yields

$$c = \frac{1}{E} \left[M - \frac{I}{\omega} \sqrt{1 + (C_0 R \omega)^2} \cos(\omega t + \alpha) \right] \quad (13)$$

where $\tan \alpha = C_0 R \omega$. From (13) it is apparent that,

$$C_{\max} = \frac{1}{E} \left[M + \frac{I}{\omega} \sqrt{1 + (C_0 R \omega)^2} \right], \quad (14)$$

and

$$C_{\min} = \frac{1}{E} \left[M - \frac{I}{\omega} \sqrt{1 + (C_0 R \omega)^2} \right]. \quad (15)$$

Using (14) and (15) the expression for C of (10) becomes

$$C = \frac{C_{\max} - C_{\min}}{2} = \frac{I}{E\omega} \sqrt{1 + (C_0 R \omega)^2}. \quad (16)$$

Solving for M/E from (15) and using the value for C from (16) yields

$$M/E = C_{\min} + C. \quad (17)$$

Substituting the values for C from (16) and M/E from (17) into (13) gives the final desired expression for c , namely,

$$c = C_{\min} + C[1 - \cos(\omega t + \alpha)]. \quad (18)$$

If, therefore, the restrictions as set forth by (12) are adhered to, a sinusoidal voltage may be produced across R by giving c a sinusoidal variation; both phase and magnitude relations between current and capacitance are given by (18).

At the lower frequencies considered in this alternator the term $C_0 R \omega$ under the square-root radical in (16) is much smaller than unity. Hence where C is known the current maximum becomes, with but negligible error, from (16)

$$I = CE\omega. \quad (19)$$

It follows, then, that for a given alternator the current output through the grid resistance R is linearly proportional to the battery potential E and to the frequency.

DESCRIPTION OF ALTERNATOR

The assembled view is shown in Fig. 3. The rotor and stator designs are shown in Fig. 4. The stator

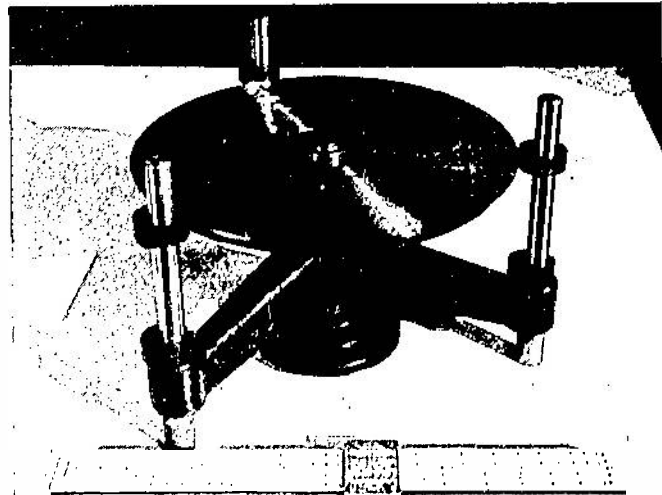

Fig. 3—Assembled view of the electrostatic low-frequency alternator.

consists of a metal-foil pattern mounted on and insulated from a ground steel disk. The foil is insulated from the disk by a thin sheet of paper and a tar-compound adhesive which secures the foil firmly to the paper and the disk.

The ordinates of the pattern are measured from the inside of the ring radially toward the center of

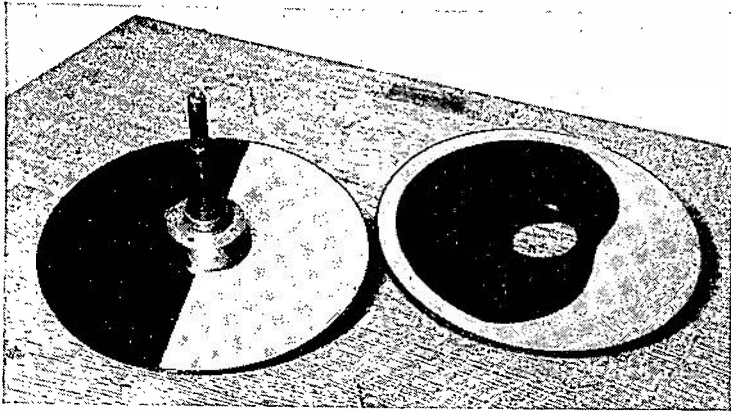

Fig. 4—Rotor and stator designs of the low-frequency alternator.

the disk and are plotted for a total of 180 degrees. The expression for plotting the ordinates is given by

$$y = R - \sqrt{R^2 - (2RH - H^2) \sin \theta}, \quad (20)$$

where y is the ordinate, R the radius from the center of the disk to the inside circumference of the ring, H the maximum ordinate, $\theta = xS/R$ where x is arc length along the circumference having radius R , and S the number of sectors or patterns per disk; in this case $S=1$. The derivation of (20) was given by the authors in a previous paper;¹ it is thus sufficient to state here that the result gives a sinusoidal change in coincident area as the rotor sector passes over the stator pattern.

The rotor sector is mounted on a rotor disk in the same manner as the stator pattern is mounted on the stator disk. The sector with its edges radially cut, as shown, occupies one half of the rotor area.

This type of mounting serves the dual purpose of affording complete shielding and directing the electrostatic flux lines in such a fashion that the capacitance is practically proportional to the coincident area of the rotor and stator sectors; thus the capacitance variation is sinusoidal in nature and the expression as set forth by (18) is satisfied.

The stator-pattern ring extends beyond the rotor so as to permit connection to a grid-resistance lead without distorting the electrostatic field. The rotor sector is connected to a battery for potential supply

¹ E. B. Kurtz and M. J. Larsen, "An electrostatic generator," *Trans. A.I.E.E. (Elec. Eng.)*, vol. 54, pp. 950-955; September, (1935).

by means of a light brush, not shown, which rides on the slip ring. All other parts of the model are grounded.

The stator disk is supported by three hard-rubber rings, each of which has a hole bored off center and slides on a rod so that centering and separation distance from the rotor are easily controlled. The dimensions of the alternator may be estimated by comparison with the foot-scale shown at the bottom of the assembled view. While this model was driven by means of a pulley with belt drive, any drive is satisfactory which does not transmit excessive vibration to the rotor.

CALIBRATION AND OPERATION

The circuit parameters for the alternator just described were approximately

$$\begin{aligned} C &= 50 \text{ micromicrofarads when rotor and stator} \\ &\text{were relatively close,} \\ C_0 &= 200 \text{ micromicrofarads,} \\ R &= 0.5 \text{ megohm or less,} \\ \omega &= 300 \text{ or less, and} \\ E &= 0 \text{ to } 300 \text{ volts.} \end{aligned}$$

These values satisfy the condition imposed by (12) and make $C_0R\omega$ so small that (16) may be written as (19). Thus the voltage across the grid resistor becomes

$$E_g = IR = CER\omega. \quad (21)$$

If facilities are available for measuring C accurately, no further calibration is necessary, assuming, of course, that E , R , and ω are known. C , however, can be measured, using (21), by means of a vacuum-tube voltmeter. The alternator is run at a relatively high speed so that a frequency of 40 or 50 cycles per second is generated; at this frequency the voltmeter, across R , may be read, and knowing the other values, C may be computed. Once found, assuming C is of a value that satisfies (12), it remains the same and may be used in (21) at any frequency. Thus E_g may be controlled by the three remaining independent variables, namely, E , R , and ω .

The wave form will be equally good at all frequencies below the upper limit because the electrostatic field between rotor and stator is purely a space function. Hence frequencies of only fractional periodicity may be generated with assurance that they are relatively pure sine waves.

Characteristics of the Ionosphere at Washington, D.C., December, 1938*

T. R. GILLILAND†, ASSOCIATE MEMBER, I. R. E., S. S. KIRBY†, ASSOCIATE MEMBER, I. R. E., AND N. SMITH†, NONMEMBER, I. R. E.

DATA on the critical frequencies and virtual heights of the ionosphere layers during December are given in Fig. 1. Fig. 2 gives the monthly average values of the maximum frequencies

which could be used for sky-wave radio communication by way of the regular layers. Fig. 3 gives the

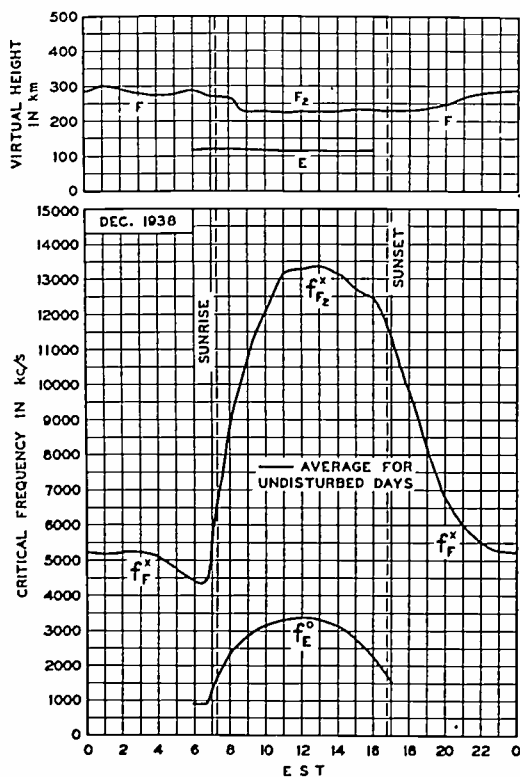

Fig. 1—Virtual heights and critical frequencies of the ionosphere layers, December, 1938.

TABLE I
IONOSPHERE STORMS (APPROXIMATELY IN ORDER OF SEVERITY)

Date and hour E.S.T.	hf before sunrise (km)	Minimum f_{min}^x before sunrise (kc)	Noon f_{min}^x (kc)	Magnetic character ¹		Ionosphere character ²
				00-12 G.M.T.	12-24 G.M.T.	
Dec. 10 (after 2100)	—	—	—	0.5	1.1	0.3
11 (until 0600)	354	3600	—	0.4	0.3	0.3
20 (0000 to 0600)	324	3500	—	0.4	0.6	0.2
19 (0000 to 0600)	332	3800	—	0.8	0.7	0.2
2 (after 1800)	—	—	—	0.2	0.8	0.2
3 (until 0600)	266	3800	—	0.9	1.0	0.2
For comparison: Average for undisturbed days	283	4480	—	0.2	0.2	0.0

¹ American magnetic character figure, based on observations of seven observatories.

² An estimate of the severity of the ionosphere storm at Washington on an arbitrary scale of 0 to 2, the character 2 representing the most severe disturbance.

* Decimal classification: R113.61. Original manuscript received by the Institute, January 10, 1939. These reports have appeared monthly in the PROCEEDINGS starting in vol. 25, September, (1937). See also vol. 25, pp. 823-840, July, (1937). Publication approved by the Director of the National Bureau of Standards of the U. S. Department of Commerce.

† National Bureau of Standards, Washington, D. C.

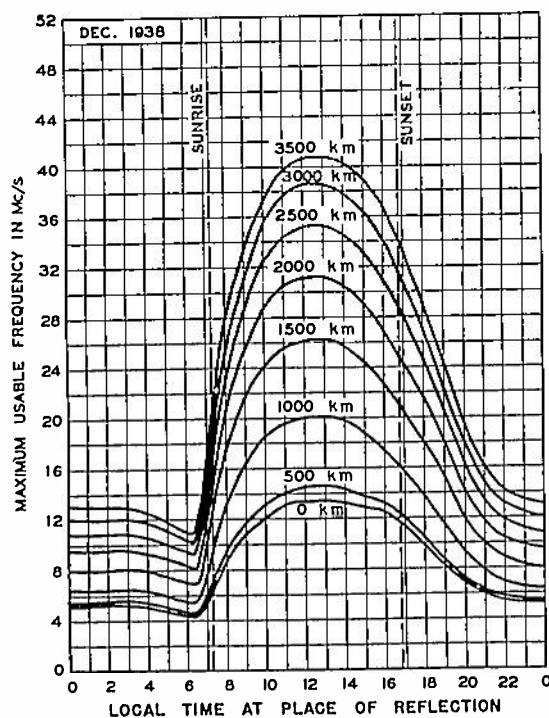

Fig. 2—Maximum usable frequencies for radio sky-wave transmission; averages for December, 1938, for undisturbed days, for dependable transmission by the regular F and F₂ layers.

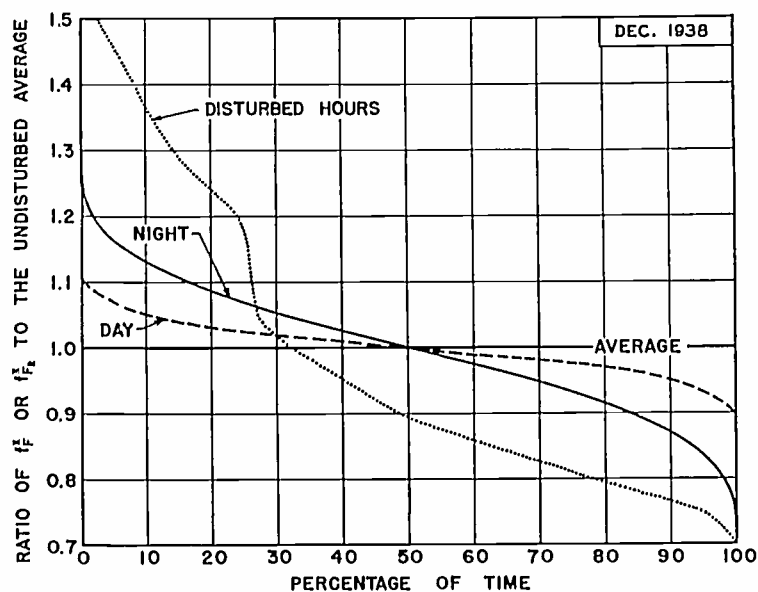

Fig. 3—Distribution of critical frequencies (and approximately of maximum usable frequencies) about monthly average. Abscissas show percentage of time for which the ratio of f_{F}^x or $f_{\text{F}_2}^x$ to the undisturbed average exceeded the values given by the ordinates. The graphs give data as follows: solid line, 452 hours of observations on undisturbed nights between 1800 and 0900 E.S.T.; dashed line, 32 hours between 1000 and 1700 E.S.T. on Wednesdays, all undisturbed; dotted line, 37 disturbed hours listed in Table I.

TABLE II
SUDDEN IONOSPHERE DISTURBANCES

Date 1938	G.M.T.		Location of transmitter	Relative intensity at mini- mum ¹	Remarks
	Begin- ning of fade-out	End			
Dec. 5	1420	1510	Ohio, Mass., D.C.	0.01	
6	1618	1700	Ohio, Mass., D.C.	0.0	Terr. mag. pulse ²
7	1813	1850	Ohio, Mass., D.C.	0.0	Terr. mag. pulse

¹ Ratio of received field intensity during fade-out to average field intensity before and after; for station W8XAL, 6060 kilocycles, 650 kilometers distant.

² Terrestrial magnetic pulse, observed on magnetograms from Cheltenham Observatory of the United States Coast and Geodetic Survey, simultaneous with the radio fade-out.

distribution of the hourly values of F- and F₂-layer critical frequencies (and approximately of the maxi-

mum usable frequencies) about the average for the month. The ionosphere storms and sudden ionosphere disturbances are listed in Tables I and II, respectively. The ionosphere storms in December were very mild and occurred during the night hours only.

As is usual in winter, sporadic-E reflections were not very prevalent during December. A burst of strong sporadic-E reflections above 10 megacycles was observed at vertical incidence around 1800 E.S.T. December 4. Strong sporadic-E reflections were also observed up to 8 megacycles during the late evening hours of December 14 and some of the early morning hours of December 15.

Institute News and Radio Notes

Board of Directors

The annual meeting of the Institute Board of Directors was held on January 4 and those present were R. A. Heising, president; H. H. Beverage, Ralph Bown, F. W. Cunningham, Alfred N. Goldsmith, Virgil M. Graham, O. B. Hanson, C. M. Jansky, Jr., F. B. Llewellyn, Haraden Pratt, B. J. Thompson, and H. P. Westman, secretary.

Melville Eastham and H. P. Westman were appointed treasurer and secretary, respectively, to serve during 1939.

Alan Hazeltine, L. C. F. Horle, A. F. Murray, A. F. Van Dyck, and P. T. Weeks were appointed to serve as directors during 1939.

On approval of the Admissions Committee, N. B. Fowler, A. R. Hodges, J. R. Poppele, N. C. Robertson, and D. P. Row were transferred to Member grade and L. S. Hall and Max Knoll were elected directly to that grade.

Twenty-six applicants for Associate, one for Junior, and twenty-two for Student membership were approved.

The personnel of committees to serve during 1939 was approved.

It was agreed that during 1939 members dropped for nonpayment of dues during the past would be permitted to resume membership without the payment of a new entrance fee.

A budget to govern the fiscal operations of the Institute during 1939 was adopted.

W. Noel Eldred, chairman of the San Francisco Section, was designated chairman of the committee to arrange for a national convention to be held in San Francisco on June 27, 28, 29, and 30, 1939. This convention will be in addition to the annual convention to be held in New York City late in September.

I.R.E.—U. R. S. I. Meeting

The annual joint meeting of the Institute of Radio Engineers and the American Section of the International Scientific Radio Union will be held in Washington, D. C., on April 28 and 29, 1939. This will be a two-day meeting. Meetings of other important scientific societies will be held in Washington during the same week. Papers on the more fundamental and scientific aspects of radio will be presented. The program will be published in the April issue of the PROCEEDINGS. This will necessitate the submission of titles to the Committee not later than February 21. It is desirable that abstracts of not over 200 words be submitted with the

titles. Correspondence should be addressed to S. S. Kirby, National Bureau of Standards, Washington, D. C.

Committees

Annual Review

The following technical committees met and completed their reports on developments during 1938. These reports are to be given final consideration by the Annual Review Committee prior to their being submitted for publication in the PROCEEDINGS in March.

Electroacoustics

The Technical Committee on Electroacoustics met on January 10 and those present were H. P. Westman, acting chairman and secretary; J. T. L. Brown, and H. F. Olson.

Electronics

The Technical Committee on Electronics met on January 6. P. T. Weeks, chairman; R. S. Burnap, H. P. Corwith, K. C. DeWalt, Ben Kievit, F. R. Lack, G. D. O'Neill, B. J. Thompson, and H. P. Westman, secretary, were present.



A rearrangement of executive personnel of the Hazeltine Service Corporation names W. A. MacDonald as vice president in charge of engineering; Harold A. Wheeler, vice president and chief consulting engineer; and Daniel E. Harnett, chief engineer. The photograph above shows, left to right, Messrs. Harnett, MacDonald, and Wheeler standing in front of the new laboratory at Little Neck, Long Island, N. Y. The laboratory planned for completion in the Spring will accommodate a staff of fifty employees and is about twice as large as the present Bayside laboratory which it will replace.

Radio Receivers

D. E. Foster, chairman; C. R. Barhydt, D. D. Israel, J. D. Parker (representing E. K. Cohan), W. E. Reichle (representing H. B. Fischer), A. E. Thiesen, Lincoln Walsh, and H. P. Westman, secretary, were present at a meeting of the Technical Committee on Radio Receivers on December 14.

Television and Facsimile

The Technical Committee on Television and Facsimile met on January 11 and those present were E. K. Cohan, chairman; Maurice Artzt (representing C. J. Young), H. S. Baird, J. C. Barnes, R. R. Batcher, J. L. Callahan, A. B. DuMont, W. G. H. Finch, D. E. Foster, C. W. Horn, A. G. Jensen, I. J. Kaar, H. M. Lewis, R. E. Shelby, and H. P. Westman, secretary.

Subcommittee on Facsimile. The Subcommittee on Facsimile operating under the Technical Committee on Television and Facsimile met on December 13. The meeting was attended by W. G. H. Finch, chairman; R. R. Batcher, F. R. Brick, Jr., J. L. Callahan (representing C. J. Young), R. H. Marriott (guest), H. C. Ressler (representing J. V. L. Hogan), and H. P. Westman, secretary.

Subcommittee on Television. Two meetings of the Subcommittee on Television operating under the Technical Committee on Television and Facsimile were held in the preparation of its report.

The first meeting on December 12 was attended by P. C. Goldmark, chairman; R. B. Dome (representing I. J. Kaar), G. F. Fernsler (representing P. T. Farnsworth), H. M. Lewis, R. E. Shelby (also representing E. W. Engstrom), and H. P. Westman, secretary.

The second meeting was on January 5 and was attended by P. C. Goldmark, chairman; A. B. DuMont, E. W. Engstrom, G. F. Fernsler (representing P. T. Farnsworth), I. J. Kaar, A. F. Murray, R. E. Shelby, J. C. Wilson (guest), J. D. Crawford, assistant secretary; and H. P. Westman, secretary.

Electronics Conference

F. R. Lack, chairman; R. M. Bowie, F. B. Llewellyn, G. A. Morton, B. J. Thompson, and H. P. Westman, secretary, attended a meeting of the committee having charge of arrangements for the electronics conference. Final decisions were made for the meeting to be held in New York City on January 13 and 14.

Sections

Atlanta

J. W. Hillegas, transmitter engineer at WSB, presented a paper on "Terman's High-Efficiency Grid-Modulated Amplifier." He reviewed briefly the various modulation systems commonly used outlining their advantages and disadvantages. He then presented a detailed analysis of the theory and practical circuit for a high-efficiency grid-modulated amplifier. A 50-watt-carrier transmitter in which the final amplifier was grid modulated and which operated into a dummy load was demonstrated. By use of plate- and grid-current meters and a cathode-ray oscilloscope, the effect of tuning adjustments on modulation and output was demonstrated. Inverse feedback was applied to show the remarkable decrease in audio-frequency distortion which resulted.

The meeting was held at WSB and refreshments were served through the courtesy of the station.

November 17, 1938—C. F. Daugherty, chairman, presiding.

Buffalo-Niagara

"The Road Ahead for Television," a paper by I. J. Kaar of the General Electric Company, was read by R. E. Moe of that organization as the author was unable to be present.

The paper covered past and current activities in the television field and pointed out trends and probable future developments. It covered such subjects as transmission frequencies, channel band-widths, the number of lines per frame and frames per second, power, and propagation characteristics. It included both British and United States developments in stationary and mobile transmission and reception.

December 15, 1938—H. C. Tittle, chairman, presiding.

Chicago

"Site and Installation of the New WLS-WENR Transmitter" was the subject of a paper by H. B. Couchene, engineer of that station. It concerned the selection of the site, building layout, antenna and transmission line considerations, and tower facilities.

This was followed by an "Engineering Description of the RCA 50-Kilowatt High-Fidelity Transmitter for WLS-WENR" which was presented by J. E. Young of the transmitter engineering department of the RCA Manufacturing Company.

November 30, 1938—J. E. Brown, chairman, presiding.

E. H. Conklin, associate editor of *Radio*, presented a "General Review of Characteristics of the Ionosphere." This paper was based chiefly on the contents of the paper by the same author appearing

in the January issue of the PROCEEDINGS.

As this was the annual meeting of the section, officers for the coming year were elected. V. J. Andrew, consulting engineer, was named chairman; E. Kohler, Jr. of the Ken-Rad Tube and Lamp Corporation, was elected vice chairman; and G. I. Martin of the RCA Institutes was designated secretary-treasurer.

December 16, 1938—J. E. Brown, chairman, presiding.

Cincinnati

G. F. Leydorf, transmission engineer of WLW-WSAI-W8XAL, presented a paper on "Sky-Wave Propagation at Broadcast Frequencies." There was first considered the effect of the height of the receiving and transmitting antennas and of the earth's conductivity on the strength of signals. It was pointed out that the reflected wave from the earth affected the sky wave somewhat differently at the sending than at the receiving antenna. It was also stated that the coefficient of reflection at the ionized layer does not vary greatly at nighttime because of changes in the angle of incidence, through a range of angles that are important, but that a low coefficient of reflection caused by a change in ion content, such as experienced in the daytime, would result in an appreciable reduction of the sky wave. The paper was discussed by Messrs. Osterbrock, Taylor, Wells and others.

December 13, 1938—R. C. Rockwell, chairman, presiding.

Connecticut Valley

A paper on "Frequency Stability" was presented by Arnold Peterson of the General Radio Company. It dealt chiefly with ultra-high-frequency negative-grid triode oscillators operating around 100 megacycles. Factors affecting stability were divided into those affecting the electrical characteristics and those involving the mechanical characteristics of the tube and associated circuit elements.

The necessity for a high capacitance-to-inductance ratio and high Q was stressed in discussing the electrical characteristics. The need for special tank-circuit construction was outlined in the consideration of the mechanical characteristics particularly with regard to oscillators for laboratory standard use. The performance and constructional details of a number of existing oscillators were illustrated and included several for operation between 300 and 600 megacycles.

December 8, 1938—E. R. Sanders, chairman, presiding.

Detroit

James Casman of the Federal Telegraph Company, presented "An Informal Discussion of Vacuum Tubes with Particular Emphasis on Transmitting Tubes." It was pointed out that although a good

knowledge of theory is essential in the development and design of a vacuum tube, experience in that work plays an important part in the development of satisfactory designs.

The practical limits of power and frequency were explained and methods employed by various manufacturers to extend the range of tubes were summarized. Various circuits useful for obtaining operation at high frequencies were shown.

A one-kilowatt water-cooled tube with the plate cut away to show the internal construction was used to show many of the points which were brought out regarding the construction of these tubes.

November 18, 1938—E. H. Lee, chairman, presiding.

Emporium

"The Road Ahead for Television" was presented by I. J. Kaar. A summary of this paper is given in the report on the Buffalo-Niagara Section in this issue.

As this was the annual meeting of the section, new officers were elected. R. K. McClintock of the Hygrade Sylvania Corporation was named chairman; M. S. May of Spear Carbon Company, vice chairman; and D. R. Kiser, secretary-treasurer.

December 12, 1938—A. W. Keen, chairman, presiding.

Los Angeles

"New NBC Facilities in Hollywood" was the subject of a paper by R. F. Schutz, design engineer in charge of equipment installation for the National Broadcasting Company. It covered the new Hollywood Radio City installation which features four auditorium-type stage studios each seating 350 persons, four nonaudience-type studios for large productions, as well as several small utility studios. The technical problems in the design and construction of these studios were described.

M. S. Adams, Hollywood field supervisor, then presented an "Exhibition and Description of NBC Short-Wave Field Equipment." He described various types of short-wave equipment used for broadcast pickups in the field. They included the "Beer-Mug" transmitter, a pack transmitter, and a 30-watt utility transmitter, all operating on ultra-high frequencies. Another utility transmitter operating in the high-frequency band was described. Various types of receivers to be used with these transmitters were displayed.

Harry Saz, sound effects chief, presented a "Sound Effects Demonstration and Exhibition." Numerous methods of producing sound effects required in broadcasting were described and demonstrated. The meeting was closed with an inspection of the new studios and equipment.

A. H. Saxton, western division engineer for the National Broadcasting Company, introduced the various speakers.

November 22, 1938—R. O. Brooke, chairman, presiding.

Montreal

"Graphical Network Synthesis" was the subject of a paper by E. A. Laport of the high-power broadcast-transmitter section of the RCA Manufacturing Company. He described simple graphical methods for obtaining directly and rapidly the required circuit values for any given impedance transformation with either specified or random phase shift. With ordinary care on the drawing board accuracy equal to that obtained with a ten-inch slide rule will result. The graphical method is much more rapid and once a diagram has been constructed, the result of any variation in the parameters may readily be seen. The method is particularly useful in calculations of the type met with in the calibration of radio ranges.

November 9, 1938—S. Sillitoe, chairman, presiding.

New Orleans

Elmo Voegtlin, manager of the service department of Walther Brothers, presented a paper on the "Philco Mystery Control." The design and construction of the device was described and a dismantled unit was available for inspection. The speaker then presented a brief review of the design of a high-gain preamplifier to raise the output of a microphone from -80 decibels to zero level.

November 22, 1938—G. H. Peirce, chairman, presiding.

Philadelphia

"Some Contributions of Radio to Other Sciences" was the subject of a paper by J. H. Dellinger, chief of the radio section of the National Bureau of Standards. The application of radio principles to meteorological investigations and weather forecasting was treated in detail. It was pointed out that much improvement in the collection of important data has come about through the use of automatically operated radio equipment carried into the high atmosphere by small balloons for the purpose of reporting to the ground the meteorological conditions encountered.

The conditions of the ionosphere are being revealed also by the behavior of radio waves and this has contributed much new knowledge of events which though taking place on the sun affect the ionosphere.

A description was given of radio waves which were reflected from some source far beyond the earth's atmosphere. Pictures were shown of unusually interesting eruptions of the sun's gases together with curves plotted to permit the study of the effects of these disturbances on electrical currents in the earth.

This meeting was held jointly with the Franklin Institute in its auditorium.

December 8, 1938—R. S. Hayes, vice

chairman, presiding for the Institute, and Mr. Weatherill for the Franklin Institute.

C. J. Young and Maurice Artzt of the RCA Manufacturing Company, presented a paper on "Broadcast Facsimile." Mr. Artzt described the circuit arrangements and the functions performed by the various parts of the equipment.

Mr. Young then considered the commercial prospects and difficulties encountered in furnishing a facsimile service. Field tests now being conducted are promising as half-tone pictures are being handled with fidelity superior to the average newspaper reproduction. The receiving paper is $8\frac{1}{2}$ inches wide and comes from the machine at a rate of 3 feet per hour. An $8\frac{1}{2}$ -inch by 12-inch sheet may be produced every twenty minutes. There are 125 lines per inch in each reproduced record.

The transmitter and receiver are automatically synchronized when operated on the same power system. Otherwise, a special synchronizing adjustment may be used on the receiver.

Scanning is accomplished by collecting in a photoelectric tube the reflection from the small spot of light directed at the copy. The output of the photoelectric tube is amplified and its wave shape changed to give a modulating signal proportional to the color of the spot scanned. The received signals actuate a carbon-paper recorder. The white recording paper and carbon paper are fed from rolls and passed between a rotating helix and a printer bar. The user is required to replenish the rolls of paper after about one hundred hours of operation.

Two receivers were operated during the meeting in the lecture hall located in the business section of Philadelphia and subject to a high local noise level. The transmitter, of one-kilowatt rating, was located in Camden. Operation was at 41 megacycles and the transmitting antenna was approximately 130 feet above street level.

January 5, 1939—H. J. Schrader, chairman, presiding.

Portland

A general discussion of the paper on "A Direct-Reading Radio-Wave-Reflection-Type Absolute Altimeter for Aeronautics," was led by E. R. Meissner of United Radio Supply, Inc. The second paper which was reviewed was "The Bridge-Stabilized Oscillator," by L. A. Meacham. This review was lead by L. M. Belleville. Both of these papers were published in the PROCEEDINGS.

This was the annual meeting and it was voted that the temporary officers be elected to serve for 1939. These are H. C. Singleton of KGW-KEX, as chairman; Marcus O'Day, associate professor of physics at Reed College, as vice-chairman; and E. R. Meissner of United Radio Supply, as secretary-treasurer.

December 28, 1938—H. C. Singleton, chairman, presiding.

San Francisco

"High-Voltage High-Frequency Phenomena," was the subject of a paper by Sidney Pickles, an engineer for the Mackay Radio and Telegraph Company. It covered recent studies of high-voltage phenomena at a frequency of 13 megacycles. An investigation of breakdown between needle and sphere gaps, and between parallel wires was discussed. It was pointed out that the main notable difference between low- and high-frequency breakdown was the absence of visible corona preceding the actual breakdown at high frequencies. Test data showed good agreement between the high-frequency arc-over gradient and what has been termed the 60-cycle "disruptive critical gradient." The paper was concluded with a discussion of the improvement in insulation of high-frequency currents that may be expected as a result of these studies.

The election of officers was held as this was the annual meeting of the section. F. E. Terman, head of the electrical engineering department of Stanford University, was named chairman; Carl Penther, of the Shell Development Company, was designated vice-chairman; and Leonard Black of the electrical engineering department of the University of California, was elected secretary-treasurer.

December 21, 1938—Noel Eldred, chairman, presiding.

Seattle

R. O. Bach, an engineer for the Pacific Telephone and Telegraph Company, presented a paper on "Multichannel Carrier Telephone Systems." It covered a new system in which the modulation and demodulation are achieved by copper-oxide units and the necessary selectivity obtained through the use of quartz-crystal oscillators. Each of the twelve incoming channels is passed into a balanced modulator and one of the resultant side bands is selected by a crystal filter. These twelve single-side-band signals lie in adjacent bands from about 80 to 120 kilocycles. The entire group is then passed through another balanced modulator and filter resulting in a combined channel from about twenty to sixty kilocycles which is transmitted over the wire lines. This process is reversed at the receiving end. Separate wire lines are used for the two directions of transmission to avoid the necessity of two-way repeaters and hybrid coils. Characteristics of the copper-oxide units and quartz-crystal filters were described.

In the election of officers for 1939, R. O. Bach of the Pacific Telephone and Telegraph Company, was named chairman; Robert Walker was elected vice chairman; and Karl Ellerbeck of the Pacific Telephone and Telegraph Company was made secretary-treasurer.

December 22, 1938—A. R. Taylor, chairman, presiding.

Washington

A series of papers on ultra-high frequencies was presented. The first, by Harry Diamond of the National Bureau of Standards, covered "Applications of Ultra-High Frequencies to the Field of Meteorology." It covered the use of meteorological sounding balloons towing lightweight transmitters and instruments into the upper atmosphere. Radio pulses transmitted to the ground enable various conditions in the upper atmosphere to be recorded automatically. Many upper-air phenomena such as cosmic-ray counts, ozone distribution, potential gradients, and ultraviolet light are being studied.

P. J. Kibler of the Washington Institute of Technology then discussed "Ultra-High-Frequency Aids to Flying Including Instrument Landing Systems." A 400-watt ultra-high-frequency transmitter used in connection with a landing-beam system was described. Performance curves and constructional details were given.

"Ultra-High-Frequency Receiver Development," was treated by P. D. McKeel of the Civil Aeronautics Authority. He described a superheterodyne receiver for aircraft use. Tuned coaxial lines were used for the oscillator, radio-frequency amplifier, and detector. A five-megacycle intermediate frequency gives stable performance and a sensitivity of about three microvolts in the range between 60 and 120 megacycles was obtained. A model of the receiver was on display.

The symposium was closed with informal remarks on "Ultra-High-Frequency Wave Propagation" by O. Norgorden of the Naval Research Laboratory, who reviewed briefly all field-strength formulas for application to ultra-high-frequency propagation. It was pointed out that simplified versions could be used in many practical cases. The laws of propagation within the optical range, just beyond it, and at somewhat greater distances were discussed.

In the election of officers, G. C. Gross, of the Federal Communications Commission staff, was designated chairman; L. C. Young, of the Naval Research Laboratory, was elected vice chairman; and M. H. Biser, of the Capitol Radio Engineering Institutes, was named secretary-treasurer.

December 12, 1938—E. H. Rietzke, chairman, presiding.

"A New Hard-Tube Relaxation Oscillator" was the subject of a paper by D. H. Black who is in charge of the valve laboratory of Standard Telephones and Cables, Ltd., of London, England. In it, Dr. Black discussed the development of a new double-grid tube and associated circuits for use as a relaxation oscillator for television applications. It was pointed out that this oscillator has the advantage of a much shorter retrace time and is not criti-

cal as to circuit constants. During the discussion, a number of features of the present 405-line television transmissions in England were described. It was estimated that 20,000 television receivers are in operation in London. It was stated that the fidelity of the received pictures was generally acceptable.

January 9, 1939—G. C. Gross, chairman, presiding.

Membership

The following indicated admissions to membership have been approved by the Admissions Committee. Objections to any of these should reach the Institute office by not later than February 28, 1939.

Admission to Associate (A), Junior (J), and Student (S).

- Abajian, H. B., (S) 113 Lyon Ave., East Providence, R. I.
- Aikman, J., (S) 66 Ormonde Ave., Glasgow S.4, Scotland.
- Aspin, J. J. E., (A) 14 Carthusian Rd., Cheylesmore, Coventry, England.
- Bennett, R. M., Jr., (A) 4541 Saratoga Ave., Downers Grove, Ill.
- Biosca, L. F., (A) 1 Bank St., New York, N. Y.
- Boucher, A. E., (A) 20 Prospect St., Nashua, N. H.
- Brannin, R. S., Jr., (A) Geophysical Research Department, Humble Oil and Refining Company, Houston, Tex.
- Brant, C. M., (A) Radio Station, Newfoundland Airport, Newfoundland.
- Carson, V. S., (S) 538 Williams St., Palo Alto, Calif.
- Chew, T. W., (A) 120 East Ave. 26, Los Angeles, Calif.
- Chorley, J. M., (A) 19 Russell Hill, Purley, Surrey, England.
- Coleman, C. F., (S) 15 Ellery St., Cambridge, Mass.
- Cork, B. B., (A) 262 N. Walnut St., East Orange, N. J.
- DeRyder, H., (A) RCA Manufacturing Company, Inc., Harrison, N. J.
- DiMarco, A., (A) Valle 1022, Buenos Aires, Argentina.
- Easton, I. G., (S) 13 Pigeon Hill St., Pigeon Cove, Mass.
- Eldredge, D., (A) 156 W. Second North St., Salt Lake City, Utah.
- Ewing, L. M., (S) 2099 Neil Ave., Columbus, Ohio.
- Fisher, S. T., (A) Northern Electric Company, 1261 Shearer St., Montreal, Que., Canada.
- Freundlich, H. F., (A) 20 Guessens Rd., Welwyn Garden City, England.
- Gaalaas, G. L., (A) Empire Sheet and Tin Plate Company, Mansfield, Ohio.
- Garman, R. L., (A) New York University, Washington Square East, New York, N. Y.
- Harrison, C. W., (S) Electrical Engineering Building, Lehigh University, Bethlehem, Pa.
- Hogg, J. E., (S) 4339-11 Ave., N.E., Seattle, Wash.
- Holman, W. A., (S) 334 E. 15 St., Oakland, Calif.
- Holstrom, A., (A) 674-56 St., Brooklyn, N. Y.
- Houston, W. M., (J) 2 Ascog St., Glasgow, S.2, Scotland.
- Howe, R. H., (A) 745 S. Main St., Butte, Mont.
- Hutchins, W. R., (S) 606 W. 113 St., New York, N. Y.
- Koch, R. F., (S) Bard College, Annandale-on-Hudson, N. Y.
- Law, H. B., (A) 59 Church ær., London N.W.9, England.
- Mautner, R., (A) 2288 Mott Ave., Far Rockaway, L. I., N. Y.
- McMillin, W. R., (A) 8 Sheperd Ave., Beechwood Heights, Bound Brook, N. J.
- Morrow, C. T., (S) 72 Perkins Hall, Cambridge, Mass.
- Nickelsen, J. C., (A) Stensgaten 25, Oslo, Norway.
- Peterson, D. R., (S) 719 Warren St., Redwood City, Calif.
- Plummer, C. B., (A) 252 Concord St., Portland, Maine.
- Procter, E. N., (S) 1324 College Ave., Palo Alto, Calif.
- Quarfoot, H. B., (A) 3838 N. Lakewood Ave., Chicago, Ill.
- Roxburgh, W. G., Jr., (S) 509 W. Maumee St., Angola, Ind.
- Seely, S., (A) Electrical Engineering Department, College of the City of New York, 139 St. and Amsterdam Ave., New York, N. Y.
- Smith, R. A., (S) 507 S. College St., Angola, Ind.
- Spence, A. E., (A) c/o Navy Office, Bombay, Indiana.
- Summerford, D. C., (A) 3037 Wirth Ave., Louisville, Ky.
- Susskind, S. E. M., (A) 16 Dizengoff Rd., Tel-Aviv, Palestine.
- Taylor, H. L., (A) 72 Norfolk Ave., Galt, Ont., Canada.
- Thomas, D. H., (A) University College, Nottingham, England.
- Vangeen, A. I., (A) 138B Trafalgar Rd., London S.E.10, England.
- Wells, F. H., (A) 45 Frewin Rd., London S.W.18, England.
- Wissenbach, J. M., (A) 1827 Clermont St., Denver, Colo.

Books

Electrolytic Capacitors, by Paul M. Deeley.

Published 1938 by Cornell-Dubilier Electric Corporation, South Plainfield, New Jersey. 286 pages, illustrated, cloth binding. Price \$3.00.

The use of electrolytic condensers has permitted a reduction in the size and cost of not only radio receivers, but also many other types of equipment. The object of this book is to take up the operating characteristics of these condensers, and to give a general outline of the chemical processes and the construction methods used with these condensers. The book may serve to overcome the reluctance shown by many engineers in using these condensers for many types of service. It should also show others where not to use this type of capacitor, as for instance in high-frequency bypass applications.

All types seem to be taken up in detail, at least from the viewpoint of those who are not actively engaged in the manufacture of condensers. The book is plentifully illustrated with photographs of numerous types and factory production processes, and sketches of assembly details.

R. R. BATCHER

St. Albans, Long Island, New York

“Eisenlose Drosselspulen, mit einem Anhang über Hochfrequenz-Massekernspulen” (Iron-Free Inductive Coils, with an Appendix on Iron-Cored Coils for High Frequencies), by J. Hak, with an introductory note by Professor Fritz Emde.

Published by the K. F. Koehler Company, Leipzig, Germany. 316 pages with 253 figures and 32 tables in the text. Price RM 28.

This treatise on inductive coils considers the subject both from a theoretical and a practical standpoint. The first eight chapters are devoted to the calculation of self and mutual inductance of coils of different types. Something more than a mere collection of formulas is attempted. Starting with derivations of the fundamental Neumann formula and the Maxwell formula for the mutual inductance of coaxial circular filaments, the formulas for the more complicated circuit elements are derived in such a way as to show their relations to one another and the simpler basic formulas. A section on calculations for circular coils is followed by one on coils wound on rectangular and polygonal forms. In another section, mutual inductance formulas are derived, both for coaxial coils and for coils with parallel and inclined axes. In all cases, a survey is given of the more important existing formulas, with references to their sources, and, for facilitating numerical computations by the formulas, tables or graphs of functions entering in the formulas are provided for cases where this is feasible.

Further chapters deal with the calculation of the force exerted between coils carrying current and for the forces acting on the turns of a coil due to currents in the other turns. Other sections give full treatment of the theory in such difficult cases as the calculation of skin effect and the calculation of the self-capacitance of a coil.

The later portions of the book consider the construction and design of coils to be used as current-limiting reactors and for protective devices against voltage surges. A short chapter is devoted to a description of methods for the measurement of the inductance, capacitance, and natural fre-

quency of coils.

Strictly speaking, the subject of coils with cores of magnetical materials lies outside of the scope of the book as indicated by its title. The author has, however, in view of the importance of this closely related subject, included in an appendix a section on coils wound on cores composed of pulverized magnetic alloys, mixed with a binder, and compressed to form a high permeability core. Such coils are much used in audio-frequency circuits.

The book on the whole presents a very complete compendium of the essentials of present-day knowledge of a subject concerning which information is for the most part to be obtained from articles scattered throughout the literature. A very valuable feature of the book is the bibliography in which no less than 687 articles are listed in chronological order. Reference is made to these by number in footnotes in the text. The figures and graphs of numerical data for use in the 253 formulas are beautifully executed and bound together at the back of the book. The caption of each figure is given in English as well as German. Full indexes, one of authors and a German-English subject index are provided. These bilingual features should help to render the formulas of the book useful to English-speaking readers. This idea might have been still further developed if the important formulas had been given captions for their ready identification by non-German readers.

The execution of the work throughout gives evidence of no sparing of pains to produce a useful reference book of handsome appearance.

FREDERICK W. GROVER
Union College, Schenectady, New York

Contributors



H. G. BOOKER

Henry George Booker was born on December 14, 1910, at Barking, Essex, England. In 1930 he received the B.A. (Hons.) degree from the University of London, and was a scholar of Christ's College, Cambridge, from 1930 to 1934,



CLEO BRUNETTI

being Wrangler at the University of Cambridge in 1933. Mr. Booker was an Allen Scholar at the University of Cambridge from 1934 to 1935, Smith's Prizeman in 1935, and received the Ph.D. degree in 1936. At the present time he is a Fellow of Christ's College and Faculty Assistant Lecturer in Mathematics at the University of Cambridge. During his sabbatical year, 1937-1938, he engaged in ionosphere research at the Department of Terrestrial Magnetism at the Carnegie Institution of Washington. Mr. Booker is a Fellow of the Cambridge Philosophical Society.

Cleo Brunetti (A '37) was born April 1, 1910, at Virginia, Minnesota. He received the B.E.E. degree from the Univer-

sity of Minnesota in 1932 and the Ph.D. degree in 1937. From 1932 to 1936 he was a Teaching Fellow in the department of electrical engineering at the University of Minnesota and from 1936 to 1937, an instructor. Since 1937 Dr. Brunetti has been an instructor in electrical engineering at



H. A. CHINN

Lehigh University. He is a member of Tau Beta Pi, Eta Kappa Nu, and Sigma Xi.

Howard A. Chinn (A '27—M '36) was born in New York City on January 5,



M. G. CROSBY

1906. He attended the Polytechnic Institute of Brooklyn, later going to Massachusetts Institute of Technology where he received the B.S. degree in 1927 and the M.S. degree in 1929. From 1927 to 1932 he was a research assistant at Massachusetts Institute of Technology. In 1932 Mr. Chinn became associated with the Columbia Broadcasting System where from 1932 to 1933 he was research associate; from

1933 to 1934, radio engineer; 1934 to 1936, assistant to the Director of Engineering; and from 1936 to date, Engineer-in-Charge of Audio Engineering.

Murray G. Crosby (A '25—M '38) was born at Elroy, Wisconsin, on September 17, 1903. He attended the University of Wisconsin from 1921 to 1925, and received the B.S. degree in electrical engineering in 1927. From 1925 to 1927 he was with the Radio Corporation of America, and from 1927 to date he has been with R.C.A. Communications, Inc.



H. A. FINKE

Herbert A. Finke was born October 28, 1914. In 1934 he received the degree of Bachelor of Science in Physics. At the present time Mr. Finke is a fourth-year



O. H. GISH

student at the Massachusetts Institute of Technology.

Oliver H. Gish was born at Abilene, Kansas, on September 7, 1883. He received

the B.S. degree from Kansas State College in 1908 and the A.M. degree from the University of Nebraska in 1913. From 1911 to 1918 he was an instructor in mathematics and physics at the University of Nebraska. In 1918 he became research engineer with the Westinghouse Electric and Manufacturing Company leaving there in 1922 to go with the Department of Terrestrial Magnetism of the Carnegie Institution of Washington where he is now Assistant Director and Chief of Section of Terrestrial Electricity. Mr. Gish is a Member of the American Association for the Advancement of Science, American Geophysical Union, Meteorological Society, Philosophical Society of Washington,



W. C. HAHN

Sigma Xi, and Washington Academy of Sciences. He is a Fellow of the American Physical Society.



W. W. HANSEN

W. C. Hahn (A '36) was born in Cedarville, Illinois, in 1901. He received the B.S. degree from Massachusetts Institute of Technology in 1923. In 1922 and 1923 he took the student engineering course at the General Electric Company,

and in 1924 was sent to their Chicago office where he was in the transmission-line and relay engineering department until 1932. Since 1933 Mr. Hahn has been in their engineering general department at Schenectady.



William W. Hansen was born in 1909 at Fresno, California. He received the A.B. degree in 1929 and the Ph.D. degree



L. M. HOLLINGSWORTH

in 1933 from Stanford University. Dr. Hansen was an instructor in physics at Stanford University from 1930 to 1932; National Research Fellow from 1933 to 1934; assistant professor of physics at



HARLEY IAMS

Stanford University from 1934 to 1937; and associate professor from 1937 to date.



Lowell M. Hollingsworth (A '37) was born at Portland, Oregon, on January 8, 1907. He received the B.S. degree in electrical engineering from Oregon State College in 1930 and the E.E. degree from Stanford University in 1935. From 1930

to 1932 Mr. Hollingsworth was with Bell Telephone Laboratories. Since 1936 he has been an instructor in engineering at San Francisco Junior College.



A. P. KING

Harley Iams (A '31—M '38) was born on March 13, 1905, at Lorentz, West Virginia. In 1927 he received the A.B. degree from Stanford University. Mr Iams



E. B. KURTZ

took the student course from 1927 to 1928, and from 1928 to 1930 was in the facsimile and television research department of the Westinghouse Electric and Manufacturing Company. Since 1931 he has been doing television research for the RCA Manufacturing Company.



Archie P. King (A '30) was born in Paris on May 4, 1901. He received the B.S. degree from California Institute of Technology in 1927. From 1927 to 1930 he was in the seismological research department of the Carnegie Institution of Washington, and from 1930 to date he has been with Bell Telephone Laboratories. Mr. King is a Member of the American Institute of Electrical Engineers.

E. B. Kurtz was born in 1894 at Cedarburg, Wisconsin. He received the B.S. degree in electrical engineering in 1917 from the University of Wisconsin; the M.S. degree in 1919 from Union College; and the Ph.D. degree in 1932 from Iowa State College. From 1917 to 1919 he was with the General Electric Company. Dr. Kurtz was at the Iowa State College from 1919 to 1925 and the Oklahoma Agricultural and Mechanical College from 1925 to 1929. Since 1929 Dr. Kurtz has been Professor of



M. J. LARSEN

Electrical Engineering and Head of Department at the University of Iowa. He is a member of Tau Beta Pi, Sigma Xi, Sigma Tau, and Phi Kappa Phi as well as being a Fellow of the American Institute of Electrical Engineers and the American Association for the Advancement of Science.



M. J. Larsen was born in 1909 at Spencer, Iowa. He received the B.S. degree in electrical engineering in 1933; the M.S. degree in 1934; and the Ph.D. degree in

1937 from the State University of Iowa. From 1928 to 1929 he was with the Northwestern Bell Telephone Company and spent the summer of 1937 in the research department of the Central Commercial Company. Since 1937 he has been an in-



G. F. METCALF

structor in electrical engineering at the Michigan College of Mining and Technology. He is a member of Sigma Xi, Eta Kappa Nu, and the Society for Promotion of Engineering Education.



G. F. Metcalf (A '34—M '37) was born on December 7, 1906, at Milwaukee, Wisconsin. He received the B.S. degree from Purdue University in 1928, and that same year took the General Electric Company's student engineering course. From 1929 to 1931 Mr. Metcalf was in the research laboratory of that company and since then has been in their vacuum-tube engineering department.



George C. Southworth (M '26) was born at Little Cooley, Pennsylvania, on August 24, 1890. He received the B.S. degree in 1914 and the M.S. degree in 1916 from Grove City College. In 1923 he was awarded the Ph.D. degree from Yale University. Dr. Southworth was assistant physicist at the Bureau of Standards from 1917 to 1918 and returned to Yale University as an instructor from 1918 to 1923. He joined the research staff on radio communication of the American Telephone



G. C. SOUTHWORTH

and Telegraph Company in 1923 and was transferred to Bell Telephone Laboratories where he has been since 1935. In 1927 and 1930 he was a De Forest (radio) lecturer at Yale University. He is a Member of the American Physical Society and a Fellow for the American Association for the Advancement of Science.



For biographical sketches of T. R. Gilliland, S. S. Kirby, and Newbern Smith, see the PROCEEDINGS for January, 1939.

THEY SPEAK FOR THEMSELVES

Erie SILVER-MICAS

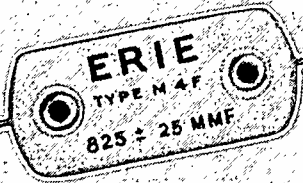

FOR ELIMINATING CONDENSER DRIFT

Erie CERAMICONS

REG. U.S. PAT. OFF.



FOR COMPENSATING FOR FREQUENCY DRIFT

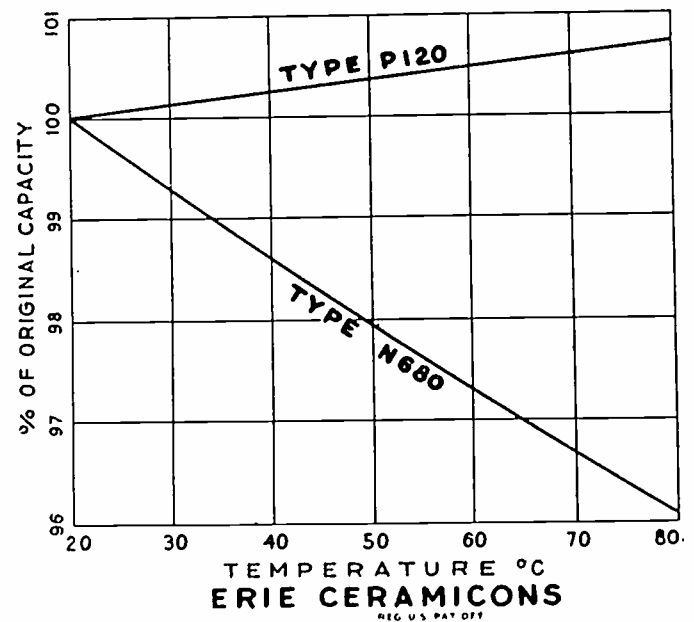
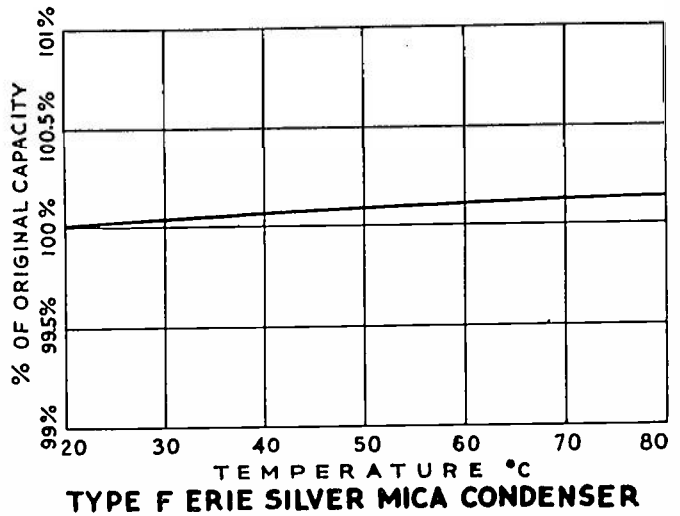

One look at these two charts tells why Erie Silver Mica Condensers and Erie Ceramicons are indispensable for keeping push button tuned receivers "tuned on the nose."

Erie Silver Micas eliminate condenser frequency drift because their temperature coefficient is only $+0.000025/°C$ —negligible for all practical purposes. And when frequency drift is present in other circuit elements, the use of a proper value Erie

Ceramicon can compensate for that change. These silver-ceramic condensers have a definite, linear and reproducible temperature coefficient.

Both of these units have been thoroughly tried and proven in the laboratory and in actual service. Their characteristics are unusually good, and their operation is unbelievably dependable.

Write today for specification booklets that give complete engineering data on these Erie Condensers.

ERIE RESISTOR CORPORATION, Erie, Pa.

TORONTO, CANADA • LONDON, ENGLAND • PARIS, FRANCE - J.E. CANETTI CO.

MANUFACTURERS OF RESISTORS • CONDENSERS • MOLDED PLASTICS

Commercial Engineering Developments

These reports on engineering developments in the commercial field have been prepared solely on the basis of information received from the firms referred to in each item.

Sponsors of new developments are invited to submit descriptions on which future reports may be based. To be of greatest usefulness, these should summarize, with as much detail as is practical, the novel engineering features of the design. Address: Editor, Proceedings of the I.R.E., 330 West 42nd Street, New York, New York.

Noise and Field Strength Meter

A portable microvolter has been developed by Ferris* for measuring the field intensity of radio noise and useful signals. It is an amplifier-detector-type instrument with an indicating output meter and a self-contained calibrator for standardizing the over-all gain of the system. Signals may be picked up by a 0.5-meter rod or introduced, voltmeter fashion, at 2 input terminals.

Since noise levels may fluctuate rapidly over wide ranges, the output meter has a logarithmic characteristic, obtained by the use of a variable- μ tube. It covers the 3 decades from 1 to 1000 microvolts or from 100 to 100,000 microvolts, depending on the setting of a multiplier switch.

By means of a panel switch, the characteristics of the rectifier-meter circuits may be changed from the "average-type" response required for carrier-voltage measurements to a quasi-peak type of response required to give readings that are approximately proportional to the interfering effectiveness of a noise wave. These weighted noise readings are stated in terms of equivalent microvolts of carrier; that is, the noise reading in microvolts is that value of carrier which would produce the same meter deflection.

The internal calibrator consists of a voltage generator that produces a uniform

*Ferris Instrument Corporation, Boonton New Jersey.

Ferris radio noise meter

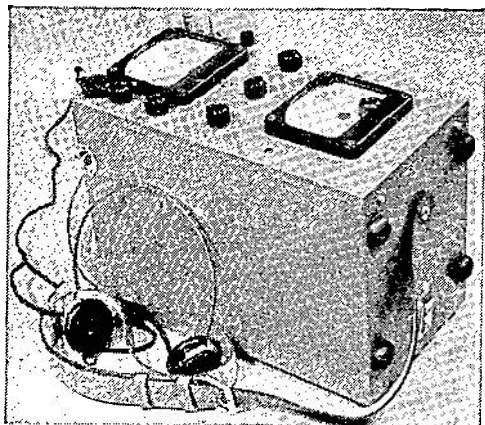

noise spectrum. No tuning of the instrument is required. The signal is derived from the shot noise of a vacuum tube whose space current has been limited by lowering the filament temperature.

The equipment is accurate to within about 3 decibels after standardizing with the shot-noise calibrator. Measurements good to within about 1 decibel are possible if an external calibrating unit is utilized. This is a small, battery-operated signal generator of conventional design.

Iron Cores for Power Oscillators

Because of voltage breakdown problems and heating in the material, efforts to apply powdered iron cores in high-frequency power oscillators have not been so successful as in the radio-receiver field. A core material and a core structure, announced by Mallory* are said to have overcome previous objections.

The material is composed of ferromagnetic particles of extremely small size

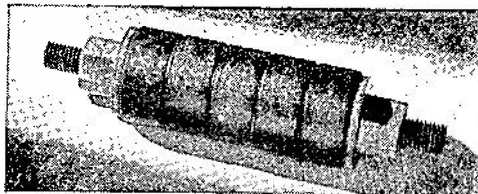

Five sections of a powdered-iron core assembled on a threaded rod of insulating material

which are compressed in a binder of insulation material. Grain sizes are such that cores made from it are recommended for general use in high- Q circuits at frequencies up to 3 megacycles. The apparent permeability is approximately 6, and an effective permeability (ratio between inductance values with and without the core) of about 3 can be realized in well-designed coils.

In the larger sizes the cores are made up of a series of annular cylindrical sections from $\frac{1}{2}$ to 2 inches in axial length and from $2\frac{3}{8}$ and $8\frac{3}{8}$ inches in outside diameter. These are assembled on an insulated shaft and insulated from each other by mica washers. Subdividing the core reduces the losses due to circulating currents and permits the use of relatively close-fitting coils in high-voltage transmitter circuits.

Numerous applications are suggested for design features in fixed and mobile transmitters. These are based on the possibility of reducing bulk and losses in inductors and of providing continuous adjustment of circuit tuning over wide frequency ranges.

Another grade of the same core material is available for use at lower frequencies and for applications where losses are of minor importance, such as antenna chokes, modulation transformers and chokes, etc. Its apparent permeability is approximately 8.

* P. R. Mallory & Co., Inc., Indianapolis, Indiana.

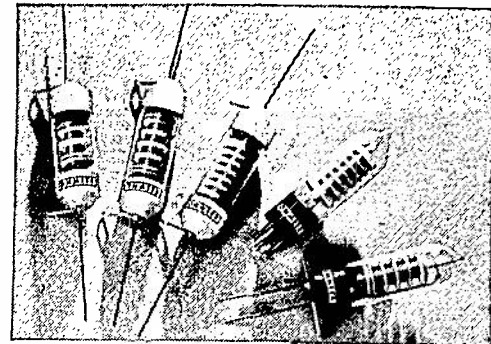

Sealed-in resistors

Resistors Sealed in Glass

Precision-type resistors, hermetically sealed in glass tubes, have been developed by Ohmite* for applications requiring protection against the effects of humid or corrosive atmospheres. They are available in a variety of mounting styles.

The resistors are non inductively wound on 2-, 4-, 6-, or 8-section spools, adjacent pies having the direction of winding reversed. After winding, the unit is baked to drive off moisture and impregnated with a material that increases the dielectric strength and bonds the wire and core together. The unit is then placed in the tube which is then evacuated, filled with a dried gas, and sealed by fusing the end of the tube onto the terminal wires.

Units are rated at 1 watt and are supplied for resistance values in the range between 0.1 ohm and 2 megohms. Although they can be supplied with a closer tolerance when required, they are ordinarily adjusted to within 1 per cent.

* Ohmite Manufacturing Company, 4860 West Flournoy Street, Chicago, Illinois.

Amplifier Gain Measuring Set

A direct-reading "gain indicator" for measuring the gain of audio-frequency power amplifiers is being manufactured by the Monarch Manufacturing Company.*

It consists of a 0- to 15-volt rectifier-type alternating-current voltmeter and a calibrated, constant-impedance attenuation network having an internal input impedance of 500 ohms and an internal output impedance that varies between 200 and 500 ohms, depending on the attenuator setting. The voltmeter can be connected across either the attenuator input or the amplifier load by means of a switch on the panel.

The instrument is intended to be used as follows: Power from an external source is supplied to the amplifier under test through the attenuation network, which is then adjusted until the meter indicates the same voltage for both positions of the meter switch. The power loss in the network is taken to be equal to the gain in the amplifier, and the result of the measurement in decibels is read directly from the attenuator scale. If the load and input im-

* Monarch Manufacturing Company, 3341 Belmont Avenue, Chicago, Illinois.

New speakers bring new significance to the term:

"Presence!"



ASK YOUR ENGINEER

to check-up on these latest pace-setters!

NEW single unit loud speakers by Bell Telephone Laboratories and Western Electric—

That give you high quality reproduction at moderate power levels—

That distribute sound over angles of 30° to 45°—making them admirably suited for monitor or public address applications—

That reproduce so faithfully, that the artists are brought into the "presence" of the listener—

That add crystal clear "definition" that enables monitor operators and production men to better evaluate program balance—

That employ an entirely new diaphragm formation, new type permanent magnet and other new design features.

Ask your engineers about this suitable companion to the Western Electric 94 type amplifier. Or better yet—order one speaker, evaluate its reproduction quality and let your monitor operators and production men tell you how much it helps them! Then you'll order more!

DISTRIBUTORS

Graybar Electric Co., Graybar Building, New York, N. Y.
In Canada and Newfoundland: Northern Electric Co., Ltd.
In other countries: International Standard Electric Corp.

HIGH QUALITY
DIRECTIVE BEAM

make the
750A and 751A

ideal for
MONITORING

Western Electric



RADIO TELEPHONE BROADCASTING EQUIPMENT

BLILEY CRYSTALS

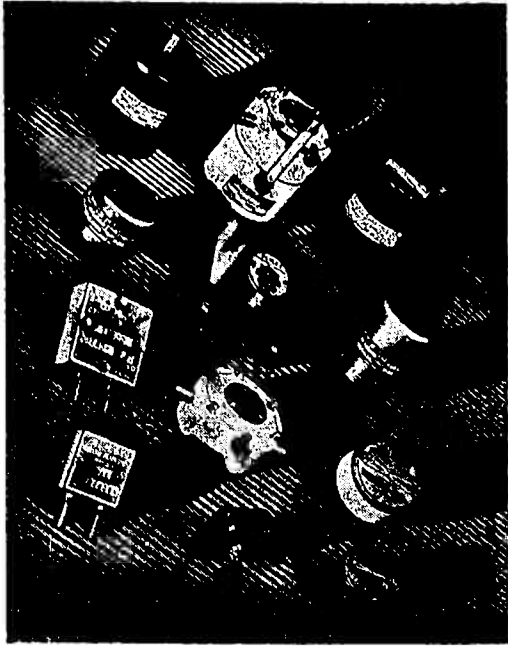

HOLDERS OVENS

ONLY carefully selected Brazilian Quartz is used in the manufacture of Bliley General Communication Frequency Crystals. As each individual crystal passes through its various processing operations, many optical, mechanical and electrical examinations are applied to insure the highest possible standards of precision and quality.

So that proper characteristics and frequency accuracy can be guaranteed, each crystal is finally checked and calibrated in the holder in which it will operate. Bliley crystal holders and oven mountings are engineered particularly for dependable performance of Bliley Crystals from 20kc. to 30mc. Various types are available to suit frequency control requirements throughout the complete crystal frequency range.

A competent engineering staff is maintained for product research and development. Recommendations and quotations covering quartz crystals for any standard or special applications will gladly be extended without obligation. Write for catalog G-10 describing Bliley General Communication Frequency Crystals.

BLILEY ELECTRIC CO.
UNION STATION BUILDING ERIE, PA.

(Continued from page ii)

pedances of the amplifier are not equal, a term (20 log impedance ratio) is applied to correct for the difference in impedance level. A chart relating the impedance ratio and the correction is supplied with the instrument.

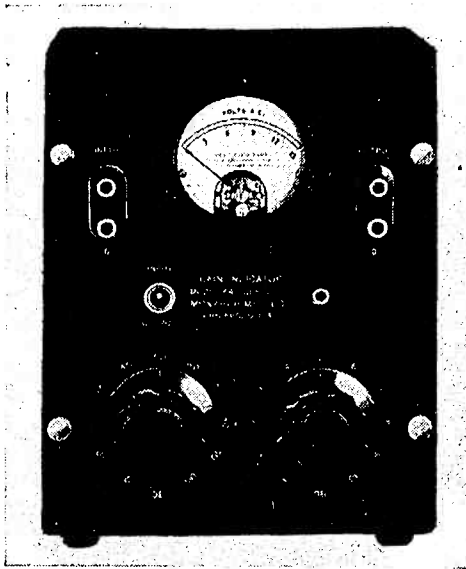

Monarch gain indicator

The attenuator is made up of resistive elements, non-inductively wound on thin cards and individually adjusted. It has a total range of 110 decibels: 10 steps of 10 decibels and 10 steps of 1 decibel.

Standards for High-Frequency Impedance Measurements

In an effort to extend the range of commercially practicable impedance measurements to higher frequencies, the General Radio Company* has developed a fixed resistor of the straight-wire type and improved the characteristics of one of its precision-type variable air condensers.

In condensers of conventional construction, current enters at one end of the rotor and stator stacks. The system was analyzed on the assumption that the current decreases linearly along the rotor shaft and stator-support rods and that the inductance and metallic resistance are uniformly distributed. It was found that by feeding the current into the center of each stack, both the resistance and inductance would be reduced to about $\frac{1}{3}$ of their values in an end-fed system.

The method adopted for feeding current at the center is shown in the accompanying photograph. A heavy strip connector feeds the stator stack, and a circular brass disk with a wide brush contactor feeds the rotor.

In the design of the straight-wire resistor, manganin wire as small as 0.0006 inch in diameter was selected in order to minimize temperature coefficient and the change in effective resistance with frequency due to skin effect. While the small values of inductance and capacitance that are inherent in the straight-wire type of construction were desirable, further studies showed that reducing one reactance parameter at the expense of the other would often materially raise the frequency

* General Radio Company Cambridge, Massachusetts.



• CREI Originated Training in Practical Radio Engineering

CREI Training is Recognized for its high Standard

The manner in which the radio industry has acknowledged CREI men as well-trained men is best exemplified by the fact that CREI students and graduates are now employed in more than 275 U. S. broadcasting stations. Among our students are engineers in top positions and those "just breaking in" . . . it is this desire of most radiomen to acquire more technical ability that forms the backbone of a growing industry.

We, too, are keeping pace. Lessons are under constant revision to embody latest developments and advances in every branch of the field. The acquisition of our own well-equipped building is another step in our constant effort to provide increased facilities for modern, practical training.

"A Tested Plan for a
Future in Practical
Radio Engineering"

You will find it worthwhile to read this interesting booklet. It contains complete details about our school and courses. Write for your free copy today.

**Capitol Radio
ENGINEERING INSTITUTE**

E. H. RIETZKE, Pres.
Dept. PR-2
3224 SIXTEENTH ST., N.W.
WASHINGTON,
D.C.

AEROVOX

CAPACITY and
RESISTANCE

Bridge

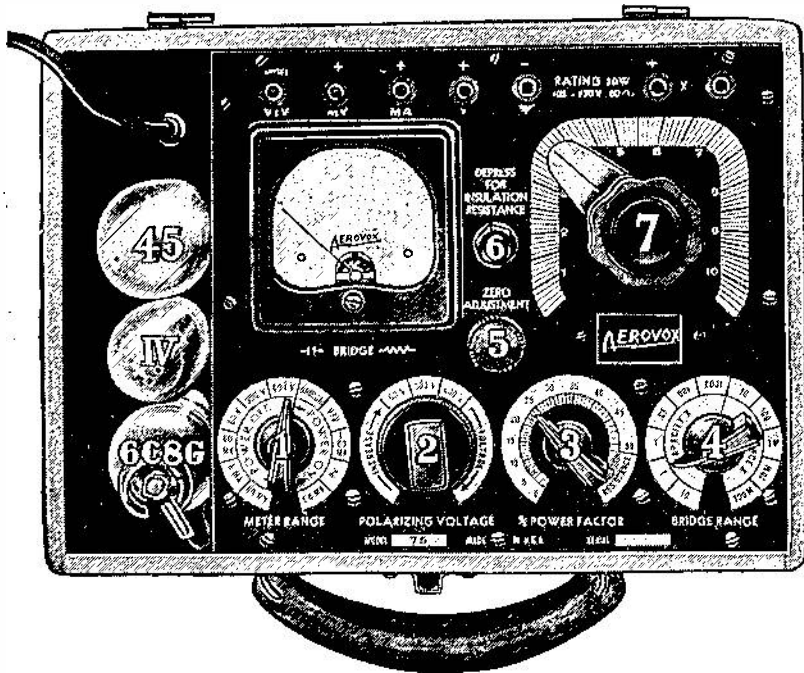

In the best interests of ALL users of condensers, AEROVOX engineers have developed this more critical checking means. Tests and readings, more than any claims and superlatives, best tell the true story of any and all condensers.

Years of experience testing and checking condenser quality have been boiled down to provide this simple, portable, moderately-priced instrument. A handy manual supplied with each instrument (or 50¢ separately) reviews the entire bridge art. You simply can't afford to be without this condenser yardstick.

Ask to See It . . .

- Your local AEROVOX jobber can show you this unique instrument. Or if you prefer, write us direct for descriptive literature.

The Latest in Condenser Checking ...and what it does

1 Motor Range Switch . . . the "brains" of the Aerovox Bridge. Provides external milliammeter first three positions; external voltmeter next three positions, ranging from 60 to 600 v. at 1000 ohms per volt; "Bridge" indicates power on and balancing position. Also provides vacuum-tube voltmeter and insulation resistance test at "VTV"; leakage test through X terminals at "L 60 MA" and "L 6 MA" positions; and polarizing voltage readings on proper meter range at "PV" position.

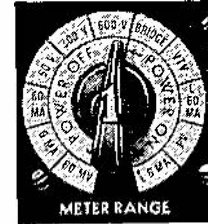

2 Polarizing Voltage Control. Inner knob serves as transformer tap switch. Outer knob is vernier control indicating continuously variable voltage 15 to 600 volts in 3 steps. Voltmeter automatically switched to proper range 0-60, 0-300, 0-600. Variable voltage available between terminals +X and Ground for meter calibration, load tests, amplifiers, etc.



3 Power factor control and switch for insulation resistance test.



4 Bridge Range control . . . for reading capacity:

- 10 — 100 mfd.
- 1 — 10 mfd.
- .1 — 1 mfd.
- .01 — .1 mfd.
- .001 — .01 mfd.
- .0001 — .001 mfd.

Multiplying factor for both capacity and resistance indicated on face of control.



5 Zero Adjustment for vacuum-tube voltmeter and bridge detector.



6 Push Button for insulation resistance test.



7 Main Dial, linear calibrated, for capacity and resistance readings.



AEROVOX CORPORATION

New Bedford, Mass.



Sales Offices in All Principal Cities

An Outstanding Patented
Circuit Recommended By
the Best Laboratories and
Technicians.

SELF-CALIBRATING VACUUM TUBE VOLTMETER

Model
1252



Only
\$48.33
Net
Price

The initial operation of adjusting bridge cancels out error independent of the tube emission values or when replacing tubes.

Model 1252 is furnished with the exclusive Triplet tilting type twin instrument. One instrument indicates when bridge is in balance—the other is direct reading in peak volts. Above, below and null point indicated by the exclusive feature of the circuit. Tube on Cable . . . Particularly desirable for high frequency work. . . Ranges: 3-15-75-300 Volts.

Furnished complete with all necessary accessories including 1-84, 1-6P5, 1-76. Case is metal with black wrinkle finish, 7⁷/₈ x 6⁵/₈ x 4⁵/₈ inches. Etched panel is silver and red on black.

Model 1251 same as 1252 but with tube located inside case . . . DEALER PRICE . . . \$47.67

Model 1250 same as 1251 except ranges are 2.5, 10, 50 volts . . . DEALER PRICE . . . \$36.67



The Triplet Electrical Instrument Co.
212 Harmon Ave., Bluffton, Ohio
Please send me more information on—

Model 1252; Model 1251; Model 1250.

Name

Address

City State

(Continued from page iv)

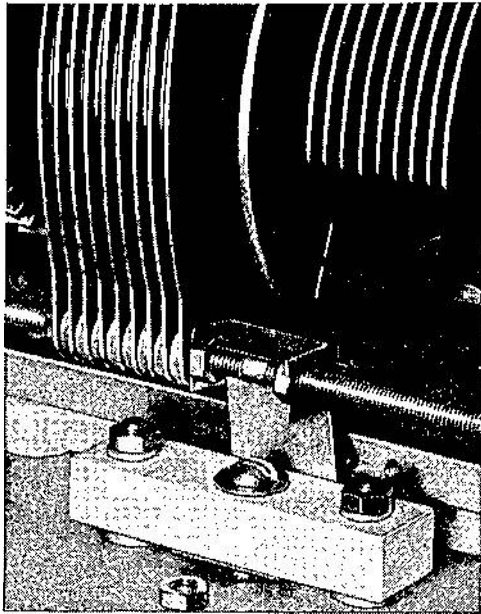

Center-fed condenser (with right-hand stator stack removed to show the method of making connections to the rotor)

limit below which the effective resistance and reactance would remain within satisfactory limits. That is why the construction shown in the following photograph was adopted.

The resistance wire is clamped down on a thin piece of mica, backed by two flat metal plates which also serve as lugs for connections. As a result, the inductance is decreased below what it would be in free space by virtue of the shielding effect of the current in the plates. The plates also help to dissipate heat and improve the power handling ability of the unit.

Resistors of this type are built in 7 sizes between 1 and 100 ohms.

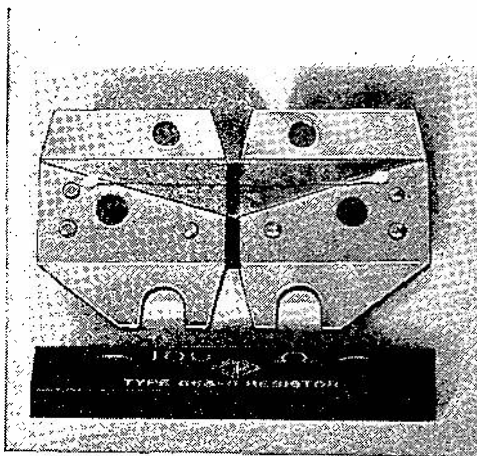

A 100-ohm straight-wire resistor with the clamping plate removed to show the element

Booklets, Catalogs and Pamphlets

The following commercial literature has been received by the Institute.

ELIMINATORS *Electro Products Laboratories, 549 West Randolph Street, Chicago, Illinois. Catalog 1138. 2 pages, 8¹/₂ x 11 inches.* Description of 3 low-hum-level battery eliminators.

INSTRUMENTS *Triplet Electrical Instrument Co., Bluffton, Ohio. Price Sheets 50-I and 50-T, 8 pages, 8¹/₂ x 11 inches.* Indicating instruments and tube- and service-test sets, prices and brief specifications.

INSTRUMENTS *Roller-Smith Company, Bethlehem, Pennsylvania. Catalog 48-a. 8 pages, 8¹/₂ x 11 inches.* Description and dimensions of 3- and 4-inch, round and square panel instruments.

MARINE RADIO TELEPHONE *Western Electric Company, 195 Broadway, New York, New York. Bulletin T1570. 4 pages, 8 x 11 inches.* 2-way radio telephone equipment for inter-ship and ship-to-shore service on small boats.

RADIO RANGE FILTER *RCA Manufacturing Company, Inc., Camden, New Jersey. Data Sheet No. 4. 2 pages, 8¹/₂ x 11 inches.* A unit to separate voice and range signals in an aircraft radio receiver.

RELAYS *C. P. Clare & Co., 4541 Ravenswood Avenue, Chicago, Illinois. Catalog CCL. 10 pages + cover, 8¹/₂ x 11 inches.* Descriptions and specifications on direct-current relays for low-power control service.

MAGNETIC TELEPHONE *Western Electric Company, 195 Broadway, New York, New York. Bulletin T1543. 4 pages, 8 x 11 inches.* A sound-powered telephone for intercommunication service on ship-board.

TRANSFORMERS *Robert M. Hadley Co., 266 So. Chapel Street, Newark, Delaware. Catalog T6. 16 pages, 8¹/₂ x 11 inches.* Power and amplifier-coupling transformers.

TUBE DATA (KEN-RAD) *Ken-Rad Tube & Lamp Corporation, Owensboro, Kentucky. Engineering Bulletin 38-21, 29 pages, 8¹/₂ x 11 inches.* Considerations involved in the application of converter and mixer tubes.

UBET DATA (KEN-RAD) *Ken-Rad Tube & Lamp Corporation, Owensboro, Kentucky, Bulletin, 8 pages, 8¹/₂ x 11 inches.* "Essential Characteristics of Metal, 'G' Series, and Glass Radio Tubes" (tabular data, base connections, and outline drawings.)

TUBE DATA (RCA) *RCA Manufacturing Company, Harrison, New Jersey. Application Note No. 101. 9 pages, 8¹/₂ x 11 inches.* "On Input Loading of Receiving Tubes at Radio Frequencies."

TUBE DATA (RAYTHEON) *Raytheon Production Corporation, Newton, Massachusetts. Data Sheets. 11 pages, 8¹/₂ x 11 inches.* Description and characteristics of 4 permatrons (magnetic-control gas-filled control tubes).

TUBE DATA (WESTINGHOUSE) *Westinghouse Electric & Manufacturing Company, Bloomfield, New Jersey. Bulletin No. 17. 4 pages, 8¹/₂ x 11 inches.* Description and brief summary of characteristics of ignitrons.

VACUUM CONDENSER *Eitel McCullough, Inc., San Bruno, California. Bulletin, 4 pages, 8¹/₂ x 11 inches.* Description and performance data on a vacuum-sealed-in-glass condenser for tank-circuit applications.

CONDENSERS *Tobe Deutschmann Corporation, Canton, Massachusetts. Catalog, 12 pages, 8¹/₂ x 11 inches.* Wet and dry electrolytics and paper condensers, a listing of specifications.

IRE membership offers many services to the radio engineer

Proceedings—An outstanding publication in the radio engineering field. Over a quarter of a century of service to the world in publishing important radio engineering discoveries and developments, the PROCEEDINGS presents exhaustive engineering data of use to the specialist and general engineer. A list of its authors is a "Who's Who" of the leaders in radio science, research, and engineering.

Standards—Since 1914 our standards reports have stabilized and clarified engineering language, mathematics, graphical presentations, and the testing and rating of equipment. They are always in the process of revision and thus remain up to date.

Meetings—In twenty-two cities in the United States and Canada, meetings of the Institute and its sections are held regularly. Scores of papers on practically every branch of the field are presented and discussed. Several convention meetings are sponsored by the Institute and add materially to its effectiveness in distributing data of value to engineers.

The Institute of Radio Engineers

Incorporated

330 West 42nd Street, New York, N.Y.

To the Board of Directors
Gentlemen:

I hereby make application for ASSOCIATE membership in the Institute of Radio Engineers on the basis of my training and professional experience given herewith, and refer to the members named below who are personally familiar with my work.

I certify that the statements made in the record of my training and professional experience are correct, and agree if elected, that I shall be governed by the Constitution of the Institute as long as I continue a member. Furthermore I agree to promote the objects of the Institute so far as shall be in my power, and if my membership shall be discontinued shall return my membership badge.

.....
(Sign with pen)

.....
(Address for mail)

.....
(City and State)

.....
(Date)

SPONSORS

(Signatures not required here)

Mr.

Address

City and State

Mr.

Address

City and State

Mr.

Address

City and State

ENTRANCE FEE SHOULD ACCOMPANY APPLICATION

ENGINEERING DIRECTORY

Consultants, Patent Attorneys,
Laboratory Services

CONSULTANTS AND DESIGNERS

including
Amplifiers · Antennas · Transmitters
Receivers · Laboratory Equipment
Special equipment designed
and constructed

RADIO DEVELOPMENT & RESEARCH CORP.

145 West 45th Street, New York, N.Y.
Tel. BRyant 9-6898

BRUNSON S. McCUTCHEM and CHARLES B. AIKEN Consulting Engineers

Technical cooperation with Attorneys in
connection with patent litigation—De-
sign and Development work—Audio and
radio frequency measurements—Equip-
ment studies—Receiver and transmitter
problems—A well equipped laboratory.
75 West Street Telephone
New York City Whitehall 4-7275

ALFRED CROSSLEY Consulting Engineer

Radio-engineering problems involving
receiver design, iron-core investigations,
and A- and B-battery substitutes

549 West Randolph Street, Chicago,
Illinois; Telephone STAt 7444

Use this directory . . .

when you need consulting serv-
ices

when you are asked to suggest
the name of a specialist on an en-
gineering or patent problem

Consulting Engineers, Patent Attor-
neys, Laboratory Services . . . Applica-
tions for card space in the Engineering
Directory are invited. Complete data
will be sent on request to

PROCEEDINGS of the I.R.E.

330 West 42nd Street New York, N.Y.

INDEX

COMMERCIAL ENGINEERING
DEVELOPMENTSii

BOOKLETS, CATALOGS, & PAMPHLETS. .vi

POSITIONS OPENx

ENGINEERING DIRECTORYx

DISPLAY ADVERTISERS

A

Aerovox Corporationv

American Telephone & Telegraph
Co.xi

B

Bliley Electric Companyiv

C

Capitol Radio Engineering Institute. iv

Cornell-Dubilier Electric Corp.xii

E

Erie Resistor Corporationi

G

General Radio Company Cover IV

R

RCA Manufacturing Co., Inc.
..... Cover III

T

Triplett Electrical Instruments Co. . .vi

W

Western Electric Companyiii

POSITIONS OPEN

The following positions of interest
to I.R.E. members have been re-
ported as open on January 27.
Make your application in writing
and address it to

Box No.

PROCEEDINGS of the I.R.E.
330 West 42nd Street, New York, N.Y.

TELEVISION SERVICE

INSTALLATION AND SERV-
ICE department of a television-
receiver manufacturer wants engi-
neers for educational, contact, and
service work among dealers in
the New York area. Applicants
should be engineering graduates
familiar with radio equipment
through practical service or ama-
teur experience. Give full details
of education and experience. Pres-
ent staff knows of these openings.
Box No. 192.



Attention

Employers . . .

Announcements for "Positions
Open" are accepted without charge
from employers offering salaried
employment of engineering grade
to I.R.E. members. Please supply
complete information and indicate
which details should be treated as
confidential. Address: "POSITIONS
OPEN," Institute of Radio Engi-
neers, 330 West 42nd Street, New
York, N.Y.

The Institute reserves the right to refuse any
announcement without giving a reason for
the refusal . . .

"I Wonder What Time My Daddy Will Telephone?"

"The minute he calls up I'm going to speak to him about Bobby. He's my cousin, and he's just five weeks old. *And they haven't got a telephone where he lives!*

"One of these days his mother's going to run out of his talcum. Or she'll want his father to stop at the drug store on the way home for oil. Or maybe she'll want to ask the doctor about that rash on his back — Bobby's back, I mean.

"Then suppose some week he gains six ounces. Don't they expect to tell their friends news like that?

"Well, how is Bobby's mother going to do all those things besides her marketing?

"I'm going to see if my Daddy can't fix it. He's always saying how good telephone service is — and how cheap."

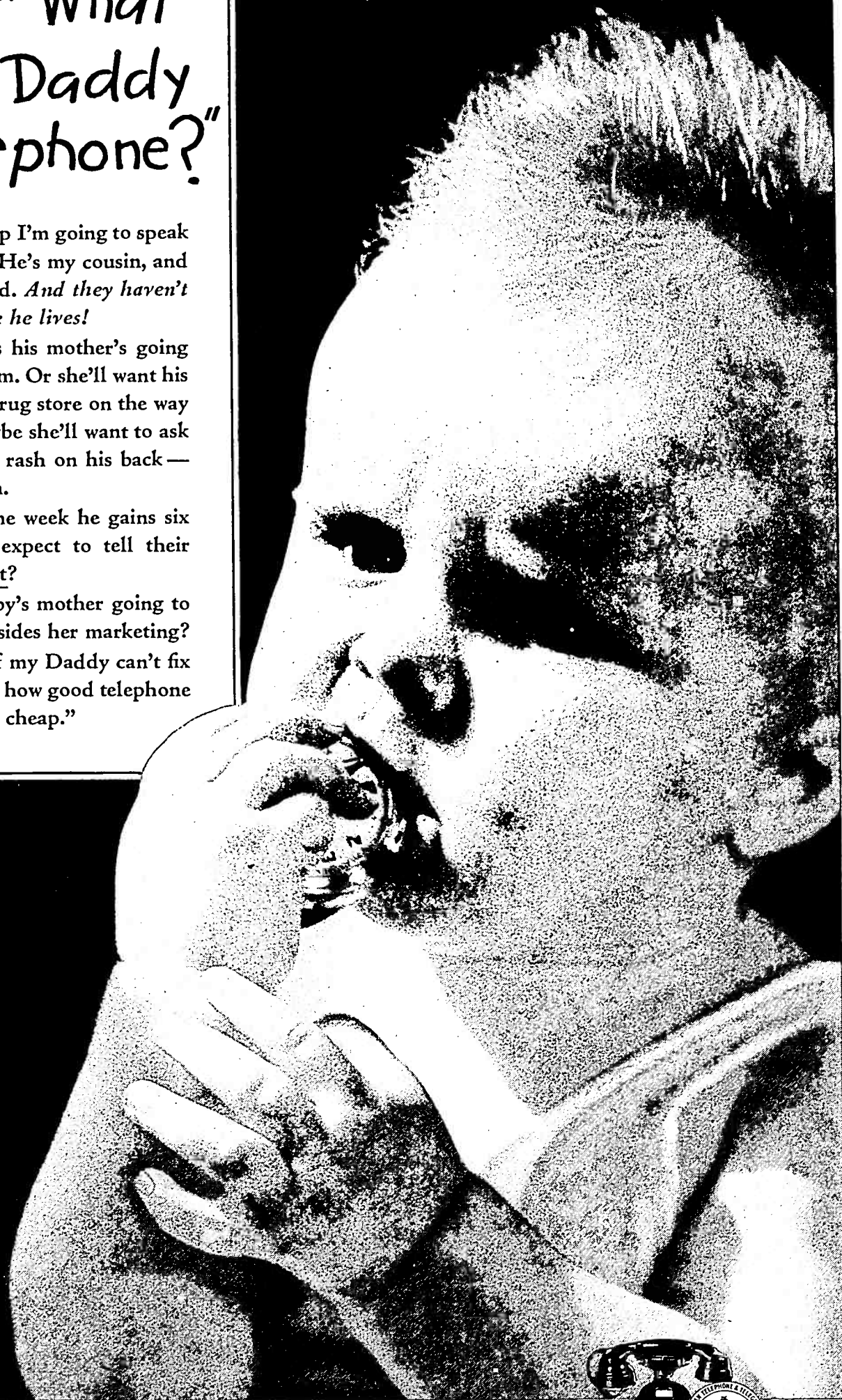

B E L L T E L E P H O N E S Y S T E M

You are cordially invited to visit the Bell System exhibit at the Golden Gate International Exposition, San Francisco



Time Table in Action...

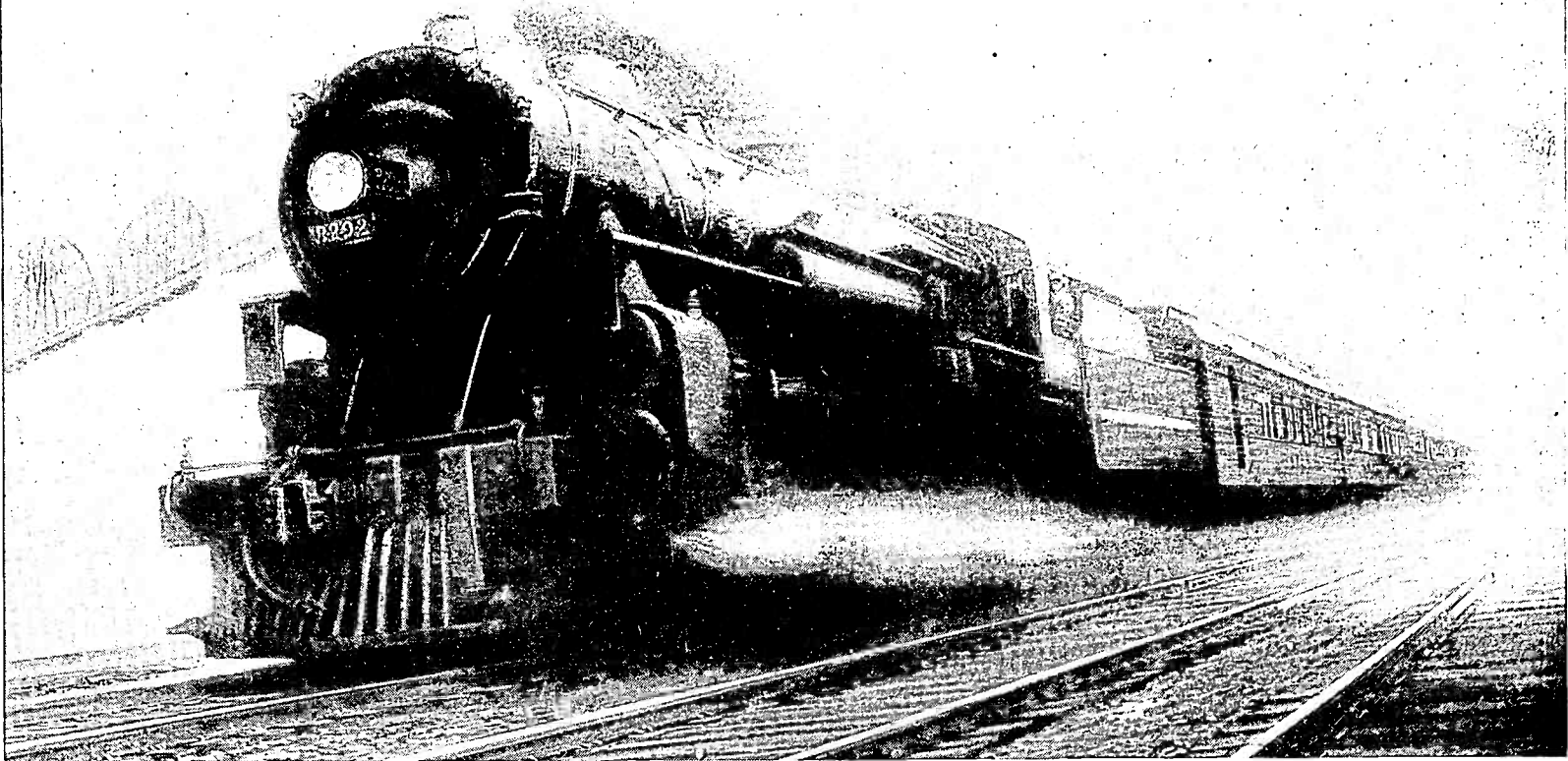

ABOVE PHOTO COURTESY NEW YORK CENTRAL SYSTEM

You'll find the same dependability in C-D Capacitors

Emphasis today is on comfort . . . luxury . . . style. But *ON TIME* is still the first consideration of the nation's railroads. A capacitor, too, may have many fine qualities—each praiseworthy in itself. But unless these add up to *DEPENDABILITY*, your capacitor is not a good investment. Cornell-Dubilier is proud of the fact that, in engineering circles today, the initials of C-D have come to *stand for capacitor dependability*.

C-D engineers will be happy to cooperate with you on your capacitor requirements. Catalog No. 160 listing the entire C-D line is available free of charge. Your inquiries are invited.

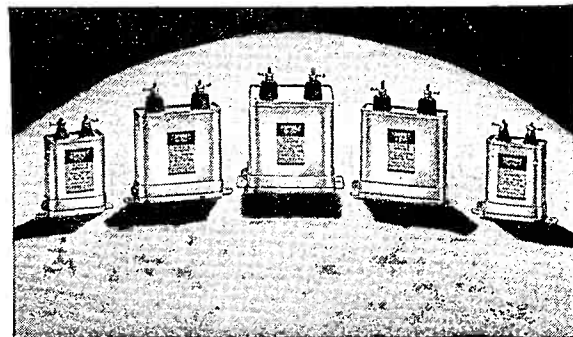

DYKANOL FILTER CAPACITORS • TYPE TJU

Carefully designed, compact, light-weight, safely-rated, furnished with universal mounting clamps, well-insulated terminals, fire-proof, these units are without a doubt the most dependable capacitors offered the radio industry. Type TJU Dykanol capacitors are being used by practically every broadcast and government station in the world. For complete description see Catalog No. 160.

Product of the world's largest manufacturer of capacitors.

MICA • DYKANOL • PAPER
WET AND DRY ELECTROLYTIC CAPACITORS

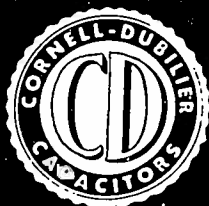

CORNELL-DUBILIER ELECTRIC CORPORATION

1012 Hamilton Boulevard, South Plainfield, New Jersey

Cable Address: "CORDU"

The Single-Ended Metal Tube

**ANOTHER RCA
ACHIEVEMENT IN
DESIGN!**

There are 6 different types—all of them small—all offering advantages radio set manufacturers will appreciate!

The special construction of the 6SA7 provides excellent oscillator frequency stability. The magnitude of input capacitance of the oscillator grid is not appreciably affected by signal-grid bias. Changes in cathode current and in oscillator transconductance with AVC voltage are small.

RCA 6SK7...this is a new r-f amplifier pentode offering the same features as the 6SA7 plus more stable amplifier operation... greater uniformity of amplifier gain...and higher gain per stage. This tube not only has the same grid plate capacitance as tubes wearing grid caps, but also offers lower input and output capacitance values—plus higher transconductance. Has remote cut-off characteristic and small wafer octal, 8-pin base to fit standard octal socket.

RCA 6SJ7...this is a new r-f amplifier pentode with the same features as the 6SK7 except that this tube has a sharp cut-off characteristic.

RCA 6SF5... a new high-mu triode... and the RCA 6SQ7... a

new duplex-diode high-mu triode, are audio type tubes. They employ the same single-ended construction and have the same characteristic features and advantages as the r-f pentodes. Base-shielding reduces hum voltage picked up by grid lead from heater leads, permits operation with satisfactory hum level.

RCA 6SC7...a new twin triode amplifier designed primarily for phase inverter service. Hum voltage picked up by the grid lead from the heater leads is greatly reduced because of inter-lead shielding between grid and heater within the base. This permits operation with satisfactory hum level.

RCA presents the Magic Key every Sunday, 2 to 3 P.M., E.S.T., on the NBC Blue Network

Over 325 million RCA radio tubes have been purchased by radio users... In tubes, as in radio sets, it pays to go RCA All the Way.

For complete details about any of these tubes write to the address below



Here are some of the fine features of the RCA 6SA7—a new Pentagrid Converter

- Self-shielded envelope
- Complete wiring below set panel
- No grid lead to connect
- Cleaner, neater chassis
- No loose or broken grid leads
- Higher conversion gain
- Small frequency shift at high frequencies
- Economy
- Simplification of tube renewal



Radiotrons

A SERVICE OF THE
RADIO CORPORATION
OF AMERICA

RCA MANUFACTURING COMPANY, INC., HARRISON, N. J.

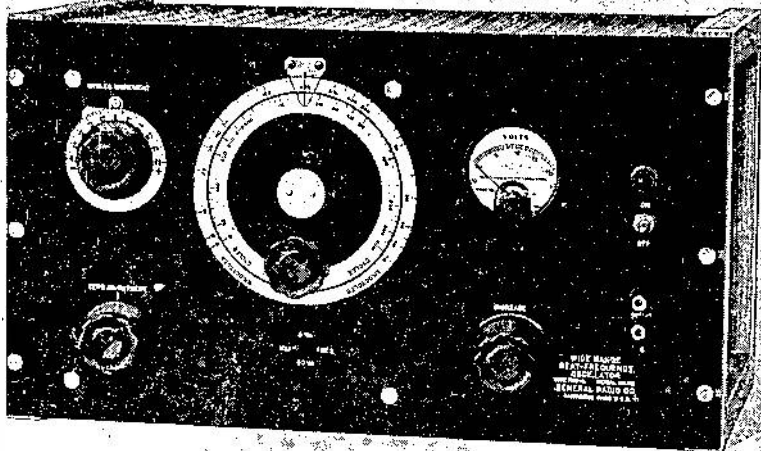
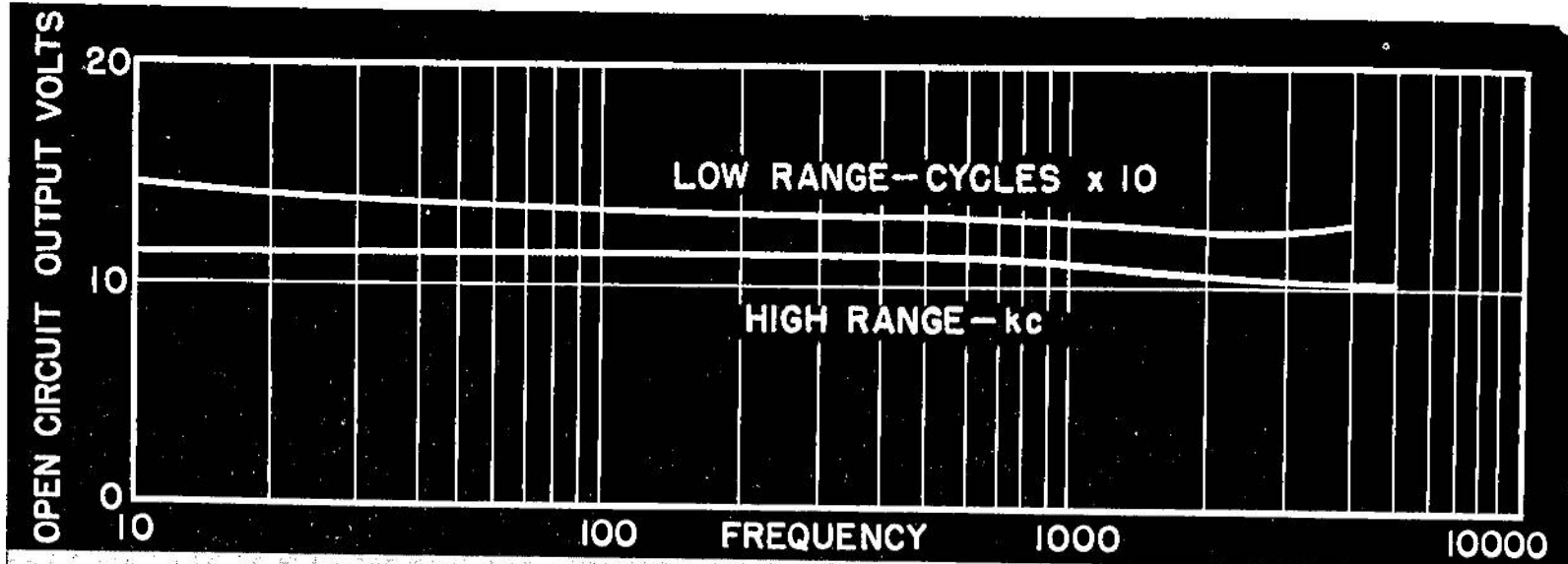

NEW WIDE-RANGE BEAT-FREQUENCY OSCILLATOR

FOR some time there has been need for a wide-range oscillator with substantially constant output of moderate power, not only for general laboratory bridge measurements but also for taking selectivity curves over a very wide range of frequencies, for measuring transmission characteristics of filters and for testing wide-band systems such as television amplifiers and coaxial cables.

The new General Radio Type 700-A Beat-Frequency Oscillator was designed for these applications. Through unique circuit and mechanical design and very careful mechanical construction it has been possible to manufacture an oscillator of good stability, output and waveform at an exceptionally low price.

FEATURES

WIDE RANGE—two ranges: 50 cycles to 40 kc and 10 kc to 5 Mc.

DIRECT READING—scale on main dial approximately logarithmic in frequency. Incremental frequency dial direct reading between -100 and +100 cycles on low range and -10 and +10 kilocycles on high range.

ACCURATE CALIBRATION—low range: $\pm 2\%$ ± 5 cycles; high range: $\pm 2\%$ ± 1000 cycles; incremental dial: ± 5 cycles low range; ± 500 cycles high range.

GOOD FREQUENCY STABILITY—adequate thermal distribution and ventilation assure minimum frequency drift. Oscillator can be reset to zero beat to eliminate errors caused by small drifts.

GROUNDING OUTPUT TERMINAL—output taken from 1,500 ohm potentiometer.

CONSTANT OUTPUT VOLTAGE—open-circuit voltage remains constant between 10 and 15 volts within ± 1.5 db over entire frequency range.

GOOD WAVEFORM—total harmonic content of open-circuit voltage is less than 3% above 250 cycles on low range and above 25 kc on high range.

A-C OPERATION—power-supply ripple less than 2% of output voltage on either range.

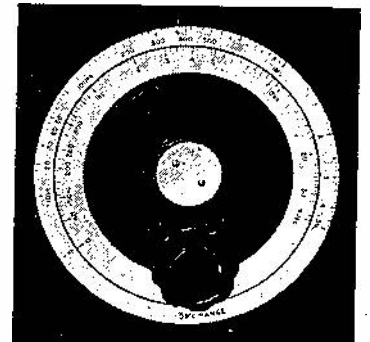

Type 700-A Wide-Range Beat Frequency Oscillator . . . \$555.00

• Write For Bulletin 363 For Complete Information

GENERAL RADIO COMPANY, Cambridge, Mass. New York
Los Angeles

MANUFACTURERS OF PRECISION RADIO LABORATORY APPARATUS