

BRUCE

VOLUME 23

JUNE, 1935

NUMBER 6

PROCEEDINGS
of
**The Institute of Radio
Engineers**



**Tenth
Annual Convention**
Detroit, Michigan
July 1, 2, and 3, 1935

Application Blank for Associate Membership on Page XIII

**INSTITUTE OF RADIO ENGINEERS
TENTH ANNUAL CONVENTION
HOTEL STATLER, DETROIT MICHIGAN
JULY 1, 2, AND 3, 1935
CONDENSED PROGRAM**

Sunday—June 30

4:00 P.M.—6:00 P.M. Registration

Monday—July 1

9:00 A.M. Registration and opening of exhibition.
10:00 A.M.—12:30 P.M. Official welcome and technical session—Large Meeting Room.
10:00 A.M.—11:00 A.M. Official greetings at ladies headquarters.
11:00 A.M.—5:00 P.M. Trip No. 1. Ladies sight-seeing trip.
12:30 P.M.—2:00 P.M. Luncheon and inspection of exhibits.
2:00 P.M.—3:30 P.M. Technical Session—Large Meeting Room.
2:00 P.M.—3:30 P.M. Technical Session—Small Meeting Room.
3:30 P.M.—6:00 P.M. Trip No. 2. General Motors Research Laboratory.
6:00 P.M.—7:00 P.M. Inspection of exhibits.

Tuesday—July 2

9:00 A.M.—10:00 A.M. Registration and inspection of exhibits.
10:00 A.M.—11:30 A.M. Technical Session—Large Meeting Room.
10:00 A.M.—11:30 A.M. Technical Session—Small Meeting Room.
10:00 A.M.—11:30 A.M. Trip No. 3. Ladies shopping tour.
11:30 A.M.—6:00 P.M. Trip No. 4. Greenfield Village.
6:00 P.M. Exhibits close.
7:00 P.M. Annual banquet and entertainment.

Wednesday—July 3

9:00 A.M. Registration and opening of exhibits.
10:00 A.M.—11:30 A.M. Technical Session—Large Meeting Room.
10:00 A.M.—11:30 A.M. Technical Session—Small Meeting Room.
11:00 A.M.—6:00 P.M. Trip No. 5. Ladies luncheon and sight-seeing trip.
11:30 A.M.—1:00 P.M. Luncheon and inspection of exhibits.
1:00 P.M.—6:00 P.M. Trip No. 6. Ford Motor Plant.
4:00 P.M. Closing of exhibits.

PROCEEDINGS OF
The Institute of Radio Engineers

Volume 23

June, 1935

Number 6

Board of Editors

ALFRED N. GOLDSMITH, *Chairman*

R. R. BATCHER

H. H. BEVERAGE

F. W. GROVER

J. W. HORTON

G. W. PICKARD

K. S. VAN DYKE

H. P. WESTMAN, *ex officio*

L. P. WHEELER

L. E. WHITTEMORE

WILLIAM WILSON

CONTENTS

PART I

Condensed Program of Tenth Annual Convention.....	Cover II
Frontispiece, Hotel Statler, Convention Headquarters.....	546
Institute News and Radio Notes.....	547
Tenth Annual Convention.....	547
May Meeting of the Board of Directors.....	566
Election Notice.....	567

PART II

Technical Papers

Image Suppression in Superheterodyne Receivers... HAROLD A. WHEELER	569
The Design and Testing of Multirange Receivers..... DANIEL E. HARNETT AND NELSON P. CASE	578
High Fidelity Receivers with Expanding Selectors..... HAROLD A. WHEELER AND J. KELLY JOHNSON	594
Acoustic Testing of High Fidelity Receivers..... HAROLD A. WHEELER AND VERNON E. WHITMAN	610
High Quality Radio Broadcast Transmission and Reception. Part II..... STUART BALLANTINE	618
A High-Frequency Sweep Circuit..... T. T. GOLDSMITH, JR., AND L. A. RICHARDS	653
Report on Ionization Changes During a Solar Eclipse..... E. V. APPLETON AND S. CHAPMAN	658
Diurnal and Seasonal Variations in the Ionosphere During the Years 1933 and 1934..... J. P. SCHAFER AND W. M. GOODALL	670
Correction to "Designing Resistive Attenuating Networks," by P. K. McELROY.....	682
Contributors to This Issue.....	683

Copyright, 1935, by the Institute of Radio Engineers

The Institute of Radio Engineers

GENERAL INFORMATION

INSTITUTE. The Institute of Radio Engineers was formed in 1912 through the amalgamation of the Society of Wireless Telegraph Engineers and the Wireless Institute. Its headquarters were established in New York City and the membership has grown from less than fifty members at the start to several thousand.

AIMS AND OBJECTS. The Institute functions solely to advance the theory and practice of radio and allied branches of engineering and of the related arts and sciences, their application to human needs, and the maintenance of a high professional standing among its members. Among the methods of accomplishing this is the publication of papers, discussions, and communications of interest to the membership.

PROCEEDINGS. The PROCEEDINGS is the official publication of the Institute and in it are published all of the papers, discussions, and communications received from the membership which are accepted for publication by the Board of Editors. Copies are sent without additional charge to all members of the Institute. The subscription price to nonmembers is \$10.00 per year, with an additional charge for postage where such is necessary.

RESPONSIBILITY. It is understood that the statements and opinions given in the PROCEEDINGS are views of the individual members to whom they are credited, and are not binding on the membership of the Institute as a whole. Papers submitted to the Institute for publication shall be regarded as no longer confidential.

REPRINTING PROCEEDINGS MATERIAL. The right to reprint portions or abstracts of the papers, discussions, or editorial notes in the PROCEEDINGS is granted on the express condition that specific reference shall be made to the source of such material. Diagrams and photographs published in the PROCEEDINGS may not be reproduced without making specific arrangements with the Institute through the Secretary.

MANUSCRIPTS. All manuscripts should be addressed to the Institute of Radio Engineers, 330 West 42nd Street, New York City. They will be examined by the Papers Committee and the Board of Editors to determine their suitability for publication in the PROCEEDINGS. Authors are advised as promptly as possible of the action taken, usually within two or three months. Manuscripts and illustrations will be destroyed immediately after publication of the paper unless the author requests their return. Information on the mechanical form in which manuscripts should be prepared may be obtained by addressing the secretary.

MAILING. Entered as second-class matter at the post office at Menasha, Wisconsin. Acceptance for mailing at special rate of postage is provided for in the act of February 28, 1925, embodied in Paragraph 4, Section 412, P. L. and R., and authorization was granted on October 26, 1927.

Published monthly by

THE INSTITUTE OF RADIO ENGINEERS, INC.

Publication office, 450-454 Ahnaip St., Menasha, Wis.

BUSINESS, EDITORIAL, AND ADVERTISING OFFICES

Harold P. Westman, *Secretary*

330 West 42nd Street, New York, N. Y.

INSTITUTE SECTIONS

- ATLANTA—Chairman, I. H. Gerks; Secretary, Philip C. Bangs, 23 Kensington Rd., Avondale Estates, Ga.
- BOSTON—Chairman, E. L. Chaffee; Secretary, Roland G. Porter, Northeastern University, Boston, Mass.
- BUFFALO-NIAGARA—Chairman, L. E. Hayslett; Secretary, E. C. Waud, 235 Huntington Ave., Buffalo, N. Y.
- CHICAGO—Chairman, Alfred Crossley; Secretary, J. Kelly Johnson, Wells-Gardner Company, 2701 N. Keldare Ave., Chicago, Ill.
- CINCINNATI—Chairman, Armand Knoblauch; Secretary, George F. Platts, Crosley Radio Corporation, Cincinnati, Ohio.
- CLEVELAND—Chairman, Carl J. Banfer; Secretary, J. S. Hill, 3325 Beachwood Ave., Cleveland Heights, Ohio.
- CONNECTICUT VALLEY—Chairman, J. A. Hutcheson; Secretary, C. B. De Soto, American Radio Relay League, 38 La Salle Rd., West Hartford, Conn.
- DETROIT—Chairman, A. B. Buchanan; Secretary, E. C. Denstaedt, Detroit Police Department, Detroit, Mich.
- LOS ANGELES—Chairman, H. C. Silent; Secretary, N. B. Neely, 1569 Munson Ave., Los Angeles, Calif.
- NEW ORLEANS—Chairman, J. A. Courtenay; Secretary, C. B. Reynolds, Radiomarine Corporation of America, 512 St. Peter St., New Orleans, La.
- PHILADELPHIA—Chairman, E. D. Cook; Secretary, R. L. Snyder, 103 Franklin Rd., Glassboro, N. J.
- PITTSBURGH—Chairman, C. K. Krause; Secretary, H. V. Noble, c/o Gulf Research and Development Company, P. O. Drawer 2038, Pittsburgh, Pa.
- ROCHESTER—Chairman, H. J. Klumb; Secretary, H. A. Brown, 89 East Ave., Rochester, N. Y.
- SAN FRANCISCO—Chairman A. H. Brolly; Secretary, R. D. Kirkland, Mackay Radio and Telegraph Company, 22 Battery St., San Francisco, Calif.
- SEATTLE—Chairman, R. C. Fisher; Secretary, C. E. Williams, 2340 Delmar Dr., Seattle, Wash.
- TORONTO—Chairman, A. B. Oxley; Secretary, L. M. Price, Radio Valve Company of Canada, 189 Dufferin St., Toronto, Ont., Canada.
- WASHINGTON—Chairman, E. K. Jett; Secretary, W. B. Burgess, 2900-26th St. N. E., Washington, D. C.

GEOGRAPHICAL LOCATION OF MEMBERS ELECTED

MAY 1, 1935

Elected to the Associate Grade

California	Los Angeles, 2459 E. 58th St.....	Lockhart, R., Jr.
	San Pedro, 222 Amar St.....	Grammes, R. W.
District of Columbia	Washington, U.S. Coast Guard Headquarters.....	Comstock, E. E.
	Washington, 3700 Mass. Ave. N.W.....	Lion, P. M., Jr.
	Washington, 1900 Lamont St. N.W.....	Wadsworth, H. A.
Georgia	Atlanta, 1011 Capitol Ave. S.W.....	Murphy, H. L.
Kentucky	Madisonville.....	Taliaferro, F. M.
Massachusetts	Brookline, 11 Euston St.....	Rogers, W. S.
	Cambridge, General Radio Company.....	Webster, W. G.
New Hampshire	Gorham, Mount Washington Observatory.....	McKenzie, A. A.
New Jersey	Collingswood, 1107 Park Ave.....	Kentner, C. D.
	River Edge, 644 Bogert Rd.....	Ennis, F. T.
New York	Brooklyn, 8300-4th Ave.....	Maresca, J. F.
	New York City, 117 Liberty St.....	Biber, L. R.
	New York City, 145 W. 84th St.....	Garos, E. A.
	New York City, 250 Hudson St.....	Rulfs, G., Jr.
	Port Chester, 24 Exchange Pl.....	Darling, A. I.
Ohio	Cleveland, John Hay High School.....	Meola, L. K.
	Columbus, 88 W. Woodruff Ave.....	Parker, A. P.
Pennsylvania	Philadelphia, 27 W. Pomona St.....	Bowley, R. J.
	Pittsburgh, 435-6th Ave.....	Hamilton, G. L.
	Pittsburgh, c/o Blaw-Knox Company, P.O. Box 1198.....	Jackson, A. H.
	Pittsburgh, 1201 Shady Ave., E. Liberty.....	Staibitz, E. J.
Washington	Seattle, 820 Fairview N.....	Kistler, R. E.
Canada	Edmonton, Alta., 9649-106th St.....	McLachlin, A. D.
	Saskatoon, Sask., 602 Queen St.....	Stevenson, G.
	Toronto, Ont., 544 Huron St.....	Hammond, R. E.
	Toronto, Ont., 247 St. Clements Ave.....	Hurlbut, A. L.
China	Nanking, 18 Tong-Chiang Rd.....	Yung-Ching, Y.
England	Bath, Somerset, 14 Daniel St.....	Denning, C. E.
	Bolton, Lancs., "Fonwen," Delph Ave., Egerton.....	Smith, W. A.
	Chelmsford, Essex, Marconi's Wireless College, Arbour Lane.....	Dev, P. K.
	Harrogate, 56 Station Parade.....	Page-Sykes, H.
	Holloway, London, Northern Polytechnic.....	Hurren, S. A.
	Huddersfield, Yorks., 119 Laund Rd., Salendine Nook.....	Dorington, W. H.
	Liverpool 15, 104 Barrington Rd.....	Ormson, C.
	N. Wembley, Middlesex, 42 The Fairway.....	Smyth, C. N.
	Sidcup, Kent, 97 Walton Rd.....	Powers, S. J.
	Southall, Middlesex, 6 Minterne Ave., Norwood Green.....	Elliott, B. C.
	Wallington, Surrey, 30 Crichton Ave.....	Barnes, W. W.
India	Bangalore, Indian Institute of Science.....	Baliga, B. V.
	Bangalore, Electrical Communication Dept., Indian Institute of Science.....	Raghunatha Rao, S.
	Coimbatore, Imperial Sugar Cane Station Lawley Rd. P.O.....	Murthi, T. V. R.
Italy	Torino, Scuola Galileo Ferraris, Via Mario Gioda 32.....	Gigli, A.
Japan	Tokyo, Military Scientific Research Lab., 4 Hyakunincho Yodobashi.....	Uyeda, H.
Mexico	Puebla, Puebla, 12 Poniente 719.....	Rojas, A.
New Zealand	Palmerston North, c/o New Zealand Express Co.....	Cuthbert, D. M.
	Wellington, c/o Messrs. C. and A. Odlin Co. Ltd.....	Undrill, E.

Elected to the Student Grade

California	Berkeley, 1515 Henry St.....	Lambert, E. G.
	Pasadena, Blacker House, California Institute of Technology.....	Hadley, C. F.
Maryland	Annapolis, U. S. Naval Academy.....	Wallis, W. R.
Massachusetts	Cambridge, Massachusetts Institute of Technology Dormitories.....	Neily, J. W.
Michigan	Detroit, 16154 Fairfield Ave.....	Ambrose, P. J.
New Jersey	Collingswood, 911 Stokes Ave.....	Gluyas, T. M., Jr.
	Princeton, 17 S. Middle Reunion.....	Shaw, R. F.
	Riverton, 219 Thomas Ave.....	Beegle, D. H.
	Rutherford, 123 Chestnut St.....	Handler, H.
Ohio	Cincinnati, 3249 Bishop St.....	Brester, W. A.
	Columbus, 2133 Neil Ave.....	Foraker, C. M.
	Columbus, 304 Deshler Ave.....	Mehrling, H. W.
	Columbus, 2920 Crescent Dr.....	Thistlethwaite, W. G.

APPLICATIONS FOR MEMBERSHIP

Applications for transfer or election to the various grades of membership have been received from the persons listed below, and have been approved by the Admissions Committee. Members objecting to transfer or election of any of these applicants should communicate with the Secretary on or before June 28, 1935. Final action will be taken on these applications July 1, 1935.

For Election to the Associate Grade

California	Bishop, Box 562.....	Rudolph, E.
	Los Angeles, 807 N. Mariposa.....	Noe, M. W.
	Los Angeles, 1117 Venice Blvd.....	Teel, W. D.
	Oakland, 4135 Opal St.....	Moore, R. E.
Maryland	Baltimore, 3622 Manchester Ave.....	Spedden, J. C.
Massachusetts	Cambridge, 74 Fayerweather St.....	Horne, C. F., Jr.
New Jersey	Clifton, 106 E. 4th St.....	Palmer, R. N.
	Westfield, 734 Coleman Pl.....	Hanson, F. E.
	West New York, 153-18th St.....	Thomas, W. E.
	New York City, 463 West St.....	Green, C. B.
	New York City, 463 West St.....	King, K. L.
	New York City, c/o J. J. Welch, Western Union Tel. Co., Rm. 1724, 60 Hudson St.....	Vehling, R. H.
	New York City, c/o American Express Co., Inc., 65 Broad- way.....	Wood, H. B.
	Ozone Park, 9527-78th St.....	Hansen, E. L.
Ohio	Cleveland, 614 Cathedral Ave.....	Fill, J.
	Convoy.....	Hoelle, L. C.
	Lakewood, 1095 Kenneth Dr.....	Stoffel, L. L.
	Marietta, 801-3rd St.....	Steely, J. D.
Oregon	Milton, Box 205.....	Ahearn, J. M.
Pennsylvania	Philadelphia, c/o Mr. Joseph K. Wang, 3618 Chestnut St.....	Woo, E. L.
Argentina	Vte. Lopez, F.C.C.A., Guemes 827.....	Arnaud, J. P.
Canada	Brandon, Manit., Suite E, Parkview Apts.....	Carpenter, H. J.
	Edmonton, Alta., 10534-129th St.....	Sagness, E. J.
	Montreal, P. Q., 3455 Prudhomme Ave.....	Hicks, B. C.
England	Birkenhead, 131 Highfield Rd., Rock Ferry.....	Corbett, W. E.
	Datchet, Nr. Slough, Bucks., "Riddings," Windsor Rd.....	Slow, E. C.
	Liverpool 11, 10 Braybrook Rd.....	McClelland, D. H.
France	Le Vesinet (Set. O.), 23 Allee du Lac Inferieur.....	Tarel, G.
India	Bombay, 28 Sankli St., Byculla.....	D'Souza, A.
	Mylapore, Madras, "Udipi House," Sullivan's Garden Rd.....	Venkata Rao, P.
Italy	Milano Via Monteverde 18.....	Vecchiacchi, F.
New Zealand	Tukisappu, Nr. Sapporo, Sapporo Broadcasting Station.....	Matubara, H.
South Africa	Grey Lynn, Auckland W. 2, 33 Allan Rd.....	Hart, G. C.
Spain	Johannesburg, c/o H. Polliack & Co. Ltd., 88 Eloff St.....	Scott, W. J.
	Madrid, Compania Telefonica Nacional de Espana, Avenida Pi y Margall 2.....	Rodriguez Apolinario, A

For Election to the Junior Grade

California	Oakland, 965-54th St.....	Harbidge, E.
Iowa	Iowa City, 430 Brown St.....	Alcock, R. W.
New Zealand	Christchurch, N. 1, 14 Gresford St.....	Fletcher, H. B.

For Election to the Student Grade

California	Belmont, 1556-6th Ave.....	Hyne, A. D.
	Berkeley, 2229 Dwight Way.....	Johnson, W.
	Berkeley, 2601 College Ave.....	Shima, R.
	Berkeley, 2701 Hearst Ave.....	White, C. F.
	Burbank, 938 Orange Grove Ave.....	Leach, F. C.
	Pasadena, 3 Blacker House, Calif. Inst. of Tech.....	Johnson, F. L.
	Petaluma, Route 2, Box 245.....	Klebanoff, J. H.
	Sacramento, 2318-C St.....	Buckius, O. E.
	San Diego, 3762 Center St.....	Harrington, K. D.
	San Francisco, 3234 Mission St.....	Dietsch, R. C.
	San Francisco, 50 Cerritos Ave.....	McLaughlin, H.
Indiana	West Lafayette, 124 Warstellar St.....	Swank, W. B.
Missouri	St. Louis, 3651a Montana.....	Dickman, K. W.
Ohio	Medina, 113 W. Friendship St.....	Hammerschmidt, A. L.
Canada	London, Ont., 17 Craig St.....	Santo, R. E.

OFFICERS AND BOARD OF DIRECTORS

(Terms expire January 1, 1936, except as otherwise noted)

President

STUART BALLANTINE

Vice President

GEORG HEINRICH BARKHAUSEN

Treasurer

MELVILLE EASTHAM

Secretary

HAROLD P. WESTMAN

Editor

ALFRED N. GOLDSMITH

Directors

O. H. CALDWELL

V. M. GRAHAM

R. A. HEISING

J. V. L. HOGAN

L. M. HULL, *Junior Past President*

F. A. KOLSTER

GEORGE LEWIS

H. M. TURNER

A. F. VAN DYCK

SERVING UNTIL JANUARY 1, 1937

ARTHUR BATCHELLER

C. M. JANSKY, JR., *Senior Past President*

WILLIAM WILSON

SERVING UNTIL JANUARY 1, 1938

E. L. NELSON

L. E. WHITTEMORE

HARADEN PRATT





Convention Headquarters. Hotel Statler, Detroit, Michigan

INSTITUTE NEWS AND RADIO NOTES

Tenth Annual Convention

The Board of Directors of the Institute accepted an invitation extended by the Detroit Section to hold our Tenth Annual Convention in that city. The dates set for this meeting are July 1, 2, and 3 and the headquarters will be located at the Hotel Statler. The various technical sessions and banquet will be held in the hotel and a number of interesting inspection trips for both the ladies and men have been arranged.

The number of papers submitted for presentation and the time required for them are such as to make necessary the holding of two technical sessions simultaneously. While it is impossible to arrange presentations so no one will be compelled to miss a paper in which he is interested, it is hoped that such probabilities have been reduced to a minimum. At each session, the paper which is being presented at the other session will be announced and it will be permissible for those interested to leave or enter a meeting at any time.

The following program is practically complete and it is expected that relatively few changes will be made in it. Such changes as may be necessary will probably be of minor nature.

SUNDAY, JUNE 30

4:00 P.M.-6:00 P.M. Registration

MONDAY, JULY 1

9:00 A.M. Registration and opening of exhibition.

10:00 A.M.-12:30 P.M. Official welcome and technical session. Addresses of welcome by Stuart Ballantine, President of the Institute; and H. L. Byerlay, Chairman of the Convention Committee.

Technical Session—Large Meeting Room

"Electron Beams and Their Application in Low Voltage Devices," by H. C. Thompson, RCA Radiotron Division, RCA Manufacturing Company, Harrison, N.J.

"Frequency Control by Low Power Factor Line Circuits," by C. W. Hansell, F. H. Kroger, and P. S. Carter, RCA Communications, New York, N.Y.

"Design and Equipment of a 50-kilowatt Broadcast Station for WOR," by J. R. Poppele, Station WOR, Newark, N.J.; and F. W. Cunningham and A. W. Kishpaugh, Bell Telephone Laboratories, New York City.

10:00 A.M.-11:00 A.M. Official greetings at ladies headquarters.

11:00 A.M.-5:00 P.M. Trip No. 1. Ladies sight-seeing trip.

12:30 P.M.-2:00 P.M. Luncheon and inspection of exhibits.

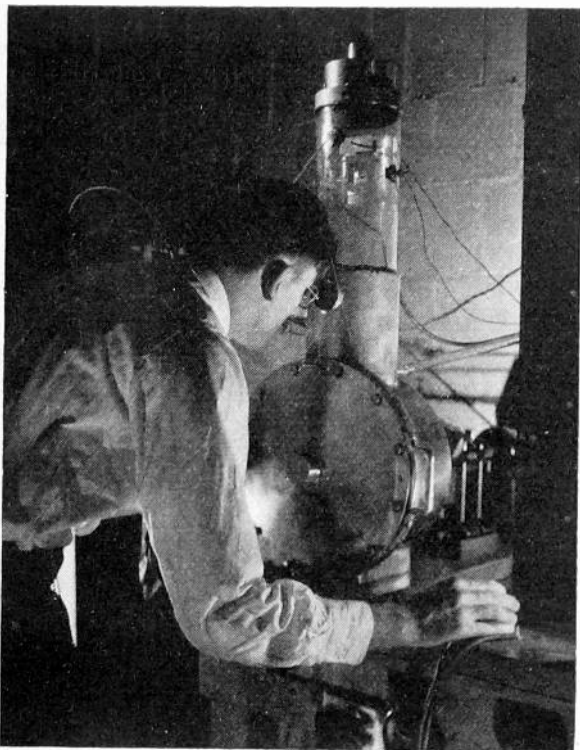

Using cathode rays to measure ignition efficiency.
at General Motors Research Laboratories

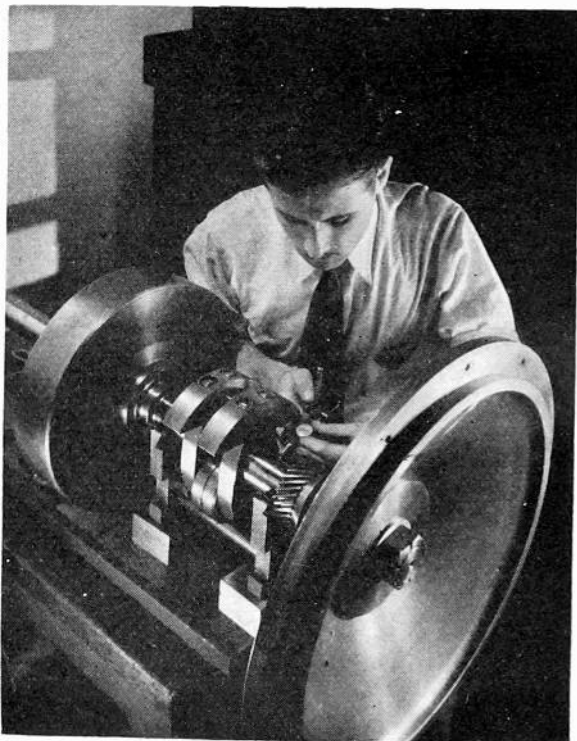

Making precision micrometric measurements before
spectrographic analysis at General Motors

- 2:00 P.M.—3:30 P.M. **Technical Session—Large Meeting Room**
 “Automatic Selectivity Control,” by G. L. Beers, RCA Victor Division, RCA Manufacturing Company, Camden, N.J.
 “Automatic Frequency Control,” by Charles Travis, RCA License Laboratory, New York City.
 “Panel Lamps and Their Characteristics,” by J. H. Kurlander, Westinghouse Lamp Company, Bloomfield, N.J.
- 2:00 P.M.—3:30 P.M. **Technical Session—Small Meeting Room**
 “Magnetron Oscillators for Generating Frequencies from 300 to 600 Megacycles,” by G. R. Kilgore, RCA Radiotron Division, RCA Manufacturing Company, Harrison, N.J.
 “An Unattended Ultra-Short-Wave Radiotelephone System,” by N. F. Schlaack and F. A. Polkinghorn, Bell Telephone Laboratories, New York City.
 “Some Notes on Piezo-Electric Crystals,” by Issac Koga, Tokyo University of Engineering, Tokyo, Japan.
- 3:30 P.M.—6:00 P.M. Trip No. 2. General Motors Research Laboratory
- 6:00 P.M.—7:00 P.M. Inspection of exhibits.

TUESDAY, JULY 2

- 9:00 A.M. Registration and opening of exhibition.
- 10:00 A.M.—11:30 A.M. **Technical Session—Large Meeting Room**
 “Recent Developments of Class B Audio- and Radio-Frequency Amplifiers,” by L. E. Barton, RCA Victor Division, RCA Manufacturing Company, Camden, N.J.
 “General Theory and Application of Dynamic Coupling and Power Tube Design,” by C. F. Stromeyer, Revelation Patents Holding Company, New York City.
 “Notes on Intermediate-Frequency Transformer Design,” by F. W. Scheer, S. W. Sickles Coil Company, Springfield, Mass.
- 10:00 A.M.—11:30 A.M. **Technical Session—Small Meeting Room**
 “Some Theoretical Considerations Relating to Vacuum Tube Design,” by G. D. O’Neill, Hygrade Sylvania Corporation, Salem, Mass.
 “Ratings and Operating Information on Large High Vacuum Tubes,” by R. W. Larson, General Electric Company, Schenectady, N. Y., and E. E. Spitzer, RCA Radiotron Division, RCA Manufacturing Company, Harrison, N.J.
 “Analysis of the Operation of Vacuum Tubes as Class C Amplifiers,” by I. E. Mouromtseff and H. N. Kozanowski, Westinghouse Electric and Manufacturing Company, East Pittsburgh, Pa.
- 10:00 A.M.—11:30 A.M. Trip No. 3. Ladies Shopping Tour.
- 11:30 A.M.—6:00 P.M. Trip No. 4. Greenfield Village.
- 6:00 P.M. Exhibits close.
- 7:00 P.M. Annual Banquet and entertainment. Main Banquet Room.

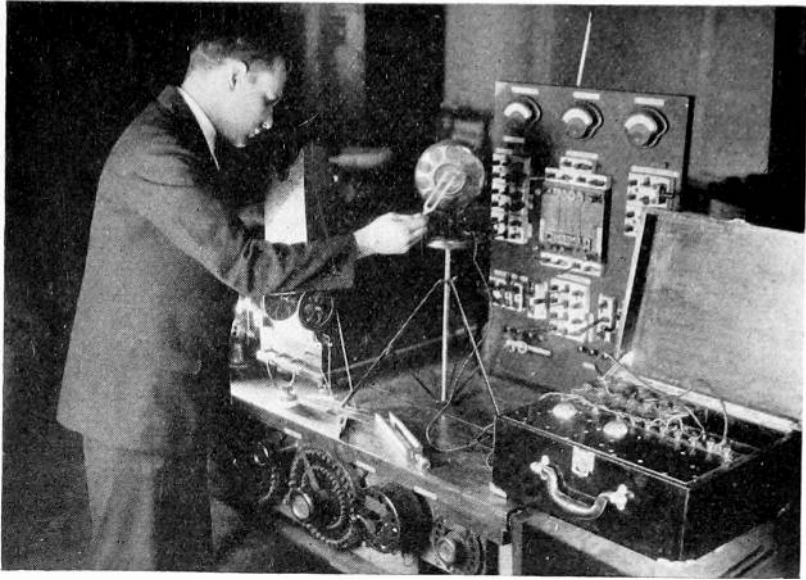

Radio types of equipment for the measurement and analysis of noises encountered in automobiles used by General Motors

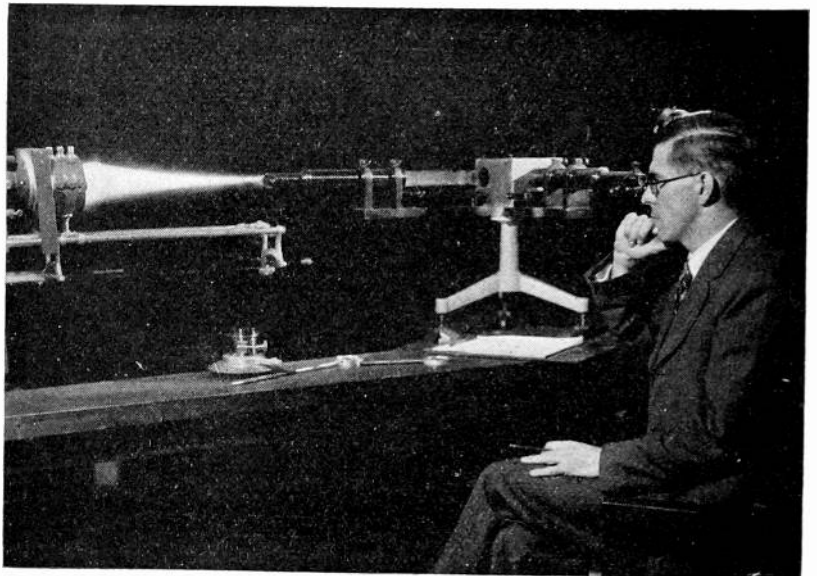

Spectroscopic analyses of metals are made at General Motors to detect even minute quantities of impurities

WEDNESDAY, JULY 3

- 9:00 A.M. Registration and opening of exhibition.
- 10:00 A.M.—11:30 A.M. **Technical Session—Large Meeting Room**
 "A New Tube for Use in Superheterodyne Frequency Conversion Systems," by C. F. Nesslage, E. W. Herold, and W. A. Harris, RCA Radiotron Division, RCA Manufacturing Company, Harrison, N.J.
 "A New Type of Gas-Filled Amplifier Tube," by J. D. LeVan and P. T. Weeks, Raytheon Production Corporation, Newton, Mass.
- 10:00 A.M.—11:30 A.M. **Technical Session—Small Meeting Room.**
 "Ultra-Short-Wave Propagation Over Land," by C. R. Burrows, Alfred Decino, and L. E. Hunt, Bell Telephone Laboratories, New York City.
 "A Note on the Source of Interstellar Interference," by K. G. Jansky, Bell Telephone Laboratories, New York City.
 "Comparison of Cosmic Data with Characteristics of the Ionosphere at Washington," by E. B. Judson, National Bureau of Standards, Washington, D.C.
 "A Study of Radio Field Intensity Versus Distance Characteristics of a High Vertical Radiator at 1080 Kilocycles," by S. S. Kirby, National Bureau of Standards, Washington, D.C.
- 11:00 A.M.—6:00 P.M. Trip No. 5. Ladies luncheon and sight-seeing trip.
- 11:30 A.M.—1:00 P.M. Luncheon and inspection of exhibits.
- 1:00 P.M.—6:00 P.M. Trip No. 6. Ford Motor Plant.
- 4:00 P.M. Closing of exhibits.

Technical Sessions

In accordance with the policy followed during the last two conventions, none of the papers presented will be available in preprint form. This has made necessary the allotment of sufficient time for the presentation of each paper in sufficient detail to permit a reasonable discussion of its contents. Inasmuch as the presentation of a paper is justified only if a valuable discussion ensues, those interested in the subjects treated are urged to be present and participate actively in the consideration given each paper. Time has been allowed for such discussion at each technical session. Because of the number of papers to be presented and the time required for the presentation of each, it is absolutely essential that all technical sessions start promptly on time.

It has been necessary to schedule two sessions of technical papers for each period available for that purpose with the exception of the opening session on Monday morning. As far as possible, the arrangement of papers has been based upon a consideration of the probable



Dearborn Inn



Edison Laboratory

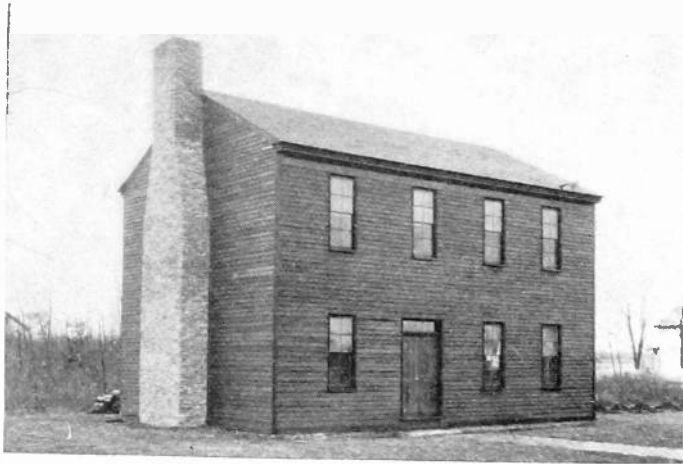

Lincoln Court House

groups interested in them. It is believed that conflict in group interests has been reduced to a minimum. Arrangements have been made to keep those at a given technical session in contact with the papers that are being presented at the other session. It will be possible to move freely from one meeting room to the other during technical sessions. Summaries of papers to be presented will be found at the end of this announcement and are arranged alphabetically by the names of the authors.

Inspection Trips

Monday, July 1—Trip No. 1

Ladies Sight-Seeing Trip

Busses will leave the hotel promptly at 11:00 A.M. when a visit will be made to Belle Isle, an island park of almost a thousand acres of natural beauty. In its zoo will be found sacred cows from India and the aquarium and horticultural hall will be visited. From the Isle the busses will pass the Hudson Motor Car Company and one of the Chrysler factories. They will proceed through Grosse Pointe and the fashionable residential section of Detroit as far as the Edsel Ford home and back to the Grosse Point Yacht Club for a luncheon-bridge and fashion show.

Trip No. 2

General Motors Research Laboratories

Departure from the hotel will be made for the General Motors Research Laboratories at 3:30 P.M. In this laboratory the research program of the General Motors Corporation centers and it is devoted to development work on chemical, physical, and electrical problems involved in the design and manufacture of the modern automobile.

Tuesday, July 2

Trip No. 3

Ladies Shopping Tour

The ladies will leave the hotel at 10:00 A.M. for the J. L. Hudson and Company department store which is Detroit's leading establishment of this type. Organized tours of the store will be made.

Trip No. 4

Greenfield Village

The entire afternoon will be devoted to this visit to Greenfield Village. Busses will leave the hotel at 11:30 A.M. and will arrive at the



Entrance to Greenfield Village



Detroit News

Grosse Pointe Yacht Club

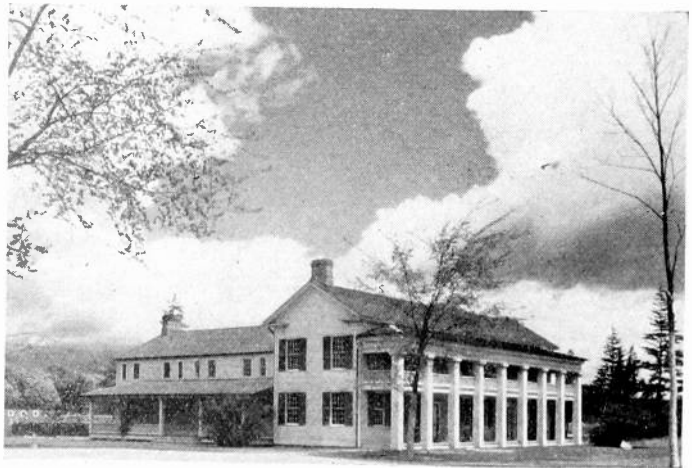

Botsford Inn

Dearborn Inn where lunch may be obtained. Greenfield Village which was founded by Henry Ford, centers on the "green" like all colonial communities. Our visit will take us to Edison's Laboratory, Clinton Inn, and several other buildings famous in American history. The village portrays early colonial life and in it are found among other structures old schools, a church, a tintype makers shop, the apothecary store and post office, the grocery and drygoods store, and the old Lincoln courthouse.

The Edison Institute Museum is entered through a replica of Independence Hall and is devoted to exhibits of early American arts and sciences. The electrical exhibition includes almost every type of electrical device developed and includes sections of every telegraph cable laid across the Atlantic Ocean.

Wednesday, July 3

Trip No. 5

Ladies Luncheon and Sight-Seeing Trip

At 11:30 A.M., busses will leave the hotel for Botsford Inn. About one hundred years old, it has been reconditioned by Mr. Ford and furnished in its original style. Luncheon will be served at the Inn and the trip will continue to the Cranbrook Educational Institutions, which include schools from elementary grades through college preparatory work for both boys and girls. Christ Church with the largest and most complete set of chimes in this country will be visited as will the Cranbrook Institute of Science and the Cranbrook Academy of Art. From Cranbrook we visit the radio-famous Shrine of the Little Flower. The next stop is at the Detroit zoo where wild animals are found in their native settings, there being no fences between them and the visitors.

Trip No. 6

Ford Motor Plant

At 1:00 P.M. busses will leave for the Ford Motor plant and the afternoon will be devoted to an inspection tour of it. This is the largest single industrial unit in the world and covers over a thousand acres. There are almost a hundred miles of railroad track within its boundaries and eighty thousand men are employed in its operation. It includes blast furnaces, a steel mill, glass plant, the world's largest foundry, and over seven million square feet of floor space.

Exhibition

Our annual exhibition of component parts, manufacturing aids, and measuring devices will be held this year as in the past. The exhibitions

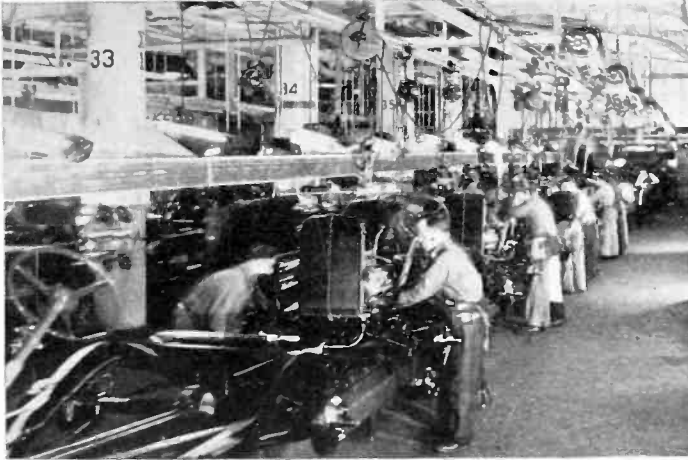

Where Ford cars are put together



Aerial view of the Ford plant

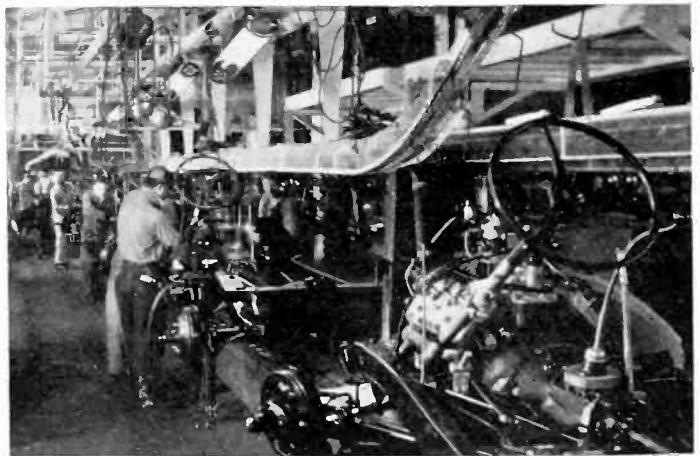

Another view of the Ford assembly line

will be arranged in booths distributed about a large central room through which everyone will pass in going to the technical sessions. Booths will be in charge of men competent to discuss the engineering aspects of the products on display and this offers an excellent opportunity for engineers to become acquainted with recent developments in the radio field.

Banquet

The annual banquet will be held on Tuesday evening at seven o'clock. The two annual Institute awards will be presented to their recipients during the banquet. The Medal of Honor will be bestowed upon Balth. van der Pol, Jr. and the Morris Liebmann Memorial Prize given to F. B. Llewellyn.

Reduced Railroad Rates

Reduced rates on the certificate plan have been granted by the railroads. It is necessary when purchasing your ticket to Detroit to request a certificate for this convention. If more than one hundred of these certificates are presented at the convention, they will be validated and will permit the holder to purchase a return trip ticket over the same route as traveled to the convention at one third of the regular railroad fare. Everyone traveling to the convention by rail is urged to obtain a certificate even though the saving in a particular case may be small. It is necessary that at least one hundred certificates be obtained and your certificate may assist someone in obtaining a substantial reduction on the railroad fare from a distant point.

Sections Committee Meeting

The annual meeting of the Sections Committee will be held in the Henry II room on the convention floor of the hotel at 6:00 P.M. on Monday, July 1. Representatives of each Institute section should be present at this meeting which will be devoted to a discussion of Institute policies concerning the operation of all sections. The chairman or secretary of each section is a logical representative but if neither of these can be in attendance, the duty may be delegated to some member of the section who will be able to attend this meeting.

SUMMARIES OF TECHNICAL PAPERS

RECENT DEVELOPMENTS OF CLASS B AUDIO- AND RADIO-FREQUENCY AMPLIFIERS

L. E. BARTON

(RCA Victor Division, RCA Manufacturing Company, Camden, N.J.)

Class B audio-frequency and radio-frequency amplifiers have many applications but may be the source of considerable distortion unless the necessary pre-

cautions are taken to prevent nonlinearity of such amplifiers. Undoubtedly, the most important factor in the design of a class B amplifier for low distortion is the characteristic of the driver system. Tube characteristics and the use of a proper load are also important but are more definite and more generally understood.

The purpose of this paper is to present the results of recent developments of the class B audio and radio amplifiers. The results of the investigations indicate that a heavily loaded driver system in general is undesirable because of the power consumed and because such loading results in greater distortion than obtainable by other means.

The general procedure adopted to reduce distortion was to prevent distortion in each unit of the amplifier system. Distortion balancing schemes are not only critical to adjust but are likely to introduce higher order harmonics which may be more objectionable than a higher measured value of a lower order harmonic. Actual performance data are presented for medium and relatively high powered audio and radio systems. The necessary input requirements to permit the performance obtained are discussed.

Sufficient theory is given to make the paper complete and to show that the actual performance of such amplifiers can be quite accurately predicted if the necessary tube characteristics are known.

AUTOMATIC SELECTIVITY CONTROL

G. L. BEERS

(RCA Victor Division, RCA Manufacturing Company, Camden, N.J.)

A receiving system is described in which the selectivity automatically varies with the sensitivity. The variation in selectivity is obtained through the use of several triodes whose plate-to-cathode impedance is shunted across a number of the receiver tuned circuits. The circuits with which these selectivity control tubes are associated are described. Circuit diagrams illustrate the method by which the control-grid potentials of the automatic selectivity control tubes are caused to vary with the strength of received signals. A manual control is described which permits the user to increase the selectivity over that determined by the strength of the received signal. Curves are given showing the change in over-all selectivity with sensitivity, the relation between fidelity and sensitivity, and distortion as a function of power output.

ULTRA-SHORT-WAVE PROPAGATION OVER LAND

C. R. BURROWS, ALFRED DECINO, AND L. E. HUNT

(Bell Telephone Laboratories, New York City)

From theoretical considerations it is found that for ultra-short-wave propagation over level terrain, the received field should equal 4π times the product of the antenna heights divided by the product of the wavelength and the distance times the field that would be received for transmission in free space.

This equation has been checked experimentally for horizontal polarization, antenna heights between two and 25 meters and frequencies between 17 and 150 megacycles for the two distances 9.4 and 26.3 kilometers. The results indicate that in the absence of detailed information regarding the transmission path, this formula gives the probable value of the received field. The deviations of an actual path from the ideal should cause corresponding deviations in the received field from that calculated by the above formula. For these two paths, the mean of the deviations was found to be about three or four decibels.

At 45 kilometers fading was observed with low antennas, and at greater distances there were rather large variations in the received field at all antenna heights available.

At higher frequencies and longer distances the curvature of the earth introduces additional attenuation. At the distance $d = 5 \times 10^4 k^{2/3} \lambda^{1/3}$ meters theoretical considerations indicate that the curvature of the earth will reduce the field strength by a factor of about 2, and beyond this "shadow distance" by the factor $2ka/\pi \sqrt{d^3/\lambda}$, where ka is the effective radius of the earth with refraction and λ is the wavelength all measured in meters. This results in the received field being inversely proportion to the seven-halves power of the distance.

The method of calculating the received field in hilly country, which was developed on a theoretical basis in an earlier paper, has been confirmed experimentally both for an optical path and for a nonoptical path in the frequency range from 17 to about 100 megacycles. The discrepancies between the experimental and theoretical frequency characteristics between 100 and 200 megacycles indicate that some element of the phenomenon of ultra-short-wave propagation that has been omitted from the theoretical formula becomes important in this frequency range.

In these experiments it was found that comparatively small sloping areas of ground near the terminals reflected an appreciable fraction of the incident wave.

FREQUENCY CONTROL BY LOW POWER FACTOR LINE CIRCUITS

C. W. HANSELL, F. H. KROGER, AND P. S. CARTER
(RCA Communications, New York, N.Y.)

The advantages of low power factor line circuits for controlling transmitters at very high radio frequencies are pointed out. The laws governing the design and performance of lines used as low power factor circuits have been worked out and applied to the design of lines for stabilizing the frequency of a number of transmitters ranging in frequency from about 13,000 to 500,000 kilocycles.

The frequency stability of these transmitters indicate that the line control will provide a frequency stabilizing device for use above about 20,000 kilocycles of as great practical value as piezo-electric crystals have been for use at lower frequencies.

Tests have been made which indicate that lines with substantially uniformly distributed inductance and capacity have a temperature coefficient of frequency corresponding closely to the linear coefficient of thermal expansion for the material of which the line is made. Several methods have been worked out for reducing the effect of temperature variation upon the frequency.

A NOTE ON THE SOURCE OF INTERSTELLAR INTERFERENCE

KARL G. JANSKY
(Bell Telephone Laboratories, New York City)

Further consideration of the data obtained during observations on interstellar interference has shown that these radiations are received any time the antenna system is directed towards some part of the Milky Way system, the greatest response being obtained when the antenna points towards the center of the system. This fact leads to the conclusion that the source of these radiations is located in the stars themselves or in the interstellar matter distributed throughout the Milky Way.

Because of the similarity in the sound produced in the receiver headset, it is suggested these radiations might be due to the thermal agitation of charged particles.

COMPARISON OF COSMIC DATA WITH CHARACTERISTICS OF THE IONOSPHERE AT WASHINGTON

E. B. JUDSON

(National Bureau of Standards, Washington, D.C.)

Ionosphere observations made at the National Bureau of Standards, over a period of several years are compared with cosmic data. Critical frequencies of the three major layers, together with their virtual heights, are especially studied in connection with magnetic activity. Annual results are shown, compared with sunspots. Seasonal variations of critical frequencies and virtual heights are also shown. Sporadic E layer, appearing after the normal E-layer critical frequency has passed, is compared with the occurrence of local and distant thunderstorms, as well as cosmic data. Results of ionosphere observations at Washington during the February 3, 1935, eclipse are discussed.

MAGNETRON OSCILLATORS FOR GENERATING FREQUENCIES FROM 300 TO 600 MEGACYCLES

G. R. KILGORE

(RCA Radiotron Division, RCA Manufacturing Company, Harrison, N.J.)

The importance of the 300- to 600-megacycle range is emphasized and the place of the magnetron oscillator in this field is pointed out.

Static characteristics of a split-anode magnetron are used to explain the operation of the negative-resistance magnetron oscillator.

Problems in the generation of large output power at very short waves are listed and methods of improving the efficiency and power output are discussed.

Several typical magnetrons are described which are capable of delivering 50 to 100 watts output at frequencies of 300 to 600 megacycles.

A STUDY OF RADIO FIELD INTENSITY VERSUS DISTANCE CHARACTERISTICS OF A HIGH VERTICAL RADIATOR AT 1080 KILOCYCLES

S. S. KIRBY

(National Bureau of Standards, Washington, D.C.)

The field intensities of radio station WBT, Charlotte, N.C., were recorded by means of automatic recorders at seven different distances from about 70 to 870 kilometers (45 to 450 miles), before and after the installation of a high vertical radiator. The records at the two nearer recording stations within 100 kilometers show that the field intensity of the ground wave was increased and the fading decreased appreciably, by the change from a T antenna to the vertical antenna. At greater distances the effects were more complex. The field intensities and fading at all seven distances are compared for the two antenna conditions. The field intensity versus distance characteristics are shown for both day and night. The maximum night sky-wave intensity was received at a distance of about 550 kilometers. The effect of changes in the structure of the vertical radiator to increase its top capacity are discussed. The work was done in coöperation with the Columbia Broadcasting System, and with the assistance of a number of university and other laboratories.

SOME NOTES ON PIEZO-ELECTRIC CRYSTALS

ISSAC KOGA

(Tokyo University of Engineering, Tokyo, Japan)

The structure of quartz crystals is described and the chief characteristics of plates cut at various angles to the crystal axes are given with particular attention to the effect of temperature on frequency of oscillation. Methods of reducing these temperature effects lead to the manufacture of zero temperature coefficient plates. Their application to existing transmitters previously employing X-cut plates is described.

RADIO PANEL LAMPS AND THEIR CHARACTERISTICS

J. H. KURLANDER

(Westinghouse Lamp Company, Bloomfield, N.J.)

Radio panel lamps were first used as a convenience in reading dial settings when the room illumination was inadequate for this purpose. Opaque dials, whose surface was illuminated by allowing the lamp to shine directly upon the surface of the dial, were subsequently displaced by translucent dials illuminated from the rear. The use of a translucent dial made it necessary to pay more attention to the design of the panel lamp in order to avoid shadows and uneven illumination.

The simple considerations of dial illumination were considerably complicated by the development of resonance tuning meters of the shadow producing type. These required a lamp with accurate optical characteristics which presented no small problem due to the use of automatic machinery in manufacture. Improvements in design eventually resulted in a satisfactory lamp for resonance meter operation. A further improvement is presented by the use of a miniature bayonet base which assures positive contact of the lamp in its socket.

Lamp characteristics in general are discussed and the various points illustrated by means of curves. The various types of lamps available for home receivers and automotive receivers are described together with the applications for the various types. A typical mortality curve, showing the rate of failure throughout life for a group of lamps, is presented and the operation of the mortality curve in connection with the Underwriters' requirement of a 5000-hour life lamp for certain types of receivers is discussed.

Design considerations with respect to lamps being subjected to vibration or shock are covered and precautions in manufacturing to guard against open circuits within the lamp, are described.

The paper concludes with some simple precautions to be observed to guard against lamp failure in various types of receivers.

RATINGS AND OPERATING INFORMATION ON LARGE HIGH VACUUM TUBES

R. W. LARSON

(General Electric Company, Schenectady, N.Y.)

AND

E. E. SPITZER

(RCA Radiotron Division, RCA Manufacturing Company, Harrison, N.J.)

The Subcommittee on "Large High Vacuum Tubes" of the Technical Committee on Electronics, operating under the IRE Standards Committee, has as one of its objectives the study of ratings and operating information. The

study was allocated to the authors and the presentation of this material in the form of a paper may serve to bring out comments and suggestions which will be valuable to the Subcommittee.

The subject has been divided into three parts:

- I. General Design Information
- II. Maximum Ratings
- III. Typical Operating Information

In publication by the manufacturer the above data usually appear in tabulated form on a sheet which may be called a Technical Information Sheet. This sheet together with a text on installation and operation and the characteristic curves forms an instruction booklet which is packed with each tube for the guidance of the purchaser. The instruction booklet plus a specification provides the information for the design of transmitting equipment in which the tube is to be used.

The purpose, method of preparation, and use of these data are discussed. Each item of the Technical Information Sheet is considered in relation to the other parts and examples are shown to illustrate relationships.

A NEW TYPE OF GAS-FILLED AMPLIFIER TUBE

J. D. LEVAN AND P. T. WEEKS
(Raytheon Production Corporation, Newton, Mass.)

The Raytheon Laboratories have had under development for several years a gas- or vapor-filled amplifier tube. This paper describes the general features of this type of tube and gives the detailed characteristics of some typical designs.

A distinctive feature of these gas-filled tubes is the introduction of an auxiliary grid-form electrode which serves as the anode for an ionizing discharge and at the same time as a cathode for the main electrode stream which is controlled in the same manner as in an ordinary high vacuum tube. Due to the close spacing of the main electrodes and the relatively low gas- or vapor-pressure employed, the main electron stream or plate current can be continuously controlled by the voltage applied to the control grid, increasing as the negative bias on the control grid is decreased and decreasing to cut-off as the grid bias is made more negative. Within the voltage limits of each particular design of tube the presence of gas ions between the main electrodes only serves to neutralize partially the space charge, the general form of the characteristics being the same as for high vacuum tubes. The plate resistance however is characteristically low and the mutual conductance much higher than in high vacuum tubes of comparable size. Because of the low space-charge characteristic it also follows that high values of plate current and mutual conductance may be obtained at relatively low values of plate voltage, although normal characteristics are also obtained with plate voltages of several hundred volts.

This type of tube may be designed for use as a low-frequency or high-frequency amplifier or oscillator and as a triode or screen-grid tetrode. It has been made in sizes from a few watts to 50 watts rating, and has been used as an ultra-high-frequency oscillator delivering 20 watts at 100 megacycles.

ANALYSIS OF THE OPERATION OF VACUUM TUBES AS CLASS C AMPLIFIERS

I. E. MOUROMTSEFF AND H. N. KOZANOWSKI
(Westinghouse Electric and Manufacturing Company, East Pittsburgh, Pa.)

The operation of class C amplifiers under carrier and modulated conditions is analyzed with the aid of constant-current charts. With these charts one can

precalculate all operating factors such as output, efficiency, and grid driving power. The analysis discloses certain fundamental differences in the behavior of modulated amplifiers, connected with self-bias and fixed, or generator-bias, operation. Audio harmonic distortion traceable directly to the amplifier is discussed in detail, together with methods for "compensating" the grid excitation to eliminate this distortion and to increase the operating efficiency. Oscillograms of the audio relations in modulated class C amplifiers experimentally verify the theoretical conclusions. The problems of grid excitation power, "true" grid dissipation, and "effective" plate dissipation for modulated amplifiers are treated for three tubes differing only in their amplification factors.

A NEW TUBE FOR USE IN SUPERHETERODYNE FREQUENCY CONVERSION SYSTEMS

C. F. NESSLAGE, E. W. HEROLD, AND W. A. HARRIS
(RCA Radiotron Division, RCA Manufacturing Company, Harrison, N.J.)

The disadvantages of existing methods of frequency mixing in superheterodyne sets are briefly summarized. The major disadvantage is found in high-frequency operation with comparatively low intermediate frequencies, where serious coupling exists between oscillator and signal circuits in spite of electrostatic screening. Suppressor grid modulation of a radio-frequency pentode largely overcomes many of the defects but the oscillator voltage required is large and the low plate resistance limits the gain. For these reasons a new tube has been developed wherein the disadvantages are largely overcome. The new tube contains five grids: the first grid is a remote cut-off signal grid, the second and fourth are screen grids, the third is used as the modulator grid controlled by a separate oscillator tube, and the fifth grid is a suppressor grid. The ideal characteristics of such a tube are derived. The actual characteristics of the tube developed are shown and a brief discussion of the results obtained is given. A discussion of electron current to a negative grid due to a peculiar transit time effect at high frequencies is given and it is shown that operation with sufficient grid bias reduces the phenomenon.

The characteristics of this tube also make it particularly suitable for use as a radio-frequency amplifier in receivers where the available automatic volume control or detector voltage is low; in this case the automatic volume control voltage is applied to both number 1 and number 3 grids.

Although not primarily intended for the purpose, the tube is also suitable for use in the volume expansion of recorded music. Such application provides an effective means of emphasizing the crescendos and diminuendos of the music. A demonstration of this application is given.

SOME THEORETICAL CONSIDERATIONS RELATING TO VACUUM TUBE DESIGN

G. D. O'NEILL
(Hygrade Sylvania Corporation, Salem, Mass.)

In designing vacuum tubes it is usual to plan on using parts, where possible, that are standard in existing tubes. Data are obtained from the latter which are fitted into equations shown and which are based either on previously published equations or formulas introduced in the text. The design data obtained are used for making a sample lot of tubes which in turn furnish sufficient information for a closer approximation to the desired characteristics or, in comparatively simple cases (e.g., triodes) for final data.

ectivity
arpness
ation to
ng con-
ed. The
circuits
rs com-

SYSTEM

quency
n of an
etween
a regu-
found
without

been made of the segregation into beams of the space current. The overall size of commercial receiver tubes and at potentials less than 1000 volts. Electrode coatings of luminescent material were used to make the space current dependent on any or all electrodes.

The relationships between beam formations and relative electrode positions have been studied.

Currents of a few milliamperes have been concentrated into beams of widths which are much wider in simple structures.

Control grids associated with ordinary cathodes have been found to be effective for space-current control with effective beam formation so that the same device can be used for beam formation, control of beam width, direction, and current in a single device.

It has been found that the segregation into beams by simple beam-forming structures is sufficiently effective to make possible a radical reduction in the ratio of space current to a positive electrode to percentage of projected area of the electrode when the latter is situated between cathode and ultimate

The relationships between beam widths and electrode potentials have been found to be such that the mutual volt-ampere relations can be radically altered from those hitherto utilized. Linear, saturation, and special volt-ampere relations can be obtained. Individual electrode volt-ampere relations can be altered by utilizing the action of the field of such an electrode upon the width and direction of the beam impinging upon that electrode independently of interelectrode coupling. A variety of negative conductance devices have been made on this principle.

AUTOMATIC FREQUENCY CONTROL

CHARLES TRAVIS

(RCA License Laboratory, New York City)

The title refers to the control of the local oscillator frequency in a superheterodyne receiver for the purpose of centering the signal carrier in the intermediate-frequency band in spite of inaccuracies of manual tuning and potential "oscillator drift."

A system is described to accomplish this by electronic means. It consists of two units, one a detector preceded by frequency discriminating circuits and a control unit acted upon by the bias output of the above detector, to vary the oscillator frequency properly. Circuits for the control unit are shown and the manner of operation of the system is discussed.

Meeting of the Board of Directors

The regular May meeting of the Board of Directors was held on the first of the month at the Institute office and those present were Stuart Ballantine, president; Melville Eastham, treasurer; O. H. Caldwell, Alfred N. Goldsmith, Virgil M. Graham, R. A. Heising, J. V. L. Hogan, L. M. Hull, F. A. Kolster, George Lewis, E. L. Nelson, Haraden Pratt, H. M. Turner, A. F. Van Dyck, L. E. Whittemore, William Wilson, and H. P. Westman, secretary.

Fifty-one Associates and thirteen Students were admitted to membership.

Instructions were issued for preparing an accumulative index for the PROCEEDINGS covering all issues up to December, 1935, to be published early in 1936.

The Emergency Employment Service registration now totals 741 and of the eight jobs which came to our attention during the month, one was filled.

The Institute Medal of Honor was voted to Balth. van der Pol, Jr. for his fundamental studies and contributions in the fields of circuit theory and electromagnetic wave propagation phenomena.

The Morris Liebmann Memorial Prize will be bestowed upon F. B. Llewellyn for his analysis and disclosures of the effects and reactions within vacuum tubes at ultra-high frequencies.

Nominations for candidates for officers to be elected during the latter part of this year were prepared and are given in an announcement following these minutes.

The committee which is studying the problems of licensing of engineers submitted a progress report which was discussed. Insufficient data are available at this time to permit the preparation of material for publication but it is anticipated that a statement can be presented in the PROCEEDINGS in the early fall.

Nominations and election of Officers

In accordance with the requirements of the Institute Constitution, Article VII of that document is reprinted herewith and is followed by a list of nominations submitted to the membership by the Board of Directors.

ARTICLE VII

NOMINATION AND ELECTION OF PRESIDENT, VICE PRESIDENT, AND THREE DIRECTORS AND APPOINTMENT OF SECRETARY, TREASURER, AND FIVE DIRECTORS

SEC. 1—On or before July 1st of each year the Board of Directors shall call for nominations by petition and shall at the same time submit to qualified voters a list of the Board's nominations containing at least two names for each elective office, together with a copy of this article.

Nomination by petition shall be made by letter to the Board of Directors setting forth the name of the proposed candidate and the office for which it is desired he be nominated. For acceptance a letter of petition must reach the executive office before August 15th of any year, and shall be signed by at least thirty-five Fellows, Members, or Associates.

Each proposed nominee shall be consulted and if he so requests his name shall be withdrawn. The names of proposed nominees who are not eligible under the Constitution, as to grade of membership or otherwise, shall be withdrawn by the Board.

On or before September 15th, the Board of Directors shall submit to the Fellows, Members, and Associates in good standing as of September 1st, a list, of nominees for the offices of President, Vice President, and three Directors. This list shall comprise at least two names for each office, the names being arranged in alphabetical order and shall be without indication as to whether the nominees were proposed by the Board or by petition. The ballot shall carry a statement to the effect that the order of the names is alphabetical for convenience only and indicates no preference.

Fellows, Members, and Associates shall vote for the officers whose names appear on the list of nominees, by written ballots in plain sealed envelopes, enclosed within mailing envelopes marked "Ballot" and bearing the member's written signature. No ballots within unsigned outer envelopes shall be counted. No votes by proxy shall be counted. Only ballots arriving at the executive office prior to October 25th shall be counted. Ballots shall be checked, opened, and counted under the supervision of a Committee of Tellers, between October 25th

An example of the use of this method is given, wherein the plate of an existing triode and the cathode of an existing pentode are to be used in a new triode.

DESIGN AND EQUIPMENT OF A 50-KILOWATT BROADCAST STATION FOR WOR

J. R. POPPELE

(Station WOR, Newark, N.J.)

AND

F. W. CUNNINGHAM AND A. W. KISHPAUGH

(Bell Telephone Laboratories, Inc., New York City)

The design, construction, and operation of the modern high power broadcast station presents problems of magnitude and complexity to the engineers responsible for its success. It is the purpose of the authors to suggest, as an aid to engineers, methods of analysis of the many factors involved in the location, the antenna design, the housing, and specification of equipment for a large transmitter, offering the new WOR 50-kilowatt station as illustration.

The station location, together with the novel directional antenna, produces a maximum field strength toward both New York and Philadelphia, while limiting radiation in the direction of the ocean and sparsely populated areas.

The layout of the transmitter building provides maximum convenience of operation. The lighting, heating, and ventilation arrangements of the windowless building are unusual in design.

A serious attempt has been made to design and operate the equipment for a performance consistent with advanced ideas of high fidelity. Curves showing the performance of the transmitter in regard to frequency characteristic and audio distortion are given, as well as the distribution of radiation.

NOTES ON INTERMEDIATE-FREQUENCY TRANSFORMER DESIGN

F. W. SCHEER

(S. W. Sickles Coil Company, Springfield, Mass.)

The effect of the intermediate frequency chosen on the gain and selectivity of amplifiers is pointed out. The computation and measurement of the sharpness of resonance of tuned transformers is outlined. Coils are studied in relation to the wire employed and form factor of the windings. The effects of tuning condensers, shields, and coupling of coils on the gain and selectivity are covered. The calculation of stage gain and selectivity is treated. High fidelity receiver circuits are considered and the use of two-winding and three-winding transformers compared. Band-pass filters are discussed.

AN UNATTENDED ULTRA-SHORT-WAVE RADIOTELEPHONE SYSTEM

N. F. SCHLAACK AND F. A. POLKINGHORN

(Bell Telephone Laboratories, Inc., New York City)

Some of the factors involved in the application of an ultra-high-frequency radio link to wire telephone plant are discussed. A description is given of an ultra-high-frequency radio circuit which has been set up and operated between Green Harbor and Provincetown, Mass. This circuit is used as a part of a regular toll telephone circuit between Boston and Provincetown. It has been found that the equipment can remain in operation over considerable periods without attention or adjustment.

GENERAL THEORY AND APPLICATION OF DYNAMIC COUPLING IN POWER TUBE DESIGN

CHARLES F. STROMEYER

(Revelation Patents Holding Company, New York City)

This paper presents a simplified method of driving a power tube without the need of coupling devices and grid-biasing means. The power section is one whose useful plate current versus grid voltage characteristic is realized only with positive values of grid voltage. Its low input impedance is in series with the cathode-ground circuit of the driver tube, and hence, the term "dynamic coupled." The impedance, also, automatically provides a negative bias for the grid of the driver, thereby eliminating external biasing.

Practical design consideration of the driver involves the working into a step-down load. It is shown that the distortion which is produced when working with such ratios, is minimized by degeneration. This is first treated with a pure resistive load. When the grid impedance is the load, a further reduction in distortion is shown for then the ratio of plate-to-load impedance more nearly remains constant throughout a signal excursion. Graphical projection of the reflected grid impedance of the power section on the driver's plate characteristic is treated in detail.

The remaining part of the paper deals with a commercial application of these principles. Certain design considerations for a tube embodying both driver and power sections are discussed. A current surge phenomenon caused by secondary emission and a practical means for its elimination is expounded. The delayed point at which the driver's grid begins drawing current is shown to be particularly advantageous in push-pull circuits. The tube's electrical and economical advantages are compared to contemporary audio systems.

ELECTRON BEAMS AND THEIR APPLICATION IN LOW VOLTAGE DEVICES

HARRY C. THOMPSON

(RCA Radiotron Division, RCA Manufacturing Company, Harrison, N.J.)

A study has been made of the segregation into beams of the space current in devices of the over-all size of commercial receiver tubes and at potentials less than 300 volts. Electrode coatings of luminescent material were used to make beam traces apparent on any or all electrodes.

Qualitative relationships between beam formations and relative electrode potentials are stated.

Space currents of a few milliamperes have been concentrated into beams less than 0.010 inch wide in simple structures.

Special control grids associated with ordinary cathodes have been found to combine good space-current control with effective beam formation so that the properties of beam formation, control of beam width, direction, and current can be combined in a single device.

It has been found that the segregation into beams by simple beam-forming structures is sufficiently effective to make possible a radical reduction in the ratio of percentage of space current to a positive electrode to percentage of projected area of that electrode when the latter is situated between cathode and ultimate anode.

The relationships between beam widths and electrode potentials have been found to be such that the mutual volt-ampere relations can be radically altered from those hitherto utilized. Linear, saturation, and special volt-ampere relations can be obtained. Individual electrode volt-ampere relations can be altered by utilizing the action of the field of such an electrode upon the width and direction of the beam impinging upon that electrode independently of interelectrode coupling. A variety of negative conductance devices have been made on this principle.

AUTOMATIC FREQUENCY CONTROL

CHARLES TRAVIS

(RCA License Laboratory, New York City)

The title refers to the control of the local oscillator frequency in a superheterodyne receiver for the purpose of centering the signal carrier in the intermediate-frequency band in spite of inaccuracies of manual tuning and potential "oscillator drift."

A system is described to accomplish this by electronic means. It consists of two units, one a detector preceded by frequency discriminating circuits and a control unit acted upon by the bias output of the above detector, to vary the oscillator frequency properly. Circuits for the control unit are shown and the manner of operation of the system is discussed.

Meeting of the Board of Directors

The regular May meeting of the Board of Directors was held on the first of the month at the Institute office and those present were Stuart Ballantine, president; Melville Eastham, treasurer; O. H. Caldwell, Alfred N. Goldsmith, Virgil M. Graham, R. A. Heising, J. V. L. Hogan, L. M. Hull, F. A. Kolster, George Lewis, E. L. Nelson, Haraden Pratt, H. M. Turner, A. F. Van Dyck, L. E. Whittemore, William Wilson, and H. P. Westman, secretary.

Fifty-one Associates and thirteen Students were admitted to membership.

Instructions were issued for preparing an accumulative index for the PROCEEDINGS covering all issues up to December, 1935, to be published early in 1936.

The Emergency Employment Service registration now totals 741 and of the eight jobs which came to our attention during the month, one was filled.

The Institute Medal of Honor was voted to Balth. van der Pol, Jr. for his fundamental studies and contributions in the fields of circuit theory and electromagnetic wave propagation phenomena.

The Morris Liebmann Memorial Prize will be bestowed upon F. B. Llewellyn for his analysis and disclosures of the effects and reactions within vacuum tubes at ultra-high frequencies.

Nominations for candidates for officers to be elected during the latter part of this year were prepared and are given in an announcement following these minutes.

The committee which is studying the problems of licensing of engineers submitted a progress report which was discussed. Insufficient data are available at this time to permit the preparation of material for publication but it is anticipated that a statement can be presented in the PROCEEDINGS in the early fall.

Nominations and election of Officers

In accordance with the requirements of the Institute Constitution, Article VII of that document is reprinted herewith and is followed by a list of nominations submitted to the membership by the Board of Directors.

ARTICLE VII

NOMINATION AND ELECTION OF PRESIDENT, VICE PRESIDENT, AND THREE DIRECTORS AND APPOINTMENT OF SECRETARY, TREASURER, AND FIVE DIRECTORS

SEC. 1—On or before July 1st of each year the Board of Directors shall call for nominations by petition and shall at the same time submit to qualified voters a list of the Board's nominations containing at least two names for each elective office, together with a copy of this article.

Nomination by petition shall be made by letter to the Board of Directors setting forth the name of the proposed candidate and the office for which it is desired he be nominated. For acceptance a letter of petition must reach the executive office before August 15th of any year, and shall be signed by at least thirty-five Fellows, Members, or Associates.

Each proposed nominee shall be consulted and if he so requests his name shall be withdrawn. The names of proposed nominees who are not eligible under the Constitution, as to grade of membership or otherwise, shall be withdrawn by the Board.

On or before September 15th, the Board of Directors shall submit to the Fellows, Members, and Associates in good standing as of September 1st, a list, of nominees for the offices of President, Vice President, and three Directors. This list shall comprise at least two names for each office, the names being arranged in alphabetical order and shall be without indication as to whether the nominees were proposed by the Board or by petition. The ballot shall carry a statement to the effect that the order of the names is alphabetical for convenience only and indicates no preference.

Fellows, Members, and Associates shall vote for the officers whose names appear on the list of nominees, by written ballots in plain sealed envelopes, enclosed within mailing envelopes marked "Ballot" and bearing the member's written signature. No ballots within unsigned outer envelopes shall be counted. No votes by proxy shall be counted. Only ballots arriving at the executive office prior to October 25th shall be counted. Ballots shall be checked, opened, and counted under the supervision of a Committee of Tellers, between October 25th

and the first Wednesday of November. The result of the count shall be reported to the Board of Directors at its first meeting in November and the nominees for President and Vice President and the three nominees for Directors receiving the greatest number of votes shall be declared elected. In the event of a tie vote the Board shall choose by lot between the nominees involved.

SEC. 2—The Treasurer, Secretary, and five appointive Directors shall be appointed by the Board of Directors at its annual meeting for a term of one year or until their successors be appointed.

FOR PRESIDENT

L. A. Hazeltine

F. A. Kolster

FOR VICE PRESIDENT

Valdemar Poulsen

K. W. Wagner

FOR DIRECTORS

E. H. Armstrong

Virgil M. Graham

W. R. G. Baker

George Lewis

H. H. Beverage

A. F. Van Dyck



TECHNICAL PAPERS

IMAGE SUPPRESSION IN SUPERHETERODYNE RECEIVERS*

BY

HAROLD A. WHEELER

(Hazeltine Corporation, Jersey City, New Jersey)

Summary—Superheterodyne receivers are particularly sensitive to interference at the intermediate frequency and at the image frequency. Several types of selective circuits are described for coupling the antenna to the grid of the first tube which have especially great selectivity against such interference. The number of selective circuits which must be tuned to the signal is thereby minimized. Performance curves are given for receivers having intermediate frequencies of 175 or 450 kilocycles.

IT IS well known that a superheterodyne receiver, when tuned to a desired signal, is particularly sensitive to interference at certain other frequencies, which are called spurious response frequencies. The principal spurious response frequencies are the intermediate frequency and the image frequency. The latter is usually higher than the signal frequency, and differs therefrom by twice the intermediate frequency. The most interference is likely to occur at the intermediate frequency or the image frequency, whichever is closer to the signal frequency. In a broadcast receiver having an intermediate frequency of 175 kilocycles, the image frequency is more likely to be closer to the signal frequency, while in a broadcast receiving having an intermediate frequency of 450 kilocycles, the latter is more likely to be closer to the signal frequency.

One or more selective circuits, tuned to the signal, are used to reduce interference at spurious response frequencies. In addition, special circuits have been devised for further reducing interference without increasing the number of tuned circuits. Some of these circuits, together with performance curves, are the subject of this paper. The most attention has been paid to the reduction of image interference, which is termed image suppression. The image suppression circuits will be described with reference to image frequencies higher than the signal frequencies.

Fig. 1 shows a simple double tuned selector for coupling the antenna to the grid of the first vacuum tube in a superheterodyne receiver.

* Decimal classification: R361.2. Original manuscript received by the Institute, February 18, 1935. Presented before New York Meeting, April 5, 1933, as part of paper "Image Suppression and Oscillator-Modulators in Superheterodyne Receivers."

The antenna is coupled to the lower part of the first tuned coil, capacitively by means of an open-end primary coil, and inductively by means of a high inductance primary coil which broadly resonates the antenna circuit just below the broadcast band. A tap on the first tuned coil is connected to another high inductance primary coil which is inductively coupled to the second tuned coil.

The advantage of this circuit resides in the tap connection. Having tuned the circuits to the signal, it is found that image frequency currents in the first tuned circuit determine a point on the first tuned coil which has zero image voltage relative to ground. The equation of Fig.

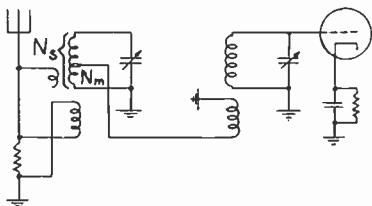

$$\frac{N_m}{N_s} = 1 - \frac{f_s^2}{f_m^2}$$

Fig. 1

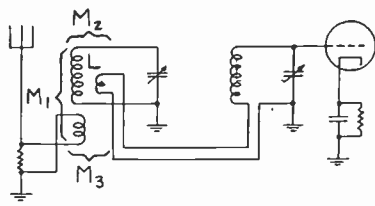

$$\frac{M_1 M_2}{M_3 L} = 1 - \frac{f_s^2}{f_m^2}$$

Fig. 2

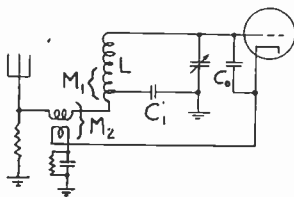

$$\frac{f_{12}^2}{f_m^2} + \frac{M_1}{M_2} = \frac{f_m^2}{f_s^2} - 1 - \frac{f_m^2}{f_0^2}, \quad f_{12} = \frac{1}{2\pi\sqrt{C_1 M_2}}, \quad f_0 = \frac{1}{2\pi\sqrt{LC_0}}$$

Fig. 3

1 indicates approximately the location of this image suppression point. N denotes number of turns on the coil, f denotes frequency, and the subscripts s and m refer to signal and image, respectively.

The ratio of signal-to-image frequency varies over the broadcast band, so that the optimum position of the tap depends on the tuned frequency. However, the tap can be located at a compromise point, such that a considerable advantage is obtained over the entire band, the advantage being greatest near the middle of the band.

This circuit was very widely used in the first commercial five-tube superheterodyne receivers, with an intermediate frequency of 175 kilocycles. In these receivers, the double tuned selector was connected directly to the modulator (or first detector).

Fig. 2 shows a simplified double tuned selector capable of nearly the same performance as that of Fig. 1. The equation of Fig. 2 gives approximately the condition for optimum image suppression. This equation is satisfied structurally by sliding the coupling coil along the first tuned coil, varying M_2 and M_3 in opposite directions until the best compromise design is found. The best position of the coupling coil is usually a little above the lower end of the tuned coil, as indicated in the diagram.

Fig. 3 shows an improved type of single tuned selector which is widely used in recent and contemporary receivers, connected in some cases to a tuned radio-frequency amplifier and in other cases directly to the modulator. The antenna is coupled to the tuned circuit by a large condenser C_1 , having about ten times the maximum capacitance of the tuning condenser, and in addition by a very small mutual inductance M_1 , which may be omitted in some cases. A series coil and shunt resistance serve to resonate broadly the antenna circuit near the middle of the operating frequency band, thereby increasing the antenna signal current and also improving the selectivity against interference outside of the operating band.

The image suppression is obtained by the cathode coil, which is coupled to the antenna circuit by mutual inductance M_2 . Having tuned the circuit to the signal by the tuning condenser, it is found that image frequency currents in the antenna circuit produce a small image voltage on the grid of the first tube. The cathode coil applies a similar image voltage on the cathode of the tube, which counterbalances in the tube any effect of the small image voltage on the grid. The equation of Fig. 3 gives approximately the condition for optimum image suppression. The inherent direct capacitance between grid and cathode, denoted C_0 , has an appreciable effect and should be kept small.

For this circuit there are two terms on the left side of the equation, both under control of the designer. The first term has the major effect, and the second term has a minor effect which is more important at higher frequencies. As a result, this circuit is capable of optimum suppression at two points in the operating band, and very nearly optimum throughout the entire band.

The image suppression is independent of the self-impedance of the antenna circuit, which allows considerable freedom of design. Best results have been obtained by making the antenna circuit resonant in the operating band, and damping the resonance by resistance to prevent the reflection of excessive resistance into the tuned circuit. Under these conditions, the tuning is practically independent of antenna characteristics, and the antenna-to-grid gain is good.

Fig. 4 shows performance curves on the circuit of Fig. 3, designed for 175 kilocycles intermediate frequency, the image frequency then being 350 kilocycles above the signal frequency. The curve across the top is the voltage gain curve from the antenna to the grid of the first tube. The broad peak in the gain curve results from the broad resonance of the antenna circuit, which has already been mentioned. The response curves show the selectivity of the circuit when tuned to 600, 1000, and 1400 kilocycles, respectively. On each curve, the frequency of greatest suppression is just 350 kilocycles above the frequency of resonance,

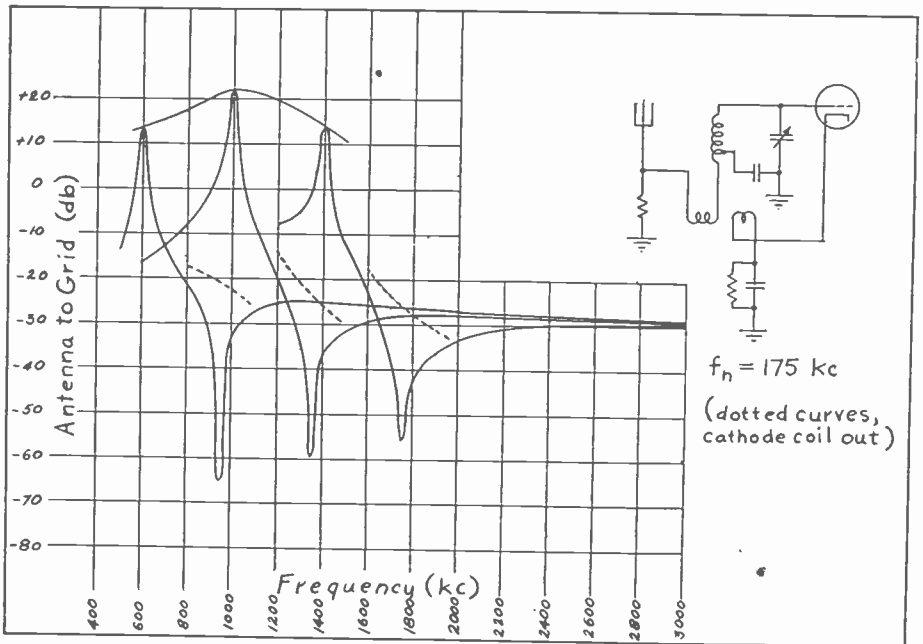

Fig. 4

which results in great attenuation of image interference. The image ratio for this single tuned selector is from 66 to 80 decibels, or 2000 to 10,000 times, over the entire operating range. The greater values are effective where the image frequencies are also in the broadcast band and are therefore more likely to cause interference. In this circuit, the improvement due to the image suppression is equivalent to another tuned selective circuit, as far as image interference is concerned. This advantage is seen by comparison with the dotted curves which were observed with the image suppression disconnected. It is important that the auxiliary circuits used to attenuate the image do not introduce any spurious resonance peaks in the response curves, especially at the higher frequencies. This was one of the problems encountered, which was solved by this circuit, as shown by the curves.

The circuit of Fig. 4 is used in some commercial receivers which also include a tuned radio-frequency amplifier stage. In these cases, the resulting image ratio for the two tuned selective circuits ranges from 100 to 120 decibels, or 100,000 to 1,000,000 times, which is found to be sufficient for very nearly all conditions. This image ratio is largely limited by refinements in shielding and grounding, rather than by the capabilities of the image suppression circuit.

In receivers having image suppression, it is found that the image frequency may become less important than other spurious response

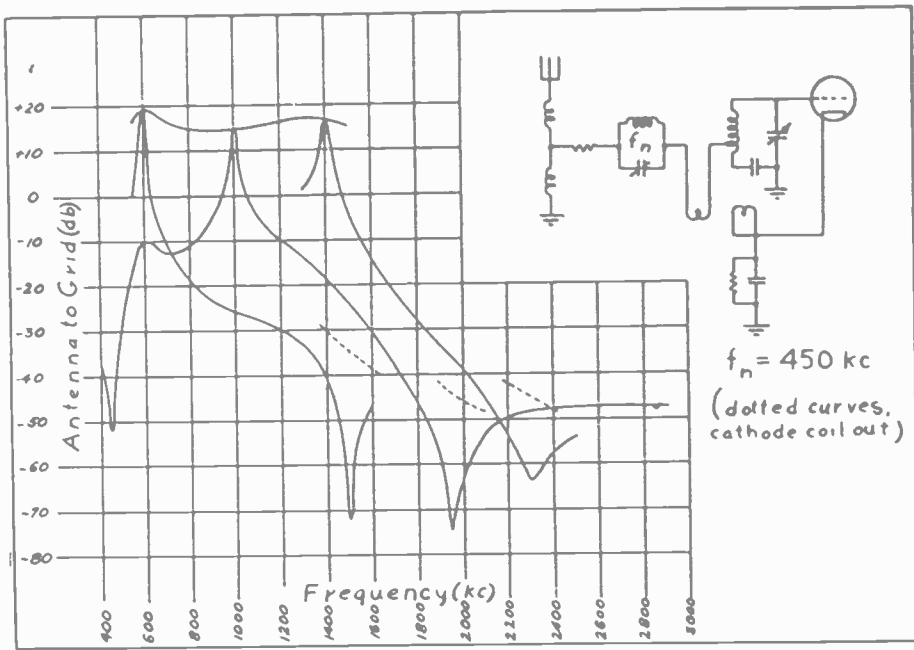

Fig. 5

frequencies, most of which are higher than the signal frequency. In receivers having an intermediate frequency near the lower limit of the operating band, this also becomes a source of interference, which is amplified directly by the intermediate-frequency amplifier.

Fig. 5 shows a modification of the circuit of Fig. 4, together with similar performance curves. This improved circuit is intended to feed the modulator tube in receivers having only a single tuned selector, and using an intermediate frequency of 450 kilocycles. The image frequency is therefore 900 kilocycles above the signal frequency. The curves show that the maximum suppression occurs at the image frequency, exactly when the receiver is tuned to 600 or 1400 kilocycles, and approximately when tuned to 1000 kilocycles. As far as broadcast interference on the image frequency is concerned, it is possible only

when the receiver is tuned between 550 and 600 kilocycles, in which case the image ratio is 90 decibels or 30,000 times.

Three other improvements are shown in Fig. 5. The gain curve at the top is held more nearly uniform by making the antenna circuit doubly resonant in the broadcast band. A trap is included which greatly attenuates interference at the 450-kilocycle intermediate frequency, as shown by the curves. The action of the trap is about the same, regardless of the tuning. This trap also coöperates in improving the gain curve. The attenuation at frequencies higher than the image frequency is considerably improved as compared with Fig. 4.

In any of these circuits, additional filtering ahead of the first tuned circuit would result in further reduction of interference outside the broadcast band. In Fig. 4, the antenna circuit is roughly equivalent to a half-section band-pass filter. In Fig. 5, the antenna circuit has in addition a half-section high-pass filter, containing the intermediate-frequency trap. A remarkable degree of selection is obtained with one variable tuned circuit, by the combination of means for suppressing the image and means for filtering out all interference outside the operating band. Better selection is needed only in very sensitive receivers operating in the neighborhood of powerful transmitters.

The circuit of Fig. 6 represents a different arrangement whose performance is nearly as good as Fig. 5, and whose cost is considerably less, due to some simplification of the circuit. This circuit is intended for use in low price receivers having an intermediate frequency of 450 kilocycles.

The main coupling between antenna and tuned circuits is provided by L_m , M_1 , M_2 , and C_m , indicated in the diagram. The inductance and condenser components have opposing coupling effects, and the resultant coupling is a minimum at the intermediate frequency f_n when the coupling components are proportioned according to (6). The total inductance and resistance in the antenna circuit is chosen to make it broadly resonant within the broadcast band, just above 550 kilocycles where the resultant coupling is less because of the proximity to 450 kilocycles. In this way, the gain is maintained nearly uniform, and the tuning is made nearly independent of antenna characteristics.

The image suppression is mainly accomplished by the grid tap on the tuned coil, in the manner described in connection with Fig. 1. The image suppression is modified by the small condenser of a few micro-microfarads connected between the top of the tuned circuit and a point in the antenna circuit. These two factors permit of maximum image suppression when the receiver is tuned to 600 or 1400 kilocycles, and nearly maximum when tuned to any frequency in the broadcast

range. The second resistance in the antenna circuit is to prevent a peak which would otherwise occur in the response curve at about four megacycles.

The circuit of Fig. 7 is a single tuned selector designed for operation over two different frequency bands. It is found especially useful in receivers covering the broadcast band and the next higher band, and having an intermediate frequency of 450 kilocycles. The selector is connected directly to the modulator. In fundamental operation, this circuit is like the other cathode coil circuits, shown in Figs. 3 to 5. An intermediate-frequency trap is included in the antenna lead. Two

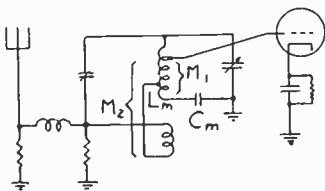

$$(L_m + M_1 + M_2)C_m = \frac{1}{4\pi^2 f_n^2}$$

$$n = 450 \text{ kc}$$

Fig. 6

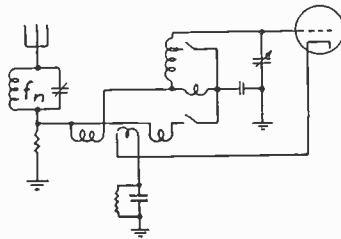

$$f_s = \begin{cases} 550 - 1400 \text{ kc} \\ 1400 - 3500 \text{ kc} \end{cases}$$

$$f_n = 450 \text{ kc}$$

Fig. 7.

switches are connected so as to change four properties of the circuit as follows: (1) the tuned circuit inductance; (2) the coupling reactance common to the antenna and tuned circuits; (3) the mutual inductance to the cathode coil; (4) the antenna circuit inductance.

In the course of the work on image suppression, many other circuits have been devised and tested. Some of these other circuits are also in commercial use at the present time. For example, special circuits have been designed to meet the requirements for European receivers, which must cover the broadcast band and also a lower frequency band. It is found that image suppression circuits lend themselves also to other uses, which fall outside the scope of this discussion.

The writer gratefully acknowledges the contributions and assistance, in the work on the subject of this paper, of Messrs. J. K. Johnson, N. P. Case, V. E. Whitman and other engineers of the Hazeltine Corporation.

Discussion

J. C. Smith:¹ The paper by Mr. H. A. Wheeler is part of a paper titled "Image Suppression and Oscillator-Modulators in Superheterodyne Receivers" which was presented at the April, 1933, New York meeting of the Institute. Much of the material presented on the oscillator-modulator on that occasion has been published elsewhere and readers are referred to the following articles:

"The Emission Valve Modulator for Superheterodynes," *Electronics*, March, 1933, page 76.

"The Emission Valve Modulator for Superheterodyne Receivers," *Proceedings of the Radio Club of America*, April, 1933, page 23.

"The Hexode Vacuum Tube," *Radio Engineering*, April, 1933, page 12.

The following discussion was presented at the New York meeting at which Mr. Wheeler's paper was originally given. While it is confined entirely to that portion of the paper concerning the oscillator-modulator, it is presented here as a matter of record.

I have particularly enjoyed Mr. Wheeler's paper this evening because of my part in unitube detector-oscillator developments which originated at Camden and were carried through by engineers of the RCA Victor and the RCA Radiotron Companies. These developments culminated commercially in the 2A7 and 6A7 pentagrid converters and a short résumé of them at this time may be of interest to the members. I hope you will pardon me if for the sake of continuity in presentation of the ideas involved I repeat points which Mr. Wheeler has just discussed.

For some years a number of circuits have been known which were available for use as a unitube detector-oscillator, but they were in general possessed of very serious defects. An analysis of the problems involved indicated that if a device were developed with signal voltage and local oscillator voltage effectively in parallel, i. e., in an additive relationship, curvature of a tube characteristic and probably an external coupling of the circuits would be necessary. Mathematically, this simply involves the summation of the signal and oscillator voltages and the expansion of this sum in a power series which represents the tube characteristic. Sum and difference terms and harmonics result and the desired signal is then selected and amplified. An alternative view considers that the oscillator voltage periodically varies the transconductance of the tube. This produces a cross product of the signal and oscillator voltages with resulting sum and difference terms.

A method of accomplishing this end without curvature of the tube characteristic or intercoupling of the circuits was seen to lie in the use of grids acting successively upon the electron stream, in series as it were. A tube was therefore devised with two negatively polarized control grids separated by an interposed positive grid. A plate was external to the whole, with appropriate screening. In the simplest form with successively a cathode, a negative grid, a positive grid, a second negative grid and a plate, there are transconductances between each of the negative grids and the positive elements. Any one of these transconductances may be chosen to feed energy back to the appropriate negative grid to produce self-oscillation, while a signal may be placed upon the other negative grid. Thus one could build up around this tube numerous circuit combinations which would give the desired cross product of signal and local oscillator voltages.

Certain other factors, however, served to restrict the choice of circuit com-

¹ Radio Manufacturing Company, RCA Victor Division, Camden, New Jersey.

binations. The most important of these was the desirability of controlling the gain of the tube through the gain control system of the receiver. It was determined that this control could best be placed upon the outer negative grid. The control grid was provided with a positively polarized screen which, in addition to performing the usual functions of a screen grid, aided in raising the output impedance of the tube. The use of complete shielding increased the total cathode current by about two milliamperes, but it was considered that this was of much less relative importance than the advantages obtained by complete shielding. We then have the A-7 pentagrid converter tube in its present form with cathode, oscillator grid, oscillator anode, screen, control grid of the exponential type, second screen, and output plate, the positive screen elements being connected together and brought out on a common lead. Since the oscillator anode has the function of furnishing a transconductance with the oscillator grid, it is unnecessary that it be in the form of a grid; it may consist simply of two side rods parallel to the cathode. There are no particularly novel or unusual features to be taken into consideration in designing a superheterodyne receiver to use the A-7. The design of the radio-frequency input coil, the intermediate-frequency transformers, and the gang tuning condensers is conventional.

It is physically very illuminating to think of the tube as being an emission valve, as Mr. Wheeler points out, having a virtual cathode for which the supply of electrons is controlled by variation of the oscillator grid potential. Mathematically, as Mr. Wheeler has indicated this evening, the operation of the tube can be expressed in terms of developments of the usual tube characteristics, particularly of transconductance. If we assume a fixed bias on the signal grid, we can determine the transconductance ($\partial I_p / \partial E_{g1}$) for a range of values of E_{g1} , the oscillator grid voltage, and plot the resulting curve, which will in general approximate a straight line. Knowing the oscillator grid voltage and operating point, it is possible to calculate or measure the various components of plate current at the various frequencies. If we then define the conversion transconductance as the ratio of the desired intermediate-frequency component of plate current to the control-grid signal voltage as that signal approaches zero as a limiting value, we have a characteristic which is a figure of merit of the tube; corresponding in a measure to the transconductance of a screen-grid tube. I say it corresponds in a measure, because it is not, strictly speaking, a function of the tube alone, but also of the associated oscillator circuit, its operating point, and wave form. Practically speaking, however, the value can be used as a means of calculating the gain of the tube for a given value of plate impedance, just as S_m is used in the ordinary tube.

It is interesting to note that while this development was undertaken primarily for economic reasons, as a means of simplifying the design of the receiver, eliminating a tube and certain associated parts, and saving space, it was realized that there would result the attainment of certain technical advantages as compared with the usual two-tube system. Among those which have resulted there might be listed the following: a high translation gain; a greater volume control effectiveness; the elimination of the necessity for intercoupling between radio-frequency and oscillator and resultant freedom of mechanical design, and the removal of troubles associated with that intercoupling. Thus we are doubly fortunate in obtaining both economic and technical improvements in the developments we have heard discussed this evening.

THE DESIGN AND TESTING OF MULTIRANGE RECEIVERS*

BY

DANIEL E. HARNETT AND NELSON P. CASE

(Hazeltine Corporation, Jersey City, New Jersey)

Summary—The principal difficulties in the design of high-frequency receivers reside in the complexity of the multirange circuits. Several circuits and a unit assembly arrangement are described which improve the frequency calibration and simplify the design. Testing is facilitated by the use of simplified signal generators having "piston" attenuators. The attenuator comprises a pair of coplanar coils, coaxial coils, or condenser plates, one fixed and one movable axially in a moderately long cylindrical copper shield. The attenuation in decibels is directly proportional to the displacement of the movable element, and the calibration can be computed.

THE problem of properly designing multirange receivers has existed for many years, but until about three years ago the only fields for such receivers were commercial communication services and amateur work. Receivers for these services could be of the laboratory type, with each receiver more or less of an individual problem; production difficulties and expense were not important factors, and the completed receivers were normally used by skilled technicians.

Presently, however, a faint but insistent demand commenced to be heard from the large body of broadcast listeners that they be supplied with means whereby they could listen to programs, perhaps of little interest in themselves, but of great popular appeal because they originated at great distances. The first answer to this demand took the form of a "converter," to be installed as an accessory to the broadcast receiver already in the listener's home. The converter was merely an extra oscillator and modulator, arranged to give a modulated output at a frequency within the normal tuning range of the broadcast receiver. Like most such afterthoughts, the converter had serious defects in performance, but at least high-frequency signals could be received, and thereby public interest was further aroused.

The next step in the progress of the all-wave receiver was the logical one of making the modulator and oscillator circuits of the receiver itself capable of tuning over the high-frequency ranges, thus eliminating an unnecessary duplication of functions. Various schemes were tried to maintain the broadcast reception at or near the standard to which the public was accustomed, such as preselectors and radio-frequency amplifiers for the broadcast band only. Fundamentally, of course, the

* Decimal classification: R261. Original manuscript received by the Institute, February 18, 1935. Presented before Ninth Annual Convention, Philadelphia, Pa., May 30, 1934.

higher frequency ranges really needed the improvements more than did the broadcast range, because of weaker signals, less efficient circuits, and inherent selectivity considerations. However, multirange receivers were still in the laboratory stage of design, and laboratory designs attempted on the production line encountered such grave difficulties that nothing but the simplest type of high-frequency circuits was at all practicable.

At this stage of development, the design work was largely a matter of cut and try; the necessary tools for accurate measurement of results were not yet developed, and such matters as stage gains and alignment of high-frequency circuits received only cursory attention, just sufficient to produce a usable receiver.

To progress beyond this point, it was necessary that the tools of design be improved to the point where the defects of existing receivers could be accurately investigated, and the pathway to further improvement could be pointed out. The principal need was for an all-wave signal generator with high output, open frequency scales, and accurate attenuation, which could be handled with convenience and speed.

In view of the important rôle played by standard signal generators in the practical work of designing all-wave receivers, it is proposed to discuss briefly in this paper several types of attenuators for such instruments.

Important points of difference between the various types of generators lie in the attenuators and in the methods of changing from one frequency range to another. Regarding the latter point, most all-wave generators produced thus far have used plug-in coils, but the tendency will probably be toward switching of permanently mounted coils, because of the time lost in changing coils, especially where the range of one coil is insufficient to cover a single range of an all-wave receiver, as is usually the case.

Of the three types of attenuator (resistance, capacitance, and inductance), the first has been so thoroughly investigated that its advantages and limitations are generally known.

Regarding the variable capacitance and variable mutual inductance types of attenuators, there is so great a variety of possible arrangements that it would be beyond the scope of this paper to attempt to treat all of them. Accordingly, this discussion will be limited to those arrangements wherein a magnetic or electrostatic field is generated at one end of a long conducting tube and is attenuated exponentially along the tube. The signal voltage delivered to the output terminals is proportional to the intensity of the field at a pick-up device which is movable along the axis of the tube. Because of the exponential change in field

strength, the attenuation in decibels varies linearly with the distance between the source and the pick-up. To take advantage of this linear relation, the attenuator output is indicated in decibels below one volt, rather than in microvolts. The rate of attenuation is accurately determined by calculation.

Fig. 1 shows two forms of the variable capacitance type of attenuator. With any shape of electrodes, the rate of attenuation is 20.9 decibels per radius along the axis of a circular tube, for large separation of the electrodes. With electrodes of the two forms shown, the separa-

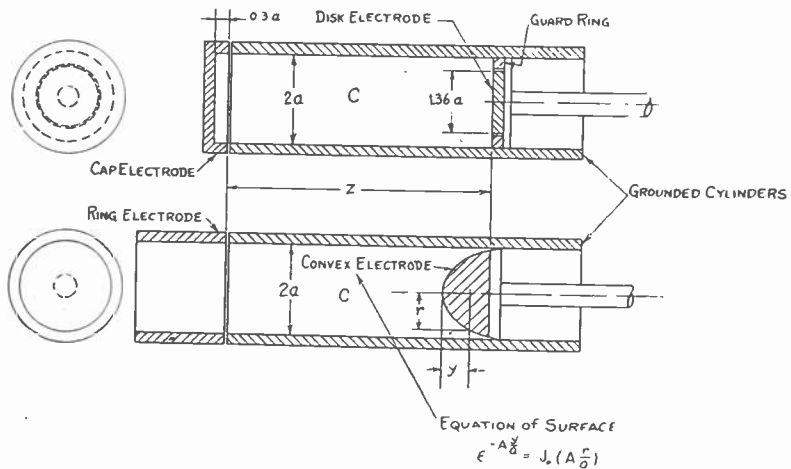

$$\frac{C}{C_0} = \epsilon^{-A(z/a)}$$

$$A = \left\{ \begin{array}{l} 2.405 \text{ napiers} \\ 20.9 \text{ decibels} \end{array} \right\} \text{ per radius.}$$

(19.3 decibels in square cylinder.)

Fig. 1—Piston attenuator, condenser in circular cylinder.

tion "z" can be reduced nearly to zero, without appreciable departure from this rate of attenuation. The capacitance between the ring and the convex electrode is greater at this point than that between the cap and the disk electrode, resulting in about 10 decibels greater maximum output from the former arrangement, with reasonable tolerances.

A circuit arrangement for the capacitive attenuator is shown in Fig. 2. The circuit elements C_a , R_a , and L_a comprise the dummy antenna. The open-circuit output voltage of this circuit depends only on the values of C and C_a . The principal advantages of the capacitive attenuator are that it has no coils to be changed for different ranges, and that the attenuation is independent of frequency for a given value of C_a .

Fig. 3 shows a piston attenuator having mutual inductance between two coaxial coils. Using a circular cylinder for the tube and keeping the coils sufficiently separated, the rate of attenuation for this type is 33.3 decibels per radius, where the effective radius "a" is the measured inside radius of the cylinder plus the "depth of penetration". Since the depth of penetration varies inversely as the square root of the frequency, the rate of attenuation varies slightly with frequency. It

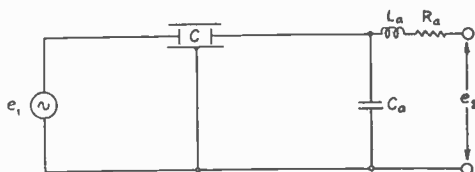

$$\frac{e_2}{e_1} = \frac{C}{C_a + C} = \text{approx. } \frac{C}{C_a} \text{ when } C \ll C_a.$$

Fig.12

is found in practice that a tube of sufficient diameter to give the desired length of attenuator scale is large enough so that the error caused by neglecting the variation of the depth of penetration is negligible over the useful range of attenuation. This error in a two-inch copper tube may be taken as an example. If the scale is marked correctly for 1000 kilocycles the actual attenuation at 25 megacycles will be about one-fourth decibel in 100 more than indicated, and at 150 kilocycles will be about one-half decibel in 100 less than indicated.

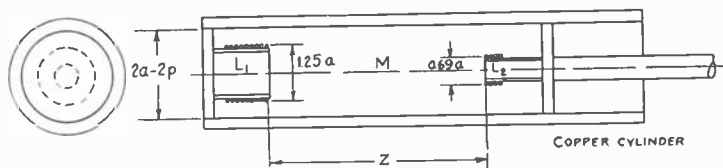

Depth of penetration: $p = \frac{1}{2\pi\sqrt{f\sigma}} = 2.6 \text{ mils at } 1 \text{ mc}$

$$\frac{M}{M_0} = e^{-A(z/a)}$$

$$A = \left\{ \begin{array}{l} 3.832 \text{ nepiers} \\ 33.3 \text{ decibels} \end{array} \right\} \text{ per radius}$$

(27.3 decibels in square cylinder)

Fig. 3—Piston attenuator, coaxial coils in circular cylinder.

When the coils are close together, the diameters of the coils have a small effect on the rate of attenuation. Choosing the values shown on Fig. 3 for the coil diameters results in keeping the rate of attenuation substantially uniform up to the setting at which the load reaction of the output circuit on the input circuit becomes appreciable. The proper

coil diameter is that which makes the flux configuration close to the input coil nearly the same as that at a considerable distance from the coil. Otherwise the field pattern will be distorted by the coil and the normal rate of attenuation will not hold when the coils are close.

There are two sources of errors in attenuation which must be carefully minimized in mutual inductance attenuators having coaxial coils. One is incidental capacitive coupling and the other is departure from axial symmetry. The latter causes a transverse magnetic field. The capacitive coupling and the "transverse" inductive coupling are sub-

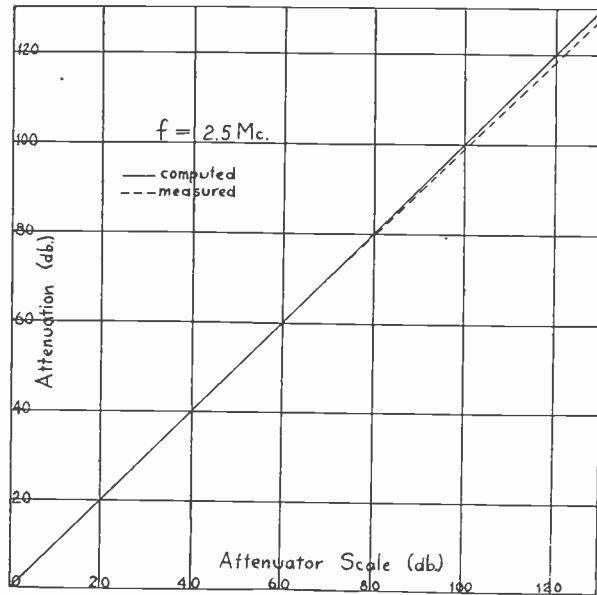

Mc	Error ± 2 db at
1	116 db
2.5	130
6	120
15	106

Fig. 4

ject to much less attenuation than the desired "axial" inductive coupling, and therefore become more detrimental with increasing attenuation. The incidental capacitive coupling is minimized by grounding the near ends of the two coils. When the coils have very few turns, the connecting leads cause appreciable transverse field. This source of error can be minimized by arranging the plane of the leads to one coil perpendicular to the plane of the leads to the other coil, both planes including the axis of the cylinder.

Fig. 4 shows the accuracy of calibration of an attenuator which has been built with coaxial coils. The cylinder is a seamless copper tube two inches in diameter. When all the known sources of error have been

carefully minimized, the calculated calibration agrees with the experimental to limits closer than can be measured with the usual laboratory equipment. The accuracy is shown to be good over 120 decibels variation. This may be the range from one volt to one microvolt or from one-third volt to one-third microvolt.

Fig. 5 shows another form of mutual inductance attenuator, having coplanar coils in a square cylinder. In this form, the desired inductive coupling is caused by the transverse field which was a possible source of error in the attenuator having coaxial coils. The inductive coupling between coplanar coils has the smallest rate of attenuation of all forms of inductive and capacitive coupling in a closed cylinder. Therefore the other forms of inductive coupling and capacitive coupling are attenuated more than the desired coupling, and become less detrimental with an increasing amount of attenuation. The coil length indicated is chosen to maintain a substantially uniform rate of attenuation when the separation of the coils is reduced nearly to zero.

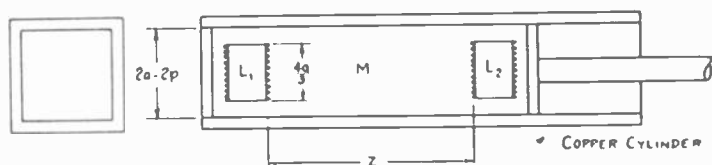

$$\text{Depth of penetration: } p = \frac{1}{2\pi\sqrt{f\sigma}} = 2.6 \text{ mils at } 1 \text{ mc}$$

$$\frac{M}{M_0} = e^{-A(z/a)}$$

$$A = \left\{ \begin{array}{l} \frac{\pi}{2} \text{ napiers} \\ 13.64 \text{ decibels} \end{array} \right\} \text{ per radius}$$

$$(16.0 \text{ decibels in circular cylinder})$$

Fig. 5—Piston attenuator, coplanar coils in square cylinder.

A preferred design of this attenuator has rectangular coils in a square cylinder. The near sides of the coils have greatest mutual inductance. The shielding surfaces close to the other sides of the coils contribute materially toward increasing the maximum coupling. Such an attenuator has been built, having 40 per cent as the maximum usable coefficient of coupling between the coplanar coils.

Fig. 6 shows two alternative circuits for connecting a mutual inductance attenuator in a signal generator. The upper circuit is a simple arrangement in which the input coil L_o may be the oscillator coil and the output coil L_a may be the inductance of a dummy antenna. This circuit is well adapted to the use of plug-in coils for different frequency

ranges. The coils may be proportioned to give the same maximum output in each range. Such an arrangement has been incorporated in several signal generators with piston attenuators having coaxial coils in a two-inch copper tube. The piston is removed from one end of the cylinder to permit changing the plug-in coils. The oscillator coil is changed with the aid of a long rod or a bayonet attachment on the piston. The attenuation scale is engraved on the piston rod, which also carries the output terminals connected to the pick-up coil. The frequency range from 100 kilocycles to 24 megacycles is covered with six pairs of coils.

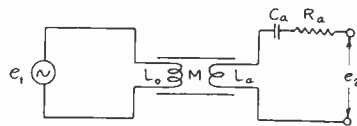

$$\frac{e_2}{e_1} = \frac{M}{L_0} = k \sqrt{\frac{L_a}{L_0}}$$

$$k^2 = \frac{M}{L_0 L_a}$$

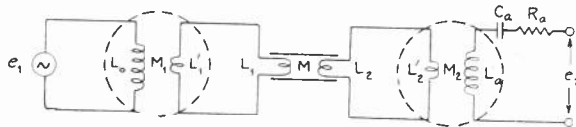

$$\frac{e_2}{e_1} = \frac{kk_1k_2}{1-k_1^2-k_2^2} \sqrt{\frac{L_a}{L_0}} = \text{approx. } \frac{kk_1k_2}{1-k_1^2} \sqrt{\frac{L_a}{L_0}} \text{ when } k^2 \ll 1.$$

$$k^2 = \frac{M^2}{(L_1+L_1')(L_2+L_2')} \quad k_1^2 = \frac{M_1^2}{L_0(L_1+L_1')} \quad k_2^2 = \frac{M_2^2}{L_a(L_2+L_2')}$$

Fig. 6

The lower circuit of Fig. 6 is an arrangement for using the same two attenuator coils over a wide range of frequency. The attenuator coils are made of sufficiently small inductance to be operable at the highest frequency. The input and output transformers shown in dotted circles are changed from range to range, preferably by switching. If plug-in coils are used, only the input coil L_0 and the output coil L_a need be changed. In either case, the former may be the oscillator coil and the latter may be the inductance of a dummy antenna. This arrangement with switching has been incorporated in a signal generator operating from 100 kilocycles to 24 megacycles with six sets of coils (outside of the attenuator). The piston is moved by a rack and pinion, such that the scale of attenuation occupies the circumference of a large dial. The scale is divided uniformly and marked in decibels below one volt. The output of the movable attenuator coil is conducted through a flexible coaxial cable.

Two principal advantages of mutual inductance attenuators over capacitance attenuators are as follows:

(1) The detuning reaction of the output circuit on the input circuit decreases with the square of the attenuation, instead of with the first power as in capacitance attenuators. This permits greater output voltage for a given permissible variation of frequency and output impedance.

(2) The input and output circuits need not be grounded to the attenuator shield. This simplifies the grounding problem, and permits the output coils of two attenuators to be connected in series for two-signal tests such as described in the 1933 Report of the I. R. E. Standards Committee.

In some respects the performance of capacitance and mutual inductance attenuators is quite different from that of resistance attenuators. If the output circuit is tuned by a load circuit, the voltage measured across its terminals is higher than the attenuator scale would indicate, although the internal voltage in series with the output circuit is correct. The results are not misleading if the output reactance is considered a part of the load circuit, as for example, where this reactance is used as part of the reactance of a dummy antenna. Otherwise, an experimentally determined correction can be applied to the output scale. The rate of attenuation is independent of this effect. In mutual inductance attenuators, the pick-up coil may resonate with a harmonic of the oscillator. The harmonic content of the terminal voltage then becomes much greater than normal, and may even affect the observed output voltage. This effect may be minimized by adding across the output coil a circuit having substantial dissipation at the resonant frequency of the pick-up coil.

The continuously variable piston attenuator, combined with convenient means for changing from one frequency range to another, tends to increase materially the speed of operation of multirange signal generators. This is an important advantage in making the large number of observations required in the design and testing of multirange receivers.

The early broadcast and short-wave receivers had the same general arrangement as the broadcast receivers. In order to change ranges, the user had to change a set of plug-in coils. This simple solution of the design problem was not acceptable to the average broadcast listener. In the first improvement the coils for the various ranges were mounted on the chassis and a gang switch was used for selecting the desired frequency. The structure was expensive and occupied considerable space. The size of the tuning system was objectionable because it re-

quired long leads, which coupled to other circuits and which constituted a large part of the inductance of the tuned circuit for the highest frequency range. The lead inductance was likely to be variable in production.

Placing all the coils for one transformer on a single coil form simplified the problem somewhat, but when a tuned radio-frequency amplifier was added, this simplification was insufficient. Mounting the coil switch close to the coils to make the leads very short, added to the difficulty of soldering the connecting leads between switch and coils.

Fig. 7 shows a four-range coil and switch unit which overcomes most of the difficulties. The coil and switch are both mounted on the one

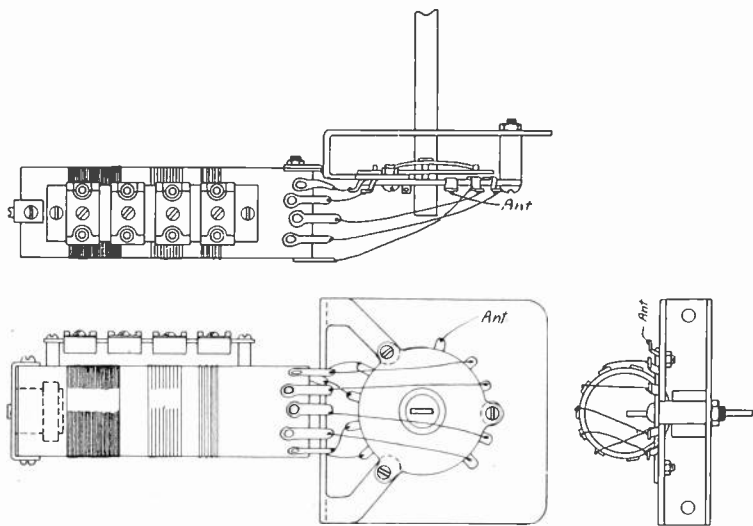

Fig. 7—Circuit preceding intermediate-frequency amplifier.

bracket. Each unit may be mounted vertically on the chassis beside the tuning condenser, or horizontally under the chassis with the switch under the tuning condenser. After all the units are mounted, the shaft of all the switches is inserted. On the coil form, the three short-wave secondaries are solenoids, the lowest inductance coil being next to the switch. The broadcast secondary is a multilayer coil inside the far end of the form. The diameter of the form is one inch. It is used in a two-inch shield can. The advantages of this assembly are:

(1) The wiring is simplified. The coil and switch can be wired as a subassembly, outside the chassis where all terminals are easily accessible. A defective unit may be replaced easily by simply sliding out the switch shaft and unsoldering three or four wires. The number of long leads around the bottom of the chassis is reduced.

(2) The lead inductance is greatly reduced by the close proximity

of switch and coils. This unit is particularly well adapted to an arrangement wherein the coils in their shields are mounted horizontally under the chassis in such positions that the switch units come directly under their respective sections of the tuning condenser, thereby minimizing the length of all leads in the tuned circuits. This reduces the coupling to near-by circuits, especially at the highest frequencies. The concentration of inductance in the coil facilitates obtaining the desired coupling to it, especially in the oscillator circuit, and also simplifies the production problem of coil matching.

(3) Mounting the padding condensers inside the shield can reduce their lead inductances and shields them against undesired couplings.

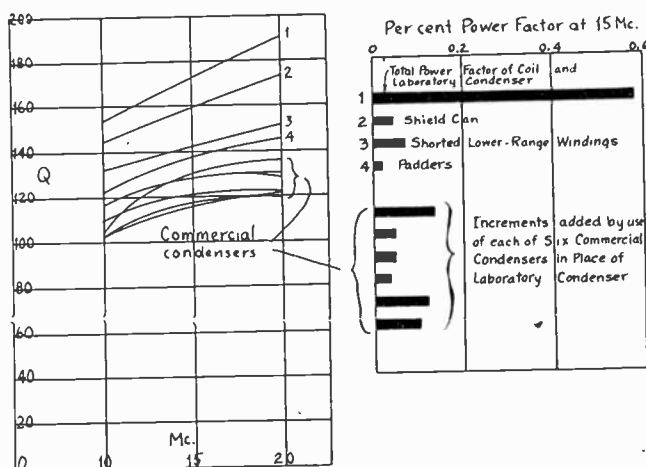

Fig. 8

Fig. 8 shows the effect of various factors on the "Q" of the coil of lowest inductance of Fig. 7. Curve 1 shows the "Q" of the coil alone, tuned by a laboratory condenser of very small dissipation. Curve 2 shows the reduction due to an aluminum shield can two inches in diameter. Curve 3 shows the further reduction due to the other coils, in position and short-circuited. Curve 4 shows the further reduction due to the padding condensers, in position along one side of the coil form. The lower curves show the further reduction due to the substitution of various commercial tuning condensers. The chart of Fig. 8 shows the contribution to the "power factor" of the tuned circuit, which is made by each of these factors.

There are two general arrangements for switching the secondary coils of the various frequency ranges, as follows:

(1) A tapped coil may be used, with provision for shorting out the unused sections.

(2) Individual coils may be used for each frequency range.

A typical circuit diagram for the tapped coil arrangement is shown in Fig. 9. It is customary to include "followers" on the switch, as shown, in order to short the unused sections individually and thereby to minimize the undesired absorption effects at the natural frequencies of the larger unused coils. The parallel padders should be across the particular sections of the coil with which they are associated, rather than be returned to ground; moreover, they should be so mounted that the capacitance of the padder frame to ground is as low as possible. The reason for these requirements is that it is usually desired to decrease the frequency ratio of each tuning range progressively from the broadcast band to successively higher ranges, in order to facilitate tuning in the higher ranges. Moreover, it is practically necessary, from a commercial

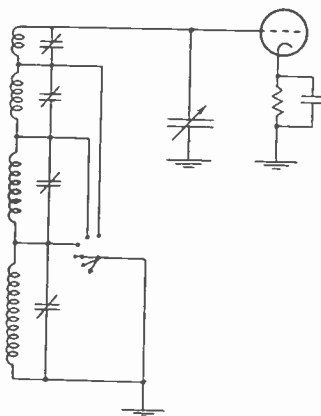

Fig. 9

point of view, to cover the entire broadcast band in a single range. Therefore, the smallest total parallel capacitance should be in circuit when the entire coil is in use. If the padders returned to ground, the maximum padding capacitance would be in circuit under this condition. A disadvantage of the tapped coil arrangement resides in the fact that the alignment adjustments for the various ranges are not independent, which necessitates aligning the various ranges in a definite order, beginning with the highest range.

The other general arrangement is shown diagrammatically in Fig. 10, in which all of the coils have a common low potential end. In order to avoid absorption dips in the response curves, it is necessary to short-circuit the coils of higher inductance than the coil in use at any particular setting of the range switch. This requirement cannot be obviated by placing the individual secondaries in separate shield cans, because the absorption circuits are substantially coupled to the circuit in use by the small capacitance existing between the switch contacts and

between the leads to the switch. If the requirement of shorting the unused coils is met, all the coils may be wound on the same form. In many cases it has been found possible to design the switch so that no additional switch sections are required to accomplish the required shorting. This arrangement has the two advantages that the tuning range of each range is determined solely by its individual padders, within the limitations imposed by the tuning condenser, and that each range can be aligned entirely independently of every other range. Its principal disadvantage is the additional switching required to short the unused coils.

The absorption effect mentioned above with reference to Fig. 10 is illustrated by the curves of Fig. 11. The measurements were made on

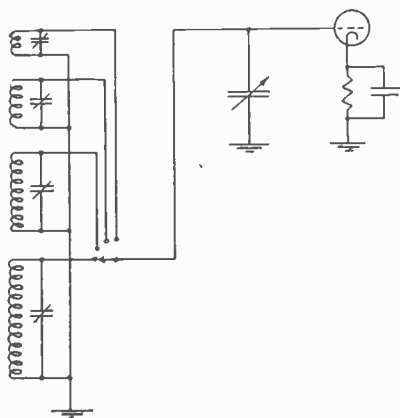

Fig. 10

the coil for the frequency range 10–23 megacycles, while the coil for the frequency range 4–10 megacycles was left unshorted. The only other coil on the form was a helical wound broadcast coil, which was shorted. A coupling capacitance of approximately three micromicrofarads existed between the high potential ends of the low inductance secondaries. Aside from the direct loss occasioned by the presence of the absorption dips, it is evident that the over-all response in a receiver is still further reduced because of the considerable misalignment that occurs on both sides of the absorption frequencies. Experience has shown that such dips as those shown in Fig. 11 are quite capable of stopping the oscillator over an appreciable frequency range, when they occur in connection with the oscillator coils. The curves of Fig. 11 illustrate two different types of absorption dips. The more prominent dip occurs at the resonant frequency of the unshorted coil, and most of the coupling is capacitive. The other dip is caused by the slight inductive coupling between the coil in use and the short-circuited broadcast

coil. In the latter case a standing wave is set up on the short-circuited broadcast coil, with voltage nodes at the ends of the coil. It is interesting to note that shorting the middle coil removes both of these dips; the reason is that the short-circuited middle coil acts as an inductive shield between the coil in use and the broadcast coil, thereby greatly diminishing the inductive coupling between them.

It seems to be well established that the best compromise performance in all-wave superheterodyne receivers is secured by using a relatively high intermediate frequency, in the neighborhood of 450 kilocycles. It is difficult enough at best to secure good image ratios in the

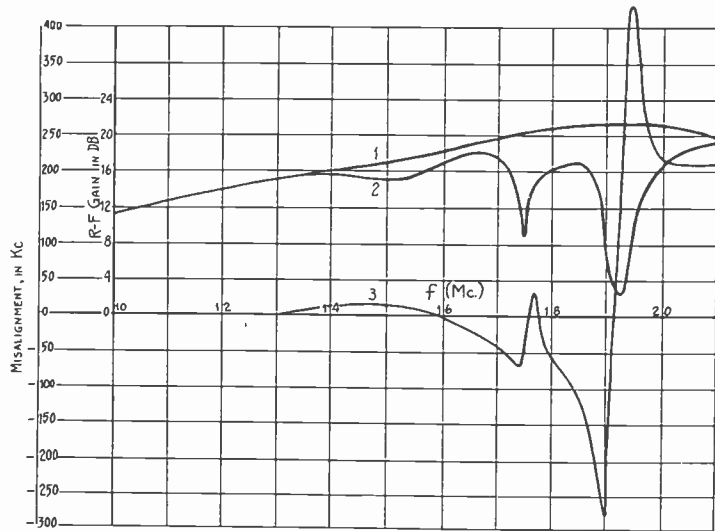

Fig. 11

high-frequency ranges and the use of a lower intermediate frequency makes the problem that much more difficult, as well as complicating the alignment processes in production. If the two principal response frequencies are close together, the aligner is continually confronted with the necessity of choosing which is the desired signal frequency and which the image frequency, with the consequent possibility of error.

It has been found that higher image ratios than are obtainable with a single tuned circuit are necessary to secure interference-free, high-frequency reception. This factor, plus a desire to secure better signal-to-noise ratios, has led to a growing use of at least one stage of radio-frequency amplification ahead of the modulator tube in all ranges. The additional selectivity obtained thereby requires that correspondingly greater pains be taken to keep the various radio-frequency circuits in accurate alignment. Conventional radio-frequency coupling circuits operate satisfactorily at the higher frequencies, al-

though the gain obtainable is not as great as at broadcast frequencies.

In view of the inherent difficulties of reducing stray couplings in radio-frequency amplifiers at very high frequencies, the unit assembly described above offers very substantial advantages. The compactness of the assembly, the short, well-shielded leads, the shielded padders, and the well-isolated ground returns make this system very stable compared to arrangements of previous types.

In order to secure the full advantages of a high-frequency radio-frequency amplifier, it is necessary that the radio-frequency gain be as

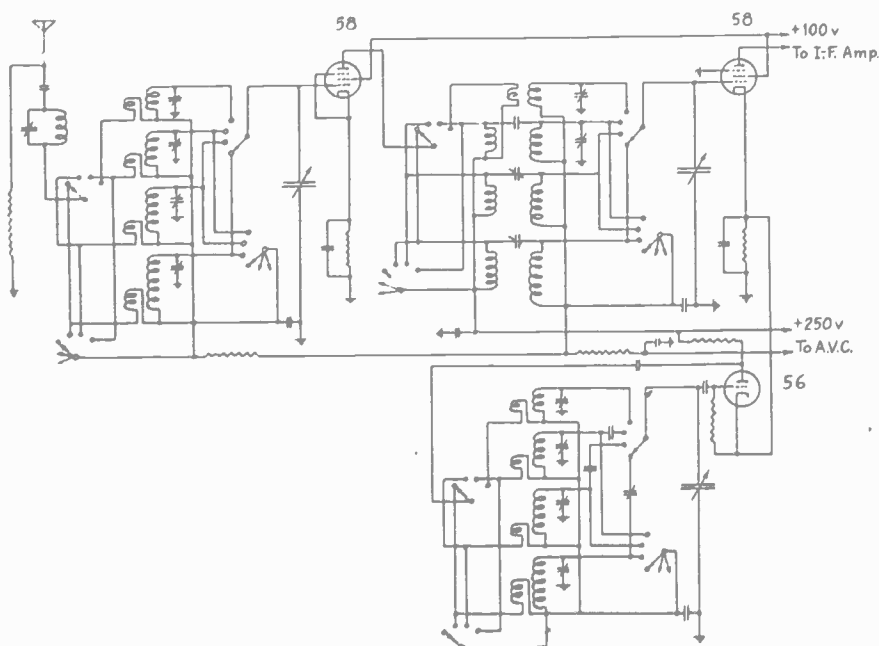

Fig. 12 Circuit preceding intermediate-frequency amplifier.

high as possible; it has been found that, in the range 10–25 megacycles in combination with an antenna-to-grid gain of two to six decibels, a radio-frequency stage gain of fourteen to eighteen decibels will reduce the equivalent noise side band input from a value of several microvolts to about a microvolt or less. Moreover, the image selectivity is very noticeably improved. This improvement is usually most noticeable when listening to broadcasting in the six-megacycle band, where the image falls in the near-by amateur band.

Fig. 12 shows the circuits preceding the intermediate-frequency amplifier in a typical well-designed superheterodyne receiver designed to receive on all frequencies from 0.53 to 23 megacycles. Four overlapping tuning ranges are used. The trap between the antenna and the antenna switch is tuned to the intermediate frequency, to minimize

interference due to signals on this frequency. Aiding inductive and capacitive coupling from the antenna to the first tuned circuit is employed to obtain relatively high and nearly uniform gain to the first grid in each range. The primary coils for the inductive coupling have very few turns.

The capacitive coupling is due to a common condenser in the ground return leads of antenna circuit and tuned circuit. A similar condenser is connected in the radio-frequency amplifier tuned circuit to maintain the alignment. The latter condenser is slightly larger because high inductance primary coils are used in the amplifier, which partly correct the alignment in the same manner. The usual series condenser in the oscillator is made smaller than would otherwise be required, thereby contributing more to the feedback in the oscillator.

In all except the highest frequency range, the radio-frequency amplifier transformer has primary coils tuned below the tuning range, capacitively coupled to the tuned secondary circuits. In the two lower frequency ranges the coupling condensers are also used as padders. This combination of expedients tends to equalize the gain in adjacent frequency ranges.

Three unit assemblies according to Fig. 7 are used, each with the general circuit arrangement of Fig. 10. In addition, all unused coils which have greater inductance than the coils in use in the tuned circuits are shorted. All the unused primary coils are shorted, which is not always necessary.

The coöperation and assistance is gratefully acknowledged of other staff members of the Hazeltine Corporation laboratories. The mathematical theory of piston attenuators of the types described was developed by Mr. Harold A. Wheeler. Professor Alan Hazeltine contributed valuable suggestions with reference to the piston condenser attenuator. Early signal generators using these attenuators were designed and built by Messrs. Harold M. Lewis and Madison Cawein. Credit for the unit assembly of coil and switch is due to Mr. J. Kelly Johnson.

Discussion

J. F. Dreyer, Jr.¹: It seems desirable to add a few comments to the first part of this paper which deals with "piston" attenuators. The discussion of these devices, summarized in Figs. 1 to 7 and attributed to Mr. H. A. Wheeler, is an excellent one but does not give sufficient indication of their merit.

An attenuator of the type illustrated in Fig. 3 was made by the writer in 1929 at the Atwater Kent Company. It was used and improved by Dr. Travis and later by Mr. C. A. Apker. We called it a "trombone" attenuator and found it to have the following advantages over the resistance type:

¹ RCA Manufacturing Company, RCA Radiotron Division, Harrison, New Jersey.

First, very high voltages can be obtained with low power oscillators, thus facilitating image response measurements in superheterodynes. Second, it is simple and cheap to construct and calibrate. Third, it is free from sliding-contact noises present in many resistance type attenuators.

The Harnett and Case paper indicates that the coaxial coil type of mutual inductance attenuator may be used with calculated scales as a primary standard. The writer's experience has been that because of mechanical simplicity this device is admirably suited for factory use. In fact many hundreds of them have been and are so used. Because they are comparatively cheap it is good practice to provide in factory test stands a separate attenuator for each different frequency of test signal. The attenuator may be calibrated by checking low attenuation points with a vacuum tube voltmeter. Then since the attenuation scale so accurately follows an exponential law the remainder of the scale can be relied upon. This was determined in our work, wholly by experiment. We, therefore, are glad to see the mathematical formula presented at this time.



HIGH FIDELITY RECEIVERS WITH EXPANDING SELECTORS*

BY

HAROLD A. WHEELER AND J. KELLY JOHNSON

(Hazeltine Corporation, Jersey City, New Jersey)

Summary—A high fidelity receiver for general use requires means for continuously expanding or contracting the resultant band width of all the carrier selectors, in order that the best compromise between fidelity and selectivity may be chosen for any given operating conditions. The expanding selector ("XPS") arrangement may be adapted for either unsymmetrical or symmetrical expansion of the resonance curve. Arrangements are described and the relative merits are discussed for both kinds of expansion. A superheterodyne receiver is described, which has a preferred form of symmetrical expanding selector, as well as other advantageous features. A tuning and expanding mechanism is described, in which the expansion is adjustable by moving the tuning knob in the axial direction. The mechanism includes an interlock which permits the operator to tune the receiver only when the band width is contracted. The operator is thereby constrained to follow the correct procedure of first tuning with maximum selectivity, and second, expanding to improve the fidelity to the extent permitted by noise or adjacent channel interference.

LABORATORY work on the improvement of radio receiver fidelity has been carried on with steadily increasing intensity during the past five years. The lower costs of component parts and the improved tubes have made it possible to manufacture a very high grade receiver in the present upper price bracket. In this field, there has been no substantial progress in extending the upper limit of audio frequencies reproduced by commercial receivers. The demand for single channel selectivity has been a major impediment to such progress, since the outer side bands are greatly attenuated by highly selective circuits.

High fidelity in radio reception requires the uniform reproduction of a wide range of audio frequencies over a wide range of loudness, free of any wave form distortion and background noise arising in the broadcast system. The increasing interest in this subject as a whole is evidenced by the many recent publications and demonstrations relating thereto. This paper is devoted entirely to only one of the several special problems arising in the design of high fidelity receivers. That problem is the extension of the upper limit of audio-frequency reproduction, as limited by the selectivity requirements.

* Decimal classification: R361.2. Original manuscript received by the Institute, February 18, 1935. Presented before Ninth Annual Convention, Philadelphia, Pa., May 30, 1934.

A high grade receiver for general use must have available sufficient selectivity to receive any one of the many stations from which reception can reasonably be expected by the user. If this receiver is to be classed as a high fidelity receiver, it must also have means for utilizing the maximum usable audio-frequency range, considering the incidental interference and noise limitations. It is not sufficient that the receiver may be capable of high fidelity reception only under ideal conditions such as are seldom met in the field. The best compromise between greatest selectivity and highest fidelity must be available to the user.

Expanding selector arrangements have been devised to meet these requirements. They include means for continuously adjusting the side band acceptance of the receiver over a wide range. This adjustment is made substantially independent of the tuning over the broadcast band. The circuits for this purpose are mainly associated with the intermediate-frequency amplifier of a superheterodyne receiver. The three-letter designation "XPS" has been adopted for expanding selectors.

The adjustable nature of expanding selectors makes available new possibilities for improving selectivity, as well as fidelity. The present nonadjustable selectors involve a severe compromise between selectivity and fidelity, each being limited mainly by the other. The expanding selector relieves the necessity for this compromise on the part of the manufacturer, and places the responsibility in the hands of the user, who may at will shift the compromise to suit operating conditions.

For present purposes, the uniform reproduction of audio frequencies up to 7000 cycles is considered adequate for high fidelity broadcast reception. This upper limit permits filtering out the 10,000-cycle beat notes between carriers on adjacent channels, and also permits filtering out the major part of the "monkey-chatter" caused by side bands of interfering signals on adjacent channels. Uniform reproduction up to 7000 cycles represents about an octave improvement over the best receivers now available.

The reproduction of the higher audio frequencies does not require the acceptance of the outer side bands on both sides of the carrier. Nor is it practicable to separate the side bands entirely and utilize one side band exclusively. It is practicable to utilize all of one side band and the inner part of the other side band, with due attention to equalizing the fidelity of the system.

When the band width of an expanding selector is contracted for greatest selectivity, double side band reception is always preferred. Further side band acceptance for higher fidelity can then be obtained by expanding the selector on one or both side bands. Expansion on

only one side band is designated "sesquiband" reception, because approximately all of one side band and half of the other side band are utilized.

All expanding selector circuits can be classified as symmetrical or unsymmetrical, according to whether the expansion is effected on both side bands or only on one side band. Before describing circuits in both classes, some of their relative advantages and disadvantages should be understood. Table I shows such a comparison in tabular form.

TABLE I

Comparison of Symmetrical and Unsymmetrical XPS Circuits		
Characteristics when expanded	Symmetrical Class (double side band reception)	Unsymmetrical Class (sesquiband reception)
Complicity of operation	One option = amount of expansion	Two options = amount of expansion and choice of side band
Dependence of fidelity on the tuning	Noncritical, tuning center of band to carrier	Critical, tuning edge of band to carrier
Selectivity possible with given fidelity	Better when comparable interference is on both sides of desired carrier	Better when major interference is on only one side of desired carrier
Distortion of modulation envelope	No distortion because side band symmetry is maintained	Slight distortion because side band symmetry is disturbed, especially at higher audio frequencies
Noise (static, circuits, tubes) relative to signal	Minimum	About three decibels above the minimum
Design limitations	Better for fidelity	Better for selectivity

Expanding selectors of the unsymmetrical class must be designed to give the user an option as to which side band he wishes to favor by expansion. This additional option, which may be exercised unskillfully, is a disadvantage of unsymmetrical circuits.

Symmetrical circuits generally require less care in tuning, because the fidelity is not a critical function of the tuning. When unsymmetrical circuits are expanded, a predetermined point on one side of the selector band must be tuned quite accurately to the carrier. The greater accuracy required is another disadvantage of the latter.

When the desired signal is subject to major interference on only one adjacent channel, the unsymmetrical circuits have a considerable advantage, assuming that the user expands on the clear side band. Great selectivity against such interference can be secured, even when the selector is fully expanded.

When the desired signal is subject to like interference or noise on both side bands, the symmetrical expanding selectors give less interference or noise relative to the signal. The reason is found in the behavior of the signal rectifier toward side bands and noise. The audio-frequency rectified signal output due to both side bands is six decibels

above that due to only one side band, because the two components of the output are of equal frequency and are additive in phase. The audio-frequency rectified noise output due to both side bands is only three decibels above that due to one side band, because the two components are unrelated in frequency and phase. The increase of noise due to unsymmetrical expanding is therefore about three decibels greater than the increase of noise due to symmetrical expanding, assuming that the signal fidelity is the same in both cases.

Unsymmetrical expanding produces a nominal amount of envelope distortion, because it disturbs the side band symmetry. The amount of distortion is not likely to be noticeable if both inner side bands are utilized for modulation below 1000 cycles, and if the expanding does not accentuate the desired outer side band more than six decibels relative to the carrier. The most obnoxious result of such distortion is the production of cross-products or beat notes between various components of modulation. This effect is minimized by the use of a linear rectifier such as a well-proportioned diode circuit.

There is not a closed case for either class of expanding selectors. Symmetrical circuits are capable of being designed to give a greater refinement of performance with respect to all properties except selectivity. Unsymmetrical circuits are capable of better performance where interference on only one adjacent channel comprises the most severe restriction on the usable fidelity. Either class of circuits, with selectors contracted, can be designed to have great sensitivity and selectivity, useful for reception from distant stations.

The further discussion deals first with unsymmetrical circuits and second with symmetrical circuits. A complete receiver is then described, and also a novel mechanism having a single knob for both tuning and expanding adjustments.

In the circuits to be described, the expanding operation generally has a slight effect on the gain of the receiver at the carrier frequency. Automatic volume control is always provided, designed to maintain the amplified carrier voltage constant during expansion or contraction of the expanding selector. This function must be substantially independent of the signal modulation which can be assured by the use of a well-proportioned diode rectifier circuit for automatic volume control.

All forms of expanding selectors are preferably adapted to the intermediate-frequency circuits of superheterodyne receivers, so that the expansion can be made substantially independent of the tuning. The radio-frequency selective circuits preceding the frequency changer are designed to have a nearly uniform resultant band width, sufficient

to pass a fourteen-kilocycle band without appreciable attenuation. The center of this broad band remains tuned to the desired carrier, while the intermediate-frequency selectors may be expanded on one or both side bands.

A major requirement in the design of expanding selectors is "consistency of expansion." When the user is adjusting from the contracted condition to the expanded condition, there must be a continuously increasing expansion of the audio-frequency range. At the same time, there must be no substantial attenuation at any intermediate audio frequencies relative to the lower audio frequencies. In terms of the

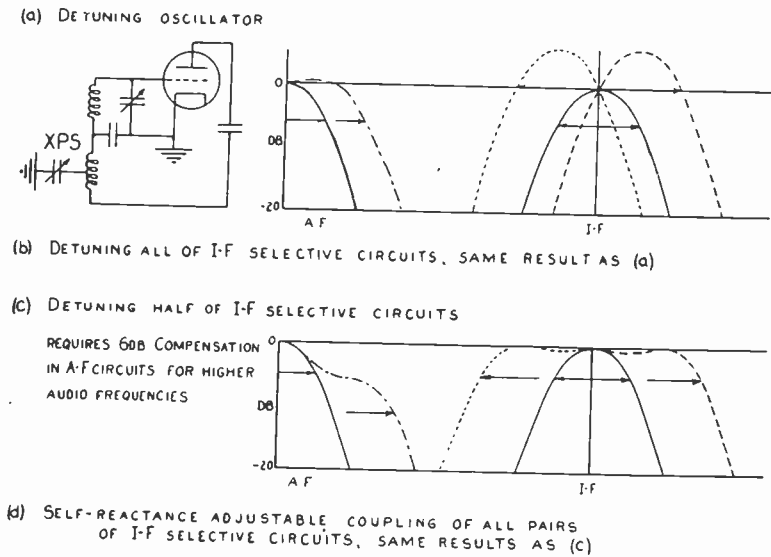

Fig. 1—Unsymmetrical XPS circuits.

fidelity curve, the expanding adjustment must shift the curve generally outward and upward, and must not cause appreciable recession of any part of the curve during any phase of the adjustment. This consistency requirement places definite restrictions on the audio-frequency ratio of expansion obtainable with any given form of expanding selector. This is discussed further in connection with symmetrical circuits.

Fig. 1 indicates the performance of several forms of unsymmetrical expanding selectors. In each case, the effect of the expanding selector on the fidelity is determined by the variation of the average acceptance of both side bands, as a function of the modulation frequency. This average is a vectorial average, with due respect to the relative phase of carrier and side band acceptance. In most practical cases, the simple average is a fair approximation.

Fig. 1(a) shows a simple arrangement for unsymmetrical expansion. The intermediate-frequency amplifier is made fairly selective, without

means for expansion. Auxiliary means are provided for detuning the oscillator frequency a few kilocycles in either direction, the amount of detuning being made nearly independent of the main tuning adjustment. The oscillator circuit shown has this provision in the form of a small adjustable condenser coupled to the main tuned circuit by combined negative mutual inductance and a common condenser. The latter are so proportioned that the frequency shift due to the auxiliary condenser is nearly the same when the oscillator is tuned for reception at any frequency in the broadcast band.

In Fig. 1(a) the consistency requirement necessitates a round-top resonance curve in the intermediate-frequency circuits. The envelope distortion caused by detuning limits the usable expansion to a ratio of about two to one. This limitation on the performance is partly counterbalanced by the extreme simplicity of this arrangement, which has only one adjustable element for expansion.

Fig. 1(b) indicates the same results obtainable alternatively by detuning all the intermediate-frequency selective circuits simultaneously. The large number of adjustments makes the use of this arrangement unnecessarily expensive, since the performance is the same as that of Fig. 1(a).

Fig. 1(c) shows unsymmetrical expansion by detuning half of the intermediate-frequency selective circuits. This reduces the number of adjustable elements to two or three, and gives very good performance. The usable expansion ratio is about three to one, as limited by the consistency requirement. The envelope distortion is minimized because there is negligible accentuation of the accepted side band relative to the carrier. The expanded fidelity is upheld by compensation in the audio-frequency circuits, to the extent of six decibels at the higher frequencies for which the expansion is effective.

The unsymmetrical detuning arrangements of Figs. 1(a), (b), and (c) all give maximum carrier gain when contracted, which is generally a desirable feature. Arrangements in which the coupling is adjustable for expansion, which are still to be described, give maximum carrier gain when the coupling is optimum, which generally corresponds to an intermediate adjustment of expansion.

Fig. 1(d) indicates unsymmetrical expansion by coupling the intermediate-frequency selective circuits in pairs by adjustable self-reactances. The number of adjustable elements and the resulting expansion are the same as in Fig. 1(c), for approximately the same performance. The effect is to vary the tuning of all circuits, and simultaneously to vary the coupling, holding one peak nearly in tune with the carrier.

Fig. 2 shows eighteen of the many possible circuits for accomplishing unsymmetrical expansion by the use of adjustable self-reactance coupling between two tuned circuits. In every example, there are two kinds of coupling, one an adjustable self-reactance and the other a fixed mutual or self-reactance. The mean coefficient of the adjustable self-reactance coupling is equal and opposite to that of the fixed coupling. Therefore the resultant coefficient of coupling is adjustable continuously between a positive maximum and an equal negative maximum. Each maximum corresponds to full expansion on one side band.

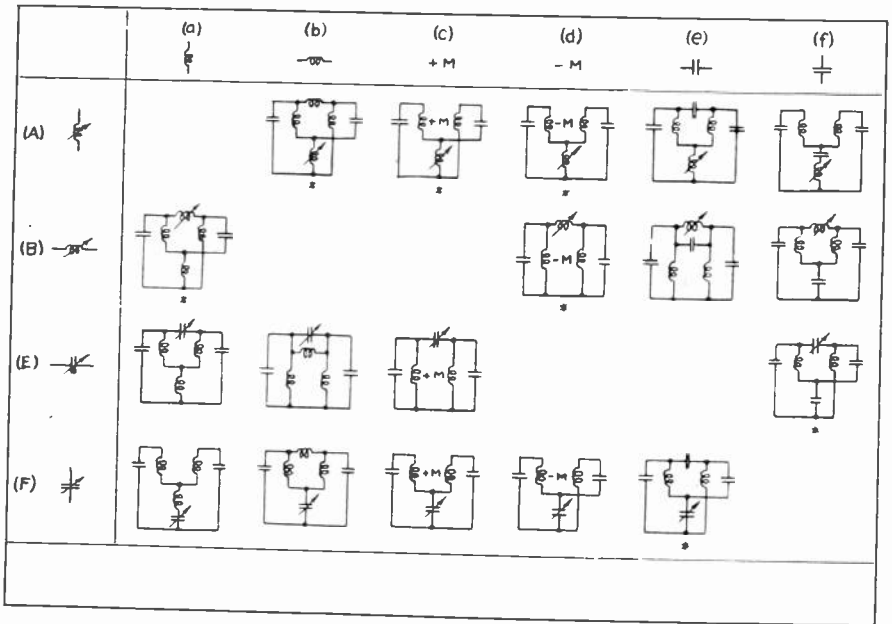

Fig. 2.—Unsymmetrical XPS circuits with adjustable self-reactance coupling.

Of the many possible coupling schemes using combinations of fixed and adjustable reactances, two general types are distinguished by their different performance characteristics. The first type is illustrated by the seven examples marked with an asterisk in Fig. 2. This type uses a combination of couplings whose reactances vary similarly with frequency. The effect secured is simply an adjustment of the resultant value of coupling between the two tuned circuits, from a negative maximum through zero to a positive maximum. Since an appreciable resistance component of coupling usually accompanies the reactance coupling, the net coefficient of coupling does not ordinarily pass through zero. Such resistance coupling may be desirable, providing it is so small as not to interfere with the desired reactive effects when the resultant reactance coupling is substantial.

The second type is illustrated by the remaining examples in Fig. 2. This type uses a combination of couplings whose reactances vary oppositely with frequency. The effect secured is similar to that of the first type, except that the amount of coupling varies with frequency, and approaches zero at a frequency not far removed from the resonant frequency of the tuned circuits. When this "trap" frequency is on one side of the resonance curve, it may have the desirable effect of improving the sharpness of selectivity on that side. When the trap frequency is equal to the resonant frequency of the tuned circuits, the signal carrier may be trapped out. When this condition exists, the signal is badly distorted.

TABLE II

A Pair of Similar Tuned Circuits (R, L, C)

<p>Center of resonance curves:</p> $\omega_0 = \frac{1}{\sqrt{L_0 C_0}}$ <p>Frequency variable:</p> $x = \frac{2\Delta\omega}{\omega_0} \ll 1$ <p>Power factor:</p> $p = \frac{R_0}{\omega_0 L_0}$ <p>Coupling coefficient:</p> $k = \frac{M}{L_0}$ <p>Detuning coefficient:</p> $h = \pm \frac{\Delta L}{L_0} \text{ or } \pm \frac{\Delta C}{C_0}$ <p>+ for one circuit - for other circuit</p> <p>Expanding coefficient</p> $\sqrt{k^2 + h^2}$	<p>Shape of resonance curves:</p> $\frac{E}{E_0} = \frac{1}{\sqrt{1 + \frac{x^2[x^2 + 2p^2 - 2(k^2 + h^2)]}{[p^2 + (k^2 + h^2)]^2}}}$ <p>Envelope of resonance curves:</p> $\left(\frac{E}{E_0}\right)_{\max} = \sqrt{1 + \left(\frac{x}{2p}\right)^2}$ <p>Shape of resonance curves multiplied by inverted envelope:</p> $\frac{E}{E_0} = \frac{1}{\sqrt{1 + \left\{ \frac{x[x^2 + 3p^2 - (k^2 + h^2)]}{2p[p^2 + (k^2 + h^2)]} \right\}^2}}$ <p>Three equal peaks at</p> $x = 0, \pm \sqrt{(k^2 + h^2) - 3p^2}$
---	--

From the preceding discussion, it is apparent that there is considerable latitude in the choice of a selector for unsymmetrical expansion and that the most suitable arrangement is that which has the greatest number of desirable characteristics and the fewest undesirable characteristics, in view of the contemplated service.

Since symmetrical expanding selectors are generally susceptible of greater refinement with respect to reduction of noise background and distortion, and with respect to improvement of audio-frequency fidelity, a more careful analysis of such circuits is warranted. Table II is a mathematical summary of the more interesting selective properties of a pair of similar tuned circuits. The carrier frequency is taken equal

to the mean of the natural frequencies of the two circuits. Three parameters of the circuits are taken into account, of which p denotes the power factor or dissipation, k denotes the coefficient of mutual inductance coupling, and h denotes the coefficient of symmetrical detuning of the circuits, one above and one below the mean frequency or carrier frequency. A pure mutual inductance is a simple fundamental type of coupling which can be adjusted to produce symmetrical expansion. The independent variable x is double the relative departure of the frequency from the mean. Therefore x is proportional to the modulation frequency in the analysis of side band acceptance.

The shape of the resonance curve depends only on the power factor and on the expanding coefficient, which latter is the quadratic sum of the coupling and detuning coefficients. Therefore the expansion is independent of the relative values of coupling and detuning, although the variation of gain with expansion depends on the relative values. The use of a level automatic volume control operated by the carrier has the effect of maintaining the carrier output uniform during expansion. In analyzing on this basis the shape of the resonance curve, the center point of the curve is taken as unity. Having reduced all of the family of resonance curves to unity at the mean frequency, the family has a peak envelope curve which is the inverse resonance curve of a single tuned circuit whose power factor is $2p$. Multiplying the resonance curves by the inverted envelope, the result is a family of curves which have three equal peaks and a nearly flat top when expanded. This resultant is obtainable in practice by the use of a third uncoupled circuit, tuned to the carrier, having double the power factor of each of the tuned circuits of the adjustable pair.

Fig. 3 shows several families of half resonance curves based on the analysis of a pair of tuned circuits. Fig. 3(a) shows the relative gain and the shape of the familiar curves in which the coupling is the variable parameter. Fig. 3(b) shows the corresponding family with symmetrical detuning as the variable parameter. Fig. 3(c) shows the same families reduced to unity at the mean frequency. This is the effect of a level automatic volume control operated by the carrier on the mean frequency. Only the shape of the curve is important, and that is determined entirely by the ratio of the expanding coefficient to the power factor. The dotted curve is the envelope of this family, and happens to be also the inverted resonance curve of a single tuned circuit having a power factor of $2p$.

Fig. 3(d) is the same family multiplied by the resonance curve of such a single tuned circuit. The result is the expansion of x in the ratio of four to one at six decibels down, with negligible violation of the

consistency requirement. Further expansion causes appreciable inconsistency. In this combination, when expanded, a pair of coupled circuits and an uncoupled third circuit produce a result which is superior to that of a single section, nondissipative, constant- K filter. Moreover, the expansion of the band width of the three-circuit combination can be effected by adjusting only one parameter, the mutual inductance of the pair of tuned circuits. The selectivity is the most that reasonably could be expected from three tuned circuits, especially when expanded.

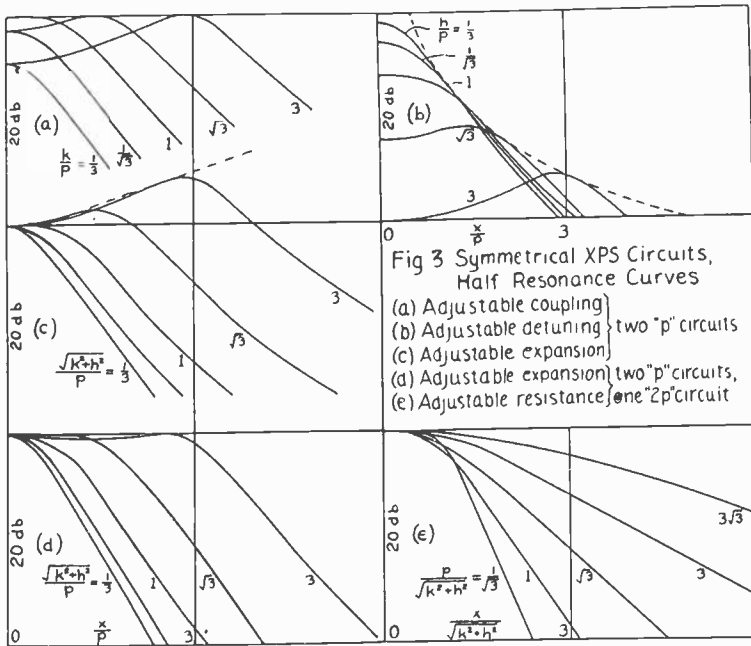

Fig. 3

For comparison, Fig. 3(e) shows several curves of the same family, but plotted with the power factor as the variable parameter. This result would require adjusting simultaneously three resistors of the three respective tuned circuits. The expansion ratio can be increased without limit, but the selectivity is very poor for the expanded condition. It is to be noted that over the inner portion of the range the requirement of consistency is violated and the fidelity might actually sound poorer with increase of power factor. The practical disadvantage of attempting to secure improved fidelity by the adjustment of resistance in such circuits with fixed coupling is thus graphically exposed.

From among the various forms of expanding selectors, the three-circuit combination with adjustable mutual inductance has many points in its favor. Two such combinations, having a total of six

intermediate-frequency selective circuits, is very well adapted for use in a high fidelity receiver. Expansion is then effected by simultaneously increasing the mutual inductance in each of two intermediate-frequency transformers.

Fig. 4 shows the circuit of a complete receiver having the six-circuit symmetrical expanding selector with mutual inductance expansion. This function is secured by three double-tuned intermediate-frequency transformers. Two of these transformers have mutual inductance adjustable by a common control. The third transformer has both of the $2p$ circuits for flattening the envelopes of the other two transformers. The $2p$ circuits are loosely coupled to give the effect of

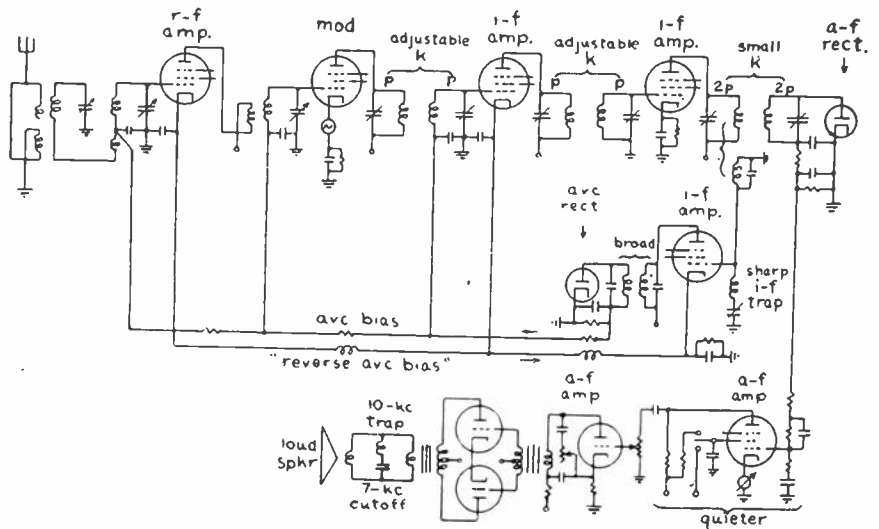

Fig. 4—Complete receiver with expanding selector.

two uncoupled circuits, as required by the mathematical analysis. The nominal expanded band width of the flat top is fourteen kilocycles, and the expanding ratio is about five to one at six decibels down.

Otherwise, the receiver is essentially a carefully designed super-heterodyne, with several improvements not yet found in commercial receivers.

The three selective circuits preceding the frequency changer are designed to have uniform gain and band width over the broadcast band. The resultant band width of these three circuits is fourteen kilocycles at four decibels down. This slight side band attenuation is compensated in the audio circuits. The adjacent channel selectance of these circuits is seven decibels, which is ordinarily adequate for avoiding cross-modulation, since the gain preceding the frequency changer is less than thirty decibels maximum, and is subject to reduction by automatic volume control.

The frequency changer should be designed to minimize cross-modulation and oscillator drift. It is especially important that the oscillator frequency be made independent of the automatic volume control action, because the receiver has great selectivity available.

The automatic volume control is performed by an auxiliary amplifier and diode rectifier circuit. The action of this circuit is modified by a sharply tuned trap circuit. This trap is designed to reduce the control action to normal when the receiver is tuned exactly to the signal carrier, but to cause excessive control action when the carrier is detuned slightly. This is a very satisfactory scheme for producing maximum loudness when the receiver is exactly tuned. Some such arrangement is practically necessary in a receiver having available such selectivity, in order to reduce the tendency toward abnormally loud and harsh reproduction when the tuning is a few kilocycles off the signal frequency. This necessity is increased by the use of a high fidelity audio system.

An additional important advantage of this trap circuit is that it causes interfering signals on adjacent channels to be subject to excessive control action. In this manner, the presence of substantial interference causes a substantial reduction in the loudness of reproduction. The user is thereby encouraged to contract the selector until the loudness of the desired signal is restored, free of interference.

A properly designed diode rectifier provides level automatic volume control, free of fluctuation due to signal modulation. The leveling is secured by means of a common cathode bias resistor for the controlled amplifiers and the auxiliary amplifier. The result is a reverse control action on the latter, decreasing its cathode bias and thereby increasing its gain in proportion to the requirements for greater automatic volume control bias.

The audio rectifier is carefully designed and is operated at a fairly high carrier voltage input level, about ten or twenty volts. The direct-current load conductance is reduced to two micromhos, and the added audio-frequency load conductance is held down to one tenth this value, except at high audio frequencies where the modulation is very small. The result is negligible distortion for modulation up to unity.

A simplified quieter circuit is employed to reduce further the loudness when the receiver is not exactly tuned to the signal carrier, or when interference is present. A pentode audio amplifier is operated with excessive resistance in the plate circuit, so that the gain is very low for zero grid bias, and increases to a maximum at a certain negative value of grid bias. This action, combined with that of the sharply tuned trap, gives very good quieting action to the extent of about

thirty decibels. A switch is provided for inserting resistance in the screen lead and thereby cutting out the pentode quieting action if desired. A visual tuning meter is connected in the pentode cathode lead to indicate precisely when the receiver is in tune with a carrier. The meter deflection is nearly independent of signal intensity, since the rectified signal carrier applied to the pentode is subject to level automatic volume control.

A tone control is provided to meet conditions frequently observed at the present time, due to the prevalence of unsatisfactory microphone location relative to the performers. The tendency in arranging an orchestra, for example, is to locate the high pitch instruments much too close to the microphone. Fairly high fidelity can still be secured at the receiver by shading off the medium high audio reproduction about six to ten decibels. Some tone control action may be desirable also where circumstances require music to be reproduced much below its normal loudness. Therefore the tone control, properly used, may still be desirable as a practical expedient.

All audio amplifiers are designed for class A operation, because the high fidelity greatly reduces the tolerance toward distortion, and generally causes the user to be satisfied with less power.

The selectivity of the receiver in the expanded condition is insufficient for discriminating against adjacent channel interference, even when the latter is only moderate. The adjacent channel discrimination is only about twenty decibels when the selector is fully expanded, and increased to sixty decibels when fully contracted. To obtain further discrimination for expanded operation, a ten-kilocycle trap is provided. This trap is preferably connected in the voice coil circuit, for two reasons. First, there is some benefit in filtering out all distortion components or noise above 7000 cycles, arising in any part of the entire receiver. Second, it is possible to utilize, as part of the filter, the voice coil inductance and the leakage inductance of the output transformer. As a result, the trap can be designed to have negligible effect below 7000 cycles and still to discriminate at least twenty-five decibels at ten kilocycles. Further discrimination is of less utility, because the usable expansion is then limited by interfering side bands overlapping the desired side bands.

Fig. 5 shows fidelity curves on the six-circuit expanding selector of this receiver. The coefficients of coupling are adjustable in the ratio of five to one, between six-tenths optimum and three times optimum. The audio band is thereby adjustable from about 1500 to 7500 cycles. There is less than one decibel violation of the requirement of consistency of expansion, as indicated by the slight interweaving of the two

outer curves. The dotted lines show the effect of adding the ten-kilocycle trap in the voice coil circuit, when the selector is fully expanded.

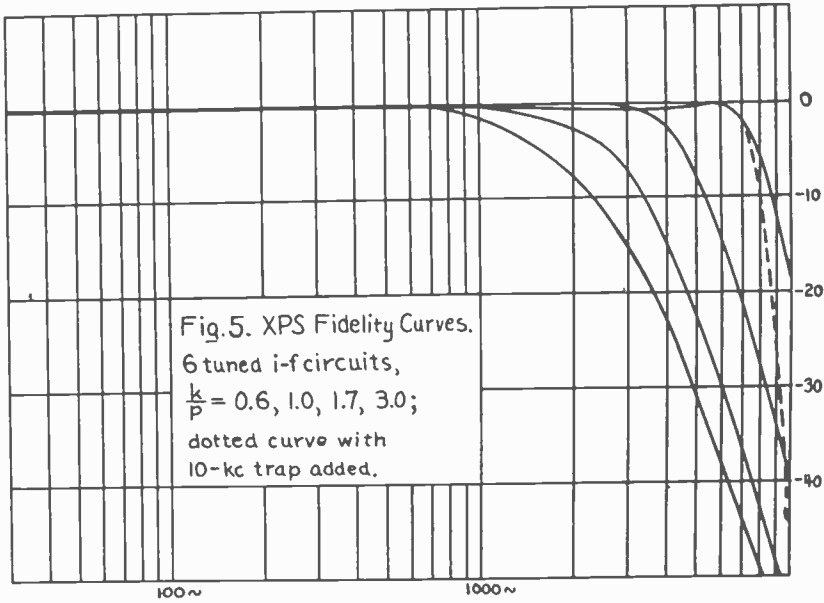

Fig. 5

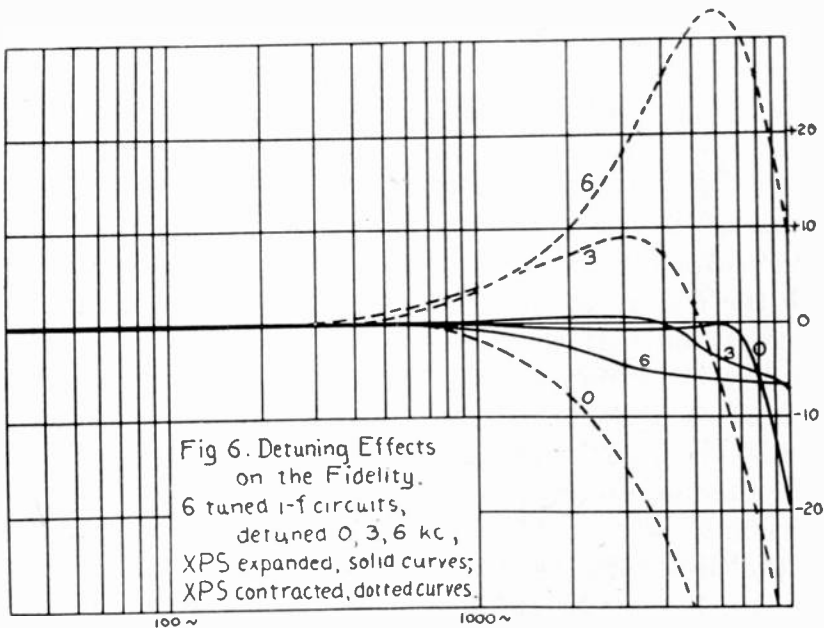

Fig. 6

Fig. 6 shows the effects on the fidelity, due to detuning the receiver when the selector is expanded or contracted. The solid curves show that the fidelity is materially decreased by slight detuning when the

to the mean of the natural frequencies of the two circuits. Three parameters of the circuits are taken into account, of which p denotes the power factor or dissipation, k denotes the coefficient of mutual inductance coupling, and h denotes the coefficient of symmetrical detuning of the circuits, one above and one below the mean frequency or carrier frequency. A pure mutual inductance is a simple fundamental type of coupling which can be adjusted to produce symmetrical expansion. The independent variable x is double the relative departure of the frequency from the mean. Therefore x is proportional to the modulation frequency in the analysis of side band acceptance.

The shape of the resonance curve depends only on the power factor and on the expanding coefficient, which latter is the quadratic sum of the coupling and detuning coefficients. Therefore the expansion is independent of the relative values of coupling and detuning, although the variation of gain with expansion depends on the relative values. The use of a level automatic volume control operated by the carrier has the effect of maintaining the carrier output uniform during expansion. In analyzing on this basis the shape of the resonance curve, the center point of the curve is taken as unity. Having reduced all of the family of resonance curves to unity at the mean frequency, the family has a peak envelope curve which is the inverse resonance curve of a single tuned circuit whose power factor is $2p$. Multiplying the resonance curves by the inverted envelope, the result is a family of curves which have three equal peaks and a nearly flat top when expanded. This resultant is obtainable in practice by the use of a third uncoupled circuit, tuned to the carrier, having double the power factor of each of the tuned circuits of the adjustable pair.

Fig. 3 shows several families of half resonance curves based on the analysis of a pair of tuned circuits. Fig. 3(a) shows the relative gain and the shape of the familiar curves in which the coupling is the variable parameter. Fig. 3(b) shows the corresponding family with symmetrical detuning as the variable parameter. Fig. 3(c) shows the same families reduced to unity at the mean frequency. This is the effect of a level automatic volume control operated by the carrier on the mean frequency. Only the shape of the curve is important, and that is determined entirely by the ratio of the expanding coefficient to the power factor. The dotted curve is the envelope of this family, and happens to be also the inverted resonance curve of a single tuned circuit having a power factor of $2p$.

Fig. 3(d) is the same family multiplied by the resonance curve of such a single tuned circuit. The result is the expansion of x in the ratio of four to one at six decibels down, with negligible violation of the

consistency requirement. Further expansion causes appreciable inconsistency. In this combination, when expanded, a pair of coupled circuits and an uncoupled third circuit produce a result which is superior to that of a single section, nondissipative, constant- K filter. Moreover, the expansion of the band width of the three-circuit combination can be effected by adjusting only one parameter, the mutual inductance of the pair of tuned circuits. The selectivity is the most that reasonably could be expected from three tuned circuits, especially when expanded.

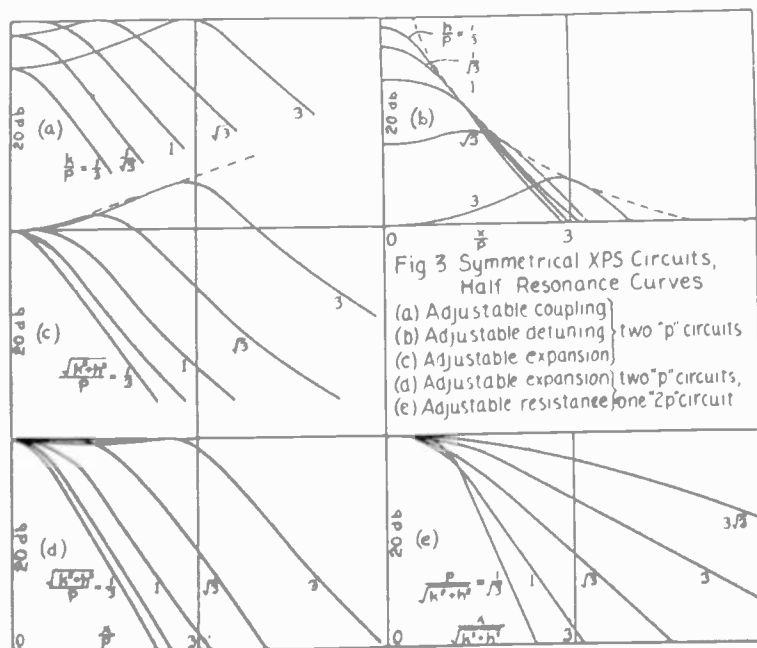

Fig. 3

For comparison, Fig. 3(e) shows several curves of the same family, but plotted with the power factor as the variable parameter. This result would require adjusting simultaneously three resistors of the three respective tuned circuits. The expansion ratio can be increased without limit, but the selectivity is very poor for the expanded condition. It is to be noted that over the inner portion of the range the requirement of consistency is violated and the fidelity might actually sound poorer with increase of power factor. The practical disadvantage of attempting to secure improved fidelity by the adjustment of resistance in such circuits with fixed coupling is thus graphically exposed.

From among the various forms of expanding selectors, the three-circuit combination with adjustable mutual inductance has many points in its favor. Two such combinations, having a total of six

thirty decibels. A switch is provided for inserting resistance in the screen lead and thereby cutting out the pentode quieting action if desired. A visual tuning meter is connected in the pentode cathode lead to indicate precisely when the receiver is in tune with a carrier. The meter deflection is nearly independent of signal intensity, since the rectified signal carrier applied to the pentode is subject to level automatic volume control.

A tone control is provided to meet conditions frequently observed at the present time, due to the prevalence of unsatisfactory microphone location relative to the performers. The tendency in arranging an orchestra, for example, is to locate the high-pitch instruments much too close to the microphone. Fairly high fidelity can still be secured at the receiver by shading off the medium-high audio reproduction about six to ten decibels. Some tone control action may be desirable also where circumstances require music to be reproduced much below its normal loudness. Therefore the tone control, properly used, may still be desirable as a practical expedient.

All audio amplifiers are designed for class A operation, because the high fidelity greatly reduces the tolerance toward distortion, and generally causes the user to be satisfied with less power.

The selectivity of the receiver in the expanded condition is insufficient for discriminating against adjacent channel interference, even when the latter is only moderate. The adjacent channel discrimination is only about twenty decibels when the selector is fully expanded, and increased to sixty decibels when fully contracted. To obtain further discrimination for expanded operation, a ten-kilocycle trap is provided. This trap is preferably connected in the voice coil circuit, for two reasons. First, there is some benefit in filtering out all distortion components or noise above 7000 cycles, arising in any part of the entire receiver. Second, it is possible to utilize, as part of the filter, the voice coil inductance and the leakage inductance of the output transformer. As a result, the trap can be designed to have negligible effect below 7000 cycles and still to discriminate at least twenty-five decibels at ten kilocycles. Further discrimination is of less utility, because the usable expansion is then limited by interfering side bands overlapping the desired side bands.

Fig. 5 shows fidelity curves on the six-circuit expanding selector of this receiver. The coefficients of coupling are adjustable in the ratio of five to one, between six-tenths optimum and three times optimum. The audio band is thereby adjustable from about 1500 to 7500 cycles. There is less than one decibel violation of the requirement of consistency of expansion, as indicated by the slight interweaving of the two

outer curves. The dotted lines show the effect of adding the ten-kilocycle trap in the voice coil circuit, when the selector is fully expanded.

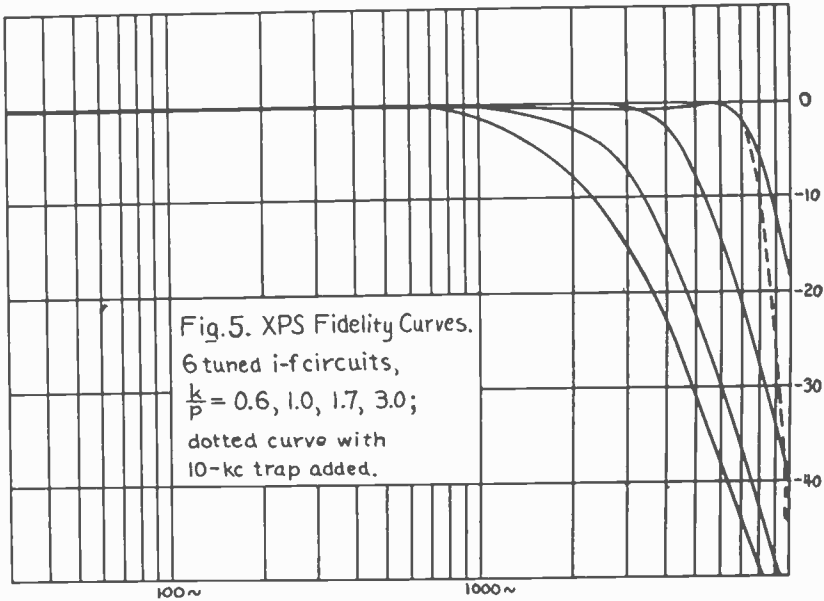

Fig. 5

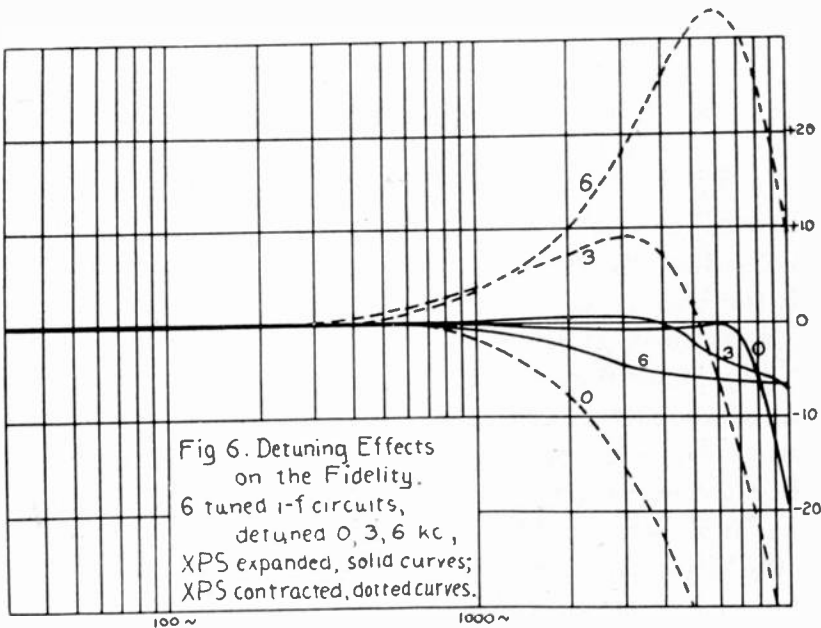

Fig. 6

Fig. 6 shows the effects on the fidelity, due to detuning the receiver when the selector is expanded or contracted. The solid curves show that the fidelity is materially decreased by slight detuning when the

intermediate-frequency selective circuits, is very well adapted for use in a high fidelity receiver. Expansion is then effected by simultaneously increasing the mutual inductance in each of two intermediate-frequency transformers.

Fig. 4 shows the circuit of a complete receiver having the six-circuit symmetrical expanding selector with mutual inductance expansion. This function is secured by three double-tuned intermediate-frequency transformers. Two of these transformers have mutual inductance adjustable by a common control. The third transformer has both of the $2p$ circuits for flattening the envelopes of the other two transformers. The $2p$ circuits are loosely coupled to give the effect of

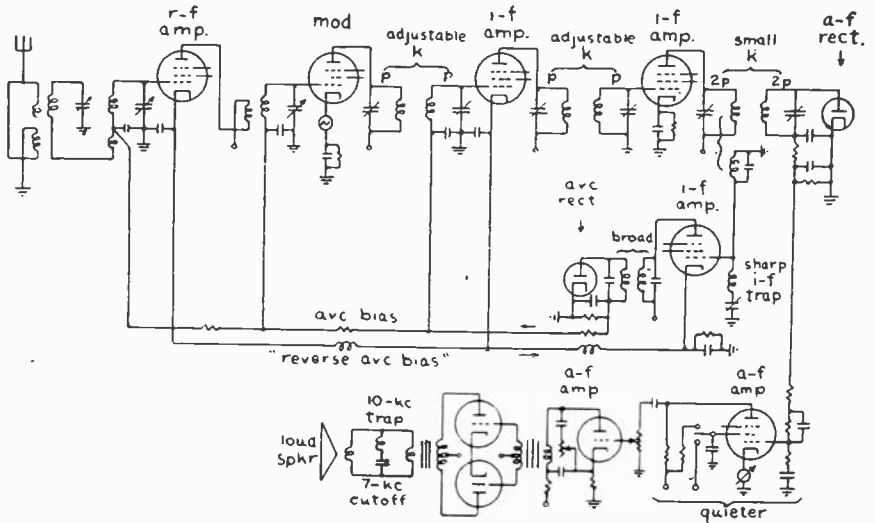

Fig. 4—Complete receiver with expanding selector.

two uncoupled circuits, as required by the mathematical analysis. The nominal expanded band width of the flat top is fourteen kilocycles, and the expanding ratio is about five to one at six decibels down.

Otherwise, the receiver is essentially a carefully designed superheterodyne, with several improvements not yet found in commercial receivers.

The three selective circuits preceding the frequency changer are designed to have uniform gain and band width over the broadcast band. The resultant band width of these three circuits is fourteen kilocycles at four decibels down. This slight side band attenuation is compensated in the audio circuits. The adjacent channel selectance of these circuits is seven decibels, which is ordinarily adequate for avoiding cross-modulation, since the gain preceding the frequency changer is less than thirty decibels maximum, and is subject to reduction by automatic volume control.

The frequency changer should be designed to minimize cross-modulation and oscillator drift. It is especially important that the oscillator frequency be made independent of the automatic volume control action, because the receiver has great selectivity available.

The automatic volume control is performed by an auxiliary amplifier and diode rectifier circuit. The action of this circuit is modified by a sharply tuned trap circuit. This trap is designed to reduce the control action to normal when the receiver is tuned exactly to the signal carrier, but to cause excessive control action when the carrier is detuned slightly. This is a very satisfactory scheme for producing maximum loudness when the receiver is exactly tuned. Some such arrangement is practically necessary in a receiver having available such selectivity, in order to reduce the tendency toward abnormally loud and harsh reproduction when the tuning is a few kilocycles off the signal frequency. This necessity is increased by the use of a high fidelity audio system.

An additional important advantage of this trap circuit is that it causes interfering signals on adjacent channels to be subject to excessive control action. In this manner, the presence of substantial interference causes a substantial reduction in the loudness of reproduction. The user is thereby encouraged to contract the selector until the loudness of the desired signal is restored, free of interference.

A properly designed diode rectifier provides level automatic volume control, free of fluctuation due to signal modulation. The leveling is secured by means of a common cathode bias resistor for the controlled amplifiers and the auxiliary amplifier. The result is a reverse control action on the latter, decreasing its cathode bias and thereby increasing its gain in proportion to the requirements for greater automatic volume control bias.

The audio rectifier is carefully designed and is operated at a fairly high carrier voltage input level, about ten or twenty volts. The direct-current load conductance is reduced to two micromhos, and the added audio-frequency load conductance is held down to one tenth this value, except at high audio frequencies where the modulation is very small. The result is negligible distortion for modulation up to unity.

A simplified quieter circuit is employed to reduce further the loudness when the receiver is not exactly tuned to the signal carrier, or when interference is present. A pentode audio amplifier is operated with excessive resistance in the plate circuit, so that the gain is very low for zero grid bias, and increases to a maximum at a certain negative value of grid bias. This action, combined with that of the sharply tuned trap, gives very good quieting action to the extent of about

thirty decibels. A switch is provided for inserting resistance in the screen lead and thereby cutting out the pentode quieting action if desired. A visual tuning meter is connected in the pentode cathode lead to indicate precisely when the receiver is in tune with a carrier. The meter deflection is nearly independent of signal intensity, since the rectified signal carrier applied to the pentode is subject to level automatic volume control.

A tone control is provided to meet conditions frequently observed at the present time, due to the prevalence of unsatisfactory microphone location relative to the performers. The tendency in arranging an orchestra, for example, is to locate the high pitch instruments much too close to the microphone. Fairly high fidelity can still be secured at the receiver by shading off the medium high audio reproduction about six to ten decibels. Some tone control action may be desirable also where circumstances require music to be reproduced much below its normal loudness. Therefore the tone control, properly used, may still be desirable as a practical expedient.

All audio amplifiers are designed for class A operation, because the high fidelity greatly reduces the tolerance toward distortion, and generally causes the user to be satisfied with less power.

The selectivity of the receiver in the expanded condition is insufficient for discriminating against adjacent channel interference, even when the latter is only moderate. The adjacent channel discrimination is only about twenty decibels when the selector is fully expanded, and increased to sixty decibels when fully contracted. To obtain further discrimination for expanded operation, a ten-kilocycle trap is provided. This trap is preferably connected in the voice coil circuit, for two reasons. First, there is some benefit in filtering out all distortion components or noise above 7000 cycles, arising in any part of the entire receiver. Second, it is possible to utilize, as part of the filter, the voice coil inductance and the leakage inductance of the output transformer. As a result, the trap can be designed to have negligible effect below 7000 cycles and still to discriminate at least twenty-five decibels at ten kilocycles. Further discrimination is of less utility, because the usable expansion is then limited by interfering side bands overlapping the desired side bands.

Fig. 5 shows fidelity curves on the six-circuit expanding selector of this receiver. The coefficients of coupling are adjustable in the ratio of five to one, between six-tenths optimum and three times optimum. The audio band is thereby adjustable from about 1500 to 7500 cycles. There is less than one decibel violation of the requirement of consistency of expansion, as indicated by the slight interweaving of the two

outer curves. The dotted lines show the effect of adding the ten-kilocycle trap in the voice coil circuit, when the selector is fully expanded.

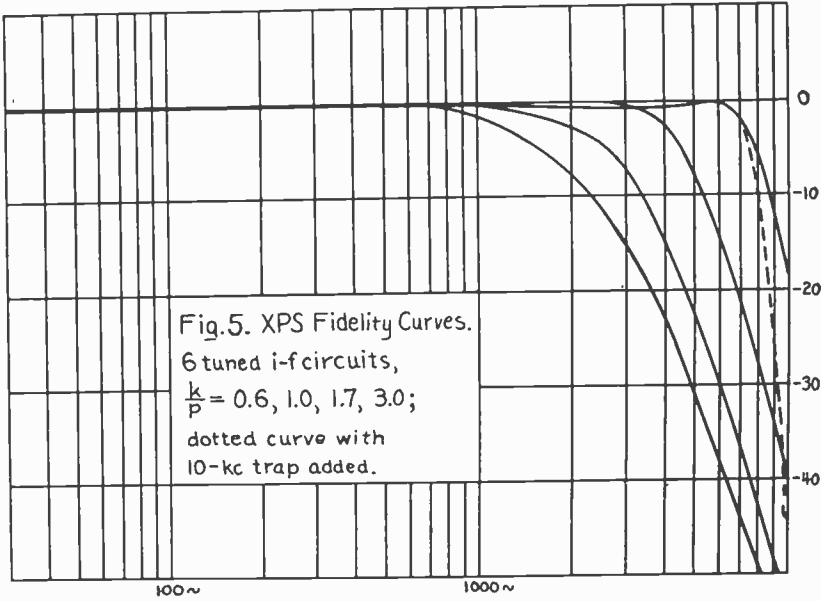

Fig. 5

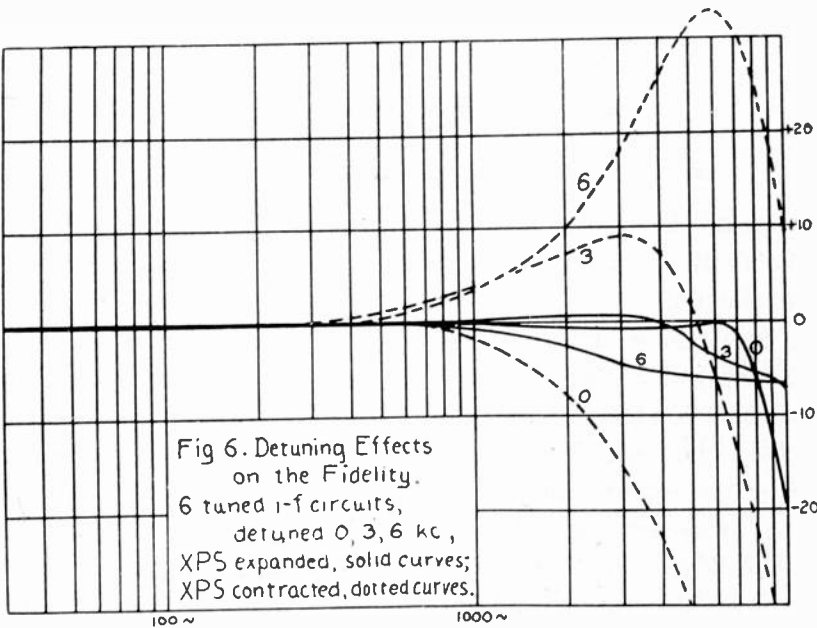

Fig. 6

Fig. 6 shows the effects on the fidelity, due to detuning the receiver when the selector is expanded or contracted. The solid curves show that the fidelity is materially decreased by slight detuning when the

selector is expanded, but this effect is not of such a nature as to sound very objectionable. The dotted curves show the extremely detrimental effect of slight detuning when the selector is contracted. In the latter case, the reproduction becomes harsh and distorted, because the side bands are greatly accentuated relative to the carrier. In the absence of suitable precautions, the loudness is greater under these abnormal conditions. The sharp trap in the automatic volume control circuit, and the pentode quieting circuit, contribute to decreasing greatly the loudness when detuned, and thereby avoiding these undesirable effects.

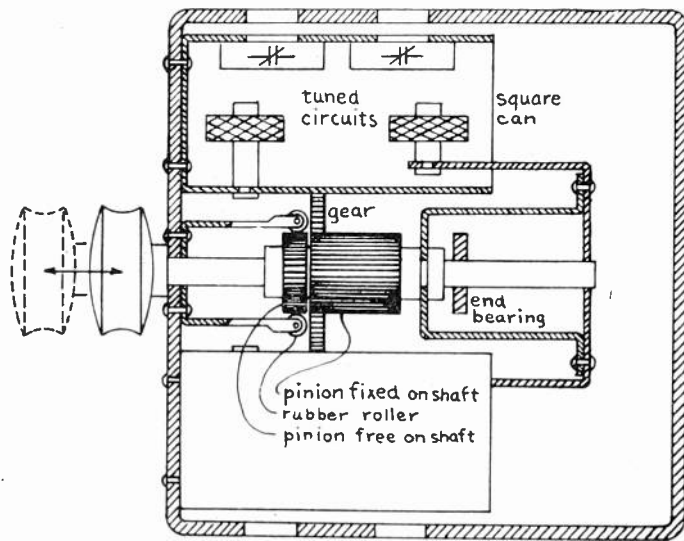

Fig. 7—XPS interlocking mechanism, bottom view.

In view of the effects of detuning, it appears that the user would be unable to tune the receiver accurately with the selector expanded, although the trap in the automatic volume control circuit would be of some assistance. If the user were subsequently to contract the selector, any inaccuracy of tuning would become apparent and the observed effect of the expanding adjustment would be erratic. It appears that the logical procedure in tuning with an expanding selector is first to tune accurately with the selector contracted, and then to expand as far as permitted by the receiving conditions. This procedure also has the advantage that the user hears every station while tuning, and therefore does not get the impression that his receiver is insensitive or nonselective.

Fig. 7 shows a simple mechanism utilizing axial motion of the tuning knob for adjusting the expansion of the expanding selector. An interlocking mechanism is also provided which permits the user to tune the receiver only when the band width is contracted. The user

is thereby constrained to follow the correct procedure of first tuning with maximum selectivity, and then expanding to improve the fidelity to the extent permitted by noise or adjacent channel interference.

The diagram shows the bottom view of an arrangement well adapted for use in a small remote control box. The tuning shaft carries a frame on which is mounted one coil of each of two intermediate-frequency transformers. Moving the knob outward from the panel increases the coupling in these transformers and thereby expands the selector. The same shaft carries a long pinion fixed on the shaft and an adjacent short pinion free to rotate on the shaft. The long pinion is always engaged with a gear on the main tuning shaft. There are two small rubber rollers pressed against the sides of one pinion or the other. The shaft is shown in the position for tuning, and the rubber rollers are on the free pinion, so they offer no resistance to turning the shaft for tuning the receiver. After the receiver is tuned, the knob is then pulled out for expanding. When the knob is pulled out, even for partial expansion, the rubber rollers grip the long pinion and prevent turning the shaft, thereby preventing the user from detuning the receiver. Since the operations of tuning and expanding are both performed by one knob in one hand, rapid manipulation is easy. This interlocking mechanism for tuning and expanding has met with considerable approval during the time it has been demonstrated in the laboratory.

It is desired to acknowledge the valuable contributions which have been made to this development by the other members of the engineering staff of Hazeltine Corporation. Among those who have taken an active part in this project are Messrs. W. A. MacDonald, D. E. Harnett, N. P. Case, J. F. Farrington, and C. K. Huxtable.



ACOUSTIC TESTING OF HIGH FIDELITY RECEIVERS*

BY

HAROLD A. WHEELER AND VERNON E. WHITMAN

(Hazeltine Corporation, Jersey City, New Jersey)

Summary—The broadcast listener desires the illusion of being present in the auditorium or studio where the sound is being produced. Therefore the sound heard by the listener in a living room should have essentially the same qualities. In broadcasting, the studio reverberation, the microphone technique, the loud speaker characteristics and the living-room reverberation are among the more important factors which must cooperate in obtaining the desired illusion. The latter two factors are evaluated by testing the loud speaker in representative living rooms. The test microphone is located respectively at each of three stations selected to be representative of listening points. Acoustic fidelity curves for these stations are superimposed on a single record. An acoustic recorder is described which has been developed for automatically tracing each curve in about three minutes. Curves are reproduced which show the effect of frequency wobbling in integrating the reverberation.

THE design of high fidelity receivers for sound reproduction in the living room is a problem very different from the problem of sound reproduction in the auditorium. The latter problem has received the most attention, in connection with talking motion pictures and the recent auditory perspective demonstrations. Reproduction in the living room has more utilization than all other forms of loud speaker reproduction, and yet the essential nature of this problem appears to have received very little attention. This deficiency is abundantly demonstrated when the present broadcasting is received and reproduced by a carefully designed high fidelity receiver, reproducing from 50 to 7000 cycles without appreciable distortion.

An encouraging sign is the steadily increasing attention being paid to the high fidelity problem as a whole, and especially as it exists in broadcast transmission and reception. This activity is evidenced by the many recent publications and demonstrations on this subject, and by the improvement of some of the equipment in broadcast transmitters.

The incentive for continued improvement is limited by the universal use of receivers whose fidelity leaves a great deal to be desired. It is an exceptional receiver which gives nearly uniform reproduction, even over the five and a half octaves between 75 and 3500 cycles. The high fidelity receivers are expected to extend the audio-frequency range an octave higher and half an octave lower, and also to improve the

* Decimal classification: R261.3. Original manuscript received by the Institute, February 18, 1935. Presented before Ninth Annual Convention, Philadelphia, Pa., May 30, 1934.

uniformity throughout the range. The result will be a seven-octave receiver adequate for excellent reproduction of broadcast programs.

This paper is directed to the problem of testing the ability of broadcast receivers to give uniform reproduction of sound, over the required audio-frequency range, when operated under normal conditions in the living room. The first requirement is a correct statement of the problem.

Very few engineers seem to appreciate that the listener desires the illusion of being present in the auditorium or studio, and that this illusion requires the sound reverberation characteristics of the latter, even though the reproduction is heard in the living room having much less reverberation. This is most important in the case of music, less important in the case of speech. Optimum reverberation is just as important as perfect rendition in the production of very good music. Optimum reverberation in a large auditorium has a mellowing effect on the music, giving both listeners and performers a satisfaction which cannot be equalled by a similar performance in a small room, regardless of the acoustic treatment of the latter. Therefore the first requirement of good broadcasting of music is a large studio with optimum reverberation. Even though there may be no audience, optimum reverberation is a necessity, because the performers should hear their own music under most favorable conditions, and because the music requires the mellowing effect of reverberation.

There is considerable reverberation in the living room, but generally less than optimum. A double reverberation effect is produced when the studio pick-up receives considerable reverberant sound in the studio. This requires that each individual source of reverberation have less than optimum effect on the reproduction. Therefore the studio pick-up should slightly favor the direct sound as against the reverberant sound. The ribbon microphone has directional properties useful for this purpose. The microphone should be located about as far from the performers as the listener would choose to sit if he were present in the studio. One of the most common faults in present technique is placing the microphone too close to the soloist or the high pitched instruments.

When the studio and performers and microphone pick-up are once arranged to meet these requirements, the problem of high fidelity reproduction in the living room is greatly simplified. The sound in all parts of the living room should be substantially the same as the sound at the microphone. Thus stated, the problem is perfectly definite, and the various steps toward its solution follow in a logical succession. The further discussion is directed to the testing procedure and equipment which have been developed for easily and quickly determining the sound distribution in the living room, produced by a loud speaker in a given position in the room.

The distribution of sound in the living room is influenced mainly by the directional characteristics of the direct radiation and by the reverberation in the room. The latter tends to mask the former, making the sound distribution more nearly uniform. The reverberation also causes irregular interference patterns due to multiple reflection. The ear seems to tolerate this effect as a necessary adjunct of the desired reverberation, and therefore frequency wobbling is employed as a means of averaging this effect in the fidelity curves. The average effect of reverberation is not a critical function of the living room acoustics, and therefore representative observations can be made in a representative living room.

Since the test microphone is the substitute for the ear in the testing, it should be pressure actuated, not velocity actuated. The sound pressure and sound velocity do not, in general, have the same frequency distribution, especially near the speaker at low frequencies.

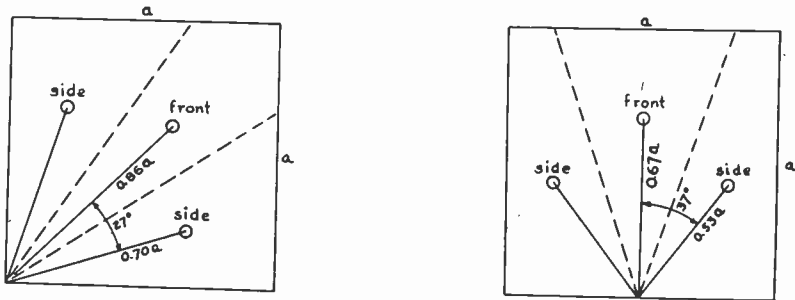

(a) Loud speaker in corner position. (b) Loud speaker in side-wall position.
Fig. 1—Microphone stations for acoustic tests.

Since the tests are intended to include the average effects of reverberation on the sound distribution, the microphone should be non-directional in all three dimensions.

These two requirements dictate the use of a pressure actuated microphone of very small dimensions. Therefore a special crystal microphone is used, comprising two very small sound cells mounted close together in a wire cage slightly larger than a one-inch cube. Its field calibration is uniform within one decibel between 50 and 7000 cycles, and is independent of any reasonable length of shielded cable between microphone and amplifier. Ten to forty feet of cable may be used.

The direct radiation of a loud speaker depends on the speaker and the speaker mounting, and also on the adjacent walls and floor of the room. The speaker and speaker mounting are predetermined factors. The floor is a predetermined factor for console speakers but not for

table models. A console speaker is usually located in the corner of the room or against a side wall, in which case the effect of the walls is fairly well predetermined for either position. Therefore a console speaker is tested in one of these two positions, as indicated in Fig. 1.

The general interference pattern due to reverberation is critically dependent on room acoustics, and therefore cannot be taken into account in the testing. There are two factors affecting reverberation which can be taken into account. These are the height of the ceiling and the height of the listener's head above the floor. The ceiling height is generally about nine feet, and the height of the listener's head is generally about three feet above the floor. Therefore the test microphone is suspended at a height of three feet in a room whose ceiling is about nine feet high.

The fidelity curves must show not only the average sound distribution in the room, but also the probable departure from the average, since the latter is determined mainly by the loud speaker, its mounting and its location in the room. Every curve has its peculiarities, according to the location of the microphone. Three curves taken at suitable points in the room are adequate for most purposes. The preferred microphone stations for these three curves are based on the diagrams in Fig. 1. For each position of the loud speaker, a square room is divided in three sectors of equal area centered on the speaker, and the center of gravity of each sector is determined. This procedure locates three preferred microphone stations relative to the loud speaker. Three such stations may then be used in all tests, even though the shape of the room and its dimensions may vary considerably. The latter do not critically affect the more important properties of the fidelity curves. On the basis of a room 14 or 15 feet square, about 2000 cubic feet, the distances from speaker to microphone stations are chosen for most tests. With the speaker in the corner position, a front distance of 12 feet and side distances of 10 feet are used, with a side angle of 27 degrees. With the speaker in the side-wall position, a front distance of 10 feet and side distances of 8 feet are used, with a side angle of 37 degrees. These microphone stations appear to form an adequate basis for testing the distribution of sound in the living room, in so far as the tests are capable of yielding valuable information on the behavior of the loud speaker under operating conditions.

Fig. 2 is a photograph of the complete acoustic recorder which has been developed especially for use in this work. Careful attention has been paid to securing maximum convenience, reliability, and speed of operation. The equipment is a rugged self-supporting unit which is easily transportable for field tests. The power is obtained entirely from

the sixty-cycle lighting circuit. All cathodes are indirectly heated, and all rectifiers are followed by voltage regulators, to minimize the effects of line voltage fluctuations. Each unit has its individual power supply circuits.

The audio-frequency generator is the lowest of the four main units. The frequency dial is motor-driven through a gear train. Any one of six speeds can be selected quickly by a simple gear-shifting operation. The time for sweeping over the audio spectrum ranges from two-thirds to eight minutes, according to the speed chosen.

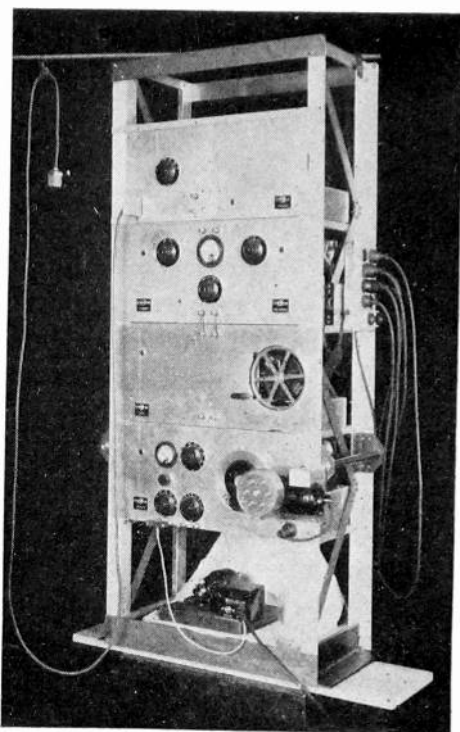

Fig. 2—Acoustic recorder.

The frequency wobbler is located on the bottom, and is also motor driven. The wobbling condenser turns five times a second. The amount of frequency wobbling is instantly adjustable by a switch in six steps from ± 10 cycles to ± 400 cycles.

The crystal microphone suspended on its cable is seen in the upper left corner of the photograph.

The first unit at the top is the microphone amplifier, using type 262A nonmicrophonic triodes with indirectly heated cathodes.

The second unit is the logarithmic amplifier-rectifier. This amplifier has automatic volume control operating on amplifier tubes having the exponential form of gradual cut-off. The rectifier output is amplified to

several milliamperes. The amplified current is made proportional to the input variation in decibels, over a range of fifty decibels.

The third unit is a photographic recorder comprising a rugged oscillograph element and a recording drum driven in synchronism with the audio-frequency dial. The oscillograph element is the movement from a portable milliammeter, with the pointer removed and a very small mirror attached to the armature. The drum carries sensitive paper for slow records or film for fast records. A switch is provided for selecting a twenty-, thirty-, or fifty-decibel range for the full width of the oscillographic record.

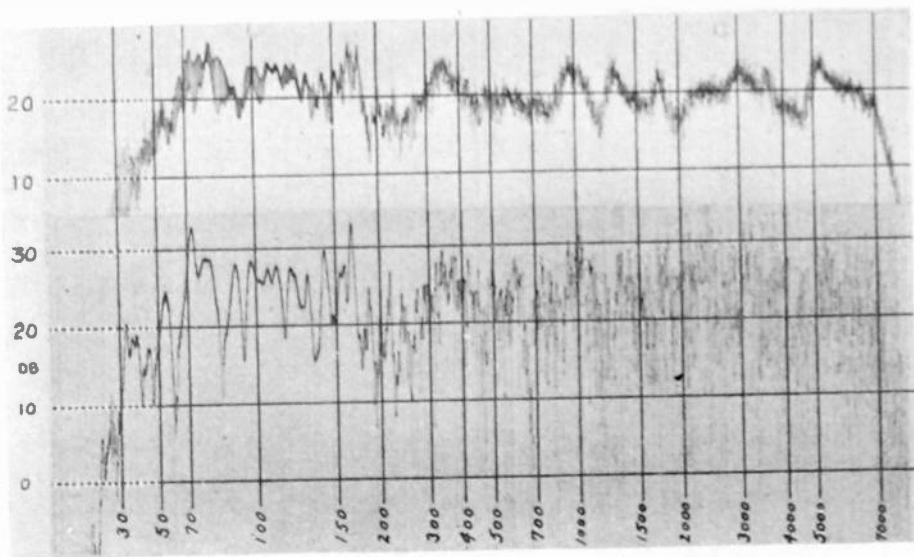

Fig. 3—Lower curve—Interference effects of reverberation in living room, loud speaker in corner position, eight-minute record.
Upper curve—Same as below, with addition of frequency wobble not exceeding \pm (10 cycles + 5 per cent).

The time constant^{*} of the photographic recorder and associated circuits is only about one-tenth second. The time lag is so small that the fluctuations caused by the wobbler can be recorded if desired. This time lag is comparable with the time required for the reverberation to build up in the living room.

The noise background in this apparatus, including the living-room sounds, corresponds to about one milliwatt in the loud speaker. Therefore records can be made accurately with fifty milliwatts or more in the loud speaker.

The records to be shown were taken on an audio system including a special cone speaker operated with about one watt in the voice coil.

The lower curve of Fig. 3 is a photographic record taken at slow speed to show the full effects of reverberation. The loud speaker was

in the corner position of the living room and the test microphone was at the front station. In the upper part of the frequency range, the anomalous dispersion of the curve is observed more than ten decibels above and twenty decibels below average.

The upper curve of Fig. 3 is a similar record taken with the addition of frequency wobbling, in order to average the reverberation effects. The oscillograph traces the cycle of wobbling to some extent, as indicated especially by the shaded band appearing on the left side of the curve.

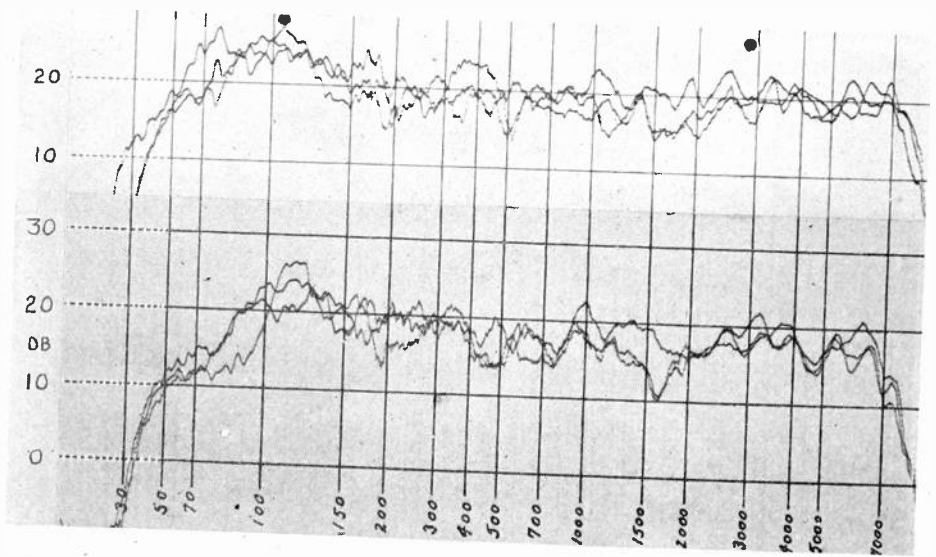

Fig. 4—Upper curves—Fidelity curves, loud speaker in corner position. Three-minute records.
Lower curves—Same as above, except loud speaker is in side-wall position.

The amount of frequency wobbling is always held within the arbitrary limit of ten cycles plus five per cent above and below the mean audio frequency. Usually the wobbling is varied between ± 10 cycles and ± 200 cycles over the audio range.

Fig. 4 comprises photographic records taken on the same loud speaker according to the preferred routine. In addition to the wobbling, a smoothing circuit is added to filter out the fluctuations during the wobbling cycle. Three curves are superimposed on the record for each position of the loud speaker in the living room. For each set of three curves, the test microphone is stationed according to the diagrams shown in Fig. 1. Each curve is recorded in three minutes, so that a set of three curves can easily be made in fifteen minutes.

The upper curves of Fig. 4 show the fidelity curves taken with the loud speaker in the corner position, while the lower curves show the

corresponding curves taken with the loud speaker in the side-wall position. These curves indicate the average fidelity over the area of the living room, and also give an indication how much departure from the average may be expected throughout the room.

It is apparent that the corner position is more favorable, because the frequency range is wider, especially at the lower limit, and also the three curves are less subject to irregularities from all causes. The reason for these advantages resides in the smaller angle into which the speaker is required to radiate from the corner position.

These curves must not be confused with curves taken outdoors, or with curves taken in a dead room. Such curves have some value in the design of loud speakers, but do not form a satisfactory basis on which to judge the final performance of the reproducing system. Curves taken in the living room are more irregular because they include the effects of many factors that are absent in tests made under specially chosen artificial conditions. These many factors are always present, however, during reproduction in the living room.

Experience indicates that curves such as in Figs. 4 give a satisfactory indication of the fidelity of an audio system or a complete radio receiver, under conditions representative of normal operating conditions.

In conclusion, it is desired to acknowledge the valuable assistance of Messrs. W. O. Swinyard and R. E. Sturm in carrying forward the work on this project.



HIGH QUALITY RADIO BROADCAST TRANSMISSION AND RECEPTION*

By

STUART BALLANTINE

(Ballantine Laboratories, Inc., Boonton, New Jersey)

PART II—THE RECEIVING SYSTEM†

THE transmitting section of the broadcast system, which was considered as extending from the microphone to the transmitting antenna, was discussed in Part I† of this paper. In Parts II and III we shall follow the same systematic program in discussing the receiving system, which we regard as extending from the receiving antenna to the sound field of the loud speaker. The present Part II will be particularly devoted to the technique of measuring the over-all performance of broadcast receivers, a subject of considerable importance which must underlie the successful development of a high quality receiver.

The receiving system may be divided broadly into two parts: the electrical part, or receiver proper, and the electro-acoustic part, or loud speaker. It is also desirable to include a third element—the *auditorium*. This term is not used in its conventional restricted sense as designating a large hall or meeting place, but in a more general sense to designate the room or place where the receiver is installed and listened to, regardless of size. The *auditorium* is included as part of the receiving system because it exercises an important influence upon the acoustical performance of the receiver and should be regarded acoustically as a part of the loud speaker system.

11. MEASUREMENT OF THE ELECTRO-ACOUSTIC FIDELITY OF BROADCAST RECEIVERS³⁷

To avoid interruption in the later discussion it will be desirable to interpose at this point some account of the technique of measuring the over-all performance of broadcast receivers.

* Decimal classification: R550. Original manuscript received by the Institute, April 16, 1935. Presented before New York Meeting, November 8, 1933; Philadelphia Section, December 7, 1933; Franklin Institute, Philadelphia, February 1, 1934; and Boston Section, April 20, 1934.

† Part I of this paper was published in PROC. I.R.E., vol. 22, pp. 564-629; May, (1934).

³⁷ Although previously unpublished, the material in this section was presented four years ago in a paper entitled: "Technique of Loud Speaker Sound Measurements," Philadelphia Section, Institute of Radio Engineers, May 13, 1931; at the Annual Convention, Chicago, June 5, 1931; and at the New York meeting of the Acoustical Society of America, May 3, 1932.

Measurements of the important electrical performance indexes of the receiver, such as fidelity, selectivity, sensitivity, noise, cross-talk, harmonic distortion, etc., have been standardized and their technique is well established. Such measurements have now become a matter of routine in the development of broadcast receivers and in the control of the quality of the manufactured product. These electrical measurements are largely concerned with the receiver chassis itself and leave out of account the loud speaker. For certain of the measurements enumerated the loud speaker may very properly be ignored, but it should certainly be included in any final estimate of the over-all performance of the receiver, particularly with regard to fidelity and distortion.

We shall use the term *electro-acoustic fidelity* to designate the relation between the acoustical pressure in the sound field and the modulation frequency of the signal applied to the antenna circuit of the receiver, and the term *electrical fidelity* to designate the relation between the *electrical* output and the modulation frequency.

Measurements of the electro-acoustic fidelity are essentially of an acoustical nature and are complicated by a multitude of factors which are not present in the much simpler measurement of electrical fidelity. There is, largely on this account, a considerable divergence in the views of technicians in this field as to the proper methods of procedure. No universally acceptable technique has been evolved and the little standardization that has been attempted is merely experimental and tentative.

The technique to be described in the following paragraphs, developed during the past ten years and based on a study of the fundamental acoustical problems involved, has been found convenient and accurate for engineering and development purposes.

For the measurement of over-all (electro-acoustic) fidelity the obvious procedure is to introduce into the artificial antenna circuit a standard modulated signal and to determine the relation between the modulation frequency and the sound pressure.

The sound pressure frequency characteristic will vary from point to point in the sound field, especially indoors; the question therefore arises as to the best point to place the measuring microphone. For example, most loud speakers are directive and the response at the higher frequencies falls off on either side of the axis. Several schemes have been proposed for avoiding this difficulty. One method, at present much in vogue, consists in rotating the microphone in front of the loud speaker in a plane 45 degrees to the horizontal, the idea being to obtain average values over a region which is supposed to represent the

"listening region." My experience with this method, however, has led me to prefer a fixed microphone for the following reasons:

(1) Nothing is measured definitely. About all that the results show is what an observer might hear if he were being rapidly rotated in front of the loud speaker. There is no way of predicting from such measurements what an observer would hear in any fixed position in the sound field;

(2) This averaging process smooths out the fluctuations in the frequency characteristic and thus tends to present an illusory picture which is much too favorable; it is, indeed, about as logical to rotate the microphone as it would be for a spectroscopist to vibrate his photographic plate;

(3) The low-frequency picture is usually considerably in error due to the defective averaging which occurs when the diameter of the circle of rotation becomes comparable with the wavelength of the sound.

There may be, however, certain measurements where the rotating microphone may be useful in spite of these objections. An example is the case of measurements in a highly reverberant environment such as an average living room, where it is desired to break up the standing wave pattern.

It must be admitted, with regard to this question, that one may learn to interpret sound-pressure records taken in a variety of ways and preference for one method over another may be in the last analysis largely a matter of habit or one's philosophical predilections.

A *fixed microphone of the proper type*, on the other hand, permits a definite measurement of the sound pressure at that point in the sound field, which since the ear is pressure-actuated, is directly related to what would be heard by an observer similarly situated. Fundamental information may be obtained by placing the microphone on the axis of the loud speaker; after this the directivity can be determined by placing the microphone at various angles from the axis. This procedure has the advantage of giving definite information about the directivity, which cannot be obtained from rotating microphone curves. It is usually sufficient to confine the measurements to a few angles, say 0, 30, 45 degrees, and for routine testing a single curve taken at 30 degrees will give values which are fairly good averages for a listening sector extending from +45 to -45 degrees. When curves are taken in a living room the sound pressure varies from point to point in the room and is affected by the room as well as the directivity of the speaker so that a greater number of microphone positions are usually necessary to obtain a complete picture.

1. Automatic Frequency Response Recorder

In measurements of the electrical fidelity of the receiver chassis *per se* the fidelity curve is usually sufficiently smooth to be quickly constructed from measurements by the ordinary point-by-point method employing relatively large frequency intervals. In the case of the electro-acoustic fidelity, however, the acoustical characteristics of the loud speaker are so irregular and serrated as to require a prohibitively large number of measurements for their accurate delineation by this method. To facilitate such measurements and to avoid such time-consuming drudgery an automatic sound-pressure recorder³⁸ has been developed

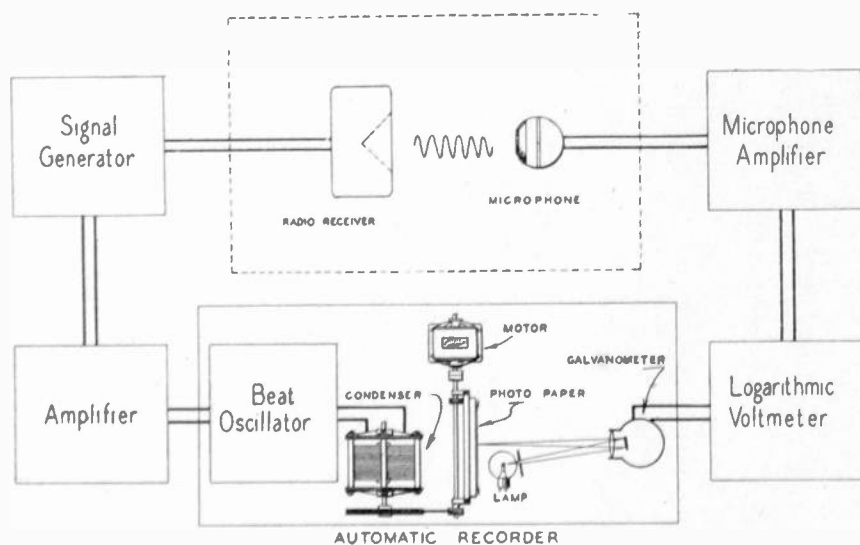

Fig. 44—Schematic diagram of apparatus for automatically recording the electro-acoustic fidelity of radio broadcast receivers.

which is capable of furnishing a complete characteristic in a few minutes which formerly required hours by the old method, and with far greater accuracy.

The fundamental scheme for automatically recording the electro-acoustic fidelity of radio receivers is shown in Fig. 44. The receiver is supplied with a standard modulated signal of which the modulation frequency is continuously variable from 50 to 10,000 cycles. The source of variable modulation frequency is a beat oscillator with which is associated a condenser having specially shaped plates, giving an accurately logarithmic relation between beat frequency and angular rotation. This provides a logarithmic frequency scale. This condenser is

³⁸ For a more detailed description of the recorder and its electro-acoustical applications see "A logarithmic recorder for frequency response measurements at audio frequencies," *Jour. Acous. Soc. Amer.*, vol. 5, p. 10; July, (1933), and *Electronics*, January, (1931).

rotated at any desired rate by a small variable speed motor. An extension of the shaft of the motor is mechanically geared to a platen, carrying a piece of photographic paper, and arranged to move vertically. The sound from the loud speaker is picked up by a microphone, amplified, and by means of a special device labeled "logarithmic voltmeter," converted into a direct current which is proportional to the logarithm of the sound pressure. This current operates a special high speed galvanometer provided with a mirror which moves a small light spot across the photographic paper, thus recording the amplitude of the sound pressure on a logarithmic scale.

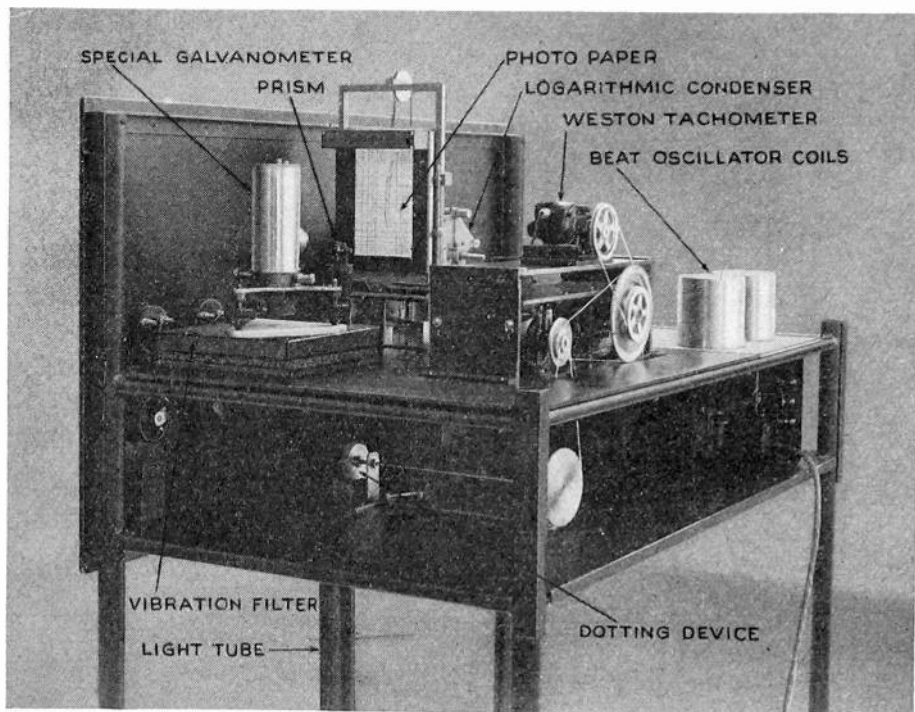

Fig. 45—Rear view of automatic frequency response recorder.

A suitable frame of coördinates is impressed upon the photographic paper by projection from a photograph plate in a separate enlarging camera. During this projection the paper is held in a frame which has been carefully aligned for registration with the platen as regards the frequency scale.

Except for the photographic processes—developing, fixing, and drying—the recording is automatic.

The speed of the platen is adjustable over a wide range and is regulated in conformity with the expected serration of the frequency characteristic. The period of the galvanometer and associated apparatus is unusually low so that an ordinary record of loud speaker response out-

doors or in a damped room can be taken in less than one minute. The records, sufficiently dry for inspection and comparison, are available in a few minutes, whereas by the point-by-point method several hours would be required.

Several curves may be recorded on one piece of paper. The results of changes in apparatus may be readily brought out by taking, on one sheet, records before and after the change, dotting one curve to facilitate recognition. Means are provided for standardizing the amplifiers so that the interval between two such records on one sheet may be as long as desired. A photographic view of the recorder from the rear is shown in Fig. 45. The accuracy with which a logarithmic frequency scale has been obtained is shown in Fig. 46.

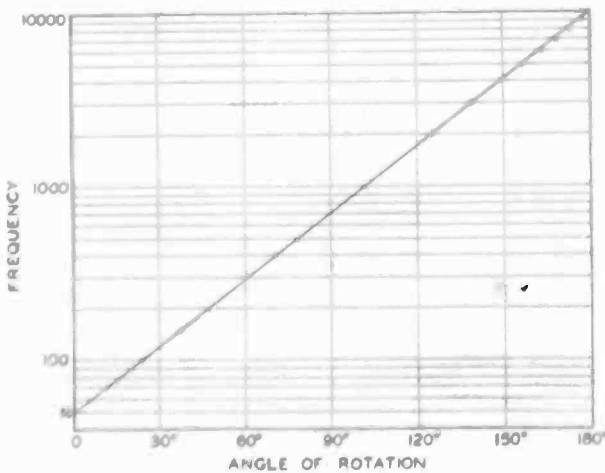

Fig. 46—Calibration of beat oscillator for frequency response recorder.

The logarithmic relation between output current and input voltage in the logarithmic voltmeter is obtained by using special variable-mu tubes having an accurately exponential relation between transconductance and control grid bias. Two amplifier stages are used, terminated by a rectifier which supplies an automatic grid bias for maintaining a constant output voltage. Over the range in which the output voltage is automatically held constant the auto grid bias is proportional to the logarithm of the input voltage. The galvanometer indicates the grid bias. The amplitude range of the present apparatus is $100\times$ (40 decibels) which is adequate for this kind of work. The performance of the logarithmic voltmeter and the accuracy with which the logarithmic relation is obtained over this range is shown in Fig. 47; the frequency characteristic at various levels is shown at the left of the figure.

On account of the logarithmic nature of the ordinate scale a uniform decibel scale of sound pressures can be employed if desired.

This apparatus represents a considerable advance over a previous recorder, built in 1926, which employed a linear scale of ordinates and in which the curve was traced by following the indications of a pointer type meter by hand. I feel that with an increasing appreciation of the value of over-all receiver measurements, an apparatus of this kind, or an equivalent, is destined to play as important a part in routine broadcast receiver engineering and testing as does the ubiquitous standard signal generator of the present day.

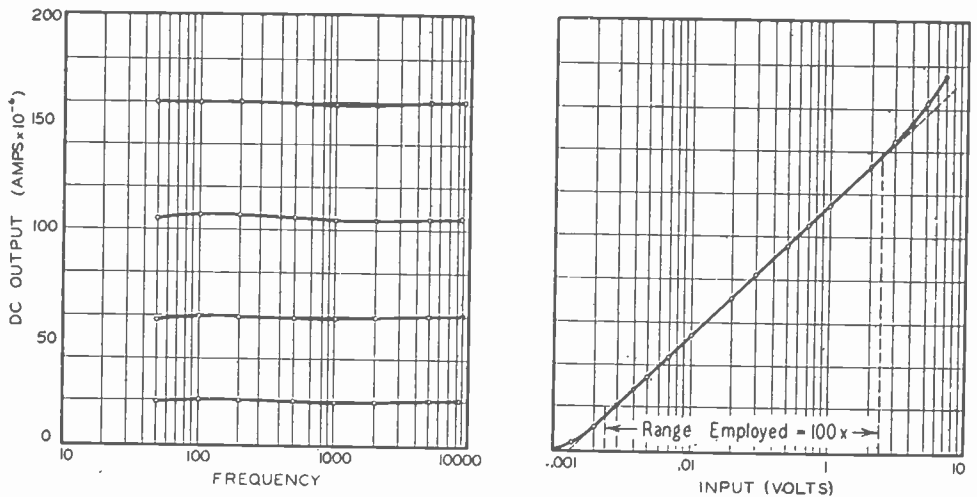

Fig. 47—Characteristics of logarithmic voltmeter; (right) direct output current versus applied alternating input voltage; (left) direct output current versus frequency, constant input voltage.

2. Microphones

For most measurements a condenser microphone of special design is employed. This is spherical in shape and the diaphragm is arranged to lie in the surface of the spherical housing in order to avoid cavity resonance.³⁹ Sensitivity is deliberately sacrificed in the interest of stability. No measurable change in sensitivity or frequency response has occurred during six years of use. Ordinary commercial condenser microphones are likely to be too unstable for work of this character (see Part I, Fig. 5, p. 579).

The microphone has been carefully calibrated against a Rayleigh disk (wave calibration) in order that the true pressure in the sound wave may be measured. The design is such that by means of a very simple type of equalization in the electrical circuits the frequency characteristic has been made uniform within one decibel from 50 to 10,000

³⁹ For a more detailed description of this microphone see Ballantine, *Proc. I.R.E.*, vol. 18, p. 1206; July, (1930), and *Jour. Acous. Soc. Amer.*, vol. 3, p. 319, (1932).

cycles; thus the true pressure is directly recorded and no corrections for the microphone characteristic are required. The constancy of the microphone response is checked from time to time by means of the electrostatic grille.⁴⁰ The wave calibration of the microphone should always be used in this work as the ordinary thermophone (or pressure) calibration may be in considerable error at the higher frequencies due to diffraction and cavity resonance.

The frequency characteristic of this type of microphone changes with the angle from which the sound is arriving with respect to the diaphragm (directivity effect). For this reason it is only suitable for measuring the pressure in a simple progressive wave. In a more complicated wave field in which waves may be arriving from more than one direction a microphone of this type cannot be used to measure the pressure. An example of such a sound field is that produced by a receiver in a reverberant closed space, such as a living room. In this case a special nondirectional microphone is used. This comprises a single Brush "sound cell" made from Rochelle salt crystals (for a description see Part I, p. 584 *et seq.*). The size of this crystal sound cell is so small ($1/4" \times 1/4"$) that diffraction effects are negligible for all frequencies of interest and the response is substantially the same for waves from any direction. This nondirectional microphone is used for measurements in living rooms where it is desired to measure the true pressure at a point.

Although they are frequently used for loud speaker measurements it should be emphasized that *velocity microphones are not suitable for measurements of sound pressure* except under exceptional conditions; i.e., that of a simple progressive plane sound wave. Such conditions are seldom encountered except outdoors at a distance from a simple source. Since the ear is a pressure-operated device measurements of loud speaker response with velocity microphones are meaningless. Fig. 9, Part I, shows the difference in the records of a loud speaker made with pressure and velocity microphones. Not only are the low-frequency patterns different but also near 1500 cycles, where the power is divided between the two speakers, there are important differences.

3. Outdoor Measurements

We come now to a consideration of the influence of the acoustical environment of the receiver and microphone upon the measurements of over-all fidelity.

The best acoustical conditions for such tests are found outdoors. The receiver and microphone should be located as far as possible from

⁴⁰ Reference 5, Part I.

all reflecting surfaces. Since clear spaces of adequate size can generally be found the chief source of embarrassment is reflection from the ground. Consider the case of a piston radiator of radius, R . The reflected wave from the ground (assuming perfect reflection) may be

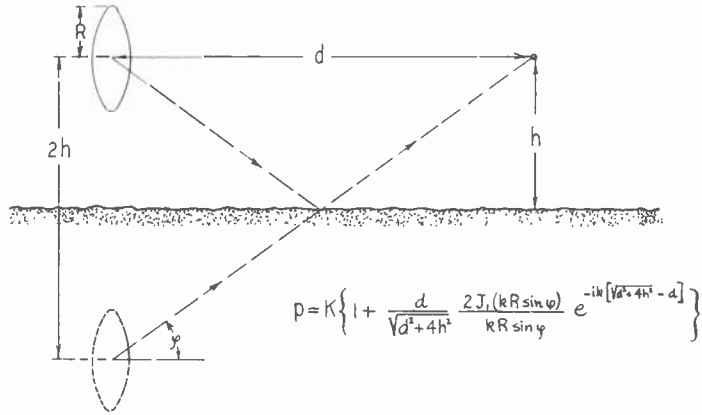

Fig. 48—Illustrating calculation of effect of reflection from the ground.

represented by a direct wave from an image piston symmetrically located below the surface (Fig. 48). Assuming that the frequency characteristic of the piston is level, and taking into consideration the directivity due to diffraction, the total pressure due to direct and reflected waves can be calculated (see formula in Fig. 48). This is plotted in

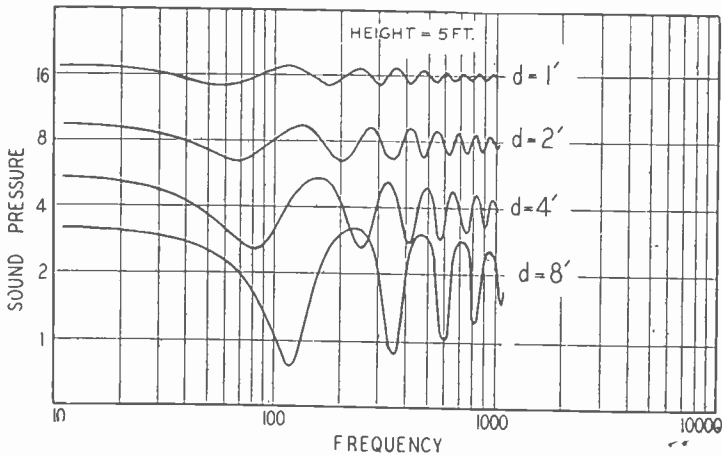

Fig. 49—Calculated effect of ground reflection on sound-pressure frequency characteristics.

Fig. 49 for a height of five feet and distances of one, two, four, and eight feet between microphone and radiator.

The effect of reflection increases rapidly as the distance between the microphone and receiver is increased, hence it is desirable to work as close to the receiver as possible. This must not be carried too far for other reasons to be considered later.

Actual experimental sound-pressure records showing the effect of height above ground upon reflection effects are shown in Fig. 50. The ordinates in each record are proportional to sound pressure but have no absolute significance; the input to the receiver was the same for each height. The depressions in the curve for a height of five feet, due

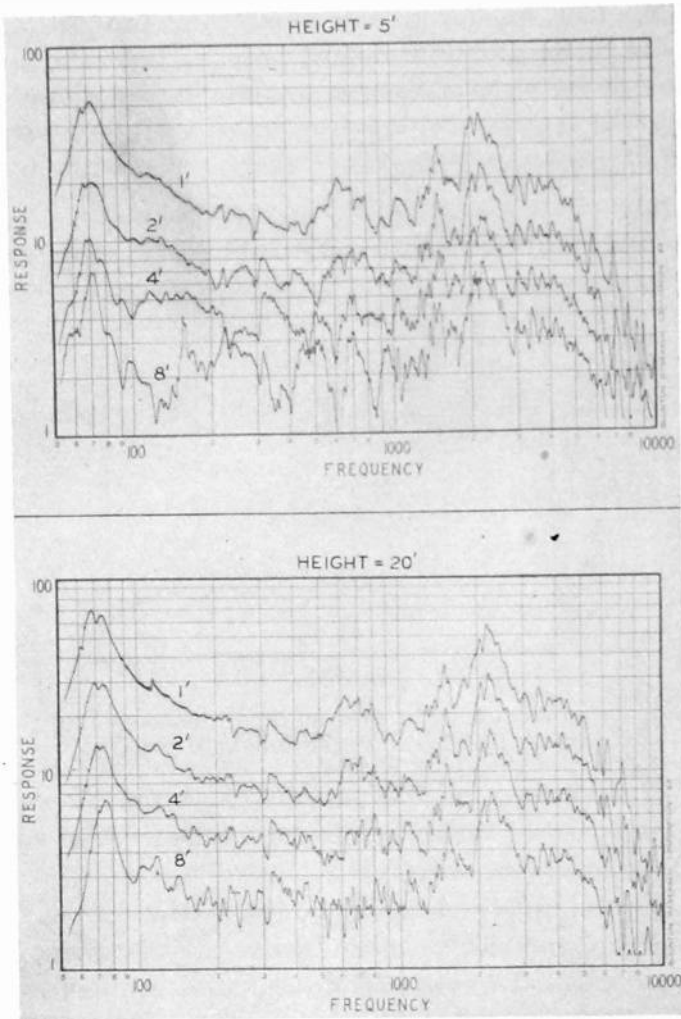

Fig. 50—Experimental outdoor sound-pressure frequency records at various heights and microphone distances.

to destructive interference between the direct wave and the wave reflected from the ground, correspond closely to those calculated and are especially noticeable at $d = \text{eight feet}$. These depressions have virtually disappeared for a height of twenty feet at $d = \text{eight feet}$. The residual higher frequency serrations in this curve are caused by reflections from a laboratory building. In general the serrations in Fig. 50 due to re-

fection from the ground are somewhat weaker than those calculated (Fig. 49). This is probably due to the fact that the reflectivity of the ground is actually less than unity, as assumed in the calculations, and to the directivity of the loud speaker being somewhat different from that of an ideal piston. It would seem that results of sufficient accuracy for engineering purposes can be obtained with a two-foot separation at a height of five feet, but for greater separations proportionally greater heights should be used. Our standard practice is to employ heights of twenty-four feet for accurate measurements up to microphone separations of eight feet, and for ordinary purposes, heights of five feet for our standard separation of two feet.

The frequencies of the minima due to reflection in Fig. 49 are odd multiples of the frequency of the first minima. The frequency of the

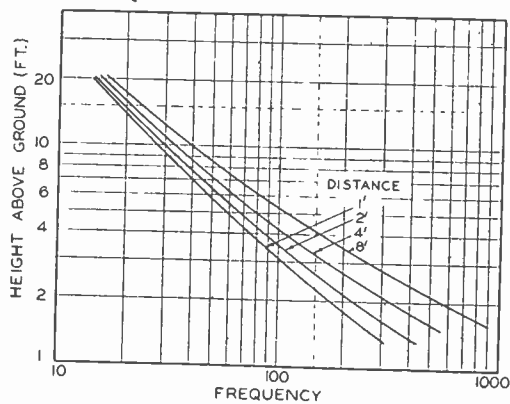

Fig. 51—Calculated frequency of first minima due to ground reflection for various heights and microphone distances.

first minima for various heights and distances are shown in Fig. 51, which is included as of possible interest in identifying suspected depressions in sound pressure curves.

A further question which arises concerns the proper distance between the microphone and receiver. From the viewpoint of avoiding trouble due to reflected waves it is desirable, as we have just noticed, to place the microphone as close to the receiver as possible. There are two additional effects, however, which come into play as the distance between the the microphone and loud speaker is decreased. Both effects are due to diffraction.

The first effect is a lowering of the high-frequency response as the distance is decreased. This is brought about by the fact that radiations from the various parts of the diaphragm get out of phase as the distance becomes comparable with the dimensions of the radiator and the wavelength of the sound. Assuming a circular piston radiator of radius R the sound pressure on the axis is given by

$$p = C \sin \frac{\pi f}{c} (\sqrt{R^2 + x^2} - x), \quad (2)$$

where C is a constant, c the velocity of sound, f the frequency and x the distance. If x is large compared with R ,

$$p = C \sin \frac{\pi f R^2}{2cx}. \quad (3)$$

At large distances the pressure is proportional to the frequency for a constant piston velocity. To isolate the diffraction effect in which we are interested from this normal variation of pressure with frequency

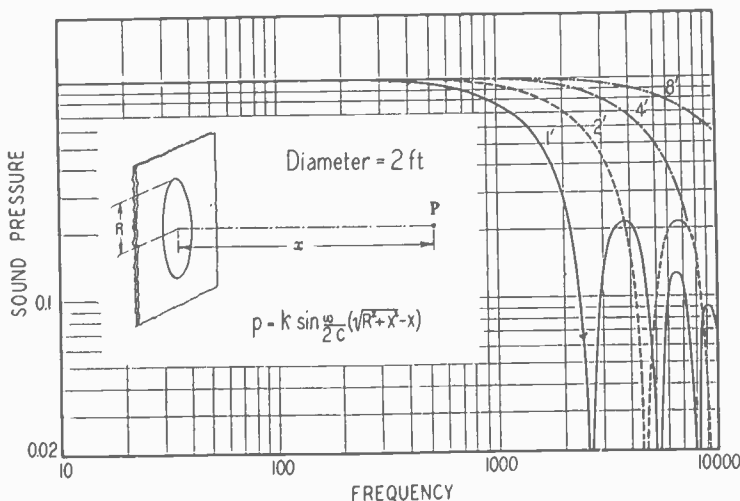

Fig. 52—Effect of diffraction upon axial sound pressure for a two-foot piston at various microphone distances.

for a piston assume that the piston velocity varies inversely with frequency so that at large distances the axial pressure is uniform with frequency. The effect is then brought out by dividing (2) by the frequency and plotting the resultant pressure against frequency for various distances as shown in Fig. 52. We see that the closer the microphone is placed to the loud speaker the sooner diffraction causes the pressure to fall off with increasing frequency.

The error due to this effect will be negligible if the distance is greater than $d^2f/1600$, where d represents the diameter of the radiating surface in feet and f is the frequency. If we wish to limit the error to two decibels the distance should be greater than $d^2f/3600$. The diameter of the average loud speaker is about nine inches. For a two-decibel error at 10,000 cycles the distance between microphone and speaker would have to be at least eighteen inches. A minimum distance of two feet can be regarded as a safe rule applicable to most radio re-

ceivers having a single loud speaker. For multiple loud speaker systems greater distances are required.

There is also a second effect, likewise due to diffraction, which manifests itself as an increase in the relative intensity of the sound pressures at low frequencies as the distance between the microphone and loud speaker is decreased. This effect is connected with the baffle (or cabinet) surrounding the loud speaker.

Consider the idealized simple case of a piston radiator in a spherical baffle. The sphere completely encloses the back of the piston and prevents any radiation from the rear. The effect of such a baffle can be found by an application of the principle of reciprocity according to which the pressure at a distant point P due to vibration of the piston in the spherical surface with unit velocity is the same as the pressure

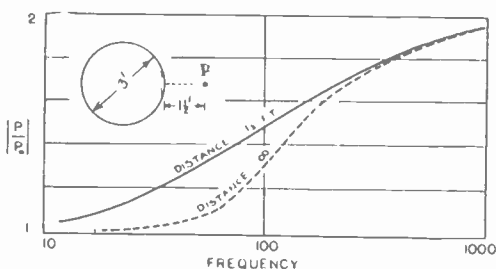

Fig. 53—Sound-pressure doubling due to spherical baffle; sound-pressure ratios versus frequency for microphone distances of $1\frac{1}{2}$ feet and infinite distance; diameter of baffle = 3 feet.

which would exist at that point of a rigid spherical surface due to an acoustical source at the point P . The problem of finding the pressure at a point of the sphere due to an incident wave is a classical one in diffraction theory, and for the case of a point at an *infinite* distance from the sphere (plane wave) calculations have been made⁴¹ from which the dotted curve shown in Fig. 53 for a baffle three feet in diameter can be drawn. According to reciprocity this curve also represents the sound pressure at a large distance due to a piston vibrating at the pole of a spherical baffle. If the baffle were of infinite diameter (perfect baffle) the pressure would be doubled at all frequencies; hence the effect of the finite spherical baffle is to halve the pressure at low frequencies.

When the point P is at a *finite* distance from the sphere we have to deal with the diffraction of a *spherical* wave by the sphere instead of a plane wave. The mathematical theory of this case is considerably more complicated than that of the plane wave case and has been considered by Lamb.⁴² Some calculations have been made by G. W.

⁴¹ Stuart Ballantine, *Phys. Rev.*, vol. 32, p. 988, (1928).

⁴² Lamb, "Hydrodynamics," p. 486, 5th Ed., Cambridge, (1924).

Stewart in connection with the theory of diffraction by the head in binaural hearing. I have recently reexamined the problem with the object of expressing the results in terms of Bessel functions whose orders are one half an odd integer. The final formula for the increase of pressure at the pole is

$$\frac{p}{p_0} = \frac{r-a}{\sqrt{ra}}$$

$$\sum_{n=0}^{\infty} \frac{(2n+1) [(-1)^n J_{-n-1/2}(kr) - i J_{n+1/2}(kr)]}{(-1)^n [(n+1) J_{-n-1/2} + ka J_{n+1/2}] - i [(n+1) J_{n+1/2} - ka J_{n-1/2}]} \quad (4)$$

where a is the radius of the sphere and r the distance between the source (point P) and the center of the sphere. The argument of the Bessel functions in the denominator is ka , where $k = \omega/c$. Computations for this spherical case are rather laborious on account of the slow convergence of (4) and the necessity for summing by special methods. I have carried them through for one case in order to exhibit the effect under discussion. This case is that in which the distance between point P and the spherical surface is equal to the radius of the sphere. The results are shown in Fig. 53 by the curve marked "distance = $1\frac{1}{2}$ feet." This represents the pressure which would be observed at this distance from the vibrating piston. It will be seen that as the microphone approaches the radiating surface the pressure at low frequencies increases. The experimental curves in Fig. 52 were taken with a loud speaker in an enclosed cubical baffle $3' \times 3' \times 3'$, and exhibit an effect of this sort.

When the back of the loud speaker is exposed, we have to deal with a double source and the effect is more pronounced. Kellogg⁴³ has given a qualitative explanation for this case.

The conclusion is that to get the proper effect of the cabinet the microphone should not be too close. The minimum distance will naturally depend upon the size of the cabinet. For cabinets of ordinary size, and for work of ordinary engineering accuracy, it is found experimentally that the microphone may approach within two feet of the loud speaker.

Measurements outdoors are usually embarrassed by inclement weather and wind, the number of clear, windless, good working days being surprisingly small. A gusty wind causes the deflections of the sound-pressure meter to become unsteady and it is impossible to judge by eye when a bona fide indication is being obtained. This unsteadiness is due presumably to a combination of effects such as variation of load on the loud speaker, variations in acoustical transmission, modulation

⁴³ E. W. Kellogg, *Jour. Acous. Soc. Amer.*, vol. 2, p. 157, (1930).

of loud speaker and microphone by gross displacements, and noise due to burbling around the microphone and variable pressure on its diaphragm.

In searching for some method of alleviating these effects it occurred to me several years ago that it might be possible to discriminate between the wind and the sound on the basis of the considerable differences in air velocities. The air-particle velocity involved in quite loud sounds is only of the order of a centimeter per second while in a ten-mile per hour gust it amounts to nearly 500 cm/sec, a ratio of 500:1. It is known from aerodynamical studies that any object, such as a cylinder, offers a resistance to airflow which is nonlinear with velocity.

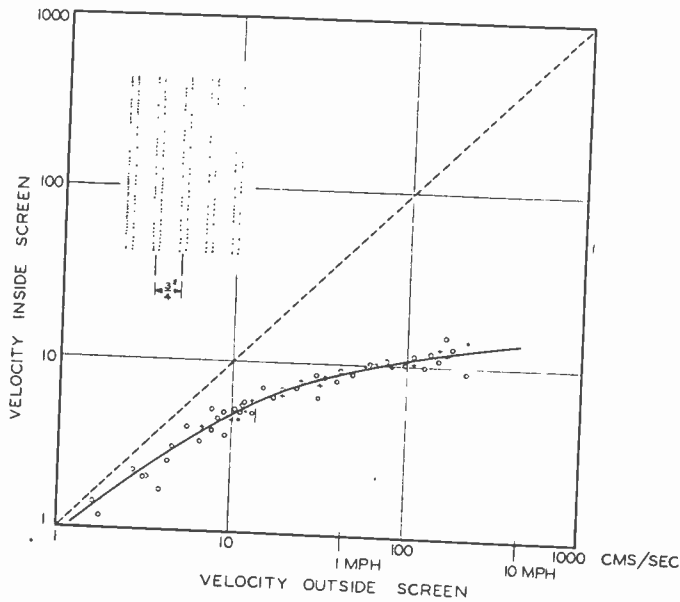

● Fig. 54—Experimental curves showing shielding action of cubical wind screen at various air velocities.

At low velocities (Stokes régime) the resistance is chiefly conditioned by viscosity and is proportional to the velocity, and to a linear dimension. For a domain of still higher velocities the density of the fluid plays an important part since some of the force is due to momentum carried away from the surface by the fluid in the form of eddies and the resistance tends to vary as the square of the velocity. The velocity at which eddies begin to form, although not well defined, depends upon Reynold's number. On the basis of some published data from wind-tunnel tests on cylinders it was computed that a screen made up of threads, loosely woven, ought to exhibit a screening action which automatically increased with the velocity within the above range of velocities. Cheesecloth was considered to have approximately the desired

structure and an experimental model wind screen was built employing five double layers of cheesecloth spaced three quarters of an inch apart. This was cubical in shape and about four feet on each side. To determine the screening action a hot-wire anemometer was mounted in the middle of the enclosure for the purpose of measuring the velocity within the enclosure. The idea here is that as the velocity increases the walls become more and more impervious to penetration by the air stream with the result that this tends to flow around the box rather

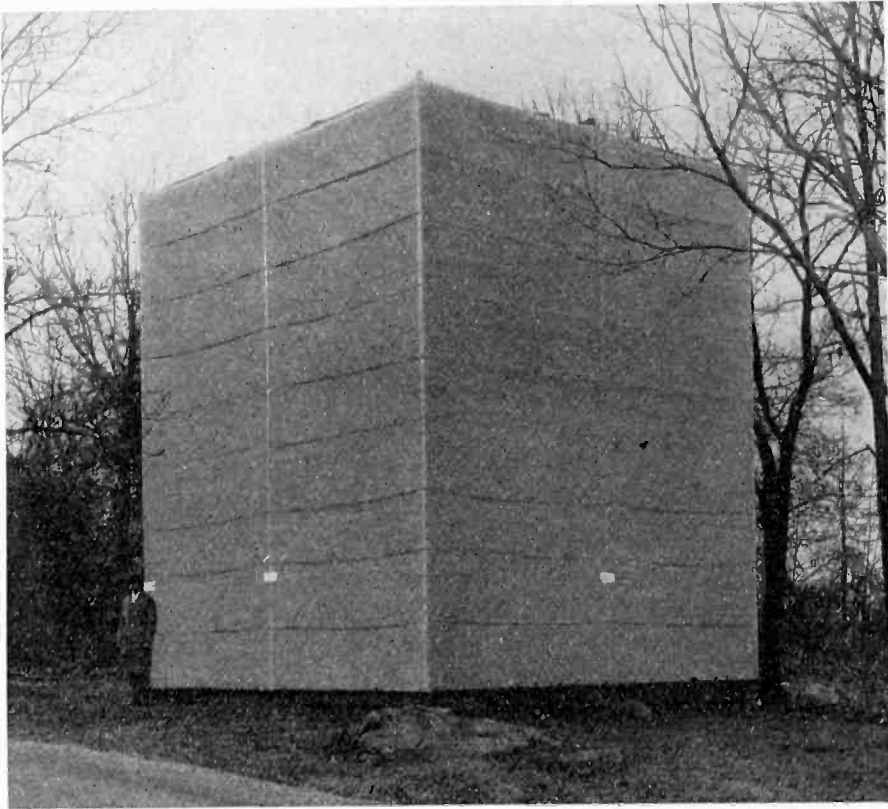

Fig. 55—View of wind screen installation for outdoor electro-acoustical measurements.

than through it. The results of experiments on the model are shown in Fig. 54, where the abscissas represent the external velocities of the air relative to the screen and the ordinates represent the corresponding velocities within the screen. The attenuation of sound in passing through the screen was immeasurably small, certainly less than one decibel. It will be seen that a significant screening action was obtained; this automatically increased with the velocity in accordance with the theoretical expectations.

Following the successful tests of the model a full scale enclosure was built of sufficient height to permit a twenty-four-foot elevation of

the receiver and microphone. The wall structure was the same as that used in the model. A photographic view of this wind screen is shown in Fig. 55. Within this enclosure measurements can be carried out on the windiest days with complete freedom from disturbances.

Some reduction in wind disturbance can, of course, be obtained by the much simpler expedient of screening only the microphone, using the same type of screen. This is, however, not nearly so effective as the large enclosure, for obvious reasons.

Another method which I have employed to reduce the effect of adverse wind conditions in outdoor measurements is made practicable by the automatic recorder. The procedure merely consists in repeating the recording several times on one sheet. Unless the wind is continuous the possibility of securing a faithful indication at each frequency during at least one of the runs is sufficient to indicate the true characteristic, or at least to suggest its form. Usually three records are sufficient for moderately gusty winds. This method is, of course, not as satisfactory as the wind screen. The curves shown in Fig. 56 were taken by this method.

4. Outdoor Measurements with Back Wall

As ordinarily operated the loud speaker is surrounded by six or more reflecting surfaces. Of these, probably the most important are the floor and the wall immediately behind the loud speaker. When it is placed in a corner, two back walls have to be considered. Information of value can be obtained by taking sound-pressure curves under conditions which simulate the effect of these surfaces.

To simulate the effect of the floor it is merely necessary to place the receiver on the ground in its normal position. It is advisable to cover the ground with a rug so that room conditions are duplicated as closely as possible. The back wall we use measures about 15' \times 12.' The receiver is placed in front of this in the middle and, when the effect of the distance between it and the wall is not under investigation, about one foot from the wall. The construction should be as rigid as possible because the vibration of the back wall affects the low-frequency picture.

The effect of these surfaces on the sound-pressure characteristic of a receiver is shown in Fig. 56. The receiver employed two loud speakers, a cone for the reproduction of the low frequencies and a small horn for the higher frequencies.

The top record in Fig. 56 represents the response of the receiver under ideal conditions, that is, at a sufficient distance from all surfaces to avoid reflection.

The second curve was taken with the receiver on the ground and represents the effect of ground reflection. The minima due to ground reflection are plainly in evidence. The position of these minima and the shape of the curve depend upon the height and distance of the microphone. In this case the distance was eight feet and the height was forty-four inches, which represents the average height of the ears of a seated

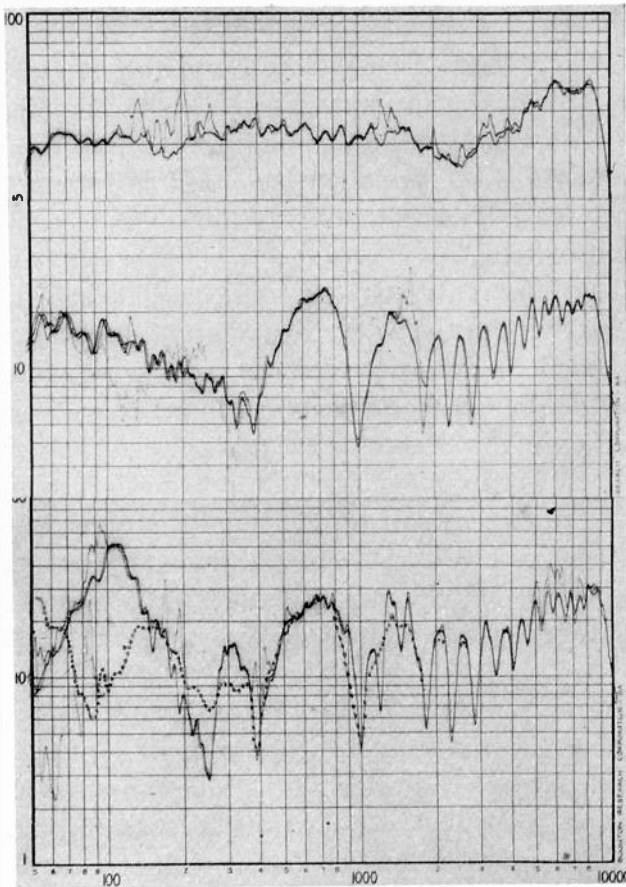

Fig. 56—Outdoor sound-pressure records of a receiver; (top curve) axial sound-pressure characteristic taken in free space; (middle curve) receiver on ground, microphone height, 44 inches, distance, 8 feet; (lower curve) receiver on ground with 12' \times 15' back wall one foot behind receiver.

person. The calculated frequencies of the minima agree very closely with those recorded.

The bottom curve in Fig. 56 was made with the back wall in position. The receiver was one foot from the wall and the microphone distance and height were the same as for the middle record. The dotted curve in this record has been traced from a record made with the back of the cabinet *closed*, to prevent the radiation of sound from the rear.

5. Indoor Measurements

Occasionally, due to inclement weather or for other reasons, one is obliged to work indoors. As is well known, the chief difficulty in acoustical measurements indoors is reflection from the walls of the enclosure. With regard to the fixed microphone there are two methods of reducing the errors due to this cause: (1) by acoustical treatment of the wall surfaces to reduce their reflectivity; and (2) by working with small distances between the microphone and loud speaker. The limitations of the latter expedient have been pointed out above. Our experimental experience has shown that it is unwise to reduce the microphone separation to less than eighteen inches and our standard separation for indoor measurements is the same as that adopted for most testing outdoors, viz., two feet. This refers only to receivers of ordinary size and having single speakers.

Various absorbing materials and constructions are available for reducing the reflectivity of the walls. The relative efficiency of the various methods of treatment does not seem to have been systematically investigated. At the higher frequencies ordinary balsa wood or hair felt have reflectivities as low as ten or twenty per cent and are sufficiently effective. At the lower frequencies, the wavelength is so large compared with reasonable thicknesses of the material that such materials are no longer very effective, and special dissipative panel constructions are indicated. These may, of course, be associated with the hair felt, or equivalent material, for simultaneous absorption of the higher frequencies.

In any case the room should be as large as possible, as the ratio of the direct to the reflected sound varies as the size of the room. If in a room of a certain size we can work with a microphone separation of two feet with a given error due to reflection, a room of double the linear dimensions will permit doubling the microphone distance for the same error.

A comparison of sound-pressure measurements made in a small sound-testing room about $16' \times 16' \times 10'$ with those obtained outdoors under conditions approaching the ideal is furnished by Fig. 57. These curves represent the sound pressure on the axis of the loud speaker at various microphone distances. The loud speaker and mode of excitation were the same in each record, so they are directly comparable.

The effect of the room is somewhat in evidence even at the one-foot distance and increases rapidly as the microphone distance is increased. For ordinary engineering purposes the curves taken at one and two feet would be sufficiently useful since the serrations at the lower frequencies can be identified, for preliminary comparison purposes, as

room effects. It will be noticed that the effect of the enclosure diminishes at the higher frequencies on account of decreasing reflectivity and increasing directivity of the loud speaker and microphone.

The rotating microphone has been resorted to in order to diminish room effects. This method has already been criticized.

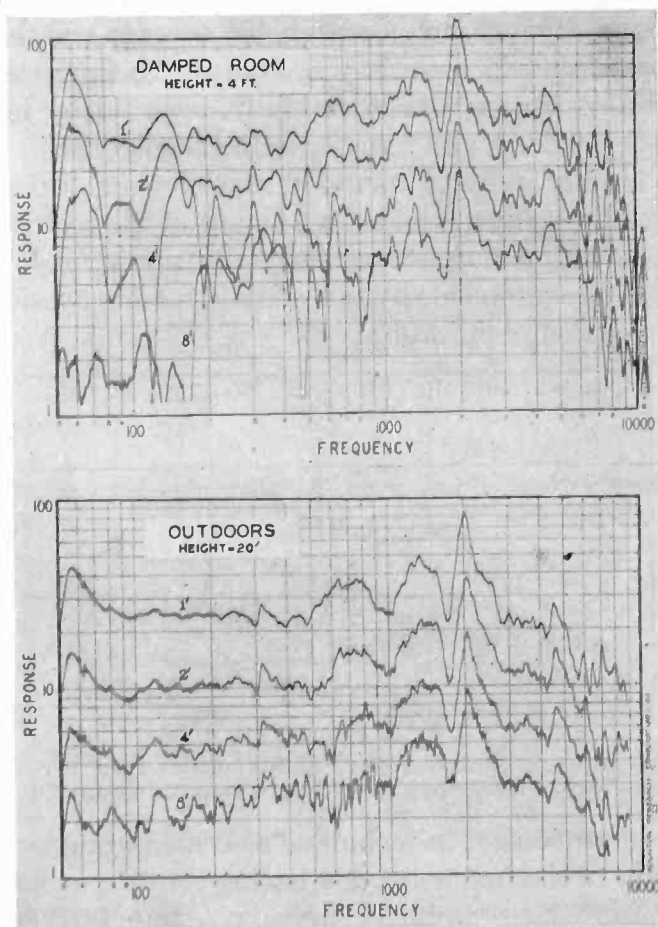

Fig. 57—Comparison of sound-pressure records of same loud speaker taken outdoors and in an indoor acoustical testing room.

6. Measurements in a Standard Living Room

Measurements made under favorable conditions outdoors and in specially treated sound-testing rooms are valuable in development studies and for engineering purposes but do not by any means tell the whole story. What we want to know ultimately is how the loud speaker performs in its natural acoustical habitat, which for our purposes may be taken to be the living room of the average home. This auditorium is acoustically a part of the loud speaker and usually profoundly modifies its performance.

Such rooms vary a good deal in size, shape, and acoustical characteristics. Strictly speaking it is not possible to predict the performance for a given room from measurements made in a room of different characteristics and dimensions. For routine testing purposes the best that can be done is to employ an average living room having representative dimensions, shape, and acoustical treatment. Our standard living room is an attempt to achieve such a reasonable average and is based upon experience in testing in a variety of rooms. The reverberation and acoustical absorption have been carefully adjusted by means of absorbing panels, curtains, and a rug covering the floor.

The first studies in living rooms were made some time ago by the ordinary point-by-point method. On account of the relatively high reflections the sound pressure at any point fluctuates violently with the frequency, and measurements by this method require considerable time and patience for their delineation.

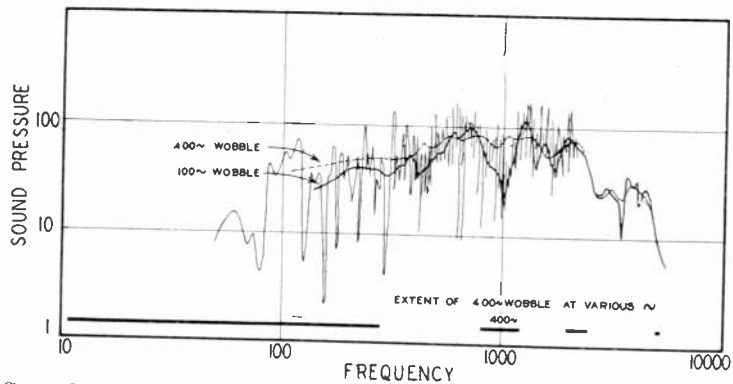

Fig. 58—Sound-pressure characteristics of a receiver in a reverberant room, illustrating effect of frequency wobbling in smoothing out fluctuations.

The next improvement in technique consisted in imparting a small cyclic variation to the frequency and letting the output meter average out the response.⁴⁴ Such “wobble” curves were found to represent very closely the average sound-pressure variation at the higher frequencies (say above 500 cycles). By adjusting the extent of the frequency wobble any desired amount of smoothing could be obtained. The wobbler curves are not accurate at the lower frequencies, hence this part of the curve is plotted by the ordinary point-by-point method. Fortunately the fluctuations at low frequencies are not so rapid as at higher frequencies so this can be done conveniently. The standard procedure then was to plot the pressure curves point by point up to 300–500 cycles, then to start the wobbler and continue the curve in that way. An example of the application of this method is shown in Fig. 58, taken

⁴⁴ This method was described several years later and has also been employed by E. Meyer and P. Just, *Zeit. für Tech. Phys.*, vol. 11, p. 253, (1930).

in 1927. Two wobble amplitudes are shown. Naturally the larger amount of wobble produces the smoother curve. The 100-cycle wobbler curve will be seen to approximate closely the trend of the real characteristic.

The manner in which the wobbler method smooths out the serrations in the sound-pressure characteristic can also be understood from the steady-state point of view. Carson has shown⁴⁵ that if a small sinusoidal variation is imparted to the capacity associated with an oscillator the frequency undergoes a variation which is expressed by an equation of the following type:

$$I = A \sin \left(\omega t + \frac{\Delta f_w}{f_a} \sin at \right), \quad (5)$$

where Δf_w is the amplitude of the frequency variation, f_w is the mean frequency, f_a is the frequency of capacity variation, and $a = 2\pi f_a$. He also showed that this variable frequency current could be expressed in a Fourier series as follows:

$$\begin{aligned} I = & J_0(m) \sin at + J_2(m) [\sin (\omega + 2a)t + \sin (\omega - 2a)t] + \dots \\ & + J_1(m) [\sin (\omega + a)t - \sin (\omega - a)t] \\ & + J_3(m) [\sin (\omega + 3a)t - \sin (\omega - 3a)t] + \dots \end{aligned} \quad (6)$$

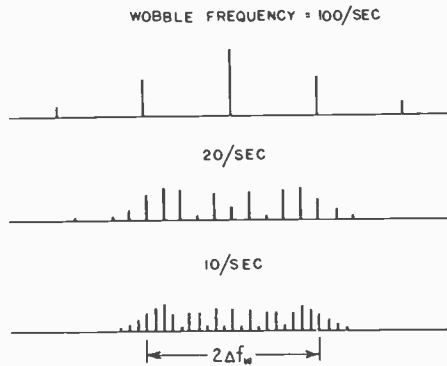

Fig. 59—Steady-state components of tone undergoing 100-cycle variation of frequency at rates of 10, 20, and 100 times per second.

where the argument m of the Bessel functions is $\Delta f_w/f_a$. The steady-state current (6) is composed of a series of components having amplitudes $J_n(m)$ and having frequencies disposed on either side of the mean frequency f_w . The spectra of 100-cycle wobble ($\Delta f_w = 100$) at rates of 10, 20, and 100 per second are shown in Fig. 59. As the rate of the wobble decreases the number of components increases while the width

⁴⁵ J. R. Carson, Proc. I.R.E., vol. 10, p. 57; February, (1922).

of the band remains practically constant. The distribution of energy among the components at the lower wobble rates is more or less uniform. The presence of a large number of components acting simultaneously averages the response over the frequency region covered by the wobble. Since the number of components in the frequency interval increases as the wobble rate decreases it is obviously advantageous to use as slow a rate of wobble as the ballistic properties of the indicating device will permit. This conclusion from steady-state reasoning is consistent with the fact that time is required for the energy to build up and die away in the room and a slow rate of frequency change favors this.

The required extent of the wobble at various frequencies depends, among other things, upon the dimensions of the room. The eigen-frequencies of the room are expressed by the second equation in Part I, page 583. Considering a one-dimensional case, where a denotes the length, the resonances will occur at

$$f = cm/2a$$

where c is the velocity of sound and m is to be assigned integral values of 1, 2, 3, The resonances are integral multiples of the fundamental and are spaced in frequency at intervals of $c/2a$. If it be desired to average over a constant number of resonances at all frequencies the extent of the wobble should be constant at all frequencies and vary inversely as the size of the room. Due to this requirement the method becomes unsatisfactory at the low frequencies. This type of variation of the extent of the wobble with frequency is shown in Fig. 58 at the lower part of the figure.

With the development of the automatic recorder the study of the performance of loud speakers in reverberant rooms was greatly simplified and a great deal of progress in this field has been made in the past few years. Ordinarily by this means a record may be obtained in about ten minutes, whereas by the older point-by-point method at least half a day was required.

The actual sound pressure existing at any point of the room is the sum of the pressures due to an infinite number of component waves arriving from various directions. Obviously to measure correctly the sound pressure in such a wave field it is necessary to use a microphone which responds uniformly to waves arriving from any direction. Ordinary microphones, whose dimensions exceed a small fraction of an inch, are unsuitable on account of their directivity. It is our practice therefore for such measurements to use a small piezo-electric microphone, $1/4" \times 1/4"$, which is nondirective for all frequencies of interest.

Specimen sound-pressure records taken in our standard living room are shown in Fig. 60. The microphone height was forty-five inches, which is about the height of the ears of the average person sitting in a chair. The microphone distances were one, two, four, and eight feet. The loud speaker in this test was the same one whose outdoor and sound-room characteristics are shown in Fig. 57 so that the characteristics obtained under these three conditions may be directly compared. The rapidly increasing serration of the curves as the microphone distance is increased is observable in Fig. 60. This is due, of course, to the increase of the reverberant sound in relation to the direct sound as the distance increases. It may also be noticed that the fluctuation decreases with rising frequency. This is probably due to two factors: (1) increasing concentration of the sound from the loud speaker along the axis; and (2) decreasing reflectivity of the walls and increasing absorption in the room, both occurring with rising frequency.

On account of the large percentage frequency spacing of the low-frequency peaks and depressions, and the large amplitude of fluctuation, *it seems doubtful if satisfactory reproduction of low frequencies in a small room will ever be possible.* The situation is made worse by the fact that at low frequencies the subjective loudness of sounds as perceived by the ear changes more rapidly with a change of sound pressure than at higher frequencies, so that the effect of these fluctuations in sound pressure are still further exaggerated by the ear. It is to be noticed that it is in this region that the sound-pressure characteristic of the loud speaker is most affected by the room. For these reasons one is not justified in spending too much effort in securing an inherently level response at low frequencies as measured outdoors; in fact a level response may be definitely undesirable. Entirely too much emphasis has been placed in loud speaker design upon level response down to low frequencies. *When the loud speaker is taken into a room the response characteristic at low frequencies is entirely changed and bears no relationship to the inherent performance as measured outdoors in free space.* As a starting point in designing a loud speaker a reasonable effort may be made to secure uniform response down to fifty cycles, but the final adjustments should always be made under actual living-room conditions. To secure the very best results the loud speaker should be "tailored" acoustically to fit the room. The most convenient way to carry out this "tailoring" is by means of compensators in the electrical circuits, and examples of this method will be given later in Part III.

The truth of the above remarks is well brought out by the records shown in Fig. 61. The response of this loud speaker outdoors was level within three decibels down to fifty cycles, the characteristic being sub-

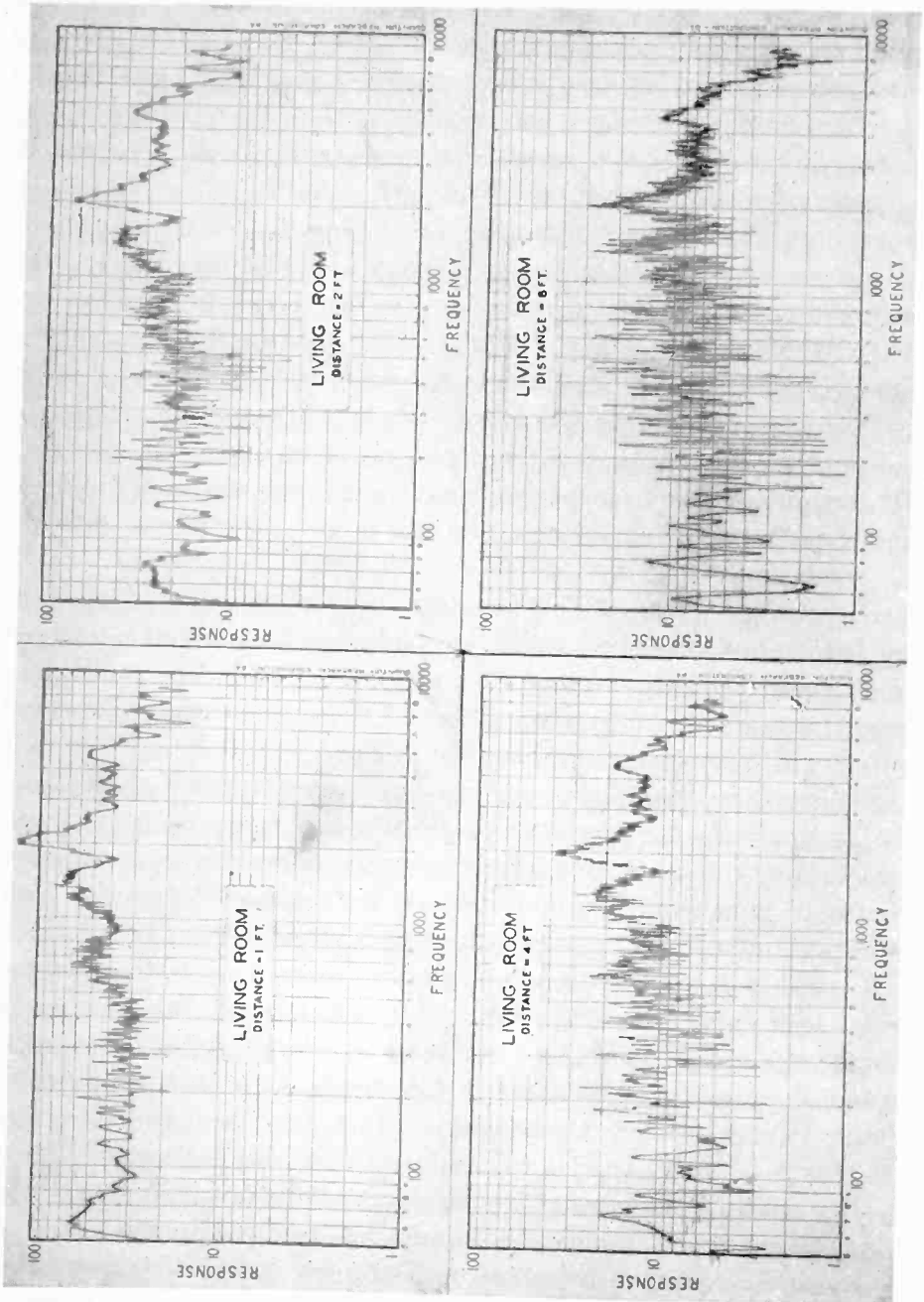

Fig. 60—Sound-pressure records taken in a living room of average reverberation at various microphone distances.

stantially as shown in Fig. 56 below 1000 cycles. In spite of this good outdoor characteristic the low-frequency response in the living room is extremely poor and exhibits violent fluctuations.

The pronounced effect of the room upon the response of the loud speaker has an important bearing upon the problem of formulating standards for the uniformity of frequency response of high fidelity receivers. It would seem rational to allow some relaxation of the requirements for uniform frequency response in frequency regions where the room becomes the predominating factor, since obviously the effect of improvements in the loud speaker in these circumstances is small. The order of the effect of the room in producing fluctuations of sound pressure in a typical case is as follows:

TABLE I

Frequency Region	Total Fluctuation	Weighted for Ear
50- 250	30 db	60 db
250- 500	20	24
500- 1000	12	12
1000- 2000	7	7
2000- 4000	2	2
4000-10,000	1	1

This represents the total fluctuation. One half of these numbers represent approximately the fluctuation on each side of the curve for the loud speaker as measured outdoors. The effect of these fluctuations will be altered by the relation between the subjective loudness and sound pressure for the ear at various frequencies. According to the latest data on this⁴⁶ the effect will be confined to frequencies below 500 cycles. At 100 cycles the variation in sound pressure required to produce a given variation in loudness is about half as great (measured in decibels) as at frequencies above 500. The last column in Table I includes the effect of the ear. A thirty-decibel variation at 100 cycles is equivalent to a sixty-decibel variation above 500 cycles, and so forth.

Instead of specifying an allowable uniform fluctuation of ± 2.5 decibels over the entire frequency range for a high fidelity receiver, this could be weighted in accordance with the above data to allow for the effect of the room at each frequency. As an arbitrary basis for this weighting we might specify a fluctuation in the loud speaker at low frequencies equal to a certain percentage of the room effect, and superpose this on the above basic tolerance. The following specification for a high fidelity receiver, derived in this way, may be proposed:

⁴⁶ H. Fletcher and W. A. Munson, *Jour. Acous. Soc. Amer.*, vol. 5, p. 91, (1933).

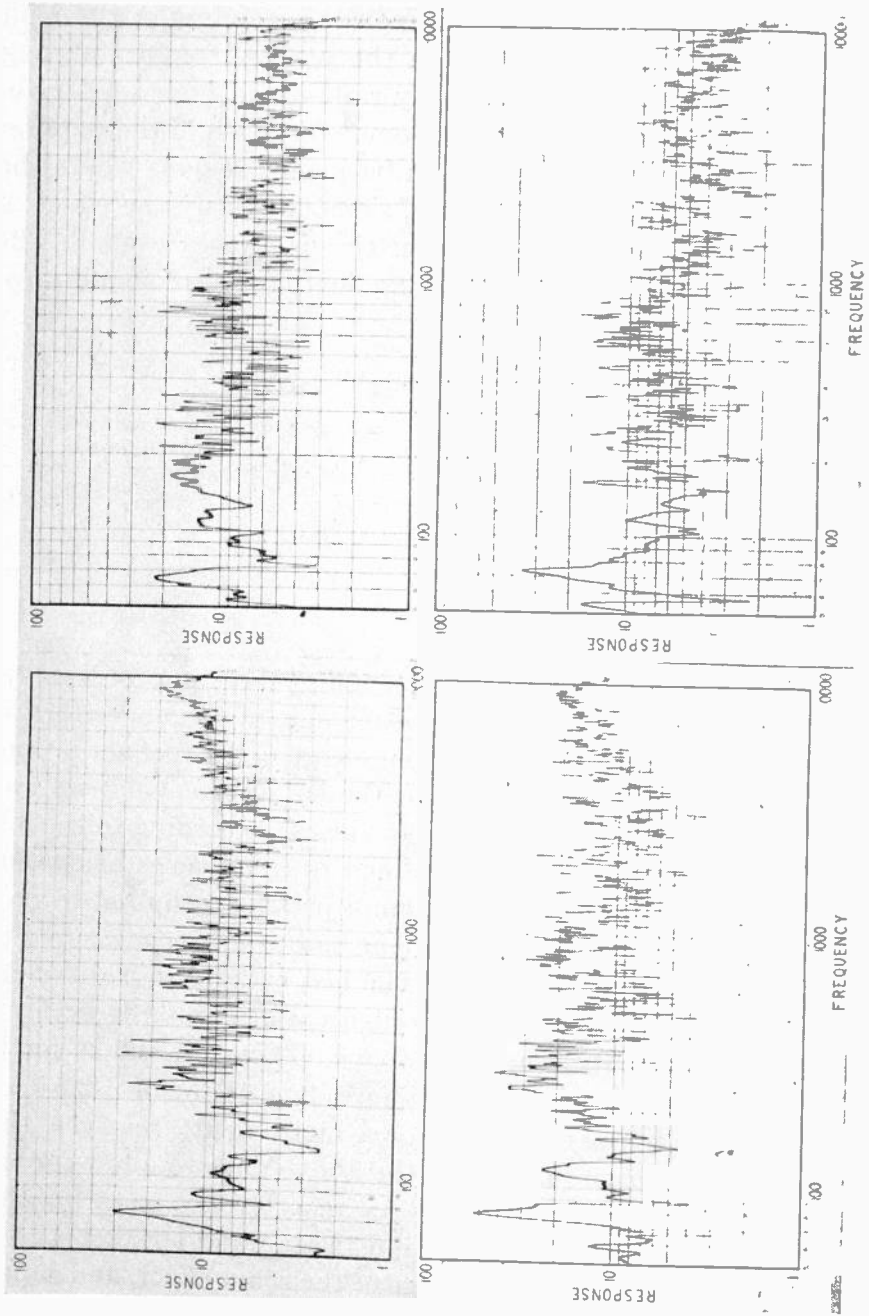

Fig. 61—Sound-pressure records taken in a standard living room showing effect of various microphone locations, microphone distance constant.

TABLE II

Proposed Specification for the Permissible Fluctuation in Response of a High Fidelity Receiver	
Frequency	Fluctuation
50	± 10 db
100	± 7
500	± 4
1000-8000	± 2.5

These figures may be regarded as tentative, subject to the test of future experience, but illustrate the principle which it is felt should govern the formulation of tolerances.

The sound-pressure characteristics as measured at a point in a room varies, as one would expect, with the position of the loud speaker in the room, the position of the microphone in the room, and the size, shape, and furnishings of the room.

The effect of the position of the microphone in the room is shown in Fig. 61. In view of the variation between different locations our practice is to take records at certain chosen microphone locations and to average out the results. These locations are generally at -45° , -25° , 0° , $+25^\circ$, $+45^\circ$ at 12 feet distance and at 0° , 8 feet distance, all angles being with respect to the plane of the loud speaker axis. After the average curves have been obtained we have sufficient data for the design of electrical compensators or other means of smoothing out the average response. This procedure has been followed out in the design of the high fidelity receivers to be described in Part III of this article and the results seem to be well supported by subjective judgments of performance.

The effect of the position of the loud speaker in the room is shown in the four records reproduced in Fig. 62. In all cases the microphone was located in the plane of the axis of the loud speaker. The two positions of the loud speaker were typical ones; in the upper records the receiver was located in a corner with the axis of the loud speaker at forty-five degrees to the two walls; in the lower records it was against a side wall, approximately midway between the corners, and about three inches from the wall. This loud speaker was the one recorded in Fig. 56 and had substantially uniform response as measured outdoors.

In the left-hand records the receiver cabinet was completely closed in order to eliminate acoustical radiation from the rear. In the right-hand records the back of the cabinet was open. The purpose of this experiment was to test an opinion I had held for many years, on theoretical grounds, namely that when a loud speaker is installed in a room it should be beneficial to eliminate the acoustical radiation from the rear. This idea was opposed to current practice in which the conventional receiver cabinet was thoroughly ventilated to allow free escape

of the sound from the rear, sides, and bottom. The experimental curves shown in Fig. 62 indicate, however, that no general statement can be made concerning the desirability of suppressing the radiation from the rear. Whether this is desirable or not depends upon the position of the loud speaker in the room, and also undoubtedly upon other factors not varied in this experiment. For example, in Fig. 62 the smoothest response is obtained with the receiver against the wall with the back in place (lower left-hand curve). With the receiver in the corner, the

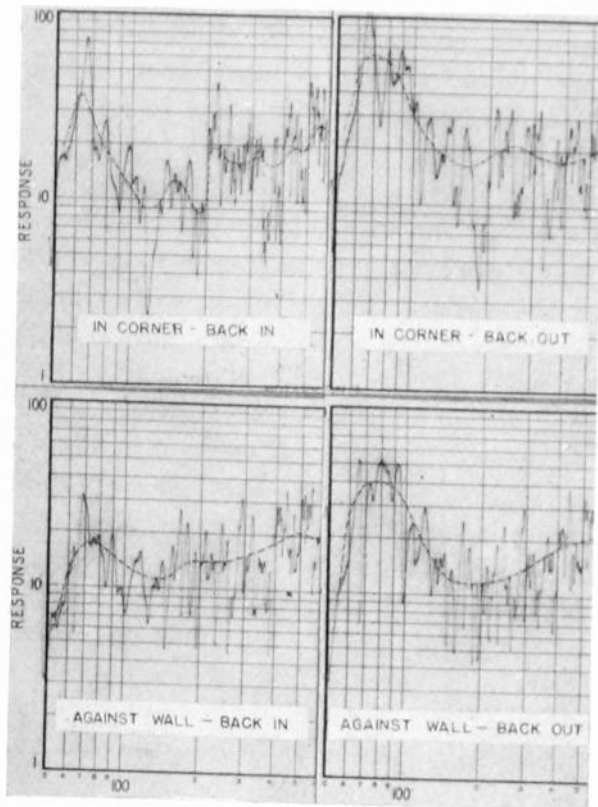

Fig. 62—Illustrating effect of location of receiver in living room.

average response (dotted line) is smoother when the back is out (upper right-hand record) than when it is in place. A smooth *average* response is important because it is easier to equalize in the electrical circuits. From this viewpoint the upper right-hand curve in Fig. 62 is somewhat preferable to the upper left-hand curve. In this particular case when the receiver is installed against the wall, the back is put in and the electrical room-equalizer is cut out; when it is installed in the corner the back is removed and the electrical equalizer is cut in. This is an example of the application of what we described above as tailoring the receiver acoustically to fit the room.

The horn-like effect of the corner in building up the response near seventy cycles is plainly in evidence in these records, especially those with the back of the cabinet out. The peak in the neighborhood of seventy cycles is probably due to the conjunction of lower resonant frequencies of the room, the dimensions of which were $9.4 \times 4.7 \times 3.35$ meters. (The length is exactly twice the width.) The first-order eigen frequencies corresponding to the length, breadth, and height of the room are obtained by substituting in the second equation, Part I, page 583, and are

length—	17.5,	35,	52.5,	70,	88,	105,	122,	140	cycles
breadth—		35,		70,		105,		140	
height—			50,		100,			150.	

The greatest effect is obtained at the first conjunction at thirty-five cycles, as shown by the oscillographic response of a microphone to shock excitation,⁴⁷ and the next highest rise occurs at seventy cycles. Due to these conjunctions this room is not a particularly good one. The room dimensions should be such that none of them is an integral multiple of another and such that the eigen-frequencies shall be separated as much as possible, especially in the region of 50 to 150 cycles.

The simplest method of eliminating acoustical radiations from the rear is to enclose the cabinet completely. The principal change in the acoustical impedance presented to the back of the loud speaker piston caused by this is an increase in the stiffness which can be allowed for in the design of the speaker. Resonances at higher frequencies may be discouraged by lining the cabinet with sound-absorbing material, although as an experimental fact I have never found that these give a great deal of trouble.⁴⁸

There has been a great deal of discussion about the effect of "cabinet resonance" on the response characteristics of loud speakers. There is no doubt that this exists. We have seen how the pressure on the diaphragm of a condenser microphone is built up by a factor of three to one due to acoustical resonance in the cavity in front of the diaphragm; in the same way the radiation from the rear of the loud speaker is influenced by resonance in the cavity formed by the receiver cabinet when it is open in the rear. The trouble, however, is this: when the receiver is outdoors in the open we can properly speak of cabinet resonance since it is a perfectly definite thing; but when the receiver is

⁴⁷ When a loud speaker of conventional design is shock-excited in an ordinary room the microphone registers free oscillations corresponding to the resonances of the room and not of the loud speaker, as has been stated.

⁴⁸ Note added April, 1935: A method which has quite recently been adopted in a commercial receiver for eliminating radiation from the rear employs a so-called "acoustical labyrinth."

taken into a room the cabinet resonance is profoundly modified by the presence of the walls. In these circumstances the resonant frequencies are changed. The term "cabinet resonance" is no longer proper since the cabinet is a small part of the picture. For the same reason the use of Helmholtz resonators mounted in the cabinet to absorb sound at the resonant frequencies of the cabinet, as has been proposed and carried out in one commercial receiver, is of doubtful value due to the wide variation in the resonant frequencies in different locations of the receiver with respect to adjacent wall structures. As a matter of fact I have never been able to detect experimentally any substantial benefit from such absorbing devices under practical conditions.

Finally the variation from room to room is illustrated in the set of records reproduced in Fig. 63. The loud speaker was the same in all cases and in each room was located against a side wall with the microphone in the axial plane at a distance of eight feet. The sizes of the rooms varied from $10' \times 10' \times 8'$ to $32' \times 16' \times 11'$.

A question which arises in connection with the perception of sound in a reverberant room is this: Is there any definite relation between the sound pressure as measured *at a point* by the above methods and the pressure which is present at the external ear of a listener at that point? A little consideration shows that in the general case the answer is "no." The pressure at the ear differs from the pressure in an incident plane sound wave on account of diffraction around the head. The ratio of the pressure at the ear to that in the undisturbed wave depends upon the frequency and the angle of incidence. In a reverberant room the sound at any point is due to an infinite number of waves of various intensities arriving from various directions. The pressure at the ear will be obtained by summing up, with due regard to the effects of diffraction, the effects of these component waves. Obviously the resulting pressure will differ from the pressure at that point as measured by a nondirectional microphone.

As a means of obtaining a measurement of pressure approximating the acoustical pressure present at the ear, the apparatus shown in Fig. 64 was constructed in 1930. This is virtually a spherical artificial head with condenser microphones for ears. The diameter of the spherical mounting is equal to the average distance between the ears. The condenser microphones are of special construction (vide reference 2) and the diaphragms are virtually part of the spherical surface.

Either microphone could be connected to the recorder, or using two complete separate channels the outputs could be combined, as shown in Fig. 65. It was expected that the use of two microphones would tend to smooth out the fluctuations at higher frequencies. As a matter of

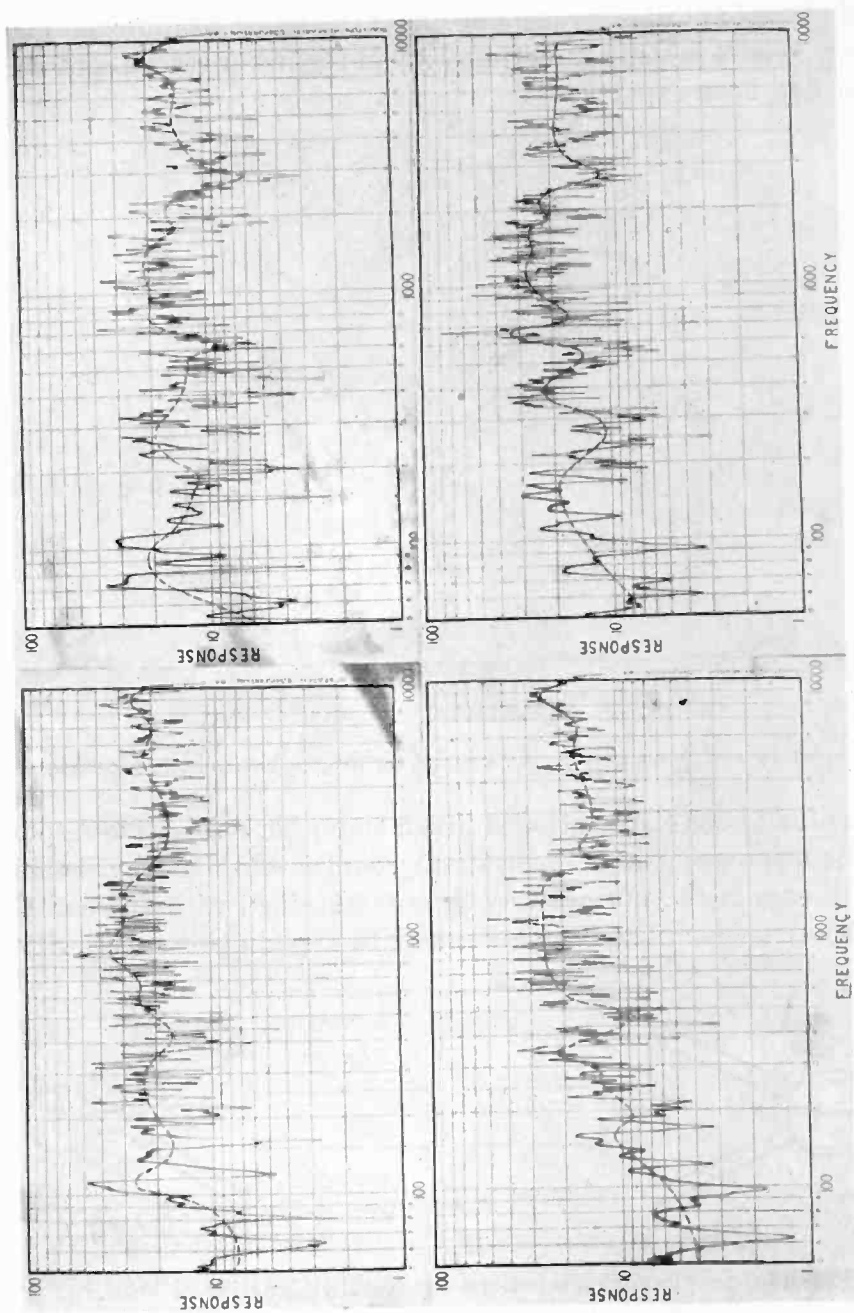

Fig. 63—Sound-pressure characteristic of same receiver in different rooms.

fact there is surprisingly little difference between the records made with one microphone and records of the combined output of both microphones. Typical records made under the two conditions are shown in Fig. 66. There is some smoothing out in the lower record, but not as much as had been expected.

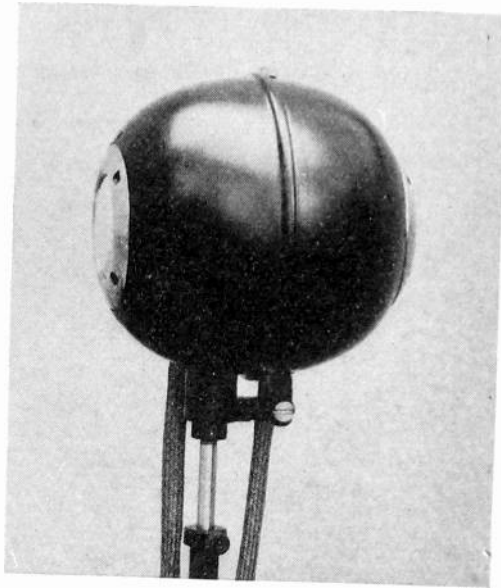

Fig. 64—Artificial head employing condenser microphones at ear locations.

It has long been known that a much smoother subjective response to sounds originating in a reverberant room is obtained by listening with both ears in the normal way than is obtained with one ear. One of the theories which has been advanced to explain this superiority of

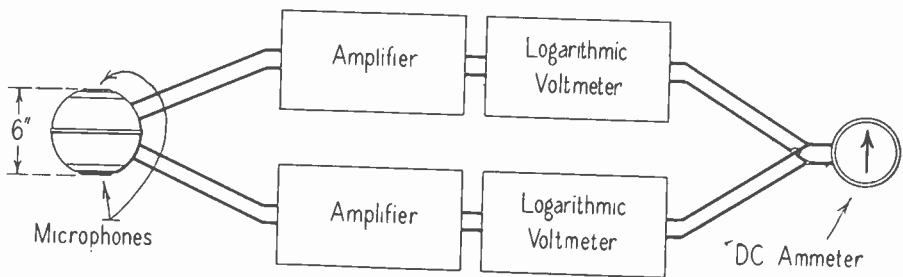

Fig. 65—Scheme of connections for tests with artificial head.

binaural over monaural pick-up is that the single ear finds itself at certain frequencies in a pressure null point whereas with two ears the probability of both ears being simultaneously in a pressure null point is considerably smaller. The two ears tend to help one another; when one is inactive some sound is still picked up by the other. This may be

expected to take place at the higher frequencies when the dimensions of the head are comparable to the wavelength of the sound. The curves in Fig. 66 would appear to show, however, that this smoothing effect is actually too small to account for the subjective observations.

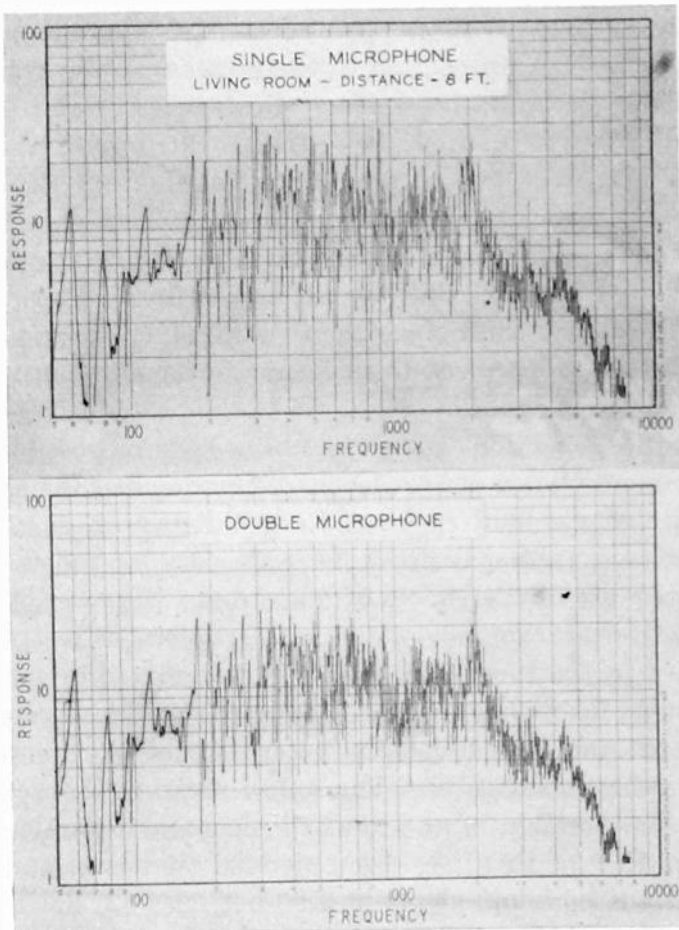

Fig. 66—Sound-pressure characteristics in reverberant room taken with artificial head, (upper curve) one microphone, (lower curve) both microphones.

7. Summary

The over-all fidelity of a broadcast receiver may be determined by introducing into an artificial antenna a standard modulated signal of variable modulation frequency and plotting the sound pressure against modulation frequency.

The sound pressure should be measured by a pressure-operated microphone, not by a velocity microphone. The microphone should preferably be fixed in position and not rotated or moved in any way. The most fundamental characteristic is obtained with the microphone on the axis of the loud speaker. The directivity of the loud speaker should

also be determined by making measurements with the microphone set at several angles to the axis.

The most favorable acoustical conditions for such measurements are found outdoors. For receivers of average size with a single loud speaker a standard microphone distance of two feet is recommended. For receivers with more than one speaker the microphone distance should be increased in proportion to the increase in the greatest overall dimension of the radiating surface. Both receiver and microphone should be sufficiently elevated above the earth to avoid the effects of reflection. A height of five to ten feet is satisfactory for a two-foot microphone distance, and proportionally greater heights for greater microphone distances. Measurements made outdoors may be regarded as supplying fundamental (but by no means final) information concerning the frequency characteristic of the receiver or loud speaker.

When it is not convenient to make measurements outdoors a specially damped testing room may be used. This should be acoustically treated to reduce reflections and should be as large as possible. A standard microphone distance of two feet is recommended for ordinary receivers with a single loud speaker. Larger distances, as required by multiple speakers, are not in general satisfactory for rooms of average dimensions because of the effects of reflection.

The ultimate performance of the loud speaker, or receiver, should be determined in the room in which it is actually to be used. This is generally inconvenient but measurements in a standard room, having the dimensions and acoustical characteristics of the average living room, will serve as a substitute. The sound-pressure characteristic depends upon the position of the loud speaker and the microphone in the room. In view of this it is recommended that two standard loud speaker positions be adopted (1) in a corner, and (2) flat against the middle of a side wall—and that for each of these positions a curve be taken with the microphone at azimuths of -45° , -25° , 0° , $+25^\circ$, $+45^\circ$ at a distance of twelve feet and height of forty-five inches. Average curves should be drawn for each position, smoothing out the serrations due to the standing wave pattern. Then an average of the average curves should be drawn. Final adjustments should then be made to smooth out this average curve, probably by electrical compensation. A nondirectional pressure microphone should be employed for living-room measurements or in any circumstances where the sound field is comprised of several components arriving from different directions.

(The discussion of the *Receiving System*, including a description of experimental model high fidelity receivers, will be concluded in Part III of this paper which, it is expected, will be published in a subsequent issue of the PROCEEDINGS.)

A HIGH-FREQUENCY SWEEP CIRCUIT*

By

T. T. GOLDSMITH, JR., AND L. A. RICHARDS

(Department of Physics, Cornell University, Ithaca, N. Y.)

Summary—A linear high-frequency sweep circuit for the cathode ray oscillograph is described. It employs a linearly charged condenser periodically discharged by a hard tube, the grid of which is biased past cut-off except for short periods when it is driven positive by an auxiliary oscillator. The frequency of this oscillator is made commensurable with that of the unknown wave form to be investigated. The circuit is particularly adaptable for high frequencies, photographs of alternating voltages of frequencies up to twelve megacycles being shown.

THE usual method for obtaining a cathode ray tube linear time axis is to make use of the uniform rise in voltage resulting when a condenser is charged by a constant current and then periodically discharged by a glow discharge in a gas-filled tube.^{1,2,3} In such tubes the discharge frequency and hence the sweep frequency is definitely limited by the gas deionization time. During the spring of 1933 while trying to obtain high sweep frequencies it was decided to avoid such a limitation by using a hard tube to discharge the sweep circuit condenser. This may be done if the high vacuum tube used to discharge the condenser is biased past cut-off except for short intervals when the grid is driven positive by an auxiliary oscillator.

When this investigation of such a sweep circuit was nearing completion, it was found that a similar scheme was being used by Zworykin.⁴ The high-frequency advantage of the circuit however is not necessary in the television application, and the present paper shows that the hard tube sweep circuit, used in connection with high vacuum cathode ray tubes, considerably extends the frequency range over which stabilized wave patterns may be obtained.

A signal generator applies the waves to be investigated to the Y plates of the cathode ray tube. The X plates are connected directly to the sweep circuit condenser which is charged by current from the

* Decimal classification: R388. Original manuscript received by the Institute, September 5, 1934; revised manuscript received by the Institute, February 5, 1935.

¹ Bedell and Reich, "The oscilloscope: a stabilized cathode ray oscillograph with linear time-axis," *Jour. A.I.E.E.*, vol. 46, pp. 563-567; June, (1927).

² Haller, "A linear timing axis for cathode ray oscillographs," *Rev. Sci. Instr.*, vol. 4, pp. 385-386; July, (1933).

³ Meier and Richards, "Power supply and linear time axis for cathode ray oscillographs," *Electronics*, pp. 110-112, April, (1934).

⁴ Zworykin, "Experimental television system and kinescope," *Proc. I.R.E.*, vol., 21, pp. 1655-1673; December, (1933).

charging tubes during the linear portion of the sweep, and then discharged by the plate current of a 59 tube. When connected as a class B triode this tube requires only a low negative bias for plate current cut-off and can pass large currents when the grid is driven positive, thus allowing rapid discharge of the sweep circuit condenser. The filament of this tube is operated for convenience from a storage battery, and the tube, its battery, and its entire feed circuit are placed in a shielding copper box.

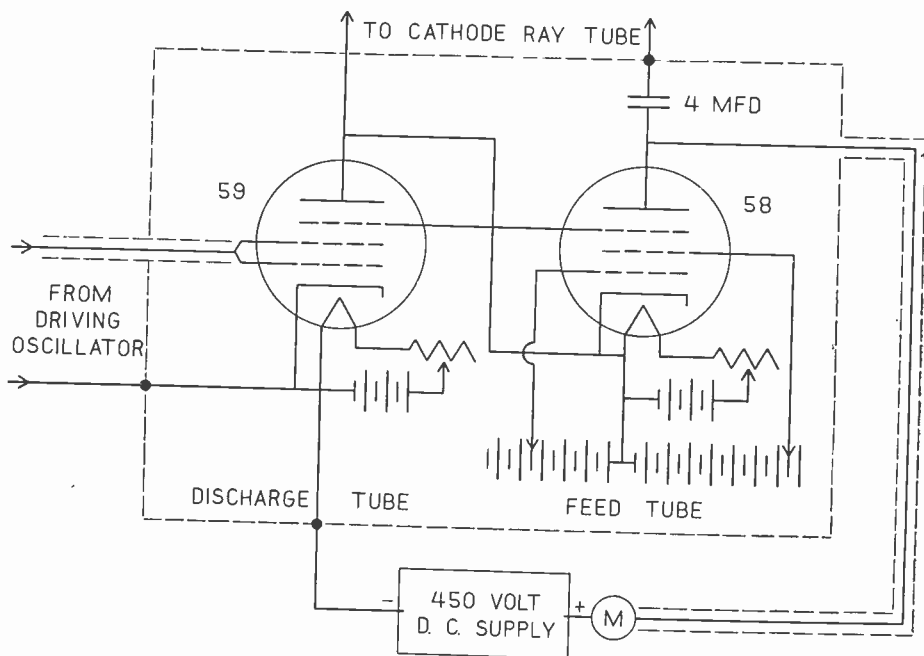

Fig. 1—Discharge tube and feed circuit.

The constant current for charging the sweep circuit condenser is supplied by four 58 tubes connected in parallel. The diagram of connections is given in Fig. 1, only one of the 58 tubes being shown.

For high frequencies it is desirable that the sweep circuit condenser have a low capacitance. The distributed capacitance of the circuit connected with the plate and cathode of the 59 tube is more than adequate for this purpose, and should be kept low by keeping the battery system of the charging tubes well spaced from the shielding case. The effective value of this distributed capacitance for our circuit was found to be 274 micromicrofarads.

A Hartley oscillator drives the sweep circuit. In order to obtain sufficient power over a wide range of frequencies, a type 250 tube is used with 45 volts grid bias and a plate supply of 450 volts with a variable plate resistor to prevent overheating of the tube. The center

of the tank circuit, consisting of grid and plate coils in series, with the tuning condenser across them both, is biased several volts negative to the cathode of the 59 tube. In this way, the output signal, tapped from about the middle of the grid coil and going directly to the grid of the discharge tube, has the proper bias for that tube. By adjusting this bias, only the very peaks of the oscillations are used to swing the discharge tube grid positive, making the tube conducting, and the entire remainder of the cycle is free for the linear portion of the sweep. Of course it is necessary that the grid stay positive long enough for a complete discharge of the plate capacitance.

Careful shielding of the driving oscillator from the output of the sweep circuit is necessary, no shielding being used on the lead from the sweep circuit to the cathode ray tube, as such shielding would very materially increase the distributed capacitance in the circuit.

We obtained the unknown wave form for the *Y* plates from a feedback oscillator using a tuned grid circuit.

In order to produce steady patterns on the screen of the cathode ray tube, some means of stabilization¹ has to be employed. By having both oscillators at ground potential it is a simple matter to produce enough coupling between the two circuits to cause them to keep in step when tuned to nearly the same or multiples of the same frequency. For precise work, it is of course best to see that the driving oscillator is completely shielded, so it will have no effect on the circuit under observation. A very small amount of the unknown voltage can be led into the case with the driving oscillator to pull it into step. Stray coupling proved sufficient in taking the pictures shown, working best when a small ratio of unknown frequency to driving frequency was used.

The ideal linear sweep circuit demands a return sweep which takes place so rapidly that the trace is invisible, but actually the discharge of the capacitance takes a finite time. However, the return time may be minimized by adjustment of the discharge tube grid bias as described above. An inspection of Fig. 2 will show the characteristic of the return sweep. As the cathode ray tube happened to be arranged, the linear portion of the sweep actually takes place from right to left, and the return sweep begins at the left and goes to the right. In Fig. 2 the return sweep takes a little more than one cycle, after which the grid of the discharge tube remains positive for the next two cycles, holding the spot at the zero position all of this time. With more careful adjustment of the bias than was here used, this extra holding of the spot in the zero position could be eliminated, as may be seen in the other pictures.

Another method of minimizing the interference of the return sweep on the waves to be studied might be the use of some scheme to turn off the cathode ray beam during this part of the cycle.

The actual linearity of the sweep circuit was checked only by the photographs of sine waves such as those here given, though at lower frequencies it was checked against a standard sweep circuit.

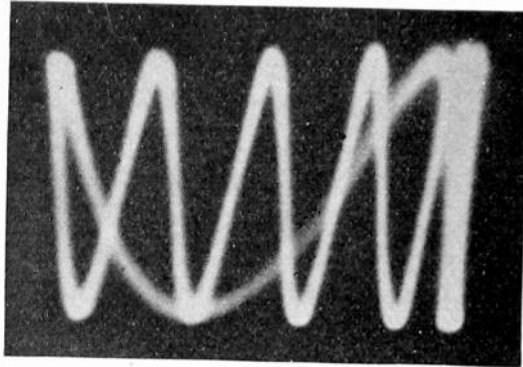

Fig. 2—4.2 megacycles per second.

A standard wave meter indicated directly the frequency of the driving oscillator, the frequency of the unknown waves being derived from an inspection of the recorded pattern. The photographs were made with an f4.5 lens on portrait panchromatic film with about a one-

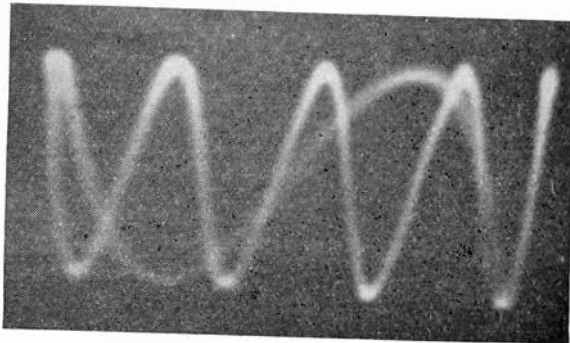

Fig. 3—6.0 megacycles per second.

second exposure. The pictures here shown are enlargements from the original negatives. The actual lengths of Figs. 3 and 4 were a little over one inch, with respective feed currents of 31.5 and 61.0 milliamperes.

With smaller feed currents and added capacitance the circuit may well be employed for waves of lower frequencies than those shown here. Higher frequencies might be attained with this circuit by using higher feed and discharge currents.

It can be noticed in all of these pictures that the peaks of the waves are tilted slightly in a clockwise direction about their centers. The difficulty may be the intercoupling within the cathode ray tube be-

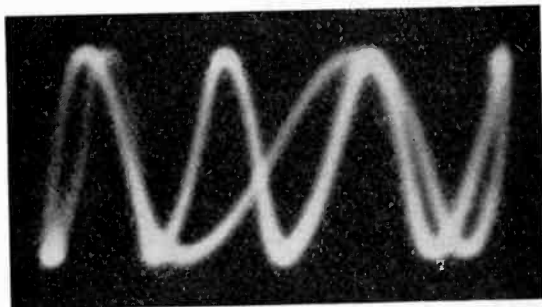

Fig. 4—12.0 megacycles per second.

tween the leads to the deflecting plates, since a type RCA-906 was used. Such coupling is to be expected at high frequencies and can be avoided only by use of a cathode ray tube with deflecting plate leads brought out through individual seals around the tube.

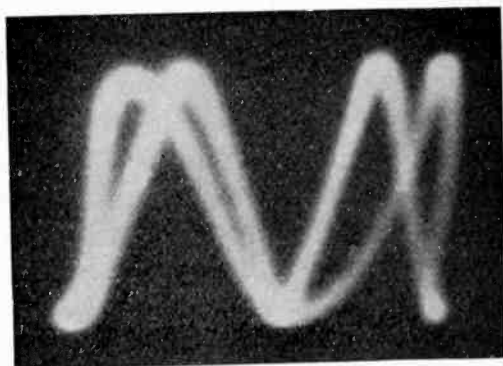

Fig. 5—12.6 megacycles per second.

ACKNOWLEDGMENT

While associated with the authors on sweep circuit work, Franklin Offner made the initial suggestion of using a high vacuum tube for discharging the sweep circuit condenser.



REPORT ON IONIZATION CHANGES DURING A SOLAR ECLIPSE*

BY

E. V. APPLETON

(King's College, London, England)

AND

S. CHAPMAN

(Imperial College of Science and Technology, London, England)

Summary—The effect of a solar eclipse upon air layers ionized by different solar agencies is described, and the observations of the actual eclipse changes in ionized layers are considered. The conclusion is reached that the normal ionizing agency for regions E and F_1 has a speed closely agreeing with that of light; hence it is natural to identify this agency with ultra-violet light (though observations of the kind here considered cannot rule out the possibility that the agency, for one or more of these layers, consists of very high speed corpuscles). Similarly there is fairly definite evidence that ultra-violet light contributes at least a part of the normal region F_2 ionization, and a suggestion that corpuscles may also contribute. In future eclipses it is very desirable that attention should be specially concentrated on this region F_2 .

THE ionization of the upper atmosphere has a pronounced daily variation, which indicates that the sun is a main factor in producing the ions. Since the ionization is greater by day than by night, the solar ionizing agent must travel to the earth along an approximately radial path; this is in strong contrast with the solar action that produces auroras and the abnormal ionization observed in high latitudes during periods of strong magnetic disturbance. It is commonly supposed that the latter group of phenomena are due to electric particles from the sun, which are much deflected in the earth's magnetic field, so that they impinge mainly in high latitudes, and over the dark as well as over the day hemisphere. The normal ionization, on the other hand, is to be attributed either to ultra-violet light, or to neutral corpuscles projected from the sun, since neither of these agents would be deflected by the earth's magnetic field, and so would impinge only on the day hemisphere.

It is possible to distinguish between these alternative sources of normal ionization by means of radio observations during a solar eclipse.¹ The test depends essentially on the difference between the

* Decimal classification: R113.61 × R113.55. Original manuscript received by the Institute, December 13, 1934.

¹ Attention was drawn to this possibility at a geophysical discussion at the Royal Astronomical Society on January 29, 1932, (cf. *The Observatory*, March, 1932), and in a letter to *Nature*, May 21, (1932).

speeds with which the two kinds of radiation travel towards the earth, and the ratio of these speeds to the moon's orbital motion. The shadow region extending from the moon on the side more distant from the sun is not radial from the sun; it lags behind this radial direction, by an angle whose circular measure is the ratio of the moon's speed to the speed of the radiation. This angle is negligible in the case of ultra-violet radiation, but is approximately one degree for neutral corpuscles having a speed of 1000 miles a second. The speed of the supposed corpuscles is unknown, but E. A. Milne² has shown that the sun is likely to be constantly emitting particles at about the speed named, and a similar speed has been inferred, for the *charged* particles supposed responsible for magnetic disturbances, from the time lag between these events and the central passage of sun spots apparently associated with them.

A consideration³ of the geometrical and time relations in the passage across the earth of the regions shaded by the moon from the sun's light and from the slower moving corpuscles shows that the corresponding eclipses will occur at different places and different times. They may, therefore, be distinguished by separate names; i.e., as the "light" or "optical" eclipse (the same for ultra-violet light as for the visible light by which the eclipse is ordinarily observed) and the "corpuscular" eclipse. It appears that, for the corpuscular speed mentioned, the corpuscular eclipse will precede the optical eclipse by about two hours in time and will occur much to the east of the track of optical totality, by a distance exceeding 1000 miles; the exact time and location must of course be calculated separately for each eclipse (assuming some definite speed for the particles). The suggested difference between the two types of eclipse is so great that radio measurements of the upper air ionization, made at suitably situated stations, should be able clearly to distinguish between them. If ultra-violet radiation is the main ionizing agent in a particular layer of the upper atmosphere, the electron density at a point in this layer above the track of optical totality should attain its minimum a few minutes after the central instant of optical totality; but if corpuscular ionization is the main cause, the minimum electron density should occur earlier, and to the east of the total shadow track.

Observations were, therefore, arranged by many radio research institutions to test these alternative possibilities at the eclipses of August 31, 1932, and August 21, 1933.

² Monthly Notices *R.A.S.*, vol. 86, pp. 459-578, (1926).

³ Monthly Notices *R.A.S.*, vol. 92, pp. 413-422, (1932).

Record of Results Obtained.

From what has been said above it is clearly advantageous to deal with the experimental results according to whether they are concerned with the optical eclipse or with the corpuscular eclipse.

Before proceeding to their summary and discussion, however, a word or two of explanation is necessary. It was discovered by radio methods in 1927 that the ionosphere may be divided into two main regions which were called region E (lower) and region F (upper). (The lower region is the well-known Kennelly-Heaviside layer.) The maxi-

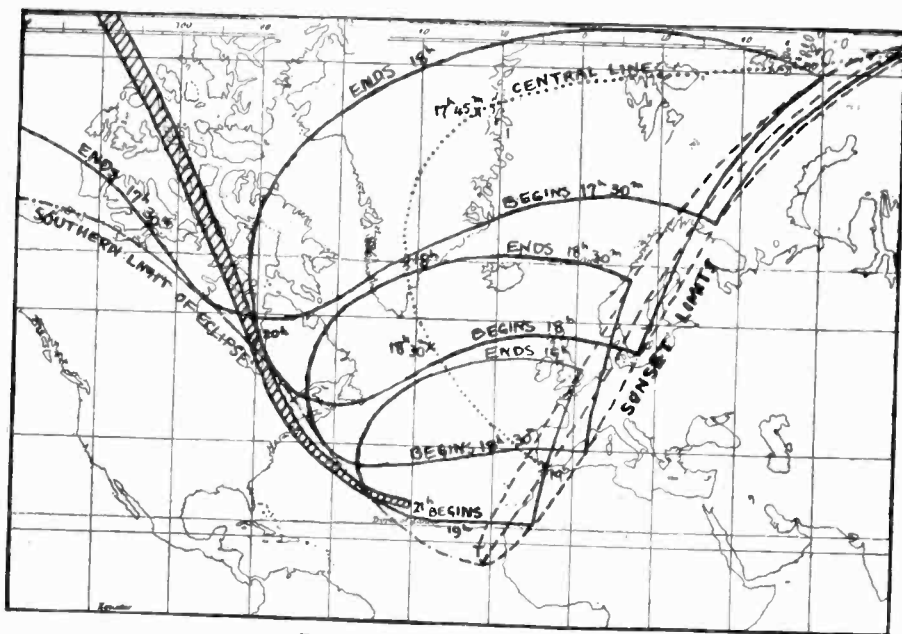

Published with the permission of the Royal Astronomical Society

Fig. 1—Eclipse of August 31, 1932. Track of optical totality (shaded) and of corpuscular eclipse.

mum ionization in each region undergoes a diurnal variation, being greater by day than by night. Later, evidence was put forward showing that, during the daytime only, there is regularly formed a kind of lower shelf on region F, while occasionally there is an intermediate maximum of ionization between region E and region F. (Intermediate region.) For purposes of distinction we have, therefore, at increasing heights in the atmosphere:

- (1) Region E (regularly occurring),
- (2) Intermediate region (occasionally occurring in the daytime),
- (3) Region F₁ (shelf-region, occurring only in the daytime),
- (4) Region F₂ (main F region, regularly occurring).

During the eclipse of 1927 in England, ionospheric observations were made on medium and long waves reflected from region E only, and such observations were confined to measurements of equivalent height and intensity of downcoming waves.

In the case of the eclipses of 1932 and 1933 it was possible to make observations of a more direct physical character using the critical frequency method of measuring maximum ionization content. This method, first described⁴ in 1931, had by 1932 been used for the study of the diurnal and seasonal variations of regions E and F and the details of its application had been sufficiently worked out to suggest that it would prove useful in the case of the special eclipse observations.

(A) ECLIPSE OF AUGUST 31, 1932, IN AMERICA

Optical Eclipse: Region E.

(1) *Observations made by J. T. Henderson at Vankleek Hill, Ontario, Canada. (Canadian Journal of Research, vol. 8, January, (1933).)*

Measurements of the maximum ionization content were made over the period 1400 to 2400 G.M.T. on August 31 and compared with the average results obtained during a similar period on a number of control days. The results obtained were quite decisive in indicating that the ionization in the path of the shadow decreased by at least fifty-eight per cent during optical totality.

(2) *Observations made by Kirby, Berkner, Gilliland, and Norton at Washington D.C., and at Sydney, Nova Scotia. (Bureau of Standards Journal of Research, December, (1933).)*

Measurements of the ionization content by Appleton's critical frequency method were made. It was found that at both sites the ionization decreased to about thirty per cent of its normal value, the variation taking place approximately in phase with the optical eclipse.

(3) *Observations at Deal, N. J. by J. P. Schafer and W. M. Goodall. (Science, November 11, (1932).)*

Equivalent height measurements on the frequencies of 2.4, 3.5, and 4.8 megacycles were made from which the observers deduce that the ionization in region E reached a minimum value at 3:45 p.m. (E.S.T.) (The optical eclipse was at its maximum at Deal at 3:34 p.m.)

⁴ E. V. Appleton, *Nature*, February 7, (1931); see also Appleton and Naimsmith, *Proc. Roy. Soc., A*, vol. 137, p. 36, (1932), for further details.

(4) *Field strength observations at British Post Office stations during the eclipse period.*

Observations were made on signals from Laurenceville (13.39 megacycles during 1700 to 2300 G.M.T. from August 29 to September 2 inclusive and on signals from Rocky Point (60 kilocycles) from August 20 to September 1 inclusive. Nothing abnormal was observed at either Dollis Hill or Baldock but Cupar in Scotland reported a marked decrease of field strength on August 31 between the times 2015 and 2018 G.M.T. (60 kilocycles). This is indicative of an ultra-violet light effect on region E because the effect was similar to a return to night-time conditions.

Optical Eclipse. Region F₁(1) *Observations made by Kirby, Berkner, Gilliland, and Norton at Washington, D.C., and Sydney, Nova Scotia.*

Deductions were made from continuous series of equivalent height measurements which indicate that the ionization decreased to about forty per cent of its normal value at about eclipse maximum.

(2) *Observations made by J. P. Schafer and W. M. Goodall at Deal, N. J.*

Deductions were made from a continuous series of equivalent height measurements that the ionization reached a minimum within three or four minutes after optical totality.

Optical Eclipse. Region F₂(1) *Observations made by D. C. Rose at Kingston, Canada. (Canadian Journal of Research, vol. 8, January, (1933).)*

The critical penetration frequency method of measuring maximum ionization was used. It was found that fifteen minutes before totality the penetration frequency dropped considerably, returning to its normal value about forty-five minutes after totality. A decrease in ionization of over thirty per cent was observed.

(2) *Fading and signal strength measurements made in Canada on commercial transmissions. (J. T. Henderson and D.C. Rose.)*

Observations were carried out at the Marconi transatlantic receiving station at Yamachiche, P.Q. The results may be summarized as follows:

- (a) Signals from WDD, Long Island,
7.5 megacycles: no abnormal effect.
- (b) Signals from VE9GW at Bowmanville, Ontario.
6.1 megacycles: abnormal fall of signal intensity between
2005 and 2030 G.M.T.

(3) *Observations made by Kirby, Berkner, Gilliland, and Norton at Washington, D.C.*

No abnormal variations of the critical frequency of F_2 region were observed. Since these observers consider that the critical frequency of this region is determined by absorption limitation and not by electron limitation they are of opinion that their results do not preclude the occurrence of a diminution of ionization during the optical eclipse.

(4) *Observations made by Kenrick and Pickard at Seabrook Beach, N. H.*
(Proc. I. R. E., vol. 21, pp. 546-567; April, (1933).)

The equivalent height of reflection on a number of frequencies was recorded. On the frequencies of 3.5 and 4.5 megacycles two height maxima, one before and one after totality, were observed. These maxima occur at approximately fifty per cent totality. No such effects were obtained on control days.

(5) *Observations made by J. P. Schafer and W. M. Goodall at Deal, N. J.*

A continuous series of equivalent height measurements disclosed no changes of ionization which can be identified as an eclipse effect. No importance is attached to the occurrence of a large increase of equivalent height thirty minutes after totality since somewhat disturbed magnetic conditions obtained and similar variations were observed at random times in the interval comprising two days before to two days after the eclipse.

Corpuscular Eclipse.

(1) *Special ionospheric measurements made in Canada and the U.S.A.*

No evidence of a corpuscular eclipse was obtained by the groups of workers (see above) at

- (a) Vankleek Hill, Ontario.
- (b) Kingston, Canada.
- (c) Washington, D.C.
- (d) Sydney, Nova Scotia.
- (e) Deal, N. J.

(2) *Observations made by E. F. W. Alexanderson at Conway, N. H.*

Signals from Schenectady on thirty-five meters, 200 miles away, were observed and found to disappear almost wholly during the two hours preceding the optical eclipse of the sun. On the other hand thirty-meter signals from Germany were at a maximum during the same period. This observer considers that the results constitute a complete proof of the theory of the electronic eclipse.

- (3) *Observations made by H. R. Mimno and P. H. Wang at Harvard University, Cambridge, Mass. (Proc. I. R. E., vol., 21, pp. 529-546; April, (1933).)*

Measurements of the equivalent height of reflection were made on a wavelength of eighty-three meters. The height record was found to exhibit two maxima, one forty minutes before totality and another forty minutes after totality. The authors say "This strongly suggests a corpuscular effect on the high layer although we are not yet willing to rule out other possibilities."

- (4) *Effect of solar eclipse on audio-frequency atmospherics, by E. T. Burton and E. M. Boardman. (Nature, January 21, (1935).)*

Although the chief effect noticed was correlated with the optical eclipse, evidence of a minor effect of corpuscular radiation was obtained.

- (5) *Observations by H. E. Paul in Germany.*

Wolf has reported a regular and distinct increase of ionization beginning at sunset and reaching a maximum between 2000 and 2200 (region F). On the day of the eclipse this evening effect set in one hour later than on the preceding days and disappeared about one hour earlier. It is, however, doubtful whether this effect can be attributed to the corpuscular eclipse since similar anomalies occurred on September 6 and 18.

- (6) *Observations made at King's College, London, by F. W. G. White.*

Continuous observations on echoes and determinations of equivalent heights were made on sixty-six meters. These were made in the evenings from about 1600 to 2230 B.S.T. on August 30 to September 2, inclusive.

On August 30 and on September 1 and 2 there was more intense region E ionization than on August 31. Another feature of the results was that the temporary increased group time separation between the two F components which occurred each evening at about 1820 was much more marked on August 31 than on the two succeeding days.

- (7) *Observations made at Slough Radio Research Station, England.*

Particular attention was paid to region E ionization and an abnormally low value was noted at 1830 G.M.T., a condition which did not show on the control days. The argument for the corpuscular effect is weakened by a subsequent increase of ionization between 1830 and 1900 which is paralleled by observations on the day preceding the eclipse.

(8) Observations made at Cambridge, England, by J. A. Ratcliffe.

The following observations were made:

- (a) Equivalent heights of reflection for 70-meter and 100-meter waves.
- (b) Intensity of downcoming waves of 100 meters and 356 meters.

No differences were observed between the eclipse day and the control days which could not be explained as due to the ordinary fluctuations normally observed. This applies to the height of region F meas-

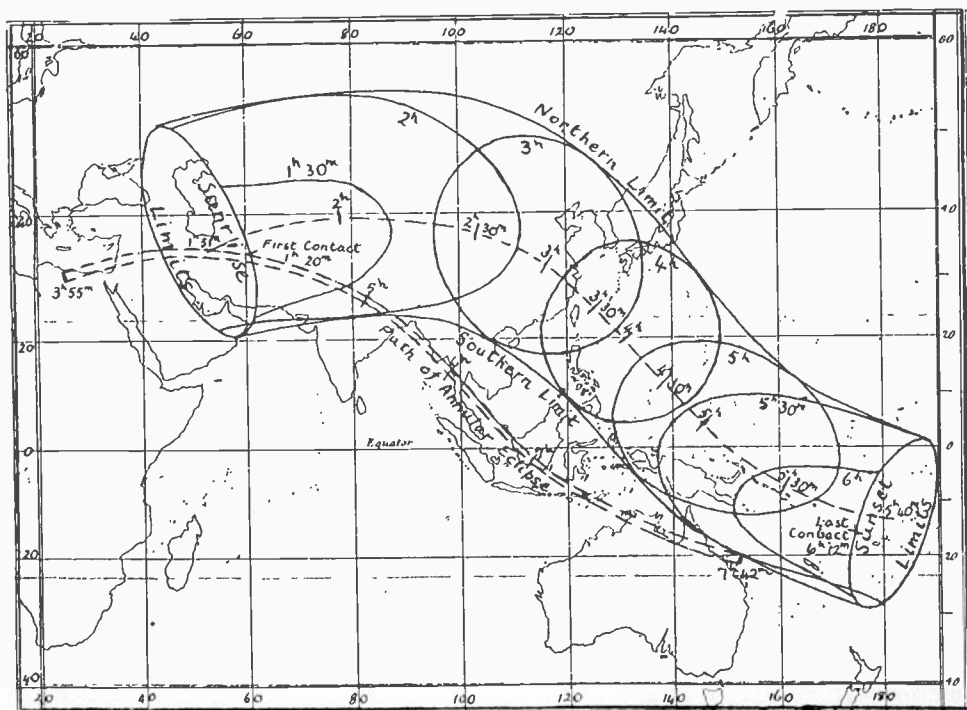

Fig. 2—Track of hypothetical corpuscular eclipse, August 21, 1933.

ured on 100 and 70 meters and to the intensity of the downcoming waves on 100 and 356 meters. It was, however, noticed that in the case of the equivalent height observations on 70 meters the ordinary ray component penetrated F region at 2130 on August 31 and at 2215 on both August 30 and September 1.

(9) Observations made in H. M. Signal School, Portsmouth, England, by C. E. Horton and J. F. Coales.

The apparatus was situated at Nutbourne (latitude $50^{\circ}51'N$, longitude $0^{\circ}52'W$) and observations were made of the apparent bearing of Daventry 5XX ($\lambda = 1500$ meters). During the day the bearing is sensibly constant but during conditions of "night effect" it changes

continuously. The apparatus was considered sufficiently sensitive to detect the presence of a reflected wave only 1/1000 of the intensity of the direct wave.

Measurements of the apparent bearing were made on August 30 and 31 and on September 1 from 1600 to 2100 B.S.T. These show that "night effect" set in two hours before sunset on all three days. No evidence of any change in the downcoming ray was noted on August 31 such as could be ascribed to the corpuscular eclipse.

Here it should be noted that the effects of an eclipse at 1930 and after would be masked by the normal operations of "night effect." On the other hand, a corpuscular eclipse giving rise to considerable changes of ionization would most probably have been detected at any time before 1815.

(10) *Observations on WQU (U.S.A.) received in London by G. C. Allen.*

August 31 is reported as being an abnormal day from transatlantic signals of 31.75 meters, signals being higher in intensity than on days preceding and succeeding. A marked increase of signal level was noticed from 1959 to 2005. (B.S.T.)

(11) *Observations made in Japan on signal strength of British and American stations.*

No effects attributable to an optical or corpuscular eclipse were observed.

(12) *Observations on atmospherics at Jablonna, Tromsø, and Bear Island. (J. Lugeon.)*

No effects attributable to the corpuscular eclipse were observed.

(B) ANNULAR ECLIPSE IN INDIA ON AUGUST 21, 1933

Observations made by S. K. Mitra and others in Calcutta. (Nature, September 16, (1933).)

Measurements were made by the critical frequency method for both E and F regions. It is concluded that "ultra-violet light is at least one of the agencies producing ionization of region E and that the corpuscular rays have little or no effect." The observations indicate a minimum in ionization of F region, a little over two hours before eclipse center, which was not paralleled on either of the control days August 20 and 22.

(C) ECLIPSE OF FEBRUARY 14, 1934 AT LOSAP ISLAND (SOUTH PACIFIC)

(1) *Observations made by K. Maeda. (Report of Radio Research in Japan, vol. 4, no. 2, p. 89, (1934).)*

It was found that the ultra-violet radiation from the sun is the prominent agent of atmospheric ionization and that the effect of neutral corpuscles is only slight, ending earlier on region F than on region E.

(2) *Observations made by T. Minohara and Y. Itô. (Report of Radio Research in Japan, vol. 4, no. 2, p. 51, (1934).)*

A marked decrease in ion density in region E was observed coinciding with the optical eclipse. The ion density of region F also diminished with the progress of the eclipse, there being a marked increase in the equivalent height about thirty minutes before and after totality.

As the frequency employed was not suitable for the purpose the effect of a corpuscular eclipse on region E could not be tested. Although the frequency used was suitable, no effect of a corpuscular eclipse on region F was observed.

Discussion of Results.

(a) *Eclipse of 1932*

The experimental evidence shows very definitely that ultra-violet light is to be regarded as the principal ionizing agency for region E, the minimum ionization values reached during optical totality being given by the Canadian and American observers as forty-two and thirty per cent, respectively. Chapman and Miller have determined theoretically the expected variation of ionization during the eclipse in Canada, assuming ultra-violet light as the sole ionizing agent and assuming the degree of recombination compatible with Appleton's daily variation curves for region E. The results agree closely with Henderson's eclipse graph of ionization and show that there is no need to attribute any part of the residual forty per cent electron content at totality to another ionizing source.

The eclipse observations also show that ultra-violet light is the principal ionizing agency for the shelf region (F_1) since the observations in Nova Scotia indicated a minimum value of forty per cent of normal coinciding approximately with optical totality. We may safely say that the calculations of Chapman and Miller apply here similarly and therefore conclude that there is no need to consider any ionizing agency other than ultra-violet light for region F_1 .

For region F_2 correspondingly definite conclusions cannot be drawn. During the three days before the eclipse a magnetic storm, which was known to be in progress, had very noticeable effects on the upper ionized region. Conditions were therefore not normal. Nevertheless it may be noted that the observations at Kingston have been inter-

preted as indicating a reduction of thirty per cent from normal ionization at totality while short-wave signals received at Bowmanville were found to be abnormally weak during the optical eclipse. The observations at Seabrook Beach also showed anomalous variations of equivalent height symmetrically situated with respect to the optical eclipse. On the other hand, the observations at Washington did not show any optical eclipse effect, though the observers are of opinion that, due to the unreliability of the measurement of F_2 region critical frequencies the results do not preclude its occurrence. The observations at Deal also showed no changes of ionization which could be identified as an eclipse effect. Taking the results as a whole, therefore, it appears as if we can conclude that ultra-violet light is responsible for at least a part of region F_2 ionization, but it is very desirable that the matter should be investigated, with perhaps improved technique, in future eclipses.

With regard to the effects of a corpuscular eclipse we need not consider any region other than F_2 . Here the evidence is a little conflicting. Fairly definite evidence of an effect is claimed by observers at Conway, New Hampshire, and Cambridge, Massachusetts; but other observers situated in various parts of the world obtained no effect. It seems clear that the matter must still be regarded as *sub judice* and further work on the subject is very desirable.

(b) *Eclipse of 1933*

In the case of the eclipse at Calcutta evidence for an ultra-violet light control of region E ionization was obtained. An anomalous effect which might have been corpuscular in origin was obtained for region F_2 .

(c) *Eclipse of 1934*

In the case of the eclipse at Losap Island conclusive evidence of an ultra-violet effect on both regions E and F was obtained. The conclusions drawn by different authors concerning the effects of a corpuscular eclipse are conflicting.

ADDENDUM

At meetings of the Plenary Congress of the International Union for Scientific Radiotelegraphy held in London in September, 1934, the above document was discussed, and the following resolutions on the propagation of waves adopted by the Commission:

- (1) That charts of the optical and corpuscular paths of future eclipse should be prepared in advance.

(2) That concentration in the future should be made on region F₂ while some attention should also be given to the intermediate region.

(3) That attempts be made to standardize the form in which results are submitted.

(4) That the proposed Permanent Committee on Ionospheric Observations should undertake the organization of special observations during eclipses, including the making of applications to administration for the financial grants necessary to carry out the work.

The personnel of the Permanent Committee on Ionospheric Observations, approved by the International Scientific Radio Union, is as follows:

Professor E. V. Appleton, Great Britain, President; Major R. Bureau, France; Dr. D. La Cour, Denmark; Dr. J. H. Dellinger, U.S.A.; Mr. R. Naismith, Great Britain; Dr. B. van der Pol, Holland; and Mr. R. A. Watson Watt, Great Britain.



DIURNAL AND SEASONAL VARIATIONS IN THE IONOSPHERE DURING THE YEARS 1933 AND 1934*

By

J. P. SCHAFER AND W. M. GOODALL

(Bell Telephone Laboratories, Inc., Deal, New Jersey)

Summary—The most important results of daily ionospheric measurements made at Deal, New Jersey, latitude $40^{\circ} 15' N.$, longitude $74^{\circ} 02' W.$, over the period from March, 1933, to May, 1934, are given in this paper and may be summarized as follows:

1. There was a definite correlation between the noon value of ionic density of the F_1 region and magnetic disturbances, a decrease in ionic density being obtained on magnetically disturbed days.

2. The noon value of ionic density of the E and F_1 region attained a maximum in summer and a minimum in winter whereas the reverse condition, of minimum in summer and maximum in winter, was found for the F_2 region.

3. The time of maximum ionic density of the F_2 region varied with the seasons of the year, occurring near noon in winter and near sunset in summer.

The paper also shows a series of virtual height contour maps for the four seasons of the year.

INTRODUCTION

IN previous publications giving the results of investigations of the ionosphere which we have made employing the radio pulse method,¹ attention has been directed to special experiments not involving routine measurements. There are important factors, however, such as seasonal and diurnal variations of ionization which can be discovered only by repeated observations extending over long periods of time. It is the purpose of this paper to report the results of such tests made during the years 1933 and 1934.

As a result of these tests we have obtained data which give us a better understanding as to the complex nature of the composition and behavior of the ionized regions as found at Deal, N. J., (latitude $40^{\circ}15' N.$, longitude $74^{\circ}02' W.$) Among the questions partially answered may be listed the following:

(1) How does the virtual height of the various regions vary with time of day, season of the year, and frequency?

(2) What are the diurnal and seasonal variations of ionization in these regions?

* Decimal classification: R113.61. Original manuscript received by the Institute, February 13, 1935. Presented before Ninth Annual Convention, Philadelphia, May 30, 1934.

¹ "Kennelly-Heaviside layer studies employing a rapid method of virtual-height determination," Proc. I.R.E., vol. 20, pp. 1131-1149; July, (1932). The method at present used is essentially the same as described in this article except that the transmitter and receiver are now located in the same room.

(3) What correlation, if any, exists between the ionization or ionization variations of these regions and magnetic disturbances?

EXPERIMENTAL RESULTS

During a large part of the time from March, 1933, to April, 1934, a virtual-height versus frequency curve was obtained near noon for

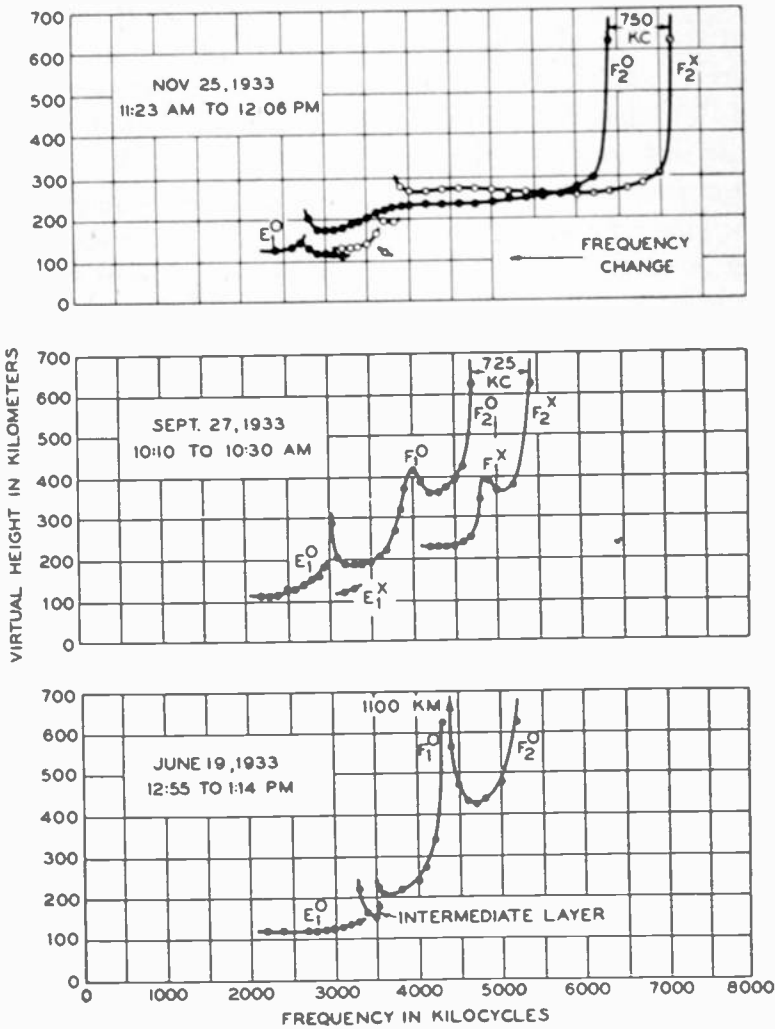

Fig. 1—Virtual height versus frequency.

practically every day of the year. This type of curve is illustrated in Fig. 1.

The three curves shown are typical examples of midday conditions for various seasons of the year; viz., summer, autumn, and winter. A number of features of these curves may be pointed out, some of which are common to all the curves and others peculiar to one curve only. In the first place it will be noted that all curves begin with virtual

heights of the order of 100 to 125 kilometers for the lower frequencies. This indicates that reflection is occurring from the E layer. As the frequency is increased a point is reached where there is a break in the curve and reflections then occur at some higher value of virtual height. The point at which this break occurs is termed the critical ionization frequency of the E layer. For the September and November curves the higher values of virtual height above the E layer represent reflections from the F_1 region at values near 200 kilometers. For the June curve there is apparently an intermediate reflecting region² between the E and F_1 regions from which reflections occur before a jump to the F_1 region is obtained. As the frequency is still further increased another discontinuity in the curve is observed at a frequency near 4000 kilocycles. This represents the frequency at which the wave penetrates the F_1 region and beyond which reflections occur from the F_2 region. This frequency is termed the F_1 critical frequency. This break or discontinuity is found in the daytime but not at night and is more pronounced in the summer than in winter. The latter fact may be noted on these three examples. As the frequency is still further increased a point is reached where another discontinuity is reached and beyond which no reflections are usually obtained. This is the critical ionization frequency of the F_2 layer. It will be noted that for the September and November curves there is almost an exact image of the first part of the curve displaced from it by approximately 750 kilocycles. This duplication is due to magnetic double refraction and represents the two components of the received wave which are circularly polarized in opposite directions.³ These two components have been termed the ordinary and extraordinary rays, and in our work we have termed them the "O" and "X" components, respectively. When the two components have widely separated virtual height values for a given frequency as in the curves of September 27, it is easy to follow them both with the ordinary receiver. When the two components are close together and the curves cross each other as in the curves of November 25, it is not so simple. We have constructed a "polarized" receiver⁴ employing two similar horizontal antennas at right angles to each other for the pur-

² This intermediate region is probably the M region whose presence we reported in *Nature*, June 3, (1933), but it is difficult to fix its location because the virtual height of this region gradually decreased through the day from values near 200 kilometers at 9 A.M. to heights near 125 kilometers at 5 P.M. See contour map of Fig. 7.

³ Appleton and Builder, *Proc. Phys. Soc.*, vol. 45, p. 208; March, (1933).

⁴ This polarized receiver is essentially the same as that of Ratcliffe and White, *Phil. Mag.*, ser. 7, vol. 16, p. 125; July, (1933), except that two horizontal-dipole antennas were used instead of loops and the method of combining the antenna outputs was somewhat different.

pose of separating the two components, and this was used in obtaining the November data.

The X component is usually much weaker than the O component and in the case of the curve of June 19 it could not be found even with the full gain of the receiver. This is frequently the case in summer.

As the values of critical frequencies give a measure of the maximum ionic density of the various layers a study of their variations with time is of considerable importance. Fig. 2 shows how the average critical

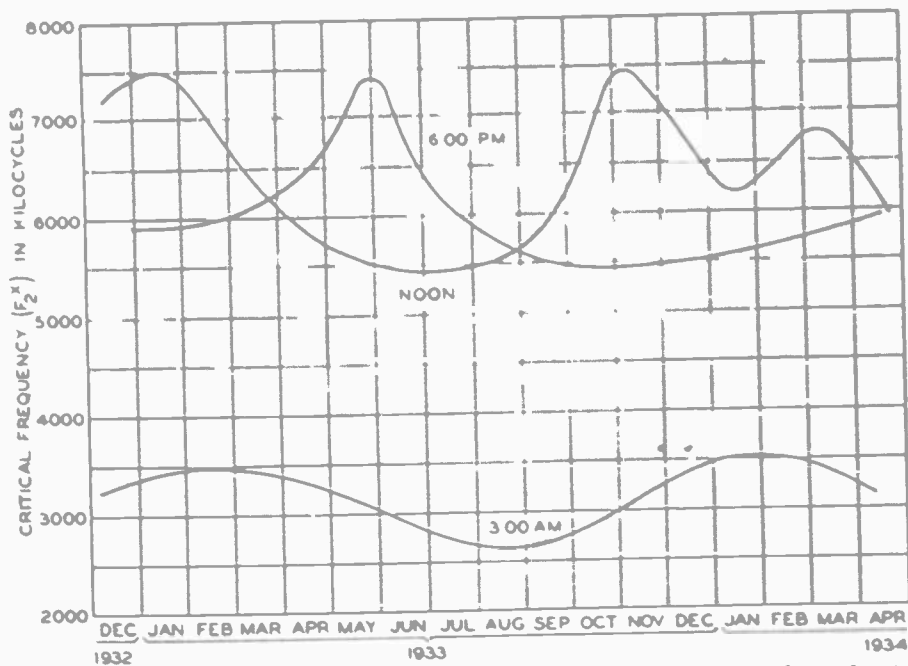

Fig. 2—Curves showing the seasonal variations of the *average* value of critical ionization frequency for the F_2 layer.

frequency value of the X component for the F_2 layer varies with the seasons of the year (1933–1934) at different times of the day, and suggests that the ionization in this layer varies in a different manner than would be expected on the basis of solar illumination. At noon the maximum occurred in winter rather than summer. At or near sunset the maximum occurred in summer⁵ and at 3 A.M. the maximum again occurred in winter. No entirely satisfactory explanation has been brought forth for these phenomena but it seems to us that no single agency or mechanism can be responsible for these effects.

⁵ Other investigators have pointed out this summer sunset phenomenon; see H. E. Paul, *Hochfrequenztechnik*, March, (1933), who speaks of the "evening concentration" in summer; and Kirby, Berkner, and Stuart, *Proc. I.R.E.*, vol. 22, pp. 481–522; April, (1934), who disclosed this phenomenon in 1932 but who have suggested that the summer sunset maximum of F_2 critical frequency may not indicate a maximum of ionic content but may be due to a change in absorption.

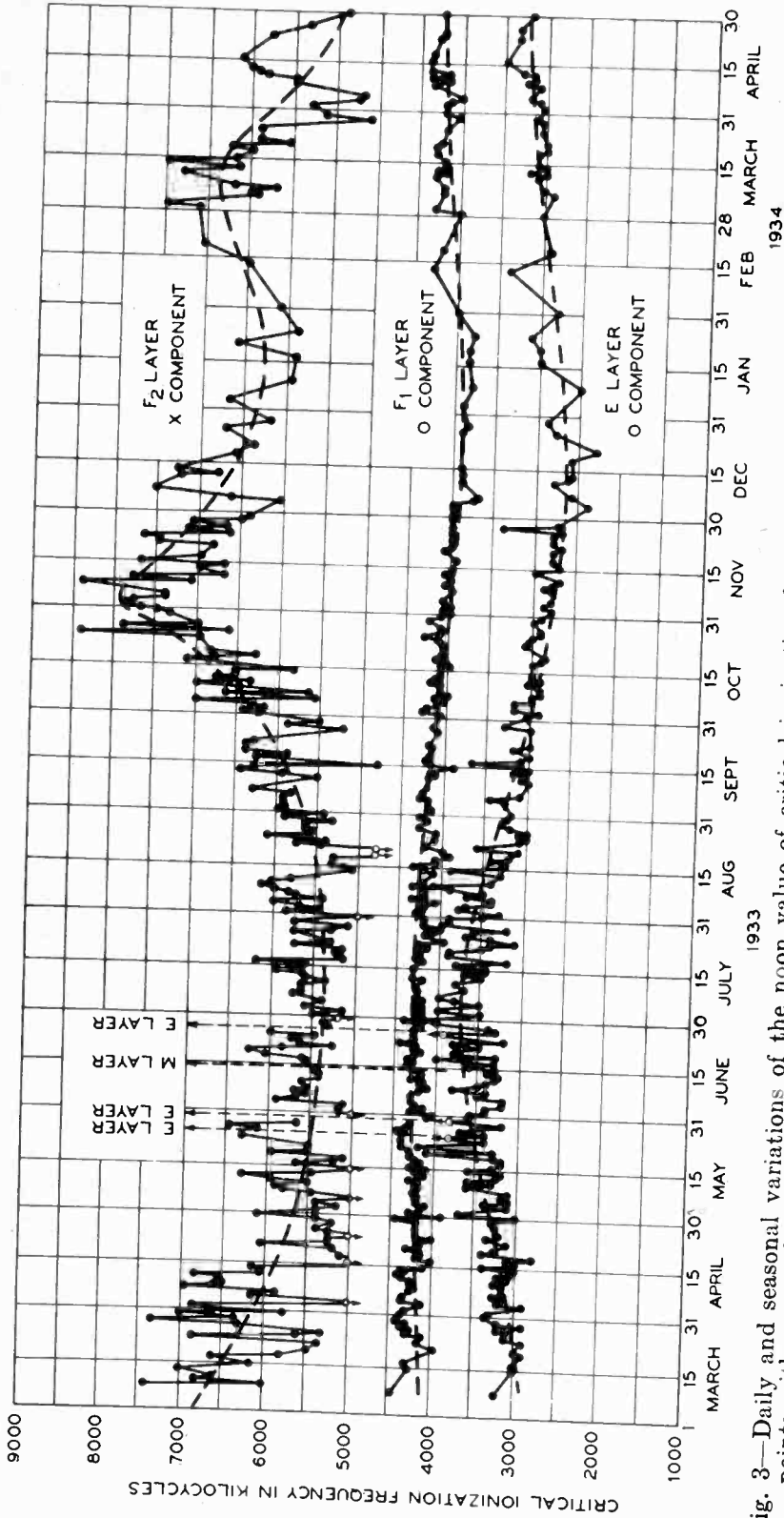

Fig. 3—Daily and seasonal variations of the noon value of critical ionization frequencies for the E, F₁, and F₂ layers. The open points with arrows shown for some days indicate that the actual value of critical frequency was not determined, but was either greater or less than the values marked.

Fig. 3 shows the manner in which the *noon* values of critical ionization frequency (f_c) for the E, F₁, and F₂ regions vary from day to day and with the seasons of the year. It must be remembered that some of the phenomena observed may be peculiar to the years 1933-1934 and that other years may disclose other seasonal variations. The lower curve represents the variation of the O component for the E layer and indicates that the ionization reaches a maximum in summer and minimum in winter. As the ionic density is proportional to f_c^2 for the O component the difference between maximum and minimum ionic density for the average curve is the ratio⁶ of $(3700/2650)^2$ or 1.95.

The second curve represents the variations in the O component for the F₁ layer and reaches a maximum and minimum in phase with that for the E region, with a ratio⁷ of summer-to-winter average of $(4300/3900)^2$ or 1.22.

The third curve represents the variations in the X component for the F₂ layer and as was said before reaches a maximum in winter and a minimum in summer. The O component of this layer varies in the same manner but at a frequency approximately 750 kilocycles lower. The X component was chosen as an illustration because it represents the highest frequency at which reflections are normally obtained, and also because the O component for this layer frequently has values of critical frequency very close to that for the F₁ layer, which would make the two curves difficult to follow. The curve of F₂ also illustrates the large day-to-day variations frequently found. It will be noted that there were two maxima⁸ in F₂ critical frequency, one near the beginning of November, 1933, and the other near the beginning of March, 1934.

These three curves seem also to confirm the belief which had already been strengthened by observations during the solar eclipse of 1932, that the principal ionizing agency of the E and F₁ regions is the ultra-violet light from the sun while they suggest that an important agency or mechanism causing the ionization in the F₂ layer is from some other more-or-less random source.

If a large number of virtual height versus frequency curves such

⁶ Values given by other observers are: 2.2 by E. V. Appleton, *Proc. Roy. Soc.*, A, vol. 141, (1933), and 1.3 by Kirby, Berkner and Stuart, *Proc. I.R.E.*, April, (1934).

⁷ A value of 1.4 is given by Kirby, Berkner, and Stuart., *Proc. I.R.E.*, April, (1934).

⁸ That these maxima were actually present in this year, although there are not enough data available to say whether they will be present every year, seems to be confirmed by the fact that similar curves for 1933-1934 recently shown by Kirby and Judson of the Bureau of Standards, also indicated the presence of these same two maxima. Both the Bureau of Standards paper and that of the writers were presented before the Ninth Annual Convention of the Institute, May 30, 1934.

as those shown in Fig. 1 are obtained on any one day it is possible to draw another type of curve which we have termed a virtual-height contour map. Figs. 4, 5, 6, 7, and 8 show contour maps⁹ for the four seasons of the year, numbers 4 and 8 being for the spring seasons of 1933 and 1934, respectively. These contour maps illustrate the diurnal variations which are found in the various layers of the ionosphere and require considerable study in order to digest their story thoroughly

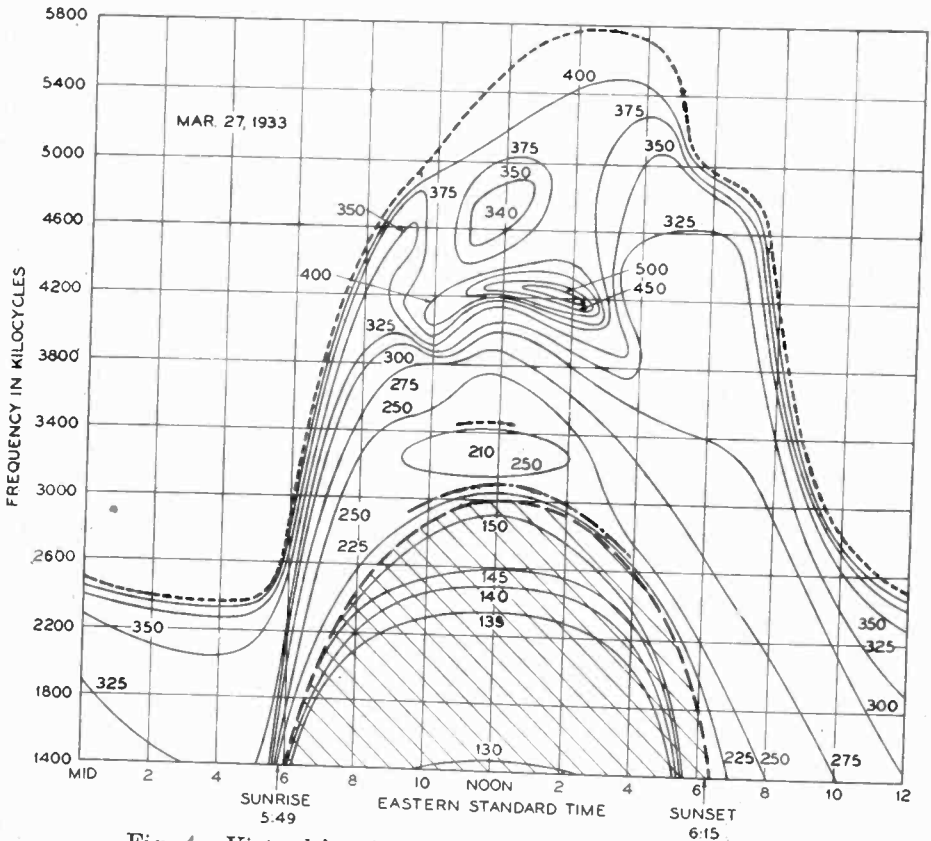

Fig. 4—Virtual height contour map for spring, 1933.

since each one represents hundreds of readings. The O component only is shown for the sake of simplicity.

Some of the principal points to be observed may be itemized as follows:

- (1) The dashed lines represent the critical frequency boundaries between layers;
- (2) An intermediate layer is formed at various times between the E and F region;

⁹ The contour map of Fig. 4 has already been published in *Nature*, September 30, (1933), where much of the material in this paper has already been summarized.

(3) There is a tendency for a third division in the lower part of the F region particularly on the map of September 27 (Fig. 6.);

(4) The critical frequency and therefore the ionic density of the E and F₁ regions is a maximum near noon for all seasons.

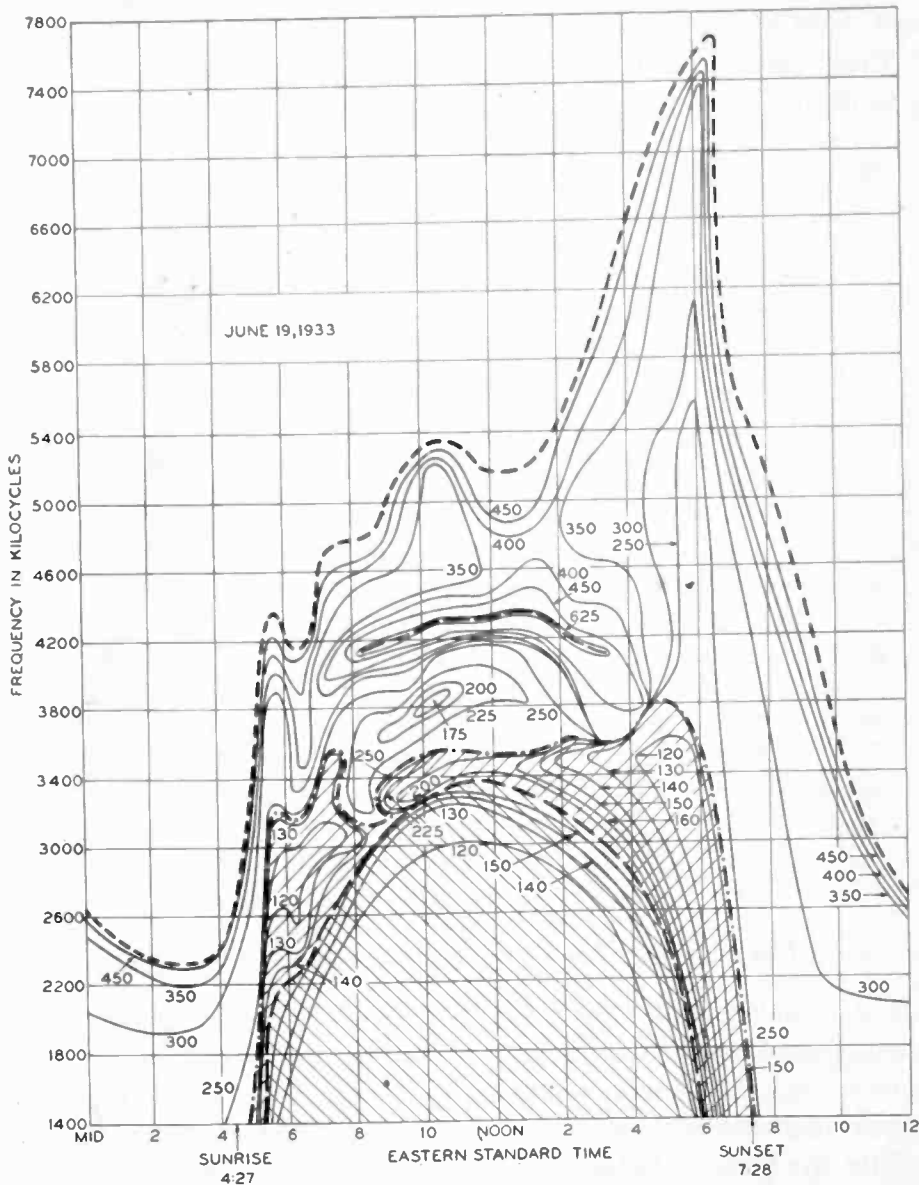

Fig. 5—Virtual height contour map for summer, 1933.

(5) There is an evening increase in F₂ critical frequency in the summer curve (Fig. 5).

(6) There is great similarity between the two spring maps which were obtained one year apart (Figs. 4 and 8).

(7) There is considerable similarity between the autumn and spring maps; which would logically be expected due to the similarity in solar conditions (Figs. 6 and 8).

(8) The summer map is much more complex than the winter map (Figs. 5 and 7), primarily due to the pronounced discontinuity between the F_1 and F_2 layers in the former.

From all the work which has been done by various experimenters in latitudes near that of Deal, Washington, and London no very

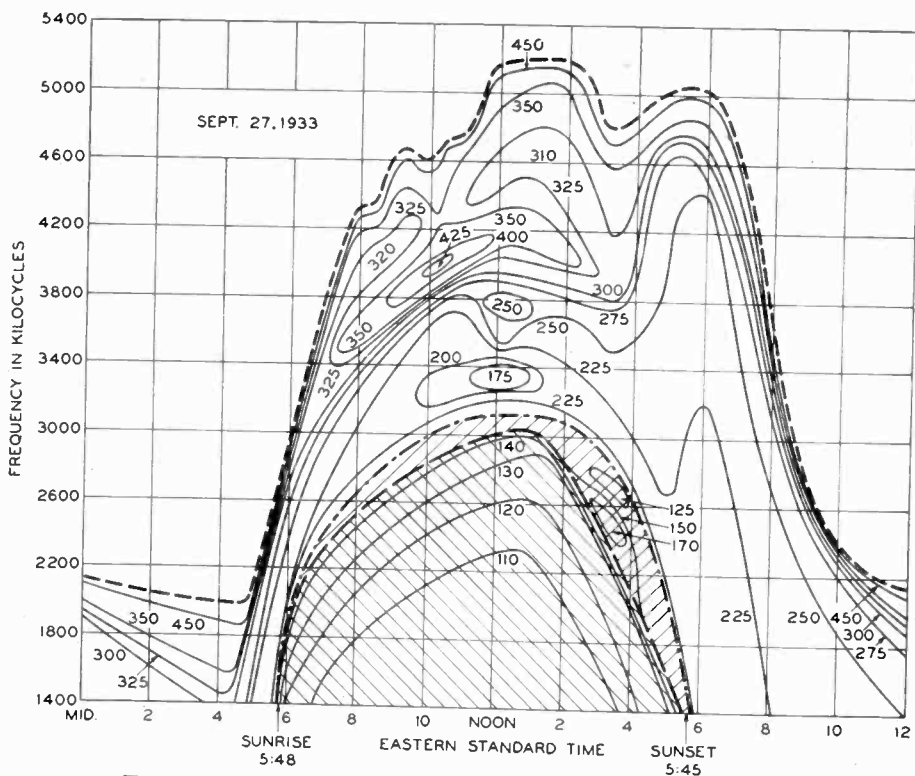

Fig. 6—Virtual height contour map for autumn, 1933.

marked correlation has been found between the virtual heights and ionization of the various layers, and magnetic disturbances. During severe storms the general tendency seems to be for an increase in absorption together with a scattering or splitting effect which manifests itself by the large number of reflections returned at slightly different virtual heights and which makes it difficult to distinguish one layer from another. During moderate storms it is usually difficult to tell whether a storm is in progress from qualitative observations of the reflections. If magnetic conditions have any characteristic effect on the ionization of the various layers, it would be expected that this fact would show up in the plot of the critical frequencies of Fig. 3 when com-

pared to a plot of magnetic conditions over the same period of time. Such a correlation has been sought but none was found in the critical frequency of the E layer and the F_2 layer.

For the F_1 layer, however, there seems to be a rather definite trend for a reduction in critical frequency, which would mean a reduction in maximum ionic density of this layer, on days of magnetic disturbances. Fig. 9 illustrates the type of correlation found. The daily

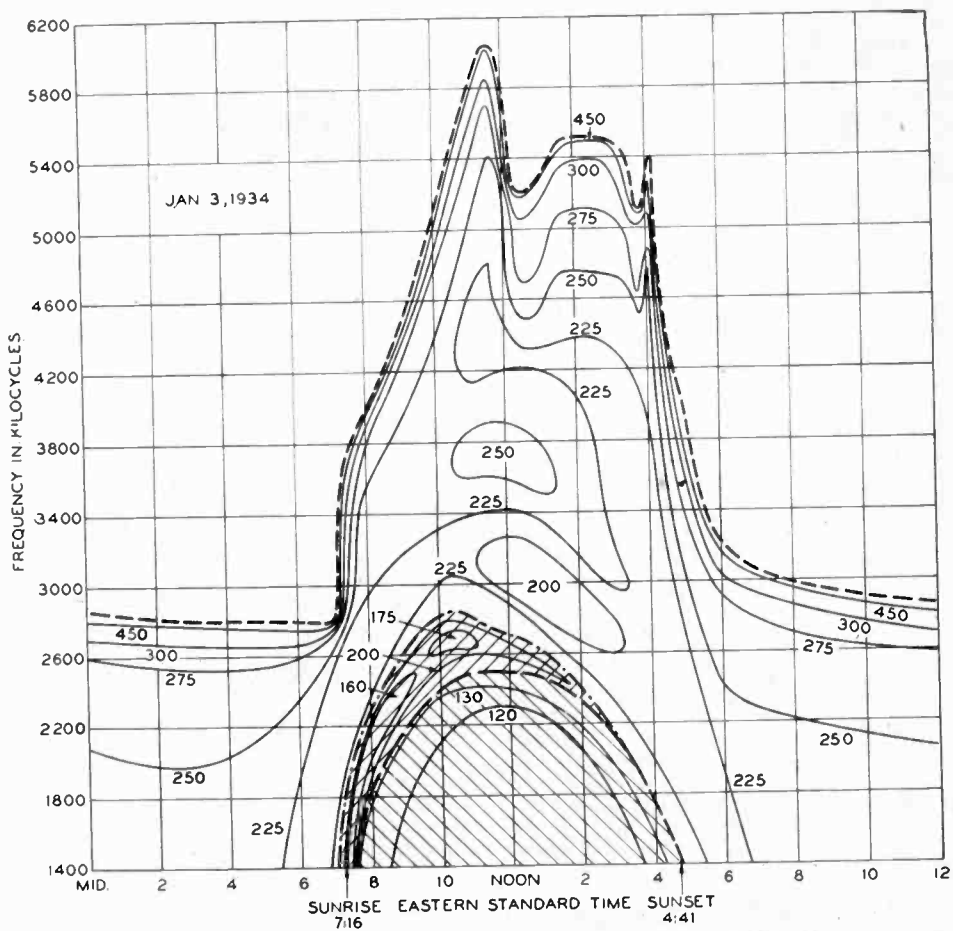

Fig. 7—Virtual height contour map for winter, 1933-1934.

noon value of F_1° has been plotted for a six-month period. Superimposed upon this curve is plotted the variation in earth potential as measured at Deal. It is known that variations in earth potentials are very closely related to magnetic variations, and as continuous records of earth potential variations are available at Deal, they were used for this purpose. The value of earth potentials used is the maximum variation for the particular day plotted, which has been found to be very closely related to the degree of magnetic disturbance. The two curves

follow each other very closely on the whole, and while not giving an exact correlation indicate that there is a definite reduction in F_1^o on magnetically disturbed days. At least there has been no occasion during the period of our measurements when the opposite effect has been found of an appreciable increase in ionic density of the F_1 layer on days of magnetic disturbances.

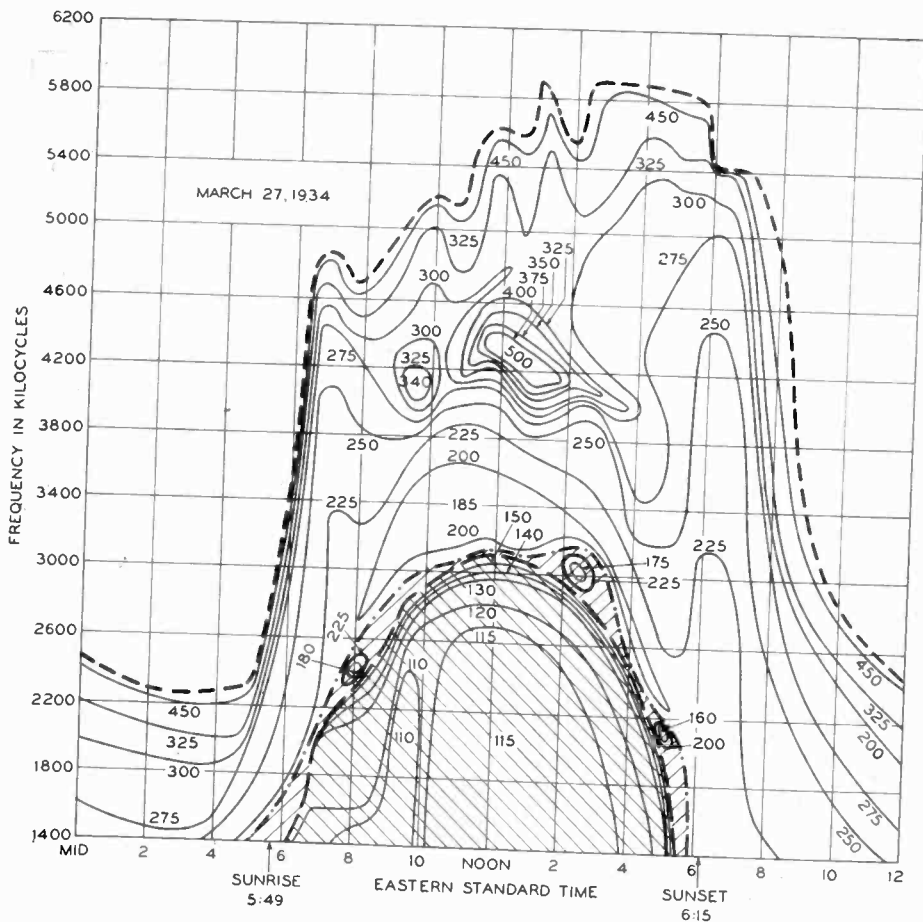

Fig. 8—Virtual height contour map for spring, 1934.

It would be interesting to speculate as to the significance of this fact. The F_1 layer has reduced ionic content during magnetic storms, and since this layer is believed to be mainly produced by ultra-violet light, the natural inference to draw is that the ultra-violet light is lessened at such times. This conclusion would be inconsistent with other observations, however, such as the failure to observe a similar correlation in the E layer, which also seems to be due to ultra-violet radiation, and the fact that the longer wave ultra-violet radiation, which is measured at low altitudes, is greater on the average during

times of maximum solar disturbance such as occurs in the eleven-year sun-spot cycle.

The reduction in ionic density of the F_1 layer during magnetic storms however, is only a relatively small amount of the total, never greater than 20 per cent, and it may be that these variations are due to changes in other solar emanations, which normally are a relatively minor factor in F_1 layer ionization, and not to a reduction in the principal ionizing agency which is believed to be ultra-violet light.

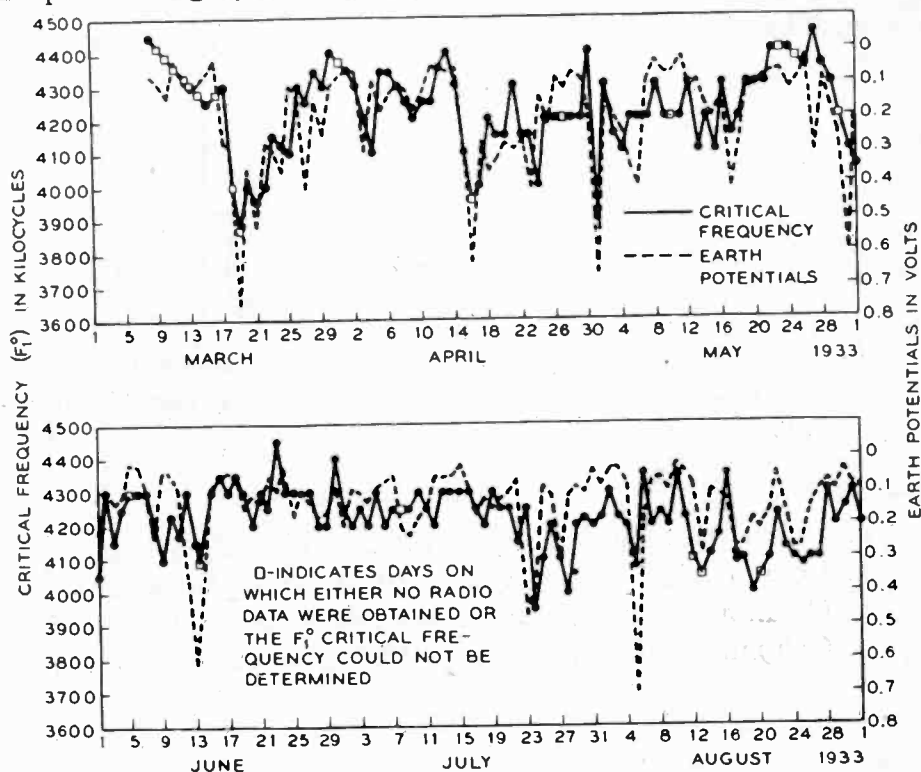

Fig. 9—Curves showing correlation between magnetic disturbances, as given by earth potential variations, and the ionization of the F_1 layer, as given by noon value of critical ionization frequency.

The reduced ionization at these times may also bear some relation to the observation that in transatlantic transmission with short waves, the most adverse effect is observed on the higher daylight frequencies. That is, if the normal band of frequencies lies between 18 and 12 megacycles, on magnetically disturbed days, the lower frequency is less affected than the higher. This might indicate that F_1 reflections play an important part in normal long-distance transmission and that on disturbed days ionization in the F_1 region is insufficient to deflect the higher frequencies. The whole process is very complicated, however, and any explanation, to be acceptable, must take account of many other aspects of transmission.

Correction

The following corrections have been received to the paper entitled "Designing Resistive Attenuating Networks," by P. K. McElroy, published in the March, 1935, issue of the PROCEEDINGS, pages 213-233, inclusive.

1. Page 226.

a. The two equations at the top of the page should read:

$$u = a \left[Z \left(\frac{k^2 + 1}{k^2 - 1} \right) - 2\bar{z} \left(\frac{k}{k^2 - 1} \right) \right]$$

$$v = a \left[z \left(\frac{k^2 + 1}{k^2 - 1} \right) - 2\bar{z} \left(\frac{k}{k^2 - 1} \right) \right]$$

b. Fourth line of the text is "the." Should be "that" so it will read: "Note that $\bar{z}[k/(k^2-1)]$ occurs in all three individual expressions" etc.

2. Table IX (Insert).

- a. Column 11, line 3. For figure 33.933 read 43.933.
- b. Column 11, line 4. For figure 19.455 read 29.455.
- c. Column 12, line 3. For figure 32.933 read 42.933.
- d. Column 12, line 4. For figure 18.455 read 28.455.



CONTRIBUTORS TO THIS ISSUE

Appleton, E. V.: Born 1892 at Bradford, Yorkshire, England. Graduated, St. John's College, Cambridge, 1914. University demonstrator in physics, Cavendish Laboratories, 1919-1924; Wheatstone professor of physics, University of London, 1924 to date. Received Morris Liebmann Memorial Prize, Institute of Radio Engineers, 1929. Vice president, Institute of Radio Engineers, 1932. Corresponding member, Prussian Academy of Science, 1934. President, International Scientific Radio Union, 1934. Fellow, Royal Society. Associate member, Institute of Radio Engineers, 1926; Fellow, 1931.

Ballantine, Stuart: Born September, 1897, at Germantown, Pennsylvania. Operator, Marconi Company, summers, 1913, 1914, and 1915; H. K. Mulford Company, bacteriologists, 1916; Bell Telephone Company of Pennsylvania, 1917; Expert Radio Aide, U. S. Navy, in charge of radio direction finder apparatus, 1917-1920. Studied mathematics at Drexel Institute, 1919; mathematical physics, graduate school, Harvard University, 1920-1921. With L. M. Hull organized technical work at Radio Frequency Laboratories, Inc., 1922-1923. John Tyndall Scholar in mathematical physics, Harvard University, 1923-1924. Privately engaged in scientific research, White Haven, Pennsylvania, 1924-1927. In charge of research division, Radio Frequency Laboratories, 1927-1929; president, Boonton Research Corporation, 1929-1935; president, Ballantine Laboratories, 1935. Received Morris Liebmann Memorial Prize, Institute of Radio Engineers, 1931; Elliott Cresson Medal, Franklin Institute, 1934. President, Institute of Radio Engineers, 1935. Fellow, American Physical Society and Acoustical Society of America; Member, Franklin Institute. Associate member, Institute of Radio Engineers, 1916; Fellow, 1928.

Case, Nelson P.: Born July 17, 1904, at Canon City, Colorado. Received B. A. degree in physics, Stanford University, 1924; E.E. degree, 1926. Geophysical research, 1926-1928; assistant physicist, Bureau of Standards, 1928-1929; research physicist, department of engineering research, University of Michigan, 1929-1931; engineer, Hazeltine Corporation, 1931 to date. Member, Phi Beta Kappa and Sigma Xi. Associate member, Institute of Radio Engineers, 1926; Member, 1931.

Chapman, Sydney: Born January 29, 1888, at Manchester, England. Received D.Sc. degree, Manchester; M.A. degree, Cambridge. Chief assistant, Royal Observatory, Greenwich, 1910-1914. Fellow and lecturer at Trinity College, Cambridge, 1913-1919; professor of mathematics, Manchester University, 1919-1924; Imperial College of Science and Technology, London, 1924 to date. Fellow, Royal Society; Royal Medallist, 1934. President, London Mathematical Society, 1929-1931; president, Royal Meteorological Society, 1932-1934; chairman, British National Committee for Geodesy and Geophysics, 1934. Non-member, Institute of Radio Engineers.

Goldsmith, Thomas T., Jr.: Born January 9, 1910 at Greenville, South Carolina. Received B.S. degree in physics and mathematics, Furman University, 1931; graduate student, Cornell University, 1931 to date. Chemistry assistant,

Furman University, 1929-1930; physics assistant, 1930-1931; physics assistant, Cornell University, 1935. Nonmember, Institute of Radio Engineers.

Goodall, W. M.: Born September 7, 1907, at Washington, D. C. Received B.S. degree, California Institute of Technology, 1928. Technical staff, Bell Telephone Laboratories, 1928 to date. Associate member, Institute of Radio Engineers, 1929.

Harnett, Daniel E.: Born July 20, 1899, at Elmira, New York. Received B.A. degree, Columbia University, 1922; E.E. degree, 1925. Engineer, Pacent Electric Company, 1925-1927; superintendent, W. J. Murdock Company, 1927-1928; engineer, Acoustic Products Corporation, 1928; engineer, Hazeltine Corporation, 1929 to date. Associate member, Institute of Radio Engineers, 1925.

Johnson, J. Kelly: Born January 27, 1903, at Oskaloosa, Iowa. Received B.A. and B.S. degrees, Penn College, 1923; B.A. degree, Columbia University, 1924; B.S. degree, 1925; E.E. degree, 1927. Instructor in electrical engineering department, Columbia University, 1928-1929. Engineer, Silver-Marshall, 1929; engineer, Hazeltine Corporation, 1930-1934; chief engineer, Wells-Gardner and Company, 1934 to date. Member, Sigma Xi, Tau Beta Pi, and Epsilon Chi. Associate member, Institute of Radio Engineers, 1926; Member, 1935.

Richards, L. A.: Born April 24, 1904, at Fielding, Utah. Received B.S. degree, Utah State Agricultural College, 1926; M.S. degree, 1927. Physics laboratory instructor, Utah State Agricultural College, 1924-1925; research assistant, 1925-1927. Received Ph.D. degree in physics, Cornell University, 1931. Graduate assistant in physics, Cornell University, 1927-1929; instructor, 1929-1935. Research physicist, Battelle Memorial Institute, 1935. Member, Phi Beta Kappa, Sigma Xi, and American Physical Society. Nonmember, Institute of Radio Engineers.

Schafer, J. Peter: Born October 29, 1897, at Brooklyn, New York. Received B.S. degree in electrical engineering, Cooper Union, 1921; E.E. degree, 1925. Member, technical staff, research department, Western Electric Company and Bell Telephone Laboratories, 1915 to date; New York City Laboratories, 1915-1922; Rocky Point Transatlantic Radiotelephone Station, 1922-1928; Deal, New Jersey, Radio Laboratories, 1928 to date. Associate member, Institute of Radio Engineers, 1924; Member, 1930.

Wheeler, Harold Alden: Born May 10, 1903, at Saint Paul, Minnesota. Received B.S. degree in physics, George Washington University, 1925. Post-graduate studies, physics department, Johns Hopkins University, 1925-1928; lecturer, 1926-1927. Assistant, Radio Section, Bureau of Standards, 1921-1922; assistant to Professor Hazeltine, 1923; engineer, Hazeltine Corporation, 1924 to date. Member, Sigma Xi. Associate member, Institute of Radio Engineers, 1927; Member, 1928.

Whitman, Vernon E.: Born April 30, 1900, at Washington D.C. Received B.Sc. degree in electrical engineering, Massachusetts Institute of Technology, 1922; M.Sc. degree in physics, 1924; M.A. degree in physics, Johns Hopkins University, 1926; Ph.D. degree in physics, 1928. Physicist, Bureau of Standards, 1923-1929; engineer, Hazeltine Corporation, 1929 to date. Associate member, Institute of Radio Engineers, 1931.



OLD - FASH I O N E D S I M P L I C I T Y



TELEPHONE SERVICE in this country is modern. It leads the world. Yet there is an old-fashioned simplicity about the Bell System. This applies to capital structure and financial methods as well as to the nationwide plan of decentralized operation under centralized control.

The American Telephone and Telegraph Company has only one class of stock and that stock is not watered.

It has 675,000 stockholders living in every corner of the land. Their average holding is twenty-eight shares. No individual or organization

owns as much as one per cent of the stock. There are no secret reserves or hidden assets.

This structure is not of recent origin, but dates back many years to the early days of the telephone. It has lived on because it is right and in the best interest of the public. It has been fundamental in making the Bell System a distinctive American business.

Research for the Bell System is carried on by Bell Laboratories. Manufacturing, purchasing, distributing by Western Electric. Both help in giving the country good, economical telephone service.

BELL TELEPHONE SYSTEM



When writing to advertisers mention of the PROCEEDINGS will be mutually helpful.

MEMBERS OF THE I.R.E.

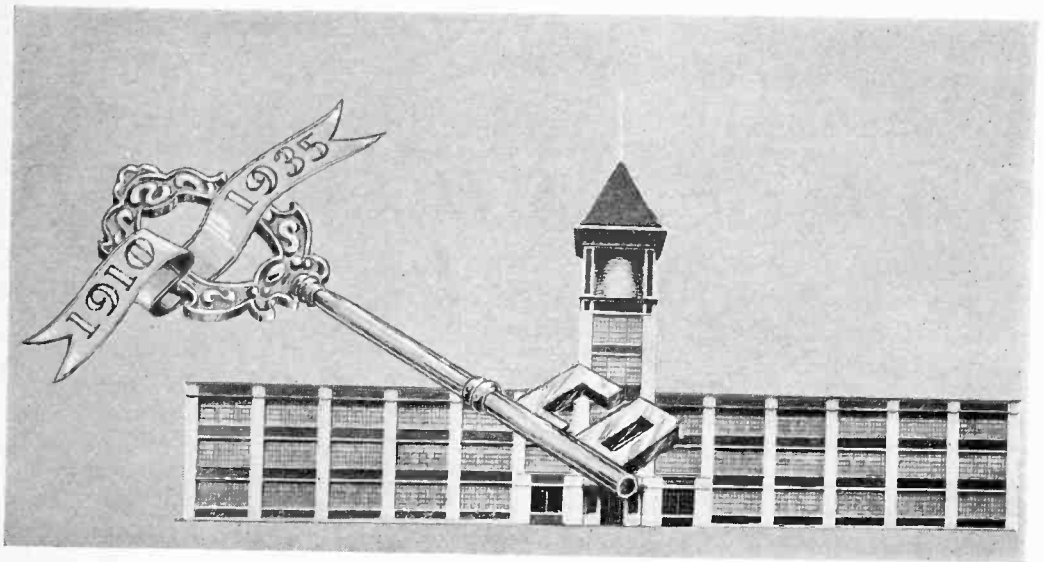

ACCEPT THIS KEY

EVERY so often a distinguished person gets a key to the city bestowed upon him . . . ticker tape fills the air and trumpets blare at the head of marching columns. To the members of the I.R.E., now assembled in convention, no clarion paean of victory sounds from the modest precincts of our plant . . . yet we offer you humbly and unostentatiously the key to our vaults of experience and knowledge.

WHAT we have, we offer, simply, quietly. A record of experience in this industry that goes back twenty-five

years. Two and a half decades of engineering development that have effected the evolution of a line of quality products. A tradition of service which has made the name Cornell-Dubilier a guarantee in every branch of the radio and electrical industries.

THIS is our welcome to the members of the I.R.E., in convention. "The doors to our wealth of experience, specialized knowledge and achievement are open to you." Engineers of the I.R.E. . . .

Accept This Key.

We offer it to you in simple honor.

**OVER
ONE BILLION
CONDENSERS SOLD
SINCE 1910**

CORNELL-DUBILIER
CORPORATION

4379 BRONX BOULEVARD • NEW YORK

When writing to advertisers mention of the PROCEEDINGS will be mutually helpful.

Stackpole Presents a new Midget Control for Auto Radios

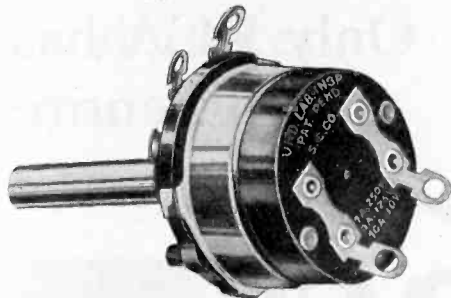

New Midget Control with
line switch

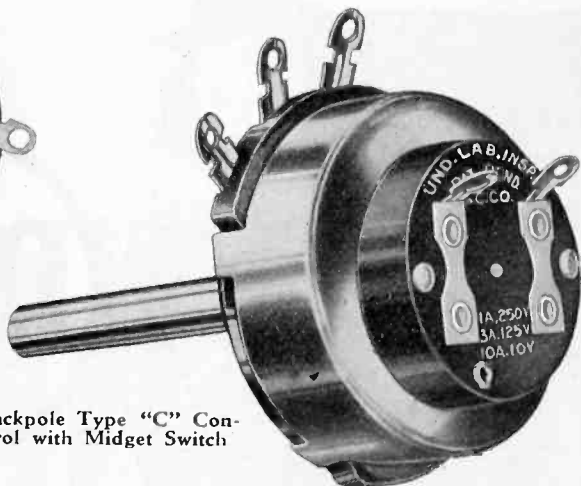

Stackpole Type "C" Con-
trol with Midget Switch

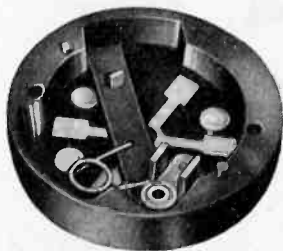

Interior Midget switch
(open)

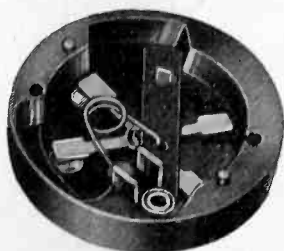

Interior Midget switch
(closed)

On behalf of modern design and engineering, you've repeatedly asked for a miniature control, with a dependable line switch, replete in all known advantages of larger size controls. You asked for it—our engineers went to work—and now after months of experimental work, we have it! A MIDGET CONTROL by STACKPOLE—100% accurate—not a single outstanding point of our larger controls is sacrificed.

The NEW MIDGET CONTROL is a "Natural" for the makers of the new Auto Radios where, at best, space is at a minimum. It's a "find" for the makers of modern household receivers—the line switch carries the APPROVAL of the UNDERWRITERS LABORATORIES.

Each terminal of the switch has two contacts—insuring POSITIVE CONTROL and LOWEST possible CONTACT DROP. MIDGET CONTROLS are available in Types "MB" and "MP." In applications where space is at a premium and our type "C" control is essential—the MIDGET SWITCH is recommended in place of our S-1 Type switch.

Write for detailed data on complete STACKPOLE line.

STACKPOLE CARBON COMPANY

St. Mary's, Pa.

U.S.A.

When writing to advertisers mention of the PROCEEDINGS will be mutually helpful.

A COMPLETELY COORDINATED

**FROM THE MICROPHONE
LOUDSPEAKER**

Only RCA has
this entire



RCA Monitor Unit

RCA Speech
Input Panel

RCA MANUFACTURING

When writing to advertisers mention of the PROCEEDINGS will be mutually helpful.

BROADCASTING SYSTEM

IN THE STUDIO TO THE
IN THE HOME

undertaken
responsibility



RCA High Fidelity
Transmitter, Type 5-C

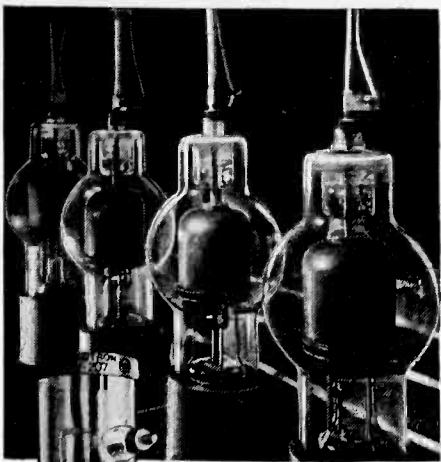

RCA Rectifier Tubes



RCA Power Radiotrons

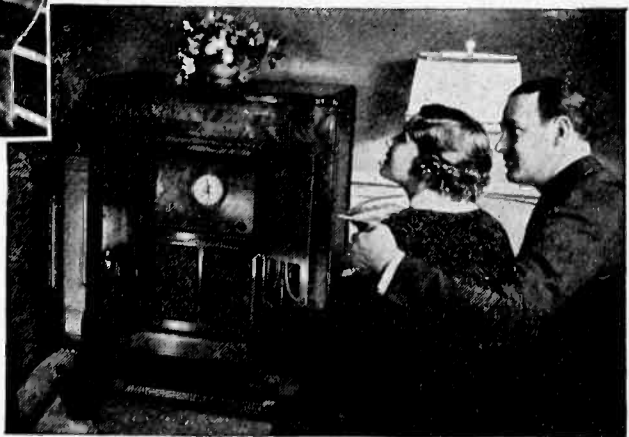

RCA Receivers for Home, Auto,
Boat, Train, 'Plane—Everywhere

CO., INC., CAMDEN, N. J.

When writing to advertisers mention of the PROCEEDINGS will be mutually helpful.

WESTON
dependability
in Modern Settings



The present trend toward rectangular instruments emphasizes Weston's leadership to a marked degree. Rectangulars were introduced by Weston over 10 years ago . . . and are today available in all standard sizes including the 3" line.

Whether rectangulars are to be used because of their greater utility, or for purposes of design . . . or whether the need is for round or fan-shaped instruments . . . each requirement can be filled from the complete Weston line. *Weston dependability is available in any shape or form . . .* Weston Electrical Instrument Corp., 589 Frelinghuysen Avenue, Newark, N. J.

WESTON
Instruments



When writing to advertisers mention of the PROCEEDINGS will be mutually helpful.

The Institute of Radio Engineers

Incorporated

330 West 42nd Street, New York, N.Y.

APPLICATION FOR ASSOCIATE MEMBERSHIP

(Application forms for other grades of membership are obtainable from the Institute)

To the Board of Directors
Gentlemen:

I hereby make application for Associate membership in the Institute of Radio Engineers on the basis of my training and professional experience given herewith, and refer to the members named below who are personally familiar with my work.

I certify that the statements made in the record of my training and professional experience are correct, and agree if elected, that I will be governed by the constitution of the Institute as long as I continue a member. Furthermore I agree to promote the objects of the Institute so far as shall be in my power, and if my membership shall be discontinued will return my membership badge.

.....
(Sign with pen)

.....
(Address for mail)

.....
(Date)

.....
(City and State)

Sponsors:

(Signature of references not required here)

Mr. Mr.

Address Address

City and State City and State

Mr.

Address

City and State

The following extracts from the Constitution govern applications for admission to the Institute in the Associate grade:

ARTICLE II—MEMBERSHIP

Sec. 1: The membership of the Institute shall consist of: * * * (c) Associates, who shall be entitled to all the rights and privileges of the Institute except the right to hold any elective office specified in Article V. * * *

Sec. 4. An Associate shall be not less than twenty-one years of age and shall be a person who is interested in and connected with the study or application of radio science or the radio arts.

ARTICLE III—ADMISSION AND EXPULSIONS

Sec. 2: * * * Applicants shall give references to members of the Institute as follows: * * * for the grade of Associate, to three Fellows, Members, or Associates; * * * Each application for admission * * * shall embody a full record of the general technical education of the applicant and of his professional career.

ARTICLE IV—ENTRANCE FEE AND DUES

Sec. 1: * * * Entrance fee for the Associate grade of membership is \$3.00 and annual dues are \$6.00.

ENTRANCE FEE SHOULD ACCOMPANY APPLICATION

(Typewriting preferred in filling in this form) No.....

RECORD OF TRAINING AND PROFESSIONAL EXPERIENCE

Name
(Give full name, last name first)

Present Occupation
(Title and name of concern)

Business Address

Permanent Home Address

Place of Birth..... Date of Birth..... Age.....

Education

Degree
(college) (Date received)

TRAINING AND PROFESSIONAL EXPERIENCE

DATES

DATES	

Record may be continued on other sheets of this size if space is insufficient.

Receipt Acknowledged..... Elected..... Deferred.....
Grade Advised of Election..... This Record Filed.....

Mica

CONDENSERS

... *AEROVOX Engineered*

TINY units . . . low in price . . . made by the millions. Yet mica condensers are an important feature of *the complete* AEROVOX line of condensers and resistors. Indeed, our plant has its own mica department, bakelite molding equipment and mica engineering staff.

Thus AEROVOX mica condensers are fully on a par with all other AEROVOX products—likewise thoroughly engineered for satisfactory performance, likewise mass produced for lowest prices consistent with lasting quality. And the AEROVOX line includes the largest assortment of standard bakelite molded and metal cased units—twelve types to choose from.

So simply specify AEROVOX mica condensers. That implies: Selected India ruby mica micrometrically calipered for uniform thickness and accurate capacity values. Best grade tinfoil. Sections thoroughly dehydrated and impregnated prior to molding in genuine Bakelite. Positive sealing and protection against temperature, moisture, chemical action and mechanical damage.

Send for DATA: New 1935 catalog covers *the complete* line of AEROVOX condensers and resistors. Also sample copy of monthly *Research Worker*. And do not hesitate to place your condensers and resistor problems before our engineers.

AEROVOX

C O R P O R A T I O N

71 Washington St.

Brooklyn, N.Y.

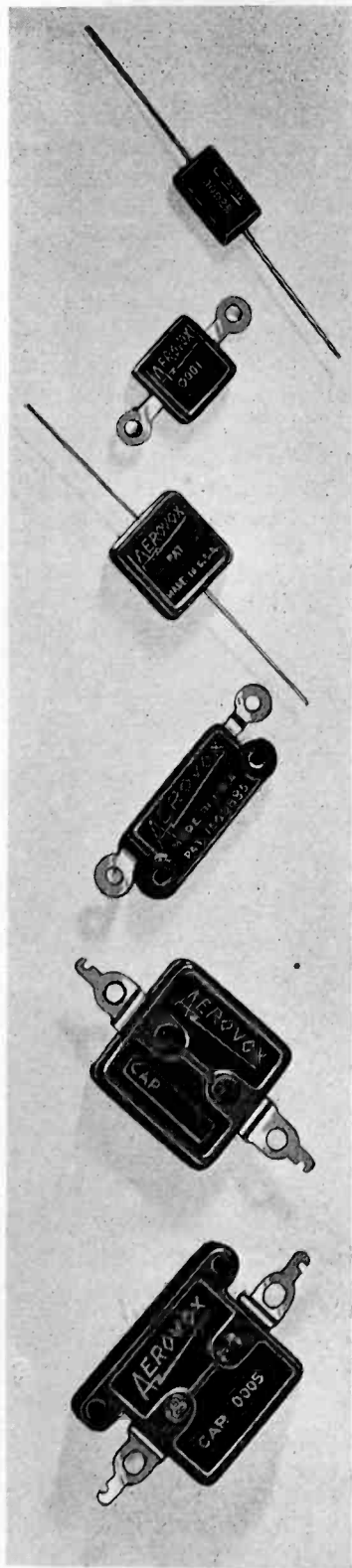

When writing to advertisers mention of the PROCEEDINGS will be mutually helpful.

When you come to Detroit...

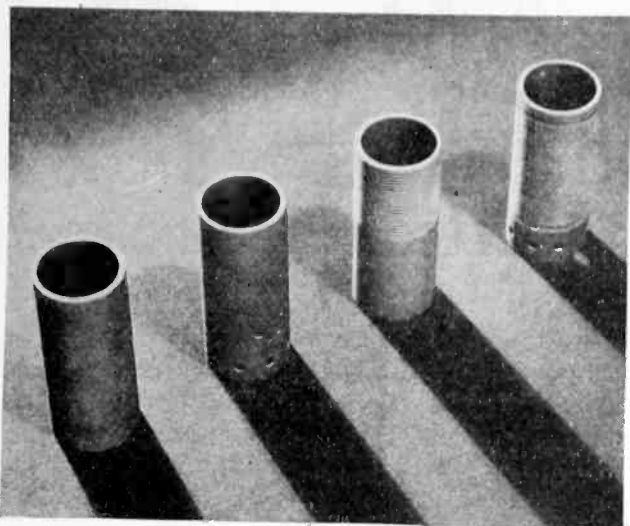

You will find a warm welcome at the Synthane Show. While you are there make a point of looking over Grade XX Radio-form tubing. Absolute uniformity, low power factor at radio frequencies and extremely low moisture absorption are three advantages you will appreciate, particularly for short-wave coil forms where selectivity and sensitivity of tuned radio circuits are of first importance.

Examine SYNTHANE radio panels and fabricated parts as well... in Grade XX for high surface and volume resistivity, high dielectric strength and low power factor—Grade XP for difficult punching operations. Notice the clean cut holes and edges and the complete freedom from cracking or delamination... You will also be interested in the SYNTHOGRAPHIC PROCESS, our new low cost method for marking radio panels, or dials, or other parts fabricated in quantity from laminated bakelite.



SEE OUR DISPLAY
July 1, 2 and 3
AT DETROIT

SHEETS . RODS . TUBES
COIL FORMS . PANELS
FABRICATED PARTS
SYNTHOGRAPHIC PROCESS

SYNTHANE
CORPORATION  OAKS - PENNA

SPECIFY SYNTHANE IN ORDERS TO YOUR SUPPLIERS

When writing to advertisers mention of the PROCEEDINGS will be mutually helpful.

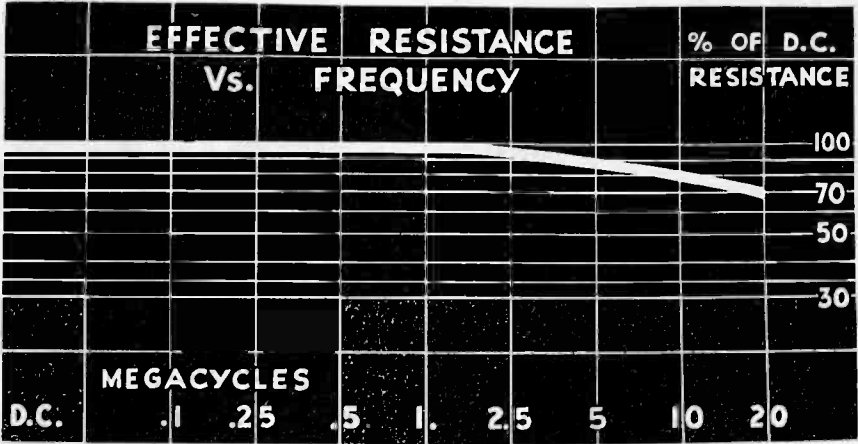

WHAT A HIGH FREQUENCY TEST SHOWS ABOUT RESISTORS

This chart based on an impartial test on standard 1.0 meg. Type "F" IRC Metallized Resistors tells its own story as to why these units are so generally specified for the exacting requirements of Short Wave oscillator circuits, AVC filter circuits, as grid leaks across r. f. tubes, etc.

. . . Only a change of 30% in resistance value on 20 megacycles! Compare this with resistance changes of over 75% on ordinary resistors under similar high frequency conditions and you have another of the important reasons why IRC'S are consistently specified by those who demand the best.

INTERNATIONAL RESISTANCE CO.

2100 Arch St., Philadelphia, Pa.

(In Canada, 187 Duchess St., Toronto, Ont.)



When writing to advertisers mention of the PROCEEDINGS will be mutually helpful.

IMPROVE *your Equipment* with **Isolantite**

*A product of
Western Electric
and a development
of Bell Telephone
Laboratories
Model 14-A
Multi Channel
Short Wave
Radio Transmitter*

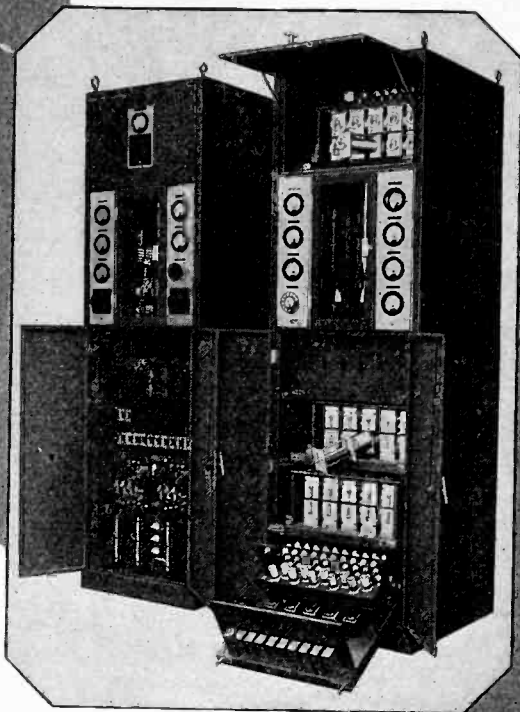

The Western Electric Company uses ISOLANTITE insulation in the radio frequency circuits of Model 14-A Transmitter—an excellent example of the manner in which ISOLANTITE can be adapted to the mechanical refinement of modern radio transmitters. *Your equipment can be improved with ISOLANTITE insulation.*

Isolantite Inc.

Factory at Belleville, N. J.

NEW YORK SALES OFFICE: 233 BROADWAY

When writing to advertisers mention of the PROCEEDINGS will be mutually helpful.

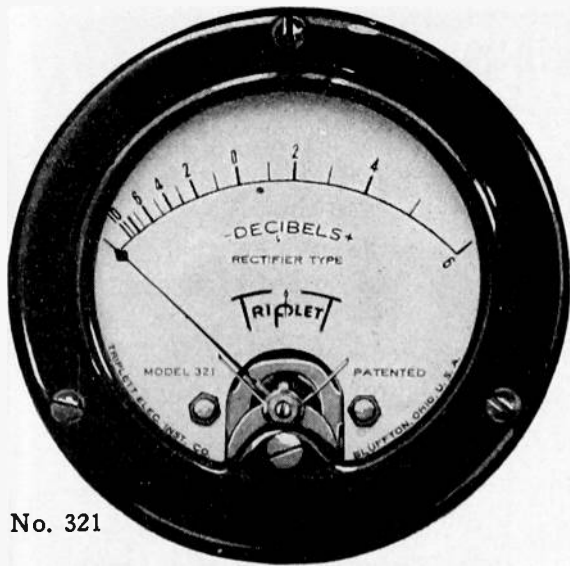

No. 321

The Decibel Meter

*Measures Sound
 and Noise Levels*

POWER Level Indicators are used to measure sound or noise levels in the amplifying systems of Public Address, Theater, Broadcasting Studio, etc. The Model 321 Decibel meter enables the operator to make immediate adjustments and keep the system free from distortion.

Furnished in two ways—either standard dampened or highly dampened, according to the particular need. Highly dampened me-

ters are generally used in Theaters, Broadcasting Studios and Public Address Systems. Standard dampened meters may be used for Broadcasting Station equipment and special requirements.

The standard range furnished reads up 6 and down 10 decibels, zero decibels at 1.73 volts, 500 ohm line, 6 millivolts. Other ranges to order only. Meter furnished in Bakelite case.

See Your Jobber

THE TRIPLETT ELECTRICAL INSTRUMENT CO.

158 Main Street

Bluffton, Ohio

MAIL TODAY FOR DETAILS

TRIPLETT ELECTRICAL INSTRUMENT CO.

158 Main St., Bluffton, Ohio

Gentlemen:

Please send me more information about Triplet Instruments. I am particularly interested in the No. 321 Decibel Meter.

Name

Street

Town State

When writing to advertisers mention of the PROCEEDINGS will be mutually helpful.

PROFESSIONAL ENGINEERING DIRECTORY

BLILEY ELECTRIC CO.

*Designers and Manufacturers
of*

QUARTZ CRYSTALS

for

Standard or Special Requirements

Write for Catalog

230 Union Station Bldg.
ERIE, PENNA.

PRACTICAL RADIO ENGINEERING

One year Residence Course
Advanced Home Study Course
Combined Home Study-Residence
Course

Write for details

Capitol Radio Engineering
Institute
Washington, D.C.

Cathode Ray Tubes and Associated Equipment For All Purposes

*Write for Complete
Technical Data*

ALLEN B. DUMONT
LABORATORIES
UPPER MONTCLAIR, N.J.

FOR MANY YEARS

the Professional Engineering Directory has helped consulting engineers, designers, and laboratory men make the right contacts in the radio industry. Perhaps we can help you with your problems too. For further information write to

Advertising Department
INSTITUTE OF RADIO
ENGINEERS
330 West 42nd Street
NEW YORK, N.Y.

Alphabetical Index to Advertisements

Aerovox Corp.	A	XV
American Tel. & Tel. Co.		VII
Central Radio Laboratories	C	XXII
Cornell-Dubilier Corp.		VIII
Erie Resistor Corp.	E	XXI
General Radio Co.	G	Inside Back Cover
International Resistance Co.	I	XVII
I.R.E.		XIII, XIV, Inside Back Cover
Isolantite Inc.		XVIII
Professional Eng. Directory	P	XX
R.C.A. Mfg. Co.	R	X, XI
Stackpole Carbon Co.	S	IX
Synthane Corporation		XVI
Triplett Elec. Inst. Co.	T	XIX
Weston Elect. Inst. Co.	W	XII

When writing to advertisers mention of the PROCEEDINGS will be mutually helpful.



ERIE INSULATED RESISTORS

An outstanding development in **CARBON
RESISTORS**

Because they offer untold possibilities in improving practically every conventional set arrangement, the new Erie Insulated Carbon Resistors represent an outstanding development in carbon resistor design.

They present the new combination of complete ceramic insulation with reduced size, plus the same high operating efficiency that is characteristic of non-insulated Erie Resistors.

See for yourself how Erie Insulated Resistors can better your product. We will be glad to send you samples.

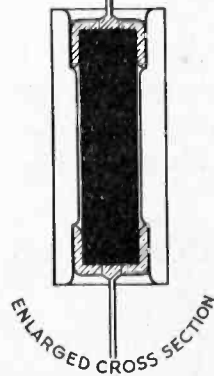

ERIE RESISTOR CORPORATION

TORONTO, CAN. ERIE, PA. LONDON, ENG.

Enlarged cross section of 1/4 watt Erie Insulated Resistor. Actual size 3/16" x 7/16". Quantity production now available in 1/4 watt units only. Larger sizes in the near future. Patent applied for.

When writing to advertisers mention of the PROCEEDINGS will be mutually helpful.

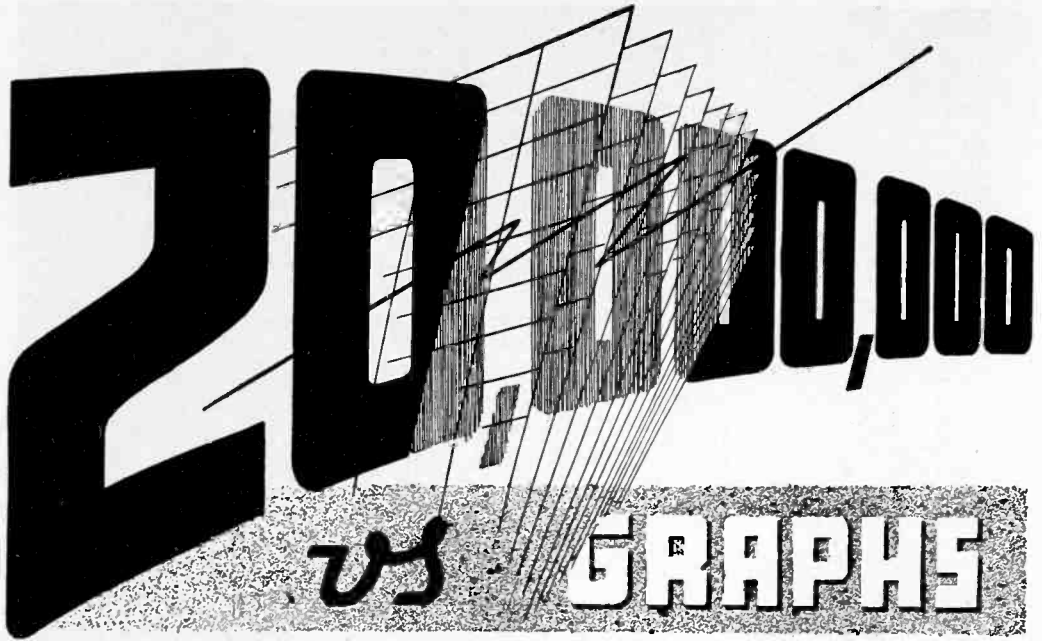

20,000,000 VERSUS GRAPHS

Candidly, we believe you are more interested in actual performance than in a library of resistor graphs showing every conceivable characteristic.

The record of more than 20,000,000 CENTRALAB resistors in use means more to you than all the graphs now in vogue.

Fundamentally, the sturdy ceramic jacket, the carefully calibrated conducting core and the unique method of establishing end contact are still the reasons why CENTRALAB resistors are specified for superlative performance.

CENTRALAB *Division of Globe-Union Mfg. Co.*
MILWAUKEE, WIS.



Centralab
CRL
RESISTORS

When writing to advertisers mention of the PROCEEDINGS will be mutually helpful.

INSTITUTE SUPPLIES

EMBLEMS



Three styles of emblems are available to members of the Institute only. They are all of 14k gold with gold lettering on an enameled background, the color of which indicates the grade of membership. The approximate size of each emblem is as illustrated.



The lapel button is supplied with a screw back having jaws which fasten it securely to the coat. The price is \$2.75, postpaid, for any grade.



The pin which is provided with a safety catch may be obtained for any grade for \$3.00, postpaid.

The watch charm is handsomely finished on both sides and is equipped with a suspension ring for attaching to a watch chain or fob. Price for any grade, \$5.00, postpaid.

BINDERS

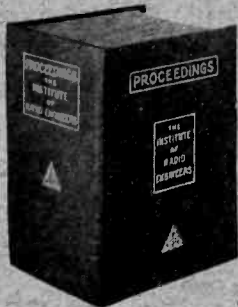

Binders are available for those who desire to protect their copies of the PROCEEDINGS with stiff covers. Each binder will accommodate the twelve monthly issues published during the year. These binders are of blue Spanish Grain Fabricoid with gold

lettering, and will serve either as temporary transfers or as permanent binders. They are so constructed that each individual copy of the

PROCEEDINGS will lie flat when the pages are turned. Copies can be removed from the binder in a few seconds and are not damaged by their insertion. They are priced at \$1.50 each, and the member's name or PROCEEDINGS Volume Number will be stamped upon the binder in gold for \$0.50 additional.

BACK ISSUES OF THE PROCEEDINGS

Complete volumes of back issues of the PROCEEDINGS are available in unbound form for the years 1918, 1921, 1922, 1923, and 1926 at \$6.75 per year (six issues). Also complete unbound for 1931, 1932, 1933, and 1934 at \$7.50 per year. A list of the available miscellaneous copies published from 1913 on may be obtained from the Secretary. Single copies published prior to 1927 are sold to members at \$1.13 each, and those issued during and after 1927 are \$0.75 each. Foreign postage on single copies is \$0.10 per copy, making \$0.60 on unbound volumes before 1927.

Issues for 1922 may be obtained bound in blue buckram at \$8.75 per volume. Similar bound volumes for 1930, 1931, 1932, 1933, and 1934 are priced at \$9.50 each to members. Foreign postage is \$1.00 additional per volume. Volumes for 1922 and 1926 bound in Morocco leather are available at \$10.25 each to members volume for 1931 is \$11.00.

TWENTY-TWO-YEAR INDEX

An Index of the PROCEEDINGS for the years 1909-1930, inclusive, is available at \$1.00 per copy. It is extensively cross indexed. The earlier references are to the PROCEEDINGS of the Wireless Institute; the PROCEEDINGS of the Institute of Radio Engineers has been published since 1913.

When ordering any of the above, send remittance with order to the Secretary, Institute of Radio Engineers, 330 West 42nd Street, New York City.

MAINTENANCE AND PRODUCTION RECEIVER TESTING

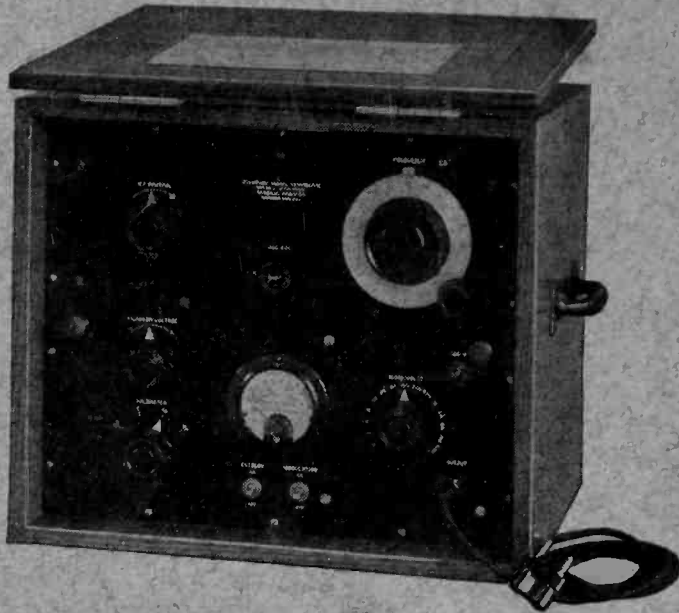

FOR

Low Frequency Telephone and Telegraph
High-Frequency Broadcast
City and State Police
Standard Broadcast
Direction Finding
Fixed and Coastal
Broadcast Pick-up
Marine Fire
Television
Aircraft
Ship

RECEIVERS operating in the 100 to 6000 kc band, the General Radio Type 601-A Standard Signal Generator is in increasing demand.

An inexpensive, accurate standard-signal generator, with vacuum-tube internal modulation of good waveform and low-frequency modulation, this instrument merits your attention.

It may be the solution to your problem, as it has to that of many governmental and commercial agencies engaged in the design, development, routine and production testing of radio receivers. Its price: \$210.00

May we send you further particulars? Ask for a copy of Catalog H-R.



GENERAL RADIO COMPANY
30 State Street Cambridge A, Mass.